

RECORDS  
OF THE  
AUSTRALIAN MUSEUM

EDITED BY THE CURATOR.

---

Vol. VII.

PRINTED BY ORDER OF THE TRUSTEES

R. ETHERIDGE, JUNR., J.P.,

Curator.

SYDNEY, 1908-1910.





## CONTENTS.

No. 1.

Published 9th March, 1908.

	Page
North Queensland Ethnography. Bulletin No. 10. Marriage Ceremonies and Infant Life, By Walter E. Roth .. .. .	1
An undescribed Australian Cystiphyllid — <i>Mictocystis</i> — from the Upper Silurian Rocks of the Mount Canoblas District. By R. Etheridge, Junr. ... .. .	18
On an unusual Nesting-site of <i>Sauloprocta melabouca</i> . By Alfred J. North... .. .	21
Ancient Stone Implements from the Yodda Valley Goldfield, North-East British New Guinea. By R. Etheridge, Junr. .. .. .	24
On three apparently undescribed Birds from Henderson or Elizabeth Island, Paumotu Group. By Alfred J. North ... .. .	29
Note on the <i>Cephalochorda</i> in the Australian Museum. By W. A. Haswell ... .. .	33
Studies in Australian Fishes. No. 1. By Allan R. McCulloch .. .. .	36
Studies in Australian Araneidae. No. 5. By W. J. Rainbow ... .. .	44
Studies in Australian Crustacea. No. 1. By Allan R. McCulloch ... .. .	51
Mineralogical Notes. No. 6. Topaz, Beryl, Anglesite, Rutile, Atacamite, Pyrite. By Chas. Anderson .. .. .	60

## No. 2.

Published 11th September, 1908.

Notes on Mimicry and Variation. By W. J. Rainbow ... ..	69
North Queensland Ethnography. Bulletin No. 11. Miscellaneous Papers. 1. Tabu and other forms of Restriction. 2. Countin and Enumeration. 3. Signals on the Road; Gesture Language. 4. Progressive Koko-yimidir Exercises. By Walter E. Roth ...	74
Mollusca from one hundred fathoms, seven miles east of Cape Pillar, Tasmania. By C. Hedley and W. L. May. ... ..	108
A New Genus and Species of Turtle, from North Australia. By Allan R. McCulloch ... ..	126
Mineralogical Notes. No. 7. Rhodonite. By Chas. Anderson ...	129
Occasional Note—No. 1.— <i>Sepia braggi</i> , Verco. A record for the State. By C. Hedley .. .. .	134

## No. 3.

Published 15th January, 1909.

Lower Cretaceous Fossils from the Sources of the Barcoo, Ward and Nive Rivers, South Central Queensland. Part 2. Cephalopoda. By R. Etheridge, Junr. ... ..	135
North Queensland Ethnography, Bulletin No. 12. On certain Initiation Ceremonies. By Walter E. Roth ... ..	166
Notes on the Nesting-site of <i>Gerygone personata</i> , Gould. By Alfred J. North ... ..	18



## No. 4.

Published 30th August, 1909.

North Queensland Ethnography. Bulletin No. 13. Fighting Weapons. By Walter E. Roth	189
Notes on the Architecture, Nesting Habits, and Life Histories of Australian Araneidæ, based on Specimens in the Australian Museum. Part 7. — <i>Entelegynæ (continued)</i> . By W. J. Rainbow	212
Lower Cretaceous Fossils from the Sources of the Barcoo, Ward and Nive Rivers, South Central Queensland. Part 2 ( <i>continued</i> )—Cephalopoda. By R. Etheridge, Junr.	235
On a new Species of Aphrodita. By T. Harvey Johnston	241
On a Cestode from <i>Dacelo gigas</i> , Bodd. By T. Harvey Johnston	246
An Australian Chaetognath. By T. Harvey Johnston	251
On a New Hemoprotozoan. By T. Harvey Johnston	257
Descriptions of New and Notes on other Australian Polyplacophora. By C. Hedley and A. F. Basset Hull	269
The Results of Deep-sea Investigations in the Tasman Sea. I.—The Expedition of H.M.C.S. "Miner." No. 5.—The Polyzoa. By C. M. Maplestone	267
Mineralogical Notes: No. 8.—Topaz, Anglesite, and other Australian Minerals. By Chas. Anderson	274
A Revised Census of the Terrestrial Mollusca of Tasmania. By W. F. Petterd and C. Hedley	283
Studies in Australian Crustacea. No. 2. By Allan R. McCulloch	305
Studies in Australian Fishes. No. 2. By Allan R. McCulloch	315
Description of the Female, with Nest and Eggs, of the Cinnamon-chested Ground Thrush ( <i>Cinclosoma marginatum</i> , Sharpe). By Alfred J. North	322
Aboriginal Drawings in Rock Shelters at Bundanoon, New South Wales. By W. W. Thorpe	322
Notes on Australian Entozoa No. 1. By T. Harvey Johnston	322

## No. 5.

Published 28th February, 1910.

Title Page, Contents, and Index.





# LIST OF THE CONTRIBUTORS.

With Reference to the Articles contributed by each.

## Anderson, Chas.—

	Page
Mineralogical Notes, No. 6.—Topaz, Beryl, Anglesite, Rutile, Atacamite, Pyrite .. .. .	60
No. 7. — Rhodonite .. .. .	129
No. 8.—Topaz, Anglesite, and other Australian Minerals .. .. .	274

## Etheridge, R., Junr.—

An Undescribed Australian Cystiphyllid— <i>Micocystis</i> —from the Upper Silurian Rocks of the Mount Canoblas District .. .. .	18
Ancient Stone Implements from the Yodda Valley Goldfield, North-East British New Guinea .. .. .	24
Lower Cretaceous Fossils from the Sources of the Barcoo, Ward and Nive Rivers, South Central Queensland. Part 2.— Cephalopoda .. .. .	135, 235

## Haswell, W. A.—

Notes on the <i>Cephalochorda</i> in the Australian Museum .. .. .	33
--	----

## Hedley, Chas.—

<i>Sepia braggi</i> , Verco. A Record for the State .. .. .	134
Descriptions of New and Notes on other Australian Polyplaco- phora. By C. Hedley and A. F. Bassett Hull .. .. .	260
Mollusca from one hundred fathoms, seven miles east of Cape Pillar, Tasmania. By C. Hedley and W. L. May .. .. .	408
A Revised Census of the Terrestrial Mollusca of Tasmania. By F. W. Petterd and C. Hedley .. .. .	283

## Hull, A. F. Bassett—

Description of New and Notes on Other Australian Polyplaco- phora. By C. Hedley and A. F. Bassett Hull .. .. .	260
---	-----

## Johnston, T. Harvey—

On a New Species of Aphrodite .. .. .	241
On a Cestode from <i>Dacelo gigas</i> , Bodd. .. .. .	246
An Australian Chatognath .. .. .	251
On a new Haemoprotozoan .. .. .	257
Notes on Australian Entozoa. No. 1. ... .. .	329

**McCulloch, Allan R.**

Studies in Australian Crustacea No. 1	...	...	...	...	51
No. 2	...	...	...	...	305
Studies in Australian Fishes, No. 1	...	...	...	...	36
No. 2	...	...	...	...	315
A New Genus and Species of Turtle, from North Australia	...	...	...	...	126

**Maplestone, C. M.—**

The Results of Deep-Sea Investigations in the Tasman Sea. I.— The Expedition of H.M.C.S. "Miner." No. 5.—Polyzoa	...	...	...	...	267
---	-----	-----	-----	-----	-----

**May, W. L.—**

Mollusca from one hundred fathoms, seven miles east of Cape Pillar, Tasmania. By C. Hedley and W. L. May	...	...	...	...	108
---	-----	-----	-----	-----	-----

**North, Alfred J.—**

On an unusual Nesting-site of <i>Sauroprocta melaleuca</i>	..	...	...	...	21
On three apparently undescribed Birds from Henderson or Elizabeth Island, Paumotu Group	...	...	...	...	29
Notes on the Nesting-site of <i>Gerygone personata</i> , Gould	...	...	...	...	186
Description of the Female, with Nest and Eggs, of the Cinnamon- chested Ground Thrush ( <i>Cinclosoma marginatum</i> , Sharpe)	...	...	...	...	322

**Petterd, W. F.—**

A Revised Census of the Terrestrial Mollusca of Tasmania. By W. F. Petterd and C. Hedley	...	...	...	...	283
---	-----	-----	-----	-----	-----

**Rainbow, W. J.**

Studies in Australian Araneidæ. No. 5	...	...	...	...	44
Notes on Mimicry and Variation	...	...	...	...	69
Notes on the Architecture, Nesting Habits, and Life Histories of Australian Araneidæ, based on Specimens in the Australian Museum. Part 7.—Entelegynæ ( <i>continued</i> )	...	...	...	...	212

**Roth, Walter E.—**

North Queensland Ethnography. Bulletin No. 10. Marriage Ceremonies and Infant Life	...	...	...	...	1
Bulletin No. 11.—Miscellaneous Papers:—1. Tabu and other Forms of Restriction. 2. Counting and Enumeration. 3. Signals on the Road: Gesture Language. 4. Progressive Koko-yimidir Exercises	...	...	...	...	74
Bulletin No. 12. On Certain Initiation Ceremonies	...	...	...	...	166
Bulletin No. 13. Fighting Weapons	...	...	...	...	189

**Thorpe W. W.—**

Aboriginal Drawings in Rock Shelters at Bundanoon, New South Wales	...	...	...	...	325
---	-----	-----	-----	-----	-----

## LIST OF THE PLATES.

---

### PART I.

- Frontispiece—Mimicry and Variation. North Queensland Butterflies.
- I.-III. North Queensland Aboriginal Customs — Marriage Ceremonies and Infant Life.
- IV.-V. *Microcystis endophylloides*, *Eth. pil.*
- VI.-VII. Ancient Stone Implements, New Guinea.
- VIII. IX. Henderson Island.
- X.-XI. Australian Fishes.
- XII. Australian Crustacea.
- XIII. Australian Minerals—Topaz.
- XIV. .. .. Anglesite.
- XV. .. .. Anglesite, Rutile, Atacamite and Pyrite.
- XVI. .. .. Beryl and Anglesite.

### PART II.

- XVII. North Queensland Aboriginal Customs — Gesture Language.
- XX. .. .. —Whirlers and Whirler Charm.
- XXI. .. .. —Painted Spear Heads and Charm.
- XXII.-XXIV. Tasmanian Mollusca.
- XXV.-XXVII. Turtle from North Australia.
- XXVIII. XXIX. Australian Minerals—Rhodonite.

## PART III.

- XXX.-XLIX. Lower Cretaceous Fossils, from North Queensland.  
 L.-LVI. North Queensland Aboriginal Customs — Initiation Ceremonies.  
 LVII. Nest of Masked Bush-Warbler built in close proximity to a Wasp's Nest.

## PART IV.

- LVIII.-LXI. North Queensland Aboriginal Customs — Fighting Weapons.  
 LXII.—LXIV. Australian Araneidæ.  
 LXV.—LXVIII. Lower Cretaceous Fossils from North Queensland.  
 LXIX. *Aphrodita haswell*, *Instn.*  
 LXX. Cestode—*Similuncinius dactylonis*, *Instn.*  
 LXXI. Australian Chætognath—*Sagitta australis*, *Instn.*  
 LXXII. Hæmoprotozoan—*Homogregarina amethystina*, *Instn.*  
 LXXIII.-LXXIV. Australian Polyplacophora.  
 LXXV.-LXXVIII. Polyzoa  
 LXXIX. Australian Minerals—Topaz and Gypsum.  
 LXXX. „ „ Anglesite and Azurite.  
 LXXXI. „ „ Phosgenite, Monazite and Cerussite.  
 LXXXII.-LXXXVII. Tasmanian Mollusca.  
 LXXXVIII.-LXXXIX. Australian Crustacea.  
 XC.-XCI. Australian Fishes.  
 XCII. Nest and Eggs of the Cinnamon-chested Ground Thrush.  
 XCIII.-XCVI. Rock Shelter at Bundanoon.

## CORRECTIONS.

---

- Page 132, line 11—add “C.”
- „ „ line 22—delete “u.”
- „ 213, line 5—for “*bullocki*” read “*bullockii*.”
- „ 214, line 4—for “*amula*” read “*amula*.”
- „ 215, line 13 from the bottom—for “silk on *stabilimentum*” read “silk or *stabilimentum*.”
- „ 221, line 22—for “Belle View Hill” read “Belle Vue Hill.”
- „ 262—*Chiton torri*, Hedley and Hull. As this name is preoccupied by Mr. H. Suter (Proc. Malac. Soc., vii., 1907, p. 295) for a New Zealand species, the Australian shell may be known as *Chiton torriana*, Hedley and Hull.
- „ 270, line 4—for “*avicircularia*” read “*avicularia*.”
- „ 285, line 3—for “*Bothriembryon gunni*” read “*Bothriembryon gunni*.”
- „ 285, line 8—for “*Bulinus gunni*” read “*Bulinus gunni*.”
- „ 285, line 14—after “Mt. Farrell” insert “Family Helicidae.”
- „ 330, under heading No. 5, line 3—after “Adelaide” insert “Johnston.”
- „ 331, line 1—omit “S.”
- „ „ line 8—for “9” read “S.”
- „ „ line 12—for “10” read “9.”
- „ 335, line 11—for “Australia” read “Australian human.”
- „ 336, under heading 23, line 2—omit the comma after “which.”
- Plate xiii., explanation—lines 3 and 5 for “Inorthographic” read “Orthographic.”
- „ l., explanation—for “Amboipo” read “Amboiba.”
- „ li., explanation—for “Amboida” read “Amboiba.”
- „ liii., explanation—for “Amboida” read “Amboiba.”
- „ lxiii., explanation—for “*Gasteracantya*” read “*Gasteracantha*.”
- „ lxxii., explanation—for “fig. 28” read “fig. 23.”
- „ lxxxi.—transpose 2 and 3.





# NORTH QUEENSLAND ETHNOGRAPHY.

BULLETIN No. 10.

## MARRIAGE CEREMONIES AND INFANT LIFE.

By **WALTER E. ROTH** Magistrate of the Pomeroon District, British Guiana; late Chief Protector of Aborigines, Queensland; Corresponding Member of the Anthropological Societies, Berlin and Florence, the Anthropological Institute, London, etc.

(Plates i.-iii.).

### CONTENTS.

Sect	1.	Essentials of Marriage:—	PAGE
		Suitable Exogamous Group... ..	1
	2.	Absence of Intimate Consanguinity ... ..	2
	3.	Suitable Social Status ... ..	3
	4.	Traces of Primitive Communal Marriage... ..	3
	5.	Ceremonial Signs of Marriage ... ..	3
	6.	Marriage by:—	
		Betrothal—Pennefather River ... ..	3
	7.	Princess Charlotte Bay ... ..	4
	8.	Cape Bedford ... ..	5
	9.	Upper Normanby River ... ..	5
	10.	Bloomfield River ... ..	5
	11.	Cape Grafton ... ..	6
	12.	Tully River ... ..	6
	13.	Rockhampton District... ..	6
	14.	N. W. Districts... ..	7
	15.	Official Authority ... ..	7
	16.	Inheritance (Widows) ... ..	8
	17.	Mutual Attachment ... ..	9
	18.	Capture ... ..	10
	19.	Exchange and Barter ... ..	11
	20.	Marital and First-night's Orgie ... ..	11
	21.	Divorce ... ..	11
	22.	Polygamy; Polyandry .. ..	12
	23.	Twins; Triplets ... ..	12
	24.	Infanticide ... ..	13
	25.	Abortion ... ..	14
	26.	Management of Babies ... ..	14
	27.	Birth and Mortality Rates .. ..	15

1. Every marriage, independently of the basis upon which it is being contracted, whether by betrothal, authority, mutual attachment, inheritance or exchange, must at least be regulated

according to the primary exogamous groups of which the contracting parties are members. This is an essential before it can be publicly recognised, its breach constituting, according to the district where committed, a crime punishable by death (*e.g.*, North-West Districts) down to a matter for ridicule and contempt (Tully River). Indeed, in those rare cases of what might be called irregular marriages, the rest of the community will assist another boy with more lawful claim, *i.e.*, an individual of the suitable exogamous group, to get possession of the woman in question for himself. Furthermore, under such circumstances both parties are continually being ridiculed, nagged and sneered at by the other females, a course of action usually quite sufficient to cause a separation.

2. But because the two would-be contracting parties do actually belong to suitable exogamous groups, it does not necessarily follow that all impediments to the proposed marriage are removed. For instance, in the North-West generally, a man cannot marry his father's sister's daughter, his mother's brother's daughter, or his daughter's daughter, while a woman must carnally avoid her mother's brother's son, her father's sister's son, or her son's son, etc., notwithstanding the fact that these particular relationships are necessarily located in the same exogamous groups<sup>1</sup> which otherwise would be allowed to join in permanent sexual partnership. Similarly, on the Bloomfield River, where the social nomenclature has also been worked out, the same thing applies.

The same holds true for other districts equally remote from one another, the commonly accepted view that the complicated systems of class-organisation met with amongst the different tribes act as a check on consanguinity requiring re-consideration. Indeed, ever since I suggested<sup>2</sup> a probable interpretation of the class-systems, closer investigation has led me to believe in its reality, *viz.*, that they have been devised, by a process of natural selection, to regulate the food supply. And so far as the food supply is concerned, the group-system certainly regulates marriage, but just as surely it does not check consanguinity. Even amongst types of black folk where the standard of morality is even for a primitive people comparatively low, and where but little attention from a marital point of view need necessarily be paid to the exogamous groups, *e.g.*, on the Tully River, there is an absolute absence of familiarity between blood brother and sister. Whatever the general faults of the natives may be, incest

---

<sup>1</sup> Roth—Ethnol. Studies, etc., 1897, Sect. 65, table.

<sup>2</sup> Roth—Ethnol. Studies, etc., 1897, Sect. 71.

is not included in them, and I am satisfied in my own mind that the idea which has prompted him to avoid as far as possible the intermarriage of blood relatives represents a gradual development of the moral sense.

3. A third essential for the marriage to be publicly recognised is that one (Princess Charlotte Bay, Tully River, etc.) or both (North-West Districts) of the contracting parties must be of suitable rank so far as initiation is concerned: where one is necessary it is that of the male.

4. A feature of more than ordinary interest is the right of marital relationship between a husband and his wife's blood-sisters on the Pennefather and Tully Rivers, and between a wife and her husband's blood brothers on the Tully River. Cases of this nature, coupled with the handing over of the widow to her late husband's brother, bear strong evidence of communal marriage in a very primitive condition, before the distinction had come to be made between blood- and group-members of the different class-systems. The sexual orgie at the expense of the bride upon her initiation into womanhood is also significant from this point of view.<sup>3</sup>

5. The ceremonial sign of marriage is represented by the building of a hut and the lighting of a fire on the part of the girl (though this duty may be performed by her mother on the Upper Normanby River) and by the seizing of her wrist on the part of the husband. In the North-West District sign language, the ideagram for marriage by capture, is represented by a wrist-grasp.<sup>4</sup>

There is no public celebration or rejoicing on the advent of a marriage, nor do the contracting parties do anything in the way of special ornaments or decorations.

There would seem to be no special season of the year devoted to the celebration of marriage. In those districts where the burial ceremonies include the growth of the mourner's hair, no marriages take place till this is cut, at the same time that the widows are handed over.

In cases where a man marries into a tribe foreign to him, his wife and children become members of his own.

6. On the Pennefather River betrothal is the usual form of giving in marriage, the old men usually getting the pick: even while yet *in utero* an infant is occasionally promised in this way on the chance of its being a girl. A present of some food, spears, etc., is usually sufficient, and the promise is invariably adhered

---

<sup>3</sup> Roth—Ethnol. Studies, etc., 1897, Sect. 305.

<sup>4</sup> Roth—Ethnol. Studies, etc., 1897, Fig. 197.

to. As a rule, the marriage is not consummated until the girl is at full puberty, but what with the advent of Europeans and the increasing competition for the possession of wives, she is now often taken possession of at an earlier age, indeed so soon as the convenient opportunity occurs. The public ceremonial of marriage consists in the bride building the bridegroom's hut and lighting the fire there.

7. In the hinterland of Princess Charlotte Bay, betrothal is left to chance, the arrangements for which are generally brought to a head by the boy's father's sister. When, before puberty, the boy's tooth is being knocked out, the names of various eligible girls are called, the one which happens to be called when the tooth is actually out being recognised as the betrothed; needless to say, the name of the favourite is always kept to the very last. The Koko-warra speak of the girl betrothed by a special term; if of the same tribe, she is generally chosen from a district different from that of her future husband's. After the young man has passed the first initiation ceremony, and the girl's parents, for family and other considerations, consider him old enough, he is brought to the girl's camp. It is the girl's father who brings him from the single men's quarters where he has been camping, and leads him during the course of the night into his future bride's hut, whence her mother has just previously taken her departure. The alleged object of this arrangement is for the girl to get accustomed to the presence of her future husband, her parents keeping strict watch at the hut entrance to see that no sexual liberties take place and to ensure the youth's return to his own quarters before day-break. This procedure continues perhaps for a few weeks, certainly for two or three, the girl and her parents being fed at the trouble, and mollified (by spears, necklaces, etc.) at the expense of the young man. When finally the mother-in-law builds a hut, lights a fire, and leaves her daughter there, the young man enters to take up his permanent abode, and consummate the marriage undisturbed, his parents-in-law, henceforth tabu to him, returning to their own camp. It will be noted that there is no restriction of age or social status at which the bride may be delivered up, and it is of no uncommon occurrence to see an individual carrying on his shoulder his little child-wife who is perhaps too tired to toddle any further; the only essential is that the girl must always have an incisor knocked out previous to her having sexual connection with her lord and master. All that the wife's parents look to is that their son-in-law is of suitable age and rank and blessed with an abundance of worldly goods, *e.g.*, spears, wommeras, necklaces, etc., which are invariably presented as a sort of solatium.

8. At Cape Bedford a system of betrothal exists, though it does not appear to be carried out very strictly. It is more usual for the man to ask the parents' consent when the girl is of marriageable age. The parents "do not give her to him willingly or with kindly feelings. Both mother and father strike the young man's head first; when he is covered with blood they give her to him. Once given to him, the wife builds the hut and lights the fire. But the girl does not readily go to meet her husband; her mother and father have to send her before she will go; then she meets him. Furthermore, during the day-time, she will not sit alongside him in the shade. She is always with her mother. So much for the bride."<sup>5</sup> She must, however, pass one whole night with him before the marriage ceremony, such as it is, can be publicly recognised. This striking of the young man's head, the symbolism of which I have been informed represents the idea of the bridegroom having to fight the parents for her, is paralleled in the neighbourhood of Cape Grafton (see Sect. II), where the future husband has to clash swords, etc., as in mimic warfare with certain of the girl's relatives before the marriage can be consummated.

9. At Boggy Creek, Upper Normanby River, there is a similar practice of asking the parent's consent, the fire being kindled and the hut built near the single men's quarters by the bride's mother, who carries the young man's belongings, spears, etc., to the new home; her father then comes and fetches the bridegroom. Or again, the wife may be given to her future husband by the wrist, the woman herself, in this case, kindling the fire. Of course in these cases where the parents' wishes have to be consulted, there is always a solatium in the way of presents.

10. On the Bloomfield River children are betrothed at birth. If already married, the husband will take charge of his betrothed wife when about four or five years old; this is especially the case if he moves about a great deal or lives some distance away from her tribe. If not already married, he has to wait until such time as she reaches puberty, though if close upon that age and he is about to leave for some other district, he will take her by the wrist in the presence of all the other natives—the ceremonial sign of marriage—tell her she is his, and warn her parents to look after her well and to report to him at once should anyone attempt to interfere with her. If ultimately the girl is too shy to go to her future husband's hut, her brother or father will accompany her; if still recalcitrant, her husband will seize her

---

<sup>5</sup> Roth—Bull. 2—Sect. 31b.

wrist and pull her in. A man here is always supposed to make presents to his future mother-in-law.

11. At Cape Grafton betrothal may similarly take place in infancy, the boy being allowed to marry her after his passing the first initiation ceremony, and cases have been mentioned to me where the future husband has put his brand, in the shape of three vertical cuts, upon the girl's shoulder.

12. Amongst the Tully River natives betrothal is also recognised; a father can give his daughter, as infant or maid, to any man young or old so long as he has the two essential decorative scars indicative of his initiation. The individual to whom she is now given or betrothed can take her straight away with him there and then if he so chooses, but if very young he usually loans her to some comparatively old man,<sup>6</sup> necessarily belonging to the same exogamous group as himself, to sleep with and train for him; this action on the part of the elder is deemed to make the little child's genitalia develop all the more speedily.

13. At Torilla and Pine Mountain, on the east central coast, the following procedure<sup>7</sup> used to be observed in the "old days." When a little girl is about three years old some blackfellow wants her to be betrothed to him, but as it is not considered good form to ask her parents, he constantly makes them presents of tit-bits of food and honey, weapons, etc. Of course they understand what he is after, and provided they fancy him for a son-in-law will call together the uncles (the girl's mother's brothers) and consult with them. If these latter are agreeable, either the father or an uncle will ask the would-be bridegroom whether he would like to have the girl, offer to betroth her to him, and he accepts. The parents next paint the little girl, and stick into her hair a lot of feathers, which are mostly eagle-hawk. In the meantime the future husband sits quite still at his camp-fire, gazing intently on the ground, and on no pretext whatever will he look behind. The uncles next bring up the little baby girl so decorated and seat her at the back of, but not touching, her future lord and master. They then leisurely take the feathers one at a time from out of the child's hair and stick them successively into the man's. When the feathers are all fixed in the latter, he arises, and without once looking behind, leaves camp and does not return for a month or longer. After coming

---

<sup>6</sup> It may be mentioned here that nothing is said (though it is of course impossible to learn how much may be thought) of any of the elder males, provided they belong to the proper groups, tampering with any young female children.

<sup>7</sup> Reported to me by Mr. W. H. Flowers.

back he continues to send the little girl various presents of food, etc., she being even allowed to go to his camp provided he happens to have anything particularly good to eat, and help him partake of it. On the other hand, he is not allowed to visit his betrothed's camp, or speak to her mother, always sending his presents through a third person, or giving them to her personally should he happen to meet her unaccompanied by her mother. When the girl's father and her mother's brothers consider her old enough for the marriage to be consummated, they tell the bridegroom so, but never a word to the girl. The future husband thereupon paints himself up, takes all his fighting weapons with him, and tells the news to the other men of his own exogamous group. He next watches his opportunity to find the girl away from her parents or out in the bush with the women, approaches her as silently as he can, and seizes her by the wrist. The other females will try and help her to get away, but he will call upon his group-mates for assistance to keep them off. Whether she approves or not, she will scream and exert her utmost to free herself, even biting his hand to make him let go, and provided she can release her wrist she has a chance of escape; her endeavours, however, invariably prove futile: she is dragged by him to his camp and the marriage consummated, after which any of her husband's group-mates who have rendered assistance may claim the temporary loan of her. Being thus proclaimed his wife, she lives with him at his camp, although he will probably take her away from the neighbourhood of her parents for some little time to come.

14. In the North-West, though I cannot find any traces of the practice in the Boulia District, a form of betrothal takes place at the first male initiation ceremony on the Upper Georgina River, certainly among the Yaro-inga,<sup>8</sup> and perhaps, independently of initiation, in the Leichhardt-Selwyn District among the Kalkadun.

15. Throughout the Boulia District, each male can have at least two wives, an official one supplied him as a member of the community by the Camp-council, and an unofficial one of his own choice, whose love, such as it is, he finds reciprocated; the former woman is known as the no-po, the latter as the pandira, though both share equal rights and responsibilities. Supposing that the Camp-council consider a man fit and suitable to have a wife, he has to take whomsoever is assigned to him thus:—The brothers, or mother's brothers, of the young woman talk among themselves

---

<sup>8</sup> Roth—Ethnol. Studies, etc., 1897—Sect. 302.

concerning this particular individual being a bachelor, etc., and convene all the other males available of first-initiation rank and upwards to a Camp-council where the qualifications of the marriageable men are put under consideration; during the deliberations, in which no women are allowed to take part, the person *sub judice* can be present to listen only, but more usually he will leave camp to go on some fishing or hunting expedition. If all is found to be proper and satisfactory,<sup>9</sup> and the vote of the Camp-council must be unanimous, the woman's brothers, or mother's brothers, present the bridegroom elect some time during the day with a smouldering fire-stick. This stick has nothing whatever distinctive about it; any small piece of wood, about five or six inches long, of any material or shape, is sufficient. The same intermediaries some time after sundown give a similar stick to the bride and direct her to her future husband's hut, whither it is obligatory on her part to go and remain. This ceremony is binding on both sides, and except by mutual agreement, the couple can only be parted by death.

16. The widow becomes the property of one of her late husband's brothers, the consummation of her re-marriage usually only taking place at Cape Bedford, the Bloomfield River, Cape Grafton, etc., when the mourner's hair which has been allowed to grow during the burial ceremonies is finally cut; on the Lower Tully, however, she can on occasion be re-married on the day following her late husband's decease, independently of all the complicated burial customs taking place there. At Cape Bedford the deceased's next younger blood- or group-brother, the former having the prior claim, has the first choice of the widow, who is not apparently forced to re-marry, though she generally thinks better of it and does. She is hammered on the head the day after her husband's decease, with a wommera, by all the old men round about, who excuse their conduct by saying that from the very first she was jealous of some other girl and forbade her late husband to have her, and further that she used to eat his food, which otherwise they might have had and enjoyed.<sup>10</sup> On the Bloomfield River the widow's own group- or blood-brother has the greatest say as to which one of her late spouse's brothers she has to be given to. There are often great disputes over arranging

---

<sup>9</sup> As to the suitable exogamous groups, both of them of at least first-initiation rank.

<sup>10</sup> Roth—Bull. 2—Sect. 31D, where it will be noted that the hammering does not take place if the deceased was an old man. [It is not worth while avenging an old man whose infirm "spirit" could do the survivors no harm.—W.E.R.]



this matter. The finally chosen one stands up to have the spear thrown over him<sup>11</sup> by the other brothers who have next claim, for until this is done he is aware that his assumed right is not generally admitted; occasionally, if any dispute or unpleasantness occurs, he may have to fight for her, though finally she is handed over to him by the wrist, and everything is settled. On the Tully River the widow is claimed by whichever of her late husband's group- or blood-brothers is old enough and strong enough to hold his own; consequently there is often a fight or two over the settlement.

17. Permanent sexual union based on the mutual attachment of the two contracting parties may have to be confirmed, so to speak, by certain official formalities, or may in itself constitute a marriage recognised and upheld by the community, a great deal depending upon whether the woman is a free agent or not, *i.e.*, single, married, betrothed, etc. In the Bouliá District, under those circumstances where a man is in love with a single woman who reciprocates, but the Camp-council, for some reason or other, refuses ratification, they will probably elope some night and after living together for a month or two return to camp. But when they do come back, both have to run the gauntlet of the outraged community, certain members of which will cripple them with knives by hacking into the shoulders and buttocks, will bruise or hammer them about the limbs and head with sticks and boomerangs, or puncture the fleshy parts of the thighs with spears. The perpetrators of the punishment take very good care that the injuries inflicted should not prove fatal, because were this contingency to occur they know full well that the death would be avenged by the victim's brothers, etc. Having undergone the recognised chastisement for breaking the old-established rule, the couple is now recognised as husband and wife.<sup>12</sup> Such a wife is the unofficially loved-one already referred to as the *pandira*; if she is not already of third-initiation rank she returns to her mother's hut every morning, and neither prepares nor cooks her husband's food; only after the birth of her first child does she remain at her husband's apartment permanently.<sup>13</sup> Amongst the Lower Tully River natives, all that either contract-

<sup>11</sup> Roth—Bull. 8—Sect. 13.

<sup>12</sup> That is to say, provided the former still wishes it; otherwise the latter is restored to her brother, etc., as being no longer required. Of course the amorous pair must be of suitable exogamous groups, and both of first-initiation rank; the sure penalty in this district for any breach of the former essential would be the death of both parties, with the tacit consent of the blood-relatives.

<sup>13</sup> The same arrangement holds good with the official wife, or *no-po*,

ing parties has to do is to build a fresh hut and fire, and beckon the other in. Thus a good orthodox method here is for the woman to make the advance. Supposing she wants a particular boy, and they are members of the suitable exogamous group, she will make a new hut and light a fire there on his return from the day's chase; she then beckons him to come, and if he accepts and comes over, they are henceforth recognised as man and wife.

A man may unfortunately fall in love with a married woman who reciprocates his affections and elope with her.<sup>14</sup> After a varying length of absence the couple will return, the seducer bringing her back to her original husband, who either forgives him<sup>15</sup> and takes her unto himself again, in which case she will receive more or less chastisement, or tells her newly found lover to keep her, expecting, of course, a solatium in the way of spears, etc., or else fights, the victor being now the recognised husband. The particular behaviour of the injured husband will vary according as he is afraid or not to fight; where the two men do come to blows they make no attempt at actual killing, for fear of retribution, and their quarrel is not joined in by any others. If the original husband, in the North-Western Districts, refuses to receive his erring spouse, the Camp-council sees that she becomes and is recognised as the wife of the man she ran away with. A man eloping with a woman only betrothed to another has to answer for his conduct to the latter in the same manner as if she were already married.

18. Marriage by capture includes those cases where, on the part of the male, the attachment is one-sided, the female not being a consenting party, with the result that more or less force and stratagem has to be brought into requisition, such as there is being usually dependent upon whether she is a tribeswoman or a stranger. Thus, on the Tully River a man may beckon a woman over to his freshly built hut and newly lighted fire, and if she refuses, will pull her in by the wrist; were she to scream too much, to show fight, and bite, etc., he will just thrash and hammer her and compel submission. The woman is absolutely passive: she may howl and try to get away, but no notice is taken, she being now his recognised wife. In most cases, however, marriage by capture of a tribeswoman is a somewhat risky affair, in that the self-assertive husband has to answer for his conduct to her male relatives, etc. Matters, of course, are different where the captured wife is a stranger, with no friends

---

<sup>14</sup> In the N.W. Districts, if he values his life, she must be of the proper exogamous group.

<sup>15</sup> Roth—Bull. 8—Sect. 2.

amongst her captors. Here the dusky Lothario will generally get certain of his mates to lend assistance and organise a regular wife-hunting expedition, for which purpose certain hip- and tail-ornaments are included in the accoutrements; lives may be lost on both sides, but if successful those who have rendered help will be rewarded with a promiscuous sexual orgie at the expense of the captive bride.

19. A man in the North-West Districts can exchange his true blood-sister for the blood-sister of another individual, the brothers or mother's brothers leading the brides to their respective future homes the same night, two marriages being thus simultaneously consummated. This arrangement only holds good, however, provided the contracting parties are of first-initiation rank and of suitable exogamous groups, and that the unanimous vote of the Camp-council sanctions it. Otherwise, and in other districts, although the husband has the power so to do, the selling or bartering of wives, independently of course of their temporary loan for venery, but rarely takes place; even in the Tully River District, where, on an aboriginal standard, morals are at a very low ebb, this practice is not in vogue. Indeed, in making a retrospect of the cases known to me, I am inclined to believe that on the whole the selling of a wife is a late innovation introduced by contamination with an undesirable class of European and Asiatic settler.

20. Throughout the North-West Districts, the female at her first-initiation ceremony, which is obligatory before her marriage can be legally recognised, is forced to undergo sexual connection with certain of the "bucks" present.<sup>16</sup> In marriage by capture, the bride has to submit to a similar ordeal from the males who have lent assistance. And on the Pennefather River there is a sort of "first-fruit" arrangement,<sup>17</sup> the husband having to allow his wife promiscuous intercourse with certain "bucks" of his own group before he is considered to possess full and sole rights.

21. Divorce is permitted to the man, but seldom to the woman. At Cape Bedford the process is very simple; if the husband does not want his wife, he just tells her so and lets her go, there being no fighting with the man who next takes possession of her, she of course being now free to marry again. Amongst the Bloomfield River natives, on the other hand, divorce is allowed to either party, although the weaker vessel does not usually resort to such a measure unless well backed by powerful relatives. If the husband wishes to free himself, he

---

<sup>16</sup> Roth—Ethnol. Studies, etc., 1897—Sect. 305.

<sup>17</sup> Rev. N. Hey, of Mapoon, drew my attention to this.

generally arranges the matter quietly with one of his group- or blood-brothers, gets him to take her, and holding her by the wrist, hands her over. In those portions of the North-West where the Camp-council ratifies the marriage of two adults, and elsewhere where the ceremony is based on mutual attachment, the two contracting parties may mutually agree to sever marital relations.

22. Polygamy, and within certain limits, polyandry, are practised and recognised throughout the North, the limits depending upon the suitable exogamous groups, acquiescence or absence of the original husband, etc. As a general rule, the older the man, other things equal, the larger is his number of wives, the favourite usually being the youngest in so far as the husband most often takes her with him on any hunting expedition, etc., such favouritism, however, having its disabilities in that while in camp she suffers most at the hands of her fellow-wives, all of whom usually live together. On the Bloomfield River, it would seem that the wife obtained by betrothal is thought far more of than the ones acquired by capture or inheritance. So also in the Boullia District the unofficial wife is always in greater favour than the official one chosen by the Camp-council; indeed the term signifying of the former, *pandira*, has almost come to mean a settler's mistress in contradistinction to his lawfully wedded wife. Once married, the husband has marital rights over his wife's blood-sisters, and indeed, as on the Pennefather River, where there is a plurality of wives, these are often blood-sisters. There would seem to be differences as to when these rights can be claimed; on the Pennefather River, for instance, the husband has to ask his step-parents for them as each arrives at marriageable age, whereas on the Tully River he may satisfy his desires by force if necessary, irrespective of any age, unless the girl is already married, when he can do so by getting her husband's permission. For, according to his mood, a husband here may or may not object to his wife having intercourse with any of his group- or blood-brothers, she being certainly punished were she to suffer the embraces of a member of any other exogamous group; on the other hand, during her husband's absence she can without fear of any consequences, regularly sleep with any of his blood-brothers.

23. The birth of twins, full blood, judging by the cases that come under notice, does not appear to be of such common occurrence as that of half-caste ones. Several are known on the Lower Tully River, but only one example on the Bloomfield.<sup>15</sup> The difficulty

---

<sup>15</sup> On the authority of Mr. R. Hislop, who was for the greater part of his life resident there.

of obtaining reliable data is increased by the fact that either no notice is taken of such an event, as at Cape Bedford, whereas in other districts they may be destroyed, and the information when sought for may prove unreliable. The only example I have seen (July, 1900) was that of Mundy's gin at Nunnville, viâ Cooktown, who had boy-twins, over twenty-four hours intervening between the two births. On the other hand, during 1899, three cases of half-caste twins came under my personal notice in the neighbourhood of Cooktown alone. That of aboriginal Rosie<sup>19</sup> was extremely interesting:—On July 15th at 10.15 p.m. the first half-caste daughter was born; on July 18th at 5 a.m. a second one made her appearance, the two separate placentæ being removed the same morning at 10 a.m.; on July 22nd both infants were weighed, the elder turning the scales at 3 lbs. and the younger at 4 lbs.

Considering the population, triplets cannot be rare on the Lower Tully River; the following four women have been reported to me<sup>20</sup> as having proved themselves worthy of receiving the Queen's bounty:—Chur-ngoi (twins on a previous occasion), Burakun, Ngunara, and Mau-uba.

24. On the Lower Tully River infanticide is fairly common; either sex is destroyed, and it is usually done by the mother. The two main reasons given for the practice here are that the child gave the mother too much pain and trouble in coming into the world, and that the mother does not want to be bothered with it. In the case of twins, the mother will often keep one, and kill the other by choking; so also will she often kill a child that is born with any deformity. Infanticide is not considered in the light of any crime or offence, provided that it is done within the first day or two of the child's existence. Furthermore, a child may here be killed for a crime committed by its parents.<sup>21</sup> At Cape Grafton infanticide, irrespective of sex, is prevalent (I am only speaking up to 1898), and effected by just throwing the baby into the water and letting it drown, or else suffocating it by throttling, but though the practice is recognised it is usually done clandestinely. On the Bloomfield River infanticide was never prevalent until the Europeans came and half-caste children appeared, the father doing it by stamping upon the child's chest (R. Hislop). At Cape Bedford the practice may be resorted to when the children appear too quickly one after the other. In the North-Western Districts infants may

---

<sup>19</sup> Under the care of Dr. Kortum.

<sup>20</sup> By Mr. E. Brooke.

<sup>21</sup> Roth—Bull. 8—Sect. 2.

be killed by the fathers with a blow from a stick, or allowed to starve.

25. In the North-Western Districts, on the east coast-line (Cape Grafton) and elsewhere, abortion does not appear to be an uncommon practice. It is performed by the fixation of a thick cord wound very tightly round and round the abdominal walls, combined with the punching by hand or stick upon the more palpable and apparently firmer portions of the unborn child. In many areas still-births are prevalent owing not only to the women fighting amongst themselves, but also on account of the way they are often knocked about by their husbands.

26. Immediately after birth, in the Boulia and Upper Georgina Districts, baby is "washed" in ashes, mud, or sand, but usually in the last-mentioned, the head and face being alike cleaned. When the Kalkadun infant is taken out of the shallow excavation into which it is allowed to tumble, any sand that may chance to stick to its face and mouth is removed with leaves; otherwise it is neither washed nor cleaned. Subsequently, however, the baby is smeared from top to toe with "iguana"-fat which is renovated continuously during its early years of life, while, at intervals, some powdered ashes are rubbed on the head over the areas of the fontanel. The Cape Bedford baby, after birth, is rubbed clean with sand and then exposed to the sun; indeed, to be left exposed like this during the day-time is a very common practice.

In all districts the suckling of children continues up to a comparatively advanced age. A mother may commonly be seen with two infants at the breast, and I have often come across children of three, four, and even five years of age running up for a suck. These women certainly do not continue breast-feeding their children for these lengths on the chance of avoiding pregnancy,<sup>22</sup> and yet several cases have been made known to me where they have been very determined on the matter; *e.g.*, during the year 1897 Mrs. L. in attempting to wean a four or five year old youngster by taking its Keppel Island mother away on a three weeks' visit to the Yeppoon, discovered that the latter had during the whole period secretly got one of the other gins to suckle her breasts regularly so as to keep them full. As the babies become older, they are fed more and more on honey, kangaroo and opossum flesh, etc. Though no exact statistics are obtainable, the loss of infant life is very marked, especially

---

<sup>22</sup> Amongst these folk I am very doubtful of there being any such physiological connection.

during the wet season, when food is comparatively difficult to obtain, and in the cold weather.

Throughout North Queensland a very common method of carrying a newly-born or comparatively young infant is in a sheet of bark slung up to the mother's side. This sheet of bark, derived from various timbers, is scorched on its inner surface so as to produce a curling-over inwards at the sides; this is slung with twine, etc., over the mother's opposite shoulder and balanced pretty carefully with the hand to prevent the youngster (lying on an old net, some rags, or soft grass) from falling out at either end. Where koolamons<sup>23</sup> are met with, these may take the place of the curled bark-sheets. In the Peninsula, and along the East Coast, a slightly older baby may be carried in a dilly-bag slung over the shoulders. As the child's age increases, it is carried on the shoulders (Plate ii., fig. 2; Plate iii., figs. 1-3) or flank, usually only on the former by the father, usually on the one or other by the mother (Plate iii., fig. 4): in the one case it grasps its parent's forehead and neck with its little hands and legs respectively, while in the latter it sits upon its mother's hip supported in position by her protecting arm.

A mother never sings lullabies to her child, beyond a sort of droning humming sound to send it to sleep. The only thing she does is to rock her baby in a basket dilly-bag, bark trough, etc., resting on the ground, or else swing it suspended from the branch of a tree. She may slap it after the approved European fashion, and sometimes frighten it by making grimaces, a favourite one in the North-West Districts being produced by passing a string through the nasal septum and drawing the nose upwards.

27. I have not come across a single reliable example of the existence of more than three generations at one and the same time.

Families may be large or small, or conspicuous by their absence, but on the whole it would appear that the largest number of children are born to those men with but one wife. At Cape Bedford it is not uncommon for women to have six or seven youngsters; at the Bloomfield River five or six, one being known to have had nine. Amongst the natives in the unsettled districts it is naturally impossible to obtain reliable data as to the numbers of children born, not only on account of the difficulty of obtaining reliable interpreters, but also because of the general dislike to speaking of those of their kith and kin who have gone before. At any rate, amongst people living a natural existence in their own environments, it is impossible that the birth rate

---

<sup>23</sup> Roth—Bull. 7—Sect. 62.

can be so low, and the death rate so high, as is met with amongst a native population living in more or less contact with the European. To show this the more forcibly, I propose giving two examples, one from Camooweal and the other from Mapoon, Batavia River, where the natives have succumbed to the encroachment and abuse of the pastoralist and pearl-sheller respectively. On 24th May, 1900, there happened to be twenty-five women in the native camp, all of them over puberty, *i.e.*, marriageable or of fertile age; taking young and old alike, I asked each one separately how many children, boys and girls, had been born to her, and how many of these, of either sex, were alive or dead. As will be seen from the following table, these twenty-five women had twenty-eight live children between them:—

Case Number.	Boys.		GIRLS.	
	Alive.	Dead.	Alive.	Dead.
1	...	...	...	...
2	...	...	1	...
3	1	...	...	...
4	1	...	...	...
5	...	...	2	...
6	1	...	...	...
7	...	...	2	...
8	..	...	2	1
9	...	..	...	...
10	...	1	...	...
11	...	...	2	...
12	...	...	1 (half-caste)	...
13	1	...	..	...
14	1	...	2	..
15	1	...	...	..
16	...	1	1	...
17	1	...	...	3
18	1	...	2	...
19	1	...	1	...
20	...	...	...	...
21	...	2	...	..
22	...	...	1	...
23	...	...	1 (half-caste)	...
24	1	..	...	...
25	...	...	..	...
Total .....	10	4	18	4

During the course of the preceding year I had made a similar investigation amongst the native women in the camp at Mapoon, making enquiry from the first one hundred women above puberty,



young and old, whom I saw. From the particulars tabulated, I found that these one hundred women had but one hundred and nine live children between them.

No.	Alive.		Dead.		Total	No.	Alive.		Dead.		Total	No.	Alive.		Dead.		Total
	B	G	B	G			B	G	B	G			B	G	B	G	
1	1	2	...	...	3	35	...	...	...	...	0	69	...	...	...	...	0
2	...	...	...	...	0	36	1	1	...	1	3	70	...	...	...	2	2
3	...	...	...	1	1	37	...	...	1	...	1	71	...	...	...	...	0
4	2	2	1	2	7	38	...	...	2	...	2	72	...	...	...	...	0
5	...	...	...	...	0	39	3	1	...	1	5	73	2	1	2	2	7
6	...	1	...	1	2	40	...	1	...	...	1	74	...	2	...	1	3
7	1	1	1	1	4	41	2	...	...	1	3	75	1	1	1	2	5
8	1	1	1	...	3	42	1	...	...	2	3	76	1	...	...	...	1
9	...	...	...	1	1	43	...	2	...	...	2	77	...	...	2	1	3
10	...	1	1	...	2	44	1	1	...	1	3	78	1	...	...	...	1
11	2	1	1	3	7	45	...	...	...	...	0	79	1	...	...	...	1
12	1	1	...	...	2	46	...	...	1	...	1	80	...	...	2	...	2
13	...	1	1	1	3	47	...	2	1	1	4	81	1	2	...	1	4
14	1	1	...	1	3	48	...	1	3	...	4	82	1	...	...	...	1
15	...	1	1	...	2	49	...	...	1	1	2	83	...	...	...	1	1
16	...	...	...	...	0	50	1	...	3	1	5	84	...	1	...	...	1
17	1	...	...	1	2	51	...	...	1	2	3	85	1	2	2	...	5
18	2	1	...	...	3	52	3	2	...	...	5	86	1	...	...	...	1
19	1	...	...	...	1	53	...	1	...	...	1	87	...	...	...	...	0
20	2	...	...	1	3	54	3	1	...	1	5	88	2	...	...	1	3
21	...	...	...	...	0	55	1	1	2	...	4	89	...	...	...	...	0
22	1	...	...	...	1	56	...	1	...	1	2	90	1	...	...	...	1
23	1	1	...	1	3	57	1	...	2	1	4	91	1	...	1	...	2
24	1	...	...	...	1	58	...	...	...	...	0	92	...	...	...	...	0
25	...	1	...	2	3	59	1	...	...	1	2	93	1	1	2	1	5
26	1	1	2	1	5	60	...	1	...	...	1	94	...	1	1	...	2
27	...	...	1	1	2	61	1	...	1	1	3	95	2	1	2	1	6
28	...	2	1	1	4	62	1	1	...	...	2	96	...	1	...	1	2
29	...	...	1	...	1	63	...	...	1	...	1	97	...	...	2	1	3
30	...	...	...	1	1	64	1	...	...	...	1	98	1	...	...	2	3
31	1	...	...	...	1	65	1	1	2	...	4	99	...	...	...	...	0
32	...	1	...	...	1	66	...	...	...	1	1	100	1	1	...	1	3
33	1	...	1	1	3	67	...	2	...	...	2	Grand total—					
34	...	...	1	1	2	68	...	...	...	...	0	62-54-52-57				225	

Numbers 45, 51, 72 were pregnant. Nos. 67 to 73 were the seven wives of one man, and had eleven children between them, though one woman alone contributed seven to this total.

AN UNDESCRIBED AUSTRALIAN CYSTIPHYLLID—  
*MICTOCYSTIS*—FROM THE UPPER SILURIAN ROCKS  
OF THE MOUNT CANOBALAS DISTRICT.

By R. ETHERIDGE, JUNR., Curator.

(Plates iv.-v.)

To Mr. C. A. Süßmilch, of the Technical College, Sydney, I am indebted for the loan of specimens, and presentation of others to the collection, of a very interesting Cystiphyllid coral from the Upper Silurian rocks in the neighbourhood of the Canobalas. So far as Australian literature is concerned, it is certainly undescribed.

The essential feature of this coral consists of a mass of coarse blister-like vesicular tissue surrounding a series of cylindrical and parallel visceral chambers, apparently without mural investment other than the convex oblique surfaces of the vesicles in question. On the upper or external surface of the corallum these vesicles have a very marked blister-like appearance and are not traversed by radiating or geniculate septal costæ at all.

The visceral chambers are provided with numerous well-developed lamellar septa which proceed almost to the middle of each chamber, cutting through the horizontal tabulate centres; these septa are confined to the visceral chambers, and do not in the least impinge on or pass over the blister-like vesicular tissue; again they do not appear to quite reach the calicinal centre, nor can I distinguish any columelarian structures; indeed there seems to be a small free central tabulate area to each visceral chamber. The tabulæ are on the whole complete, although here and there lenticular vesicles are formed.

The affinities of this coral form a difficult problem. In the first place the vesicular tissue constituting the general mass is essentially that of the Cystiphyllidæ, blister-like vessels closely superimposed on one another. Any further affinity with this family can only be traced to some extent through *Actinocystis*, Lindström, and *Mesophyllum*, Schlüter. In the former the centres of the corallites are septate, but the septal areas small, and I believe not tabulate; the whole of the broad external zone being entirely vesicular in the usual cystiphyllid manner. The visceral chambers also appear to be formed in the same way as

in our present fossil—a longitudinal cavity without mural investment enveloped in cyst-like tissue. The latter genus, *Mesophyllum*, Schlüter (= *Spongophylloides*, Meyer), is but an amplification of *Actinocystis*, by increase of the septal area, corresponding decrease of the vesicular peripheral zone, and a modified pinnate arrangement of the septal lamellæ: as in the former, tabulæ are said to be absent. To sum up, my conception of this coral is that of a loosely constructed compound *Actinocystis* with tabulæ.

Were the question put to me, how does *Mictocystis* differ from *Endophyllum*, as we understand the latter, I would answer, it is possibly very much a matter of degree, although there is more than one marked feature that will serve to distinguish them, thus—In *Endophyllum* the corallites are formed by a series of invaginated ob-cones, the free calicinal edges of which lie over and connect with those of contiguous corallites. To a certain extent, therefore, they possess a kind of spurious mural investment, whilst in *Mictocystis*, as I have already explained, even that does not exist. Again, in *Endophyllum* the vesicular tissue lies between more or less horizontal laminæ, the extensions of these invaginated cup-edges, instead of forming a mass of heaped-up cysts. Further, the septa at their distal or outer ends mingle, or are lost in the vesicular tissue, but in *Mictocystis* they seem to be absolutely free of any connection with the vesicular tissue. In fact the septal lamellæ and tabulæ of *Mictocystis* resemble a series of long plugs dropped into cylindrical holes in the tissue.

Dr. C. Rominger described a compound vesicular genus from the Niagara Group of Michigan, called *Vesicularia*,<sup>1</sup> composed of a “superimposed series of calycinal cups, of coarsely blistered surface, which in vertical sections appear as a uniform succession of layers of large, unequal, vesiculose plates, perfectly resembling a vertical section through a Cystiphyllum.” The blistered calycinal layers bear pseudo-costal radii, and the margins of the calyces are expanded and confluent without lines of demarcation. At a casual glance there is some resemblance to *Mictocystis*, principally in consequence of the blistered surface, but the invaginated form of the calyces and the lateral extension of the pseudo-costæ at once distinguish the corals from one another. Furthermore, the name *Vesicularia*, Rom., does not stand, having been used as a genus of Polyzoa by Dr. J. V. Thompson between the years 1829-1834.

---

<sup>1</sup>*Vesicularia*, Rominger, 1876 (*non* Thompson, 1829-34), Geol. Survey Michigan. Report Lower Peninsula, 1873-76, iii., 1876, pt. 2, p. 135.

The following is a description of the genus and species :—

*Genus Mictocystis,*<sup>2</sup> *gen.nov.*

*Gen. Char.*—Corallum compound-cystiphylloid, coarse vesicular tissue enveloping disconnected cylindrical corallites, without proper walls. Septa lamellar, confined to visceral chambers, not impinging on the vesicular tissue. Tabulæ usually complete.

*MICTOCYSTIS ENDOPHYLLOIDES, sp.nov.*

*Sp. Char.*—Corallum of large size, consisting of a mass of large lenticular vesicles enveloping unequally spaced-apart corallites; surface convex and slightly blistered. Corallites long, cylindrical, with an average diameter of ten millimetres. Calices moderately deep, more or less crateriform at the surface; sides inclined, blistered. No evidence of proper walls or inner mural investment to the corallites (visceral chambers). The latter are surrounded by the vesicular tissue, which is highly developed and composed of large blister-like, arched, inwardly inclined vesicles of different shapes and unequal size, but the lenticular predominating. Septa well developed in and confined to the visceral chambers as simple vertical lamellæ, of one order, and to the number of about twenty-four, extending almost (if not quite) to calicinal centre, but without mingling or revolving, and neither passing over the surface blisters nor extending on to those forming the spurious walls of the visceral chambers. Tabulæ horizontal, close, slightly bent downwards at their peripheries.

*Loc.*—Junction of Spring and Gap Creeks, Portion 98, Parish Barton, County Ashburnham (*C. A. Süssmilch*—Colls. Australian Museum and Süssmilch).

*Hor.*—Upper Silurian, Halysites Limestone (Bed A of Mr. Süssmilch's section<sup>3</sup>).

<sup>2</sup>μικτός = compound; κύστις = a bladder or vesicle.

<sup>3</sup>Süssmilch—*Journ Roy. Soc. N. S. Wales*, xl., 1907, p. 131, pl. xix.

ON AN UNUSUAL NESTING-SITE OF *SAULOPROCTA*  
*MELALEUCA*.

By ALFRED J. NORTH, C.M.Z.S., Ornithologist.

A pair of Black and White Fantails (*Sauloprocta melaleuca*) has frequented the garden and the verandahs of my house at Roseville, for the past four years, usually breeding in the trees in the neighbourhood. This year Mrs. North remarked that this pair of birds was always under the wooden screen protecting the breakfast-room window and thought the birds were building there. On the 1st September, 1907, I saw both birds carrying nesting-material, and on making an examination found no less than four nests about one-third built, had been formed on the top of a smooth and painted wooden beam two inches and three-quarters wide under the screen. Three of these partially built nests were afterwards found on the ground, whether pulled off by Sparrows or Starlings, as I know of the destructive habits of these species, or blown off by the wind, I cannot tell. The birds completed the remaining structure, and when I examined it again on the 12th September it contained one egg; as the nest did not feel too firmly attached to the beam, I applied some thin liquid glue to its base. An egg was deposited on each of the two following days, and on the latter the female began to sit. Lowering down each day the upper sash of the window, the panels of which were filled with coloured glass completely obscuring the nest when closed, one could watch while seated at meals only a few feet away, or walking about the room, the birds sharing the duties of incubation. A revelation was the remarkably short time that each bird sat before calling to its mate to be relieved, and as I was just recovering from an accident met with in the field, I had ample opportunities for making observations. The average time each bird sat was a quarter of an hour; once it was as short as four minutes, and once its duration lasted twenty-five minutes. After calling, the sitting bird would keep a sharp look out for its mate, and directly

it appeared in sight left the nest in an opposite direction from that in which the bird about to resume its duties was approaching. On the latter reaching the nest it immediately took possession of it and invariably, while it contained eggs, rubbed each side of its head and bill half way round the outside of the nest, backwards and forwards several times to get rid of the legs and any portion of insects attached to its bill. The bird which we took to be the male, being larger, and sitting higher up in the nest, would respond to either Mrs. North's or my call of "Sweet pretty creature," but would not do so to strangers. The period of incubation lasted fourteen days, the three eggs being hatched on the morning of the 28th September.

The newly hatched young are queer looking yellowish-white creatures with the feather tracts visible on the centre of the head and back. At that early stage of their existence, and only a few hours old, they mutely appealed for food with widely distended mouth. The labours of the parents were now increased, and both birds were busily engaged supplying their wants.

Sanitation is perfect, and cleanliness must be an instinct, for I first observed, when they were five days old, these callow helpless young, with eyes yet unopened, take the voidings of each other in their mouths, when with upturned head and open mouth, it was taken by a parent in its bill and dropped in the garden a few yards away. When the young were ten days old and feathered the voidings were taken direct by the adult when ejected by the young. At this stage the young birds well filled the nest, and were fed by the parents until dusk, when the old pair of birds left them for the night, roosting on an apricot tree in the garden, and returning to feed them early next morning.

The young birds were fed by their parents regularly as a rule three times a day, in the early morning, noon, and just before sundown, both old birds working assiduously to satisfy their cravings, insects being quickly obtained on a manure heap in the garden. Shortly before the young ones left the nest they were fed on butterflies, and, in one instance, with the comparatively large and beautiful blue and black Wanderer (*Papilio sarpedon*) after the wings had been torn off the body. During the whole of the time that the young ones were in the nest, the parents were exceedingly aggressive, swooping down on an intruder and giving vicious snaps with their bills. They chased a Raven away that used at times to come and prowl about the fowl-yard, but on one venturing to chase a Yellow-tufted Honey-eater out of the garden, two young ones of the latter assisted the

parent and the Fantail had to beat a hasty retreat. One young Fantail left the nest when fourteen days old, and the remaining two on the following day. They lived about the garden, roosting at night in an apricot tree, were very tame, and only to be distinguished from their parents when four weeks old by their duller black plumage, narrow brown tips to the upper wing-coverts, and shorter tails.

This is the only instance I have known of the Black and White Fantail, or more popularly known "Willy Wagtail," resorting to a house for the purpose of breeding. It is much more peculiar owing to the fact that the house is surrounded with trees—their usual nesting-place—as far as the eye can see on every side.

ANCIENT STONE IMPLEMENTS FROM THE YODDA  
VALLEY GOLDFIELD, NORTH-EAST BRITISH  
NEW GUINEA.

By R. ETHERIDGE, JUNR., Curator.

(Plates vi.-vii.)

From time to time rumours of the discovery of ancient stone implements in the auriferous alluvium of the Yodda Valley Goldfield have reached us, supposed to be those of a pre-existing race. I have been unsuccessful in finding any description of these implements or references to their discovery other than the following brief statement by Mr. C. A. W. Monckton, one of the New Guinea Resident Magistrates:—"A remarkable pestle and mortar of plainly great antiquity have been found by some miners in gold workings at a depth of 12 feet below the surface in the Yodda Valley. The mortar, which with the pestle weighed 66 lbs., was roughly ornamented with barbaric carving. . . . The pestle and mortar were discovered in the same creek as an obsidian battle axe given by me some years ago to the Hon. David Ballantine, and both would appear to be relics of a forgotten race. The natives to whom the recently found articles were shown could not make any suggestion as to their original use or purpose, and all agree that it is not the work of any now existing tribes."<sup>1</sup>

No description or measurements of this interesting relic are given, which has unfortunately found its way to the British Museum. From the drawing accompanying the above remarks it appears to be a depressed, hardly round piece of rock hollowed in the centre, and scalloped round the edge. Two other objects, a pounding-mortar and a nondescript implement, are in this Museum, also from the Yodda Valley Goldfield, presented by Mr. A. L. Joubert.

---

<sup>1</sup> Monckton—Brit. N. Guinea. Ann. Report for Year ending 30th June, 1904 (1905); Commonwealth Parl. Papers, 1905, No. 1. C. 7001, p.31, 4th pl.



The mortar (Plate vi., fig. 1) weighs 30 lbs., and consists of mica schist. It is more or less heraldic shield-shaped in outline, truncated at the base, and with its upper outer edge broad and bevelled outwards. The length is fourteen inches, the width twelve, and five inches at the deepest point. The interior has been unequally worn, the deeper hollow at the truncated end, the smoothed or ground surface being very apparent. In common with the next object to be noticed, it was found at a depth of eight feet from the surface, but whether the two were discovered together I am unable to say. We have no stone mortars from New Guinea for comparison with this ancient implement, but from the Marshall Bennett Islands and from Woodlark Island we possess large, heavy, and slightly concave (on one surface) stones used for sharpening stone adze-heads on: these are much rougher, more primitive, and less concave than the Yodda Valley mortar. The nearest illustration I have seen is that of a rough stone mortar from the Solomon Islands figured by Edge-Partington.<sup>2</sup>

The second specimen (Plate vi., fig. 2) presented by Mr. Joubert might at first sight be put aside as fortuitous, but I believe it to have been manufactured. It is a piece of clay-stone, ten inches long, four inches wide, and generally speaking dagger-shaped and compressed; it weighs 3 lbs. It is flattened on one face and somewhat arched on the other. When viewed sideways there is nothing of moment to remark, but when looked at on either face there is an unmistakable conventional resemblance to the human form. At any rate this is so to the eye of a student accustomed to follow the hundred-and-one conventionalised modifications under which it and other natural objects are concealed in Western Pacific carvings and drawings. As to the figure itself, above is a rounded (in outline) compressed portion answering to a head, cut off by a neck and unsymmetrical shoulders from the long pointed body, in which there is no division into limbs. On the arched aspect of the implement is a central longitudinal ridge. The object of this must remain unknown; it is certainly not a pounder.

Certain stones used by the New Caledonians as a fetish, or charm, for success in fishing, or buried by the sorcerer in yam plantations to render the ground fruitful, bear a general resemblance.<sup>3</sup> We have in our collection a semi-human wooden figure from Easter Island terminating below in an undivided pointed and rounded base.

<sup>2</sup> Edge-Partington—Atlas, 2nd Series, pl. III, f. 5.

<sup>3</sup> Edge-Partington—Atlas, 3rd Series, pl. 71, f. 4 and 5.

I have now to call attention to a very extraordinary figure lent to me by the well known Sydney collector Mr. P. G. Black, and of which I have been permitted to take a copy for the Museum collection. This animal figure (Plate vii., figs. 1 & 3) was discovered in a village towards the head-waters of the Giriwo River, at from 3,000 to 4,000 feet above sea-level. Mr. Black informs me that the Giriwo River, which does not yet appear in any of our maps, is on the Buna Bay to Yodda Valley Road, and such being the case, it is evidently not a tributary of the Yodda River, but rises to the eastward in the same high country as that in which the northern tributaries of the Yodda rise; most probably the Giriwo River falls into Buna Bay. As to the figure, Mr. Black writes me thus:—"This image must evidently have come into the possession of the present race of natives by accident and probably some considerable time ago, for it clearly belongs to the same age as the discoveries made in the Yodda Valley. The natives evidently thought a good deal of it . . . and it evidently belonged to the village, and to no one man in particular."

The object represents a rude animal figure, fourteen and a half inches long by six inches wide, and weighs 17 lbs. The head, arms, and upper part of the body generally are tolerably well formed, the head thrust forward and inclined rather to one side; the fore-arms are also bent forward and the indistinct hands closed over what would be the abdomen, but is simply an obtuse obconical pivot-like termination. When viewed from the side the head is seen to be of a very low type, certainly not human, but possibly marsupial. The antero-posterior outline of the head in the middle line is nearly flat at the top but arched facially, and the nose flattened with small nostrils and mouth. There is no chin, the under surface being flat, with a central throat-lappet. The eyes are large and prominent, the ears small, depressed, and set far back, in fact represented simply by low prominences with central depressions; the neck behind is represented by a projecting roll. When viewed from behind the shoulders are high and narrow, and the central or vertebral region raised and rounded, and terminating below in a short coxygeal projection; the arms in their great length are decidedly simian. The stone is a horn-blendic rock, and the tool marks are plainly visible.

The use of this object is beyond speculation; some have suggested it to be a pestle or pounder, although I hardly think it is of this nature. When seen from the front, back, or side in profile, there is no suggestiveness about it, except that the head presents a rude resemblance to that of the Spotted Cuscus (*Phalanger maculatus*, Geoff.). On the other hand, if laid hori-

zontally on the back, the phallic nature is self-evident, and I think it much more likely to have been an emblem (priapus or lingam) of that nature.

Although not found in the Yodda Valley, we have another stone of equal interest (Plate vi., fig. 3). but it would not surprise me to find it originally came from that area. It is a heavy slab of basalt bearing an excellent example of spiral incising. It is from Boianai, Goodenough Bay, North-east Coast of New Guinea, and was presented by Mr. F. de S. Buchanan, but whether disinterred or found on the surface I am unable to say; the origin is said to be quite unknown to the present natives. The object as a whole was called by the latter *wakima kirukiru mana*, and the spiral design *giripipina*. The slab measures sixteen inches long, by eleven inches wide, and six deep, and weighs 62 lbs. The incised spiral, a very perfect one, is ten and a half inches in diameter and consists of six whorls. It is quite unnecessary to dilate here on the widespread occurrence of this form of petroglyph in America and Europe, and even in Australia as rock-shelter pictographs and churinga ornamentation. Spiral motive does not appear to be common in New Guinea present day decorative art. It is found on some Trobriand lime spatulas and Buruburu drums and shields from the Papuan Gulf District.

In 1905 Mr. P. J. Money, a member of the New Guinea Anglican Mission, presented us with a large quantity of pottery fragments and incised shell-pieces, found on digging into ancient village mounds at his station of Wanegela. The incised motive on this pottery is quite different to that on any of the existing New Guinea pottery, and to Mr. Money the present natives disclaim all knowledge of it, and the fabricators. The interesting point, however, in connection with the present subject is the occurrence of shell-pieces (Cones) bearing beautiful examples of spiral incision-work! Referring to this find, Mr. Monckton says—"In some excavations carried out by the Mission and natives at Rainu, in Collingwood Bay, an interesting discovery was made of an old village site of a forgotten people and a quantity of broken and ancient pottery found, of curious and unique design and shapes. The pottery was much superior to any now made or in use, and there is no tradition or record of the people by whom it was made. Among human remains at a depth of 4 feet, two fragments of carved shell were found, placed, I think, originally in graves. The art of carving on hard shells is not now practised"<sup>4</sup> This discovery of ancient pottery and

---

Monckton -*Loc. cit.*, p. 33.

carved shell work has been since described, and some examples figured by Dr. Rudolf Poch,<sup>5</sup> of Vienna

I think it may now fairly be conceded there is ample evidence of the existence of an extinct, or at any rate former population in Eastern New Guinea, of a highly interesting nature. Although the information to hand is not sufficient to prove the hypothesis, it is possible that this pottery and the buried works of art of the Yodda Valley Goldfield are the productions of one and the same people.

---

<sup>5</sup>Poch—Mittl. Anthrop. Gesellsch. Wein. xxxvii., 1907, p.67-71, f. 7 and 8.



am correct in doing so, for in the longer and graduated form of the tail, the central feathers much exceeding the lateral ones, it may be considered necessary to institute a sub-genus of *Calliptilus* for its reception. A second specimen of *C. stephensi*, probably a younger bird, has the green patch on the side of the fore-neck larger and more irregularly defined, and the vent light green, shaded with yellow like the under tail-coverts.

*PTILOPUS INSULARIS, sp. nov.*

*Adult.*—General colour above, including the wings, dull bronze-green, the apical portion of the outermost primaries blackish-brown, slightly glossed with bronze-green, the first primary much attenuated towards the tip, the remainder of the quills with very narrow whitish edges on their outer webs, the innermost secondaries externally margined and tipped with dull yellow; tail bronze-green, approaching a coppery hue on the central pair of feathers, the inner webs of the remainder grey crossed with a subterminal blackish-brown band, which is succeeded by an apical band of light grey, both of these bands being almost obsolete on the outer webs of the feathers; forehead and crown of the head deep rose-pink; feathers above the eye and the occiput green, passing into a greyish-green on the hind-neck; chin and centre of the throat white; cheeks, sides of the neck, and under surface grey, the feathers on the fore-neck with indistinct whitish centres, those on the centre of the breast broadly tipped with olive-yellow, some of the feathers on the thighs indistinctly tipped with dull green; vent white; under tail-coverts white, the apical portion of the longer ones pale yellow; under surface of tail grey, with a subterminal blackish-brown and an apical greyish-white band; under wing-coverts grey; “bill, legs and feet crimson-lake; iris rich yellow” (Stephen). Total length, 9·5 inches; wing, 5·7; tail, 4·5; bill, 0·58; tarsus, 1.

*Type.*—In the Australian Museum.

*Remarks.*—*Ptilopus insularis* is undoubtedly very closely allied to *P. coralensis*, as described by Count Salvadori<sup>1</sup> in the “Catalogue of Birds in the British Museum,” and to the “supposed type of *Ptilopus coralensis*,” described by Count Salvadori on the following page under the name of *Ptilopus smithsonianus*. From both, however the present species may be

---

<sup>1</sup>Salvadori—Cat. Bds. Brit. Mus., xxi., 1893. p. 104.

distinguished by the deep rose-pink feathers of the crown of the head and forehead, extending right on to the culmen, and having no narrow intervening greenish band of feathers as found in the former of these species, nor greenish grey forehead as in *P. smithsonianus*; moreover the chin, centre of throat, and vent are white, and the tail is longer. Another specimen, evidently an immature bird, judging by the feathers of the breast, has only an indication of the rose-pink hue on the forehead, and the olive-yellow patch on the centre of the breast is very much paler, and only the extreme tips of the longer under tail-coverts are yellow. Wing, 5.55 inches.

*PORZANA ATRA, sp. nov.*

*Adult.*—The entire plumage black, with a slight gloss on the upper parts; “bill, black; iris, ruby-red; eyelid, orange-yellow; legs and feet, orange-yellow” (Stephen). Total length, 7 inches; wing, 3.1; tail, 1.6; bill, 0.75; tarsus, 1.12.

*Type.*—In the Australian Museum.

*Remarks.*—The existence of a Water Crake on the island is an important discovery, for Mr. Stephen informs me that no permanent fresh water is found there. The two specimens he procured are alike in plumage, and were obtained in thick scrub. These birds were never seen to fly, but could run with great rapidity, their legs and feet being comparatively thicker than the Australian members of this genus. They were very tame, and would approach near to the party while they were seated at lunch in the scrub. The Black Water Crakes were shot by Mr. Stephen with a revolver, as were also the other birds he obtained on the island. The sexual organs were too mutilated to satisfactorily identify the sex of the specimens.

Mr. Stephen also showed me photographs of a young “Mutton Bird” (*Puffinus, sp. ?*) and of the egg of *Gygis candida*, laid on the limb of a tree. The eggs of this species were also found laid on the top of bare rocks on the highest part of the island.

The following are Mr. Stephen’s notes:—“The birds in spirits I presented to the Trustees of the Australian Museum were collected by me on the 10th September, 1907, during a visit paid to Henderson Island by a party from the S.S. ‘Tyrian,’ under charter to the Pacific Phosphate Co., Ltd.

“Henderson Island (Plate viii.) is an elevated coral islet about six miles long and three miles broad, fifty feet above sea level. The tableland is flat and roughly strewn with dead coral fragments and pointed or knife-edged

weathered compact coralline limestone. The vegetation is dense scrub, with vines and ferns (Plate ix.). *Pandanus* trees were about the highest on the island, some quite thirty feet high. The soil is very scanty, and the vegetation most often thickest in slight depression areas where it is more abundant. No water or swampy places were found, drinking water having to be taken on the various excursions. The island is uninhabited, and has rarely been visited by vessels, but the Pitcairn Islanders occasionally visit it for fishing purposes, since fish are very plentiful there. There are two coconut trees on the beach on the north end of the island, planted many years ago by some of the Pitcairn Islanders.

“Henderson or Elizabeth Island belongs to Great Britain, and the British Consul at Tahiti has jurisdiction over it.

“Animal life noticed during the short stay was as follows :— One variety of rat, very similar to the Pacific type; one skink (very plentiful); one small butterfly; one paroquet (not very plentiful—only seen on the high part of the island, and generally in pairs); one black crake (fairly plentiful in the interior of island, probably lives on tiny land molusks, which abound in the scanty soil over the high land); one dove, pink-crested, found more or less in flocks of about 20 or more; ‘mutton birds’ (*Puffinus*, sp. ?) were very plentiful, and laid their eggs on the ground among the scrub in more or less secluded places all over the island; white terns were also plentiful; noddies were not so plentiful; frigate birds were numerous; one species of small brown bird with white tail feathers, similar to one at Pitcairn.”



NOTE ON THE *CEPHALOCHORDA* IN THE AUSTRALIAN  
MUSEUM.

By PROFESSOR W. A. HASWELL, M.A., D.Sc., F.R.S., Trustee.

(Figure 1.).

Seven specimens of *Amphioxus* obtained in the dredge by Messrs. C. Hedley and A. R. McCulloch, at a depth of 5 to 8 fathoms at Murray Island, represent two of the sections into which the genus *Branchiostoma* may be divided.

HETEROPLEURON (*ASYMMETRON*) LUCAYANUM. *Andrews*.

The discovery of this species, originally found in the West Indies, in such a distant locality as Torres Strait, would appear somewhat remarkable (though by no means without parallel) were it not that the species of *Asymmetron*, obtained by Willey, in the Louisiade Archipelago, and named by that author *A. caudatum*, is now looked upon by him as not distinct specifically from the original type form of the sub-genus. As Murray Island is only about five or six hundred miles west of the Louisiades, there are many resemblances between the respective faunas, and it is not surprising to find a species of *Amphioxus* common to both.

HETEROPLEURON HEDLEYI, *sp. nov.*

The three specimens are of the same length—2·8 cm. In each of the two complete specimens there are fifty-four myotomes and nineteen gonads. In the third specimen several myotomes and gonads have been destroyed.

The opening of the oral hood is opposite the interval between the fifth and sixth segments; the atriopore opposite the thirty-third, the anus opposite the forty-fourth, and behind the anus there are either ten or eleven myotomes. The myotome formula is 33.11.10 or 11.

The rostral fin is slightly expanded, not separated off from the dorsal. The dorsal fin is moderately developed, not more than one-seventh of the whole vertical diameter. The caudal fin is distinctly lancet-shaped. The notochord is produced a little behind the last myotome. The ventral fin is without rays. The dorsal is without rays behind about the fortieth myotome. There are twenty-five to thirty oral cirri, united at their bases by a web. The velar tentacles are ten to twelve.

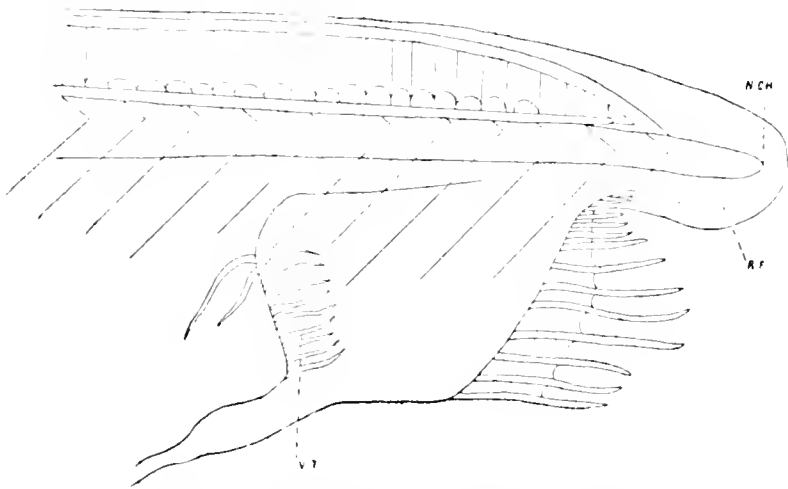

Fig. 1.—*Heteropleuron hedleyi*, Haswell.

N.C.H., anterior end of notochord; R.F., rostral fin; V.T., velar tentacles.

When the Murray Island specimens of *Heteropleuron* are compared with Kirkaldy's description and figure of *H. cultellum*, and with my specimens of the latter species obtained in Torres Strait during the cruise of H.M.S. "Alert," a very marked difference is at once recognisable. Apart from the myotome formula and the number of gonads, the high dorsal fin quite definitely separates *H. cultellum* from all other species of *Amphiorus*. From *H. bassanum* the Murray Island form is also quite clearly separated by different and constant, though less striking, differences. *H. bassanum* has about seventy-five myotomes or more and twenty-six to thirty-one gonads; it has paired fin-rays in the ventral fin, and it has the rostral fin separated off from the dorsal by a marked "dip." *H. cingalense*, the only other described species of *Heteropleuron*, has sixty-one to sixty-four myotomes, with the formula 39 or 31 + 17 or 16 + 6 or 8. The ventral fin has paired fin-rays and there are twenty-five gonads.

Altogether six species of *Amphiorus* are now known to be in Australian seas. These are:—*Heteropleuron bassanum*, Gün-

ther, which is very abundant in Port Phillip; *H. cultellum*, Peters, and *H. belcheri*, Gray, the former known to occur in Torres Strait, and as far south on the Queensland coast as Moreton Bay, the latter known from Torres Strait (as well as from the coast of Borneo); *H. hectori*, Benham, from the east coast of the North Island of New Zealand; and *Asymmetron lucayanum*, Andrews, from Murray Island, Torres Strait, as well as the Louisiade Archipelago and the Bahamas; and *Heteropleuron hedleyi* from Murray Island.

An *Amphioxus* has been dredged in Port Jackson by Dr. E. P. Ramsay, but the specimens obtained were never critically examined, and have been lost. The only specimens from the coast of New South Wales in the Australian Museum collection are two from Port Stephens. These are hardly in a condition for certain identification, but have, in all ascertainable points, the features of *A. bassanum*. The myotomes are about ninety in each of them, as against a maximum of only seventy-eight in Kirkaldy's description. But the same holds good of my specimens from Port Phillip, many of which have from eighty to ninety.

---

LITERATURE.

- Günther, A.—Fishes, H.M.S. "Challenger."  
 Gunther, A.—Fishes, H.M.S. "Alert," 1884.  
 Kirkaldy, J. W.—A Revision of the Genera and Species of the Branchiostomidae. *Quart. Journ. Micro. Sci.*, xxxvii., 1895.  
 Willey, A.—On a new *Amphioxus* from the Louisiade Archipelago. *Quart. Journ. Micro. Sci.*, xxxix., 1896-7.  
 Benham, W. B.—*Heteropleuron hectori*, the New Zealand Lancelet. *Quart. Journ. Micro. Sci.*, xlv., 1901.  
 Herdman, W. A.—Cephalochorda. *Comb. Nat. Hist.*, vii.  
 Andrews, —.—An Undescribed Acaniatae—*Asymmetron lucayanum*. *Stud. Johns Hopkins University*, v.

STUDIES IN AUSTRALIAN FISHES.

No. 1.

By ALLAN R. McCULLOCH, Zoologist.

(Plates x.-xi.)

It is my intention to contribute under this heading a series of short papers dealing with material as it comes to hand.

The present article contains an account of some species of the genera *Clinus*, *Petraites* and *Cristiceps*. They are an extremely variable group, and it is only by an examination of large series that the limits of the many species can be determined. The Australian Museum Collection, together with that of the late Sir William Macleay, affords such material, and I take the opportunity of figuring the eight species available, as well as giving a short comparative description of each.

To Mr. George Masters, Curator of the Macleay Museum, my best thanks are due for enabling me to examine the specimens under his charge; also to Messrs. J. Gabriel, of Melbourne, and H. E. Finckh and Bassett Hull, Junr., of Sydney, for additional specimens.

The species dealt with, including synonyms, are as follows:—

- Cristiceps aurantiacus*, Cast.—Syn. *C. pictus*, Macl.  
„ *australis*, Cuv. & Val.—Syn. *C. macleayi*, Cast.;  
*C. howitti*, Cast.; *C. pallidus*, Macl.; *C. splendens*, Cast.  
„ *argyroleura*, Kner.  
*Petraites heptaolus*, Ogilby.—Syn. *Cristiceps wilsoni*, Lucas.  
„ *roseus*, Günther.  
„ *fasciatus*, Macl.—Syn. *Clinus whiteleggii*, Ogilby.  
„ *phillipi*, Lucas.  
*Clinus perspicillatus*, Cuv. & Val.—Syn. *Clinus despicillatus*.  
Rich.

CLINUS, *Cuvier*.

*Clinus*, Cuvier, Règne Anim., ii., 1817, p. 251 (*mustelaris*).

This genus was proposed for Blennies in which the anterior rays of the dorsal fin, while widely spaced from those following, are nevertheless connected with them by membrane.

CRISTICEPS, *Cuv. & Val.*

*Cristiceps*, Cuv. & Val., Hist. Nat. Poiss., xi., 1836, p. 402  
(*australis*).

This was erected to receive such species as had the first three rays entirely separated from those following. Beyond this there appears to be no other character to distinguish it from *Clinus*. It must be noted here, however, of the type, *C. australis*, that while many specimens have the membrane from the third ray ending a little way in front of the anterior spine of the second dorsal, in others it extends to, or even up its base.

PETRAITES, *Ogilby.*

*Petraites*, Ogilby, Proc. Linn. Soc. N. S. Wales, x., 1885, p. 226  
(*heptaolus*).

This is to accommodate the species "which oscillate between the two genera mentioned."

Apart from the general appearance, there are no definite characters by which any one of these may be separated from the others, for while such species as *Cristiceps aurantiacus* and *Clinus perspicillatus* are readily divisible into two genera, they are connected by an unbroken series of intermediate species. The same must be said of several other genera not found in Australia.

It is obvious that no good purpose can be subserved by uniting all these under the oldest name *Clinus*, and I therefore propose that the above three be provisionally restricted as follows:—

- |    |   |                    |
|----|---|--------------------|
| A. | First dorsal spine placed over or in front of the eye.<br>First and second dorsal fins entirely separated or connected by membrane..... | <i>Cristiceps.</i> |
| B. | First dorsal spine placed behind the eye.   |                    |
| C. | Third spine connected to the basal portion only of the first spine of the second dorsal.....  | <i>Petraites.</i>  |
| D. | Third spine connected to the middle or upper half of the first spine of the second dorsal.....  | <i>Clinus.</i>     |

Key to the species examined:—

*Cristiceps.*

- |    |  |                      |
|----|--|----------------------|
| A. | Anterior spine placed just before the front margin of the eye. Two dorsals separate.....                                       | <i>aurantiacus.</i>  |
| B. | Anterior spine over the front half of the eye. Two dorsals connected.....  | <i>argyropleura.</i> |
| C. | Anterior spine over the hinder portion of the eye. First dorsal either distinct from, or joined to the base of the second..... | <i>australis.</i>    |

*Petraites.*

## D. Body deep.

E. Dorsal spines of moderate length; the rays though spaced, not distinctly divided into two parts..... *rosus.*

EE. Dorsal spines short; the rays divided into two parts by a transparent interspace..... *heptaotus.*

## DD. Body slender.

F. Spines of first dorsal sub-equal..... *fasciatus.*

FF. Third spine of first dorsal much shorter than the first..... *phillipi.*

*Clinus.*

G. First dorsal connected to the upper half of the anterior spine of the second; spines sub-equal .. *perspicillatus.*

CRISTICEPS AURANTIACUS, *Castelnau.*

(Plate x., fig. 1.)

*Cristiceps aurantiacus*, Castelnau, Proc. Linn. Soc. N. S. Wales, iii., 1879, p. 386. Macleay, Cat. Austr. Fishes (Proc. Linn. Soc. N. S. Wales, vi., 1881), p. 22. Stead, Fish. Austr., 1906, frontispiece.

*Cristiceps pictus*, Macleay, *loc. cit.*, p. 25.

D. iii., xxviii.-xxx.; 4-5 + 2. A. ii.; 23-25. V. 3.

First dorsal spine placed just before the front margin of the eye. The two dorsals not connected by membrane. Generally the two posterior rays of the second dorsal are separated from the others by an interspace. Caudal peduncle very long and slender, the membrane from the posterior dorsal ray reaching half-way along its length. A branched tentacle on the snout, and another long simple one over the eye. Vertebrae 14 + 32.

This is a common species along the coast of New South Wales. An examination of the type of *C. pictus*, Macl., shows that it is identical with Castelnau's species.

Specimens examined:—

(a) 1 Port Jackson, New South Wales.—Type *C. pictus*.

(b) 4 Port Jackson, New South Wales.

(c) 3 New South Wales Coast.

(d) 2 Lord Howe Island.

(e) 7 without locality.

CRISTICEPS ARGYROPLEURA. *Kner.*

(Plate x., fig. 2.)

*Cristiceps argyropleura*, Kner., Reise Novara, Zool. i., Fische, p. 199, pl. vii, fig. 4. Macleay, Cat. Austr. Fishes (Proc. Linn. Soc. N. S. Wales, vi., 1881), p. 25. Waite, Mem. Austr. Mus., iv., 1, 1899, p. 113, pl. xi., f. 3.

D. iii., xxvii.-xxix.; 5-7. A. ii.; 22-24. V. 3.

The first dorsal spine is placed over the anterior part of the eye, and the third spine is more or less completely connected with the base of the second dorsal by membrane. Dorsal rays equidistant. The caudal peduncle is long and slender, the membrane from the last dorsal ray reaching about half way along its length. A branched tentacle on the snout, and a long simple one over the eye. Snout short.

The five specimens of this species I have seen appear to differ from the original description only in having two rays less in the anal fin.

(a) 1 Off Jibbon, New South Wales.—Thetis Expedition.

(b) 2 Port Jackson, New South Wales.

(c) 2 without locality.

CRISTICEPS AUSTRALIS, *Cuv. & Val.*

(Plate x., fig. 3.)

*Cristiceps australis*, Cuv. & Val., Hist. Nat. Poiss., xi., 1836, p. 402, pl. ccxxxvi. Günther, Cat. Fish. Brit. Mus., iii., 1861, p. 275. Macleay, Cat. Austr. Fishes (Proc. Linn. Soc. N. S. Wales, vi., 1881), p. 20. Waite, Rec. Austr. Mus., iii., 1900, p. 209; and *loc. cit.*, v., 1904, p. 224. Lucas, Proc. Roy. Soc. Vict., (n.s.), iii., 1891, p. 10, pl. iii., f. 3.

*Cristiceps macleayi*, Castelnau, Proc. Linn. Soc. N. S. Wales, iii., 1879, p. 385. Macleay, *loc. cit.*, p. 21.

*Cristiceps howittii*, Castelnau, Proc. Zool. Soc. Vict., ii., 1873, p. 48; and Proc. Linn. Soc. N. S. Wales, iii., 1879, p. 385. Macleay, *loc. cit.*, pp. 20, 21.

*Cristiceps pallidus*, Macleay, *loc. cit.*, p. 26.

? *Cristiceps splendens*, Castelnau, Proc. Zool. Soc. Vict., ii., 1873, p. 66. Macleay, *loc. cit.*, p. 22.

D. iii., xxvi.-xxix.; 6-8. A. ii.; 24-26. V. 3.

First dorsal spine situated rather behind the middle of the eye. The two dorsals either entirely separate, or the first just

connected to the base of the second by membrane. The dorsal rays equidistant. Caudal peduncle long and slender, the membrane from the last dorsal ray reaching from half to two-thirds along its length. A branched tentacle on the snout, and a long simple one over the eye. Snout sub-conical. Vertebrae 14 + 30.

This is the commonest species of the genus in New South Wales, and is taken in the sea-grass *Zostera*, by net fishermen. Its general colour is green, with darker bands and silvery markings.

Specimens examined:—

- (a) 11 Port Jackson, New South Wales.
- (b) 3 Port Phillip, Victoria.
- (c) 1 Western Port, Victoria.—Co-type *C. howittii*.
- (d) 4 Port Jackson, New South Wales.—Co-type *C. macleayi*.
- (e) 1 King George's Sound, Western Australia.—Type *C. pallidus*.
- (f) 1 King George's Sound, Western Australia.
- (g) 35 without locality.

In the Museum collection there is a specimen labelled "*Cristiceps splendens*, Cast., Adelaide," which agrees well with the description of that species in all but having the interorbital space much less than the vertical diameter of the eye. Other specimens from South Australia, and Fremantle, Western Australia, and one from Jervis Bay, New South Wales, have the fin formulæ as follows:—

D. iii., xxvi.-xxviii.. 6-7. A. ii.; 22-24. V. 3.

Beyond the reduced number of rays in the anal fin, I am unable to find any differences between these and *C. australis*, *C.* and V.

- (a) 1 Adelaide, South Australia.
- (b) 3 South Australia.
- (c) 2 Fremantle, Western Australia.
- (d) 1 Jervis Bay, New South Wales.

#### PETRAITES ROSEUS, Günther.

(Plate x., fig. 4.)

*Cristiceps roseus*, Günther, Cat. Fish. Brit. Mus., iii., 1861, p. 274.

Macleay, Cat. Austr. Fishes (Proc. Linn. Soc. N. S. Wales, vi., 1881), p. 19. Ogilby, Mem. Austr. Mus., ii., 1889, p. 63.

*Petraites roseus*, Waite, Rec. Austr. Mus., v., 3, 1904, pp. 181 and 224.

D. iii., xxv.; 3-5. A. ii., 18-20. V. 3.



First dorsal spine placed between the eye and the preopercular margin. The membrane from the third spine extends to, rarely up, the base of the first spine of the second dorsal. The dorsal rays are widely spaced, the second and third slightly more so than the others. Caudal peduncle short and broad, the dorsal membrane reaching to the base of the caudal rays. A branched tentacle on the snout and a broad fringed one over the eye. Body deep. Vertebrae 14 + 26.

All the fresh specimens I have seen were of a deep brown colour, with darker bands and silvery and transparent markings. Specimens long preserved in alcohol become yellowish with bright pink bands. Lives among weeds in pools along the New South Wales coast.

- (a) 4 Port Jackson, New South Wales.
- (b) 2 New South Wales coast.
- (c) 5 Lord Howe Island.
- (d) 2 without locality.

PETRAITES HEPTAEOLUS, *Ogilby*.

(Plate xi., fig. 1.)

*Petraites heptaolus*, Ogilby, Proc. Linn. Soc. N. S. Wales, x., 1885, p. 225.

*Cristiceps wilsoni*, Lucas, Proc. Roy. Soc. Vict., (n.s.), iii., 1891, p. 10, pl. iii., f. 1.

D. iii., xxv.-xxvii.; 1 + 2. A. ii.; 17-20. V. 3.

First dorsal spine placed over the preopercular margin. The membrane from the third spine extends rarely to, generally a little up the base of the anterior one of the second dorsal. The two posterior rays separated by an interspace from the first. Caudal peduncle short and broad, the dorsal membrane reaching to the caudal rays. A branched tentacle on the snout, and a broad fringed one over the eye. Body deep.

I have taken this species with *P. roseus* at Long Bay, to which it is nearest allied. It differs, however, by having much lower fins, the dorsal rays less numerous than is usual in that species, and the two last being separated from the first. Those of the anal are also generally distinct. There seems to me to be no doubt that *Cristiceps wilsoni*, Lucas, must be included under this heading, the only apparent difference lying in a greater range of variation in the number of spines and rays in the dorsal

and anal (D. iii., xxiv.-xxviii.; 1 + 2. A. ii.; 17-21) of the Victorian species, than in any I have seen from New South Wales.

- (a) 3 Long Bay, New South Wales.
- (b) 1 Port Jackson, New South Wales —Type *P. heptaeolus*.
- (c) 1 Port Jackson, New South Wales.
- (d) 2 without locality.

PETRAITES FASCIATUS, *Macleay*.

(Plate xi., fig. 2.)

*Cristiceps fasciatus*, Macleay, Cat. Austr. Fishes (Proc. Linn. Soc. N. S. Wales, vi., 1881), p. 19.

*Clinus whiteleggii*, Ogilby, Proc. Linn. Soc. N. S. Wales, xix., 1894, p. 371.

D. iii., xxviii.-xxxii.; 1 + 1. A. ii.; 18-22. V. 2, rarely 3.

First dorsal spine placed above the hinder margin of the preopercle. The two dorsals connected by membrane. The last two rays are rather widely spaced. Caudal peduncle short and broad. A small branched tentacle on the snout, and a short, broad simple one over the eye. Rarely both are large and branched.

This is the common species living among sea-weeds in pools along the coast. In colour it may be anything from dark green without markings to pale green with darker bands and silvery or transparent markings. Specimens living in the pink coralline sea-weed common on the coast are of a bright pink variegated with brown, throughout which, however, the typical bands and silver spots are maintained.

Having examined Macleay's type of this species as well as Ogilby's *C. whiteleggii*, I am able to recognise the two as identical, although a comparison of the two descriptions would not lead to such a conclusion. Macleay's specimen is in very bad condition, but is sufficiently good to show all the important features. Ogilby's type is malformed, some of the rays of the various fins being distorted or absent. The above characters are therefore drawn up from a large series taken by myself at Long Bay, near Sydney.

- (a) 28 Long Bay, New South Wales.
- (b) 1 Jervis Bay, New South Wales.—Type *C. whiteleggii*.
- (c) 1 Port Jackson, New South Wales.—Type *C. fasciatus*.

PETRAITES PHILLIPI, *Lucas*.

(Plate xi., fig. 3.)

*Cristiceps phillipi*, Lucas, Proc. Roy. Soc. Vict., (n.s.), iii., p. 11, pl. iii., f. 2.

D. iii., xxx.-xxxii.; 2-3. A. ii.; 22-25. V. 2.

First dorsal spine placed over the margin of the preopercle. The membrane from the third extending on to the base of the first of the second dorsal. The rays are widely spaced, the last being joined to the base of the caudal. Caudal peduncle short and broad. Rostral and supraorbital tentacles very small and simple. Ventrals long and slender.

Five specimens are in the collection from Mr. J. Gabriel, who dredged them at Western Port, Victoria. They differ from the description only in the depth of the body, but this character varies according to the age and sex of the individual.

(a) 5 Western Port, Victoria.

CLINUS PERSPICILLATUS, *Cuv. & Val.*

(Plate xi., fig. 4.)

*Clinus perspicillatus*, Cuv. & Val., Hist. Nat. Poiss., xi., 1836, p. 372.

*Clinus despicillatus*, Richardson, Proc. Zool. Soc., 1839, p. 90, and Trans. Zool. Soc., iii., 1849, p. 128, pl. vi., fig. 2. Günther, Cat. Fish. Brit. Mus., iii., 1861, p. 271. Macleay, Cat. Austr. Fishes (Proc. Linn. Soc. N. S. Wales, vi., 1881), p. 14.

D. iii., xxxii.-xxxiv.; 3-5. A. ii., 24-26. V. 3.

First dorsal spine placed above the preopercular margin. The three anterior spines are sub-equal and joined to those following them by membrane. The dorsal rays are not spaced. Caudal peduncle short and broad, the dorsal membrane extending on to the base of the caudal. A slender branched tentacle on the snout and another large one over the eye.

It seems to me that Richardson's species is without doubt identical with *C. perspicillatus*, the distinguishing characters mentioned by him being of but little value, and dependent largely upon the method and condition of preservation.

(a) 2 Tasmania.

(b) 1 Western Port, Victoria.

(c) 8 Launceston, Tasmania.

## STUDIES IN AUSTRALIAN ARANEIDÆ.

No. 5.

By W. J. RAINBOW, F.L.S., Entomologist.

(Figures 2—5).

### *Family* ARGIOPIDÆ.

Mr. W. Bullock, of the Parkville Public School, near Scone, New South Wales, has from time to time presented to the Trustees many interesting forms both of Spider and Insect life. Amongst his recent donations were two species of Araneidæ, and as these appear to be new, they are described hereunder. The first of these is an *Argiope*, Aud. in Sav., for which I propose the name *A. bullockii*, and the second a species of *Celenia*, Thor., for which the name *C. calotoides* is proposed. The first of these specific names is in honour of the collector, and the second is applied on account of the remarkable resemblance borne by the cocoons or ova-sacs to the fruiting heads of *Calotis*, R.Br., especially *C. lappulacea*, Benth. I am indebted to Mr. J. H. Maiden, Director of the Botanic Gardens, for his courtesy in examining the cocoons, and comparing them with the fruiting heads of the plants referred to above.

In reference to *C. calotoides*, I would like to point out that some time ago Mr. Bullock forwarded to the Museum a series of these peculiarly burr-like egg-bags, but without the spider. The egg-bags were new to me, but on examining them I concluded they were the work of a species of *Celenia*. Accordingly I sent Mr. Bullock some sketches and notes of *C. distincta*, Cambr., asking him at the same time to keep a sharp look out, when collecting, for the maker of the cocoons. In this respect my correspondent was ultimately successful, securing three specimens, each of which had a series of cocoons. One of these Mr. Bullock retained for his own collection, but the other two are now in our cabinets.

Writing to me upon the subject of *C. calotoides* and its cocoons, Mr. Bullock observed:—“I had had a ramble in the bush, and had collected a number of spiders, and was on my way home

when I saw suspended from a little prickly (tree) shrub, what I supposed to be two egg-cases or cocoons of a *Celænia*, sp. As they looked rather fresh I pulled one off, and on turning it over in my hand I observed that it was not round. I then examined it with my lens, and, lo! and behold, it was a spider!

I can assure you it was the biggest surprise I have received for many a day." In a further letter my correspondent tells me the cocoons are always suspended in a line, and that the spider in each instance he has observed was always clinging to the bottom one. Each cocoon is globose, dark brown, and armed, burr-like, with a number of sharp tubercles or spines, and these latter are each covered with yellow silk. This peculiarity is especially interesting in that the abdomen of the spider is also of a dark brown colour, and is armed with a number of tubercles, each of which is yellow at its apex. As the spiders were alive when they reached me, I put them in a box in which I had first of all suspended their cocoons. Each spider upon being introduced to its string of cocoons soon took up its position on the lower egg-sac, which position it maintained, as though on guard, until the preparation of this paper rendered it necessary for me to kill it. Each cocoon is hard and capable of bearing considerable pressure. Within, the walls are smooth,

and the chamber is filled with loose flocculent silk, amidst the threads of which some thirty eggs repose in security. The number of ova enclosed in the cocoons varies somewhat. Without, the walls are coloured and armed as previously described. The cocoons, of which apparently there may be five, or six, or eight, are suspended one under the other, like a number of beads, and each is attached to its neighbour by fine, silken threads (fig. 2).

Both the spider and its cocoons form admirable examples of protective formation and colouration. The former, when resting upon a twig, has the appearance of a woody, wart-like excrescence, which must serve it not only in shielding it from predatory foes, but also aid it in the capture of unsuspecting prey. The *Celænieæ*, although included in the family *Argiopidæ*, do not fab-

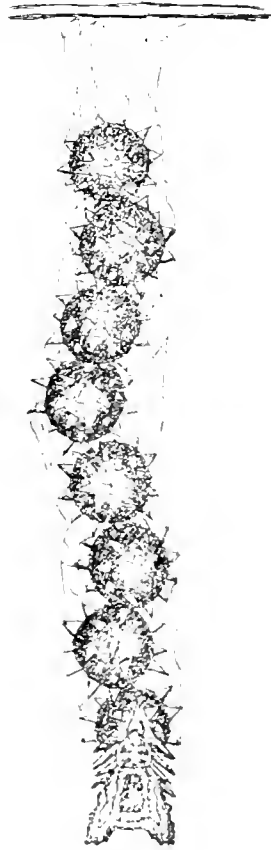

Fig. 2.—Cocoons with spider. *C. calotoib.*s. Rainb., attached.

riate snares for the capture of prey. *C. excavata*, L. Koch, which simulates, in form and colour, the excreta of a bird, usually rests upon the upper surface of a leaf; other species, such as the one collected by Mr. Bullock, take up their position, when at rest, upon the stems and branches of shrubs, and in such positions simulate wart-like excrescences or irregularities of bark. Such examples as these can only be regarded in the light of (1) *protective*, (2) *attractive*, (3) *aggressive* formation and colouration: Firstly, because by it the animal is more or less shielded from natural enemies; secondly, because by its appearance insects upon which it preys are attracted; and, thirdly, in this respect it is aggressive.

*Argiope bullockii* calls for little comment. The genus *Argiope* is, of course, remarkable for the beauty of its species, and the one hereunder described is no exception. Together with the spider, Mr. Bullock forwarded its cocoon. This consists of a mass of loose, flocculent silk, which enveloped two rather closely fabricated cushion-like ova-sacs. The loose material had a number of small green silken pellets attached to it, and wrought in amongst its threads; the eggs within the sacs were of a translucent reddish colour, and from these a day or two after arrival, hundreds of spiderlings hatched out, and, as is their wont, soon commenced to fabricate a dense sheet of web in common.

*Sub-family* ARGIOPINÆ.

*Group* ARGIOPEÆ.

*Genus* *Argiope*, *And.* in *Sav.*

ARGIOPE BULLOCKII, *sp. nov.*

(Fig. 3).

♀ Cephalothorax 3.5 mm. long, 3.4 mm. broad; abdomen 6.7 mm. long, 4.4 mm. broad.

*Cephalothorax*.—Broadly ovate, yellow, densely clothed with silvery pubescence. *Pars cephalica* arched, narrow in front. *Pars thoracica* broad, arched; segmental and radial grooves distinct; median groove or depression deep; marginal band narrow.

*Eyes*.—Eight, in three groups of 4, 2, 2. The four comprising median group form a trapezium; of these the median pair are much the largest, and are separated from each other by a space

equal to about one-half their individual diameter; the pair constituting the front row are individually about half the size of one of the rear eyes, and are separated from each other by about once their individual diameter, and the two rows are again separated from each other by a space equal to fully the diameter of one of the posterior eyes; lateral eyes somewhat remote, arranged in pairs: the two forming each lateral pair are contiguous; of these the rear eye is smaller than its posterior neighbour of the median group, but larger than the anterior; each lateral front eye is minute.

*Legs.*—Long, tapering, yellow, armed with long, slender, black spines; trochanters and femurs sparingly clothed with fine, pale yellowish hairs; metatarsi and tarsi rather thickly clothed with long black hairs. Measurements (in millimetres):—

Leg.	Coxa.	Trochanter and Femur.	Patella and Tibia.	Metatarsus and Tarsus.	Total.
1	1·0	5·8	5·5	6·6	18·9
2	1·0	5·8	5·5	6·6	18·9
3	0·7	3·1	3·1	4·1	11·0
4	0·9	5·7	4·9	5·6	17·1

*Palpi.*—Concolorous with legs, short, pubescent, and furnished with a few long, coarse bristles.

*Fulcra.*—Concolorous also: apices divergent, dark brown; upper margin of the furrow of each falx armed with four teeth and the lower with three.

*Maxilla and labium.*—Normal, pale yellowish; the former have a few coarse hairs over their surface.

*Sternum.*—Shield-shaped, longer than broad, densely hairy, pale yellow, lateral margins dark, with a small yellowish tubercle opposite each coxa of the first, second and third pairs of legs.

*Abdomen.*—Ovate, overhanging base of cephalothorax, somewhat truncated in front, arched, yellow, finely reticulated with yellowish-brown, has a broad brownish leaf-like design on the upper surface, and a delicate scheme of tracery running down the centre; laterally there are a few dark brown markings and spots; on the underside there is a broad dark brown patch

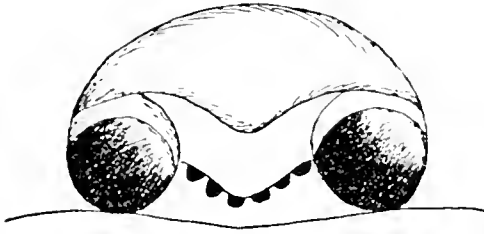

Fig. 3.—*A. bullockii*, Rainb., epigyne.

running from the epigastric fold to the spinnerets; the patch is relieved by a series of eight yellow spots arranged in pairs.

*Epigyne*.—A small tubercular eminence with an overhanging lip and deep lateral pits (fig. 3).

*Loc.*—Parkville, near Scone, New South Wales.

Group CELÆNIÆ.

*Genus* *Celænia*, *Thor.*

CELÆNIA CALOTOIDES, *sp. nov.*

(Fig. 4 and 5.)

Cephalothorax 2·5 mm. long, 2·3 mm. broad; abdomen 5 mm. long, 6·2 mm. broad, 7·3 mm. high (fig. 4)

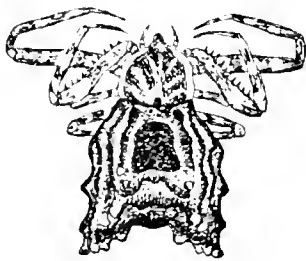

Fig. 4.—*C. calotoides*, Rainb., with abdomen in profile.

♀ *Cephalothorax*.—Broadly obovate, dark brown, ornamented with yellow markings and lines. *Pars cephalica* narrow, ascending, ridged laterally and down the centre, ridges fringed with short yellowish hairs, head acuminate in front. *Clypeus* broad, steep, sloping. *Pars thoracica* broad, strongly arched at centre, posterior portion declivous, a deep lateral depression on each side, seated low down towards the marginal band; lateral and radial ridges and margin fringed with yellow hairs. *Marginal band* pale yellowish.



*Eyes.*—Distributed in three series of 2, 4, 2. Of these those comprising the median group of four are much the largest, and are arranged in a somewhat trapezoidal form, the anterior pair being separated from each other by a space equal to about twice their individual diameter, and the posterior pair by about two-and-a-half diameters; each lateral pair of eyes is seated upon a small tubercle, and occupies about the same general line as the median group; they are not contiguous.

*Legs.*—Laterigrade, granulated, mottled with yellow and dark brown; femora of first and second pairs have each a groove on their underside for the reception of the lower joints wherein they rest when folded, like the blade of a pocket-knife: the edges of the grooves are armed with numerous short, sharp, strong tooth-like spines; the femora of the first pair are modified in form and outline to accommodate those of the second pair when the legs are folded and bunched up when the animal is at rest; the femora of the third pair is also grooved and has its ridges armed with spine-like teeth, but the groove is not so deep, nor are the spines so long as those of the first and second pairs; each patella, tibia, tarsus, and metatarsus are attenuated. Measurements (in millimetres):—

Leg.	Coxa.	Trochanter and Femur.	Patella and Tibia.	Metatarsus and Tarsus.	Total.
1	0·7	4·2	3·4	1·8	9·9
2	0·7	4·2	3·4	1·8	9·9
3	0·5	2·0	1·7	1·6	5·8
4	0·5	2·7	1·9	1·7	6·8

*Palpi.*—Short, concolorous with the legs.

*Falces.*—Normal.

*Maxille.*—Short, broad, arched, apices divergent.

*Labium.*—Short, broad, arched.

*Sternum.*—Elongate, somewhat shield-shaped, truncated in front, mottled dark brown and yellow.

*Abdomen.*—Overhanging base of cephalothorax, yellowish-brown with patches of blue-black, and furnished with a few

short scale-like yellowish hairs; it is short, broad, high, and deeply excavated at its apex; the surface in front has numerous

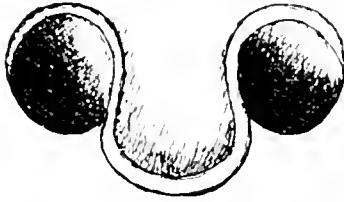

Fig. 5.—*C. calotoïdes*,  
Rainb., epigyne.

round shallow pits, and numerous lateral and apical tubercles; apices of the latter yellowish and hairy; laterally, and at the rear, there are more pits and tubercles; at rather more than half the distance from the apex towards the spinnerets there are two large and prominent pale yellowish tubercles, one of which is seated on each side; apex

closely set with tubercles.

*Epigyne*.—As in figure (fig. 5).

*Loc.*—Parkville, near Scone, New South Wales.

STUDIES IN AUSTRALIAN CRUSTACEA.

No. 1.

By ALLAN R. McCULLOCH, Zoologist.

(Plate xii.)

Under this heading I contemplate a series of short papers dealing with small collections as they come to hand.

The specimens referred to herein were mostly collected by my friends Mr. J. D. Ogilby, of Brisbane, in Moreton Bay, Queensland, and Mr. J. Gabriel, of Melbourne, in Port Phillip, Victoria. At present I am dealing only with the more notable forms, but an examination of these collections shows that the range of many of the southern species extends much farther northward than is generally supposed and *vice versa*. With further material I hope to be able to add to these, and so place our knowledge of the Eastern Australian Crustacea on a better footing than it is now.

The following species are dealt with :—

*Hoplophrys ogilbyi*, sp. nov.

*Halimus spinosus*, Hess.

„ *tumidus*, Dana.

„ *lavis*, Haswell.

*Gabrielia*, gen. nov.

„ *haswelli*, Fulton and Grant.

„ *punctatus*, Haswell.

*Eurycarcinus maculatus*, A. M. Edw.

*Eucrate hamiltoni*, sp. nov.

*Trigonoplax unguiformis*, var. *longirostris*, var. nov.

*Aniculus aniculus*, Fabr.

HOPLOPHRYS OGILBYI, *sp. nov.*

(Plate xii., figs. 2, 2<sup>a</sup>.)

Carapace bearing very long and strong spines, and with the regions well defined. The gastric region with two transverse rows of spines, the anterior with seven, and the posterior with

three, of which the median one is the strongest, and very slightly compressed laterally. Two blunted spines on the cardiac region, which are a little less prominent than the posterior gastric one, and two similar ones on the genital area. Branchial region with three spines, a very large and strong one on the anterior portion which is the largest of all the spines on the carapace; another big one extending straight outwards from the lateral epibranchial angle, and a third small spine posteriorly. On the sides anterior to and below the epibranchial spine is another small one marking the commencement of a ridge which extends to the anterior margin of the buccal frame.

There are two spines on the hepatic region, the upper being the larger, and a small one on the pterygostomial. A long spine extends outwards and a little forwards over each orbit, at the base of which is a second smaller one. Post-orbital process with the free border emarginate, and in close contact with the supra-ocular spine. The cornea is surmounted by a spinule. Rostral spines slender and divergent. There are groups of hooked hairs on the frontal, gastric, and lateral branchial regions. The surface is otherwise smooth between the spines.

Basal antennal joint rather slender, with antero-external angle strongly produced so as to be easily seen from above.

Ischium of external maxillipeds with a broad median groove, and the inner margins finely dentate. Merus triangular, with the antero-external angle produced, and the anterior border with a small lobe exterior to the articulation of the flagellum.

Chelipeds slender; the arm and wrist with strong spines on the upper surface and sides. Hand with a spiny tubercle and some small irregularities on the upper margin. Lower finger with a tuft of hairs on its inferior border; the mobile finger curved and crossing the lower one; both finely dentate, and meeting along their proximal half.

Ambulatory legs, with strong spines superiorly; those on the propodi of the three last pairs changing to elevated groups of tubercles. Dactyli curved, and with one or more spinules on the posterior basal portion.

Anterior portion of carapace pink, and some bands of the same colour on the legs; otherwise white except for some fine lines on the posterior portion.

This species differs from *H. oatesii*, Henderson, in the spines of the carapace being much larger and longer. The epibranchial spine is not bifid. The basal antennal joint appears to be more

slender, and there is an additional lobe on the merus of the external maxillipeds.

Off Moreton Bay, Queensland, in eight fathoms, living upon a colony of *Sponyodes*. The colour and formation of the carapace closely resemble its host, as in *H. oatesii*, while fragments had been broken off and fastened in the hooked hairs to complete the imitation. Named after Mr. J. D. Ogilby, who collected the specimen.

HALIMUS SPINOSUS, *Hess*.

*Halimus spinosus*, Hess, Arch. fur. Naturg., 1865, p. 129, pl. vi., f. 1. Haswell, Proc. Linn. Soc. N. S. Wales, iv., 1880, p. 434; and Cat. Austr. Crust., 1882, p. 6. Fulton & Grant, Proc. Roy. Soc. Vict., (n.s.), xix., 1906, p. 16.

*Halimus truncatipes*, Miers., Ann. Mag. Nat. Hist., (5), iv., 1879, p. 3. Fulton and Grant, *loc. cit.* Baker, Trans. Roy. Soc. S. Austr., xxix., 1905, p. 120, pl. xxii., fig. 2, 2<sup>a</sup>.

Notwithstanding that both Fulton and Grant and Baker have reinstated *H. truncatipes*, Miers, as a distinct species, I am convinced that Haswell was right in including it in the synonymy of the above. Miers' short description fits *H. spinosus* exactly, as does Baker's figure and description.

This species is characterised by the tubercles of the carapace being obtusely pointed, and the lateral spines short and thick. The legs are short, and the propodus of each is thick, flattened, and truncate distally. This is the commonest species of the genus near Sydney.

(Since writing the above note I have received a letter from Mr. Baker, who kindly compared a Sydney specimen of this species with those he called *H. truncatipes*, and he agrees with me that there can be no doubt of the identity of the two.)

HALIMUS TUMIDUS, *Dana*.

*Halimus tumidus* (Dana), Baker, Trans. Roy. Soc. S. Austr., xxix., 1905, p. 121, pl. xxii., f. 3.

This species is closely allied to *H. spinosus*, but is readily recognised by the tubercles and lateral spines of the carapace being both shorter and blunter. The anterior orbital angle is less spiniform, and the basal antennal process is denticulate on its posterior border.

Several specimens from Moreton Bay, the largest measuring 32 mm.

HALIMUS LEVIS, *Haswell*.

*Halimus levis* (Haswell), Baker, Trans. Roy. Soc. S. Austr., xxix., 1905, p. 119, pl. xxi., f. 1, 1<sup>a</sup>.

This is easily distinguished by the carapace being almost without tubercles, and the lateral spines long and sharp. The legs are long and slender, and the distal end of the propodi, though thickened, is far from truncate as in *H. spinosus*. The basal antennal spine is also much less prominent than in that species.

Five specimens from Port Phillip, and one measuring 48 mm. from Fremantle, Western Australia.

GABRIELIA, *gen. nov.*

Carapace broad; front prominent, almost horizontal or deflexed, more or less rounded and entire, and not distinct from the orbital angle. Orbits small, almost concealing the eyes from above; two sutures above and one below; the external angle inconspicuous and continuous with the antero-lateral margins. Antero-lateral borders long and arched, divided into obscure lobes. Basal antennal joint short, filling the orbital hiatus, and touching a downward process of the front; flagellum very short, lying in the orbit. Merus of external maxillipeds sub-quadrilateral. Fingers sharp-pointed. Abdomen of male consists of five movable pieces, of female seven.

*Type*.—*G. haswelli*, Fulton & Grant.

GABRIELIA HASWELLI, *Fulton & Grant*.

(Plate xii., figs. 5, 5<sup>a</sup>.)

*Cyclocanthus punctatus*, Fulton & Grant, Proc. Roy. Soc. Viet., xix., (n.s.), 1906, p. 6, pl. iii. (*nec* Haswell).

*Lioxantho haswelli*, Fulton & Grant, *loc. cit.*

Length of carapace about three-quarters of the breadth. The regions which are scarcely elevated are moderately well defined by narrow grooves; anterior parts with scattered punctations, smooth posteriorly. Front very obtusely pointed, almost rounded, a little less than half the width of the carapace. Antero-lateral borders a little arched, and divided into four obscure lobes, of which the first is the longest and least distinct. Postero-lateral borders much constricted behind the last antero-lateral lobe, thence straight and strongly convergent. Sternum

and abdomen pitted; the other under-surfaces smooth. Orbits with two sutures above and another below; the lower borders minutely granular internally.

Eyes small, with a small sub-apical tubercle.

External maxillipeds flat and a little pitted, with a shallow somewhat oblique groove on the ischium. Ischium much longer than broad, and about twice as long as the merus. Outer angle of merus very slightly produced, flagellum attached to antero-internal angle. Exopod long and broad.

Chelipeds equal (?) (left cheliped missing in the young specimen, but in a specimen twice as big, and others bigger, left and right are equal in size). Right cheliped a little pitted and roughened exteriorly, smooth internally. Arm trigonal, with a few tubercles on the upper margin distally. Wrist with an internal tubercle, and another faint one below it. The upper border of the hand forms a crest, and the lower is carinate, more especially anteriorly. Fingers each with four stout teeth on their inner borders, which meet along their whole length and cross at the tips; mobile finger also with a crest.

Ambulatory legs a little punctate, and with indications of crests on the anterior and posterior margins of the joints. Dactyli dilated behind and with a curved ridge on either side.

Colour whitish, with light red patches. Length, 6.2 mm.; breadth, 8 mm.

For purposes of comparison with the next species a young specimen was selected for the basis of the above description.

The adult specimens I have examined, including a co-type, differ from the above description in having the front relatively narrower, it being about 2.6 in the breadth of the carapace, owing to the expansion of the branchial regions; in Fulton and Grant's figure the front is shown as very much too wide. The inter-regional grooves are more distinct, and the surface of the carapace, abdomen, chelipeds and legs is almost quite smooth, the punctations being nearly obsolete. The crests on the chelipeds and legs are absent, and the dactyli are long and cylindrical.

Colour, light brick-red, with some white marbling on the hinder part of the carapace.

Fulton and Grant supposed this species to be identical with *Cycloxanthus punctatus*, Haswell, and for reasons given proposed the new name *haswelli* for it. This supposition was incorrect, but as they distinctly applied the name to the Victorian species,

it can be properly used here. They recognised, however, that it could not enter the genus *Cycloxanthus*, A. M. Edw. (= *Cycloxanthops*, Rathb.) and transferred it to *Lioxantho*, Alcock. I fail to see that it has any relationship here, and being unable to refer it to any other known genus, propose a new one, *Gabrielia* (*ante*) for its reception, together with *Cycloxanthus punctatus*, Hasw., and *C. carinatus*, Baker.

Port Phillip, Victoria. Dredged by Mr. J. Gabriel.

GABRIELIA PUNCTATA, *Haswell*.

(Plate xii., fig. 4.)

*Cycloxanthus punctatus*, Haswell, Proc. Linn. Soc. N. S. Wales, vi., 1882, p. 752; and Cat. Austr. Crust., 1882, p. 50.

Length of carapace about three-quarters of the breadth. The regions are somewhat elevated, and the summits of either gastric and epibranchial regions surmounted by a tuberculiform eminence; inter-regional grooves deep and smooth. Scattered punctations or pits on the anterior half of the carapace, becoming very numerous behind. Front broadly rounded, equal to one-half the width of the body, and its upper surface somewhat concave. Antero-lateral borders strongly arched and divided into four rather obscure lobes; the first is the longest and least distinct, and the second forms a hepatic angle. Postero-lateral borders almost straight, strongly convergent. Under-surfaces of the carapace and abdomen closely pitted everywhere, with the exception of the front and sub-branchial portions. Orbits with two indistinct sutures above, and a very indistinct one below; lower borders minutely granular.

Eyes smaller than in *G. haswelli*, with a small subapical tubercle.

External maxillipeds similar to that species, but much more densely pitted.

Chelipeds unequal; the larger closely pitted on all its outer surfaces, and smooth internally. Arm trigonal, its upper margin denticulate. Wrist with an internal tubercle and a second smaller one below it. Hand with a prominent crest on its upper border, and a weaker one below, which is more pronounced on the immobile finger; also some indication of ridges on the outer surface. Fingers each with four stout teeth on their inner borders, which meet along their whole length and cross at the tips; mobile finger also crested. Smaller cheliped similar to the larger, though smoother.



Ambulatory legs deeply pitted all over; all the joints with distinct crests on the front and hinder margins. Dactyli expanded behind with a curved ridge on either side.

Colour, quite white all over. Length, 8.3 mm.; breadth, 10.8 mm.

I have compared this specimen with the type in the Macleay Museum, which is about the same size, and there can, therefore, be no doubt of its correct identification. The adult form is unknown.

Coogee Bay, near Sydney, after a storm.

*GABRIELIA CARINATA*, Baker.

*Cycloxanthus* ? *carinatus*, Baker, Trans. Roy. Soc. S. Austr., xxxi., 1907, p. 173, pl. xxiii., f. 1.

Through the kindness of Mr. Baker, I have received a fine specimen of this species from Port Lincoln, South Australia. I agree with him that it is easily distinguished from the other two species by its nearly horizontal front, and the thin cristate antero-lateral margins.

In these two characters it approaches *Cycloxanthops*, and shows the close relationship of *Gabrielia* to that genus, but the arched front lacking a median notch is quite sufficient to distinguish the two. I may add here that it is the only one of the three species which has any trace of the notch near the inner orbital angles which is so characteristic of *Cycloxanthops*.

*EURYCARCINUS MACULATUS*, A. M. Edw.

*Eurycarcinus maculatus* (A. M. Edw.), De Man, Journ. Linn. Soc., Zool., xxii., 1888, p. 44, pl. ii., figs. 2-3. Ortmann, Zool. Jahrb., vii., 1894, p. 435.

*Actumnus nudus*, Grant & McCulloch, Proc. Linn. Soc. N. S. Wales, xxxi., 1906, p. 17 (*nec.* A. M. Edw.).

Owing to the numbers at the foot of De Man's plate being transposed, we have wrongly recorded this species from Port Curtis as *Actumnus nudus*. Specimens from Moreton Bay agree perfectly with his figure, and it has also been recorded by Ortmann from East Australia. *Actumnus nudus* does not, so far as I am aware, occur in Australia.

EUCRATE HAMILTONI, *sp. nov.*(Plate xii., figs. 1, 1<sub>a</sub>.)

Carapace smooth, and, with the exception of the cardiac, with very slight indication of the regions; convex fore and aft, and a little also from side to side; the length 1·2 in the breadth. Front nearly straight, with a median notch, its anterior face sulcate, and the lower margin with two mesial lobes, which project so as to be visible from above; the width 3·8 in that of the body. Orbits equalling one-half the front, their superior angles well defined, the exterior indistinct; the upper borders with two sutures, the lower with a blunt lobe internally, followed by a second smaller one; a small hiatus at the exterior angle.

Antero-lateral borders arched and clearly defined only anteriorly, their even curve is scarcely broken by two very indistinct nodules. A faintly indicated ridge extends inwards and backwards from the sides behind the second nodule, and at its base a similar one trends forwards again. There are a few punctations near the margins on the anterior portions of the carapace. Post-lateral margins distinct in their hinder portions; the sides extending outwards.

Pterygostomial regions anteriorly bordered with thick felted hairs. A prominent ridge crosses its hinder portion, which is minutely granular, and with or without long hairs.

Basal joint of the antennæ with a process into the inner orbital hiatus, which excludes the flagellum from the orbit.

Ischium of external maxillipeds with a longitudinal sulcus, and its inner border finely denticulate. Merus with a prominent outer angle, which makes it a little wider than the preceding joint, which is one and a half times its length; there are two curved grooves on its outer face.

Chelipeds unequal, the larger more than twice the length of the carapace, and longer than the legs. Arm with a large tubercle at the distal end, and another smaller one halfway along its length, the lower surface with minute scattered granules. Wrist with a strong inner tooth, and its anterior margins clothed with a dense felted pubescence. Hands massive, with a strong external tooth between the fingers, and a blunt ridge near the lower anterior border. Fingers crossing when closed, strongly toothed, and those of the larger hand with the distal half gaping.

Ambulatory legs smooth, the carpal joints with a few hairs distally. Propodi and dactyli each with eight rows of puncta-

tions or cilia, three on both upper and lower borders, and one down the middle on either side. These joints are more compressed and broader in the last pair than in the preceding ones.

Ground colour yellow, but the anterior half of the carapace, the arms, wrists, and upper parts of the hands closely covered with red dots, which give them a pink colour. A large heart-shaped carmine spot on the middle of the back. Lower half of the hand white. On the legs the red dots combine to form a darker shade.

This species is very similar to *E. crenata*, de Haan, but the absence of teeth on the antero-lateral borders at once distinguishes it. With further material, it may prove that this is but the adult form of one of the other species known from the Queensland coast, but for the present it is deemed best to figure it under a new name.

Moreton Bay, Queensland, in shallow water. Three specimens; the largest being 53 mm. and the smallest 46 mm. wide; collected by Mr. W. Hamilton, after whom the species is named.

TRIGONOPLAX UNGUIFORMIS, *de Haan, var. LONGIROSTRIS, var. nov.*

(Plate xii., fig. 3.)

*Elamena (Trigonoplax) unguiformis* (de Haan), Fulton & Grant, Proc. Roy. Soc. Vict., (n.s.), xix., 1906, p. 10, fig.

I have compared four specimens of this southern form, including one from Mr. Grant's collection, with a specimen of *T. unguiformis* from Japan. They differ from it in having the length of the body equal to its width, and the front much longer and differently shaped. The dactyli of the ambulatory legs also appear to be much broader. Though I think it probable that an examination of further specimens will show these characters to be constant, and therefore of specific value, I prefer for the present to regard them under a varietal name only.

Length of specimen figured (a female), 15 mm.

Port Phillip, Victoria.

ANICULUS ANICULUS, *Fabricius.*

*Aniculus aniculus* (Fabricius), Alcock, Cat. Ind. Dec. Crust., pt. II., fas. I., 1905, p. 94, pl. vii., f. 6.

A large specimen from Moreton Bay agrees perfectly with the above figure and description.

MINERALOGICAL NOTES: No. VI.—TOPAZ, BERYL,  
ANGLESITE, RUTILE, ATACAMITE, PYRITE.

By C. ANDERSON, M.A., B.Sc., Mineralogist.

(Plates xiii.-xvi.).

TOPAZ

COW FLAT, NEAR TORRINGTON, NEW SOUTH WALES

(Plate xiii., figs. 1, 2.)

Two specimens from this locality were examined and measured. Fig. 1 represents a crystal from the collection of the Department of Mines; it occurs *in situ* in a small vugh, accompanied by crystallised quartz and three smaller topaz crystals, at Fielder's Hill. The habit is stout prismatic, the dimensions  $12 \times 12 \times 12$  mm., and the colour pale blue. For measurement the entire specimen was mounted on the two-circle goniometer with the face  $m'''$  ( $1\bar{1}0$ ) polar, the forms being determined from the stereographic projection by aid of Penfield's protractors. The base is quite rough;  $f$  and  $y$  slightly inter-oscillate.

☞ The other specimen (Plate xiii., fig. 2) consists of an isolated, transparent, colourless crystal of  $2.7 \times 2.2 \times 1.6$  cm. The basal plane and the dome  $f$  are roughened by oscillation with  $y$  and  $h$ . The prism faces are as usual striated vertically, and some of them yield multiple images;  $n$  ( $140$ ) is doubtfully present.

☞ The measured and calculated co-ordinate angles are tabulated below; Dana's ratios and lettering are used throughout.

Forms.		Measured.		Calculated.		Difference.	
		$\phi$	$\rho$	$\phi$	$\rho$	$\phi$	$\rho$
<i>c</i>	001	—	—	—	—	—	—
<i>b</i>	010	0 2	90 3	0 0	90 0	0 2	0 3
<i>m</i>	110	62 11	89 59	62 8	„	0 3	0 1
<i>M</i>	230	51 55	89 57	51 35	„	0 20	0 3
<i>l</i>	120	43 25	90 0	43 25	„	0 0	0 0
<i>g</i>	130	31 58	89 59	32 14	„	0 16	0 1
<i>n</i> (?)	140	23 33	89 55	25 19	„	1 46	0 5
<i>d</i>	201	90 14	60 56	90 0	61 0	0 14	0 4
<i>h</i>	203	90 10	29 53	„	31 2	0 10	1 9
<i>f</i>	021	0 1	43 37	0 0	43 39	0 1	0 2
<i>y</i>	041	0 1	62 20	„	62 20	0 1	0 0
<i>o</i>	221	62 13	63 53	62 8	63 54	0 5	0 1
<i>u</i>	111	62 13	45 35	„	45 35	0 5	0 0
<i>i</i>	223	62 6	34 14	„	34 14	0 2	0 0

## STANTHORPE, QUEENSLAND.

(Plate xiii., figs. 3, 4.)

At Stanthorpe, topaz is usually found as waterworn pebbles without crystalline facets, but in the collection of the National Museum, Melbourne, is a fine crystal which was kindly lent for description and is here figured. The specimen, which measures 3.1 × 3 × 2.3 cm., is of a beautiful deep blue colour, and is well and symmetrically developed. The large *d* faces are striated parallel to their intersection with *o*; the dome *f* shows markings with a general direction parallel to the plane of the *c* and *b* axes; the lower end is truncated by the basal cleavage. The crystal has a striking resemblance to the large waterworn crystals obtained at Oban, New South Wales.<sup>1</sup>

## PAKENHAM, VICTORIA.

(Plate xiii., figs. 5-7.)

Some small crystals, obtained on loan from the National Museum, Melbourne, are of considerable interest. A crystal of about 4 mm. in greatest diameter is represented in Fig. 5; the

<sup>1</sup> Anderson—Rec. Austr. Mus., vi., 2, 1905, p. 85, pl. xviii., fig. 2.

faces are for the most part smooth and bright, but the prism faces are strongly striated vertically and sometimes give multiple images.

Angles :—

Forms.		Measured.		Calculated.		Difference.	
		$\phi$	$\rho$	$\phi$	$\rho$	$\phi$	$\rho$
<i>c</i>	001	—	—	—	—	—	—
<i>b</i>	010	0 0	90 1	0 0	90 0	0 0	0 1
<i>m</i>	110	62 3	90 1	62 8	„	0 5	0 1
<i>M</i>	230	51 30	90 2	51 35	„	0 5	0 2
<i>l</i>	120	43 26	90 0	43 25	„	0 1	0 0
<i>g</i>	130	33 56	90 0	32 14	„	1 42	0 0
<i>n</i>	140	25 35	90 4	25 19	„	0 16	0 4
<i>d</i>	201	89 52	61 3	90 0	61 0	0 8	0 3
<i>f</i>	021	0 5	43 36	0 0	43 39	0 5	0 3
<i>y</i>	041	0 0	62 18	„	62 20	0 0	0 2
<i>o</i>	221	62 5	63 58	62 8	63 54	0 3	0 4
<i>u</i>	111	62 8	45 36	„	45 35	0 0	0 1
<i>i</i>	223	62 12	34 11	„	34 14	0 4	0 3

The other figured crystal is a fragment of  $1 \times .7 \times .4$  cm., but it has what seems to be a new macrodome *j* (501) as a fairly large but somewhat rough (apparently etched) face, yielding only a patch of light in the telescope. It may possibly be an accidental plane, caused by contact with a neighbouring crystal, but, if so, it would be unlikely to fall in a zone as the measurement indicates.

Measured.		Calculated.	
$\phi$	$\rho$	$\phi$	$\rho$
$89^\circ 35'$	$77^\circ$	$90^\circ$	$77^\circ 30'$

The presence of the rare prism *U* is indicated by a very narrow plane which, however, was measured in maximum illumination.

## BERYL.

TORRINGTON, NEW SOUTH WALES.

(Plate xvi., figs. 1, 2.)

Some fine large prisms of beryl have recently been discovered near Torrington. They occur attached to crystals of quartz,

which with masses of wolfram are found in a matrix of clay at Heffernan's Lease. The specimens were donated by Mr. Charles Bogenrieder, mining engineer, from whom particulars of the occurrence were obtained. Individual crystals measure up to 6 cm. in horizontal diameter by 5 cm. vertically; the prisms are striated vertically and invariably broken across. The crystals are very simple, usually showing only the base and a hexagonal prism with an occasional face of a second prism.

THE GULF, NEAR EMMAVILLE, NEW SOUTH WALES.

(Plate xvi., figs. 4-8.)

Here beryl occurs embedded in, or associated with, quartz; the habit is long prismatic; terminated simply by  $c(0001)$ ; colour pale bluish-green. Broken crystals measure up to  $5.5 \times 2$  cm.

ANGLESITE.

BROKEN HILL, NEW SOUTH WALES.

(Plate xiv.; Plate xv., fig. 1; Plate xvi, fig. 3.)

Mr. P. T. Hammond<sup>2</sup> in 1895 figured some crystals of anglesite from the Consols Mine; in the present paper anglesite from the Central, Block 14, and Proprietary Mines are described. From the Central nine crystals were measured, and two each from Block 14 and the Proprietary; for any one mine the habit is fairly constant and the combinations similar.

(1) From the Central come as a rule small crystals of about 2 to 3 mm. in diameter, which are seated on reticulated cerussite; sometimes the latter projects as long slender prisms or thin plates amongst the anglesite, and, now and then, a minute, perfectly formed anglesite crystal is poised on the tip of a slender rod of cerussite. The crystals are transparent and colourless to opaque white, or sometimes have a slight yellowish tinge.

Thirteen forms were determined, of which three are new; in addition  $O$  is doubtfully present, and approximate measurements were obtained of what are most likely vicinal faces not deserving of crystallographic symbols. The new forms  $Y(187)$ ,  $X(3.4.12)$ , and  $v(598)$  give by no means satisfactory measurements, as the faces are either small or wavy and the signals distorted, hence the

---

<sup>2</sup> Hammond—Rec. Geol. Surv. N. S. Wales, iv., 4, 1895. p. 163.

angles vary between rather wide limits, and it is desirable that the forms be confirmed before they are finally accepted.

New forms :—

Forms.	Measured.		Calculated.		Limits.		No. of faces.			
	$\phi$	$\rho$	$\phi$	$\rho$	$\phi$	$\rho$				
<i>Y</i> 187	9	7 56	19	9 3 56	10	5 37 to 14 34 54	11 to 58	58	9	
<i>X</i> 3·4·12	43	28 30	31 43	41 30	43 42	41 to 44	41 29	53 to 31	22	4
<i>v</i> 598	35	16 60	26 35	17 60	38 34	16 to 36	41 59	10 to 62	36	16

*Y* and *v* form narrow planes between *m* and *o*, and *m* and *y* respectively; *X* is sometimes a fairly large face, but it does not give a sharp image. The general habit of the crystals is sufficiently indicated in Plate xiv., figs. 1-3.

Angles :—

Forms.	Measured.		Calculated.		Difference.	
	$\phi$	$\rho$	$\phi$	$\rho$	$\phi$	$\rho$
<i>c</i> 001	—	—	—	—	—	—
<i>a</i> 100	90 0	89 58	90 0	90 0	0	2
<i>O</i> 520	73 25	—	72 34	„	51	—
<i>m</i> 110	51 54	89 59	51 51	„	3	1
<i>o</i> 011	0 0	52 10	0 0	52 12	0	2
<i>l</i> 104	89 59	22 20	90 0	22 19	1	1
<i>d</i> 102	89 59	39 20	„	39 23	1	3
<i>g</i> 113	51 50	34 13	51 51	34 50	1	37
<i>z</i> 111	51 51	64 17	„	64 24	0	7
<i>y</i> 122	32 29	56 46	32 29	56 48	0	2
$\mu$ 124	32 35	37 4	„	37 23	6	19

(2) The characteristic habit of Block 14 anglesite is shown in Plate xiv., fig. 4; the crystals are shortened vertically, and the prism zone may be entirely wanting as in one measured crystal which is a combination of *d*, *l*, *o*, *y* simply, forming a flattened plate. The crystals, which are associated with galena and



cerussite [twinned on  $r$  (130)], attain a fair size,  $2 \times 2 \times .8$  cm., and are yellowish with a pronounced adamantine lustre. The crystal drawn is  $5 \times 2.5 \times 1$  mm.

Angles:—

Forms.		Measured.		Calculated.		Difference.	
		$\phi$	$\rho$	$\phi$	$\rho$	$\phi$	$\rho$
<i>c</i>	001	—	—	—	—	—	—
<i>a</i>	100	89 58	89 51	90 0	90 0	2	9
<i>m</i>	110	51 56	89 57	51 51	90 0	5	3
<i>o</i>	011	0 0	52 2	0 0	52 12	0	10
<i>l</i>	104	90 6	22 13	90 0	22 19	6	6
<i>d</i>	102	90 12	39 24	„	39 23	12	1
<i>y</i>	122	32 37	56 41	32 29	56 48	8	7

(3) The Proprietary Mine furnishes very fine anglesite specimens, individual crystals sometimes reaching a size of  $2.5 \times 2 \times 1.3$  cm., and the crystalline development and symmetry are excellent. Plate xvi., fig. 3, is a photograph, natural size, of a beautiful group of crystals; the drawing (Plate xiv., fig. 5) illustrates the crystal habit. Here the faces  $r$  and  $Y$  are comparatively large but much corroded, and  $r$  oscillates with  $z$ .

Angles:—

Forms.		Measured.		Calculated.		Difference.	
		$\phi$	$\rho$	$\phi$	$\rho$	$\phi$	$\rho$
<i>c</i>	001	—	—	—	—	—	—
<i>a</i>	100	90 5	89 53	90 0	90 0	5	7
<i>m</i>	110	51 45	89 59	51 51	90 0	6	1
<i>o</i>	011	0 4	52 0	0 0	52 12	4	12
<i>l</i>	104	90 8	22 20	90 0	22 19	8	1
<i>d</i>	102	90 3	39 18	„	39 23	3	5
<i>z</i>	111	51 42	64 38	51 51	64 24	9	14
<i>y</i>	122	32 31	56 41	32 29	56 48	2	7
$\mu$	124	32 26	37 14	„	37 23	3	9

## RUTILE.

## VICTOR HARBOUR, SOUTH AUSTRALIA.

(Plate xv., fig. 2.)

For the opportunity to figure these I am indebted to the Director of the National Museum, Melbourne, who courteously lent some crystals for study. The mineral occurs in felspar and in quartz.<sup>3</sup> Crystals are comparatively simple, the forms being *a*, *m*, *k* (*l*), *e* and *s*. Twinning on the common law *e* is frequent, and the figure represents a crystal in which this law is combined with the rarer twin law *r*(301); I. in the conventional position (as measured) is twinned to II. on *e*, and to III. on *v*.

Angles :—

Forms.		Measured.				Calculated.				Difference.	
		$\phi$		$\rho$		$\phi$		$\rho$		$\phi$	$\rho$
		°	'	°	'	°	'	°	'	'	'
<i>a</i>	100	0	0	90	0	0	0	90	0	0	0
<i>m</i>	110	45	3	90	2	45	0	„		3	2
<i>e</i>	011	0	9	32	47	0	0	32	47	9	0
<i>s</i>	111	45	0	42	20	45	0	42	19	0	1
<i>a</i> <sub>2</sub>	0 $\bar{1}$ 0	0	3	24	12	0	0	23	39	3	33
<i>e</i> <sub>2</sub>	0 $\bar{1}$ 1	0	8	81	21	0	0	80	52	8	29
<i>e</i> <sub>3</sub>	101	38	28	60	31	38	16	60	58	12	27

## MOUNT GAMBIER, SOUTH AUSTRALIA.

(Plate xv., fig. 3.)

A small collection of crystals in the Mining and Geological Museum, Sydney, was examined, and one typical crystal of 7 × 3.5 mm. measured.

<sup>3</sup>Brown—Cat. S. Australian Minerals, p. 27, Adelaide, 1893.

Angles :—

Forms.		Measured.		Calculated.		Difference.					
		$\phi$	$\rho$	$\phi$	$\rho$	$\phi$	$\rho$				
		°	'	°	'	°	'				
<i>a</i>	100	0	7	89	59	0	0	90	0	7	1
<i>m</i>	110	45	0	89	59	45	0	„	0	0	1
<i>k</i>	340	36	50	90	0	36	52	„	2	0	0
<i>e</i>	011	0	5	32	47	0	0	32	47	5	0
<i>s</i>	111	45	3	42	16	45	0	42	19	3	3

## ATACAMITE.

DUGALD R., CLONCURRY, QUEENSLAND.

(Plate xv., fig. 4.)

A single specimen consisting of a large number of small, green, transparent crystals about 1.5 mm. in length, associated with massive cuprite is in our collection. Two crystals were measured, and yielded the forms enumerated below; in addition *k* (130) and *l* (230) are doubtfully present. Because of the striated nature of the prism faces accurate centering is difficult and the measurements are not good.

Angles :—

Forms.		Measured.		Calculated.		Difference.						
		$\phi$	$\rho$	$\phi$	$\rho$	$\phi$	$\rho$					
		°	'	°	'	°	'					
<i>b</i>	010	0	10	89	48	0	0	90	0	0	10	12
<i>m</i>	110	56	12	89	57	56	31	„	0	19	3	
<i>s</i>	120	39	46	89	43	37	5	„	2	41	17	
<i>e</i>	011	0	19	37	19	0	0	36	55	0	19	24
<i>n</i>	121	40	36	62	28	37	5	62	2	3	31	26

## PYRITE.

UNITED MINERS' MINE, MAJOR'S CREEK, NEW SOUTH WALES.

(Plate xv., fig. 5.)

Splendid cubes of pyrite measuring up to 4 cm. along the edge are found at the United Miners' Mine, embedded in dolomitic

calcite.<sup>4</sup> The cube corners are modified by small faces of  $n$  (211),  $o$  (111),  $p$  (221).

Angles obtained from two crystals :—

Forms.		Measured.				Calculated.				Difference	
		$\phi$		$\rho$		$\phi$		$\rho$		$\phi$	$\rho$
		°	'	°	'	°	'	°	'	'	'
$a$	010	0	6	90	3	0	0	90	0	6	3
$n$	121	26	33	65	51	26	34	65	54	1	3
	112	44	36	35	14	45	0	35	16	24	2
$o$	111	44	41	54	24	„		54	44	19	20
$p$	221	44	14	70	11	„		70	31	46	20
	122	27	24	47	48	26	34	48	11	50	23

<sup>4</sup> Card—Rec. Geol. Surv. N. S. Wales, viii., 2, 1905, p. 156.



EXPLANATION OF PLATE I.

---

ABORIGINAL CUSTOMS.

Figs. 1 and 2. Assisting in confinement. Tully River.



1

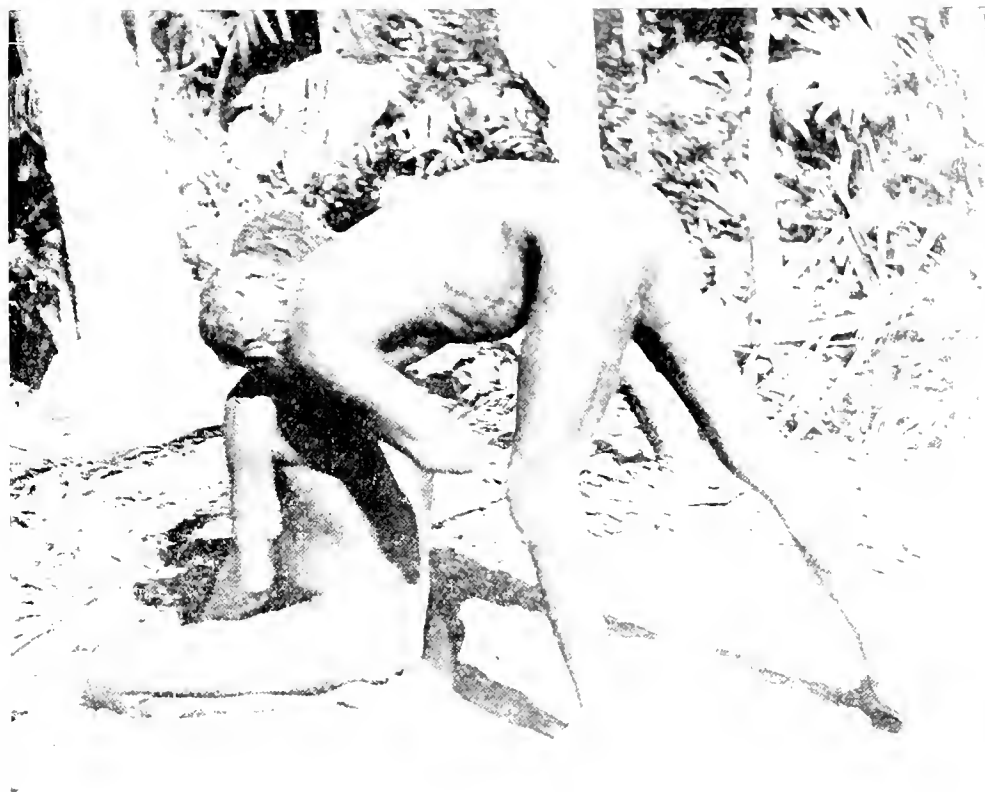

2







## EXPLANATION OF PLATE II.

---

### ABORIGINAL CUSTOMS.

- Fig. 1. Assisting in confinement. Tully River.  
,, 2. Man and two women, the latter with children astride on their shoulders.



1



2





EXPLANATION OF PLATE III.

---

ABORIGINAL CUSTOMS.

Figs. 1, 2 & 4. Women carrying children astride on their shoulders.  
Bentinck Island.

Fig. 3. Woman carrying child astride on her right hip. Glenormiston.



1



2



3



4







#### EXPLANATION OF PLATE IV.



##### MICTOCYSTIS ENDOPHYLLOIDES, *Eth. fil.*

- Fig. 1. Highly weathered example seen from above, displaying the coarse, blister-like vesicular tissue, three corallites and portion of a fourth; septa weathered out may be seen on the right-hand upper corallite, and a tabulate surface in the right-hand lower and central corallites.  $\times \frac{1}{3}$
- „ 2. A similar specimen to that seen in Fig. 1, viewed longitudinally displaying a calice and portion of a visceral chamber with tabulae, etc.  $\times \frac{1}{3}$ .
- „ 3. Portion of a visceral chamber surrounded by cysts; in the former septal lamellae and close-set tabulae.
- „ 4. The same visceral chamber seen in Fig. 3, but viewed at a somewhat different oblique angle.







EXPLANATION OF PLATE V.

---

MICTOCYSTIS ENDOPHYLLOIDES, *Eth. fil.*

Portion of a highly weathered corallum seen longitudinally. The blister-like vesicular tissue is excellently shown, and in the centre is the faint outline of a corallite extending from top to bottom of the specimen.

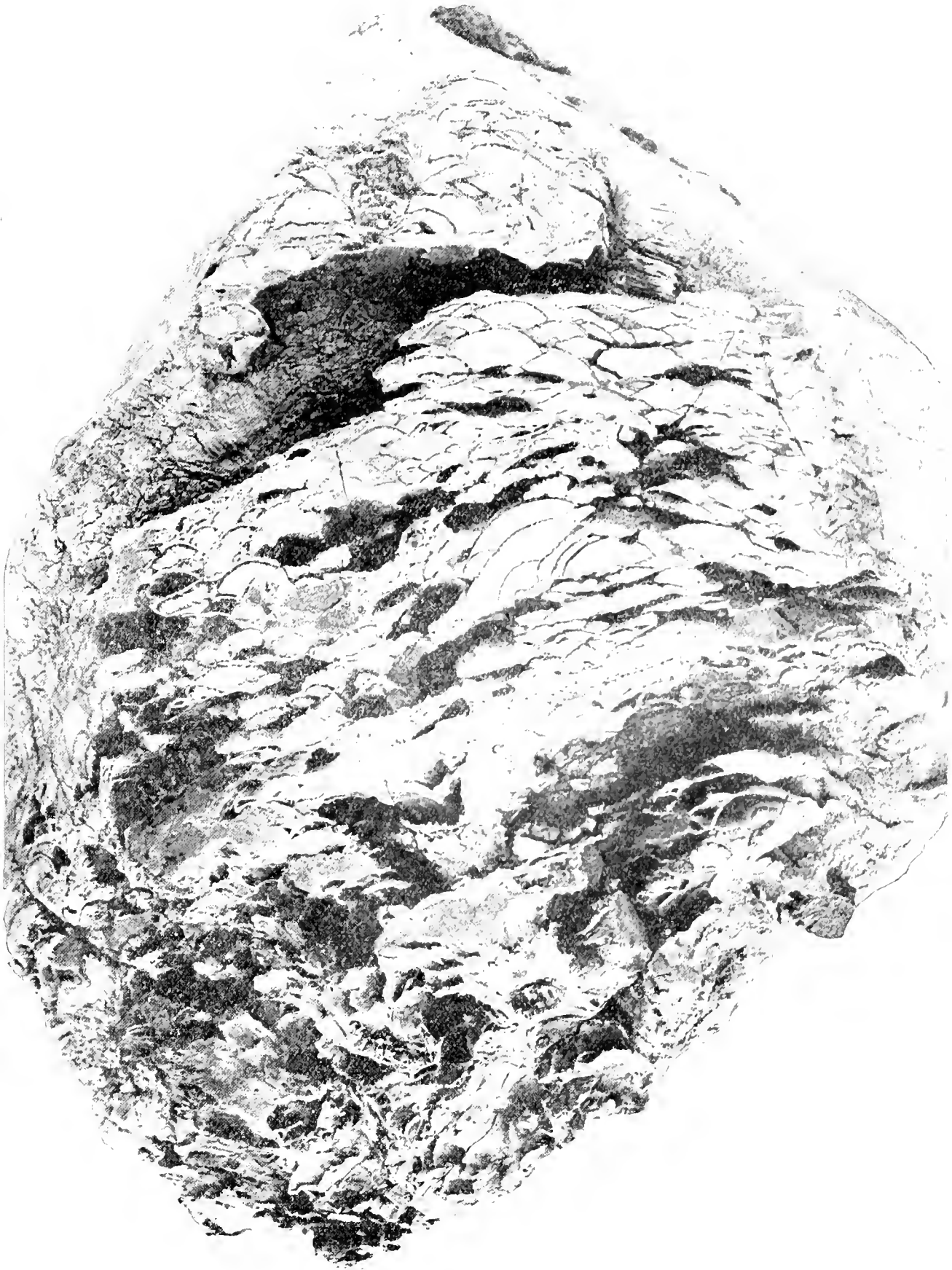

H. BARNES, Jun., photo.,  
Austr. Mus.







## EXPLANATION OF PLATE VI.

---

### ANCIENT STONE IMPLEMENTS, NEW GUINEA.

- Fig. 1. Stone Mortar of mica schist, weighing 30 lbs. Yodda Valley Goldfield.
- „ 2. Dagger-shaped object of clay-stone, weighing 3 lbs. Yodda Valley Goldfield.
- „ 3. Slab of basalt weighing 62 lbs. from Boianai, Goodenough Bay, with spiral incised motive.

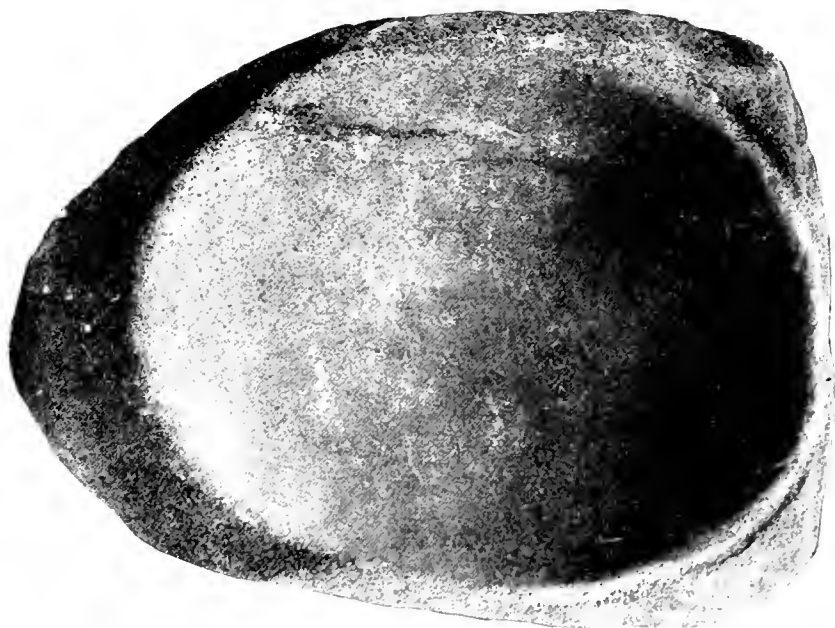

1



2



3





EXPLANATION OF PLATE VII.



ANCIENT STONE IMPLEMENTS, NEW GUINEA.

- Fig. 1. Phallic animal figure of hornblende rock weighing 17 lbs., from the head waters of the Giriwo River.  
,, 2. Side view of the same figure.  
,, 3. Back view of the same figure.



1

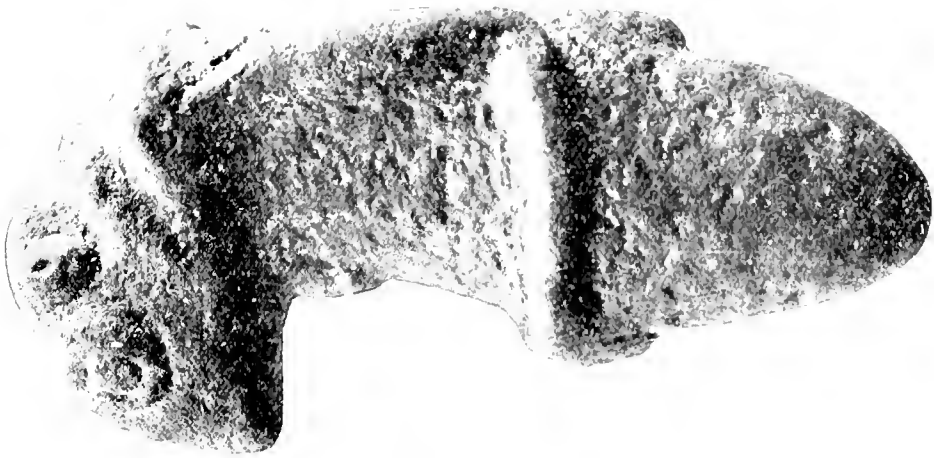

2

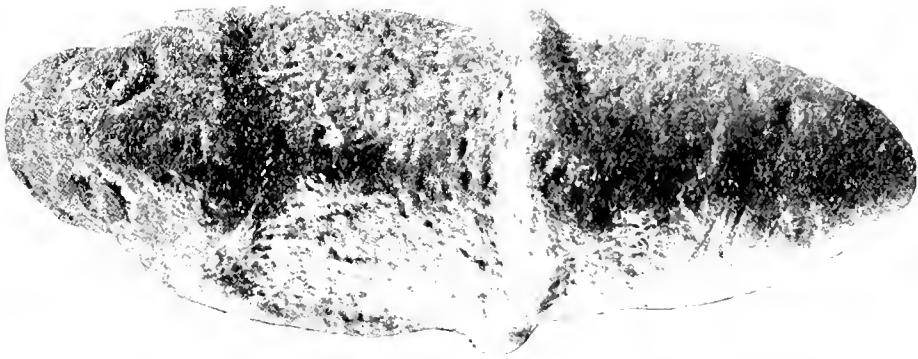

3







EXPLANATION OF PLATE VIII.

---

HENDERSON ISLAND.

General View of Island.







EXPLANATION OF PLATE IX.

— — —

HENDERSON ISLAND.

Dense Scrub in which birds breed.









EXPLANATION OF PLATE X.

---

AUSTRALIAN FISHES.

- Fig. 1. *Cristiceps aurantiacus*, Castelnau.  
,, 2. ,, *argyropleura*, Kner.  
,, 3. ,, *australis*, Cuvier and Valenciennes.  
,, 4. *Petraites roseus*, Günther.

All the figures are of the natural size.

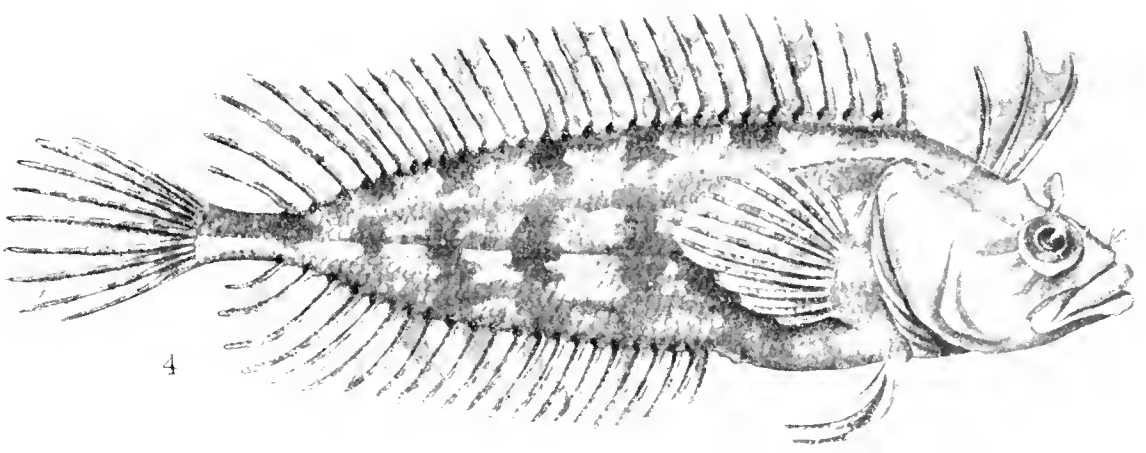
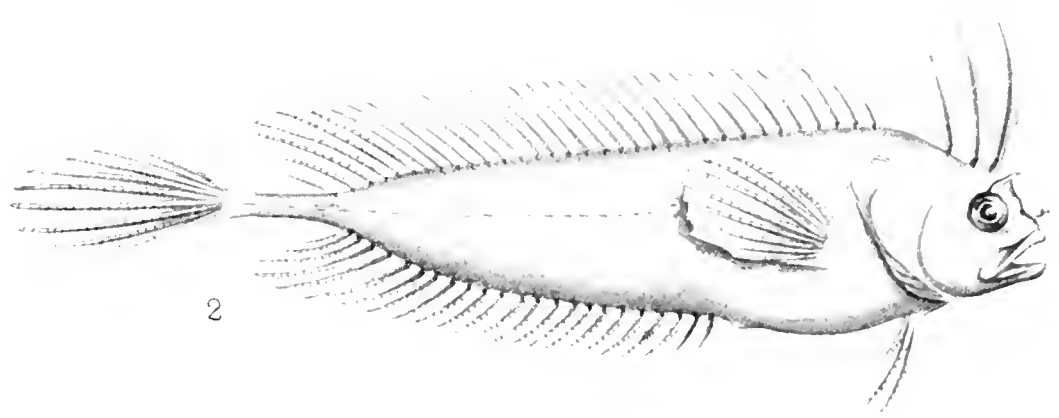
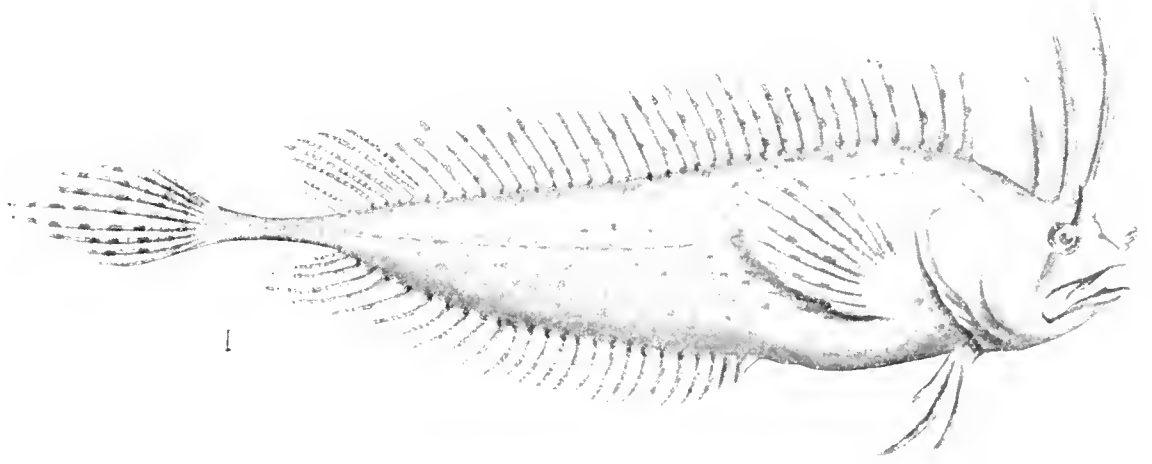





EXPLANATION OF PLATE XI.

---

AUSTRALIAN FISHES.

- Fig. 1. *Petraites heptacolus*, Ogilby.  
,, 2. ,, *fasciatus*, Maeleay.  
,, 3. ,, *phillipi*, Lucas.  
,, 4. *Clinus perspicillatus*, Cuvier and Valenciennes.

All the figures are of the natural size.

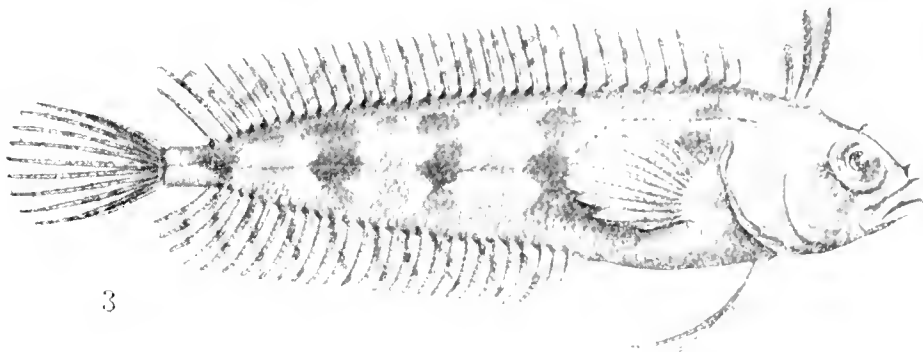
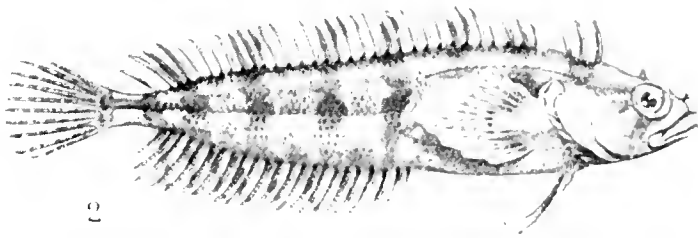
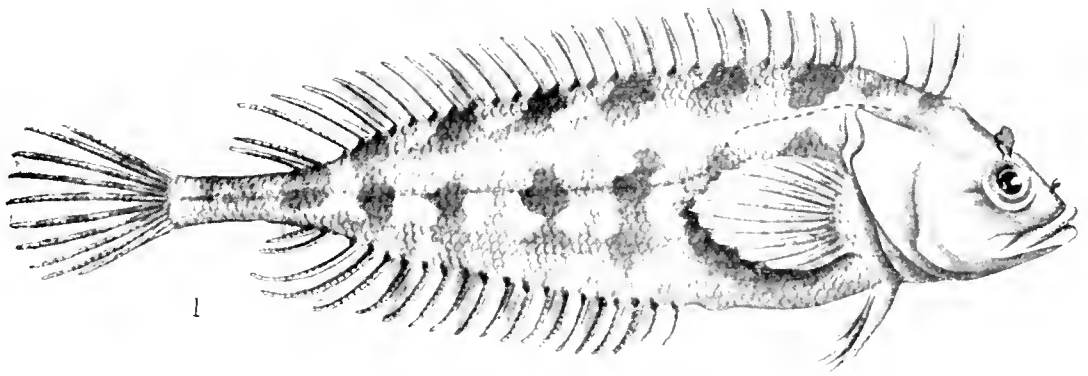







EXPLANATION OF PLATE XII.

— — — — —  
AUSTRALIAN CRUSTACEA.

- Fig. 1. *Eucrate hamiltoni*, McCulloch.  
,, 1<sup>a</sup>. ,, ,, larger cheliped.  
,, 2. *Hoplophrys ogilbyi*, McCulloch.  
,, 2<sup>a</sup>. ,, ,, mouth parts, etc.  
,, 3. *Trigonoplax unguiformis*, var. *longirostris*, var. nov.  
,, 4. *Gabrielia punctata*, Haswell.  
,, 5. ,, *haswelli*, Fulton & Grant.  
,, 5<sup>a</sup>. ,, ,, mouth parts, etc.

— — — — —  
Figs. 1, 1<sup>a</sup>. reduced, the others much enlarged.

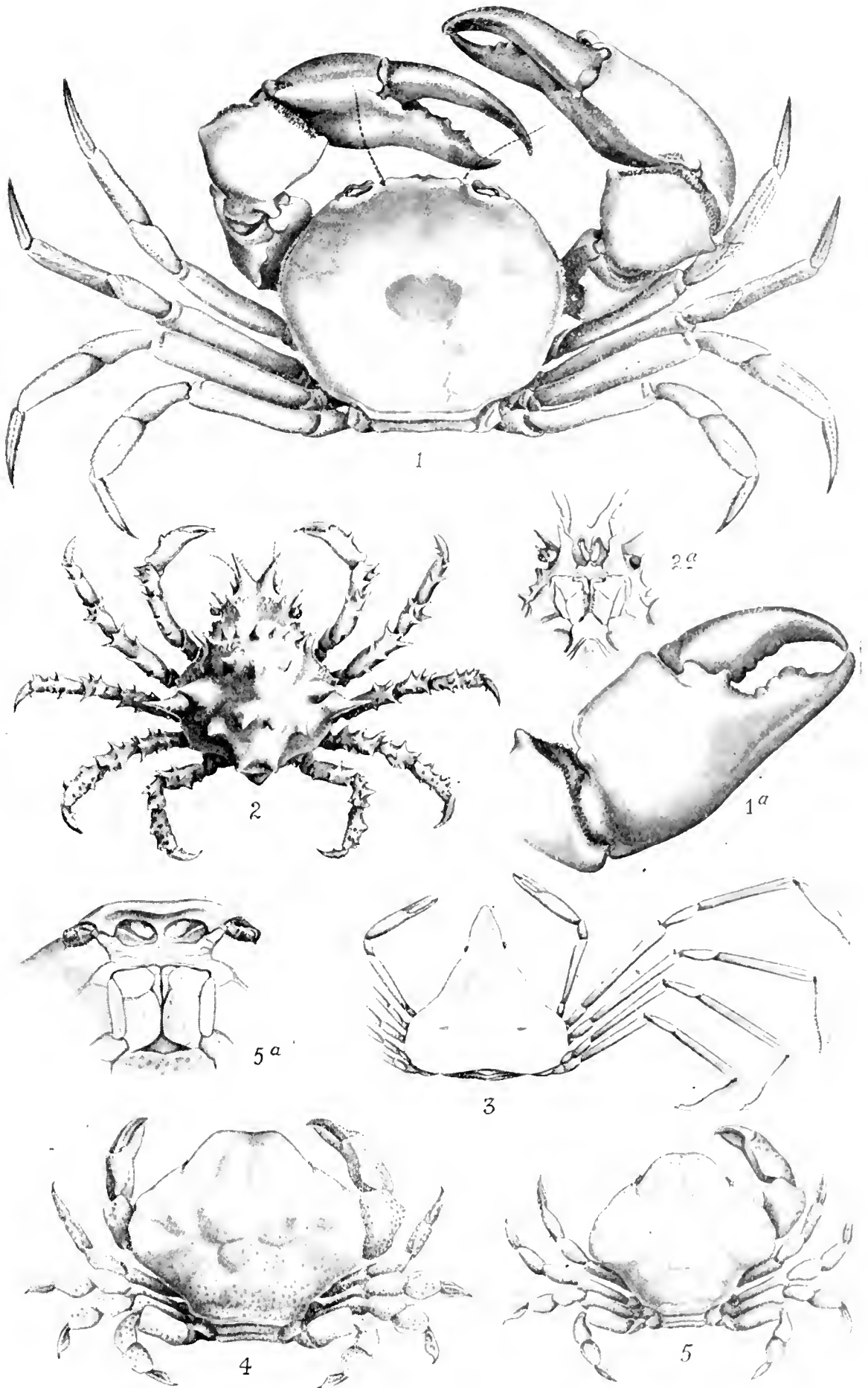





EXPLANATION OF PLATE XIII.

TOPAZ.

- Fig. 1, 2. Cow Flat, near Torrington, N. S. Wales.  
,, 3, 4. Stanthorpe, Queensland. Inorthographic and clinographic projection.  
,, 5. Pakenham, Victoria.  
,, 6, 7. Pakenham, Victoria. Inorthographic and clinographic projection.

Forms.—*c* (001), *b* (010); *m* (110), *M* (230), *l* (120), *g* (130), *n* (140), *U* (160);  
*j* (501), *d* (201), *h* (203), *f* (021), *y* (041); *o* (221), *u* (111), *i* (223),  
*x* (243).

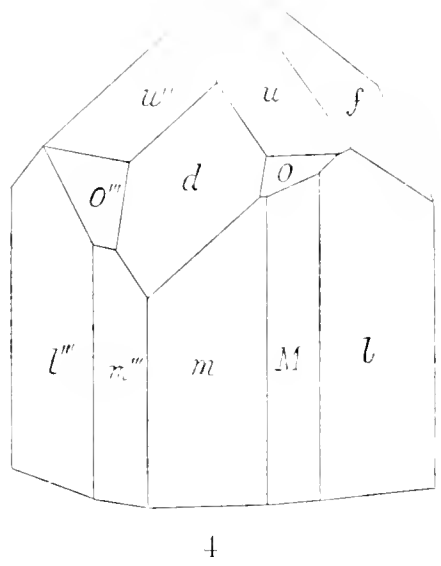
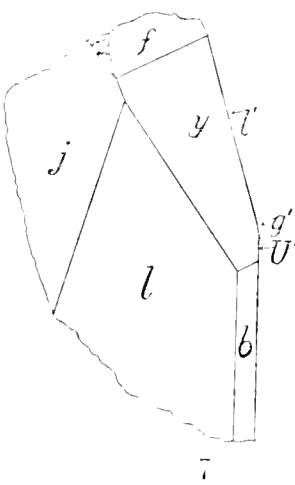
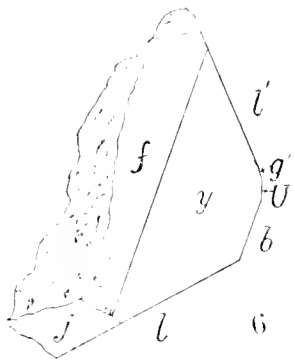
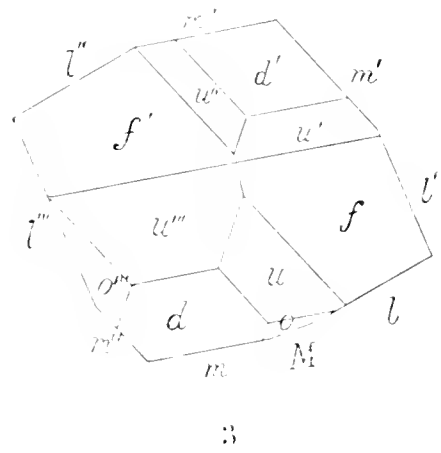
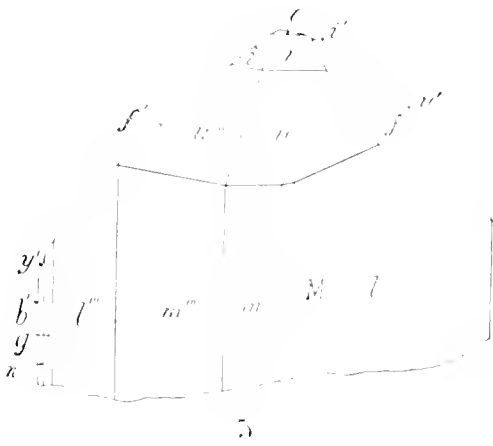
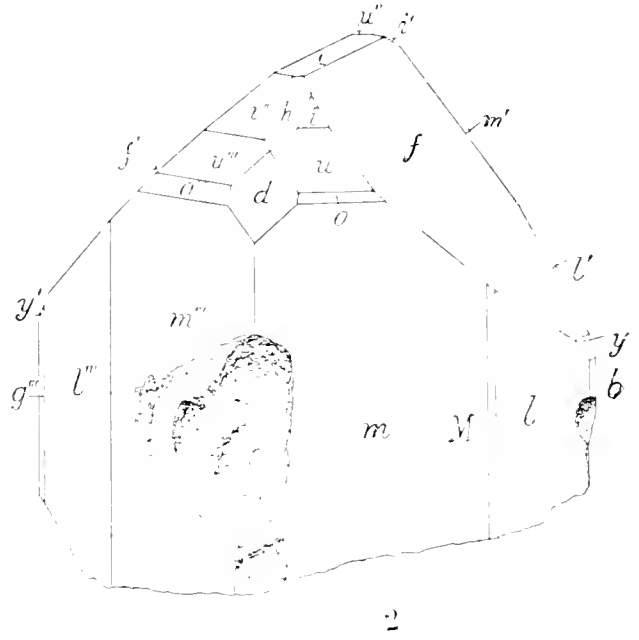
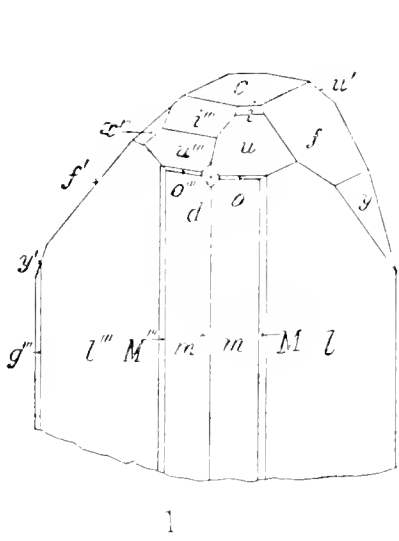







EXPLANATION OF PLATE XIV.

---

ANOLESITE.

Broken Hill, N. S. Wales.

- Fig. 1, 2. Central Mine. Inorthographic and clinographic projection.  
,, 3. Central Mine.  
,, 4. Block 14 Mine.  
,, 5. Proprietary Mine.

Forms.— $c$  (001),  $\alpha$  (100);  $m$  (110);  $o$  (011),  $l$  (104),  $d$  (102);  $z$  (111),  $g$  (113),  
 $y$  (122),  $\mu$  (124),  $Y$  (187),  $v$  (598),  $X$  (3·4·12).

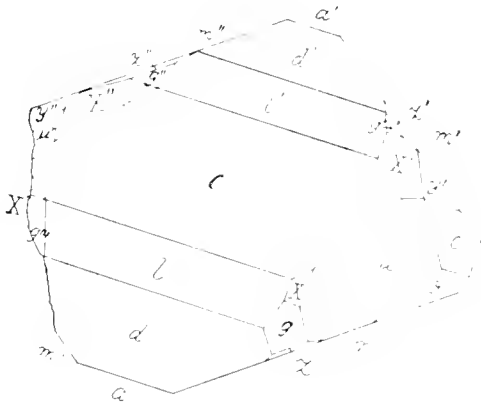

1

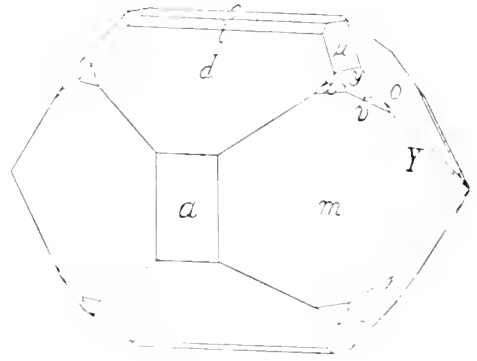

2



3



4

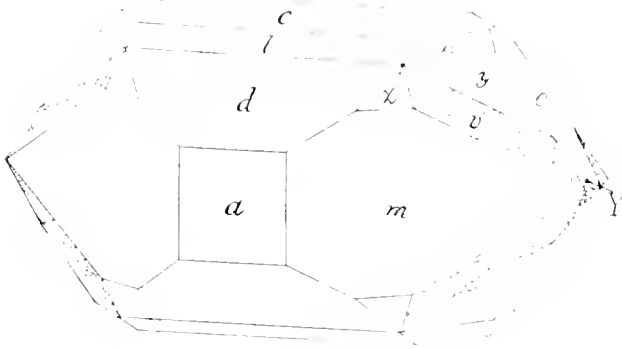

5





## EXPLANATION OF PLATE XV.

---

### ANGLESITE.

Fig. 1. Broken Hill, N. S. Wales. Stereogram.

(For indices see Explanation of Plate XIV.).

### RUTILE.

Fig. 2. Victor Harbour, S. Australia. Twinned on  $e(101)$  and on  $e(301)$ .

,, 3. Mt. Gambier, S. Australia.

Forms.— $a(100)$ ,  $m(110)$ ,  $k(430)$ ,  $e(101)$ ,  $s(111)$ .

### ATACAMITE.

Fig. 4. Cloncurry, Queensland.

Forms.— $b(010)$ ,  $m(110)$ ,  $s(120)$ ,  $e(011)$ ,  $n(121)$ .

### PYRITE.

Fig. 5. Major's Creek, Braidwood, N. S. Wales. ( $010$  to front).

Forms.— $a(100)$ ,  $o(111)$ ,  $p(221)$ ,  $n(211)$ .

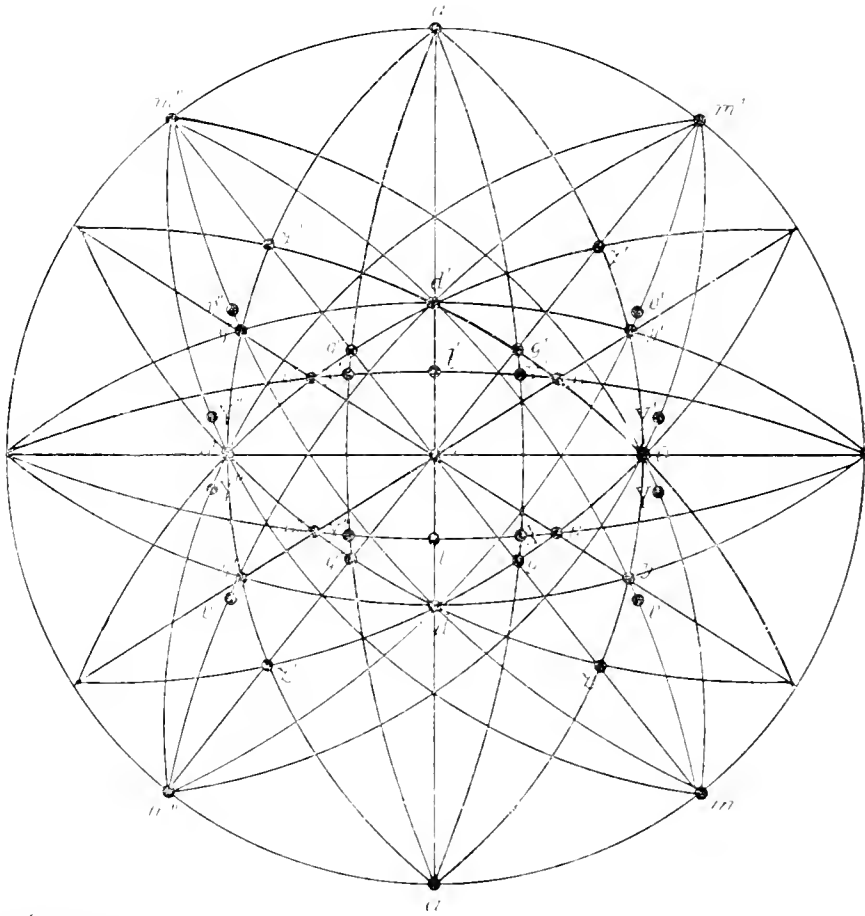

C ANDERSON, del.,  
Austr. Mus.







EXPLANATION OF PLATE XVI.

---

BERYL.

- Fig. 1, 2. Heffernans' Lease, Torrington, N. S. Wales.  
,, 4-8. The Gulf, near Emmaville, N. S. Wales.

ANGLESITE.

- Fig. 3. Proprietary Mine, Broken Hill, N. S. Wales.  
(All natural size).



1



2

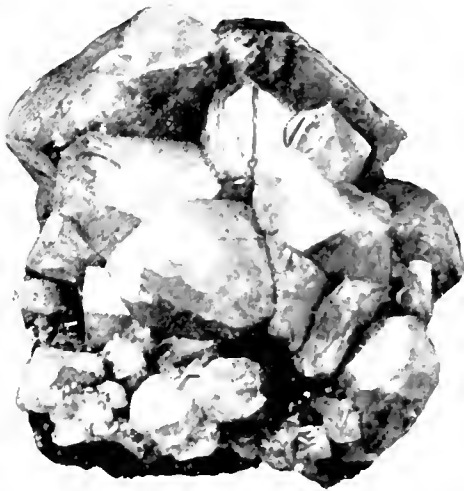

3



4



5



6



7



8







## NOTES ON MIMICRY AND VARIATION

By W. J. RAINBOW, F.L.S., Entomologist.

(Frontispiece.)

Recently there were added to the Australian Museum cabinets

### CORRECTIONS.

Page 33, line 10, for "Strait" read "Straits."

Page 34, line 17, for "different" read "definite."

Page 34, line 26, for "in" read "inhabitants of."

Page 34, bottom line, for "Australia" read "Australasian"  
(New Zealand being included).

Plate ii., fig. 1. Figured in error as "Assisting in Confinement." This figure has already been published in "North Queensland Ethnography," Bull. v., fig. 28, as "Doctor using sucking string," *c/* page 33, section 141, which is the correct explanation of the figure.

Although obviously distinct from one another, it would nevertheless be an exceedingly difficult matter to differentiate between the two when on the wing and in flight. Our Australian Lepidoptera, although presenting numerous instances of protective colouration, affords very little in the way of true mimicry. For this reason such an instance as the one referred to above is decidedly interesting.

The genus *Hypolimnas*, Hübn. (= *Diadema*, Boisd.), is apparently, as pointed out by Wallace, of Austro-Malayan origin. Of the fifteen species and their numerous varieties all, with the excep-





## NOTES ON MIMICRY AND VARIATION

By W. J. RAINBOW, F.L.S., Entomologist.

(Frontispiece.)

Recently there were added to the Australian Museum cabinets specimens of *Phœnicops porphyropis*, Meyr. & Low., and *Milionia queenslandica*, Roths. All were obtained from Mr. F. P. Dodd, of Kuranda, N. Queensland. They are particularly interesting from the fact that the former is apparently a mimic of the latter.

The Skipper, *P. porphyropis* (Front., fig. 1), has dark fuscous wings, suffused with iridescent purple; on the forewing there is a moderately broad transverse bright yellow band, the edges of which are irregularly dentate, whilst on the hindwing, at the termen, and just below the apex, there is a rather narrow patch of yellow. Except in point of size there is no apparent difference between the male and female forms, the latter being somewhat the larger of the two. They are really beautiful insects, and although rare in collections, may nevertheless be fairly prevalent in the deep recesses of the rich tropical jungle of Northern Queensland.

The moth, *M. queenslandica* (Front., fig. 2), like the butterfly, has dark fuscous wings. The forewings have each a broad, transverse, bright yellow band, the edges of which are uneven; the hinder angle has a somewhat dusky crimson bar, and this terminates in and suffuses the lower extremity of the transverse yellow bar. In some examples the crimson bar is much more vivid than in others. The lower wings are edged and dentated with yellow, and each is further ornamented with a large, irregularly-shaped concolourous spot.

Although obviously distinct from one another, it would nevertheless be an exceedingly difficult matter to differentiate between the two when on the wing and in flight. Our Australian Lepidoptera, although presenting numerous instances of protective colouration, affords very little in the way of true mimicry. For this reason such an instance as the one referred to above is decidedly interesting.

The genus *Hypolimnas*, Hübn. (= *Diadema*, Boisd.), is apparently, as pointed out by Wallace, of Austro-Malayan origin. Of the fifteen species and their numerous varieties all, with the excep-

tion of about five (African), occur within this area. Two, *H. bolina*, Linn., and *H. misippus*, Linn., have a wide range, the former occurring on every island in the Malayan Archipelago, as well as India, Australia, and the Pacific Islands, and the latter in Java, Borneo, Lombok, Timor, Celebes, India, Guiana, Australia, and Africa.

“This genus,” says Wallace,<sup>1</sup> “and those which have been separated from it, furnish us with examples of almost all the anomalies of variation. Some species present an amount of variation perhaps greater than any to be found among butterflies; others scarcely vary at all. The sexes are, in some species, absolutely without a feature of their colouration in common; in others they are hardly distinguishable. In a large number of species there is the most wonderful mimicry of other groups, so that they have been mistaken for *Danaidæ* and *Acræidæ*, and there is perhaps nothing more striking than the accurate manner in which some African species imitate the striped and spotted *Acrææ*, which inhabit the same districts. In the Eastern islands the protective mimicry has sometimes caused the usual sexual characters to be completely reversed, which has led to confusion in the determination of species.” The mimicry of *Danaus chrysippus*, Linn., by *Hypolimnas misippus*, is not only a wonderful, but a well-known example. The common *Danaus* (*Limnas*) *petilia*, Stoll., is regarded as the Australian form of *D. chrysippus*. The last-named species occurs in India, Burmah, Malayan Archipelago, Africa, and even Europe.

In respect of the Australian form of *Hypolimnas bolina*, Linn., the males are very constant in colouration and ornamentation, but the females present an almost unending series of variations, both in size, colour, and ornamentation. The chief feature of interest to the student is that the female is apparently, in a state of flux, the examination of many examples showing a tendency on the part of the insect to conform to the Danaid type.

In our cabinets we have a number of varieties. One, collected some years ago by Mr. G. Masters at Gayndah, Queensland (Front., fig. 3), measures, in expanse, four inches. It is dark olivaceous-brown, suffused with purple. The forewing has a few small sub-costal spots above the cell; a transverse blue macular fascia beyond the end of the cell; a submarginal series of white spots placed between the nervules, the two uppermost of which are

<sup>1</sup> Wallace.—Trans. Ent. Soc. Lond., 1869, p. 278.

largest and separated from each other by a nervule; beyond the series just described there is a submarginal and marginal series of waved bluish-grey spots, and these vary both in size and in intensity; viewed in different angles the colour of these spots varies, a deep purple being sometimes noted; fringe picked out with patches of white; between the median and first submedian nervules there is a small patch of orange. Hindwings have two submarginal rows of bluish-grey spots between the nervules, those of the inner row being much the smallest and placed singly, whilst those of the outer row are in pairs; a marginal row of more or less obscure concolorous markings lie close to the outer angle; fringe as in forewings. On the underside the wings are of a greyish-brown colour. The forewing has the lower half suffused with ferruginous; the transverse fascia beyond the cell is obscurely greyish; a narrow transverse bar of dark chocolate brown commences near the costal nervure and terminates at the distal extremity of the anal angle: between the costa and the costal nervure there are a number of scattered white scales, whilst just within the cell there are two large patches of white scales, each patch seated upon a dark brown back ground; beyond the cell and just before the transverse grey fascia there is a third patch of white scales, and these are also seated upon a dark back ground; the marginal and submarginal spots coincide in position to those on the upper surface: those nearest the posterior extremity of the anal angle are large and bluish-grey; the intermediate ones are smaller and more or less obscure; the apical pair of the innermost submarginal series are large and oval. On the lower wing there is a faint transverse bar of grey running across the centre of the wing, and this commences with a large roundish grey spot near the middle of the anterior angle; there is a submarginal row of small bluish-grey spots placed singly between the nervules; below these again a row of large, conical greyish markings seated in pairs between the nervules, and below the latter series a waved greyish line interrupted and broken by nervules. All these spots and markings are prominent and distinct on the lower side, whilst on the upper they are obscure.

The next example to which I desire to draw attention comes from the Clarence River, N.S. Wales (Front., fig. 4). It is as large as the preceding example, but is markedly distinct from it. In this form we can trace what appears to be a further step in the process of evolution towards the Danaid type. The blue macular fascia referred to as occurring on the upper wing of the former is in the present example a short but prominent, broken, trans-

verse bar consisting of four large elliptical white patches; the orange-coloured patch is also more than twice the size of the one in the forewing of the first example; the inner submarginal series of spots, except the apical pair, are very small and white; marginal rows of bluish spots only faintly discernible. On the lower wing, instead of a faint blue transverse fascia there is a large median white patch, the edges of which are suffused with blue; marginal spots and markings obscure, bluish; cilia of both wings alternately dark brown and white. On the underside the wings agree in general colour with those of the first example, but differ from them by the transverse macular fascia on the forewing being white, and again by a broad transverse white bar running obliquely across the hindwing; the marginal and submarginal patches of white are also much heavier than are those of first example.

A third example (Front., fig. 5) comes from Kensington Downs, Queensland, where with a number of others it was collected by Mr. A. J. Ewen. An examination of these shows a wide range of variation, both in colouration and size. In the form under consideration the upper wings are velvety black; the transverse macular fascia is white, and each of the large spots comprising it is edged with blue; each of the two large apical spots, and the series of small, submarginal spots that proceed from them are also white and faintly edged with blue; the marginal and submarginal markings are distinct though fine; the orange-coloured patch on the lower half of the wing is much larger than that of the second example quoted (Front., fig. 4). The lower wing is velvety black at base, outer and anal angles very dark velvety brown, median area white edged and faintly suffused with blue, marginal markings indistinct; cilia alternately black and white. On the underside the wings are much darker than in the second example, and this has the effect, naturally, of making the transverse marginal and submarginal white markings, as also the series of small bluish spots, stand more prominently out.

Other examples collected by Mr. Ewen show, in their variation, the same apparent tendency towards mimicry, and in some not only is there present the bright orange-red patch on the upper wing, but the lower wing also bears indications of a gradual evolutionary tendency towards the same colour. Taking the underwings of both sexes of this species into account, there appears to me to be little doubt, that when the insects are at rest, the colouration and markings must be protective, else, considering that the species is decidedly edible to insectivorous animals it could scarcely be so common. We must not forget that its earlier stages may have something to account for in this

respect. The larvæ are gregarious and “when first produced they are green, with black heads, and are thinly covered with hairs. After the first moult the body is covered with whorls of tubercles, each emitting three or four hairs. The head bears two bristly spines. When full fed, the body becomes throughout of a rich velvety black, with whorls of branched spines of a yellow colour, whilst the two on the head are black. . . . In length the larvæ attains to nearly three inches, and is of a full and plump form. It is extremely handsome in appearance, but of very offensive habits.”<sup>2</sup> Then, again, the pupa, with its abdominal segments armed with stout pointed tubercles, in addition to its colour, which is purple-brown blotched with black on the wing-cases, must also be of advantage in aiding the species in the struggle for existence.

In addition to the preceding forms we have other examples—one from this State and one from Thursday Island, for instance—which are so distinct that a tyro could scarcely be blamed for regarding them as separate. In the first place they are much smaller; the one from New South Wales has an expanse of rather more than three inches, and the other of only two and three-quarters. In size and colour of the wings on their upper side, save for the splash of orange-red on the forewings, they more nearly conform to *Danaus* (*Salatura*) *affinis*, Fab., a species ranging from Clarence River, N. S. Wales, to Cape York and Port Darwin. The ground colour of the Danaid and Satyrid is dull brown, and each has on the forewing an oblique, transverse, white macular fascia, and white apical, marginal and submarginal spots. But it is in the lower wings that the greatest resemblance between the two species exists; each are of the same chocolate-brown and each have a large patch of white. In the Danaid the latter extends right to the anal angle, but in the Satyrid it scarcely reaches it. On the under side the resemblance in colour and markings of *H. bolina* to *D. affinis* is less distinct, but the New South Wales example of the former, owing to its large median area of white, extending as it does to the anal angle, together with its large marginal and submarginal white markings, and its alternating white and brown cilia, is the closest example of the Satyrids to the Danaid insect.

There can be little doubt that the Australian forms of *H. bolina*, like the Indian butterflies of that species, are affected by the seasons; that we have in fact “wet” and “dry” season forms, but these seasonal changes have not yet been studied.

<sup>2</sup> Rainbow—A Guide to the Study of Australian Butterflies, 1907, pp. 80 and 81, fig. 48.

# NORTH QUEENSLAND ETHNOGRAPHY.

BULLETIN No. 11.

Miscellaneous Papers.

1. Tabu and other forms of Restriction.
2. Counting and Enumeration.
3. Signals on the Road ; Gesture Language.
4. Progressive Koko-yimider Exercises.

By WALTER E. ROTH, Magistrate of the Pomeroon District, British Guiana ; late Chief Protector of Aborigines, Queensland ; Corresponding Member of the Anthropological Societies, Berlin and Florence, the Anthropological Institute, London, etc.

(Plates xvii.-xxi., figs. 6-7.)

## PART I.

### TABU, AND OTHER FORMS OF RESTRICTION.

(to accompany Bulletin 8).

#### CONTENTS.

Sect.	1.	Local Names of Tabu	...	...	...	...
	2.	Permanent Restrictions	...	...	...	...
	3.	Temporary	..	..	..	..
	4.	Tabu may be declared by women	...	...	...	...
	5.	Diets forbidden to all young people	...	...	...	...
	6.	.. all women	...	...	...	...
	7.	.. the exogamous group	...	...	...	...
	8.	.. at certain occasions	...	...	...	...
	9.	.. person's namesake	..	..	..	..
	10.	Localities forbidden	..	..	..	..
	11.	Names	..	..	..	..
	12.	Relatives	..	..	..	..

1. Certain prohibitions, varieties of "Tabu," are in force throughout the whole of North Queensland, and their disregard is either met by punishment at the instigation of the Council of Elders<sup>1</sup>, if discovered, or else by some form of disease, accident

---

<sup>1</sup> Roth--Bull. 8--Sect. I.

or death, when not<sup>2</sup>. These restrictions, which deal with such varied subjects as dietaries, personal relations and property, localities, names, etc., are known under different terms:—*ji-anna* on the Pennefather River, *tá-mi* on the Middle Palmer, *tamanda* by the Kundara Blacks of the Lower Gulf Coast, *ahn-ta* to the Koko-warra Natives of the hinterland of Princess Charlotte Bay, *chanolo* and *kamma* on the Lower Tully River, *tcha-bul* on the Bloomfield River, and strange to say as *ta-bul* at Cape Bedford and on the Lower Endeavour River.

2. Some forms of the tabu are constant in that it can never be removed, in others it may be released by the elders, occasionally by one individual only (not necessarily an elder), but never by women, who sometimes have the power of declaring it. During her menstrual periods a female can never be freed from the tabu imposed upon her consequent upon her condition; so also in connection with the final place of burial, etc., the prohibitions are inexorable. The tabu on certain dietaries is often relaxed by some of the very old men in favour of the young males when food happens to be extra scarce on the Bloomfield (*R. Hislop*). Amongst the Tully River Blacks, who account for their food restrictions as having been in existence as long as they can remember, the only individual who can remove the tabu, and then only from the *kamma* variety (see further), is the one whose business it is to wash the corpse's skin and rub its hair off during the course of the burial celebrations (*E. Brooke*). At Cape Bedford the word indicative of the release from tabu is *dai-tchen*.

3. Where the restriction is only temporary, it may be declared by reason of animosity and pure wantonness, for the protection of property, and sometimes as a recognised punishment. There may be differences in the family circle; the wife may have gone to all the trouble and labour of collecting and preparing the day's food for herself and family, when the husband will declare it tabu in favour of the children, which accordingly precludes her having even so much as a taste. A man will be going out of camp and leaving some weapons, food, etc., behind, if he urinates upon the former or in close proximity to the latter, they become "tami," and he will find everything intact upon his return (Middle Palmer River). On the Bloomfield, the Palmer, and elsewhere, a form of "roarer" hung up by a string (Pls. xx., xxi.) will make everything near or underneath it tabu; it is usually decorated with white stripes on a red background, and sometimes has a nick at its free

---

<sup>2</sup> Roth—Bull. 5—Sect. 150.

extremity. Dilly-bags when used by the men are tabu, the prohibition including everything therein contained; when used by women, nothing beyond the ordinary family possessions, nothing liable to tabu, is carried in them. Supposing a person break his promise and speak by name of his pi-wal, the individual who bores his nose at the initiation ceremony, he is punished by having certain of his property, or perhaps a dietary to which he has been accustomed, made tcha-bul in favour of the person mentioned (Bloomfield River).

4. Although tabu is thus generally declared by men, it can here and there be instituted by women, but then only in the male interests. The women, for instance, will be quarreling, perhaps over some alleged inequality in sharing the food, when one of them will suddenly declare it all tabu in favour of her husband or any male belonging to the same exogamous group as herself (Bloomfield River), or to her son (Cape Bedford), when it cannot, of course, be eaten or touched by anyone else.

5. Certain dietaries are strictly forbidden to all young people before arriving at puberty, the full attainment of which is generally dependant upon the first of the initiation ceremonies in the male, or upon initiation (where practised), or the birth of the first baby in the female. On the Pennefather River, for instance, stingaree, wild-fowl eggs, certain sharks, certain snakes, emu flesh, and, before the introduction of the iron harpoon, turtle, are forbidden them. The dependency of the turtle upon iron (which is capable of piercing the carapace) was explained to me by the young men by reason of the fact that while wooden harpoons were in vogue these creatures could only be caught by striking them in the soft parts, *i.e.*, the neck and posteriorly, and their capture was consequently no easy matter, thus rendering their flesh a very scarce commodity. On the Tully River there is a distinction made in the foods forbidden to the young according as it is derived from the sea or land, in the former case the tabu being spoken of as chamolo, in the latter as kamma. Here chamolo includes stingaree, barramundi, mullet, trevally, and salmon, its disregard entailing the culprit's hair turning prematurely grey. Kamma embraces bandicoot, iguana, porcupine, black snake, carpet snake and platypus; and were any young person to transgress, the particular animal would make him sick by building its nest or laying its eggs inside the back of his neck.

6. More than this, certain foods, varying with each district, are forbidden to any woman whatsoever, old or young; thus, stingaree and mullet are tabu to all females at Cape Grafton and along a large extent of coast-line northward. During their



pregnancy the weaker sex have the limits of their menu still further reduced, by not being allowed to eat this or that, *e.g.*, rock-cod between the Mossman and Cairns, where, should the forbidden fruits be partaken of, the fish would entirely disappear out of the sea, and the guilty parties die of sore bellies. And to crown all, whatever is cooked by men, all women have to regard as tabu. Old men may, indeed, institute the ban over any food which, owing to scarcity, they may wish to reserve for themselves. The social organisation of the tribe also bears important relations to the restrictions placed upon food, in that an individual dare not eat the various animals belonging to his or her own exogamous group; or, as the natives will often describe it, "belong all same skin." In certain districts, however, *e.g.*, Boulia, the animal, etc., may be killed by him for others. But again, a native is everywhere restricted both from giving or accepting presents of food to or from certain of his relatives (see further). Parents have, of course, to provide the necessary food for their children up to the time of their first initiation, but in the hinterland of Princess Charlotte Bay, whatever a child up to that period finds in the way of diet, *e.g.*, iguana, sugar-bag, is tabu from its parents; this particular prohibition having the special term of womba applied to it by the Kokowarra.

8. Certain foods are also tabu (neither mentioned nor eaten) in connection with the various ceremonies. For instance, both during, and for some time subsequently to initiation, the young man is specially forbidden different diets; during the course of the burial celebrations on the Pennefather River, and Peninsula generally, the relatives specially charged with the proper execution of the rites are prohibited eating meat-flesh, etc.

9. There appears to be no constancy in the light with which the eating by the individual of his name-sake, when it happens to be an animal or plant, is regarded; on the Palmer River it is tabu, on the Tully it is not.

10. The spot where anyone has been finally buried is tabu from the women only, men can visit there. This form of restriction also includes certain things connected with the present history of the deceased from the dilly-bag in which the mourning-string has been placed, even anything and everything in the hut where the bark trough with its enclosed corpse has rested (Bloomfield River), down to the particular locality where his own or other nature-spirits are supposed to linger. At Cape Bedford the birth-place is similarly tabu from everybody except the parents, the prohibition comprising anything brought to the spot where the baby is lying, or anything that it is allowed to touch; the navel-strings

can thus place the tabu upon yams, etc. The particular piece of ground reserved for the holding of the initiation ceremonies is always strictly tabu from all those who are not specially privileged to visit it.

11. The tabu of names of persons deceased has been fully dealt with already, and the explanation given<sup>3</sup> accounting for it. At Cape Bedford whenever an Aboriginal unintentionally makes use of such a forbidden word, he will immediately correct himself, and say "barkar kada," *i.e.*, "(my) mouth (is) foul," and expectorate.

12. Certain of an individual's relatives are strictly tabu from him, in so much that he must neither approach, converse with, accept from, nor give them anything. This especially refers to the father-in-law and mother-in-law. These, and other relationship restrictions are, however, far from constant. Thus, on the Pennefather a man must not look at either of his step-parents, though it is permissible for him to converse with them with face averted; a woman may talk with both in a natural manner, the business of the mother-in-law here being to attend her in her confinements. At Miriam Vale, south of Rockhampton, and at Boggy Creek, Upper Normanby River, as well as elsewhere, a man may, under certain circumstances, address his step-parents from a distance in a comparative whisper. On the Tully, both male and female talk to the father-in-law either by his individual name, whatever it may be, or by the generic one of ni-ubi; but their teeth would rot out were they to converse with the mother-in-law, though they may speak of her by the generic term of wai-min, but never by her individual name. With the sole exception, perhaps, of those cases where the mother-in-law acts as midwife, the practice of both males and females refusing to touch any food prepared by their step-parents is universal. In some districts it is usual for the wife not even to converse with her husband's blood-brothers, but on the Tully she may lawfully have marital relations with them; the converse of husband and wife's blood-sisters, with its corresponding inconstancy, also holds true. It is the usual practice for a man never to talk to his blood-sister, or sometimes not even mention her name, after she has once reached womanhood; her father, mother's or father's brother, or her husband if she has one, looks after her interests, and when necessary takes up her quarrels.

<sup>3</sup> Roth—Bull. 5—Sect. 72.

## PART II.

## COUNTING AND ENUMERATION.

In a previous Bulletin<sup>4</sup> mention is made of the so-called tournaments held in the Cardwell and other districts throughout the year, except at flood-time, the variations in the number of days between successive performances and the interesting fact that the blacks have special terms for enumerating the days in the interval. The distances to be traversed, other engagements elsewhere, the control of the food supplies, etc., are some of the factors which make it very important that no mistakes should be made as to the dates fixed upon, the liability to error being increased through some of the camps having irregular intervals. Thus, in 1901, on the Lower Tully River, the *prun* was held either every seventh or thirteenth day from the termination of the last preceding, but on the upper portions of the same river it was on the eighth or thirteenth; while in the neighbourhood of Cairns the Yidinji Blacks would seem to have held them pretty regularly on the twelfth day. As often happened, owing, perhaps, to a case of homicide consequent on the fighting, or to a good season with plenty of food, the performance might either be shorter or longer than usual, and a good deal of unnecessary quarrelling and bickering, through some of the visitors arriving too early and others too late, was prevented by fixing names to the days in the intervals. This was the explanation given to account for this primitive kind of calendar, which lasted throughout the performances, *i.e.* the whole of the dry season. It must be admitted, however, that not only was this calendar shifted, but that it might be shorter or longer. However, as it referred to time when solely in connection with the performances, the arrangement made but little practical difference.

When a *prun* is completed, the old men will arrange amongst themselves as to when and where the next is to be held, and a messenger will be sent to the different camps to tell them they are expected at such and such a place on a certain day. But many of the larger camps in the neighbourhood have their own calendar, which is similarly always being altered, so that the names of the days will, perhaps, not correspond. To obviate all mistakes, the messenger employs at least three methods to make matters clear—the message-stick, the fern-frond, and where it is understood, by mnemonics with the hand. The Yidinji Blacks apparently used all three. The stick is employed

---

<sup>4</sup> Roth—Bull. 4—Sect. 15.

by cutting nicks on it, each cut representing a day, but contrary to expectation I have never been able to find the passing of a day indicated by the crossing of a cut. With the fern-leaf, it is split in half, the number of leaflets left attached indicating the number of days of the interval, a leaflet being folded on itself for each day passed. On the Lower Tully River the intervening days are borne in mind by the different parts of the palms and digits, as follows, the messenger being able to explain to the various camps

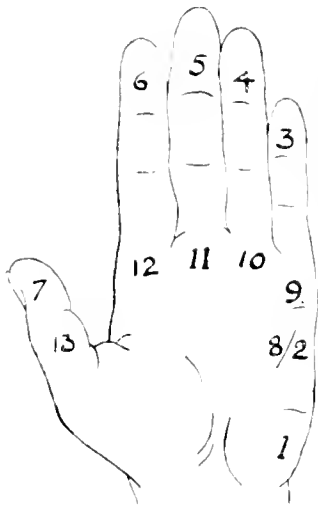

Fig. 6.

visited exactly how many days later they are expected :—Opening his left hand the reckoner names the first and second days as he points to the spots respectively so marked in the figure (fig. 6), the same with the fourth, fifth and sixth; and now, with fingers all closed, he seizes the extended thumb and mentions the seventh, the date for which the next prun has been appointed. But supposing that it has been decided to hold the next performance after an interval of thirteen instead of seven days, the reckoner will open his hand again and point respectively to the spots numbered eight to thirteen, the final day always ending with the thumb, giving them names identical with

those already mentioned by him for the first to seventh days, thus :—

1st day	=	chalgur
2nd or 8th day	=	chalguro-kabun
3rd or 9th day	=	meriri
4th or 10th day	=	mono chano
5th or 11th day	=	moko-pulo
6th or 12th day	=	karapo
7th or 13th day	=	kari-unggol

These words have no other significance, are absolutely distinct from the terms indicative of number, and are only applied to a day as a portion of the interval between the successive pruns, the idea of time-when being otherwise always reckoned by the number of sleeps. Amongst the blacks of the Upper Tully River the performance was held either on the eighth or thirteenth day, the numbers referred to being shown in fig. 7, where the names for the fourth and ninth, for the fifth and tenth, etc., are identical. The Cairns Natives (the Yidinji), who had an interval of eleven days between the performances, puloga as they called them there,

reckoned the intermediate days on both hands: first and second on ball and tip respectively of left thumb, third to sixth on tips of remaining fingers, the seventh to tenth on right hand fingers, commencing with the little one, the eleventh falling on right thumb: the names applied bore traces of the three numerals, as well as compounds of them.



Fig. 7.

Natives do not possess special terms to express numbers over three collectively, everything beyond this being relatively either few or many. Not that they lack the mental ability to appreciate a conception of higher values—I have known of black children working at decimal fractions, and a young full-blood engaged as draughtsman in a large engineering works—but that the opportunity so seldom arises of having to exercise it. Ask a black as to the number of occupants in a camp, he will probably tell you there are few or many, and if pressed for further information, will mention the names of Tom, Dick, Harry, etc., ticking them off or not on either his fingers or in the sand, but always in pairs. He apparently takes a concrete view of the case, leaving you to form a mental picture of the number as a whole. He can certainly form such a mental picture for himself, because he will describe any large number of strangers, a flock of pigeons, anything in fact, of which the components are not individually known to him, in some such form as “plenty sit down all round about.”

It is true I have met with natives here and there who can count up to twenty pretty accurately in their own language, making use of the term for hand, foot, leg or arm to indicate a group of five (digits or toes), and forming the compounds from them accordingly, *e.g.*, 8 = 5 + 3, 11 = 5 + 1 + 5, etc. But in all such cases they have mixed pretty freely with whites, and can speak fairly good English, with the result that, for ethnographical purposes, it is quite sufficient to mention its occurrence.

Taking three northern languages of which we have accurate information, the numerals are as follows:—

		Cape Bedford.	Bloomfield River.	Tully River.
One	...	nobun	nupun	yungkul
Two	...	godera	ma-ma-ra	bulai
Three	...	kundo	kollur	karbo

At Cape Bedford the adverbial form *kundoi-go* means three only, and is used to express any small number, but only in comparison with a large one, and is the nearest approach to our word "few"; *kundo-kundo*, or threes and threes, *i.e.*, many, is comparable with our expression "dozens and dozens"<sup>5</sup>. On the Bloomfield any number beyond three is *wor-pul*, corresponding to our "plenty." The Tully Blacks speak of a comparatively smaller and larger lot beyond three as *mundi* and *katai* respectively, with the result that they have been in perfect good faith applied to our words "four" and "five."

As already mentioned, the counting is always done in pairs, and whatever the object of enumeration (excepting only the intervening days of the *prun*) no other aids to memory than the fingers are utilised. Opening the one hand (generally the right at Cape Bedford), he turns down digit by digit, commencing with the thumb (Bloomfield) or little finger (Cape Bedford), counting as he does so; over five he commences again, but turns down two at a time, with each couplet saying "and two." On the Tully, after counting up anything, the Tully Blacks will often express the total as it were by using the term *ballan-jo*, *i.e.*, the lot.

### PART III.

#### SIGNALS ON THE ROAD: GESTURE LANGUAGE.

The ideagrams represented here are additional to those given in the "Ethnological Studies," etc., the figures in which are here referred to as "E.S." with a corresponding number. Since that work was written, I must include the eating of the corpse by the near relatives (see Pennefather River, etc., Burial Ceremonies)<sup>6</sup> as another condition where gesture language is employed.

#### *Signals on the Road.*

Throughout the unsettled districts there are narrow path-ways, regular beaten pads, more or less all over the country. When a tree falls across this track, it is the latter which is shifted to the right or left as the case may be.

To indicate the route taken by the traveller to those who are following behind, he makes use of certain signals, the commonest of which is done with the big toe. On the Pennefather River, for instance, between it and the Batavia, the trail of the big toe

<sup>5</sup> Both—Bull. 2—Sect. 25.

<sup>6</sup> Both—Austr. Mus. Rec., vi., 5, 1907, p. 368.

in the sand acts the same rôle as a finger-post would to the European. In the area drained by the Middle Palmer River, a mark made on the ground outwards (from the track) with the ball of the toe indicates the proximity to a camping-ground. Around Princess Charlotte Bay the whole foot is scraped along the soil forwards, and the impression of the toes made as distinct as possible; close to its extremity in front, a stick, from one to two feet long, around the free end of which some tea-tree bark has been wound, is stuck into the ground at more or less of an angle towards the direction pursued. The Palmer River Blacks appear to use the stick separate from the imprint; for instance, direction pure and simple is by them indicated with a short withe, to the top of which is attached a tussock of grass, or with a small piece of bark by itself, the whole fixed at the required angle; while a digging-stick similarly placed shews that the individual who left it there has gone a very considerable distance on the track pointed towards. On other occasions, as I have noticed in the hinterland of Princess Charlotte Bay, a piece is knocked off the summit of an ant-bed, and the stick is fixed on the top of the remaining portion. Where there happen to be cross-roads, the Tully River Blacks break off small boughs and lay them on the track to be followed; on the other hand, if there are no boughs available, but grass is present, the tips of the grass-blades will be tied together over the path-way *not* to be pursued<sup>7</sup>. In the Rockhampton area the natives would at times make use of a tree by stripping a narrow piece of bark from above down and placing in the fork connecting it with the butt, any tussock of grass, the "heads" of which point towards the particular route taken<sup>8</sup>.

If a tribesman, on the other hand, is dealing with his own immediate people, and the atmospheric conditions and state of the

<sup>7</sup> Roth—Ethnological Studies, etc., 1897—Sect. 225.

<sup>8</sup> Mr. T. Petrie has given me the following notes on road-signals, etc., amongst the now defunct Brisbane Blacks. A tuft of grass, *in situ*, tied round with another bunch which has been pulled up, bent in the direction to be followed. In the scrubs the natives would just snap down, but not break, a twig here and there; they were always especially afraid of making a distinct pathway in the scrubs when once the Europeans came, for they had to be very careful about being hunted down by the black troopers. On a cleared space which they would make by the side of a pathway, they would stamp the imprint of a foot, and to hide their tracks they would often walk backwards. In tracking a kangaroo, etc., over rocks, the natives would bend down and blow on the "leaves" of the moss to see if any were loose, and so could tell whether the animal had passed over it or not; this action of bending down to blow seems to have given rise in certain quarters to the erroneous impression that the scent was being smelt.

soil are favourable, his own "tracks" would be quite sufficient, independently of any sign-posts so to speak, because in a camp each one's footprints are known to all the others.

The advent of strangers is recognised in other ways. The scrub-blacks on the Tully River certainly regard the screeching of the white cockatoo as warning them of danger. Just previously to one of my visits in this district, some years ago, my host (Mr. E. Brooke) had a personal experience of this kind:—While the natives were rendering him assistance with some fencing, a European stranger suddenly put in an appearance on the edge of the scrub without having been observed coming; the blacks expressed themselves in their own dialect as follows:—"What was the matter with the cockatoos? they never told us anyone was coming." On the other hand, crows, hawks, and perhaps some other birds, will indicate proximity to a camp.

The camping-ground, however, is usually sufficiently demonstrable by the fires burning, sometimes by the smell of the smoke alone. On more than one occasion my black companions have discovered a camp by the smell and the direction of the wind.

Beyond the smoke being proof positive of a fire, and so indicative of the presence of human agency, I am now satisfied, after repeated enquiry and cross-examination, that the allegation of a method of communication by so-called "smoke signal," is not warranted by the facts.

#### *Gesture Language.*

Adult man.—(= E.S. 110), G.B., P.R., Ro., and Pu. R., where, in addition, this ideagram means a father or any old man.

Bushman, traveller (Pl. xvii., fig. 1).—The left hand, holding the spear, is raised; the right arm, holding the wommera, swinging. Pu.R.

Government tracker, policeman (Pl. xvii., figs. 6, 23).—Two ideagrams representing either the peaked cap (*i.e.*, the official uniform), or the military salute. C.B.

Woman, young woman (Pl. xvii., fig. 15).—Hands rubbed up and down the corresponding breasts, Ro.; or circled round the breasts to indicate their rotundity. Pu.R.

Mother (Pl. xvii., fig. 19).—Either hand placed on corresponding breast. Ro. (Compare E.S. 112).

Mother—Pulling down the nipple to shew the dependent breast (= E.S. 113), Pu.R. At Mornington Island, on suddenly surprising some women at one of the native encampments, they not only



shrieked and screamed, but squeezed the milk out of their nipples, apparently to shew that they were mothers, and not *virgines intacte*.

Venery, solicitation, etc.—A stretching forwards, and pulling backwards of the hand to indicate the seizure of the girl's wrist when she is captured by a man, is used in combination with the sign of a young woman (rotund breasts, see *ante*) to express a man's wishes which he does not care to express verbally. Pn.R.

Venery (Pl. xvii., fig. 14).—Forefinger and thumb (representing the two thighs) are extended and widely separated. C.B.

Venery (Pl. xvii., fig. 12).—Forefinger of one hand rubbed backwards and forwards into the ring formed by the thumb and forefinger of the other hand. Ro.

Mother's or father's father (Pl. xvii., fig. 10).—The length of the thumb touching the forehead. Ro. (Compare E.S.124).

Father (Pl. xvii., fig. 3).—Thumb and fingers touching corresponding shoulder. Ro. (Compare E.S.120).

Brother, sister (Pl. xvii., fig. 7).—Extended hand situate on corresponding thigh. Ro.

Son, daughter (Pl. xvii., fig. 11).—Hand placed over the genitals. Ro.

Father's sister's child (Pl. xvii., fig. 8).—Hand extended over umbilicus. Ro. (Compare E.S. 123).

Husband (=E.S. 114). Ro.

Little brother, sister, or child.—By pointing the forefinger to the back of the neck, where the infant is most generally carried. Pn.R.

Orphan.—Represented by the signaller tugging at the nipple, and then putting the forefinger in the mouth; the idea being that the child has lost the breast at which it sucked. P.C.B.

Cattle (Pl. xvii., fig. 4).—The two horns are represented by the raised hands and flexed wrists. P.C.B. (At C.B. and P.R. = E.S. 4).

Horse (Pl. xvii., fig. 13).—The trunk, with arms fixed as depicted, is flexed alternately from side to side to shew the "swing" of the animal in motion. P.C.B.

Horse (Pl. xvii., fig. 9).—The swing of the animal is here imitated with either arm alternately. P.R.

Dog, dingo.—The heels are alternately kicked backwards along the ground and then one of the legs cocked up sideways. Ro. (At P.C.B. the ideagram = E.S.1, which in addition represents

an opossum here). Indicated by the raising of the paws (Pl. xvii., fig. 21). Pn.R.

Dog, dingo (Pl. xvii., fig. 5).—Tapping on the shoulder with the finger-tips, but no interpretation obtainable. C.B., P.R.

Kangaroo, wallaby in general (Pl. xvii., fig. 2).—In the former, the hands (the animal's paws) are held at some distance in front, and motioned forwards and upwards (the hop); in the latter, the same idea, but the hands are held closer to the chest. Pn.R.

Large Kangaroo (Pl. xix., figs. 1 and 2).—The first sign indicates large size, while the second shows the position in which the paws are held. P.R.

Kangaroo (Pl. xix., fig. 5).—Some say that the thumb represents the long ear, but the majority that it indicates the long foot. C.B.

Kangaroo (Pl. xix., fig. 8).—The two extended fingers represent the animal's elongate toes; there is a suitable accompanying movement. Ro. (Compare E.S.23).

Red Kangaroo, male (Pl. xix., fig. 3).—The leg kicking out is represented. P.C.B. Note the extended thumb as in the ideagram of a kangaroo at C.B.

Red Kangaroo, female (Pl. xix., fig. 4). Rotation at wrist with the open hand. Said to represent the movement of the animal's paws. P.C.B. At P.R. this ideagram is a sand-ridge kangaroo.

Brown Kangaroo, male (Pl. xix., fig. 7).—A vertical flexion of the wrist, indicative of the way the animal travels. P.C.B.

Brown Kangaroo, female (Pl. xix., fig. 6).—To represent the pricking up of the animal's ears. P.C.B. At P.R. this sign refers to any small kangaroo.

Scrub-Wallaby (Pl. xix., fig. 9).—In imitation of the way in which the paws are held. P.C.B.

Small Rock-Wallaby (Pl. xix., fig. 10).—Both hands with palms backwards, imitating the position of the animal's front paws, or one hand held on a higher level than the other. Ro.

White Wallaby (Plate xix., fig. 11).—Hands held, like the creature's, lower down, but with the palms up. Ro.

Paddymelon (Pl. xix., fig. 13).—In imitation of the position of the paws. C.B.

Opossum (Pl. xix., fig. 12).—Indicative of the footpads. C.B., P.R. (Compare initial position of E.S. 1).

Opossum (Pl. xix., fig. 15).—At C.B. an almost similar position is said to represent the rounded cheeks of the animal.

Bandicoot (Pl. xix., fig. 18).—The extended little finger is supposed to be the creature's long foot. P.C.B., P.R.

Porcupine (Pl. xix., fig. 17).—The thumb and little finger indicate the two feet, or according to some natives, the spines. C.B.

Porcupine (Pl. xix., fig. 20). The pricking up of the ear is imitated. P.R.

Native Companion (Pl. xix., fig. 14).—Indicating peculiarity of bill. Similar to E.S. 50, but the two fingers are in close opposition laterally instead of one being underneath the other. P.C.B., P.R.

Native Companion (Pl. xix., fig. 19).—The shin is grazed with the fingers to shew the large rough scales on the bird's legs. C.B.

Pelican (Pl. xix., fig. 16).—Slow, sluggish movement of the bird's wings. C.B. See ideagram for snake in general at P.C.B.

Duck (Pl. xix., fig. 21).—The flattened bill is represented by the forefinger flattening the tip of the nose. C.B.

Emu (Pl. xix., fig. 24).—Head and neck, with movements, imitated with the hand and forearm. C.B., P.R., Ro. (Compare E.S. 38). The local ideagram for the bird at P.C.B. (= E.S. 36).

Turkey-Bustard.—At P.C.B. (= E.S. 38), which in addition, expresses a pelican.

Cockatoo (Pl. xix., fig. 22).—The raising of the top-knot. P.R.

Cockatoo (Pl. xix., fig. 26).—Representation of the curved beak. C.B. (Compare E.S. 45).

Eagle-Hawk (= E.S. 31) Ro.—At P.C.B. and C.B. it is identical, except that the palm is turned down instead of up.

Mosquito (= E.S. 76) but on the opposite arm only at C.B.

Bee, honey (Pl. xix., fig. 23).—The open hand brushed down the side of the face which is upturned: this represents the shading of the eyes from the sun while the individual is locating the bees' nest in the tree. P.R. At Rockhampton, the signaller gazes intently on the ground for the pellets of dung, and then raises his head at the same time that he shades his eyes with his hand to escape the sunlight, etc.

Bee, honey (Pl. xix., fig. 25).—The bee (*i.e.*, the forefinger) is flying home into the hole in the tree-trunk (*i.e.*, the top of the shoulder). P.C.B., P.R.

Bee, honey (Pl. xix., fig. 27).—The tom hawk (hand) is cutting the nest out of the tree. (Compare E.S. 81). C.B.

Head-louse (=E.S. 85).—C.B., P.R.

Yam in general (Pl. xix, fig. 28).—The finger is brought sharply downwards and forwards from in between the protruded lips, and a final click made with the voice. (The wiping off of any remnant from the lips). P.C.B.

Yam (Pl. xix., fig. 34).—The shaking of the hands in this position indicates the washing of the plant during the course of preparation. C.B.

Yam (Pl. xix., fig. 29).—The act of digging it up from out of the ground. C.B. (Compare E.S. 89).

Yam (Pl. xix., fig. 30).—The rolling movement of the upper hand indicates the action of squeezing the "mush" through the interstices of the dilly-bag colander. P.R.

Water (Pl. xix., fig. 33).—Tapping with the closed fingers upon the bulged-out cheek to show there is water inside there. Pn.R., P.C.B., P.R.

Water (=E.S. 105).—C.B.

Water-hole (Pl. xix., fig. 35).—Motion of the hand shows its circumference, the previous ideagram signalled with it indicating that water is being spoken about. C.B. (Compare E.S. 108, 109 where the movement of the hand shews the convexity of a mountain, etc.).

River, creek (Pl. xix., fig. 31).—The moving arm represents the flowing water in the depression of country indicated by the flexure of the wrist of the fixed arm. P.R.

River, creek (Pl. xix., fig. 36).—The finger shews the course of the stream. C.B.

Mountain (Pl. xix., fig. 37).—The hand raised above the head to indicate both height and slope. P.R. (Compare E.S. 108, 109).

Mountain (Pl. xix., fig. 38).—Similar to preceding, the arm above the head indicating height, its motion expressing the general contour. C.B. (Compare E.S. 108, 109).

Waist-skein (=E.S. 128).—C.B.

Fore-head band (Pl. xix., fig. 41).—In the act of being put on. C.B. (Compare E.S. 130 for a correspondingly similar ideagram).

Spear (=E.S. 143).—P.C.B.

Spear, Wommera-spear (Pl. xix., fig. 40).—The finger represents the peg on the wommera, the shaking of the fore-arm indicating the quivering of the spear just previous to being thrown. Pn.R., C.B. (Compare E.S. 143).

Spear-thrower (Pl. xix., fig. 39).—Arm raised in the act of throwing. C.B. (Compare previous ideagram).

Tomahawk (=E.S. 146), but only the lower hand is used.

Large number, etc. (Pl. xviii., fig. 1).—Tapping both shoulders with the fingers. Interpretation not obtainable. P.C.B.

Large number, etc. (Pl. xviii., fig. 2).—Finger-tips on shoulders and an up-and-down movement at the elbows. Interpretation not obtainable. C.B.

Large number, etc. (Pl. xviii., fig. 3).—Indicated by the cluster of digits. When two boys are together I have seen them express this ideagram collectively by joining all four hands together in a clump. P.R. (Compare E.S. 163, 164).

Direction.—Indicated with the forefinger at C.B. (Compare E.S. 171). On the Pennefather River "to look in a certain direction" would be represented by pointing the finger to the eye, and then fixing the digit in the quarter required.

Interrogation, of any sort (Pl. xviii., fig. 4).—A movement downwards and simultaneous closure of the fingers (very like the act of catching a fly) with the palm of the hand turned away from the signaller. Pn.R.

Request, demand (=E.S. 176).—C.B.

Silence (Pl. xviii., fig. 5).—Hand placed over the closed mouth, and then turned upwards and outwards. Pn.R. (Compare E.S. 178).

Silence (Pl. xviii., fig. 9).—Open hand moved from the level of the chest downwards and outwards. C.B.

Corroboree, dance (Pl. xviii., fig. 6).—The heel is raised, with an out-and-in movement at the knee, *i.e.*, the local dancing step. C.B.

Fire (Pl. xix., fig. 32).—Blowing the spark into flame. C.B. (Compare E.S. 188). At P.C.B. the two ideagrams are identical with E.S. 188, 192.

Sleep (=E.S. 193).—C.B., P.C.B.

Swimming—Represented by a movement of the arms swimming dog-fashion

Anger (Pl. xviii., fig. 7).—Expressed by breaking the spear between the teeth. P.C.B. Also represented, as in other districts (C.B., etc.), by biting the ball of the thumb (=E.S. 199).

Anger (Pl. xviii., fig. 10).—Showing his teeth, the individual bites the spear which he is shaking with his hands on either side. C.B.

Death, killing, corpse, etc. [*a*] (Pl. xviii., fig. 8).—Flicking the sides of the chest with the thumb and middle finger, and simultaneously “clicking” with the mouth—to signify the spear, etc., entering the body. Pn.R.

[*b*] (Pl. xviii., fig. 11).—Placing the forefinger of the one hand over the corresponding finger of the other hand; its signification is the breaking of the neck. Pn.R.

[*c*] (Pl. xviii., fig. 12).—The lower edge of the hand placed at an angle over the bridge of the nose; this indicates the descending blade of the wommera. Pn.R.

[*a*] (Pl. xviii., fig. 13).—By the raised hand, with the fingers open and clawed, Pn.R. At Cape Bedford the same ideagram is complete, both hands being used with fingers in similar position, to represent the individual in the act of falling back dead.

Death, killing, corpse, etc. (Pl. xviii., fig. 14).—Closed eyes, and fixed arms in extended position; the stage of *rigor mortis*. P.R. (Compare E.S. 204).

Forgetfulness, etc. (Pl. xviii., fig. 15).—Plugging the ear with the forefinger and pulling out that which originally entered there. C.B. Amongst these natives the ear is the seat of intelligence, consciousness, etc. (Compare E.S. 205).

Knavery, foolery (Pl. xviii., fig. 18).—Tapping with the forefinger on the ear. The individual referred to will not listen to reason. See note to previous ideagram. C.B.

Derision, contempt.—Turning the buttocks at the person addressed and smacking them. P.C.B. and elsewhere.

Affirmation.—Smacking of the hip with the palm of the hand. C.B.

Negation (Pl. xviii., fig. 16).—Hand, with flexed fingers, is thrown from under the chin outwards, the fingers falling loose. Pn.R. The same idea is also represented here by the European head-shake, but whether this has been introduced or not, it is difficult to say; a similar remark may be applied to the Cape Bedford Natives, who in addition nod the head for affirmation.

Nothing, none (Pl. xviii., fig. 20).—The hand is shewn empty. C.B.

Nothing, no more (Pl. xviii., fig. 21).—In the sense of all being eaten, everything being now below that line. C.B.

Tracks.—The signaller will touch the sole of one foot (raised) with the forefinger, and point to the direction which the tracks have taken. Pn.R.

“Ghost,” evil spirit (Pl. xviii., fig. 19)—He who with his claws catches the women and children who will go out of camp at night. C.B. (Compare E.S. 213).

Good-bye (Pl. xviii., fig. 22).—Hooked forefinger points in direction of person addressed. No interpretation forthcoming. Rockhampton.

Bird, turtle (Pl. xviii., figs. 23, 24).—The same initial position for both, but in former case an outward swimming (flapper) movement, and in the latter a vertical one (wings). Pn.R.

Frog (Pl. xviii., fig. 25).—The movement of the arms represents the “jump.” P.C.B.

Iguana (Pl. xviii., fig. 29).—The wobbling gait of the creature is imitated in the position of the elbows, which are alternately drawn, one backwards, the other forwards. Pn.R. At P.C.B. it is represented by the same sign as the red (female) kangaroo, but additionally with a wobbling movement of the limbs.

Lizard (Pl. xviii., fig. 27).—A vibratile movement at the wrist—the idea of rapidity of motion. C.B. (Compare E.S. 54).

Lizard (=E.S. 54).—P.R.

Frilled Lizard (Pl. xviii., fig. 28).—Shewing the “frill” by pulling at the ear-lobe. C.B.

Crocodile (Pl. xviii., fig. 30).—The extended arm and hand represents the creature’s long snout, head and neck. P.R.

Crocodile (Pl. xvii., fig. 16).—Its snout and teeth are indicated by the forefinger and incisors. C.B.

Snake in general (Pl. xviii., fig. 17).—The forefinger is drawn slowly down from the root to the tip of the nose to indicate length. P.C.B. This ideagram indicates a pelican on P.R.

Snake in general (=E.S. 58, where the forefinger ought to be pointing downwards instead of up). C.B., Rockhampton.

Water-snake (Pl. xvii., fig. 22).—The forefinger is the animal’s head protruded above the surface of the water. C.B., P.R. (Compare previous ideagram).

Carpet-snake (=E.S. 61). C.B. It can also be indicated here (Pl. xvii., fig. 20), with the two separated digits on either side of the nose, to express the reptile’s flattened snout

Snake, fish.—Indicated by the same initial position, the extended forefinger with the thumb closed over the other fingers. In the former, the fingers traverse a sinuous course; in the latter, a vibratile movement laterally from the elbow gives the appearance of the animal when viewed through the rippling water-surface. Pn.R.

Stingaree (Pl. xvii., fig. 17).—The forefinger drawn upwards on the thigh indicates the long tail. Pn.R.

Fish, fish-net (Pl. xvii., fig. 18).—The outstretched arms with closed hands are holding the two triangular nets in suitable position for catching them; may be represented with the one hand only. Rockhampton.

Mullet (Pl. xviii., fig. 26).—The finger expresses the tail, and is moved quickly in such manner as to shew how the fish skips along the surface of the water. C.B. (No other fish is represented here).

#### PART IV.

#### A SERIES OF PROGRESSIVE EXERCISES IN THE KOKO-YIMIDIR DIALECT, WITH TRANSLATIONS.

(To accompany Bulletin 2).<sup>9</sup>

These exercises have been based, as far as possible, on those accompanying the Pitta-Pitta Grammar in the "Ethnological Studies."<sup>10</sup> As the first three examples of the latter, however, were originally drawn up only to illustrate certain peculiarities not met with in the Koko-yimidir dialect, the exercises commence here with No. 4. They have all been revised by Rev. G. H. Schwarz, Superintendent of Hope Valley Mission Station, Cape Bedford.

#### *Example 4.*

1. kalka nanu. 2. burnga ngando-ga. 3. bobo burla-ngan-be. 4. nanggor ngando-we. 5. dirimba yubalenbe. 6. bayenga danananga. 7. kalka bamaga. 8. magar ngando-we. 9. bobo nanu-mun nulu dudara. 10. goda bama-we.

#### *Translation.*

1. Thy spear. 2. A woman's dilly-bag. 3. At their (dual) place. 4. At the woman's camp. 5. The yam-stick belonging to you two. 6. Towards the hut belonging-to-them. 7. A man's spear. 8. The woman's net. 9. He is running from the direction of your place. 10. The man's dog.

<sup>9</sup> Folio, Brisbane, 1901.—By Authority.

<sup>10</sup> Roth—Ethnological Studies, 1897, p. 1.





*Example 8.*

1. peba danangan. 2. ganggal-ngai dirainggur-be. 3. ganggal-kambakamba-we ninggal burnga nangu. 4. kalka peba nanunga (*vel* nanu-me). 5. ganggal yaba-nangume. 6. wandi kabir. 7. kalka-ngai peba ngato-me. 8. burnga ngamu-nangume. 9. dirngur-ngai danangan-be. 10. bayen dirngur-ngai ngantanun-be.

*Translation.*

1. Their uncle. 2. The old-man's children. 3. A dilly-bag belonging to the old-woman's child. 4. Thy uncle's spear. 5. Her brother's child. 6. A female eagle-hawk. 7. My father's spear. 8. His mother's dilly-bag. 9. Their sisters. 10. Our sister's hut.

*Example 9.*

1. milbir yaba-nangu-me. 2. dirngar ngamu-nanu-me. 3. yambun ganguru kabir-be. 4. dirngur-ngai dirainggurbe. 5. ganggal-ngai dirngur dananganbe. 6. yaba diral-nanu-me. 7. ganggal-ngai ngamu nangu-me. 8. milbir gammi nanu-me. 9. kalka peba-ngato-nga (*vel* ngato-me). 10. burnga-ngai ngamu nanu-me.

*Translation.*

1. Her brother's wommera. 2. Thy aunt's necklace. 3. A female kangaroo's young one. 4. The old-man's sisters. 5. Their sister's children. 6. Thy wife's brother. 7. Her mother's children. 8. Your grandfather's wommera. 9. My father's spear. 10. Your mother's dilly-bags.

*Example 10.*

1. ganggal kambakamba-we dunggul pudai. 2. diral dirainggur-e nulu dirngur yerka-we kundanu. 3. ngamu-gar (-ngai) nanu dana magar peba ngatonga yitaren. 4. pitagur(-ngai) dirainggur-e dana burnga ngamu nangun-ga mane. 5. peba danangan nulu wandi-kabir pudarai. 6. peba ngauangan nulu milbir yaba nanun-ga mane. 7. ganggal yaba nanu-me nulu dakatinu. 8. dirngur-ngai ngamu nangu-me dana mayi pudal. 9. yaba peba ngato-me nulu ngamu nanu dabil. 10. yambun ganguru-kabir-e nulu munu pudaral.

*Translation.*

1. The old-woman's child was eating a snake. 2. The old-man's wife will beat the young-man's sister. 3. Your aunts brought my father's net. 4. The old-man's children fetched his mother's dilly-bag. 5. Their uncle was eating the female eagle-hawk.

6. Our father is bringing thy brother's wommera. 7. Her brother's child will sit down. 8. Her mother's sisters are eating. 9. My father's brother is kicking thy mother. 10. The female kangaroo's young-one is eating the grass.

*Example 11.*

1. dirngur dirainggur-e nulu mayi mandega. 2. kalka peba nangu  $\left\{ \begin{array}{l} \text{-ga} \\ \text{-me} \end{array} \right.$  yambun gangura-we bakanu. 3. ngamu nganangan nulu ngando kundai. 4. dirngur nangu-me nulu burnga-ngai woguren. 5. yambun wandi-we nulu boi-be ninggal. 6. yaba dirainggure nulu milbir peba ngatonga yitaren. 7. peba ngato nulu purai pudanu. 8. dirngur dirainggur-e nulu gangga bau-a-nu. 9. peba ngato nulu yaba nanu kundal. 10. diral dirainggur-e nulu pita-gur nanu gari kundanu.

*Translation.*

1. The old-man's sister was bringing the food. 2. His father's spear will hit the kangaroo's pup. 3. Our mother was beating the woman. 4. Her sister was weaving dilly-bags. 5. The eagle-hawk's young-one is sitting in the nest. 6. The old-man's brother brought my father's shield. 7. My uncle will drink the water. 8. The old-man's sister will cook the yams. 9. My father is beating your brother. 10. The old-man's wife will not strike thy children.

*Example 12.*

1. yambun buriwe ga walli dudara. 2. peba ngato nulu dirngur-nanu godera mane. 3. yaba ngato nulu dirngur nanu mandenu. 4. pitagur kambakamba-we dana ninggal. 5. yaba nangu nulu mayi nanu pudai. 6. dirngur ngato nulu yoku nanu mandenu. 7. milbir nanu warra. 8. ngayu burnga ngando-ga mandenu. 9. kalka nanu nulu ganguru tindai. 10. ngamu ngato nulu mayi dirainggur-ga pudai.

*Translation.*

1. The emu's young are running about. 2. My father married (took) your two sisters. 3. My brother will marry your sister. 4. The old-woman's children are sitting down. 5. His brother was eating thy food. 6. My sister will fetch your fire-wood. 7. Your wommera is a bad one. 8. I will bring the dilly-bag belonging to the woman. 9. Thy spear hit the kangaroo. 10. My mother is eating the old-man's food.

*Example 13.*

1. dabaigo ngayu yaba dirainggure natinu. 2. ngando burla bodan-gur-ngai burla burnga-ngai wogurnu. 3. kabir godera, burla gangga bau-ai. 4. peba nulu ganggal-ngai nangn kundal. 5. ngayu ngando-ngai godera mane. 6. yambun ganguru-we nulu mayi warkangamu pudaral. 7. buriwe warka nulu purai kandal pudaral. 8. pitagur ngato dana ningganu. 9. ngayu ngando-warra-ngai kundanu. 10. bama muru nulu milbir warka-ngai mandenu.

*Translation.*

1. I will see the old-man's brother to-morrow. 2. The two good women will be weaving dilly-bags. 3. Both girls were cooking yams. 4. The father is beating his children. 5. I married the two women. 6. The kangaroo's young is eating a lot of food. 7. A big emu is drinking the clear water. 8. My children will sit down. 9. I will beat the bad women. 10. The short-fellow will bring the long wommeras.

*Example 14.*

1. kalka dallel nulu tindalgo wanggar-waraigo dudara. 2. ngando nulu burnga bodan-ngai mane. 3. ngamu nulu purai warra pudaral. 4. kalka nulu ganguru kabir bakanu. 5. kanal dirainggure-e nulu kuman woketi. 6. ngantan (mina) buriwe pudaral. 7. burla mayi bodan mandenu. 8. bama-warragur dana milbir bodan-gur balkai. 9. burla burnga-ngai wogurgur. 10. ngali godera purai bobo-dir pudai.

*Translation.*

1. A light spear flies (runs) swiftly along the sky. 2. The woman fetched the good dilly-bags. 3. Mother is drinking dirty water. 4. A spear will hit the female kangaroo. 5. The old man's sister cut her leg. 6. We are eating emu. 7. They will both bring good food. 8. The bad men were making good spears. 9. Both are weaving dilly-bags. 10. We were both drinking muddy water.

*Example 15.*

1. nundu ganggal ngato dabelbil. 2. yambun ganguru nulu dudara. 3. dirainggur milwarga : nulu bama-kaka-we munu umalma. 4. bama yerlbur nulu mayi warka pudal. 5. ngando-burbur-ngai dana kabir kabir kima-ngai kundai. 6. buriwe yambun nulu purai warka pudanu. 7. bama pinalgo nulu ngando milwari dabinu. 8. ngando-warragur-ngai dana gari ningganu :

dana dadanu. 9. ngamu bodan-gur dana ganggal-warragur (dana ngango) kundal. 10. bama burla gangga warra gari bau-a-nu.

*Translation.*

1. You are kicking my little child. 2. A young kangaroo is running. 3. The old-man is mad: he is giving grass to the invalid. 4. A fat fellow eats a lot of food. 5. Strong women were beating the delicate girls. 6. A young emu will drink plenty of water. 7. The clever man will kick the mad woman. 8. The bad women won't sit down: they will go away. 9. Good mothers thrash their bad children. 10. The two men will not cook the yams.

*Example 16.*

1. dabaigo ngantan bayen-ga dadanu. 2. bama warra tjira-ga gari dadanu. 3. dirainggur kalka buriwe-ga dambaren. 4. ngayu kalka ganguru-ga dambar. 5. burla nanggor ( -ngan / -ngoal dudara. 6. kabir-kabir ngamugar-ngan ngondu kadanu. 7. yubal bobo bama warragur-ngan dadanu. 8. bama nulu nakalmun (*vel* nakalmungan) dudai. 9. yura mantchal warka walu ganggar-lu dadanu: piri-we walu gangar galumba garbanu. 10. ngantan nila ganguru wogurgur-nu.

*Translation.*

1. We will go to the hut to-morrow. 2. Bad men will not go to heaven (the sky). 3. The old-man threw a spear at the emu. 4. I am throwing a spear at the kangaroo. 5. They are both running away from the camp. 6. The girls will come back from their mothers. 7. You both will go away from the neighbourhood of bad men. 8. The man was running from the east. 9. You all will go to the mountain's north side (*i.e.*, cross the mountain): also across a creek (*lit.* jump to the creek's north side). 10. We will all go a-hunting kangaroos to-day.

*Example 17.*

1. ngayu goa-lu kadagaiga dadanu. 2. kamba-kamba goda dabadaba-dir-ngai ngondu kadai. 3. yaba ngato nanggor-ga walli-yirngai. 4. nulu diral nangume-ga ninggal, goda-dir milbir-tchir. 5. yerka-ngai mayi warka-dir dabaigo kadanu. 6. ngayu danangangal dadanu bobo dananganga-me (*vel* danangan-be)

7. ngali dadanu pita-dir. 8. dirainggur kalka-ngai ngalbi-nu.  
 9. kabir-kabir-be.  
 ( *vel* burnga-bodan-ngai una, *vel* burnga bodan-gur una.  
 ( *vel* burnga bodan-gur-ngai una, *vel* burnga-ngai bodan una.  
 10. yubalen ganggal-ngai ningganu.

*Translation.*

1. I shall go westwards after my possessions. 2. The old-woman returned with her big dogs. 3. My brother was running round the camp. 4. He is sitting down alongside his wife, with his dog and boomerang. 5. The boys will come back to-morrow with plenty of food. 6. I will go with them to their-place. 7. We will both run, (taking) the child with us. 8. The old-man will steal the spears. 9. The girls have good dilly-bags. 10. Both of you will have babies.

*Example 18.*

1. yambun ngamu-ngartchar-we diar-en ninggal. 2. pirra dana pinda-we una goboi kuman ngato-nga garbar dudara. 4. bunn mil-gal garbar una. 5. bama warra nulu ngando-ngai-gal garbar ningga-nu. 6. burnga ngayu bai-tchar. 7. ngando ninggal: ngayu walu dibar-ingar ningganu. 8. yoku-dingal galbai be nundu mabelbil. 9. ganguru burla godera piri wogorgor. 10. wandi nulu wanggar-go waril.

*Translation.*

1. The dingo's pup lives in the hole. 2. Leaves rest on branches. 3. A lizard is running between my legs. 4. The nose is between the eyes. 5. A bad man will sit down between the women. 6. The dilly-bag is beneath me (*lit.* I cover the dilly-bag). 7. I will sit on the south side of the women. 8. You are climbing up the tall tree-trunk. 9. Both kangaroos run-along the creek. 10. The eagle-hawk is flying through the sky.

*Example 19.*

1. kabir nulu burnga warka yaba-nangume uma. 2. peba nulu milbir ganggal nangume wudinu. 3. milbir-nda burnga baitcharen. 4. ngayu mayi ngando-gal warngur-nu. 5. mayi yerlugar gurala: mundal ngato, nundal nangu. 6. bama yerlmbur kambul dargarnu. 7. dirainggur buriwe magaren-en mandenu. 8. kumba kamba-ngun wada nambal-nda kuudal. 9. kanal-  $\left\{ \begin{array}{l} \text{to} \\ \text{ngato} \end{array} \right.$  milbir bodangur ngato wudi. 10. pirra pitagur pinda dabadaba-ve una.

*Translation.*

1. The sister is giving her brother a big dilly-bag. 2. A father will give his child a wommera. 3. The wommera is under the dilly-bag (*lit.* the dilly-bag covers, etc.). 4. I will ask food from the woman. 5. Divide the food: some for me, some for her. 6. The fat man will be full-up (stomach). 7. The old-man will catch an emu with the net. 8. An old-woman is hitting a crow with a stone. 9. My sister gave me good wommeras. 10. Small leaves rest on big branches.

*Example 20.*

1. ngantan ngondu kadai yewaigo: godera barbi. 2. ngayu godera barbi-nu: kadanu. 3. dingal-bau-aiga-me ngantan dantchinu dadara. 4. bama dadai: dirainggur ngalgonbe diral nangu mane. 5. peba ngato mayi pudaral, ngalgonbe ngayu dadanu. 6. ngurgoigo ngayu dunggul kundai. 7. dabaigo-bada ngayu dirainggur kundanu. 8. keda nobango dirainggur-warragar ngondu kadanu. 9. ngando mamba-dir nulu goda dargai nangu-me dabaigo mayi wutinu. 10. nulu purai-kandal-be maril.

*Translation.*

1. We all returned three days ago (*lit.* we came back here: slept twice). 2. I will come back in three days time (*lit.* I will sleep twice, etc.). 3. At sunrise, we will all go for a dive. 4. While the man went away, the old-man stole his wife. 5. When my father is eating, I shall go away. 6. I hit a snake yesterday. 7. The day after to-morrow I will strike the old-man. 8. The wicked old men will come back in a month's time. 9. The fat woman will to-morrow give food to her thin dog.

*Example 21.*

1. ngando-we burnga woa: purai-kaka galmba. 2. ngando burbur nulu daba-dir dudara. 3. bama nulu nanggor-ga ngondu kadara: diral nangu galmba. 4. dirainggur nulu milbir-ngai mandenu: kalka-ngai galmba. 5. kanal-to (mina) dunggul pudaral: yaba-to galmba. 6. nayuu bama ninggal: nangu kalka kundo una. 7. nundu kalka kundo nangunga ngalbi. 8. pitagur-nanu-ngu:—nanu milbir-ngai ngayu wudinu. 9. bayen-ga ngatan yirnganu. 10. dirainggur diral-ga ningganu.

*Translation.*

1. Give the woman a dilly-bag: and  $\left. \begin{array}{l} \text{sick} \\ \text{bad water} \end{array} \right\}$  (*lit.* grog) also. 2. The strong woman is running with a yam-stick. 3. The

man returns to camp : and his wife too. 4. The old-men will bring wommeras, and spears also. 5. My sister is eating a snake, and so is my brother. 6. That fellow yonder has three spears. 7. You stole his three spears. 8. I shall bring you the wommeras for your children. 9. We will run-around the hut. 10. The old-man will sit by his wife.

*Example 22.*

1. kalka ngalinun walu gulboigo. 2. nanu milbir moimon : ngato gura-moimon. 3. goda burla ganguru tindal gulboigo. 4. bama nulu dani dadara, yimidir golan. 5. ngando purai warka pudal, yimidir kutchu. 6. dirimba nanu gura milbir ngato galbai-gulboigo. 7. goda yerlmbur : bama nulu gura-yerlmbur. 8. kabir nulu wau-u-bieni : bama nayun gura-waubieni. 9. yewaigo bama warka ninggal : nayun gura-warka. 10. milbir galbai kalka gura-galbai.

*Translation.*

1. Our two spears are similar. 2. My wommera is smoother than yours. 3. A dog runs as quickly as a kangaroo. 4. The man is walking as slowly as an opossum. 5. The woman is drinking as much as a fish. 6. Your yam-stick is as long as my wommera. 7. The man is fatter than a dog. 8. A man is more thirsty than a girl. 9. There are a larger number of people there than here. 10. A spear is longer than a wommera.

*Example 23.*

1. goda kabir wau-u-bieni : goda yerka gura waubieni. 2. nundu kana balkati : ngayu goror. 3. wandu kana yerlmbur : yerka ngoba, kabir ngoba. 4. nundu waubieni : nganda gura-waubieni. 5. nulu karbunmal : nundu gura karbunmal. 6. bama nulu wobuntchir manaya. 7. mantchal yinaren kana warka. 8. nayun mantchal : nulu warka-budon. 9. ngando nulu tindalگو dudai. 10. dirainggur nulu kana muru ninggal.

*Translation.*

1. The dog is more thirsty than the slut. 2. I am younger than you (*lit.* you were born first : I after). 3. Who is the fattest ? the man or the woman ? 4. The woman is more thirsty than you. 5. You are-happier (to be glad) than he is. 6. The man will be satisfied. 7. These mountains are the highest. 8. That hill is very big. 9. The woman was running very quickly. 10. The old-man is the smallest.



*Example 24.*

1. wandi, nulu kana tindal waril. 2. milbir kana galbai una : nayun ngayu mandenu. 3. nundu burnga dara-pita-dir ngondu kadai. 4. yaba nanu milbir pita-pita manana. 5. ngamu yambun-go yimi-yimidir mil-waril. 6. ngayu kalka galbai-budon uma : ngato dirlen milbir muru-budon woa. 7. milbir dara muru ngato woa. 8. nulu bayen pita-budon-ga dudanu. 9. ngando nayun nulu burnga-ngai mandega. 10. kalka yimidir mande.

*Translation.*

1. The hawk is the swiftest, *i.e.*, flies very quick. 2. I will bring the longest sword (*lit.* the longest sword exists: I will bring it). 3. You were coming back with a small dilly-bag. 4. Your brother is fetching a comparatively-short wommera. 5. The mother is as mad as her child (this is a special form to express "mother-and-child"). 6. My spear is very long: give me in exchange the smallest wommera. 7. Give me a fairly short wommera. 8. He will be running to the smallest hut. 9. That woman yonder was bringing dilly-bags. 10. Fetch a similar spear.

*Example 25.*

1. peba nulu yumur nangu-go kundamu : nulu bodan ningganu. 2. nanggor-go ngayu ninggal : kokoyimidir mandenu. 3. ngando nulu duno nangu detchuren : nulu ngani kundanu. 4. nundu yaba ngato detchuro : nulu ganguru wogurnu. 5. ngali diraing-gur-e mayi wudinu. 6. nundu yaba ngato detchuren : nulu koko-mul matinu. 7. ngayu nangu gunggar-ngun deganu. 8. bama nulu mayi-ngu nanggor-ga koko-balkal. 9. ngamu nulu ganggal nangu mari-nu pinal-gural. 10. kamba kamba nulu kabir burnga : wogurnu pinal-gural.

*Translation.*

1. A father will beat his son to (make him) be good. 2. I am sitting down in the camp to learn koko-yimidir. 3. The woman told her husband to hit me. 4. Tell my brother to hunt kangaroo. 5. We will both give the old-man something to eat. 6. You told my brother to be silent. 7. I will send her away from the north. 8. The man is asking for food to bring to the camp. 9. A mother teaches her infant to swim. 10. The old-woman will teach the girl (how) to weave a dilly-bag.

*Example 26.*

1. bayen kanal nanume : nulu wauu-dir waminu. 2. ngantan dabaigo buriwe pudal ngoba ! 3. godera barbega : ngayu ngondu kadanu ngoba. 4. ngando warragur-ngai danangan ngayu kundanu. 5. ngali nila bama warra-ngoal dudanu. 6. bobonanume ngayu wauu-dir ningganu. 7. goderego barbila : kadanu nundu. 8. dana ganguru nila wau-u-dir wogurnu. 9. nulu yirgalgal magar-tchir kadanu. 10. bama muru nulu bama galbai kundaya.

*Translation.*

1. He would like to go (*lit.* he will go with-all-his heart) to your sister's hut. 2. We are perhaps eating the emu to-morrow. 3. I may perhaps come back in two days (*lit.* having-slept twice, etc.). 4. I will beat the bad women. 5. We-two are about to run away from the direction of the bad men. 6. I would like to sit-down at your place. 7. You must come back in three days (twice slept). 8. They would like soon to go emu-hunting. 9. He is speaking about coming with a net. 10. The short fellow might hit the tall one.

*Example 27.*

1. yubal dadara : budo galakati ; ngatonga ngondu gari gura kada. 2. yura warkangamu buriwe warka pudala. 3. diraing-gur ! nundu ngondu kada ! ngatonga mayi pudala. 4. danangan warka-ngamu detchuro dudor ningganu. 5. koko-yimidir ngato merila : ngayu koko mandenu. 6. mayi nila pudanu : nundu ngantanun nila woa. 7. ngando warra ngayu dubinu. 8. bayen ngamu-ngato-me ngayu gurna unanu. 9. yerka nulu yoku-dingabe madatinu : nangu ngandaimara. 10. kalka-ngai ngondu maude : dana damaigamu.

*Translation.*

1. Go away, you two fellows, keep going : don't come back to me here. 2. Here ! all you people ! come and eat the big emu. 3. Come back here, old-chap, and dine with me. 4. Tell the whole lot of them to be quiet. 5. Teach me to speak koko-yimidir ; I will learn. 6. Give us this day our daily bread (*lit.* to eat to-day : give us food now). 7. I shall leave the bad woman. 8. Permit me to rest in mother's hut. 9. The boy will climb the tree-trunk : don't let him. 10. Bring the spears here : or they will fight.

*Example 28.*

1. dirainggur warkangamu damalmati. 2. ngurgoigobada, ngayu ngakul dumbeti. 3. dabaigo nulu-go durnggáya. 4. kalka gura milbir-tchir ngali wudaya. 5. ngalau puleli: burla wametinu. 6. nulu-go nambal-nda kundati. 7. piri burla wameya: nayum nundu nangu waminu. 8. bayen ngando-we dana yirgalgal. 9. dirainggur gura kambakamba milbir-tchir dana kundatinu. 10. ngayu kuman dumbeya.

*Translation.*

1. The whole lot of the old men were fighting between themselves. 2. I broke my arm the day-before-yesterday. 3. He will smear himself to-morrow. 4. We two are bartering a spear for a wommera. 5. They-two will meet one another, when the sun goes down. 6. He was hitting himself with a stone. 7. You will meet him, where the two-rivers meet. 8. They were all chattering in the woman's hut. 9. The old-man and the old-woman will be hitting each other with wommeras. 10. I might break my leg.

*Example 29.*

1. pitagur kambakamba-we piri-we walli-maril. 2. yambun ganguru-we munu-we walli-dudara. 3. dirainggur mayi-we: ngando nulu purai pudarai. 4. peba-to nila gari dadanu: nulu mil-waril. 5. yambun goda-we piri-we walli-marinu. 6. ngando kaka-dir nulu bantchentchil. 7. ngali kabir kima bantchinu. 8. mil-nda nangu gari dubila nulu kalka ngalbegamu. 9. dirainggur mayi-we ningganu. 10. bama bodan gari bieninu.

*Translation.*

1. The old woman's children are swimming about in the river. 2. The kangaroo's pups were running about among the grass. 3. The old-man was at dinner; the woman was having a drink. 4. Father will not get away to-day; he is drunk (*lit.* eyes-fly). 5. The dog's pups will be swimming about in the creek. 6. He is attending to the sick woman. 7. We will both look after the delicate girl. 8. Do not let him steal the spear (*lit.* do not take your eyes off him: he might steal the spear). 9. The old-man will be at dinner. 10. Good men will not die.

*Example 30.*

1. diral ngato nulu dadara. 2. bayen nundu unanu: ngayu nama. 3. milbir nundu mane: nayun ngato woa. 4. Yerka yoku-we mabelbi: nayun nundu bandi. 5. goda diral nanu-we

melbi: nangu ngayu kundanu. 6. ngando-we nundu burnga wudinu: ngando nayun ngali nati. 7. bama mayi warka pudaral: nulu wobun-tehir manaya. 8. bama dinggadir nulu mayi warka pundanu. 9. kamba kamba yoku bantinu. 10. yaba nanu bobo nangu-me ninggal

*Translation.*

1. My wife is going away. 2. I see the hut you will be sleeping in. 3. Give me here the wommera which you fetched. 4. You were cutting the tree which the boy climbed. 5. I will strike the dog which you promised to your wife. 6. We both saw the woman whom you will give the dilly-bag to. 7. The man who eats too much food will be full-up. 8. A fellow who is hungry will eat plenty. 9. The old-woman will cut the fire-wood. 10. Your brother is sitting down at-her-place.

*Example 31.*

1. bama yura bodan ninggal: yura gari bieninu. 2. kalka bama-we ngayu ngalbinu. 3. nulu kalka nanu dumbinu ngayu nanu yendu wudinu. 4. burnga kabir-ga nundu ngalbi: nayun kabir ngayu nati. 5. ganggal nulu ngalbinu: nangu ngayu nama. 6. ganguru nulu kundanu: nangu ngayu pundanu. 7. kutchu ngayu karbanu: nangu nulu pundanu. 8. kalka dirainggur-ga nundu mane: dirainggur nulu bobo ngato-me ninggal. 9. bama nayun nulu ganggal unggadir kundanu. 10. golan yambun-gar walli dudara: ngamu danangan ngayu pudanu.

*Translation.*

1. You who are good, will not die. 2. I will steal another's (*i.e.*, a man's) spear. 3. He will break your spear: I will give you another. 4. I saw the girl whose dilly-bag you stole. 5. I see the child which he is going to steal. 6. He will hit the kangaroo, which I intend eating. 7. I will catch the fish which you will eat. 8. The old-man, whose spears you brought, is sitting at my place. 9. He yonder will strike the child who is crying. 10. I will eat the opossum whose young are running about.

*Example 32.*

1. wandu nanu milbir wudi! 2. ngando ganggal-tehir wandu nulu? 3. wanun nundu wamil! 4. ganggal wanun? nanu? 5. ngando nayun wanun-gal ninggal! 6. wondalga bama nulu dadara! 7. nganingan nundu kaka una! 8. yoku wonda nulu golan mane! 9. ngato merila, peba, nganna! 10. mina ganguru wonda ngantan pudanu.

*Translation.*

1. Who gave you the wommera? 2. Who is the woman with a child? 3. To whom are you going? 4. Whose child? thine? 5. Alongside whom is that-woman-yonder sitting? 6. Whither is the man travelling? 7. Why are you sick? 8. From which tree did he fetch the opossum? (*lit.* where the tree he took the opossum from?) 9. Tell me, father, what (do you want). 10. Where is the kangaroo we are going to eat?

*Example 33.*

1. nangu mayi gangga mundal-go una. 2. dirainggur-e mayi warka unanu. 3. ngando-we nayun mayi warka woa. 4. ngato mayi gangga warka una. 5. ngayu mina kutchu warka magar-tchir mandenu. 6. dana kadagai-tchir kadanu. 7. piri burla wameya: bama warkangamu  $\left\{ \begin{array}{l} \text{namo} \\ \text{nayun} \end{array} \right.$  dadanu. 8. ngando-ngai warkangamu didar-ngan ngondu kadara. 9. dirainggur nulu nanggog-ga ngondu kadai, ngando galmba. 10. yerka mayi pudal: kabir galmba.

*Translation.*

1. She has a small quantity of yams. 2. The old man will have a lot of food. 3. Give that woman yonder a large quantity of food. 4. I have a large amount of yams. 5. I shall catch a large amount of fish with my net. 6. They will come with all their possessions. 7. All the men will go to where-the-rivers-meet. 8. The whole lot of women are returning from didar (Cape Bedford). 9. The old-man came back to camp: and so did the woman. 10. The boy is eating—and the girl too.

*Example 34.*

1. bama nulu milbir mandenu: kalka galmba. 2. dirainggur kundodana yerlugar-go ninggal. 3. kalka, wondara nanu una? 4. ganggal wondara galbai? 5. nanu mayi gangga warka una? 6. mina kutchu warka nundu mane? 7. nulu kutchu kundoigo mane: ngayu warkangamu. 8. dongoinga-ngai dana murkar walu pita, kundoigo galmba murkar ninggal. 9. dana ngando-ngai yerlugar-go yoku yubaigo ninggal. 10. buriwe-ngai dana mina dabadaba: dana warkangamu galmba ninggal.

*Translation.*

1. The man will fetch the wommera: and the spear too. 2. Three old men are sitting apart (*lit.* there are three old men: they are sitting apart). 3. How many spears are yours?

4. How big is the child? 5. Have you a large quantity of yams? 6. What quantity of fish have you brought? 7. He caught a few fish: I caught a lot. 8. Ducks are a bit small: and they are also scarce. 9. The women are sitting apart near the tree. 10. The emus are large: they are also plentiful.

*Example 35.*

1. bama nulu bodan ngoba: ugayu pinal-mul. 2. ngando nulu bodan ngoba, warra ngoba: ngayu pinal-mul. 3. nulu dadai ngoba: gari ngoba. 4. mina-ganguru purai-e maril ngoba, —(ngayu) nadelmul (go) 5. goda-we ngayu mina mundal wudinu? 6. ngautan yuelelinu! ningga-nu ngoba? 7. ngando-ngai ngauni ninggal? 8. nanu-ngu ngayu nanggorga dudanu? 9. ngalan netchin yandal. 10. garko nundu ngondu kadanu? manu-budon!

*Translation.*

1. One hardly knows whether this fellow is a good one. 2. This woman may be good or bad: I don't know. 3. One hardly knows whether he went or not. 4. One would think that a kangaroo swims, but you can't be sure. 5. Shall I give the dog some food? 6. Shall he stand or sit? 7. Why are the women sitting? 8. Shall I run up to the camp for you (for your advantage, etc.) 9. The sun rises daily. 10. Will return later on. Certainly!

*Example 36.*

1. nundu purai kana pudala: mayi goror. 2. gari dadara, burnga ngato kana woa. 3. nanggor-ngan ngayu kana dadanu, nulu goror. 4. wondalngan nundu milbir mane? 5. mina golan wonda ninggal? yoku-we? 6. wondalga nundu dadara? 7. bobo wanun-game nulu ninggal? 8. didar bobo yubaigo! galakati. 9. ngautan ngondu kadamu. nila? ngan-go! 10. kanabudo!

*Translation.*

1. Drink before you eat. 2. Give me a dilly-bag before you go (*lit.* don't go! give me a dilly-bag first). 3. He will be going away from the camp after I do. 4. From whereabouts did you fetch the boomerang? 6. Where does an opossum live? In a tree. 5. Whither are you going? 7. At whose place is he staying? 8. How far is didar (Cape Bedford)? 9. We shall soon come back. When? Soon. 10. Adieu.

*Example 37.*

1. kabir nulu ngakul dumbediga, nulu nanggor-ga dudai. 2. nundu mayi pudaiga, wobuntchir-mati. 3. ngayu nina kundaiga : nundu dudai. 4. nundu ngani dabega ; ngayu batchi. 5. dirainggur kuman dumbetiga : nulu dakati. 6. ngando nulu mangal wokedi : nulu bayen ngato-me ngondu kadai. 7. dantchega : ngayu durnggatinu. 8. ngayu dadai-game nundu ngato ganggal nawa. 9. mareliu-ga : kamba-kamba nulu tamal nambalnda woketi. 10. bama nayun tindal-be kuman dumbeti.

*Translation.*

1. Having broken her arm, the girl ran up to the camp. 2. After having had your food, you were full up. 3. Being struck by me, you ran away. 4. I cried because you kicked me. 5. Having broken his leg, the old-man sat down. 6. The woman came back to my place : she had cut her hand. 7. When I have had a swim, I will grease myself. 8. Look after my child when I am gone. 9. While swimming, the old-woman cut her foot with a stone. 10. That fellow yonder broke his leg when running.

*Example 38.*

1. mina golan ngayu woguren : ngakul dumbeti. 2. peba nanu nina degai : nayun bobo wamila. 3. ngayu garko nanggor-ga ngoddu kadara : nundu ngato gangga wudinu ? 4. ngamu-to ngantanun detchuren, nawaigo ngantan ningganu. 5. nulu detchurenga : yura dadara. 6. ngamu nangu detchuren : nayun nulu pudanu. 7. yerka ngurgoigo kadai : nangu ngayu mayi wudi. 8. mayi pudaiga : bama nulu dudai. 9. yerka batcheltchil : yaba nangu-mun kundaiga. 10. kanabudo ! ngayu wauubieni.

*Translation.*

1. While after opossums, I broke my arm. 2. Go to that place your father told you. 3. Will you give me yams (when) I come back to camp by-and-by ? 4. We shall stay (where) mother told us. 5. You are going, as he told you. 6. He will eat what his mother told him. 7. I gave food to the boy who came yesterday. 8. Having had his dinner, the man ran away. 9. The boy is crying because his brother hit him. 10. Enough ! that'll do ! I am tired.

MOLLUSCA FROM ONE HUNDRED FATHOMS,  
SEVEN MILES EAST OF CAPE PILLAR, TASMANIA.

By C. HEDLEY, Conchologist, and W. L. MAY.

(Plates xxii-xxv.)

No vessel equipped for deep sea investigation like the "Challenger" has ever explored the Tasmanian coast. The nearest point where a deep sea dredge has been hauled is off Twofold Bay, about four hundred miles from the scene of our work. Hitherto Tasmanian naturalists have confined their attention to shallow and sheltered waters.

To search further and deeper the writers engaged the "Sea-Bird," a serviceable steamer of twenty-five tons, and spent some hours of December 17th and 18th, 1907, in dredging around a spot seven miles east of Cape Pillar in an estimated depth of one hundred fathoms. We enjoyed the company and assistance of Dr. J. C. Elkington during the cruise. The weather was rough and unpleasant, and the success attained was due to the skilful management of the apparatus by the ship's engineer, Mr. Gulliver. We employed the bucket dredge, and for the final haul trailed a dredge behind the bucket with excellent results.

The submarine slope of the land is here extremely steep. The contour has not been fully developed by soundings, but the few scattered observations indicate that a depth of three hundred and forty-three fathoms is reached about eight miles from the land, descending to over a thousand fathoms at twelve miles and the level floor of the abyss, two thousand two hundred and seventy five fathoms beneath the surface, is attained at a distance of seventy miles.

A remarkable feature was the total absence of mud in the area examined. The hard ground diminished the proportion of bivalves to gasteropods. The sea-floor was shown by the dredge to be carpeted by a dense growth of tunicates, aleyonaria, sponges, bryozoa, etc., on a firm bottom of sand, rolled pebbles, and a conglomerate of recent shells. The rock was hard enough to dint the lip of the bucket. Some specimens of the siliceous pebbles, quartz, chert, jasper, etc., which Dr. C. Anderson kindly weighed for us, were 1.092, 0.774, and 0.509 grams respectively. The coral *Flabellum australe*, Moseley, was abundant, and reached a large size. While we worked, a strong current drifted us north-



wards, and we were led to believe from the fauna and composition of the sea-floor that this powerful current swept the bottom clear of mud, even at a depth of a hundred fathoms.

We have here increased the known marine mollusca of Tasmania by one-eighth. Probably so large a proportion will never again be added in one act. Including fragments, illegible or undetermined forms, the collection amounts to about two hundred and eighty species, of which we record two hundred and fourteen. Representatives of groups other than the mollusca have been handed to specialists, and it is hoped that further reports may appear.

Under the giant cliffs of Tasman Island have sailed so many great captains and so many famous naturalists, that the spot has revered memories to inspire the worker of to-day. For here in 1642 passed Abel Janz Tasman in the "Heemskerck" and "Zeehan." After a long interval the ill-fated Marion du Fresne followed him in 1772. Five years later came Cook in the "Resolution." The "Recherche" bore D'Entrecasteaux with La Billardière in 1792. And Péron with Freycinet under Baudin voyaged in the "Géographe" and "Naturaliste" in 1802. Past here again, in 1826, Quoy and Gaimard travelled in the "Astrolabe" under Dumont D'Urville. From the deck of the "Beagle" Darwin saw the huge basalt columns in 1836. Four years later his friend Hooker, under Ross, passed in the "Erebus" and "Terror."

The following are the species identified. A star (\*) indicates that the species has not been recorded from Tasmania:—

- \**Scissurella australis*, Hedley.
- Schismope atkinsoni*, Tenison Woods
- ,, *pulchra*, Petterd.
- \**Emarginula superba*, Hedley and Petterd.
- ,, *caudata*, A. Adams.
- Fissurella concatenata*, Crosse and Fischer.
- \**Gibbula galbina*, Hedley and May.
- \**Monilea philippensis*, Watson.
- Cantharidus irisodontes*, Quoy and Gaimard.
- \**Calliostoma columnarium*, Hedley and May.
- ,, *incertum*, Reeve.
- ,, *alporti*, Tenison Woods.
- \*    ,, *retiarium*, Hedley and May.
- ,, *hedleyi*, Pritchard and Gatliff
- ,, *legrandi*, Tenison Woods.
- Astele subcarinatum*, Swainson.
- \**Basilissa niceterium*, Hedley and May

- Euchelus scabriusculus*, Angas.  
*Cirsonella weldii*, Tenison Woods.  
*Cyclostrema crebrisculptum*, Tate.  
     "    *micron*, Tenison Woods.  
     "    *inscriptum*, Tate.  
     "    *charopa*, Tate.  
     "    *angeli*, Tate.  
     "    *porcellanum*, Tate and May  
*Luotia annulata*, Tenison Woods.  
     "    *josephi*, Tenison Woods.  
 \* "    *petalifera*, Hedley and May.  
 \* "    *mayana*, Tate.  
*Acmaea flammea*, Quoy and Gaimard.  
     "    *calamus*, Crosse and Fischer.  
 \* *Phenacolepas calva*, Verco.  
*Cocculina tasmanica*, Pilsbry.  
*Rissoa unilirata*, Tenison Woods.  
 \* "    *columnaria*, Hedley and May.  
     "    *olivacea*, Frauenfeld.  
     "    *layardi*, Petterd.  
     "    *dubitabilis* Tate.  
     "    *approxima*, Petterd.  
     "    *cheilostoma*, Tenison Woods.  
     "    *tenisoni*, Tate.  
     "    *tasmanica*, Tenison Woods.  
 \* "    *incompleta*, Hedley.  
 \* *Rissoina lineata*, Hedley and May.  
 \* "    *jansta*, Hedley and May.  
     "    *gertrudis*, Tenison Woods.  
 \* *Capulus devotus*, Hedley.  
*Cerithiopsis semilævis*, Tenison Woods.  
     "    *turbonilloides*, Tenison Woods.  
     "    *crocea*, Angas.  
     "    *purpurea*, Angas.  
*Atacocerithium serotinum*, A. Adams.  
*Triphora granifera*, Brazier.  
     "    *angasi*, Crosse and Fischer.  
     "    *tasmanica*, Tenison Woods.  
     "    *fasciata*, Tenison Woods.  
 \* *Turritella smithiana*, Donald.  
 \* "    *cupulenta*, Hedley.  
     "    *subsquamosa*, Dunker.  
     "    *accisa*, Watson.  
 \* *Epitonium morchi*, Angas.  
 \* "    *validum*, Verco.

- \**Crossea carinata*, Hedley.  
 „ *cancellata*, Tenison Woods.  
 \**Sirius badius*, Tenison Woods.  
*Siliquaria weldii*, Tenison Woods.  
 \**Vermicularia nodosa*, Hedley.  
 \* „ *flava*, Verco.  
 \**Enlima munita*, Hedley.  
*Odostomia metcalfei*, Pritchard and Gatliff.  
 \**Turbonilla scalpidens*, Watson.  
 „ *hofmani*, Angas.  
*Cingulina spina*, Crosse and Fischer.  
 \**Pseudorissoina capitivara*, Hedley and May.  
*Oscilla tasmanica*, Tenison Woods.  
 \**Septa petulans*, Hedley and May.  
 \**Cymatium columnarium*, Hedley and May.  
 „ *kampylum*, Watson.  
 \**Natica elkingtoni*, Hedley and May.  
 „ *subcostata*, Tenison Woods.  
 „ *tasmanica*, Tenison Woods.  
 „ *umbilicata*, Quoy and Gaimard.  
*Polinices beddomei*, Johnston.  
 \**Amauropsis globulus*, Angas.  
*Calyptraea pellucida*, Reeve.  
 „ *calyptraeformis*, Lamarck.  
*Trivia australis*, Lamarck.  
*Cypraea angustata*, Gmelin.  
*Cassidea pyrum*, Lamarck.  
 \**Marginella agapeta*, Watson.  
 „ *biplicata*, Tate and May.  
 \* „ *columnaria*, Hedley and May.  
 „ *cratericula*, Tate and May.  
 \* „ *flindersi*, Pritchard and Gatliff.  
 \* „ *lævigata*, Brazier.  
 „ *mayi*, Tate.  
 „ *mustellina*, Angas.  
 „ *ovulum*, Sowerby.  
 „ *simsoni*, Tate and May.  
 \* „ *stilla*, Hedley.  
 „ *tridentata*, Tate.  
*Ancilla marginata*, Lamarck.  
*Terebra bicolor*, Angas.  
 \**Cancellaria pergradata*, Verco.  
 „ *lævigata*, Sowerby.  
*Mitromorpha alba*, Pritchard and Gatliff.  
 \* „ *pallidula*, Hedley.

- \**Drillia haswelli*, Hedley.  
 \* „ *nenia*, Hedley.  
*Daphnella kingensis*, Petterd.  
 „ *minuta*, Tenison Woods.  
 \* „ *excavata*, Gatliff.  
*Donovania fenestrata*, Tate and May.  
 \**Mangelia dyscritos*, Verco.  
 „ *delicatula*, Tenison Woods.  
 \* „ *spica*, Hedley.  
 „ *cancellata*, Beddome.  
 „ *granulosissima*, Tenison Woods.  
 „ *molestata*, Angas.  
 „ *desalesi*, Tenison Woods.  
 \* „ *hilum*, Hedley.  
*Scaphella papillosa*, Swainson.  
 „ *manilla*, Gray.  
*Mitra tasmanica*, Tenison Woods.  
 \* „ *vincentiana*, Verco.  
 „ *scalariformis*, Tenison Woods.  
 \**Microvoluta purpureostoma*, Hedley and May.  
*Euthria tenuicostata*, Tenison Woods.  
*Pisania reticulata*, A. Adams.  
*Colubraria bednalli*, Brazier.  
 \**Arcularia mobilis*, Hedley and May.  
 \* „ „ var. *costata*, Hedley and May  
 „ *jacksonensis*, Quoy and Gaimard.  
 \**Pyrene plexa*, Hedley.  
 „ *angasi*, Brazier.  
 \**Murex livinus*, Hedley and Petterd.  
 „ *angasi*, Crosse.  
 \**Trophon columnarius*, Hedley and May.  
 \* „ *molorthus*, Hedley and May.  
 „ *petterdi*, Crosse.  
 \* „ *rudolphi*, Brazier.  
 \* „ *sarmentosus*, Hedley and May.  
 \* „ *simplex*, Hedley.  
 \* „ *stimuleus*, Hedley.  
 \**Coralliophila lischkeana*, Dunker.  
*Cylichna arachis*, Quoy and Gaimard.  
*Leucotina micra*, Pritchard and Gatliff.  
 \**Philina columnaria*, Hedley and May.  
 \**Limacina inflata*, D'Orbigny.  
 \**Carolina trispinosa*, Leseur.  
 \* „ *tridentata*, Forskal.  
 \**Clio virgula*, Rang.

- \* *Clio pyramidata*, Linne.
- \* „ *balantium*, Rang.
- \* *Acanthochites crocodilus*, Torr and Ashby.
- \* *Lepidopleurus columnarius*, Hedley and May.
- Cadulus spretus*, Tate and May.
- \* *Nucula beachportensis*, Verco.
- „ *micans*, Angas.
- „ *obliqua*, Lamarck.
- \* *Limopsis tenisoni*, var. *penelopeis*, Verco.
- Lissarca rubricata*, Tate.
- \* „ *rhomboidalis*, Verco.
- Arca reticulata*, Gmelin.
- \* *Glycymeris sordida*, Tate.
- „ *tenuicostata*, Reeve.
- Philobrya fimbriata*, Tate
- Philippiella crenatulifera*, Tate.
- „ *rubra*, Hedley.
- Ostrea angasi*, Sowerby.
- Trigonia margaritacea*, Lamarck.
- Chlamys asperrimus*, Lamarck.
- Pecten medius*, Lamarck.
- \* *Cyclopecten nepeanensis*, Pritchard and Gatliff.
- \* „ *obliquus*, Hedley.
- \* *Lima angulata*, Sowerby.
- „ *bullata*, Born.
- „ *lima*, Linne.
- \* *Limea murrayi*, Smith.
- Mytilus planulatus*, Lamarck.
- Modiola australis*, Gray.
- Modiolaria barbata*, Reeve.
- Thraciopsis angustata*, Angas.
- Myochama anomioides*, Stutchbury.
- Myodora albida*, Tenison Woods.
- „ *ovata*, Reeve.
- Cuspidaria tasmanica*, Tenison Woods.
- Cuna atkinsoni*, Tenison Woods.
- \* „ *compressa*, Hedley and May.
- „ *delta*, Tate and May.
- \* „ *hamata*, Hedley and May.
- Mytilicardia calyculata*, Linne.
- Venericardia anabilis*, Deshayes.
- \* „ *caratica*, Hedley.
- \* „ *columnaria*, Hedley and May.
- \* „ *dilecta*, Smith.
- „ *rosulenta*, Tate.

- \**Condylocardia porrecta*, Hedley.  
 „ *pectinata*, Tate and May.  
 \**Codakia jacksonensis*, Smith.  
 „ *tatei*, Angas.  
 \**Diplodonta adamsi*, Angas.  
 „ *zealandica*, Gray  
 \**Bornia radiata*, Hedley.  
*Dosinia caerulea*, Reeve.  
*Chione gallinula*, Lamarck.  
*Tellina decussata*, Lamarck.  
 \**Soletellina hedleyi*, Sowerby.  
*Saxicava arctica*, Linne.  
*Panopaea australis*, Sowerby.  
*Megasella cumingi*, Davidson.  
*Kraussina atkinsoni*, Tenison Woods.  
 \**Terebratulina radula*, Hedley.  
 „ *cancellata*, Koch.  
 \**Cryptopora brazieri*, Crane.

We have placed the whole of the types of the new species in the Australian Museum collection ; they are as follows :—

GIBBULA GALBINA, *sp.nov.*

(Plate xxii., fig. 2).

Shell depressed-turbinata, broadly perforate, translucent, glossy. Colour variable, either uniform buff, uniform white, or brown spirals on a white ground. Whorls four and a half, rounded on the base, subangled at the periphery, flattened above and impressed at the suture. Sculpture : the protoconch smooth, the next whorl with a couple of spiral keels, which by intercalation multiply in number, but decrease in relative importance as the whorls advance, the last whorl carrying close fine spiral threads, of which every fourth or fifth predominates. The radials are confined to faint growth lines. Aperture slightly descending, oblique, angled above, rounded below: outer lip simple; columella expanded, and a little reflected above, a substantial callus unites the lips. Umbilicus deep, narrow, spiral, externally funicular, exempt from the spiral sculpture. Height, 5.5 mm.; maj. diam. 7; min. diam. 6 mm.

Several specimens.

The novelty is nearest to *G. tasmanica*, Petterd, of which it may be regarded as a deep water representative. *G. galbina* is thinner, larger, proportionately lower and broader, and more

widely umbilicate. A single specimen of *G. galbina* was taken by the "Thetis" in 63-75 fathoms off Port Kembla, New South Wales, but was catalogued<sup>1</sup> as *G. tasmanica*, Petterd.

CALLIOSTOMA COLUMNARIUM, *sp. nov.*

(Plate xxii., fig. 3).

Shell rather solid, imperforate, turbinate, angled at the periphery. Colour buff. Whorls five and a half, including a protoconch of a whorl and a half, which is tilted, malleated, and concluded by a small varix. Sculpture: three spiral keels appear on the second whorl; as growth proceeds these increase in number but decrease in strength, till at last behind the aperture they are represented by twenty engraved spiral lines extending from the suture to the centre of the base. These are decussated by faint oblique growth lines. Aperture oblique, rhomboidal, outer lip simple, columella thickened, insertions joined by a thin callus. Height, 7.5; maj. diam., 8; min. diam., 7 mm. A larger broken specimen is 10 mm. in major diameter.

Four imperfect shells were taken. In general appearance this resembles *C. legrandi*, Tenison Woods, but differs by blunter keel and the distant engraved spirals.

CALLIOSTOMA RETIARIUM, *sp. nov.*

(Plate xxii., fig. 1).

Shell small, subperforate, conical, with sharply keeled periphery, overlapping spire whorls and a flat base. Colour and number of whorls uncertain, the latter exceeding six. Sculpture: small spiral threads parted by wider interstices amount to seven on the penultimate, and to twenty on the last whorl, of these a double row compose the peripheral keel. On either side of the keel the interstices are wider than usual. The radials are irregular oblique wave-like folds, twenty-two on the last whorl, which raise beads on the keel rows, and there cease abruptly. On the base incipient radials bead the inner spirals. Aperture oblique, trapezoidal, outer lip simple, sharply angled by the periphery, columella insertion a little reflected over the minute umbilicus. Length, 7; maj. diam., 6; min. diam., 5 mm.

A single worn specimen represents this species, whose sculpture and contour are not approached by any other Australian *Calliostoma*.

---

<sup>1</sup> Hedley—Austr. Mus. Mem., iv., 1903, p. 334.

*BASILISSA NICETERIUM, sp.nov.*

(Plate xxii., figs. 4, 5).

Shell imperforate, conical-turbinate, thin, of silken lustre. Colour uniform pale cream. Whorls five and a half, including a small pointed obliquely set protoconch of a whorl and a half. Sculpture: prominent spiral keels, three to the penultimate, ten to the body whorl, successively diminishing from the suture to the base, undercut below the narrow summit, parted by much broader flat interstices. These keels, apparently folds in the shell substance, are microscopically beaded by fine radial striæ, represented in the interstices as hair lines. The protoconch does not share the adult sculpture, but is minutely malleated. Aperture oblique, subcircular, columella glazed, arched, running out to a spur. Outer lip unfinished, the ends of the ribs projecting beyond the interstices like claws. In the throat a furrow corresponds to each external keel. Height, 7; maj. diam, 7; min. diam., 6 mm.

One whole and some fragmentary specimens were taken.

The novelty is by no means a characteristic *Basilissa*, for it is imperforate, its lustre is rather silken than nacreous, if the sutural sinuation exists, it is masked by the sculpture. Yet the aggregate of its characters agree better with *Basilissa* than with another genus. From *Seguenzia*, for instance, which the sculpture immediately suggests, the entire columella excludes it.

*LIOTIA PETALIFERA, sp.nov.*

(Plate xxii., figs. 6, 7, 8.)

Shell minute subdiscoidal, spire very little elevated, base broadly and deeply umbilicate. Colour white. Whorls four, of which two constitute the protoconch, the last descending, and in slight contact with its predecessor. The protoconch is smooth, helicoid, and sharply defined. Sculpture: last whorl with twenty-four, penultimate with nineteen, elevated curled and forwardly-directed lamellæ, whose broad summits nearly equal their interstices. The lamellæ are smooth and glossy, but the interstices are distantly spirally striated. Aperture complete circular. Height, 0.6; maj. diam, 1.25; min. diam, 0.85 mm.

Several specimens. The species has a general resemblance to *L. capitata*, Hedley, from which the denser varices of *L. petalifera* at once separate it.



*RISSOA COLUMNARIA, sp. nov.*

(Plate xxii., fig. 9).

A "Rissoa" of the group of *R. bicolor*, Petterd. Small, glossy, subcylindrical, summit blunt. Whorls six, divided by impressed sutures. Colour variable, red, purple, or orange on the apex, fading on the lower whorls; the last usually white, with a pale narrow median yellow band. Sculpture: fine close radial hair lines. Aperture perpendicular, circular, peristome reflected all round. Length, 2.6; breadth, 1.1 mm.

Several specimens. In colour, size, and form this approaches *Rissoa subfusca* var. *micronema*, Suter,<sup>2</sup> from which it differs by absence of spiral sculpture and more slender shape.

*RISSOINA LINTEA, sp. nov.*

(Plate xxiii, fig. 11).

Shell elongate, turreted, thin, translucent, glossy. Colour white. Whorls eight and a half, separated by a channelled suture, first two smooth and dome-shaped. Sculpture: numerous close, fine, spiral threads wind over the whole of each whorl. Last whorl ascending at the aperture. Aperture effuse, not provided with a varix, anterior canal well marked, columella arched and broadly reflected on the body whorl. Length, 7; breadth, 2.5 mm.

A few specimens. The lack of radial sculpture at once separates this from other spirally grooved Australian *Rissoina*.

*RISSOINA FAUSTA, sp. nov.*

(Plate xxii., fig. 10).

Shell smooth, glossy, translucent, elongate, with impressed suture. Colour pale cream, with orange spots disposed in five rows, two of which ascend the spire. Whorls eight. Aperture subtriangular, anterior notch distinct, columella thickened, arched, outer lip slightly reflected, thickened within. Length, 6.5; breadth, 1.5 mm.

Several specimens. This is nearly related to *R. linteata*, but differs in being smaller, coloured and smooth.

---

<sup>2</sup> Suter—Proc. Malacol. Soc., iii., 1898, p. 4.

PSEUDORISSOINA CAPITICAVA, *sp. nov.*

(Plate xxiii., figs. 12, 13).

Shell slender, elongate, diaphanous, smooth, constricted at the suture, and thus conveying a nodose expression to the spire. Colour white. Whorls six, exclusive of the protoconch, margined at the suture. The heterostrophæ apex of this genus is more complex than was at first supposed. The early whorls are concealed by the later, and the vertex of the shell is a whorl which rises as an arch and encloses the protoconch in a hood. It may be that the first whorls are not merely wound at right angles to the adult, but are completely reversed by rotation through ninety degrees. Aperture subtriangular, channelled above, effusive below, outer lip thickened, inner lip with a distinct callus deposit. Length, 4.4; breadth, 1.5 mm.

Several specimens. This is closely related to *P. tasmanica*, Tenison Woods, but the novelty is a narrower shell, with an additional and more inflated whorls.

SEPTA PETULANS, *sp. nov.*

(Plate xxiii., fig. 14).

Shell small, conical, produced. Whorls asymmetrically swollen, six remaining on the type. Our material does not present a complete apex. Colour cream, with rusty irregular scattered dashes. Sculpture: seven varices, being at the rate of about one to two-thirds of a whorl, between these slight radial plications raise the larger threads into low tubercles, interstices microscopically transversely striated. The spirals consist of fine revolving threads parted by shallow interstices, sixteen on the penultimate, and about thirty-five on the last whorl. Here and there, especially on the base, the threads tend to be alternately larger and smaller, while a few of the peripheral threads stand out more conspicuously than the rest. Aperture perpendicular, ovate, a conspicuous tubercle in the posterior angle. Anterior portion of the columella crossed by several transverse wrinkles. Outer lip faintly dentate within. Canal short and broad. Length, 3.5; breadth, 1.4 mm.

Several broken shells were dredged, but our figure and description is based on a dead shell gathered by one of us (May) on the beach at Pirate's Bay, near Cape Pillar.

Dr. Dall finds in the radula generic distinction between *Septa* and *Cymatium*. We associate our species with the former from the general resemblance it bears to *S. tritonis*, Linne.

CYMATIUM COLUMNARIUM, *sp.nov.*

(Plate xxiii., fig. 15).

Shell small, thin, elongate, spire rather distorted. Whorls eight, including a smooth, rounded two-whorled protoconch. Colour pale straw. Sculpture: varices eight, sculptured by the spirals, disposed irregularly at intervals of half or two-thirds of a whorl. Longitudinal ribs small, about twenty to a whorl, not reaching the base of the last whorl, narrower than their interstices. Both ribs and interstices crossed by small spiral threads, towards the periphery some threads pack in two prominent bundles, giving the whorl a slightly bicarinate outline; on the final whorl the threads amount to thirty-five. Edge of aperture produced into a thin upstanding rim. On the base of the columella are two elongate tubercles, and distributed within the outer lip are half a dozen others. Canal short. Length, 21; breadth, 8.5 mm.

Several specimens, all dead and mostly broken, were taken off Cape Pillar. The species was previously dredged off the Pilot Station, Derwent River, by one of us (May).

The novelty stands nearest to *C. quoyi*, Reeve, from which it differs by being thinner, more slender, and with weaker sculpture. Three tertiary shells, *T. oligostirus*, *T. gemmulatus*, and *T. sexcostatus*, are described by Prof. R. Tate<sup>3</sup> as related to *quoyi*. Dr. Dall is inclined to refer *Triton quoyi* to Conrad's genus *Personella*<sup>4</sup>. Kesteven has suggested that *Nassaria kampyla*, Watson, should also be grouped with *C. quoyi*<sup>5</sup>. Apparently *Peristernia murrayana*, Tate<sup>6</sup>, is related to Watson's species. Dr. J. C. Verco, who kindly compared the species at our request, writes, 2 vi. '08: "*P. murrayana*, Tate, is quite distinct from *N. kampyla*, Watson, in being more solid, and in having three plicate teeth at the end of the columella."

NATICA ELKINGTONI, *sp.nov.*

(Plate xxiii., fig. 18).

Shell small, smooth, rather thin, globose, spire exsert, whorls four. Colour dull white, apex orange, gradually fading away on the succeeding whorls, the last trace being a faint subsutural

<sup>3</sup> Tate—Trans. Roy. Soc. S. Austr., x. 1888, pp. 126-7.

<sup>4</sup> Dall—Smithsonian Miscell. Coll., 47, 1904, p. 130.

<sup>5</sup> Kesteven—Proc. Linn. Soc. N.S. Wales, xxvii., 1902, p. 473.

<sup>6</sup> Tate—Trans. Roy. Soc. S. Austr., x. 1888, p. 155; xi. 1889, pl. iv., f. 4.

band on the final whorl. Aperture semilunate. Umbilicus small, half filled by a central spiral callus which expands as a pad on reaching the margin of the aperture. Height, 9; maj. diam., 9; min. diam., 7 mm.

A few specimens. Nearly related to *N. subcostata*, Tenison Woods, but differs by larger size and exsert spire. Named in honour of Dr. J. C. Elkington, our companion on the cruise.

MARGINELLA COLUMNARIA, *sp.nov.*

(Plate xxiii., fig. 19).

Shell rather large, thin, translucent, narrow, subcylindrical, spire slightly elevated. Colour amber. Whorls four. Aperture long, linear, three strong plications on the columella, a thin callus on the inner lip. The outer lip rises above the penultimate whorl from a callus base, which does not quite reach the apex, in a low arch, bends far forward, and then descends vertically. No denticules appear within the lip. Length, 7.5; breadth, 3.5.

Several specimens. The subcylindrical shape of this species readily distinguishes it from co-generic forms, among which *M. caledonica*, Jousseau, makes the nearest approach.

MICROVOLUTA PURPUREOSTOMA, *sp.nov.*

(Plate xxiii., figs. 20, 21).

Shell small, rather thin, fusiform, blunt at either end. Colour white, within the aperture stained purple. Whorls five. Shell almost smooth; a few faint spiral grooves occur on the base and below the suture. Aperture elliptical, outer lip simple, smooth within. In the conventional attitude two plaits are visible on the columella, but turning the shell to show the deepest interior, a small plait appears above and another below the central couple. Canal short, rounded. Length, 6; breadth, 3 mm. Another specimen, length, 8; breadth, 3.5 mm.

Two specimens. The novelty is distinguished from *M. australis* by lack of colour, feebler plaits, smaller size, and less breadth. Dall has compared *Microvoluta* to *Conomitra*<sup>7</sup>. The characters of the former genus, as now enlarged, seem to us to incline to the Mitridæ rather than to the Volutidæ.

---

<sup>7</sup> Dall—Bull. Mus. Comp. Zool., xviii., 1889, p. 163.

*ARCULARIA MOBILIS, sp.nov.*

(Plate xxiii., fig. 16).

Shell small, rather thin, conical. Whorls well rounded, thus appearing a little contracted at the sutures, in number five and a half, including a smooth two-walled protoconch. Colour dull white, with irregular brown spots, which tend to disposal in spiral bands. Sculpture: the whole shell is neatly engraved with sharp narrow grooves, about ten to the penultimate and eighteen behind the aperture. Wave-like radial ribs, about a dozen to a whorl, are usually more conspicuous above, and become obsolete on the last whorl. Aperture oblique, round, strongly varixed without, crenulated within to correspond with the external sculpture, a slight tubercle posteriorly. Canal short and strongly bent. Length, 7; breadth, 4 mm.

Numerous specimens. We cannot recall any near ally of this very variable shell.

Var. *COSTATA.*

(Plate xxiii., fig. 17).

In this form, which perfectly intergrades with the type, the spiral sculpture is suppressed, and a radial sculpture is assumed of close, strong rounded ribs, about twenty to a whorl, which traverse the whole shell perpendicularly. If the intermediates were unseen, the extreme would be readily granted specific rank.

*TROPHON COLUMNARIUS, sp.nov.*

(Plate xxiv., fig. 22).

Shell of medium size, elongate, roughened by the profuse decoration. Colour pale yellow, with brown on the apex, a basal and a sutural band. Whorls nine, including a smooth conical protoconch of two and a half whorls. Sculpture: thin projecting varices, nine to a whorl on the larger whorls, ascend obliquely and continuously from whorl to whorl. These varices are scalloped by the passage of the spirals, and develop sharp points on the shoulder; on the base they degenerate to mere scales. The spirals amount to twelve on the body whorl, and to three or four on the upper whorls; they are crowded on the base, but separated on the shoulder by flat interstices of equal or greater breadth. A secondary microscopic sculpture of faint radial threads, and still fainter spiral scratches, appears between the varices. Aper-

ture oval, shielded by the youngest varix; columella excavate. Length 20 mm.; breadth, 8 mm.

Some fragments of this distinct species were also dredged in eighty fathoms twenty-two miles east of Narrabeen, N. S. Wales, by Prof. W. A. Haswell and one of us.

TROPHON MOLORTHUS, *sp.nov.*

(Plate xxiv., fig. 23).

Shell narrowly fusiform. Whorls subgradate, seven, including a smooth pointed two-whorled protoconch. Colour dull white. Sculpture: the radial ribs about twelve to a whorl, are broad and wave-like, divided by interstices of equal breadth, commence at the shoulder, swell at the periphery, and fade away towards the lower suture, or, in the case of the last whorl, the base. The upper whorls are traversed by about eight evenly spaced spiral low cords, separated by flat interstices of equal breadth, which cross ribs and interstices alike. On the last whorl the cords amount to twenty-two. Aperture oval, lip unfinished, canal turned a little to the right. Length, 10.5; breadth, 4.5.

Several specimens. A near ally, a variety of which occurred with it at Cape Pillar, is *T. simplex*, Hedley.<sup>7</sup> From that *T. molorthus* differs by less rounded and more slowly increasing whorls, shorter canal, and more numerous spirals.

TROPHON SARMENTOSUS, *sp.nov.*

(Plate xxiv., fig. 24).

Shell small, thin, rather glossy, narrowly fusiform, angled at the shoulder. Whorls six, including a smooth, pointed two-whorled protoconch. Colour pearl grey, with ferruginous on base, apex, and sometimes a sub-sutural line. Sculpture: ten low, broad, solid varices, equal in breadth to their flat smooth interstices, continue perpendicularly from whorl to whorl. On the shoulder these develop a pointed tubercle, and on the base are crossed by indistinct spirals. Aperture oval; from the base of the columella projects the inner side of the short rather straight canal. Length, 5; breadth, 2.15 mm.

Several specimens were obtained. *T. petterdi*, Crosse, *T. rudolphi*, Brazier, and the present form a graduated series. The

<sup>7</sup> Hedley—Austr. Mus. Mem., iv. 1903, p. 380, f. 93.

intermediate form, *Peristernia rudolphi*<sup>9</sup>, Henn and Brazier, which also occurred off Cape Pillar, is distinguished from the novelty by its coarse spirals.

PHILINE COLUMNARIA, *sp. nov.*

(Plate xxiv., figs. 25, 26).

Shell trapezoidal oblong, thin, semitransparent. Colour milk-white. Sculpture: fine close spiral scratches crossed by irregular and inconspicuous growth lines. Aperture below broad, above narrow, the summit arched, projecting beyond the spire, inserted below the top of the last whorl. Edge of outer lip simple. Inner lip defined by a thick layer of callus, at the base of which is a small umbilical groove. Centre of the summit occupied by a shallow pit margined by a groove, but the nucleus is concealed by a layer of callus spreading from the suture. Length, 6.5; breadth, 5 mm.

Several specimens. The novelty is larger than other Australian forms, except *P. anyasi*. It is not, however, the young of that species, for it is more trapezoidal, has distinct spiral lines, and an axial hollow above.

LEPIDOPLEURUS COLUMNARIUS, *sp. nov.*

(Plate xxiv., figs. 27, 28).

Valves round backed, greatly arched, lateral areas inclined to the rest of the valve. Posterior valve with full rounded umbo. Girdle with minute, dense, imbricating scales. Colour uniform waxy. Sculpture: minute grains strung in longitudinal radiating rows, parted by deep grooves of equal width. Going forwards from the mucro additional rows are intercalated. The pleural and jugal areas together have about fifty rows. The lateral areas are differentiated by densely packed, less prominent and disarranged grains. Length of single curled and shrivelled specimen about 8 mm.; breadth, 3 mm.

This is the first deep water Chiton to be reported from Australian waters. We have not the advantage of comparison with specimens, but, judging from literature, the novelty has a general resemblance to *L. cancellatus*, Sowerby, and in detail differs by smaller and denser granulations. Compared with *L. inquinatus*,

---

<sup>9</sup> Henn and Brazier—Proc. Linn. Soc. N.S. Wales, (2), ix., 1894, p. 166, pl. xiv., f. 1.

Reeve, *L. columnarius* lacks colour, has a more prominent muero, longer and more arched valves, the granules are sharper and their radial arrangement more distinct.

GLYCYMERIS SORDIDA, Tate.

*Pectunculus sordidus*, Tate, Trans. Roy. Soc., S. Austr., xiv., 1891, p. 264, pl. xi. f. 8. *Glycymeris sordida*, Verco., *loc. cit.*, xxxi., 1907, p. 227.

This shell appeared plentifully as worn and separate valves. It had not been seen before either in Tasmanian waters or on the Pacific coast. *G. insignis*<sup>10</sup> is probably a synonym.

CUNA COMPRESSA, *sp. nov.*

(Plate xxiv., figs. 29, 30, 31, 32).

Shell rather large for the genus, ovate truncate, the anterior and dorsal margins forming a right angle, solid, very shallow lunule and escutcheon both narrow and inconspicuous. Colour dull white. Sculpture: irregularly furrowed by growth interruptions, and rayed by about twenty half obliterated riblets, which do not extend over the anterior and posterior extremities. Prodissoconch, a smooth well defined dome, followed by a step. Inner ventral margin denticulated by twenty small tubercles and sockets. Length, 9.2; height, 8.6; depth of single valve, 2 mm.

One of the largest of the genus. Our dredging showed it to be a common shell off Cape Pillar, as Dr. J. C. Verco had previously found it to be in forty fathoms off Beachport, South Australia.

CUNA HAMATA, *sp. nov.*

(Plate xxv., figs. 33, 34, 35, 36).

Shell solid, rather inflated, spiral-ovate, hooked above, lunule faint, escutcheon evanescent. Colour dull white. Sculpture: surface roughened by irregular concentric growth lines, radials wanting. Umbo spirally produced, directed ventrally. Inner ventral margin beset with about thirty small tubercles. Height, 5; length, 4; depth of single valve, 1.5 mm. >

At the scene of our investigations this is an abundant species. The "comma" shape distinguishes it readily from the rest of the

<sup>10</sup> Pilsbry—Proc. Acad. Nat. Sci. Philadel., 1906, p. 231



genus. An unnamed shell related to the above, but differing by being half the size, faintly radially ribbed, and not so sharply bent over above, was taken in Half-moon Bay, Stewart Island, New Zealand, by Mr. A. Hamilton.

VENERICARDIA COLUMNARIA, *sp.nov.*

(Plate xxv, figs. 37, 38, 39, 40).

Shell small, trapezoid-oblong, solid, inflated and inequilateral. The anterior side produced, about twice the length of the posterior. Colour uniform pale yellow. Sculpture: twenty-two low radial ribs parted by narrow grooves; anteriorly these are few and broad, posteriorly small and crowded. Irregular growth stages segment the ribs, which are also traversed by a secondary sculpture of fine concentric hair lines. Lunule long and narrow. Inner ventral margin with about eighteen small tubercles. Length, 8; height, 7; depth of single valve, 3 mm.

A few worn and separate valves.

CONDYLOCARDIA PORRECTA, Hedley,

(Plate xxv, figs. 41, 42).

We were surprised to find as a common shell off Cape Pillar this<sup>4</sup> species, described two years ago<sup>11</sup>, from the Capricorn Islands. And we take the opportunity of substituting an excellent drawing by Miss W. West for the poor figure which accompanied the original description. To facilitate the determination of this difficult group, we also add a figure (Pl. xxv., figs. 43, 44, 45) of the related *C. pectinata*, Tate and May.

---

<sup>11</sup> Hedley—Proc. Linn. Soc. N.S. Wales, xxxi., 1906, p. 475, pl. xxxviii., f. 24.

A NEW GENUS AND SPECIES OF TURTLE, FROM  
NORTH AUSTRALIA.

By ALLAN R. McCULLOCH, Zoologist.

(Plates xxvi-xxvii.)

The Trustees have recently received from Mr. Hugh W. Christie, Lighthouse-keeper at Point Charles, a small turtle 153 mm. long, captured near Port Darwin, North Australia. While entering the family Cheloniidae it is apparently distinct from any of the three genera at present known, and I therefore propose for it the name *Natator*. We know nothing either of its habits or food, and as it is a unique specimen I have been unable to examine its skull.

It is most nearly related to *Chelonia*, and judging by the similar form of its upper jaw, which is not hooked, is doubtless herbivorous. From that genus, however, it is separated by the different arrangement of the shields of the head, and the distinctly paired nuchal. Also the upper shields of both head and body have each a large symmetrical areola placed rather behind their centres.

*Eretmochelys* is distinguished by its hooked jaws and the two pairs of prefrontal shields, while *Caretta* has five or more pairs of costal shields.

NATATOR,<sup>1</sup> *gen. nov.*

Head and carapace covered with horny shields, each with distinct symmetrical areolæ; nuchal shield divided into two, each half having its own areola; five vertebrals, and four pairs of costals; twelve pairs of marginals. Plastron as in *Chelonia*, with a well developed intergular. Head with a pair of large prefrontals; frontal in contact with the prefrontals and a pair of large supraoculars; parietal shield very large and followed by a single post-parietal; two pairs of temporals. Upper jaw not hooked. Limbs paddle shaped, with one claw each.

---

<sup>1</sup>*Natator*—a swimmer.

The sides of the carapace, or marginal shields, are reflexed, and though it would seem that this is the natural condition, it is not certain that it has not been caused by lateral pressure in packing during transit.

NATATOR TESSELLATUS, *sp. nov.*

(Plates xxvi.-xxvii.)

Head covered with large symmetrical shields of which the greater portion of each is occupied by a more or less rugose areola. Upper jaw with a small triangular incision at the tip. A pair of large prefrontal shields separated from the maxillary sheath by a small scale. Frontal much smaller than the supraoculars, pentagonal, its anterior edge wedged in between the prefrontals. Parietal very large, connected with and surrounded by the frontal, supraoculars, two pairs of temporals, and a single post-parietal. Two suboculars, and one postocular, between which and the soft skin of the neck are six or seven irregular shields. Mandible strongly hooked.

Carapace rounded, it being only one-ninth longer than broad; unicarinate in the young, and with the sides reflexed (see note above.). Lateral and posterior margins serrated and formed of twenty-six shields. The nuchal is divided in the median line into two distinct shields. All the shields of the carapace have very distinct symmetrical areolæ placed rather behind the centre, which are coarsely pitted; those of the vertebral shields are six or seven sided, while on the costal series they are four, five, or six sided; on the marginals they are quadrangular, the postero-external angle being produced as a spine.

Plastron with a large intergular, and a series of inframarginals. Each shield with a more or less central areola which is smooth and not so well defined as those of the back. Two prominent ridges, commencing on the gular shields, pass backwards and outwards along the line of areolæ, being most widely spaced and strongly developed on the pectoral and abdominal shields, whence they converge again and are lost on the anals. A small triangular shield separates the distal ends of the anals, but it is very soft and imperfect and is possibly lost with age.

The upper surface of the fore-limbs is margined anteriorly with a row of squamiform shields which become larger as they approach the tip. Hinder margin with six shields. The remainder of the upper surface is covered with small, irregular, juxtaposed scales. Lower surfaces similar, but without the scales

on the hinder margin. Hind-limbs short and rounded, otherwise like the fore-limbs.

Colour brownish-olive above, with tortoise-shell markings, the areole and margins of the carapace of a lighter shade. Margins of the limbs and the under surfaces yellowish.

Measurements—

Total length	...	...	...	152 mm.
Length of head	...	...	...	34 „
Length of carapace	...	...	...	116 „
Breadth of carapace	...	...	...	104 „
Length of anterior limb	...	...	...	67 „
Length of posterior limb	...	...	...	43 „

My thanks are due to Mr. J. Douglas Ogilby who kindly examined the turtles in the Queensland Museum and otherwise assisted me in the preparation of the above.

MINERALOGICAL NOTES: No. VII.—RHODONITE,  
BROKEN HILL, NEW SOUTH WALES.

By C. ANDERSON, M.A., D.Sc. (EDIN.), Mineralogist.

(Plates xxviii-xxix.).

Fine specimens of rhodonite are found in the sulphide zone of the Broken Hill silver-lead mines, associated with galena, blende and garnet. The occurrence seems to have been first noted by Professor R. Beck of Freiberg, by whom it has been described.<sup>1</sup> It is found either as crystals with the characteristic rounded edges of rhodonite, or as isolated fragments disseminated through the ore; it generally shows evidence of corrosion by the metalliferous solutions, and various stages of replacement by galena and blende may be traced. The mineral is of a pleasing deep red colour, and in small well crystallised specimens is quite transparent; it greatly resembles some varieties of garnet.

Of the seven specimens which form the subject matter of this paper three were kindly lent by the Director of the National Museum, Melbourne, one by the Geological Department of Sydney University, the others are from the Australian Museum collection.

Five crystals (referred to hereafter as Nos. i.-v.) were measured on the two-circle goniometer and the co-ordinate angles obtained; a few interfacial angles were also determined. The position chosen is that of Goldschmidt,<sup>2</sup> which, for rhodonite considered by itself, and particularly for the usual habit of the Broken Hill crystals, is more suitable than Dana's,<sup>3</sup> as the three most prominent faces, which are also the directions of cleavage, are made axial planes, but Dana's elements show more clearly the relation of rhodonite to the other members of the pyroxene group.

In habit the crystals vary somewhat, but they may be generally described as extended parallel to  $c$  (010). The commonest forms are  $a$  (001),  $c$  (010),  $b$  (100),  $o$  (110),  $s$  (110), the three first being particularly well developed. In all twenty-eight forms were recognised, of which ten are new, or at least not recorded in Goldschmidt's 'Winkeltabellen.' The new faces occur principally

---

<sup>1</sup> Beck—Zeits. prakt. Geol., March, 1899, pp. 65-71 (*trans. Rec. Geol. Surv. N.S. Wales*, vii., 1, 1900, pp. 20-28).

<sup>2</sup> Goldschmidt—*Krystallographische Winkeltabellen*, p. 287.

<sup>3</sup> Dana—*System of Mineralogy*, 6th Edition, 1892, p. 378.

in the zones  $[010, 001]$  and  $[100, 001]$ , and are, as a rule, long and very narrow, giving only fair reflections, hence some of them may be merely vicinal in character; the face  $(\bar{1}\bar{1}3)$  is dull, and the reflection was obtained by cementing a fragment of glass on it;  $(\bar{1}\bar{1}2)$  appears as a small square patch. On crystal iv. there is a dull rounded face, probably  $(\bar{1}\bar{1}2)$ , but it did not admit of even approximate measurement. The faces  $(207)$  and  $(0\bar{3}7)$  may be vicinal to  $(103)$  and  $(0\bar{1}2)$  respectively, the others are undoubtedly valid forms. The available information regarding the new forms is tabulated below; two readings enclosed by brackets are independent determinations made on the same plane. Crystals i., iii., iv. are from the collection of the National Museum, Melbourne; ii from the Sydney University collection.

Form.	Cryst.	Measured.		Calculated.		Reflection.
		$\phi$	$\rho$	$\phi$	$\rho$	
A 013	i.	30 30	38 16	30 11	38 10	} fair +
		30 35	38 0			
B $0\bar{1}5$	ii.	127 20	26 27	127 21	26 26	} fair
C $0\bar{1}4$	i.	134 8	29 0	134 53	29 9	} fair +
		134 17	29 2			
	iii.	134 44	29 18			} fair +
	iv.	134 47	29 8			} good
D $0\bar{1}3$	i.	144 28	34 3	144 9	34 1	} fair
		144 15	33 58			
	ii.	143 39	33 37			} fair +
	iv.	143 31	34 9			} poor
E $0\bar{3}7$	i.	151 19	39 24	151 19	39 28	} fair
		151 19	39 31			
F 103	ii.	87 32	44 8	87 33	44 1	} good
G 207	ii.	86 51	40 58	87 6	41 33	} fair +
		88 41	39 38			
H $20\bar{1}$	iii.	87 3	71 45			} poor
	iii.	86 6	71 41	85 56	71 51	} fair
		86 2	71 54			
K $\bar{1}\bar{1}3$	iv.	161 21	29 30	161 32	29 9	
L $1\bar{1}2$	iii.	150 16	43 9	150 27	43 10	} good
		150 13	43 15			

The elements were calculated from the following angles, all the reflections being sharp :—

Form.	Mean.		Limits.				No. of Measurements.
	$\phi$	$\rho$	$\phi$		$\rho$		
<i>o</i> 110	44 11½	— —	44 5 to 44 19	— —	— —	— —	14
<i>b</i> 100	92 30	— —	92 27 „ 92 41	— —	— —	— —	16
<i>a</i> 001	80 30	21 50½	80 22 „ 80 44	21 48 to 21 52	— —	— —	13
<i>p</i> 102	88 41	51 25	88 37 „ 88 45	51 23 „ 51 30	— —	— —	4

The elements deduced are compared below with those given by Goldschmidt in his Winkeltabellen :—

	$a$	$\beta$	$\gamma$	$a$	$c$
	° ' "	° ' "	° ' "		
Anderson ..	94 46	111 34	85 56	1.14792	1.83158
Goldschmidt.	94 42	111 27	86 06	1.15550	1.8317

The elements for Dana's position were also calculated for comparison with Flink's<sup>4</sup> as corrected by Dana, and Pirsson's for the fowlerite variety<sup>5</sup> :—

	$a$	$\beta$	$\gamma$	$a$	$c$
	° ' "	° ' "	° ' "		
Anderson ..	103 21	108 42	82 6	1.07281	.62379
Flink .. ..	103 18	108 44	81 39	1.07285	.62127
Pirsson ..	103 39	108 48½	81 55	1.078	.62627

Comparison of these elements suggests a morphotropic relationship, and it is very desirable that the exact composition of Broken Hill rhodonite should be ascertained; at present, however, a sufficient quantity of suitable material is not available.

A brief description of the individual specimens follows (lettering according to Goldschmidt).

<sup>4</sup> Flink—Zeits. Kryst., xi., 1886, p. 506.

<sup>5</sup> Pirsson—Amer. Journ. Sci., xl., 1890, p. 484.

*Crystal i.* (Plate xxviii., figs. 1, 2).—This is the smallest and the best crystal; it measures  $1 \times .2 \times .5$  cm. in the axial directions, is practically free from gangue, and quite transparent. In habit it is elongated parallel to the  $a$  axis, and might almost be described as tabular on (010).

Combination:— $a c b o s \pi A C D E m k i q p u r l n$ .

*Crystal ii.* (Plate xxviii., figs. 3, 4).—It is the front half of a crystal, incomplete below, measuring  $1.6 \times 1.1 \times 1.5$  cm., and carries a good deal of attached galena as cleavage fragments and small grains. The faces  $o(110)$  and  $k(0\bar{1}1)$  are unusually large.

Combination:— $a c b o s \kappa B D m k i p F G \mu$ .

*Crystal iii.* (Plate xxix., figs. 1, 2).—This crystal measures  $1.1 \times .8 \times 1.2$  cm., and may be described as thick tabular on (010); on 100 there is a rounded depression like a small thumb mark; the left side of the figure is bounded mainly by a cleavage plane. Galena in cleaved lumps is attached to the lower surface.

Combination:— $a c b o s \kappa \pi C k r l u H L \phi$ .

*Crystal iv.* (Plate xxix., fig. 3).—The crystal is broken in front and below; size  $1.8 \times 1 \times 1$  cm. It seems to consist of two sub-individuals not quite in parallel position with galena intruding between.

Combination:— $a c b o C m k u r l k L(?)$ .

*Crystal v.*—This is the largest measured crystal,  $2.2 \times 1.1 \times 1.3$  cm., but it carries much galena.

Combination:— $a c b o k p G \mu$ .

Of the remaining specimens one consists of several crystals, large and small, accompanied by galena; one broken crystal measures about  $5 \times 3 \times 2.5$  cm.; this specimen and crystal v. are from the Block 10 mine. The other is similar, but the crystals of rhodonite and galena are all small, forming a sort of mosaic.

The mean angles are tabulated below along with the theoretical values deduced from the calculated elements; the lettering according to Goldschmidt and Dana, with the corresponding Miller indices, are given side by side; new forms are distinguished by an asterisk.

The equations for transforming  $h k l$  of Goldschmidt to  $h' k' l'$  of Dana are,  $h' = -(h+k)$ ,  $k' = -(h-k)$ ,  $l' = -\frac{1}{2}l$ ; thus any face  $P, h k l$ , becomes  $P', h' k' l'$ .



Forms.				Measured.		Calculated.	
Goldschmidt.		Dana.		$\phi$	$\rho$	$\phi$	$\rho$
<i>a</i>	001	<i>c</i>	001	80 30	21 50 $\frac{1}{2}$	80 30	21 50
<i>c</i>	010	<i>M</i>	$\bar{1}\bar{1}0$	0 0	90 0	0 0	90 0
<i>b</i>	100	<i>m</i>	110	92 30	89 59	92 30	90 0
<i>o</i>	110	<i>a</i>	100	44 11 $\frac{1}{2}$	89 59 $\frac{1}{2}$	44 11 $\frac{1}{2}$	90 0
$\sigma$	$\bar{1}\bar{1}0$	<i>b</i>	010	138 10	89 59	138 8	90 0
$\kappa$	011	$\kappa$	$\bar{2}\bar{2}1$	12 9	63 15	11 43	62 48
$\pi$	012	$\pi$	$\bar{1}\bar{1}1$	21 50	46 48	21 50	46 44
* <i>A</i>	013	<i>A</i>	$\bar{2}\bar{2}3$	30 32	38 8	30 11	38 10
* <i>B</i>	015	<i>B</i>	$\bar{2}\bar{2}5$	127 20	26 27	127 21	26 26
* <i>C</i>	014	<i>C</i>	112	134 33	29 7	134 53	29 9
* <i>D</i>	013	<i>D</i>	223	144 0	33 49	144 9	34 1
* <i>E</i>	037	<i>E</i>	667	151 19	39 28	151 19	39 28
<i>m</i>	012	<i>m</i>	111	155 10	43 16	155 9	43 15
<i>k</i>	011	<i>k</i>	$\bar{2}\bar{2}1$	167 32	61 15	167 26	61 21
<i>i</i>	021	<i>i</i>	$\bar{4}\bar{4}1$	173 48	74 39	173 45	74 36
<i>q</i>	101	<i>q</i>	$\bar{2}\bar{2}1$	90 14	64 20	90 14	64 37
<i>p</i>	102	<i>p</i>	111	88 41	51 25	88 41	51 25
* <i>F</i>	103	<i>F</i>	223	87 32	44 8	87 33	44 1
* <i>G</i>	207	<i>G</i>	447	87 28	40 31	87 6	41 33
<i>u</i>	$\bar{1}03$	<i>u</i>	223	63 10	11 14	62 42	11 15
<i>r</i>	$\bar{1}02$	<i>r</i>	$\bar{1}\bar{1}1$	77 31	25 17	77 22	25 22
<i>l</i>	203	<i>l</i>	$\bar{4}\bar{4}3$	81 3	37 13	81 11	37 10
<i>n</i>	$\bar{1}01$	<i>n</i>	$\bar{2}\bar{2}1$	83 47	53 9	83 54	53 1
* <i>H</i>	$\bar{2}01$	<i>H</i>	$\bar{4}\bar{4}1$	86 4	71 47	85 56	71 51
$\mu$	111	$\mu$	401	48 59	70 18	49 4	70 19
* <i>K</i>	$\bar{1}\bar{1}3$	<i>K</i>	$\bar{4}03$	161 24	29 30	161 32	29 9
* <i>L</i>	$\bar{1}\bar{1}2$	<i>L</i>	$\bar{2}01$	150 14	43 12	150 27	43 10
$\phi$	$\bar{1}\bar{1}1$	$\phi$	401	142 2	65 6	142 8	65 4

Our thanks are due to the Director of the National Museum, Melbourne, and to Acting-Professor W. G. Woolnough, for the ready loan of specimens.

## OCCASIONAL NOTE.

No. I.

### *SEPIA BRAGGI*, VERCO.—A RECORD FOR THE STATE.

By C. HEDLEY, Conchologist.

Heavy and continuous gales had prevailed for a fortnight, during which eighteen inches of rain had fallen and several wrecks had occurred on the coast. A Museum party then spent a profitable afternoon inspecting the pelagic drift on Maroubra Beach. On 8th August, 1908, a tremendous sea still running, we found a continuous purple streak of *Ianthina*, *Verella*, and *Physalia* along the wash of the waves. This drift was wholly pelagic, no ground fauna appeared at all; probably such was carried down by the undertow. The drift seemed also southern, such surface forms as *Glaucus* and *Porpita* were remarkable for their absence. The storm had overwhelmed sea fowl; Cadet D. B. Fry found a dead, though fresh, Penguin (*Eudyptula minor*) on the sand, a bird which rarely reaches so low a latitude. Carcasses of *Prion uriel* were numerous.

Cadet R. Kinghorn found a *Spirula spirula* shell with part of the animal attached. A drift spar encased in living barnacles yielded the crab *Nautilograpsus minutus*, Linn., to the scrutiny of Mr. A. R. McCulloch. Amongst the thousands of *Ianthina ianthina*, Linn., we detected a dozen of the rarer *Ianthina exigua*, Lamarek, with their floats complete.

Perhaps the most interesting article fell to my share in the shape of a couple of shells of *Sepia braggi*, Verco,<sup>1</sup> described last year from South Australia, but as yet undetected on the Pacific Coast. Our specimens are only an inch in length. The South Australian type is 60 mm. long, while a specimen from the Heytesbury Coast, Victoria, kindly presented by Mr. G. B. Pritchard, is 62 mm. in length.

It is probable that the Tasmanian record of *Sepia elongata*, D'Orbigny & Ferussac,<sup>2</sup> is based on *Sepia braggi*.

An ichthyological treasure, the second known specimen of *Eupetrichthys angustipes*, Ramsay and Ogilby, rewarded Cadet E. le G. Troughton, who found it stranded on Maroubra Beach the following Saturday.

---

<sup>1</sup> Verco—Trans. Roy. Soc. S.A., xxxi., 1907, p. 213, pl. xxvii., figs. 6, 6a, 6b, 6c, 6d.

<sup>2</sup> Tate and May—Proc. Linn. Soc. N.S.W., xxvi., 1901, p. 351.



## EXPLANATION OF PLATE XVII.

---

### GESTURE LANGUAGE.

- Fig. 1. Bushman; traveller.  
,, 2. Kangaroo; wallaby.  
,, 3. Father.  
,, 4. Cattle.  
,, 5. Dog; dingo (see also fig. 21).  
,, 6. Government tracker; policeman (peaked cap; see also fig. 23).  
,, 7. Brother; sister.  
,, 8. Father's sister's child.  
,, 9. Horse (see also fig. 13).  
,, 10. Mother or father's father.  
,, 11. Son; daughter.  
,, 12. Venery (see also fig. 14).  
,, 13. Horse (see also fig. 9).  
,, 14. Venery (see also fig. 12).  
,, 15. Woman; young woman.  
,, 16. Crocodile (see also Pl. xviii., fig. 30).  
,, 17. Stingaree.  
,, 18. Fish; fish-net.  
,, 19. Mother.  
,, 20. Carpet snake.  
,, 21. Dog; dingo (see also fig. 5).  
,, 22. Water snake.  
,, 23. Government tracker; policeman (military salute; see also fig. 6).

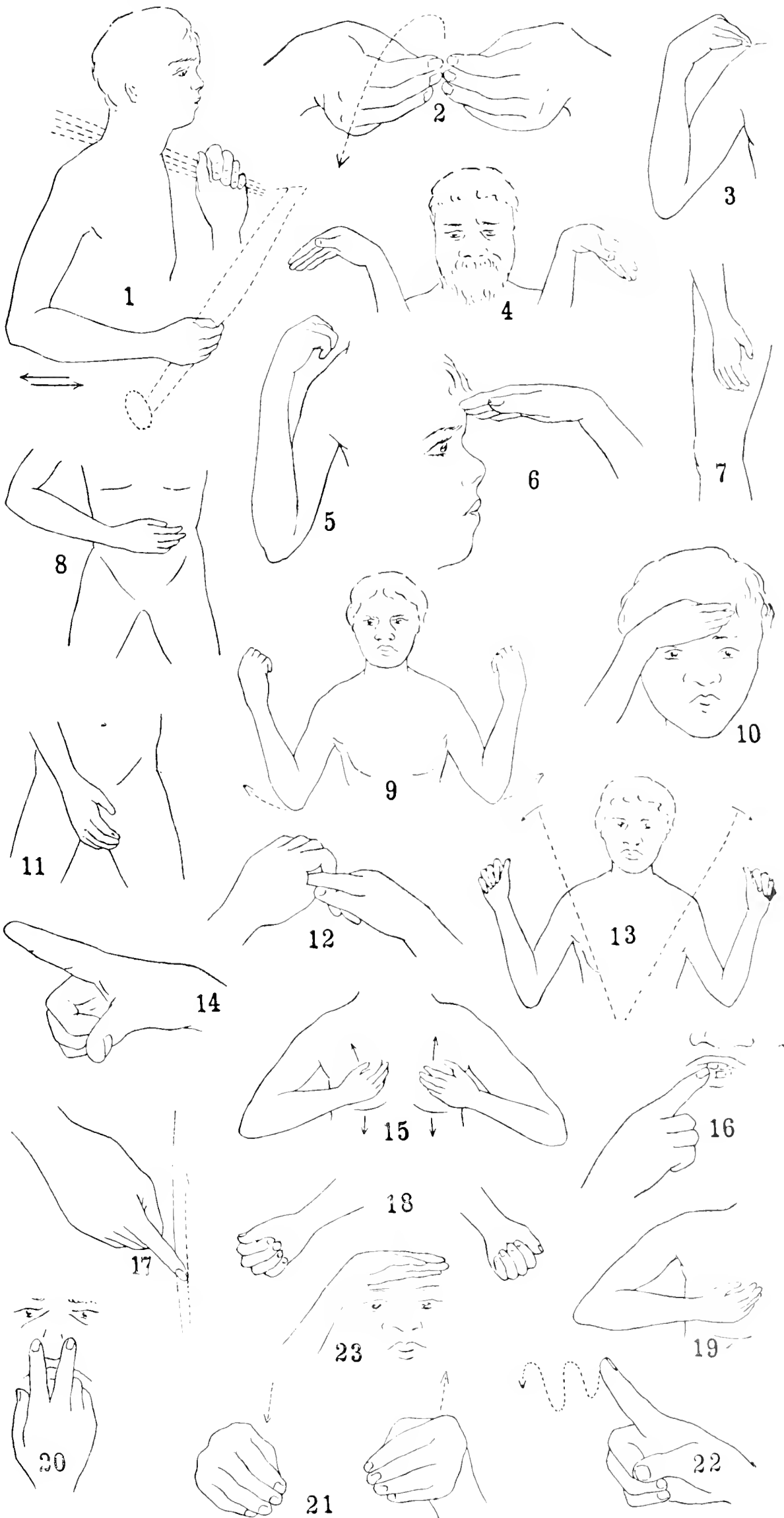





EXPLANATION OF PLATE XVIII.

—————  
GESTURE LANGUAGE.

- Fig. 1. Large number.  
" 2. " "  
" 3. " "  
" 4. Interrogation.  
" 5. Silence (see also fig. 9).  
" 6. Corroboree; dance.  
" 7. Anger (see also fig. 10).  
" 8. Killing; death; corpse (see also fig. 14)  
" 9. Silence (see also fig. 5).  
" 10. Anger (see also fig. 7).  
" 11. Act of killing.  
" 12. "  
" 13. "  
" 14. Killing; death; corpse (see also fig. 8)  
" 15. Forgetfulness.  
" 16. Negation.  
" 17. Snake in general.  
" 18. Knavery; foolery.  
" 19. Ghost; evil spirit.  
" 20. Nothing; none.  
" 21. Nothing; no more.  
" 22. Good-bye.  
" 23. Bird or turtle.  
" 24. Frog.  
" 25. Mullet.  
" 26. Lizard.  
" 27. Frilled lizard.  
" 28. Iguana.  
" 29. Crocodile (see also Pl. xvii., fig. 16).



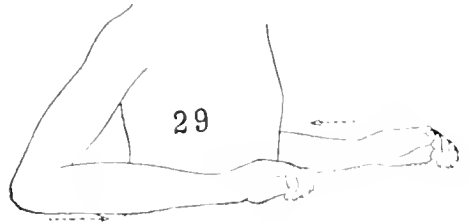
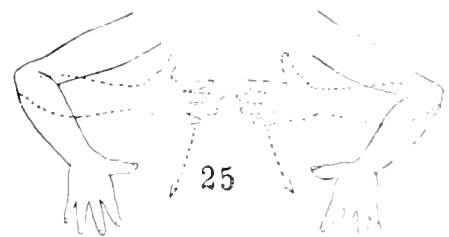
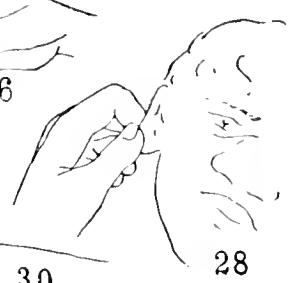
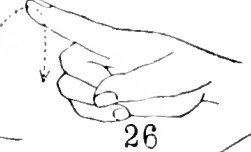
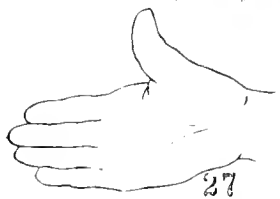
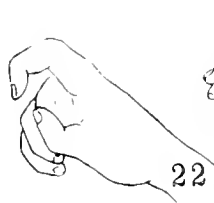
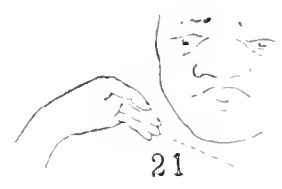
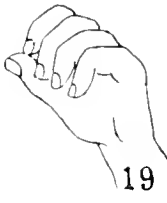
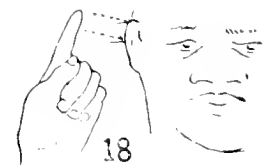
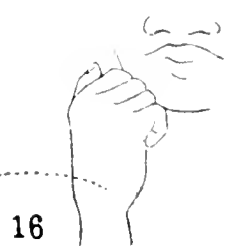
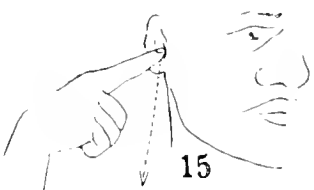
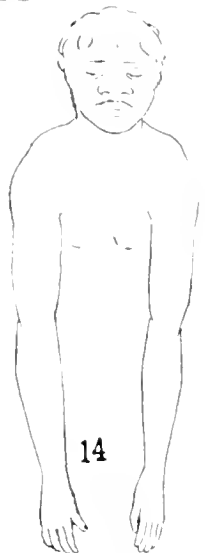
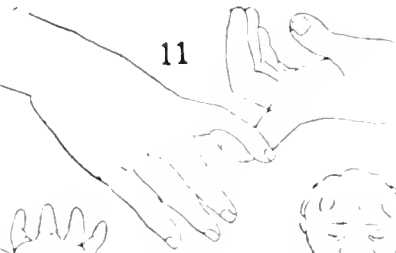
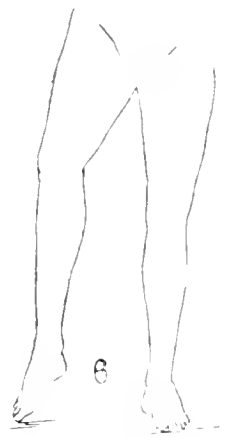
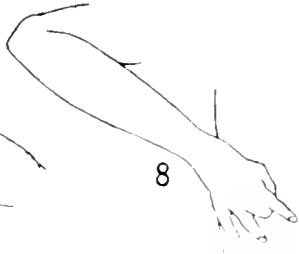
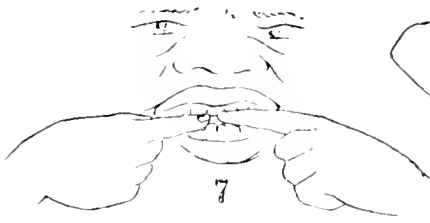
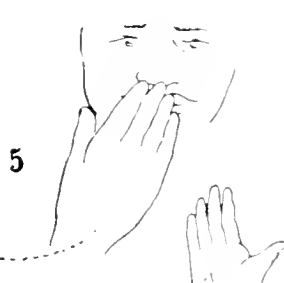
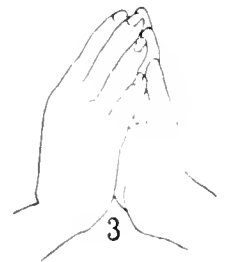
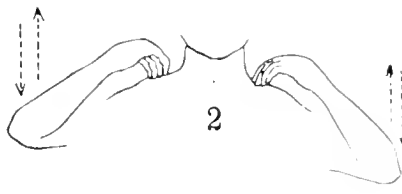
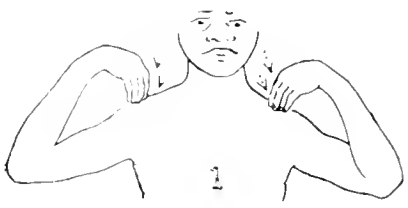





## EXPLANATION OF PLATE XIX.

### GESTURE LANGUAGE.

- |      |     |  |
|------|-----|--|
| Fig. | 1.  | Large kangaroo.                        |
| "    | 2.  | }                                      |
| "    | 3.  | Male red kangaroo                      |
| "    | 4.  | Female "                               |
| "    | 5.  | Kangaroo in general (see also fig. 8). |
| "    | 6.  | Female brown kangaroo.                 |
| "    | 7.  | Male "                                 |
| "    | 8.  | Kangaroo in general (see also fig. 5). |
| "    | 9.  | Scrub-wallaby.                         |
| "    | 10. | Small rock wallaby.                    |
| "    | 11. | White wallaby.                         |
| "    | 12. | Opossum (see also fig. 15).            |
| "    | 13. | Paddy melon.                           |
| "    | 14. | Native-companion (see also fig. 19).   |
| "    | 15. | Opossum (see also fig. 12).            |
| "    | 16. | Pelican.                               |
| "    | 17. | Porcupine (see also fig. 20).          |
| "    | 18. | Bandicoot.                             |
| "    | 19. | Native-companion (see also fig. 14).   |
| "    | 20. | Porcupine (see also fig. 17).          |
| "    | 21. | Duck.                                  |
| "    | 22. | Cockatoo (see also fig. 26).           |
| "    | 23. | Bee; honey (see also figs. 25, 27)     |
| "    | 24. | Emu                                    |
| "    | 25. | Bee; honey (see also figs. 23 and 27). |
| "    | 26. | Cockatoo (see also fig. 22).           |
| "    | 27. | Bee; honey (see also figs. 23 and 25). |
| "    | 28. | Yam (see also fig. 34)                 |
| "    | 29. | Yam digging.                           |
| "    | 30. | "                                      |
| "    | 31. | River; creek (see also fig. 36).       |
| "    | 32. | Fire.                                  |
| "    | 33. | Water.                                 |
| "    | 34. | Yam (see also fig. 28).                |
| "    | 35. | Water-hole.                            |
| "    | 36. | River; creek (see also fig. 31).       |
| "    | 37. | }                                      |
| "    | 38. | } Mountain.                            |
| "    | 39. | Womerah or spear-thrower.              |
| "    | 40. | Womerah spear.                         |
| "    | 41. | Fillet, or forehead band.              |







#### EXPLANATION OF PLATE XX.

---

- Figs. 1 and 2. Whirlers. These are hung by the string to catch the wind, and so made to revolve near a baby, rendering the latter "tabu;" used at Butcher's Hill, Cooktown and Bloomfield River. In the Koko-yimidir dialect, spoken from the Annan and Endeavour Rivers along the coast line to Cape Flattery, they are called *marpan*. In the Koko-yellangi dialect, spoken at Butcher's Hill, the name is *jinna-juronggor*. The colours used are red and white. Both implements are from Butcher's Hill.
3. A whirler charm to render an object "tabu." Mapoon--Dr. Roth surmises this to be a modern form of the charm represented in Pl. xxi., figs. 1 and 2. The colours used are red and white.



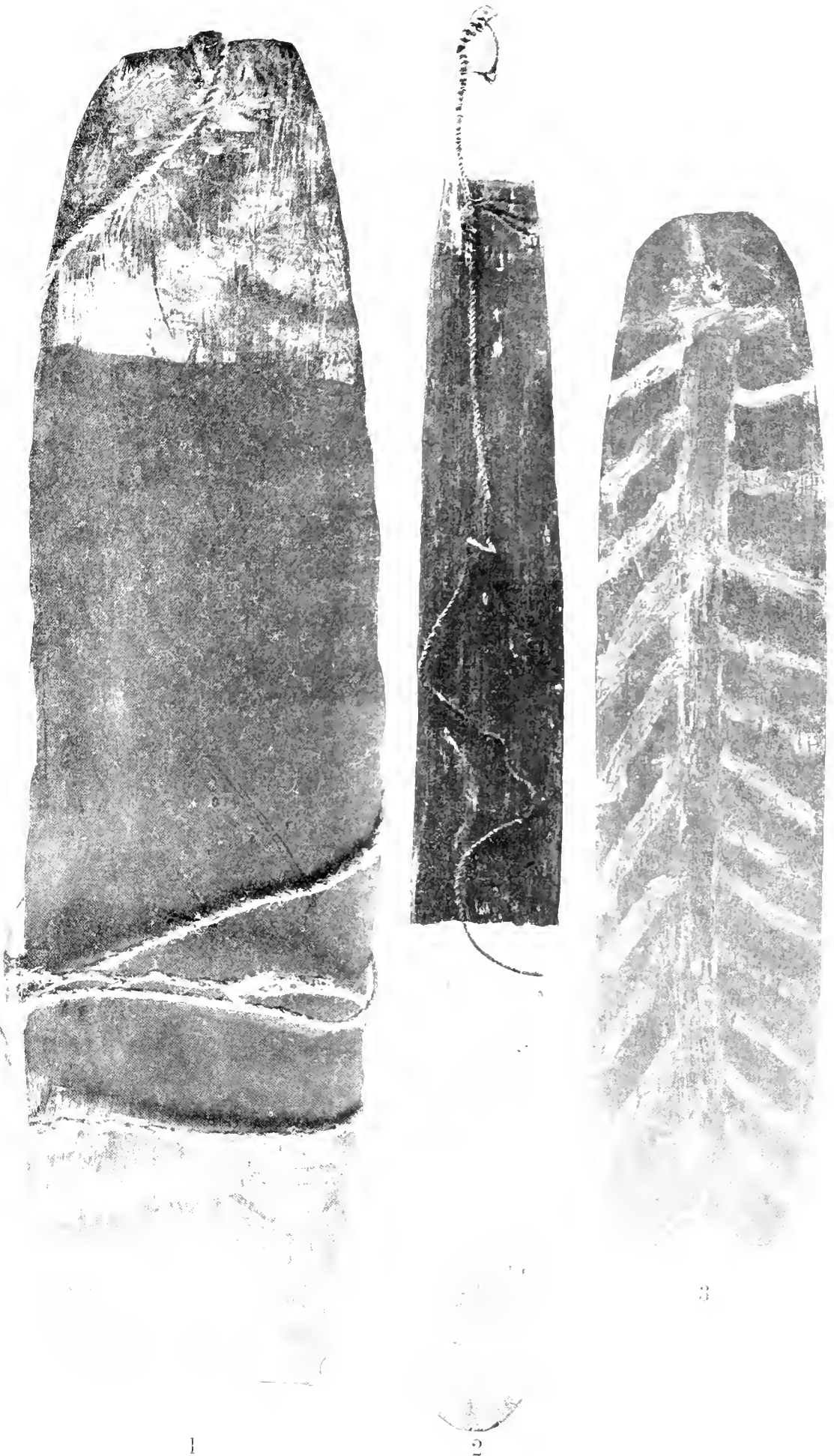

H. BARNES, Junr., photo.,  
Austr. Mus.





#### EXPLANATION OF PLATE XXI.

---

- Figs. 1 and 2. Painted spear heads hung in proximity to an object to render it "tabu." The colours used are red and white. Mapoon.
3. A charm to render an object "tabu." By the Koko-minni Blacks of the Middle Palmer River it is called *timi* (see Pl. xx., fig. 3). The colours used are red and white. The implement was obtained at the Palmer Native Police Camp.

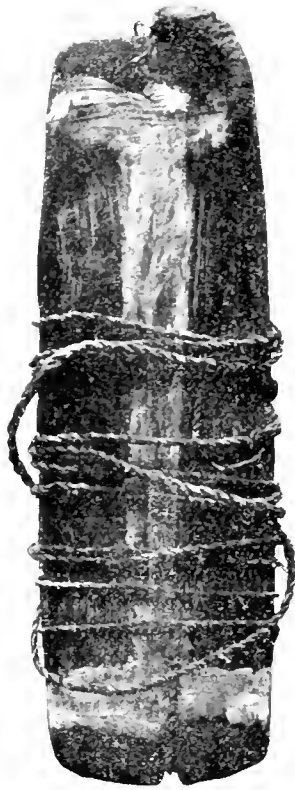
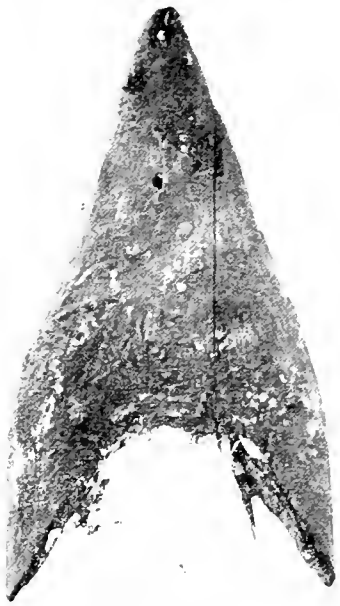

1

3

2





EXPLANATION OF PLATE XXII.

---

- Fig. 1. *Calliostoma retiarium*, Hedley and May.  
,, 2. *Gibbula galbina* ,, ,,  
,, 3. *Calliostoma columnarium* ,, ,,  
,, 4-5. *Basilissa niceterium* ,, ,,  
,, 6, 7, 8. *Liotia petalifera* ,, ,,  
,, 9. *Rissoa columnaria* ,, ,,  
,, 10. *Rissoina fausta* ,, ,,



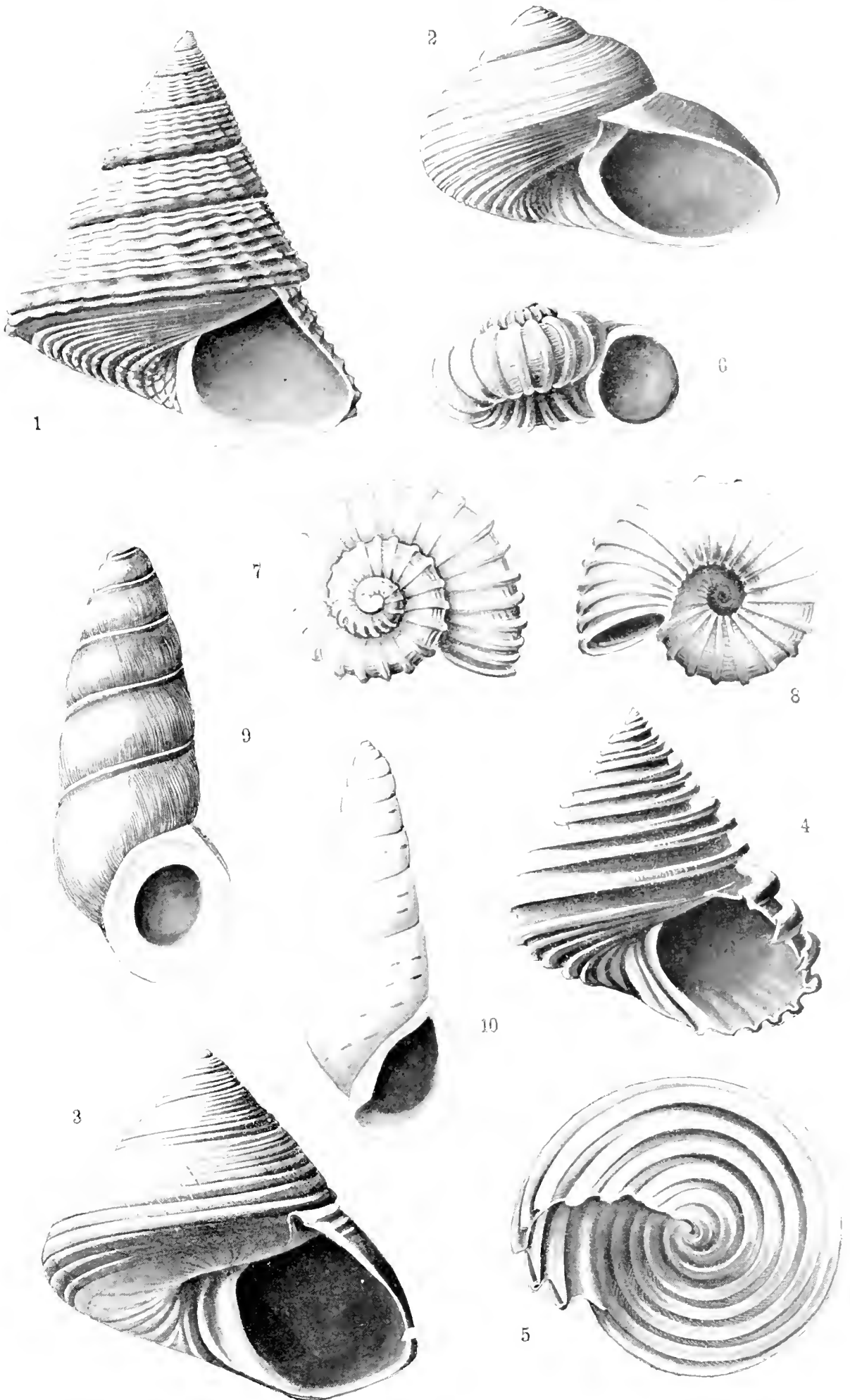





EXPLANATION OF PLATE XXIII.

---

- Fig. 11. *Rissoina lutea*, Hedley and May.  
,, 12, 13. *Pseudorissoina capitivara*, Hedley and May.  
,, 14. *Septa petulans*, Hedley and May.  
,, 15. *Cymatium columnarium*, Hedley and May.  
,, 16. *Arcularia mobilis*, Hedley and May.  
,, 17. ,, ,, var. *costata*, Hedley and May.  
,, 18. *Natica elkingtoni*, Hedley and May.  
,, 19. *Marginella columnaria*, Hedley and May.  
,, 20, 21. *Microrobuta purpurcostoma*, Hedley and May.

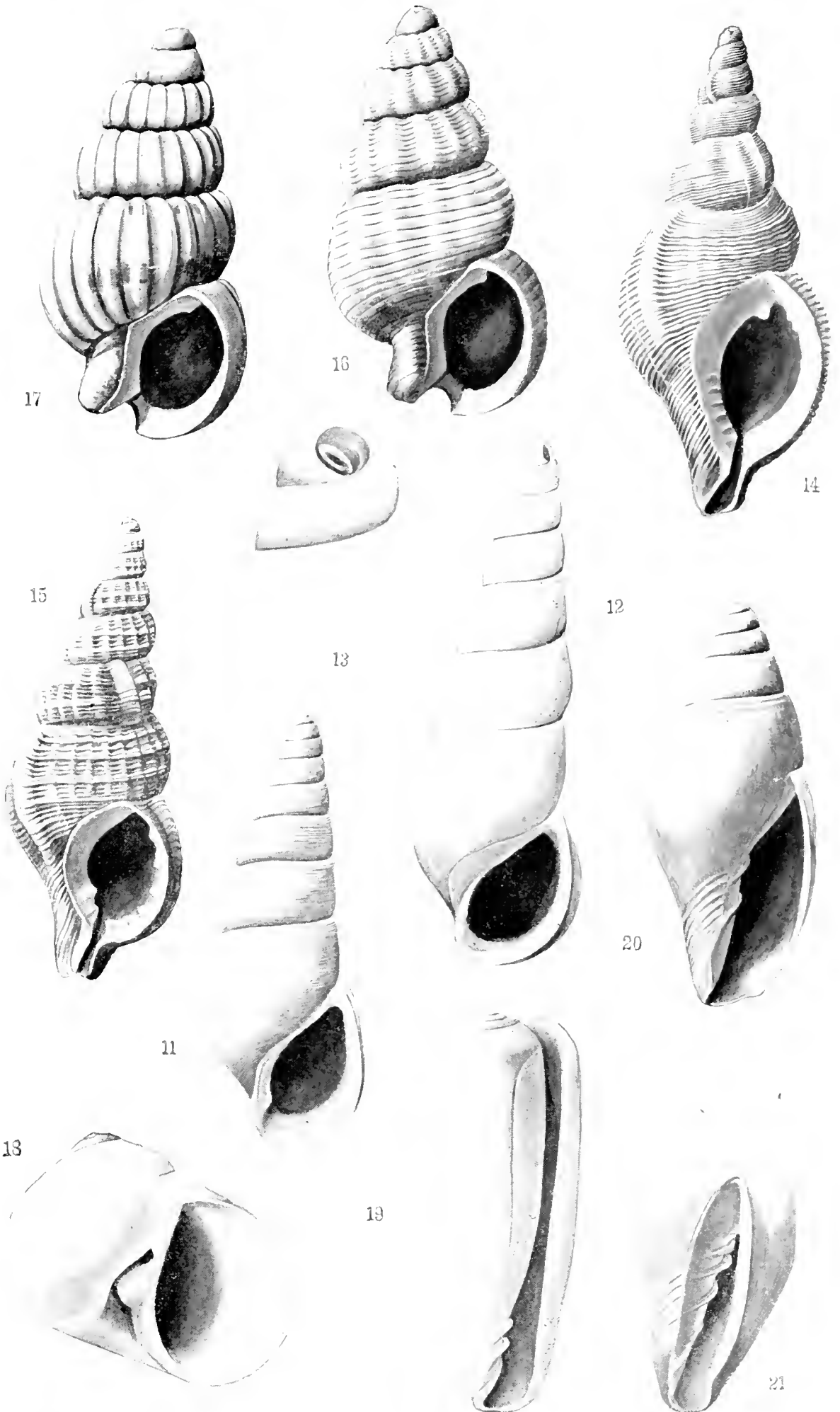





EXPLANATION OF PLATE XXIV.

---

- Fig. 22. *Trophon columnarius*, Hedley and May.  
,, 23. ,, *molorthus* ,, ,,  
,, 24. ,, *sarmentosus* ,, ,,  
,, 25, 26. *Philine columnaria* ,, ,,  
,, 27, 28. *Lepidopleurus columnarius*, Hedley and May.  
,, 29, 30, 31, 32. *Cunna compressa* ,, ,,





22



25



24

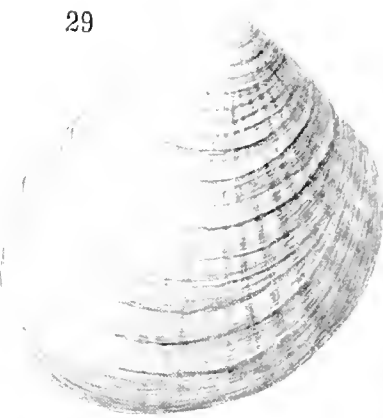

29



26



23

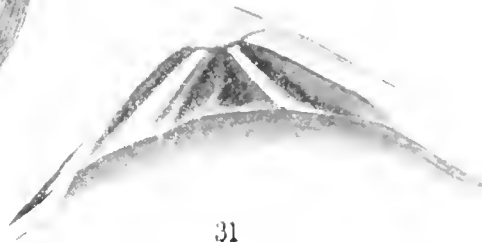

31

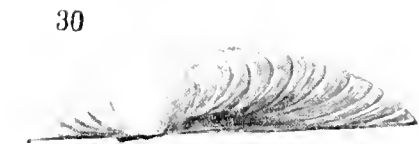

30

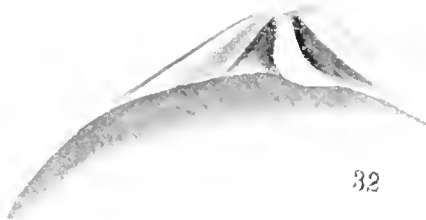

32

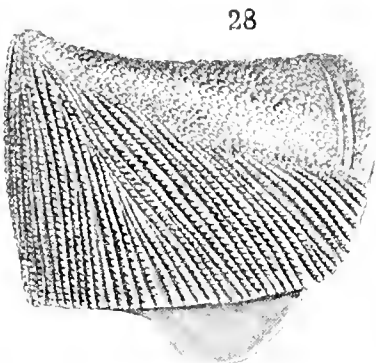

28

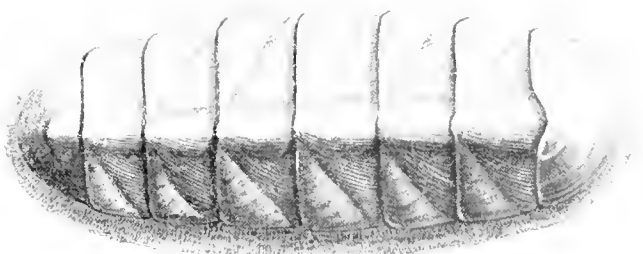

27





EXPLANATION OF PLATE XXV.

---

- Figs. 33, 34, 35, 36. *Cyba longata*, Hedley and May.  
,, 37, 38, 39, 40. *Ventricardia columnaria*, Hedley and May.  
,, 41, 42. *Cnidylocardia porrecta*, Hedley.  
,, 43, 44, 45. ,, *pectinata*, Tate and May.



37



44



39



45

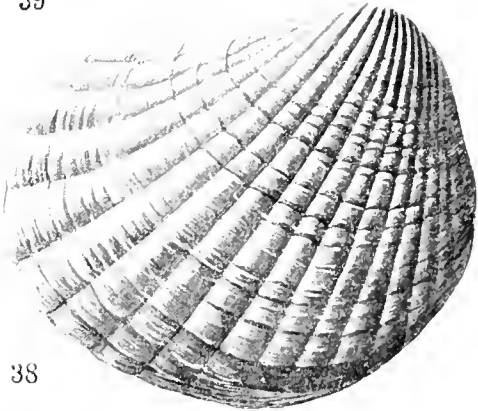

38

43

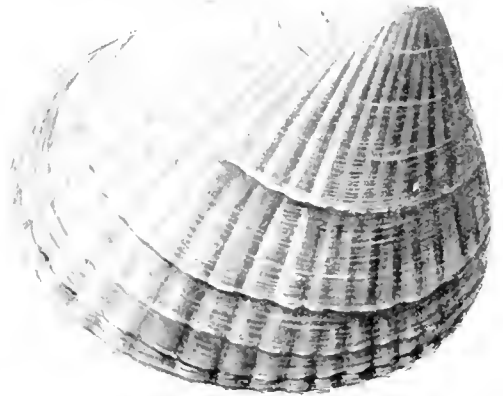

40



34

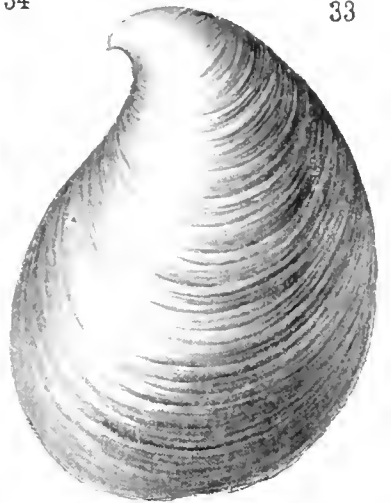

33



35

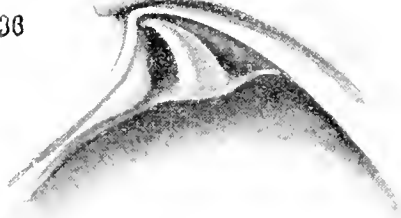

36

41

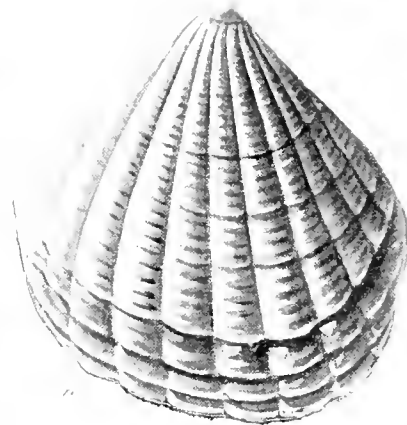

42





EXPLANATION OF PLATE XXVI.

---

*Natator tessellatus*, McCulloch.

Slightly reduced.



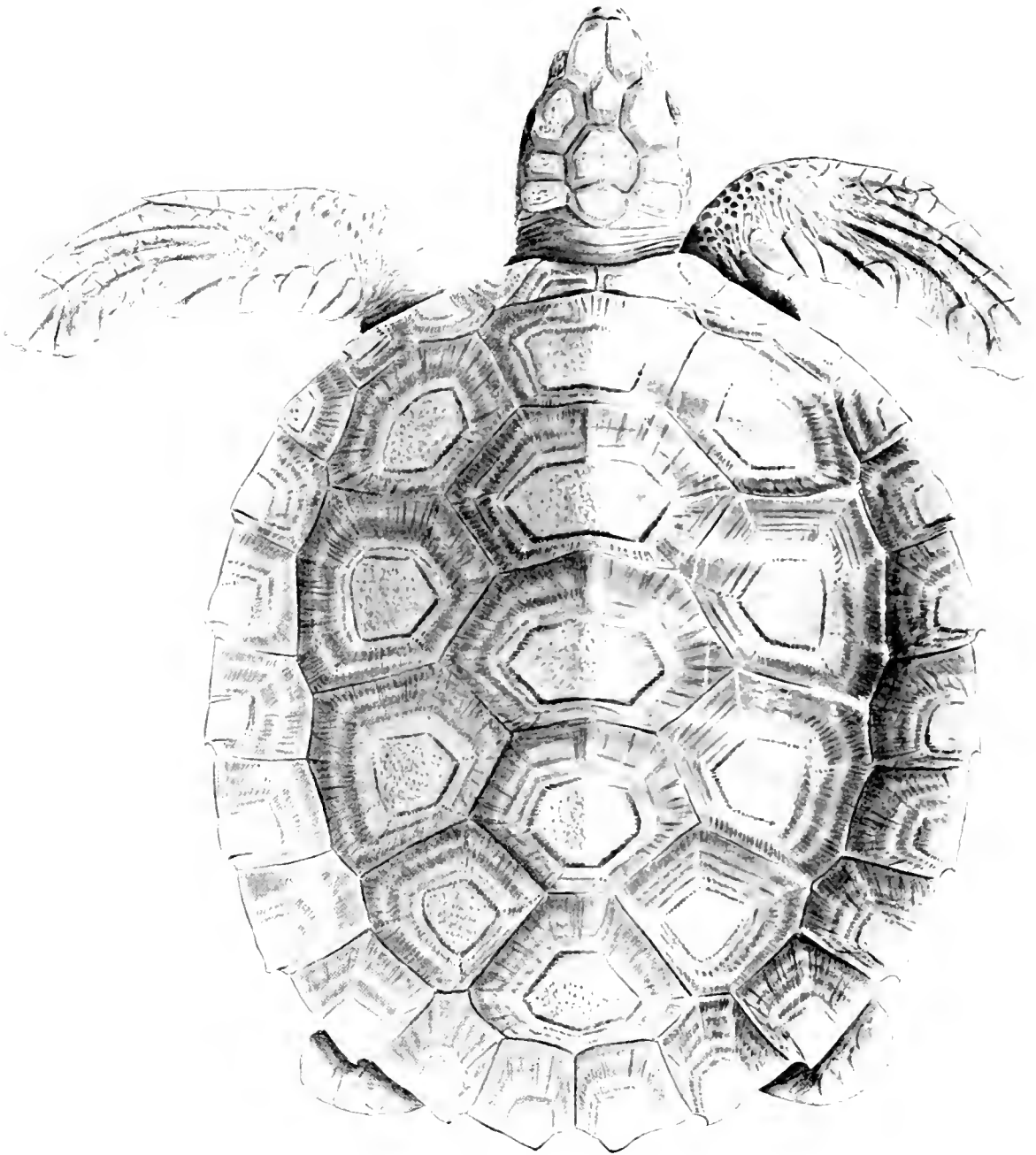





EXPLANATION OF PLATE XXVII.

-----  
*Natator tessellatus*, McCulloch.

Slightly reduced.

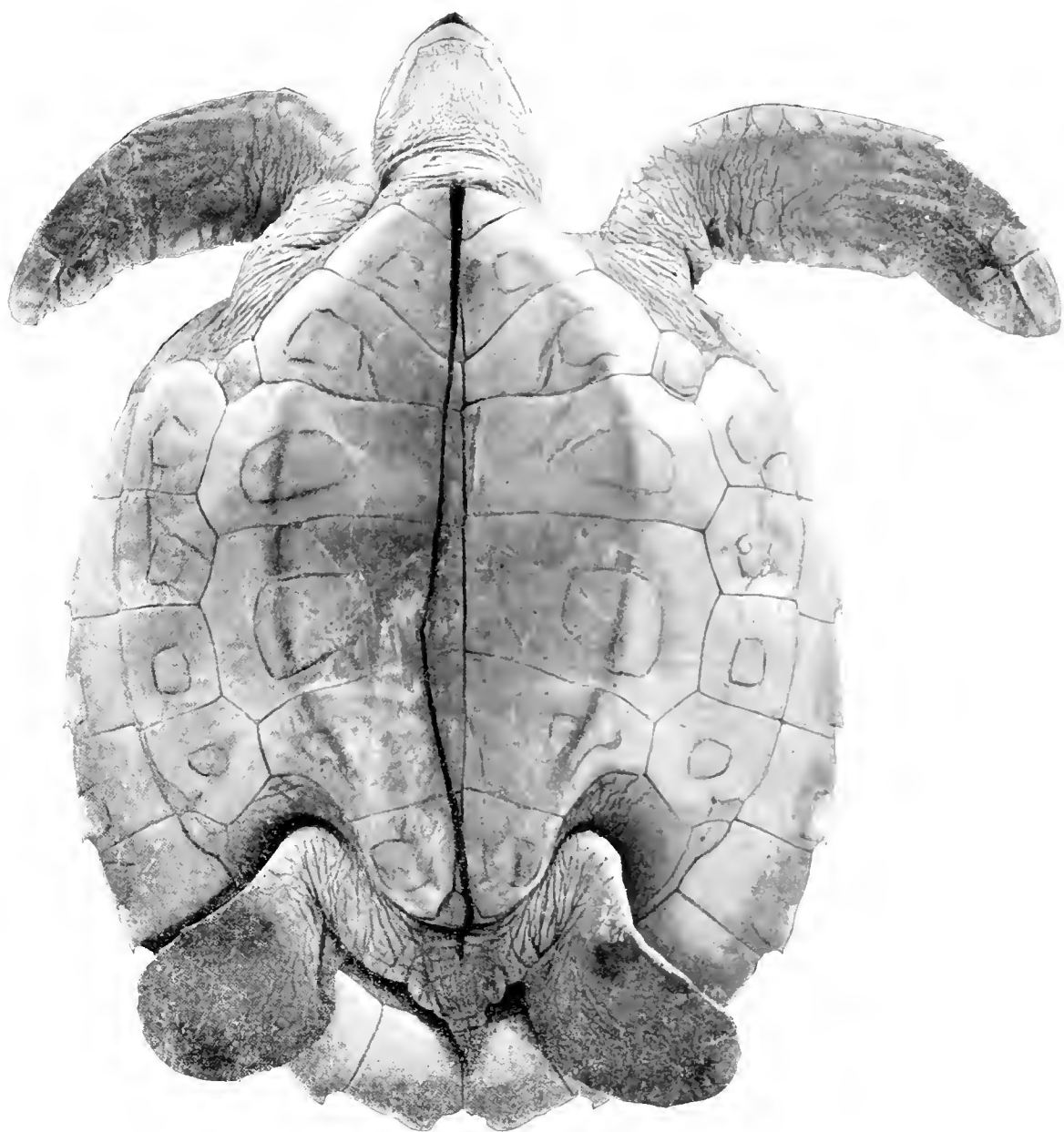





## EXPLANATION OF PLATE XXVIII.

RHODOSITE.

Broken Hill, N.S. Wales.

Figs. 1, 3. Orthographic projection.

Figs. 2, 4. Clinographic projection of figs. 1 and 3 respectively.

Forms.— $a$  (001),  $c$  (010),  $b$  (100),  $o$  ( $\bar{1}\bar{1}0$ ),  $s$  ( $\bar{1}\bar{1}0$ ),  $\kappa$  (011),  $\pi$  (012),  $m$  ( $0\bar{1}\bar{2}$ ),  
 $k$  ( $0\bar{1}1$ ),  $i$  (021),  $q$  (101),  $\rho$  (102),  $u$  (103),  $r$  (102),  $l$  ( $\bar{2}03$ ),  $n$  ( $\bar{1}01$ ),  
 $\mu$  (111),  $\phi$  (111).

(Lettering and indices according to Goldschmidt; unlettered faces are new)



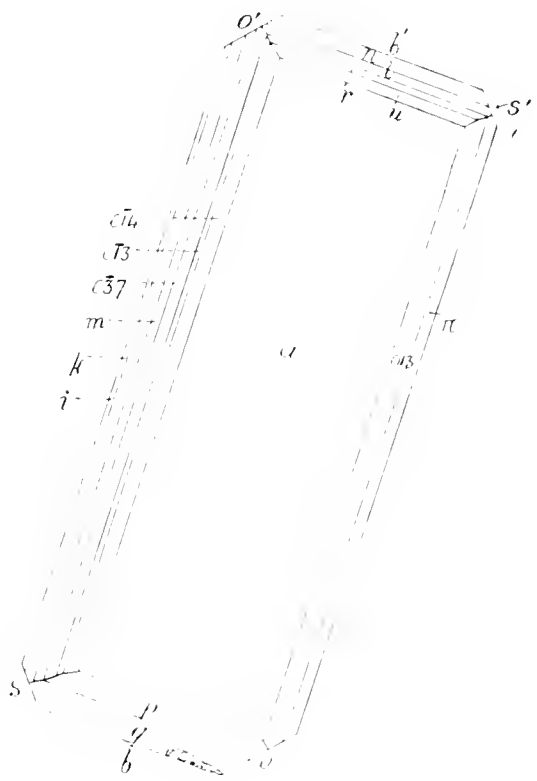

1



3

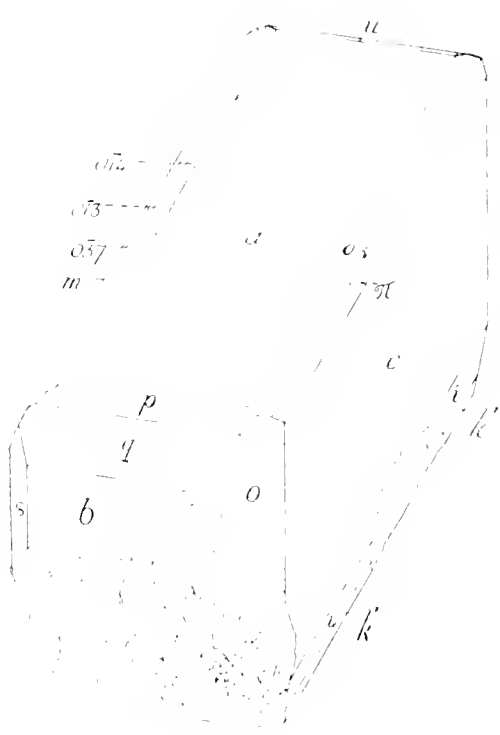

2

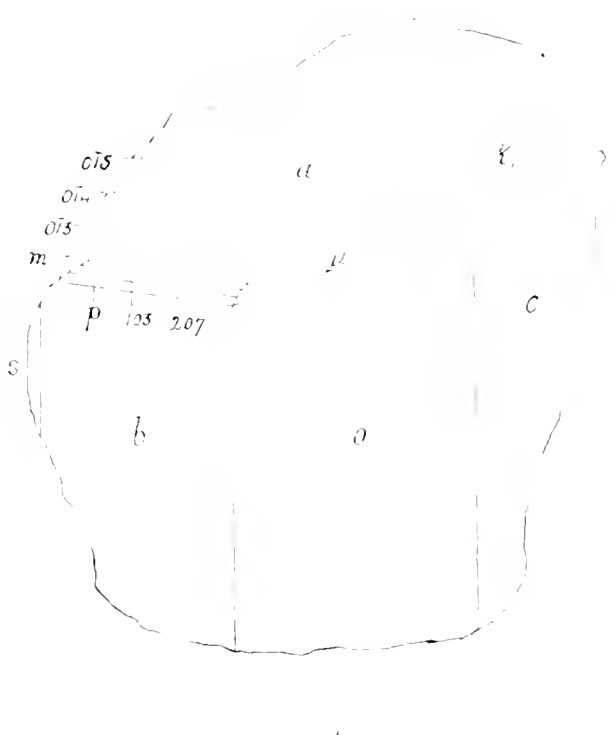

4





EXPLANATION OF PLATE XXIX.

---

RHODONITE.

Broken Hill, N.S. Wales.

Figs. 1, 3. Orthographic projection.

Fig. 2. Clinographic projection of fig. 1.

., 4. Stereogram.

(For lettering and indices see explanation to Plate xxviii.)

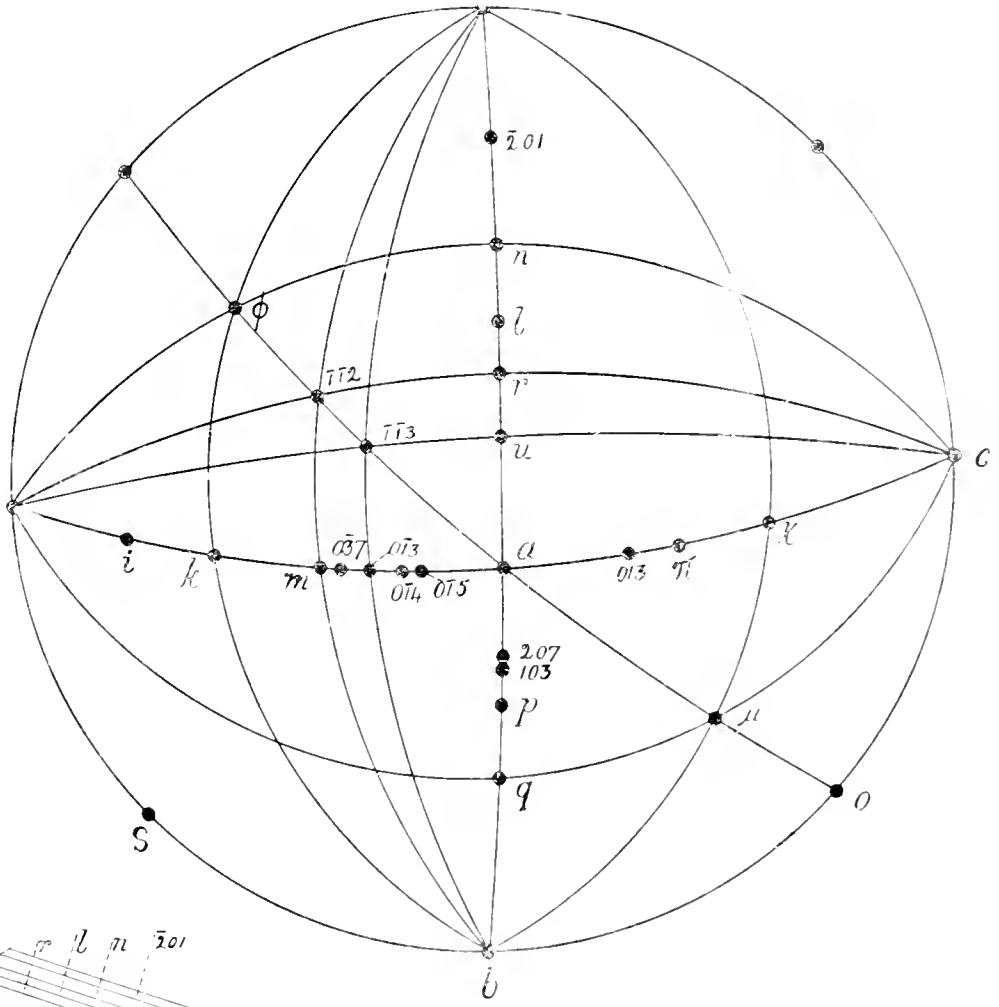

4

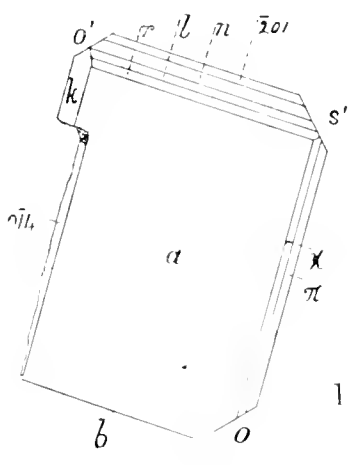

1

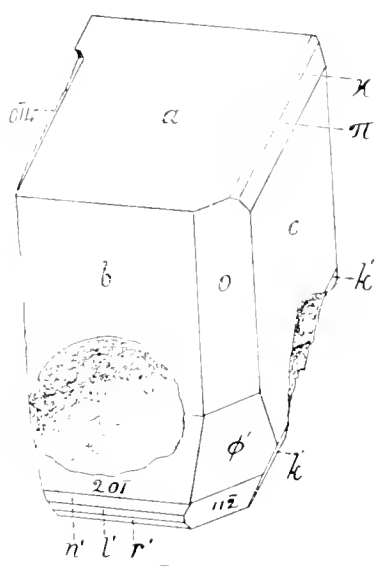

2



3









## CORRECTIONS.

---

Substitute the Explanations of Plates I. and II. herewith,  
for those formerly supplied.





EXPLANATION OF PLATE I.

---

ABORIGINAL CUSTOMS.

- Fig. 1. Assisting in confinement.  
„ 2. Medicine man sucking bone out of wound.



#### EXPLANATION OF PLATE II.

---

- Fig. 1. Doctor using sucking string (this has been already published, see Bull. v., fig. 28.)  
„ 2. Man and two women, the latter with children astride on their shoulders.

LOWER CRETACEOUS FOSSILS FROM THE SOURCES OF  
THE BARCOO, WARD AND NIVE RIVERS SOUTH  
CENTRAL QUEENSLAND

PART II.<sup>1</sup>—CEPHALOPODA.

By R. ETHERIDGE, JUNR., Curator.

(Plates xxx.-xlix., and Fig. 8.)

I.—INTRODUCTION.

The "Ammonites" proper contained in Mr. H. W. Blomfield's collection are few in number, and will be noticed in a later part of this Memoir. The following descriptions of the "Crioceri" are offered with a considerable amount of diffidence, and to arrive at these results I found it imperative to undertake a general review of our Cretaceous forms hitherto associated with the names *Crioceras* and *Ancyloceras*; the outcome of this work, extending over many months, is to my mind, I regret to say, anything but satisfactory. This arises from two primary causes, the fragmentary state in which the fossils are frequently found, and the difficulty experienced in grouping such portions, from many and widely separated localities, in well defined species. A secondary cause is due to the fact that many of the hitherto described forms are based on portions of shells only, and in two instances at least the descriptions are so inadequate that recognition of the species is practically reduced to guess work. In no instance is this more apparent than in that of *Crioceras australe*, Moore, the Australian type of the group.

To render my investigations as complete as possible, I assembled all the specimens of the above two genera within my reach, and drew upon the following collections, as well as our own:—The Mining and Geological, and Macleay Museums, Sydney; National Museum, Melbourne; Geological Survey, and Queensland Museums, Brisbane; Geological Survey Collection, Adelaide; and the Sweet Collection, Melbourne. For the loan of specimens from

---

<sup>1</sup> Part I.—See Austr. Mus. Rec. vi., 5, 1907, p. 317.

these collections, my thanks are due, respectively, to Mr. E. F. Pittman, Prof. T. W. E. David, Prof. W. Baldwin Spencer, Mr. H. Y. L. Brown, Mr. B. Dunstan, Mr. C. J. Wild, and Mr. G. Sweet, all of whom responded in the most cordial manner to my applications.<sup>2</sup>

With the intention of ascertaining all that could be learnt of the Australian type, *C. australe*, Moore, I enlisted the sympathy and help of my friend, Dr. A. Smith Woodward, who endeavoured to obtain for me a reproduction of Moore's figured specimen, believed to be in the Bath Museum, where the remainder of Moore's collection of Australian Mesozoic fossils is deposited. Most unfortunately, however, this particular fossil appears to be non-extant, either lost or mislaid, and so this avenue of information is closed to me.

This investigation has necessitated an entire reconsideration of all the facts hitherto published regarding our *Crioceri* and *Ancyloceri*, and the modification of a good deal of pre-existing work, including my own.

If *Crioceras australe*, Moore, is to remain on our list, then a goodly proportion of the following results is open to suspicion; but if it be permissible to absolutely reject this name, on the ground of insufficient description and loss of type, then I believe the suggested determinations following are as near to the truth as the materials now gathered together will permit of.

## II.—AS TO *CRIOCERAS AUSTRALE*, Moore.

It is not my intention to recognize *C. australe* as a species, and it is as well, once for all, to give my reasons for so doing. The only characters worthy of note, and they are not of much value, given by Moore are the following:—(1) large size; (2) volutions closely fitting; (3) earlier costæ regular, rounded and slightly curved; (4) later costæ widely separated and acute, with two "depressed bosses on either side" (of the median line of the venter it is presumed?); (5) younger sulci (intercostal valleys) rounded; (6) older sulci regularly concave; (7) mouth seven and a half inches by seven; (8) siphuncle small and immediately ventrad; (9) venter broad, three and a half inches.

Only one of these characters is of sufficient importance to be specific, the occurrence of the two "depressed bosses" on either

---

<sup>2</sup> The present paper will therefore contain descriptions of fossils from localities other than those comprised within the geographical boundaries given in the title.



side; the others are common to all our larger *Crioceri* at some period of their growth. Moore could have told us whether or no these large tubercles occur on each costa, or on alternate costæ, or the tubercle-bearing costæ separated by many or few undecorated ribs, all important points in the separation of our species, as will be seen later. Again, nothing definite is said of the relative positions of these tubercles, whether abdominal, lateral, or supra-dorsal.

I certainly laboured under the impression I knew *C. australe*, and have so named specimens; now, however, I can only regard such determinations as hasty generalisations. If Moore's species is to be retained and distinguished by possessing two rows of tubercles on each side the middle line of the venter in the gerontic condition, then we are left with many non-tuberculate specimens in a younger stage of growth that must remain, from their imperfect condition, nameless. During my researches in Australian Cretaceous Palæontology, I have never met with a large *Crioceras* possessing two such rows of tubercles in the aged condition of the coil.

Moore said of his species—"shell very large." We certainly do possess a huge so-called *Crioceras*, or perhaps even two, in our Cretaceous beds. Mr. Felix Ratte figured<sup>3</sup> about one-half of a shell ascribed to *C. australe*, the perfect diameter of which would have been about four feet, and so far as the state of preservation discloses, non-tuberculate.

The late Dr. W. Waagen ascribed to this species a large Indian Cretaceous shell<sup>4</sup> without any trace of the two rows of tubercles on the more adult whorls, but, on the other hand, with fasciculate costæ and two rows of large tubercles on the younger, or inner whorls; this was a direct departure from Moore's description. I committed a further mistake by including<sup>5</sup> a shell of fine growth in *C. australe*, apparently entirely devoid of tubercular ornamentation.

Under these circumstances, viz., the incompleteness of Moore's description; the loss of his type-specimen; and the different interpretation put on the meaning of the name by Messrs. Ratte, Waagen, myself, and collectors in general, I am induced to abandon the name as the most direct way out of a serious difficulty.

<sup>3</sup> Ratte.—Proc. Linn. Soc. N. S. Wales, (2), i. 1886, pl. ii.

<sup>4</sup> Waagen—Jurassic Fauna of Kutch (Pal. Ind.), Ceph., 1875, i., No. 4, p. 246, pl. ix., figs. 1 a-c.

<sup>5</sup> Etheridge—Geol. Pal. Q'land, etc., 1892, pl. xxxi., f. 1.

III.—THE NAMES *CRIOCERAS* AND *ANCYLOCERAS*.

Before proceeding with the specific descriptions, it may be well to pass in review some facts in the history of these genera. Leveillé's original description as *Crioceratites* is not available, and I have to fall back on D'Orbigny's,<sup>6</sup> which is a very wide definition. The principal features of his *Crioceras*, irrespective of the sutures, were a discoidal form, the coil enrolled in one plane, the whorls non-contiguous, and an oval, round, or compressed mouth. From the figures, the first of which is Leveillé's type (*C. duvalii*), we learn these interesting facts, viz., the increase in the circumference of the whorls was comparatively slow and slight, the coil a very open one, and in the type three rows of tubercles on each side the middle line of the venter. D'Orbigny's *Ancyloceras* so closely resembles *Crioceras* in its earlier stages that Mr. J. E. Astier<sup>7</sup> united the two, in which he was followed by Messrs. Pictet and Campiche, but unfortunately they selected the former name, thereby denying to Leveillé's genus its undoubted priority. Palaeontologists have since used both names, some one and some the other. The whole question is excellently and clearly put in favour of *Crioceras* by Messrs. Sarasin and Schondelmayer, to whose remarks the reader is referred, but they point out that the genus *Crioceras* is, amongst all the genera of Ammonitidæ, one of those interpreted very differently by authors. Amongst those who are in accord with the above authors are Messrs. M. Neumayr, M. Neumayr and V. Uhlig, and E. Haug.

The difficulty appears to have been to find some satisfactory method of division into genera of the heterogeneous assemblage of forms previously known as *Crioceras*, to replace the old D'Orbignyan one of degree of enrolment. The artificial nature of this method was, I believe, first pointed out by Dr. M. Neumayr, who suggested a division of the Ammonitidæ on the basis of natural kinship, to some extent then already foreshadowed by Quenstedt and Pictet.

Neumayr and Uhlig described<sup>8</sup> three lines of development of *Crioceras* forms from Ammonite stocks — one from *Olcostephanus*, viz., *C. fissicostatum*; a second from *Hoplites* (*H. hystrix*), viz., *C. roemeri*, N. & U.; and the third also from *Hoplites* (*H. longinodis*), viz., *C. seeleyi*, N. & U. These authors did not

<sup>6</sup> D'Orbigny—Pal. Franç. Terr. Crét., i., Ceph., p. 475.

<sup>7</sup> Astier—Ann. Sci. Phys. Nat. Soc. Nat. Agric. Lyon, (2), iii., 1851, p. 435.

<sup>8</sup> Sarasin and Schondelmayer—Mem. Soc. Pal. Suisse, xxix., 1902, p. 99.

<sup>9</sup> Neumayr and Uhlig—Palaeontographica, xxvii., 3-6, 1881, p. 184.

define *Crioceras*, but from developmental facts brought forward discussed the propriety of subdividing the genus. Glancing through their figures I find their conception of the latter includes—(a) close coiled forms (*C. seeleyi*); (b) the same with a shaft or limb (*C. urbani*); and (c) open coiled forms (*C. capricornu*, *C. roemeri*).

In 1883(?) Dr. V. Uhlig restricted *Crioceras*<sup>10</sup> by removing from it *C. asterianum*, D'Orb., and with *Hamites depressus* establishing for them the genus *Pictetia*,<sup>11</sup> as a connecting link with the Ammonite *Lytoceras*, Suess. Uhlig further removed from *Crioceras* a group of species typified by *C. puzosianum*, D'Orb., of a more or less dwarfed habit, and a loose open coil, as *Lytoceras*.<sup>12</sup> The embryonal chamber in the last named is followed by one, or one and a half, smooth whorls, when costae are gradually acquired, with a limb and crozier. Uhlig, after a close study of the Cephalopoda of the Wernsdorf beds, arrived at the conclusion that the major part of the forms referred to as *Crioceras* or *Ancyloceras* were genetically annexed to *Hoplites*, and that a generic distinction between the spiral *Crioceri* and those of the *Ancyloceras* type was superfluous.

In 1889 Mr. E. Haug suggested a separation of *Crioceras* and *Ancyloceras* based on the sculpture which he considered was much stronger on the "dwelling chamber" (shaft and crozier) of *Ancyloceras* than on the spirally inrolled whorls "which in *Crioceras* never appear to be the case"<sup>13</sup>; he selected *Ancyloceras mathernianum*, D'Orb., as the type of *Ancyloceras*, and included in it both close and open-coiled shells<sup>14</sup>; as an example of the former is *Scaphites coquandi*, Math., and of the latter *S. provinciale*, Math. The sculpture selected by Haug as typical of his definition of *Ancyloceras* consists of a uniform double row of tubercles on the flanks and two rows of abdominal tubercles (*i.e.*, one on each side the median line of the venter) always on the crozier, and sometimes on the spiral.<sup>15</sup> So far as I can understand his meaning, Haug appears to regard all *Crioceri* as constantly inrolled in a plane, bow-shaped, or spiral, in the latter case with or without a crozier.

<sup>10</sup>Uhlig—Denks. K. Akad. Wiss. Wien., xlvi., 2, p. 258.

<sup>11</sup>Uhlig—*Loc. cit.*, p. 202. The name *Pictetia* was subsequently (1885) proposed by C. Brongniart for a Neuropterous insect.

<sup>12</sup>Uhlig—*Loc. cit.*, p. 260.

<sup>13</sup>Haug—Beiträge Pal. Öster.-Ung. Orients, vii., 3 and 4, 1889, pp. 207 and 212.

<sup>14</sup>Haug—*Loc. cit.*, p. 214.

<sup>15</sup>Haug—*Loc. cit.*, p. 214.

Haug's restriction of *Ancyloceras* was regarded by Dr. D. J. Anthula<sup>16</sup> as unsatisfactory; although he stated his opinion that a trustworthy definition of the D'Orbignyan genus could not be given.

In 1902 appeared the paper, already quoted, by Messrs. Sarasin and Schondelmayer.<sup>17</sup> These authors vigorously dispute Dr. Haug's definition of *Ancyloceras* on the grounds that it is contrary to the generally admitted opinion in phylogenetic classification to give importance to the characters of the terminal portion of the shell in preference to the initial. They define *Crioceras* as consisting of species "derived from *Hoplites*, which present disjointed whorls with an enrolment sometimes crioceratic, sometimes ancyloceratic." The mode of enrolment employed by D'Orbigny is not of preponderating importance, nor is a group classification of the species assisted by the structure of the sutures, in consequence of their uniform and constant characters; on the other hand, the sculpture of the initial whorls is a good feature for differentiation into groups.

These authors divide *Crioceras* (+ *Ancyloceras*) into seven groups, each corresponding to a subgenus. For their second group (or subgenus) they reserve the name *Ancyloceras*, with *C. renauxianum*, D'Orb., as type, instead of *A. matheronianum*, D'Orb., the more usually accepted type. Messrs. Sarasin and Schondelmayer, whose paper is dated 1902, do not appear to have had the advantage of consulting Hyatt's classification published in 1900. Their second group, just referred to, contains two of Hyatt's genera—*Tomoceras* (*A. duralianum*, D'Orb.), and *Dirrimoceras* (*A. simplex*, D'Orb.). The third group, typified by *Ancyloceras matheronianum*, D'Orb., is, according to Hyatt, *Ancyloceras* (*sensu strictu*)! Lastly, the fourth group, with *A. tabarelli*, Astier, as its representative, is more or less equivalent to Hyatt's *Acrioceras*, of which the species named is the type.

In 1900 appeared the first volume of Eastman's translation<sup>18</sup> of Zittel's 'Grundzüge der Paläontologie,'<sup>19</sup> with the article 'Cephalopoda' revised and in a great measure rewritten by the late Prof. A. Hyatt, and containing the classification referred to above: it is to be regretted that this highly

<sup>16</sup>Anthula—Beiträge Pal. Öster.-Ung. Orients, xii., 3, 1899, p. 124.

<sup>17</sup>Sarasin & Schondelmayer—Mém. Soc. Pal Suisse, xxix., 1902, p. 99.

<sup>18</sup>Eastman—Text-Book of Paleontology. By Karl A. von Zittel, i., 1900. Svo. London.

<sup>19</sup>Zittel—Grundzüge der Paläontologie (Paläozoologie) Svo. Munich and Leipzig, 1895.

talented man did not live to elaborate the classification there forecast. Hyatt distributed the evolute Cephalopods through several families, but those with which we are at present chiefly concerned are the following:—

1. *Ancyloceratida*—“Includes only such forms usually assigned to *Ancylloceras*, *Crioceras*, etc., as have three rows of tubercles on either side on the larger costæ. Between the latter are smaller costations without tubercles. Costæ sometimes interrupted across the venter by a smooth zone.” Figures *A. matheronianum*, D’Orb.

2. *Crioceratida*—“ . . . with only two lines of tubercles on either side of the median line of the venter. The latter may have a smooth zone or be crossed by the costæ, which are either single or double between the tubercles ”

3. *Anisoceratida*—“ . . . . two rows of tubercles on either side the median line of the venter. Costæ large and single, or imperfectly bifurcate, and may cross the venter.”

4. *Hamitida*—Single costæ crossing the venter uninterruptedly, and no tubercles at any stage.

It appears to me that Hyatt attached considerable classificatory value to the external sculpture, and had he lived to complete his work a path very difficult to others would have been rendered smoother.

#### IV.—AUSTRALIAN CRIOCERI.

There is a strong community of structure throughout all the Australian shells of this type. It is only by attention to the degree of involment, breadth of the venter, convexity of the flanks and the sculpture, that specific separation and demarcation can be attained; I have paid attention, as a primary means, to the sculpture of the initial whorls, in the few instances in which it is visible. Nearly all our forms appertain to the more closely coiled type; apparently only two show any tendency to the open coil condition. I do not give detailed descriptions of the sutures. The specific differences appear to be so trivial that short of a special terminology for the lobe and saddle subdivisions it is impossible to express oneself clearly and at the same time tersely. Suffice it to say that throughout the species the community of structure in this respect is remarkable. In this they appear to be in accord with those forms studied by Messrs. Sarasin and Schondelmayer. The septa, speaking generally, throughout our specimens, are divided into six principal lobes as in the typical Hoplite-like *Crioceri*, such as *C. emerici*, *C. matheronianum*, etc.; the superior lateral lobes are always the longest with a broad body.

The descriptions that follow cannot be regarded as eminently satisfactory, nor do I see how such can be the case when the

sculpture varies at different stages of growth, and I am mainly dependant, although not in every instance, on incomplete material.

If the tuberculation be made use of as a guide, to some extent following Hyatt's lead, we find the Australian species can be arranged as follows:—

1. Without tubercles of any kind. *C. taylori*, mihi.
2. Tubercles only in the youngest condition, one row on each side the middle line of the venter. *C. nautiloides*, mihi.
3. The same as No. 2, with three rows of tubercles. *C. jackii*, mihi.
4. With one row of tubercles on each side the middle line of the venter throughout life (*i.e.*, as far as known)—*C. aronoides*, mihi; *C. flindersi*, McCoy; and *C. plectoides*, mihi.
5. With two rows in a similar position throughout life. *C. laqueus*, mihi; *C. cordycepoides*, mihi.
6. With three rows in aged individuals (young stage unknown). *C. lampros*, mihi.

According to Hyatt's classification, only one of these groups (No. 5) can be strictly regarded as a member of the Crioceratidæ, and one referable to his Ancyloceratidæ (No. 6).

The diminutive forms of the Point Charles and Shoal Bay beds are too fragmentary, in most cases, for an opinion to be formed of their more perfect condition. Not long since I endeavoured<sup>20</sup> to provisionally refer these to genera, but without marked success.

It is almost superfluous to mention that our Australian species, with one possible exception, are not typical *Crioceri* of the *C. durali* group. The latter throughout their volutions are more or less pipe-like, and increase but little in diameter. On the contrary, the former do, and are much more ammonoid, and even to some extent nautiloid, in appearance. In this respect if one conceives *Pictetia asterianum*, D'Orb.,<sup>21</sup> to be closer coiled than it is, the resemblance to our *C. jackii* in the gerontic stage is very marked. This ammonoid-like appearance was remarked on by Neumayer and Uhlig in *C. fissicostatum*, Roemer.<sup>22</sup>

In some dwarfed European species Uhlig discovered<sup>23</sup> that the first, or first and a half, volutions succeeding the embryonal are

<sup>20</sup>Etheridge—S. Austr. Parl. Papers, 1907 (Suppl. to No. 55, 1906). pp. 15-18, pls. ix.-xi.

<sup>21</sup>D'Orbigny—Pal. Franç. Terr. Crét., Ceph. i., 33-42, 1842, pl. cxv. *bis*, figs. 3 and 4.

<sup>22</sup>Neumayer & Uhlig—Palaeontographica, xxvii., 3, 1881, p. 182, pl. lvi., f. 1.

<sup>23</sup>Uhlig—Denk. K. Akad. Wiss. Wien, xlvi., 2, p. 260.

smooth, the following whorls gradually acquiring costæ as growth went on. These he separated as *Leptoceras*, and one of our smallest species appears to me to fulfil these conditions, viz., *C. edkinsi*, *mihl*.<sup>24</sup>

As Hyatt did not live to elaborate his classification, it is my intention, in the following pages, to refer the whole of the Australian forms to *Crioceras*, with the exception of the species just mentioned. When the limits of *Crioceras* have been defined by those with large collections at their disposal and access to the old types, it will be possible to relegate our local species to their respective groups.

Genus CRIOCERAS (*Leveillé*), *D'Orbigny*, 1842.<sup>25</sup>

*Crioceratites*, *Leveillé*, *Mém. Soc. Géol. France*, ii, 1836, p. 313 (*vide* *D'Orb.*).

*Crioceras*, *D'Orbigny*, *Pal. Franç. Terr. Crét. i. (Ceph.)*, 33-42 1842,<sup>26</sup> p. 457.

*Ancyloceras*, *D'Orbigny*, *ibid.*, p. 491.

*Ancyloceras*, *Astier*, *Ann. Sci. Phys. Nat. Soc. Nat. Agric. Lyon*, (2), iii, p. 435.

*Crioceras*, *Neumayer and Uhlig*, *Palæontographica*, xxvii., 3, 1881, p. 181.

*Crioceras*, *Uhlig*, *Denk. K. Akad. Wiss. Wien*, xlvi., 2, 1883, p. 258.

*Crioceras*, *Haug*, *Beiträge Pal. Ost.-Ung. Orient*, vii., 3 and 4, 1888, p. 206.

*Ancyloceras*, *Haug*, *ibid.*, pp. 211 and 214.

*Crioceras*, *Anthula*, *ibid.*, xii., 3, 1899, p. 124.

CRIOCERAS(?) LEPTUS,<sup>27</sup> *sp. nov.*

(Plate xxx.; Plate xxxiv., fig. 2.)

*Sp. Chars.*—Size of shell unknown. Venter rounded, narrow; abdominal margins rounded; dorsum flat, costate; impressed

<sup>24</sup>Etheridge—*Geol. Pal. Q'land, etc.*, 1892, p. 502, pl. xxx., figs. 8 and 9.

<sup>25</sup>As an addition to Mr. C. D. Sherborn's remarks (*Geol. Mag.*, (4), vi., 1899, p. 223) on the dates of publication of the "Livrasons" of *D'Orbigny's* Cephalopoda (*Pal. Franç.*) I would point out that *Bronn* (*Index Pal.*, i., 1848, p. 348) gives 1840 as *D'Orbigny's* date of *Crioceras*. It may also be mentioned parenthetically that the latter in one publication (*Pal. Franç. loc. cit.*, p. 459) gives *Leveillé's* date as 1836, and in another (*Prod. Pal.*, ii., 1850, p. 65) as 1837, whilst *Bronn* (*loc. cit.*) as 1835.

<sup>26</sup>Date *vide* *Sherborn*.

zone absent; flanks so very little rounded as to appear almost flat; section longitudinally and obtusely triangular (or longitudinally deltoid). Costæ single, obtuse, broadening forwards, straight on the venter, curved slightly forwards on the dorsum, and simply oblique, or very slightly sigmoidal on the flanks; intercostal valleys delicately lined to correspond with the costæ.

*Obs.*—Three disunited portions of whorls are referred to under this name, two of which may belong to the same individual specimen. Three characters combined serve to distinguish these, viz., the narrow venter, comparatively flat flanks, and the absence of tubercles. In the second of these features there is a general agreement with *C. aronoides*, but the tubercles of the latter are wanting. The three specimens are to some extent exfoliated, but I hardly think this would have obliterated all trace of tubercles, had the latter ever existed. The costæ agree with those of the median and older conditions of *C. jackii*. The flat, or almost straight-walled flanks assist materially in giving rise to the longitudinally deltoid outline of the transverse section of the walls, which is entirely unlike that of *C. jackii*. Pending the acquisition of more perfect material, the claim of these disunited portions to specific rank can only be regarded as tentative.

*Loc.*—Lind River, a branch of the Mitchell River, Cape York Peninsula [G.S.Q.; and A.M. (*W. Cope*)].<sup>27a</sup>

CRIOCERAS, *sp.*

(Plate xxxviii., figs. 1, 2.)

*Obs.*—This fragment is figured for future reference. It consists of portion of one whorl only, long-oval in transverse section, with a narrow rounded venter, a flat dorsum, exhibiting hardly any trace of an impressed zone, and absolutely flat flanks. The costæ are obtuse (although not large), particularly on the venter, which they cross without curvature, but on the dorsum are faintly inflected forwards, whilst on the flanks these ribs are slightly

<sup>27</sup>λεπτός, thin.

<sup>27a</sup>The abbreviations used in this and following localities are as follows:—

A.M. = Australian Museum Collection, Sydney.

Q.M. = Queensland Museum Collection, Brisbane.

G.S.Q. = Geological Survey of Queensland Collection, Brisbane.

G.S. = G. Sweet Collection, Melbourne.

U.S. = Macleay Museum, University of Sydney.

M.G.M. = Mining and Geological Museum, Sydney.

N.M.M. = National Museum, Melbourne.

G.S.S.A. = Geological Survey S. Australia Collection, Adelaide.



sigmoidal; here and there one is bifurcate, the bifurcations supra-dorsal in position. There is one row of pimple-like, uniform tubercles, on either side the median line of the venter, along the abdominal margins, one on each costa.

The specimen agrees with *C. leptus* except in the bifurcation of a few of the costæ, and the presence of the pimple-like tubercles.

Amongst the Port Darwin Cretaceous fossils of Shoal Bay occurred a small *Crioceras*<sup>25</sup> whorl which may possibly be an inner evolution of this form, although the venter is subtruncate instead of round, and a well-marked impressed zone is present. Attention is mainly called to this with the view of future identification.

*Loc.*—Barcoo, Ward, and Nive Rivers District [A.M. (H. W. Blomfield).]

*CRIOCERAS JACKII, Eth. fil.*

(Plate xxxi.; Pl. xxxii., figs. 1, 2 and 3; Pl. xxxiii., fig. 1; Pl. xxxiv., fig. 1; Pl. xxxv., fig. 1; Pl. xxxvi., fig. 1; Pl. xxxvii.; Pl. xxxviii., figs. 3-5.)

*Crioceras jackii*, Eth. fil., Proc. R. Phys. Soc. Edinb., v., 1880, p. 305, pl. xvii., figs. 55-58.

*Crioceras irregulare*, Ten. Woods, Proc. Linn. Soc. N. S. Wales, xvi., 1882, p. 151, pl. viii., f. 2.

*Crioceras australe*, Eth. fil., Geol. Pal. Q'land, etc., 1892, p. 499, pl. xxxi., f. 1; pl. xxxii., figs. 1-5.

*Crioceras irregulare*, Eth. fil., Geol. Pal. Q'land, etc., 1892, p. 501, pl. xxxiii., f. 1; pl. xlii., f. 16.

*Sp. Chars.*—Shell large, robust, whorls five or six, close coiled, rapidly enlarging and overhanging one another; venter rounded or convex, rapidly broadening as the shell grew; siphuncle small; abdominal margins obtuse; dorsum more or less concave, costate; impressed zone broad, shallow; flanks convex; umbilical cavity wide and open; section varies from octagonal round the fully tubercled costæ to transversely deltoid around the non-tubercled. Sculpture varies at different stages of growth; the first two and a half to three whorls bear a series of prominent or thickened obtuse costæ separated by from two to four (commonly two) ordinary round small costæ, all close together; beyond the above point costæ are all simple, regular and uniform, or a few bifurcate

<sup>25</sup>Etheridge—S. Austr. Parl. Papers (Suppl. to No. 55, 1906), 1907, p. 17, pl. ix., figs. 7 and 8.

merely, gradually enlarging or broadening, and becoming separated by wider and wider intercostal spaces, on the venter somewhat convex forwards, on the dorsum more so, and on the flanks distinctly sigmoidal; intercostal spaces (or valleys) finely lined. Tubercles very characteristic and confined to the earliest whorls, comprised in from one to three rows on each side the middle line of the venter as prominent, bold nodes; when only one row, this occurs along each abdominal margin; when two, the second appears at about the middle line of each flank; and when three, the third is supra-dorsal in position; when in three series, these nodes gradually die out in the following order—the supra-dorsal disappear first, the flank nodes next, and finally the abdominal nodes on some part of the third whorl. Septa with very undulating surfaces from the high development of the lobes and saddles.

*Obs.*—It will be remembered that subsequent to my original description of *C. jackii*, I referred<sup>29</sup> the latter to *C. australe*, Moore, as the younger stage of the latter. This determination I can no longer uphold, through my inability to recognise *C. australe*. I was led to this chiefly by Dr. W. Waagen's conception of *C. australe*, and still believe that the last named and my *C. jackii* are one and the same. The acquisition of additional material has increased my knowledge of both the older and younger conditions of *C. jackii*, and it now appears to be one of our best defined species.

In a former synonymy I united with *C. jackii* under the common name *C. australe*, the late Mr. F. Ratte's figures<sup>30</sup> of the large *Crioceras* in the Australian Museum. This monster, when perfect, must have possessed a diameter of upwards of four feet, but its state of preservation is so unsatisfactory that I now feel diffident of passing an opinion on its identity; tubercles are not visible. The largest specimen I feel disposed to refer to this species measures eleven inches by nine inches cross-diameters, the breadth of the last existing whorl being five inches from the middle of the venter to the umbilical edge.

The general appearance is decidedly ammonoid, particularly that of the *Lytoceras* group, arising to some extent from the close contiguity of the whorls to one another, although in this feature there is slight variability. In some cases the coil is close, in others there is an appreciable void between the volutions, when the projecting conical tubercles along the ventro-lateral margins become conspicuous.

<sup>29</sup>Etheridge—Geol. Pal. Q'land, etc., 1892, p. 499.

<sup>30</sup>Ratte—Proc. Linn. Soc. N. S. Wales, (2), i., 1886, p. 133, pls. i. and ii.

The costæ of the specimen mentioned in the latter portion of the last paragraph but one, are one inch apart, and as the shell increases in age the sigmoidal curvature becomes less apparent, and the costæ straighter or less curved. On these mature whorls these large costæ are more abruptly inclined on their fore aspects, gradually sloping or shelving off on their hinder faces into the concave valleys or intercostal spaces; this is a characteristic feature of *C. jackii*.

The costæ of the tuberculate whorls, and for some distance beyond the termination of the nodes, are uniformly convex, obtuse and close. Those bearing tubercles are always more or less swollen and enlarged, with from two to four simple ribs between them. The normal number of rows of tubercles is certainly three, as already described, but specimens are before me with two, or even only one row visible. At the same time it may be accepted as a fact that in no instance has a specimen with the general characters ascribed to this species been found to possess nodes beyond about the third or certainly the fourth whorl.

The section of the tubercle whorls is octagonal, the venter between the two abdominal rows being truncate and hollowed. The section of the remainder of the whorls is transversely deltoid.

The convexity of the flanks and the marked difference in sectional outline at once distinguishes *C. jackii* from the portions I have termed *C. leptus*.

To some extent in its young state it is our representative of the magnificent European *C. romeri*, N. & U.,<sup>31</sup> but the latter is much more highly ornate and the costæ of the two forms differ otherwise. In general appearance *C. jackii* is not unlike the American form *C. percostatum*, Gabb<sup>32</sup>; a comparison may also be made with *C. ramososeptatum*, Anthula,<sup>33</sup> in which the first three whorls are also nodose.

In a previous paragraph it is stated only one row of tubercles may occur on the earliest volutions of this species. Indeed, one may go a step further by calling attention to specimens in which no trace of tubercles is visible, but otherwise presenting the costal features of the more mature conditions of *C. jackii*. These costæ are remarkably regular, thick, rounded, although rather depressed, particularly on the venter, where they are

---

<sup>31</sup>Neumayr and Uhlig—Palaeontographica, (3), xxiii., 1881, 3, p. 187, pl. lv.

<sup>32</sup>Gabb—Pal. California, i., 4, 1861, pl. xvi.

<sup>33</sup>Anthula—Beiträge Pal. Öster.-Ung. Orients, xii., 1900, pl. xiv., f. 4a.

slightly inflected forwards, broadening as the shell grew; on the flanks some of the costæ are directly transverse, others faintly sigmoidal.

I have repeatedly hesitated to unite these shells (typified by Pl. xxxi.) with *C. jackii* proper (typified by Pl. xxxii., fig. 1; Pl. xxxiii., fig. 1; Pl. xxxv., fig. 1), but their respective forms, mode of involment and costal characters are so similar, I ultimately felt unjustified in separating them in the present state of my knowledge. It may ultimately be necessary to do so, if it can be shown by dismembering the whorls, or obtaining portions in such a condition, that even one row of the characteristic *C. jackii* tubercles is not present, although some specimens undoubtedly possess the swollen costæ of *C. jackii*.

*Locs.*—Walsh River, a tributary of the Mitchell River, Cape York Peninsula [G.S.Q.; Q.M.]. Saltern Creek, north of Barcaldine, Central Queensland [Q.M.]. Roma, South-east Queensland [Q.M.]. Hughenden, North-Central Queensland [Q.M.; G.S.]. Tate River, a branch of the Lynd River, Cape York Peninsula [G.S.Q.]. Barcoo, Ward and Nives Rivers District, South-Central Queensland [A.M. (*H. W. Blomfield*)]. West-south-west of Mount Mulligan, near Walsh Telegraph Station, Cape York Peninsula [G.S.Q.].

CRIOCERAS NAUTILOIDES, *sp. nov.*

(Plate xlv., and Fig. 8.)

*Sp. Chars.*—Shell of medium size, robust. Whorls, only two known, close coiled, very rapidly enlarging and greatly overhanging one another; initial whorl unknown; venter very broad and convex; abdominal margins very obtuse; dorsum broad, flattened, impressed, costate; impressed zone broad; flanks very convex; umbilical cavity wide and deep; section transversely-broad-oval. Sculpture varies at different stages of growth; in the first whorl known the costæ are both simple and fasciculate, from one to three of the former separating two or three of the latter; on the succeeding large whorl all are simple, straight on the venter, gently bent forwards on the dorsum, and faintly sigmoidal on the flanks; tubercles are confined to the first whorl preserved, one row on each side the middle line of the venter, latero-ventral in position, uniting the costæ in fasciculi of two or three.

*Obs.*—The specimen yielding the above characters is imperfect, lacking the inner whorls except one, and also deficient at the distal end. Although only a cast and possibly at one time semi-

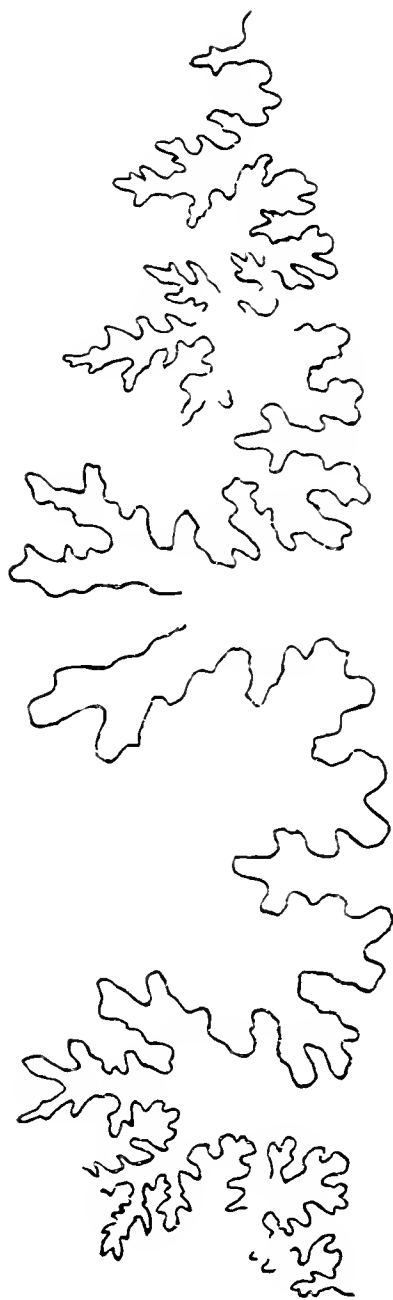

Fig. 8. Incomplete suture of *Crioceras nautiloides*, Eth. pl.

plastic, I do not think it has undergone distortion. If the latter be the case, it is remarkable for the breadth of the rounded venter, and convexity of the flanks. The section, a transverse broad oval, is more truly oval than any other of our forms, even than that of *C. plectoides*.

In possessing tubercle-united fasciculi of costæ *C. nautiloides* resembles *C. aronoides*, but whilst the tubercles of the latter continue throughout life (so far as the shell is known), in the present species they stop short at a certain period of growth, as in *C. jackii*, and do not appear on the more mature whorls. Were it not for the fasciculate condition of the costæ, no objection could be raised to including this with *C. jackii* provisionally on the ground of distortion arising from plasticity as a cast.

*Loc.*—Aramac, Thomson River, Central Queensland [G.S.Q.]

CRIOCERAS AXONOIDES,<sup>34</sup> *sp. nov.*

(Plate xxxii., fig. 4; Pl. xlv., fig. 1.)

*Sp. Chars.*—Shell large, with a depressed discoidal appearance. Whorls four (as far as known), close coiled, very gradually enlarging and not greatly overhanging one another; initial whorl unknown; venter comparatively narrow; abdominal margins rounded and tuberculated throughout life; dorsum flat, costate; impressed zone imperceptible; flanks very gently rounded, inclined to be straight-walled; umbilical cavity wide, comparatively shallow, and open; section longitudinally and obtusely triangular (deltoid). Sculpture varies at different stages of growth; on the earlier whorls the costæ are oblique and both simple and in fasciculi, the former one or two in succession, the latter in groups of two or three; on the later whorls all are simple and non-fasciculate; on the venter of the inner whorls straight, and simple or fasciculate; on the flanks of the outer whorls oblique, and on the venter straight; on the dorsum throughout bent forwards. Tubercles in one row on each side the middle line of the venter along the abdominal margins; on the inner whorls prominent, pointed, and conical, uniting the fasciculate costæ in bundles of two or three, usually the latter, gradually lessening in size as the shell grew, and on the fasciculi ceasing, one blunt tubercle to each costa.

*Obs.*—This species must have attained a large size; the figured example possesses a diameter of ten and a half inches. One of

---

<sup>34</sup>*αξων*, *oros*, a wheel.

the most important features is the retention of the tubercles throughout life, or at any rate so far as the latter is known, and their occurrence on each costa after the cessation of the fasciculate grouping of the costæ. At what precise stage this took place it is difficult to say, as the inner whorls are incomplete. In the figured example, however, the shell had attained to a diameter of four inches before the change from fasciculation to simplicity took place. This change in the sculpture is a very important feature, because in a species to follow *C. hindersi* the grouping of the costæ continued on to the shaft and crozier, *i.e.*, throughout life. The fasciculi usually consist of three costæ, but sometimes two, gathered into a bundle by the conate tubercles, then crossing the venter separately; these fasciculi are separated by from one to two simple ribs. In this grouping of the costæ there is a good deal of character, difficult to express in words, for although the early costation of *C. nautiloides* is fasciculate, the general appearance from that of the present form is quite different.

*Loc.*—Queensland! [U.S.].

*CRIOCERAS AMMONOIDES, sp. nov.*

(Plate xlix., figs. 1, 2.)

*Sp. Chars.*—Shell small, ammonoid, compressed. Whorls two and a half known; earliest whorls open and loosely coiled; later whorls close and contiguous; initial whorl verniform, with an acute apex (!); venter narrow, depressed convex; abdominal margins rather sharp, inclined to be angular; dorsum and impressed zone unknown; dorsal or umbilical margin rather sharp and somewhat angular; flanks broad and almost flat; umbilical cavity wide and open; section deltoid-ellipsoidal. Sculpture on the initial whorl of transverse micro-striae, on the remainder of the whorls either of single or bifurcate costæ, or in fasciculi of two; on the venter straight, on the flanks sigmoidal; tubercles small and papilla-like, in a single row along each abdominal margin, and at varying distances apart, both on single costæ, or uniting the fasciculi, separated by from one to four non-tuberculated costæ.

*Obs.*—I have three specimens of this form before me, agreeing in characters and size; from this I opine they are more or less mature individuals. At any rate they certainly appear distinct from the earlier condition of any of the other species, so far as I know those portions of the latter. The species is remarkable for its narrow and almost flat venter, the lateral flatness of the whorls,

and hence generally compressed form; the longitudinal narrow, and oval section is not seen in any other of our species.

The costæ are also more truly sigmoidal than in other Australian forms. The tubercles are arranged to some extent as in *C. plectoides*, with intervals occupied by non-tuberculated costæ, and like those of the latter they are always small. On the other hand, there is a most important difference between the initial whorl of the two species, here it forms a free open coil, but in *C. plectoides* the coil is close and the whorl contiguous; I regard this initial condition as a very important feature in these shells. The almost flat flanks recall those of *C. leptus*.

The general appearance is very Ammonite-like, hence the specific name.

*Loc.*—Barcoo, Ward and Nive Rivers District, South-Central Queensland [A.M. (*H. W. Blomfield*)]. Port Douglas [G.S.Q].<sup>34a</sup>

CRIOCERAS PLECTOIDES,<sup>35</sup> *sp. nov.*

(Plate xxxiii., fig. 2; Pl. xlvi., fig. 1; Pl. xlvii., figs. 1-4.)

*Sp. Chars.*—Shell of medium size, robust. Whorls contiguous, at least six, overhanging one another, and rapidly broadening as the shell grew; initial whorl vermiform, with an acute apex; venter obtusely rounded, broadening much with age; abdominal margins rounded, indicated only by the positions of the distant tubercles; dorsum flat, costate; impressed zone wide and faintly indicated; flanks obtusely rounded; umbilical cavity wide, open and deep, the latter feature arising from the rounded and overhanging condition of the whorls; section markedly quadrate. Sculpture similar throughout life, consisting of narrow, rounded costæ, seldom bifurcate, and varying in strength and distance apart according to position on the whorls; simply transverse or very faintly concave backwards on the venter, convex forwards on the dorsum, and faintly sigmoidal on the flanks. Tubercles obtuse, node-like, in one row on each side the median line of the venter, and defining the abdominal margins not otherwise indicated; at irregular distances apart, but closer in the young condition than during middle life and on single costæ; in the

<sup>34a</sup>If Port Douglas, north of Cairns, is meant, possibly a mistake has been committed in this locality. On Dunstan's Geological Sketch Map of Queensland (1905) the area around Port Douglas is coloured Desert Sandstone (Upper Cretaceous); the specimen has all the appearance of a Rolling Downs (Lower Cretaceous) fossil.

<sup>35</sup>πλεκτη a coil.



former stage there occur from three to five plain costæ between every two node-bearing ribs, but in the latter there may be as many as ten plain costæ occupying such a position, and here the tubercles often extend across three costæ, but without rendering the latter fasciculate. Septa concave on the whole, but with a very rolling surface arising from the development of the lobes and saddles, which are highly digitate.

*Obs.*—*C. plectoides* is remarkable for the general uniformity of its characters throughout the various stages of growth so far as they are known to me; it is a compact and well grown shell and one of the neatest of our *Crioceri*.

The costæ are narrow rounded ribs, not sharp crests, and appear to retain this character throughout life. Tuberculation of the costæ is similarly preserved, so far as the growth of the species is known to me. The tubercles are node-like, obtuse, and round in the earlier stages of growth, one to each costa, but in later conditions three ribs appear to be involved in each tubercle, the latter perched on them as it were: these, however, do not divert the course of the costæ and render them fasciculate. The finer details of the sculpture are unknown, as the test is not preserved in any case.

In the sectional outline of the whorls, and wide venter, *C. plectoides* approaches *C. nautiloides*, but differs in its costation and tuberculation.

The shaft and crozier are unknown.

*Locs.*—Cameron Downs, south of Hughenden, North Queensland [G.S.Q.]. Wellshot Run, near Barcaldine, Central Queensland [G.S.Q.]. Walsh River, a tributary of the Mitchell River, Cape York Peninsula [Q.M.]. Mount Cornish, near Muttaborra, Central Queensland [Q.M.]. Barcoo, Ward and Nive Rivers District [A.M. (*H. W. Blomfield*)]. Queensland! [U.S.]. Central Australia [G.S.].

*CRIOCERAS FLINDERSI, McCoy, sp.*

(Plate xxxvi., fig. 2; Pl. xxxix.; Pl. xl.; Pl. xli.; Pl. xlii., fig. 2; Pl. xliii.; Pl. xliv., fig. 2.)

*Ancyloceras Flindersi*, McCoy, Ann. Mag. Nat. Hist., 4., xx., 1867, p. 356.

*Ancyloceras Flindersi*, Eth. fil., Mem. Geol. Survey N.S. Wales, Pal. No. 11, 1902, p. 44, pl. viii., figs. 1-3.

*Crioceras Flindersi*, Eth. fil., S. Austr. Parl. Papers, 1905, No. 71, p. 14, pl. i., f. 1., pl. iii., figs. 1-8.

*Sp. Chars.*.—Shell attaining a large size, robust. Whorls, at least four, close coiled, rapidly enlarging and overhanging one another: crozier sharply and shortly curved; shaft often with a compressed and lank or lean appearance; initial whorl vermiform, with an acute apex; venter of the whorls narrow and much arched in the young state, broadening and less arched in the older condition, narrow and gently rounded on the crozier and low convex or almost truncate on the shaft; abdominal margins rounded; dorsum flattened, costate, impressed zone very faintly indicated, more apparent in the young state, not visible on the shaft and crozier; flanks of the whorls and shaft compressed, flattened, on the crozier slightly rounded; umbilical cavity wide and open; section longitudinally oval. The nature of the costæ and tubercles varies according to growth and position; in the young state the costæ are obtuse and rounded, some more prominent and obtuse than others, single, or bifurcate low down on the flanks: as growth progressed the costæ became sharp and angular, and either single (venter, dorsum, and flanks), larger and smaller alternately, bifurcate as before, or fasciculate (flanks and venter) in bundles of two to four (usually three) on whorls, shaft, and crozier; on the venter straight, on the flanks sigmoidal, varying only in degree, and bent forwards on the dorsum; intercostal spaces, or valleys, very narrow in the young condition, wide and concave on the old whorls. Tubercles very prominent and well marked, one row on each side the middle line of the venter along the abdominal angles, and at irregular distances apart in the young, but on the maturer whorls, shaft, and crozier on nearly every costa or group of costæ; those of the simple costæ node-like, those uniting fasciuli on the whorls cristiform, elongated in the direction of the coil, those on the shaft low and conical; mid-lateral and dorso-lateral nodes absent.

*Obs.*.—This is one of the three Australian *Crioceras* in which I have been able to trace the various parts of the entire shell, whorls, shaft, and crozier; the nature of the sculpture is so characteristic, little or no mistake can be made, the retention of strong fasciculate bundles of costæ and prominent nodes throughout life being very characteristic.

No doubt this shell attained to a very large size, although I have not the means of saying how large, but McCoy compared it with the *C. gigas*, J. de C. Sby., of the British Cretaceous, and speaks of it as a "gigantic" species. The largest portion of a whorl to come under my notice, as elsewhere recorded, is eight inches long by four and a half wide (*i. e.*, transversely), but this is only a portion of a flank, or side of a whorl the circumference

therefore, allowing for the full venter, dorsum, etc., must have been considerable.

The limb, or shaft, always has a laterally compressed or flattened outline, giving it a "lean" appearance, except in an instance to be noted immediately. The relation of limbs of this nature to the coiled portions is satisfactorily shown in a specimen from the Queensland Museum (Pl. xl., figs. 1, 2).

The costæ are more or less always sigmoidal on the flanks, often strongly so, frequently bifurcate, the points of bifurcation being either low down on the flanks, supra-dorsal to all intents and purposes, or along the middle line. The former occur on the flanks of the whorls usually, and the latter on the shaft; at these points the costæ are not tuberculate. These subdivided costæ may, or may not, pass over the venter singly; when not so doing they are gathered into fasciculate bundles along the rounded abdominal margins by the prominent tubercles. A fasciculus of three or four costæ on a flank may be continued across the venter as two costæ only, and *per contra*, a similar bundle on the latter may be represented on a flank simply by two also. A specimen in the National Museum, Melbourne, displays a marked departure from the typical condition of the costæ, in that many of the flank ribs are single, but on the venter between the two rows of tubercles all are double. The appearance of the tubercles is also worthy of note, in that they are cristiform, or longitudinally elongated on the whorls, other than the youngest, becoming more mammillary on the shaft and crozier.

I received from the Geological Survey of Queensland a portion of a large whorl measuring thirteen inches long by four inches in diameter, but in a poor state of preservation. In comparison to its size, the venter is not wide, but decidedly convex, although the flanks are by no means so. The dorsum is costate, without an impressed zone, and rather flat. The costæ are very large, one inch apart from crest to crest, straight and simple on the flanks, curved forwards on the dorsum, and directly transverse on the venter and double, the single line of nodes on each side separating these double costæ from the single on the flanks. This may be a condition of *C. flindersi*, like the smaller example already referred to as in the National Museum, Melbourne, one in which the fasciculate condition of the costæ on the flanks has not been developed; this opinion, however, is expressed with all reserve.

I now wish to draw attention to three marked conditions of costation, indicating its variability notwithstanding a fundamental resemblance throughout the whole suit of specimens.

*Flinders River, Queensland.*—Portion of a whorl, the flank costæ either single or in fasciculi of two, chiefly the latter, each fasciculus and single costa tuberculate along the abdominal lines. The venter is low convex, and in crossing it the single costæ become duplicated as well as those forming the fasciculi (Pl. xxxix., figs. 2 and 3).

*Saltern Creek, Queensland.*—Portion of a whorl, the venter low convex, the flank costæ again slightly sigmoidal in fasciculi of three to five. These fasciculi are complex, thus:—the nodes along the abdominal lines unite two or three costæ as the case may be, each group with an anterior and posterior rib derived from the others by bifurcation, the latter passing over the venter free without reference to the tubercles. On the other hand, those united by the tubercles either retain their individuality of two or three, or become four to the bundle (Pl. xl., figs. 3 and 4).

*Wellshot (?), Queensland.*—Portion of a large shaft or limb without the compressed or "lean" appearance already referred to, tentatively referred to *C. flindersi*. The venter is decidedly convex, the flank costæ faintly sigmoidal, and less oblique than in the two preceding instances. The abdominal tubercles either unite fasciculi of two flank costæ, or a tubercle of equal size interrupts the course of a single rib, but in either case all the costæ on crossing the venter are double. Here and there single costæ of equal strength to the former are interpolated between the fasciculi without relation to the latter, and are non-tuberculate; these encircle the whole limb. Another modification occurs by the anterior costa of one fasciculus, and the posterior of the fasciculus preceding being derived by bifurcation from one and the same parent rib along the mid-lateral or dorso-lateral lines. This is the most varied decoration of any of the specimens referred to *C. flindersi*, and, as already stated, the specimen is only provisionally placed with that species (Pl. xxxvi., fig. 2; Pl. xlii., fig. 2; Pl. xliv., fig. 2).

*C. flindersi*, by the characters of its costæ and tubercles, much resembles the European *C. seeleyi*, N. & U.<sup>36</sup>

In the specific description reference is made to the low convex or almost truncate condition of the shaft venter. This feature is reproduced in even a more marked degree on the shaft venter of *C. cordycepoides*, mihi,<sup>37</sup> and were it not for the second line of tubercles, dorso-lateral in position on the latter, and the difference in size, it would be difficult to separate *C. cordycepoides* from *C. flindersi*.

<sup>36</sup>Neumayr and Uhlig—Palaeontographia, xxvii., 1881, p. 185, pl. li., f. 1.

<sup>37</sup>Etheridge—S. Austr. Parl. Papers, 1905, No. 71, p. 14.

Another very interesting point in connection with this species is the occurrence in the Port Darwin beds of shaft portions<sup>33</sup> reproducing in every particular, in miniature, the features of the flat-ventered variety of *C. flindersi* just referred to. I am at present at a loss to account for these miniature forms at Point Charles, unless they represent a dwarfed race of species found in other portions of the Australian Cretaceous.

*Loc.*—Whitewood Ridge, Sesbania, North-Central Queensland [G.S.Q.]. Cameron Downs, south of Hughenden, North Queensland [G.S.Q.]. Flinders River, Carpentaria [Q.M.]. Saltern Creek, north of Barcaldine, Central Queensland [Q.M.]. Well-shot Run, near Barcaldine, Central Queensland [G.S.Q.]. Mount Cornish, near Muttaborra, Central Queensland [Q.M.]. Barcoo, Ward and Nive Rivers District [A.M. (*H. W. Blomfield*)]. Head of Flinders River, North Queensland [N.M.M. (*Messrs. Carson and Sutherland*; McCoy's type)]. Olive Downs, near Milparinka, North-west New South Wales [M.G.M.]. Charlotte Waters, Central Australia [N.M.M., G.S.S.A.]. Dalhousie Springs, north of Oodnadatta, Central Australia [G.S.S.A.]. Central Australia [G.S.].

CRIOCERAS LAMPROS,<sup>34</sup> *sp. nov.*

(Plate xlviii.)

*Sp. Chars.*—Shell ponderous, attaining a diameter of twenty-one inches at least, but only one and a quarter whorls are known. Venter generally truncate; abdominal lines indicated by a row of tubercles on each side the middle line of the venter; dorsum flat, costate, very broad at the distal end; impressed zone obliterated; flanks flattened, broad; section generally quadrate, becoming distinctly octagonal on the fully tuberculated costæ. Sculpture consisting of costæ of two kinds, primary and secondary; the former on the venter and flanks are large upstanding crests at regular intervals apart, and tubercle-bearing, but on the dorsum are not to be distinguished from the secondary costæ occupying the intercostal spaces; on the venter the costæ are straight (transverse), straight or very slightly curved on the flanks, and on the dorsum convex forwards. Tubercles very large and strong, in three rows on each side, one abdominal, one infra-abdominal, and the third supra-umbilical (or supra-dorsal).

*Obs.*—This form is known to me only as two almost completely exfoliated whorls of large size, and a few disjointed pieces. It

<sup>33</sup>Etheridge—*Ibid*, 1907 (Suppl. No. 55, 1906), p. 16, pl. x., figs. 6-9.

<sup>34</sup><sup>3</sup>λαμπρὸς, magnificent.

vies in size with the large *Crioceras* in the Australian Museum already referred to, but the entire absence of any trace of tuberculation on the latter renders a further comparison impossible. It is the only instance amongst our large *Crioceri* of a shell bearing three rows of tubercles in advanced age; certainly *C. jackii* possesses the same number, but this occurs at the commencement of its career only.

The tubercles are borne upon what may be termed the primary costæ, which at the distal end of the coil are two and a half inches apart from crest to crest. On the dorsum, where some trace of the test remains, they decrease very greatly in size, and are there similar to the ordinary or secondary costæ. The section of the whorls when taken on the primary costæ is octagonal, viz., three angular lateral lines on each side or flank, with the truncate venter and flat dorsum, but if the section is taken on the secondary costæ in the valleys it is simply quadrangular; the infra-abdominal line of tubercles is the largest.

*C. lampros* must have attained a very large size; the diameter of the one whorl alone is twenty-one inches.

This is the only one amongst our *Crioceri* that conforms to Hyatt's definition of his Family Ancyloceratidæ, after the type of *A. matheronianum*, D'Orb.

A similar arrangement of the tubercles occurs in *C. thiollierei*, Astier,<sup>39</sup> and also in the smaller form *C. tabarelli*, Astier.<sup>40</sup>

Another exotic *Crioceras* much resembling this species in the form of the costæ and again in the presence of three rows of prominent tubercles is *C. muniéri*, Sar. & Schön.,<sup>41</sup> of the French Neocomian.

In the Point Charles deposit, Port Darwin, occur fragments of whorls with three rows of tubercles. In this and *C. lampros* the tubercles are confined to the larger or primary costæ, and the venters are more or less flattened or depressed. In one case the tuberculate costæ are single,<sup>41a</sup> in the other they are double across the venter, between the latter and the flank nodes, and again between the latter and those along the dorsal edge, the nodes

<sup>39</sup>Astier—Ann. Sci. Phys. Nat. Soc. Nat. Agric. Lyon, (2), iii., p. 448, pl. xix., f. 7.

<sup>40</sup>Astier—*Loc. cit.*, p. 449, pl. xxi., f. 9.

<sup>41</sup>Sarasin and Schöndelmayer—Mém. Soc. Pal. Suisse, xxix., 1902, pl. xiv., f. 1.

<sup>41a</sup>Etheridge—S. Austr. Parl. Papers, 1907 (Suppl. to No. 55), 1906, p. 16, pl. x., figs. 4 and 5.

acting as centres of union.<sup>41b</sup> What the relation of these fragmentary and comparatively diminutive north-western forms may be to the larger species of Eastern Australia it is at present impossible to say.

*Locs.*—Cambridge Downs, near Richmond, North-Central Queensland [Q.M.]. (?)Maranoa River, South-East Queensland [G.S.—sketch].

The fine specimen (Pl. xlvi.) from the Queensland Geological Survey Collection is without a locality.

CRIOCERAS CORDYCEPOIDES, *Eth. fil.*

*Ancyloceras cordycepoides*, *Eth. fil.*, S. Austr. Parl. Papers, 1905, No. 71, p. 14, pl. i., figs. 3-5; pl. ii., fig. 4.

*Sp. Char.*—Shell small, coil and shaft in one plane; proximal end of one whorl, little more than crooked, terminating in an obtuse apex; shaft slightly bent; venter truncate, flat; dorsum rounded; flanks slightly rounded; section longitudinally oval, or obscurely quadrate. Costæ strong, oblique on the flanks, straight or advancing ventrally and retreating dorsally, gathered into fasciculi of three or four costæ by a line of nodes along the dorso-lateral lines, and another along the abdominal lines, the median rib of each fasciculus stronger than the others; on the truncate venter usually straight, a few arched forward, corresponding in number to those of the flanks, and the median rib stronger than the others. Tubercles of the abdominal lines large and node-like, or produced as short acute spines.

*Obs.*—The resemblance of the shaft of this species to certain conditions of the corresponding part to *C. flindersi* has already been referred to.

Relying on Pictet and Loriol's illustration of *C. (Ancyloceras) tabarelli*, Astier,<sup>42</sup> I instituted a comparison between the latter and *C. cordycepoides*, but now I am in possession of Astier's Memoir, "Catalogue Descriptif des Ancyloceras," I find the resemblance to Astier's species<sup>43</sup> is not so close. There is this manifest difference—*C. tabarelli* possesses three lines of tubercles on each side the middle line of the venter, whilst *C. cordycepoides*,

<sup>41b</sup>Etheridge—*Loc. cit.*, p. 16, pl. ix., figs 2 and 3.

<sup>42</sup>Pictet and Loriol—*Descrip. Foss. Terr. Néoc. Voirons*, Pt. 2, 1858, p. 27, pl. v., figs. 1-7.

<sup>43</sup>Astier—*Ann. Sci. Phys. Nat. Soc. Nat. Agric. Lyon*, (2), iii., 1851, pl. xxi., f. 9.

as already stated, has but two. *C. tabarelli* was selected by Hyatt as the type of his genus *Acrioceras*.<sup>44</sup>

*C. cordycepoides* and the next species, *C. laqueus*, are the only forms falling into Hyatt's Family Crioceratidae, as defined by him.<sup>45</sup>

*Loc.*—Oaka-towya or Dalhousie Springs, north of Oodnadatta, Central Australia.

CRIOCERAS LAQUEUS, *Eth. fil.*

(Plate xlix., figs. 7-9.)

*Ancyloceras* or *Hamites*, sp., *Eth. fil.*, *Trans. Roy. Soc. N. S. Wales*, xvii., 1883, p. 89, 2d pl., lower l. h. fig.

*Hamites* (?) *laqueus*, *Eth. fil.*, *Geol. Pal. Q'land, etc.*, 1892, p. 496, pl. xlii., figs. 14 and 15.

*Crioceras*, sp., *Eth. fil.*, *Geol. Pal. Q'land, etc.*, 1892, p. 502, pl. xxxiii., figs. 4 (? 5 and 6).

*Anisoceras* (?) sp., *Eth. fil.*, *S. Austr. Parl. Papers*, 1905, No. 71, p. 14, pl. i., f. 2; pl. ii., figs. 1-3.

*Sp. Chars.*—Shell small. Whorls apparently not more than two; shaft long, curved; crozier comparatively large, unsymmetrical, loop- or link-shaped, returning directly towards the shaft, but not quite in the same plane, almost touching the latter; initial apex vermiform, blunt; lumen large. Venter of the whorls and shaft narrow but convex, comparatively broad on the crozier; dorsum of the shaft appears to be costate, but in the bend of the crozier flat and smooth; flanks gently convex. Costae strong and sharp, transverse on the venter, oblique or slightly sigmoidal on the flanks, absent (?) on the dorsum of the crozier, some single, but usually fasciculate in bundles of two or three, the component ribs of each fasciculus united by a series of very prominent tubercles, supra-dorsal in position, again passing over the dorsum of the shaft single, double, or treble; along the abdominal lines on each side the middle line of the venter is a row of smaller tubercles or nodes, one to each costa.

*Obs.*—A comparison of all the specimens represented by the above synonymy has convinced me they are one and the same species, and that the name *Anisoceras* applied to one of them must be dropped.

<sup>44</sup>Hyatt—Zittel's Text-Book Pal., Eastman's Edition, i., 1900, p. 588.

<sup>45</sup>Hyatt—*Loc. cit.*, p. 588.



In the specimens figured in the "Transactions of the Royal Society of New South Wales," and again refigured in the "Geology and Palæontology of Queensland," there is an indication of an oval margin or lip, in that the terminal costæ are much more prominent, and on the centre of the venter are backwardly curved, forming a kind of shallow "hyponomic" sinus.

The tuberculation of this form is very marked. There is a line of prominent, almost spine-like tubercles, supra-dorsal in position, which unite the costæ, or most of them, into bundles of two or three, but instead of then passing over the dorsum as single ribs, as is usually the case, the costæ again split up into a like number as before. Along each side the median line of the venter there is a farther row of small pimple-like nodes, one to each costa.

There is another specimen that may be only a variety of *C. laqueus* (or possibly a distinct species) in which the venter is much broader, the costæ far more numerous and finer, but with the same marked supra-dorsal tubercles as in *C. laqueus* proper, although the rows of pimple-like nodes along the abdominal angles are absent. Again, at one end of the specimen there certainly seems to be a definite margin representing the lip of the living chamber with a shallow sinus, but in this instance the marginal costæ are not elevated above the others.

This form is represented in the Point Charles beds of the Northern Territory of South Australia by two indifferently preserved specimens. For the present I regard these fossils merely as a variety of *C. laqueus*.

In the "Geology and Palæontology of Queensland," etc., another specimen was figured,<sup>46</sup> apparently a portion of a shaft, and evidently related to *C. laqueus* in that some of the costæ are gathered in fasciculi by tubercles more nearly lateral than supra-dorsal, but as in the above species again dividing to pass over the dorsum. The identity of this specimen must for the present remain in doubt.

*Loc.*—Aramac Well (at 184 ft.), Aramac, Thomson River, Central Queensland [G.S.Q.]. Fifteen miles south-west of Hughenden, North-Central Queensland [G.S.Q.]. Tower Hill, Landsborough Creek, a head tributary of the Thomson River, North Queensland [Q.M.]. Barcoo, Ward and Nive Rivers District, South Queensland [A.M. (*H. W. Blomfield*)]. Dalhousie Springs, north of Oodnadatta, Central Australia [G.S.S.A. and A.M.]. (?) Point Charles Lighthouse, Port Darwin [A.M. (*Messrs. Christy and Godfrey*)].

<sup>46</sup>Etheridge—Geol. Pal. Q'land., &c., 1892, Pl. xxxiii., figs. 5, 6.

CRIOCERAS TAYLORI, *Eth. fil.*

(Plate xlix., figs. 3-6.)

*Ancyloceras Taylори*, *Eth. fil.*, *Geol. Pal. Q'land, etc.*, 1892, p. 498, pl. xlii., f. 13.

(<sup>1</sup>) *Ancyloceras, sp. ind.*, *Eth. fil.*, *Bull. Geol. Survey, Q'land, No. 13*, 1901, p. 33, pl. ii., f. 5.

*Sp. Chars.*—Shell below medium size. Whorls apparently not more than three, close coiled; shaft moderately stout, slightly curved, but total length unknown; crozier loop- or link-shaped, unsymmetrically curved, returning directly towards the limb, but not quite in the same plane, almost touching the latter; venter of both whorls, shaft and crozier broad and rounded; dorsum of the whorls and shaft rounded, of the crozier flat; flanks of the whorls rounded, but of the shaft and crozier flattened; section of the shaft gradually becoming longitudinally oval, and on the crozier transverse or broad-oval. Costæ obtuse, on the whorls simple transverse and touching one another; on the shaft similar but separated by well marked valleys, those of the venter inclined forwards, on the dorsum backwards, and on the flanks slightly sigmoidal; on the crozier transverse or slightly sigmoidal, well separated, and often bifurcate, the bifurcation taking place low down on the flanks around the dorsal or umbilical edges. Tubercles absent.

*Obs.*—One of the most striking features of *C. taylori* is the general simplicity of its thick costæ. There is no trace of tubercles at any stage of growth.

*C. taylori* is undoubtedly allied to *C. laqueus* in size, form, and presence of the loop-like crozier, the remarkable fact being that the outer limb of the crozier is not quite in the same plane as the curve of the shaft proper, and whilst returning towards the latter does not appear to abut against it.

The costæ are round and cord-like, very regular, without fasciculation, and no trace of bifurcation until the curve of the crozier is reached. In their simplicity they greatly resemble both those of the genus *Macroscaphites*, and *Ancyloceras simplex*, D'Orb., chosen by Hyatt as the type of his *Dirrymœceras*.<sup>17</sup>

I have provisionally incorporated in the synonymy the reference to an "*Ancyloceras*" I described from the collection of Mr. G. Sweet, Melbourne, obtained at Hughenden; it certainly possesses features in common with *C. taylori*.

<sup>17</sup>Hyatt—Zittel's Text-Book Pal., Eastman's Edition, i., 1900, p. 586.

Portions of small *Crioceri*(?)<sup>45</sup> with simple, non-tuberculate costæ occur plentifully in the Port Charles and Shoal Bay beds of the Northern Territory, but the costæ are relatively coarser for the size of the specimens than those of *C. taylori*.

*Locs.*—Aramac Well, Aramac, Thomson River, Central Queensland [G.S.Q.]. Head of Walsh River, a tributary of the Mitchell River, Cape York, Queensland [Q.M.]. Barcoo, Ward and Nive Rivers District [A.M. (*H. W. Blomfield*)]. (?)Central Australia [G.S.].

CRIOCERAS (?), *sp.*

(Plate xxxv., fig. 2; Pl. xlii., fig. 1; Pl. xlvi., fig. 2; Pl. xlvii. fig. 5.)

*Sp. Chars.*—Shaft and crozier large, the extension of the former into the latter forming a broad curve, uncompressed. Shaft straight; venter narrow; abdominal lines defined by tubercles; dorsum broad and almost flat; impressed zone obliterated; flanks biangular, but on the whole rounded; section around the primary costæ unsymmetrically hexagonal, around the valleys broad-oval, or almost round. Costæ primary and secondary, the former single, strong, and often separated by shallow valleys of varying width, but usually wide; primary costæ of the shaft and crozier venters straight and trenchant between the two rows of tubercles marking the abdominal lines; on the shaft dorsum inclined slightly forwards; on shaft flanks oblique or faintly sigmoidal, and biangular, the angles separated by a line of dorso-lateral tubercles on each flank; costæ in the crozier bend straight; secondary costæ straight and flat, filling the valleys; test with delicate encircling lines. Tubercles arranged in two rows on each side the median line of the venter on the primary costæ only, two rows abdominal and two rows dorso-lateral, all conical, acute and prominent.

*Obs.*—I have here united three specimens, believing them to be the same, although differing in a few minor details; the coiled portions are at present unknown to me.

The first of the three specimens is a large shaft with very prominent, outstanding, and irregularly distant primary costæ; it is on the dorsum of this example that the secondary costæ and test are visible. It is a remarkable specimen, and in some of its aspects resembles the coil *C. lampros*, such as the angularity of the primary costæ, here hexagonal instead of octagonal as in the species named; the straight or horizontal nature of the trenchant primary costæ on the venter is another point of resemblance.

---

<sup>45</sup>Etheridge—Mem. Roy. Soc. S. Austr., ii., 1. 1902, p. 46, pl. vii., figs. 12, 13; S. Austr. Parl. Papers, 1907 (Suppl. to No. 55, 1906), p. 16, pl. ix., figs. 11-15.

The arrangement of the tubercles in three rows on each side the median line of the venter, and but two here, would in the ordinary course separate the two portions, but in many *Crioceri* the number of rows varies on different portions of the shells. There is, on this account, the bare possibility of the shaft now under description being that of *C. lampros*. Of the three specimens this also exhibits the truncate outline of the venter in a more marked degree than in the other two, although it is quite apparent there also.

Again, the hexagonal section around the primary costæ, the simplicity of the latter, and their markedly straight course and trenchant nature of the venter, with the additional line of tubercles on each side, will serve to distinguish this limb and crozier from those of *C. hindersi*, McCoy.

The second is a crozier and part of a shaft on which the primary costæ are more regularly spaced apart.

In the third specimen, provisionally united with the first and second, the proximal end of the limb is preserved (Pl. xlvi., fig. 2); this does not lead to a coil, but is returned on itself in the form of a hook after the manner of D'Orbigny's *Hamites*. The contiguity of the two portions is so close there could by no possible means have been room for a coil; the deduction is therefore reasonable that we are here dealing with a specimen possessing generally the appearance of such a shell as *Hamites elegans*, D'Orb., nor does there appear to have been space for a second return of the limb as in *H. attenuatus*, J. Sby., the type of Hyatt's genus *Tornentoceras*.<sup>19</sup> On the whole, this form does not appear to be a *Crioceras* pure and simple, nor can it be included in the Hamitidae of Hyatt's classification, one of the characters of the latter being "no tubercles at any stage."

*Locs.*—Tambo, Barcoo River, Central Queensland (Plate xlii., fig. 1) [A.M. (Mrs. Alice Hamilton)]. Barcoo, Ward and Nive Rivers District (Pl. xlvi., fig. 2; Pl. xlvii., fig. 5) [A.M. (H. W. Blomfield)]. (?)Central Australia [G.S.].

#### GENUS LEPTOCERAS, Uhlig, 1883.

(Denksch. K. Akad. Wissensch. Wien., xlvi., 2, 1883, p. 260.)

*Obs.*—Mr. V. Uhlig established *Leptoceras* as a subgenus of *Crioceras* for dwarfed forms with an open coil and the first or first and a half whorls noncostate, and the sutural divisions with few ramifications; he cited as examples of his subgenus *C. puzosianum*, D'Orb., and *C. cristatum*, D'Orb. The costæ are straight and slightly inclined towards the front. Uhlig remarks that the

<sup>19</sup>Hyatt—Zittel's Text-Book Pal., Eastman's Edition, i., 1900, p. 586.

difference between these dwarfed and little sculptured shells with comparatively simple sutures and the gigantic highly ornamented forms with abundantly ramified sutures is so marked that the bestowal of a subgeneric appellation seems perfectly just.

Messrs. Sarasin and Schöndelmayer,<sup>50</sup> on the contrary, consider Uhlig's *Leptoceras* to be based on fragments of much larger shells possessing a regular spiral, and terminal portions straight or curved.

We have in our Cretaceous one form that in all probability conforms to Uhlig's definition.

#### LEPTOCERAS (?) EDKINSI, *Eth. fil.*

*Crioceras edkinsi*, *Eth. fil.*, *Geol. Pal. Q'land, etc.*, 1892, p. 502, pl. xxx., figs. 8, 9.

*Sp. Chars.*—Shell small, not exceeding three-quarters of an inch in diameter, open-coiled. Whorls not more than one and a half; shaft straight; venter narrow, convex; abdominal angles rounded, defined by small nodes; dorsum flattened and very feebly costate; impressed zone none; flanks very gently rounded, almost flat; section longitudinally oval. Costæ simple, obtusely angular, equidistant ribs, neither fasciculate, bifurcate, nor interpolate, but occasionally one becoming larger than the others; on the venter bent forwards, and steep-faced in that direction; on the dorsum faint but apparently bent forwards also; on the flanks oblique or here and there sigmoidal. Tubercles small, one row on each side the middle line of the venter, either on each costa or with intervening barren costæ.

*Obs.*—In 1892 I wrote as follows of this little shell:—"As the examples are numerous, and constant in their characters, they can only be regarded as adult individuals, and as such are certainly new to the Cretaceous rocks of Queensland;" this still holds good. It is a small and pretty species, and needs comparison only with some of the small forms from the Point Charles beds of Port Darwin.

Small more or less curved fragments<sup>51</sup> occur in the Point Charles beds with narrow rounded venters, and simple and equal costæ, with one row of nodes along each abdominal angle and on each alternate rib; there is a community of appearance between these and *L. edkinsi*.

*Loc.*—Wells (at 230 ft.) seven miles east of Mount Cornish Homestead, near Muttaborra, Central Queensland [G.S.Q.].

<sup>50</sup>Sarasin and Schöndelmayer—*Mém. Soc. Pal. Suisse*, xxix., 1902, p. 97.

<sup>51</sup>Etheridge—*Mem. Roy. Soc. S. Austr.*, ii., 1, 1902, p. 46, pl. vii., figs. 14, 15; *S. Austr. Parl. Papers*, 1907 (Suppl. to No. 55), 1906, p. 16.

# NORTH QUEENSLAND ETHNOGRAPHY.

## BULLETIN No. 12.

### On Certain Initiation Ceremonies.

By WALTER E. ROTH, Magistrate of the Pomeroon District, British Guiana; late Chief Protector of Aborigines, Queensland; Corresponding Member of the Anthropological Societies, Berlin and Florence, the Anthropological Institute, London, etc.

(Plates l.-lvi.; Figs. 9-11.)

#### CONTENTS.

Sect. 1.	The why and wherefore of the Ceremonies...	p. 166
2.	Do the Initiation Dances bear relationship to certain Totemic Performances? ... ..	p. 168
3.	Initiation on the McIvor River. ... ..	p. 169
4.	„ „ Bloomfield River ... ..	p. 176
5.	„ „ Tully River ... ..	p. 177
6.	„ at Princess Charlotte Bay ... ..	p. 178
7.	„ in the Rockhampton District ... ..	p. 183

1. I have been present at initiation ceremonies on the East Coast (Princess Charlotte Bay, McIvor River, etc.), and several<sup>1</sup> in the North-Western Districts; I cannot say that I have been initiated into the latter, for the very good reason that I was not prepared to submit myself to the necessary sexual mutilation, an ordeal to which I am not aware that any European, however keen on Anthropological Science, has hitherto allowed himself to be subjected.

Though various customs, *e.g.*, marriage, scarring, nose-piercing, certain food restrictions, a new name, social rank, etc., may here and there depend upon initiation, very little of a definite nature appears to be known of the why and wherefore of the ceremonies at all, beyond the fact that the prevailing European idea of their having a beneficently moral and educational value is erroneous. At Cape Bedford, some of the old men told the Rev. Schwarz<sup>2</sup> and myself that initiation is a matter of custom, and still pre-

---

<sup>1</sup>For descriptions see *Ethnol. Studies*, etc., 1897—Sects. 299 to 315.

<sup>2</sup>A gentleman who has lived upwards of 20 years among these people.

served for custom's sake. Others told us, and I am more and more convinced that this is an essential of the *raison d'être* of all these initiation ceremonies, that they were hungry, and had to prevent the younger men and boys from eating those food-stuffs of which they (the old ones) were in want. The old men do their best to carry out this idea by showing the younger generation the influence they wield in executing certain performances, by giving an air of uncanniness and mystery to the proceedings in carrying them out in secret, and by making them believe that any violation of the orders given concerning the eating of certain things will be punished by the infliction of various diseases and deformities. The food-stuffs which are here forbidden include the wokai (*Dioscorea sativa* var. *rotunda*), gangga (*Vitis acetosa*), barwan (a fruit), wátan and bánu (both of them roots), fresh-water eels, a particular variety of turtle, a certain kind of honey, etc. The novice must attend two whole ceremonies before being allowed to partake of any of these until finally one of the old men rubs each of these articles successively on his (the novice's) chest. Should he, however, eat of the forbidden fruit within the prescribed period, his face will become disfigured, his nose rot away, etc.—one such example being shown me in proof. Beyond being commanded what not to eat, the novice here receives no instructions whatever concerning his sexual or social relationships,<sup>3</sup> no moral or ethical precepts are inculcated, nor is any form of education (in the ways of hunting, weapon-making, etc.) imparted; indeed, from what I learnt and saw, I should judge that his education, such as it is, is greatly misguided and retarded by attendance at the ceremony. When during the dance connected with the Body-louse (Pl. liv., fig. 1), the actors hunted in the central performer's head and on his genitalia, and ate or pretended to eat the vermin, I naturally concluded that it was a lesson in cleanliness. When, in the poisonous "Stone-fish" dance (Pl. lii., fig. 2) a performer accidentally trod, or pretended to tread, on the dorsal fin and yelled out with the pain, the first thought that struck me was that this was a warning to the novices to take extra precautions in the hunting of this particular animal. But I was wrong in both these and similar conclusions, for after every form of enquiry, direct and indirect, I was able to satisfy myself that throughout all these series of performances, not one has any ethical or educational significance—there is not indeed the slightest intention of pointing a moral to adorn a tale. So also on the Bloom-

---

<sup>3</sup>He may, however, receive such instructions on the Bloomfield River.

field River<sup>4</sup> no moral principles are inculcated during the initiation performances; if anything, the novice is let into a few of the swindles, etc., and the reasons for practising them to his own advantage and self-preservation—at any rate, a marked change comes over the lad about this time, and whereas previously he could be taught and given explanations of certain of the natural phenomena that might be brought under his notice, it is almost futile to attempt doing so subsequently. On the Tully River, apparently the one and only particular object of the performance is the infliction of the belly-scars, without which no man can marry. At Princess Charlotte Bay, throughout all the many weeks that the performances continue, the novice learns nothing special in the way of bush-craft, weapon-making, or any thing else of use to him in the future; all this he picks up as best he can, as opportunity offers. In all cases, however, the novice has two or three virtues inculcated into him, viz., obedience to and respect for his elders, and self-control: with what profit, however, remains to be seen.

It is noteworthy that many of the dances relative to animals and plants which are performed specially at the initiation ceremonies may be re-enacted here and there on occasions of ordinary rejoicing as the common corroboree, *e.g.*, the Crocodile Dance of the Pennefather River.<sup>5</sup>

2. It is quite possible that subsequent enquiry may show that the various dances representing the antics of the different animals or the growth of certain plants, which as will be seen are throughout Northern Queensland more or less intimately connected with the initiation ceremonies, bear relationship to the Totemic performances described by Messrs. Gillen and Spence in Central Australia. By Totemism I understand a certain connection between an animal or plant, or group of animals or plants, and an individual or group of individuals respectively, and judged by this standard, the only Totemism discoverable throughout North Queensland is that met with in the animals, etc., forbidden to the different exogamous groups, and to a far less degree to women and children generally, and to the novices temporarily at the initiation ceremonies.<sup>6</sup> But such Totemism as this is explicable, as I have already shown,<sup>7</sup> on the more rational grounds of food-supply, to regulate the proper distribution of the total quantity

---

<sup>4</sup>According to Mr. R. Hislop, who has spent most of his life there.

<sup>5</sup>Roth—Bull. 4—Sect. 26 (d), pls. xxxiii., xxxiv.

<sup>6</sup>Roth—Bull. xi., part I. Tabu and other forms of Restriction.

<sup>7</sup>Roth—Ethnol. Studies, etc., 1897—Sect. 71.



of food available. Thus the husband, according to his particular exogamous group, lives on articles of diet different from those of his wife or wives, who of course belong to another group; both of which again are different from those permissible to their resulting offspring who belong to a third group. Hence, to put it shortly, whereas in a European community with a common dietary, the more children there are to feed the less will become the share for the parents, in the North Queensland system the appearance of children will make no appreciable difference in minimising the quantity of food available for those who give them birth. Any scarcity in the total quantity of all the food is met by a change of camping ground, any scarcity of particular diet, or any diet difficult to obtain and capture, being rendered tabu at the expense of the women, younger people, and children. It is noteworthy also that while the four exogamous groups are practically identical throughout North Queensland, the different animals, etc., associated with each group vary in the different districts with local requirements.

Holding these views, I therefore speak of these initiation dances as possibly bearing relationship to Central Australian totemic performances, but what the particular relationship is, there is not at present sufficient evidence to say. Should, however, a connection be ultimately found, the very pertinent question will then arise as to whether the North Queensland initiation dances represent a primitive condition which has become developed into the advanced and intricate ceremonials recorded from the centre of Australia, or whether it is an example of degeneration. The true solution must be sought for in arduous field-work, and not in academic study.

3. It was towards the end of June, 1899, that I witnessed an initiation ceremony amongst the Koko-yimidir-speaking Blacks at a spot on the southern bank of the McIvor River about four miles from its mouth. The presence of a European interpreter with a twenty years' knowledge of the language enabled me to understand the meaning and explanation of everything I saw and wanted to know. This particular ceremony took between four and five weeks to get through; both Cape Bedford, Endeavour, McIvor, and Starcke River Blacks were taking part in it. The food-supply for so large a number of natives, some one hundred and fifty, not being procurable in the immediate locality, a few days' spell was necessitated every now and again to allow of the participants hunting further afield.

The ceremony itself is known as ngan-teha; this word has the same meaning as ta-bul (= "tabu"), the words being interchange-

able in all cases except when expressing this rite, for which the former term is exclusively used. Considering that at so comparatively short a distance removed as Princess Charlotte Bay there are five or six different and progressive initiation ceremonies, it is interesting to learn that here but one ceremony is known and practised. It is not necessarily held every year, two or three intervening perhaps, and the location is shifted on each occasion. The exact time of year would appear to be immaterial, though usually it is held after the wet season, messengers being sent to neighbouring tribes telling them to assemble; it is also held independently of any particular phase of the moon.

The age at which the novices are chosen to attend the ceremony has nothing whatever to do with puberty; anyone from an old man with children to quite a young lad. The extreme ages of those I myself observed must have been from twenty-two or twenty-three down to eight or nine. They wear no accoutrements, neither are they painted (until the last days' proceedings), nor is any new name applied to any of them individually, nor is silence enforced throughout the whole ceremony. After the performance the late novice is known as a ngumbal.

The performers paint themselves all over with red, with white streaks over and below the eyes, meeting on either side of the face in a single line running down either side of the neck, and hence either diverging along each shoulder and arm or continuing down over the chest to join below the navel, or else converging into a single median band. On the head is worn the merrimbal, the cockatoo top-knot feather head-dress, or when this is not obtainable a small bunch or even a single feather may be stuck into the hair. There is no special performer who is leader, chorus-master, etc., all arrangements being made by the old men collectively.

The initial proceedings may be described as follows:—In the morning the novices are seized by the hair of the head and led away from the main camp by the men to a spot selected at some considerable distance away, and left there in charge of a keeper who accompanies them throughout the proceedings. This keeper has no special name applied to him, his duties being to see that his wards eat only of the prescribed foods (a list of those tabu has already been given), see only what is allowed to be seen, and keep within the boundaries limited to them. The men next return to the main camp, where they hold their first performance, that of the Native Companion, which alone the women are permitted to see; the dance of this particular bird invariably constitutes the first of the performances. Subsequently the women

are told, not shown, the boundary of the initiation-ground, this being marked by certain stakes stuck into the earth; should any female even see these boundary-marks, she will get ague,<sup>8</sup> and should she trespass beyond it, will be certain to die.

A more or less circular space is next made (Fig. 9) in the presence of the novices, at any time during daylight, and henceforth all subsequent proceedings take place herein. This space, about fifty feet in its longest diameter, is cleared of stumps, leaves, etc., and the sandy soil levelled as carefully as possible.

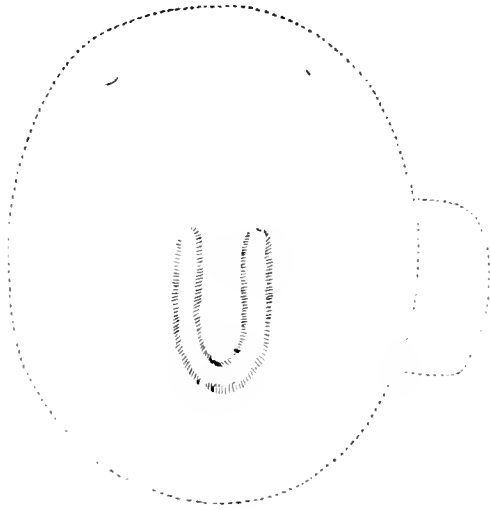

Fig. 9.

Near the centre the sand is scooped out and thrown up on either side in the form of a horse-shoe magnet, the arms of such "magnet" pointing to the north; I learnt that this is invariably the position assumed, with regard to the compass, by this central portion. On the eastern side is the low bush-fence wherein the fires burn at night, and the novices with their guardian sleep. The circular space is known as the *bó-ral*, a word signifying anything level, the central rut as the *piri* (= river)

and its banks as the *woln-gur*.

The main proceedings commence after the sun is well up and continue until the rising sun is at about an angle of 45° with the horizon, when there is an interval until the afternoon when the sun is in a corresponding position, the performance ceasing with the dark. In the daily interval the majority of the performers go hunting, the movements of the novices with their guardian being confined within a limited area. At night, when various dances take place in the circle, the novices lie in the bush-fence with eyes closed or covered so as not to see what is going on; these dances relate to various night animals and night birds. The essential portion of the ceremony, that indeed which the novices are permitted to watch and have explained to them, takes place during the day-time, and consists of different dances representing various members of the fauna and flora. Some three or

<sup>8</sup>My attack of ague-fever here was in all good faith ascribed by these folks to this cause.

four performers would particularly play the part, all the others circling around in Indian file and playing chorus; it is the business of the latter to shout in unison, to keep time with the stamping of the feet and the clapping of the hands laterally. The shouting is nearly all "au! au! au!" hardly any words being actually spoken, the whole performance being what we should almost call "dumb show." Among the performances so gone through are the dances relative to the native companion (invariably the initial one as already mentioned), owl, pheasant, body-louse (Pl. liv., fig. 1), black palm (Pl. lv.), frog, a certain fresh-water fish, mosquito, crab, honey, kangaroo, dog running after a lizard, fresh-water mussel (Pl. lvi.), stone-fish, alligator, eel, and flying-fox (with the blacks all hanging by their legs from the branches of the trees around), these three coming on just before the snake-dance, which closes the whole rite. As can be imagined, only some two or three of these dances can be performed daily, the more enjoyable ones bearing repetition longer than others. Thus, beyond the change of *répertoire*, the ceremony proceeds from day to day with but slight, if any, variations.

The scene opens daily as follows:—Say the time for the afternoon show has arrived, some of the performers may be resting in the low bush-fence, or elsewhere, outside the boral, when the guardian will bring up his wards from the spot where they have been camped and lead them into the central rut where they squat down one behind the other. The performers next take up their position around the boral (as in Pl. liv., fig. 2, where the low bush-fence can be recognised in the intervals of legs) and circle round the rut some three or four times in Indian file, shouting, stamping, and clapping as they go. When this is over, some of the other performers rush into the cleared area from the northern aspect, each stopping suddenly in front of the novices and pretending to let fly a spear at them, but the latter sit motionless. Leaving their spears in the bush-fence, these late arrivals join the other performers, one of whom drags each novice in turn by the hair of the head out of the rut, which he is not allowed to touch, and leads him to the edge of the circle.

The following are some notes concerning the dances already referred to:—

(a) Body-louse (Pl. liv., fig. 1). Here are represented three central figures with some of the others dancing and skipping around. Of the three central ones, the performer on the left is just in the act of putting into his mouth the vermin caught, while he on the right is looking for more, the centre one having his head pulled

about most unmercifully and in all directions during the search. But this is not all, for the last-mentioned individual is next laid on his back, and the search continued in the groin, fork, and on the testicles. As each insect is caught, an extra "au! au!" is given. When no more are discoverable, all three stamp the ground with their knees, raising the elbows and arms as each jump is made, the chorus circling and shouting all the time.

(b) The Black-palm(Pl.lv.). In this show, while things are being got ready, the novices, standing on the edge of the boral, are made to turn their backs to it. At the same time certain of the old men cover their eyes and ears to make the mystery doubly sure. In the meantime a large black-palm leaf is brought in from the neighbouring scrub and stuck upright in the centre of the circular area. The novices are now turned round and allowed to see it, when it is shaken about and subsequently torn to pieces, the central figures stamping with their knees, and the chorus shouting and dancing around as before. The novices—one of the little fellows can be distinguished in the plate—are told by the old men that they made the plant grow there where they saw it, and they believe them.

(c) The Milkandar (a bird). The central performers on their knees, with arms raised, imitate the sound of the bird towards which they are spasmodically jumping up in order to try and catch it; chorus as before.

(d) The Wo-dil (a bird associated with water-lilies) is represented by the central individuals picking up small handfuls of sand and tossing it here and there—the idea of the little tit skipping from flower to flower.

(e) The Mosquito. In this, which requires some little time for preparation, the performers hide in the surrounding scrub. Some three or four with leafy branches in their hands come rushing out into the ring, jump about in all directions and brush away the imaginary mosquitoes from off their bodies, heads, thighs and legs. They are soon joined by the singers, and again a repetition of chorus, stamping and clapping.

(f) The Crab. The novices, as in the Black-palm ceremony, have their backs turned, some Grevillea nuts being, in the meantime, brought from their hiding-place behind a neighbouring tree, and hidden in the circular area. The novices on turning round see one of the performers on a neighbouring branch beckoning to two others in the far distance to come up as the fire is ready, and only waiting for the crabs to be roasted. These two then advance, and amid great excitement will find crab (*i.e.*, Grevillea

nut) after crab, the chorus yelling extra strong as each is discovered.

(g) The Dornorn (poison "stone-fish,"<sup>9</sup> well known to the Cooktown Europeans) is very dangerous in that a stab from its dorsal fin can produce a very ugly poisonous wound. While the backs of the novices are turned, a *bees-wax model of such a fish* (Pl. lii., fig. 2) is placed, but left visible, in the ring. On being allowed to gaze upon the boral again, they see the chorus circling round and round the three central performers, who, with down-pointed spears, are trying to find it, and pretending to miss it each time. Indeed, so well is the mimicking carried on that finally one of the central figures treads upon the model and, seemingly poisoned, utters an unearthly yell, in which of course the dancing chorus join, and falls to the ground in agony.

(h) The Fresh-water Mussel (Pl. lvi.). Here again the credulity of the novices is imposed upon, for while they are made to turn their backs and have their eyes closed, several live shells are planted within the central rut or piri. When allowed to see, there is one performer sitting on the bend of the horse-shoe with his legs inside, and holding an empty palm-scale trough in his hands. On either side of him, and sitting on the edge of the rut, is another performer, each taking his turn at diving into the supposed water. After many contortions, standing on his head even, and legs outstretched, amid the cries of the chorus, he comes up to the imaginary surface with a shell, and, accompanied with much yelling and rejoicing, hands it to the other "diver," who places it in the trough. The photo. from which the illustration is prepared has just caught the one man putting the shell in the trough, and the other cocking up his leg to make ready for another dive. The realism may be carried still further by the divers pretending to get their fingers nipped, or else sitting on the banks of the rut and shivering with the cold after having been in the water so long.

Thus day after day, morning and afternoon, the performances follow each other in rapid succession, the final proceedings being constituted as follows:—When the last dance is over, the central horse-shoe is obliterated, and the whole surface rendered level by all the performers, with spears down, gradually converging from the circumference and stamping as they get to the centre. A "murla" is then placed in the ground where the bend of the horse-shoe originally was; the word murla means honey, and is applied to the object intended to represent a honey-comb, the

---

<sup>9</sup>*Synoncydium horridum*, Linn. (*Ed.*).

hollow log indicating the hollow trunk or limb of the tree, while the two beeswax funnels are supposed to be the lipped openings whereby the bees enter. It is placed in the ground as shown in the diagram (Fig. 10), and renders the area tabu;<sup>10</sup> all have to

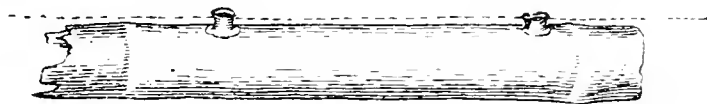

Fig. 10.

tread upon it as they pass over it. The novices are next entirely covered with red paint (but wearing no cockatoo top-knot head-dress) and taken down in procession to the main camp; here each one, while held by an old man at the side, is beaten on the calves with wet bushes by his youngest group-mother, and then goes into hiding. They ultimately return, join in the dancing with the men and women, and sleep in the main camp that night. Next day the novices are covered with bushes and led to another and smaller cleared circular space (unconnected by any alley-way with the original one) where they are hidden under a heap of bushes, and where the wrestling contests take place in the presence of the women. So as to prevent any quarrelling, brothers as a rule are made to wrestle with each other, though the participants may have to be separated by relatives intervening with raised hands. Here the novices stay all night, and during the course of the next few mornings get painted with white streaks, one above and below the eyes, joining at the outer angles, continued down each side of the neck, and so over the trunk on to the front of each thigh. They are then told to lie down and go to sleep, which they pretend to do by lying perfectly still on their backs with eyes closed. Each one is next suddenly "awakened" by a sharp pinch on the arm and told that he has been snake-bitten, at which he commences to be frightened, and then starts crying. His old mentor then proceeds to kill the imaginary snake by means of a small variety of bull-roarer which he whirls through the air in various directions, such action being believed to prevent the bite having a fatal effect. This bull-roarer is now given to the novice, who then has the power not only to kill snakes but even people by its agency; it is called *dunggul*, a term also meaning a snake. Two or three days later the snake dance is ended by the novices being shown a

---

<sup>10</sup> I had already met with these *murla* on initiation grounds on the Starcke River and on the Bloomfield River; the specimen from the latter locality is, however, solid.

huge representation of a carpet snake fixed on a tree, and the ceremony is completed.

No personal ornaments are worn signficatory of having undergone the rite, this being only known by the man's word or by public report. Women go through no ceremonial.

4. On the Bloomfield River, when a sufficient number of friendlies can be got together in one locality, and this will depend upon a suitable season and adequate food-supply, all the boys who are to undergo the rite are taken to a spot well removed from the women and the actual camp, to where a "lean-to" of branches is set up. About ten or fifteen yards distant from this shed is the initiation ring, an oval space about twelve yards by six, formed in some sandy spot, the sand scooped out, and thrown up to form a raised edge just wide enough for one individual to walk along on. At the lean-to each boy is covered from head to foot with *Grevillea*-bark charcoal by his father or mother's brother, the ashes being applied with the hands, which are spat upon. The proceedings will commence at any time during the day or evening. The boys are now taken to the cleared space within sight or sound of which no woman or other uninitiated males dare to be present. Here the elders go through a whole series of dances or performances relative to various birds and animals, and as each is executed the father or mother's brother explains to his ward the meaning and details of it; at the commencement of each separate dance, except that of the wild-cat, during the whole course of which their faces are turned aside in the direction of "home," they are directed to look homewards while things are being got ready. These dances are done in relays and extend over a space of sometimes four days, without sleep and but little food, and that only of a certain kind, with the result that the poor novices are pretty well half-starved and knocked-up for want of sleep. The novices are also painted differently at the close of the ceremony, with red ochre, to what they were at the opening. As soon as the elders have decided that they have had enough of it, the men in charge of the boys will collect some leafy boughs under cover of which, just like a moving forest, they all march back towards the original camp. Before reaching it, however, they stop at another cleared more or less circular space with its accompanying lean-to shed, and stand up in two rows, the novices forming the front one. The mothers (blood- or group-) of the initiated youths are now allowed to approach, each woman coming close up with a leafy bough which she switches lightly across the thighs of her own particular boy, who thereupon enters the lean-to, where he has a short rest. Having so rested a while,



the snake dance is performed in this smaller cleared space, this being followed by the wrestling matches. At last they all return to the original encampment, where the novices now occupy the bachelors' quarters. Some time subsequently, depending upon the season, etc., the young fellow commences to eat certain of the foods that have previously been forbidden him, the first that he is allowed to partake of being the wo-kai yam (*Dioscorea*, sp.), the last, many months later, being the scrub-hen's eggs. None of these food-stuffs, however, is he allowed to speak of by their right name; to specialise—he must generalise them all as bandil-maja. Furthermore, during all this period that he is being allowed to gradually partake of more and more of the various foods which had hitherto been forbidden him, all women and any uninitiated males are strictly to avoid, touch, etc., anything that he has eaten from or drunk of. At length he gets his nose pierced by an individual known as the pi-wal (who is sometimes a woman), one being appointed to each novice, whose duty it is to acquaint him with the relationship, etc., that he now bears to other members of the tribe; from this time onwards the young man never speaks by name either to or of his pi-wal unless by chance there happens to be some blood-feud springing up between them. It is only subsequently to the initiation that the young men are taught the use of the bull-roarers. Females go through none of these initiation rites; men need not necessarily have gone through it, even before marriage or even before children have been born to them.

5. On the Lower Tully River there is no name attached to the ceremony which is carried out for boys alone, and apparently with one particular object only—the infliction of the belly-scars. No women, and no young boys who have not already been initiated, are allowed to be present. Several youths may be initiated at the same time, from one up to five or six. They are informed of it a week or so beforehand, as also are a few of the gins who are told-off to prepare large quantities of a particular food-stuff, the "bara" nut. The boys are about seventeen or eighteen years of age, when the moustache is developed, when they are considered ready for the rite. The ceremony lasts from four to five days, but does not take place at any particular time of the year; it is usually gone through in the neighbourhood of a river-bank, but not necessarily always in the same spot. No special dresses, ornaments, etc., for either the men or the young boys, and no special implement beyond flint-flake, are brought into requisition; the novice's name is not changed, nor is anything special taught him. All who have undergone the ceremony

have the same social rights in that, as soon as the scars are healed, they are "men," and can have wives.

After having been erammed with the bara nut, their bellies distended, and the incisions made, the novices next get up and go inside a hut specially reserved for them, a very big grass one, and there they stay by themselves. The same food, which the women have prepared for them, is brought here by the men, with whom only, besides amongst themselves, are they allowed to speak. They may walk about in the close neighbourhood, but must wear the bark blanket around them when the gins may see them thus covered, but from a distance only. This goes on for two or three days, during which period certain of the elder men go hunting for eels. At the end of this time, the novices are taken to some isolated spot away from their camp, and while their attention is purposely diverted to something else, another old man will suddenly jump into view and frighten them. The latter generally appears from behind, holds the cooked eels in front of him, and then divides them amongst the lads, who eat them, rubbing the fat over their bellies. After the eating of these fish, the kokai-kokai (as the boy is called after he receives his chest-mark) becomes a ngu-teha. He still remains within, or in the neighbourhood of, the special grass-hut for another day or two, during which period the elder men prepare the kumbi (*Colocasia macrorrhiza*) root and frighten him with it as was done in the case of the eels. Some four or five days after the commencement of the ceremony, the scars begin to heal, and the youth is called a mulari, when he may be seen by the others as well as by the women. A few weeks later the scars are quite healed and raised, and he is called a chalma, a "man," when he is allowed to marry.

During the whole ceremony, the novice only partakes of the eels and the *Colocasia*, everything else being forbidden him, but when it is over the restriction is removed and he can eat anything he chooses.

6. In the hinterland of Princess Charlotte Bay, amongst the Koko-warra and Koko-rarnul, where I watched the initiation proceedings during November, 1898, the first takes place during the latter months of the dry season, after the lad has arrived at early puberty. He is caught up from amongst his mates in camp and taken by force, notwithstanding his own screams and his mother's entreaties, to a cleared circular space, the name of which (KWA. bo-ata, KRA. barta) gives the name to the first of the series of rites which take place here. This space is about twenty to twenty-four feet diameter with the edges all raised except that portion of it facing the north, where there is a sort

of entrance-way; there are no marked trees or distinctive signs anywhere around. The novice, in company with others in the same predicament, is made to sit at a fire on the eastern side of the space, at some distance removed, and from here he watches the elder men taking part in the performance, though he is not permitted to witness them actually dressing themselves, their sole decorations consisting of the cockatoo feather head-dress and a streak of white paint on face and trunk (Pl. lii., fig. 1) with sometimes another or two put on the thighs of the leaders. Dancing commences at sunrise to continue until about breakfast-time, and starts again when the sun is getting low until sunset. It consists of a representation at each performance of the antics and movements peculiar to the following animals, and many others, *e.g.*, native-companion, mopoke, eagle-hawk, sparrow-hawk, owl, frog, iguana, dead blackfellow, whistler-duck (all in this particular order), etc. That relative to the native-companion always comes first. It is said that a very long time ago this bird found a ground-chili, and not knowing what it then was, ate it, with the result that not only did his head and beak take on a scarlet colour, but that he got all hot and "all-same drunk"; and that it was during this predicament that he learnt his steps which he subsequently taught to all the other animals and birds in the order mentioned, each finally coming to have a special one of its own. These performances are repeated almost daily until the commencement of the wet season, when the dancing, instead of ceasing at sunset, continues all night until sunrise, the pre-prandial one being at the same time discontinued. All this time the novices do not approach anywhere near the general camp, or the women, but are tended night and day by one of the elder men who take on this duty turn and turn about. They are permitted certain foods only and forbidden others; among the former are dugong, kangaroo, opossum, lily-roots and seed, *Vitis trifolia* root, and (big-bee) honey, while the latter include yams, (small-bee) honey, eel, stingaree, turtle, big mullet or any other big fish, red bream, and anything else red. They also learn and have to avoid the animals belonging to their own exogamous group. The names of all these forbidden things must not be mentioned by them, although they may be indicated by signs; any transgression in this respect would be followed by disease. They also regularly practise the various dances they see performed, especially those peculiar to their own particular group, but they do this well away from the circular space, which they are strictly forbidden to enter; they are also told all the places and things that are tabu. When at last the ceremony is over, with the commencing wet season, they return to the general camp, but dare not mention anything they have seen or heard to either their mothers, sisters,

or any females whatever. In the following season when the next bo-ata ceremony takes place, the novice is allowed to enter the cleared space with his decorations, and join in the dancing along with the other performers. After he has thus twice, *i.e.*, during two seasons, taken an active part in the actual dance within the precincts of the bo-ata ring he is led up before one of the very old men who rubs his (the novice's) chest and stomach with each of the different food-stuffs so long forbidden, which he successively places in the younger man's hand, as a sign of their being now permitted him. Having completed this initiation, the novice is a bárnbata, can speak by name of all these food-stuffs to his fellow-men, and is now allowed to marry.

The Koko-warra here have six initiation ceremonies through which an individual, if he is anxious to reach the top rung of the social ladder, has progressively to pass. Taking them in their proper order, they are the bo-ata, urr-dú, gaun-darang, andén, alkír, and alkán-jinna. As an individual passes the first three, he is known successively as a bárnbata, karkánta, and alpó-anna. The neighbouring Koko-rarnul Tribe have only four rites, the barta, antára, an-pí, and an-púl, an individual passing the first two being called first a baru-batang, and then an antántang.

I was witness to portion of the alkír or fifth Koko-warra initiation ceremony, which I was informed was a replica of what had been going on daily for some six or seven weeks previously. For

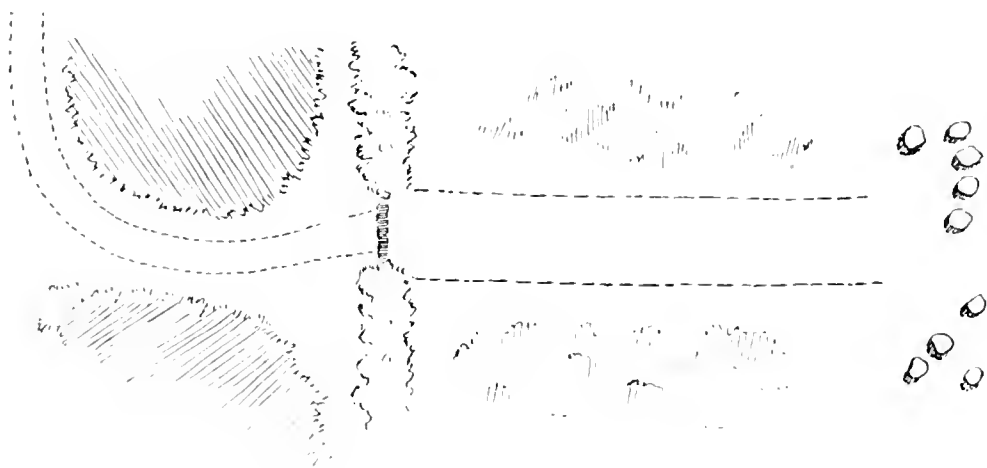

Fig. 11.

this rite a special piece of ground known as the rau-rár (KWA.) was laid off; this consists of a broad path separated from a narrow one by a screen, an arrangement which in diagram would appear something like Fig. 11. The broader pathway, cleared of timber, leaves and rubbish, which thus constitute the slightly

raised e lges, is about twenty feet wide, and well over one hundred and fifty feet long, forming a fine sandy tract leading straight from the main camping-ground to the screen. The latter, or aréria (KWA. term signifying any fence in general, *e.g.*, a fish-trap one) is about five feet six inches high formed of switches tied at their upper ends on to a cross-piece which in turn is maintained in position at either extremity by resting in the fork formed of two slanting uprights. This structure is shown in the centre of the Pl. liii., fig. 1, taken at a spot about half-way down the broad track, a portion of which is distinguishable in front. On either side of it is an artificial bush-fence which, with the screen, thus together shut off from observation from the main-camp side anything which is taking place beyond. No one, except the actual participants and novices for the particular rite, are allowed to come, or even to look, behind the screen: the whole of the initiation ground is of course tabu from the women. On the further side, the narrower pathway leads a sinuous course into a patch of dense scrub where in a secluded spot the dressing and decoration of the principal characters take place.

The "orchestra" take up their places just behind the screen, the musical accompaniment of the song consisting of a length of hollow log, split in half, with the concavity turned downwards; upon its convexity some five or six individuals were hammering away, and keeping good time, with their sticks, a splendid-toned reverberation being thus produced. Plate liii., fig. 4, shows these musicians *in situ*, four of them squatting on one side of the log and three on the other; the sticks are in evidence. To the left of them are three figures standing upright, these are smeared from top to toe with charcoal-grease, which gives them quite a shiny appearance, and are known as the crows. It is they who help to dress and decorate the two principal individuals to be immediately described, and hence may be quite correctly described as "dressers." On the extreme right of the picture can be just recognised the horizontal cross-piece on to which the switches and light leafy saplings constituting the screen are tied. In the very centre is the fire, which is of course required considering that the ceremony only commences when the sun begins to set. The main figures actually distinctive of the ceremony are also shown in Pl. liii., fig. 3, representing the Amboiba,<sup>11</sup> individuals who,

---

<sup>11</sup>Similarly masked and dressed figures (Pl. l., figs. 13-14) known as Amboipo, are met with in the initiation ceremonies further north, *e.g.*, Margaret Bay, where the decorations of the performers are even more elaborate (Pl. li.).

in days gone by, are believed to have driven the Blacks on their different peregrinations. They are covered with strips of tea-tree bark, each from two and a half to three feet in length, fixed into a top-string or rather rope so as to form what may be described as a huge "corner-fringe" (the upholsterer's term) quite nine or ten yards long. Starting at the waist, this fringe is wound round and round the individual from below up over his arms and covering him, except for the face, in his entirety. Over the face is worn a mask, formed of an oblong piece of tea-tree bark, on which is painted a red cross over a white back-ground; two eye-holes are inserted in the horizontal limb of the cross. The mask is kept in position by means of three finely pointed small spears upon which, here and there, some blobs of feather-down are stuck; these bits of down can be recognised as the white spots above the mask on the right-hand figure. The spears themselves, the *alkir*, have some important signification, and give the name to this particular rite. At another stage of the proceedings (Pl. liii., fig. 2) the Amboiba assumes a kneeling position, his face uncovered and the mask fixed in between the spears over his head; he thus remains immovable for some considerable time, while certain explanations and injunctions are given to the novice by a third party, for an Amboiba never speaks. While the latter's faces are uncovered, and only so long as this lasts, a hand is placed over the novice's eyes, so that he should see nothing of the change being made in the accoutrements by the crows. The special injunctions given to the novice are that for the whole of the coming season (*i.e.*, practically a twelvemonth), the shortest time before which an opportunity can prevent itself for his taking the sixth or final degree, he must not give either to his own, or any other, women, or his children, any (small-bee) honey, eels, large iguana, barramundi, or red bream. Should he happen to catch any of these animals, etc., on his travels, and not require them for himself, he must give them to the elder men only. On the other hand, supposing the women can obtain any of these things through their own personal exertions, which is almost impossible for them to do, they are allowed to eat them provided they do not happen to be tabu to them individually.

When the change of dress had been made, and the novices taken away, the dressers unwound the tea-tree bark from the Amboiba, a signal that the main portion of the ceremony had come to a close. The sun had now set well below the horizon, the enveloping darkness was becoming very pronounced, and soon the further side of the screen was deserted, the participants and myself returning to the main camp.

After the evening meal was over, the two Amboiba were again dressed up with their masks, etc., in the scrub on the further side of the screen, but on this occasion they advanced to the open end of the broad alley-way where the orchestra had already taken up their places. The women and children were thus allowed an opportunity of looking at them, and they joined in clapping hands to keep the time. A youngish looking lad was next seized, and his eyes covered; he was firmly held in his captor's grip while the two Amboiba purposely and forcibly dug into him their elbows and shoulders from under their crinkled tresses. Instead of advancing now with the dancing, the two central figures retired a few paces towards the screen (with the masks all the time turned towards the main camp) and then rested; the orchestra shifted their positions during the interval, at the same time that the boy was again knocked about. This kind of music and dancing, with alternate retiring and resting, continued all the way back to the screen, and when about half-way down the alley-way the women and children were sent about their business back to camp. The boy must have been somewhat badly bruised, considering the time taken, at least three-quarters of an hour, to cover the length of alley-way, and the number of times, corresponding with the intervals, that he must have been knocked about. He was never allowed to see what was actually taking place, for when he was at last permitted to free his eyes, upon arrival at the screen, the Amboiba had disappeared behind it. I learnt subsequently that this particular lad was completing his noviceship in some ceremony earlier than the present alkir or fifth rite, and that it was only during the few final nights of the latter that this "bruising" business took place. It must be remembered that up in these districts several of the initiation rites may be going on all more or less at one and the same time.

7. In the Rockhampton District<sup>12</sup> when the old men consider that there are enough young men, of the age of puberty, to be operated upon, they call all the tribe together, stating publicly that they will have a big dance. Word is soon passed round, and certain men who have been previously agreed upon each catch such a young boy. These certain men belong to that particular exogamous group whence the novice will eventually take his wife, and so their relationship to the boys may be spoken of as that of brothers-in-law or nu-pa. Each nu-pa tells his novice what to do during the whole time, something like three months, that he is being initiated. Having thus all been finally

---

<sup>12</sup>This is from notes given me by Mr. W. H. Flowers, late of Torilla and Pine Mountain, *via* Rockhampton, 1867-1891.

collected, the young unmarried men take the novices into the bush, while the old men prepare the ground, *i.e.*, make a clearing, leaving neither grass nor stick. In the evening, the women are told to lie down in the camp and keep themselves covered, so that they should see nothing. Fires are lighted round the clearing, and the novices then brought in from the bush, made to sit cross-legged in the middle, and told not to look up at whatever is being said or done, but just simply to beat the ground in front of them and look only at the spot they are beating. The other Blacks then wrestle, carry on various dances, and make noises suddenly here and there, and all round about, but the novices dare not look up. This goes on until midnight or perhaps later, when the other Blacks have a meal, but only a very little honey is given to the novices, and then only by the nupas. The other Blacks go on to their own camp and sleep, leaving the novices with their guardians within the ring of fires; finally the nupas retire to outside the fiery circle, leaving only their wards within. Next morning the novices with their attendants leave camp before sunrise, and are allowed to hunt, but they may only eat of certain foods, and in addition are kept on very short rations. At sundown, the women and children are again sent to camp, and about dark the novices are brought to the clearing wherein they find some other blacks wrestling and dancing, and walking slowly round the circle of fires look only down on the ground directly in front of them, until such time as they are told to go inside. The nupas do not accompany them now within the cleared space, but advise and explain the various dances to them from the outside, the novices continuing to sit cross-legged and to beat the ground just in front. This goes on daily and regularly for about a month, the novices having very little food or rest, and camping at night within the circle of fires on the bare ground without covering of any sort, though should heavy rain fall in the interval they are allowed, in company with their guardians, to go into the bush and erect a hut in which to camp. During the whole of this month, the women and children never see the novices, who are submitted to various ordeals, in one of which each is held up at full arm's length by his nupa and nupa's tribal brothers for some little period, during which procedure he is not supposed to move a muscle. In the course of the following month the novices are tried still more. The other blacks will make jokes and laugh loudly quite close to them, but the novices must not even smile. At other times, they will shout out something like this—"I say! Some heavy rain is coming! Where's your blanket?"—but the novice must take no notice, and must not show by any sign that he has even heard.



Again, a black will sidle up to a novice and drop a billet of wood, saying, "See the fine fish I caught. Won't we have a big feed to-night!"—a remark rather trying for a young man who for the past two months has been almost on starvation diet. Everything indeed that can be thought of is done to get him to forget himself even for a moment, and make him look up, speak or laugh. When finally the old men consider the novices have been sufficiently tried, they tell the nupas so. That same evening the novices paint themselves up as "men," with feathers in their hair, and cease to be novices any longer. Now for the first time since the ceremonies began are they seen by their mothers and sisters, and as by this time they have become very thin, not only do their relatives in particular, but the whole camp in general, make a great fuss and cry over them. Still even for three or four months later, the newly-made "men" may only eat honey, yams, and "old man opossum" flesh, but they must not gnaw the bones. After this lapse of time they may eat anything except emu-flesh, which must always be brought to the old men in camp, and never eaten by young men at all.

NOTES ON THE NESTING-SITE OF *GERYGONE*  
*PERSONATA*, Gould.

BY ALFRED J. NORTH, C.M.B.O.U., C.F.A.O.U., Ornithologist.

(Plate lvii.)

Among the animal kingdom, birds, owing usually to their non-combative habits, and lack of powers of retaliation, appear to be highly endowed with instinct enabling them to resort to many stratagems and devices to secure protection, either from an enemy when threatened by danger, or during the usually anxious period of the breeding season. Birds that deposit their eggs on the grassy sward, or nearly bare earth, would appear to stand more in need of a protector than any others, but strange as it may seem, the bare and exposed situation in which the eggs are laid, affords them the very best protection. Take, for instance, the eggs of the Southern Stone Plover (*Burhinus grallarius*) and the Spur-winged Plover (*Lobivanellus lobatus*), how closely in colour do they resemble their surroundings; or the eggs of the Black-faced Dotterel (*Egialitis melanops*), the surrounding pebbles on the margin, or in the dried up bed of a creek or river. The eggs too of the Pratincole (*Stiltia isabella*), so frequently deposited on a sun-baked plain, and as the wheel marks show sometimes right in the centre of the track, how hard they are to distinguish even in their apparently unprotected state. Again the eggs of the Red-capped Dotterel (*Egialitis ruficapilla*) deposited on sandy dunes and sea-beaches, with only a few small pieces of gravel to keep them from rolling away, how closely do they assimilate to their surroundings, and how very difficult they are to discover by the untrained eye. The actions of the birds alone are frequently the only means of discovering them, by their feigning a broken wing or leg. This is where instinct is at fault, for to anyone but a novice it is the most fatal mistake the birds could make, and is a sure indication that either eggs or young are near at hand. Some birds, however, to me appear to be endowed with a certain amount of reasoning powers, for why will the Red-kneed Dotterel (*Erythrogonys cinctus*) when

laying her eggs near the margins of a swamp often slightly smear them with mud; the Australian Dotterel (*Peltohyas australis*) when leaving her eggs cover them with a layer of thin sticks, two or three inches in length; and the Black-backed Magpie (*Gymnorhina tibicen*) when leaving the nest cover her eggs with a layer of wool and rabbit fur?<sup>1</sup> Many species, too, when a Cuckoo deposits an egg in their nest, if it contains no eggs of their own, covers up the Cuckoo's egg with a layer of lining material, sufficiently thick to prevent incubation.

Of the many stratagems used by birds to secure immunity from harm, probably no more ingenious device is utilized than that of the Masked Bush Warbler (*Gerygone personata*), who nearly always builds its hooded dome-shaped nest close to a wasp's nest, of which fuller details may be found in "Nests and Eggs of Australian Birds."<sup>2</sup> The White-throated Bush Warbler, too, or Native Canary (*Gerygone albigularis*), a migratory species visiting South-eastern Australia during the spring and summer months, and at present common in the vicinity of Sydney, often builds its nest in trees affected with scale, and thickly infested with ants, while yet another species, the Large-billed Bush Warbler (*Gerygone magnirostris*), inhabiting Northern and North-eastern Australia, more frequently builds a long pendant nest on a vine or branch overhanging water, and closely resembling a mass of debris, left by the receding water after the creeks or rivers have been in flood. Hence the name of "Flood-bird" locally applied to this species in the neighbourhood of Cooktown and the Bloomfield River District, North-eastern Queensland.

My colleague, Mr. Allan R. McCulloch, who was collecting in 1907 at Somerset, Cape York, and on some of the adjacent islets, returned with a number of birds in different stages of plumage, in some instances from the young in down to the adult, also some nests, and eggs and photographs of eggs, sea-birds and young, *in situ*, of which the latter will form figures for future Parts of the "Nest and Egg Catalogue" now being prepared for the press. Among the photographs is a very interesting one of a deserted nest of *Gerygone personata* built in close proximity to a wasp's nest, which is reproduced (Plate lvii.). Mr. McCulloch has also kindly supplied me with the following notes relating to the taking of it.

---

<sup>1</sup> North.—Austr. Mus. Sp. Cat., I. Nests and Eggs of Austr. Birds, i., 1900, p. 6.

<sup>2</sup> North.—Austr. Mus. Sp. Cat., I. Nests and Eggs of Austr. Birds, i., 1903, p. 202.

“On the 10th October, 1907, Mr. Bertie Jardine and myself were walking through the dense scrub near Somerset, Cape York, on the lookout for birds' nests, I having my camera ready for use. In a particularly quiet and shady part, Mr. Jardine pointed out a nest of *Gerygone personata* hanging on some low bushes about three feet from the ground, and placed only eight or nine feet off the track. As is usual with this bird it was hung close by a wasp's nest, and surrounded by a tangle of vines, some of them very prickly. Both the birds' and wasps' nests were deserted, though there were a few of the insects flying around, and we had little difficulty therefore in securing a photograph.”

*Gerygone personata*, in building its nest close to an occupied wasp's nest, may be regarded as living with comparative safety from human enemies, unless one chooses to disregard what we are taught in our early school primers—“Do not irritate wasps.”



EXPLANATION OF PLATE XXX.

---

CRIOCERAS LEPTUS, *Eth. fil.*

- Fig. 1. Lateral view of portion of a whorl with a broad, almost flat flank, traversed by regular hardly sigmoidal nontuberculate costae.  
,, 2. Ventral view of Fig. 1, displaying the narrow venter and compressed outline; the costae are practically straight on crossing the former.  
,, 3. Dorsal view of Figs. 1 and 2, exhibiting the flat costate dorsum destitute of groove, the costae bent slightly forward, and the longitudinally obtusely triangular section. Compare this with the section of a typical *C. jackii* (Plate xxxii., fig. 1).

(Figures slightly less than natural size.)



2



1



3







EXPLANATION OF PLATE XXXI.

---

CRIOCERAS JACKII, *Eth. fil.*

- Fig. 1. Lateral view of a fine partly testaceous specimen with obtuse rounded costæ in the earlier stages, becoming more angular with growth; tubercles are not visible.
- ., 2. Dorso-ventral view of Fig. 1, displaying the overhanging whorls, convex venter, and broad oval section.  
(Figures slightly more than half natural size.)

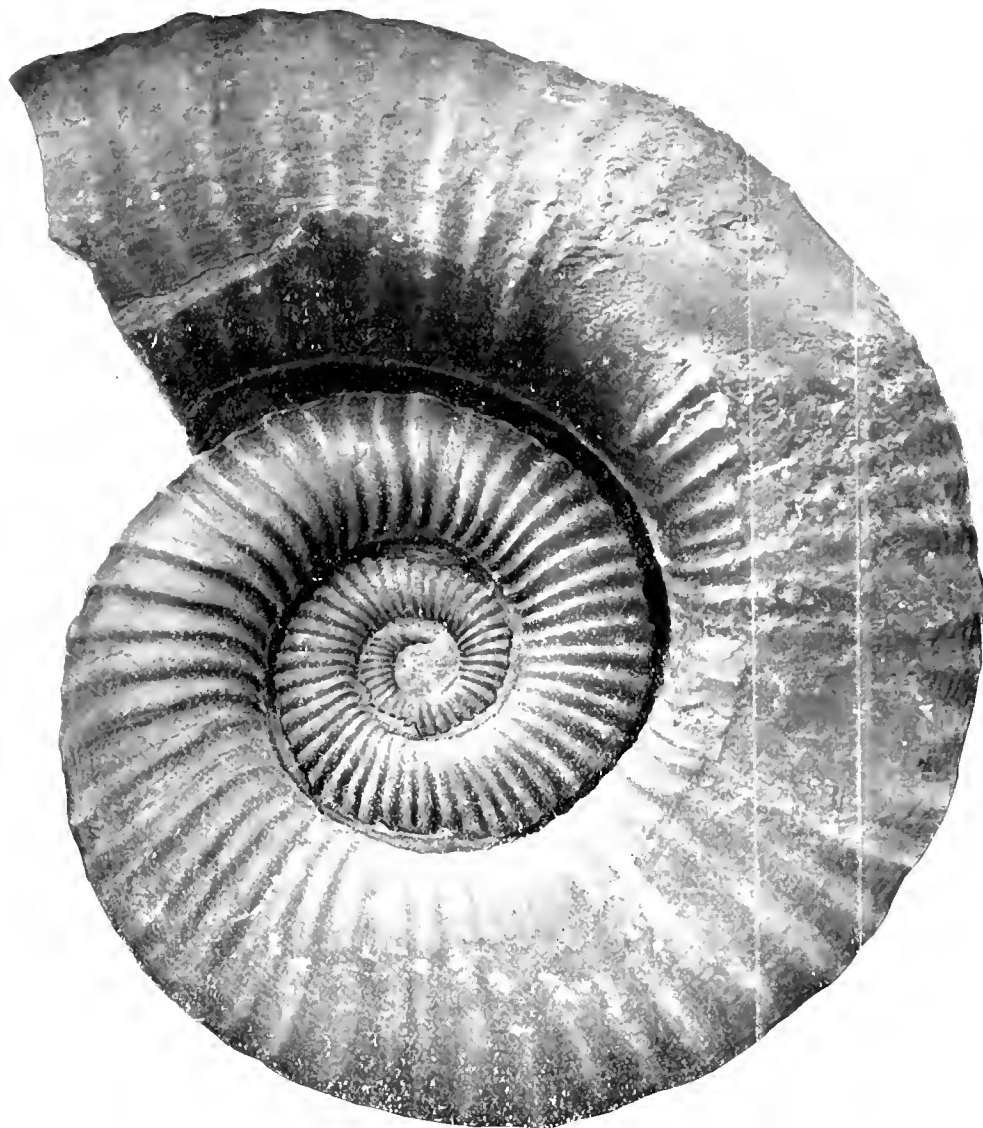

1

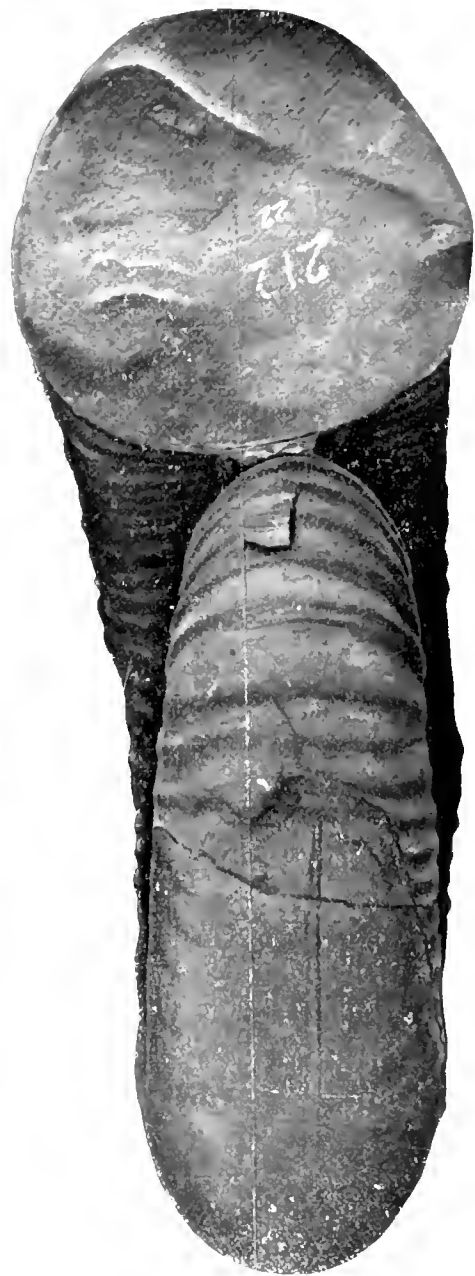

2





EXPLANATION OF PLATE XXXII.

---

*CRIGERAS JACKII, Eth. fil.*

- Fig. 1. Ventral view of a cast wholly devoid of test. The swollen primary costae with the intermediate secondary costae are well shown, the former bearing two ventral and two infra-ventral lines of tubercles; on the left hand side of the figures two of the supra-dorsal tubercles are also visible. This is the typical *C. jackii*.
- .. 2. Similar view of a partly testiferous example, without tubercles. (See Plate xxxi., fig. 1; Pl. xxxiv., fig. 1).
- .. 3. Portion of a septal suture.

*CRIGERAS AXONOIDES, Eth. fil.*

- .. 4. Portion of a septal suture.

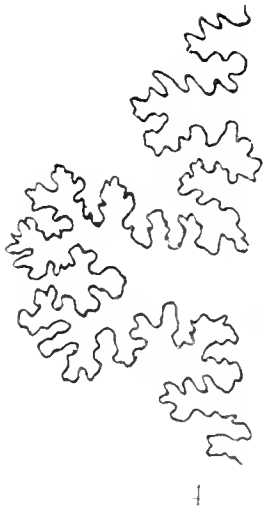

2

3







## EXPLANATION OF PLATE XXXIII.

---

### CRIOCERAS JACKII, *Eth. fil.*

- Fig. 1. Lateral view of the shell represented in Plate xxxii., fig. 1, an imperfect internal cast; the secondary costæ are, in this instance, almost always two between each pair of primaries. The weathered sutures are quite perceptible at the distal end.

### CRIOCERAS PLECTOIDES, *Eth. fil.*

- ,, 2 Portion of a septal suture.



1

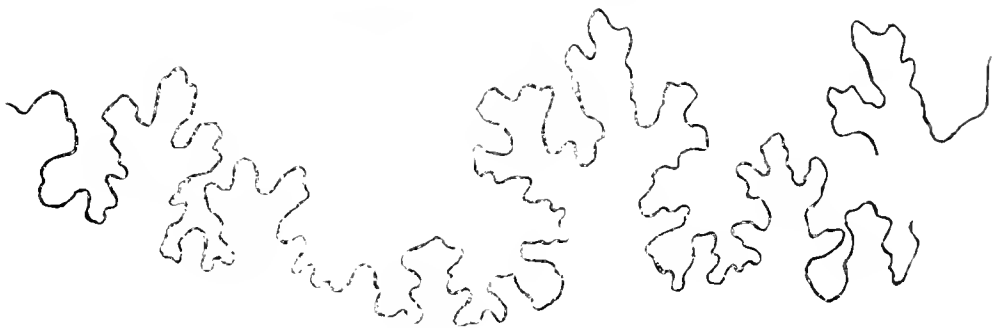

2





EXPLANATION OF PLATE XXXIV.

---

CRIOCERAS JACKII, *Eth. fil.*

Fig. 1. Lateral view of a partially testiferous example with characteristic obtuse and somewhat sigmoidal costæ destitute of tubercles.

CRIOCERAS LEPTUS, *Eth. fil.*

.. 2. Portions of three septal sutures.



1



2







EXPLANATION OF PLATE XXXV.

CRIOCERAS JACKII, *Eth. fil.*

Fig. 1.—Lateral view of a partly testiferous example with overhanging whorls, and tubercles on the oldest whorl preserved. Three-quarters natural size.

CRIOCERAS, *sp.*

2. Ventral view of a large shaft or limb (seen in lateral view in Plate xlvii., fig. 5) with a narrow venter, strong, distant, cristiform costae; three angles of the hexagonal primary costate section and two rows of acute tubercles on each side are visible, two abdominal and two dorso-lateral. (See Plate xlii., fig. 1; Pl. xlv., fig. 2; Pl. xlvii., fig. 5).

(About one-half natural size.)

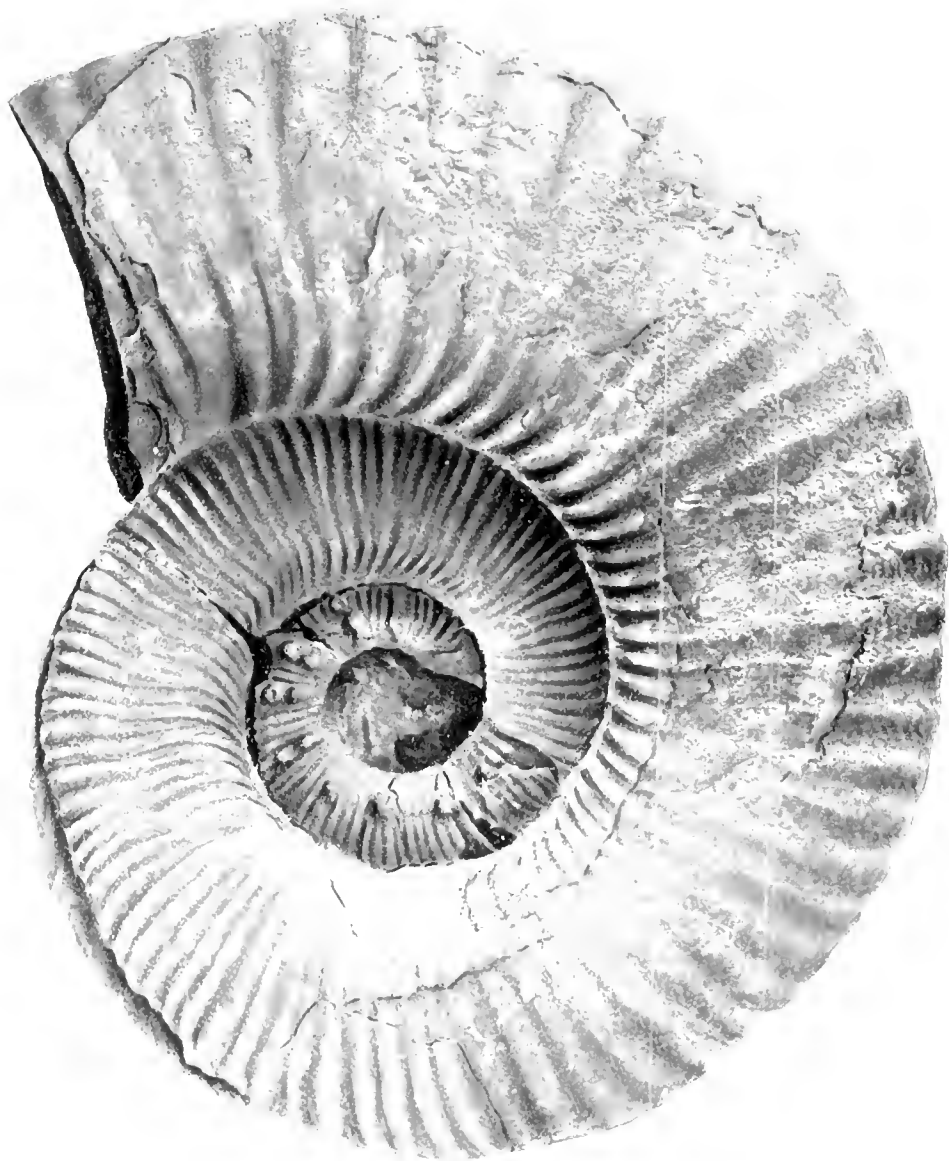

1



2





EXPLANATION OF PLATE XXXVI.

---

CRIOCERAS JACKII, *Eth. fil.*

- Fig. 1. Lateral view of a medium sized imperfect cast on which the older and smaller whorls are wanting, but at the proximal end so preserved, three rows of tubercles are visible. Three quarters natural size.

CRIOCERAS FLINDERSI, *McCoy., sp. (?)*.

- „ 2. Lateral view of a large nontestiferous limb or shaft, showing a convex venter, sharp, slightly sigmoidal and sometimes bifurcate, fasciculate costæ; between the two lines of strong abdominal tubercles it will be seen the costæ are double. (See Plate xlii., fig. 2; Pl. xliv., fig. 2). Three-quarters natural size.

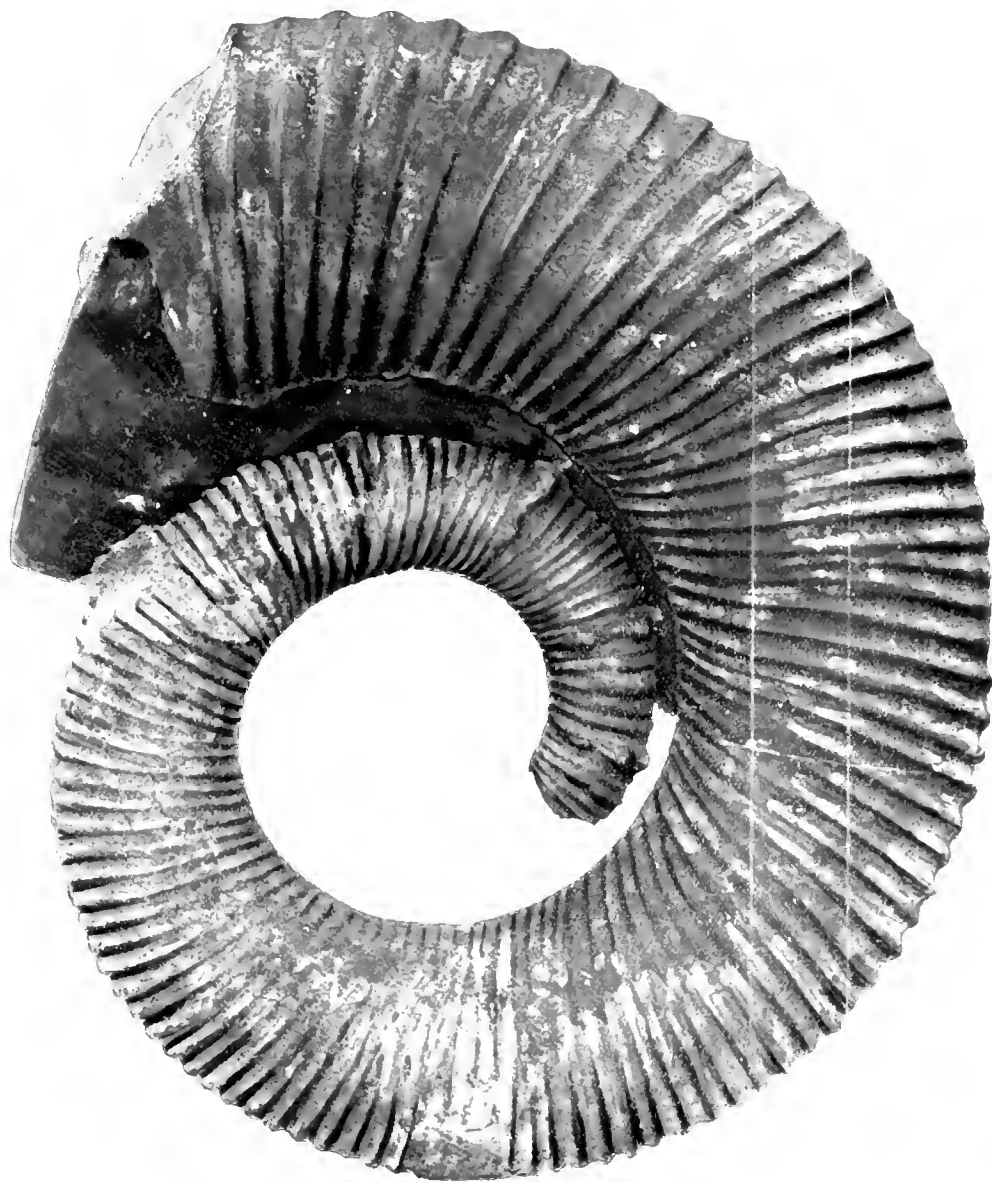







EXPLANATION OF PLATE XXXVII.

---

*CRIOCERAS JACKII, Eth. fil.*

- Fig. 1. Lateral view of the earlier whorls, partly testiferous, displaying the semi open coil and swollen tuberculate costae; the costae in general are gently sigmoidal and at rare intervals bifurcate; the secondary costae are also more numerous than usual, and, like the primary, increase in thickness towards the venter. The three rows of tubercles are also well shown, the abdominal and supra-dorsal rows in this instance continuing as far as one another.
- ,, 2. Similar view of another specimen, partly testiferous, and possibly somewhat older than that represented in Fig. 1, with rugged and large tubercles; here there is usually the normal number of secondary costae.



1

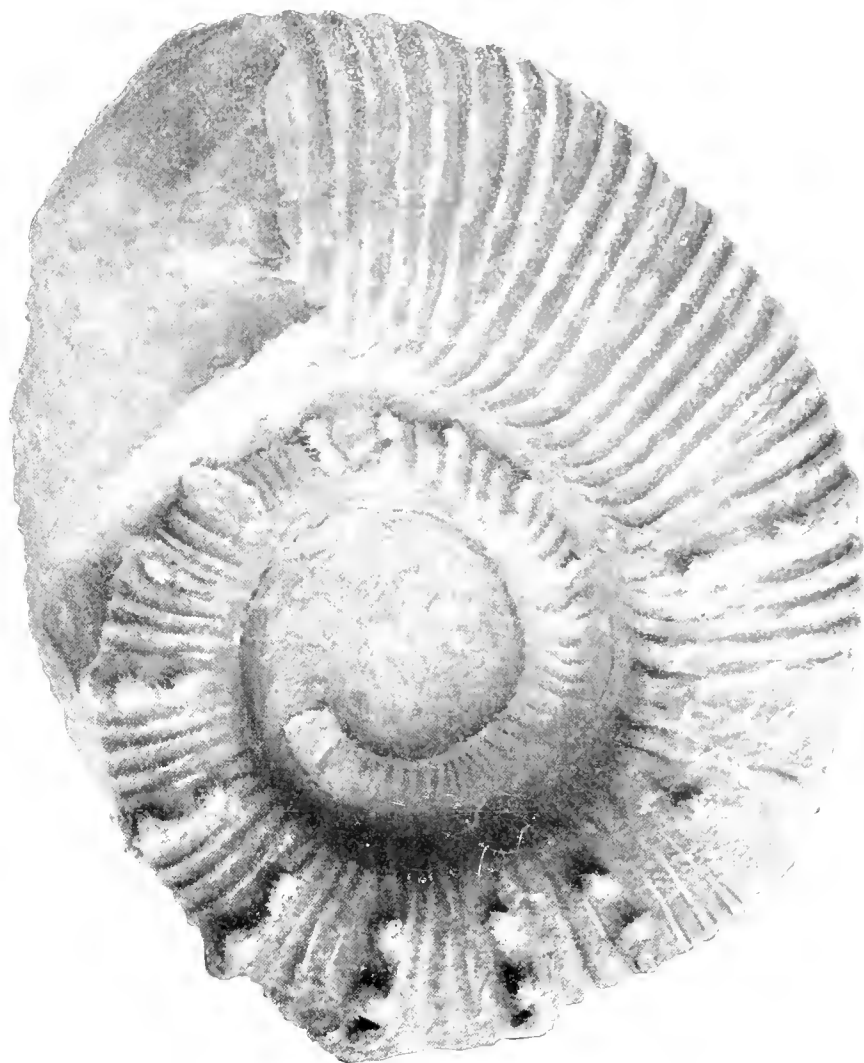

2





EXPLANATION OF PLATE XXXVIII.

---

CRIOCERAS, *sp.*

- Fig. 1. Lateral portion of a whorl with direct, or very faintly sigmoidal, sharp costæ, each bearing a simple pimple-like node.  
,, 2. Ventral view of Fig. 1; the costæ are very slightly bent forwards.

CRIOCERAS JACKII, *Eth. n.*

- ,, 3. Lateral view of the older whorls with obtuse thick costæ, but those tubercle-bearing more swollen than the others. Careful inspection of the innermost revolution will reveal the three rows of tubercles, the dorsal first dying out, then the lateral (supra-dorsal), and finally the abdominal row at about the twelfth costa before the distal fractured end.  
,, 4. Lateral view of a shell rather larger than that represented in Fig. 3, with very regular thick costæ, here and there slightly sigmoidal. No tubercles visible.  
,, 5. Ventral view of Fig. 4.

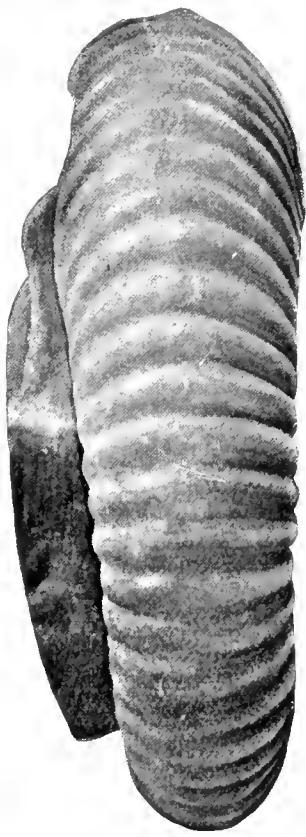

5



1



3



2



4







EXPLANATION OF PLATE XXXIX.

---

CROCERAS FLINDERSI, *McCoy, sp.*

- Fig. 1. Lateral view of part of a large whorl (McCoy's type) with a portion of the convex venter defined from the flank by the longitudinally elongated tubercles; the costæ are curved. Three-quarters natural size.
- „ 2. Lateral view of a natural cast, with sigmoidal costæ, and similar tubercles to those seen in Fig. 1.
- „ 3. Ventral view of Fig. 2. In nearly every instance the costæ crossing the venter are double.

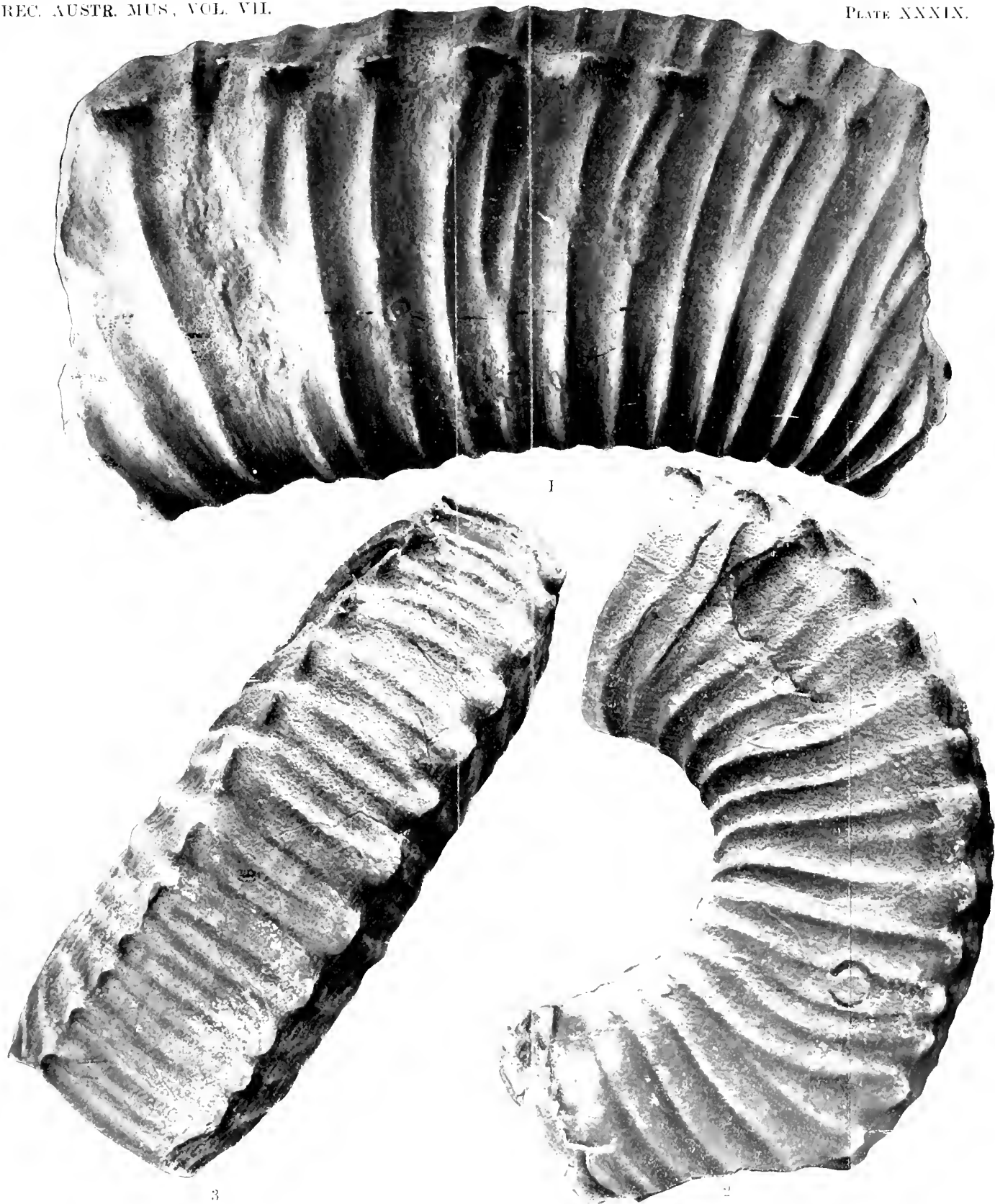





## EXPLANATION OF PLATE XL.

---

### *CRIOCERAS FLINDERSI, McCoy, sp.*

- Fig. 1. Lateral view of a partly testiferous coil and a portion of the shaft or limb, with both simple, bifurcate and fasciculate sigmoidal costae.
- „ 2. Ventral view of the limb portion of Fig. 1. The costae crossing the venter are either single or double between the tubercles marking the positions of the abdominal angles.
- „ 3. Lateral view of portion of a natural whorl cast in which the fasciculation of the costae is excellently shown.
- „ 4. Ventral view of Fig. 3. Here the costae crossing the venter are, some single and others treble between the tubercles, which have assumed a more node like outline than in other similar specimens.
- „ 5. Lateral view of a natural limb or shaft cast with fasciculate and bifurcate curved costae and the characteristic longitudinally elongated tubercles.
- „ 6. Ventral view of Fig. 5. The venter is narrower than usual, with three and even four costae crossing it between the two rows of tubercles.

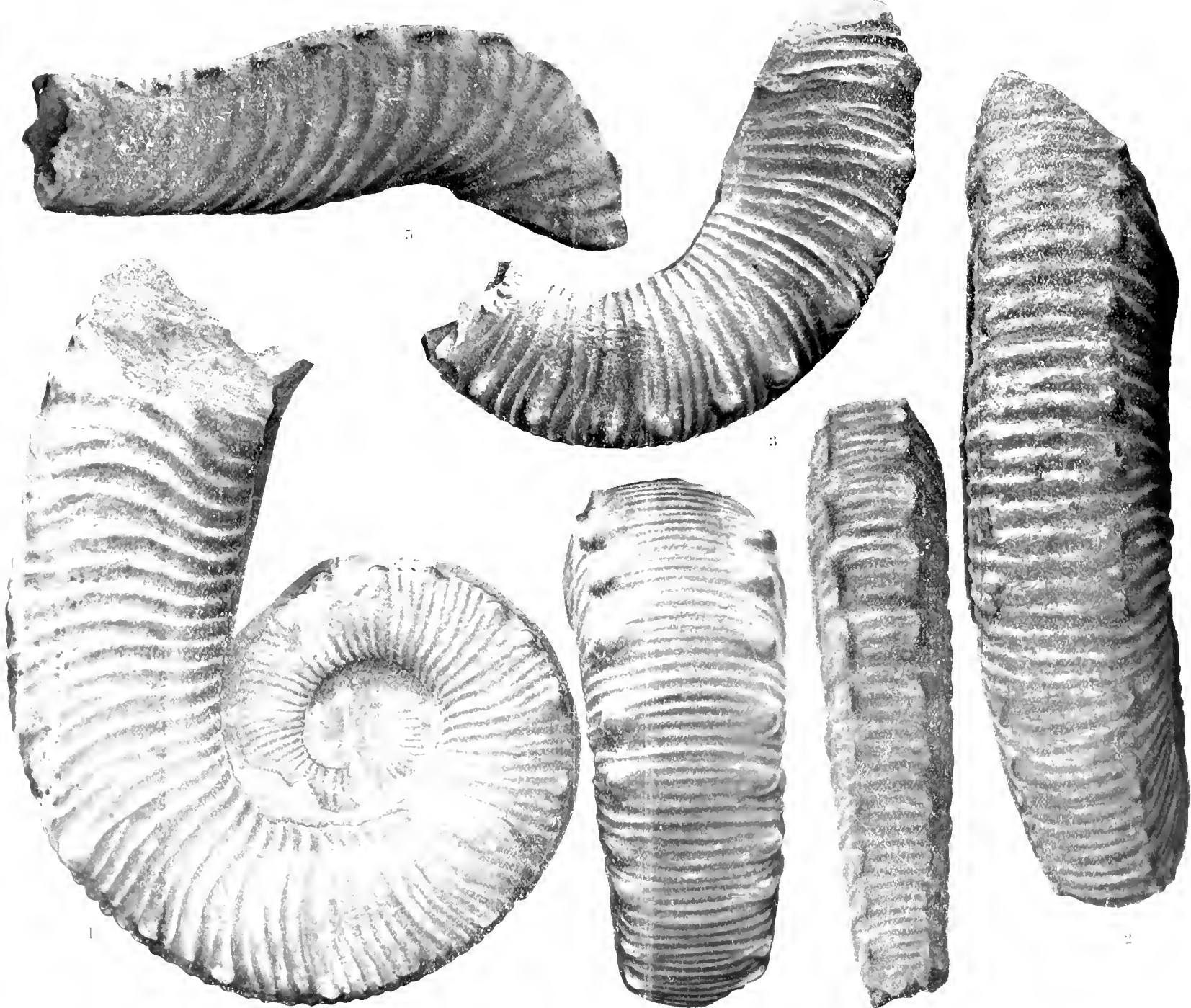







## EXPLANATION OF PLATE XLI.

---

### CRIOCEBAS FLINDERI, *McCoy, sp.*

- Fig 1. Lateral view of the proximal portion of a large natural cast with rather sigmoidal costae in places slightly fasciculate, the component ribs of the fasciuli united by the usual longitudinally elongated tubercles.
- „ 2. Lateral view of portion of a large whorl, partly testiferous, in which the characters referred to under Fig. 1 are more forcibly emphasised.
- „ 3. Lateral view of portion of a shaft or limb with the remains of the nacreous layer, provisionally referred to this species, in which the tubercles have become rounder and more node-like.

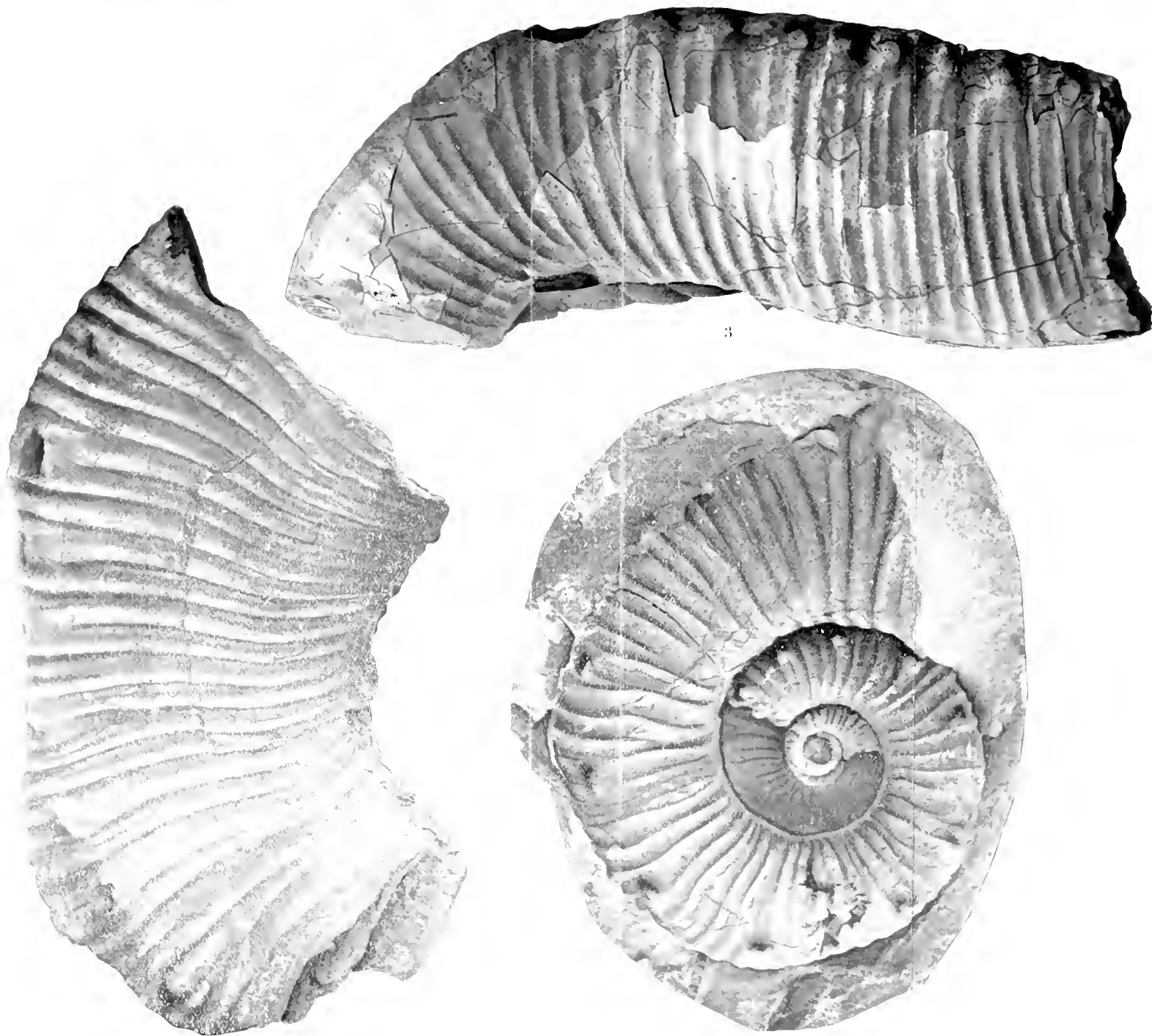

3

2

1





EXPLANATION OF PLATE XLII.

---

*CROCERAS, sp.*

- Fig. 1. Lateral view of a crozier and part of a limb or shaft possibly identical with the specimens represented in Plate xxxv., fig. 2, and Pl. xlvi., fig. 2, and Pl. xlvii., fig. 5. In this instance the tubercles are confined to the abdominal angles, and are not developed on the flanks. Slightly more than half natural size.

*CROCERAS FLINDERSI, McCoy, sp. (?)*

- .. 2. Dorsal view of the limb or shaft cast represented in Plates xxxvi., fig. 2, and xlv., fig. 2, exhibiting a flat dorsum, and strong, single, slightly curved costae. Seven-eighths the natural size.



1



2







EXPLANATION OF PLATE XLIII.

---

CRICERAS FLINDERSI, *McCoy, sp.*

Lateral view of a natural cast of a crozier arch exhibiting the typical costae and tubercles of the species. Slightly less than natural size.

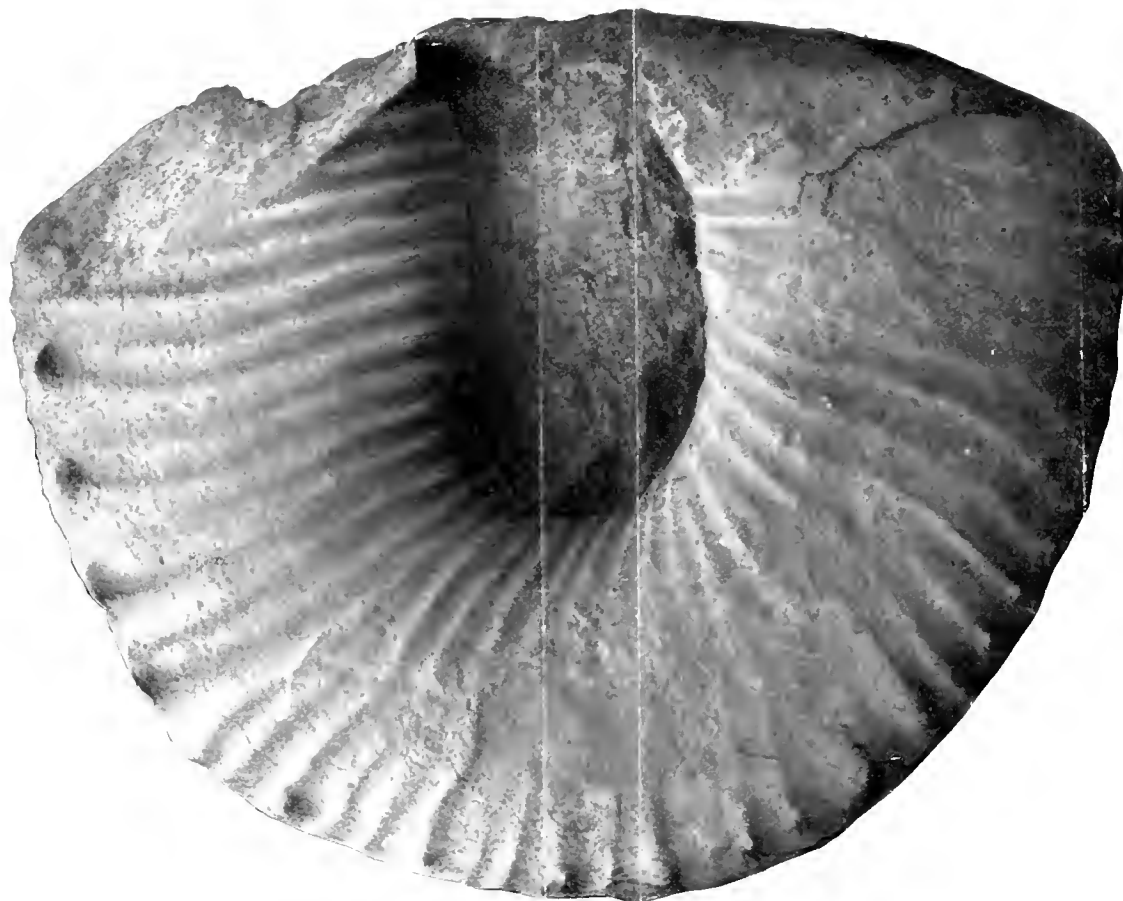





## EXPLANATION OF PLATE XLIV.

---

### CRIOCERAS AXONOIDES, *Eth. fil.*

- Fig. 1. Lateral view of a portion of a fine, partly testaceous, disk-like shell. The costæ are all single, sharp, slightly sigmoidal, and moderately close; at the proximal end large and prominent tubercles gather the costæ into fasciculi, but from the point at which the latter cease the costæ each bear a single tubercle along the abdominal angles. A similar fasciculation is seen in *C. nauti-  
loides* (Plate xlv., fig. 1), but the remainder of the costæ are non-tuberculate, and the sections of the two forms are very different. Slightly more than half the natural size.

### CRIOCERAS FLINDERSI, *McCoy, sp.*

- .. 2. Ventral view of the limb or shaft portion seen in Plate xxxvi., fig. 2, and Pl. xlii., fig. 1, with a broad, almost flat venter, strong abdominal tubercles, and the costæ on crossing the venter occasionally single, but usually paired. Slightly more than half natural size.

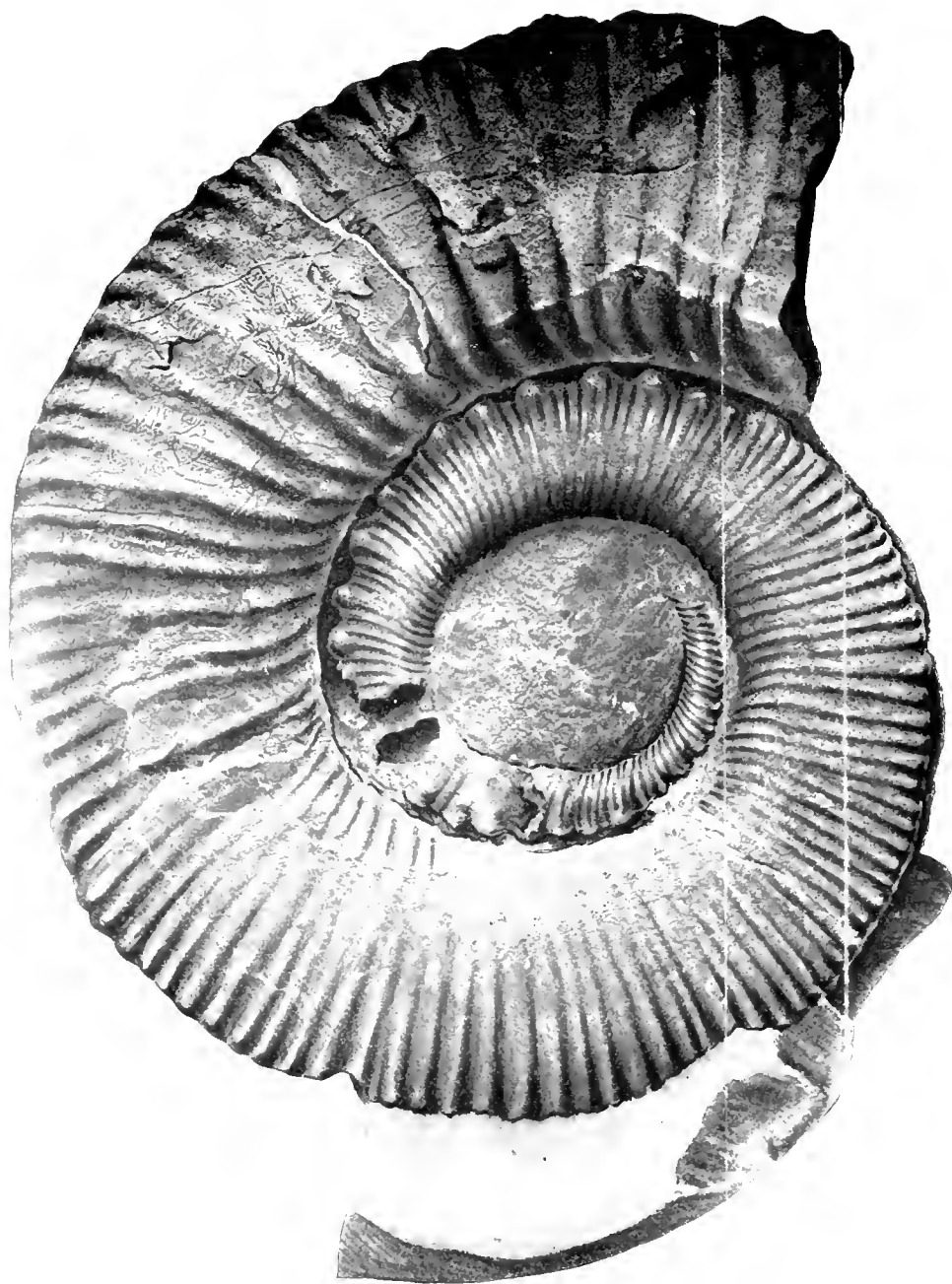

1

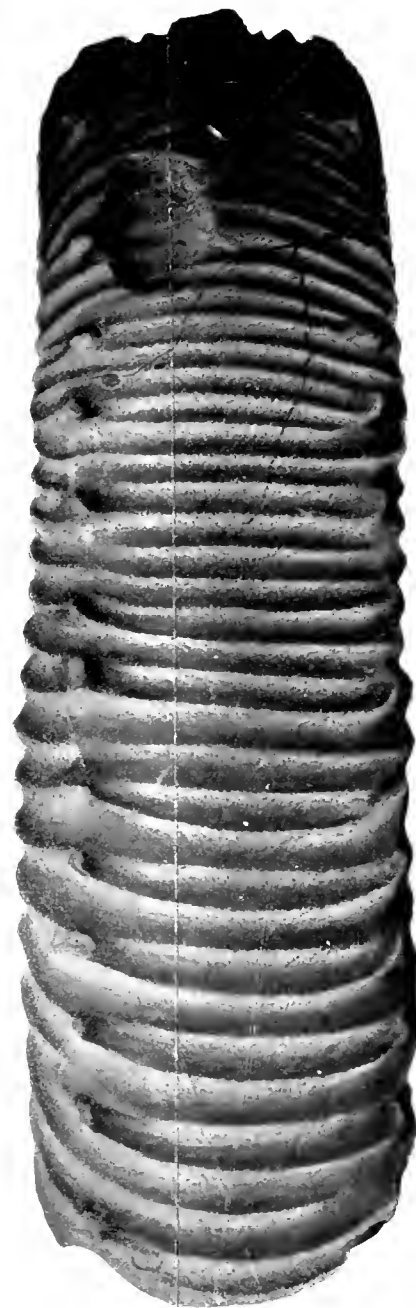

2







## EXPLANATION OF PLATE XLV.

---

### CRIOCERAS NAUTILOIDES, *Eth. fil.*

- Fig. 1. Lateral view of a natural cast with overhanging whorls, and very convex flanks. On the inner half whorl the costæ are fasciculate in bundles of two or three, and the uniting tubercles large and blunt; the remainder of the costæ are devoid of tubercles. Slightly less than half natural size.
- „ 2. Ventro-dorsal view of Fig. 1, displaying the broad rounded venter, nontuberculate costæ, overhanging whorls, and the very broad-oval section. Slightly less than half natural size.

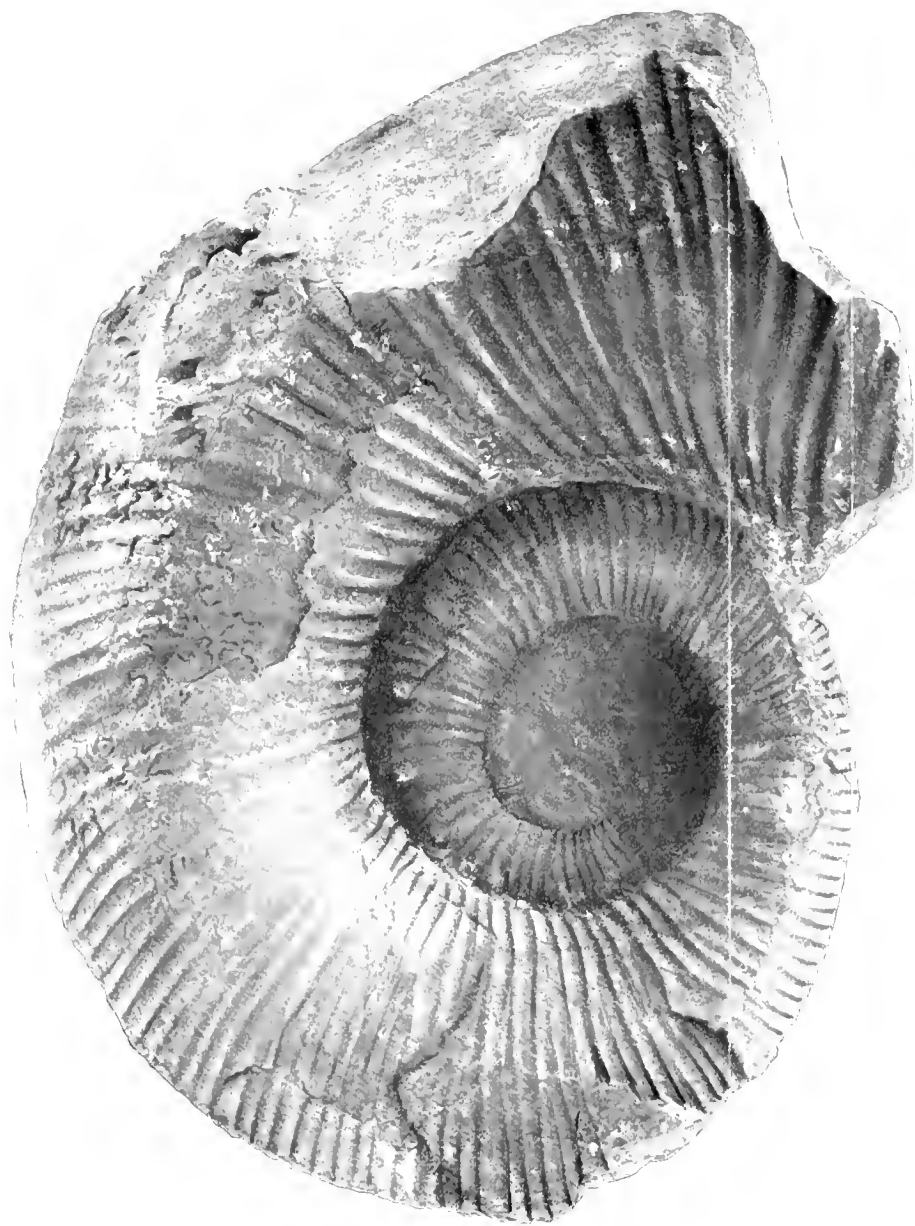

1



2





## EXPLANATION OF PLATE XLVI.

---

### CRIOCERAS PLECTOIDES, *Eth. fl.*

- Fig. 1. Lateral view of a partially testiferous example, with a row of obtuse, node-like tubercles along the abdominal angle at variable distances apart—from three to ten intermediate and nontuberculate costæ (see Plate xlvii., figs. 1-4); sutures are visible.

### CRIOCERAS, *sp.*

- ,, 2. Lateral view of a partly testiferous shaft or limb, the proximal end not concealed, but simply hooked as in D'Orbigny's *Hamites*. The primary costæ only bear tubercles in two rows, one abdominal, the other lateral (see Plate xxxv., fig. 2; Pl. xlii., fig. 1; Pl. xlvii., fig. 5, which may be identical). Seven-ninths the natural size.

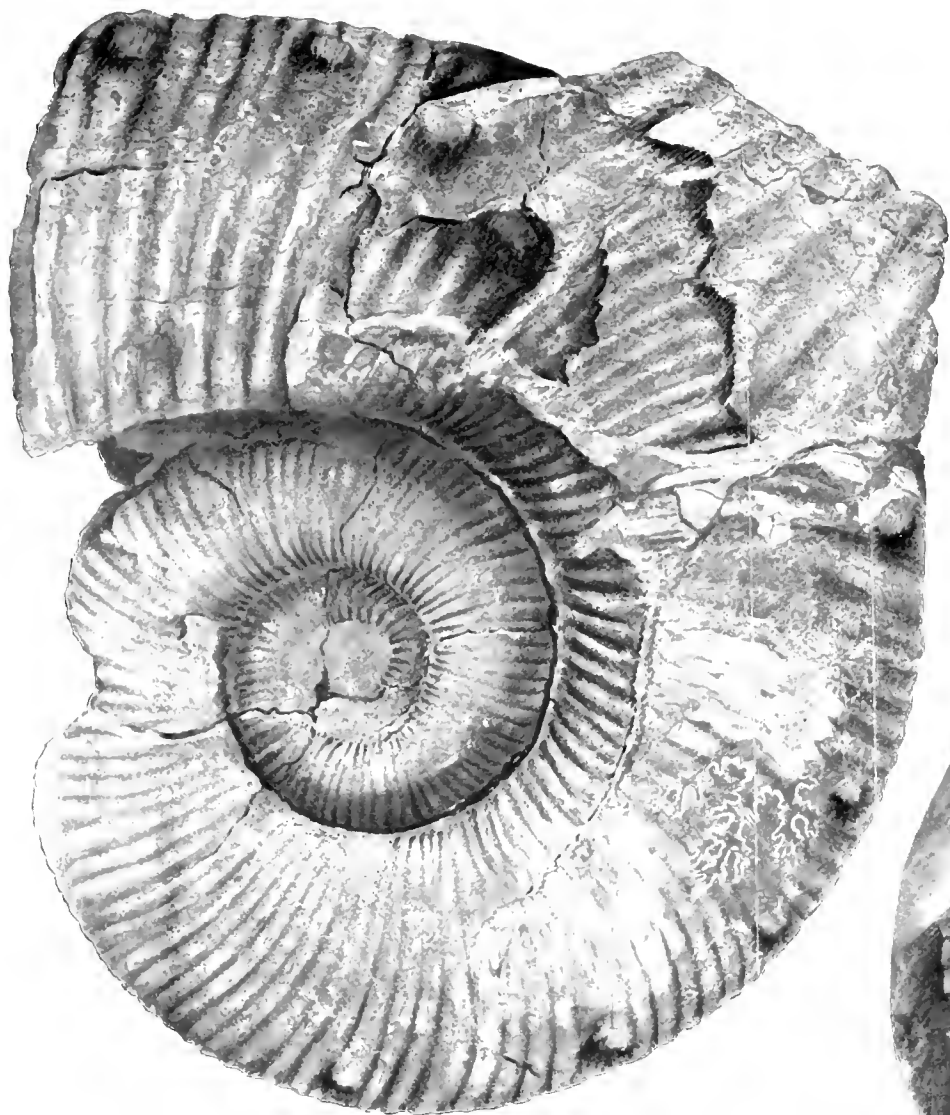

1



2







EXPLANATION OF PLATE XLVII.

---

CRIOCERAS PLECTOIDES, *Eth. fil.*

- Fig. 1. Lateral view of a neat and well preserved partially testiferous specimen illustrating the principal characters of the species.
- „ 2. Ventral view of Fig. 1, exhibiting the wide and rounded venter.
- „ 3. Ventro-dorsal view of Figs. 1 and 2, displaying the broad rounded venter, overhanging whorls, and nearly round section.
- „ 4. Lateral view of portion of a natural cast whorl corresponding in size to the subject of Plate xlvi., fig. 1; an almost complete suture is here visible.

CRIOCERAS, *sp.*

- „ 5. Lateral view of the specimen represented in Plate xxxv., fig. 2, exhibiting the dorso-lateral line of tubercles (see Plate xxxv., fig. 2; Pl. xlii., fig. 1; and Pl. xlvi., fig. 2). Seven-twelfths the natural size.

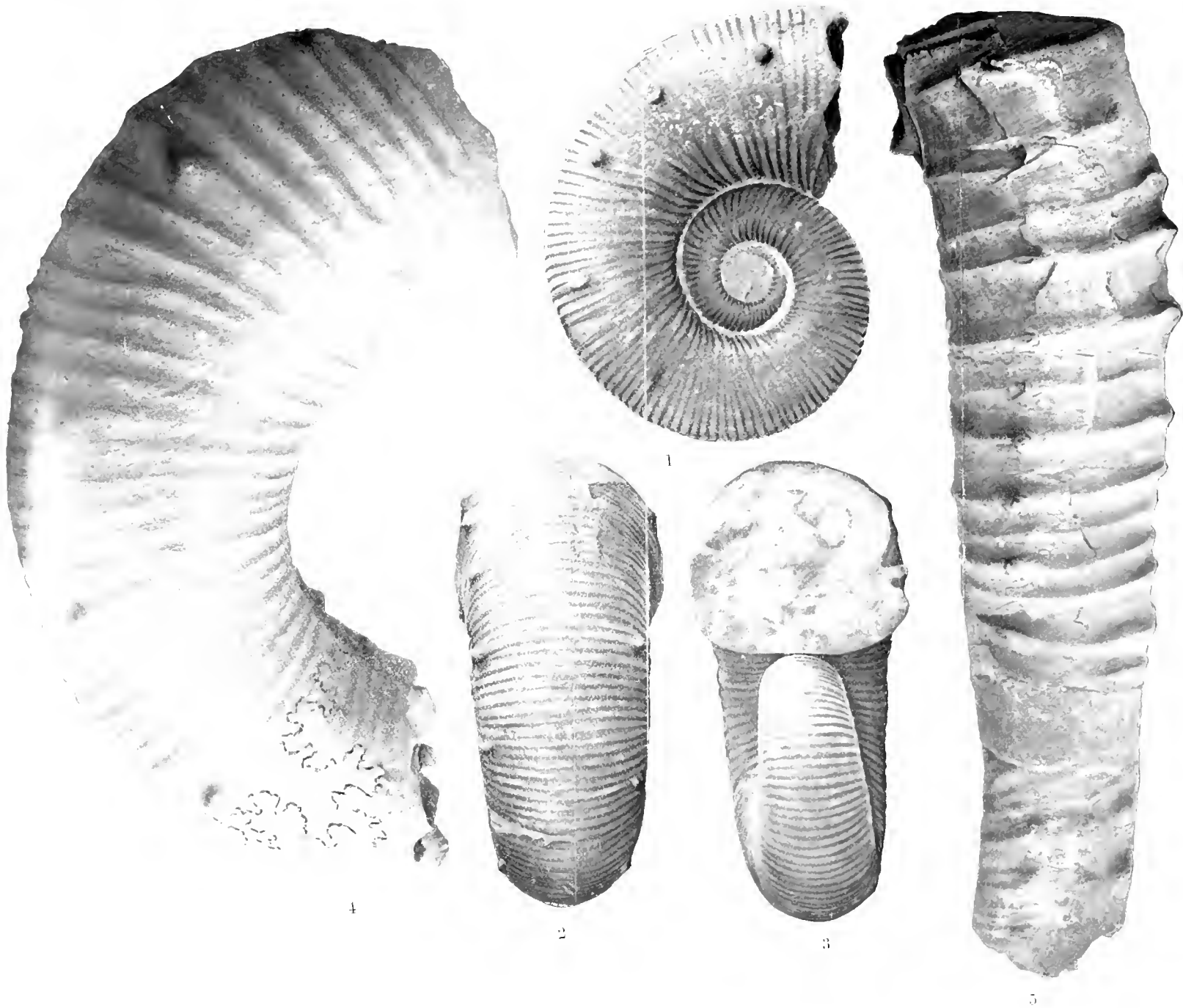





## EXPLANATION OF PLATE XLVIII.

---

### CRIOCERAS LAMPROS, *Eth. fil.*

- Fig. 1. Lateral view of an imperfect but fine shell, partly testiferous, measuring two feet across the longest diameter. The strong cristi-form, distant coste with three tubercles on each are very noticeable: the latter are abdominal, infra-abdominal (or lateral) and supra-dorsal in position. At the proximal end the test has been entirely removed, revealing the sutures.
- .. 2. Ventral view of Fig. 1, exhibiting a broad, generally convex venter.



1



2







## EXPLANATION OF PLATE XLIX.

### CRIOCERAS AMMONOIDES, *Eth. fil.*

- Fig. 1. Lateral view of a fairly well preserved specimen exhibiting slightly sigmoidal costæ, usually single, but at times united into bundles of two by pimple-like tubereles; the latter may also occur on single costæ.
- „ 2. Ventral view of Fig. 1, showing the narrow depressed-convex venter and abdominal tubereles.

### CRIOCERAS TAYLORI, *Eth. fil.*

- „ 3. Lateral view of the proximal end of a nontestiferous specimen with regular obtuse costæ.
- „ 4. Lateral view of the distal end of another similar specimen exhibiting the curvature of the crozier, and nontubereulate nature of the species.
- „ 5. Lateral view of another distal end with coarser costæ.
- „ 6. Ventral view of Fig. 5.

### CRIOCERAS LAQUEUS, *Eth. fil.*

- „ 7. Lateral view of portion of a partly testiferous crozier (?) displaying the sharp costæ arranged in bundles of two or three, the fasciculi united by a row of prominent tubereles supra-dorsal in position. Slightly above natural size.
- „ 8. A similar specimen to Fig. 7 with coarse costæ and larger and more acute tubereles. Slightly above natural size.
- „ 9. A third and somewhat similar specimen with marked fasciculation of the costæ; the supra-dorsal row of tubereles is very distinct, and at the upper end of the figure is a tuberele of the abdominal series.

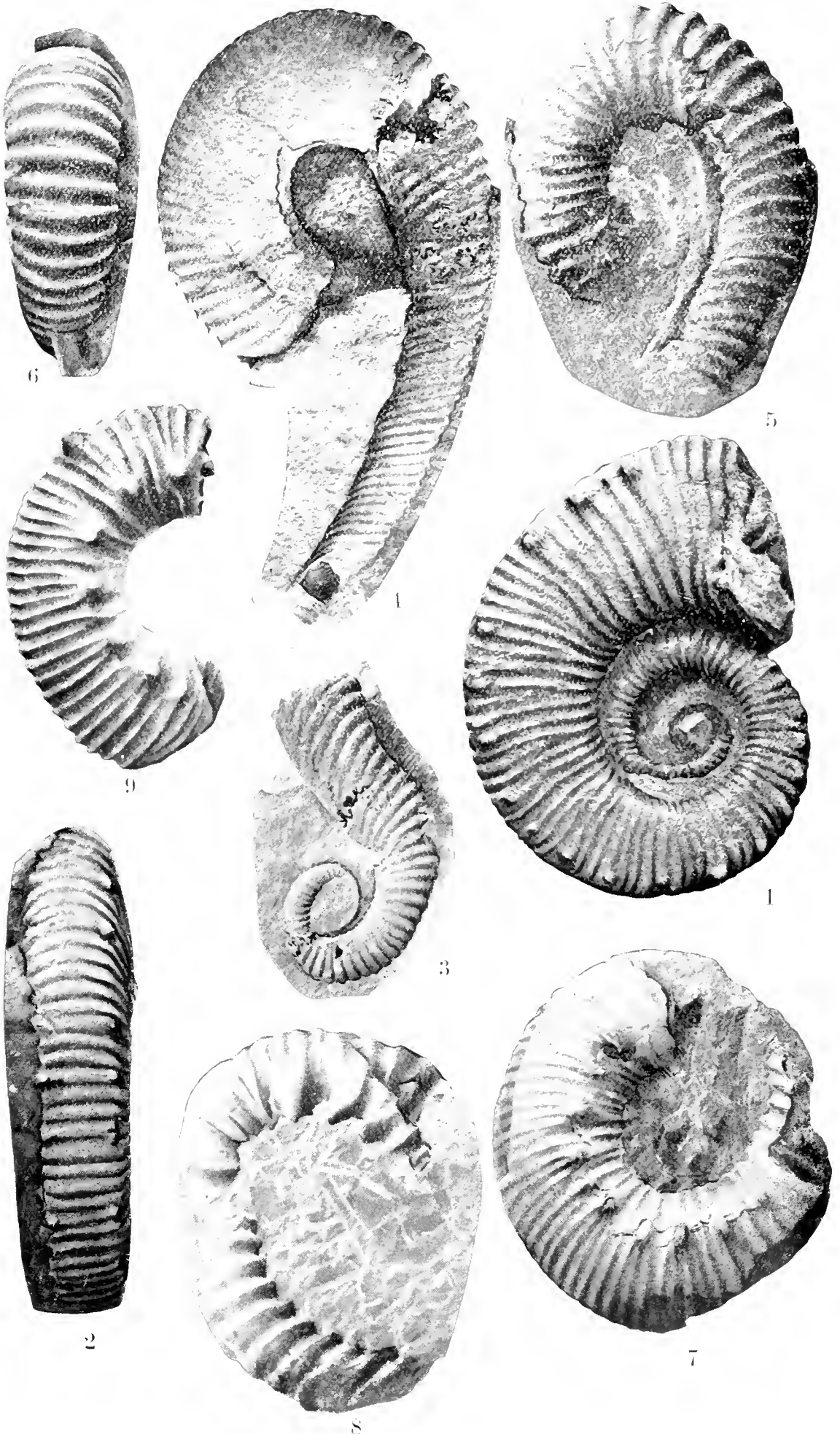





EXPLANATION OF PLATE L.



One of the masked figures, Amboipo, met with in the initiation ceremony at Margaret Bay.









EXPLANATION OF PLATE LI.

---

The masked figure Amboipo, in the Giant Kingfisher Dance at Margaret Bay.







EXPLANATION OF PLATE LII.

---

- Fig. 1. Form of decoration of one of the performers at the bo-ata in the first series of initiation rites of the Koko yimdir Blacks in the hinterland of Princess Charlotte Bay.
- Fig. 2. Beeswax model of the dornorn or "poison stone-fish" (*Synan-  
cydium horridum*, Linn.) used in the dance of that name amongst the Koko-yimdir Blacks at the McIvor River.



1

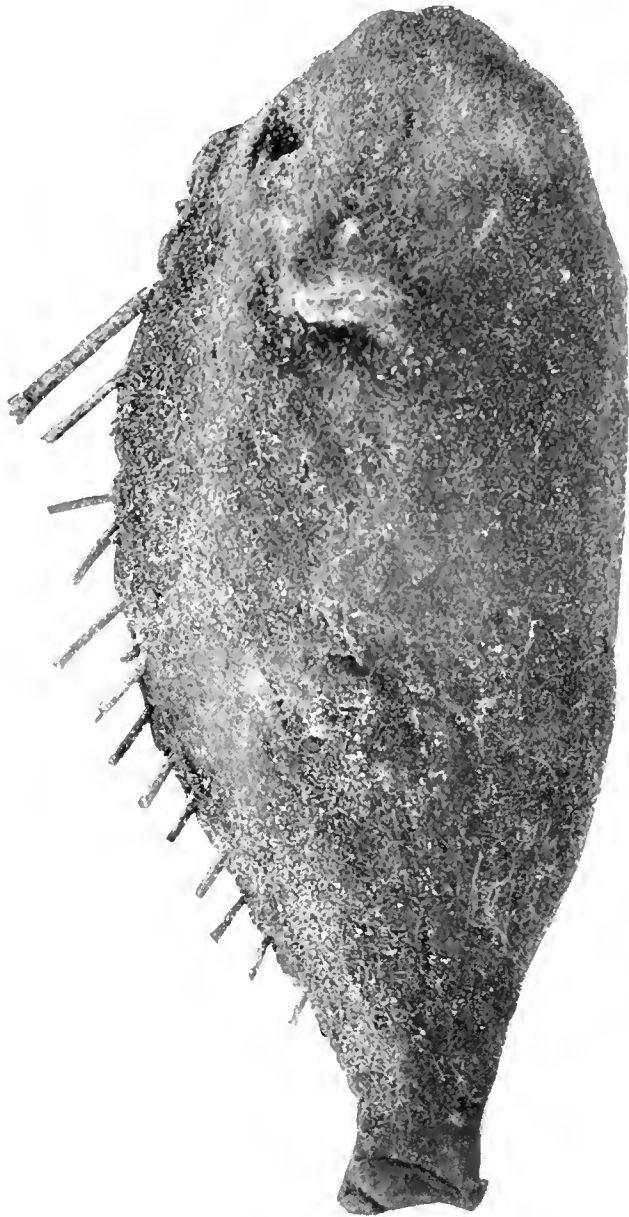

2

1. Dr. W. E. ROTH, photo.  
2. H. BARNES, Junr., photo,  
Austr. Mus.







#### EXPLANATION OF PLATE LIII.

---

- Fig. 1. The screen separating the broad from the narrow paths of the rau-râr in the alkir or fifth initiation ceremony of the Kokowarra Blacks, at Princess Charlotte Bay.
- Fig. 2. The two Amboida, the two main performers of the alkar or fifth initiation ceremony of the Kokowarra Blacks at Princess Charlotte Bay, kneeling with faces uncovered.
- Fig. 3. The same standing with the faces covered.
- Fig. 4. The "orchestra," behind the screen seen in fig. 1, with the three crows or "dressers" standing on the left hand.

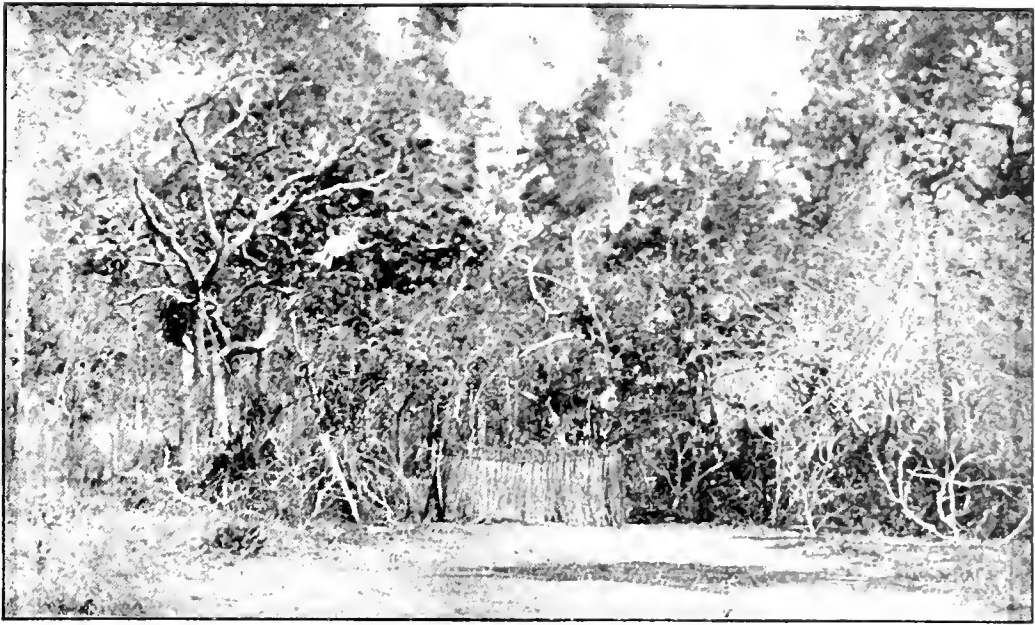

1



2



3

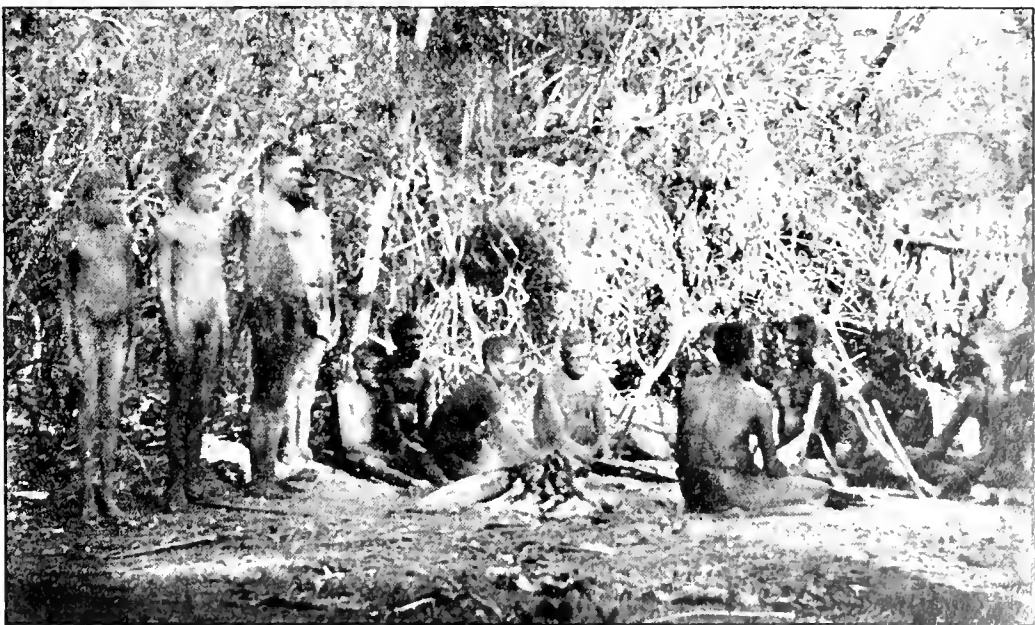





EXPLANATION OF PLATE LIV.

---

- Fig. 1. Dance of the Body-louse of the Koko-yimidir Blacks at the McIvor River.
- Fig. 2. Each day's opening scene of the Koko-yimidir initiation ceremonies with the performers standing around the bo-nal, or circular space of the initiation ground, and the initiates in the piri, or central rut.

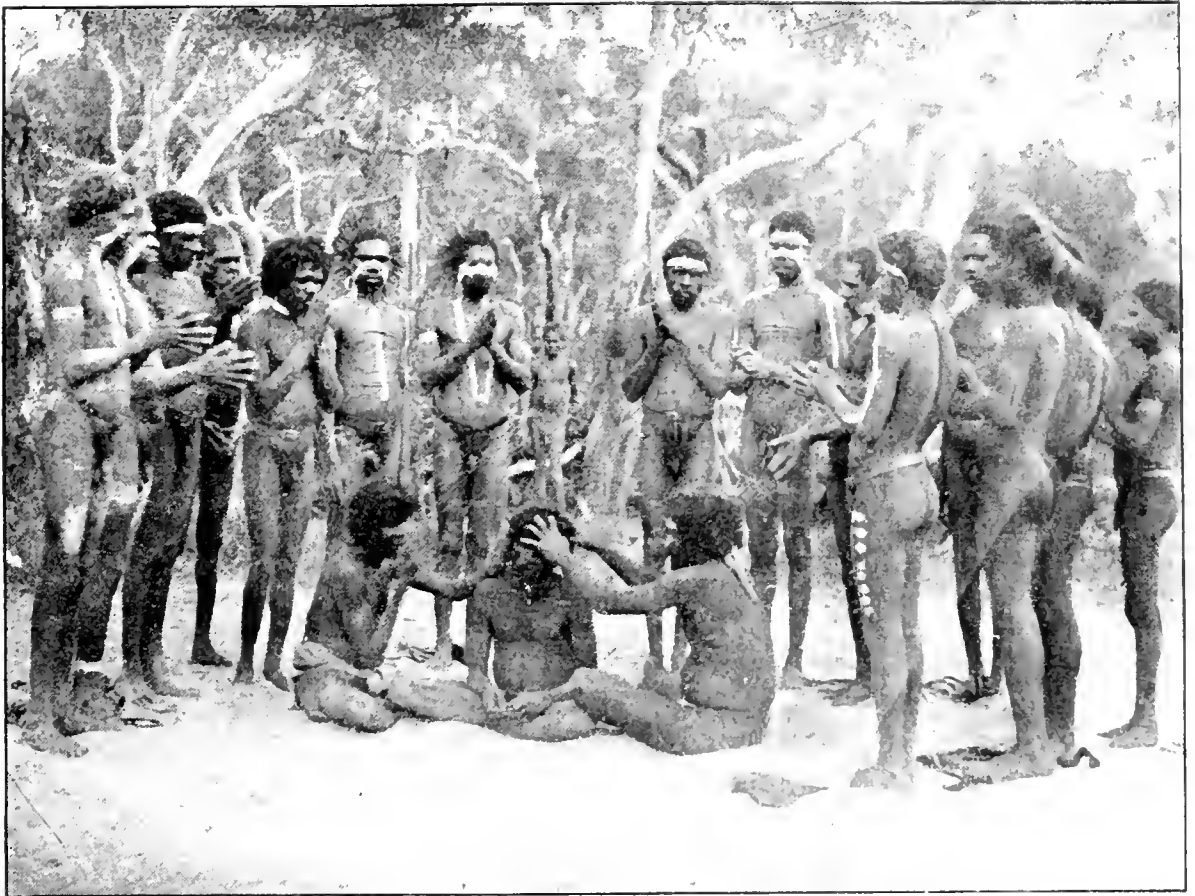

1

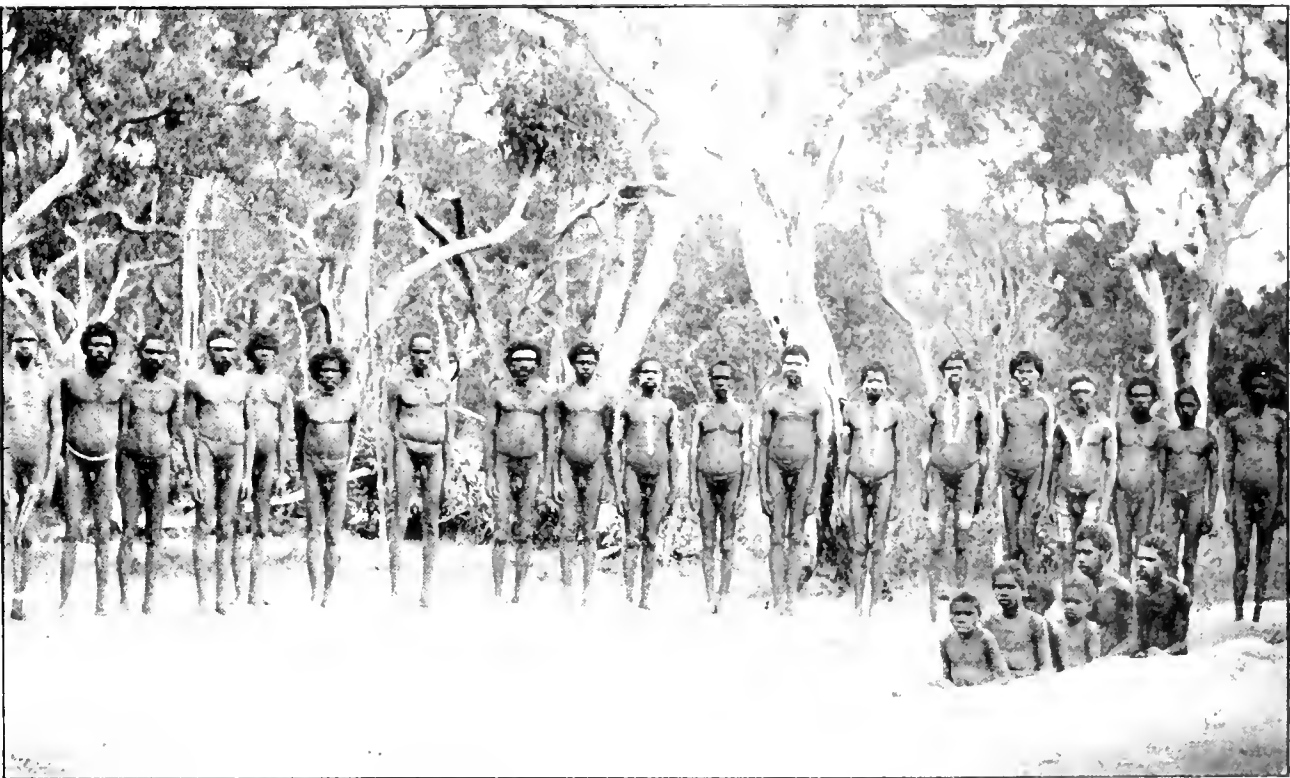

2







EXPLANATION OF PLATE LV.

---

Dance of the Black Palm of the Koko-yimidar Blacks at the Melvor River.

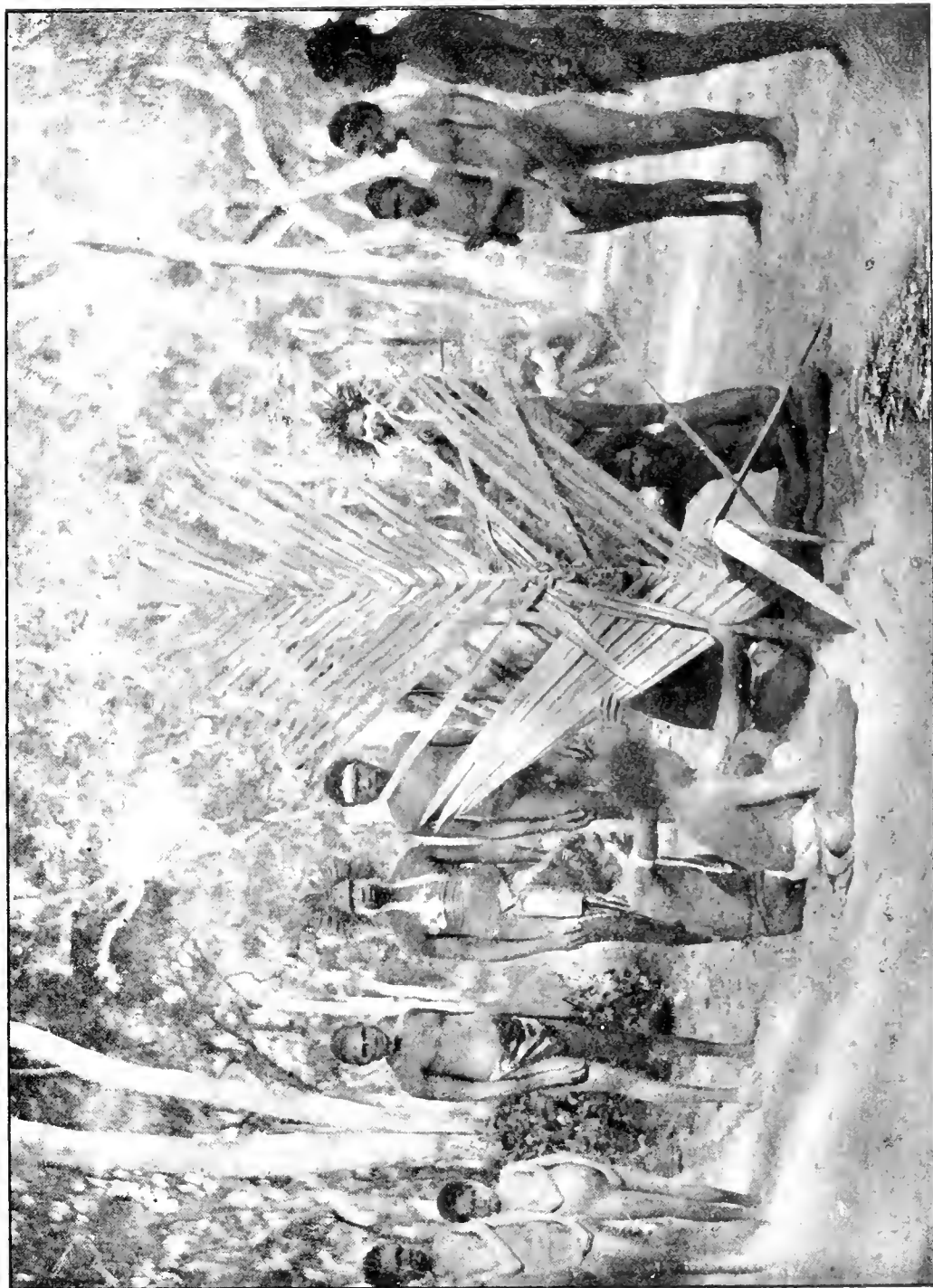





EXPLANATION OF PLATE LVI.

---

Dance of the Fresh-water Mussel of the Koko-yimidir Blacks at the McIvor  
River.

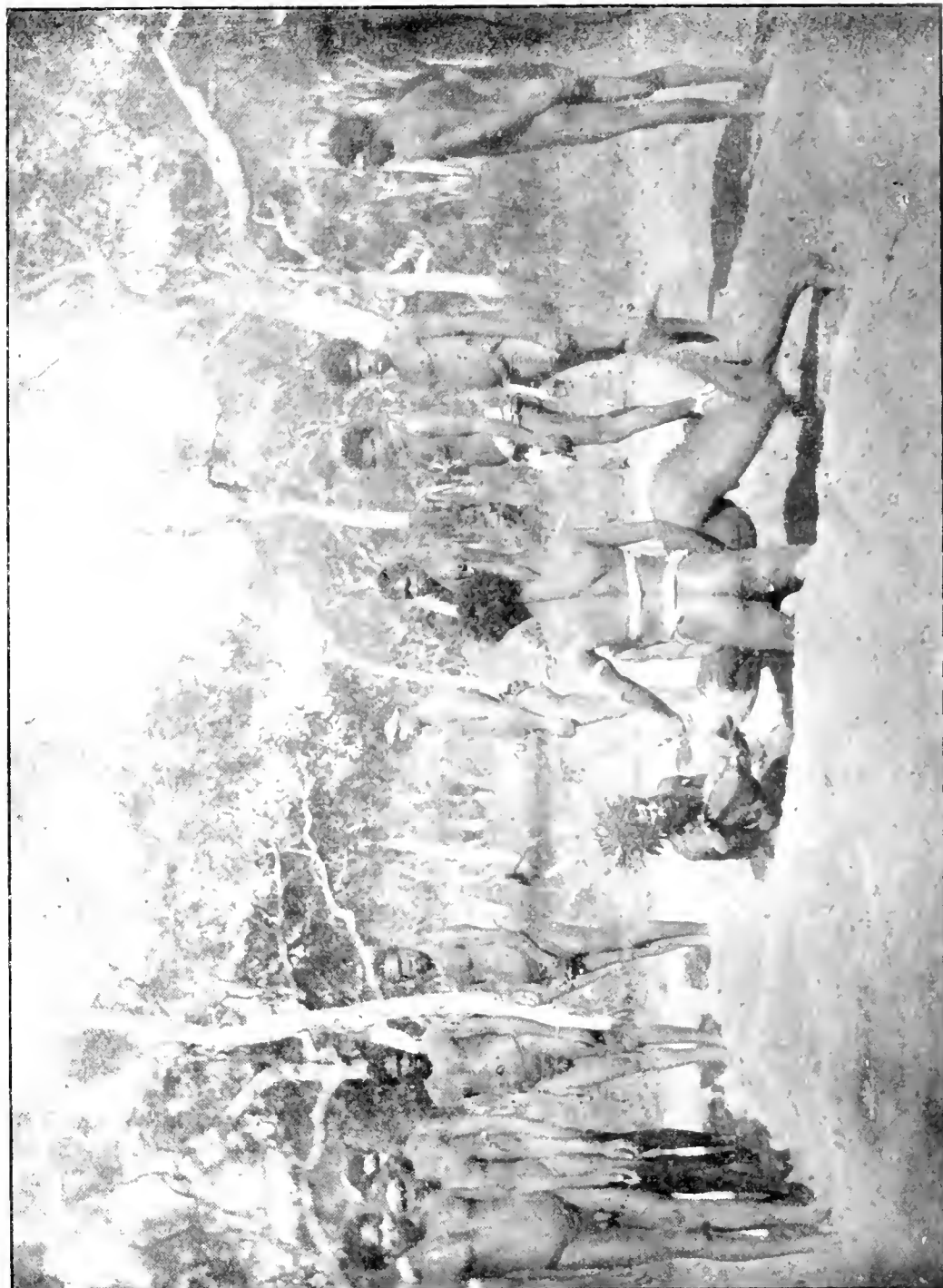







EXPLANATION OF PLATE LVII.

---

Nest of Masked Bush-warbler (*Gerygone personata*, Gould) built in close proximity to a wasp's nest.



A. R. McCULLOCH, photo:  
Austr. Mus.



# NORTH QUEENSLAND ETHNOGRAPHY.

BULLETIN No. 13.

## FIGHTING WEAPONS.<sup>1</sup>

By WALTER E. ROTH, Magistrate of the Pomeroon District, British Guiana ; late Chief Protector of Aborigines, Queensland ; Corresponding Member of the Anthropological Societies of Berlin and Florence, the Anthropological Institute, London, etc.

(Plates lviii.-lxi.; Fig. 12.)

### CONTENTS.

Sect.	1. Spears :—		190
	2. North-West and Lower Gulf Districts		190
	3. Pennefather River Districts		191
	4. Princess Charlotte Bay, Cape Bedford, Bloomfield River, and Palmer River		192
	5. Lower Tully River District		194
	6. Rockhampton District		195
	7. Brisbane		196
	8. Spear-throwers (Wommeras) :—		197
	9. Pennefather River District		197
	10. Palmer and Laura Rivers		198
	11. Cape Bedford, Endeavour and Bloomfield Rivers		199
	12. Princess Charlotte Bay		200
	13. Lower Tully River		200
	14. North-West Districts		200
	15. Boomerangs :—		201
	16. Lower Tully River		201
	17. Mackay District		202
	18. Rockhampton District		202
	19. Brisbane		203
	20. North-West and Lower Gulf Districts		203
	21. Shields—Peninsula and North-West Districts :—		203
	22. Tully River and Cardwell Districts		204
	23. Bloomfield and Endeavour Rivers		205
	24. Rockhampton District		205
	25. Brisbane		206
	26. Throwing-sticks (Nulla Nullas)—North-West Districts :—		207
	27. Tully River		207
	28. Rockhampton District		207
	29. Brisbane		209
	30. Fighting-Poles		209
	31. Two-handed Swords		209
	32. Single-handed Swords		210
	33. Manner of Fighting—Inter-tribal		210
	34. „ „ Individual		211

<sup>1</sup> Dr. Roth, when transmitting his MS., requested that the details of a few implements in his collection left undescribed, might be added ; these are now incorporated and distinguished by being placed within brackets. — (Ed.)

1. Spears:—As to how much labour is entailed in the manufacture of a spear depends largely upon the nature of the timber employed according as to whether this is a bamboo or a thin sapling, or whether the implement is cut out of a tree *en bloc*, as happens sometimes in the Boulia and Rockhampton Districts, or split out of the solid. The different methods adopted in getting it into shape, *e.g.*, bending, straightening, etc., as well as the tools, etc., required for the purpose, have already been described<sup>2</sup>. I propose including certain mention of the spears used in hunting and fishing, which although not fighting weapons, find a more or less natural place here.

2. Most of the weapons used in the North-Western Districts have been fully detailed<sup>3</sup>, and hence require little additional description. Mr. E. Palmer, however, records three additional timbers used for spears in these areas:—*Phragmites communis*, Trin., stems used for reed-spears on the Mitchell River; *Sesbania aegyptiaca*, Persoon, stems for the ends of reed-spears at Cloncurry; *Thryptomene oligandra*, F.v.M., for the points of reed-spears only, on the Mitchell and Gilbert Rivers. Spears that have since been met with are the stone-spears<sup>4</sup> of Burketown, Point Parker, and the ranges along the Queensland Northern Territory Border, and the multiple-prong fish-spears of the Wellesley Islands. The lancet flake of the former is fixed into the split extremity of the shaft after the manner of a wedge<sup>5</sup>, and then bound round with twine, and finally strengthened with cement. The prongs of the fish-spears, spliced and fixed only with twine on to the proximal portion, have their barbs one behind the other, cut out *en bloc* (Fig. 12).

[The spear selected for description has the shaft scarfed, and is tri-pronged. Both portions of the former consist of stick-saplings fied down. The following are the measurements:—

			ft.	in.
Length over all	...	...	11	2
„ of butt	...	...	4	0
„ shaft proper	...	...	5	2
„ prongs	...	...	2	0

The butt is cupped for the reception of a wommera peg at the proximal end, and bound with coarse native twine; at the distal end it is scarfed to fit against a corresponding proximal scarf on

<sup>2</sup> Roth—Bull. 7—Sects. 2, 3, 4.

<sup>3</sup> Roth—Ethnol. Studies, etc., 1897—Sects. 246-251.

<sup>4</sup> Roth—Bull. 7—Plate vi. and Sect. 24.

<sup>5</sup> Roth—Bull. 7—Sect. 31.

the shaft piece, this union being also bound or lashed with similar twine (Pl. lviii., figs. 1 and 2). The head or distal end of the shaft is grooved on three faces to receive the basal ends of the prongs, the whole union for the length of eight inches being again bound round or whipped with native twine. The inserted portion of each prong is five inches, leaving a barbed length of nineteen inches; the blunt barbs are cut-out of the solid, one behind the other, and all facing inwards, but the distance apart on the same prong is not uniform, varying from one to two inches.]

3. On the Pennefather River spears have the generic term of *ché-a* applied to them, and are formed of a proximal (butt) portion morticed into a distal (shaft tip) one<sup>6</sup>, the latter being either simple or multiple. The extreme tip is called *pe-údana*. All these spears are thrown with a spear-thrower or *wommerá*, though they can occasionally be used with the hand alone. The barb, except in the stingaree-tail spears, is of a kangaroo-bone pencil (nowadays oft replaced by thick iron wire) fixed into a longitudinal groove, cut with a tooth-scraper<sup>7</sup>, into the spear tip beyond which it projects; it is bound round and round with twine, the cording finally giving place to a plain looping (Pl. lviii., fig. 3), the whole of which is ultimately covered with cement substance. The colouring of these spears is fairly uniform; starting from the proximal end is a short length of white, a corresponding one of red, and a longer one of black, the latter being "fixed" with a special medium, this latter is either the gum of a *Melaleuca*, or human blood obtained from the arm. The timber employed for the distal portion of all these spears, except (d), is the *Acacia rothii*, Bail. (NGG. lar.), that for the proximal varying, as will be seen in the following short descriptions of the different varieties:—

(a) Short light spears, proximal longer (from two-and-a-half times down) than the distal position, and no barbs. Used only for playing with, and all known by the general term of *pó-íni*. Made of *Hibiscus brachysiphonius*, F.v.M. (NGG. *yí-awara*), *Croton triacros*, F.v.M. (NGG. *bó-atha*), *Macaranga taurinus*, F.v.M. (NGG. *arm-butá*), *Desmodium umbellatum*, DC. (NGG. *owono*), or *Pluchea indica*, Less. (NGG. *onogona*).

(b) Heavier and longer spears, proximal longer than the distal portion, and armed with stingaree-barb fixed on to the tip--a

<sup>6</sup> Roth—Bull. 7—Sect. 43, for method of mortising and for treatment of the butt end.

<sup>7</sup> Roth—Bull. 7—Sect. 30.

few central ones surrounded by others in form of a circle. These spears, used for fighting, have all the general name of larna-pe (the Nggerikudi term for a stingaree-barb) applied to them. Made of "bamboo" (NGG. ro-amada), or *Hibiscus tiliaceus*, Linn. (NGG. kórnbrana)<sup>7</sup>.

(c) Heavier and longer spears, but the proximal portions much shorter (one-fifth or even less) than the distal. Used for hunting kangaroo, fish, etc. Made from timber called ombo, which is bartered from the Embly River, or from *Premna obtusifolia*, R.Br. (NGG. mo-odo), or *Eucalyptus tessularis*, F.v.M. (NGG. winnichanna). These spears pass by the general name of to-ono.

(d) Weight and length similar to (c), but the proximal portion much longer (five times) than the distal, which is multiple (three or four pieces) and barbed, and used for hunting kangaroo, fish, etc. They have the generic name of dá-ro. Proximal portions manufactured from *Hibiscus tiliaceus*, Linn., *Thespesia populnea*, Corr. (NGG. pe-amanggan), or *Tristania suaveolens*, Sm. (NGG. ta-andruno), the distal from the *Carappa moluccensis*, Lam. (NGG. adaimbite).

4. The Princess Charlotte Bay, Cape Bedford, Bloomfield and Middle Palmer River spears may be dealt with collectively, with the Cape Bedford ones, about which very reliable information is known, as the type. Local generic names for spears are KRA. KYI. KYE. KMI. kalka<sup>8</sup>, KWA. alkír. All the following Cape Bedford spears are made of a distal (shaft) morticed into proximal (butt) portion, the one extremity of the barb invariably forming the very tip of the completed spear.

(a) Stingaree-barbed, single (Pl. lviii, fig. 5) or multiple (Pl. lviii, fig. 6) with the barb or barbs pointing forwards, long proximal end of bamboo or reed, and short distal end of *Acacia holocarpa*, Benth. (KYI. o-yur) or *Drymophloeus normanbyi*, F.v.M. (KYI. do-war, the local "black palm.") At Cape Bedford such spears are known as mu-lon, a term probably connected with the Butcher's Hill KYE. word mollun, a stingaree. On the Bloomfield the single-barb variety is known as ta-ehal, but here the weapon is built of a short *Xanthorrhoea* butt, and long black-palm (*Acacia*) or blood-wood shaft. On the Middle Palmer the stingaree barbs are bartered

<sup>7</sup> Two other timbers sometimes employed for making these heavy spears (b) and (c) are *Wedelia biflora*, DC. (NGG. toudronga-nama) and *Cordia subcordata*, Lam. (NGG. lava).

<sup>8</sup> Strange to say, kalka is the generic term for a spear amongst the coastal blacks (Gunanni) between the Mitchell and Staaten Rivers.



into the district from the Musgrave River on the east coast, or from down the Mitchell, etc., on the Gulf coast: they are fixed in multiple, and the weapon called a tikara (KMI.). Other local names for the single-barb variety are KRA. ri-ang-pal, KWA. ri-angapa; for the multiple-barb, KRA. challawang, KWA. gu-laba.

(b) Stingaree-barbed, multiple, with the barbs placed one behind the other (Pl. lviii., fig. 4), pointing backwards; long proximal end of reed, short distal portion of black-palm or hardwood, and known as dekara. On the Bloomfield River, built of similar proportions and materials as the ta-chal just mentioned, and called dikara. At Princess Charlotte Bay, the local names are KRA. to-wara, KWA. de-kir.

(c) Quartz-tipped. Pieces of quartz flake (Pl. lviii., fig. 9), often now replaced by glass, fixed with cement on to opposite sides of the spear-tip, long butt and short shaft, known as ku-yan. Same name on the Bloomfield River. The small white quartz flakes are fixed, at their bases, oppositely, like the teeth of a lady's small hair-comb, they are fixed with gum cement, of which a certain length is attached to the spear-head, with a slot run longitudinally up it by means of a thumb nail, and there secured with heat and careful manipulation of the fingers. Their axes are not at right angles with that of the spear, but project forwards. It would seem that the flakes decrease in size proportionately as they reach the spear-tip. The Middle Palmer Blacks call such a weapon tural, and manufacture the proximal portion from *Gleroderolron iwerne* (KMI. ochi-illa). At Princess Charlotte Bay the proximal is usually made from *Premna dallachyana*, Benth., the distal from *Erythrophloeum laboucheii*, F.v.M.; local names, KRA. to-rii, KWA. war-pa.

(d) Multiple pronged fish-spears (Pl. lviii., fig. 7). Usually four prongs (distal pieces) morticed into the proximal<sup>10</sup>, with a wooden barb on each prong; called yin-ba. On the Bloomfield River these fish-spears, known as yimba, are made of some light wood, preferably *Xanthorrhoea* (grass-tree), and are said to have been imported here originally, although they were certainly manufactured in the district for some time previous to 1885<sup>11</sup>. At Princess Charlotte Bay these weapons are made from grass tree and black-palm (proximal and distal respectively), the latter material being bartered into these parts from the McIvor River: the barbs are

<sup>10</sup> Roth—Bull. 7—Sect. 43.

<sup>11</sup> On the authority of Mr. R. Hislop.

either of hardwood or bone; the blacks throw these spears either at fish *in situ*, or else, as I have often watched them do in a muddy water-hole, aim here and there in the water on the chance of hitting one: local names are KWA. lu-yu, gurpan, KRA. larwa, karanja, KLA. pur-ta. The Middle Palmer River Natives make the proximal portion of bamboo, which is bartered from the Princess Charlotte Bay Blacks, and use bone-barbs; they call this spear ur-ché-ra.

(e) Long grass-tree proximal, and short *Acacia holocarpa*, Benth., distal portion with wooden barb; known as wur-poi. Similar name on the Bloomfield River.

(f) Similar to preceding, but the grass-tree is replaced by reed; called nambar.

(g) Long proximal portion made of reed, the timber used being immaterial, and a short black-palm distal end, the latter giving the particular name to the spear, do-war. Same name and weapon on the Bloomfield River.

(h) Short grass-tree proximal portion, long *Acacia* or *Erythrophloeum* distal end; wooden barb; called mu-rongal.

The Princess Charlotte Bay Natives have a special spear made with a proximal bamboo portion, and a distal *Acacia* one; local names, KRA. andarma, KWA. bar-nga; the bamboo is obtained from the Ham and Kennedy Rivers, and forms a staple barter, *e.g.*, to the Koko-mimi of the Middle Palmer River, etc. Here and there an odd spear or two are met with, not necessarily introduced from anywhere else, which appears to have a local name, yet without sufficient history to allow of its being considered a typically local weapon. Such for instance, is the mon-gil mon-gil of Cape Bedford, a long reed proximal, and a short hardwood distal, the latter armed with wooden barbs placed in pairs alternately on opposite sides. Other examples are the burongámo and o-wórú of the Middle Palmer and Bloomfield Rivers respectively, and from their very nature require no detailed description.

A timber, which so far, I have not had cause to mention, used for making spears on the Middle Palmer River, is the *Acacia lysiphloea*, F.v M. (KMI. urr-te). Another<sup>1 2</sup> is *Corypha australis*, R.Br. (Cabbage-tree Palm), the wood of which is split and made into spear-heads on the Endeavour and Normanby Rivers.

5. On the Lower Tully River are to be met the four following varieties of spear, the three and four-pronged fish-spear being an introduction of but comparatively recent years:—

<sup>1 2</sup> On the authority of Mr. E. Palmer.

(a) The wommera-spear is built of two pieces, the proximal longer than the distal; the former is made of grass-tree (MAL. pi-ran) or *Eupomatia laurina*, R.Br. (MAL. mu-jir), the latter from a split *Archontophoenix alexandra*, Wendl. (MAL. kopangara), *Ptychosperma elegans*, Blume. (MAL. warkai), or from a sapling of *Myrtus exaltata*, Bail. (MAL. yambi). Stingaree-barbs may be attached or not; if present, the spear is called a warra-katcha, and its distal extremity covered with red and white rings, but if not present, this extremity is smeared with a uniform red. It is used for fighting purposes, and for spearing wallabies.

(b) The chukaji is a hand-spear, formed of a single piece of local "hard-wood" (MAL. pindanyo), obtained only from Mount Mackay, either cut out from, or a sapling itself of, the tree. Its proximal end is pointed, but of course not so sharp as the distal. From about five to eight to nine feet in length. It is this spear which is used by the four gins at the Prun ground<sup>13</sup>, and also employed by men for fighting.

(c) The warkai, also thrown without a wommera, is so named from the black-palm (*Ptychosperma elegans*, Blume.), out of which it is split, and is mostly used for spearing eels and other fish.

(d) The wi-valli is another hand-spear also cut out of one piece, seven to eight feet long, heavy, clumsily made, and the only spear having a spatulate tip, the latter being covered with ngobi<sup>14</sup> gum; the butt-end tapers somewhat. Made of local "hard-wood" (*Myrtus exaltata*, Bail.), or another timber known as yalma.

6. In the Rockhampton District, where I made my enquiries in 1897, the spears met with were of the simple (single-piece) acicular type, about seven to eight and a-half feet long, with the butt ending in a sharp abrupt point; any marked shortening than this was due in all probability to the weapon having been broken, and subsequently sharpened up again. The weapon was always thrown with the hand, no spear-throwers being known here, as well as all up the coast-line certainly as far north as Townsville. Its manufacture consists in cutting it out in its entirety from a "wattle"-core, or from an outer strip of "brigalow" or "rose-wood." Sometimes, just previous to a fight, a barb or two, placed oppositely, might be fixed on with twine and cement-substance at some considerable distance from the tip (Pl. lviii., fig. 8). At Glenroy, on the Upper Fitzroy River, I saw a

<sup>13</sup>Roth—Bull. 4—Sec. 15.

*Melicope australasica*, F.v.M. See Bull. 7—Sect. 13.

couple of spears manufactured within the previous two years by local blacks (presumably Karun-burra) similar to the preceding, with a thickish girdle taking the position of the barb (Pl. lviii., fig. 10); but the Rockhampton (Tarumbul) Natives knew nothing of this substitution. Three spears in the possession of Mr. A. Cowie, of Rockhampton, were of interest, not only in that he himself had obtained them from the blacks in the district under consideration some eighteen or twenty years previously, but that the barbs were cut out of the wood *en bloc*. I made careful enquiry from the older natives concerning any information about these weapons, which were all about eight feet six inches long, and learnt that they passed under the name of mi-lo, the term for a barb, peg, etc., but that they had not been made for many-a-long day, the necessary timber, owing to the white settlers, being then obtainable at no less a distance than nine or ten miles from the township. The first is a "rosewood" one obtained in Rockhampton from Westwood aborigines. It has a flattened expanded head twenty inches long and three inches wide, sloping in a graceful curve to a slender point, each side being carved into four barbs (Pl. lviii., fig. 11); from this enlargement, which has been raddled, the diameter of the shaft progressively diminishes to the butt where it abruptly tapers off. The second, from the same locality, with tip similarly flattened, has five barbs, but only on the one edge (Pl. lviii., fig. 12): the shaft is peculiar in that it progressively increases down to the butt. The third example, believed to have come originally from the Marlborough District is of the common acicular type, but bears a barb cut out of the wood itself, the tip of the weapon not being flattened (Pl. lviii., fig. 13).

7. The Brisbane Blacks<sup>15</sup> had three kinds of spears, all of them simple, *i.e.*, of one single piece, and thrown by hand only.

(a) The pi-lar was made from *Eucalyptus crebra*, F.v.M. (local "iron-bark," the tander of the local natives). They would pick out a young straight-grained tree, one that would split well, climb up to ten or eleven feet, cut a transverse notch above deep in, then two vertical ones reaching down from it, a transverse one below according to the length they wanted, and split it off. Then gradually trimmed it down to the size required. They then spoke-shaved it with a *Mytilus* (mainlanders) or *Donax* valve<sup>16</sup> (coastal ones), smoothed it down with a piece of broken shell, which was subsequently replaced by glass, straightening and

<sup>15</sup>Notes from Mr. T. Petrie.

<sup>16</sup>Roth—Bull. 7—Sect. 28.

bending, etc., as required, blacked it all over in the fire and finally hardened the point by the same means. This pi-lar was made from nine to ten feet long, and used for fighting at close quarters. Sometimes old ones were nicked very nearly through, about two inches from the tip, for some fellow they had a special "down" on, so that when stuck in, it would break off and remain behind. At other occasions one or two stingaree barbs might be stuck on with beeswax and twine for a similar purpose.

(b) The kannai was made from a young sapling of a certain scrub-wood, chosen to about the size required, the bark must be scraped off, and then pointed. Used for fighting and hunting; and just before a fight bundles of these would be collected from the scrubs. It was blacked all over in the fire, as in the case of the pi-lar, and hardened at the point, the last twelve inches or so of which was finally scraped quite white; this was done to enable one to see it coming when thrown. Sometimes the tip might be left blunted, when three or four prongs, each from six to seven inches long, would be attached to it, the weapon being then used for purposes of fishing.

(c) The rose-wood timber spears, not manufactured here, but bartered from the Ipswich Blacks, were also called pi-lar, and used similarly for fighting at close quarters.

8. Spear throwers (wommeras) were absent in the eastern coastal districts, extending from Townsville to Rockhampton, and were unknown in Brisbane (*T. Petrie*), but they were present in the area around what is now Charters Towers. In their most primitive form of a hooked stick (Pl. lviii., fig. 14) they are met with in the Wellesley Islands and neighbouring mainland.

9. Wommeras on the Pennefather River are known by the general name of arái-i<sup>17</sup>. Used both as a spear-guard and as a spear-thrower. The blade (Pl. lviii., fig. 15) varies greatly in width, but with greater width there has, of course, to be a correspondingly larger peg; greater width, however, is not considered an advantage. It is manufactured from five different timbers:—*Erythrophloeum laboucheii*, F.v.M. (NGG. nau-muta, "iron-wood"), *Acacia rothii*, Bail. (NGG. lar), *Mimusops parvifolia*, Linn. (NGG. ngó-ru), *Eucalyptus terminalis*, Sieb. (NGG. rar-ru), and *Aglaia elaeagnoides*, Benth. (NGG. andró-e). To prevent the timber from splitting after being cut from the tree it may be buried in the ground for two or three months before anything further is done

---

<sup>17</sup> Further down the Gulf coast-line between the Mitchell and Staaten Rivers the Gunanni call them yur-nganya.

to it<sup>18</sup>. The different parts of such a weapon are spoken of as follows:—the proximal (handle) portion to-o, the distal kwanna, the blade a-rár, the peg kó-kan, edge of the blade bú-ni, the shell-haft pé-ra (after the name of the shell), and the extreme proximal end of the blade beyond the haft teriwan (= tail). For decorative purposes the blade may be covered with a mixture of resin and fat, producing a polished or varnished appearance<sup>19</sup>. The peg is a circular pencil of iron-wood, not flattened at all, projecting somewhat below the lower edge of the blade. It is fixed into the vertical edge of the blade-head, which is split for the purpose (Pl. lviii., fig. 16), by means of a shell, or with the teeth; two holes are then drilled, through which twine, etc., is passed to tie the peg in position, slipping being prevented by means of a thick covering of *Canarium australicum*, F.v.M., cement<sup>20</sup>. The handle is covered with a similar cement, so as to prevent it from slipping through the hand. The cement at one or both extremities of the blade may be occasionally decorated with the dried (yellow) strips from the outer covering of the "Rock Lily" (*Dendrobium bigibbum*, Lindl.) orchid. The shell-haft is formed of two oval-cut pieces of pera shell (*Melo dialema*, Lamk.)<sup>21</sup> attached with beeswax, while a few *Abrus precatorius* beans may help to ornament the edges in-between: the angle at which the shell-haft is affixed varies a good deal, and appears to depend on individual caprice.

10. The Koko-minni Blacks of the Middle Palmer River, Laura River, Maytown, have "iron-wood" (*Erythrophloeum labouchei*, F.v.M.) spear-throwers. The blade is long, comparatively narrow (though wider at the centre), with gradually sloping proximal (handle) extremity<sup>22</sup>. The long peg, which has a deep transverse nick in it to catch into the extremity of the spear-butt, is formed from an *Acacia* and fixed on to the blade by tendon passing through two holes in it, this portion of the peg being accordingly flattened from side to side, into two holes correspondingly drilled into the blade (Pl. lviii., fig. 17); the ligature is covered with *Grevillea* cement, the back of the peg remaining free of it (Pl. lviii., fig. 18). The haft, fixed at from anything of an acute to an obtuse angle, is either of *Melo*

<sup>18</sup> Roth—Bull. 7—Sect. 2.

<sup>19</sup> Roth—Bull. 7—Sect. 19. This blade may be sometimes stained.

<sup>20</sup> Roth—Bull. 7—Sect. 13.

<sup>21</sup> "Melo Wommera." See Etheridge—Proc. Linn. Soc. N. S. Wales (2), vi., 1891, p. 699; Luschan—in Bastian-Festschrift, 1896, pl. x., fig. 5.—(Ed.)

<sup>22</sup> Both here and at Cooktown, and the Bloomfield River, *Ficus* leaves are employed for smoothing down the blades. Roth—Bull. 7—Sect. 3.

shell (KML. torng, or ye-cha) bartered from the Musgrave River, etc., or else of a lath of wood doubled upon itself. The spear-thrower is known here as borna.

11. At Cape Bedford, on the Endeavour and Bloomfield Rivers, and at Butcher's Hill, the iron-wood spear-thrower has a comparatively long blade, even width throughout, and a short peg with a slight nick. The peg, which is cut from *Petalostigma quadriloculare*, F.v.M. (KYI. ckn. dun jo), is neither flattened nor drilled, but tied with tendon, etc., on to two holes drilled into the blade (Pl. lviii., fig. 19), the cement covering the back of the peg (Pl. lviii., fig. 20); a similar arrangement to what is met with on the Pennefather. The cement used is usually that of the iron-wood, but the *Grevillea*<sup>23</sup> is preferable when obtainable, as it lasts better. The handle is either haftless (Pl. lviii., fig. 21) or else hafted with two pieces of *Melo* shell fixed on with bees-wax (Pl. lviii. fig. 22), or else with a thin lath bent on itself (Pl. lviii., fig. 23). The Cape Bedford name of the implement is milbir.

At Butcher's Hill I have seen wommeras made out of a yellow-coloured timber (KYE. nga-til), which I have not yet succeeded in getting identified.

On the Bloomfield River, and along the small stretch of coast-line between it and Cape Grafton, is to be seen the bent or moon-shaped variety of spear-thrower (KYE. ballur), in addition to the straight kind. The ballur<sup>24</sup> (Pl. lviii., fig. 24) is employed for spearing fish or birds with, especially anything at very close quarters. It is comparatively short, made of a light timber, is haftless, and generally decorated with red and white pigment at its distal extremity. It is thrown in a manner different from all other wommeras, in that the blade rests in the fork between the first finger and the thumb, instead of, as in the ordinary style, between the first and second fingers<sup>25</sup>. As an example of how two tribes, although almost contiguous, may be ignorant of each other's ways and customs, it is interesting to note that sometime during 1897 one of these moon-shaped spear-throwers was thrown up on the beach at Cape Bedford<sup>26</sup>, and brought to the Rev. Schwarz, who, never having seen one before and being anxious to

<sup>23</sup> Roth—Bull. 7—Sect. 13.

<sup>24</sup> Illustrations of modifications of this wommera will be found in Etheridge—Proc. Linn. Soc. N. S. Wales, (2), viii., 1894, pl. xiv., fig. 2; in Luschán—Bastian-Festschrift, 1896, pl. x., fig. 2—(Ed.)

<sup>25</sup> Roth—Ethnol. Studies, etc., 1897—Sect. 253.

<sup>26</sup> Cape Bedford is only about thirty miles as the crow flies from the Bloomfield River, where the moon-shaped spear-throwers are manufactured.

know something about it, asked the local blacks what it was; they could not give it a name, but they told him that the person who made it must have been mad!

12. At Princess Charlotte Bay the wommera is made of iron-wood. The blade is longer than at Cape Bedford, etc., wide at the centre, narrower at the handle, with the shell-haft fixed at any angle, obtuse or acute. The long peg is flattened at its attachment; if drilled it is only partly covered with cement, if tied on it is wholly covered. Local names:—KRA. bo-un, KWA. alvau-ul. North-west of Princess Charlotte Bay, the koko-olkulo type of spear-thrower is comparatively short and wide, almost leaf-bladed with a long peg, this peg is made of "beef-wood," and tied on, not drilled, its back being covered with beef-wood (*Grevillea*) cement. With this kind of wommera a very short spear, about six feet long, is employed.

13. On the Lower Tully River the spear-thrower, used with the bangkai spear, is called charin (= nasal septum) from its flatness. It is a long thin lath with two holes drilled at its extremity, and the peg (MAL. kom) tied on with small strips of "lawyer-cane" (*Calamus*, sp.).

14. In the North-Western Districts I have nothing to add to the descriptions of spear throwers already given<sup>27</sup>, but must draw attention to a very primitive form of implement met with in the Wellesley Islands, and on the adjoining mainland in the neighbourhood of Burketown<sup>28</sup> (Pl. lviii., fig. 14).

[It is a straight stick in one piece, two feet five inches long, obtusely pointed at the proximal end, and round throughout the entire length until within about the last six inches, when the sides are flattened more and more, resulting in an "eel-tailed" distal end. The latter is higher than the shaft, the fore upper angle forming the "peg"; it is a very light implement.]

Two other types, it is true, are occasionally to be found in the area around Burketown, but they are certainly not of local manufacture, being brought in from the eastward<sup>29</sup>.

[The first of these is, again, a plain stick<sup>30</sup>, gradually tapering a little from proximal to distal, two feet long and raddled.

<sup>27</sup> Roth Ethnol. Studies, etc., 1897—Sect. 253. Note the small projection on the edge of the blade at the distal extremity illustrated in fig. 369 of the same work.

<sup>28</sup> Type in general figured by Luschan-Bastian-Festschrift, 1896, pl. ix., fig. 9 (Ed.).

<sup>29</sup> Westward and southward—(Ed.).

<sup>30</sup> See Spencer and Gillen—Northern Tribes of C. Austr., 1904, p. 669, fig. 224.



At the proximal end is placed a tassel of human hair "ringlets," each ringlet a two-ply twist (Pl. lxi., fig. 1); it is prevented from slipping off by a washer of gum-cement around the stick (Pl. lxi., fig. 2), but hidden by the tassel. The distal peg is of wood, held in position by string lashing, gum-cement covered.

The second implement<sup>31</sup> is narrow, rigid, and lath-like, about three-quarters of an inch in thickness, plano-convex or slightly bi-convex, and two feet ten inches in length by one and three-quarters wide. The proximal end is cut out for the reception of the hand of the spearsman, but affording a very small grasp (Pl. lxi., fig. 3). The wooden peg at the distal end is large and obtuse (Pl. lxi., fig. 4), and held in position by a gum-cement coating, and doubtless lashed on beneath. The whole of both surfaces is highly raddled and decorated with broad pipeclay transverse bands at both ends, the whole intermediate surface being pipeclay cross-hatched.]

15. Boomerangs are either manufactured from the flange of a tree (a natural form) or else cut *en bloc*. North of the Palmer River, they may be said to be absent in the Peninsula. Employed for both fighting and hunting purposes.

16. The generic name for a boomerang on the Lower Tully River is wa-ngal. This can be either a charal-jego (charal — to bounce on the ground), a fighting one, *i.e.*, one which, on striking the ground, flies low; or a nyaral (= to buzz, hum), a toy one, *i.e.*, one that flies high. The quality of either cannot be gauged except by experience<sup>32</sup>. Fortunately or unfortunately, the natives have learnt that if, during a fight, a good fighting-one gets broken, they can utilize a toy one by throwing it wrong end-on on to the ground, when it will rise but little. With either kind, a left-handed one (*i.e.*, one which, when thrown, will swerve to the left) is spoken of as chaku-i, and a right-handed one as yural-bara, similar terms as the particular attributes in a man.

The boomerang is manufactured from the following timbers, only one of which have so far been identified:—the yarran (*Rhodomyrtus macrocarpa*, Benth.), yandan, bokobai, charkala, puchera, yalma. In all cases, as well as around Cardwell, it is made from the flange on the butt of the tree, and hence is an example of a natural form. Furthermore, it is always got-out

<sup>31</sup> "Biletta"—See Etheridge—Proc. Linn. Soc. N. S. Wales, (2), vii., 1893, pl. xi.; Luschan—Bastian-Festschrift, 1896, pl. x., fig. 6; Spencer and Gillen, *loc. cit.*, p. 669, figs. 222-3—(Ed.).

<sup>32</sup> Roth—Bull. 4—Sect. 22.

in the same manner, represented in Pl. lix., fig. 1, with a cut above and below, and one behind. This last cut is made about three inches from the free edge, the split travelling simultaneously up and down, and used to be done with a stone tomahawk; even without this split a smart blow will remove the piece required. The timber so removed is then cut into shape by splitting, then chipped, then scraped with flint, then with shell, and finally rubbed over with the pumice stone which is obtained both in the Tully River and at its mouth. The fighting boomerang is clumsier made and heavier than the toy one, and is always used for offensive purposes by making it strike the ground first. Originally it used to be ornamented with a uniform coating of red pigment. Its parts are only named as the mollo or handle, and its opposite extremity as the chinna or foot.

17. Around Mackay, the natives will describe the local boomerang as having two knees, *i.e.*, a more or less defined double bend, which results in giving the weapon a very typical appearance (Pl. lix., fig. 2).

18. In the Rockhampton and surrounding coast-district, except its southern portions, *e.g.*, Gladstone and Miriam Vale, the boomerang (Pl. lix., fig. 3) has a very marked bend or knee close to its proximal (handle) extremity, the upper convex surface showing a fine stone-chisel fluting; its extremities are tapering, while the width of the shaft gradually increases from the handle onwards, until it reaches its maximum of about two and half inches at a spot situated at about three-quarters of its length. Lumholtz figures<sup>33</sup> one similar to this from Coomooboolaroo, Central Queensland. A straight line joining its two extremities measures about twenty-six and a half inches, this increasing slightly as one travels northwards from Rockhampton. It is made of brigalow, rosewood or wattle. At Marlborough (1897) a local aboriginal told me that in the olden times boomerangs used to be ornamented on their convex surface with large diamonds (?graved) placed end on end, each diamond being subdivided by parallel lines into four smaller ones. On the Keppel Islands I could learn nothing about boomerangs, whereas at Miriam Vale the only two specimens obtainable were bi-laterally symmetrical, *i.e.*, with the knee at the middle, its widest portion, and were said to be return or toy boomerangs.

<sup>33</sup>Lumholtz—Among Cannibals, 1890, p. 334, 2 figs. I do not think that Lumholtz's figure represents the same weapon as above, described by Dr. Roth.—(Ed.).

19. At Brisbane<sup>34</sup> the boomerang, or braggan, was made from the spur of a tree as on the Tully River, cut above and below, and split off. Both the toy and fighting variety were thrown either on to the ground, or direct into the air. As compared with the toy, the fighting one had less of a bend, was heavier, more rounded on both sides, and thrown lower. It would, when thrown on the ground, proceed at first in a straight course and then gradually taper to the right or to the left, the thrower learning by previous experience when it would turn off, on which side, and where it would hit. When thrown on to the ground direct it would turn off at the spot struck. The natives would often practice on the trees with these weapons, each owner thus getting to know just exactly what his particular weapon could do.

20. The boomerang of the North-West Districts has already been described by me<sup>35</sup>. Around Normanton and the Gulf Coast, just to the North of it<sup>36</sup>, the weapon becomes heavier and clumsier, the more or less acute angle at the wider knee (Pl. lix., fig. 4) gradually giving place to an only slightly perceptible curve (Pl. lix., fig. 5). Thus, on the coast-line between the Mitchell and Staaten Rivers the Gunanni call both varieties by the same name of *we-angala*, but use the angular one for fighting at close quarters by throwing it on the ground, the curved one for knocking over wallaby, native companion, and bandicoot.

21. Throughout the Peninsula no indigenous shield is to be met, the place of the weapon being taken by the broad-bladed spear-thrower, which, in the hands of a skilful fighter, can brush to the right or the left, as the case may be, any spear that may be thrown at him. On the Gulf Coast-line, the northernmost limit of the shield would appear to be the Mitchell River, where the weapon is more or less identical with the Normanton and North-West District pattern, in that it is made from a split timber and subsequently trimmed down into shape. The North-West types I have already described<sup>37</sup>. The Normanton District shields are usually decorated with red and white bands.

[A typical example (Pl. lx., figs. 17, 18) measures three feet three and a half inches in length by one foot in width. It is a large and proportionately very elongate oval shield, not unlike a drawn out "Goolmarry," and concavo-convex, convex externally, slightly concave on the inner surface, becoming flatter towards

<sup>34</sup> Notes from Mr. T. Petrie.

<sup>35</sup> Roth—Ethnol. Studies, etc., 1897—Sects. 239 to 244.

<sup>36</sup> In areas where it is made from the flange of a tree.

<sup>37</sup> Roth—Ethnol. Studies, etc., 1897—Sect. 254.

the apices, which are obtusely rounded; the lateral margins are parallel in the central region, and slightly converging at the ends. Both surfaces are raddled, the outer decorated with three pipeclay and four dark-red narrow transverse bands at the centre, with a pipeclay panel occupying the whole of each apex. The handle or holdfast, on the inside, is of the ordinary pattern, but rather larger than usual.]

22. On the Lower Tully River the shield or pi-kan is made from *Ficus chretioides*, F.v.M. (MAL. *magura*) and from another timber, not identified, but known to the local Mallanpara Blacks as keba. It is cut from the tree on similar lines as the boomerang. A curved incision is made in the flange both above and below, and the spur next chipped about half-way through on either side along the lines required (Pl. lix., fig. 6), and the piece then hammered or pushed out. Such shields are therefore not exactly oval, their shape on one edge depending upon the greater or less concavity of the flange. After this piece has been removed it is chipped away on both surfaces except at the centres, which remain; in section, this stage of its manufacture would be represented in Pl. lix., fig. 7. To the central boss on the front of the shield nothing more is done for the present, though it may subsequently be shaved down a little; into the projection at its future back, however, two longitudinal holes are chipped, these being united below by hot cinders, together constitute a handle at the end of the process. The weapon is then lightened by means already detailed<sup>38</sup>, then rubbed down with pumice stone, etc., and finally painted. In the designs of the patterns so depicted (Pl. lix., figs. 8-10) there is no meaning or interpretation, and on this subject very careful enquiries have been made, both by myself and on my behalf throughout the district; there may be some three or four typical styles, but, as a rule, one man copies another's, the copy being either a travesty or an improvement, according to the light in which it is regarded. The front of the shield is called *kanauja*, a word signifying "the inside" in reference to its outside (outer bark) having been removed in course of manufacture. The central projection is the *namma*, the back of the shield the *chu-cha* (=person's back, dorsum), while *dumbul* (a term signifying the female genitalia) is applied to the handle portion<sup>39</sup>. This manufacture of a shield from the

<sup>38</sup> Roth—Bull. 7—Sect. 2.

<sup>39</sup> There is a very fine series of these shields in the Australian Museum. See Etheridge—Journ. Anthrop. Inst., xxvi., 1896, p. 157, pl. vii.—(Ed.).

flange of a tree extends southwards to below Cardwell, and northwards to the Bloomfield River, and is met with along the mountain ranges of the hinterland, *e.g.*. Atherton.

23. The Bloomfield weapon was somewhat more oblong and rectangular as compared with that of the Tully, and usually larger, such dimensions as three and a half by one and a half feet being not uncommon; it is, however, fast falling into disuse, and even so late as 1898 was only being occasionally manufactured by some of the very old men. The Bloomfield Natives called it *kún-juri*, and used to paint it with varying designs. Although no shields are found on the Endeavour River and at Cape Bedford at the present day, the local Koko-yimidar Blacks speak of them as *gorndor-e*. Indeed, so far as the eastern coast-line is concerned, the Endeavour River must be regarded as the northerly limit of the weapon.

24. In the Rockhampton District shields are all made from the local "cork-wood," the *rumul* of the Tarumbal Blacks, and present a more or less similar shape<sup>10</sup> (Pl. lx., figs. 1 and 2)—an elongate oval, with flat (Pl. lx., figs. 3 and 4), in some cases approaching a markedly convex (Pl. lx., fig. 5), posterior surface, and incised handle. Each main encampment used separate characteristic gravings on the anterior surface:—

(a) Rockhampton and Gladstone. Two transverse incisions, comparatively deep on occasion, divide it into a large central and two terminal compartments (Pl. lx., fig. 6), the former is blackened with charcoal grease, the latter whitened. Two specimens measured from twenty-one to twenty-one and a half inches long, eight and a half to nine inches wide, and two and a half to three and a half inches thick; in the smaller the handle-groove extended close to the sides of the weapon (Pl. lx., fig. 7), a somewhat unusual feature in this locality.

(b) Yeppoon. Three transverse, and one longitudinal band, raised slightly above the general surface; these are blackened, the intermediate spaces being whitened (Pl. lx., fig. 8). Sometimes patterns of red and black may be observed in addition, either in alternate row or in their entirety, independently of the graving, but this colouring would appear to be empirical. The number of transverse raised bands—up to four, even five—usually varies with the size of the weapon. From twenty to twenty-one and a half inches long, nine to ten inches wide, and two to three and a half inches thick.

<sup>10</sup> "Goolmarray" type—See Etheridge—Proc. Linn. Soc. N. S. Wales, (2), ix., 1874, p. 514, pls. xxxiii. and xxxiv.; *Id.*—Journ. Anthropol. Inst., xxvi., 1896, p. 157, pl. vi., figs. 7 and 8.—(Ed.)

(c) Marlborough. There are two transverse incisions with a contained raised pattern in the form of a cross (Pl. lx., fig. 9); the posterior surface also has a raised surface of a crossed type (Pl. lx., fig. 10). These shields are sometimes to be seen painted, but the colours vary. A specimen, with slightly convex back, measured twenty by nine by two and a half inches.

(d) Tilpal, Torilla. Anterior surface similar to the Yeppoon pattern, and the posterior (Pl. lx., fig. 11) somewhat a development of the Marlborough type. A specimen with distinctly convex back measured twenty-seven and a half by ten and a half by three inches.

(e) Miriam Vale. Smaller, more truly oval and much more flattened than any of the preceding (Pl. lx., figs. 13 and 14); anterior surface blackened. Used for protection in the case of weapons thrown from a distance. The measurements of one example were twenty by ten and three-quarters by one and a half inches. Another type here is heavier (Pl. lx., figs. 14 and 15) comparatively, and differing from all the others in having almost equally convex anterior and posterior surfaces; it is employed at close quarters for fighting with the heavier varieties of nulla. The measurements of an example were twenty-two by nine by three and a half inches.

Nothing definite was known concerning shields on the Keppel Islands.

25. At Brisbane<sup>41</sup> the shield or kuntan<sup>42</sup> was made from "cork-wood" (*Erythrine*, sp.) by splitting, each split half being trimmed into the ultimate shape required<sup>43</sup>. It was then put aside for two weeks, until quite dry, because while damp the wood could not be charred. The handle was next made as follows:—the two holes were outlined in charcoal, the lines then cut in with a flint or celt, the intervening parts picked and dug out with a hardened-pointed stick, then hot cinders put on and blown on, more picking, and finally joining the two holes beneath. The whole surface was next covered with warm beeswax, producing a dark brown colour. There were two kinds of shields, but both called by the same name—a thin broader one for warding off spears in the big fights, and a thick narrower one for receiving blows from waddies in single-hand combat. The former, after the beeswax had dried, was painted with pipe-clay according to pattern (Pl. lx., fig. 16) on the upper surface and uniformly covered with it on the under; the thick narrower shield had nothing on them beyond the beeswax.

<sup>41</sup> Notes from Mr. T. Petrie.

<sup>42</sup> Also the name of the timber from which it was made.

<sup>43</sup> As in the case of the Northern Koolamons. Roth—Bull. 7—Sect. 62.

26. The nulla-nulla is not so much a hand implement as a throwing implement, *i.e.*, it is used more for throwing at short distances than for hitting at close quarters, and is very often employed in hunting wallaby, kangaroo, etc. Its manufacture is gradually dying out in the Boulia District, where it is not employed for purposes of barter, though it was (1897) pretty common along and to the north of the Leichhardt-Selwyn Ranges. It is made from the "gidyea" (*Acacia homalophylla*, F.v.M), coloured black with charcoal grease, and measures up to about two feet in length. The distal extremity is enlarged and tapers to a point. A good one is usually incised with some circular bands at the proximal end, and with a longitudinal fluting which reaches either to the tip or ceases abruptly about an inch from it. The Pitta-Pitta Blacks speak of it as mor-ro; the Maitakudi call it ma-ro. This type of weapon (Pl. lxi., fig. 6) is common throughout the whole of North Queensland<sup>44</sup>, as well as the Central Districts, and was to be met among the old Brisbane Blacks. In shape it is comparable with the wooden mallet of the Wellesley Islands<sup>45</sup>.

27. On the Tully River there are, in addition to the common type just mentioned, a two-pronged variety known as wirka, as well as a globular and a decorative (pine-apple) pattern, all more or less identical with those to be observed in the Rockhampton District (Pl. lxi., figs. 7, 9, 10). The pine-apple type has on occasion been seen in the Peninsula and Eastern Coast-line; Lumholtz figures<sup>46</sup> it from Herbert Vale, and Petrie from Brisbane. Considering its limitation to the extreme north and to the coast-line, and its resemblance to the pine-apple stone club of New Guinea, I am inclined to regard it in the light of a Papuan introduction.

✂ 28. In the Rockhampton District nullas were usually made from "brigalow" or wattle, timbers known to the local Tarumbal (Rockhampton Tribe) as ku-nun and pakkar respectively; rosewood was occasionally employed, and on the Keppel Islands mangrove. Six or seven varieties are known, the first three of which are manufactured in large (heavy) and small (light) size. The heavy ones never left the hand, being used for the offensive and defensive at close quarters. The light ones were thrown from a distance, but were often used for knocking over native-bears, kangaroo and other game, *i.e.*, employed as hunting weapons.

<sup>44</sup> At Princess Charlotte Bay it has the following names:—KRA. kunbai-il, KWA. pa-ul.

<sup>45</sup> Roth - Bull. 7—Sect. 38.

<sup>46</sup> Lumholtz—Among Cannibals, 1890, p. 73, fig. b—(Ed.)

Good nullas should show the fine fluting caused by the stone chisel, and all possess handle-marks to prevent the implement slipping. Of late years, some of these weapons have been (?) improved by the addition of horse-shoe nails stuck into the distal extremity. In the neighbourhood of Rockhampton itself the Tarumbul had a word—barkel (=any stiek or handle)—to express all these varieties of nulla collectively. To the following short description of each the Tarumbal name is attached :—

(a) The distal or free extremity progressively enlarges, to end finally in a gradually tapering point (Pl. lxi., fig. 6), and is the commonest of the series. The smaller kinds are called barkal, the larger tindil.

(b) The weapon gradually enlarges from the handle-end to the globular extremity, this knob being either distinct from or merged into the shaft (Pl. lxi., figs. 7, 8). Known as tanda.

(c) The head of the implement is girdled, the girdle being subsequently cut into from two to five rows of squares, by means of transverse and longitudinal incisions (Pl. lxi., fig. 9) ; it is called a nil-li. For decorative purposes, I have here and there seen one of these weapons with two opposite sides of the girdle shaved down to the general surface level and then coloured red and white respectively.

(d) Cut out on the same general lines as the common barkal, but having the distal end fissured into two, three (Pl. lxi., fig. 10) or four prongs. It varies from twenty-eight and a half to thirty-one inches in length. Called tambara or yambara.

(e) The distal extremity is in the shape of a more or less beak-like projection (Pl. lxi., fig. 11) ; sometimes there may be two of these "beaks" (Pl. lxi., fig. 12) opposite to one another, while occasionally there may be found an intermediate third or fourth. When decorated, the implement often has the beaks coloured white, and the intervening bases raddled. Called yu-lun.

(f) A form only made apparently by the Karun-burra Blacks of the Upper Fitzroy River, etc., but not within recent years. As compared with the commonest type, the "head" is defined from the shaft by a distinct ledge, and its tip tapers far more abruptly (Pl. lxi., fig. 13). A specimen which I obtained in 1897<sup>17</sup> was twenty-six and a half inches long.

(g) The distal extremity is in the form of a curve flattened from side to side. It is said to have been cut from the flange of

---

<sup>17</sup> Now in the Queensland Museum, Brisbane.



a tree, and was called *bí-teran*<sup>48</sup> (Pl. lxi., fig. 14). At Glenroy, a selection on the Upper Fitzroy River, in Karun-burra country, I obtained a variety of this weapon having the curve sharply bent, and a couple of deep nicks cut into its extreme convex edge<sup>49</sup> (Pl. lxi., fig. 15); the handle marks were of a regular diamond pattern.

In regard to the above varieties of *nulla*, all save (f) were met with, or records concerning them obtained, throughout the Rockhampton District, except at Keppel Island, at Gladstone, and at Miriam Vale; at the last-mentioned localities (d), (e) and (f) were not recognised, while on the Keppels only (a) proved to be familiar.

29. At Brisbane<sup>50</sup> the *nullas* were made out of iron-bark and saplings; they were all painted black, similar to the Rockhampton types; the *tabri* (a) for fighting and hunting, the *mur* (f) for fighting, a weapon similar to (c) for fighting at close quarters, and the *bakkan* (g) for killing by a blow on the back of the head.

30. On the Middle Palmer River the men's fighting pole (KML. *eln-bá-la*) is made of "box-wood" (*Eucalyptus resinifera*, Smith), on the same pattern and used after the same methods as that of the North-Western Districts<sup>51</sup>. At Princess Charlotte Bay the implement (KRA. *albé-ila*, KWA. *alkau-úra*) is somewhat shorter. In the Rockhampton area the women's fighting pole (TAR. *rang-kwan*) is about six feet long, and used in the same three positions of defence as has already been recorded; the weapon, which is made of "brigalow" becomes progressively thicker from the proximal to the distal extremity, both being sharply pointed.

31. In the Rockhampton District, at the North-Rockhampton Yaamba-Road Camp, I obtained in 1898 a two-handed sword that had recently been made by an old relative of a Karun-burra friend of mine. The old man told me that in the days before the advent of the whites it used to be employed in the area extending from Yaamba towards Broadsound, and made to strike either with its convex or concave edge. He called it a *bi-teran*, a term identical with that applied to the similar but much smaller pattern of Rockhampton *nulla-nulla* (Pl. lxi, fig. 14). The

<sup>48</sup> This is the "Bendi" type—See Linnholtz—Among Cannibals, 1890, p. 334, 2 figs; Etheridge—Internat. Archiv. Ethnographie, x., 1897, pl. iii., fig. 22—(Ed.)

<sup>49</sup> The "Langeel" type—see Etheridge, *loc. cit.*, pl. iii., fig. 6—(Ed.)

<sup>50</sup> Note from Mr. T. Petrie.

<sup>51</sup> Roth—Ethnol. Studies, etc., 1897—Sect. 255.

straight line joining the two extremities of this particular specimen<sup>52</sup> measured forty-six inches, while the greatest width of the blade, with equally convex sides, was three and a half inches; it was made of brigalow. Humboldt figures<sup>53</sup> one of these, and says it is usually covered with cross-bars of chalk. The two-handed swords of the North-West Districts have already been described<sup>54</sup>.

32. Single-handed swords are met with in the Cardwell and Bloomfield Districts. On the Lower Tully River this weapon, the barkur (Pl. lxi., fig. 16), is made from *Myrtus exaltata*, Bail. (MAL. yambi), and from another tree which I have not been able to identify. Such a tree of about six inches in diameter is cut off at the butt and felled, the length required removed, and then split down the centre (Pl. lxi., fig. 17). A slab can then be taken from either half (Pl. lxi., fig. 18), and chipped to shape. The shape of weapon thus follows the shape of the tree, straight or bent; the straighter it is the more preferable it would appear to be. To make the handle a cut is made into either side of the slab, which is then split; fibre twine is finally wound round the handle and covered with beeswax. One edge is as a rule sharper than the other, but both edges can be used for cutting; if the weapon has a distinct bend or curve, it is the convex edge which is apparently only used, but if straight, both are used, and the whole may be uniformly raddled. The proximal or handle-end amongst these Mallanpara Blacks is known as mura, and the distal extremity ngorn, a term signifying the forehead. It is from four and a half to five feet in length, and always used with the one hand stretched over the shoulder, the weapon hanging behind the back, and brought forward from above down with a more or less sudden jerk; well directed, a blow from it can split a man's skull. This weapon used to be manufactured on the Bloomfield River, but now (1898) only occasionally by the old men. The Koko-yellanji Natives here call it worran.

33. Very little reliable information is to hand as to the methods and procedure adopted in cases of one tribe fighting with another collectively; indeed, the progress of settlement and opening up of the country has rendered warfare such a comparatively rare institution nowadays, as to limit it to districts, *e.g.*, portions of the Gulf Coast-line not ordinarily accessible to European observers. What was observed in the Boullia District

<sup>52</sup> Since presented to the Queensland Museum, Brisbane.

<sup>53</sup> Humboldt—Among Cannibals, 1800, pp. 332, 334, fig. on l.h.—(Ed.)

<sup>54</sup> Roth—Ethnol. Studies, etc., 18—Sect. 245.

has already been recorded<sup>55</sup>. On the Bloomfield River (*R. Hislop*) there was one individual, not necessarily the oldest, who took the lead and planned out the whole mode of attack; this leader wore the cockatoo top-not feather-tuft head ornament, which rendered him sufficiently conspicuous. At the field of battle the older women would either try to prevent blood-shed or else with dancing egg the combatants on to greater fury, their conduct depending upon local circumstances, cause of quarrel, etc. Prisoners were not taken, but the final victors would seize the opportunity of capturing any women of whom they might be in want.

34. With regard to individual fighting, the following notices may not be out of place:—

At Miriam Vale (*C. E. Roe*, in 1892) the men would often, when at close quarters during the wrestle, try to seize each other by the testicle, the successful one increasing the pull by pressing his free hand on his adversary's shoulder: outsiders would then interfere. They used to fight very hard in the old days, but one would never take advantage of another—at least, not in the case of a weapon being accidentally broken. They were very stubborn, and would continue the strife on the following morning if one had been rendered unconscious or perhaps received a sufficiently severe wound to incapacitate him for the rest of the day. The women in fighting would throw hot cinders at one another.

At Boyne Island, Gladstone District (*C. Hedley*, 1887) the natives, when fighting, would try and rupture each other.

On the Bloomfield River (*R. Hislop*), fighting between two people alone was not common. The one about to be attacked might be ignorant of the attacker's intentions, and yet would stand up to a blow or cut without so much as flinching; were he to turn tail and run, he would be considered a coward and probably speared. On the other hand, the two might throw down their weapons, rush at each other and wrestle, during which process one would try and throw the other—unlike the wrestling contests at the initiation ceremony. At last they will fall, the one on top trying to throttle the one below; the former, however, will then often get the worst of it by the by-standers and mutual friends striking him with wommeras, etc., on the back and head, while the latter will be saved. Friends and relatives will always try and prevent fatal consequences.

---

<sup>55</sup> Roth—*Ethnol. Studies, etc.*, 1897—Sect. 238, last par.

NOTES ON THE ARCHITECTURE, NESTING HABITS, AND  
LIFE HISTORIES OF AUSTRALIAN ARANEIDÆ,  
BASED ON SPECIMENS IN THE AUSTRALIAN  
MUSEUM.

By W. J. RAINBOW, F.L.S., F.E.S., Entomologist.

(Plates lxii.-lxiv.; Figs. 13-15.)

PART VII.—ENTELEGYNÆ (*Continued*).

*Family* ARGIOPIDÆ (= EPEIRIDÆ, *Auct.*).

*Sub-family* ARGIOPINÆ.

This sub-family is not only the largest of the family of which it forms part, but contains some of the commonest, and most familiar of all spiders. It is the sedentary, orb-weaving species that are the first to attract the attention of the casual observer or amateur collector. The reason for this is obvious, for not only are many of the species large and more or less striking in appearance but, with the exception of a few aberrant forms, construct orbicular webs in prominent situations. Missionaries and travellers in out-of-the-way places, who are good enough to think of museums or arachnological students, when making collections, invariably "bag" large numbers of Argiopidæ—often duplicating a species many times over—and little of aught else. In fact, so numerous are arboreal spiders in such collections, that one is often inclined to think that amateur collectors ignored the fact that there were such things as ground-roving species.

In Australia, the Argiopinæ are represented by the following groups: Argiopeæ, Cyrtophoreæ, Arachnureæ, Cycloseæ, Mangoreæ, Araneæ, Cærostreæ, Gasteracanthæ, Anepsiæ, Cyrtarachneæ, Glyptocranieæ, Poltyæ, Celeniæ, Arcyæ, Dolophoneæ, and Anapeæ.

The spiders included in the first of these groups are easily distinguished. The cephalothorax is very flat, rarely longer than broad; *pars cephalica* is truncated in front, relatively short and straight, and has the segmental grooves well-defined laterally, but indistinct or effaced posteriorly; *pars thoracica* is rounded laterally, the radial and median transverse grooves are distinct;

usually the cephalothorax is thickly clothed with a silky, silvery-white pubescence. Amongst those species in which the cephalothorax is longer than wide are *Argiope protensa*, L.K., and those species described by myself as *A. extensa*, *A. pallida*, *A. gracilis*, and *A. bullocki*. The posterior row of eyes are strongly procurved, and are usually the largest of the group; the median pair are in an almost straight line, poised upon a tubercular eminence, and are closer together than are those of the posterior pair; the lateral eyes are contiguous, and are poised on tubercles; of these latter the anterior eye is much smaller than its neighbour. The *epigynum* is, with a few exceptions, either a rounded or transverse elliptical depression divided by a strongly arched, longitudinal process. In the genus *Argiope*, Aud. in Sav., the females are remarkable for their exquisite beauty. *A. aetherea*, Walck., = *A. regalis*, L.K., and *A. amula*, Walck., = *A. magnifica*, L.K., are familiar, and brilliantly coloured Australian examples. Speaking of the latter, Workman<sup>1</sup> says:—

“When living this is a very beautiful spider, the colours being most brilliant. It has certainly the power (possessed by several other tropical spiders) of turning quite dark when disturbed. I imagine it is able to do so by raising and depressing the hairy covering of the body.”

Both *A. aetherea* and *A. amula* are widely distributed, the former, which is popularly known as the “Cris-cross” and “St. Andrew’s Cross” spider, occurs both in New Guinea and Australia, and, although a tropical species, has been recorded as far south as Wollongong<sup>2</sup>; the latter species ranges through the Malaysian Archipelago, New Guinea and Northern Queensland.

Compared with the females those of the opposite sex are veritable pigmies, and are much more soberly tinted. As with the Nephilinae so with this sub-family, the males live on the upper edge of the web, and subsist upon the smaller insects that have been ensnared, and which are too insignificant to attract the attention of the female.

Two genera constitute the group Argiopeæ, namely, *Argiope*, Aud. in Sav., and *Gea*, C. Koch, and both occur in Australia. The range of the former has been defined as “Orbis utriusque reg. trop. et subtrop. rarius temper. ;” and the latter: “Africa

<sup>1</sup>Workman—Spiders, i.; Malaysian Spiders, 1896, p. 27.

<sup>2</sup>L. Koch—Arach. Austr., i., 1871, p. 44.

trop. occid. (*africana* E. Sim.); Asia trop. (*spinipes* C. Koch); Malaisia; Papuasia; Nova-Hollandia et Polynesia; Amer. sept. calid. et Antillæ (*heptagon* Hentz)."<sup>3</sup>

The webs of *A. annula* and *A. atherea*, according to Workman's description and figure are much alike.<sup>4</sup> The orbicular portion varies from fifteen ins. to seventeen ins. in diameter, and is composed of from twenty-five to forty-eight rays; the inner spiral has from six to nine turns; the free zone measures about one inch; and the outer spiral has from twenty-five to fifty-six turns. At the centre of the web, and extending from the inner lines of the outer spiral right across the free zone, there are two distinct ribbons of white silk which meet at the centre, cross each other, and so produce the figure of a St. Andrew's Cross. Sometimes the ribbons extend well into the inner rings of the outer spiral, but each ribbon is always zig-zaged in outline. Other species also weave a zig-zag ribbon of silk (in fact this feature is peculiar to the webs of these orb-weavers), but in some instances the ribbon is a single one, and is placed perpendicularly, in others it takes the form of a more or less round ring, much like the ribbons or *stabilimenta* in the webs of some exotic Uloboridae. None of our Australian Argiopinæ, so far as I have been able to observe, make what Dr. McCook describes as a central shield, but it is quite possible that some of our native species—at any rate the more typical forms—may do so. Speaking of this in connection with the American Argiopinæ, McCook says:—

"The peculiarity which first strikes the observer is the oval shield of white silk which covers the hub. This is thickest and closest in the centre, and grows thinner and more open towards the margin, where it gradually merges into the radii which are attached to it. In the adult spider it is usually about two inches long by one and a half wide. Attached to the shield above and below, and extending upward and downward between two radii, is a zigzag ribbon of white silk, an inch or more long and one-fourth of an inch or more wide. It traverses the whole central space, and extends downward about two inches until it is lost in the spirals of the lower half of the orb."<sup>5</sup>

From the time when the young *Argiope* spreads its first orbicular snare, the zigzag ribbon is present, but it is always much more highly developed in the webs of adults. The question

<sup>3</sup>Simon—Hist. Nat. Araignées, 2nd ed., i., 1892, p. 769.

<sup>4</sup>Workman—*Loc. cit.*, p. 27, fig. *h*.

<sup>5</sup>McCook—American Spiders and their Spinning Work, 1889, i., p. 97, figs. 52 and 89.

naturally arises as to the reason for the presence of this ribbon. It cannot be for special protection, because the web is usually built in an open space, where owing to the animal's colour and the conspicuous position it takes up at the centre of its web, it can be easily seen. A bird or predatory insect in quest of such prey (for the Argiopids are often found in wasps' nests) would not be likely to miss it. McCook expressed the opinion that the ribbon is introduced for the purpose of strengthening the shield, but since all the species do not construct a shield or screen, that cannot fully explain the reason for its presence. Personally, I am inclined to the opinion that it acts as a support to the central space and hub and also that it materially assists in bearing the weight of the spider's body: where a shield is constructed, the zigzag ribbon would, doubtless, be beneficial. The central space and hub of the web of *Argiope* is very fragile and delicate, whilst the spider, in proportion to it, especially when gravid, is large and heavy.

The spider, like all orb-weaving species (with the exception of those which roll or fold leaves, whose habits will be referred to later on) when at rest takes up her position at the centre or hub, and always head downwards; but the Argiopeæ differ from all other Argiopidæ in the disposition of their legs, for whereas orb-weavers in general spread their eight ambulatory limbs well out, *Argiope*, on the other hand, always rests with hers arranged in pairs, well extended, and so approximated that they describe the letter X. *A. attherea* and *A. annula* always dispose theirs in pairs over the zigzag ribbons forming the St. Andrew cross design.

The general structure of an *Argiope* web is very similar to that of the typical orb-weaver; it varies in dimension, according to the size of the architect, and sometimes according to environment; but whatever the size or surroundings may be, the zigzag band of silk on *stabilimentum* is always present, hence the naturalist can always tell when he sees one of these snares (even though the architect be absent) the genus to which the latter belonged. It is interesting to note the *modus operandi* of working-in the ribbon. The main structure of the web with its supports consisting of outer lines or groups, radii and concentric rings having been completed, *A. attherea* drops down to a point a little below the centre of the snare and takes up its position between two rays running in an oblique direction towards the central point of the hub; this she ascends, discharging silk from her spinnerets as she does so, and as all are at work voiding simultaneously, it follows that a broad ribbon is the result. The zigzag effect is caused by the animal swinging its abdomen from side to side as

it climbs. This process is repeated on each side of the hub, both above and below, until the work is completed.

The web is always suspended in a more or less vertical position, with the ordinary framework and supporting lines, but if the locality be one that is exposed to strong gusts of wind, an irregular or retitelarian web may be spun, as a means of protection, on either side of the orb. I have not infrequently seen such in the scrub land around Botany Bay. When a retitelarian web is constructed in conjunction with the orb, the lines of the former are continued both above and below the latter. McCook has noted the same feature in connection with American spiders of the genus *Argiope*. This retitelarian web being built in front of each face of the orb, has been termed by the American author quoted "protective wings," and he suggests that they may be a protection against hostile insects or other enemies hovering around the web, the slightest touch of which on one or other of the protecting wings would instantly telegraph the presence of an undesirable visitor, and so allow the legitimate tenant of the web time to drop to the ground and seek cover.

The cocoon of *Argiope atherea* is much like that of *Nephila ventricosa*, mihi, figured and described in my last paper upon this subject.<sup>6</sup> Usually it is found at the end of a twig of some shrub hard by the maker's orb-web. Occasionally I have seen one attached to the tops of the blades of some coarse grass or at the tips of brackens, and sometimes amongst the stems of the latter. The ova-sac is completely surrounded by a mass of loose flocculent yellowish silk, and is composed of a thin, crisp, papery substance; it is flask-like in shape, and perfectly impervious to water. Within this papery shell there is another sac, more or less bag-shaped, and this contains the eggs. Unlike the outer or flask-shaped sac, this bag is soft and flexible. Interposed between the outer walls of the latter, and the inner walls of the flask-like structure there is a quantity of soft, loose, flocculent silk, which completely surrounds the bag. Thus, it will be seen, the eggs are admirably provided for in the way of protection, not only against heavy rains, but predatory foes such as birds, lizards and mice. They do not wholly escape, however,—nothing in nature ever does—for certain Hymenopterous insects, such as Ichneumon flies, sometimes succeed in piercing the entire mass with their long ovipositors. The eggs are of a glossy, translucent, yellowish tint. The cocoon of *A. atherea* may be looked for during the autumn months, and the spiderlings in spring.

---

<sup>6</sup>Rainbow—Aust. Mus. Rec., vi., 5, 1907, pp. 336-7, fig. 53.



*Gea*, C. Koch=*Ebaea*, L. Koch, occurs in "Africa trop. occid. (*africana* E. Sim.); Asia trop. (*spinipes* C. Koch); Malaisia; Papuasia; Nova-Hollandia et Polynesia; Amer. sept. calid. et Antille (*heptagon* Hentz)."<sup>7</sup> Notwithstanding its geographical range, the genus is a small one, only about a dozen species being known; of these, six have been described from Indo-China, one from Australia (*G. theridioides*, L. K., Port Mackay); one from New Guinea (*G. bituberculata*, Thor.); and one (*G. praeincta*, L. K.) from Samoa. The individuals are all small, but there is little difference in size between the sexes; if anything, the males are slightly the smaller.

The architecture of only one species (*G. festiva*, Thor.<sup>8</sup>) has been described and figured. It is a small and closely fabricated orb, erected perpendicularly, and measuring from five to six inches in diameter; rays, 48-56; inner spiral, 7-11 turns; free zone, 1 in.; outer spiral, 32-58 turns. This web, which had no zigzag ribbon (*stabilimentum*), was noted at Singapore. Nothing is known of the spider's cocooning habits.

The section *Cyrtophorea* includes only one genus, *Cyrtophora*, E. Sim., and its distribution is: "Orbis utriusque reg. tropicae et subtropicae."<sup>9</sup> Our species *C. hirta*, L.K., *C. parvasia*, L.K., and *C. sculptilis*, L.K., were each originally recorded from Bowen. According to Simon, the latter Australian species is a synonym of *C. citricola*, Forsk., a form that has been recorded from the Mediterranean region, tropical, East and West Africa, South Africa, Madagascar and neighbouring islands, Yemen, India, Ceylon, and Singapore.

The webs of *Cyrtophora* differ from the characteristic snares of the family to which it belongs. Examples of these have been described by both Workman (*C. citricola*<sup>10</sup>) and McCook (*C. basilica*,<sup>11</sup> McCook). The orb is of a very primitive type, and takes the form of a dome, which latter consists of a large number of radii and spirals, all closely woven; the latter extend entirely and with equal regularity to the summit. Immediately below the dome and supported by the radii of the latter is a horizontal sheet or floor composed of lines irregularly cast. Both above and below dome and floor, and surrounding both, is a complicated reticularian structure. Primitive though it be, this form of snare

<sup>7</sup>Simon—*Loc. cit.*, pp. 769-770.

<sup>8</sup>Workman—*Loc. cit.*, p. 30, fig. *h*.

<sup>9</sup>Simon—*Loc. cit.*, p. 775.

<sup>10</sup>Workman—*Loc. cit.*, p. 32, fig. *h*.

<sup>11</sup>McCook—*Loc. cit.*, p. 164, fig. 154.

is distinctly beautiful. Considering their beauty, it is a pity these structures are so fragile; and also that when kept in captivity the architects persistently decline to give an example of their architectural skill. I have kept many species for observation at different times, but none have ever favoured me with a web such as they fabricate in nature. Doubtless the surroundings were not favourable.

Dr. R. H. Pulleine, of Adelaide, informs me that he has often noted a web of a South Australian spider exactly like that described by McCook in respect of *C. basilica*.

The section Arachnureæ, like the preceding, includes only one genus, *Arachnura*, Vinson, and it abounds in "Afric trop., orient., conti. et insul.; India; Malasia; N.-Hollandia et N.-Zelandia."<sup>1 2</sup> It has not yet been recorded from Papua, but it is only reasonable to suppose that it exists there. Simon says he possesses an undescribed form from the Philippines.

These spiders are not large, but they are of striking form. Our species are *A. higginsi* and *A. caudata*, Bradl. I have collected the former at Waterfall, National Park, and at Guildford, and have also seen specimens from Tasmania. Mr. W. Bullock has collected it at Parkville near Scone, and Mrs. Ross at Armidale. Originally it was taken at Darling Downs, Queensland.

The cephalothorax is flat, and the grooves at the junction of the cephalic and thoracic segments, as well as the median transverse thoracic groove, are deep and strongly defined; the abdomen overhangs the base of the cephalothorax, and at its anterior extremity is deeply indented; it is long and attenuated, the posterior extremity tapering so as to appear like a tail, which latter is terminated with a spur-like process, but the projections forming it are small and, in point of size, unequal. The males of our species are unknown; Simon, however, observed one in Ceylon, probably the male of *A. scorpionoides*, Vinson, which was only about one millimetre in length, whilst the female measured 15, so that the disparity between the sexes is very great.

The webs of *A. higginsi* observed by me at Waterfall and Guildford were perpendicular, of the normal orbicular form, and about fifteen inches in diameter. When disturbed, this species drops from its web and hangs suspended by its spinnerets to a fine thread of silk. In this position it would certainly escape the persecution of predatory foes, since both in colour and appearance it resembles a dead rolled leaf. If greatly alarmed, this spider will drop to the ground and feign death. On one occasion when

---

<sup>1 2</sup>Simon—*Loc. cit.*, p. 777.

collecting in the bush, I came across an individual of this species amongst the fallen sticks and leaves that constitute the forest *débris*, and had it not been that I observed a slight movement in one of its legs, probably due to disturbing the rubbish, it would have escaped my notice.

It would seem, however, that the orbicular form of snare is not constant with *Arachnura*. A New Zealand species discovered by Dr. Llewellyn Powell "spins only a few irregular threads, crossing each other at various places, among twigs or small branches and stems of herbaceous plants, very similar to spiders of the genus *Theridion*."<sup>13</sup> Simon's observations of the webs of species of this genus at Manilla<sup>14</sup> agree with mine as detailed above in respect of *A. higginsi*.

Four genera are included in the next section, the Cycloseæ, but only one of them, *Cyclosa*, Menge, is included in our fauna. The range of this genus is "Orbis totius reg. temp. et calidæ."<sup>15</sup>

*Epeira rhombocephala*, Thor., from Cape York, and *E. vallata*, Keys., from Rockhampton, together with a number of Malaysian, Papuan, and Polynesian forms, have been transferred by Simon from *Araneus* (*Eperia*) to the genus *Cyclosa*. Of the two Australian forms quoted, *Cyclosa vallata* is alone known to me. It is a very small species, measuring only about three and a half millimetres in length; the abdomen is longer than broad, strongly arched, and has two large tubercles on its upper surface. The species included in the genus are very variable, and the abdomen may be ovate, obtusely rhomboidal, subquadrate, or shortly ovate and subglobose. The webs of *Cyclosa* are orbicular, and are fabricated in an almost vertical position, the spirals are numerous and very closely woven; a *stabilimentum* is present, but this latter varies with the different species. The ova are deposited in a series of cocoons, which are sometimes concurrent with or constitute the *stabilimentum*.

The species described by me, together with its web and cocoons, as *Epeira pallida*, must be transferred to the genus *Cyclosa*.<sup>16</sup>

Mangoreæ is a section to which no Australian species have as yet been assigned, but seeing that one genus, *Lobetina*, Simon, included in it is represented both in New Guinea (*L. opaciceps*,

---

<sup>13</sup>Cambridge—Ann. Mag. Nat. Hist., (4), vi., 1870, p. 116.

<sup>14</sup>Simon—*Loc. cit.*, p. 777.

<sup>15</sup>Simon—*Loc. cit.*, p. 783.

<sup>16</sup>Rainbow—Proc. Linn. Soc. N. S. Wales, xxiii., 1897, p. 514, pl. xvii., fig. 1, and pp. 534 and 535, fig. 1.

Simon), and also in New Zealand (*L. plagata*, Simon), it is only natural to suppose that it will sooner or later be found to exist upon the mainland of the Commonwealth. The range of this genus is "N. Guinea et N. Zealandia."<sup>17</sup>

Notwithstanding the fact that the section Araneæ comprises only five genera, three of which are represented in Australia, it nevertheless includes one, *Araneus*, Clerck, which probably embraces more species than any other included in this branch of the fauna. About one thousand species are known to naturalists, and many still await description. The series or groups into which the genus may be systematically divided have been exhaustively treated by Simon in his masterly work, "Histoire Naturelle des Araignées," and to this every arachnological student, anxious to acquire something more than a superficial knowledge of his subject, must turn.

The genus *Araneus* (= *Epeira*, Auct.) is represented in all parts of the habitable globe; many of the species are widely distributed, and some are exceedingly common and variable. Simon defines the range of the genus as "Orbis totius regiones omnes."<sup>18</sup>

Amongst trees, between bushes, amidst coarse herbage, in gardens and orchards from early spring to late autumn these spiders may be found. The webs are orbicular, but varying degrees of regularity and skill may be noted in the structure, and in the habits of the species. Some construct a perfect orb, the size of which depends largely upon the species; but it may also be influenced by situation or surroundings. There is usually a "nest" or resting-place at the extremity of some spur or branchlet, formed by bringing a number of leaves together and binding them into position with silk. This retreat, when found, is always connected with the hub of the web by what McCook terms a "trap-line." The retreat is used as a refuge from insectivorous foes or shelter in wet or excessively windy weather. Some orb-webs are imperfect: that is to say, they do not always form a complete circle—a sector may be wanting; some, indeed, only fabricate about half an orb. One of the most extraordinary webs I have ever seen I saw at Mosman. This was some years ago, before this favourite suburb of Sydney was built upon as it is now, and when it was a beauty spot as Nature designed it. This interesting snare was stretched between three large native shrubs, the positions of which described a triangle. For the want of a better term this may be described as a *double* web, to differentiate

<sup>17</sup>Simon—*Loc. cit.*, p. 795.

<sup>18</sup>Simon—*Loc. cit.*, p. 829.

it from the *compound* web to be described later on. The main body of the mesh consisted of the typical orb, with the customary outer lines or guys, but at the back, and running down the centre, a semi-orb had been built. This latter may not have been the work of the architect of the complete orb; it may have been purely adventitious. I am the more convinced that this is so, because I have carefully examined many webs since, and have not found another example, and I certainly think I should if it had been the result of instinct. At the time I discovered this web I sought for the architect, but it had evidently made good its escape, and was probably simulating death amongst rubbish, or hiding in some quiet nook or corner. Occasionally orb webs may be met with that have two or three more or less horizontal lines fixed to the hub and some adjacent object. These lines communicate with a tubular or leafy retreat and, as they are drawn tightly, cause the snare to be somewhat depressed at the centre.

Frequently huge orbicular snares are erected at considerable heights. I have recorded one such that I saw on the South Head Road, Belle View Hill, Sydney,<sup>19</sup> the topmost transverse line of which ran from a tree on one side of the road to a telegraph post on the other. By a well directed stone, I succeeded in bringing the builder down, and it proved to be the common *Aranus heriow*, L.K. It is remarkable, considering how fragile these structures are, the amount of wind-pressure they can bear; this is due, no doubt, to their elasticity. The *compound* web, to which I referred above, consists of an orb, and an elaborate and complicated reticularian snare, which latter is sometimes at the rear of the web, sometimes at both sides of it, and sometimes continued both above and below (fig. 13) much like some of the snares constructed by certain species of *Argiope*.



Fig. 13. Compound Web.

<sup>19</sup>Rainbow—*Loc. cit.*, p. 531.

All these orb-weaving spiders have the habit of enshrouding superfluous prey, or such as are powerful and likely to do damage to the snare, with silk. As the victim struggles, the spider pays out a line of silk, which not only becomes entangled in legs and wings, but is made to closely and tightly encircle the insect's body, and so render it helpless. Insects thus enclosed may be seen hanging on the outskirts of a web.

It is really remarkable what differences are found to exist in the common orbed web, when one takes the trouble to make and compare notes. The old school of naturalists contented themselves by simply noting the fact that spiders of certain genera constructed geometric webs, and these were generally accepted as being round or wheel-like. But, as a matter of fact, all orb webs are not round, nor is the hub always strictly at the centre. The radial lines may be, and often are, longer above the hub than below, and sometimes *vice versa*; then again the number of radii varies: there may be only seventeen of these, or more than fifty. I have counted in different webs 17, 22, 24, 25, 26, 32, 36, and 52 radii; but the differences are not specific. Three webs made by one species, *Aranus productus*, L.K., among the shrubs in my garden, had 26, 32, and 36 respectively. Another interesting feature is that it is not necessarily the largest web that has the greatest number of radii; indeed, I have most frequently found that the smaller webs made by the diminutive species of *Aranus* have not only more radii, but also a greater number of spirals than those made by their larger congeners. The snares of *A. productus*, *A. heroine*, and *A. brisbanæ*, L.K., may each vary, and often do, both in size, number of radii, number of spirals, and supporting lines or guy-ropes, but all these variations are due to peculiarities of site. The webs of *Aranus* are almost invariably parallel to the plane of the horizon, but frequently exigencies of construction compel such an arrangement of foundation lines as to deflect the snare more or less sharply from the vertical plane.

One of the commonest spiders around Sydney is *Aranus waagneri*, mihi<sup>20</sup>; a species which, together with its web, nest, ova-sac and other details of its life-history, I described and figured some years ago. Another species common around Paramatta and Liverpool, *A. sylvicola*, mihi,<sup>21</sup> makes, it is interesting to note, a web like that of the former species; moreover, its nest consists of a rolled leaf, and its ova-sac a folded one,

<sup>20</sup>Rainbow—*Loc. cit.*, xxiii., 1896, p. 25, pl. xix., figs. 2, 2a, 2b, 2c, 2d, and p. 335.

<sup>21</sup>Rainbow—*Loc. cit.*, xxiii., 1897, p. 25, pl. xvii., figs. 4, 4a, and p. 536.

exactly like *A. wagneri*. Indeed, the life-history of these two widely distinct species appears to be exactly similar in every detail.

*A. wagneri* is apparently far from being particular as to the material it uses for its nests. At the moment of writing I have before me four examples of paper nests collected by me at Canterbury. Notwithstanding that there was no shortage of material in the shape of leaves available for nests, four individuals had actually utilised scraps of newspaper for the purpose. Two of these examples are rolled so as to form cylindrical retreats, one is in the form of an elongated cone, and the fourth is simply folded. Each of these nests have their edges held in position with silk, and the interior of the chamber lined in the usual manner with the same material. Messrs. Philip de la Garde, R.N., and J. J. Walker, R.N., each collected specimens of such paper nests made by *A. wagneri* on Garden Island, Port Jackson, so that the habit of utilising such material does not appear to be uncommon.

The cocoon of *Araucus heroïne* is about an inch and a half long and half an inch wide; it is ovate, densely matted, and the silk of which it is composed is dark green. The cocoon is usually located near the extremity of a small branch, and is surrounded and held in position by an irregular network of fine lines. Both the density of the cocoon and the labyrinthine lines surrounding it must be decidedly protective. The cocoons of some spiders are penetrated by the stings of parasitic wasps, but those of many species of Argiopidæ are rendered fairly immune from attack by the defensive reticularian network that surrounds them. Within the cocoon there is, of course, the ova-sac; this latter is invariably white, of a paper-like texture, and it encloses a number of yellowish eggs surrounded by yellowish, flocculent silk. Some species of *Araucus* enclose three small ova-sacs in their cocoons.

When the time arrives for the Argiopid spiderlings to make their appearance, they cut a small opening at the apex of the cocoon, but they are probably a few days old when they do this, as they have already passed through one moult. This is proved by the fact that when a cocoon is opened numbers of cast skins are seen. In cutting their way out, they are not assisted by the mother. In fact she almost invariably dies long before the young ones make their appearance. Professor B. G. Wilder, an American naturalist, was of opinion that birds were instrumental in aiding the escape of young spiders from their cocoons, because he had observed a bird, about the size of a sparrow, pulling at a

cocoon hanging in a tree. I am doubtful if such a provision exists in Nature. My experience is that a cocoon is never designedly opened until the time is ripe for the young ones to escape, and this is controlled by the instinct of the latter. Birds do undoubtedly pull spider-cocoons and webs to pieces, but it is in order that they may line their nests with the material.

Food is not necessary to spiderlings when domiciled within the cocoon, and therefore no provision is made in this respect; and furthermore nothing in the shape of cannibalism obtains until some time, probably a week or ten days, after the young have escaped. No time is lost after escaping from the cocoon, in the fabrication of a web, but it is a common one in which every member of the community, males and females—at this stage indistinguishable—assist in constructing, and in which all have a share. This web consists of a closely woven sheet that envelopes everything within its vicinity and from which, until after the second moult, they evince no desire to wander. It is interesting to note that these sheet-webs are usually densest above the cocoon (Plate lxii.), for it is there that the majority of the infantile spider community will be found. If the web be disturbed but slightly, immense numbers of these tiny creatures will rapidly descend by means of their drop-lines (which are emitted as they fall) and hang dangling in the air. For about a fortnight the spiderlings live together gregariously, but the migratory instinct then manifests itself. Each individual that has escaped the dangers, including cannibalism, with which the life of an infant spider is beset, assumes the attitude common to the *Araucidæ* prior to the aeronautic flight. In some species the eight legs are so spread as to describe a circle, the abdomen is then depressed and silk is voided, the animal turning round and round as it does so; in this way a “foot-basket” is made, after which the abdomen is raised, and a delicate gossamer thread is thrown out until sufficient has been voided to carry the tiny animal off. Even the calm air of a room is sufficient of itself to lift one of these animals and waft it along in its current. In the field, prior to ballooning, the young orb-weaver takes up a position, back downwards, on some of the reticularian lines, and commences to pay out silk as follows:—

First the spinnerets are brought into close contact, and the liquid silk is emitted; the spinnerets are then separated by a lateral motion, which breaks up the silk into fine filaments; on these filaments the air-current impinges, drawing them out to a length which is regulated by the will of the animal; and, on the spinnerets being again brought together, the filaments



coalesce and form a compound line.<sup>22</sup> In flight, the animal is carried off back downwards, and its feet control and aid in spreading out the filaments, at the base of which there is, in the case of some species, a small quantity of flocculent silk which forms a kind of hammock or basket. This latter is often considerably larger than the spider. When the spider wishes to descend, it hauls in and rolls up the filaments in a tangled mass.

The orbs made by young spiders are very similar to those of the adults. They are, of course, much smaller, and have a lesser number of rays and spirals, but where there is any ornamentation, as in the case of *Argiope*, or where it is customary for a matured spider to make a nest or retreat, we find the young ones, as soon as they start constructing orbicular snares, doing exactly the same. The young of *A. wagneri* and *A. sylvicola* each roll a small leaf or piece of paper in exactly the same manner as do the adults. But after each succeeding moult, and as the animal grows, webs and nests become larger until they have attained their maximum. *A. herione* passes through eight moults or changes of skin, after which it is adult.

Amongst the synonyms of this genus Simon, with a query, includes *Hemodes*, Keys. This genus was erected by Keyserling to receive a species which he named *turrita*,<sup>23</sup> on account of the curious structure of its abdomen. I think, however, that Keyserling's genus should stand for the reasons stated by him. In a brief note he says:—"This genus is near to *Epeira* W., but is distinguished therefrom by its spineless legs, the high clypeus, and the great breadth of the cephalic segment in front."

Two other small genera are included in this section:—*Carepalxis*, L.K., and *Acroaspis*, Karsch. The first of these occurs in "N.-Guinea; N.-Hollandia; Amer. centr. et merid.," and the latter is restricted to "Nova-Hollandia."<sup>24</sup> Of about a dozen species assigned to *Carepalxis*, six occur in Australia. The species described by me as *Epeira coronata*<sup>25</sup> belongs to this genus. The web of *C. tuberculata*, Keys., is small, but of the normal orbicular type. *Acroaspis* contains only two species, both of which are unknown to me.

Two genera are included in the group Gasteracanthæ, namely *Gasteracantha*, Sund., and *Encyosaccus*, Simon. The range of the

<sup>22</sup>Blackwall—Ann. Mag. Nat. Hist., xv., 1845, p. 241.

<sup>23</sup>Keyserling—Die Arach. Austr., ii., Suppl., 1886, p. 116, pl. ix., figs. 3, 3a.

<sup>24</sup>Simon—*Loc. cit.*, p. 830.

<sup>25</sup>Rainbow—Proc. Linn. Soc. N. S. Wales, xxii., 1896, p. 629, pl. xlix., fig. 1.

former has been defined by Simon as "Orbis totius regiones tropicæ,"<sup>26</sup> but it also occurs in subtropical and, to a limited extent, in temperate zones: the latter genus is only found in "Brasilia: Amazonas."<sup>27</sup>

About 200 species of *Gasteracantha* have been described, and these have been divided by Simon into two sections, based upon the structure of the abdomen, and the number and proportion of the spines, and these include several subgenera.<sup>28</sup>

The *Gasteracantha* are easily distinguished by the abdomen, which is hard (chitinous), armed with two, four, or six spines, which vary in length, strength, and direction, and issue from different points of the margin. The abdomen is also marked on the upper surface, and sometimes underneath, with numerous symmetrically disposed cicatrose spots, varying a little in size, form, and position. These markings Cambridge designated *sigilla*, owing to their resemblance to seals impressed upon the surface. The number, distribution, and relative distinctiveness of these *sigilla* are often of assistance in the determination of the species. The males are veritable pigmies compared with the females, and differ much from the latter in respect of abdominal armature. In some species of *Gasteracantha* the abdomen is very flat, in others it is more or less arched, but whichever it may be it is always very large in proportion to the cephalothorax, and its anterior angle always overhangs the latter. The legs are always short.

The webs of *Gasteracantha* are usually constructed in open places. The species common around Sydney, *G. minac*, Thor, = *G. flavomaculata*, Keys., constructs a snare about eighteen inches in diameter; it is orbicular, vertical, and closely meshed. The rays vary in number (22 to 30) and do not meet at the centre, but are connected with a common ring. When the web is newly constructed the rays do meet, but the central extremities are afterwards cut away, thus leaving an open ring or hub. The beaded spirals commence close to the ring and continue towards the outer lines or framework. There is no *stabilimentum* present. According to McCook and Simon, some species decorate their webs with tufts of white, flossy silk, but those that I have seen in the bush around Sydney were not so ornamented. The latter author, however, says that the habit is variable with the same

<sup>26</sup>Simon—*Loc. cit.*, p. 845.

<sup>27</sup>Simon—*Loc. cit.*, p. 847.

<sup>28</sup>Simon—*Loc. cit.*, pp. 838-843, pp. 845-847.

species. There is no retreat constructed in connection with these snares. When resting in the web a *Gasteracantha* always occupies the centre, and, as usual, rests head downwards. In such a position, owing to their colouration, they form very conspicuous objects, but their spiny armature doubtless protects them from the raids of insectivorous birds. I have seen many spiders that have been taken from the crops of the latter, but never a *Gasteracantha*.

*G. minor* occurs also in Queensland and Victoria. There is a common black variety of this form to which L. Koch gave the name *lugubris*, and which he regarded as a distinct species. The differences are merely those of colour, and the size and shape of the spines. Another variety to which the same author also gave specific rank is *G. minax*, var. *astrigera*. This latter variety is black only on the upper surface, whilst the former is black both above and below. Both the typical form and its melanic varieties are common in Queensland, New South Wales and Victoria.

The cocoon of *G. minax* is very variable, but very pretty. It is usually found attached to the stem of some adjacent plant, such as a weed, grass, or wild flower, and is more or less elongate in form. Usually it is bound to a stem, longitudinally, but sometimes it is pendulous. The colour varies from dark brown to golden-brown or even bright yellow, and examples vary in length from about 35 mm. to 15 mm.; of these the larger are by far the most attenuated. The cocoons are beautifully made and closely woven. Two specimens in the collection of the Museum are attached—one partly to the stem and partly to a leaf of a Flannel Flower (*Actinotus helianthi*, Labill.), and the other partly to a petal and partly to a stem of a Flannel Flower; a third example is suspended from a grass stem (Plate lxiii., figs. 1, 2, 3).

Other species recorded as occurring in Australia are: *G. fornicata*, Fab., "Neu Holland"; *G. vittata*, Thor., Port Mackay, Queensland; *G. westringii*, Keys., "Neu Holland"; *G. sacerdotalis*, L.K., Bowen and Cape York, and to these localities I now add Port Darwin; *G. suminata*, Cape York; and *G. variegata*, Walek., Bowen.

Three genera are included in the group Anepsieæ, viz., *Aspidolasius*, E. Sim., *Anepsia*, L.K., and *Paraplectanoides*, Keys. The first of these is, as far as we know at present, restricted in its range to Central America; the second, although it has not yet been recorded from Australia except in error, may, nevertheless, be reasonably expected to occur here, seeing that it is found in

“Asia merid.; Malaisia et Polynesia;”<sup>29</sup> the third, which consists of two species only, viz., *P. crassipes*, Keys., and *P. kochi*, Cambr., occurs only in “Nova Hollandia.”<sup>30</sup> Nothing is known of the habits or life-history of either of these species; in fact, no observations have been recorded as to the economy of any members of the group.

The group *Cyrtarachne* is a widely distributed one, and contains half-a-dozen genera, many of the species of which are striking forms. Two genera occur in Australia, viz., *Cyrtarachne*, Thor., and *Pacilopachys*, E. Sim. Of these the range of the former is “Reg. mediterr. occident.; Africa tropica occid. orient., austr. et ins.; Asia centr., merid. et orient.; Japonia; Malaisia; Nova Hollandia; and that of the latter, “Nova Hollandia et Polynesia.”<sup>31</sup>

In reference to their webs, Simon remarks that those that have been observed are large and very regular. I have collected several specimens of *Pacilopachys bispinosa*, Keys., around Sydney. Most of them were obtained by beating bushes over an inverted umbrella; one individual that I was fortunate enough to observe was resting on a bright green leaf, in which position it simulated, to a marvellous degree of fidelity, the excreta of a bird. Indeed I at first regarded it as such, but knowing that this habit is common with many species of the Arthropoda, I was induced to look more closely, and so detected the deception. Others who have brought me specimens, or to whom I have pointed out this habit, have confirmed my observation. The legs of the animal are short, and when it is at rest these are bunched-up closely to its sides; the abdomen is large, and its anterior extremity projects boldly over the cephalothorax; on its upper surface there are two large acuminate tubercles; these latter are dull white, and are elevated on a broad transverse field of yellow-brown, in front of which is a transverse bar of dull white; hence the colours of the animal, together with its dorsal abdominal tubercles and bunched-up legs, simulate most unmistakably the irregular mass of chalky-white and brown so characteristic of the excreta of birds. I have seen specimens of this species from the South Sea Islands and from many parts of Australia.

*Cyrtarachne setosa*, Keys., is another striking form, the legs and abdomen of which are armed with stout bristles. The type

<sup>29</sup>Simon—*Loc. cit.*, p. 870.

<sup>30</sup>Simon—*Loc. cit.*, p. 871.

<sup>31</sup>Simon—*Loc. cit.*, p. 880, p. 876, fig. 942.

of this species, which was collected at Sydney, was in the Godeffroy Museum, but its whereabouts now is not known.

Cyrtarachind cocoons that have been collected are described as being globose and attached to a long peduncle. Several such have been forwarded to me from time to time, but always, unfortunately, without the spider (Fig. 14).



Glyptocraniæ includes four genera, two of which occur in Australia, viz., *Ordgarius*, Keys., and *Dicrostichus*, E. Sim. The former occurs in "India et ins.; Taprobane (*Hobsoni* Cb.); Birmania (*serpiginosa* Th.); ins. Amboina (*clypeatus* E. Sim.); Nova Hollandia (*monstrosus* Keyserl.);"<sup>32</sup> *Dicrostichus*, on the other hand, occurs only in "Nova Hollandia."<sup>33</sup>

Fig. 14. Cocoon of  
*Cyrtarachne* sp.

Notwithstanding its wide range, very few species of *Ordgarius* have been described. These are *O. hobsoni*, Camb., from India and Ceylon; *O. serpiginosa*, Thor., from Burmah; *O. clypeatus*, E. Sim., from Amboina; and *O. monstrosus*, Keys., from Peak Downs, Queensland. Besides these, Simon says he has one (unnamed) in his collection from Java.

*Dicrostichus* includes three species and one variety, viz., *D. furcatus*, Camb., and its variety *distinctus*, mihi; also *D. caliginosus*, mihi; and *D. magnificus*, mihi.

The reticularian web, egg-bags, and leaf-nest (the latter in the form of a *cornucopia*) have already been described and figured by me.<sup>34</sup> I now have the pleasure of figuring and describing the nest of *D. furcatus* (Plate lxiv.). The web of this species, like that of *D. magnificus*, is small and of the reticularian type, the lines of which are closely woven amongst the leaves of the plant upon which the spider has become domiciled. On referring to the right-hand side of the plate, a little above the spider, the reader will perceive the body of a wasp which has become entailed in the outer lines of the snare. The nest or retreat is among the thick maze of leaves at the top of the plate. It is very closely and densely woven, but is not nearly so neat a structure as that made by *D. magnificus*. It will be noted on referring to the plate that the spider does not rest in its snare after the manner of other Argiopids, but with the head upwards. Some years ago

<sup>32</sup>Simon—*Loc. cit.*, p. 885.

<sup>33</sup>Simon—*Loc. cit.*, p. 886.

<sup>34</sup>Rainbow—*Proc. Linn. Soc. N. S. Wales*, xxiii., 1897, p. 538, figs. 2 and 3.

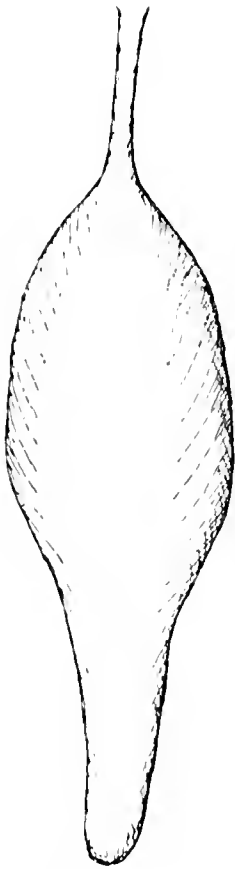

Fig. 15. Cocoon of *Dicrostichus* sp.

my friend, Mr. A. G. Hamilton, gave me a photograph of *D. magnificus* with egg-bags and nest, and that spider also is shown resting head upwards.

The egg-bags of *D. furcatus* differ from those of *D. magnificus*; they are smaller, have a shorter peduncle, which latter have again flattened apical extensions, that are directed either at right or oblique angles according to the position of the objects to which they are attached. The effect of these flattened extensions is to give to the egg-bag a flask-like appearance. In other respects, both externally and internally, those now figured are similar to the ones previously described by me, and quoted above. Besides these egg-bags, there is, in the Museum collection, two others attached to a nest of leaves bound together. These are probably constructed by another species of *Dicrostichus*, but they are much larger and have a different shape. Those figured in the plate herewith are delineated at their actual size. The ova-sac figured in the text is five inches long and three inches in circumference at its widest girth (Fig. 15).

The nest and cocoons (two) of *D. furcatus* described above were collected by Mr. W. Bullock at Parkville, near Scone, and presented by him to the Trustees of the Australian Museum. Besides this we have in our collection a nest made by the same species to which four egg-bags are attached. The latter was collected at Sydney by Mr. E. D. Lee, and by him presented to the Trustees. The large one is merely labelled "New South Wales."

The group Poltyeæ contains five genera, only one of which, however, occurs in Australia, *i.e.*, *Poltya*, C. Koch, and its range is "Reg. tropicæ cunctæ Africae, Asiae et Oceaniæ."<sup>55</sup> Keyserling has described five species from Queensland,<sup>56</sup> and I have described two others, one from Cooktown (*P. multituberculatus*),<sup>57</sup> and one from Fremantle, W. Australia (*P. salebrosus*).<sup>58</sup> Keyserling's

<sup>55</sup>Simon—*Loc. cit.*, p. 893.

<sup>56</sup>Keyserling—*Die Arach. Austr.*, Suppl., 1886, pp 123-133.

<sup>57</sup>Rainbow—*Austr. Mus. Rec.*, iii., 4, 1888, p. 82, pl. xviii., figs. 2, 2a, 2b.

<sup>58</sup>Rainbow—*Loc. cit.*, v., 2, 1904, p. 30, figs. 28, 29.

species are *P. lacinosus*, Peak Downs; *P. manneatus*, Peak Downs; *P. coronatus*, Cape York; *P. keyserlingi*, Gayndah; *P. bimaculatus*, Peak Downs. To the range of the latter I now add: Canley Vale, near Sydney, and Springwood, Blue Mountains.

The webs and nesting-habits of these spiders do not appear to have been observed. Usually the species are obtained from withered branches, to which their colour and form so closely harmonise. The field-note given to me by Mr. J. J. Walker, R.N., with *P. salebrosus*<sup>39</sup> agrees with those recorded by Keyserling.<sup>40</sup>

Two genera, viz., *Celania*, Thor., and *Taczanowskia*, Keys., are included in the group Celeniæ. The range of the former is "N. Hollandia; Tasmania; N Zealandia," but the latter occurs only in Peru and Brazil.<sup>41</sup>

The spiders included in this group are decidedly abnormal—so much so, indeed, that some authors have at first regarded them as members of that very distinct family the Thomisidæ. Cambridge, for instance, founded a genus, which he named *Thlaosoma*<sup>42</sup> for the family just quoted, but it is now accepted by authors as a synonym of *Celania*, and is, as such, one of the numerous genera included in the great family Argiopidæ. All the species of *Celania* are striking forms, and the commonest of them, *C. excavata*, L.K., and *C. (=Thlaosoma) dubium*, Cambr., are remarkable for their simulation of the excreta of birds.

Prior to receiving Simon's great work, I had, in common with others, regarded *C. excavata* and *C. dubium* as Thomisids, and in one of my early papers<sup>43</sup> in which I described the life-history, mimetic habits and egg-bags of the first named species, I so placed them. Up to the present date, five species of *Celania* have been described from Australia and five from New Zealand. Our Australian species are: *C. kinbergi*, Thor., from "New Holland"; *C. excavata*, from Brisbane, but now known to range from N.E. Queensland to Tasmania; *C. dubia*, Cambr., New Holland (fairly common around Sydney); *C. distincta*, Cambr., "New Holland"; and *C. calotoides*, mihi, from Parkville near Scone.

In reference to *C. distincta*, I pointed out in a previous paper<sup>44</sup> that Cambridge founded his species upon an immature and dried

<sup>39</sup>Rainbow—*Loc. cit.*, p. 31.

<sup>40</sup>Keyserling—*Loc. cit.* pp. 125, 127, 131.

<sup>41</sup>Simon—*Loc. cit.*, pp. 597-8.

<sup>42</sup>Cambridge—*Journ. Linn. Soc.*, x., 1869, p. 271.

<sup>43</sup>Rainbow—*Proc. Linn. Soc. N. S. Wales*, xxii., 1896, p. 336.

<sup>44</sup>Rainbow—*Loc. cit.*, xxvii., 1902, p. 488.

example, and that in all probability a specimen that had fallen into my hands would prove to be synonymous with the species described by Cambridge. I am still inclined to that opinion, but must await material for comparison with the type before venturing to express a decided opinion upon the matter.

The example which I regard as *C. distincta* came from Prospect, near Sydney. When discovered it was resting upon a twig, in which position it closely resembled a broken spur. Had it not been for an indiscreet movement upon its part, it would have been passed by unobserved, and so would not have been included in our collection.

The life-history and cocooning habits of *C. calotoides* was described and figured by me last year.<sup>45</sup> I now figure *C. excavata* and her egg-bags (Plate lxiii., fig. 4).

The young of *Celenia* disperse by "ballooning." They make "foot-baskets" and throw out filaments until the latter are sufficiently long to overcome the laws of gravitation just as do those species previously referred to in this paper.

Seven species only are included in the group *Areyeæ*, and these are divided into two genera, viz., *Arcys*, Walek., the range of which is "N. Hollandia et Tasmania; ins. Fidji (*brevipalpus* Karsch.); ins. N. Caledonia (*perlatus* E. Sim.); and *Archemorus* E. Sim., from Tasmania.<sup>46</sup>

Nothing has been noted in respect of the weaving and cocooning habits of the *Areyeæ*. All the specimens I have collected have been taken by "beating" and "sweeping."

*Arcys lancearis*, Walek., ranges from Brisbane to Tasmania; *A. cornutus*, L.K., has been recorded from Rockhampton, Bowen, and Peak Downs, Queensland, and to these localities I now add, Tweed River, New South Wales; *A. alatus*, Keys., Sydney; and *A. elacatus*, Keys. In his description of the latter species, Keyserling does not state the locality from whence his type came, but concludes with a note "Museum Godeffroy." I have, however, received specimens from the Jenolan Caves District. *Archemorus* contains but one species, *A. simsoni*, E. Sim., and that comes from Tasmania.

By the comparative hardness of their abdominal integument, and the cicatrose impressions on the upper surface of the latter, spiders of the group *Dolophoneæ* present a somewhat superficial resemblance to the *Gasteracanthids*. They are not, however,

<sup>45</sup>Rainbow—Austr. Mus. Rec., vii., 1, 1908, pp. 44-46, fig. 2.

<sup>46</sup>Simon—*Loc. cit.*, p. 901.



armed with spines, and only two species are at present known that possess a vertical tubercle, which arises from the middle of the dorsal surface of the abdomen like a column; they are *Dolophones turrigera*, L.K., and *D. nasalis*, Butl. Generally speaking, the abdomen is flat, broad, and transversely oval or cordiform.

Two genera are included in this group, viz., *Dolophones*, Walek. = *Tholia*, L.K., and *Pitharatus*, E. Sim. The former is distributed over "Ins. Ceram; ins. Paem.; N. Hollaudia; and N. Caledonia;" and the latter "Ins. Java et pen. Malayana."<sup>47</sup>

Of Australian species *D. testudinea*, L.K., has been recorded from Port Mackay and Bowen, but it has also been collected in New Caledonia; *D. turrigera*, L.K., from Brisbane, and to that locality I now add: Sydney, Parramatta; *D. clypeata*, L.K., Queensland; *D. noctacantha*, Walek, Sydney; *D. nasalis*, Butl., Queensland; *D. peltata*, Keys., ? locality; *D. tuberculata*, Keys., no locality given, but I have received specimens from Bungendore, New South Wales collected by Mr. A. M. Lea; *D. pilosa*, Keys., from Peak Downs, Queensland, to which I now add Antonio, near Rydal, New South Wales, collected by Mr. S. J. H. Moreau; *D. mammeata*, Keys., Australia; *D. coultera*, Keys., from Peak Downs; and *D. simpla*, Keys., Sydney.

The locality from whence *D. clypeata* was obtained was unknown to Koch, who states at the foot of his diagnosis:—"Vaterland: ? Zwei. Exemplare in K. K. Museum zu Wien";<sup>48</sup> and Keyserling, in respect of his species, *D. mammeata*, vaguely records it as "Australien."<sup>49</sup>

The webs, nests, and cocoons of *Dolophones* have not been recorded. On referring to my note-book, I find that in November, 1890, I collected a specimen of *D. testudinea* at Belle Vue Hill, Sydney, from an orbicular web.

Anapea is the last section into which this great family is divided. It is split up into four genera, only one of which occurs in Australia. This genus, *Chasmocephalon*, the distribution of which is "Africa max. austr.; N. Hollandia,"<sup>50</sup> was founded by Cambridge in 1889<sup>51</sup> for the reception of a West Australian species which he named *neglectum*, and which is the only one of the group, so far as we know at present, occurring in Australia.

<sup>47</sup>Simon—*Loc. cit.*, p. 904.

<sup>48</sup>Koch.—*Die Arach. Austr.*, i., 1871, p. 24.

<sup>49</sup>Keyserling—*Op. cit.*, Suppl., 1886, p. 109.

<sup>50</sup>Simon—*Loc. cit.*, p. 928.

<sup>51</sup>Cambridge—*Proc. Zool. Soc.*, 1889, p. 45.

*Chasmocephalon* was placed by Cambridge in the family Theridiidæ, from which it has been removed to the Argyropidæ by Simon. In the introduction to his paper<sup>52</sup> the Rev. O. P. Cambridge says :—“ One of the spiders described here is remarkable, not only for its minuteness, being no more than half a line in length, but for the peculiar character of its cephalothorax, in which the ordinary indented lines showing the junction of the caput and thorax are replaced by two deep oblique fissures, necessitating, along with other characters, the formation of a new genus. . . . This specimen has been in my possession for many years past, but had until lately been overlooked owing to its having been accidentally concealed among the hairs on one of the legs of a large spider received in 1864 from the Swan River.”

---

<sup>52</sup>Cambridge—*Loc. cit.*, p. 35.

LOWER CRETACEOUS FOSSILS FROM THE SOURCES OF  
THE BARCOO, WARD AND NIVE RIVERS, SOUTH  
CENTRAL QUEENSLAND.

PART II.—CEPHALOPODA.<sup>1</sup>

By R. ETHERIDGE, JUNR., Curator.

(Plates lxxv.-lxxviii.)

Of the few "Ammonites" contained in Mr. H. W. Blomfield's Collection only one requires detailed notice; this will conclude the account of the fossils presented by him to the Trustees. The whole series is a most instructive one, and has added largely to our knowledge of Australian Cretaceous Palaeontology.

The species are:—

*Schlenbachia rostratus*, J. Sby., sp.

*Haploceras daintreei*, Eth., sp.

*Amaltheus olene*, Ten Woods, sp.

I take the opportunity, also, of describing another Ammonite new to our Cretaceous rocks, and also a Gasteropod; these were sent to me from the Queensland Museum amongst the *Crioceræ* lately described.

Genus SCHLENBACHIA, *Neumayr*, 1875.

(Sitz. K. Akad. Wissensch. Wien., lxxi., 1 Abth., No. 5, 1875  
p. 658.)

*Obs.*—A genus created for a series of variable species of Chalk Ammonites with strong and pronounced keels, such as *A. rostratus*, J. Sby., *A. teanus*, F. Roemer, *A. varians*, J. Sby., etc.

SCHLENBACHIA ROSTRATUS, *J. Sby.*, sp.

(Plates lxxv., lxxvi., lxxvii.)

*Ammonites rostratus*, J. Sby., *Min. Conchol.*, ii., 1817, p. 163, pl. clxxiii.

*Ammonites inflatus*, J. Sby., *ibid.*, p. 170, pl. clxxviii.

*Ammonites inflatus*, D'Orb., *Pal. Franç. Terr. Crét.*, i. (Ceph.),  
1841, p. 304, pl. xc.

---

<sup>1</sup> Continued from p. 188.

*Ammonites inflatus*, Stoliczka, Foss. Ceph. Cret. Rocks S. India (Pal. Ind.), i., ser. 3, pt. 1, 1863, p. 48, pl. xxvii., pl. xxviii., pl. xxix., pl. xxx., figs. 1-3.

*Ammonites (Schlœnbachia) inflatus*, Eth. fil., Geol. Pal. Q'land, &c., 1892, p. 493, pl. xxxiv., figs. 1-4, (?) pl. xli., fig. 12.

*Sp. Chars.*—Shell large, discoid; whorls numerous (precise number unknown); venter variable, narrow or broad according to age, broad in young examples, narrower in more mature and aged individuals; keel more prominent and sharper in older than in younger shells, the surface of the venter always channelled on each side the keel; abdominal angles defined by lines of large tubercles varying in character according to position, and always hidden by the embracement of the whorls; dorsum corresponding in width to the venter, with a U-shaped impressed zone, in the young sharply angular but in older individuals wider and shallower; flanks flat to depressed convex; umbilical cavity wide and open exposing all the whorls; section variable, according to age, but always higher than wide, and in strict outline octagonal; costæ on the older and smaller whorls gracefully sigmoidal and usually bifid at about the middle of the flanks, but in aged examples this bifurcation ceases and the costæ are all single, long and short alternately; tubercles in two or three lines, or rows, on each side of the keel, one row abdominal in position, the other supra-umbilical, and if a third be present it is mid-lateral; all increase in size with age, the abdominal in the gerontic condition are large, conical and pointed; spiral lyre also occur on middle-aged shells, roughening the costæ, but faint in the valleys, and crenulating the abdominal rows of tubercles, also visible in the ventral channels.

*Obs.*—Although known as an Australian species I am induced to figure the accompanying specimens as indicative of size and confirmatory of the previous determination. The mouth has not been observed in an Australian specimen and the rostrum only doubtfully so. The variation in size and form of the tubercles is remarkable; where crossed by the spiral lyre they are more expanded and blunter as compared with the conical projections of other parts of the shell.

The section, inclusive of the dorsal groove, is octagonal in the smaller and younger whorls, but longitudinally elongated in consequence of the projection of the keel; the embracement of the whorls always conceals the abdominal row of tubercles.

Dr. F. Stoliczka commented on the variability in the number of rows of tubercles in Indian specimens of this species. The same instability appears to exist in the present specimens, one of the matrix casts exhibiting three rows, two others two rows only; the coiled cast (Pl. lxvii., fig. 1) one row on the concealed whorls, and two on the exposed volutions; the testiferous example reveals only two, but between these rows, the intersection of the costæ and lyræ become prominent and sub-echinate.

The sigmoidal curvature of the costæ is far more noticeable on the young than the more mature individuals, and the sharpest curve of each sigmoid is always in the ventral channels where it practically forms a continuation or extension of the tubercles, and is directed forwards.

The largest matrix cast represents a perfect shell of one foot in diameter.

The resemblance between the Australian examples of *S. rostratus* and Stoliczka's figures of specimens from the Ootatoor Group of the Indian Cretaceous, particularly that represented in his Plate xxvii. is very strong.

*S. ROSTRATUS*, *J. Sby.*, var. *ANTIPODEUS*, *Eth. fil.*

*Hystrichoceras*, sp., *Eth. fil.*, *Mem. R. Soc. S. Austr.*, ii., 1, 1902  
p. 47.

*Hystrichoceras antipodeus*, *Eth. fil.*, *ibid.*, pl. vii., fig. 6.

*Obs.*—In my account of the South Australian Cretaceous fossils I placed a few small fragmentary Ammonites provisionally in *Hystrichoceras*, Hyatt<sup>2</sup>. These shells, I have since learnt, occur at Point Charles in incredible numbers, and never appear to attain to more than a small size, as I now find through the reception of successive collections. At the time I wrote the fragmentary specimens before me did not reveal what I now believe to be their close relation to the inner, or younger whorls of *S. rostratus*. Hyatt selected *Ammonites coupei*, Brong., as the type of his proposed genus, but figured *A. varians*.<sup>3</sup>

Our Point Charles Cephalopods present a most unmistakable resemblance to the latter, but less to the former. Now, Mr. A.

<sup>2</sup>Hyatt—Zittel's Handb. Pal. (Eastman ed.), i. 1900, p. 589.

<sup>3</sup>Hyatt—*Loc. cit.*, p. 589, fig. 1233.

de Grossouvre. in his account of the French Upper Chalk Ammonites<sup>4</sup> amended Neumayr's *Schlaenbachia*, saying—"Je prendrai donc comme espèce type de ce genre *Schlönbachia varians*." It follows, therefore, if *A. varians*, J. Sby., is to be considered a typical example of *Hystrichoceras*, the latter and *Schlaenbachia*, Grossouvre, are in a measure synonymous, but, if on the other hand, Hyatt's name is restricted to *A. coupei*, it may not be so. Be this as it may, until we are better acquainted with the limits of *Hystrichoceras* as intended by Hyatt, I consider it sounder policy to place the Point Charles shells under *Schlaenbachia rostratus*, retaining my specific name *antipodens* as a varietal one.

The finer structural details, owing to the peculiar state of preservation, are not visible on the Point Charles specimens, but the abdominal tubercles, as in the larger *S. rostratus*, are canted forwards towards the mouth.

---

The fine specimen now to be described, from the collection of the Queensland Museum, combines in one two fossils not hitherto recorded from the Australian Cretaceous. These are an Ammonite, appertaining to the genus *Perisphinctes*, Waagen, and a Pleurotomarid, in all probability a species of *Leptomaria*, Deslonchamps. In their present condition these fossils are simply casts, all trace of the tests having disappeared. Both genera are met with in the Jurassic and Cretaceous formations, but these types are essentially Cretaceous. For the opportunity of describing them I am indebted to Mr. C. J. Wild, Acting-Director of the Queensland Museum.

GENUS PERISPINCTES (*Waagen*), *Neumayr and Uhlig*, 1881.

(*Palaeontographica*, xxvii., 1881, p. 143.)

PERISPINCTES KAYSERI, *N. and U.*

(Plate lxviii.)

*P. kayseri*, *N. and U.*, *Palaeontographica*, xxvii., 3-6, p. 146, pl. xix., figs. 1, 1a and b.

*Sp. Chars.*—Shell large, obtusely planorbiform; number of whorls unknown, but the volutions increasing in width slowly; venter convex; flanks rounded, although not greatly so; umbilical or dorsal edge abrupt and declivitous; section longitudinally

---

<sup>4</sup>Grossouvre—*Mém. Carte Geol. Dôt. France*, 1893, p. 109.

oval. Sculpture consisting of strong costæ, bent very slightly concave forwards on the flanks, and single as far as the line of embracement of the volutions, there dividing into two or three subordinate costæ forming fasciculi, with here and there single, interpolated, and free costæ, all crossing the venter almost at right angles to the plane of the whorls; tubercles wanting.

*Obs.*—A large Ammonite measuring fourteen by twelve inches on cross diameters, and three feet six and a half around the circumference (central line of the venter).

The strong costæ, single on the flanks, usually divide into three subordinate ribs, or there may be two only, at the ventro-lateral or abdominal lines, and then cross the venter. When a costa simply bifurcates, there is always a free interpolated secondary rib. The fasciculation of the costæ, a marked feature of the genus, is here a very pronounced character. In common with other species of *Perisphinctes*, tubercles are entirely wanting.

The smaller Ammonite nestling in the umbilical cavity with the *Leptomaria* may be a young stage of the more mature shell.

A glance at the beautiful figures by Messrs. Neumayr and Uhlig of the North German Hills Formation *Perisphinctes*<sup>5</sup> will at once convince the reader how very closely this Queensland fossil approaches to the European. In fact, I quite fail to appreciate any difference between the former and *P. kayseri*, N. and U., other than that of size, and by a less curvature of the costæ on the local shell, which is slightly more than double the size of the European fossil. It appears to be more akin to this species than to the larger *P. losseni*, N. and U.<sup>6</sup>, although even this has some points of resemblance to the Australian representative of the genus.

Genus LEPTOMARIA, *Deslouchamps*, 1865.

(Bull. Soc. Linn. Normandie, ix., 1865, p. 423).

LEPTOMARIA (?), sp.

(Plate lxviii.)

*Obs.*—The close resemblance of these casts to *Leptomaria gigantea*, J. de C.<sup>7</sup>Sby.<sup>7</sup>, of the Lower Greensand of England

<sup>5</sup>Neumayr & Uhlig—*Palaeontographica*, xxvii., 3-6, 1891, pls. xvii.-xxi.

<sup>6</sup>Neumayr & Uhlig—*Loc. cit.*, pl. xviii.

<sup>7</sup>Sowerby—*Trans. Geol. Soc.*, (2), iv., p. 339, pl. xiv., fig. 16; Stoliczka—*Leptomaria*, *Cret. Fauna S. India (Pal. Ind.)*, ii. (Gastropoda), 7-10, 1868, p. 386.

emboldens me to refer them to the genus in question, for little more than resemblance can be made of them. *L. gigantea* is a large conical species with the height and breadth equal, the whorls overlapping, and the sides in general straight. In the present instance, merely internal casts, the whorls were very slightly convex and did not overlap; no signs of the band or sculpture remain. This slight convexity may not quite afford an index to the true outline, for Stoliczka says of *L. indica*—"only when the surface of the shell is worn off do they present a continuous convex outline."

I have not seen the base, the reference to *Leptomaria* being made solely on the lateral resemblance to *L. gigantea*, *L. indica*, etc.



## ON A NEW SPECIES OF APHRODITA.

By T. HARVEY JOHNSTON, M.A., B.Sc., Parasitologist, Bureau of Microbiology, Sydney; Hon. Zoologist, Australian Museum.

(Plate lxix., figs. 1-8.).

There are in this Museum a number of Polychætes formerly labelled *Aphrodita australis*, Baird<sup>1</sup>. The original description of this species is sufficiently general to include several allied forms. Prof. W. McIntosh,<sup>2</sup> however, gave a much better description, accompanied by figures, of specimens collected off Port Jackson by H.M.S. "Challenger." As he had examined Baird's type in the British Museum, we may safely take his description as a means for comparing our own worms with *A. australis*.

The animals are apparently distinct. Both possess forty-two segments, which narrow very rapidly towards the posterior extremity. Our type, an adult female, is seventy-five millimetres long; its greatest width (excluding the setæ) is in the region of the tenth, eleventh and twelfth segments, being thirty-two millimetres. The posterior fifteen segments total only nine millimetres in length. The region of greatest width is more anteriorly situated than is shown in McIntosh's figure.

The prostomium or head is very small, rounded, and completely covered by the anterior pair of elytra. The median tentacle is very short, being almost rudimentary. It is more rounded than in *A. australis*. There are two pair of simple, sessile, black eyes, the anterior pair being much larger and more darkly pigmented than the posterior. The latter are situated above and behind the former (Pl. lxix., fig. 2). The eyes are directed forwards, their appearance from the front being on Pl. lxix., fig. 3.

The first stigerous segment (peristomium) is visible dorsally on removing the elytra, as a collar-like ridge behind the prostomium. The scales of the next segment completely overlap this segment and the head. Extending forwards from below the tentacle is

---

<sup>1</sup> Baird—Monograph of the Aphroditidæ Journ. Linn. Soc., Zool., x., 1865, p. 176). Haswell—Mon. Australian Aphroditea (Proc. Linn. Soc. N.S. Wales, vii., 1882, p. 250).

<sup>2</sup> McIntosh—Polychæta (Chall. Rep., Zool., xii., 1885, p. 34).

the frontal ridge, broad above but keel-like between the palps. This ridge ends ventrally in front of the mouth, a transverse aperture on the peristomium. Behind the mouth is the longitudinally ridged lip. The parapodia of this segment are shifted forwards and lie in front of the mouth, just external to the bases of the palps.

Each palp is fairly long, measuring nine mm. in the type (Pl. lxix., fig. 1), *i.e.*, less than one-eighth of the length of the animal. In a co-type figured on Pl. lxix., fig. 2, they are relatively shorter. McIntosh does not mention their length in *A. australis* but the figures show them to be relatively longer, being more than one-fifth of the body-length. In our specimens they are rounded and tapering, the base of each showing a swollen part just laterally to the tentacle. The surface of the palp, except at the distal end, is beset with very small chitinous papillae, the extremity of each being fine, sharp and bent towards the tip of the organ (Pl. lxix., fig. 4.)

As in other Aphroditidae, there are several sets of bristles; the strong laterally-situated setae, the so-called "hairs" and dorsal "felt." The felt consists of very closely matted delicate setae, forming a tough, dense mass, in which mud becomes entangled, giving a dirty grey appearance to it. The elytra are completely concealed by it. Iridescent setae are very numerous along the sides of the animal. They are long, jointed, highly flexible and hairlike, and taper to a fine point. They arise from the lower part of the dorsal division of the foot (notopodium). These "hairs" are responsible for the beautiful colours characteristic of a "Sea-mouse." A pale bluish green hue predominates, but it merges into red, orange, and yellow. The colour is scarcely noticeable in very young specimens but increases with the size of the worm. The dorsal setae are rather stiff. They arise from the upper part of the notopodium, but curve upwards and inwards, penetrate the dorsal felt, and come to lie over the dorsum, those from opposite sides almost meeting in most cases, and actually overlapping in places. They taper gradually and end in a delicate hook (Pl. lxix., fig. 2), similar to that figured for *Latmatonice aphroditoides*, McInt.,<sup>3</sup> and *Aphrodita aculeata*, Linn.<sup>4</sup> Longitudinal and transverse striations are fairly well marked. Their structure is thus quite different to those in *A. australis*, as figured. The bristles which project from the sides of the animal closely resemble in position and shape those of *A. aculeata*. They are

---

<sup>3</sup> McIntosh—*Loc. cit.*, p. 51.

<sup>4</sup> McIntosh—*Mon. Brit. Annelida*, Pt. ii. (Ray Soc., 1900, p. 247).

firm structures, dark brown in the adult but much lighter in colour in young specimens. They seem to be arranged in three rows on the neuropodium. The uppermost consists of two very strong, dark setæ; the next, of three or four smaller and lighter coloured ones; and the lowest, of several still smaller bristles. This division is not as well marked posteriorly, the two lower rows becoming one, the uppermost remaining fairly distinct. All of these setæ are similar in shape (Pl. xlix., fig 8). They taper rather rapidly at the end, which is bent slightly and has a rounded extremity. There are no processes present, but longitudinal striations occur. *A. australis* has ventral setæ of two or three kinds, one ends in a rather broad point and bears minute processes, whilst the others may be either dart-shaped or else slightly hairy. There seems to be only one seta present in each peristomial neuropodium. It is short and thick, very little of it projecting beyond the foot. The next segment bears two on each side, these representing the uppermost of the three rows visible in segments situated more posteriorly. The aciculum of each division of the foot is a short, dark, slightly curved, sharp-pointed body, which does not project. The parapodia are ringed and like the ventral surface of the animal, bear numerous tubercles.

The ventral cirri are short, the majority being only two mm. long. They are rather thicker at the base than the dorsal cirri. Each tapers towards the end, becoming swollen some distance from it, so as to become rather spatulate (Pl. xlix., figs. 1, 2.) This may be caused by the preserving fluid. There is a ringed appearance externally. A strand of tissue is visible in the middle. The dorsal and ventral cirri of the peristomium are very long compared with those of other segments, and lie close behind the palps, constituting the peristomial tentacles. They are long in the next segment also, but decrease in size rapidly in succeeding segments. Near the base of each ventral cirrus there is situated a small whitish tubercle, probably representing the segmental papilla.<sup>5</sup>

The dorsal cirri alternate with the elytra, the peristomium bearing cirri. Excepting those which are borne on the most anterior segments and are relatively long, these organs are about nine millimetres long. They are rounded and tapering, ending in a slightly enlarged tip. Like the ventral cirri, they are ringed and possess a median strand of tissue. The peculiar net-

---

<sup>5</sup> Haswell—Note on Segmental Organs of Aphrodita (Proc. Linn. Soc. N. S. Wales, vii., 1882, p. 610).

work of fibres, mentioned by McIntosh, is also present, and in addition there may be seen a number of rather large nucleated cells, some rounded, others branched, resembling nerve cells. They are scattered throughout the organ. Both dorsal and ventral cirri bear some very minute papillæ.

As before mentioned, there are thirteen pairs of elytra, commencing on the second setigerous segment. The three or four anterior pairs are rather smaller than those succeeding. The shape is sub-circular, the scale from the fourth segment measuring seven and a half millimetres in breadth by eight in length. The scar marking the point of attachment of the peduncle connecting it with the dorsum is situated near the outer edge. The margin is entire, but there are some very small processes arranged in a row at fairly regular intervals close to the edge of the scale, there being three or four such rows near the scar. A few processes may occur on the edge itself. The whole scale is whitish, membranous and slightly iridescent; this condition being due to the finely reticulate granulations on the upper surface. The fibrous layer connecting the two surfaces of the elytron can be distinguished under the high power, the fibres crossing each other in such a way as to form an irregular network.

The peduncle of the scale is broad, tabular, and short. It bears a number of small, almost conical capillæ with a truncate cylindrical extremity. There is a depression in the centre of the tip (Pl. xlix., figs. 5, 6). A strand of tissue is present in the stalk.

The type specimen is a ripe female dredged in five fathoms in Nelson's Bay, Port Stephens, in 1882. It contained an enormous number of ova, situated mainly in the coelome at the bases of the parapodia. These ova are spherical, averaging 0.21 mm. in diameter and are crowded with yolk granules.

Other specimens, all dredged in Port Jackson, were also examined. They varied in size from ninety mm. by twenty-nine mm. to twenty-five mm. by thirteen mm., but agree in all essentials with the above description. In one specimen the nerve cord could be seen through the epidermis. All the worms are too macerated for dissection.

I propose to name the species *Aphrodita haswelli* in honour of Professor W. A. Haswell, a Trustee of this Museum, who has kindly assisted me with specimens and literature.

The main characters of *A. haswelli* may be summed up thus:—Forty-two segments; thirteen pairs of elytra; very short median tentacle; well developed palps and lateral tentacles; four sessile eyes; ventral setæ all alike, with somewhat pointed and slightly

curved ends; the dorsal setæ lying over the dorsum have hook-like extremities.

Attached to the ventral surface of the type were a number of organisms, mainly Foraminifera. They were abundant on some specimens and absent on others. Mr. F. Chapman, of Melbourne, kindly determined those I sent to him as *Miliolina subrotunda*, Montagu, an organism characteristic of shore lines and shallow water. There was also another foraminifer present, the test of which resembles a *Truncatulina*. At least one species of this genus<sup>6</sup> may at times cover its test with particles of sand loosely cemented together. This was observed on some of the worms. McIntosh<sup>7</sup> mentions that an arenaceous foraminifer lives parasitically on the ventral surface of *A. australis*. Possibly the same organism is referred to, though in our specimens the test is not really arenaceous, but chitinous, the sand forming an extra covering. Other animal remains also occurred, and may as well be mentioned here. A small siliceous sponge was located between two parapodia. Entangled in the felt and setæ were Foraminifera (chiefly *Tectularia*); siliceous and calcareous sponges; a free living Nematode (?Enoplidæ) which was too macerated for determination; Holothurian spicules; Echinoid spines; and fragments of shells.

---

<sup>6</sup> Chapman—Foraminifera, 1902, p. 220.

<sup>7</sup> McIntosh—Chall. Rep., Zool., xiii., 1885, p. 36.

ON A CESTODE FROM *DACELO GIGAS*, BODD.

(Communication from the Government Bureau of Microbiology,  
Sydney.)

By T. HARVEY JOHNSTON, M.A., B.Sc., Parasitologist, Bureau  
of Microbiology, Sydney; Hon. Zoologist, Australian  
Museum.

(Plate lxx.).

My friend, Mr. S. J. Johnston, of the Biology Department, Sydney University, recently handed over to me a collection of Entozoa, mainly Cestoda, collected by himself and Professor J. P. Hill. The specimens now to be described were obtained from the stomach of a Laughing Jackass (*Dacelo gigas*, Bodd.) at Gloucester, New South Wales. Tapeworms do not commonly occur in the stomach, most of them preferring the alkaline conditions and abundant food supply present in the duodenum.

The largest specimen is about one hundred and twenty millimetres long and consists of approximately four hundred and twenty proglottids. Just behind the scolex, the breadth is 0.3 mm., gradually increasing to two mm. at about one third of the total length of the strobila, the remaining segments being practically uniform (2.5 mm.) In flattened and mounted specimens the dimensions are increased.

A neck is hardly recognisable, as constrictions appear marginally immediately behind the scolex and segmentation is distinctly seen in the strobila one millimetre from the head. There is no marked constriction between the scolex and the strobila.

There is very little overlapping of the anterior edges of segments by the posterior parts of those in front of them, nor is there much lateral projection. Excepting in the anterior fifth or quarter of the chain, there is not much difference in the size of the segments, the ripe and the sexually mature proglottids measuring about two to two and a-half millimetres in width by 0.7 to 0.8 mm. in breadth. They are thus from three to four times as broad as long. Those near the scolex are 0.4 mm. long by 0.3 mm. broad, the succeeding segments gradually broadening.

There is no marked narrowing or lengthening at the posterior end of the chain, the last segments being only a little longer and slightly narrower than those further forward.

The scolex is somewhat rounded, but its width is greater than its length, that is if the rostellum be not included as it may be retracted (Pl. lxx., fig. 1.) Its size in this latter condition is about 0.45 mm. broad by 0.31 mm. long. It is thus only a little wider than the anterior segments. The retractile rostellum is 0.14 mm. long, its base being about 0.05 mm. in breadth, the whole structure being short and conical.

Near its apex, there is borne a single circle of from thirty to thirty-six hooks, all similar in shape and size, and measuring about 0.05 mm. in length. They are so closely arranged that there is difficulty in accurately determining their number, arrangement and structural details. Their curvature is slight. The apical attachment is long and apparently rather pointed, the posterior attachment being short and blunt and rounded. The free end is short and pointed. A cavity is present (Pl. lxx., fig. 2). The apices of the hooks do not reach the summit of the rostellum. An apical muscle plug is absent.

The scolex bears four typical suckers which are unarmed and possess fairly prominent rims. The cavity of each is nearly spherical, the internal diameter being almost 0.1 mm. The openings are directed more towards the front than towards the sides. Two suckers lie on each surface, *i.e.*, two dorsal and two ventral. Their musculature is well developed (Pl. lxx., fig. 1).

The cuticle is well defined and smooth. A basement membrane is hardly distinguishable and sub-cuticular muscle fibres are not well developed. The medulla occupies the middle third of the thickness of the parenchyma. The cortex contains abundance of calcareous corpuscles, especially in the neck region. They are absent in the scolex. Their shape is rounded or elliptical, the size varying from 0.003 to 0.008 mm. in diameter.

The musculature of the cortex is strongly developed. The longitudinal muscles are disposed in two concentric sets of bundles, numbering about seventy altogether. The inner set consists of smaller and fewer bundles than the outer. The inner masses are generally opposite the outer, rather than alternating with them. Laterally these muscles-bundles are very small and numerous, being separated by the fibres of the transverse muscles, which lie within the longitudinal but pass out laterally to the cuticle. These transverse fibres are poorly developed so that it is difficult to exactly define the limits of the cortex and

medulla. The dorsoventral fibres are more distinct and pass between the longitudinal bundles and through the medulla.

The nervous system is not well marked. There appears to be only one longitudinal fasciculus, this being situated on the outer side of each main longitudinal excretory vessel. I cannot make out the various concomitant fasciculi described in some *Tæniadae*.

The excretory system consists of the usual parts. The outer longitudinal vessel has a much wider lumen than the inner one, the former representing the dorsal and the latter the ventral vessel. Their relative position varies somewhat in the segments but the inner trunk is generally placed more ventrally. Connecting the outer trunks, there is in the posterior part of each proglottis, a wide transverse commissural canal. There do not appear to be any valves present.

Of the genital system, the earliest trace appears in about the sixtieth segment, as a cord of cells representing the rudiments of the cirrus sac and vas deferens. The testes are well developed in the hundredth. Meanwhile, the vitelline gland, ovary and vagina have made their appearance. In the next eighty proglottids both sexes are mature. Beyond this the testes disappear rapidly, the segments becoming full of developing ova. The final proglottids are densely crowded with eggs containing hexacanth embryos (onchospheres).

The genital apertures are marginal and unilateral, being on the right side. Very rarely there may be an opening on the left instead. There is no genital eminence, the position of the aperture only being visible in stained and mounted preparations unless the cirrus be more or less everted. It is situated near the junction of the anterior third and posterior border of the overlapping portion of the preceding segment.

The testes are situated in a single layer lying nearer the dorsal surface. They gradually increase in number, the more anterior segments possessing about fifty, later segments about sixty. They are thus fairly numerous. Their shape is subspherical, the average diameter being about thirty-seven micra. They are well within the medulla and occur more abundantly in the middle and posterior region of each proglottis, comparatively few being present in the anterior third. Arising from each testis is a rather strong vas efferens which joins with others to form the vas deferens at about the middle of the anterior part of the segment, in front of the ovary. This passes on laterally towards the right, becoming enlarged and coiled near the neighbourhood of the excretory vessels. It is here strongly muscular. After passing



ventrally to both excretory vessels and the longitudinal nerve, it enters the posterior end of the cirrus sac.

This sac is thick-walled and muscular. It does not contain a vesicula seminalis, but that part of the vas deferens which lies within it, is again considerably coiled. In some segments the sac was partly everted, resembling a short cylinder fifty-seven  $\mu$  long by fifty  $\mu$  broad; and in one case (Pl. lxx., fig. 4) the cirrus seen projecting under compression at the end of the cylinder was as a delicate transparent tube twenty-eight  $\mu$  long by eight  $\mu$  in diameter. There was no trace of spines on it. There is a strong sphincter at the external opening of the cirrus sac.

The vagina is a delicate tube lying immediately behind and below the vas deferens, the course of the two ducts being generally parallel. It opens externally into the genital cloaca just behind the cirrus sac. In mature segments the vagina proceeds inwards for a short distance ventrally to both excretory canals, becoming gradually enlarged to form the elongated, thin-walled, pyriform receptaculum seminis. Masses of sperms were present in the structure. From its inner broad end there courses inwards and backwards a narrow somewhat coiled tube, the fertilisation duct, which possesses well-developed walls. The common oviduct enters this duct, the ova become fertilised here and are carried onwards to receive the secretions from the vitelline and shell glands before entering the uterus.

The ovary is a small organ situated in the anterior part of the segment, at about its middle, though in young proglottids, it is nearer the edge bearing the genital pore. It is not distinctly bilobed, but consists of a number of short tubular glands slightly divided into two masses. The products are discharged ultimately into the short common oviduct. This joins the fertilising duct. I could not detect paired oviducts. The ovary, as a whole, is rather rounded, extending dorso-ventrally as well as posteriorly, the common duct being surrounded by it during most of its course.

The vitelline gland is small, slightly bilobed and transversely elongated. Its duct joins the fertilising duct after the union of the oviduct with the latter. The shell gland is very small and not easily distinguishable. It appears to me to lie between the vitelline gland and the ovary. The whole female complex is so small and crowded that the details are not as satisfactorily followed out as I would wish.

It seems as if the uterus arises as a tube, the continuation of the fertilising duct. This gives off very numerous, narrow, branching diverticula, which come to surround the testicular

vesicles as in *Dipylidium caninum*, Linn. These pouches become filled with ova, and lose their connection with the rest of the female system by the abortion of the uterus. Thus the ova are seen in section in small groups lying in a small capsule in the parenchyma. The testes have become atrophied long before this, the cirrus sac being the only male structure still persisting. The segment becomes so full of eggs that not only is the medulla crammed with them, but the lateral fields becomes almost obliterated, ova being present laterally beyond the excretory canals close up to the cuticle. The longitudinal muscle bundles persist in ripe segments.

The eggs are spherical, excepting where crowded, and then they become polygonal through mutual pressure. Two shells are present and are fairly widely separated. The diameter of the embryo is eighteen  $\mu$ , that of the outer shell being twenty-six  $\mu$ . The arrangement of the hooklets in the onchosphere is illustrated on Pl. lxx., fig. 8. Each hooklet is 0.017 mm. long and appears to possess a slightly swollen extremity.

The Cestode belongs to the family of Dilepinidae and to the sub-family Dipylidiinae (Prof. Fuhrmann's<sup>1</sup> classification, 1908). Its characters are such that they may be regarded as belonging to a new generic type. I accordingly propose the name *Similuncinus daceionis*, gen. et. sp. nov., the generic name referring to the possession of hooks all similar in shape.

The characters of the proposed genus may be stated provisionally, as follows:—Retractile rostellum bearing a single circle of uniform hooks; four unarmed suckers; unilateral genital pores; genital papilla not prominent; single genitalia; numerous testes mainly situated behind the ovary; ovary in the anterior part of the segment; uterus a reticulum surrounding the testes at first, but afterwards becoming aborted so that the eggs lie in the masses surrounded by the parenchyma; the genital ducts pass ventrally to longitudinal nerve and excretory canals.

This new genus would differ from *Dipylidium*, R. Lekt., in possessing only one row of uniform hooks and single genitalia; from *Monopylidium*, Fuhrmann, in the structure of the rostellum and the position of the sex canals in regard to the excretory system; from all genera in the sub-family Dilepininae in the character of the uterus.

Type presented to the Trustees of the Australian Museum.

---

<sup>1</sup> Fuhrmann—Die Cestoden der Vogel (Zool. Jahrb., x., Suppl. Bd., 1, 1908, p. 27).

## AN AUSTRALIAN CHÆTOGNATH.

By T. HARVEY JOHNSTON, M.A., B.Sc., Parasitologist, Bureau of Microbiology, Sydney; Hon. Zoologist, Australian Museum.

(Plate lxxi.)

The Chaetognatha of the South Pacific are very imperfectly known. Dr. G. H. Fowler<sup>1</sup> in his Monograph mentions "the amazing fact that between 160° E. and 80° W. we have not a single record of a Chaetognath . . . ." Dr. O. Steinhaus<sup>2</sup> recorded the capture of *Sagitta enflata*, Grassi, in 28° S., 160° E., that is west of New Caledonia, and Prof. F. J. Parker<sup>3</sup> mentioned the finding of *Krohnia hamata*, Moebius, south of New Zealand. Mr. S. Kent's<sup>4</sup> *Sagitta tricuspidata* from the South Pacific bears no definite locality and is now regarded as a variety of *S. hexaptera*, d'Orb. Excluding the important work of Mr. T. Aida<sup>5</sup> on Japanese forms and of Dr. Fowler on specimens collected by the "Siboga"<sup>6</sup> (East Indies), "Challenger"<sup>7</sup> (Arctic and Sub-Antarctic waters), and "Discovery"<sup>7</sup> (Antarctic Ocean), I do not know of any other references to Pacific forms. There has not been any record whatever of any Australian members, excepting the mention of *Sagitta*, sp., by Mr. T. Whitelegge,<sup>8</sup> as occurring in Port Jackson.

This aberrant group appears to be well represented in New South Wales waters. In 1898 Mr. Whitelegge found some specimens washed up on Maroubra Beach, just south of Sydney. These were presented to the Sydney University (Biology Department), some of which were given to me by Dr. J. P. Hill. These are described in this paper. In 1906 Professor W. A. Haswell

---

<sup>1</sup> Fowler—Chaetognatha (Siboga Expd. Monogr., xxi., 1906, p. 67).

<sup>2</sup> Steinhaus—Die Verbreitung der Chaetognathen im Sudatlantischen und indischen Ozean, 1896.

<sup>3</sup> Parker—Remarks on a Spadella from N.Z. waters. (Trans. N.Z. Instit., xxviii., 1895, p. 758.)

<sup>4</sup> Kent—On a New Species of *Sagitta* from the South Pacific. (Ann. Mag. Nat. Hist., (4), v., 1870, p. 268.)

<sup>5</sup> Aida—Chaetognaths of Misaki Harbour. (Annot. Zool. Japon., i., Parts 1, 2, 1897, p. 13.)

<sup>6</sup> Fowler—*Loc. cit.*

<sup>7</sup> Fowler—Chaetognatha (National Antarctic Expedn., iii., 1908.) The "Challenger" forms are recorded along with those obtained by the "Discovery."

<sup>8</sup> Whitelegge—List of Marine and Freshwater Invert. Fauna of Pt. Jackson. (Journ. Roy. Soc. N. S. Wales, xxiii., 1889, p. 163.)

collected some about fifty miles east of Sydney; in 1907 Mr. J. H. Close secured a fair number of small forms in Port Jackson, and last year (1908) Mr. S. J. Johnston secured some more, also in Sydney Harbour. Besides *Sagitta serrodentata*, Krohn, several other species are represented in the above collections, all of which have been handed over to me.

Fowler<sup>9</sup> and Michael<sup>10</sup> state that the best preservative for these delicate organisms is weak formalin; spirit producing considerable distortion and the disappearance of the corona ciliata. Whitelegge's specimens were preserved in alcohol, hence the contracted state of the worms.

Many writers have mentioned the fact that insufficient descriptions have led to the establishment of many doubtful species. The limits of variation in this group being very considerable, the examination of a large number of specimens is necessary to firmly establish and accurately define a species. There were only a dozen at my disposal, all already mounted, and consequently I am giving as complete a description as possible, leaving authorities on this group to decide the validity of the proposed new species.

The main results are tabulated along lines similar to those in Fowler's papers. The headings are (a) length of animal in millimetres, (b) length of tail in mm, (c) length of tail as approximate percentage of total length, (d) number of jaws, (e) number of anterior teeth, (f) number of posterior teeth. The tail fin is not included in the following measurements:—

a	b	c	d	e	f	
12	2.1	17.5	9	6.7	9	ova present
13.5	2.5	18	9?	?	?	„ „
14.2	2.5	17	9	6.7	8.9	„ „
15.0	2.7	18	9	8.12	7.9	„ „
15.0	2.4	16	9	10?	8.9	adult
17.5	2.9	16.5	9	7?	11	ova present
18.2	3.0	16.5	9	7	7	„ „
18.5	3.4	18	9	7?	8?	„ „
19.0	3.1	16	9	12	7	adult
21.3	3.7	17	9	?	9?	„
24.0	4.0	16.5	9	6?	11	„

<sup>9</sup> Fowler—*Loc. cit.*, p. 2.

<sup>10</sup> Michael—Notes on the Identification of Chaetognaths. (Biol. Bull. xv., 1908, No. 2.)

The last specimen is the most typical and has been selected as the type, the description referring mainly to it.

The head is fairly prominent, its breadth being about 1·8 mm. and its length one millimetre. The jaws are set fanwise, the animal being in a state of medium contraction. There is a neck constriction present, the breadth here being one mm. From the point the body widens rapidly to 1·2 mm. and then gradually to 2·7 mm. in the region of the ventral ganglion, finally reaching 3·2 mm. at about the middle of the body. The breadth is fairly well maintained almost to tail septum, where there is a sudden narrowing to 1·5 mm. The tail is four mm. long, thus being one-sixth of the total length of the animal (sixteen to eighteen per cent.). The extremity is rounded. There is no collarette present. The lateral fields are rather wide, and the longitudinal muscles moderately developed. Consequently the worm is transparent and flabby (Plate lxxi, fig.1).

There are two pairs of fins, the anterior being carried out of their normal position in most specimens, probably the result of preservation in alcohol. The relative position and size of the anterior and posterior fins have been determined by examining serial sections kindly lent by Professor Haswell. The two pairs are approximately equal in length. The anterior is perhaps slightly longer and extends from just in front of the ventral ganglion backwards for about five mm., its greatest width being at some distance behind the ganglion. It is not quite as wide as the posterior fin. Between the two fins on the same side there is a considerable interval amounting to about eight per cent. of the total length of the worm. The posterior fin is somewhat triangular, the apex being rounded. The greatest width is just behind the tail septum. The anterior end does not extend as far forwards as the front of the ovary in some specimens, while in others it reaches beyond it. The posterior extremity of this fin is 1·3 mm. distant from the vesicula seminalis. The tail fin is bilobed and prominent. It does not extend as far forwards as the seminal vesicles. Rays are present in all fins.

A characteristic feature of the Chaetognatha is the possession of jaws, the number varying within the species. If the table be referred to, it will be noticed that there are nine pairs in every specimen examined, though the animals vary in size from twelve to twenty-four millimetres. The presence of nine pairs may be specifically constant. They are rather strongly curved, the back of the "point" of the jaw being a little more bent than the back of the "shaft." The inner edges of point and shaft are evenly curved. The jaws of *Sagitta furcata*, Steinhaus, and *S. enflata*,

Grassi, possess certain characters noted by Dr. T. Krumbach,<sup>11</sup> which are very similar to what occurs in this species. *S. sibogæ*, Fowler, judging from a sketch of the tip of a jaw, seems to approach even more nearly. The base of the point is oval, and the pulp is situated nearer the back than the front edge, but not as closely as in *S. furcata*. The pulp reaches further towards the tip than is figured in other species. The shaft bears neither crest nor serrations. The outermost jaws are longest, being nearly a millimetre in length, and most curved. Their bases are relatively small. The youngest are only about 0.25 mm. long, and are least curved. They possess a large basal part (Pl. lxxi., figs. 2, 3, 4).

There are two rows of teeth, the anterior containing from six to twelve, the posterior seven to eleven. These teeth are fairly long and strong, the points being small and sharp, especially in the case of those belonging to the posterior row. The inmost tooth of this row measured .079 mm. long, .013 mm. being the greatest breadth (Pl. lxxi., fig. 2).

The vestibular ridge is rather high and bears a number of low rounded papillæ. It ends in a prominent lateral process. The whole structure does not extend as far outwards as the tooth row, two posterior teeth being situated quite externally to it (Pl. lxxi., fig. 5).

A satisfactory account of the nervous and sensory systems cannot be given here, on account of the imperfect preservation. Neither optic nerves nor eyes are recognisable with any degree of certainty. The position of the brain is outlined on Pl. lxxi., fig. 2. The buccal nerves could be traced only a little distance. The ventral ganglion is rather long and broad. It lies between the epidermis and the muscle layer. The corona ciliata has disappeared from all specimens. One specimen shows a structure which may be a remnant of that organ.

The body wall consists of the usual layers, (a) epidermis, (b) muscle layer, and, internally, (c) the cœlomic epithelium. There is a very delicate basement membrane between (a) and (b). The muscles are arranged in four bundles, two dorso-lateral and two ventro-lateral, each pair being separated along the mid-dorsal and mid-ventral lines respectively by the mesentery. The individual muscle fibres are easily recognisable. The oblique and transverse muscles of the head, whose function is to move the jaws, are powerful.

---

<sup>11</sup> Krumbach—Zoolog. Jahrb. Abth. Syst., xviii., 1903, p. 579.

The cœlomic epithelium lines the inner surface of the muscle as a single celled layer. It is present on the mesentery and forms the cœlomic lining of the alimentary canal.

This canal extends as a simple wide tube from the slit like longitudinal mouth to the anus situated just behind the junction of the body and tail. There are no diverticula in the neck region. The mouth and anus are both ventral. The wall of the digestive tube consists of a single layer of columnar cells, the enteric epithelium covered on the outer side by the cœlomic epithelium.

The intestine is suspended by the dorsal and ventral mesenteries. Thus the body cœlome is divided into two parts longitudinally. The tail cœlome is similarly divided. The anterior septum, dividing the head cœlome from that of the body, passes forwards laterally. The tail septum is well marked and projects behind the anus into the tail, consequently it appears in a transverse section of the anterior end of the tail (Pl. lxxi, fig. 8).

The gonads are well developed in the type, but are longer in one of the smaller specimens. The ovaries extend forwards about as far as the anterior end of the posterior fin, a little beyond it in some cases. They are apparently not attached along the middle of the lateral border but just ventrally to it. This may be the result of some distortion, though I do not think so. The oviduct is on the outer edge of each ovary, and terminates laterally at the junction of the body and tail. The mature ova are spherical, measuring 0.24 mm. in diameter.

The testes are located in the anterior and lateral part of each tail cœlome, their length being about 1.5 millimetres. Sperm morulae averaging 0.04 mm. in diameter fill this cœlome. The vasa deferentia are small, but each terminates in ripe animals in a large prominently projecting vesicula seminalis. As mentioned before, neither the posterior fins nor the tail fin reach these structures, which are situated about 1.1 mm. in front of the extremity of the tail.

The detailed histological structure of some Chaetognaths is described fully by Dr. O. Hertwig.<sup>12</sup>

The main characters of this species, for which the name *Sagitta australis* is proposed, may be summed up thus:—Head rather small; neck distinct; no collarette; body transparent and flabby, thickest in the posterior third, tapering gradually for-

---

<sup>12</sup> Hertwig—Die Chaetognathen. (Jenaische Zeitschr. Med. und Naturwiss., xiv., 1880, p. 196.)

wards but very rapidly near the tail septum ; tail segment rather narrow, between sixteen and eighteen per cent. of total length of animal ; anterior fins long and narrow, extending to about the middle of the ventral ganglion ; posterior fin shorter and somewhat broader than the anterior, being widest at about the plane of the tail septum, it does not reach vesicula seminalis ; tail fin very deeply bilobed and not extending forwards to reach vesicula ; jaws nine, strong, most are well curved, youngest with very strong base but nearly straight ; anterior teeth six to twelve ; posterior seven to eleven ; vestibular ridge bearing short, rounded papillæ and ending in a prominent process laterally ; ridge shorter than posterior row of teeth.

Its nearest allies appear to be *S. bedoti*, Beraneck,<sup>13</sup> *S. furcata*, Steinhaus,<sup>14</sup> and *S. siboga*, Fowler.<sup>15</sup> It differs from *S. bedoti* in that the latter has a firm body, five to seven jaws, five to thirteen anterior teeth and from ten to thirty-two posterior teeth, a much longer tail segment (twenty-one to thirty-five per cent.), and posterior fins reach the vesiculæ. *S. furcata* differs from it in the absence of a well marked neck ; in the position of the widest part of the posterior fin, and in its greater length ; in the distance between the two fins ; the number of jaws (six to nine) and anterior teeth (three to eight). In *S. siboga*, there are large head ; short collarette ; firm, rather opaque body ; longer tail segment (twenty-one to thirty-three per cent.) ; tail fin reaching vesiculæ ; slender and comparatively straight jaws. In the above comparisons, only the points of difference from *S. australis* have been mentioned.

I wish to express my indebtedness to Professor Haswell for the loan of literature and specimens, and to Dr. C. H. Fowler's Monograph of the Siboga Chaetognaths.

Type presented to the Australian Museum. The sections are the property of the Biology Department, Sydney University.

All drawings were made using a Zeiss camera lucida.

---

<sup>13</sup> Beraneck—Rev. Suisse Zool., iii., 1895, p. 137.

<sup>14</sup> Steinhaus—*Loc. cit.*

<sup>15</sup> Fowler—"Siboga," *loc. cit.*, p. 21.



## ON A NEW HÆMOPROTOZOAN.

By T. HARVEY JOHNSTON, M.A., B.Sc., Assistant Government Microbiologist; Hon. Zoologist, Australian Museum.

*Contribution from the Government Bureau of Microbiology, Sydney, New South Wales.*)

(Pl. lxxii.)

The blood parasites of Australian animals have received very little attention as yet. Our only snake hæmoprotezoan known is *Hæmogregarina shattocki*,<sup>1</sup> described by Messrs. L. W. Sambon and C. G. Seligmann. The host is the Diamond Snake, *Python spilotes*, Lacép. Blood films taken from a close ally, *Python amethystinus*, Schneider, captured during a trip to Port Curtis, Queensland, revealed the presence of numerous parasites inhabiting the erythrocytes only. The percentage of infected cells was 1·8. A few corpuscles were infected by two sporozoans (Pl. lxxii., fig. 25.) By using Giemsa's stain the organism becomes differentiated from the host and appears bluish whilst the latter stains pinkish. The nuclei of both become deeply stained. I have followed Sambon and Seligmann's terminology and their extended definition of the genus *Hæmogregarina*.

The red corpuscles vary in size from twenty  $\mu$  long by 9·6  $\mu$  broad to nineteen  $\mu$  by seven  $\mu$ , the variation being mainly due to alteration as a result of making the film. A typical specimen is shown in Pl. lxxii., fig. 1.

No merozoites were present either in the plasma or in the cells. There were plenty of young forms, long, thin, and more or less crescentic in shape, lying within the host. The concavity more usually faced the nucleus of the latter (Pl. lxxii., fig. 2, 3). The opposite condition is seen in Pl. lxxii., fig. 4, 7.

The ends of the parasite are nearly alike, though, generally, one is slightly wider and more rounded than the other. The former is regarded as the anterior end, and the nucleus is often

---

<sup>1</sup> Sambon & Seligmann—Proc. Zool. Soc., 1907, p. 284.

seen nearer this end as a dense deepstaining body, having about the same width as the animal. The size of the parasite at this stage is from nine  $\mu$  by 1.8  $\mu$  to thirteen  $\mu$  by 2.4  $\mu$ , the nucleus being about two  $\mu$  long. One or two specimens were only as long as the nucleus of the host (Pl. lxxii., fig. 23). The corpuscles were not much affected at this stage, their nuclei remaining central.

The young forms increase in bulk and become encapsuled as sporonts, the ultimate host being probably a tick since these ectoparasites are frequent on snakes. In the encapsuled parasite the posterior end becomes bent round so as to be close to the cell (Pl. lxxii., fig. 12, 14). This "tail" is very short and is not distinguishable in most of the specimens. The nucleus is either median or approaches the anterior end, and is now relatively larger and less dense, vacuoles appearing to separate its chromatin fibres. The cytoplasm has a number of deeply-staining granules occurring at each end of the cell. The capsule is hard to make out unless the tail is well marked (Pl. lxxii., fig. 14, 21).

The sporonts vary from twelve  $\mu$  by 3.6  $\mu$  to 10.5  $\mu$  by 2.4  $\mu$ , the average being 10.8  $\mu$  by three  $\mu$ . They are thus very much smaller than *H. shattocki*.

There are also large forms present. These resemble schizonts (*i.e.*, the stage which undergoes fission to produce merozoites) in most of their characters but do not possess the large refracting granules in the cytoplasm. These cells are reniform and broad, with a fairly distinct capsule. The nucleus is round, large and approximately median. The size of the latter is from three to four  $\mu$  long by 2.5 to three  $\mu$  broad, the parasite varying from 13.5  $\mu$  by 4.5  $\mu$  to eleven  $\mu$  by four  $\mu$ . Perhaps these are only large sporonts in which the "tail" is not visible (Pl. lxxii., figs. 19, 21).

The host cell does not seem to be affected to any degree by the organism, though the nucleus is usually displaced, sometimes actually lying against the periphery (Pl. lxxii., fig. 21). The only ones of both host and parasite are parallel in nearly every instance. Exceptions are sketched in Pl. lxxii., figs. 10, 16. The distortion of the host cell shown in some of the figures was, no doubt, artificially produced in making the film. I propose for this sporozoan the name, *Hamogregarina amethystina*, borrowing the specific name of the host. Its nearest ally seems to be *H. pococki*, Sambon and Seligmann, from the erythrocytes of the Indian python, *Python molorus*, Linn.

The range of *Python amethystina*, Schm., is from the Moluccas and Timor, through New Guinea to New Britain and New Ireland and southerly to Northern Queensland.

I have recently taken a number of ticks from the specimen but have not yet examined them to ascertain whether the other stage in the life-cycle is present in them.

I wish to express my thanks to the Director of the Bureau of Microbiology (Dr. F. Tidswell), for his assistance and for his courtesy in obtaining permission to publish this note of work, performed, mainly, in the State Laboratory; also, to Mr. A. R. McCulloch, of this Museum, for determining the snake.

The figures were drawn using compensating ocular, one-eighteenth oil immersion objective and a Zeiss camera lucida.

A type slide has been presented to the Trustees of the Australian Museum, Sydney.

DESCRIPTIONS OF NEW AND NOTES ON OTHER  
AUSTRALIAN POLYPLACOPHORA.

By C. HEDLEY, Conchologist, and A. F. BASSET HULL.

(Plates lxxiii.-lxxiv.)

LEPIDOPLEURUS BADIUS, *sp. nov.*

(Plate lxxiii., figs. 1-2.)

Shell small, broad in proportion to length, rather low, rounded dorsally. Sculpture uniformly grain-striate. Colour entirely ochraceous, the valve margin sometimes rust.

Anterior valve densely radially grained.

Median valves narrow with a straight posterior edge, central and jugal areas confluent, lateral areas indistinctly indicated by a slight fold. About fifty grain-rows to a valve, medially about a dozen grains are close set in a row, but wider apart from row to row, the rows longitudinal in the middle, converging at the sides, and losing their regularity on the lateral areas.

Posterior valve with central elevated apex and concave posterior slope.

Girdle beset with small chaffy scales, fringed with spicules.

Interior white, sutural plates rounded, jugal sinus very broad and shallow. Insertion plates entirely absent. Length, 6; breadth, 3.5 mm.

*Station.*—Under stones in sheltered pools at low water.

*Habitat.*—Balmorai and Shark Island (Port Jackson); Long Reef near Narrabeen. Though a rare shell, fifteen specimens were found under one small stone at Long Reef. The body of the animal is of a deep red colour.

*Affinities.*—Related to *L. matthewsiannus*, Bednall,<sup>1</sup> from St. Vincent Gulf, South Australia, but distinguished by the darker colour, broader shape and coarser granules of *L. badius*, and especially by the direction of the grain-rows on the lateral areas. In *L. matthewsiannus* the rows are oblique to those of the central area, but in *L. badius* they are confused. In *L. matthewsiannus* the apex of the posterior valve is nearer the margin.

A more distant relation is the New Zealand *L. inquinatus*, Reeve,<sup>2</sup> in which the lateral areas are differentiated by small crowded grains set in rows oblique to those of the central area.

<sup>1</sup> Bednall—Proc. Malacol. Soc., vii., 1906, p. 92, pl. ix., f. 1.

<sup>2</sup> Sykes—Proc. Malacol. Soc., ii., 1896, p. 86., pl. vi., f. 4.

CHITON VAUCLUSENSIS, *sp. nov.*

(Plate lxxiv., figs. 19-23.)

Shell rather large, oblong, strongly elevated, carinated, side slope slightly curved and steep. Colour an olive buff, flamed with sepia in the pleural areas, the jugal area with sepia dots, most ribs picked out with orange or chocolate.

Anterior valve ornamented with irregular flattened pustules arranged in 20-28 radiating riblets multiplied by splitting of the fewer radii of the young shell.

Posterior valve: mucro very prominent, slightly in front of the centre, posterior slope concave, rayed with tubercular ribs similar to the head valve, but the grains rounder and flatter.

Median valves: lateral areas raised, carrying three to four prominent tuberculate ribs, the ribs tending to divide as growth proceeds. The central area furrowed by about thirty-three strong, raised, longitudinal ribs, of which the central crowns the valve, crowded medially and wider spaced distally, narrower than their deep, square cut interstices, traversing the whole jugal tract and leaving only the apex of the valve smooth.

Girdle tessellated by alternate bands of buff and bottle-green, covered with large compactly imbricating polished convex scales, obsoletely striated.

Interior pale bluish-green; sinus deep, narrow, denticulate. Anterior valve having 8, median valve 1-1, and posterior valve 12 slits; teeth finely pectinate on the edge. Eaves spongy. Length, 33; breadth, 20 mm.

*Station.*—On the upper side of stones in 4-5 feet of water at dead low tide.

*Habitat.*—Bottle and Glass Point, Vacluse, Port Jackson; two specimens.

*Affinities.*—Related to *Chiton limans*, Sykes, but larger, more elaborately sculptured, and differing in the lateral areas and girdle scales.

CHITON COXI, *Pilsbry.*

(Plate lxxiii., figs. 3-5.)

*Chiton coxi*, Pilsbry, Proc. Acad. Nat. Sci. Philadelphia, 1894, p. 85.

This species has not hitherto been figured. We therefore offer an illustration of a specimen 17 mm. long and 10 mm. broad from the Bottle and Glass Reef, Port Jackson. The consideration of it leads us to the next species.

CHITON TORRI, *sp. nov.*

(Plate lxxiii., figs. 6-11.)

The individual figured is 15 mm. long and 9 mm. broad. It was taken at Hog Bay, Kangaroo Island, S. Australia, by Dr. W. G. Torr and one of us during the Australian Association excursion of the "Governor Musgrave" in January, 1907. Hitherto it has been confused by local collectors with *C. coxi*,<sup>3</sup> but we regard it as a distinct species which replaces and represents *C. coxi* in western waters. Instead of the usual diagnosis, it may be better defined by the following comparison with related forms.

Differential characters of *Chiton jugosus*, Gould, *C. coxi*, Pilsbry, and *C. torri*, H. & H. :—

<i>C. jugosus.</i>	<i>C. torri.</i>	<i>C. coxi.</i>
Central area— Ribs high, rounded, prominent, of the same width the whole length. Colour bright orange-brown. Lines 10-14 on large, 5-7 on small specimens. 5-9 on posterior valve. Sulci deep, wide, colour blue.	Ribs low, sloping downwards, not prominent. Colour: fine line of dark olive-green. 4-6 on median valves, 3-4 on posterior. Sulci shallow, narrow, colour similar to main body of shell.	Ribs low, sloping downwards, not prominent. Colour: fine line of dark olive-brown. 6-11 on median valves, 6 on posterior. Sulci very shallow and broad. Colour similar to main body of shell.
Anterior valve— Concentrically lined, 12-14 lines.	Concentrically lined, 6-8 lines.	Smooth, finely reticulated. Colour of body of shell.
Posterior valve— Mucro blunt, in front of middle, posterior slope slightly concave.	Similar to <i>C. jugosus</i> , but posterior slope even less concave.	Mucro acute, central, projecting, posterior slope deeply concave.
Girdle scales— Large, convex, obsoletely striated, not smaller towards the outer edge. Small light coloured triangle on tail valve, extending broadly across girdle.	Similar to <i>C. jugosus</i> . Very faint small triangle on tail valve, does not extend over girdle.	Dense, small, striated, slightly convex. Smaller towards edge of girdle. Light coloured triangle on tail valve not constant, and where present a light bar of even width crosses the girdle.
Tegmentum— Minutely punctulate.	Minutely punctulate.	Minutely reticulate.
Interior— 8-1-12.	8-1-12.	8-1-(10-12).

<sup>3</sup> Bednall—Proc. Malacol. Soc., ii., 1897, p. 151.

CHITON TRANSLUCENS, *sp. nov.*

(Plate lxxiv., figs. 14-18.)

Shell large, oblong, elevated, carinated, side slopes straight. Colour buff clouded with olive and sage-green and microscopically freckled with rufous, in some specimens shaded with orange-red on the lateral areas. Under the lens the whole surface finely granulated in quincunx. The general smoothness of the valves is only interrupted by a few impressed growth lines.

Posterior valve: mucro median, subprominent.

Median valves: lateral areas raised, the remoter pleural areas crossed by half-a-dozen vestigial furrows, in and about which are a few scattered eyes.

Girdle olive-green, alternately lighter and darker, narrowly edged with magenta, covered with small, finely striated, oval, polished, and densely subimbricate scales.

Interior flesh tint passing into green, sinus narrow, deep, denticulate. Anterior valve having 8, median valves 1-1, posterior valve 10 slits; teeth deeply irregularly pectinated on the edge and outside.

Specimen figured; 38 mm. long by 21 mm. broad.

*Station.*—Under stones in 3-5 feet of water at dead low tide.

*Habitat.*—Bottle and Glass Point, Vacluse, Port Jackson; Caloundra, Queensland.

*Remarks.*—Two specimens of this shell were found by Mr. John Brazier at the Bottle and Glass Point in 1864, one of which was sent to the British Museum, and the other is now in the Australian Museum. It was not, so far as we can ascertain, previously described. Recently Dr. W. G. Torr, of Adelaide, forwarded a specimen for identification, labelled "Vacluse," and several expeditions to that locality resulted in a fair number of specimens in all stages of growth being found. When alive, this shell is of a beautiful translucent green; it is very clean, being apparently of a nomadic disposition, and therefore less exposed to the attacks of parasites. It prefers very smooth surfaces, and shows a marked partiality for the undersides of sunken glass bottles. Two young specimens have recently been taken by Mr. Tom Iredale at Caloundra, Queensland.

ISCHNOCHITON MAYI, *Pilsbry*.

(Plate lxxiv., fig. 28.)

*Ischnochiton (Haploplax) mayi*, Pilsbry, Nautilus, 1895, viii., No. 11, p. 128.

Since this species has never been illustrated, we figure an example from Frederick Henry Bay, Tasmania, received from Mr. W. L. May. The description is in a serial known to few local workers, and we therefore reprint the following original description:—

Shell, short-oval, moderately elevated, carinated, the side slopes slightly convex. Surface smooth to the naked eye, but finely granular. Color of valves and girdle uniform black above, or slightly brownish at the beaks when eroded.

The intermediate valves have almost straight sutures, even a trifle concave in old specimens, the beaks projecting a trifle in young ones. Lateral areas distinctly raised (the diagonal distinct and rather wide), sculptured with several arcuate indistinct growth marks, sometimes showing very slight traces of coarse, low pustules, but these are hardly mentionable; all over minutely granulose in diamond pattern. Central areas with faint growth-striae anteriorly, distinctly granulose at the sides, the granules arranged to form forward converging riblets, which, though slight, are apparent on the outer half of each valve; central portion of central areas smoothish, with faint granulation only, beaks smooth. End valves sculptured like lateral areas. Valve viii. with mucro projecting, at about the anterior third; the posterior slope concave below the mucro and then straight.

Interior dull blue-green, greener behind the rather heavy valve-callus, the depth of the cavity rather lead colour. Sutural laminae small, projecting less than half the length of a valve, sinus wide. Slits in valve i., 11, valves ii. to vii., 1-1; valve viii., 12-13. Teeth sharp, smooth and short.

Girdle black, clothed with densely imbricating, coarse, convex, smooth scales.

Length 8, breadth 6 mm.; large "curled" examples would measure at least 10 mm. long. Divergence the same as in *I. smaragdinus*.



*LIOLOPHURA CURTISIANA*, *Smith*.

*Chiton (Ischnochiton) curtisianus*, *Smith*, *Zool. Coll. Alert*, 1884, p. 78, pl. vi., f. D.

*Liolophura curtisiana*, *Pilsbry*, *Man. Conch.*, xiv., 1892, p. 242, pl. xxiv., f. 6.

*Enoplochiton torri*, *Bastow & Gatliff*, *Proc. Roy. Soc. Vict.*, xx., 1907, p. 27, pl. iii, iv.

This shell is common near Gladstone, where Dr. Torr, Mr. T. Iredale, and one of us have gathered it. Messrs. Bastow and Gatliff appear to have overlooked the original description and to have redescribed it as above.

*ACANTHOCHITES MAUGHANI*, *Torr & Ashby*.

(Plate lxxiv., fig. 24-27).

*Acanthochites maughani*, *Torr & Ashby*, *Trans. Roy. Soc. S. Austr.*, xxii., 1898, p. 218, pl. vii., f. 5.

This species, new to our coast, was taken by one of us (A.F.B.H.) at the Bottle and Glass Reef, and at Freshwater Bay, near Manly.

*ACANTHOCHITES WILSONI*, *Sykes*.

*Acanthochites (Notoplax) wilsoni*, *Sykes*, *Proc. Malacol. Soc.*, ii., 1896, p. 92, pl. vi., f. 2.

This species is rarer here than in the south, two specimens from Long Reef, near Narrabeen, being all that have been found. Except in size these correspond well to examples from St. Vincent Gulf, South Australia, collected and kindly forwarded by Dr. W. G. Torr. One N. S. Wales individual measured when dry 19.5x11 mm. Pilsbry's remark, quoted by Sykes, notes that "tufts seem quite absent." When alive the girdle of our specimens was very wide and fleshy, dark purple in colour, with small sutural tufts which disappeared in drying. From this we are unable to distinguish *A. verconis*, Torr and Ashby.<sup>4</sup>

*ACANTHOCHITES CARINATUS*, *Adams & Angas*.

*Acanthochites carinatus*, *Pilsbry*, *Man. Conch.*, xv., 1903, p. 17.

Mr. E. A. Smith regards this as identical with the European *A. discrepans*, while Dr. Pilsbry hints that a closer scrutiny may

---

<sup>4</sup>Torr and Ashby—*Trans. Roy. Soc. S. Austr.*, xxii., 1898, p. 217, pl. vi., f. 4.

discover structural differences. No such shell is known to us from Port Jackson, and we think that, as was the case in other instances, a foreign shell was accidentally included with Angas' Sydney collection.

*ACANTHOCHITES VARIABILIS, Adams & Angas.*

*Hanleya variabilis*, Adams & Angas, Proc. Zool. Soc., 1864, p. 194.

*Acanthochites (Loboplaea) variabilis*, Bednall, Proc. Malacol. Soc., ii., 1897, p. 156.

We can add to the fauna of New South Wales this brightly coloured and variable *Acanthochites*. It occurs generally on the coast line in the vicinity of Port Jackson and as far south as Bellambi. It affects sheltered pools and shows a preference for stones overgrown with *Halimeda*, selecting a position at or near the edge of the insertion of the stone in the sand, being rarely found underneath.

3

THE RESULTS OF DEEP-SEA INVESTIGATIONS IN THE  
TASMAN SEA.

I.—THE EXPEDITION OF H.M.C.S. "MINER."<sup>1</sup>

5.—THE POLYZOA.

By C. M. MAPLESTONE, Eltham, Vict.

(Plates lxxv.-lxxviii.)

I.—INTRODUCTION.

Some time ago I received for examination from Professor W. A. Haswell a very interesting collection of Polyzoa which had been dredged in about eighty fathoms at about twenty-two miles east of Port Jackson, by H.M.C.S. "Miner." Most of the specimens were "dead" and somewhat worn, showing, I consider, that the place from which they were obtained was a resting-place for an accumulation of material carried from a considerable distance by ocean currents. Very few, if any, seem to have been living on the spot.

The collection consisted of some roughly-sorted specimens and a small portion of unsorted material. I was doubtful when I received them whether I could undertake the examination. I am sorry to say that I cannot at present complete the task, but I have been able to deal with the most striking forms.

The *Biporæ* are by far the most interesting of them, of which there are six new species. A detailed description is given of these, and some other new species and one new genus, below.

The known species which I have been able to identify are as follow:—

- Caberea grandis*, Hincks.
- Membranipora gemmata*, Waters.
- "    *profunda*, McGil.
- "    *bellula*, Hincks.
- Cellaria australis*, McGil.
- Lunutites canaliculata*, McGil.

---

<sup>1</sup> Continued from Vol. VI., p. 311.

- Selenaria punctata*, Ten. Woods.  
 „ *maculata*, Busk.  
 „ *concinna*, Ten. Woods  
*Caleschara denticulata*, McGil.  
*Micropora coriacea*, Esper, sp.  
*Cribrilina radiata*, Moll., sp.  
*Microporella ciliata*, Linn., sp.  
*Adeona mucronata*, McGil.  
 „ *parvipuncta*, McGil.  
*Schizoporella flabellata*, Maplestone.  
 „ *cecilii*, Audouin, sp.  
*Bipora angulopora*, Ten. Woods.  
*Smittia reticulata*, McGil.  
*Mucronella praestans*, Hincks.  
*Rhyncopora longirostris*, McGil.  
*Porina gracilis*, Milne Ed., sp.  
*Cellepora fossa*, Haswell, sp.  
*Lagenipora nitens*, McGil.  
*Lekythopora hystrix*, McGil.  
*Idmonca contorta*, Busk.  
*Hornera foliacea*, McGil.  
*Lichenopora holdsworthii*, Busk, sp.

## II.—DESCRIPTIONS OF NEW SPECIES.

### BIPORA BIARMATA, *sp. nov.*

(Plate lxxv., figs. 1a, 1b.)

Zoarium conical, 2 mm. high, 1·5 mm. broad at the base; apex rounded. Zoecia immersed, in directly vertical series. Thyrostome elliptical, 0·1 to 0·15 mm. high; 0·07 to 0·1 mm. broad, elevated above the surface with a deep sinus in the lower lip. Peristome slightly raised. An avicularium on each side of the lower part of the thyrostome, bearing an acute mandible pointing horizontally outwards and having a cross-bar, with a central ligula, near the base. Base of zoarium flat, with uneven surface but with no indication of the position of the zoecia; avicularia similar to those on the front of the zoecia scattered about.

### BIPORA MULTIARMATA, *sp. nov.*

(Plate lxxv., figs. 2a, 2b.)

Zoarium conical, 2·2 mm. high, 1·7 mm. broad at the base. Zoecia immersed, in vertical, but slightly slanting series. Thyrostome 0·1 to 0·15 mm. high; 0·07 to 0·1 broad, raised,

irregularly elliptical, with a sinus in the lower lip; peristome thickened unequally, causing the aperture to be irregular in shape. Four to six very small oval avicularia arranged round the thyrostome and occasionally one on the thickened peristome. Base of zoarium nearly flat, with scattered avicularia, some similar to those on the front of the zooecia, others with an acute mandible similar to those on *B. biarmata*. No indication of the position of the zooecia.

*BIPORA MAGNIARMATA, sp. nov.*

(Plate lxxv., figs. 3a, 3b.)

Zoarium conical, 4 mm. high; 3 mm. broad at base. Zooecia immersed, in slightly slanting vertical series. Thyrostome elliptical; peristomes oval, very much thickened and raised; a ligulate operculum with a longitudinal fold; no indication of a sinus on the lower lip, probably hidden by the operculum. One large acute avicularium (sometimes two) opposite the thyrostomes in the hollow between the series of zooecia, pointing diagonally. Base of zoarium flat, with radial ridges indicating the position of the last series of zooecia and with scattered avicularia, some with round and some with acute mandibles.

*Obs.*—These three species are very similar in character. *B. biarmata* and *B. multiarmata* are so much alike that it requires a microscope to distinguish them. The principal difference in them is the size and number of avicularia on the surface of the zooecia; in *B. biarmata* there is one avicularium on each side of the thyrostomes with long acute mandibles pointing horizontally outwards; in *B. multiarmata* there are from four to six very small broadly oval avicularia ranged round the thyrostome. In both these species there is no indication of the position of the last series of zooecia. *B. magniarmata* is a slightly larger form, the apical angle is greater, there is a single series (sometimes two) of large avicularia between the rows of zooecia, and on the base there is a slight indication of the position of the last series of zooecia.

*BIPORA AMPULLA, sp. nov.*

(Plate lxxvi., figs. 4a, 4b, 5a and 5b.)

Zoarium disc-shaped but convex on the upper surface; 6 to 7 mm. in diameter; calcification covering the whole of the central portion of the upper surface, with a few small round avicularia and pores scattered about. Zooecia flask-shaped and with greatly extended tubular peristomes, which can be seen from above pro-

truding round the periphery. The thyrostome being far below in the tube of the peristome is not clearly visible; it is apparently oval, and on the summit of some of the peristomes there are two very minute circular avicularia. The central portion of the base of the zoarium is concave and mamillated, with minute circular avicularia on the summit of the mamillæ (or pores where they are broken away); the zooecia are ranged round the circumference of the zoarium.

*Obs.*—This is a very remarkable species. Viewed from above the central portion shows a convex calcareous surface with a few small circular avicularia with a bar, or small pores; round the margin are seen the long tubular peristomes radiating from the centre; there are two rows of them in the adult specimens.

In the "unsorted" material I found two small very young zoaria which I have mounted with the others; they show a star-like arrangement of zooecia with a few avicularia and mamillæ in the central calcified part.

The figures drawn show a half of the upper and under surfaces of two different specimens of medium size and the upper and under surfaces of two young zoaria.

BIPORA (CONESCHARELLINA?) EBURNEA, *sp.nov.*

(Plate lxxvii., figs. 6a, 6b.)

Zoarium disc-shaped; 4 to 5 mm. in diameter; concave in upper surface which is covered with low, large, irregularly disposed mamillæ which appear to have no correlation to the individual zooecia; the whole surface being minutely granulated. Zooecia totally immersed and undefined. Thyrostome depressed, transversely elliptical with a deep sinus in the lower margin; a very small oval avicularium on each side above. Under surface of the younger zoaria mamillated with small round avicularia on the summits. In the older zoaria the under surface is flat, with thick reticulated ridges with small round avicularia (sometimes absent) in the centre of the intervening flat circular depressions and in many of the depressions the calcareous surface is wanting so that they appear as large round perforations.

*Obs.*—This is probably referrible to D'Orbigny's genus *Conescharellina*.

BIPORA MAMILLATA, *sp.nov.*

(Plate lxxvii., fig. 7.)

Zoarium flat, irregularly oval in shape. Zooecia totally immersed and undefined. Thyrostome orbicular with a slightly

raised peristome ; one or two small elevated pores on lower margin. Surface of zoarium covered with mamillæ and numerous avicularia of various forms, some with sub-circular, some with oval, some with triangular mandibles ; one of them bears a striking resemblance to the thyrostome of *B. eburnea*, being semi-circular in shape with a sinus in the straight margin.

*Obs.*—This species, of which there is only one specimen, is very near *B. (Eschara) umbonata*, Haswell, but I consider it to be distinct from it. Haswell's description of the species says:—"Mouth varying in form, the lower lip sometimes straight, sometimes with a round central lobe. Surface ornamented with numerous rounded knobs of various sizes and small scattered avicularia," and his figure agrees with his description ; but a specimen lent to me some time ago by Mr. T. Whitelegge showed all the mouths (thyrostomes) to be broadly oval with a sharp sinus in the lower part and all the avicularia were small, elongated and oval. In the present species the thyrostomes are orbicular with no trace of a sinus, and have a slightly raised margin (peristome) and are much further apart, showing that the zooecia are much larger. The avicularia, as above stated, have variously shaped mandibles, and one, as noted, exactly resembles the thyrostome of *B. eburnea*, but is very much smaller.

SELENARIA NITIDA, *sp. nov.*

(Plate lxxvii., fig. 8.)

Zoaria discoid, slightly raised in the centre. Base flat and smooth. Zooecia in radiating lines, front surface with sub-quadrate ridges within which the thyrostome is raised ; surface granular. Thyrostome small, arched above, nearly straight below. Vibracular area elongated, constricted in the middle ; surface perforated, vibracular pit at distal end circular, with a notched process on the proximal end below the level of the opening.

*Obs.*—This is very near *S. concinna*, but the zooecia are uniformly smaller in size ; the vibracular area is different and the under surface of the zoaria is quite smooth.

HIANTOPORA PERFORATA, *sp. nov.*

(Plate lxxviii., fig. 9.)

Zoarium encrusting. Zooecia undefined, surface covered with large round pores. Thyrostomes broad, somewhat irregular in shape with raised margins and a prominent mucro on the proximal one ; elongated avicularia scattered about.

The pores on the surface of the zooecia are not always open ; many are closed with a calcareous layer which in some bears a small perforation ; the margins of the pores are very slightly raised and expanded, showing a suture between them. The thyrostomes are very irregular in shape owing to the presence sometimes of more than one mucro ; the avicularia have a semi-circular cavity and lateral processes at the basal end.

*CELLEPORA DOLIARIS, sp.nov.*

(Plate lxxviii., figs. 10a, 10b.)

Zoaria encrusting. Zooecia barrel-shaped, with encircling ribs, with small pores in the depressed spaces between the ribs ; closely aggregated. Thyrostomes orbicular. Peristomes thickened, with broad, flattened spines surrounding the thyrostomes. Small cornucopia-form avicularia between the zooecia.

*Obs.*—A very singular species. The upper surface shows a series of orbicular thyrostomes surrounded by high, flattened spines, and a few small cornucopia-shaped avicularia. The side view shows it as an aggregation of annulated barrels with a row of small pores between the rings with the funnel-like avicularia. The annulated and perforated side walls are very distinctive features.

*ZEUGLOPORA, gen.nov.*

Zoarium bilaminate, lanceolate. Zooecia on both surfaces, immersed, undefined. Thyrostome suborbicular, with a raised semi-elliptical ridge on proximal margin.

*Obs.*—This is a very interesting form of an escharine character. The shape of the zoarium is very like a long lanceolate leaf with crenulated edges. The thyrostome with the semi-elliptical ridge extending up each side is very distinctive and warrants the establishment of a new genus for its reception.

*ZEUGLOPORA LANCEOLATA, sp.nov.*

(Plate lxxviii., fig. 11.)

Zoarium bilaminate, lanceolate, with crenulated edges. Zooecia on both surfaces, immersed, totally undefined ; surface covered with scattered mamillations and some small oval avicularia. Thyrostome suborbicular with a raised semi-elliptical ridge on the proximal margin and extending about half-way up the sides. Under the microscope the crenulated edges of the zoarium are seen to be due to the projecting parts of the marginal zooecia.



LEKYTHOPORA AVICULARIS, *sp. nov.*

(Plate lxxviii., fig. 12.)

Zoaria erect, with zooecia on all sides. Zooecia flask-shaped, surface minutely granular with a few small perforations. Thyrostome orbicular with a raised margin in which is sometimes a minute pore, probably avicularian. On the front of some of the zooecia there is a long spatulate avicularium.

*Obs.*—This species differs from *L. hystrix* in that the necks of the flask-shaped zooecia are shorter, the thyrostome has a raised margin and in the presence of the long spatulate avicularia on the front of the zooecia. A single specimen.

MINERALOGICAL NOTES : No. VIII.—TOPAZ, ANGLE-SITE, AND OTHER AUSTRALIAN MINERALS.

By C. ANDERSON, M.A., D.Sc. (EDIN.), Mineralogist.

(Plates lxxix.-lxxxii.)

TOPAZ.

CARPET SNAKE CREEK, NEAR TORRINGTON, N. S. WALES.

(Plate lxxix., figs. 1, 2.)

The specimens here described consist of a small lot of isolated crystals and a fragment of matrix carrying one magnificent crystal and several smaller ones; they were acquired by the Trustees from Mr. Charles Bogenrieder, Mining Engineer. The figured crystal, which measures  $0.8 \times 1.5 \times 3.25$  cm., is loosely attached to a matrix consisting of a clayey decomposition product (evidently felspathic), quartz, wolfram, molybdenite, and a small quantity of a purplish mineral too minute for determination, but which is in all probability fluor spar. The topaz is closely moulded on the accompanying minerals, which therefore preceded it in most cases. No information is available regarding the geological conditions of its occurrence, but the hand specimen indicates a decomposed pegmatite vein as its original home.

The crystals are colourless, transparent, and of a uniform habit, belonging to the Russian domatic type; the crystallographic characters are very similar to those of the Emmaville topaz.<sup>1</sup> The faces, with the exception of the base which is always more or less rough, are highly polished and give good signals. Prism forms are numerous,  $m$  (110) being the best developed;  $l$  (120) has fairly large faces, but other forms in this zone are very narrow. Of the domes,  $f$  (021) and  $d$  (201) are prominent,  $y$  (041) and  $h$  (203) small;  $o$  (221) and  $u$  (111) are the most important pyramids. An interesting feature is the presence on the  $m$  faces of very distinct, quadrangular markings, resembling the

---

<sup>1</sup>Anderson—Austr. Mus. Rec., v., 1904, pp. 296-299; *Ib.*, vi., 1905, pp. 83-85.

“wachtums-figuren” described by Goldschmidt on the topaz from the Thomas Range, Utah.<sup>2</sup> The prism faces in general show a slight vertical striation. The dome *d* is striated somewhat irregularly in a direction parallel to its intersection with *o*; this is not due to oscillatory combination, but to etching, and, now and then, indications are seen of a definite etch-figure shaped somewhat like a pear with the blunt end directed upwards. The faces of *y* and *f* inter-oscillate.

Five crystals were measured on the two-circle goniometer; the mean angles obtained are tabulated below, together with the calculated values given by Goldschmidt<sup>3</sup> (Dana's axes and lettering are adopted).

Forms.		Measured				Calculated.				Difference.	
		$\phi$		$\rho$		$\phi$		$\rho$		$\phi$	$\rho$
		°	'	°	'	°	'	°	'	'	'
<i>c</i>	001	—		—		—		—		—	
<i>b</i>	010	0	6	90	0	0	0	90	0	6	0
<i>N?</i>	210	75	0	—	—	75	12	„	„	12	0
<i>m</i>	110	62	7½	90	0	62	8	„	„	—	—
<i>O?</i>	560	57	38	89	58	57	37	„	„	1	2
<i>M</i>	230	51	42	89	58	51	35	„	„	7	2
<i>r?</i>	7·13·0	46	1	—	—	45	32	„	„	29	—
<i>l</i>	120	43	25	90	0	43	25	„	„	0	0
<i>u?</i>	5·11·0	40	32	—	—	40	42	„	„	10	—
$\pi$	250	37	4	90	2	37	7	„	„	3	2
<i>g</i>	130	32	18	89	59	32	14	„	„	4	1
<i>n</i>	140	25	19	89	59	25	19	„	„	0	1
<i>f</i>	021	0	0	43	38	0	0	43	39	0	1
<i>y</i>	041	0	2	62	24	„	„	62	20	2	4
<i>h</i>	203	90	1	31	16	90	0	31	2	1	14
<i>d</i>	201	90	0	61	1	„	„	61	0	0	1
<i>i</i>	223	62	6	34	16	62	8	34	14	2	2
<i>u</i>	111	62	9	45	36	„	„	45	35	1	1
<i>o</i>	221	62	7½	63	55	„	„	63	54	½	1
<i>x</i>	243	43	20	41	10	43	25	41	12	5	2

Of the doubtful faces *N* and *r* were observed twice (images not good), *O* and *u* once each (images fairly good).

<sup>2</sup>Goldschmidt—Zeits. Kryst., xl., 1905, pp. 379, 382, pl. x., fig. 6b.

<sup>3</sup>Goldschmidt—Krystallographische Winkeltabellen, 1897, pp. 346-348.

The observed combinations are shown in the following table (ii. is the figured crystal).

Cryst.	<i>c</i>	<i>b</i>	<i>N</i>	<i>m</i>	<i>O</i>	<i>M</i>	<i>r</i>	<i>l</i>	<i>u</i>	$\pi$	<i>g</i>	<i>n</i>	<i>f</i>	<i>y</i>	<i>h</i>	<i>d</i>	<i>i</i>	<i>u</i>	<i>o</i>	<i>x</i>
i.	<i>c</i>	<i>b</i>	—	<i>m</i>	—	<i>M</i>	—	<i>l</i>	—	$\pi$	<i>g</i>	<i>n</i>	<i>f</i>	<i>y</i>	<i>h</i>	<i>d</i>	<i>i</i>	<i>u</i>	<i>o</i>	<i>x</i>
ii.	<i>c</i>	<i>b</i>	—	<i>m</i>	<i>O</i>	<i>M</i>	—	<i>l</i>	—	$\pi$	<i>g</i>	<i>n</i>	<i>f</i>	<i>y</i>	<i>h</i>	<i>d</i>	<i>i</i>	<i>u</i>	<i>o</i>	<i>x</i>
iii.	<i>c</i>	<i>b</i>	<i>N</i>	<i>m</i>	—	<i>M</i>	—	<i>l</i>	—	$\pi$	<i>g</i>	<i>n</i>	<i>f</i>	<i>y</i>	—	<i>d</i>	—	<i>u</i>	<i>o</i>	<i>x</i>
iv.	<i>c</i>	<i>b</i>	—	<i>m</i>	—	<i>M</i>	—	<i>l</i>	—	$\pi$	<i>g</i>	<i>n</i>	<i>f</i>	<i>y</i>	<i>h</i>	<i>d</i>	<i>i</i>	<i>u</i>	<i>o</i>	—
v.	<i>c</i>	<i>b</i>	<i>N</i>	<i>m</i>	<i>O</i>	<i>M</i>	<i>r</i>	<i>l</i>	<i>u</i>	$\pi$	<i>g</i>	—	<i>f</i>	<i>y</i>	<i>h</i>	<i>d</i>	<i>i</i>	<i>u</i>	<i>o</i>	<i>x</i>

From the means of a large number of excellent measurements yielded by the forms *m* and *o* the following axial ratio was calculated:— $a : b : c = .52894 : 1 : .47754$ .

### GYPSUM.

MOUNT ELLIOTT MINE, CHILLAGOE DISTRICT, QUEENSLAND.

(Plate lxxix., fig. 3.)

At this mine very fine examples of crystallised selenite are found in association with native copper; I am told that prismatic crystals ten feet in length have been obtained. The crystal figured measures  $2 \times 1.5 \times 20$  cm.; it is terminated by the fibrous fracture parallel to  $t$  ( $\bar{1}01$ ) and twinned on  $a$  (100). The forms were determined by measurement with a contact goniometer, the approximate angles obtained being:—

$$b(010) \wedge \delta(350) = 41^\circ; \text{ calc. } 41^\circ 22'.$$

$$b(010) \wedge m(110) = 55^\circ; \text{ calc. } 55^\circ 44'.$$

### ANGLESITE.

PROPRIETARY MINE, BROKEN HILL, N. S. WALES.

(Plate lxxx., fig. 1.)

Some brilliant colourless crystals of about 3 mm. diameter, associated with crystallised iodyrite and marshite, were observed on a limonitous matrix from this mine. Two crystals were measured and found to be anglesite of a type quite different from previously described Broken Hill anglesite.<sup>4</sup> The most prominent faces belong to  $a$  (100),  $o$  (011),  $y$  (122);  $m$  (110) and  $a$  inter-

<sup>4</sup>Toborlfy—Ann. Mus. Nat. Hung., v., 1907, pp.494-496, pl.xi., figs.1-6; *Id.*—Zeits. Kryst., xlv., 1908, pp. 601-603, pl. xi., figs. 1-6; Anderson—Austr. Mus. Rec., vii., 1908, pp. 63-65, pl. xiv.

oscillate and are deeply striated ; *a* (018) is doubtfully present as striated, slightly irregular planes giving poor reflections.

MEAN ANGLES.

Forms.		Measured.		Calculated.				Difference.	
		$\phi$	$\rho$	$\phi$	$\rho$	$\phi$	$\rho$	$\phi$	$\rho$
<i>c</i>	001	—	—	—	—	—	—	—	—
<i>a</i>	100	90 0	90 0	90 0	90 0	90 0	90 0	0	0
<i>m</i>	110	51 57	89 59	51 51	51 51	„	„	6	1
<i>a?</i>	018	—	10 14	0 0	0 0	9 9	9 9	—	1 5
<i>o</i>	011	0 1	52 11	„	„	52 12	52 12	1	1
<i>d</i>	102	89 57	39 24	90 0	90 0	39 23	39 23	3	1
<i>z</i>	111	51 54	64 25	51 51	51 51	64 24	64 24	3	1
	122	32 31	56 49	32 29	32 29	56 48	56 48	2	1

MONTALBION, WALSH AND TINAROO DISTRICT, QUEENSLAND.

(Plate lxxx., fig. 2.)

The occurrence of anglesite at the Montalbion mines has been noticed by Skertchly.<sup>5</sup> One specimen in which crystals of clear, colourless anglesite are seated on sandstone is in our collection. The habit is fairly uniform, the best developed forms being *m* (110) and *d* (102) ; *c* (001) and *d* are striated parallel to their intersections, but the reflections are generally good.

MEAN ANGLES.

Forms.		Measured.		Calculated.				Difference.	
		$\phi$	$\rho$	$\phi$	$\rho$	$\phi$	$\rho$	$\phi$	$\rho$
<i>c</i>	001	—	—	—	—	—	—	—	—
<i>b</i>	010	0 2	90 0	0 0	0 0	90 0	90 0	2	0
<i>m</i>	110	51 52	90 0	51 51	51 51	„	„	1	0
<i>o</i>	011	0 2	52 9	0 0	0 0	52 12	52 12	2	3
<i>d</i>	102	90 0	39 22	90 0	90 0	39 23	39 23	0	1
<i>z</i>	111	51 52	64 22	51 51	51 51	64 24	64 24	1	2
<i>r</i>	112	51 53	46 13	„	„	46 14	46 14	2	1
<i>p</i>	324	62 21	54 15	62 22	62 22	54 16	54 16	1	1

<sup>5</sup>Skertchly—Geol. Survey Q'land, Publication No. 119, 1897, pp. 29, 30.

## AZURITE.

MULDIVA, WALSH AND TINAROO DISTRICT, QUEENSLAND.

(Plate lxxx., fig. 3.)

This occurrence of azurite has been known for many years,<sup>6</sup> but its crystallography has not been investigated. A specimen, probably from the Paisley Mine, was recently secured by exchange with the Geological Survey of Queensland; it consists of numerous good crystals measuring up to about  $0.5 \times 1.5 \times 1$  cm. accompanied by small crystals of cerussite on a matrix of limonite. The crystals are constant in habit; elongated parallel to the  $b$  axis,  $a$  (100),  $m$  (110) and  $\theta$  ( $\bar{1}01$ ) having the largest faces. The dome faces are striated parallel to their edges. Five crystals were measured. Combinations are tabulated below.

Cryst.	$c$	$a$	$m$	$w$	$l$	$f$	$p$	$\sigma$	$\theta$	$\eta$	$v$	$h$	$k$	$o$
i.-ii.	$c$	$a$	$m$	$w$	$l$	$f$	$p$	$\sigma$		$\eta$	$v$	$h$	$k$	$o$
iii.	$c$	$a$	$m$	$w$	$l$	$f$	$p$	$\sigma$	$\theta$	$\eta$	—	—	$k$	$o$
iv.	$c$	$a$	$m$	$w$	$l$	$f$	$p$	$\sigma$	$\theta$	—	—	—	$k$	$o$
v.	$c$	$a$	$m$	—	$l$	$f$	$p$	$\sigma$	$\theta$	$\eta$	$v$	$h$	$k$	$o$

## MEAN ANGLES.

Forms.		Measured.				Calculated.				Difference.	
		$\phi$		$\rho$		$\phi$		$\rho$		$\phi$	$\rho$
$c$	001	90	0	2	24	90	0	2	24	0	0
$a$	100	89	57	89	59	„		90	0	3	1
$m$	110	49	25	89	59	49	39	„		14	1
$w$	120	30	18	89	59	30	29	„		11	1
$l$	023	4	0	30	45	4	5	30	28	5	17
$f$	011	2	48	41	37	2	43	41	23	5	14
$p$	021	1	27	60	32	1	22	60	25	5	7
$\sigma$	101	90	0	47	2	90	0	47	10	0	8
$\theta$	$\bar{1}01$	90	1	44	46	90	0	44	51	1	5
$\eta$	302	90	1	56	53	„		56	32	1	21
$v$	201	90	1	63	49	„		63	47	1	2
$h$	221	50	2	70	16	50	13	70	2	11	14
$k$	$\bar{2}21$	48	51	69	38	49	4	69	36	13	2
$o$	241	30	2	76	16	29	58	76	11	4	5

<sup>6</sup>Skertchly—*Loc. cit.* p. 36.

GIROFLA MINE, CHILLAGOE, QUEENSLAND.

(Plate lxxx., figs. 4, 5.)

This occurrence is represented in the Museum Collection by an exceedingly fine specimen of crystallised azurite associated with malachite and chalcocite. The azurite is of two generations, the earlier consisting of long prismatic crystals (to  $10 \times 2.5 \times 1.5$  cm.) of a deep velvety-blue colour and almost iridescent. The azurite is partly changed to malachite, which forms embedded patches of a vivid green; the later generation of smaller, better developed crystals implanted on the older azurite and in cavities is unaltered and well adapted for goniometric determination. The whole forms an extremely beautiful object.

Four crystals were measured; they are tabular on  $\mu$  ( $\bar{1}05$ ) and elongated parallel to the  $b$  axis. The largest faces are those of  $a$  (100),  $m$  (110) and  $\mu$ ; the base and the orthodome faces are strongly striated, as shown in the figures, and their signals overlap slightly. The following combinations were observed (iv. is figured).

Cryst.	$c$	$a$	$m$	$p$	$\sigma$	$\mu$	$n$	$\theta$	$\eta$	$h$	$Q$	$o$	$e$
i.	$c$	$a$	$m$	$p$	$\sigma$	$\mu$	$n$	$\theta$	$\eta$	—	—	—	—
ii.	$c$	$a$	$m$	$p$	$\sigma$	$\mu$	$n$	$\theta$	$\eta$	$h$	$Q$	—	—
iii.	$c$	$a$	$m$	—	$\sigma$	$\mu$	$n$	$\theta$	$\eta$	$h$	$Q$	—	—
iv.	$c$	$a$	$m$	$p$	$\sigma$	$\mu$	$n$	$\theta$	$\eta$	$h$	$Q$	$o$	$e$

MEAN ANGLES.

Forms.		Measured.				Calculated.				Difference.	
		$\phi$		$\rho$		$\phi$		$\rho$		$\phi$	$\rho$
		°	'	°	'	°	'	°	'	'	'
$c$	001	89	56	2	14	90	0	2	24	4	10
$a$	100	89	59	89	58	„	„	90	0	1	2
$m$	110	49	26	89	58	49	39	„	„	13	2
$p$	021	1	19	60	24	1	22	60	25	3	1
$\sigma$	101	89	59	47	1	90	0	47	10	1	9
$\mu$	$\bar{1}05$	90	10	10	11	90	0	9	23	10	48
$n$	102	90	9	25	27	„	„	25	28	9	1
$\theta$	101	90	1	44	51	„	„	44	51	1	0
$\eta$	302	90	2	56	41	„	„	56	32	2	9
$h$	221	49	58	69	57	50	13	70	2	15	5
$Q$	223	50	59	43	3	51	19	43	12	20'	9
$o$	$\bar{2}41$	29	53	76	17	29	58	76	11	5	6
$e$	$\bar{2}45$	27	50	38	34	27	53	38	33	3	1

## PHOSGENITE.

BROKEN HILL, N. S. WALES.

(Plate lxxxii., figs. 1, 2.)

The description is founded on a hand specimen of  $6 \times 5\frac{1}{2}$  cm. almost entirely composed of stout prismatic crystals colourless and nearly transparent. The figured crystal is a fragment of  $8 \times 4 \times 4$  mm., terminated below by the basal cleavage. The largest faces are  $c$  (001),  $m$  (110) and  $a$  (100), but the development is very irregular. The faces are in general somewhat etched, but the reflections are good. The  $m$  prism is slightly striated in the vertical direction.

## MEAN ANGLES.

Forms.		Measured.		Calculated.				Difference.	
		$\phi$	$\rho$	$\phi$	$\rho$	$\phi$	$\rho$	$\phi$	$\rho$
$c$	001	—	—	—	—	—	—	—	—
$a$	100	0 6	90 0	0 0	90 0			6	0
$m$	110	45 0	90 0	45 0	90 0			0	0
$n$	120	26 30	89 59	26 31	89 59			4	1
$o$	201	0 8	65 23	0 0	65 20			8	3
$x$	111	45 4	56 57	45 0	57 0			4	3
$w$	221	45 3	72 2	45 0	72 0			3	2
$s$	211	26 19	67 37	26 34	67 40			15	3

## MONAZITE.

TRUNDLE, NEAR CONDOBOLIN, N. S. WALES.

(Plate lxxxii., figs. 3, 4.)

We are indebted to Mr. Charles Bogenrieder for the loan of a collection of isolated crystals, the largest measuring approximately 3 cm. in greatest diameter. The colour is reddish-brown, the lustre good, but the faces in general are imperfect, being wavy and irregular. In habit they are tabular on  $a$  (100);  $v$  ( $\bar{1}11$ ) is a fairly large form. A probable new form,  $\rho$  ( $\bar{1}03$ ) is present as a rather large face, which, however, is wavy and gives only an approximate measurement. The pinacoid  $a$  is slightly striated



vertically. Three crystals were measured; the figures show a typical, partly idealised crystal with all the recognised forms except *g*.

## MEAN ANGLES.

Forms.		Measured.				Calculated.				Difference.	
		$\phi$		$\rho$		$\phi$		$\rho$		$\phi$	$\rho$
<i>c</i>	001	90	2	13	53	90	0	13	40	2	13
<i>a</i>	100	90	7	90	0	„	90	0		7	0
<i>m</i>	110	46	40	90	1	46	43	„		3	1
<i>n</i>	120	28	9	90	3	27	58	„		10	3
<i>g</i>	012	28	1	27	54	27	43	27	36	18	18
<i>e</i>	011	14	28	43	40	14	43	43	44	15	14
<i>u</i>	021	7	21	61	41	7	29	61	49	8	8
<i>x</i>	101	90	3	36	14	90	0	36	29	3	15
* <i>p</i>	$\bar{1}03$	—		3	36	„	4	50		—	1 14
<i>v</i>	$\bar{1}11$	38	44	49	35	38	37	49	50	7	15
<i>l</i>	$\bar{1}12$	28	43	27	10	28	12	27	42	31	2

## CALIFORNIA CREEK, MT. GARNET, QUEENSLAND.

(Plate lxxxii., fig. 5.)

This crystal, kindly lent by the Director of the National Museum, Melbourne, measures  $1 \times 3 \times 2.5$  cm. in the directions of the axes *a*, *b*, *c* respectively. It is brown in colour and is attached to a matrix of quartz and decomposed mica. In habit it is tabular on *a*(100); the faces are dull, and, for determination, pieces of cover-glass were attached; thus the angles obtained are approximate only. The probable new forms,  $\rho$ ( $\bar{1}03$ ) and  $\sigma$ ( $\bar{3}01$ ) were determined by the following measurements with contact goniometer:—

$$a' \wedge \sigma = 20^\circ, \text{ calc. } 20^\circ 17'.$$

$$a \wedge \rho = 94\frac{1}{2}^\circ, \text{ calc. } 94^\circ 50'.$$

In all ten forms are present, namely:—*c*(001), *a*(100), *m*(110), *l*(210), *x*( $\bar{1}01$ ),  $\rho$ ( $\bar{1}03$ ),  $\sigma$ ( $\bar{3}01$ ), *v*( $\bar{1}11$ ), *i*(211), *z*( $\bar{3}11$ ).

## CERUSSITE.

TOLWONG MINE, NEAR MARULAN, N. S. WALES.

(Plate lxxxii., fig. 6.)

The handspecimen consists of stout prismatic cerussite elongated parallel to the  $a$  axis, accompanied by galena, siderite, and pyrite. The cerussite is coated with galena so that the crystals are quite dark and opaque; they preserve their polish, however, and reflect well.

## MEAN ANGLES.

Forms.		Measured.				Calculated.				Difference.	
		$\phi$		$\rho$		$\phi$		$\rho$		$\phi$	$\rho$
		'	'	'	'	'	'	'	'	'	'
<i>b</i>	010	0	0	90	0	0	0	90	0	0	0
<i>m</i>	110	58	37	90	0	58	37	„	0	0	0
<i>x</i>	012	0	0	19	50	0	0	19	52	0	2
<i>k</i>	011	0	1	35	59	„	„	35	52	1	7
<i>i</i>	021	0	2	55	21	„	„	55	20	2	1
<i>v</i>	031	0	3	65	11	„	„	65	15	3	4
<i>p</i>	111	58	38	54	17	58	37	54	14	1	3

A REVISED CENSUS OF THE TERRESTRIAL  
MOLLUSCA OF TASMANIA.

By W. F. PETERD (Launceston) and C. HEDLEY, Conchologist.

(Plates lxxxii.-lxxxvii, and fig. 16.)

This paper is confined to the rehabilitation of species. We have endeavoured to supply illustrations of all Tasmanian land shells hitherto unfigured, to simplify the tangled synonymy and to arrange the species in genera and higher groups in harmony with modern classification.

Our work has been facilitated by the loan of the collection of the Tasmanian Museum, for which we are indebted to the kindness of the late Mr. Alexander Morton, the then Curator. Examples of most of the species have been added to the Australian Museum Collection.

Group O R T H U R E T H R A.

Family PUPIDÆ.

Genus V E R T I G O, Müller, 1774.

V E R T I G O L I N C O L N E N S I S, Coe.

*Pupa lincolnensis*, Cox, Proc. Zool. Soc., 1867, p. 39; *Id.*, Mon. Austr. Land Shells, 1868, p. 80, pl. xiv., f. 16. *Id.*, Pilsbry, Proc. Acad. Nat. Sci. Philad., 1900, p. 428. *Id.*, (*P. tasmanica*) Johnston, Proc. Roy. Soc. Tas., 1882 (1883) p. 144, pl. i.

*Hab.*, Swansea. Obtained plentifully on the sand-dunes; extends to South Australia.

Group H E T E R U R E T H R A.

Family SUCCINEIDÆ.

Genus S U C C I N E A, *Draparnaud*, 1801.

S U C C I N E A A U S T R A L I S, *Ferussac*.

*Succinea australis*, Ferrussac, Tabl. Syst., ii., 1821, p. 27. *Id.*, Gray, Ann. Phil., 1825, p. 415, pl. ix. *Id.*, Ferrussac and Deshayes, Hist. Nat. Moll. Terr. et Fluv., ii., pt. 2, n.d., p. 137, pl. xi., fig. 11. *Id.*, Quoy et Gaim. Voy. Astrolabe, Zool., ii, 1832, p. 150, pl. xiii., f. 19-23.

*S. legrandi*, Cox in Legrand, Coll. Mon., 1871, sp. 2.

Var. *queenboroughensis*, Petterd, Mon. Tas. Land Shells, 1879, p. 49.

*Hab.*—Generally distributed and abundant in moist places.

*Obs.*—We consider this to be the shell usually called *Succinea strigata*, Pfr., originally described from Port Clarence, Behring Strait. The localities for the types of *S. australis* are Kangaroo Island and the Isles of St. Peter and St. Francis in South Australia.

#### SUCCINEA TAMARENSIS, *Petterd.*

(Plate lxxxii., fig. 1).

*Succinea australis*, Fer., var. *tamarensis*, Petterd, Mon. Tas. Land Shells, 1879, p. 49.

This was given as a variety of the generally distributed species of *Succinea* in the Monograph of Tasmanian Shells, but as pointed out *in litteris* by the late Professor Ralph Tate it is very distinct and resembles the European *S. Pfeifferi*.

The shell is acuminate, very thin, with a long attenuate spire. It is invariably thickly coated, with a layer of dark mud, and is then most difficult to recognise at its restricted habitat.

It is well worthy of a specific appellation.

Figured from a co-type, 9 mm. long, presented by Mr. W. F. Petterd to the Australian Museum.

*Hab.*—In the tea-tree swamps on the western margin of the Tamar River, near Launceston.

#### Group SIGMURETHRA.

##### Subgroup HOLOPODA.

##### Family ACAVID.E.

#### Genus ANOGLYPTA, *Martens*, 1860.

##### ANOGLYPTA LAUNCESTONENSIS, *Reeve.*

*Helix launcestonensis*, Reeve, Proc. Zool. Soc., 1852 (1853), p. 31, pl. xiii., f. 11, a-c.

*Anoglypta launcestonensis*, Hedley, Proc. Linn. Soc. N. S. Wales, (2), vi., 1891, p. 22, pl. ii., f. 5, pl. iii., f. 2.

*Hab.*—North-east Tasmania. About Scottsdale this fine shell may be collected in the dense myrtle scrub amid decaying vegetable matter and under logs.

Genus CARYODES, *Albers*, 1850.CARYODES DUFRESNII, *Leach*.

*Bulinus dufresnii*, Leach, Zool. Miscell., ii, 1815, p. 154, p. cxx.  
*Id.*, Ferussac, Tabl. Syst., 1821, p. 48.

*Caryodes dufresnii*, Semper, Reis. Phil., iii., 1870, p. 103, pl. xii.,  
f. 23, 24, 25, pl. xvi., f. 7. *Id.*, Hedley, Proc. Linn. Soc.  
N. S. Wales, (2), vi., 1891, p. 19, pl. i., f. 1, pl. ii., f. 1. *Id.*,  
Pilsbry, Man. Conch., xiii., 1900, p. 125, pl. v., f. 85-93.

*Hab.*—Generally distributed. It varies within certain limits,  
in both size and colouration, the largest being found in moist  
thick scrub. Noted localities are Mt. Wellington, Ringarooma,  
Magnet Range and Mt. Farrell.

Genus CHLORITIS, *Beck*, 1837.CHLORITIS BRUNONIA, *Johnston*.

(Plate lxxxii, figs. 2, 3, 4).

*Helix brunonia*, Johnston, Proc. Roy. Soc. Tas., 1887, p. 75.

*Obs.*—In moist situations in tea-tree scrub. This species is very  
closely allied to, if not identical with *Helix victoria*, Cox, from  
the opposite mainland of Victoria.

It belongs to a genus not known to occur in Tasmania; so far  
it is only recorded from the locality stated.

Figured from Johnston's type in the Tasmanian Museum.

*Hab.*—The Springs, Cape Wickham, King Island.

## Family BULIMULIDÆ.

Genus BOTHRIEMBRYON, *Pilsbry*, 1894.BOTHRIEMBRYON GUNNII, *Sowerby*.

*Bulinus gunnii*, Sowerby in Strzelecki, Phy. Descrip. N.S. Wales,  
etc., 1845, p. 298, pl. xix., f. 6 (not 5 as quoted.)

*Bulinus tasmanicus*, Pfeiffer, Proc. Zool. Soc., 1851 (1853),  
p. 260. *Id.*, Hedley, Proc. Linn. Soc. N. S. Wales, (2), vi.,  
1891, p. 21, pl. ii., f. 2.

*Bothriembryon gunnii*, Pilsbry, Man. Conch., (2), xiii., 1900,  
p. 18, pl. iii., f. 50, 51, 52.

Var. *brachysoma*, Pilsbry, *op. cit.*, p. 19, pl. iii., f. 53.

*Hab.*—East Coast. Near the sea on trees and bushes. It is gregarious and very plentiful, but only known as from the east coast.

### Subgroup AGNATHOMORPHA.

#### Family RHYTIDIDÆ.

Genus RHYTIDA, *Albers*, 1860.

#### RHYTIDA LAMPRA, *Reeve*.

*Helix lampra*, *Reeve*, *Conch. Icon.*, vii., 1854, pl. clxxxvi., sp. 1295. *Id.*, *Pfeiffer*, *Proc. Zool. Soc.*, 1854 (1855), p. 53.

*Rhytida lampra*, *Hedley*, *Proc. Linn. Soc. N. S. Wales*, (2), vi., 1893, p. 23, pl. ii., f. 8, 9, pl. iii., f. 3.

*Hab.*—Confined to the northern portion of Tasmania.

#### RHYTIDA LAMPROIDES, *Cox*.

*Helix lamproides*, *Cox*, *Proc. Zool. Soc.*, 1867, p. 722. *Id.*, *Cox*, *Mon. Austr. Land Shells*, 1868, p. 28, pl. x., f. 13. *Id.*, (*Patula*), *Cox* in *Legrand*, *Col. Mon.*, 1871, sp. 7. *Id.*, *Petterd*, *Mon. Tas. Land Shells*, 1879, p. 3.

*Hab.*—This species is very distinct from all others found in Tasmania; it is strictly confined to the north-western scrubs where it is not uncommon. At the Montague River it reaches its maximum size, being but little inferior to *H. launcestonensis* in this respect. The specimens that Dr. Cox had under review were but half-grown.

The bluntly angular periphery is very characteristic.

#### RHYTIDA RUGA, *Cox*.

*Helix ruga*, *Cox* in *Legrand*, *Col. Mon.*, 1871, sp. 24, pl. i., fig. 5. *Id.*, *Petterd*, *Mon. Tas. Land Shells*, 1879, p. 7.

*Obs.*—This is easily separable from the last and preceding by its constant smaller size and sculpture. It is absolutely distinct and need not be confused with any of its congeners.

*Hab.*—North, south and east coasts, always in dry positions in open forest, and usually under stones.

It is not known from the western portion of the island.

## RHYTIDA SINCLAIRI, Pfeiffer.

*Helix sinclairi*, Pfr., Zeitsch. Mal., iii., 1845, p. 154. *Id.*, Reeve, Conch. Icon., vii., 1854, p. ccv, f. 1444 a. b. *Id.*, Johnston, Proc. Roy. Soc. Tas., 1882 (1883), p. 49.

*Rhytida sinclairi*, Suter, Ann. Mag. Nat. Hist., (6), xiii., 1894, p. 64.

*Helix bombycina*, Pfr., Proc. Zool. Soc., 1854 (1855), p. 54.

*Helix dubitans*, Cox in Legrand, Col. Mon., 1871, sp. 29, pl. ii., f. 7.

*Helix vexanda*, Cox, *op. cit.*, sp. 43.

*Helix margatensis*, Cox, *op. cit.*, sp. 54.

*Helix quæstiosa*, Cox, *op. cit.*, s. 59.

*Hab.*—Generally distributed, but only in favourable positions in dense damp scrub.

## Genus PARYPHANTA, Albers, 1850.

## PARYPHANTA MILLIGANI, Pfeiffer.

*Vitrina milligani*, Pfr., Proc. Zool. Soc., 1852 (1854), p. 56. *Id.*, Reeve, Conch. Icon., xiii., 1862, pl. iii., f. 18 a. b.

*Hab.*—Macquarie Harbour, in the thick pine and myrtle forests.

## PARYPHANTA FUMOSA, Tenison Woods.

*Helicarion fumosa*, Ten. Woods, Proc. Linn. Soc. N. S. Wales, iii., 1879, p. 124, pl. xii., f. 3, 3a.

*Paryphanta fumosa*, Murdoch, Trans. N.Z. Inst., xxxv., 1904, pp. 156-160, pl. vi.

*Obs.*—The specific distinction between this and the foregoing is slight.

*Hab.*—Duck River, Mt. Montague, Mt. Bischoff.

## PARYPHANTA DYERI, Petterd.

(Plate lxxxvi, figs. 38, 39, 40).

*Helix dyeri*, Petterd, Mon. Tas. Land Shells, 1879, p. 40; Journ. Conch., ii., 1879, p. 210.

*Obs.*—We figure a specimen in the Australian Museum collection from Distillery Creek, Launceston. Height, 1.8; maj. diam., 3; min. diam., 2.2 mm.

*Hab.*—North Tasmania. The type specimens were collected at Distillery Creek, near Launceston, where the species occurs in the scrub on the banks of the stream.

Genus DELOS, *Hutton*, 1904.

DELOS NELSONENSIS, *Brazier*.

*Helix nelsonensis*, *Brazier*, Proc. Zool. Soc., 1870, p. 661.

*Rhenea nelsonensis*, *Suter*, Ann. Mag. Nat. Hist., (6), xiii., 1894, p. 64.

*Helix fulgetrum*, *Cox* in *Legrand*, Coll. Mon., 1871, sp. 31, pl. i, f. 11.

*Hab.*—Generally distributed, but only in certain widely separate localities such as Mt. Nelson, Recherche Bay, Chudleigh, Surrey Hills, Mt. Bischoff, and in the vicinity of Launceston.

Subgroup AULACOPODA.

Family ENDODONTIDÆ.

Genus ENDODONTA, *Albers*, 1850.

ENDODONTA ALBANENSIS, *Cox*.

*Helix albanensis*, *Cox*, Proc. Zool. Soc., 1867 (1868), p. 723; Mon. Austr. Land Shells, 1868, p. 15, pl. iv., f. 2.

*Charopa albanensis*, *Hedley*, Proc. Linn. Soc. N. S. Wales., (2), vii., 1892, p. 163, pl. ii., f. 5, 6, 7, 8.

*Endodonta albanensis*, *Hedley*, Austr. Mus. Rec., ii., 1896, p. 104.

*Helix officieri*, *Cox* in *Legrand*, Coll. Mon., 1871, sp. 57.

*H. macdonaldi*, *Cox*, *op. cit.*, sp. 32, pl. i., f. 14.

*H. kingstonensis*, *Cox*, *op. cit.*, sp. 40, pl. ii., f. 5.

*H. stanleyensis*, *Petterd*, Mon. Tas. Land Shells, 1879, p. 32.

*H. petterdiana*, *Taylor*, Journ. Conch., ii., 1879, p. 287.

*Hab.*—Generally distributed. Extends to Western Australia and N. S. Wales. One of the most abundant species which is extremely plentiful about the Nut at Circular Head.

ENDODONTA ANTIALBA, *Beddome*.

*Helix antialba*, *Beddome*, Proc. Roy. Soc. Tas., 1879, p. 23

*Id.*, *Petterd*, Mon. Tas. Land Shells, 1879, p. 41.

*Endodonta antialba*, *Hedley*, Proc. Linn. Soc. N. S. Wales., (2), vii., 1892, p. 166, pl. i., f. 5, 6, 7, 8.

*Hab.*—Mount Bischoff. Fairly plentiful under logs and in moist positions. Noted for the fact that half the specimens are milk-white and the balance brown colour.



ENDODONTA ARCHITECTONICA, *Brazier*.

(Plate lxxxv., figs. 29, 30, 31.)

*Helix architectonica*, Brazier, Proc. Zool. Soc., 1871, p. 696.*H. assimilis*, Brazier, *op. cit.*, p. 697 (not *H. assimilis*, H. Adams).*H. spectra*, Cox in Legrand, Col. Mon., 1871, sp. 55.*H. gunnii*, Brazier, Proc. Roy. Soc. Tas., 1876 (1877), p. 168.*Obs.*—The original of our figure (Australian Museum) is from Hobart. Height, 4; maj. diam., 3.3; min. diam., 2.85 mm.*Hab.*—Mount Wellington, Recherche Bay, Myrtle Bank, Mount Farrell, and Magnet Range.ENDODONTA BARRENENSIS, *Petterd*.

(Plate lxxxvii., figs. 41, 42, 43.)

*Helix barrenensis*, Petterd, Mon. Tas. Land Shells, 1879, p. 38 : Journ. Conch., ii., 1879, p. 247.*Obs.*—Drawn from one of the type series in the Tasmanian Museum. Height, 0.85; maj. diam., 2; min. diam., 1.75 mm.*Hab.*—Furneaux Group, Bass Strait. This species is apparently confined to the locality given where it clusters in depressions on the sand dunes.ENDODONTA BASSI, *Brazier*.

Fig. 16.

*Helix ammonitoides*, Brazier, Proc. Zool. Soc., 1870, p. 661 (not *H. ammonitoides*, Reeve).*Helix bassi*, Brazier, Proc. Zool. Soc., 1871, p. 699.

*Helix rigens*, Cox in Legrand, Col. Mon., 1871, sp. 30, pl. i., f. 12.

*Helix lottah*, Petterd, Mon. Tas. Land Shells, 1879, p. 37; Journ. Conch., ii., 1879, p. 216.

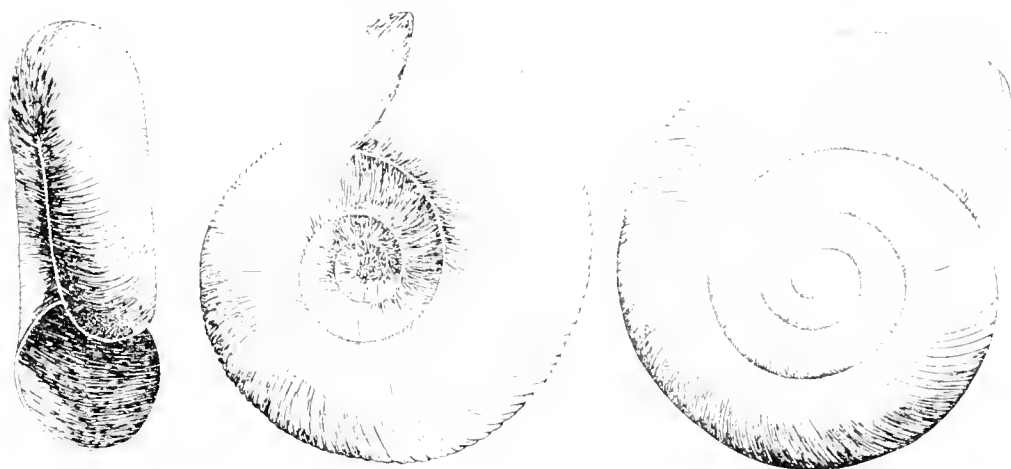
*Obs.*—Our figure was drawn from a specimen in the Tasmanian Museum labelled "Mount Nelson." Height, 0·8; maj. diam., 3; min. diam., 2·4 mm.

*Hab.*—Launceston, Mount Nelson, and Domain, Hobart.

ENDODONTA DISPAR, *Brazier*.

(Plate lxxxiv., figs. 17, 18, 19.)

*Helix dispar*, Brazier, Proc. Zool. Soc., 1870, p. 661; *Op. cit.*, 1871, p. 699.

*Obs.*—Figured from Brazier's type in the Australian Museum. Height, 2; maj. diam., 2·85; min. diam., 2·45 mm.

*Hab.*—Mount Wellington, Mount Bischoff, Chudleigh, Middlesex, Mount Farrell and Blue Tier.

ENDODONTA HOOKERIANA, *Johnston*.

*Helix hookeriana*, Johnston in Petterd, Mon. Tas. Land Shells, 1879, p. 38.

*Endodonta hookeriana*, Hedley, Proc. Linn. Soc. N. S. Wales, xxix., 1904, p. 182, pl. viii., f. 1-3.

*Hab.*—Surrey Hills. On trunks of dead trees, under moss, and in damp scrub.

ENDODONTA LEGRANDI, *Cox*.

*Helix legrandi*, Cox, Mon. Austr. Land Shells, 1868, p. 23, pl. xii., f. 7.

*Helix kershawi*, Petterd, Mon. Tas. Land Shells, 1879, p. 28.

*Obs.*—The author of this species appears to have distributed *E. ricei*, under this name. What passes in all collections as *H. legrandi* is a species at variance with the original figure and description.

*Hab.*—Near Launceston, River Mersey, Circular Head, Table Cape, Mt. Bischoff and Mt. Farrell

ENDODONTA RICEI, *Brazier*.

(Plate lxxxiii., figs. 11, 12, 13.)

*Helix ricei*, Brazier, Proc. Zool. Soc., 1870 (1871), p. 660.*Helix rotella*, Brazier, *op. cit.* (colour variation).*Helix onslowi*, Brazier in Legrand, Coll. Mon., 1871, sp. 46. *Id.*,  
Ancey, Journ. de Conch. xlix., 1901, p. 146, footnote.

*Obs.*—This is usually known by the name of *H. legrandi*, Cox. Authors have compared it with *H. iuloides*, Forbes, but it more nearly approaches *H. funerea*, Cox, from which it differs by narrower umbilicus, greater height in proportion to diameter and finer sculpture. We illustrate an example from Maria Island (in the Tasmanian Museum). Height, 2·5; maj. diam. 4·6; min. diam., 3·7 mm.

*Hab.*—Generally distributed; it is one of the most widely distributed species and very constant in character, but a white variety has been obtained

ENDODONTA MIMOSA, *Petterd*.

(Plate lxxxvi., figs. 32, 33, 34.)

*Helix mimosa*, Petterd, Mon. Tas. Land Shells, 1879, p. 33;  
Journ. Conch., ii., 1879, p. 211.

*Obs.*—A specimen from the Tasmanian Museum, one of the type series, is here figured. Height, 0·85; maj. diam., 1·65; min. diam., 1·35 mm.

*Hab.*—Launceston. Among mosses on the branches of trees.

ENDODONTA SERICATULA, *Pfeiffer*.*Helix sericatula*, Pfr., Proc. Zool. Soc., 1849 (1850), p. 127. *Id.*,  
Reeve, Conch. Icon., vii., 1852, pl. cxxxii., f. 812. *Id.*, Cox,  
Mon. Austr. Land Shells, 1868, p. 12, pl. xii., f. 6, 6a.*Helix limula*, Cox, in Legrand, Coll. Mon., 1871, sp. 72.

*Hab.*—North Tasmania. Extends to N. S. Wales. This has only been found in the scrubs about the northern portion of the island.

ENDODONTA TAMARENSIS, *Petterd*.*Helix tamarensis*, Petterd, Mon. Tas. Land Shells, 1879, p. 30.*Endodonta tamarensis*, Hedley, Proc. Linn. Soc. N. S. Wales,  
xxvii., 1903, p. 605, pl. xxxi., f. 18, 19, 20; Austr. Mus.  
Rec., ii., 1896, p. 104.

*Helix rosacea*, Petterd, Journ. Conch., ii., 1879, p. 213 (not *Helix rosacea*, Müller, 1774).

*Hab.*—North Tasmania. Extends through Victoria to Mount Kosciusko, N. S. Wales. At the rifle butts near Launceston it is extremely abundant; in fact it is the only locality hitherto discovered in this island.

ENDODONTA TASMANIÆ, *Coc.*

*Helix tasmanicæ*, Cox, Mon. Austr. Land Shells, 1868, p. 22, pl. xii., f. 4.

*Endodonta tasmanicæ*, Hedley, Aust. Mus. Rec., ii., 1896, p. 104.

*Hab.*—Mount Wellington, George Bay, and Recherche Bay. Recurs on Mount Kosciusko, N. S. Wales. So far this species has not been detected in the northern or western portions of the island.

ENDODONTA SUBRUGOSA, *Brazier.*

*Helix subrugosa*, Brazier in Legrand, Col. Mon., 1871, sp. 68.

*Id.*, Brazier, Proc. Zool. Soc., 1871, p. 697. *Id.*, Petterd, Mon. Tas. Land Shells, 1879, p. 35.

*Obs.*—This is a really beautiful little shell, very boldly sculptured and differing from its nearest ally, *H. dispar*, by not possessing the bold characteristic tooth inside the aperture. The general sculpture, riblets and finer lines, also differ from that species.

The depression of the last whorl near the aperture is extremely characteristic of the species.

*Hab.*—Mount Wellington, Chudleigh, Lottah, Blue Tier, Myrtle Bank, Mt. Farrell.

GENUS CYSTOPELTA,<sup>1</sup> *Tate*, 1881.

CYSTOPELTA PETTERDI, *Tate.*

*Cystopelta petterdi*, Tate, Proc. Roy. Soc. Tas., 1880 (1881), p. 17. *Id.*, Hedley, Proc. Linn. Soc. N. S. Wales, (2), v., 1890, p. 44, pl. i.; Hedley, *op. cit.*, vii., 1891, p. 24, pl. iii., f. 5.

<sup>1</sup> This name, proposed by Tate (Proc. Roy. Soc. Tas. 1880-1881-), has escaped the compilers of the Zoological Record.

*Obs.*—This form is probably related to *Ranfurlya constanceæ*, Suter.<sup>2</sup>

*Hab.*—North Tasmania, and extends to Victoria and N.S. Wales. In the vicinity of Launceston this species is gregarious; hiding under logs in somewhat exposed positions. It is not by any means abundant.

CYSTOPELTA BICOLOR, *sp. nov.*

*Obs.*—The most notable peculiarity of this undoubted new species of *Cystopelta* is the striking colouration; the contrast of the rich brown upper surface with the bright green of the lower portions of the animal at once arrests attention.

The preliminary description may be stated as follows:—Mantle thick, does not nearly cover the whole animal surface somewhat rough and rugosely wrinkled, colour a rich chocolate-brown, with minute specks of a darker shade; foot, elongate, tapering, of a bright pale-green colour; mucus distinctly green; tentacles four in number, the upper smooth, black at apex; lower part short. Length, 22 millimetres; width, 7 mill.

This slug is apparently confined to the western portion of the island; it is usually found singly in low trees. The specimens were obtained in the head of a fallen *Melaluca* tree that had smashed down on the scrub and let in the sun. The tree had been down some time, as told by the litter of rotting leaves and sticks. Other examples have been secured under logs, but it may be considered that the animal is usually arboreal in habit and thus, as well as in other respects, differing so essentially from *C. petterdi*. From its habits it is rare or rather difficult to obtain. All the specimens collected are exactly alike, except a slight variation in size.

*Hab.*—Magnet Range and Upper Pieman River.

Genus LAOMA, *Gray*, 1849.

LAOMA WELDII, *Tenison Woods*.

(Plate lxxxiii., figs. 8, 9, 10.)

*Helix weldii*, Ten. Woods, Proc. Roy. Soc. Tas. (1876) 1877, p. 160.

*Laoma weldii*, Suter, Ann. Mag. Nat. Hist., (6), xiii., 1894, p. 64.  
Petterd, Mon. Tas. Land Shells, 1879, p. 23.

---

<sup>2</sup> Suter—Journ. Mal., x., 1903, p. 62, pl. iv. (from the Auckland Islands, N.Z.)

*Obs.*—Figured from a specimen from Circular Head in the Australian Museum. Height, 1.2; maj. diam., 1.85; min. diam. 1.6 mm.

*Hab.*—Circular Head. Plentiful around The Nut.

LAOMA MORTI, *Cox.*

*Helix morti*, Cox, Ann. Mag. Nat. Hist., (3), xiv., 1864, p. 182; Cat. Austr. Land Shells, 1864, p. 22; Mon. Austr. Land Shells, 1868, p. 21, pl. xi., f. 13.

*Helix paradoxa*, Cox, Cat. Austr. Land Shells, 1864, p. 21.

*Helix hobarti*, Cox, Mon. Austr. Land Shells, 1868, p. 22 (not pl. xii., f. 11, as quoted).

*Helix similis*, Cox, Mon. Austr. Land Shells, 1868, p. 23, pl. xii., f. 12 (not *H. similis*, C. B. Adams)

*Helix derelicta*, Cox in Legrand, Coll. Mon., 1871, sp. 11.

*Helix stellata*, Brazier, Proc. Zool. Soc., 1870, p. 662.

*Helix arenicola*, Tate, Proc. Linn. Soc. N. S. Wales, ii., 1878, p. 291.

*Helix discors*, Petterd, Proc. Roy. Soc. Tas., 1900 (1902), p. 2.

*Hab.*—Generally distributed. Extends to S. Australia, Victoria and N. S. Wales. Always in dry positions nestling under stones.

LAOMA PICTILIS, *Tate.*

(Plate lxxxvi., figs. 35, 36, 37.)

*Helix pictilis*, Tate, Proc. Linn. Soc. N. S. Wales, ii., 1878, p. 290.

*Id.*, Petterd, Mon. Tas. Land Shells, 1879, p. 17.

*Laoma pictilis*, Suter, Ann. Mag. Nat. Hist., (6), xiii., 1894, p. 64.

*Obs.*—Figured from a specimen in the Australian Museum from Duck Creek, Circular Head. Height, 3.75; maj. diam., 4; min. diam., 3.5 mm.

*Hab.*—North-west Tasmania. Extends to S. Australia and Victoria. Quite recently this distinct form has been collected at the Alum Rocks, Brown's River road.

LAOMA CESUS, *Cox.*

*Helix cesus*, Cox, in Legrand, Coll. Mon., 1871, sp. 21, pl. i., f. 4.

*Helix occultus*, Cox, in Legrand, Coll. Mon., 1871, sp. 23, pl. i., f. 6.

*Laoma cesus*, Suter, Ann. Mag. Nat. Hist., (6), xiii., 1894, p. 64.

*Hab.*—Widely distributed, but very local. At Recherche Bay, Southport, Circular Head, and islands in Bass Straits, it occurs literally in countless numbers, usually but a trifle above tide mark.

LAOMA MINIMA, *Cox.*

*Helix minima*, Cox, Mon. Austr. Land Shells, 1868, p. 10, pl. xii., f. 8.

*Helix collisi*, Brazier, Proc. Roy. Soc. Tas., 1876 (1877), p. 168.

*Helix heuryana*, Petterd, Mon. Tas. Land Shells, 1879, p. 21.

*Laoma heuryana*, Suter, Ann. Mag. Nat. Hist., (6), xiii., 1894, p. 64.

*Helix furneauxensis*, Petterd, Mon. Tas. Land Shells, 1879, p. 21; Journ. Conch., 1879, p. 215.

*Laoma furneauxensis*, Suter, Ann. Mag. Nat. Hist., (6), xiii., 1894, p. 64.

*Obs.*—Dr. Cox's type of *Helix minima*, preserved in the Australian Museum, has served as a standard for the above synonymy.

*Hab.*—Generally distributed, but never abundant. It is apparently confined to dry positions, hiding under small stones and decaying leaves.

LAOMA HALLI, *Cox.*

*Helix halli*, Cox in Legrand, Coll. Mon., 1871, sp. 34, pl. ii., f. 9.

*Id.*, Petterd, Mon. Tas. Land Shells, 1879, p. 22.

*Laoma halli*, Suter, Ann. Mag. Nat. Hist., (6), xiii., 1894, p. 64.

*Hab.*—Generally distributed and common.

LAOMA SPICERI, *Petterd.*

(Plate lxxxvii., figs. 47, 48, 49, 50.)

*Helix spiceri*, Petterd, Mon. Tas. Land Shells, 1879, p. 23; Journ. Conch., ii., 1879, p. 212.

*Obs.*—Drawn from a specimen in the Tasmanian Museum labelled New Norfolk. Height, 0·95; maj. diam., 1·5; min. diam., 1·3 mm.

*Hab.*—Generally distributed. This has been collected at many widely separated localities, at all of which it is fairly plentiful.

LAOMA TRUCANINI, *Petterd.*

(Plate lxxxvii., figs. 44, 45, 46.)

*Helix trucanini*, Petterd, Mon. Tas. Land Shells, 1879, p. 19.

*Laoma pipaensis*, Suter, Ann. Mag. Nat. Hist., (6), xiii., 1894, p. 64.

*Obs.*—Drawn from a specimen in the Australian Museum Height, 1·45 ; maj. diam., 2·2 ; min. diam., 1·85 mm.

*Hab.*—Launceston, near the First Basin ; among moss on the branches and trunks of trees ; also more sparingly on rocks overgrown by mosses.

It is of gregarious habit being commonly found in large numbers. It has also been collected at the Piper River under similar conditions. It is certainly distinct from all the other small *Helices* with which it associates.

LAOMA JUNGERMANNIÆ, *Petterd.*

(Plate lxxxv., figs. 26, 27, 28.)

*Helix jungermanniæ*, Petterd, Mon. Tas. Land Shells, 1879, p. 17 ; Journ. Conch., ii., 1879, p. 213.

*Flammulina jungermanniæ*, Suter, Ann. Mag. Nat. Hist., (6), xiii., 1894, p. 64.

*Obs.*—Figured from an author's specimen in the Australian Museum. Height, 1·5 ; maj. diam., 2·5 ; min. diam., 2·05 mm.

*Hab.*—Launceston, found almost under the same conditions as the last but not nearly so plentiful.

LAOMA PARVISSIMA, *Cox.*

*Helix parvissima*, Cox in Legrand, Coll. Mon., 1871, sp. 39, pl. ii., f. 1.

*Endodonta parvissima*, Hedley, Austr. Mus. Rec., ii., 1896, p. 104. *Id.*, Petterd, Mon. Tas. Land Shells, 1879, p. 22.

*Hab.*—Generally distributed. Extends to Mount Kosciuszko, N. S. Wales.

This is a minute conical species that cannot well be mistaken for any other. It is remarkably abundant at Mount Bischoff, Mount Farrell, Brown River, and at the Middlesex Plains, all widely separate localities. It would appear to prefer somewhat dry positions under stones and among decaying leaves.

LAOMA LUCKMANII, *Brazier.*

(Plate lxxxii., figs. 5, 6, 7.)

*Helix neglecta*, Brazier, Proc. Zool. Soc., 1870 (1871), p. 660 (not *H. neglecta*, Draparnaud). *Id.*, Legrand, Coll. Mon., sp. 17.

*H. luckmanii*, Brazier, Proc. Roy. Soc. Tas., 1876 (1877), p. 168.

*Helix siliens*, Cox in Legrand, Coll. Mon., 1871, sp. 60.



*Obs.*—Our figure is derived from an authentic specimen in the Australian Museum, labelled Mount Wellington. Height, 1.5; maj. diam., 2.95; min. diam., 2.35 mm.

*Hab.*—Knocklofty, Mount Nelson, and foot of Mount Wellington in the south of the island, and the Cataract and Distillery Creek, near Launceston.

Genus FLAMMULINA, *Martens*, 1873.

FLAMMULINA MARCHIANÆ, *Cox*.

*Helix marchianæ*, Cox in Legrand, Coll. Mon., 1871, sp. 25, pl. i., f. 7.

*Flammulina marchianæ*, Suter, Ann. Mag. Nat. Hist., (6), xiii., 1894, p. 64.

*Helix fuscoradiata*, Cox in Legrand, Coll. Mon., 1871, sp. 61, pl. ii., f. 2.

*Hab.*—Widely distributed, but confined to a few localities where it is numerous, notably Cora Linn, Springs, Mount Wellington, and near Ben Lomond. It is a very distinct form, having a remarkable glassy appearance. On Ben Lomond it occurs associating with *Helix lampra* and *Helix ruga*.

FLAMMULINA HAMILTONI, *Cox*.

*Helix hamiltoni*, Cox, Proc. Zool. Soc., 1867 (1868), p. 722; Mon. Austr. Land Shells, 1868, p. 32, pl. vii., f. 2, 2a.

*Flammulina hamiltoni*, Suter, Ann. Mag. Nat. Hist., (6), xiii., 1894, p. 64.

*Helix stephensi*, Cox in Legrand, Coll. Mon., 1871, sp. 26, pl. ii., f. 8. *Id.*, Johnston, Proc. Roy. Soc. Tas., 1879 (1880), p. 48.

*Helix plexus*, Cox in Legrand, Coll. Mon., 1871, sp. 28, pl. i., f. 10.

*Helix cepta*, Cox, *op. cit.*, sp. 41, pl. ii., f. 13.

*Helix irvinae*, Cox, *op. cit.*, sp. 71.

*Helix pascoei*, Brazier, *op. cit.*, sp. 65.

*Helix scrupulus*, Cox, *op. cit.*, sp. 76.

*Helix ducani*, Cox, *op. cit.*, sp. 56.

*Helix spoliata*, Cox, *op. cit.*, sp. 75.

*Helix floodi*, Brazier, Proc. Zool. Soc., 1871 (1872), p. 697.

*Helix milligani*, Brazier, *op. cit.*, p. 698.

*Helix langleyana*, Brazier, Proc. Linn. Soc. N. S. Wales, i., 1875, p. 18.

*Helix kingi*, Brazier, Proc. Zool. Soc., 1870, p. 662.

*Hab.*—This is perhaps the most abundant, most widely distributed, and at the same time most variable species as to size that occurs in the island. Examples from the Upper Leven River are about three times the size of those collected at Mount Wellington, although living apparently under like conditions. At Mount Farrell, and at the Mount Range they are also very fine, while at Scottsdale they are small and stunted. There is a remote possibility that they represent a group and not a single species.

FLAMMULINA WYNYARDENSIS, *Petterd.*

*Helix wynyardensis*, Petterd, Mon. Tas. Land Shells, 1879, p. 8.

*Obs.*—This is a very distinct species and may be separated from all congeners by the prominent close-set riblets and by the very distinct colouration of the upper and lower surfaces. In the latter character it resembles *Helix lampra*, but not in any other manner. The sculpture is absolutely distinct from *Helix hamiltoni*. It is confined to the dense scrubs of the localities mentioned.

*Hab.*—Table Cape, Circular Head.

FLAMMULINA SAVESI, *Petterd.*

*Helix sawesi*, Petterd, Mon. Tas. Land Shells, 1879, p. 12.

*Obs.*—The coarse sculpture and thin texture distinguish this species which peculiarities are remarkably constant and separate it from the two preceding species.

*Hab.*—Table Cape and Rocky Cape. Found in the thick scrubs with the last.

FLAMMULINA FORDEI, *Brazier.*

*Helix fordei*, Brazier, Proc. Zool. Soc., 1870, p. 662. *Id.*, Johnston, Proc. Roy. Soc. Tas., 1879 (1880), p. 50.

*Flammulina fordei*, Suter, Ann. Mag. Nat. Hist., (6), xiii., 1894, p. 64.

*Helix trajectory*, Cox in Legrand, Coll. Mon., 1871, sp. 36, pl. ii., f. 6.

*Helix mixta*, Cox, *op. cit.*, sp. 38, pl. ii., f. 11.

*H. tranquilla*, Cox, *op. cit.*, sp. 37, pl. ii., f. 3.

*Helix tabescens*, Cox, *op. cit.*, sp. 77.

*Helix allporti*, Legrand, *op. cit.*, sp. 18, pl. i., f. 2.

*Helix austrinus*, Cox, *op. cit.*, sp. 22, pl. i., f. 3.

*Helix medianus*, Cox, *op. cit.*, sp. 19, pl. i, f. 1.

*Helix helice*, Cox, *op. cit.*, sp. 20.

*Hab.*—Widely distributed. This is an abundant species only at Recherche Bay. At Mount Bischoff, Pieman River, and Mount Wellington it is comparatively rare.

FLAMMULINA DIEMENENSIS, *Cox.*

*Helix diemenensis*, Cox, Proc. Zool. Soc., 1867 (1868), p. 723; Mon. Austr. Land Shells, 1868, p. 20, pl. vii., f. 6, 6a. *Id.*, Johnston, Proc. Roy. Soc. Tas., 1879 (1880), p. 49.

*Flammulina diemenensis*, Suter, Ann. Mag. Nat. Hist., (6), xiii., 1894, p. 64.

*Helix wellingtonensis*, Cox, Proc. Zool. Soc., 1867 (1868), p. 723; Mon. Austr. Land Shells, 1868, p. 29, pl. vii., f. 5, 5a.

*Helix thompsoni*, Cox in Legrand, Coll. Mon., 1871, sp. 73.

*Helix daveyensis*, Cox, *op. cit.*, sp. 35, pl. ii., f. 4.

*Helix atkinsoni*, sp. 62, Cox, *op. cit.*, pl. ii., f. 12.

*Helix camilla*, Cox, *op. cit.*, sp. 74.

*Helix midsoni*, Brazier in Legrand, Coll. Mon., 1874, Addenda.

*Hab.*—Generally distributed; also islands in Bass Straits. It is common all over the island.

FLAMMULINA AGNEWI, *Cox.*

*Helix agnewi*, Cox in Legrand, Coll. Mon., 1871, sp. 27, pl. i., f. 8.

*Helix petterdi*, Brazier in Legrand, sp. 67. Brazier, Proc. Zool. Soc., 1871, p. 696.

Var., *peroni*, Brazier, *op. cit.*

*Hab.*—So far this distinct species has only been found at the Huon Road, and the lower portion of Mount Wellington. It is evidently an uncommon shell.

Subgenus ALLODISCUS, *Pilsbry*, 1892.

*Obs.*—The following species are assigned to this subgenus by reason of their spirally striated nuclear whorls.

FLAMMULINA MATHINNÆ, *Petterd.*

*Helix mathinnæ*, Petterd, Mon. Tas. Land Shells, 1879, p. 26; Journ. Conch., ii., 1879, p. 214.

*Flammulina mathinnæ*, Suter, Ann. Mag. Hist., (6), xiii., 1894, p. 64.

*Endodonta mathinnæ*, Hedley, Proc. Linn. Soc. N. S. Wales, xxix., 1904, p. 182, pl. viii., f. 4, 6.

*Hab.*—Near Launceston, at a locality a little beyond the First Basin. It has not, so far, been located anywhere else. Doubtless one of the most beautifully sculptured species known in the island.

FLAMMULINA ROBLINI, *Petterd.*

(Pates lxxxiv., figs. 20, 21, 22.)

*Helix roblini*, Petterd, Mon. Tas. Land Shells, 1879, p. 38; Journ. Conch., ii., 1879, p. 210.

*Obs.*—Figured from an authentic specimen in the Tasmanian Museum. Height, 1; maj. diam., 2·2; min. diam., 1·8 mm.

*Hab.*—Distillery Creek, near Launceston. Extremely difficult to find.

FLAMMULINA CURACOE, *Brazier.*

(Plate lxxxiii., figs. 14, 15, 16.)

*Helix curacoe*, Brazier, Proc. Zool. Soc., 1870, p. 659.

*Helix ramsgatensis*, Cox in Legrand, Coll. Mon., 1871, sp. 33, pl. i., f. 13.

*Obs.*—The original of our figure is from Recherche Bay and is in the Tasmanian Museum. Height, 3; maj. diam., 5·85; min. diam., 4·75 mm.

*Hab.*—Mount Wellington, Recherche Bay, and doubtfully at Mount Nelson. A rare species that has only been obtained at the localities indicated.

FLAMMULINA OTWAYENSIS, *Petterd.*

(Plate lxxxv., figs. 23, 24, 25).

*Helix otwayensis*, Petterd, Mon. Tas. Land Shells, 1879, p. 39; Journ. Conch., ii., 1879, p. 356. *Id.*, Johnston, Proc. Roy. Soc. Tas., 1879 (1880), p. 24.

*Endodonta otwayensis*, Hedley, Proc. Linn. Soc. N. S. Wales, xxvii., 1903, p. 605, pl. xxix., f. 10, 11, 12.

Var.—ALPINA, Johnston, in Petterd, *op. cit.*, p. 39.

*Hab.*—Surrey Hills.

*Obs.*—We figure a specimen of var. *alpina* from Surrey Hills, the property of the Tasmanian Museum. Height, 2·35; maj. diam., 3·9; min. diam., 3·25 mm.

*Hab.*—North-west Tasmania. Extends to Victoria. Another rare species that is apparently confined to the portion of the island indicated.

FLAMMULINA BISCHOFFENSIS, *Beddome*.

*Helix bischoffensis*, Beddome, Proc. Roy. Soc. Tas., 1879 (1880), p. 23. *Id.*, Petterd, Mon. Tas. Land Shells, 1879, p. 39.

*Charopa bischoffensis*, Hedley, Proc. Linn. Soc. N. S. Wales, (2), viii., 1892, p. 167, pl. i. 1, f. 1, 2, 3, 4.

*Hab.*—Mount Bischoff and Gad's Hill. At the first locality this is an abundant species, usually obtained in dense scrub under decaying timber.

FLAMMULINA GADENSIS, *Beddome*.

*Helix gadensis*, Beddome, Proc. Roy. Soc. Tas., 1879 (1880), p. 23. *Id.*, Petterd, Mon. Tasm. Land Shells, 1879, p. 29.

*Charopa gadensis*, Hedley, Proc. Linn. Soc. N. S. Wales, (2), viii., 1892, p. 168, pl. 1, 2, 3, 4.

*Flammulina gadensis*, Suter, Ann. Mag. Nat. Hist., (6), xiii., 1894, p. 64.

*Hab.*—Mount Bischoff and Gad's Hill. Obtained in and under decaying timber. It is only known from the localities stated, where it is apparently fairly abundant.

## Family ZONITIDÆ.

Genus HELICARION, *Ferussac* (em.). 1879.HELICARION CUVIERI, *Ferussac*.

*Helicarion cuvieri*, Ferussac, Tabl. Syst., 1821, p. 20.

*Helicarion cuvieri*, Semper, Reis in Philipp., iii., 1870, p. 31, pl. iii., f. 7a, b, pl. vi., f. 11.

*Vitriina nigra*, Quoy & Gaimard, Voy. Astrolabe, Zool., ii., 1832, p. 135, pl. xi., f. 8, 9.

*Vitriina verreauxi*, Pfeiffer, Proc. Zool. Soc., 1849 (1850), p. 132. *Id.*, Reeve, Conch. Icon., xiii., 1862, pl. iv. f. 21.

*Helicarion verreauxi*, Hedley, Proc. Linn. Soc. N. S. Wales, (2), vi., 1891, p. 24, pl. ii., f. 10-12, pl. iii., f. 4.

*Hab.*—Throughout Tasmania. Extends to Victoria. Varies in size, the largest specimens coming from the extreme south of the islands.

HELIX VITRINIFORMIS, *Cox*.

*Helix vitriniformis*, Cox in Legrand, Coll. Mon., 1871, sp. 58.

*Id.*, Legrand, Hardwicke's Science Gossip, xv., 1879, p. 70.

*Obs.*—In "Additions" to "Coll. Mon." Legrand observes that it is "without doubt a *Helicarion*." Because the name was

preoccupied by Mousson, Petterd (Mon., p. 55) proposed to call it *H. buttoni*. The species has not been figured and we are not aware that either a type or an authentic specimen now exists. Under these circumstances it may be abandoned.

*Species erroneously accredited to Tasmania.*

HELIX BISULCATA, Pfeiffer.

*Obs.*—*Helix bisulcata* was originally described by Pfeiffer,<sup>3</sup> from Tasmania. Reeve<sup>4</sup> further added that it was collected there by Gunn. An examination of the types of both species enabled Mr. E. R. Sykes<sup>5</sup> to recognise *H. bisulcata* as the New Caledonian shell generally known by the later name of *Helix beraudi*.

HELIX SUBANGULATA, Pfeiffer.

*Obs.*—This species was also described by Pfeiffer<sup>6</sup>, from Tasmania, and Reeve again added that Gunn was the collector. At the instance of one of us Messrs. E. A. Smith and J. Ponsonby examined the type in the British Museum and identified it as *Planispira zonalis*, Ferussac, from Halmahera.<sup>7</sup>

PUPA VARIUS, Bonnet.

*Obs.*—This was originally described by Bonnet<sup>8</sup> as from Tasmania. It has been pointed out by Pilsbry<sup>9</sup> that it is a variety of *Cerion glans*, Kuster, and is really a native of Nassau in the West Indies. Gunn misreported several marine West Indian shells as Tasmanian.<sup>10</sup>

HELIX PRUNUM, Ferussac.

*Obs.*—In the Paris Museum, we are told by Dr. H. Fischer<sup>11</sup>, two specimens of *Helix prunum* are labelled as having been collected by Peron and Lesueur in the D'Entrecasteaux Channel. Several species from North-west Australia such as *Area semitorta*,

<sup>3</sup> Pfeiffer—Proc. Zool. Soc., 1852, p. 135.

<sup>4</sup> Reeve—Conch. Icon., viii., 1853, sp. 969.

<sup>5</sup> Sykes—Journ. Malacol., iv., 1895, p. 72.

<sup>6</sup> Pfeiffer—Proc. Zool. Soc., 1851, p. 53.

<sup>7</sup> Hedley—Proc. Linn. Soc. N. S. Wales, xxvii., 1903, p. 604.

<sup>8</sup> Bonnet—Rev. Mag. Zool., (2), xvi., 1864, p. 71, pl. vi., f. 3, 4.

<sup>9</sup> Pilsbry—Man. Conch., (2), xiv., 1902, p. 255.

<sup>10</sup> Hedley—Proc. Roy. Soc. Tas., 1902 (1903), p. 77.

<sup>11</sup> Fischer—Journ. de Conch., l., 1902, p. 385.

*Conus pontificalis*, or *Crenatula modiolaris* were reported from Tasmania by these collectors, who had evidently mixed specimens from the localities in question.

*Species naturalised in Tasmania.*

LIMAX MAXIMUS, *Linne.*

*Obs.*—Introduced in Hobart and Launceston.<sup>12</sup> Now extremely abundant all over the island.

LIMAX FLAVUS, *Linne.*

Launceston, Musson (*op. cit.*, p. 892).

AGRIOLIMAX AGRESTIS, *Linne.*

*Obs.*—This appears to be the species described by Tate<sup>13</sup> from Tasmania as *Limax legrandi*.<sup>14</sup> Widely distributed, but not so plentiful as the preceding.

MILAX GAGATES, *Draparnaud.*

*Obs.*—Described by Tate (*op. cit.*) from Tasmanian material as *Milax tasmanicus*. Very plentiful.

VALLONIA PULCHELLA, *Müller.*

*Obs.*—Abundant round Hobart.<sup>15</sup>

VITREA CELLARIA, *Müller.*

*Obs.*—Well established in Hobart and Launceston (Petterd, *op. cit.*).

HELIX ASPERSA, *Linne.*

*Obs.*—Introduced by Mr. C. E. Beddome to Hobart.<sup>16</sup> Unfortunately too plentiful, both north and south.

VITREA CRYSTALLINA, *Müller.*

*Obs.*—Has not been previously recorded. It was taken by one of us (W.F.P) in Hobart. This was found in some numbers living in gardens.

<sup>12</sup> Musson—Proc. Linn. Soc. N. S. Wales, (2), v., 1890 (1891), p. 892.

<sup>13</sup> Tate—Proc. Roy. Soc. Tas., 1880, p. 16).

<sup>14</sup> Hedley—Proc. Linn. Soc. N. S. Wales, (2), v., 1891, p. 896.

<sup>15</sup> Petterd—Mon. Tas. Land Shells, 1879, p. 13.

<sup>16</sup> Petterd—Journ. Conch., ii., 1879, p. 96.

HELICELLA CAPERATA, *Montagu*.

*Obs.*—Observed by one of us (W.F.P.) at Risdon, near Hobart, in vast profusion a trifle above high water mark.

GEOSTILBIA APERTA, *Swainson*.

*Obs.*—Not hitherto recorded but collected by one of us (W.F.P.) at Hobart. Obtained from six inches to eight inches beneath the surface soil in a garden.

HELIX VERMICULATA, *Müller*.

*Obs.*—Now abundant at Ulverstone, Leven River. It is a native of Southern Europe and Northern Africa.



STUDIES IN AUSTRALIAN CRUSTACEA.

No. 2\*.

By ALLAN R. McCULLOCH, Zoologist.

(Plates lxxxviii.-lxxxix., and figs. 16, 17.)

CÆNOBITA SPINOSUS, *M. Edwards.*

(Plate lxxxviii., figs. 1-2.)

*Pagurus clypeatus*, Olivier, Encycl. Meth. Ins., viii., 1812, p. 643, pl. ccexi., fig. 1 (*nec. Cancer clypeatus*, auct.).

*Cænobita spinosa*, M. Edw., Hist. Nat. Crust., ii., 1837, p. 242. *Id.* Ortmann, Zool. Jahrb. Syst., vi., 1892, p. 318, pl. xii., fig. 24.

*Cænobita olivieri*, Owen, Zool. "Blossom," 1839, p. 84. *Id.* Dana, U.S. Expl. Expt., Crust., pt. i., 1852, p. 470. *Id.* Heller, Reise Novara, Crust., 1865, p. 82. *Id.* Haswell, Cat. Austr. Crust., 1882 p. 166.

*Cænobita brunnea*, Dana, *loc. cit.*, p. 470, pl. xxix., fig. 10. *Id.* Haswell, *loc. cit.*, p. 161.

*Birgus hirsutus*, Hess, Arch. Nat., xxxi., 1865, p. 36, pl. vii., fig. 16.

? *Cænobita perlata*, var. *affinis*, Miers, Ann. Mag. Nat. Hist., (5), v., 1880, p. 372, pl. xiv., fig. 8 (*vide* Ortmann).

*Obs.*—Ortmann has included under the heading of *C. spinosus* a variety differing from the typical form in having the dactyli of the third left legs less slender, and flattened externally. Following Dana, he determined this variety as *C. olivieri*, Owen, but a reference to the original description and Olivier's figure of that species shows that it has the dactyli rounded and spiny as in the typical *C. spinosus*, and the name therefore cannot be applied to those in which they are smooth and flattened. I therefore propose the new name *variabilis* for the variety in which the two last joints of the third left legs are smooth and flattened externally, and the hand of the larger cheliped is nearly smooth, and with an oblique row of larger granules on its upper exterior surface.

---

\* For No. 1, see p. 51.

The following notes and the accompanying plate show the great range of variation in the characters, usually relied upon to differentiate the species of this genus, as presented by a splendid series of *C. spinosus* from Cape York, N. Australia.

The gastric region may be strongly convex or flattened, and the width of the front varies between 3 and 3.5 in the length of the carapace. The length of the eyes is also variable. The hand of the larger cheliped may be intensely spiny, or the lower portion of the outer surface may be perfectly smooth, and a more or less distinct stridulating ridge on the upper part may be present or absent. The propodus and dactylus of the second and third, or third only, pairs of left legs may be sub-cylindrical and long, or markedly flattened and shorter. If flattened, there is a prominent crest on the upper and lower posterior margins of the dactylus, and sometimes also on the distal portion of the propodus.

Great as these variations seem, they are certainly within the limits of the one species, as I found all my specimens living together under a sheet of bark at Cape York, and they form an unbroken series between the two extremes I have figured. Further, though they would suggest that the variations are due to the age of the individuals (young, *variabilis*: adult, *spinosus*), other specimens in the Museum collection from the north-west coast of Australia, Murray Islands, Torres Straits, the Fiji Islands, and the New Hebrides show that this supposition is incorrect.

As *Birgus hirsutus*, Hess has recorded this species from Sydney. This is, however, certainly wrong, as the genus is confined on the eastern coast of Australia to North Queensland. For the same reason, Heller's record<sup>1</sup> of *C. rugosus*, M. Edw., from Sydney, is incorrect.

LEANDER SERENUS, *Heller*.

(Plate lxxxix., figs. 9-12.)

*Leander serenus*, Heller, Reise Novara, Crust., 1865, p. 110, pl. x., fig. 5. *Id.* Haswell, Cat. Austr. Crust., 1882, p. 195.

*Palaemon affinis*, Bate, Chall. Rep., Zool., xxiv., 1888, p. 782, pl. cxxviii., fig. 5 (*ucc. P. affinis*, M. Edw.).

Carapace smooth and polished. The rostrum is very variable in shape, being either broad or narrow, and its upper margin may be almost straight, or else bent upwards towards the tip. It is armed with six to nine nearly equidistant teeth above, and three

---

<sup>1</sup>Heller—Reise Novara, Crust., 1865, p. 82.

or four below, those near the apex generally placed near one another, so as to give it a bi- or tridentate appearance; the posterior two or three teeth are placed over the anterior part of the carapace. The antennal and branchiostegal spines are well developed, the latter being placed rather behind the vertical of the other, but overlapping the anterior border of the carapace.

Antennular peduncles not quite so long as the rostrum, their flattened outer portions armed each with a terminal and median spine. The two external flagella are united for about one-third the length of the thickened flagellum, the outer margin of which is obscurely serrated. The basal joint of the antennal peduncle with a strong external spine: the flagellum about as long as the entire body.

The external maxillipeds extend a little beyond the antennal peduncles, and their exopods are large and reach to the ends of the ante-penultimate joints.

The first pair of legs are very slender and reach a little beyond the tip of the scaphocerite. The second pair are large and cylindrical, and, when fully developed, extend almost as far as the tip of the inner antennular flagellum. The merus does not reach so far forward as the end of the scaphocerite. The carpus is thickened distally, and is slightly longer than the palm, its length varying a little with age. The palm is swollen and one-third longer than the fingers.

The three posterior pairs of legs are subequal in length, slender, cylindrical, and, with the exception of a row of minute spinules on the lower border of the propodus, are unarmed. Short brushes of setae overhang the bases of the dactyli, and there are scattered bristles on the carpus and propodus of each leg.

The telson terminates in an acute spine, on either side of which is a long internal and short external one, both being movable. Two pairs of spinules are placed on the hinder half of the upper surface.

*Obs.*—Miers<sup>2</sup> regarded *L. serenus* as a variety of *L. intermedius*, but it is readily distinguished from that species by the branchiostegal spine being placed on the margin of the carapace, and by the different proportions of the carpus and propodus of the second legs.

There can be no doubt that the specimens from Port Jackson determined by Spence Bate as *Palaeomon affinis*, M. Edw., are not

---

<sup>2</sup>Miers—Zool. Rep. "Alert," 1884, p. 295.

that species, as was suggested by Ortmann,<sup>3</sup> but are identical with the above. The late Mr. F. E. Grant, when in England, compared Victorian specimens of *L. sereneus* with the "Challenger" specimens and found them to be identical.

*Hab.*—I have collected this species in rock-pools at Rat Island, Port Curtis, and around Sydney, and there are specimens in the Australian Museum collected by Mr. J. Gabriel in Port Phillip, Victoria.

LEANDER LITOREUS, *sp. nov.*

(Fig. 16.)

*Obs.*—Compared minutely with *L. sereneus*, this species appears to be distinguished by the following important characters alone.

The two external flagella of the antennules are united only at their bases, six or seven joints being joined, while twenty-seven or more form the free portion of the thickened flagellum, which is distinctly serrated on its outer edge.

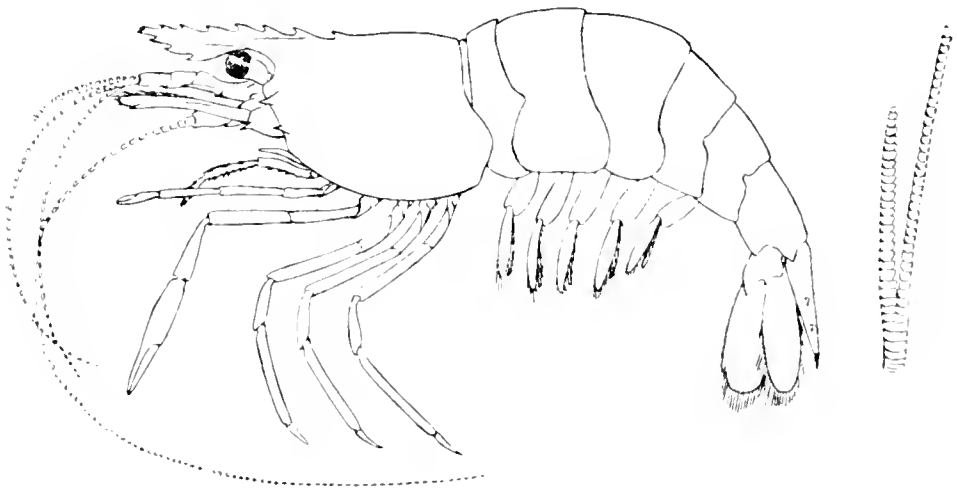

Fig. 16.

The second pair of legs are much shorter, reaching in my largest specimen only a trifle beyond the thickened antennular flagellum. The carpus is much thickened distally and is shorter than the palm, and does not extend to the tip of the scaphocerite. The palm is thick and swollen, and is not much longer than the fingers.

Four specimens from rock-pools on the coast near Sydney. Largest specimen measuring 39 mm. from the tip of the rostrum to that of the telson.

<sup>3</sup>Ortmann—Zool. Jahrb. Syst., v., 1890, p. 521.

From *L. natator*, M. Edw., to which this species is closely allied, it is distinguished by the different proportions of the joints of the second pair of legs and in having a greater number of joints in the thickened antennular flagellum.

LEANDER INTERMEDIUS, *Stimpson*.

(Plate lxxxix., figs. 13-14.)

*Leander intermedius*, Stimpson, Proc. Acad. Nat. Sci. Phil., xii., 1861, p. 41. *Id.* Haswell, Cat. Austr. Crust., 1882, p. 195. *Id.* Ortmann, Zool. Jahrb. Syst., v., 1890, p. 523. *Id.* Grant in Sayce, Vict. Nat., xviii., 1902, p. 155.

Carapace smooth and polished. Form of the rostrum variable, straight or bent upwards and extending nearly or quite as far forward as the scaphocerite. There are six to nine teeth above and four or five below, those near the apex placed so close together as to give the tip a bi- or trifid appearance. The posterior two or three teeth are placed over the anterior part of the carapace. The antennal and branchiostegal spines are well developed, the latter being placed well behind the vertical of the other, and at some distance from the anterior margin of the carapace.

The antennular peduncles are not so long as the rostrum, and the outer margin of their flattened portion is armed with a terminal and median spine. The two external flagella are united for rather more than one-third the length of the thickened flagellum, the outer margin of which may be obscurely serrated. The basal joint of the antennal peduncle has a strong spine at its outer angle, and the flagellum is about as long as the entire body.

The external maxillipeds extend a little beyond the antennal peduncles, and their exopods are large and reach to the ends of the ante-penultimate joints.

The first pair of legs are very slender and reach to, or a little beyond the tip of the scaphocerite. The second pair are more slender than those of *L. serenus* and are somewhat shorter, the end of the carpus in my largest specimen being but little in advance of the tip of the rostrum. The carpus is thickened distally and is much longer than the palm, being, in young specimens, equal to the length of the whole hand. The palm is swollen, and is only a little longer than the fingers.

The three posterior pairs of legs are very slender, and the fifth pair is rather longer than the third. Except for a row of spinules

on each propodus, they are unarmed, but there are short brushes of setæ overhanging the bases of the dactyli, and scattered bristles on the carpus and propodus of each leg.

The telson terminates in an acute spine, on either side of which is a long internal and short external one, both of which are movable. Two pairs of spinules are placed on the hinder half of the upper surface.

*Obs.*—This species is readily distinguished from its allies by the position of the branchiostegal spine. From *L. sereneus* it further differs by having the second pair of legs shorter, and the palm being much shorter than the carpus. The ambulatory legs are also more slender than in that species.

*Hab.*—Common in Port Jackson, where it is found on weedy bottoms. It is also recorded by Miers<sup>4</sup> from King George's Sound, S. W. Australia, and Tasmania. His specimens from Ovalau, Fiji Group, probably do not belong to this species, and those from Port Molle, Queensland, are possibly *L. sereneus*. Grant records it from Port Phillip, Victoria.

#### RHYNCHOCINETES RUGULOSUS, *Stimpson*.

(Plate lxxxix., figs. 1-8.)

*Rhynchocinetes rugulosus*, Stimpson, Proc. Acad. Nat. Sci. Phil., xii., 1860, p. 36. *Id.* Haswell, Cat. Austr. Crust., 1882, p. 180.

The surface of the whole body is roughened by very fine and close-set lines which sometimes support a short but dense pubescence. In large specimens these lines are also present on the appendages, but in smaller ones they appear smooth.

The carapace is armed with six large spines; one at the base of the rostrum and a second behind it, a pair of supraocular and a pair of antennal spines. The antero-lateral angle of the carapace is also armed with a minute spinule. The rostrum reaches a trifle beyond the scaphocerite and is inclined upwards towards the end, but its extreme tip is directed downwards. The upper margin bears two large teeth on the posterior half and five or six smaller ones distally, the last being the tip of the rostrum. There are eleven to thirteen teeth on the lower margin, which increase in length backwards to the eighth, those following being shorter and broader, and the last two recurved inwards.

<sup>4</sup>Miers—Zool. Rep. "Alert," 1884, p. 295.

The antennular peduncles reach to about the middle of the rostrum, and the shorter flagellum a little way beyond its tip. The flattened basal portion is armed on the outside with a long slender spine, and the joints of the peduncle are provided with brushes of short stiff setae.

The basal antennal joint has a strong spine on its outer angle. The scaphocerite is long and narrow, the flattened portion being obliquely truncate from the tip. The flagellum is a little shorter than the whole body.

The mandibles have a short cylindrical molar process and a large toothed cutting edge. The palp is three-jointed, the last joint and distal portion of the second being densely setose.

The first maxillae are three-branched, the median branch being the longest and with a double row of teeth on its edge. The superior branch is curved and terminates in a short bristle, and the inferior is rounded with setose margins.

The second maxillae consist of five plates and a slender, twisted, median process. The two outer plates forming the branchial fan are the largest, and the hinder one terminates in extremely long setae. All the other plates have their inner margins setose.

The first maxillipeds have also two outer fan-plates, which, however, are not setose. A long jointed lash extends from the inner angle of an oblong, setose plate. The median process is jointed to a thickened basal portion, both being setose.

The basal joint of the second maxilliped supports a small leaf-like plate externally, and a long jointed lash springs from the second. The last joint is large and reflexed upon the others, its distal portion being thickened and set with two opposing clusters of bristles which are more numerous than those on the hinder part of the joint.

The external maxillipeds are very large and setose, and reach beyond the scaphocerite. The merus has a spine at its distal end, and the last joint bears about six black thorns at its tip. The exopod reaches to the end of the merus.

The first pair of legs are comparatively short and thick, and reach beyond the antennal peduncle. The upper margin of the merus ends in a strong spine. The fingers are tipped with three or four black points which interlock when closed. There is a patch of short hairs on the lower surface of the palm.

The second legs are slender and reach beyond the first. Beyond the black thorns on the tips of the fingers they are unarmed.

The ambulatory legs vary somewhat with age, being shorter and thicker in smaller than in larger specimens. The first is the longest and reaches to or beyond the scaphocerite. The ischium is armed with a spinule, and there are three more on the lower exterior margin of the merus. The carpus has two spinules, and the lower margin of the propodus bears a row of minute spiniform setae. The dactylus also has some teeth on its lower edge. There are scattered setae on the end of the merus and on the following joints. All three pairs of ambulatory legs are similar, except in length.

The telson has three pairs of spinules on its upper surface, and ends in an acute point, on either side of which are three spinules, the median being the longest.

*Obs.*—*Rhyuchocinetes rugulosus* is a common species around Sydney, inhabiting dark crevices between rocks and in weedy pools. It is very beautifully marked when alive with streaks and dots of a bright blue colour on a darker ground. There are also specimens in the Australian Museum collection from Lord Howe Island.

According to Stimpson, the anterior part of the rostrum in the type specimens was tridentate. In all that I have seen there are five or six teeth at the tip of the rostrum. My specimens being from the same locality as the types, however, places their identification beyond doubt.

*Rhyuchocinetes typus*, M. Edw., is included in the Australian fauna on the authority of Miers,<sup>5</sup> who wrote in the Catalogue of New Zealand Crustacea that it was found also on the coasts of Australia and Chili. I have not seen this species, and think that he probably confused it with *R. rugulosus*, Stimp., which, however, appears to be readily distinguished by having fewer teeth on the upper and lower margins of the rostrum.

Having sent Miss M. J. Rathbun a tracing of my figure of *R. rugulosus* for comparison with specimens of *R. typus*, she has very kindly favoured me with the following notes.

The rostrum has seven or eight spines above, near the tip, and they occupy a greater space than in *R. rugulosus*; there are nineteen spines below. Maxillipeds longer and more slender; antennal scale not reaching the last segment of the maxilliped. Carpus of the first leg less than half as long as the propodus, and equal to the dactylus in length; margins of the palm not convex. Second leg very little longer than the first; propodus about four-fifths as long as the carpus and not stouter than that joint.

---

<sup>5</sup>Miers—Cat. Crust. N. Zealand, 1876, p. 77.



ALOPE AUSTRALIS, *Baker*.

*Alope palpalis*, Haswell, Cat. Austr. Crust., 1882, p. 193 (*nee* White).

*Alope australis*, Baker, Trans. Roy. Soc. S. Austr., xxviii., 1904, p. 154, pl. xxx, figs. 1-7.

*Obs.*—This is a very common species in rock-pools near Sydney. Mr. W. A. Baker has kindly compared specimens from here with his types, and confirms my identification. He adds that he has overlooked the division of the ischium and merus of the second pereopoda into two joints each, they being obscure in his specimens.

Mr. G. M. Thomson has also compared others with those used by him when writing upon *A. palpalis*, White,<sup>6</sup> and he has favoured me with the following notes and sketches of the rostrum of both species.

The rostrum of *A. australis* (fig. 17, 1) is shorter than that of the New Zealand species, and is armed with six teeth above, as against 3-4-5 teeth in *A. palpalis* (fig. 17, 2-3). It is also a much smaller species, the largest specimens being one and a half inches long, while *A. palpalis* attains two or three inches in length. *A. australis* is marked with darker spots and bars, while *A. palpalis* is of a uniform whitish colour.

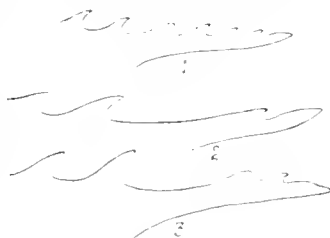

Fig. 17.

The rostrum of *A. australis* is also subject to some variation, some of my specimens having only four or five teeth; but they are always equally spaced and not separated by wide gaps as in the figures of *A. palpalis*. It should also be noted that *A. australis* also fades to a uniform white after long preservation in spirits.

*A. palpalis* is therefore not an Australian species.

METAPENEUS MONOCEROS, *Fabricius*.

*Penaeus monoceros*, Haswell, Cat. Austr. Crust., 1882, p. 200.

*Metapeneus monoceros*, Alcock, Cat. Ind. Dec. Crust., pt. iii., 1906, p. 18, pl. iii., fig. 7.

*Penaeus*, sp., Whitelegge, Proc. Roy. Soc. N.S. Wales, xxiii., 1890, p. 225; Whitelegge in Ogilby, Edible Fish. and Crust. N.S. Wales, 1893, p. 203.

*Obs.*—The specimens recorded by Whitelegge as an undescribed species of *Penaeus* are identical with the above. Though stated

<sup>6</sup>Thomson—Trans. Linn. Soc., (2), viii., 1903, p. 440, pl. xxviii., figs. 3-12.

to be the commonest species offered for sale, he adds that it is abundant at certain seasons only, and he informs me that all his specimens were secured at the fish-markets by Mr. J. D. Ogilby.

This species has not been previously recognised from N.S. Wales, though Haswell records it from the Endeavour River, Queensland.

EUCRATE DORSALIS, *White*.

*Cancer (Galene) dorsalis*, White, Proc. Zool. Soc., 1848 (1849), p. 144, Annulosa pl. vi.

On page 58 of the present volume I unfortunately described this species under the new name *E. hamiltoni*. Though no definite locality is given, White states that his specimen was obtained by Mr. John MacGillivray during the voyage of the "Rattlesnake," and it therefore probably came from N. Eastern Australia.

STUDIES IN AUSTRALIAN FISHES.

No. 2\*.

By ALLAN R. McCULLOCH, Zoologist.

(Plates xc.-xci., and fig. 18.)

MUSTELUS ANTARCTICUS, *Gunther*.

(Plate xc, fig. 3.)

*Mustelus antarcticus*, Gunther, Brit. Mus. Cat. Fish., viii., 1870, p. 387. *Id.*, McCoy, Prod. Zool. Viet., l., 9, 1884, pl. lxxxvii., fig. 1.

*Galeus antarcticus*, Waite, Rec. Austr. Mus., iv., 1902, p. 176, fig. 19 (*fetus*).

Head, to last gill opening, 5.1 in the length: depth, 11.1. Width of head, 1.9 in its length. Snout, 3 in the head, and not quite as long as the mouth is wide, including the supra-labial folds. Eye, 6.5 in the head, and 2.1 in the interorbital space, which is almost equal to the length of the snout.

Form slender, tail tapering, not quite as long as the head and body. Breadth of the head greater than the height of the body. Snout, long and depressed, somewhat rounded in front. Eyes, elongate, lateral, and placed midway between the tip of the snout and the first gill-opening. Mouth angular, the tip of the mandible reaching a little farther forward than the eye. Teeth small, pavement-like, in many rows, each with a median, obtusely angular, horizontal ridge. A long longitudinal fold at either angle of the mouth; posterior labial folds very narrow, and equal to a little more than a third of each ramus of the lower lip. Nostrils very large, and nearer the mouth than the tip of the snout, the inner with a large simple lobe. Spiracles very small, rather oblique, and placed behind the posterior angle of the eye. Gill-openings decreasing in size backwards, the last placed over the base of the pectoral.

Scales minute, angular. Lateral line distinct.

Origin of the first dorsal almost midway between the tip of the snout and that of the ventral, and a little behind the inner pos-

---

\* For No. 1, see p. 36.

terior angle of the pectorals; its height is less than the depth of the body, and the posterior lobe is greatly produced. Second dorsal similar to the first, though smaller, the hinder end of its base placed over the middle of the anal, and a little nearer the origin of the ventrals than the tip of the tail. Anal smallest, similar to the second dorsal, and nearer the caudal than the ventrals. Pectorals a little larger than the first dorsal, their hinder margins emarginate. Ventrals small, their origins much nearer that of the anal than of the pectorals.

Total length, 895 mm.

*Obs.*—The above description was drawn up from a fine female example presented to the Trustees by Mr. J. Blair, who caught it near Manly, Port Jackson. The only figure of the adult published being very inaccurate, and the several descriptions either too short or unsatisfactory, I take this opportunity of supplementing them.

*CHEILOBRANCHIUS PARVULUS, sp. nov.*

(Fig. 18.)

Head nearly one-ninth of the total length, or 1·8 in the distance between the gill opening and the vent, and equal to the height of the body. The distance between the end of the snout and the vent is 1·7 to 2·1 in the remaining portion. Eye large, one-fourth the length of the head, and covered by a transparent membrane. Snout longer than the eye, the maxillary not quite reaching its anterior margin. Nostrils placed on the upper surface of the head, the anterior tubular, and placed just before the eye, the posterior simple, and anterior to the middle of the eye.



Fig. 18.

The dorsal fin originates a little behind the vertical of the vent, and is highest above the commencement of the last quarter of the fish. The anal arises behind the middle of the length, and is similar in form to the dorsal. Both are united to the caudal, which is distinguished by the presence of a few minute rays, no traces of which are present in the other fins.

The gill-opening is a very small semi-circular opening situated below the hinder margin of the head, and its posterior margin is slightly raised, though there is no trace of the free lobes of *C. dorsalis* and *C. rufus*.

The vent is followed by a minute papilla.

*Colours*.—Darkest anteriorly, often with a series of about fourteen broad brown bands on the back, which are lost on the dorsal fin. Sides of abdomen with more or less numerous vertical narrow brown bars, while anteriorly it is crossed with four or five broad carmine bars below. Colourless behind the vent except for a prominent brown vertebral band.

In many specimens the dorsal bars are absent, and the abdominal markings are represented by brown spots only. There are others in which all the markings are wanting.

Total length, 47 mm.

*Obs.*—This species is sometimes found in small numbers in rock-pools near Sydney. When first collected, I supposed it to be the larval form of some larger species, but a number of females only 37 mm. in length, and distended with eggs, have since been procured for me by Mr. Basset Hull, Junr., to whom I am indebted for many interesting rock-pool fishes and crustaceans.

*C. parvulus* differs in the form of the gill-opening from that of *C. dorsalis* as described by Richardson<sup>1</sup> by the absence of the supplementary free lobes to the posterior margin. These lobes are very distinct in *C. rufus*, Macleay, and are regarded by Waite<sup>2</sup> as being rudimentary ventral fins. Whatever may be their function, I think it probable that their presence or absence is of specific value only, especially as in all other characters the three species are very similar.

#### UROCAMPUS CARINIROSTRIS, *Castelnau*.

(Plate xc., fig. 2).

*Urocampus carinirostris*, Castelnau, Proc. Zool. Soc. Viet., i., 1872, p. 200. *Id.*, Stead, Proc. Linn. Soc. N.S. Wales, xxxi., 1906, p. 428.

D. 14. Body-rings. 8-9. Caudal 50-53 (rarely 43).

Form elongate and very slender. Body with nine ridges: two on the back, four on the sides and three below. The upper pair on the

<sup>1</sup> Richardson—Voy. Ereb. & Terr., 1845, p. 50, pl. xxx., figs. 1-5.

<sup>2</sup> Waite—Rec. Austr. Mus., vi., 1906, p. 195, pl. xxxvi., fig. 1.

sides are continuous with the lower margins of the tail, which is quadrangular, though a fifth ridge is sometimes indicated on the back near the base of the dorsal fin. Head moderate, varying from less than half to two-thirds the length of the trunk. Snout short and thick, equal to or more than one-third the head, and with a very strong median ridge above; from this, two other ridges pass backwards over and behind the eyes, while there is a fourth median one on the occiput. A small blunt spine on the side of the snout in front of the eye. Operculum with a distinct transverse ridge. The length of the head and body as compared with the tail is very variable, it equalling in some examples one-third, and in others nearly one-half of that member. Branched or simple tentacles may be distributed more or less abundantly over the head, body and tail, or they may be altogether absent.

Pectoral and dorsal fins well developed, the latter commencing on the seventh segment behind the vent and extending over the three following. Caudal and anal fins present, but minute.

General colour, greenish with darker and lighter spots and cross-bands.

*Obs.*—Most of the discrepancies between this description and that of Castlenau may be accounted for by the great variation in the characters of the species. In his measurements of the snout, however, he writes that it is "contained once and a half in the diameter of the eye." This should be once and a half as long as the eye. Of the operculum also he says that it is "almost carinated," whereas really it has a very distinct ridge.

*Hab.*—Twelve specimens collected by Mr. Deue Fry far up Middle Harbour, Port Jackson, where they are common in the sea-grass *Zostera*. They agree perfectly with three others in the collection received from Castlenau, taken at Melbourne.

#### ICHTHYOCAMPUS FILUM, *Gunther*.

(Plate xc., fig. 1).

*Ichthyocampus filum*, *Gunther*, Brit. Mus. Cat. Fish., viii., 1870, p. 178.

D. 14; Body-rings, 13-14; Tail-rings, 46-47.

Form elongate and slender; body with seven very obscure ridges, tail with four, those on the sides continuous with the lower margins of the tail. Head very short, equal to about two-fifths of the distance between it and the vent. Snout turned upwards, one-third the length of the head. Operculum without a trans-

verse ridge. There is a small tubercle over the eye, and another on the occiput, besides several minute ones scattered over the upper part of the head. Length of the head and body 2.50 to 2.75 in that of the tail. The rings of the body and tail have each above and below on either side a minute tubercle at their hinder ends. There is a row of minute tentacles on the mid-line of the body, and there are others on the dorsal ridges of the tail and on the sides of the egg-pouch.

Dorsal, pectoral, and caudal fins well developed, and in the female specimens there is also a minute anal. Dorsal placed opposite to the vent, its base covering three segments, and the rays equal to about three-fourths the depth of the body. Egg pouch of the males equal to the trunk in length.

Colours of preserved examples various, but generally with broad darker cross bands on the sides, and a chain-like pattern of lighter markings on the back. In life they are most brilliant. Some are bright blue along the sides, with broad dark-brown vertical bars, which are more or less in pairs. Back either pure white or variegated with lighter and darker chain-like circles. Opercles scarlet. Others have a similar pattern, but the blue ground is more or less broken by yellow and pink areas.

*Hab.*—Seven specimens taken in rock-pools on the coast near Sydney. They appear to differ from Gunther's description only in having fourteen instead of sixteen body-rings.

CARANX HULLIANUS, *sp. nov.*

(Plate xci.)

D. viii. 30; A. 24; P. 2 + 22; V. i. 5; C. 17.

Body ovate, compressed, the dorsal profile more arched than the ventral. Length of head 3.1, height of body 2.3 in length to base of caudal fin. Snout 3.4 in the head, shorter than the eye, which is 3.0 in the head and placed almost wholly above the level of the snout. Nostrils close together and placed nearer the eye than the end of the snout; the anterior a simple round opening, the posterior a lunate slit and closed by a small flap. Jaws of equal length, the maxillary reaching to below the middle of the eye. Vomer, palatines, and tongue without teeth; those of the jaws of moderate size and arranged in two or three irregular rows. Opercles weak and unarmed, bordered by skinny flaps. Gill-rakers of the first arch very long and slender, extending forwards alongside the tongue; those of the other arches short and blunt.

Body, with the exception of the breast, covered with minute scales which extend forwards to the first dorsal spine, and thence downwards and forwards to above the hinder margin of the eye, leaving the top of the head and the nape bare. The cheeks are also minutely scaly. Lateral line strongly arched anteriorly, its straight portion armed with about thirty plates, which are large posteriorly and with broad blade-like spines directed forwards.

First dorsal originating over the operculum, its spines very weak and flexible, the fourth the longest, a little longer than the eye. No recumbent spine in front. Second dorsal very high and rounded, the tenth to fourteenth rays longest, 1.19 in the head; the bases of the rays are enclosed in a thin skinny sheath. Anal similar to the second dorsal, but with its rays shorter; the anterior spines are very weak and entirely hidden in the skin. Margin of pectoral rounded, the fifth ray the longest. Ventrals very large, the fourth ray reaching to the base of the fifth anal ray. Caudal emarginate, the tips of the lobes rounded.

*Colours.*—Brownish, with ten darker vertical bars, the first over the eye, the second in front of the first dorsal, six more below the dorsal fins, and two on the caudal peduncle. The bars are indistinctly continued on to the dorsal and anal fins, which are also blotched with white posteriorly. Ventrals dark brown. Total length 112 mm.

*Obs.*—This is doubtless the young form of some large species of *Caranx* or allied genus, though just which of the several closely-related divisions of the Carangidae I am unable to decide. The great development of the fins and the pronounced colour markings at once distinguishes this species from all others that are known to me.

*Hab.*—Found stranded on the beach at Freshwater, near Sydney, by Mr. A. T. Basset Hull.

#### DIRETMUS ARGENTEUS, *Johnson*.

*Dirctmus argentous*, Johnson, Proc. Zool. Soc., 1863, p. 403, pl. xxxvi., fig. 1.

*Obs.*—In June, 1908, the Trustees received from Mr. H. E. Lane a specimen of this rare species, 85 mm. in length, which he found floating dead upon the surface of the sea to the south-east of Cape Howe, N.S. Wales. It agrees perfectly with Goode & Bean's<sup>3</sup>

<sup>3</sup> Goode & Bean—Oceanic Ichthyology (Spec. Bull. U.S. Nat. Mus., ii., 1895, p. 211, pl. lxxv., fig. 234).



description and figure, and therefore supports Gunther's suggestion that *D. aureus*, Campbell, known only from Hokitika Beach, on the west coast of New Zealand, is identical with Johnson's species.

NEOSEBASTES SCORPÆNOIDES, *Guichenot*.

*Neosebastes scorpenoides* (Guichenot), McCoy, Prod. Zool. Vict., ii., 20, 1890, pl. exciii.

*Obs.*—A fine specimen of this species was caught off Coogee Bay, near Sydney, in October, 1908, by some local fishermen, who presented it to the Trustees. It agrees in every particular with others from Victoria, and constitutes a new record for this State.

CREEDIA HASWELLI, *Ramsay*.

*Hemerocates haswelli*, Ramsay, Proc. Linn. Soc. N. S. Wales, vi., 1881, p. 575.

*Creedia clathrisquamis* (Ogilby), Waite, Austr. Mus. Mem., iv., 1899, p. 63, fig. 6.

A large specimen, 70 mm. long, was dredged in Western Port, Victoria, by Mr. J. Gabriel. This rare species has been previously known only from the vicinity of Sydney and Newcastle, N. S. Wales.

DESCRIPTION OF THE FEMALE, WITH NEST AND EGGS  
OF THE CINNAMON-CHESTED GROUND THRUSH.

(*Cinclosoma marginatum*, SHARPE).

By ALFRED J. NORTH, C.M.B.O.U., C.F.A.O.U., Ornithologist.

(Plate xcii.)

In July, 1908, the Trustees of the Australian Museum received the skin of an adult female of *Cinclosoma marginatum*, Sharpe, from Mr. Chas. G. Gibson, Assistant Government Geologist of Western Australia. It was procured the previous month at Wiluna, Western Australia, where Mr. Gibson was also successful in finding the nest and eggs of this species, which he photographed, and will be found reproduced on the accompanying plate.

*Cinclosoma marginatum* was described by Dr. R. Bowdler Sharpe from a single adult male skin, obtained by the late Mr. J. R. Elsey in North-western Australia. Owing to Mr. Gibson's absence during nearly the whole of the latter half of 1908 with the party engaged on the survey of the proposed Trans-Continental Railway-line between Western Australia and South Australia, the eggs on loan for description, and the information relative to the taking of them, have only been recently received.

CINCLOSOMA MARGINATUM, *Sharpe*.

*Adult female*.—General colour above rich cinnamon brown, the scapulars and upper tail-coverts slightly darker and having narrow indistinct blackish shaft-streaks; the inner series of the upper wing-coverts like the back, the outer series black largely tipped with white, some of the outer greater coverts strongly washed with rich cinnamon-brown; quills dark brown, the middle of the outer webs of the primaries edged with white, tinged with cinnamon-brown; the secondaries broadly margined with rich cinnamon-brown; central pair of tail-feathers rich cinnamon-brown, the apical portion brownish near the shaft, the remainder black largely tipped with white; forehead, crown of the head, nape and sides of the neck brown, with a faint cinnamon wash; lores blackish; ear-coverts dark brown; stripe over the eye

reaching on to the sides of the nape, the chin and throat light cinnamon-brown, the fore neck a slightly clearer brown; remainder of the under surface rich cinnamon-brown; down the centre of the breast and the abdomen a broad irregular whitish streak reaching to the vent; thighs pale brown with darker brown centres to the feathers; under tail-coverts rich cinnamon-brown, with a sub-apical blackish streak and a whitish tip or margin which is confined chiefly to the inner web; the longest coverts much darker than those just below the vent; bill (of skin) black; legs and feet brownish black. Total length 9.25 inches, wing 3.6, tail 4.2, bill 0.6, tarsus 1.1.

*Locality*.—Wiluna, Western Australia.

*Remarks*.—The female of the Cinnamon-chested Ground Thrush may be readily distinguished from that of any other species of *Cinclosoma* inhabiting Australia, by the almost uniform rich cinnamon-brown colour of the upper and under parts.

Mr. Gibson writes:—“*Cinclosoma marginatum* is found in Western Australia, north of Lat. 30° S., south of this it is replaced by *C. castaneotum*. It is fairly common in the central districts north of this, but not numerous, very shy, and is usually found on stony ridges or stony flats. This species prefers running to flying, unless flushed suddenly from under a bush in the hot weather, and then it flies low and fast with a wavy flight. It has a plaintive whistling call which it occasionally utters when perched on a low limb usually of a dead tree; this note is very hard to locate when any distance off.

“The nests are similar to those of other species of *Cinclosoma*, and two eggs are laid for a sitting. They are placed on stony ground in exposed positions, or under small bushes, one was under a salt bush six inches high. I took them with eggs on the 13th June, 30th August and 1st September, 1908. The photograph of the nest and eggs of *C. marginatum* is that of the one taken at Wiluna, Lake Way, on the 13th June, 1908, and the skin of the female sent you I shot a day or two later, and may have belonged to it.”

The nest is an open cup-shaped structure formed throughout principally of thin strips of dead bark, with which is intermingled a few dried grasses and plant stems. Outwardly it is irregularly constructed, the inner cup measuring three inches and a half in diameter by two inches and a quarter in depth.

The eggs are two in number for a sitting, varying in shape and size even in the same set. Of those taken at Wiluna on

the 13th June, 1908, one is a slightly swollen oval, the other being more elongated and pointed at the smaller end—as will be seen on the accompanying plate—the shell being close-grained, smooth and lustrous. They are of a dull white ground colour, over which is distributed numerous freckles, small irregular shaped spots, and a few larger blurred markings of different shades of brown, intermingled with a few underlying spots of dull bluish-grey. In the smaller specimen the markings are slightly more thickly and evenly disposed; in the other there is a tendency to form an irregular zone at the larger end; many of the markings are penumbral or partially overlie one another. Length—(A) 1.02 x 0.77 inches; (B) 1.13 x 0.8 inches. Another set of two taken by Mr. Gibson at Lake Way, Western Australia, on the 19th August, 1906, are thickly spotted over the entire surface of the shell with different shades of brown and wood-brown, and intermingled with a few superimposed and underlying markings of pale violet-grey. Length—(A) 1.18 x 0.8 inches; (B) 1.17 x 0.8 inches.

ABORIGINAL DRAWINGS IN ROCK SHELTERS AT  
BUNDANOON, N.S. WALES.

By W. W. THORPE, Ethnologist.

(Plates xciii.-xcvi.)

Whilst on a collecting visit to Bundanoon in October of last year, my attention was directed to the existence of two Rock-Shelters which contained Aboriginal Pictographs. Bundanoon is about ninety-seven miles from Sydney on the southern railway. The shelters are situated close to Patrick or Paddy's River (which runs fairly parallel to the line, about a mile south of Bundanoon. The "river" referred to is a sluggish stream, and when the writer saw it, consisted of a chain of ponds or billabongs, some very deep and noted for eels (*Anguilla*, sp.), the same fish being freely depicted in one of the shelters.

Paddy's River rises at Exeter and unites with the Wollondilly, near Goulburn, one hundred and thirty-six miles south-west of Sydney. For purpose of convenience the shelters will be referred to as "No. 1" and "No. 2," being the order in which they were shown to the writer.

Both are of the usual form found wherever the Hawkesbury Sandstone occurs and frequently used by the Aborigines for camping in, the cooking of food, and sometimes for burial.

Shelter No. 1 is close to the river on the eastern side, not far from a crossing or ford. No. 2 Shelter is about a quarter of a mile south of No. 1 on the western side of the river and one hundred yards from the latter on elevated ground. The dimensions of the first shelter are as follows:—Greatest height, ten feet; the ceiling shelving back to four feet from the ground, the length on the floor being about thirty feet. In this shelter most of the drawings are made on the ceiling. The second example is much larger, and immediately under the centre of the eaves is a large sandstone block (Pl. xciv.) displaying about twenty grooves resulting from the rubbing-down and sharpening of axe-heads, the water during rainy seasons dripping from the roof assisting in the process. The following are the measurements of Shelter No. 2:—Seven feet high, fifteen feet from front to back, and forty-five feet long on the floor. Plate xciii. is taken rather from the northern end of the shelter, and

hardly does justice to the size of the recess. The material used in the drawings is charcoal with a probable admixture of grease, as the pigment appears to have penetrated the stone, and will not rub off on the hand.

The shelters and drawings have been known for forty years. Aborigines have not been resident in the district during that period, though parties of them have been known to pass through.

The following is a description of the pictographs that were observed in them:—In the first, which I call No. 1 Shelter (Pl. xcv.), there is a figure representing what I suppose to be a conventional animal or perhaps the tail of a lyre-bird (*Menura*, sp.); another which I think is undoubtedly a representation of an eel (*Anguilla*, sp.); as stated elsewhere, the river at this place is noted for these fish; the next is probably a Goana (*Varanus*, sp.) or water lizard (*Physignatus*, sp.), but the rear portions of the figure have weathered away, rendering identification difficult; another is a nondescript object, which may possibly have been intended for a human being; and there is the figure of a turtle.<sup>1</sup>

In the second, which I call No. 2 Shelter (Pl. xcvi.), I observed figures representing an aboriginal corroboree, with portions of six performers, a very old drawing and much weathered; probably a frog with its mouth agape; a figure somewhat lacertilian in outline, but not well drawn; a rather puzzling representation, for which I cannot suggest what the artist intended; another which looks like a fish, possibly a mullet (*Mugil*, sp.); one that is probably a tribal mark, the chevron motive is the same as frequently occurs on aboriginal carved trees; then there is what looks like a shell, a shield, or a leaf; a human being; and finally a figure which I think is undoubtedly meant for a shield.

The drawings are not the work of the same artist, nor were they contemporaneously drawn. Generally speaking, the pictographs in Shelter No. 1 are the oldest.

In trying to search out records of similitude in objects depicted I find that Dr. W. E. Roth<sup>2</sup> refers to "saurian type of figures (lizards, &c.) painted in red ochre upon blocks of granite." While the foregoing are not figured the same author gives a representation of a human being<sup>3</sup> which closely resembles Fig. 8 of Shelter 2.

<sup>1</sup> A turtle drawing is figured by Worsnop—Prehist. Arts, &c., Ab. of Austr., 1897, pl. xviii., fig. 1; and Bassett-Smith—Journ. Anthropol. Inst., xxiii., 1893, pl. xviii. (in part).

<sup>2</sup> Roth—Ethnol. Studies, 1897, sect. 187.

Most of the animals drawn in charcoal at Bundanoon have been represented in rock carvings and figured by Mr. W. D. Campbell.<sup>4</sup> Special attention may be directed to the following. Shields occur frequently as carvings, likewise fish and turtle, whilst gravings of the human figure are freely made along with other objects of natural history.

From these comparisons it will be apparent that the Aborigines did not depict certain objects with pigment and carve others, but all were produced by either method.

As far as the Bundanoon pictographs are concerned, I do not think the objects have any ritual significance or esoteric meaning. Their presence may be accounted for in the following manner. "Art," we are told, "is the expression of human emotion in drawing, music, ornamentation, &c." Perhaps in the personnel of a tribe one or more of its members possessed a penchant for drawing, and the artistic taste has expressed itself on these rough walls.

Some of the objects are fairly true to nature, others again are below the average of Aboriginal art.

Fig. 3, Shelter No. 1, is a characteristic attitude of the lacer-tilians, while the corroboree has often been depicted better elsewhere. The nearest approach to the pictures which form the subject of this paper are those drawn on bark (in colours) from Essington Island, North Australia, and figured by Dr. J. C. Cox.<sup>5</sup>

A series of charcoal drawings was figured by Mr. Bassett Smith,<sup>6</sup> discovered by him at Parry Island, North-West Australia.

A great deal has been written and figured on this subject, namely, the mural art of the Australian Aborigines, and I have sought out some references which may be useful for comparison and study.

Mr. R. Brough-Smyth, in his voluminous work,<sup>7</sup> records many instances of animals, etc., depicted in caves. E. M. Curr<sup>8</sup> also mentions the occurrence of shelter pictographs. While brief reference is made to the subject in their "Northern Tribes."<sup>9</sup>

<sup>3</sup>Roth—*Loc. cit.*, fig. 280.

<sup>4</sup>Campbell—*Aborig. Carvings of Port Jackson & Broken Bay* (Mem. Geol. Survey N.S.Wales, Eth. Series, i., 1899).

<sup>5</sup>Cox—*Proc. Linn. Soc. N.S.Wales*, iii., 1878, pt. ii., pls. xv.-xvi.

<sup>6</sup>Bassett-Smith—*Loc. cit.*

<sup>7</sup>Smyth—*Aborigines Vict.*, ii., 1878, p. 222 (appendix).

<sup>8</sup>Curr—*Austr. Race*, i., 1886, p. 95; ii., pp. 403 and 476.

<sup>9</sup>Spencer and Gillen—*Northern Tribes Cent. Austr.*, 1904, p. 716.

Spencer and Gillen devote a chapter to describing the rock drawings of the Central Tribes.<sup>10</sup> The Rev. John Mathew<sup>11, 12</sup> deals with the better class of (native?) art, "where higher artistic skill has been exhibited," including those paintings discovered by Sir George Grey<sup>13</sup> on the Glenelg River, North-West Australia.

A resumé of the subject has been compiled by Mr. T. Worsnop.<sup>14</sup>

Dr. W. E. Roth<sup>15</sup> also describes certain drawings executed by Aborigines in Queensland.

W. D. Campbell's<sup>16</sup> masterly Monograph has already been referred to, in which the local rock drawings are exhaustively described.

Last but not least are the occasional papers by Mr. R. Etheridge<sup>17</sup> describing mural art at Burraborang, Milton, Kuringai and Copmanhurst, all in New South Wales. The first-named locality is that nearest Bundanoon, being about forty miles north-east of the latter.

The Bundanoon shelters are known to many of the local residents, and the mark of the vandal is already in evidence as monograms, etc., but recent additions may easily be distinguished from native art by the way the latter has penetrated the stone.

In conclusion I have to thank Mr. Samuel Tooth, Junr., who guided me to the shelters, and Mr. W. A. Nicholas who at some personal inconvenience prepared photographs of Shelter No. 2 and the rubbing stone. My colleague, Mr. A. R. McCulloch, assisted me willingly with suggestions in the preparation of the figures from my rough field sketches.

<sup>10</sup> Spencer and Gillen—Nat. Tribes Cent. Austr., 1899, p. 614, et seq.

<sup>11</sup> Mathew—Eaglehawk & Crow, 1899, chapt. x.

<sup>12</sup> Mathew—Journ. Anthropol. Inst. Gt. Brit., xxiii., pp. 42-52, pls. iv.-vii.

<sup>13</sup> Grey—Journ. Two Expeditions Discov. N.W. & W. Austr., 1837-9.

<sup>14</sup> See *ante*.

<sup>15</sup> Roth—Eth. Studies, 1897, sect. 187; and Bulletin 4, sect. 10.

<sup>16</sup> See *ante*.

<sup>17</sup> Etheridge—Rec. Austr. Mus., ii., 4, pp. 46-54, pl. xii.; v., 2, pp. 80-5; v., 2, pp. 118-20, pls. xii.-xiii.; v., 5, pp. 271-3, pl. xxxiii.





## NOTES ON AUSTRALIAN ENTOZOA, No. I.

(Communication from the Government Bureau of Microbiology,  
Sydney.)

BY T. HARVEY JOHNSTON, M.A., B.Sc., Parasitologist, Bureau of  
Microbiology; Hon. Zoologist, Australian Museum.

Australian Entozoa have until now been comparatively neglected. The parasites of man and of the common domesticated animals are not accurately known. There were only occasional references scattered in medical and agricultural journals until Miss G. Sweet, D.Sc.,<sup>1</sup> of Melbourne, published her excellent census a few weeks ago in the Royal Society of Victoria (March, 1909), whilst this note was in the press. In order that this series of records should contain as much information as possible I preferred to amend it by incorporating Miss Sweet's new species and a few references mentioned by her, which I had no opportunity for finding. All records mentioned in Dr. Sweet's paper have accordingly been denoted thus † in front of the reference.

In all probability, many of the records of the occurrence of Entozoa in Australia are unreliable, as we know to-day that it requires a specialist to identify with certainty even common species. All specimens that I have examined will be marked with an asterisk following the locality from which the specimens were obtained.

Many parasites occur here as accidental infections, by which I mean that they have been collected in Australia from hosts that have been infected in some other country, e.g., *Schistosomum haematobium*, Bilharz, introduced from South Africa. Such Entozoa may or may not become established here. All such records, when the history is known, will be denoted (introd.)

---

<sup>1</sup> Sweet—The Endoparasites of Australian Stock and Native Fauna. Parts I. and II., Proc. Roy. Soc. Vict., xxi., (n. s.), Pt. II., 1908 (1909), p. 454.

MAN, *Homo sapiens*, Linn.*Trematoda* :—

1. *Distomum (Fasciola) hepaticum*, L.—bileduct. † Crawford, Austr. Med. Journ., ix., 1864, p. 29 (S. Aust.)—bileduct. Johnston, Agric. Gaz. N.S. Wales, xx., 1909, p. 581.
2. *Opisthorchis sinensis*, Cobbold, From Chinamen (introd.) † Jamieson, Austr. Med. Gaz., xvi., 1897, pp. 71, 147 (Sydney): † Corlette, *ibid.*, xvi., 1897, pp. 146, 195 (Sydney): Johnston, *l.c.*, p. 581.
3. *Schistosomum (Bilharzia) haematobium*, Bilharz (introd. from S. Africa)—bladder. † Stacy, Austr. Med. Gaz., xxv., 1906, p. 397 (Sydney): † Newmarch, *Ibid.* xxvi., 1907, p. 336 (Newcastle, N.S. Wales): Johnston, Proc. Linn. Soc. N.S. Wales, xxxiv., 1, 1909, p. 118; Agric. Gaz. N.S. Wales, xx., 1909, p. 581 (Sydney\*): Hinder, Austr. Med. Gaz., xxiii., 1904, p. 511 (Sydney). Nash (Austr. Med. Gaz., xxvi., 1907, p. 419) points out that Newmarch's record is invalid, a statement with which I agree.

*Cestoda*:—

4. *Taenia solium*, L.—intestine. Johnston, Proc. Linn. Soc. N.S. Wales, xxxiv., 1, 1909, p. 118; Agric. Gaz. N.S. Wales, 1909, p. 582 (N.S. Wales\*). There are two other references to *Taenia solium*, but the very imperfect descriptions would apply rather better to *T. saginata*, viz., Iffla, Austr. Med. Gaz. (Melbourne), 1869 (Vict.); Anonymous, N.S. Wales Med. Gaz., v., 1874-5, p. 57 (N.S. Wales).
5. *Taenia saginata*, Gaeze (*T. mediocanellata*, Kchm.)—intestine. † Johnson, Trans. Inter. Med. Cong. Austr., 1905, p. 380 (Adelaide); Proc. Linn. Soc. N.S. Wales, 1909, xxxiv., 1, p. 118; Agric. Gaz. N.S. Wales, xx., p. 582 (N.S. Wales\*).
6. *Dibothriocephalus latus*, L.—(? introduced).—There is a specimen in the Bureau Collection obtained locally, but no history is stated—intestine. Johnston, Proc. Linn. Soc. N.S. Wales, xxxiv., 1, 1909, p. 118; Agric. Gaz. N.S. Wales, xx., 1909, p. 582 (N.S. Wales\*).
7. *Sparganum (Bothriocephalus, Ligula) mansoni*, Cobbold (*B. liguloides*, Lekt.)—peritoneum and urinary tract. † Spencer, Trans. Int. Med. Congr. Austr., 1892, p. 433 (near Bathurst, N.S. Wales): † Hill, Trans. Inter. Med. Cong. Austr., 1905, p. 368 (Sydney).

8. *Dipylidium caninum*, L.—normally from the intestine of the dog\* and cat\*; *Hymenolepis diminuta*, Rud., from *Mus rattus*\*, *M. decumanus*\* and *Mus musculus*\*, and *Hymenolepis (Drepanidoteenia) lanceolata*, Bl., from the goose\*; all occur in this State. In some parts of the world, but apparently not in Australia as yet, these have occurred as accidental human parasites.
9. *Echinococcus multilocularis*, Virchow (*E. alveolaris*, Virchow), a very rare and specialised form of *E. hominis*, Rud. Muuro, Austr. Med. Gaz., xxi., 1902, p. 560 (Mudgee, N.S.Wales); *id.*, xxv., 1906, p. 281 (Sydney).
10. *Echinococcus hominis*, Rud. (*E. veterinorum*, Rud., *E. hydatidosus*, Lekt., *E. polymorphus*, Dies., etc.). In nearly all organs, forming "Hydatids."

The literature is very extensive, as Hydatid disease is extremely common in Australia, and often ends fatally. The following list refers to Australian occurrences of this human parasite :—

TRANS. INT. MED. CONG. AUSTR.—

Eichler, 1892, p. 439 (N.S.W.): Gardner, 1889, p. 347 (S. Austr.): Graham, 1892, p. 427 (N.S.W.): † Johnson, 1905, p. 380 (Austr.): MacCormick, 1905, p. 154 (N.S.W.): Marten, 1892, p. 435, (S. Austr.): Poulton, 1892, p. 404 (Austr.): Ross, 1892, p. 437 (Austr.): Stirling, 1892, p. 408 (S. Austr.): Thome, 1892, p. 394 (N.S. Wales): † Thomas, 1887, p. 60 (Vict.); † 1889, p. 329 (Austr.); 1892, p. 378 (Austr.); 1889, p. 337 (Vict.); p. 339 (N.S.W.); p. 340 (Q'ld., S. Austr.); p. 341 (N. Z'ld., W. Austr.); p. 342 (Tas.); p. 390 (S. Austr.): Tuompson, 1889, p. 385 (W. Austr.): Tremearne, 1892, p. 398 (Vict.): † Verco, 1887, p. 81 (Austr.); 1889, p. 377, p. 386 (S. Austr.): Whitcombe, 1889, p. 389 (Vict.).

AGRIC. JOURN. VICT.—

† Brown, i., 1902, p. 405 (Vict.).

TRANS. ROY. SOC. S. AUSTR.—

† Thomas, iv., 1880-81, p. 161 (S. Austr.); † vi., 1883, pp. 11, 22 (S. Austr.), p. 9 (Vict.), p. 12 (Q'ld.), p. 13 (Tas.), p. 14 (N.S.W.).

AGRIC. JOURN. QUEENSLAND.—

† Wills, ii., 1898, p. 490 (Austr.).

## LANCET.—

Welsh & Chapman, 1908 (N.S. Wales).

## “ENTOZOA.”—

Cobbold, 1879, p. 286 (Austr.).

## “HYDATID DISEASE.”

Thomas, Adelaide, 1884, p. 56 (Vic., etc.).

## ALBUTT &amp; ROLLESTON'S SYSTEM OF MEDICINE.—

Sterling & Verco, “Hydatid Disease,” ii., pt. ii., 1907, p. 796 (Austr.).

## AUSTR. MED. JOURNAL.—

Allen iii., 1881, p. 193 (Vict.); iv., 1882, p. 160 (Vict.):  
 † Atkinson, 1867, p. 290 (Austr.): Barrett xii., 1890  
 (Vict.): Bird, 1875, p. 304: iii., 1881, p. 171 (Austr.):  
 Blair, 1875, p. 144 (Austr.): † Cooper, 1863, p. 122 (Austr.):  
 † Dowling 1864, p. 105 (Vict.): Dunn, 1863, p. 23 (Austr.):  
 Gardner, ix., 1887, p. 251 (S. Austr.): † Gilbee, 1862,  
 p. 273 (Austr.): Girdlestone, x., 1888, p. 537 (Vict.):  
 MacGillivray, 1867, p. 70 (Austr.): † Motherwell, 1862,  
 p. 40 (Austr.): Pardey, xii., 1890 (Tasm.): Shields, xi.,  
 1889, p. 360 (Vict.): Thomas, x., 1888, p. 457 (S. Austr.);  
 xi., 1889, p. 306 (S. Austr., Tas.): Tracy, 1862, p. 58  
 (Austr.): Webb, xii., 1890 (Austr.): Zouche, v., 1883, p. 9  
 (Austr.): † ———, 1864, p. 46 (N.S.W.), p. 316 (N.S.W.):  
 † Richardson, 1862, p. 9 (Austr.): † Robertson, 1862, p. 41  
 Austr.).

## AUSTR. MED. GAZETTE.—

Barnett, xvi., 1897, p. 222 (N.Z.): Beeston, xvi., 1897, p. 121  
 (N.S.W.): Brown, vii., 1887-88, p. 3 (N.S.W.): Chisholm,  
 xii., 1893, p. 38 (N.S.W.): Cudmore, xxiii., 1904, p. 633  
 (S. Austr.): Fiaschi, xvii., 1898, p. 5 (N.S.W.): Fischer,  
 xvii., 1898, p. 431 (S. Austr.): Fisher vi., 1886-7, p. 64,  
 (N.S.W.): Fitzpatrick, xiii., 1894, p. 399 (N.S.W.): Garde, xii.,  
 1893, p. 316 (Q'land): Gardner, x., 1890-1, p. 85 (S. Austr.):  
 Graham, ix., 1889-90, p. 243, p. 250, (N.S.W.): Hayward,  
 xv., 1896, p. 394 (S. Austr.): Hawkins, i., 1882, p. 1  
 (Austr.): Hinder, xvii., 1898, p. 348 (N.S.W.); xviii., 1889,  
 p. 150 (N.S.W.): Jamieson, xvi., 1897, p. 598 (N.S.W.):  
 Jenkins, v., 1885-6, p. 246 (N.S.W.): Jones, xi., 1892,  
 p. 53 (S. Austr.): Joske, xxii., 1903, p. 406 (Vict.): Leacock,  
 vii., 1887-8, p. 29 (N.S.W.): Lendon, xiv., 1895, p. 441  
 (S. Austr.): Lipscomb, xxvi., 1907, p. 124 (N.S.W.):

Macdonald, xvii., 1898, p. 348 (N. Z'd.): MacLaurin, xviii., 1899, p. 71 (N.S.W.): McMurray, xv., 1896, p. 185 (N.S.W.): Miers, xi., 1892, p. 409 (N.S.W.): Mills, MacCormick, xxiii., 1904, p. 549 (N.S.W.): Mueller, xiv., 1895, p. 43 (Vict.): Mullins, xiv., 1895, p. 44 (N.S.W., Vict., S. Austr., Q'land, Tas., N. Z'd.): Munro, xviii., 1899, p. 370 (N.S.W.): Muskett, vi., 1886-7, p. 57 (N.S.W.): Parry, xi., 1892, p. 315 (N.S.W.): Poulton, ix., 1889-90, p. 198 (S. Austr.); xii., 1893, p. 193 (S. Austr.); xv., 1896, p. 318 (S. Austr.): Reid, xxi., 1902, p. 127 (N.S.W.): Rennie, xxi., 1902, p. 547 (N.S.W.): Rennie & Crago, xix., 1900, p. 270 (N.S.W.): Russell, xxvi., 1907, p. 514 (Vict.): Ryan, xiv., 1895, p. 392 (Vict.): Sawkins, xii., 1893, p. 363; xiii., 1894, p. 7 (N.S.W.); xxvii., 1908, p. 179 (N.S.W.): Scott, xii., 1893, p. 142 (Vict.): Shewen, vi., 1886-7, p. 13; ix., 1889-90, p. 134 (N.S.W.): Shuter, xviii., 1899, p. 246 (S. Austr.): Smith, xiii., 1894, p. 219 (N.S.W.): Sprott, xiv., 1895, p. 440 (Tas.): Stevenson, xi., 1892, p. 376 (Tas.): Stewart, xii., 1893, p. 302 (S. Austr.): Stirling, viii., 1888-9, p. 39 (S. Austr.); xiv., 1895, p. 315 (S. Austr.), p. 316 (N.S.W., Vict.), p. 317 (Tas., W. Austr., N. Z'd), p. 318 (Q'd): Thane, vii., 1887-8, p. 159 (N.S.W.): Thomas, vi., 1886-7, p. 215 (S. Austr.); vii., 1887-8, pp. 190, 216 (S. Austr.); ix., 1889-90, pp. 72-73 (S. Austr.): Thomson, xiii., 1894, p. 191 (N.S.W.): Turner, x., 1890-1, p. 65 (Q'land): Vance, xvii., 1898, p. 431 (S. Austr.): Vaughan, vi., 1886-7, p. 191 (S. Austr.): Verco, xii., 1893, p. 295 (S. Austr.); xv., 1896, p. 321 (S. Austr.): Verco and Poulton, xxiii., 1904, p. 265 (S. Austr.); xxvii., 1908, p. 290 (S. Austr.): Watson, xiv., 1895, p. 161 (N.S.W.); xv., 1896, p. 303 (S. Austr.); xxv., 1906, p. 617 (Austr.): Welsh and Barling, xxv., 1906, p. 383 (N.S.W.): Welsh and Chapman, xxvii., 1908, p. 1 (N.S.W.), p. 653 (N.S.W.): Wilson, xxiv., 1905, p. 469 (Vict.): Maclaurin, xxviii., 1909, p. 295 (N.S. Wales).

**N.S.W. MED. GAZETTE.—**

Brady, v., 1874-75 (N.S.W.): Morgan, iv., 1873-4, p. 377 (N.S.W. and Vict.): Wright, ii., 1871-2, p. 363 (N.S.W.):  
———, iv., 1873-4, p. 371 (N.S.W.).

**JOURN. SYD. UNIV. MEDICAL SOCIETY.—**

Parkinson and MacCormick, i, 1908, p. 13 (N.S.W.):  
Storey, i., 1908, p. 77 (N.S.W.).

**AGRIC. GAZ. N.S. WALES—**

Johnston, xx., 1909, p. 582.

JOURN. TROP. MED. HYG.—Cleland and Cumpston, xi., 1908, p. 165 (W. Austr.).

*Nematoda*:—

10. *Strongyloides intestinalis*, Bavay (*Anguillula*, *Rhabdonema stercoralis*, Bavay)—intestine. Ashwood, Austr. Med. Gaz., xv., 1896, p. 482 (Q'land): Johnston, Agric. Gaz. N.S. Wales, xx., 1909, p. 583 (Q'land).
11. *Trichinella (Trichina) spiralis*, Owen—muscles. † Austr. Med. Journ., 1870, p. 318 (Tasm., introd. from Germany), † 1871, p. 224 (N.S. Wales): † Johnson, Austr. Med. Gaz., xxi., 1902, pp. 120, 415 (S. Austr.\*); † Trans. Inter. Med. Cong. Austr., 1905, pp. 370, 380 (S. Austr.): Johnston, *loc. cit.*, p. 583.
12. *Trichocephalus trichiurus*, Linn. (*T. dispar*, Rud.)—caecum. Hogg, Austr. Med. Gaz., viii., 1888-9, p. 133 (Q'land): † Bancroft, xii., 1893, p. 258 (Q'land, N.S. Wales): † Mollison, Inter. Med. Cong. Austr., 1898, p. 417 (N.S.W., Q'land): † Lawes, Austr. Med. Gaz., xiv., 1895, p. 446 (Q'land): Johnston, Proc. Linn. Soc. N.S. Wales, xxxiv., I, 1909, p. 119 (N.S. †Wales\*); Agr. Gaz. N.S. Wales, xx., 1909, p. 583 (N.S. Wales\*).
13. *Eustrongylus gigas*, Dies.,? ——— —kidney. Allan, Austr. Med. Gaz., xvi., 1897, p. 607 (N.S. Wales). I think that the reference is doubtful, judging by the account given.
14. *Ankylostoma (Dochmius) duodenale*, Dubini.—intestine. † Ashworth, Austr. Med. Gaz., xv., 1896 p. 482 (Q'land): † Bancroft, Austr. Med. Gaz., xii., 1893, p. 258 (N. Q'land); xxi., 1902, p. 66 (Q'land); Trans. Inter. Med. Cong. Austr., 1896, p. 101 (Q'land): Bacot, Austr. Med. Gaz., xiv., 1895 (Q'land): † Gibson and Turner, Trans. Inter. Med. Cong. Austr., 1892, p. 134 (N. Q'land): † Hogg, Austr. Med. Gaz., viii., 1888-9, p. 133 (Q'land); † Brit. Med. Journ., 1889, i., p. 792 (Q'land): † H. Kenny, Austr. Med. Gaz., xxv., 1906, p. 399 (Q'land): † Lawes, *Ibid.*, xiv., 1895, p. 445 (Tweed R., N. S. Wales, Q'land): † O'Brien, *Ibid.*, xxvii., 1908, p. 121 (Q'land): Turner, Trans. Inter. Med. Cong. Austr., 1896, p. 101 (Q'land); † Proc. Roy. Soc. Q'land, xi., 1895, p. 99: Austr. Med. Gaz., xxviii., 1909, p. 351 (Q'land, Northern N. S. Wales): Johnston, Agr. Gaz. N. S. Wales, xx., 1909, p. 583: Salter, Austr. Med. Gaz., xxviii., 1909, p. 355 (Q'land).
15. *Aecator americanus*, Stiles—intestine. Salter, Austr. Med. Gaz., xxviii.; 1909, p. 355 (Q'land).

16. *Ascaris lumbricoides*, Linn.—intestine. † Sweet, Proc. Roy. Soc. Vict., 1908 (1909), p. 515 (Vict.); Johnston, Proc. Linn. Soc. N. S. Wales, xxxiv., 1909, p. 119 (N. S. Wales\*); Agr. Gaz. N. S. Wales, xx., 1909, p. 583 (N. S. Wales\*). Dr. J. B. Cleland brought under my notice a reference to the presence of “teres” or roundworms in children in the early days of New South Wales, by Surgeon P. Cunningham, in his work, “Two years in New South Wales” (2nd ed.), i., 1827, p. 172. This refers to the above species since *Lumbricus teres* is one of its former names, and is probably the first published reference to Australia Entozoa.
17. *Oxyuris vermicularis*, Linn.—intestine, usually in children. † Cobb, Proc. Linn. Soc. N. S. Wales, (ii.), v., 1890, p. 168 (N. S. Wales); Johnston, *ibid*, xxxiv., 1909, p. 119 (N. S. Wales\*); Agr. Gaz. N. S. Wales, xx., 1909, p. 583 (N. S. Wales\*).
18. *Filaria medinensis*, Velsch, † Macgillivray, Austr. Med. Journ., v., 1860, p. 172 (Vict., introd.); Johnston, Agr. Gaz. N.S. Wales, xx., 1909, p. 583 (Vict.).
19. { *Filaria bancrofti*, Cobbold—lymphatics.  
*Microfilaria nocturna*, Manson (*Filaria sanguinis hominis*, Lewis), the larva of *F. bancrofti*—blood.
- Cobbold, Journ. Linn. Soc., Zool., xiv., 1879, p. 356 (Q'land); Parasites (Entozoa), 1879, pp. 186, sqq. (Q'land); Lancet, 1877, pp. 70, 495 (Q'land); Brit. Med. Journ., 1876 (Austr.); Lancet, 1877, pp. 70, 495 (Q'land); *Ib.*, ———, 1878 (Q'land); *Ib.*, 1877; Brit. Med. Journ., 1876 (Austr.); Braun, Animal Parasites of Man, Eng. transl. 1906, pp. 289, 291 (Q'land); † Bancroft, Austr. Med. Journ., iv., 1882, p. 361 (Q'land); † Austr. Med. Gaz., xii., 1893, p. 258 (Q'land); † Trans. Inter. Med. Cong. Austr., 1889, p. 49 (Q'land); Austr. Med. Gaz., xvii., 1898, p. 271 (Q'land); † Journ. Roy. Soc. N. S. Wales, xxxiii., 1899 (1900), p. 48 (Q'land); Austr. Med. Gaz., xviii., 1899, p. 120 (Q'land); Jour. Trop. Med. Lond., 1899-1900, ii., pp. 91, 149, 1901, i., p. 822 (Q'land); † Austr. Med. Gaz., xxii., 1903, p. 251 (Q'land); Bancroft and Jackson, *Ibid.*, xiii., 1894, p. 6 (Q'land); Jackson, *Ibid*, xii., 1893, p. 260 (Q'land); † Colledge, Proc. Roy. Soc. Q'land, xv., 1900, p. 127 (Q'land); † Flynn, Austr. Med. Gaz., xxii., 1903, p. 248 (Q'land); † Johnson, Trans. Inter. Med. Cong. Austr., 1905, p. 380 (S. Austr.); Manson and Shipley in Allbutt and Rolleston's Syst. Medicine, ii., part ii., pp. 933, 936 (Q'land, Samoa); Turner, Austr. Med. Gaz., x., 1890-1,

p. 65 (Q'land): Looss, Handb. d. Tropenkrankh., i., 1905, p. 162 (Austr.): Johnston, Agric. Gaz. N.S. Wales, xx., 1909, p. 583 (Q'land, N.S. Wales, S. Austr., W. Austr.), p. 581 (W. Austr.). Dr. Cleland showed me North-west Australian specimens, and Dr. O'Neill informed me that he commonly met with *Filaria nocturna* in Sydney\* (introduced).

20. *Filaria demarquayi*, Manson?—blood. † Manson, Tropical Diseases, Lond., 1898, p. 446 (N. Guin): Braun, Animal Parasites, Eng. transl, 1906, p. 297 (N. Guin): Looss, Handb. d. Tropenkrankh., i., 1905, p. 169 (N. Guinea): Johnston, *loc. cit.*, p. 583.

We will only mention certain Acarida which are really Ectozoa, though they live below the surface, *e.g.*,<sup>2</sup> *Sarcoptes scabiei*, Linn., and *Demodex folliculorum*, Simon,<sup>3</sup> both occurring in N. S. Wales,\* the latter in Tasmania also.

*Protozoa*:—

21. *Entamoeba coli*, Loesch.—intestine. I have seen examples obtained in Sydney.
22. *Entamoeba histolytica*, Schaudinn (*Amoeba dysenterica*)—in cases of tropical dysentery and certain abscesses of the liver. Verco, Austr. Med. Gaz., xviii., 1899, p. 66 (S. Austr.): O'Brien, *id.*, xviii., 1899, p. 390 (Q'land): Fiaschi, *id.*, xvii., 1898, p. 511 (N. S. Wales): Isbister, *id.*, xvii., 1898, p. 512 (N. S. Wales): Goldsmith, Trans. Inter. Med. Cong. Austr., 1902, p. 180 (N. Terr., S. Austr.): Johnston, *loc. cit.*, p. 581 (N.S. Wales). Dr. Finckh has shown me specimens obtained in Sydney.
23. *Entamoeba buccalis*, Sternberg?—in dental caries. I have seen amoeba-like bodies from decaying teeth, which probably belong to this species. Johnston, *loc. cit.*, p. 581 (N. S. Wales).

Several species of *Flagellata* occur here, viz. :—

24. *Spirochaeta refringens*, Schaudinn, associated with the organism allied to syphilis. N. S. Wales and all other States. Johnston, *loc. cit.*, p. 581.
25. *Spirochaeta aboriginalis*, Cleland (MSS.), in a granuloma allied to syphilis. Cleland, Trans. Inter. Med. Cong. Austr., 1908 (in press), (W. Austr.\*); Austr. Med. Gaz.,

<sup>2</sup> Rainbow—Rec. Austr. Mus., vi., 3, 1906, p. 189 (N. S. Wales, Vict.).

<sup>3</sup> Lea—Insect and Fungus Pests, etc. Tasm., 1908, p. 106 (Tasmania).



- xxviii., 1909, p. 304 (W. Austr.): Cleland and Hickinbotham, Journ. Trop. Med. Hyg., xii., 1909, p. 143, (W. Austr., N. Terr., Thursday I.): Johnston, *loc. cit.*, p. 581.
26. *Spirochaeta vincenti*, R.Bl.—mouth. I have seen specimens from West Australia and N. S. Wales (Dr. Cleland, Dr. Finckh).
27. *Spirochaeta dentium*, Koch (? syn. *S. buccalis*, Cohn.)—teeth. N.S. Wales\* (Dr. Finckh): Johnston, *loc. cit.*, p. 581.
28. *Spirochaeta pertenuis*, Castellani, associated with "yaws." McGregor, Trans. Inter. Med. Cong. Austr., 1889, p. 47 (Brit. N. Guin., Solomons, N. Hebrides, Somoa, Fiji, Tonga, adjacent islands): Plehn, Handb. d. Tropenkrankh., i., 1905, p. 60 (N. Guin., Fiji). Cases have occurred in Queensland and New South Wales, the disease having been contracted in the Pacific Islands.—(Dr. O'Neill, Dr. Cleland).
29. *Treponema (Spirochaeta) pallidum*, Schaudinn, the parasite of syphilis. Most of the following references are to the disease, not to the organism, but to make the list complete I have preferred to include them:—Bird, Austr. Med. Gaz., xi., 1889 (Austr.), xxiv., 1905, p. 446 (Austr.): Bowe, Trans. Inter. Med. Cong. Austr., 1889, p. 61 (Q'land): Cleland, Austr. Med. Gaz., xxii., 1903, p. 68 (S. Austr.): Clatworthy, x., 1891, p. 140 (N. Q'land): Davidson, *id.* xxviii., 1909, p. 174 (N.S. Wales): Fiaschi, *id.* xxvii., 1908, p. 294 (N. S. Wales): Herring, *id.* xxi., 1902, p. 70 (Vict.): Hinder, *id.* xx., 1901, p. 92 (N. S. Wales): Hogg, *id.* xiii., 1894, p. 365 (N. S. Wales): Kenny, *id.* xviii., 1898, p. 531 (Vict.): McMurray, *id.* xxvii., 1908, p. 652 (Austr.), xxviii., 1909, p. 77 (N. S. Wales); xxviii., 1909, p. 388 (N. S. Wales): MacLaurin, N. S. Wales Med. Gaz., v, 1874-5, p. 163 (N. S. Wales): Marten, Austr. Med. Gaz., xxi., 1902, p. 608 (S. Austr.): Munro, xxv., 1906, p. 341 (N. S. Wales); xxiv., 1905, p. 637 (N. S. Wales): Ryan, Trans. Inter. Med. Cong. Austr., 1889, p. 994 (Vict.): Stirling, 1899, p. 991 (Vict.); Austr. Med. Journ., xii., 1890 (Austr.): Syme, xii., 1890, p. 221 (Vict.); Trans. Inter. Med. Cong. Austr., 1889, p. 771 (Vict.): ——— Austr. Med. Gaz., xxvii., 1908, p. 674 (Vict.): Johnston, *loc. cit.*, p. 581 (W. Austr., N.S. Wales). Dr. Cleland showed me slides of *T. pallidum* from New South Wales\* and West Australia.

The Sporozoa are represented by the malaria parasites.

30. *Plasmodium (Hæmamoeba, Laverania), malariae*, Laveran—the parasite of quartan fever (erythrocytes of the blood).

31. *Plasmodium vivax*, Gr. and Fel.—tertian fever parasite.
32. *P. falciparum*, Lemaire (*P. immaculatum*, Gr. and Fel.)—parasite of tropical or aestivo-autumnal fever. The references to malaria in Australasia are as follows:—Dyson, Trans. Inter. Med. Cong. Austr., 1889, p. 64 (N. Q'land—the three types of fever); Hudson, Austr. Med. Gaz., xvi., 1897, (N. Z'd); xvii., 1898, p. 225 (N. Z'd); Hunt, x., 1890-1, p. 75 (N. Q'land); Trans. Int. Med. Cong. Austr., 1892, p. 598 (N. Q'land); James, Austr. Med. Gaz., x., 1890-1, p. 300 (N. Q'land); Turner, x., 1890-1, p. 65 (Q'land); Johnson, Trans. Austr. Med. Cong., 1905, p. 370 (S. Austr.). Malaria (especially tertian) occurs in Sydney\* (Dr. Finckh, Dr. O'Neill), the disease being contracted in New Guinea, New Hebrides, and other Pacific Islands; and it occurs also in North West Australia\* (Dr. Cleland) and Northern Territory: Johnston, *loc. cit.*, p. 581 (N.S. Wales, W. Austr.).
33. *Cytoryctes variolae*, Guarn.—cowpox organism.
34. *Cytoryctes vaccinae*, Guarn.—smallpox organism. Both of these occur in the blood corpuscles. Their protozoan nature is still doubted by some authorities. These two diseases occur in every state of Australasia. Nearly all the following references relate to smallpox. Coutie, Austr. Med. Gaz., iv., 1885, p. 118 (N. S. Wales); Haynes, *id.* xiii., 1893, p. 211 (W. Austr.); Lendon, *id.* iv., 1885, p. 61 (S. Austr.); MacLaurin, *id.* vi., 1887, p. 104 (W. Austr.); Mullins, *id.* xv., 1896, p. 501 (N. S. Wales), xvi., 1897, pp. 74, 376, 492 (N. S. Wales), xvii., 1898, p. 57 (Vict.), p. 147 (N. S. Wales), p. 431 (S. Austr.); Mussett, iv., 1884-5, p. 57 (N. S. Wales); Pardy, Austr. Med. Journ., x., 1888, p. 193 (Tas.); Rowling, Austr. Med. Gaz., iv., 1884-5, p. 114 (N. S. Wales); Stow, *id.* vi., 1886-7, p. 175 (Pt. Darwin); Thompson, *id.* iv., 1884-5, p. 62 (N. S. Wales); ———, Austr. Med. Gaz., 1869 (1870), pp. 2, 10, etc. (Vict.); *id.* iv., 1884-5, p. 240 (N.S. Wales); *id.* v., 1885-6, p. 179 (N. S. Wales); *id.* vii., 1887-8, p. 16 (Tas.), p. 97 (Tas., Vict., S. Austr.); *id.* xii., 1893, p. 19 (S. Austr.), p. 165 (W. Austr.); Austr. Med. Journ., ix., 1887, p. 193 (Tas.); Tidswell, Proc. Austr. Assoc. Adv. Sc., 1898 (N.S. Wales, S. Austr., Vict.).

Two fairly common tropical diseases, Beri-beri and Dengue fever, are at present regarded as being produced by the presence of undiscovered protozoa.

*Beri-beri*:—

Molloy, Trans. Inter. Med. Cong. Austr., 1892, p. 101 (Vict., from China): White, *id.* 1902, p. 185 (Thursday I.): Wood, *id.* 1889, p. 54 (N. Terr.): Hayward, Austr. Med. Gaz., xxi., 1902, p. 614 (S. Austr.): Jamieson, *id.* xvi., 1897, p. 71 (N. S. Wales): Nall, *id.* xvii., 1898, p. 149 (Q'land, N. S. Wales, Vict., W. Austr.): Paton, *id.* xiii., 1894, p. 363 (N. S. Wales). Dr. O'Neill informed me that beri-beri is often met with in Sydney, though contracted elsewhere.

*Dengue*:—

Manson in Allbutt and Rolleston, Syst. Medicine, ii., pt. ii., p. 346 (Fiji): Bancroft, Austr. Med. Gaz., xxv., 1906, p. 17 (Q'land): Gibson, *id.* xxv., 1906, p. 227 (Q'land): Hare, *id.* xvii., 1898, p. 98 (Q'land): Gibson, *id.* xvii., 1898, p. 339 (Q'land): Bowkett, xvii., 1898, p. 177 (Q'land): ———, *id.* xxiv., 1905, p. 617 (Q'land); *id.* xxvi., 1907, 265 (Fiji).

Dr. Johnson briefly describes and figures an organism, "a rare worm," from the renal tract of a boy (Austr. Med. Gaz., xxi., 1902, p. 524)—S. Australia. The description does not allow of the parasite being assigned to any particular animal group. I have disregarded all references to the occurrences of unnamed "worms," unless the description is such as to enable one to identify the organism.

HORSE—EQUUS CABALLUS, *Lin.**Cestoda*:—

1. *Anoplocephala mamillana*, Mehlis—small intestine. † Cobb, Agr. Gaz. N. S. Wales, xvi., 1905, p. 639 (N. S. Wales): Johnston, Agr. Gaz. N. S. Wales, xx., 1909, p. 583 (N. S. Wales\*).
2. *Anoplocephala pertoliata*, Goeze—caecum. † Perrie, Agr. Gaz. N. S. Wales, iii., 1892, p. 821 (N. S. Wales): † Cobb, *Ibid.*, xvi., 1905, p. 631 (N. S. Wales): Johnston, *Ibid.*, xx., 1909, p. 583 (N. S. Wales\*): † Brown, Agr. Journ. Vict., i., 1902, p. 698 (Vict.?): † Desmond, Journ. Agr. Ind. S. Austr., ix., 1905-6, pp. 248, 252 (S. Austr.): † Sweet, Proc. Roy. Soc. Vict., xxi., (2), 1908 (1909), p. 505 (Vict.). Mr. A. M. Lea informed me of its occurrence in Tasmania.
3. *Anoplocephala plicata*, Rud.—small intestine. † Cobb, Agr. Gaz. N. S. Wales, xvi., 1905, p. 628 (N. S. Wales): Johnston, *Ibid.*, xx., 1909, p. 583 (N. S. Wales\*, Fiji\*): † Desmond, *loc. cit.*, ix., 1905-6, p. 249 (S. Austr.): † Sweet, *loc. cit.*, p. 505 (Vict.). Dr. Cleland brought me specimens from West Australia.\*

The above Cestodes do not appear to be common. This applies especially to the first and last, *A. mamillana* being quite rare. *A. plicata* may grow to much larger dimensions than that given in most descriptions of this worm, some that I have examined reaching fourteen and a-half inches in length by one and a quarter in breadth.

4. *Echinococcus veterinorum*, Rud. (*E. polymorphus*, Dies.) — kidney. † Sweet, *loc. cit.*, p. 506 (Vict.) I have examined specimens collected by Dr. Cleland from a horse at Berry, N.S. Wales.\*

*Nematoda* :—

5. *Ascaris megaloccephala*, Cloq—small intestine. † Perrie, Agr. Gaz. N. S. Wales, iii., 1892, p. 821 (N. S. Wales) : Johnston, *Ibid.*, xx., 1909, p. 583, 584 (Fiji\*, N. S. Wales\*) : † Brown, Australian, 1897, ii., p. 224 (Vict. ?) : † Sweet, *loc. cit.*, p. 514 (Vict.) : † Desmond, *loc. cit.*, vii., 1903-4, p. 570 ; ix., 1905-6, p. 252 (S. Austr.) : † von Linstow, Arch. Naturg., lxiii., 1897, p. 282 (Bismarek Archpgo.) : ——— W. Austr. (informed by Dr. Cleland).

6. *Oxyuris curvula*, Rud.—large intestine. † Perrie, Agr. Gaz. N. S. Wales, iii., 1892, p. 822 (N. S. Wales) : Johnston, *ibid.*, xx., 1909, p. 583 (N. S. Wales\*, Tas.\*).

The variety often termed *O. mastigodes*, Nitzsch, I have taken near Bathurst, New South Wales. Johnston, *loc. cit.*, p. 583.

7. *Sclerostomum equinum*, Müller, (*syn. Strongylus armatus*, Rud.)—caecum, large intestine, intestinal muscles, arteries. † Perrie, Agr. Gaz. N. S. Wales, iii., 1892, p. 821 (N. S. Wales) : † Desmond, Journ. Agr. Ind. S. Austr., viii., 1904-5, p. 569, and ix., 1905-6, p. 952 (S. Austr.) : † Brown, Agr. Journ. Vict., iii., 1905, p. 144 (Vict.).

This so-called species has been shown by Looss to contain a number of distinct species, some of which are mentioned below.

8. *Sclerostomum edentatum*, Looss.—stomach and intestine. † Sweet, *loc. cit.*, p. 507 (Vict.) : Johnston, *loc. cit.*, p. 583 (N. S. Wales\*).
9. *Sclerostomum vulgare*, Looss—stomach, intestine. † Sweet, *loc. cit.*, p. 508 (Vict.).
10. *Sclerostomum sp.*—stomach. † Weir, Agr. Journ. Vict., ii., 1904, p. 242 (Vict.).
11. *Priodontophorus intermedius*, Sweet—stomach, intestine (?). † Sweet, *loc. cit.*, p. 511 (Vict.).

12. *Cylichnostomum calicatum*, Looss—stomach, intestine (?).  
† Sweet, *loc. cit.*, p. 513 (Vict.).
13. *Cylichnostomum poculatum*, Looss—stomach, intestine (?).  
† Sweet, *loc. cit.*, p. 511 (Vict.).
14. *Cylichnostomum* (*Sclerostomum*) *tetracanthum*. Dies—  
† Perrie, Agr. Gaz. N. S. Wales, iii., 1892, p. 821 (N. S. Wales):  
Johnston, *ibid.*, xx., 1909, p. 583 (N. S. Wales\*).
15. *Cylichnostomum* spp. ———stomach, intestine. † Sweet,  
*loc. cit.*, pp. 511, 512 (Vict.).
16. *Sclerostomum* (*Dochmius*) *hypostomum* (Dies)—tumours in  
stomach. † Desmond, Journ. Agr. Ind. S. Austr., vii., 1904,  
p. 519 (S. Austr.).
17. *Eustrongylus gigas*, Dies—kidneys. † Brown, Australasian,  
1896, ii., p. 1262 (Vict.).
18. *Filaria loa*, Guyot (*Dracunculus oculi*, Dies)—eye. † Brown,  
Australasian, 1896, ii., p. 1262 (Vict.?).
19. *Spiroptera megastoma*, Rud.—stomach (tumours). † Desmond,  
*loc. cit.*, ix., 1905-6, p. 252 (S. Austr.): † Perrie, Agr. Gaz.  
N. S. Wales, iii., 1892, p. 822 (N. S. Wales): Johnston,  
*ibid.*, xx., 1909, p. 583 (N. S. Wales\*): Henry, *ibid.*, xx.,  
1909, p. 579 (N. S. Wales): † Weir, Journ. Dept. Agric.  
W. Austr., xii., 1905, p. 60 (W. Austr.).
20. *Spiroptera microstoma*, Schneider—stomach (tumours).  
† Perrie, Agr. Gaz. N. S. Wales, iii., 1892, p. 822  
(N. S. Wales): Johnston, *id.* xx., 1909, p. 583 (N. S.  
Wales\*): Cleland, Dep. Agr. W. Austr., Bull. 33, 1908  
(1909), p. 3; *ibid.*, Bull. 34, 1909, p. 15 (W. Austr.).
21. *Strongylus micrurus*, Mehlis—lungs, bronchi. † Perrie,  
*loc. cit.*, iii., 1892, p. 821 (N. S. Wales).
22. *Trypanosoma evansi*, Steel, “surra”—experimental, Cleland.  
“*Trypanosomiasis*,” Dep. Agr. W. Austr., Bull. 34, 1909,  
pp. 5, 14 (W. Austr.).

*Diptera* (e.g., larvae of bot-flies).

23. *Gastrophilus equi*, Fabr. —stomach. † Perrie, *loc. cit.*, iii., 1892,  
p. 822 (N. S. Wales): ———, Agr. Gaz. N. S. Wales, xx.,  
1909, p. 203 (Vict. and N. S. Wales): † Brown, Australasian,  
1894, i., p. 190 (Vict.): Agr. Journ. Vict., ii., 1904, p. 634  
(Vict.): † French, Agr. Journ. Vict., i., 1902, p. 693 (Vict.):  
† Thompson, Journ. Council Agr. Tas., ii., 1894, p. 76  
(Tasm.): Lea, Insect and Fungus Pests, etc., Hobart,

- 1908, p. 99 (Tasm.): Stewart, Agr. Gaz. N. S. Wales, xvi., 1905 (Vict., N.S. Wales): Johnston, *Ibid.*, xx., 1909, p. 583 (N. S. Wales\*): † Desmond, Journ. Agr. Ind. S. Austr., ix., 1905-6, p. 252 (S. Austr.): † ———, Agr. Ind. S. Austr. iv., 1901-2, pp. 523, etc. (S. Austr.).
24. *Gastrophilus haemorrhoidalis*, Linn.—rectum. Stewart,<sup>†</sup>*loc. cit.*, March, 1905 (N.S. Wales): Johnston, *loc. cit.*, p. 583 (N.S. Wales\*): ———, Agr. Gaz. N. S. Wales, xx., 1909, p. 203 (Vict., N. S. Wales): † Desmond, *loc. cit.*, ix., 1905-6, p. 252 (S. Austr.): † Brown, Agr. Journ. Vict., ii., 1904, p. 635 (Vict.?).
25. *Gastrophilus nasalis* (*G. salutaris*, Walker)—stomach. † Helms, Journ. Agric. W. Austr., i., 1899, p. 23 (W. Austr.): Froggatt, Agr. Gaz. N. S. Wales, xi., 1900 (N. S. Wales, Vict.): Johnston, *loc. cit.*, p. 583 (N. S. Wales\*).
26. *Gastrophilus*, sp.—† Stewart, *loc. cit.*, xi., 1900, p. 841 (N.S. Wales): † Williams and Webb, Journ. Agr. Ind. S. Austr., iii., 1900, p. 622 (S. Austr.): † Brown, Agr. Journ. Vict., v., 1907, p. 448 (Vict.): † ———, Journ. Agr. W. Austr. x., 1904, p. 43 (W. Austr.): † Despeissis, Journ. Agr. W. Austr., xiv., 1906, p. 450 (W. Austr.): Froggatt, Agr. Gaz. N.S. Wales, xix., 1908, p. 229 (N.S. Wales).

By far the commonest species of bot-fly larvae which I have examined is *G. nasalis*, *G. equi* and *G. haemorrhoidalis*, especially the latter, being rather uncommon. No doubt, very many of the references to *G. equi* should be to *G. nasalis*.

The specimens of *Anoplocephala perfoliata*, *Gastrophilus nasalis*, and *Ascaris megalocephala* recorded above from Fiji were taken from a mule there. Johnston, Agr. Gaz. N.S. Wales, xx., 1909, p. 584.

#### RABBIT—ORYCTOLAGUS (LEPUS) CUNICULUS, Linn.

##### Protozoa:—

1. *Coccidium oriforme*, Leuckt. (*C. cuniculi*, Riv.)—liver and intestine. Johnston, Agr. Gaz. N. S. Wales, xx., 1909, p. 584 (N. S. Wales\*).

##### Cestoda:—

2. *Cysticercus pisiformis*, Zeder—mesentery. † Brown, Agric. Journ. Vict., i., 1902, p. 614 (Vict.): † Sweet, Proc. Roy. Soc. Vict., xxi., (2), 1908 (1909), p. 506 (Vict.): Johnston, Agric. Gaz. N. S. Wales, xx., 1909, p. 584 (N. S. Wales\*).

3. *Cœnurus serialis*, Gervais—muscles. † Sweet, *loc. cit.*, p. 507 (Vict.): Johnston, *loc. cit.*, p. 584 (N. S. Wales\*).
4. *Echinococcus veterinorum*, Rud. (*E. polymorphus*, Dies.)—  
† Sweet, *loc. cit.*, p. 506 (Vict.): Johnston, *loc. cit.*, p. 584 (N. S. Wales\*).

Miss Sweet has apparently overlooked an error in her paper where a reference to the occurrence of *Taenia serrata*, Goeze, in the intestine of a dog in N. S. Wales († Cobb, Agric. Gaz. N. S. Wales, xvi., 1905, p. 314) has been set down on p. 478, as from a rabbit.

*Nematoda* :—

5. *Spiroptera megastoma*, Rud.—intestine. † Brown, Australasian, 1896, ii., p. 1262 (Vict.).
6. *Strongylus strigosus*, Duj.—stomach. Johnston, *loc. cit.*, p. 584 (N. S. Wales\*).

#### HARE—LEPUS TIMIDUS, Linn.

*Cestoda* :—

1. *Cysticercus pisiformis*, Zeder.—mesentery. † Brown, Agr. Journ. Vict., i., 1902, p. 614 (Vict.): † Sweet, Proc. Roy. Soc. Vict., xxi., (2), 1908 (1909), p. 506 (Vict.).
2. *Coenurus serialis*, Gerv. Camb. Nat. Hist., ii., Worms, p. 82 (Austr.).

#### GUINEA PIG—CAVIA CUTLERI, Bennet.

*Cestoda* :—

1. *Cysticercus pisiformis*, Zeder.?—mesentery. Johnston, Agr. Gaz. N. S. Wales, xx., p. 481 (N. S. Wales\*).

*Nematoda* :—

2. *Trichinella spiralis*, Owen—experimental animal, fed with trichinised human flesh. Johnson, Austr. Med. Gaz., xxi., 1902, p. 415 (Adelaide).
3. *Trypanosoma evansi*, Steel—(experimental), Cleland, "Trypanosomiasis," *loc. cit.*, p. 10 (West Austr.).

#### GOAT—CAPRA HIRCUS, Linn.

*Cestoda* :—

1. *Cysticercus tenuicollis*, Dies. West Australia (collected by Dr. J. B. Cleland). This is the first Australian reference to an entozoon from this host. Johnston, Agr. Gaz. N. S. Wales, xx., p. 584 (W. Austr.).

SPARROW—PASSER DOMESTICUS, *Linn.**Cestoda* :—

1. *Monopylidium passerinum*, Fuhrmann—intestine. Johnston, Agric. Gaz. N. S. Wales, xx., 1909, p. 584 (Sydney, N. S. Wales\*).

*Sporozoa* :—

2. *Plasmodium præcox*, Gr. and Fel.? (syn., *Proteosoma ilanilewskyi*, Kruse)—in erythrocytes. Johnston, Agric. Gaz. N. S. Wales, xx., 1909, p. 584 (Sydney, N. S. Wales\*).

SUN FISH—MOLA MOLA, *Linn.**Trematoda* :—

1. *Distomum contortum*, Rud.—on gills. † Macleay, Proc. Linn. Soc. N. S. Wales, i., 1875-7, p. 12 (Port Stephens, N. S. Wales).
2. *Anchistrocephalus microcephalus*, Rud.—intestine. (Port Stephens, N. S. Wales\*). † Macleay, *loc. cit.*, p. 12, and from a Sunfish mentioned by Stead, Proc. Linn. Soc. N. S. Wales, 1908, (4), p. 797, taken off the coast of N. S. Wales\*.
3. *Tetrarhynchus* (*Rhynchobothrius*) *reptans*, Wag., syn., *Anthocephalus elongatus*, Rud.)—encysted in muscles and viscera. † Macleay, *loc. cit.*, p. 12 (Port Stephens\*).
4. *Cysticercus*, *sp.?*—intestine. † Macleay, *loc. cit.*, p. 12 (Port Stephens, N. S. Wales).

The above four references occur again in the N. S. Wales Med. Gaz., v., 1874-5, pp. 175-6.

In conclusion, I wish to thank the Trustees for publishing this paper; the Director of the Bureau of Microbiology, Dr F. Tidswell, for permission to incorporate information acquired officially by me; Dr. J. B. Cleland and Dr. A. E. Finckh, my colleagues in the Bureau, for references and specimens; Mr. M. Henry, M.R.C.V.S., of Stock Department; Mr. A. M. Lea, of Tasmania, and Mr. F. H. Taylor for forwarding specimens.

I have examined all the Eutozoa contained in the Museum collections which relate to the animals mentioned in the paper.





### EXPLANATION OF PLATE LVIII.

- Fig. 1. Fish spear, the distal end, or head, exhibiting grooves to receive the basal ends of two of the three prongs—Wellesley Islands.
- .. 2. Portion of the shaft of the same spear (fig. 1) showing the method of scarling the two portions of the shaft.
- .. 3. Method of binding-on the barb with twine, ending in a plain looping below.—Pennefather River.
- .. 4. Multiple sting-ray-barbed spear, the barbs placed one behind the other.—Bloomfield River.
- .. 5. Single sting-ray-pointed spear.—Cape Bedford, Princess Charlotte Bay, Bloomfield and Middle Palmer Rivers.
- .. 6. Multiple sting-ray-pointed spear.—Same localities as fig. 5.
- .. 7. Multiple pronged fish spear, four prongs, each with a single barb.—Same localities as figs. 5 and 6.
- .. 8. Single acicular spear, with two barbs added at some distance from the tip.—Rockhampton District.
- .. 9. Distal end of spear mounted with quartz flakes on both sides.—Same localities as figs. 5-7.
- .. 10. Acicular spear with the barbs (fig. 8) replaced by a "girdle."—Glenroy, Upper Fitzroy River.
- .. 11. Spear, with flattened and expanded head, bearing four barbs on each side below.—Westwood.
- .. 12. A rather similar spear to Fig. 11, with five barbs on one side.—Westwood.
- .. 13. Acicular spear with non-flattened head, and one cut-out barb.—Marlborough District.
- .. 14. Primitive wommera, in the form of a hooked stick.—Wellesley Islands, etc.
- .. 15. Wommera, with haft formed of two oval pieces of *Melo* or pera shell.—Pennefather River.
- .. 16. Distal end of pera wommera, with the blade head split for the reception of the peg.
- .. 17. Distal end of iron-wood wommera, with a long peg fixed on by tendon passing through two holes in the latter, and two others correspondingly drilled through the blade.—Middle Palmer and Laura Rivers.
- .. 18. Distal extremity showing the back of the long peg in fig. 17 exposed free of the cement covering.
- .. 19. Distal end of iron-wood wommera, showing the peg tied on with tendon through two holes drilled in the blade only.—Cape Bedford, Bloomfield River, and Butcher's Hill.
- .. 20. A more complete example of fig. 19, exhibiting the final cement covering of the back of the peg.
- .. 21. Haftless handle of the same wommera (figs. 19, 20).
- .. 22. Handles or proximal end of the same wommera (figs. 19-21), halted with two oval pieces of *Melo* shell fixed on with beeswax.
- .. 23. A further modification (figs. 19-22), with a thin lath bent on itself at the proximal end.
- .. 24. Moon-shaped haftless wommera.—Bloomfield River.

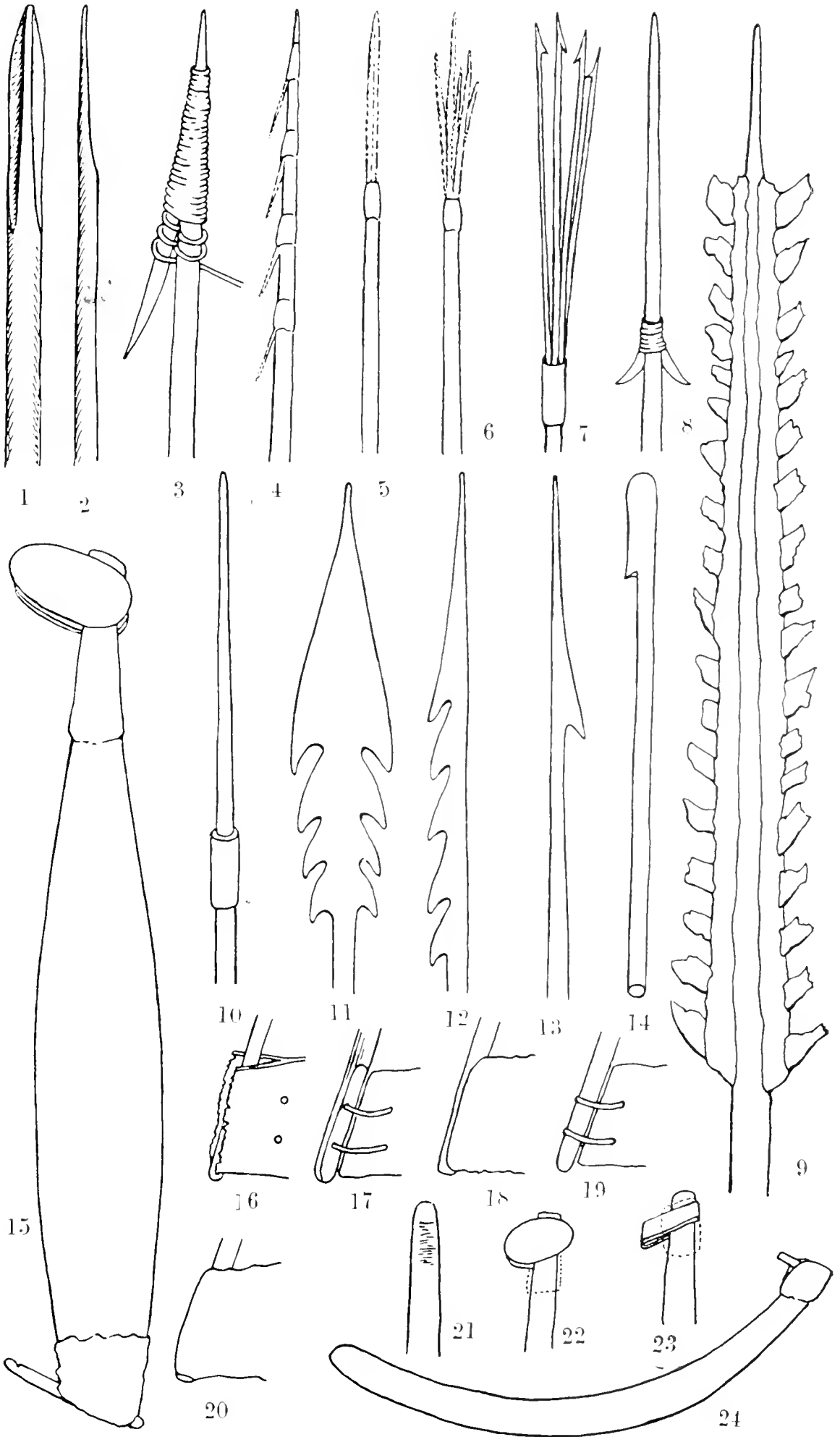

D. B. FRY, del. after ROTH  
Austr. Mus.





#### EXPLANATION OF PLATE LIX.

- Fig. 1. Method of cutting a boomerang from a flange on the butt of a tree.—Cardwell, etc.
- „ 2. Boomerang, with double bend, or “two knees.”—Mackay District.
- „ 3. Boomerang with bend, or “knee,” close to the proximal extremity.  
— Rockhampton District (except in its southern portion).
- „ 4. Boomerang, with a more or less acute angle at the knee.—  
Normanton and Gulf Coast.
- „ 5. Boomerang, with only a slightly perceptible curve.
- „ 6. Method of cutting out the pi-kan shield from the buttress of a tree.—Lower Tully River.
- „ 7. Section of the pi-kan shield after removal from the tree buttress, with the surface chopped away, except at the centres of the two faces.
- „ 8-10. Decorative motive on the fronts, or kanaanja of pi-kan shields (cross-hatching, left to right, red; close-dotting, yellow; double-dashes, red dots or splashes).

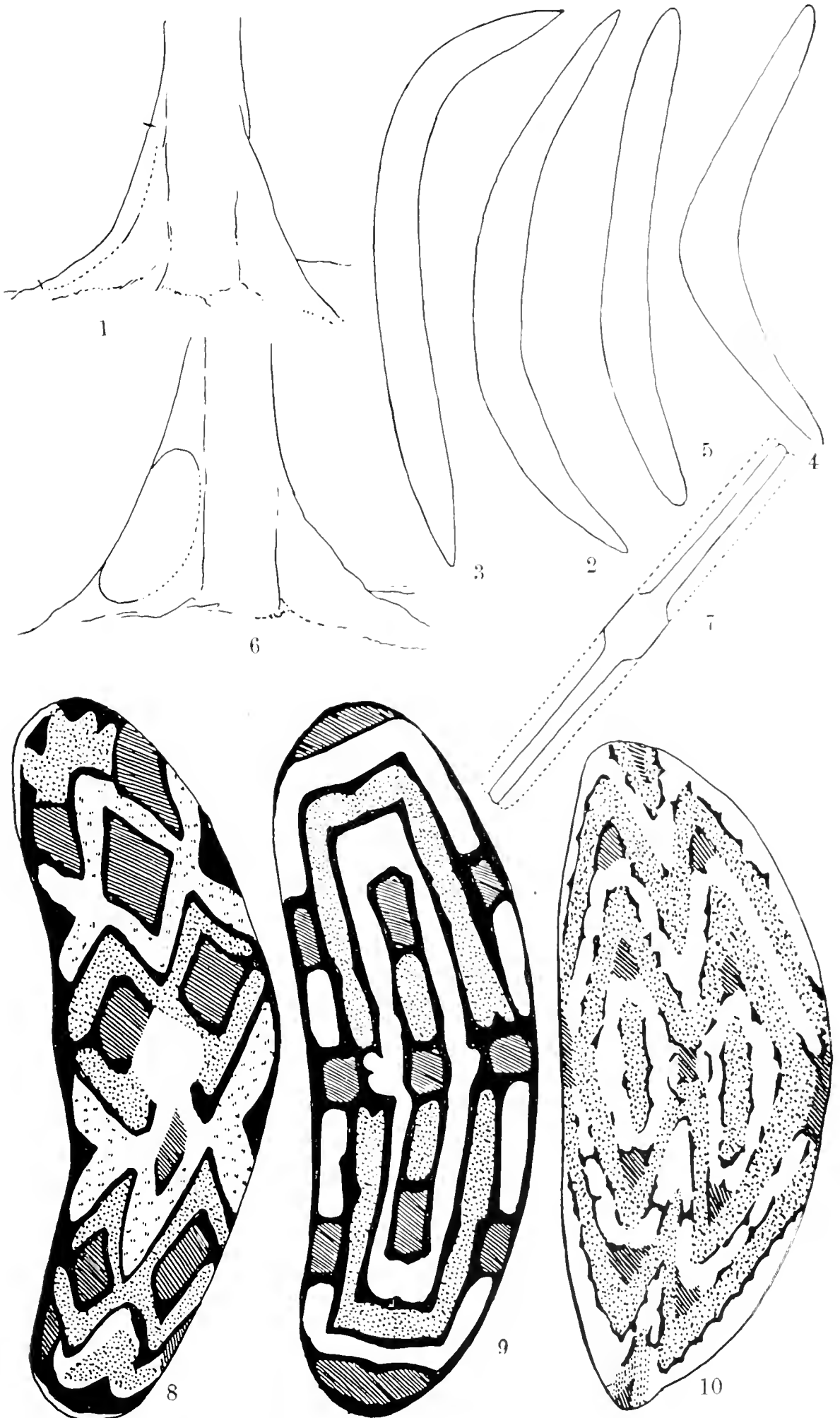







### EXPLANATION OF PLATE LX.

---

- Fig. 1. Elongately-oval cork-wood shield, inner face showing hand-grip.  
—Rockhampton District.
- „ 2. Outer convex face of fig. 1.
- „ 3. Longitudinal section of figs. 1 and 2.
- „ 4. Transverse section of figs. 1-3.
- „ 5. Transverse section of variety of figs. 1-4.
- „ 6. Outer convex face of cork-wood shield, with the surface divided into a central blackened panel and apical spaces whitened.—Rockhampton and Geraldton.
- „ 7. Transverse section of fig. 6, showing the handle-groove extending close to the lateral margins of the shield.
- „ 8. Outer convex face of shield, with three transverse and one longitudinal band, slightly raised and blackened, with the intermediate spaces white.—Yeppoon.
- „ 9. Outer convex face of shield, with raised motive in the form of a St. Andrew's cross, Marlborough.
- „ 10. Inner face of fig. 9, with bi-geniculate motive, or double St. Andrew's cross.
- „ 11. Inner face of shield, the motive a modification of that of fig. 10.—Tilpal, Torilla.
- „ 12. Outer face of shield, more truly oval, smaller and flatter than the shields represented in figs. 1-11.—Tilpal, Torilla.
- „ 13. Longitudinal section of fig. 12.
- „ 14. Heavy bi-convex shield used for close-quarter fighting.—Miriam Vale.
- „ 15. Longitudinal section of fig. 14.
- „ 16. Outer face of cork-wood shield.—Brisbane.
- „ 17. Convex outer half face of large elongately-oval shield, with white and red transverse bands.—Normanton District.
- „ 18. Inner half-face of fig. 17, slightly concave.

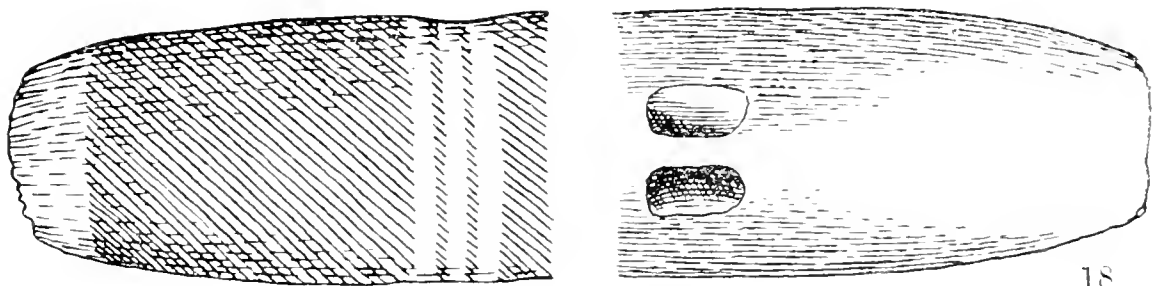

17

18

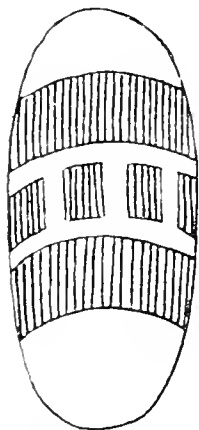

16



15

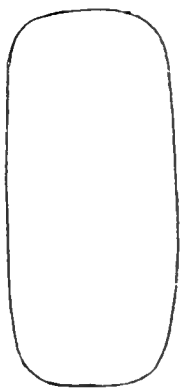

14



13

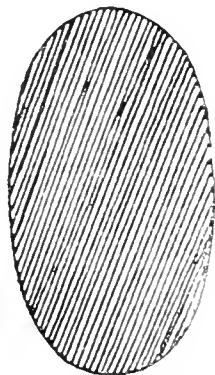

12

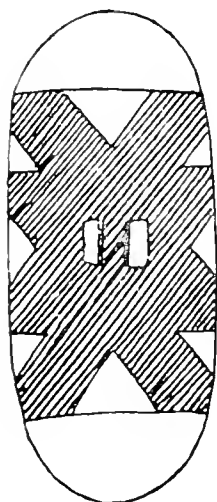

11

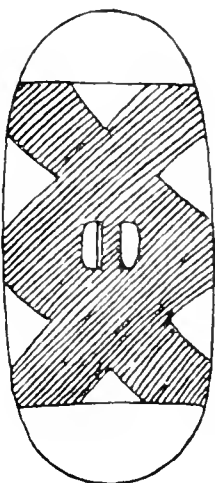

10

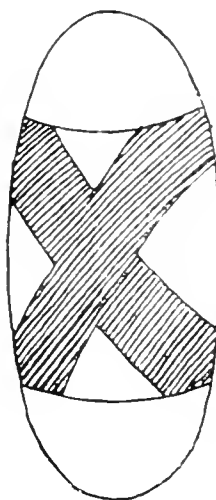

9

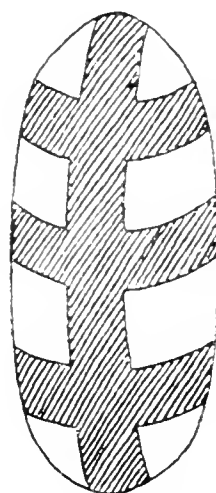

8

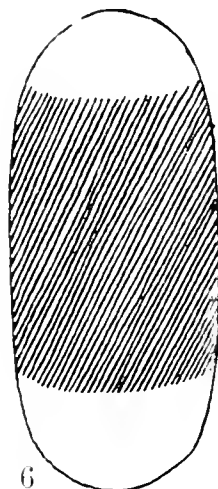

6

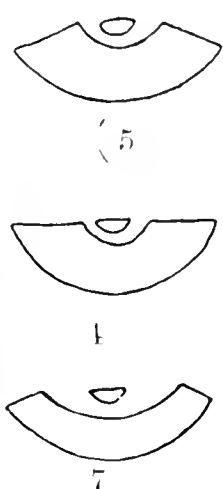

7



3

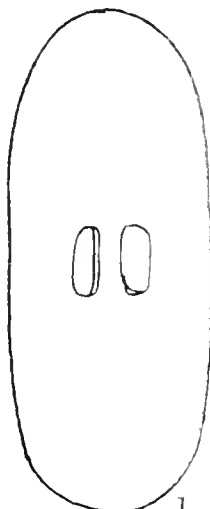

1



2





### EXPLANATION OF PLATE LXI.

- Fig. 1. Wommera. A plain stick with tassel of human hair ringlets at the proximal end.—Burketown.
- „ 2. The tassel and terminal “washer” of fig. 1.
- „ 3. Lath-shaped wommera, with the proximal end cut out to form a hold-fast; high decorated.—Burketown.
- „ 4. Side view of fig. 3.
- „ 5. Section of fig. 3.
- „ 6. Single-pointed nulla-nulla.—North Queensland.
- „ 7. Knob-headed nulla-nulla, the head merged with the shaft.—Rockhampton District.
- „ 8. Knob of another example of fig. 7, with the head distinct from the shaft.
- „ 9. Pineapple-headed nulla-nulla.—Rockhampton District.
- „ 10. Three-pronged nulla-nulla.—Rockhampton District.
- „ 11. Beak-headed nulla-nulla.—Rockhampton District.
- „ 12. Double beak-headed nulla-nulla.—Rockhampton District.
- „ 13. Bi-conate-headed nulla-nulla.—Upper Fitzroy River.
- „ 14. Nulla-nulla, at the distal end flattened from side to side.—Upper Fitzroy River.
- „ 15. Variety of fig. 14, with nicks cut on its distal convex edge.—Upper Fitzroy River.
- „ 16. Single-handed sword.—Lower Tully River.
- „ 17. Sapling to be split along centre for preparation of the single-handed sword.
- „ 18. Slabs to be “got out” from the halves of sapling (fig. 17).

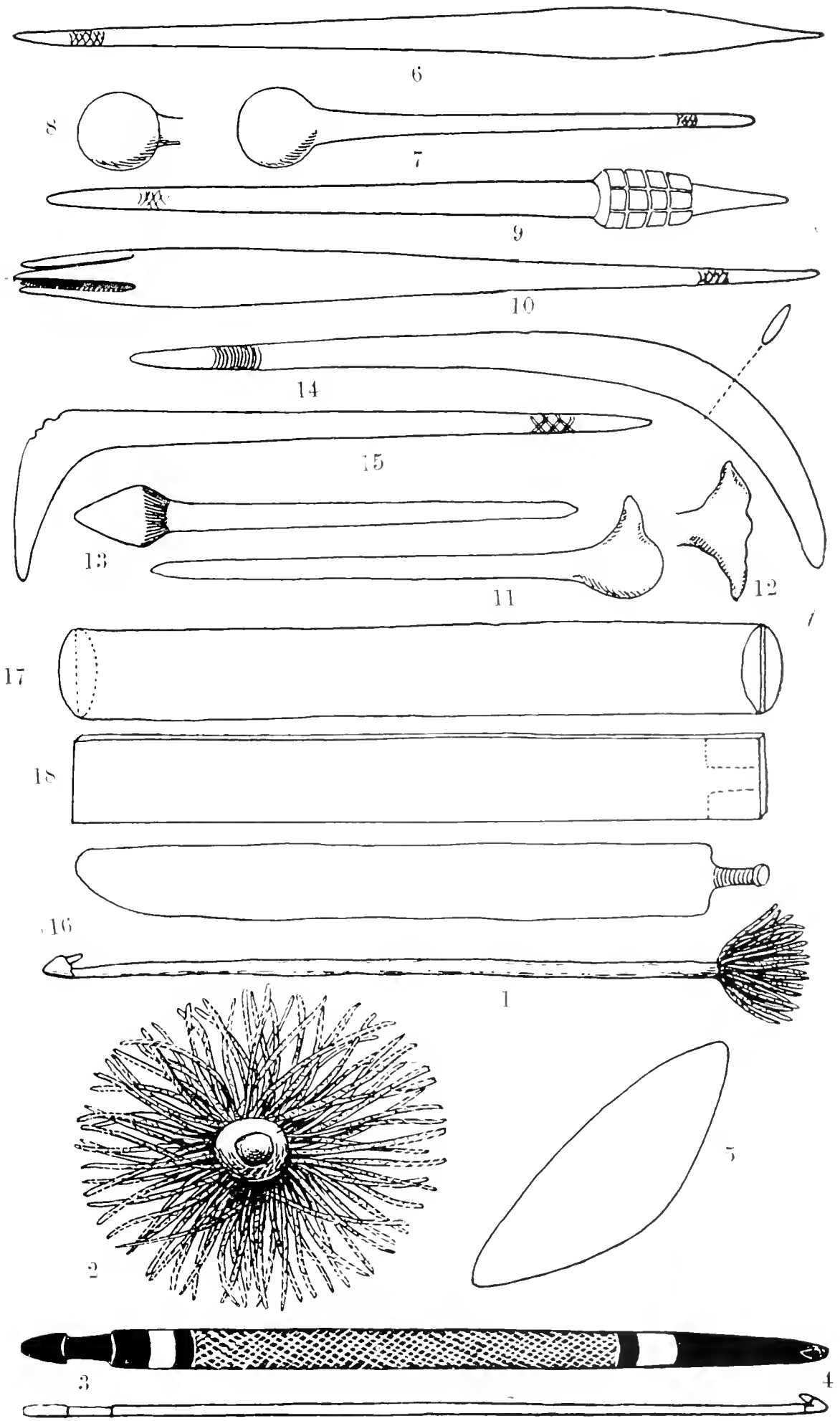

A. R. McCULLOCH, del. after ROTH  
Austr. Mus.







EXPLANATION OF PLATE LXII.

—  
AUSTRALIAN ARANEIDÆ.

Cocoon and Spiderlings of *Araneus herome*, L. K.



H. BARNES, Junr., photo.  
Austr. Mus.





EXPLANATION OF PLATE LXIII.

AUSTRALIAN ARANEIDÆ.

Figs. 1, 2, 3. Cocoons of *Gasteracantya minax*, Thor.  
Fig. 4. *Celunia excavata*, L.K., and cocoons.

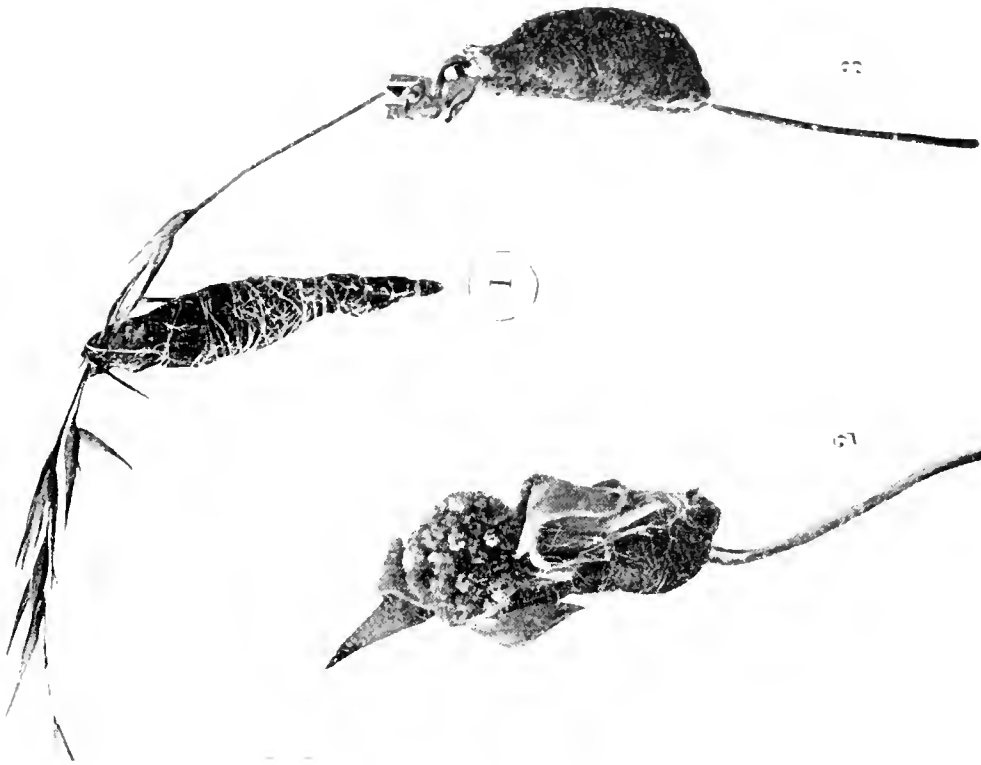







EXPLANATION OF PLATE LXIV.

—  
AUSTRALIAN ARANEIDÆ.

*Dicrostichus furcatus*, O.P. Cambr., and cocoons.







EXPLANATION OF PLATE LXV.

---

SCHLÖNBACHIA ROSTRATUS, *J. Sby.*

Portion of a large cast measuring six by eight inches, showing the abdominal lines of tubercles inclined forwards on the slightly sigmoidal single costæ; bifurcation of the costæ is visible on the inner whorl.



Hy. KING, photo.  
Sydney.







EXPLANATION OF PLATE LXVI.

*SCHLENBACHIA ROSTRATUS, J. Sby.*

- Fig. 1. Cast of portion of a whorl with tubercles in two lines, one row abdominal, the other supra-umbilical—slightly reduced.  
„ 2. Portion of a whorl partly testiferous with spiral lyra crossing the costa— $\frac{3}{4}$  nat.







EXPLANATION OF PLATE LXVII.

SCHLENBACHIA ROSTRATUS, *J. Sbg.*

- Fig. 1. Inner whorls of a large specimen exhibiting many of the costa-bifurcate, with here and there single interpolated ribs— $\frac{1}{5}$  nat.  
,, 2. Transverse view of Pl. lxvi., fig. 2. displaying a septum— $\frac{3}{4}$  nat.  
S. ROSTRATUS, var. ANTIPODEUS, Eth. fil.  
,, 3. Lateral view.  
,, 4. Ventral view with keel.

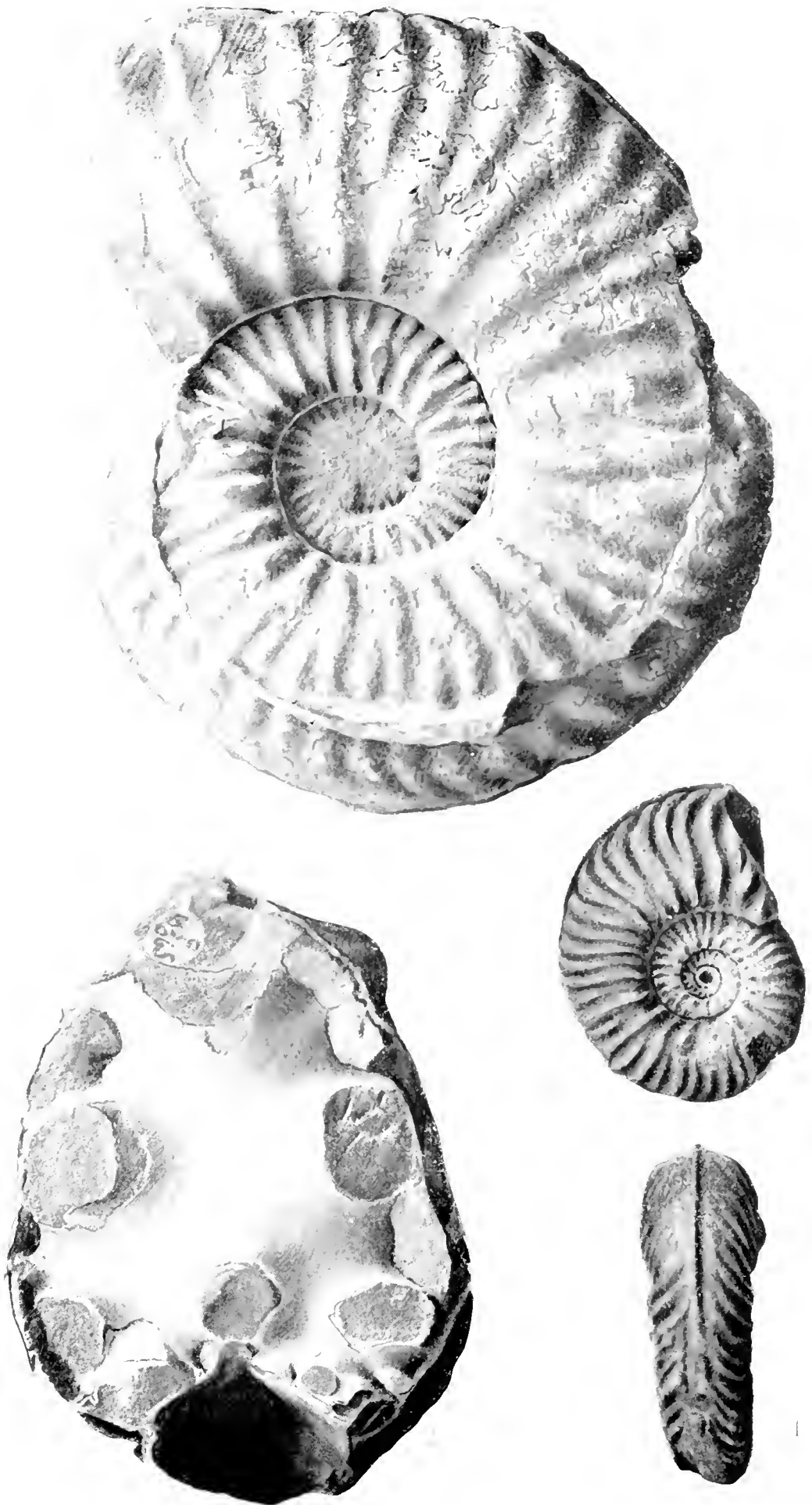







EXPLANATION OF PLATE LXVIII.

PERISPIINCTES KAYSERI, *N. & U.*

Lateral view of a large planorbiform specimen measuring fourteen by twelve inches.

LEPTOMARIA, sp.

Casts nestling on centre of *Perispiinctes*.







EXPLANATION OF PLATE LXIX.

APHRODITA HASWELLI, *Justu.*

- Fig. 1. Anterior end, ventral view.  
" 2. " " dorsal " "  
" 3. Head (front view) showing eyes.  
" 4. Portion of palp.  
" 5. Portion of stalk of elytron.  
" 6. Papilla (side and end view), from stalk of elytron.  
" 7. Tip of dorsal seta.  
" 8. Two ventral setae.

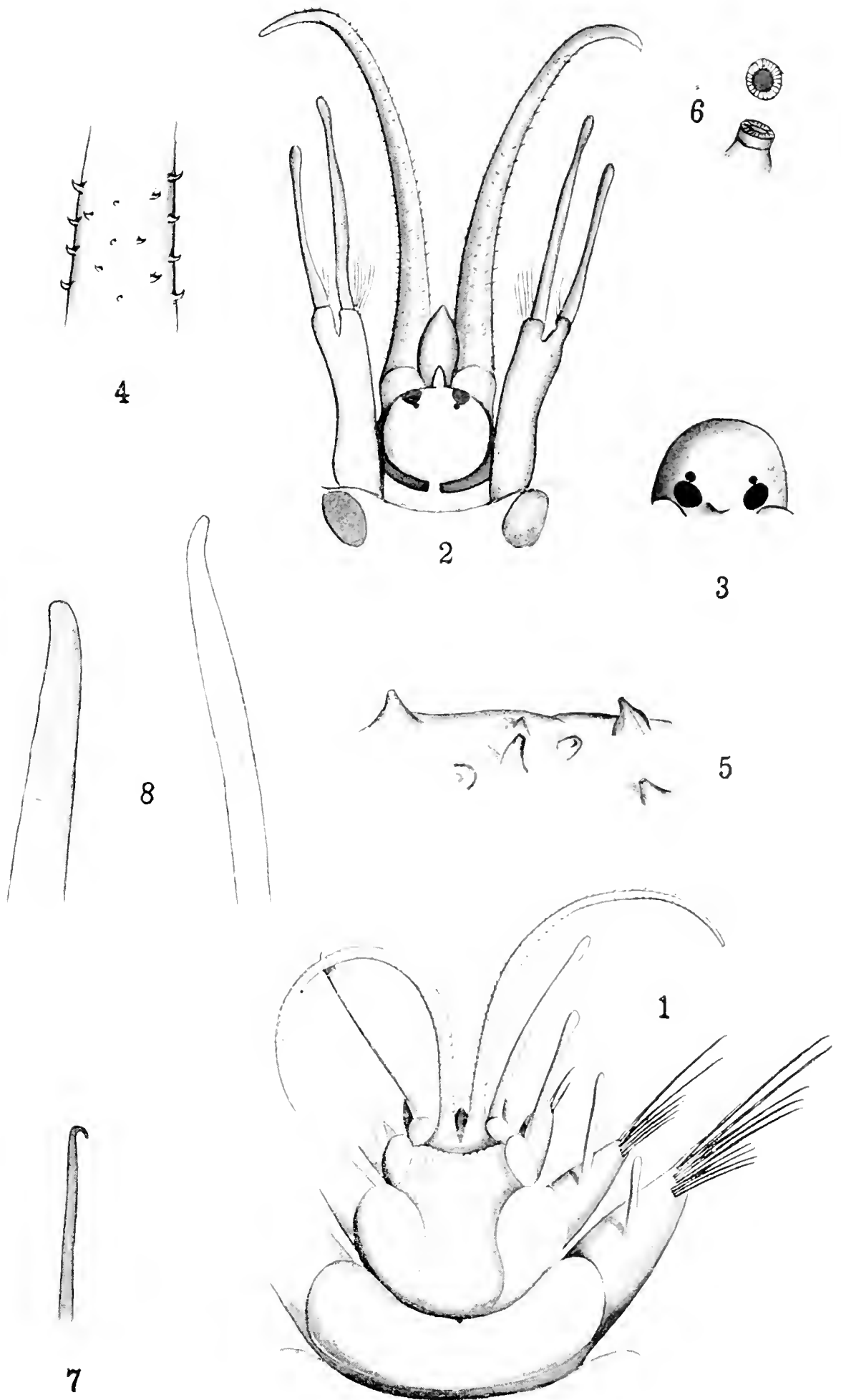







EXPLANATION OF PLATE LXX.

*SIMILUNCINUS DACELONIS, Justu.*

- Fig. 1. Scolex, rostellum retracted.  
.. 2. " " " everted.  
.. 3. Portion of strobila, showing nerves and excretory canals.  
.. 4. Edge of segment, showing cirrus everted.  
.. 5. Hook, very highly magnified.  
.. 6. Internal anatomy seen in Longit. Horiz. Section.  
.. 7. " " " " " transv. section.  
.. 8. Oncosphere.
- 

Explanation of lettering:—C, corp., calcareous corpuscle; cir. sac., cirrus sac; cu., cuticle; d.v., dorsal excretory vessel; l.m., longit. muscle bundle; n., longit. nerve; ov., ovary; r. sem., recept. seminis; tr. exc. v., transverse excretory vessel; t., testis; tr. m., transverse muscle; ut., uterus; vag., vagina; v. def., vas deferens; v. eff., vas efferens; vit. gld., vitelline gland; v. sem., vesicula seminalis; v. vess., ventral vessel.

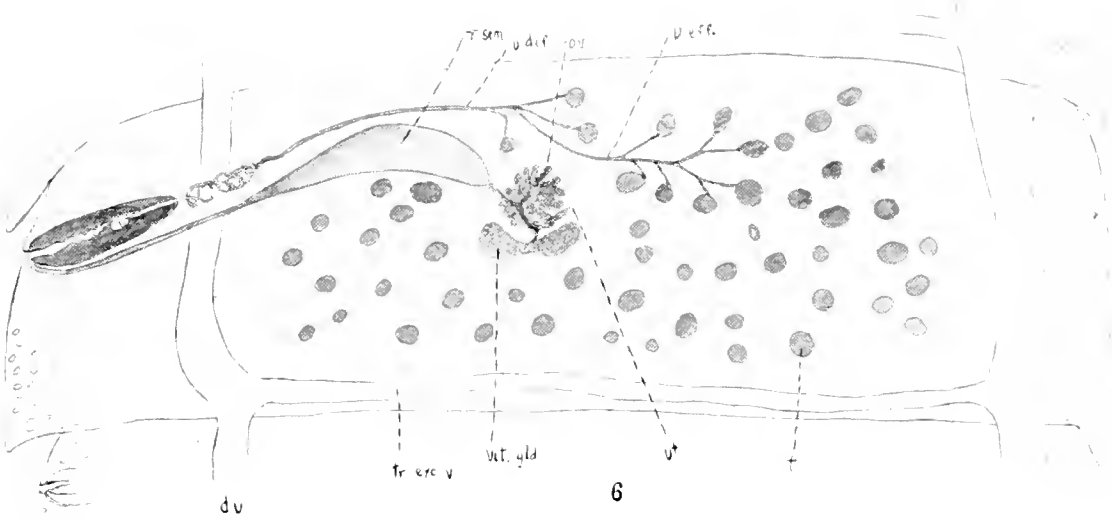
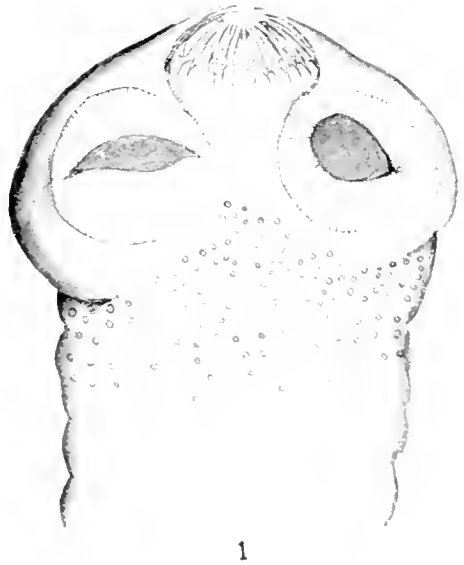
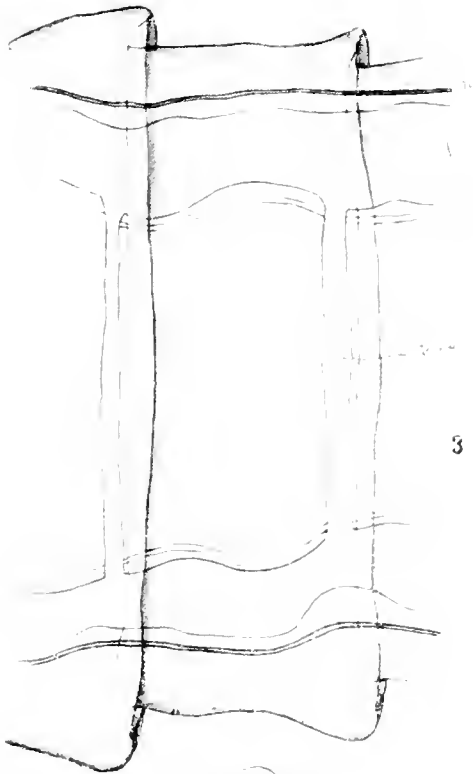
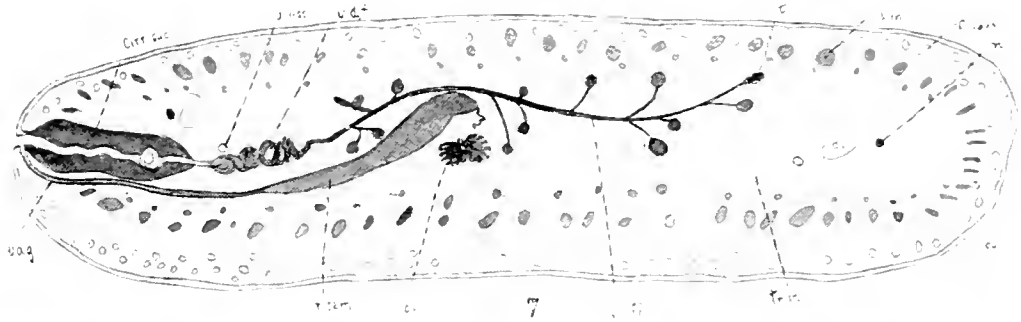





## EXPLANATION OF PLATE LXXI.

### SAGITTA AUSTRALIS, *Justu.*

- Fig. 1. — Entire specimen.  
 „ 2. Head.  
 „ 3.—Jaw.  
 „ 4.—End of a jaw.  
 „ 5.—Vestibular ridge.  
 „ 6.—Transv. sect. in region of ventral ganglion.  
 „ 7.— „ „ „ „ ovary.  
 „ 8.— „ „ „ „ anus.  
 „ 9.— „ „ „ „ testes (tail).  
 „ 10.— „ „ „ „ vesiculae seminales.  
 „ 11.— „ „ „ „ tail fin.

In the drawing of sections, the muscle is lined, the epidermis plain, the intestinal and coelomic epithelium dotted.

References to lettering:—a.f., anterior fin; a.t., anterior teeth; b., base of point; b.n., buccal nerve; b.p., back of point; br., brain; c., coelome; c. ep., coelomic epithelium; d.l.m., dorso-lateral muscle; d.m., dorsal mesentery; e., edge of point; ep., epidermis; e.s., edge of shaft; f., fin; f.r., fin ray; g., insertion of base of point; h., head; int., intestine; i.e., intestinal epithelium; i.t., inmost tooth of posterior row; j., jaw; k., anus; l.p., lateral process of vestibular ridge; m., muscle; mo., mouth; o., ovary; o.d., oviduct; o.o., external opening of oviduct; o.m., oblique muscles; o.t., outermost posterior tooth; ph., pharynx; p., pulp; p.r., posterior row of teeth; pt., point of jaw; p.f., posterior fin; s., shaft of jaw; s.m., sperm morulae; t., tail; t.c., tail coelome; t.f., tail fin; t.g., testes; t.m., tail mesentery; tr.m., transverse muscle; t.s., tail septum; v.g., ventral ganglion; v.l.m., ventral longit. muscles; v.m., ventral mesentery; v.r., vestibular ridge; w., anterior septum; x., posterior extension of body coelome behind anus; y., oesophagus.

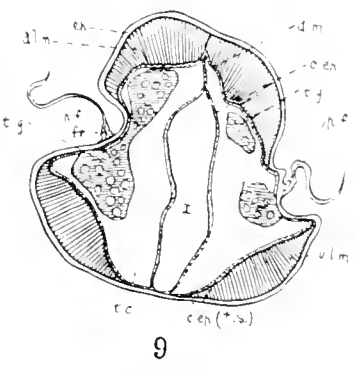
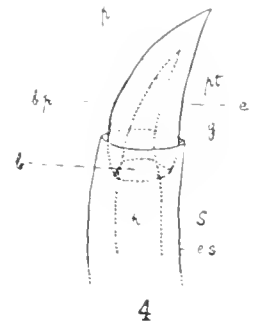
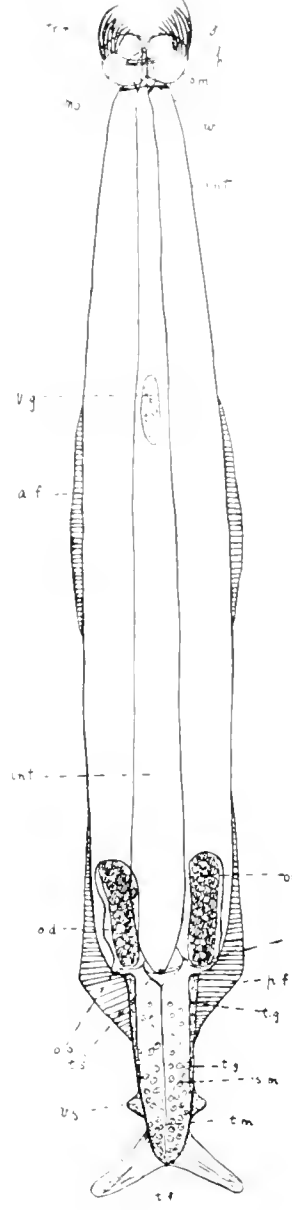
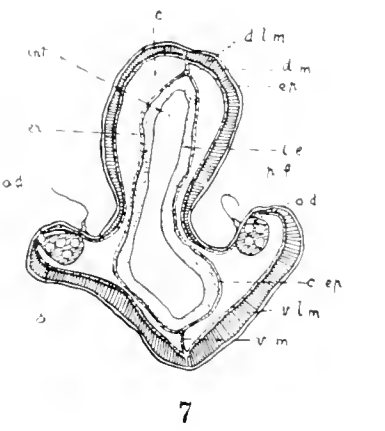
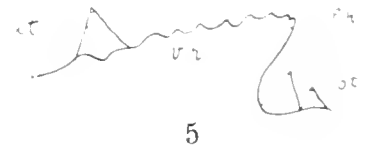
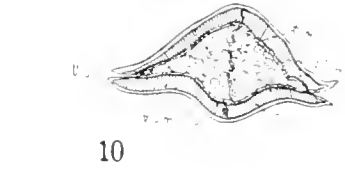
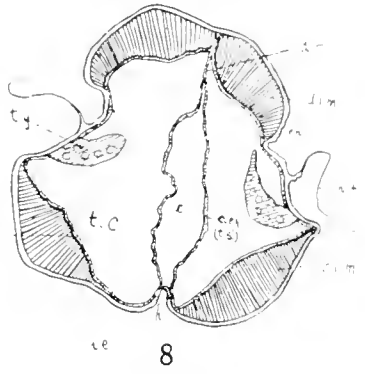
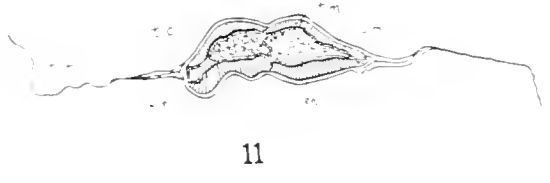
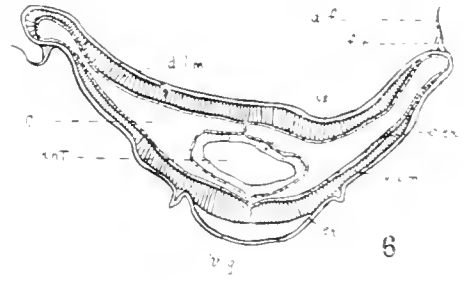
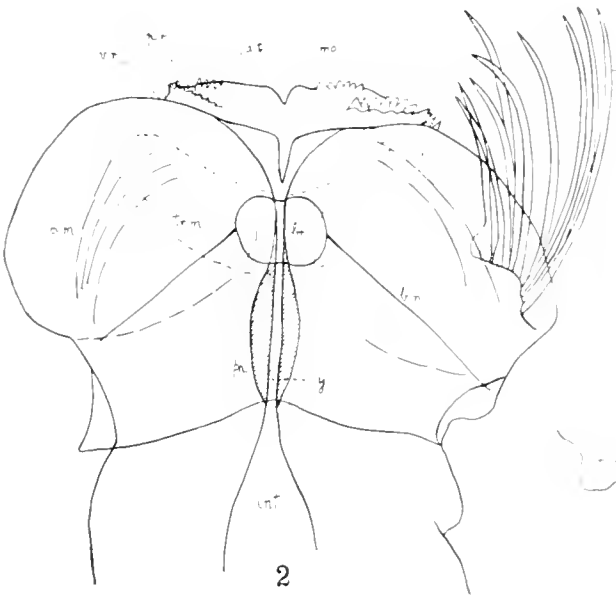







EXPLANATION OF PLATE LXXII.

---

HEMOGREGARINA AMETHYSTINA, *Justo*.

- Fig. 1. Uninfected erythrocyte.  
Figs. 2, 23, 24. Parasites without capsule.  
,, 3 to 22. Encapsuled parasites.  
Fig. 28. Very young form.  
,, 25. Erythrocyte containing two parasites.

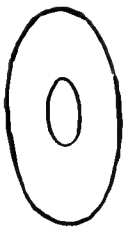

1



2



3



4



5

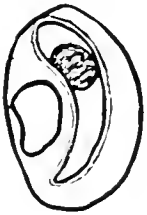

6



7



8



9



10

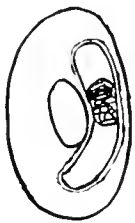

11

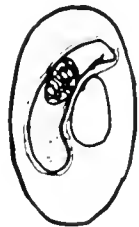

12



13



14



15



16

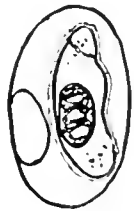

17



18



19



20

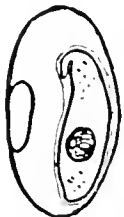

21

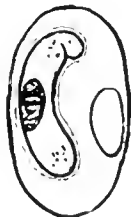

22



23

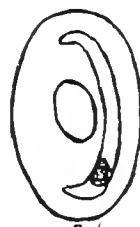

24



25





EXPLANATION OF PLATE LXXIII.

AUSTRALIAN POLYPLACOPHORA.

- Fig. 1. *Lepidopleurus badius*, Hedley & Hull.  
" 2. " " " " median valve from within.  
" 3. *Chiton coxi*, Pilsbry.  
" 4. " " " " sculpture of median valve.  
" 5. " " " " posterior valve in profile.  
" 6. *Chiton torri*, Hedley & Hull.  
" 7. " " " " sculpture of median valve.  
" 8. " " " " interior of same.  
" 9. " " " " posterior valve in profile.  
" 10. " " " " interior of anterior valve.  
" 11. " " " " interior of posterior valve.  
" 12. *Chiton jugosus*, Gould—sculpture of median valve.  
" 13. " " " " posterior valve in profile.

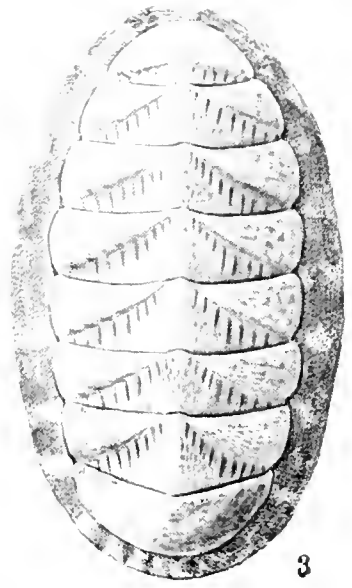
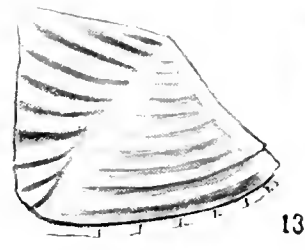
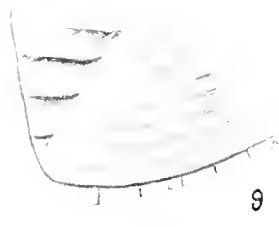
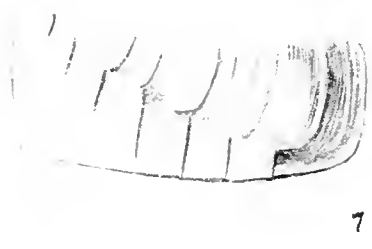
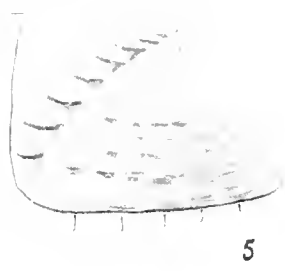
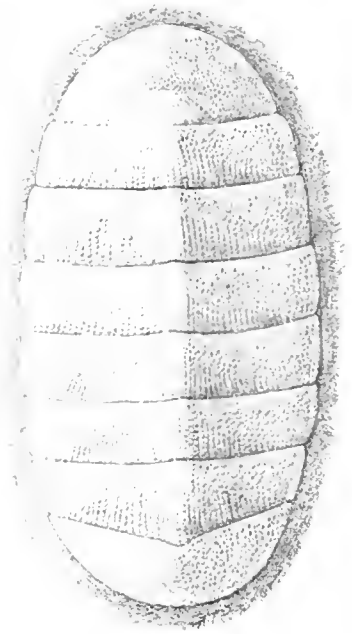
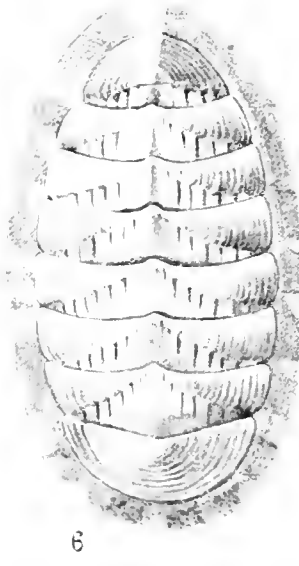
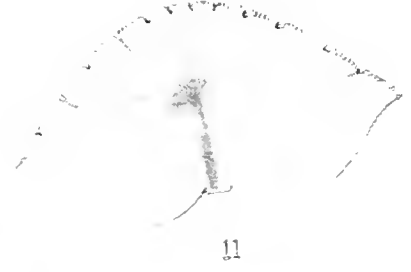
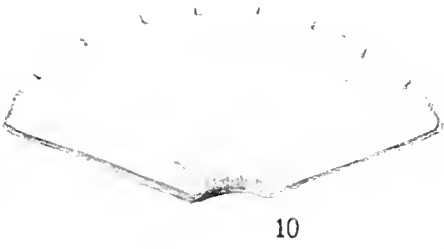
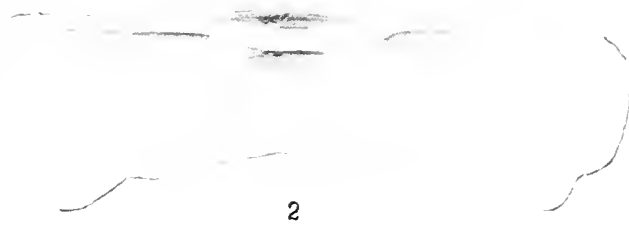







EXPLANATION OF PLATE LXXIV.

—  
AUSTRALIAN POLYPLACOPHORA.

- |         |   |
|---------|---|
| Fig. 14 | <i>Chiton translucens</i> , Hedley & Hull.    |
| „ 15.   | „ „ sculpture of median valve.                |
| „ 16.   | „ „ interior of anterior valve.               |
| „ 17.   | „ „ interior of posterior valve.              |
| „ 18.   | „ „ girdle scales.                            |
| „ 19.   | <i>Chiton rauchusensis</i> , Hedley & Hull.   |
| „ 20.   | „ „ sculpture of median valve.                |
| „ 21.   | „ „ interior of posterior valve.              |
| „ 22.   | „ „ interior of anterior valve.               |
| „ 23.   | „ „ girdle scales.                            |
| „ 24.   | <i>Acanthochites maughani</i> , Torr & Ashby. |
| „ 25.   | „ „ sculpture of median valve.                |
| „ 26.   | „ „ anterior valve.                           |
| „ 27.   | „ „ posterior valve.                          |
| „ 28.   | <i>Ischnochiton mayi</i> , Pilsbry.           |

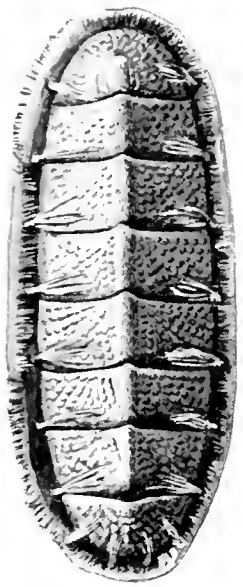

24

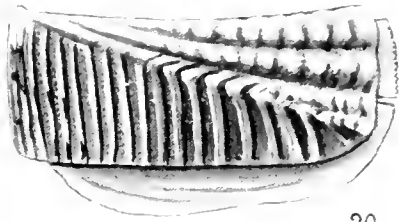

20



14

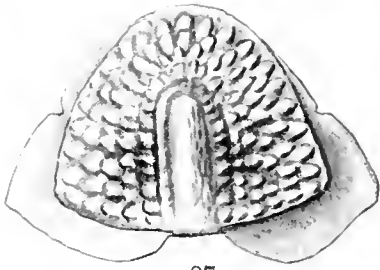

27

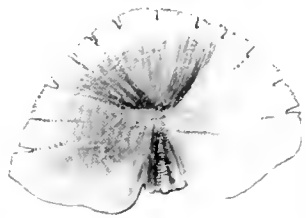

21

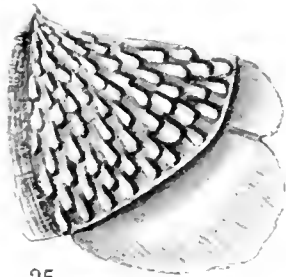

25

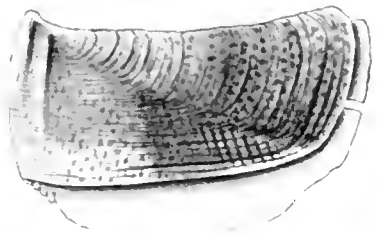

15

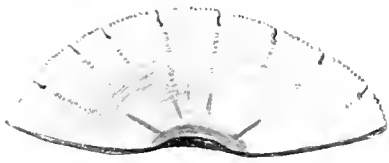

22

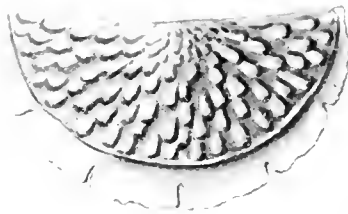

26

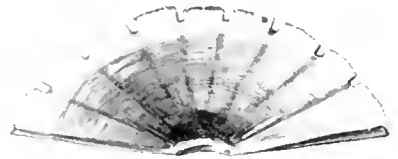

16

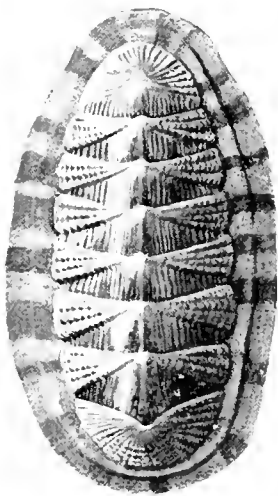

19

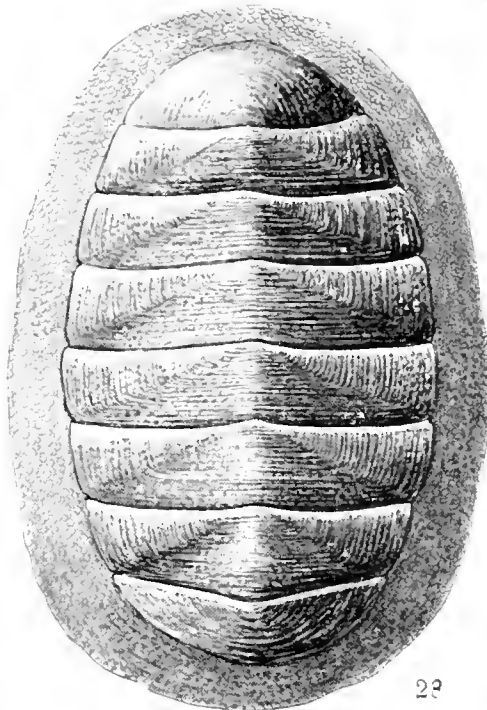

28

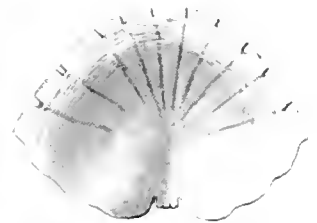

17



23

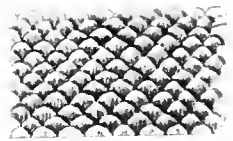

18





EXPLANATION OF PLATE LXXV.

POLYZOA.

- Fig. 1a. *Bipora biarmata*, Mapl.—× 50.  
1b. „ „ (thyrostome and avicularia) × 110.  
2a. „ *multiarmata*, Mapl.—× 50.  
2b. „ „ (thyrostome and avicularia) × 110.  
3a. Portion of *Bipora magniarmata*, Mapl.—× 50.  
3b. „ „ „ (thyrostome and avicularia) × 110.

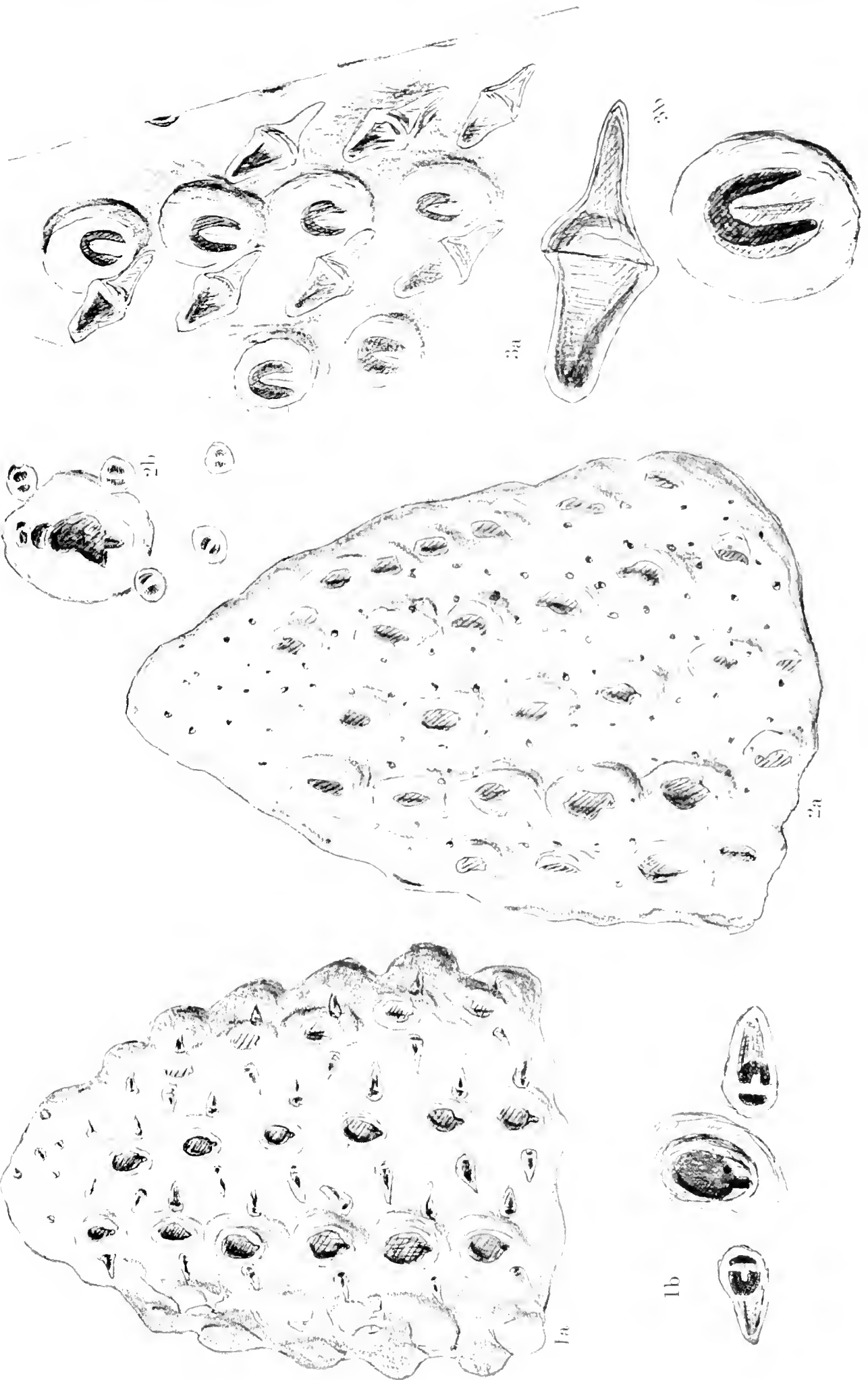







EXPLANATION OF PLATE LXXVI.

POLYZOÄ.

- Fig. 4a. *Bipora ampulla* Mapl. (under surface)—× 26.  
,, 4b. ,, ,, (upper surface)—× 26.  
,, 5a. ,, ,, young (upper surface)—× 26.  
,, 5b. ,, ,, young (under surface)—× 26.

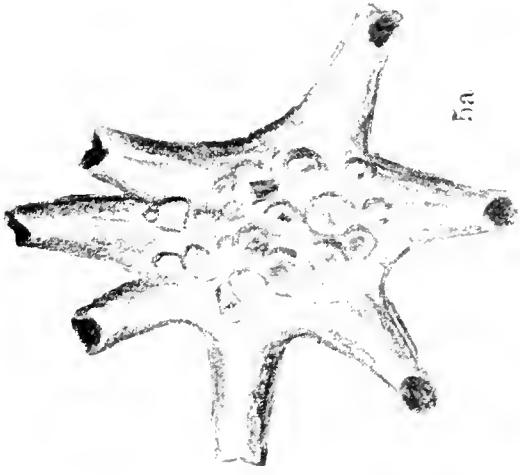

5a



5b



4a



4b





EXPLANATION OF PLATE LXXVII.

---

POLYZOA.

- Fig. 6a. *Bipora churnea*, Mapl. (portion of upper surface)— $\times 50$ .  
,, 6b. ,, ,, (portion of under surface)— $\times 26$ .  
,, 7. *Bipora mamillata*, Mapl. (portion of upper surface)— $\times 50$ .  
,, 8. *Selenaria nitida*, Mapl. (portion of upper surface)— $\times 50$ .



6a

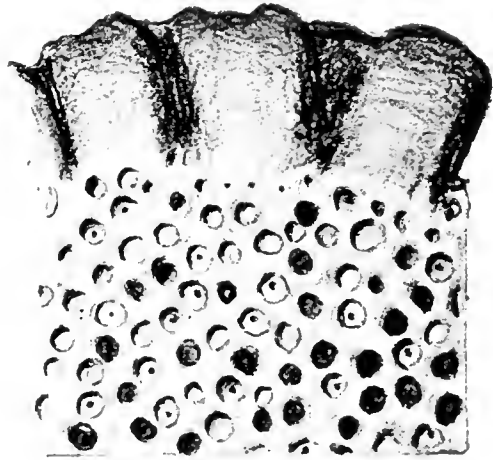

6b

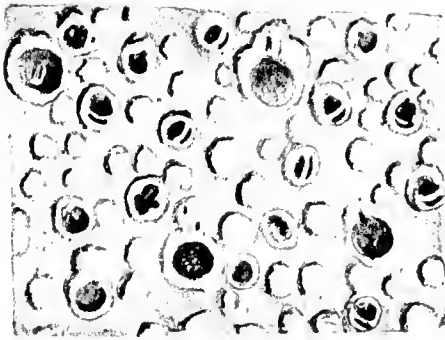

7

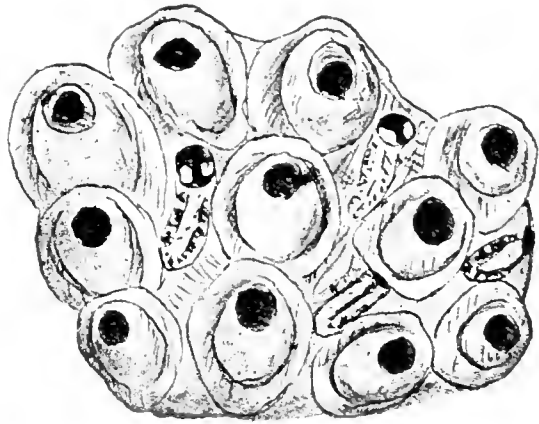

8







EXPLANATION OF PLATE LXXVIII.

POLYZOA.

- Fig. 9. *Hiantopora perforata*, Mapl.—× 50.  
,, 10a *Cellepora doliaris*, Mapl. (viewed from above)—× 50.  
,, 10b. ,, ,, (side view)—× 50.  
,, 11. *Zuglopورا lanceolata*, Mapl.—× 50.  
,, 12. *Lekythopora avicularis*, Mapl.—× 50.

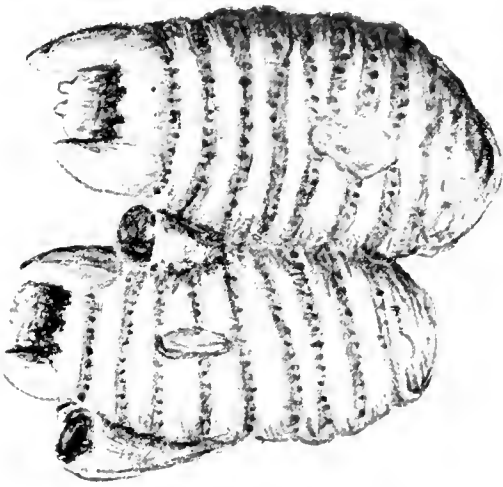

10b



10a

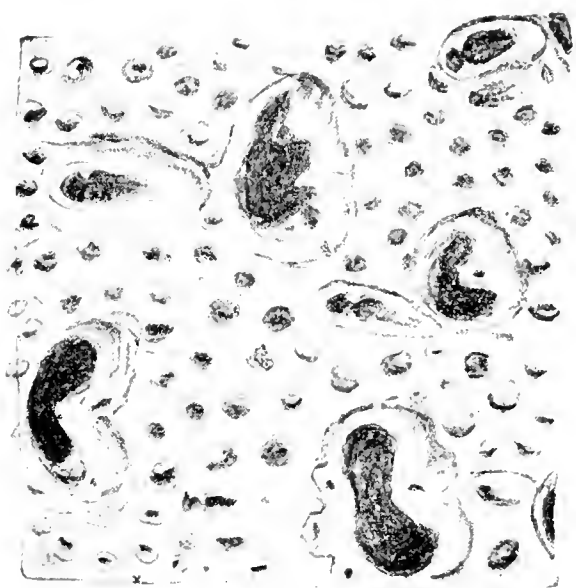

9

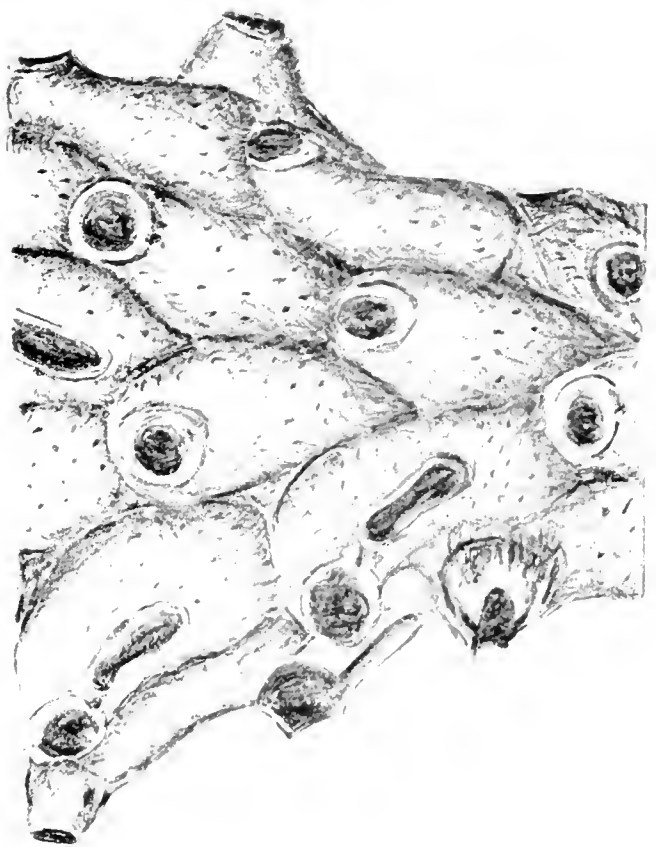

12

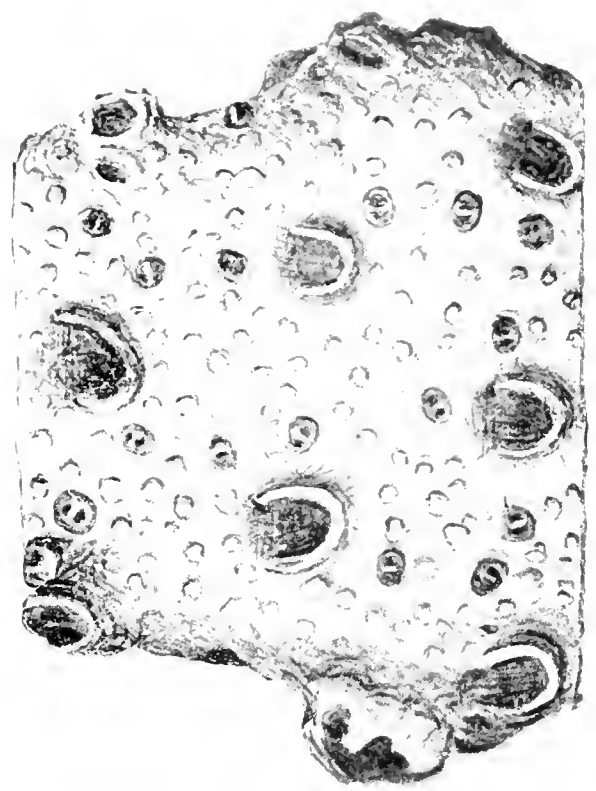

11





EXPLANATION OF PLATE LXXIX.

TOPAZ.

Figs. 1, 2. Carpet Snake Creek, near Torrington, N. S. Wales; orthographic and clinographic projection.

Forms.— $c$  (001),  $b$  (010),  $m$  (110),  $O$  (560),  $M$  (230),  $l$  (120),  $\pi$  (250),  $g$  (130),  
 $n$  (140),  $f$  (021),  $y$  (041),  $h$  (203),  $d$  (201),  $i$  (223),  $u$  (111),  $o$  (221),  
 $x$  (243).

GYPSUM.

Fig. 3. Mt. Elliott Mine, Chillagoe, Queensland; twinned on  $a$  (100).  
Orthographic projection on (010).

Forms.— $b$  (010),  $m$  (110),  $\delta$  (350).

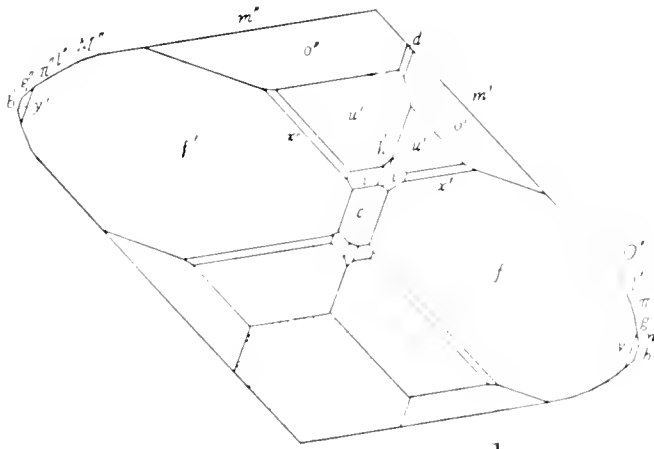

1

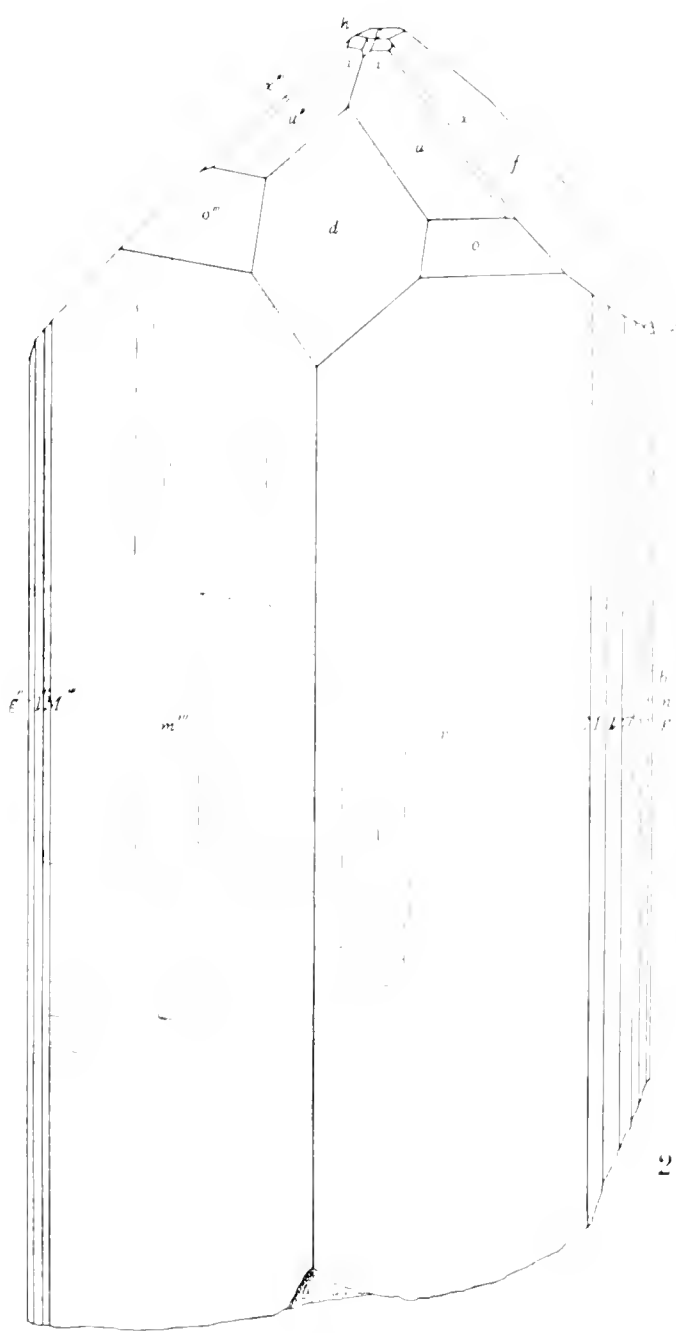

2

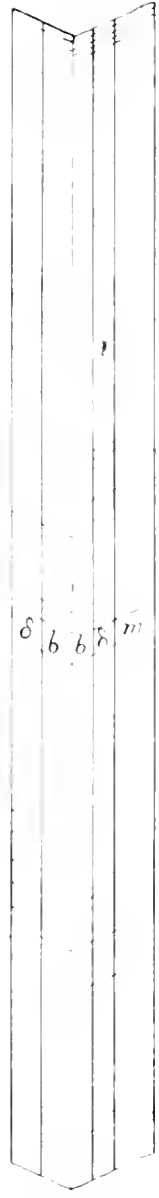

3







## EXPLANATION OF PLATE LXXX.

### ANGLESITE.

Fig. 1. Proprietary Mine, Broken Hill, N. S. Wales.

Fig. 2. Montalbion, Queensland.

Forms.— $c$  (001),  $b$  (010),  $a$  (100),  $a$  (018),  $o$  (011),  $d$  (102),  $z$  (111),  $r$  (112),  
 $p$  (324),  $y$  (122).

### AZURITE.

Fig. 3. Muldiva, Queensland. Orthographic projection on (010).

Figs. 4, 5. Girofla Mine, Chillagoe, Queensland. Orthographic and clinographic projection.

Forms.— $c$  (001),  $a$  (100),  $m$  (110),  $w$  (120),  $l$  (023),  $f$  (011),  $p$  (021),  
 $\sigma$  (101),  $\mu$  (105),  $n$  (102),  $\theta$  ( $\bar{1}$ 01),  $\eta$  (302),  $v$  ( $\bar{2}$ 01),  $h$  (221),  
 $q$  (223),  $k$  ( $\bar{2}$ 21),  $o$  ( $\bar{2}$ 41).

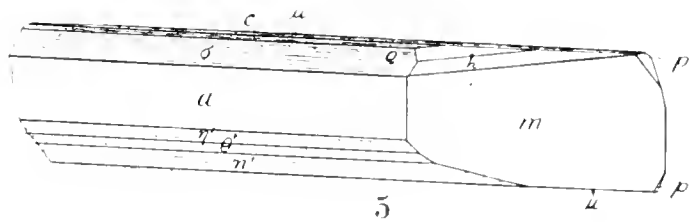
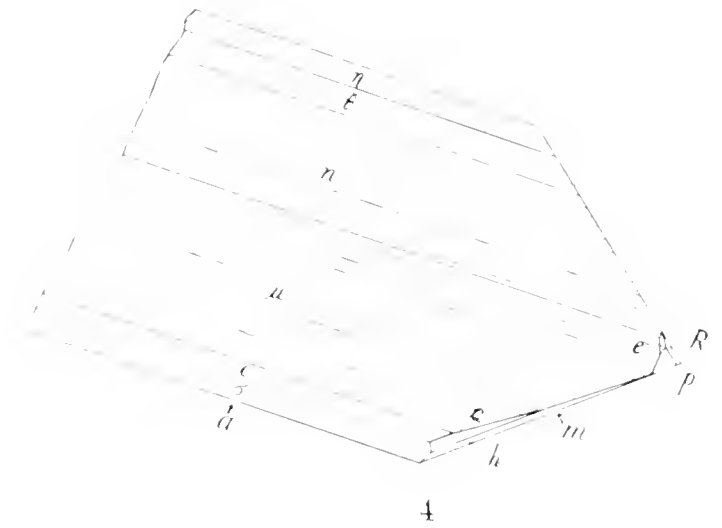
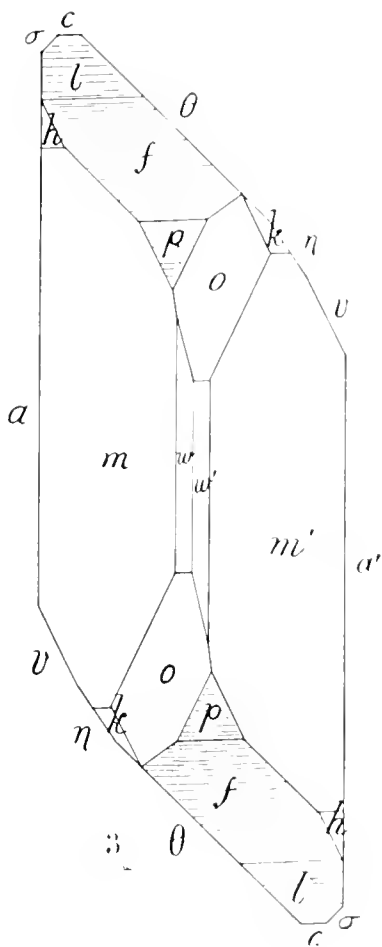
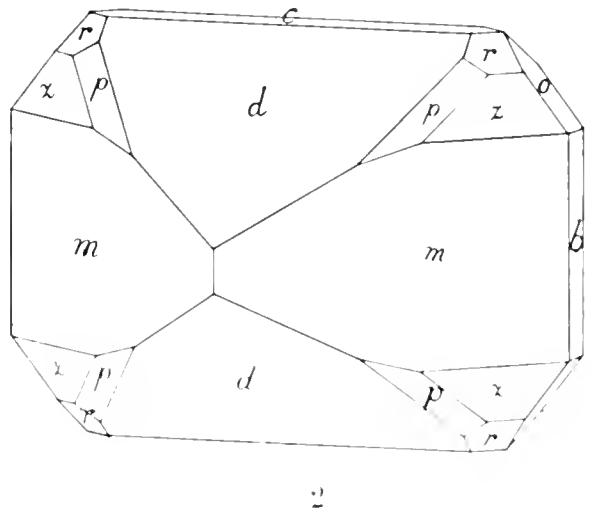
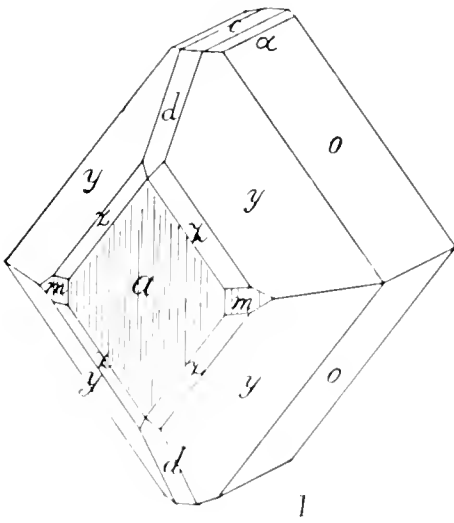





EXPLANATION OF PLATE LXXXI.

PHOSGENITE.

Figs. 1, 2. Broken Hill, N. S. Wales. Orthographic and clinographic projection.

Forms.— $c$  (001),  $a$  (100),  $m$  (110),  $u$  (210),  $o$  (201),  $x$  (111),  $w$  (221),  $s$  (211).

MONAZITE.

Figs. 3, 4. Trundle, N. S. Wales. Orthographic and clinographic projection.

Fig. 5. California Creek, Queensland.

Forms.— $c$  (001),  $a$  (100),  $m$  (110),  $u$  (120),  $l$  (210),  $g$  (012),  $e$  (011),  
 $u$  (021),  $x$  (101),  $p$  (103),  $\sigma$  (301),  $r$  (111),  $d$  (112),  $i$  (211),  $z$  (311).

CERUSSITE.

Fig. 6. Talwong Mine, near Marulan, N. S. Wales.

Forms.— $b$  (010),  $m$  (110),  $x$  (012),  $k$  (011),  $i$  (021),  $r$  (031),  $p$  (111).

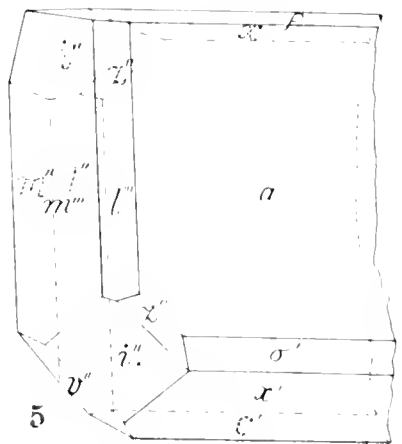
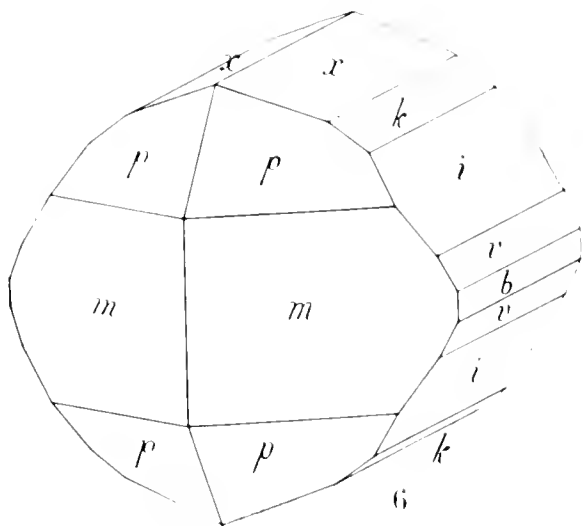
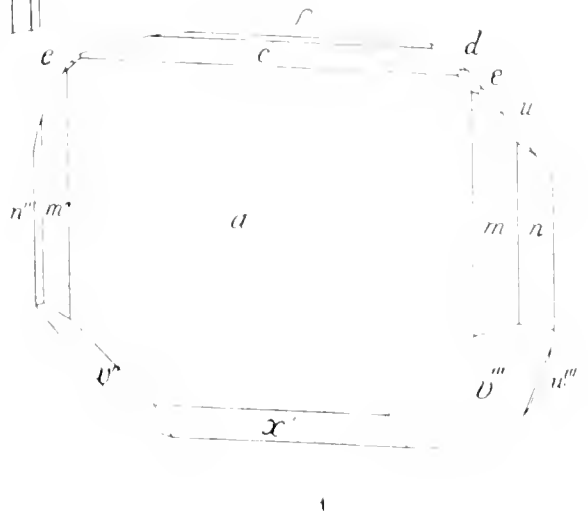
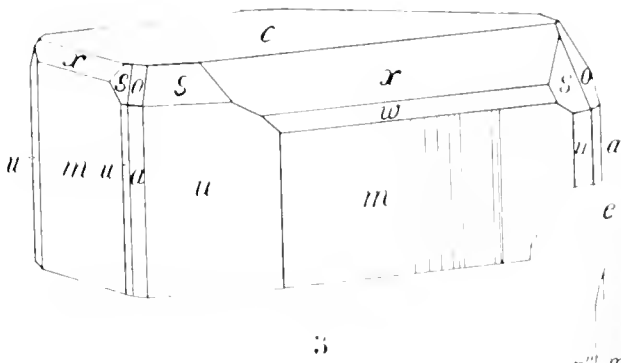
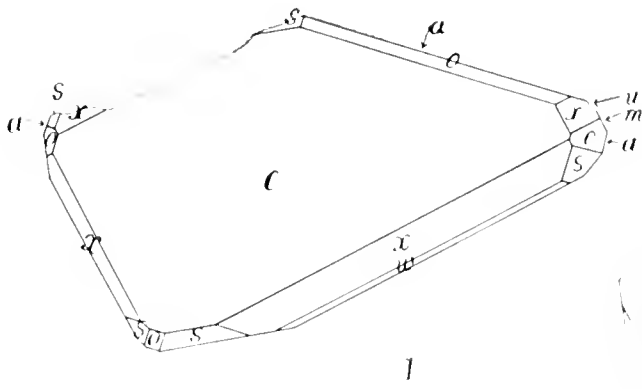







EXPLANATION OF PLATE LXXXII.

---

TASMANIAN MOLLUSCA.

- Fig. 1. *Succinea tamaricensis*, Petterd.  
,, 2, 3, 4. *Chloritis brunoniana*, Johnston.  
,, 5, 6, 7. *Luoma luckmanii*, Brazier.

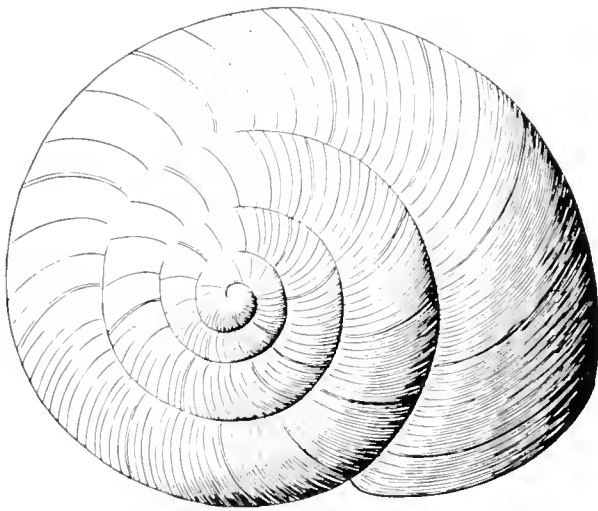

2

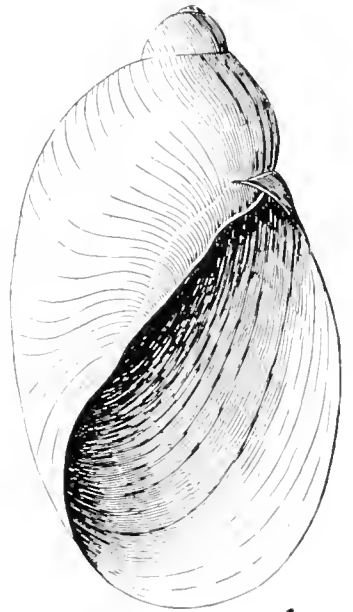

1

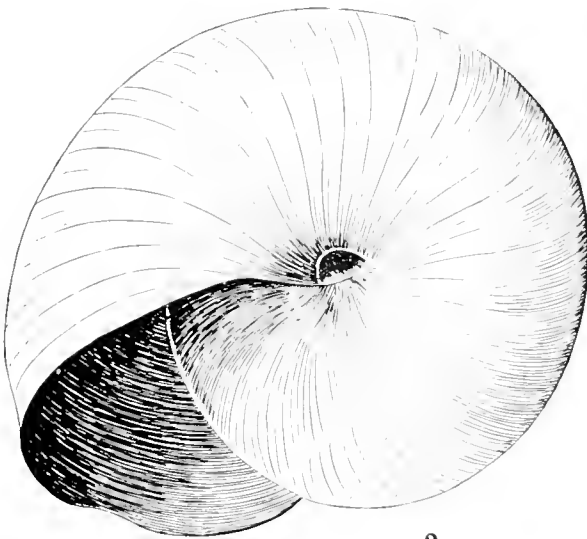

3

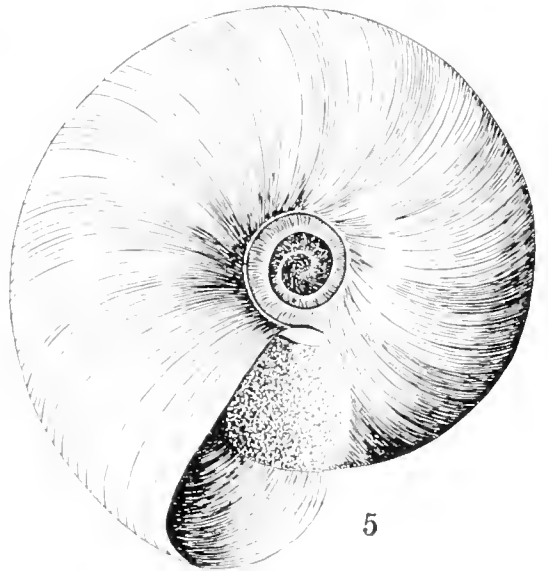

5

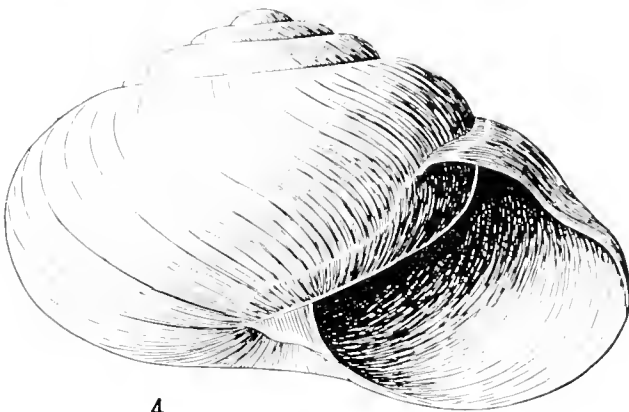

4

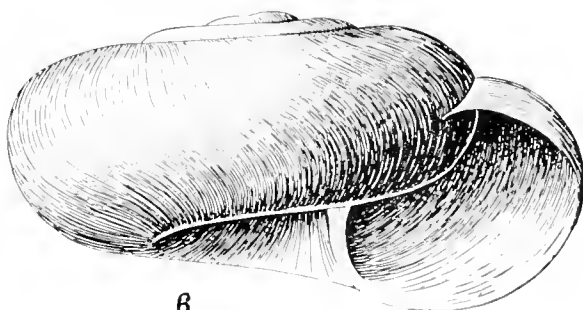

6

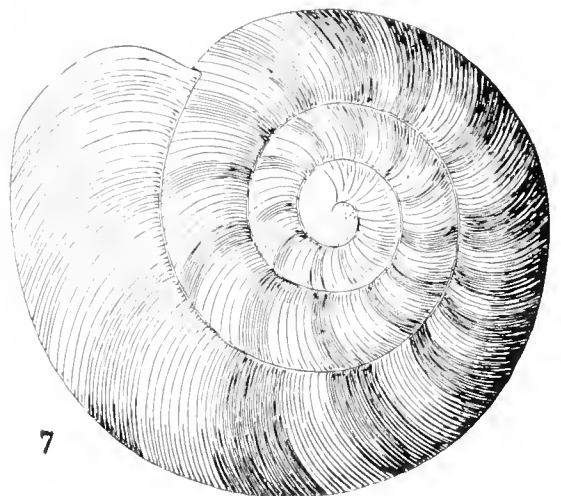

7





EXPLANATION OF PLATE LXXXIII.

---

TASMANIAN MOLLUSCA.

- Figs. 8, 9, 10. *Flammulina wildii*, Ten. Woods.  
,, 11, 12, 13. *Endodonta ricei*, Brazier.  
,, 14, 15, 16. *Flammulina curacao*, Brazier.

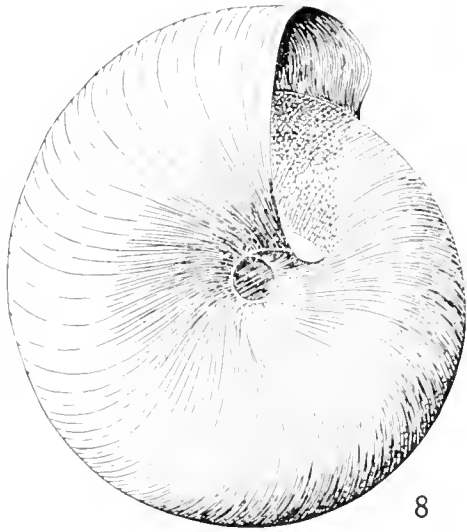

8

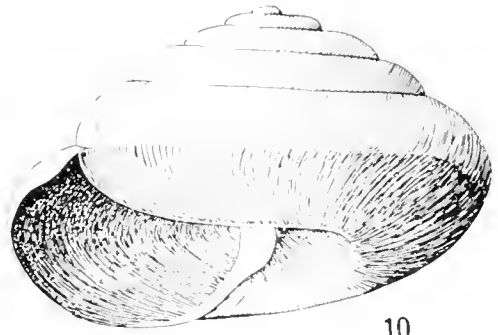

10

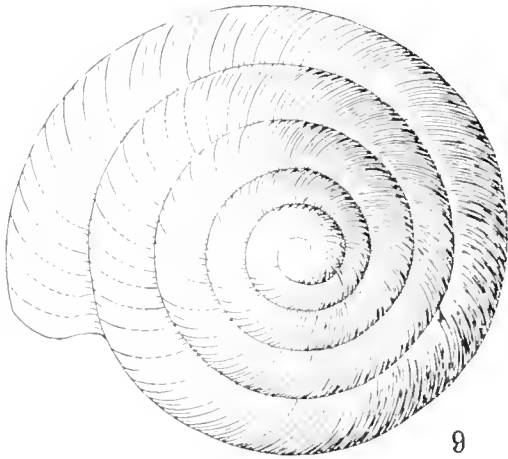

9

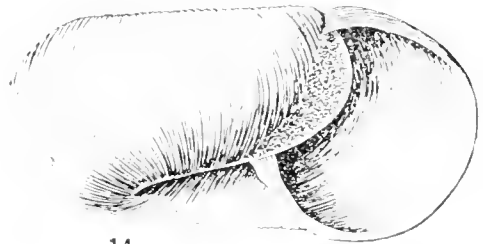

14

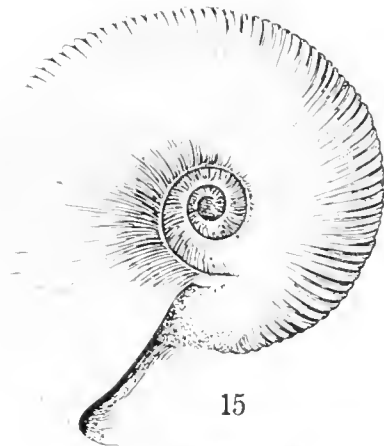

15



11

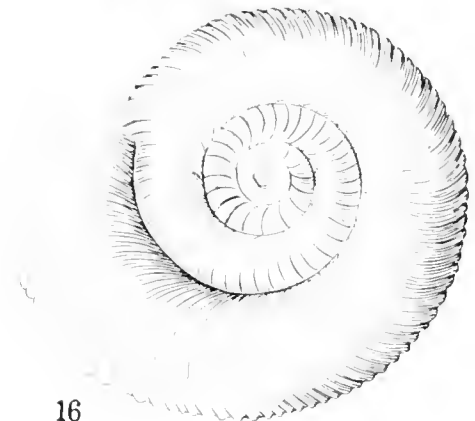

16

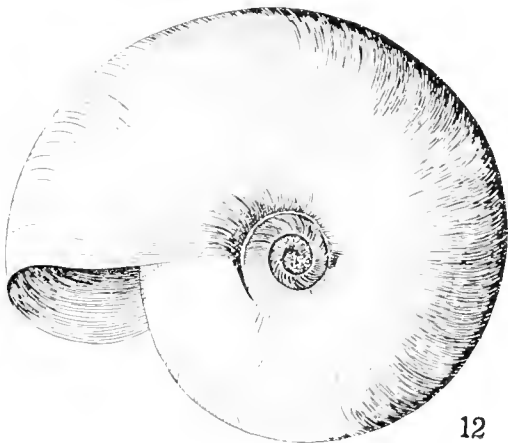

12

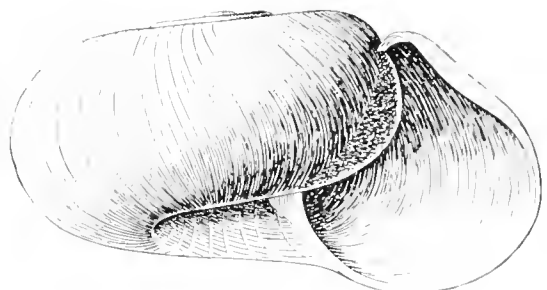

13







EXPLANATION OF PLATE LXXXIV.

---

TASMANIAN MOLLUSCA.

Figs. 17, 18, 19. *Endodonta dispar*, Brazier.  
„ 20, 21, 22. *Flammulina roblini*, Petterd.

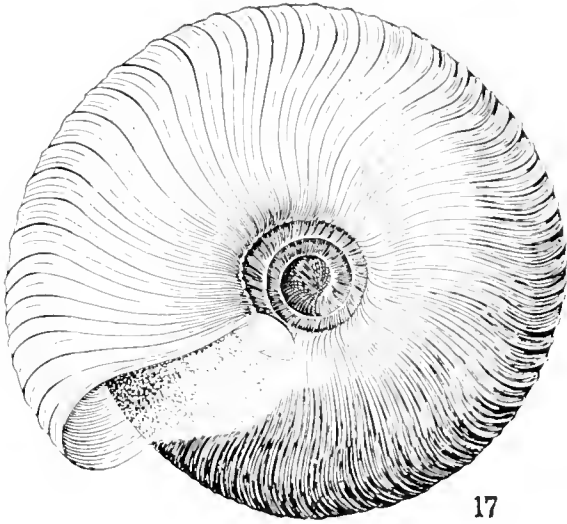

17

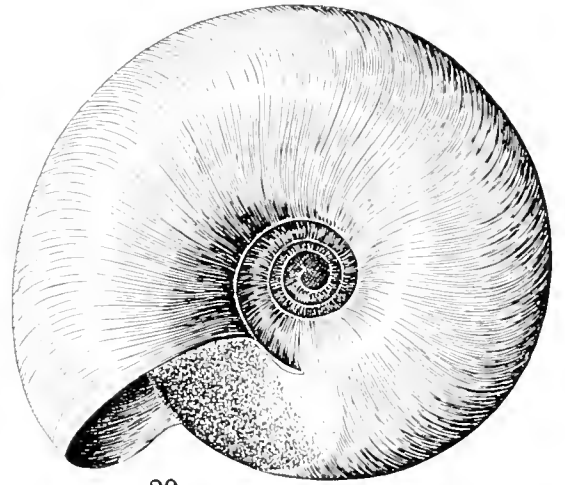

20

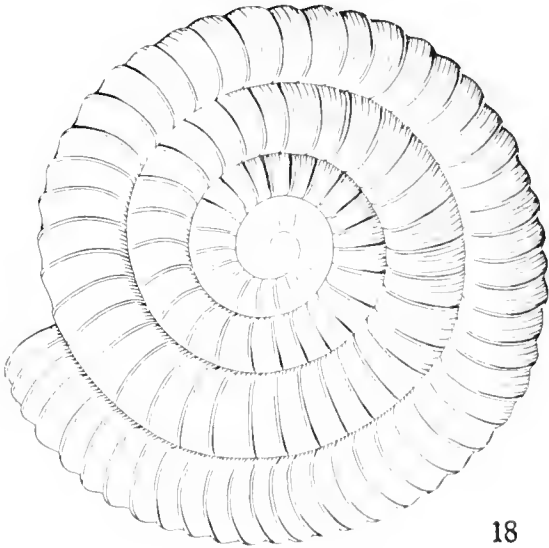

18

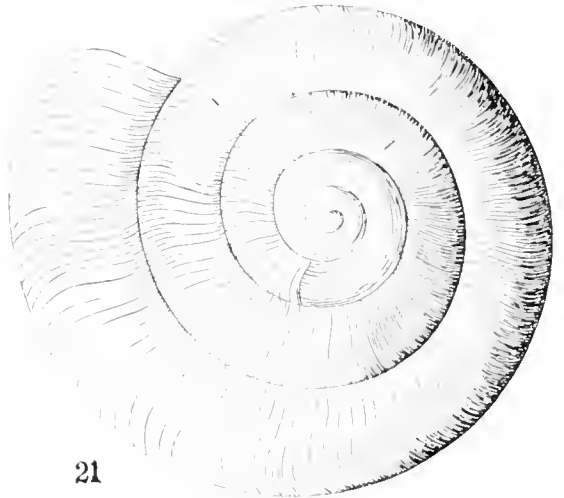

21

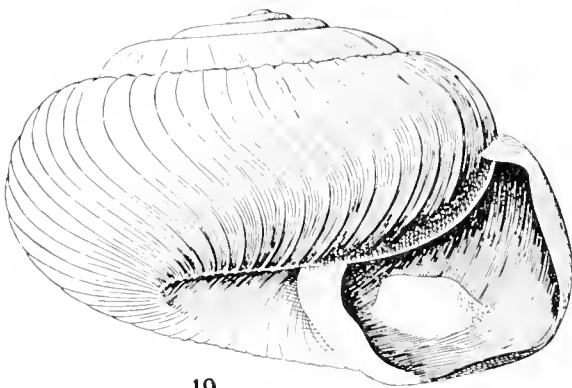

19

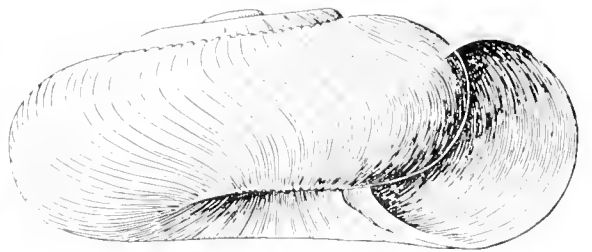

22





EXPLANATION OF PLATE LXXXV.

— — — — —  
TASMANIAN MOLLUSCA.

- Figs. 23, 24, 25. *Flammulina otwayensis*, Petterd, var. *alpina*, Johnston.  
.. 26, 27, 28. *Laoma jungermannia*, Petterd.  
., 29, 30, 31. *Eulodonta architectonica*, Brazier.

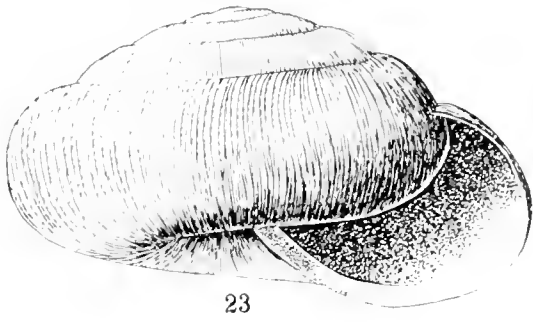

23

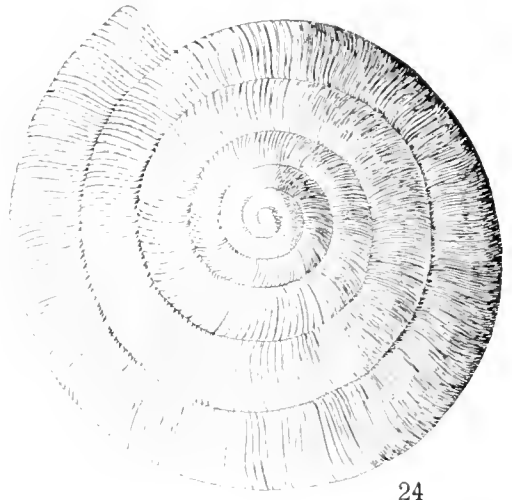

24

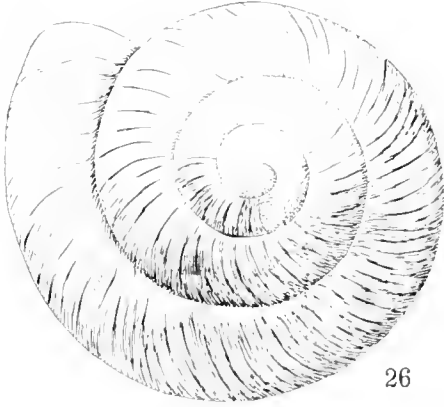

26



25

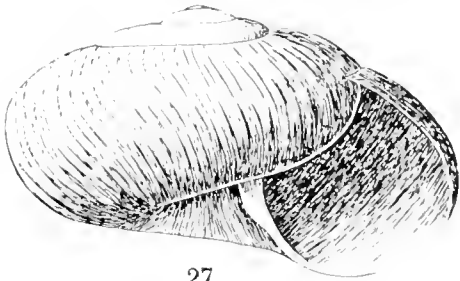

27

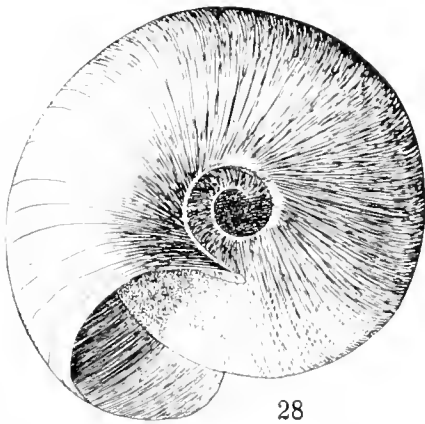

28

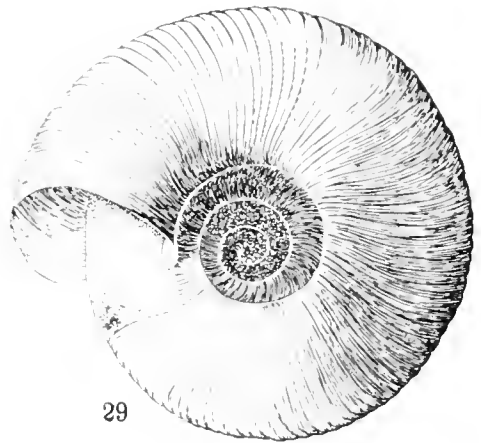

29

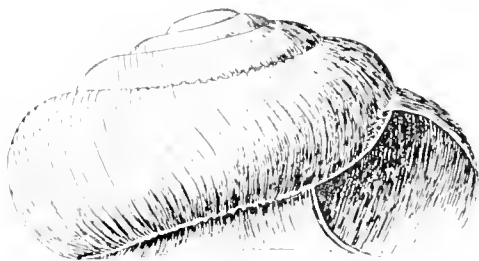

30

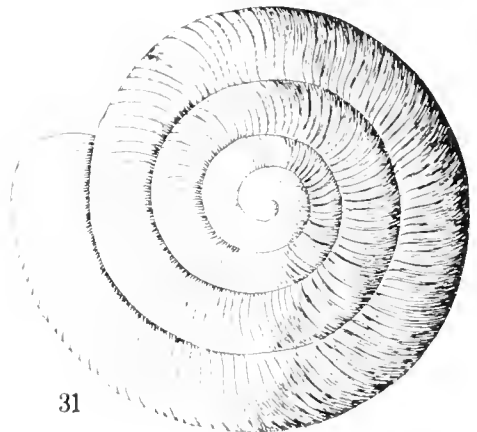

31







EXPLANATION OF PLATE LXXXVI.

TASMANIAN MOLLUSCA.

- Figs. 32, 33, 34. *Endodonta mimosa*, Petterd.  
,, 35, 36, 37. *Laoma pictilis*, Tate.  
,, 38, 39, 40. *Paryphanta dyeri*, Petterd.

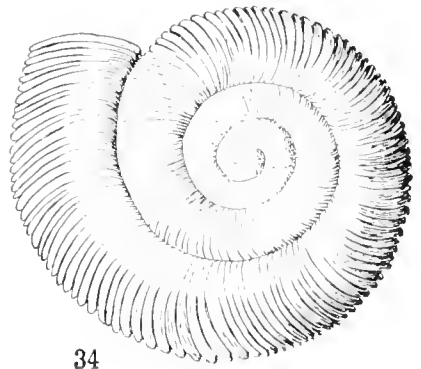
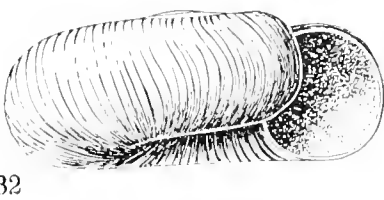
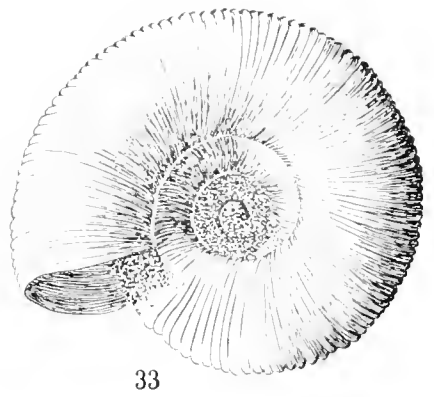
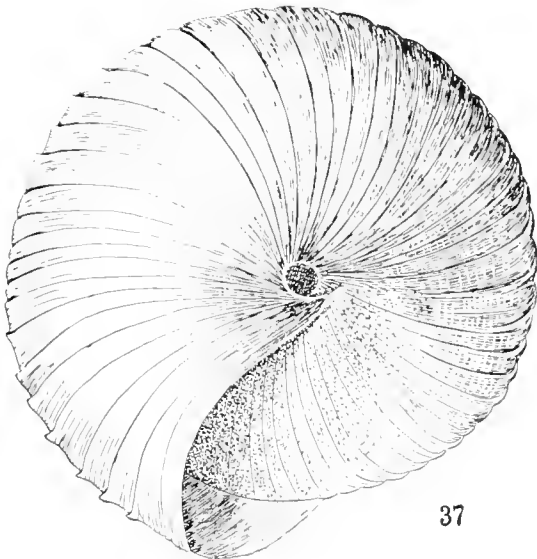
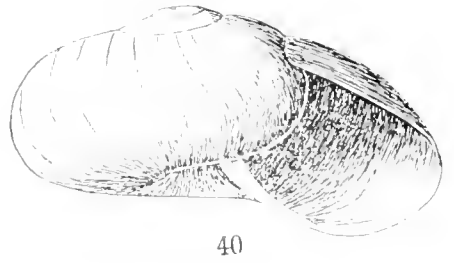
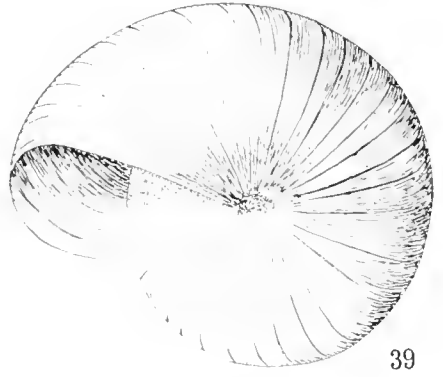
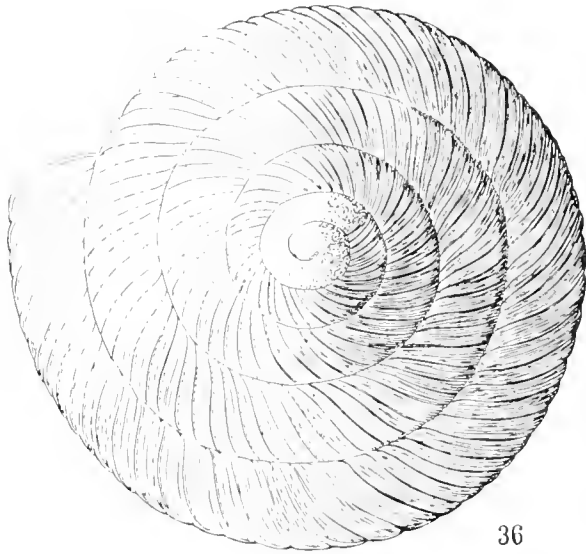
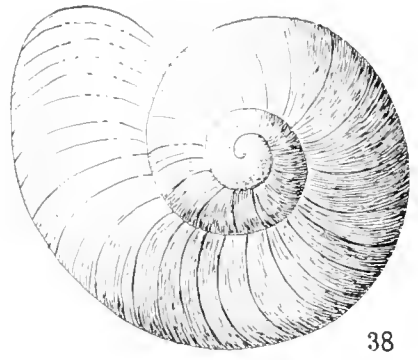
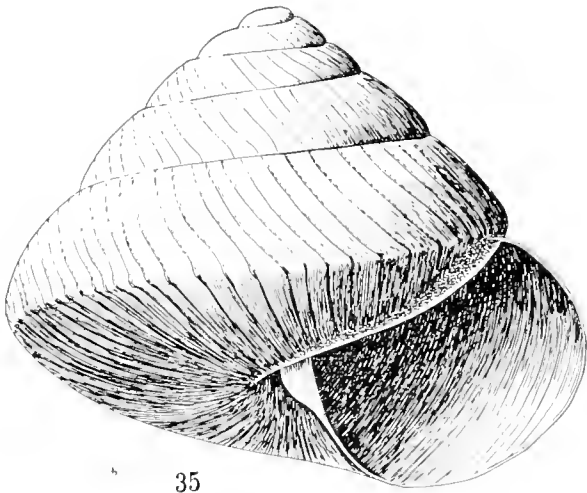





EXPLANATION OF PLATE LXXXVII.

---

TASMANIAN MOLLUSCA.

- Figs. 41, 42, 43. *Endodonta barrenensis*, Petterd.  
,, 44, 45, 46. *Laoma trucanini*, Petterd.  
,, 47, 48, 49. *Laoma spiceri*, Petterd.  
,, 50. Sculpture of ditto.

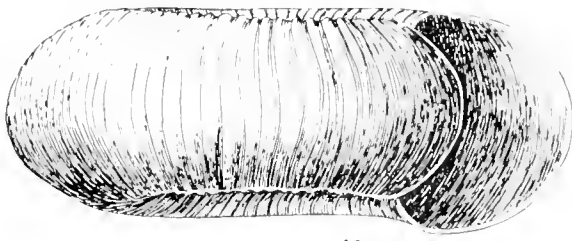

41

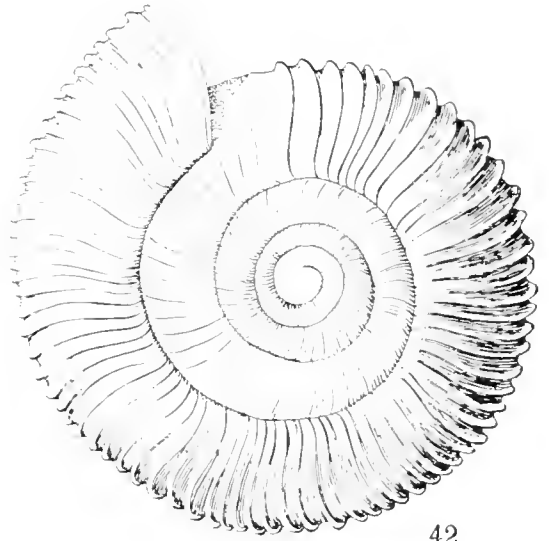

42

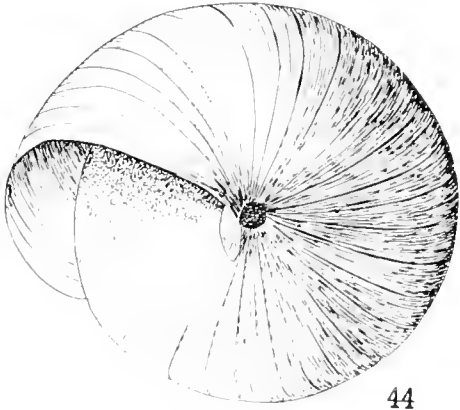

44

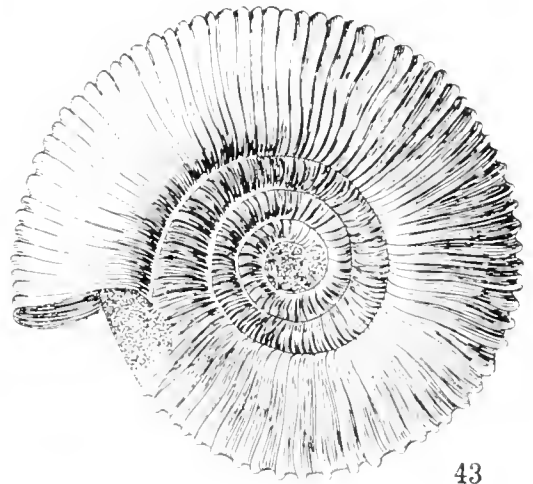

43

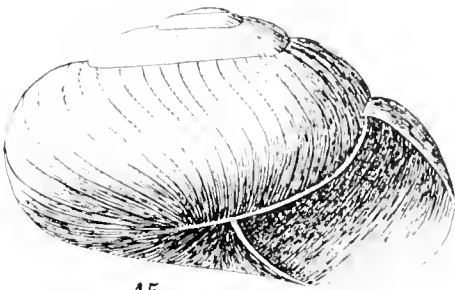

45

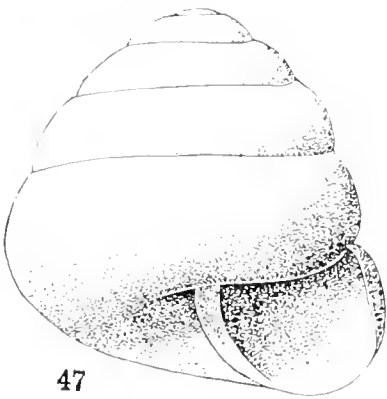

47

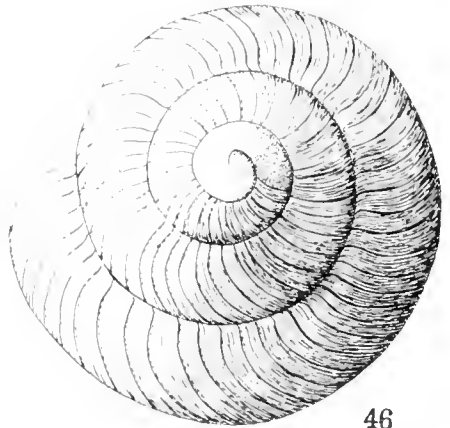

46

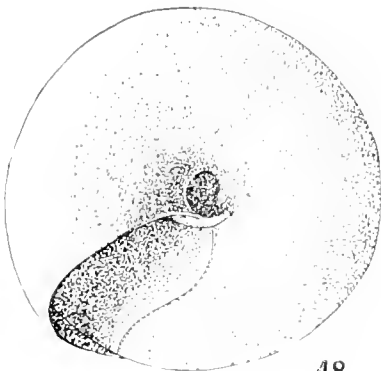

48

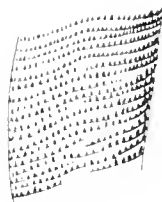

50

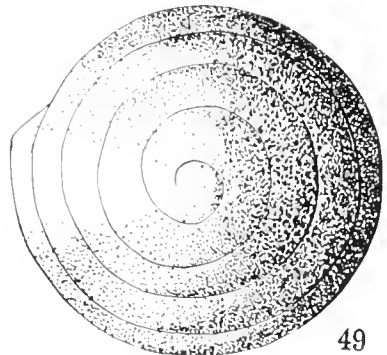

49







EXPLANATION OF PLATE LXXXVIII.

AUSTRALIAN CRUSTACEA.

- Fig. 1. *Canobita spinosus*, M. Edwards.  
,, 1A. ,, ,, coxae of the fifth legs of the male.  
,, 2. ,, ,, var. *variabilis*, McCulloch.  
,, 2A. ,, ,, ,, in shell of *Turbo*.

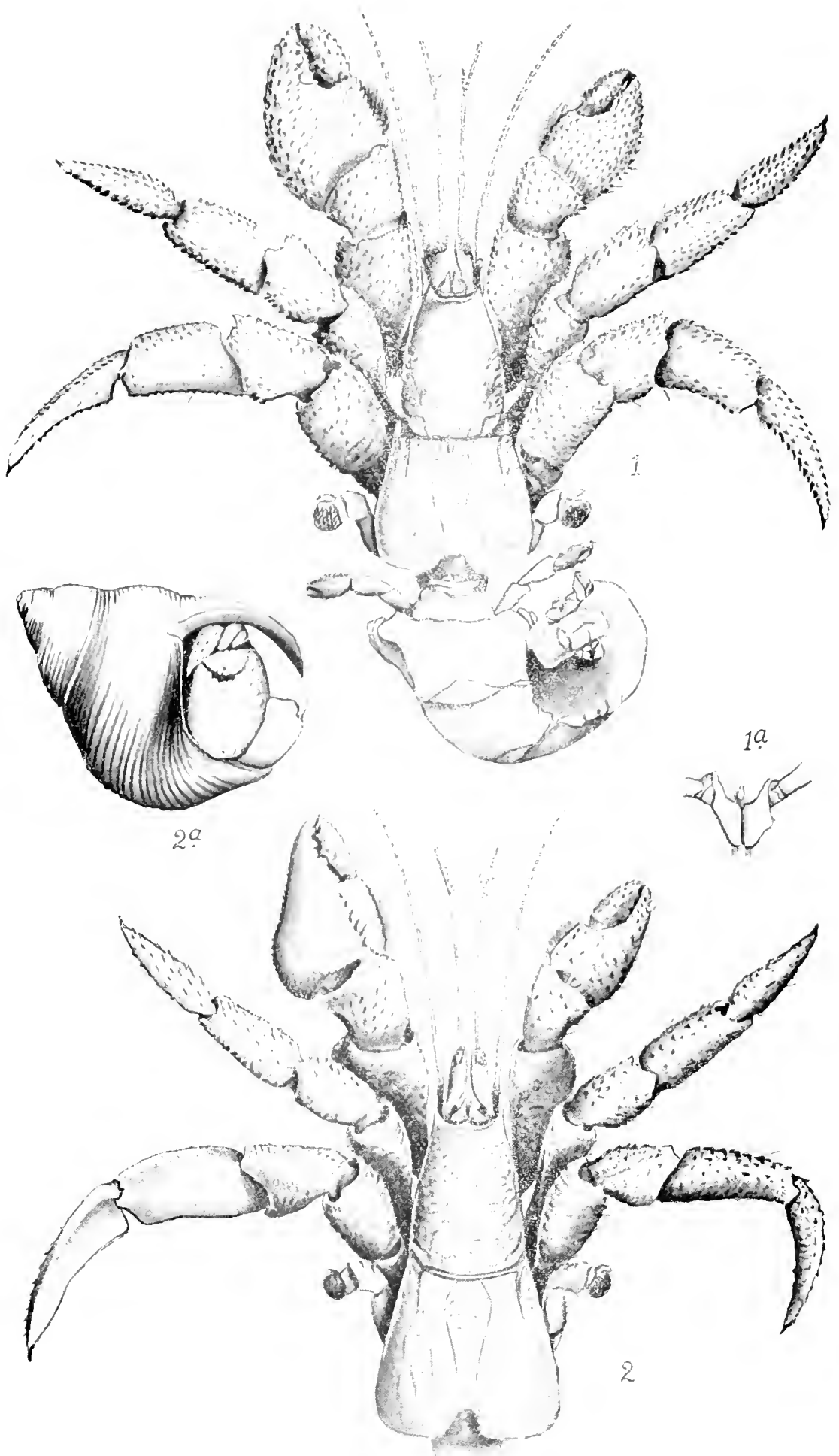





EXPLANATION OF PLATE LXXXIX.

—  
AUSTRALIAN CRUSTACEA.

- |      |     |                                   |  |
|------|-----|-----------------------------------|--|
| Fig. | 1.  | <i>Rhynchocinetes rugulosus</i> , | Stimpson.  |
| „    | 2.  | „                                 | „ mandible.  |
| „    | 3.  | „                                 | „ first maxilla.   |
| „    | 4.  | „                                 | „ second maxilla.  |
| „    | 5.  | „                                 | „ first maxilliped   |
| „    | 6.  | „                                 | „ second maxilliped.   |
| „    | 7.  | „                                 | „ telson   |
| „    | 8.  | „                                 | „ dorsal view of anterior portion of the<br>carapace and appendages. |
| „    | 9.  | <i>Leander strenuus</i> ,         | Heller.  |
| „    | 10. | „                                 | „ dorsal view of anterior portion of the carapace<br>and appendages. |
| „    | 11. | „                                 | „ telson.  |
| „    | 12. | „                                 | „ antennular flagellum.  |
| „    | 13. | <i>Leander intermedius</i> ,      | Stimpson.  |
| „    | 14. | „                                 | „ antennular flagellum.  |

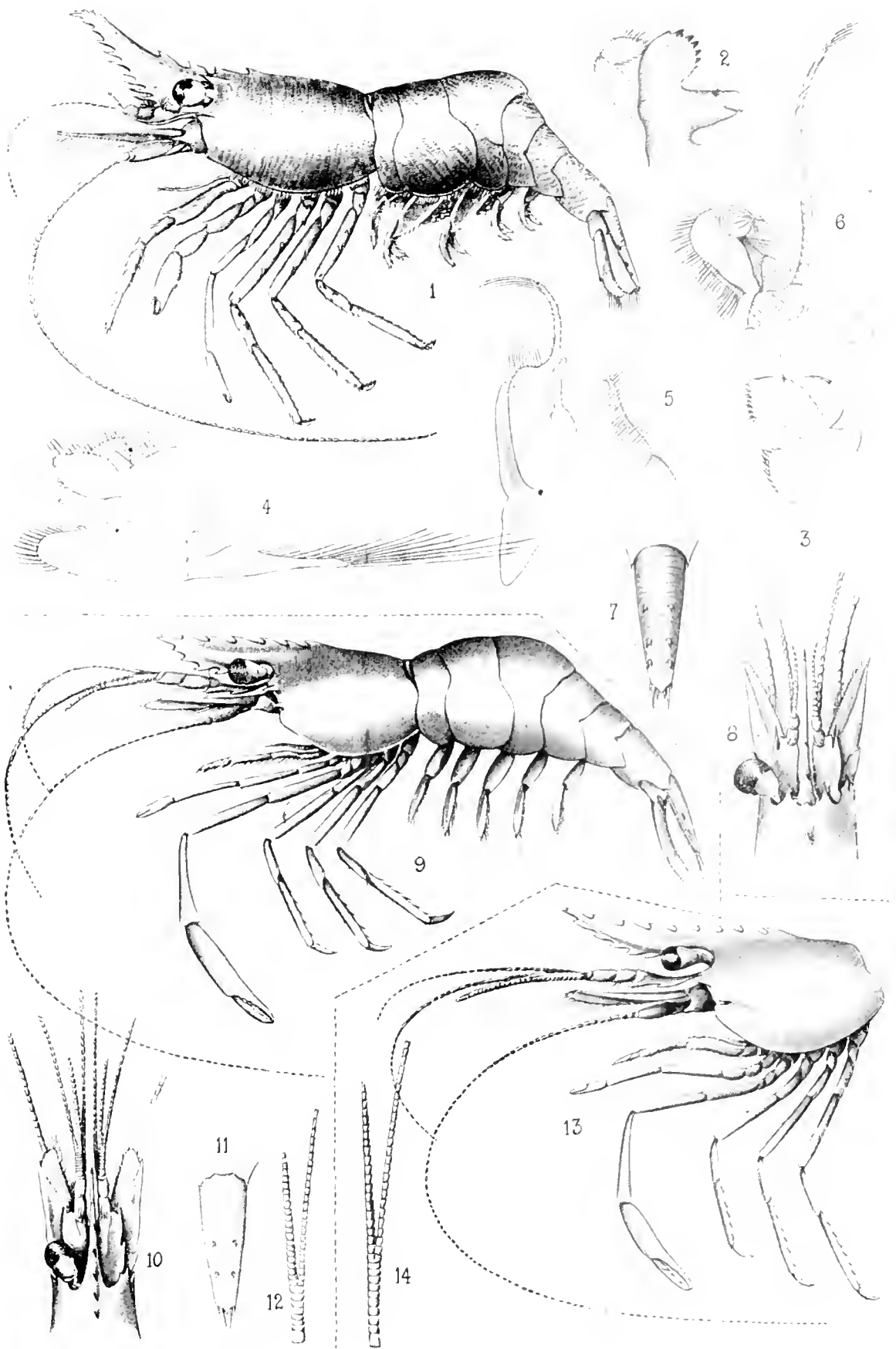







EXPLANATION OF PLATE XC.

---

AUSTRALIAN FISHES.

- Fig. 1. *Ichthyocampus filum*, Gunther.  
,, 2. *Urocampus carinirostris*, Castlenau.  
,, 3. *Mustelus antarcticus*, Gunther.

Figs. 1 and 2 enlarged. Fig. 3 reduced.

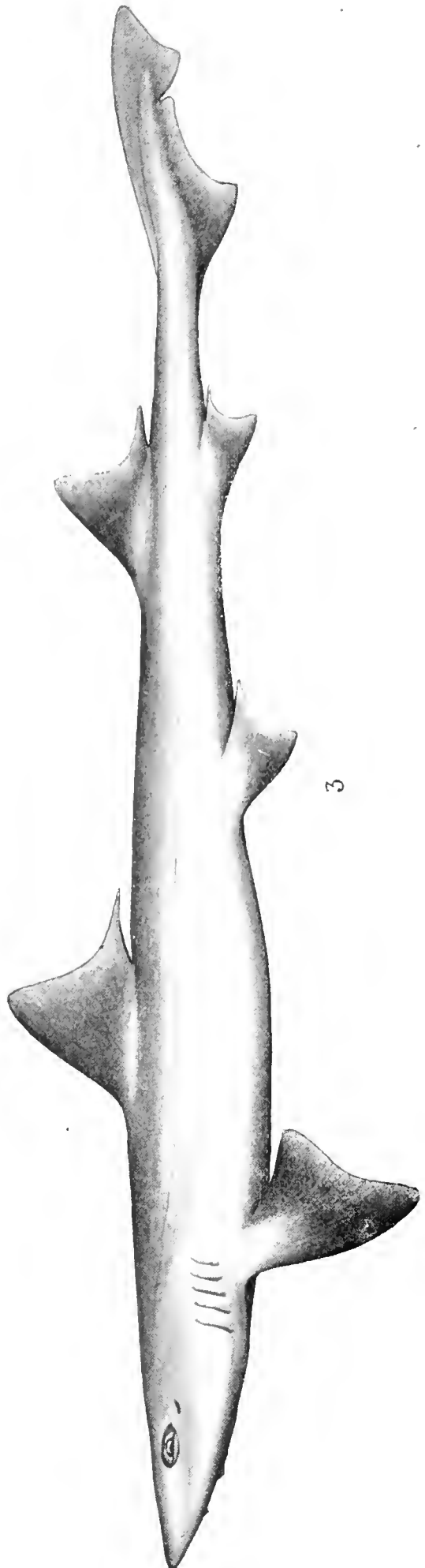





EXPLANATION OF PLATE XCI.

---

AUSTRALIAN FISHES.

*Caranx hullianus*, McCulloch, natural size.

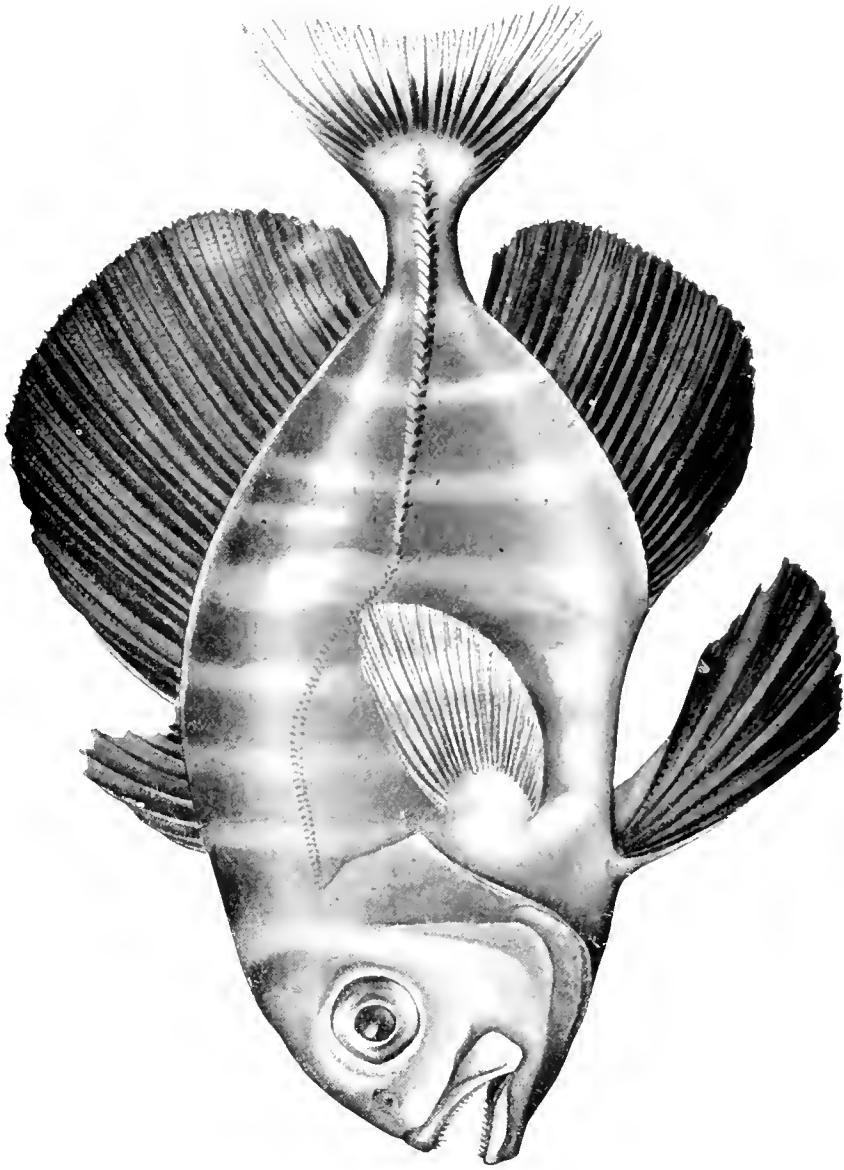







EXPLANATION OF PLATE XCII.

---

Nest and Eggs of the Cinnamon-chested Ground Thrush (*Cinclosoma marginatum*).







DESCRIPTION OF PLATE XCIII.

---

View of Rock Shelter at Bundanoon.



W. A. NICHOLAS, photo.  
Bundanoon.







DESCRIPTION OF PLATE XCIV.

---

Sandstone block with rubbing marks, in Rock Shelter at Bundanoon.







DESCRIPTION OF PLATE XCV.

---

OBJECTS FOUND DEPICTED IN ROCK SHELTER AT BUNDANOON.

*No. 1 Shelter.*

- Fig. 1. A conventional animal or tail of lyre-bird.  
,, 2. Undoubtedly an eel.  
,, 3. Probably a "Goana" (*Varanus*, sp.); or water lizard (*Physignathus*  
sp.).  
,, 4. A nondescript object, may be intended for a human being.  
,, 5. A turtle.

One-eighth natural size.

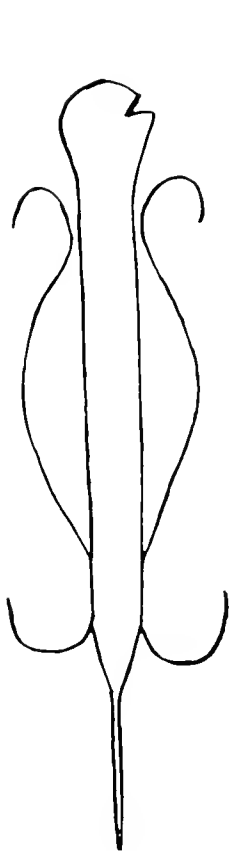

1

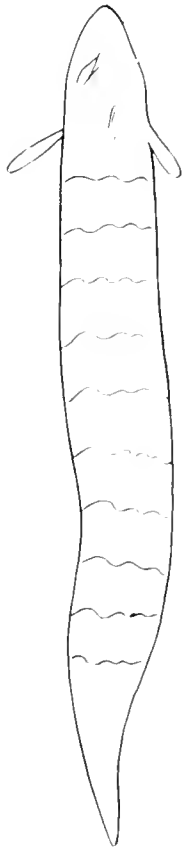

2

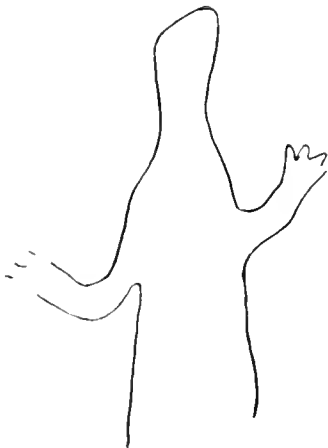

3



4

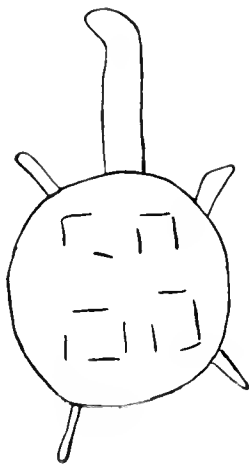

5







## DESCRIPTION OF PLATE XCVI.

---

### OBJECTS FOUND DEPICTED IN ROCK SHELTER AT BUNDANOON.

#### *No. 2 Shelter.*

- Fig. 1. Aboriginal corroboree, portions of six performers.
- .. 2. Probably a frog with its mouth agape.
- .. 3. Somewhat lacertilian in outline.
- .. 4. Representation not identified.
- .. 5. Fish.
- .. 6. Tribal mark.
- .. 7. Shell, shield, or leaf ?
- .. 8. Human being.
- .. 9. Undoubtedly a shield.

One-eighth natural size.

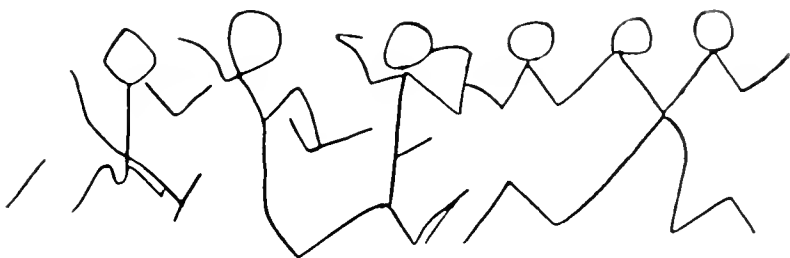

1

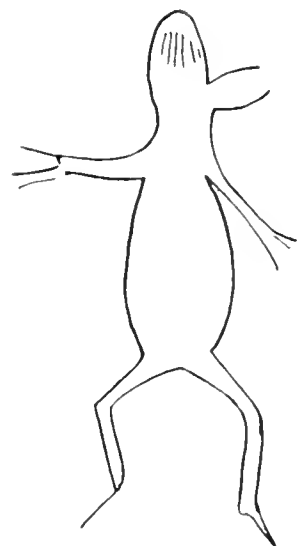

2



4

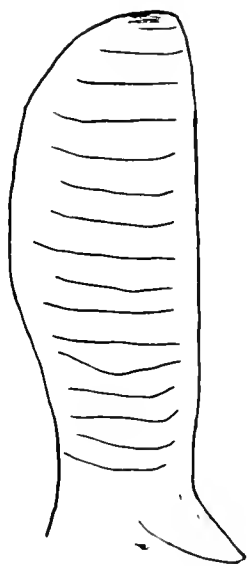

5

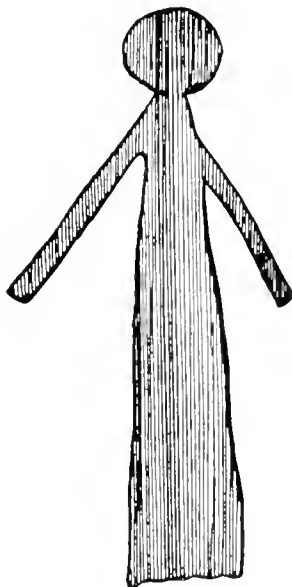

8

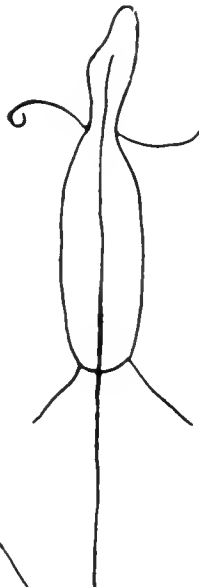

3



7

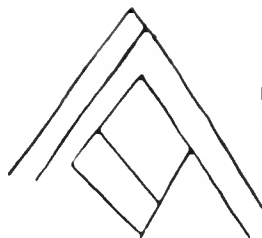

6

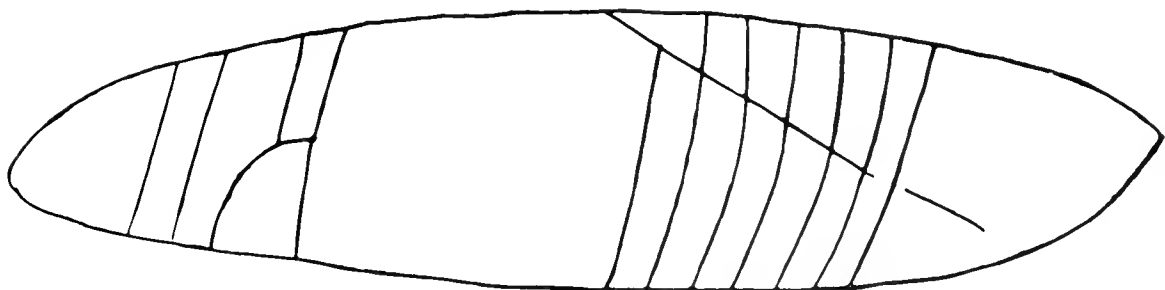

9





## INDEX.

	PAGE
<b>A</b>	
<i>aboriginalis</i> , SPIROCHLETA ...	336
ACANTHOCHITES <i>carinatus</i> ...	265
ACANTHOCHITES <i>crocodilus</i> ...	113
ACANTHOCHITES <i>discrepanus</i> ...	265
<i>maughani</i> ...	265
<i>variabilis</i> ...	266
<i>verconis</i> ...	265
<i>wilsoni</i> ...	265
ACAVIDE ...	284
<i>accisa</i> , TURRITELLA ...	110
ACMLEA <i>calamus</i> ...	110
<i>flammea</i> ...	110
ACREIDE ...	70
ACROASPIS ...	225
ACTINOCYSTIS ...	18
ACTUMNUS <i>nudus</i> ...	57
<i>aculeata</i> , APHRODITA ...	242
<i>adamsi</i> , DIPLODONTA ...	114
ADEONA <i>micronata</i> ...	268
<i>parrispuncta</i> ...	268
<i>amula</i> , ARGIOPE ...	213
<i>atherca</i> , ARGIOPE ...	213
<i>affinis</i> , var. CENOBITA <i>pro-</i> <i>lata</i> ...	305
<i>affinis</i> , DANAUS ...	73
<i>affinis</i> , PALEMON ...	306
<i>affinis</i> , SALATURA ...	73
<i>agapata</i> , MARGINELLA ...	111
AGNATHOMORPHA ...	286
<i>agucivi</i> , FLAMMULINA ...	299
<i>agucivi</i> , HELIX ...	299
<i>agrestis</i> , AGRHOLIMAX ...	303
AGRHOLIMAX <i>agrestis</i> ...	305
<i>alatus</i> , ARCYS ...	232
<i>alba</i> , MITROMORPHA ...	111
<i>albanensis</i> , CHAROPA ...	288
<i>albanensis</i> , EXDODONTA ...	288
<i>albanensis</i> , HELIX ...	288
<i>albida</i> , MYODORA ...	113
ALLODISCTS ...	299
<i>allporti</i> , CALLIOSTOMA ...	109
<i>allporti</i> , HELIX ...	298
ALOPE <i>australis</i> ...	313
<i>pulpatilis</i> ...	315
<i>alpina</i> , (var.) FLAMMULINA <i>otwayensis</i> ...	300
<i>alveolaris</i> , ECHINOCOCCUS ...	331
<i>amabilis</i> , VENERICARPIA ...	113
AMAUROPSIS <i>globulus</i> ...	111
<i>americanus</i> , NECATOR ...	334
<i>amethystina</i> , HEMOGREGARINA ...	258
AMMONITES <i>coupei</i> ...	237, 238
<i>inflatus</i> ...	235, 236
<i>rostratus</i> ...	235
<i>varians</i> ...	237, 238
<i>ammonitoides</i> , HELIX ...	289
<i>ammonoides</i> , CRIOCERAS ...	151
AMEBA <i>dysenterica</i> ...	336
AMPHIOXUS ...	33
<i>ampulla</i> , BIPORA ...	269
ANCIHISTROCEPHALUS <i>micro-</i> <i>cephalus</i> ...	344
ANCILLA <i>marginata</i> ...	111
ANCYLOCERAS ...	143
<i>condylopoïdes</i> ...	159
<i>glidderi</i> ...	153
Ancyloceras, Lower Creta- ceous ...	135
ANCYLOCERAS <i>matheronianum</i> ...	136
<i>taylori</i> ...	162
ANEPHIA ...	227
<i>angasi</i> , MUREX ...	112
<i>angasi</i> , OSTREA ...	113
<i>angasi</i> , PYRENE ...	112
<i>angasi</i> , TRIFORA ...	110
<i>angasi</i> , CYCLOSTREMA ...	110
Anglesite, Broken Hill, N.S. Wales ...	63
Anglesite, Montalblon, Walsh & Tinaroo Distr., Queensland ...	277
Anglesite, Propy. Mine, Bro- ken Hill, N.S. Wales ...	276
ANGUILLULA ...	334
<i>angulata</i> , LIMA ...	113
<i>angulopora</i> , BIPORA ...	268
<i>angustata</i> , CYPREA ...	111
<i>angustata</i> , THRACOPSIS ...	113
<i>angustipes</i> , EUPETRICHTHYS ...	134
ANICULUS <i>aniculus</i> ...	59
<i>aniculus</i> , ANICULUS ...	59
ANKYLOSTOMA <i>duodenale</i> ...	334
<i>annulata</i> , LIOTIA ...	110
ANGLIYTA <i>lancestonensis</i> ...	284
<i>anomioïdes</i> , MYOCHAMA ...	113
ANOPELOCEPHALA <i>mamillana</i> ...	339
<i>perfoliata</i> ...	339
<i>plicata</i> ...	339
<i>antarcticus</i> , GALEUS ...	315

	PAGE		PAGE
<i>antarcticus</i> , MUSTELUS ..	315	ARGIOPID.E ..	44, 212
ANTHOCEPHALUS <i>elongatus</i> ...	344	ARGIOPIN.E ..	46, 212
<i>antialba</i> , ENDODONTA ...	288	<i>argyroleura</i> , CRISTICEPS ...	39
<i>antialba</i> , HELIX ...	289	<i>armatus</i> , STRONGYLUS ...	340
<i>antipodeus</i> , HYSTRICOCERAS	237	ASCARIS <i>lumbricoides</i> ...	335
<i>antipodeus</i> , var. SCHLÆNBA-		<i>mega'ocephala</i> ...	340
<i>CHIA rostratus</i> ...	237	<i>asperimus</i> , CHILAMYS ...	113
<i>aperta</i> , GEOSTILBIA ...	304	<i>aspersa</i> , HELIX ..	303
APHRODITA <i>aculeata</i> ...	242	ASPIDOLASIUS ...	227
APHRODITA <i>australis</i> ...	241	<i>assimilis</i> , HELIX ...	289
<i>haswelli</i> ...	244	ASTELE <i>subearinatum</i> ...	109
<i>aphroditoides</i> , LETMATOIDES	242	<i>asterianum</i> , CRIOCERAS ...	139
<i>apricoma</i> , RISSOA ..	110	<i>astrigera</i> , (var.) GASTERACAN-	
<i>arachis</i> , CYLICHNA ...	112	THA <i>minax</i> ...	227
ARACINURA ..	218	ASYMMETRON <i>caulatum</i> ..	33
<i>caudata</i> ...	218	<i>lucayum</i> ...	33, 35
<i>higginsi</i> ...	218	Atacamite, Dugald R., Clon-	
<i>scorpionoides</i> ...	218	<i>curry</i> , Queensland ...	67
ARANEID.E ...	44	ATAXOCERITHIUM <i>serotinum</i>	110
ARANEUS ...	220	<i>atkinsoni</i> , CUNA ...	113
<i>brisbane</i> ...	222	<i>atkinsoni</i> , HELIX ..	299
<i>hircion</i> ..	221-223, 225	<i>atkinsoni</i> , KRAUSSINA ..	114
<i>productus</i> ..	222	<i>atkinsoni</i> , SCHISMOPE ...	109
<i>sylicola</i> ...	222, 225	<i>atra</i> , PORZANA ..	31
<i>waguri</i> ...	222, 225	AULACOPODA ...	288
ARCA <i>reticulata</i> ...	113	<i>aurantiacus</i> , CRISTICEPS ...	38
<i>semitorta</i> ...	302	<i>australe</i> , CRIOCERAS	136, 145
ARCHEMORUS ...	232	<i>australe</i> , FLABELLUM ...	108
<i>simonsi</i> ...	232	<i>australis</i> , ALOPE ...	313
<i>architectonica</i> , ENDODONTA..	289	<i>australis</i> , APHRODITA ...	241
<i>architectonica</i> , HELIX ..	289	<i>australis</i> , CELLARIA... ..	267
<i>arctica</i> , SAXICAVA ..	114	<i>australis</i> , CRISTICEPS ...	39
ARCUULARIA <i>jacksonensis</i> ...	112	<i>australis</i> , MODIOLA ...	113
<i>mobilis</i> ..	112, 121	<i>australis</i> , PANOPLEA... ..	114
<i>mobilis</i> , var. <i>costata</i>	112, 121	<i>australis</i> , SAGITTA ...	255
ARCYE.E ...	232	<i>australis</i> , SCISSURELA ...	109
ARCYS ..	232	<i>australis</i> , SUCCINEA... ..	283
<i>alatus</i> ...	232	<i>australis</i> , var. <i>quensborough-</i>	
<i>heriopalpis</i> ...	232	<i>ensis</i> , SUCCINEA... ..	284
<i>clavatus</i> ...	232	<i>australis</i> , var. <i>tamercensis</i> ,	
<i>cornutus</i> ...	232	SUCCINEA ...	284
<i>lanccaris</i> ...	232	<i>australis</i> , TRIVIA ..	111
<i>perlatus</i> ...	232	<i>austemus</i> , HELIX ...	298
<i>arenicola</i> , HELIX ...	294	<i>aricularis</i> , LEKYTHOPORA ...	273
<i>argentens</i> , DIRETMUS ...	320	<i>aeonides</i> , CRIOCERAS ...	150
ARGIOPE ..	213	Azurite, Girofla Mine, Chil-	
<i>amula</i> ... ..	213	<i>lagoe</i> , Queensland ...	279
<i>atherea</i> ...	213	Azurite, Muldiva, Walsh &	
<i>bullockii</i> ...	46, 213	<i>Tinaroo Distr.</i> , Q'land	278
<i>cetusa</i> ...	213		
<i>gracilis</i> ...	213		
<i>magnifica</i> ...	213		
<i>pallida</i> ...	213		
<i>protensa</i> ...	213		
<i>regalis</i> ... ..	213		
ARGIOPE.E ...	46		

## B

<i>badius</i> , LEPIDOPLEURUS ...	260
<i>badius</i> , SIRIUS ...	111
<i>balantium</i> , CLIO ...	113
<i>baurrofti</i> , FILARIA ...	335

	PAGE		PAGE
<i>barbata</i> , MODIOLARIA ...	113	<i>brunonia</i> , HELIX ...	258
<i>barrenensis</i> , ENDODONTA ...	289	<i>buccalis</i> , ENTAMEBA ...	336
<i>barrenensis</i> , HELIX ..	289	<i>buccalis</i> , SPIROCHLETA ...	337
<i>basilica</i> , CYRTOPHORA ...	217	BULIMULIDÆ ...	285
BASILISSA <i>niceterium</i> ...	109, 116	BULINUS <i>dufresnoii</i> ...	285
<i>bassanum</i> , HETEROPLEURON ...	34	<i>gunnii</i> ...	285
<i>bassi</i> , ENDODONTA ...	289	<i>tasmanicus</i> ...	285
<i>bassi</i> , HELIX ...	289	<i>bullata</i> , LIMA ...	113
<i>beachportensis</i> , NUCULA ...	113	<i>bullockii</i> , ARGIOPE ...	46, 213
<i>beddomei</i> , POLINICES ...	111	<i>buttoni</i> , HELIX ...	302
<i>bednalli</i> , COLUBRARIA ...	112		
<i>bedoti</i> , SAGITTA ...	256	C	
<i>belcheri</i> , HETEROPLEURON ...	35	CABEREA <i>grandis</i> ...	267
<i>bellula</i> , MEMBRANIPORA ...	267	CADUUS <i>spretus</i> ...	113
<i>berandi</i> , HELIX ...	302	CENOBITA <i>oliveri</i> ...	305
Beri beri ...	339	<i>carulea</i> , DOSINIA ...	114
Beryl, The Gulf, nr. Emma- ville, N.S. Wales ...	63	<i>calamus</i> , ACMEA ...	110
Beryl, Torrington, N.S.W. ...	62	CALESCHARA <i>denticulata</i> ...	268
<i>biarmata</i> , BIPORA ...	268, 269	<i>calicatum</i> , CYLICHNOSTOMUM ...	341
<i>bicolor</i> , CYSTOPELTA ...	293	<i>caliginosus</i> , DICROSTICHUS ...	229
<i>bicolor</i> , TELEBRA ...	111	CALLIOSTOMA <i>allporti</i> ...	109
BILHAZIA <i>hamatobium</i> ...	330	<i>columnarium</i> ...	109, 115
<i>bimaculatus</i> , POLTYS ...	231	<i>hedleyi</i> ...	109
<i>biplicata</i> , MARGINELLA ...	111	<i>incertum</i> ...	109
BIPORA <i>ampulla</i> ...	269	<i>legrandi</i> ...	109
<i>angulopora</i> ...	268	<i>retiarium</i> ...	109, 115
<i>biarmata</i> ...	268, 269	CALLIPTILUS <i>solitarius</i> ...	29
<i>chrysea</i> ...	270	<i>stephani</i> ...	29
<i>maguarmata</i> ...	269	<i>calotochis</i> , CELLENIA 48, 231, 232	
<i>mamillata</i> ...	270	<i>calva</i> , PHENACOLEPAS ...	110
<i>multiarmata</i> ...	268, 269	<i>calyculata</i> , MYLICARDIA ...	113
<i>umbonata</i> ...	271	<i>calyptroformis</i> , CALYPTREA ...	111
BIRGUS <i>hirsutus</i> ...	305	CALYPTREA <i>calyptroformis</i> ...	111
<i>bischoffensis</i> , CHAROPA ...	301	<i>pellucida</i> ...	111
<i>bischoffensis</i> , FLAMMULINA ...	301	<i>camilla</i> , HELIX ...	299
<i>bischoffensis</i> , HELIX ...	301	<i>canaliculata</i> , LUNUTITES ...	267
<i>bispinosa</i> , PÆCULOPELTA ...	228	CANCELLARIA <i>laevigata</i> ...	111
<i>bisulcata</i> , HELIX ...	302	<i>pyradata</i> ...	111
<i>bituberculata</i> , GEA ...	217	<i>cancellata</i> , CROSSEA ...	111
<i>bolina</i> , HYPOLIMNAS ...	70, 73	<i>cancellata</i> , MANGELIA ...	112
<i>bombycina</i> , HELIX ...	287	<i>cancellata</i> , TEREBRATULINA ...	114
BORSIA <i>radiata</i> ...	114	CANCER <i>clypeatus</i> ...	305
BOTHRIOEMBRYON <i>gunnii</i> ...	285	<i>dorsalis</i> ...	314
<i>gunnii</i> , var. <i>brachysoma</i> ...	285	<i>candida</i> , EMARGINULA ...	109
BOTHRIOCEPHALUS <i>liguloides</i> ...	330	<i>candida</i> , GYGIS ...	31
<i>mansonii</i> ...	330	<i>canium</i> , DIPYLIDIUM ...	250, 331
<i>brachysoma</i> , var. <i>gunnii</i> ...	285	CANTHARIDUS <i>irisodontes</i> ...	109
BOTHRIOEMBRYON ...	285	<i>caperata</i> , HELICELLA ...	304
<i>braggi</i> , SEPIA ...	134	<i>capiticava</i> , PSEUDORISSOINA ...	111, 118
BRANCHIOSTOMA ...	33	CAPULUS <i>derotus</i> ...	110
<i>brazieri</i> , CRYPTOPORA ...	114	CARANX <i>hullianus</i> ...	319
<i>brevipalpis</i> , ARCOYS ...	232	CAREPALXIS ...	225
<i>brisbane</i> , ARANEUS ...	222	<i>tuberculata</i> ...	225
<i>brunnea</i> , CENOBITA ...	305	<i>carinata</i> , CROSSEA ...	111
<i>brunonia</i> , CHLORITIS ...	285	<i>carinata</i> , GABRIELLA ...	57

	PAGE		PAGE
<i>carinatus</i> , ACANTHOCHITES	265	CINCLOSOMA <i>castanotum</i>	... 323
<i>carinatus</i> , CYCLOXANTHUS	... 57	<i>marginatum</i>	... 322
<i>carinirostris</i> , UROCAMPUS	... 317	<i>cingalense</i> , HETEROPLEURON	34
CARYODES <i>dufresnii</i>	... 285	CINGULINA <i>spina</i>	... 111
CASSIDEA <i>pyrum</i>	... 111	CIRSONELLA <i>weldii</i>	... 110
<i>castanotum</i> , CINCLOSOMA	... 323	<i>citricola</i> , CYRTOPHORA	... 217
<i>caudata</i> , ARACHNURA	... 218	<i>clathrisquamis</i> , CREEDIA	... 321
<i>caudatum</i> , ASYMMETRON	... 33	<i>claratus</i> , ARCYS	... 232
<i>caraticus</i> , VENERICARDIA	... 113	CLINUS	... 36
CAVOLINA <i>tridentata</i>	... 112	<i>despicillatus</i>	... 43
<i>trispinosa</i>	... 112	<i>perspicillatus</i>	... 43
<i>cecilia</i> , SCHIZOPORELLA	... 268	<i>whiteleggii</i>	... 42
CELEENIA	... 48, 231	CLIO <i>balantium</i>	... 113
<i>calotoides</i>	... 48, 231, 232	<i>pyramidata</i>	... 113
<i>distincta</i>	... 231, 232	<i>virgula</i>	... 112
<i>dubium</i>	... 231	<i>clypeata</i> , DOLOPHONES	... 233
<i>crecarata</i>	... 231, 252	<i>clypeatus</i> , CANCER	... 305
<i>kinbergi</i>	... 231	<i>clypeatus</i> , ORDGABIUS	... 229
CELENE, E.	... 48	<i>clypeatus</i> , PAGURUS	... 305
CELLARIA <i>australis</i>	... 267	COCCIDIUM <i>cunneuli</i>	... 342
<i>cellaria</i> , VITREA	... 303	<i>oriforme</i>	... 342
CELLEPORA <i>doliaris</i>	... 272	COCCULINA <i>tasmanica</i>	... 110
<i>fossa</i>	... 268	CODAKIA <i>jacksonensis</i>	... 114
CENOBITA <i>brunnea</i>	... 305	<i>tatei</i>	... 114
CEPHALOCHORDA	... 33	CENOBITA <i>peclata</i> , var. <i>affinis</i>	305
Cephalopoda, Lower Cretaceous	... 135, 235	<i>rugosus</i>	... 306
CERION <i>glans</i>	... 302	<i>spinosa</i>	... 305
CERITHIOPSIS <i>crocea</i>	... 110	<i>spinosus</i>	... 305
<i>purpurea</i>	... 110	<i>variabilis</i>	... 305
<i>semilaris</i>	... 110	CÆMURUS <i>socialis</i>	... 343
<i>turbanilloides</i>	... 110	<i>copta</i> , HELIX	... 297
Cerussite, Tolwong Mine, nr. Marulan, N.S. Wales	... 282	<i>caesus</i> , HELIX	... 294
CESTODA 246, 330, 339, 342-344		<i>caesus</i> , LAOMA	... 294
CHELETOGNATHA	... 251	<i>coli</i> , ENTAMBEA	... 336
CHAROIA <i>albaniensis</i>	... 288	<i>collisi</i> , HELIX	... 295
<i>bischhoffensis</i>	... 301	COLUBRARIA <i>tednalli</i>	... 112
<i>charopa</i> , CYCLOSTREMA	... 110	<i>columnaria</i> , MARGNELLA	111, 120
CHAROPA <i>gudensis</i>	... 301	<i>columnaria</i> , PHILINE	112, 123
CHASMOCEPHALON	... 231	<i>columnaria</i> , RISSOA	... 110, 117
<i>neglectum</i>	... 233	<i>columnaria</i> , VENERICARDIA	113, 125
CHEILOBRANCHIUS <i>parvulus</i>	... 316	<i>columnarium</i> , CALLIOSTOMA	109, 115
<i>chondostoma</i> , RISSOA	... 110	<i>columnarium</i> , CYMATIUM	111, 119
CHIONE <i>gullinula</i>	... 114	<i>columnarius</i> , LEPIDOPLEURUS	113, 123
CHITON <i>caci</i>	... 261-262	<i>columnarius</i> , TROPHON	112, 121
<i>curtisianus</i>	... 265	<i>compressa</i> , CUNA	... 113, 124
<i>jugosus</i>	... 262	<i>concatenata</i> , FISSURELLA	... 109
<i>limatus</i>	... 261	<i>concinna</i> , SELENARIA	268, 271
<i>torri</i>	... 262	CONDYLOCARDIA <i>pectinata</i>	114, 125
<i>translucens</i>	... 263	<i>porrecta</i>	114, 125
<i>vauchousensis</i>	... 261	CONESCHABELLINA <i>burnea</i>	... 270
CHLAMYDASPERMUS	... 113	<i>conifera</i> , DOLOPHONES	... 233
CHLORITIS <i>brunnea</i>	... 285	<i>constancia</i> , RANFURLYA	... 293
<i>chrysippus</i> , DANAEUS	... 70	<i>contorta</i> , IDMONEA	... 268
<i>ciliata</i> , MICROPORELLA	... 268	<i>contortum</i> , DISTOMUM	... 344



	PAGE		PAGE
<i>CONUS pontificalis</i> ...	303	<i>crocea</i> , CERITHIOPSIS ...	110
<i>coquandi</i> , SCAPHITES ...	139	<i>crocodilus</i> , ACANTHOCITES ...	113
<i>coralensis</i> , PTILOPUS ...	30	<i>CROSSEA cancellata</i> ...	111
<i>CORALLIOPHILA lischkeana</i> ...	112	<i>carinata</i> ...	111
<i>cordycepoides</i> , ANCYLOCERAS ...	159	CRYPTOPORA <i>brazieri</i> ...	114
<i>cordycepoides</i> , CRIOCERAS ...	159	<i>crystallina</i> , VITREA ...	303
<i>coriacea</i> , MICROPORA ...	268	<i>cultellum</i> , HETEROPLEURON ...	34, 35
<i>cornutus</i> , ARCYDS ...	232	<i>cumingii</i> , MEGASELLA ...	114
<i>coronata</i> , EPEIRA ...	225	<i>CUNA atkinsoni</i> ...	113
<i>coronatus</i> , POLTYS ...	231	<i>compressa</i> ...	113, 124
<i>costata</i> , (var.) ARCULARIA		<i>delta</i> ...	113
<i>mobilis</i> ...	112, 121	<i>hamata</i> ...	113, 124
<i>coupei</i> , AMMONITES ...	237, 238	<i>cuniculi</i> , COCCIDIUM ...	342
<i>coxi</i> , CHITON ...	261, 262	<i>curacao</i> , FLAMMULINA ...	300
<i>crassipes</i> , PARAPLECTANOIDES ...	228	<i>curacao</i> , HELLIN ...	300
<i>cratericula</i> , MARGINELLA ...	111	<i>curtisiana</i> , LIOTOPHURA ...	265
<i>crebrisculptum</i> , CYCLOSTREMA ...	110	<i>curtisianus</i> , CHITON ...	265
<i>CREEDIA clathrisquamis</i> ...	321	<i>curtisianus</i> , ISCHNOCHITON ...	265
<i>howelli</i> ...	321	<i>curcula</i> , OXYURIS ...	340
CRENATULA <i>modiolaris</i> ...	393	CUSPIDARIA <i>tasmanica</i> ...	113
<i>crenatulifera</i> , PHILIPPIELLA ...	113	<i>curieri</i> , HELICARION ...	301
CRIBRILINA <i>radiata</i> ...	268	<i>curieri</i> , HELIXARION ...	301
CRIOCERAS ...	143	CYCLOPECTES <i>nepomensis</i> ...	113
<i>ammonoides</i> ...	151	<i>obliquus</i> ...	113
<i>asterianum</i> ...	139	CYCLOSA ...	219
<i>australe</i> ...	136, 145	<i>callata</i> ...	219
<i>axonoides</i> ...	150	CYCLOSTREMA <i>angeli</i> ...	110
<i>cordycepoides</i> ...	159	<i>charopa</i> ...	110
<i>edkinsi</i> ...	143, 165	<i>crebrisculptum</i> ...	110
<i>flindersi</i> ...	153	<i>inscriptum</i> ...	110
<i>irregulari</i> ...	145	<i>micrea</i> ...	110
<i>jackii</i> ...	145	<i>porcellanum</i> ...	110
<i>laqueus</i> ...	160	CYLOXANTHUS <i>carinatus</i> ...	57
<i>lampros</i> ...	157	<i>punctatus</i> ...	54, 56
<i>leptus</i> ...	143	CYLICHA <i>arachis</i> ...	112
Crioceras, Lower Cretaceous ...	135	CYLICHNOSTOMUM <i>edicutum</i> ...	341
CRIOCERAS <i>nautiloides</i> ...	148	<i>poecilatum</i> ...	341
<i>plectoides</i> ...	153	<i>spp.</i> ...	341
<i>pusosianum</i> ...	139	<i>tetractanthum</i> ...	341
<i>sp.</i> ...	144, 163	CYMATIUM <i>columnarium</i> ...	111, 119
<i>taylori</i> ...	162	<i>kampylum</i> ...	111
CRIOCERATITES ...	113	<i>quoyi</i> ...	119
CRISTICEPS ...	37	CYPREA <i>angustata</i> ...	111
<i>agyropleura</i> ...	39	CYPRARACHNE ...	228
<i>australicus</i> ...	38	<i>setosa</i> ...	228
<i>australis</i> ...	39	CYRTOPHORA <i>basilica</i> ...	217
<i>fasciatus</i> ...	42	<i>citricola</i> ...	217
<i>howitti</i> ...	39	<i>hirta</i> ...	217
<i>macleayi</i> ...	39	<i>parusia</i> ...	217
<i>pallidus</i> ...	39	<i>sculptilis</i> ...	217
<i>phillipi</i> ...	43	CYSTICERCUS <i>pisiformis</i> ...	342, 343
<i>pictus</i> ...	38	<i>sp.</i> ...	341
<i>rosicus</i> ...	40	<i>tenuicollis</i> ...	343
<i>splendens</i> ...	39	CYSTOPFLTA <i>bicolor</i> ...	293
<i>wilsoni</i> ...	41	<i>petterdi</i> ...	292

	PAGE
CYTORYCTES <i>caccina</i> ...	338
<i>variolar</i> ...	388
D	
DACELO <i>gigas</i> ...	246
<i>dacelonis</i> , SIMILUNCINUS ...	250
DANAIDE ...	70
DANAUS <i>affinis</i> ...	73
<i>chrysiptus</i> ...	70
<i>petilia</i> ...	70
<i>danilewskyi</i> , PROTEOSOMA ...	344
DAPHNELLA <i>excavata</i> ...	112
<i>kingensis</i> ...	112
<i>minuta</i> ...	112
<i>dareyensis</i> , HELIX ...	299
<i>decussata</i> , TELLINA ...	114
<i>delicatula</i> , MANGELIA ...	112
DELOS <i>nelsonensis</i> ...	288
<i>delta</i> , CUNA ...	113
<i>demarquayii</i> , FILARIA ...	336
DEMODOX <i>folliculorum</i> ...	336
<i>denticulata</i> , CALESCILARA ...	265
<i>dentium</i> , SPIROCHLETA ...	337
<i>depressus</i> , HAMULES ...	139
<i>dercleta</i> , HELIX ...	294
<i>desalei</i> , MANGELIA ...	112
<i>despicillatus</i> , CLINUS ...	43
<i>detotus</i> , CAPULUS ...	110
DIADEMA ...	69
DIBOTHOCEPHALUS <i>latus</i> ...	330
DICROSTICHUS ...	229
<i>caliginosus</i> ...	229
<i>furcatus</i> ...	229, 230
<i>furcatus</i> , var. <i>distinctus</i> ...	229
<i>magnificus</i> ...	229, 230
<i>sp.</i> ...	230
<i>diemenensis</i> , FLAMMULINA ...	299
<i>diemenensis</i> , HELIX ...	299
<i>dilecta</i> , VENERICARDIA ...	113
DILEPINID.E ...	250
DILEPININ.E ...	250
<i>diminuta</i> , HYMENOLEPIS ...	331
DIPLODONTA <i>adamsi</i> ...	114
<i>calandica</i> ...	114
DIPTERA ...	341
DIPYLIDIN.E ...	250
DIPYLIDIUM ...	250
<i>caninum</i> ...	250, 331
DIRETMUS <i>acqueatus</i> ...	320
<i>discors</i> , HELIX ...	294
<i>discrepanis</i> , ACANTHOCHITES ...	265
<i>dispar</i> , ENDODONTA ...	290
<i>dispar</i> , HELIX ...	290
<i>dispar</i> , TRICHOCEPHALUS ...	334

	PAGE
<i>distincta</i> , CELENIA ...	231-232
<i>distinctus</i> , (var.) <i>furcatus</i> , DICROSTICHUS ...	229
DISTOMUM <i>contortum</i> ...	344
<i>hepaticum</i> ...	330
DOCHMIUS <i>duodenale</i> ...	334
<i>hypostomum</i> ...	341
<i>doliaris</i> , CELLEPORA ...	272
DOLOPHONES <i>clypeata</i> ...	233
<i>conifera</i> ...	233
<i>mammata</i> ...	233
<i>nasalis</i> ...	233
<i>noctacantha</i> ...	233
<i>peltata</i> ...	233
<i>pilosa</i> ...	233
<i>simplex</i> ...	233
<i>testudinea</i> ...	233
<i>tuberculata</i> ...	233
<i>turriqera</i> ...	233
DONOVANIA <i>fenestrata</i> ...	112
<i>dorsalis</i> , CANCER ...	314
<i>dorsalis</i> , EUCRATE ...	314
<i>dorsalis</i> , GALENE ...	314
DOSINIA <i>curulea</i> ...	114
DRACUNCULUS <i>oculi</i> ...	341
DREPANIDOTLENIA <i>lancoolata</i> ...	331
DRILLIA <i>haswelli</i> ...	112
<i>novia</i> ...	112
<i>dubitabilis</i> , RISSOA ...	110
<i>dubitans</i> , HELIX ...	287
<i>dubium</i> , CELENIA ...	231
<i>dubium</i> , THLAOSOMA ...	231
<i>ducami</i> , HELIX ...	297
<i>dufresnii</i> , BULIMUS ...	285
<i>dufresnii</i> , CARYODES ...	285
<i>duodenale</i> , ANKYLOSTOMA ...	334
<i>duodenale</i> , DOCHMIUS ...	334
<i>dyeri</i> , HELIX ...	287
<i>dyeri</i> , PARYPHANTA ...	287
<i>dyscritos</i> , MANGELIA ...	112
<i>dyscritica</i> , AMOLEA ...	336

## E

<i>churnea</i> , BIFORA ...	270
<i>churnea</i> , CONESCIARELLINA ...	270
ECHINOCOCCUS <i>alveolaris</i> ...	331
<i>hominis</i> ...	331
<i>hydatidosus</i> ...	331
<i>multilocularis</i> ...	331
<i>polymorphus</i> ...	331, 340, 343
<i>retinerorum</i> ...	331, 340, 343
<i>dentatum</i> , SCLEROSTOMUM ...	340
<i>edkinsi</i> , CRIOCERAS ...	143, 165
<i>edkinsi</i> , LEPTOCERAS ...	165
ELAMENA <i>uniquiformis</i> ...	59

	PAGE		PAGE
<i>elkingtoni</i> , NATICA ...	111, 119	<b>F</b>	
<i>elongatus</i> , ANTHOCEPHALUS ...	344	<i>falciparum</i> , PLASMODIUM ...	338
EMARGINULA <i>candida</i> ...	109	Fantail, Black and White...	21
<i>superba</i> ...	109	<i>fasciata</i> , TRIFORA ...	110
ENCYOSACCUS ...	225	<i>fasciatus</i> , CRISTICEPS ...	42
ENDODONTA <i>albaniensis</i> ...	288	<i>fasciatus</i> , PETRAITES ...	42
<i>antialba</i> ...	285	FASCIOLA <i>hejaticum</i> ...	330
<i>architectonica</i> ...	289	<i>fausta</i> , RISSOINA ...	110, 117
<i>barrenensis</i> ...	289	<i>fenestrata</i> , DONOVANIA ...	112
<i>bassii</i> ...	289	<i>festiva</i> , GEA ...	217
<i>dispar</i> ...	290	FILARIA, <i>baneroffi</i> ...	335
<i>hookeriana</i> ...	290	<i>denarquani</i> ...	336
<i>legrandi</i> ...	290	<i>lea</i> ...	341
<i>matthiense</i> ...	290	<i>medicinis</i> ...	335
<i>mimosa</i> ...	291	<i>sanguinis hominis</i> ...	335
<i>otwayensis</i> ...	300	<i>filum</i> , ICHTHYOCAMPUS ...	318
<i>purcissima</i> ...	296	<i>finchii</i> , PHILOBRYA ...	113
<i>ricei</i> ...	290, 291	FISSURELLA <i>concatenata</i> ...	109
<i>sericatula</i> ...	291	<i>flabellata</i> , SCHIZOPORELLA ...	268
<i>subrugosa</i> ...	292	FLABELLUM <i>australe</i> ...	108
<i>tamaricis</i> ...	291	FLAGELLATA ...	336
<i>tasmania</i> ...	292	<i>flammea</i> , ACMEA ...	110
ENDODONTID.E ...	288	FLAMMULINA <i>agnovi</i> ...	299
<i>endophylloides</i> , MICTOCYSTIS ...	20	<i>bischoffensis</i> ...	301
ENDOPHYLLUM ...	19	<i>curacao</i> ...	300
<i>enflata</i> , SAGITTA ...	251, 253	<i>diemenensis</i> ...	299
ENOPLID.E ...	245	<i>fordi</i> ...	298
ENOPLOCHITOS <i>torri</i> ...	265	<i>galensis</i> ...	301
ENTAMEBA <i>buccalis</i> ...	336	<i>hamiltoni</i> ...	297
<i>coli</i> ...	336	<i>jungermanniae</i> ...	296
<i>hystolitica</i> ...	336	<i>marchiana</i> ...	297
ENTELEGYN.E ...	212	<i>matthiense</i> ...	299
ENTOZOA ...	246	<i>otwayensis</i> ...	300
EPEIRA ...	220	<i>otwayensis</i> , var. <i>alpina</i> ...	300
<i>coronata</i> ...	225	<i>reblini</i> ... ...	300
<i>pallida</i> ...	219	<i>saresi</i> ...	298
<i>rhombocéphala</i> ...	219	<i>rynyardensis</i> ...	298
<i>vallata</i> ...	219	<i>flava</i> , VERMICULARIA ...	111
EPEIRID.E ...	212	<i>flavomaculata</i> , GASTERACANTHA ...	226
EPITONIUM <i>morehi</i> ...	110	<i>flavus</i> , LIMAX ...	303
<i>validum</i> ...	110	<i>flindersi</i> , ANCYLOTERAS ...	153
<i>equi</i> , GASTROPHILUS ...	341	<i>flindersi</i> , CRICERAS ...	153
<i>equinum</i> , SCLEROSTOMUM ...	340	<i>flindersi</i> , MARGINELLA ...	111
ESCHARA <i>umbonata</i> ...	271	<i>floodi</i> , HELIX ...	297
EUCHELLUS <i>scabriusculus</i> ...	110	<i>foliacea</i> , HORNERA ...	268
EUCRATE <i>dorsalis</i> ...	314	<i>folliculorum</i> , DENDOX ...	336
<i>hamiltoni</i> ...	58	<i>fordi</i> , FLAMMULINA ...	298
EUDYPTULA <i>minor</i> ...	134	<i>fordi</i> , HELIX ...	298
EULIMA <i>munita</i> ...	111	<i>fornicata</i> , GASTERACANTHA ...	227
EUPETRICHITHYS <i>angustipes</i> ...	134	<i>fossa</i> , CELLEPORA ...	268
EURYCARINUS <i>maculatus</i> ...	57	<i>fulgetrum</i> , HELIX ...	288
EUSTRONGYLUS <i>gigas</i> ...	334, 341	<i>fumosa</i> , HELICARION ...	287
EUTHRIA <i>tennicostata</i> ...	112	<i>fumosa</i> , PARYPHANTA ...	287
EVANSI, TRYPANOSOMA ...	341, 343	<i>funerea</i> , HELIX ...	291
<i>excavata</i> , CELENIA ...	231-232	<i>fureata</i> , SAGITTA ...	253, 254, 256
<i>excavata</i> , DAPHNELLA ...	112	<i>furcatus</i> , DICROSTICHUS ...	229, 230
<i>extensa</i> , ARGIOPE ...	213		



	PAGE		PAGE
<b>HELIX</b> <i>arenicola</i> ... ..	294	<b>HELIX</b> <i>matthiuvae</i> ... ..	299
<i>aspera</i> ... ..	303	<i>medianus</i> ... ..	298
<i>assimilis</i> ... ..	289	<i>midsoni</i> ... ..	299
<i>atkinsoni</i> ... ..	299	<i>milligani</i> ... ..	297
<i>austrinus</i> ... ..	298	<i>mimosa</i> ... ..	291
<i>barrenensis</i> ... ..	289	<i>minima</i> ... ..	295
<i>bassi</i> ... ..	289	<i>mixta</i> ... ..	298
<i>beraudii</i> ... ..	302	<i>morti</i> ... ..	294
<i>bischoffensis</i> ... ..	301	<i>neglecta</i> ... ..	296
<i>bisulcata</i> ... ..	302	<i>nelsonensis</i> ... ..	288
<i>bombycina</i> ... ..	287	<i>occultas</i> ... ..	294
<i>brunonia</i> ... ..	285	<i>officineri</i> ... ..	288
<i>buttoni</i> ... ..	302	<i>onslowi</i> ... ..	291
<i>camilla</i> ... ..	299	<i>otwayensis</i> ... ..	300
<i>capta</i> ... ..	297	<i>paradoxa</i> ... ..	294
<i>casus</i> ... ..	294	<i>parvissima</i> ... ..	296
<i>collisi</i> ... ..	295	<i>pascuorum</i> ... ..	297
<i>curacaoe</i> ... ..	300	<i>pettardi</i> ... ..	299
<i>dacryensis</i> ... ..	299	<i>pettardi, var. peroni</i> ... ..	299
<i>derelicta</i> ... ..	294	<i>pettardiana</i> ... ..	288
<i>dimoniensis</i> ... ..	299	<i>pictilis</i> ... ..	294
<i>discors</i> ... ..	294	<i>plebeus</i> ... ..	297
<i>dispar</i> ... ..	290	<i>peruviana</i> ... ..	302
<i>dubitans</i> ... ..	287	<i>quastiosa</i> ... ..	287
<i>durani</i> ... ..	297	<i>ramsgatensis</i> ... ..	300
<i>dyeri</i> ... ..	287	<i>ricci</i> ... ..	291
<i>floodi</i> ... ..	297	<i>robbini</i> ... ..	300
<i>fordii</i> ... ..	298	<i>rosacea</i> ... ..	292
<i>fulgurum</i> ... ..	288	<i>rotella</i> ... ..	291
<i>funerea</i> ... ..	291	<i>rufa</i> ... ..	286, 297
<i>funereocensis</i> ... ..	295	<i>sarisi</i> ... ..	298
<i>fuscopulvata</i> ... ..	297	<i>scrupulus</i> ... ..	297
<i>gadiensis</i> ... ..	301	<i>sericatulata</i> ... ..	291
<i>gmani</i> ... ..	289	<i>similis</i> ... ..	294
<i>halli</i> ... ..	295	<i>sinclairi</i> ... ..	287
<i>helice</i> ... ..	298	<i>sitiens</i> ... ..	296
<i>henryana</i> ... ..	295	<i>spectra</i> ... ..	289
<i>hobarti</i> ... ..	294	<i>spiciferi</i> ... ..	295
<i>hookeriana</i> ... ..	290	<i>spoliata</i> ... ..	297
<i>irvina</i> ... ..	297	<i>stanleyensis</i> ... ..	288
<i>inloida</i> ... ..	291	<i>stellata</i> ... ..	294
<i>jungermannia</i> ... ..	296	<i>stephensi</i> ... ..	297
<i>kerskawi</i> ... ..	290	<i>subangulata</i> ... ..	302
<i>kingi</i> ... ..	297	<i>subrugosa</i> ... ..	292
<i>kingstonensis</i> ... ..	288	<i>tabescens</i> ... ..	298
<i>lampra</i> ... ..	286, 297	<i>tamarensis</i> ... ..	291
<i>lamproides</i> ... ..	286	<i>tasmania</i> ... ..	292
<i>langleyana</i> ... ..	297	<i>thompsoni</i> ... ..	299
<i>lancestonensis</i> ... ..	284	<i>trajectura</i> ... ..	298
<i>legrandi</i> ... ..	290, 291	<i>tranquilla</i> ... ..	298
<i>limula</i> ... ..	291	<i>trucanini</i> ... ..	295
<i>lottah</i> ... ..	290	<i>vermiculata</i> ... ..	304
<i>luckmanii</i> ... ..	296	<i>rezanda</i> ... ..	287
<i>macdonaldi</i> ... ..	288	<i>victoria</i> ... ..	285
<i>marchiana</i> ... ..	297	<i>vigens</i> ... ..	290
<i>margatensis</i> ... ..	287	<i>vitrinaformis</i> ... ..	301

	PAGE		PAGE
HELIX <i>weldii</i> ...	293	<i>inmaculatum</i> , PLASMODIUM	338
<i>wellingtonensis</i>	299	<i>incertum</i> , CALLIOSTOMA	169
<i>wynyardensis</i>	298	<i>incompleta</i> , RISSOA	110
HELIXARION <i>currieri</i> ...	301	<i>indica</i> , LEPTOMARIA	239
HEMEROCETES <i>haswelli</i>	321	<i>inflata</i> , LIMACINA	112
<i>henryana</i> , HELIX	295	<i>inflatus</i> , AMMONITES	235-236
<i>henryana</i> , LAOMA	295	<i>inflatus</i> , SCHLENBACHIA	236
<i>hepaticum</i> , DICTOMUM	330	<i>inquinatus</i> , LEPIDOPLEURUS	260
<i>hepaticum</i> , FASCIOLA	330	<i>inscriptum</i> , CYCLOSTREMA	110
<i>heptaolus</i> , PETRAITES	41	<i>insignis</i> , GLYCYMERIS	124
<i>heroine</i> , ARANEUS	221-225	<i>insularis</i> , PHTLOPUS	30
HETEROPLEURON <i>basanum</i>	24	<i>intermedius</i> , LEANDER	307, 309
<i>belcheri</i>	35	<i>intermedius</i> , TRISDONTOPHORUS	340
<i>cingalense</i>	34	<i>intestinalis</i> , STRONGYLOIDES	334
<i>cultellum</i>	34, 35	<i>irisodontes</i> , CANTHARIDUS	109
<i>hectori</i>	35	<i>irregulare</i> , CRIOCERAS	145
<i>helleyi</i>	33-35	<i>irruva</i> , HELIX	297
<i>lucayum</i>	33	ISCHNOCHITON <i>curtisianus</i>	265
HETERURETHRA	283	<i>mayi</i>	264
HEURODES <i>turrata</i>	225	<i>smaragdinus</i>	264
<i>hexaptera</i> , SAGITTA	251	<i>uloidea</i> , HELIX	291
HIANTOPORA <i>perforata</i>	271	J	
<i>higginsii</i> , ARACHNURA	218	<i>jacki</i> , CRIOCERAS	145
<i>hilum</i> , MANGELIUM	112	<i>jacksonensis</i> , ARCULARIA	112
<i>hirtus</i> , BIRGELIUS	305	<i>jacksonensis</i> , CODAKIA	114
<i>hirta</i> , CYRTOPHORA	217	<i>josephi</i> , LIOTIA	110
<i>hobarti</i> , HELIX	294	<i>jugosus</i> , CHITON	262
<i>hobsoni</i> , ORDGARIUS	229	<i>jungermannia</i> , HELIX	296
<i>hofmani</i> , TUKBONILLA	111	<i>jungermannia</i> , FLAMMULINA	296
<i>holdsworthii</i> , LICHIENOPORA	268	<i>jungermannia</i> , LAOMA	296
HOLOPODA	284	K	
<i>hominis</i> , ECHINOCOCCUS	331	<i>kampyla</i> , NASSARIA	119
<i>hominis</i> , FILARIA <i>sanguinis</i>	335	<i>kampylum</i> , CYMATHIUM	111
<i>hookeriana</i> , ENDODONTA	290	<i>kayseri</i> , PLRISPHINCTES	238
<i>hookeriana</i> , HELIX	290	<i>kershawi</i> , HELIX	290
HOPTOPHYRYS <i>ogilbyi</i>	51	<i>keyserlingi</i> , POLTYS	231
HORNERA <i>joliacea</i>	268	<i>kinbergi</i> , CELENIA	231
<i>horvathi</i> , CRISTICEPS	39	<i>kingensis</i> , DAPHNELLA	112
<i>hullianus</i> , CARANUS	319	<i>kingi</i> , HELIX	297
<i>hydatidosus</i> , ECHINOCOCCUS	331	<i>kingstonensis</i> , HELIX	288
HYMENOLEPIS <i>diminuta</i>	331	<i>kochi</i> , PARAPLECTANOIDES	228
<i>lancoolata</i>	331	KRAUSSINA <i>atkinsoni</i>	114
HYPOLIMNAS	69	KROHNIA <i>hamata</i>	251
<i>bolina</i>	70, 73	L	
<i>missippus</i>	70	<i>laciniatus</i> , POLTYS	231
<i>hypostomum</i> , DOCHMIUS	341	LEIMATONICE <i>aphroditoides</i>	242
<i>hypostomum</i> , SCLEROSTOMUM	341	<i>laevigata</i> , CANCELLARIA	111
<i>hystolitica</i> , ENTAMBEA	336	<i>laevigata</i> , MARGINELLA	111
HYSTRICOCERAS <i>antipodens</i>	237	<i>levis</i> , HALIMUS	54
<i>sp.</i>	237	LACENIOPORA <i>nitens</i>	268
<i>hystrix</i> , LEKYTHOPORA	268		
I			
ICHTHYOCAMPUS <i>filum</i>	318		
IDMONEA <i>contorta</i>	268		

	PAGE
<i>lampra</i> , HELIX ...	286, 297
<i>lampra</i> , RHYTIDA ...	286
<i>lamproides</i> , HELIX ...	286
<i>lamproides</i> , RHYTIDA ...	286
<i>lanpros</i> , CRIOCERAS ...	157
<i>lancearis</i> , ARCEYS ...	232
<i>lanceolata</i> , DREPANIDOTÆNIA ...	331
<i>lanceolata</i> , HYMENOLEPIS ...	331
<i>lanceolata</i> , ZEUGLOPORA ...	272
LAOMA <i>caesus</i> ... ..	294
<i>furneaurausis</i> ...	295
<i>hallsi</i> .. ..	295
<i>henryana</i> ...	295
<i>jungermannia</i> ...	296
<i>luckmanni</i> ...	296
<i>minima</i> ...	295
<i>morti</i> ...	294
<i>parvissima</i> ...	296
<i>pictilis</i> ...	294
<i>pipensis</i> ...	295
<i>spiceri</i> ... ..	295
<i>trucanini</i> ...	295
<i>weldii</i> ...	293
<i>laqueus</i> , CRIOCERAS... ..	160
<i>laqueus</i> , HAMITES ...	160
<i>latus</i> , DIBOTHRIOCEPHALUS... ..	330
<i>laugleyana</i> , HELIX .. ..	297
<i>launcestonensis</i> , ANOGLYPTON ...	284
<i>launcestonensis</i> , HELIX ...	284
LAVERIANA <i>malaria</i> ...	337
<i>layardi</i> , RISSOA ...	110
LEANDER <i>intermedius</i> ...	307, 309
<i>litoreus</i> ...	308
<i>natator</i> ...	309
<i>serenus</i> ...	306
<i>legrandi</i> , CALLIOSTOMA ...	109
<i>legrandi</i> , ENDODONTA ...	290
<i>legrandi</i> , HELIX ...	290, 291
<i>legrandi</i> , SUCCINEA ...	283
LEKYTHOPORA <i>aricularis</i> ...	273
<i>hystrix</i> ...	268
LEPIDOPLEURUS <i>badius</i> ...	260
<i>columnarius</i> ...	113, 123
<i>inquinatus</i> .. ..	260
<i>mattheusianus</i> ...	260
LEPTOCERAS ... ..	143, 164
<i>edkinsi</i> ...	165
LEPTOMARIA <i>gigantea</i> ...	239
<i>indica</i> ...	239
<i>sp.</i> ...	239
<i>leptus</i> , CRIOCERAS ...	143
LEUCOTINA <i>micra</i> ...	112
LICHENOPORA <i>holdsworthii</i> ... ..	268
<i>licinus</i> , MUREX ...	112
LIGULA <i>mansonii</i> ...	330
<i>liguloides</i> , BOTHRIOCEPHALUS ...	330

	PAGE
LIMA <i>angulata</i> ...	113
<i>bulbata</i> ...	113
<i>lima</i> ...	113
<i>lima</i> , LIMA ...	113
LIMACINA <i>inflata</i> ...	112
<i>limans</i> , CHITON ...	261
LIMAX <i>fluvius</i> ...	303
<i>maximus</i> ...	303
LINEA <i>murrayi</i> ...	113
LIMNAS <i>petitiæ</i> ...	70
LIMOPSIS <i>tenisoni</i> , var. <i>penetrans</i> ...	113
<i>limula</i> , HELIX ...	291
<i>lincolnensis</i> , PUPA ...	283
<i>lincolnensis</i> , VERTIGO ...	283
<i>lutea</i> , RISSOA ...	110, 117
LILOPHURA <i>cutisiamæ</i> ...	265
LIOTIA <i>annulata</i> .. ..	110
<i>josephi</i> ... ..	110
<i>myana</i> .. ..	110
<i>petalifera</i> ...	110, 116
LIXANTHO <i>haswelli</i> ...	54
<i>lischkeani</i> , CORALLOPHILA... ..	112
LISSARCA <i>rhomboidalis</i> .. ..	113
<i>rubricata</i> .. ..	113
<i>litoreus</i> , LEANDER ...	308
<i>loa</i> , FILARIA ...	341
LOBETINA .. ..	219
<i>opariceps</i> ...	219
<i>pluyata</i> ...	220
LOBOPLAX <i>caribabilis</i> ... ..	266
<i>longirostris</i> , RHYNCOPORA ...	268
<i>longirostris</i> , (var.) <i>linguiformis</i> , TRIGONOPLAX ...	59
<i>losseni</i> , PERISPINCTES .. ..	239
<i>lottah</i> , HELIX ...	290
<i>lucayum</i> , ASYMMETRON ...	35
<i>lucayum</i> , HETEROPLEURON ...	33
<i>luckmanni</i> , HELIX .. ..	296
<i>luckmanni</i> , LAOMA ...	296
<i>lumbrioides</i> , ASCARIS ...	335
LUNUTITES <i>canaliculata</i> ...	267
LYTOCERAS ... ..	139

M

<i>macdonaldi</i> , HELIX .. ..	288
<i>macleayi</i> , CRISTICEPS ...	39
<i>maculata</i> , SELENARIA ...	268
<i>maculatus</i> , EURYCARCINUS ...	57
<i>magnarmata</i> , BIPORA ...	269
<i>magnifica</i> , ARGIOPE .. ..	213
<i>magnificus</i> , DICROSTICHUS ...	229, 230
<i>malaria</i> , HEMAMOËBA ...	337
<i>malaria</i> , LAVERIANA ...	337
<i>malaria</i> , PLASMODIUM ...	337

	PAGE		PAGE
<i>mamilla</i> , SCAPHELLA ...	112	MEMBRANIPORA <i>profunda</i> ...	276
<i>mamillana</i> , ANOPILOCEPHALA ...	339	MESOPHYLLUM ...	19
<i>mamillata</i> , BIPORA ...	270	METAPENUS <i>monoceros</i> ...	313
<i>mammicata</i> , DOLOPHONES ...	233	<i>metcalfei</i> , ODOSTOMIA ...	111
<i>mammicatus</i> , POLTYS ...	231	<i>micans</i> , NUCULA ...	113
MANGELIA <i>canellata</i> ...	112	<i>miera</i> , LEUCOTINA ...	112
<i>delicatula</i> ...	112	<i>microcephalus</i> , ANCHISTRO-	
<i>desalesi</i> ...	112	CEPHALUS ...	344
<i>dyscritos</i> ...	112	MICROFILARIA <i>nocturna</i> ...	335
<i>granulosissima</i> ...	112	<i>micron</i> , CYCLOSTREMA ...	110
<i>modesta</i> ...	112	MICROPORA <i>coriacea</i> ...	268
<i>spica</i> ...	112	MICROPORELLA <i>ciliata</i> ...	268
MANGELIUM <i>hilum</i> ...	112	<i>microstoma</i> , SPIROPTERA ...	341
MANGORELE ...	219	MICROVOLUTA <i>purpurcostoma</i>	112, 120
<i>mansonii</i> , BOTHRIOCEPHALUS ...	330	<i>micrurus</i> , STRONGYLUS ...	341
<i>mansonii</i> , LIGULA ...	330	MICTOCYSTIS ...	19, 20
<i>mansonii</i> , SPARGANUM ...	330	<i>endophylloides</i> ...	20
<i>marchiana</i> , FLAMMULINA ...	297	<i>midsoni</i> , HELIX ...	299
<i>marchiana</i> , HELIX ...	297	MILAX <i>gagates</i> ...	303
<i>margaritacea</i> , TRIGONIA ...	113	<i>tasmanicus</i> ...	303
<i>margaritensis</i> , HELIX ...	287	MILIOLINA <i>subrotunda</i> ...	245
<i>marginata</i> , ANCHILLA ...	111	MILONIA <i>queenslandica</i> ...	69
MARGINELLA <i>ayapata</i> ...	111	<i>milligani</i> , HELIX ...	297
<i>biplicata</i> ...	111	<i>milligani</i> , PARYPHANTA ...	287
<i>columnaria</i> ...	111, 120	<i>milligani</i> , VITRINA ...	287
<i>cratericula</i> ...	111	Mimicry ...	69
<i>finchersi</i> ...	111	<i>minosa</i> , ENDODONTA ...	291
<i>laevigata</i> ...	111	<i>minosa</i> , HELIX ...	291
<i>mayi</i> ...	111	<i>minor</i> , var. <i>astrigera</i> , GAS-	
<i>mustellina</i> ...	111	TERACANTHA ...	227
<i>oculata</i> ...	111	<i>minor</i> , GASTERACANTHA ...	226, 227
<i>simsoni</i> ...	111	<i>minima</i> , HELIX ...	295
<i>stilla</i> ...	111	<i>minima</i> , LAOMA ...	295
<i>tridentata</i> ...	111	<i>minor</i> , EUDYPTULA ...	134
<i>marginodes</i> , ONYURIS ...	340	<i>minuta</i> , DAPHNELLA ...	112
<i>matheronianum</i> , ANOPILOCERAS ...	139	<i>missippus</i> , HYPOLIMNAS ...	70
<i>mathewsianus</i> , LEPIDOPLEURUS ...	260	MITRA <i>scalariformis</i> ...	112
<i>matthinna</i> , ENDODONTA ...	290	<i>tasmanica</i> ...	112
<i>matthinna</i> , FLAMMULINA ...	299	<i>vincentiana</i> ...	112
<i>matthinna</i> , HELIX ...	299	MITROMORPHA <i>alba</i> ...	111
MAGGHANI <i>acanthochites</i> ...	265	<i>pallidula</i> ...	111
<i>majorinus</i> , LIMAX ...	303	<i>micta</i> , HELIX ...	298
<i>majorina</i> , LIOPIA ...	110	<i>mobilis</i> , ARGULARIA ...	112, 121
<i>mayi</i> , HAPLOPLAX ...	264	<i>mobilis</i> , var. <i>costata</i> , ARGU-	
<i>mayi</i> , ISCHNOCHITON ...	264	LARIA ...	112, 121
<i>mayi</i> , MARGINELLA ...	111	<i>modesta</i> , MANGELIA ...	112
<i>mediarius</i> , HELIX ...	298	MODIOLA <i>australis</i> ...	113
<i>mediensis</i> , FILARIA ...	335	MODIOLARIA <i>barbata</i> ...	113
<i>mediocanellata</i> , TENIA ...	330	<i>modiolaris</i> , CRENATULA ...	303
<i>medius</i> , PECTEN ...	113	<i>molorthus</i> , TROPHOS ...	112, 122
<i>megalocephala</i> , ASCARIS ...	340	Monazite, California Ck., Mt.	
MEGASELLA <i>cunningii</i> ...	114	Garnet, Q'd. ...	281
<i>megastoma</i> , SPIROPTERA ...	341, 343	Monazite, Trundle, nr. Con-	
<i>melaleuca</i> , SAPHOPROCTA ...	21	dobolin, N.S.W. ...	280
MEMBRANIPORA <i>bellula</i> ...	267	MONILIA <i>philippensis</i> ...	109
<i>gemmata</i> ...	267		





	PAGE		PAGE
O			
<i>obliqua</i> , NUCULA ... ..	113	<i>parcipuncta</i> , ADEONA ... ..	268
<i>obliquus</i> , CYCLOPECTEN ... ..	113	<i>parrissima</i> , ENDODONTA ... ..	296
<i>occultus</i> , HELIX ... ..	294	<i>parrissima</i> , HELIX ... ..	296
<i>oculi</i> , DRACUNCULUS ... ..	341	<i>parrissima</i> , LAOMA ... ..	296
<i>Odostomia macleayi</i> ... ..	111	<i>parrulus</i> , CHEILOBRANCHUS ... ..	316
<i>atherca</i> , ARGIOPE ... ..	213	PARYPHANTA <i>dyeri</i> ... ..	287
<i>afflicti</i> , HELIX ... ..	288	<i>fumosa</i> ... ..	287
<i>oqilhyi</i> , HOPLOPHRYX ... ..	51	<i>millygani</i> ... ..	287
<i>olivacea</i> , RISSOA ... ..	110	<i>pascoci</i> , HELIX ... ..	297
<i>olivieri</i> , CENOBITA ... ..	305	<i>passerinum</i> , MONOPYLIDIUM ... ..	344
<i>onslowi</i> , HELIX ... ..	291	PECTEN <i>medius</i> ... ..	113
<i>opaciceps</i> , LOBETINA ... ..	219	<i>pectinata</i> , CONDYLOCARDIA ... ..	114, 125
OPISTHORCHIS <i>sinensis</i> ... ..	330	PECTUNCULUS <i>sordidus</i> ... ..	124
<i>opulenta</i> , TURRITELLA ... ..	110	<i>pellucida</i> , CALYPTREA ... ..	111
ORDGARIUS ... ..	229	<i>peltata</i> , DOLOPHONES ... ..	233
<i>clypeatus</i> ... ..	229	PENEUS <i>monoceros</i> ... ..	313
<i>Hobsoni</i> ... ..	229	<i>sp.</i> ... ..	313
<i>monstrosus</i> ... ..	229	<i>pucleris</i> , (var.) LIMOPSIS <i>tenisoni</i> ... ..	113
<i>seespingsa</i> ... ..	229	<i>perfoliata</i> , ANOPELOCEPHALA ... ..	339
ORTHURETHRA ... ..	283	<i>perforata</i> , HANTOPORA ... ..	271
OSCILLA <i>tasmanica</i> ... ..	111	<i>perigradata</i> , CANCELLARIA ... ..	111
OSTREA <i>auyasi</i> ... ..	113	PERISPIRNCUTES <i>kayseri</i> ... ..	238
<i>otwayensis</i> , ENDODONTA ... ..	300	<i>losseni</i> ... ..	239
<i>otwayensis</i> , FLAMMULINA ... ..	300	PERISTERIA <i>murrayana</i> ... ..	119
<i>otwayensis</i> , var. <i>alpina</i> , FLAMMULINA ... ..	300	<i>perlata</i> , var. <i>affinis</i> , CENOBITA ... ..	305
<i>otwayensis</i> , HELIX ... ..	300	<i>perlotus</i> , ARCYX ... ..	232
<i>orata</i> , MYODORA ... ..	113	<i>peroni</i> , (var.) HELIX <i>petterdi</i> ... ..	299
<i>oriforme</i> , COCCIDIUM ... ..	342	<i>personata</i> , GERYGONE ... ..	186
<i>orulum</i> , MARGINELLA ... ..	111	PERSONELLA ... ..	119
ONYURIS <i>curcula</i> ... ..	340	<i>perspicillatus</i> , CLINUS ... ..	43
<i>masligodes</i> ... ..	340	<i>perturnis</i> , SPIROCHLETA ... ..	337
<i>vermicularis</i> ... ..	335	<i>petalifera</i> , LIOTIA ... ..	110, 116
P			
PAGURUS <i>clypeatus</i> ... ..	305	<i>petilia</i> , DANAEUS ... ..	70
PALEMOS <i>affinis</i> ... ..	306	<i>petilia</i> , LIMNAS ... ..	70
<i>pallida</i> , ARGIOPE ... ..	213	PETRAITES ... ..	37
<i>pallida</i> , EPEIRA ... ..	219	<i>fasciatus</i> ... ..	42
<i>pallidula</i> , METROMORPHA ... ..	111	<i>heptaolus</i> ... ..	41
<i>pallidum</i> , SPIROCHLETA ... ..	337	<i>phillipi</i> ... ..	43
<i>pallidum</i> , TREPONEMA ... ..	337	<i>rosus</i> ... ..	40
<i>pallidus</i> , CRISTICEPS ... ..	39	<i>petterdi</i> , CYSTOFELTA ... ..	292
<i>palpalis</i> , ALIPE ... ..	313	<i>petterdi</i> , HELIX ... ..	299
PANOPAEA <i>australis</i> ... ..	114	<i>petterdi</i> , var. <i>peroni</i> , HELIX ... ..	299
PAPIUS <i>scapdon</i> ... ..	22	<i>petterdi</i> , TROPHOS ... ..	112
<i>papillosa</i> , SCAPHELLA ... ..	112	<i>petterdiana</i> , HELIX ... ..	288
<i>paradara</i> , HELIX ... ..	294	<i>petulus</i> , SEPTA ... ..	111, 118
PARAPLECTANOIDES ... ..	227	<i>pijifleri</i> , SUCCINEA ... ..	284
<i>crassipes</i> ... ..	228	PHENACOLEPAS <i>calra</i> ... ..	110
<i>kochi</i> ... ..	228	PHILINE <i>voluminaria</i> ... ..	112, 123
<i>parausia</i> , CYRTOPIHORA ... ..	217	<i>philippensis</i> , MONILEA ... ..	109
		PHILIPPIELLA <i>crenata</i> <i>ifera</i> ... ..	113
		<i>rubra</i> ... ..	113
		<i>phillipi</i> , CRISTICEPS ... ..	43
		<i>phillipi</i> , PETRAITES ... ..	43
		PHILOERYA <i>fimbriata</i> ... ..	113
		PHENICOPS <i>porphyropis</i> ... ..	69

	PAGE		PAGE
Phosgenite, Broken Hill, N.S.W. ... ..	280	<i>prunum</i> , HELIX ... ..	302
PICTETIA ... ..	139	PSEUDORISSOINA <i>capitata</i> H11,	118
<i>pictilis</i> , HELIX ... ..	294	Ptilopus <i>coralensis</i> ... ..	30
<i>pictilis</i> , LAOMA ... ..	294	<i>insularis</i> ... ..	30
Pictographs, Aboriginal, Bandanoon, N.S.W. ... ..	325	<i>smithsonianus</i> ... ..	30, 31
<i>pictus</i> , CRISTICEPS ... ..	38	PUFFINUS <i>sp.?</i> ... ..	31
<i>pilosa</i> , DOLOPHONES ... ..	233	<i>pulchella</i> , VALLONIA ... ..	303
<i>pipensis</i> , LAOMA ... ..	295	<i>pulchra</i> , SCHISMOPE ... ..	109
PISANIA <i>reticulata</i> ... ..	112	<i>punctata</i> , GABRIELLA ... ..	56
<i>pisiformis</i> , CYSTICERCUS ... ..	343	<i>punctata</i> , SELENARIA ... ..	268
PITHARATUS ... ..	233	<i>punctatus</i> , CYCLOXANTHUS ... ..	54, 56
<i>plagata</i> , LOBETINA ... ..	220	PUXA <i>lincolniensis</i> ... ..	283
PLANISPIRA <i>zonalis</i> ... ..	302	<i>tasmanica</i> ... ..	283
<i>planulatus</i> , MYTILUS ... ..	113	<i>rarius</i> ... ..	302
PLASMODIUM <i>falci-parum</i> ... ..	338	PUPIDLE ... ..	283
<i>immaculatum</i> ... ..	338	<i>purpurea</i> , CERITHIOPSIS ... ..	110
<i>malaria</i> ... ..	337	<i>purpurostoma</i> , MICROVOLUTA	112, 120
<i>præcox</i> ... ..	344	<i>purpuratum</i> , CRIOCERAS ... ..	139
<i>viride</i> ... ..	338	<i>pyramidata</i> , CLIO ... ..	113
<i>pletoides</i> , CRIOCERAS ... ..	153	PYRENE <i>angasi</i> ... ..	112
<i>plexa</i> , PYRENE ... ..	112	<i>pleura</i> ... ..	112
<i>plexus</i> , HELIX ... ..	297	Pyrite, United Miners' Mine, Major's Creek, N.S.W. ... ..	67
<i>plicata</i> , ANOPELOCEPHALA ... ..	339	<i>pyrum</i> , CASSIDEA ... ..	111
<i>pococki</i> , HÆMOGREGARINA ... ..	258		
<i>poculatum</i> , CYLICHNOSTOMUM	344	Q	
PECILOPACHYS ... ..	228	<i>quastiosa</i> , HELIX ... ..	287
<i>bispinosa</i> ... ..	228	<i>quasboroughensis</i> , (var.) SUC-	
POLINICES <i>beddomi</i> ... ..	111	<i>cinea australis</i> ... ..	284
<i>polymorphus</i> , ECHINOCOCCUS	331, 340, 343	<i>quenslandica</i> , MILIONIA ... ..	69
POLTYELE ... ..	230	<i>quoyi</i> , CYMATIUM ... ..	119
POLTYS ... ..	230	<i>quoyi</i> , TRITON ... ..	119
<i>bimaculatus</i> ... ..	231		
<i>coronatus</i> ... ..	231	R	
<i>kyserlingi</i> ... ..	231	<i>radiata</i> , BORNIA ... ..	114
<i>laciniatus</i> ... ..	231	<i>radiata</i> , CRIBRILINA ... ..	268
<i>membratus</i> ... ..	231	<i>radula</i> , TEREBRATULINA ... ..	114
<i>multituberculatus</i> ... ..	230	<i>ramsgateensis</i> , HELIX ... ..	300
<i>salebrosus</i> ... ..	230, 231	RANFRILYA <i>constancea</i> ... ..	293
<i>pontificalis</i> , CONUS ... ..	303	<i>refringens</i> , SPIROCHÆTA ... ..	336
<i>porcellanum</i> , CYCLOSTREMA ... ..	110	<i>regalis</i> , ARGIOPE ... ..	213
PORINA <i>gracilis</i> ... ..	268	<i>reptans</i> , RHYNCOBOTHRIVS ... ..	344
<i>porphyropis</i> , PHENICOPS ... ..	69	<i>reptans</i> , TETRARIHYNCHUS ... ..	344
<i>porrecta</i> , CONDYLOCARDIA H14,	125	<i>retiarium</i> , CALLIOSTOMA ... ..	109, 115
PORZANA <i>atra</i> ... ..	31	<i>reticulata</i> , ARCA ... ..	113
<i>præcincta</i> , GEA ... ..	217	<i>reticulata</i> , PISANIA ... ..	112
<i>præcox</i> , PLASMODIUM ... ..	344	<i>reticulata</i> , SMITIA ... ..	268
<i>præstans</i> , MUCRONELLA ... ..	268	RHABDONEMA <i>stercoralis</i> ... ..	334
<i>productus</i> , ARANEUS ... ..	222	RHENEAE <i>nelsonensis</i> ... ..	288
<i>profunda</i> , MEMBRANIPORA ... ..	267	Rhodonite, Broken Hill, N.S.W. ... ..	129
<i>protensa</i> , ARGIOPE ... ..	213	<i>rhombocephala</i> , EPEIRA ... ..	219
PROTEOSOMA <i>danilevskyi</i> ... ..	344	<i>rhomboidalis</i> , LISSARCA ... ..	113
PROTOZOA ... ..	336, 342		
<i>provinciale</i> , SCAPHITES ... ..	139		

	PAGE		PAGE
RHYNCHOCINETES <i>rugulosus</i>	310	SAGITTA <i>sp.</i>	251
<i>typus</i> ... ..	312	<i>tricuspidata</i> ... ..	251
RHYNCHOTHRIUS <i>reptans</i> ..	344	SALATURA <i>affinis</i> ... ..	73
RHYNCHOPORA <i>longirostris</i> ...	268	<i>salebrosus</i> , POLTYS ... ..	230, 231
RHYTIDA <i>lamprea</i> ... ..	286	<i>salutaris</i> , GASTROPHILUS ...	342
<i>lamproides</i> ... ..	286	<i>sanguinis hominis</i> , FILARIA	335
<i>rugosa</i> ... ..	286	SARCOPTES <i>scabiei</i> ... ..	336
<i>sinclairi</i> ... ..	287	<i>sarmentosus</i> , TROPHON	112, 122
<i>ricei</i> , ENDOLONTA ... ..	290, 291	<i>sarpedon</i> , PAFILIO ... ..	22
<i>ricei</i> , HELIX ..	291	SAULOPROCTA <i>melaleuca</i> ...	21
RISSOA <i>approxima</i> ... ..	110	<i>saresi</i> , FLAMMULINA ... ..	298
<i>cheilostoma</i> ... ..	110	<i>saresi</i> , HELIX ... ..	298
<i>columnaria</i> ... ..	110, 117	SAXICAVA <i>arctica</i> ... ..	114
<i>dubitabilis</i> ... ..	110	<i>scabiei</i> , SARCOPTES ... ..	336
<i>incompleta</i> ... ..	110	<i>scabriusculus</i> , EUCHELUS ...	110
<i>layardi</i> ... ..	110	<i>scalariformis</i> , MITRA ... ..	112
<i>olivacea</i> ... ..	110	<i>scalpidens</i> , TURRONILLA ..	111
<i>tasmanica</i> ... ..	110	SCAPHELLA <i>mamilla</i> ... ..	112
<i>tenisoni</i> ... ..	110	<i>papillosa</i> ... ..	112
<i>unilicata</i> ... ..	110	SCAPHITES <i>coquandi</i> ... ..	139
RISSOINA <i>fausta</i> ... ..	110, 117	<i>provinciale</i> ... ..	139
<i>gertrudis</i> ... ..	110	SCHISMOPE <i>atkinsoni</i> ... ..	109
<i>littora</i> ... ..	110, 117	<i>pulchra</i> ... ..	109
<i>roblini</i> , FLAMMULINA ..	300	SCHISTOSOMUM <i>hamatobium</i>	329, 330
<i>roblini</i> , HELIX ... ..	300	SCHIZOPORELLA <i>cecilii</i> ... ..	268
<i>rosacca</i> , HELIX ... ..	292	<i>flabellata</i> ... ..	268
<i>rosens</i> , CRISTICEPS ... ..	40	SCLEROSTOMUM <i>edentatum</i> ...	340
<i>rosens</i> , PETRAITES ... ..	40	<i>equinum</i> ... ..	340
<i>rostratus</i> , AMMONITES ... ..	235	<i>hypostomum</i> ... ..	341
<i>rostratus</i> , var. <i>antipodens</i> ,		<i>sp.</i> ..	340
SCHLENBACHIA... ..	237	<i>tetracanthum</i> ... ..	341
<i>rostratus</i> , SCHLENBACHIA ..	235	<i>culgare</i> ... ..	340
<i>rosalenta</i> , VENERICARDIA ...	113	SCHLENBACHIA ... ..	235
<i>rotella</i> , HELIX ... ..	291	<i>inflatus</i> ... ..	236
<i>rubra</i> , PHILIPPIELLA ... ..	113	<i>rostratus</i> ... ..	235
<i>rubricata</i> , LISSARCA... ..	113	<i>rostratus</i> , var. <i>antipo-</i>	
<i>rudolphi</i> , TROPHON ... ..	112	<i>dens</i> ... ..	237
<i>rugosa</i> , HELIX ... ..	286, 297	<i>carians</i> ... ..	238
<i>rugosa</i> , RHYTIDA ... ..	286	SCISSURELLA <i>australis</i> ... ..	109
<i>rugosus</i> , CENOBITA ... ..	306	<i>scorpanoides</i> , NEOSEBASTES	321
<i>rugulosus</i> , RHYNCHOCINETES	310	<i>scorpionoides</i> , ARACHNURA...	218
Rutile, Mount Gambier,		<i>scrupulus</i> , HELIX ..	297
S. Australia ... ..	66	<i>sculptilis</i> , CYRTOPHORA ..	217
Victor Harbour, S. Aust.	66	SELENARIA <i>concinna</i>	268, 271
		<i>maculata</i> ... ..	268
		<i>nitida</i> ... ..	271
		<i>punctata</i> ... ..	268
		<i>semilaris</i> , CERITHIOPSIS ...	110
		<i>semitorta</i> , ARCA ... ..	302
		SEPIA <i>braggi</i> ... ..	134
		SEPTA <i>petulans</i> ... ..	111, 118
		<i>serenus</i> , LEANDER ..	306
		<i>serialis</i> , CENURUS ... ..	343
		<i>sericatulula</i> , ENDODONTA ...	291
		<i>sericatulula</i> , HELIX ... ..	291

## S

<i>sacredotalis</i> , GASTERACANTHA	227
<i>saginata</i> , TENIA ... ..	330
SAGITTA <i>australis</i> ... ..	255
<i>badoli</i> ... ..	256
<i>enflata</i> ... ..	251, 253
<i>furcata</i> ... ..	253-254, 256
<i>heraphora</i> ... ..	251
<i>serrodentata</i> ... ..	252
<i>siboga</i> ... ..	254, 256

	PAGE
<i>serotinum</i> , ATAXOCERITHIUM	110
<i>serrata</i> , TENIA ... ..	343
<i>serrodentata</i> , SAGITTA ... ..	252
<i>setosa</i> , CYETARACHNE ... ..	228
<i>se.espinosa</i> , ORDGARIUS ... ..	229
<i>shattocki</i> , HÆNOGREGARINA	256
<i>siboga</i> , SAGITTA ... ..	254, 256
SIGMURETHRA ... ..	284
SILIQUARIA <i>waldii</i> ... ..	111
<i>similis</i> , HELIX ... ..	294
SIMILUNCINUS <i>daectonis</i> ... ..	250
<i>simplex</i> , DOLOPHONES ... ..	233
<i>simplex</i> , TROPHON ... ..	112
<i>simsoni</i> , ARCHEMORUS ... ..	232
<i>simsoni</i> , MARGINELLA ... ..	111
<i>sinclairi</i> , HELIX ... ..	287
<i>sinclairi</i> , RHYTIDA ... ..	287
<i>sinensis</i> , OPISTHORCHIS ... ..	330
SIRIUS <i>hulius</i> ... ..	111
<i>sitiens</i> , HELIX ... ..	296
<i>smaragdinus</i> , ISCHINOCYTHON	264
<i>smithiana</i> , TURRITELLA ... ..	110
<i>smithsonianus</i> , PTILOPUS	30, 31
SMITTFIA <i>reticulata</i> ... ..	268
SOLETELLINA <i>hedleyi</i> ... ..	114
<i>solitarius</i> , CALLIPTILUS ... ..	29
<i>solum</i> , TENIA ... ..	330
<i>sordida</i> , GLYCYMERIS	113, 124
<i>sordidus</i> , PECTUNCULUS ... ..	124
SPARGANUM <i>mansonii</i> ... ..	330
<i>spectra</i> , HELIX ... ..	289
<i>spica</i> , MANGELIA ... ..	112
<i>spicari</i> , HELIX ... ..	295
<i>spicari</i> , LAOMA ... ..	295
<i>spina</i> , CINGULINA ... ..	111
<i>spinosa</i> , CENOBITA ... ..	305
<i>spinosa</i> , CENOBITA... ..	305
<i>spinosa</i> , HALIMUS ... ..	53
<i>spiralis</i> , TRICHINA ... ..	334
<i>spiralis</i> , TRICHINELLA	334, 343
SPIROCHLETA <i>aboriginalis</i> ... ..	336
<i>buccalis</i> ... ..	337
<i>dentium</i> ... ..	337
<i>pallidum</i> ... ..	337
<i>pertenais</i> ... ..	337
<i>refringens</i> ... ..	336
<i>cincenti</i> ... ..	337
<i>megastoma</i> ... ..	341, 343
<i>microstoma</i> ... ..	341
<i>splendens</i> , CRISTICEPS ... ..	39
<i>spoliata</i> , HELIX ... ..	297
SPONGOPHYLLOIDES ... ..	19
SPOROZOA ... ..	344
<i>spretus</i> , CADULUS ... ..	113
<i>stanleyensis</i> , HELIX ... ..	288
<i>stellata</i> , HELIX ... ..	294

	PAGE
<i>stephensi</i> , CALLIPTILUS (?) ... ..	29
<i>stephensi</i> , HELIX ... ..	297
<i>stercoralis</i> , RHABDONEMA ... ..	334
<i>stillia</i> , MARGINELLA ... ..	111
<i>stimuleus</i> , TROPHON... ..	112
<i>strigosus</i> , STRONGYLUS ... ..	343
STRONGYLOIDES <i>intestinalis</i> ...	334
STRONGYLUS <i>armatus</i> ... ..	340
<i>micrurus</i> ... ..	341
<i>strigosus</i> ... ..	343
<i>subangulata</i> , HELIX... ..	302
<i>subcarinatum</i> , ASTELE ... ..	109
<i>subcostata</i> , NATICA ... ..	111
<i>subrotunda</i> , MILIOLINA ... ..	245
<i>subrugosa</i> , ENDODONTA ... ..	292
<i>subrugosa</i> , HELIX ... ..	292
<i>subsquamosa</i> , TURRITELLA ... ..	110
SUCCINEA <i>australis</i> ... ..	283
<i>australis</i> , var. <i>queens-</i>	
<i>boroughensis</i> ... ..	284
<i>australis</i> , var. <i>tamar-</i>	
<i>ensis</i> ... ..	284
<i>legrandi</i> ... ..	283
<i>piiffrii</i> ... ..	284
<i>tamarensis</i> ... ..	284
SUCCINEIDE ... ..	283
<i>suminata</i> , GASTERACANTHA... ..	227
<i>superba</i> , EMARGINULA ... ..	109
<i>sylvicola</i> , ARANEUS ... ..	222, 225

T

<i>tabescens</i> , HELIX ... ..	298
TACZANÓWSKI ... ..	231
TENIA <i>medioranellata</i> ... ..	330
<i>saginata</i> ... ..	330
<i>serrata</i> ... ..	343
<i>solum</i> ... ..	330
<i>tamarensis</i> , ENDODONTA ... ..	291
<i>tamarensis</i> , HELIX ... ..	291
<i>tamarensis</i> , SUCCINEA ... ..	284
<i>tamarensis</i> , (var.) SUCCINEA	
<i>australis</i> ... ..	284
<i>tasmanic</i> , ENDODONTA ... ..	292
<i>tasmanic</i> , HELIX ... ..	292
<i>tasmanica</i> , COCCULINA ... ..	110
<i>tasmanica</i> , CUSPIDARIA ... ..	113
<i>tasmanica</i> , GIBBULA ... ..	114
<i>tasmanica</i> , MITRA ... ..	112
<i>tasmanica</i> , NATICA ... ..	111
<i>tasmanica</i> , OSCILLA ... ..	111
<i>tasmanica</i> , PUPA ... ..	283
<i>tasmanica</i> , RISSOA ... ..	110
<i>tasmanica</i> , TRIFORA... ..	110
<i>tasmanicus</i> , BULIMUS ... ..	285
<i>tasmanicus</i> , MILAX ... ..	303

	PAGE		PAGE
<i>tatei</i> , CODAKIA .. ...	114	TRICHOCEPHALUS <i>trichiurus</i> ..	334
<i>taylori</i> , ANCYLOCERAS .. ...	162	<i>trispinosa</i> , CAVOLINA .. ...	112
<i>taylori</i> , CRIOCERAS .. ...	162	TRITON <i>quoyi</i> .. ...	119
TELLINA <i>decussata</i> .. ...	114	TRIVIA <i>australis</i> .. ...	111
<i>tenisoni</i> , var. <i>penuleris</i> , LIM- OPHIS .. ...	113	TROPHON <i>columnarius</i> ..	112, 121
<i>tenisoni</i> , RISSOA .. ...	110	<i>molorthus</i> .. ...	112, 122
<i>tennicollis</i> , CYSTICERCUS .. ...	343	<i>petterdi</i> .. ...	112
<i>tennicostata</i> , EUTHIRIA .. ...	112	<i>rudolphi</i> .. ...	112
<i>tennicostata</i> , GLYCYMERIS .. ...	113	<i>sarmentosus</i> .. ...	112, 122
TEREBRA <i>bicolor</i> .. ...	111	<i>simplex</i> .. ...	112
TEREBRATULINA <i>cancellata</i> ..	114	<i>stimuleus</i> .. ...	112
<i>radula</i> .. ...	114	<i>trucanini</i> , HELIX .. ...	295
<i>tessellatus</i> , NATATOR .. ...	127	<i>trucanini</i> , LAOMA .. ...	295
<i>testulinea</i> , DOLOPHONES .. ...	233	<i>truncatipes</i> , HALIMUS .. ...	53
<i>tetracanthum</i> , CYLICHNOSTO- MUM .. ...	341	TRUNCATULINA .. ...	245
<i>tetracanthum</i> , SCLEROSTOMA ..	341	TRYPANOSOMA <i>eransi</i> ..	341, 343
TETRARHYNCHUS <i>reptans</i> .. ...	344	<i>tuberculata</i> , CAREPALXIS ..	225
TEXTULARIA .. ...	245	<i>tuberculata</i> , DOLOPHONES ..	233
<i>theridioides</i> , GEA .. ...	217	<i>tumidus</i> , HALIMUS .. ...	53
THLAOSOMA .. ...	231	TURBONILLA <i>hofmani</i> .. ...	111
<i>dabium</i> .. ...	231	<i>scalpidens</i> .. ...	111
THOLIA .. ...	233	<i>turbonilloides</i> , CERITHIOPSIS ..	110
<i>thompsoni</i> , HELIX .. ...	299	<i>turrigera</i> , DOLOPHONES .. ...	233
THRACIOPSIS <i>angustata</i> .. ...	113	<i>turrita</i> , HEURODES .. ...	225
Thrush, Cinnamon-chested Ground .. ...	322	TURRITELLA <i>accisa</i> .. ...	110
Topaz, Carpet Snake Creek, nr. Torrington, N.S.W. ..	274	<i>opulenta</i> .. ...	110
Topaz, Cow Flat, nr. Tor- rington, N.S.W. .. ...	60	<i>smithiana</i> .. ...	110
Topaz, Pakenham, Victoria ..	61	<i>subsquamosa</i> .. ...	110
Topaz, Stanthorpe, Q'land. ..	61	<i>typus</i> , RHYNCHOCINETES ..	312
<i>torri</i> , CHITON .. ...	262		U
<i>torri</i> , ENOPLOCHITON .. ...	265	<i>umbilicata</i> , NATICA .. ...	111
<i>tractura</i> , HELIX .. ...	298	<i>umbonata</i> , BIPORA .. ...	271
<i>tranquilla</i> , HELIX .. ...	298	<i>umbonata</i> , ESCHARA .. ...	271
<i>translucens</i> , CHITON .. ...	263	<i>unguiformis</i> , ELAMENA .. ...	59
TREMATODA .. ...	330, 344	<i>unguiformis</i> , var. <i>longirostris</i> , TRIGONOPLAX .. ...	59
TREPONEMA <i>pallidum</i> .. ...	337	<i>unilirata</i> , RISSOA .. ...	110
TRICHINA <i>spiralis</i> .. ...	334	UROCAMPI S <i>carinirostris</i> ..	317
TRICHINELLA <i>spiralis</i> ..	334, 343		V
<i>trichinurus</i> , TRICHOCEPHALUS ..	334	<i>raccina</i> , CYTORYCTES .. ...	338
<i>tricuspidata</i> , SAGITTA .. ...	251	<i>validum</i> , EPITONIUM .. ...	110
<i>tridentata</i> , CAVOLINA .. ...	112	<i>vallata</i> , CYCLOSA .. ...	219
<i>tridentata</i> , MARGINELLA .. ...	111	<i>vallata</i> , EPEIRA .. ...	219
TRIFORA <i>angasi</i> .. ...	110	VALLONIA <i>pulchella</i> .. ...	303
<i>fasciata</i> .. ...	110	<i>variabilis</i> , ACANTHOCHITES ..	266
<i>granifera</i> .. ...	110	<i>variabilis</i> , CENOETTA .. ...	305
<i>tasmanica</i> .. ...	119	<i>variabilis</i> , HANLEYA .. ...	266
TRIGONIA <i>margaritacea</i> .. ...	113	<i>variabilis</i> , LOBOPLAX .. ...	266
TRIGONOPLAX <i>unguiformis</i> , var. <i>longirostris</i> .. ...	59	<i>varians</i> , AMMONITES ..	237-238
TRIDONTOPHORUS <i>intermedius</i> ..	340	<i>varians</i> , SCHLONBACHIA .. ...	238
TRICHOCEPHALUS <i>dispar</i> .. ...	334	<i>variegata</i> , GASTERACANTHA ..	227
		<i>variola</i> , CYTORYCTES .. ...	338

	PAGE		PAGE
<i>carius</i> , PUPA ... ..	302	<i>vitrinaformis</i> , VITRINA ...	301
<i>rauculensis</i> , CHITON ...	261	<i>vivax</i> , PLASMODIUM ...	338
VENERICARDIA <i>amabilis</i> ...	113	<i>volgare</i> , SCLEEROSTOMUM ...	340
<i>carativa</i> ... ..	113		
<i>columnaria</i> ... ..	113, 125	W	
<i>dilecta</i> ... ..	113		
<i>rosulenta</i> ... ..	113	<i>wagneri</i> , ARANEUS ...	222, 225
<i>ventricosa</i> , NEPHILA... ..	216	Water Crane, Black ...	31
<i>cerconis</i> , ACANTHOCHITES ...	265	<i>weldii</i> , CIRSONELLA ... ..	110
VERMICULARIA <i>flava</i> ... ..	111	<i>weldii</i> , HELIX ... ..	293
<i>nodosa</i> ... ..	111	<i>weldii</i> , LAOMA ... ..	293
<i>vermiculata</i> , HELIX... ..	304	<i>weldii</i> , SILIQUARIA ... ..	111
<i>vermicularis</i> , OXYURIS ... ..	335	<i>wellingtonensis</i> , HELIX ...	299
<i>verreauxi</i> , HELICARION ... ..	301	<i>westringii</i> , GASTERACANTHA... ..	227
<i>verreauxi</i> , VITRINA ... ..	301	<i>whiteloggii</i> , CLINUS ... ..	42
VERTIGO <i>lincolniensis</i> ... ..	283	"Willy Wagtail" ... ..	23
VESICULARIA ... ..	19	<i>wilsoni</i> , ACANTHOCHITES ...	265
<i>ceterinorum</i> , ECHINOCOCCUS	331, 340, 343	<i>wilsoni</i> , CRISTICEPS ... ..	41
<i>rezanda</i> , HELIX ... ..	287	<i>wilsoni</i> , NOTOPLAX ... ..	265
<i>victoria</i> , HELIX ... ..	285	<i>wynyardensis</i> , FLAMMULINA ...	298
<i>rigens</i> , HELIX ... ..	290	<i>wynyardensis</i> , HELIX ... ..	298
<i>vincenti</i> , SPIROCHLETA ... ..	337		
<i>vincentiana</i> , MITRA ... ..	112	Z	
<i>virgula</i> , CLIO... ..	112		
VITREA <i>cellaria</i> ... ..	303	<i>zealandica</i> , DIPLODONTA ...	114
<i>crystallina</i> ... ..	303	ZEUGLOPORA ... ..	272
VITRINA <i>nigra</i> ... ..	301	<i>lancoolata</i> ... ..	272
<i>milligani</i> ... ..	287	<i>zonalis</i> , PLANISPIRA... ..	302
<i>verreauxi</i> ... ..	301	ZONITIDE ... ..	301





W 7  
1908  
MUSEUM

# RECORDS

OF THE

# AUSTRALIAN MUSEUM

EDITED BY THE CURATOR.

---

Vol. VII., No. 1.

---

PRINTED BY ORDER OF THE TRUSTEES

**R. ETHERIDGE, JUNR., J.P.,**

Curator.

SYDNEY, 9TH MARCH. 1908.

## CONTENTS.

	PAGE
North Queensland Ethnography. Bulletin No. 10. Marriage Ceremonies and Infant Life. By Walter E. Roth ... ..	1
An undescribed Australian Cystiphyllid — <i>Mictocystis</i> — from the Upper Silurian Rocks of the Mount Canoblas District. By R. Etheridge, Junr. ... ..	18
On an unusual Nesting-site of <i>Sauloprocta melaleuca</i> . By Alfred J. North ... ..	21
Ancient Stone Implements from the Yodda Valley Goldfield, North-East British New Guinea. By R. Etheridge, Junr. ... ..	24
On three apparently undescribed Birds from Henderson or Elizabeth Island, Paumotu Group. By Alfred J. North ... ..	29
Note on the <i>Cephalochorda</i> in the Australian Museum. By W. A. Haswell ... ..	33
Studies in Australian Fishes. No. 1. By Allan R. McCulloch ...	36
Studies in Australian Araneidæ. No. 5. By W. J. Rainbow ...	44
Studies in Australian Crustacea. No. 1. By Allan R. McCulloch...	51
Mineralogical Notes. No. 6. Topaz, Beryl, Anglesite, Butile, Atacamite, Pyrite. By Chas. Anderson ... ..	60

Plates i. to xvi.





RECORDS  
OF THE  
AUSTRALIAN MUSEUM

EDITED BY THE CURATOR.

Vol. VII., No. 2.

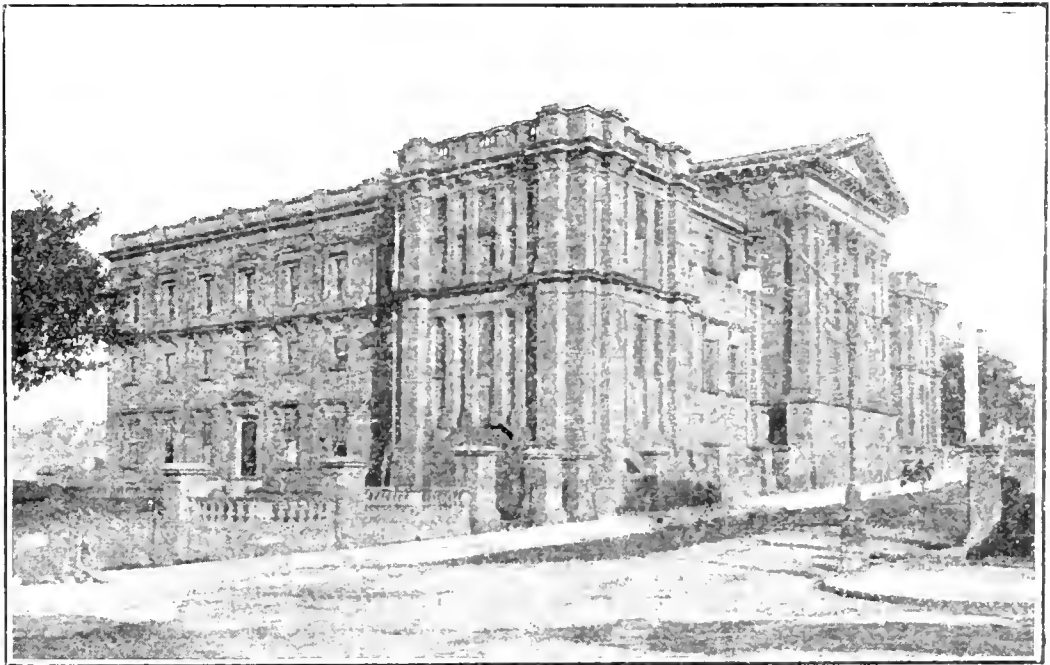

PRINTED BY ORDER OF THE TRUSTEES

R. ETHERIDGE, JUNR., J.P.,

Curator.

SYDNEY, 11TH SEPTEMBER, 1908.

## CONTENTS.

	PAGE
Notes on Mimicry and Variation. By W. J. Rainbow, F.L.S. ...	69
North Queensland Ethnography. Bulletin No. II. Miscellaneous Papers. 1. Tabu and other forms of Restriction. 2. Counting and Enumeration. 3. Signals on the Road; Gesture Language. 4. Progressive Koko-yimidir Exercises. By Walter E. Roth ...	74
Mollusca from one hundred fathoms, seven miles east of Cape Pillar, Tasmania. By C. Hedley and W. L. May .. ...	108
A New Genus and Species of Turtle, from North Australia. By Allan R. McCulloch ... ..	126
Mineralogical Notes. No. 7. Rhodonite, Broken Hill, New South Wales. By C. Anderson, M.A., D.Sc. ... ..	129
Occasional Note -	
No. 1.— <i>Sepia braggi</i> , Verco. A record for the State. By C. Hedley ... ..	134

Plates xvii. to xxix.







P

RECORDS  
OF THE  
AUSTRALIAN MUSEUM

EDITED BY THE CURATOR.

---

Vol. VII., No. 3.

---

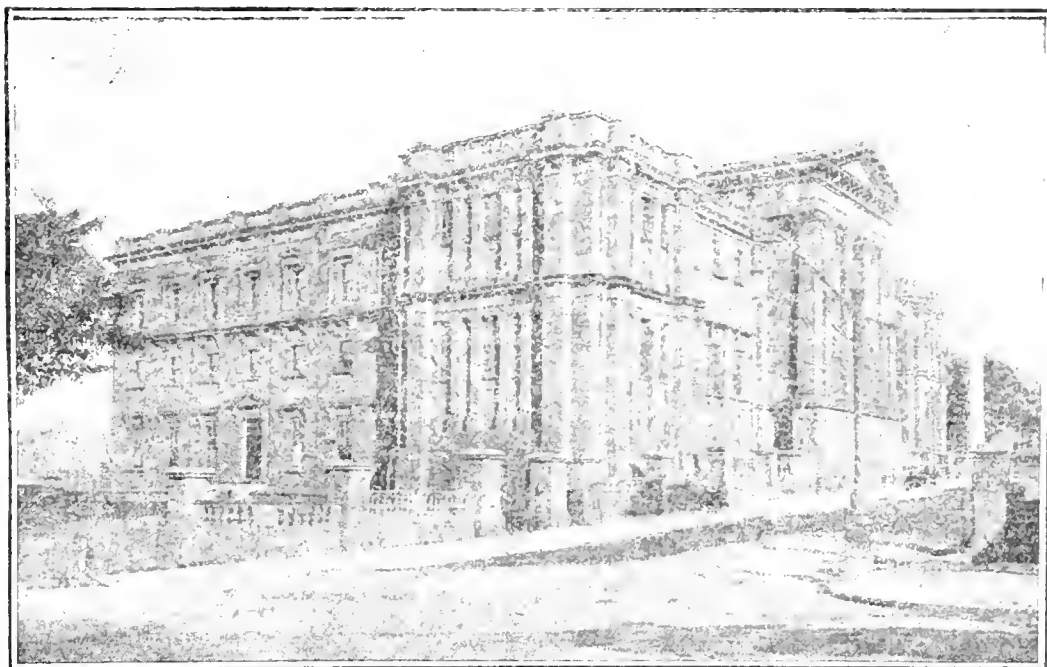

PRINTED BY ORDER OF THE TRUSTEES

R. ETHERIDGE, JUNR., J.P.,  
Curator.

SYDNEY, 15TH JANUARY, 1909.

## CONTENTS.

	PAGE
Lower Cretaceous Fossils from the Sources of the Barcoo, Ward and Nive Rivers, South Central Queensland. Part II.—Cephalopoda. By R. Etheridge, Junr., Curator ... ..	135
North Queensland Ethnography. Bulletin No. 12. On certain Initiation Ceremonies. By Walter E. Roth ... ..	166
Notes on the Nesting-Site of <i>Gerygone personata</i> , Gould. By Alfred J. North ... ..	186

Plates xxx. to lvii.





RECORDS  
OF THE  
AUSTRALIAN MUSEUM

EDITED BY THE CURATOR.

---

Vol. VII., No. 4.

---

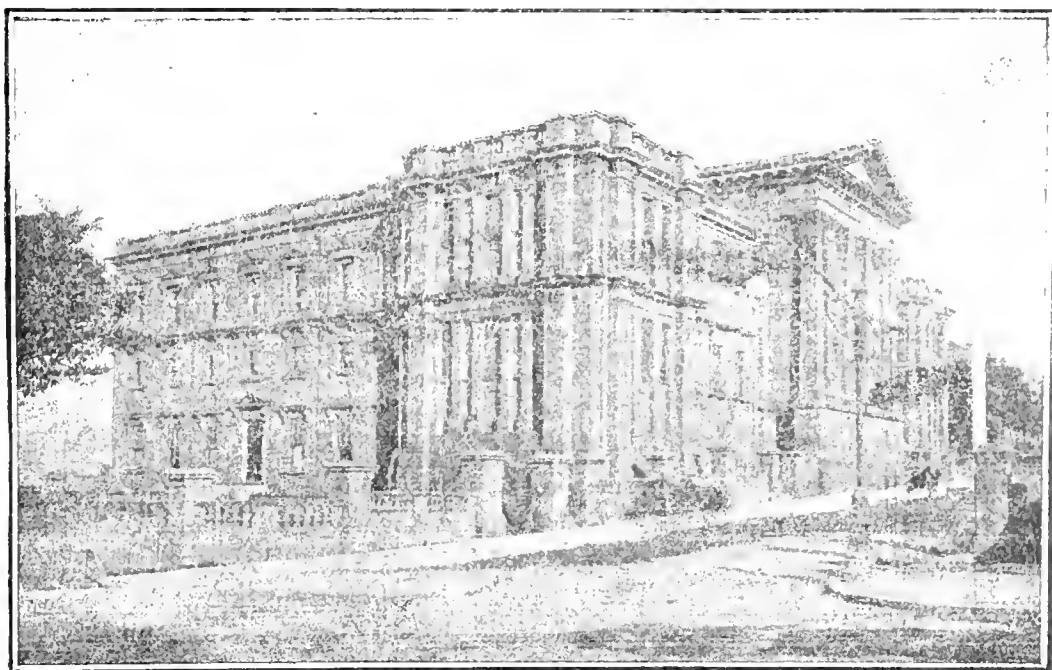

PRINTED BY ORDER OF THE TRUSTEES

R. ETHERIDGE, JUNR., J.P.,  
Curator.

SYDNEY, 30TH AUGUST, 1909.

## CONTENTS.

	PAGE
North Queensland Ethnography. Bulletin No. 13. Fighting Weapons. By Walter E. Roth ... ..	189
Notes on the Architecture, Nesting Habits, and Life Histories of Australian Araneidæ, based on Specimens in the Australian Museum. Part 7.—Entelegynæ ( <i>continued</i> ). By W. J. Rainbow... ..	212
Lower Cretaceous Fossils from the Sources of the Barcoo, Ward and Nive Rivers, South Central Queensland. Part 2.—Cephalopoda. By R. Etheridge, Junr., Curator ... ..	235
On a new Species of Aphrodita. By T. Harvey Johnston ... ..	241
On a Cestode from <i>Dacelo gigas</i> , Bodd. By T. Harvey Johnston ... ..	246
An Australian Chætognath. By T. Harvey Johnston ... ..	251
On a New Hæmoprotzoan. By T. Harvey Johnston ... ..	257
Descriptions of New and Notes on other Australian Polyplacophora. By C. Hedley and A. F. Basset Hull ... ..	260
The Results of Deep-sea Investigations in the Tasman Sea. I.—The Expedition of H.M.C.S. "Miner." No. 5.—The Polozoa. By C. M. Maplestone ... ..	267
Mineralogical Notes: No. 8.—Topaz, Anglesite, and other Australian Minerals. By C. Anderson... ..	274
A Revised Census of the Terrestrial Mollusca of Tasmania. By W. F. Petterd and C. Hedley ... ..	283
Studies in Australian Crustacea. No. 2. By Allan R. McCulloch... ..	305
Studies in Australian Fishes. No. 2. By Allan R. McCulloch ... ..	315
Description of the Female, with Nest and Eggs, of the Cinnamon-chested Ground Thrush ( <i>Cinclosoma marginatum</i> , Sharpe). By Alfred J. North ... ..	322
Aboriginal Drawings in Rock Shelters at Bundanoon, N. S. Wales. By W. W. Thorpe ... ..	325
Notes on Australian Entozoa, No. 1. By T. Harvey Johnston ... ..	329







RECORDS P  
OF THE  
AUSTRALIAN MUSEUM

EDITED BY THE CURATOR.

Vol. VII., No. 5.

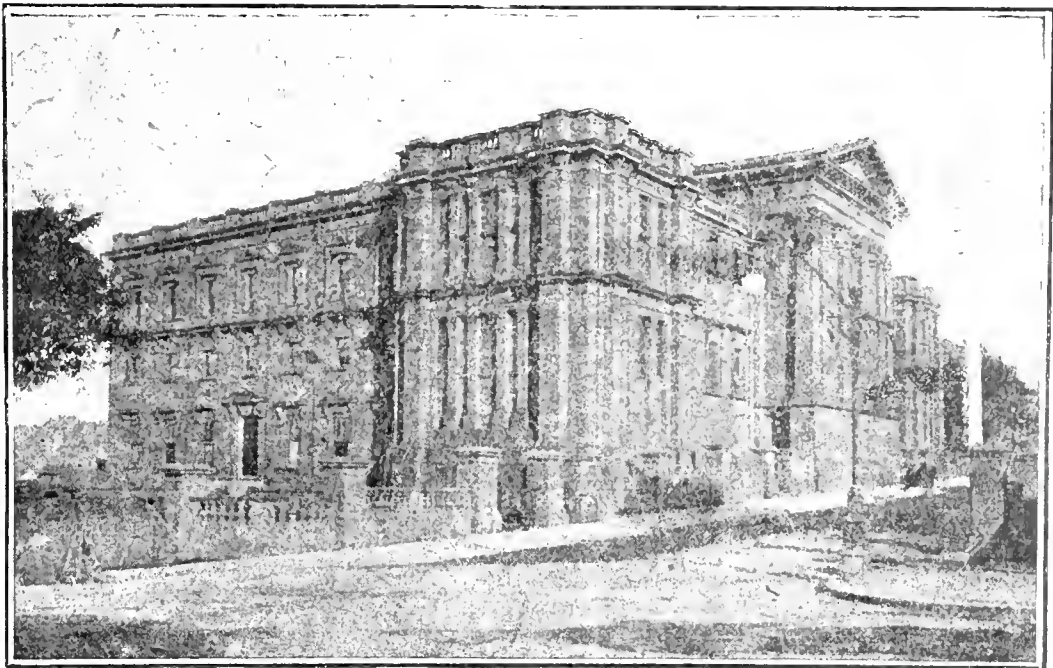

PRINTED BY ORDER OF THE TRUSTEES

R. ETHERIDGE, JUNR., J.P.,

Curator.

SYDNEY, 28TH FEBRUARY, 1910.

CONTENTS.

---

Title Page, Contents, and Index.









5 WHSE 00880

