

RECREATION

ESTABLISHED
1887
NEW YORK
PUBLISHED BY
G. O. SHIELDS

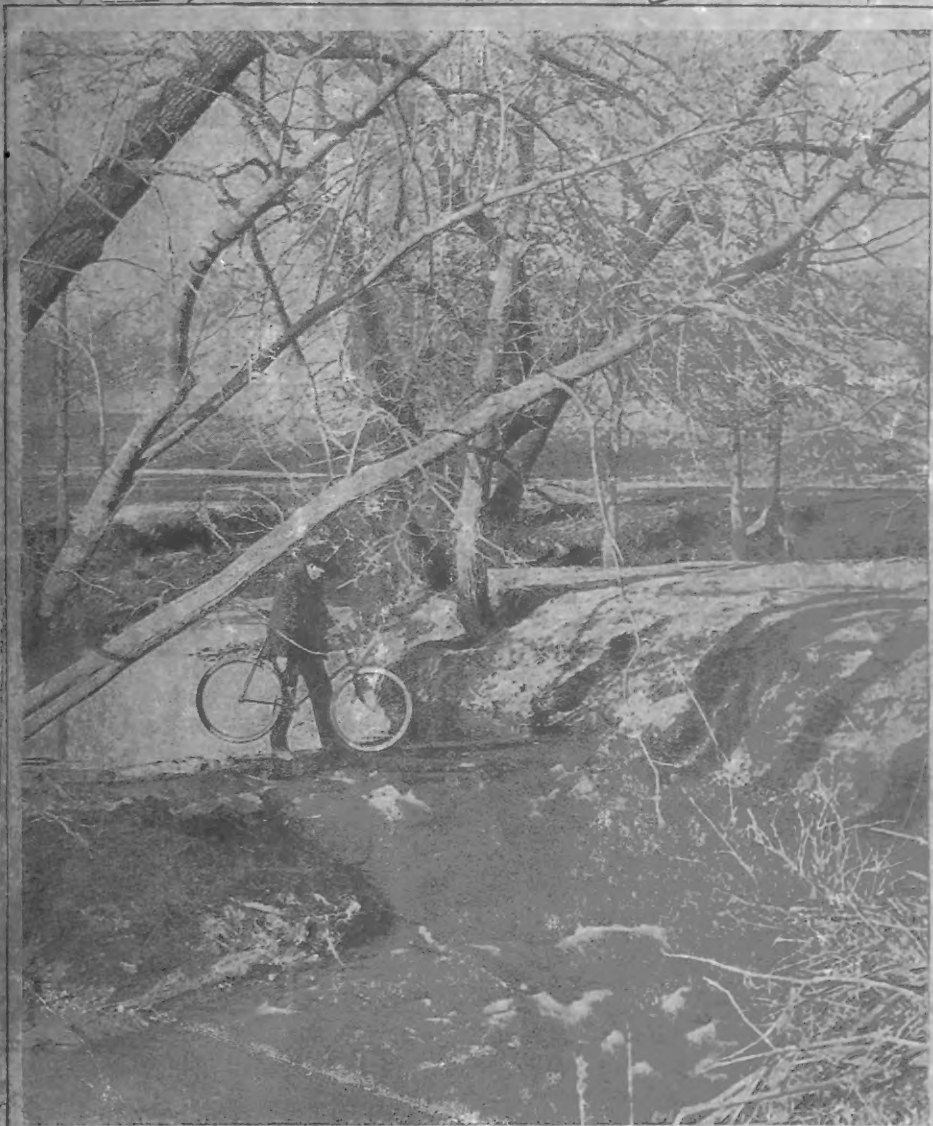

AMATEUR PHOTO. BY ROBERT WALSTROM.

WANTED: A GOOD BRIDGE.

Awarded 21st Prize in RECREATION'S 2d Annual Photographic Competition.

PUBLISHED BY G. O. SHIELDS (COQUINA)
19 WEST 24TH ST. NEW YORK





FOR...
Long
Range
Targets



Big
Game
Hunting



Black
Powder
Ranges



Schuetzen
Target
Ranges



Small
Game
Hunting



Short
Range
Use

One Savage Rifle

TAKES ALL THESE
DIFFERENT
CARTRIDGES

Write for our new Catalogue

.303

Savage Repeating
Arms Co.

UTICA, N. Y.
U. S. A.

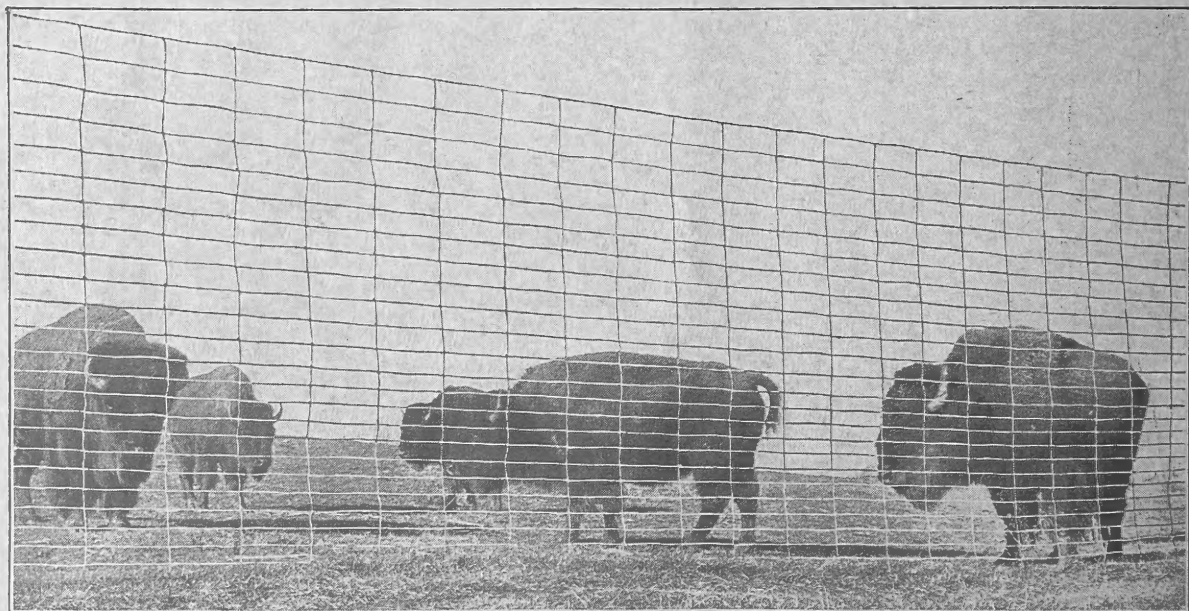

STOP THE GAME!!! KILL THE UMPIRE?

NO!

Simply build a PAGE FENCE around the premises and you've got 'em. No obstruction to the view. Holds Buffalo, Deer, Elk, anything.

Write for Particulars....

PAGE WOVEN WIRE FENCE CO.

ADRIAN, MICH.

RECREATION

Copyright, December, 1896, by G. O. Shields

A Monthly Magazine Devoted to Everything the Name Implies

\$1.00 A YEAR.
10 CENTS A COPY.

G. O. SHIELDS (COQUINA),
Editor and Manager.

19 WEST 24TH STREET,
NEW YORK.

CONTENTS OF THIS NUMBER

	PAGE
"He Threw the Dog about Ten Feet in the Air" Frontispiece	BERT CASSIDY
Will a Dog Bay a Moose? Illustrated	ED. H. TRAFTON 409
"Too Bad." (Poem).....	YELLOW HAMMER 410
A Remarkable Landscape. Illustrated. See page 412	RAMBLER 413
A New Species of Mountain Sheep. Illustrated.....	DR. J. A. ALLEN 413
The Nest of the Brown Thrush. Illustrated.....	ANGUS GAINES 420
The Origin of Negro Minstrelsy. Illustrated.....	VAUGHAN KESTER 423
The Army Pack Train Service. Illustrated.....	J. A. BRECKONS 426
Wild Turkey Shooting. Illustrated.....	CAPT. C. J. CRANE, U. S. A. 431
The Prairie Dog at Home. Illustrated.....	GEO. G. CANTWELL 433
The Sheep Eater Campaign. Illustrated.....	LT. C. B. HARDIN, U. S. A. 436
The Sheep Eater Campaign	MAJOR T. E. WILCOX, U. S. A. 441
"Lil' Joe." (Poem). Illustrated.....	GEO. W. STEVENS 443
Camp Fire Tales.....	J. LOEFERIC 445
A Wedding Tour in the Rockies	MRS. IRA. DODGE 448
A Day with Quinault Trout	F. J. CHURCH 451
The Strategy of Two Anglers.....	GARDNER C. TEALL 453
"Whiskers".....	JAS. WEIR, JR., M. D. 454
"Recreation" (Poem).....	SAM. LEVEL CROFOOT 455
A Quail Hunt in the Indian Territory	LEVI LUIGO 456
From the Game Fields.....	465 Bicycling..... 480
Fish and Fishing.....	468 Amateur Photography..... 485
Guns and Ammunition	472 Publisher's Department..... 498
Natural History.....	476 Puzzle Page..... 500
Editor's Corner.....	479

Entered as Second-Class Matter at New York Post-Office, Oct, 17, 1894.

Hon. Thomas Marshall

Mayor of Keithsburg, Ill.

25

STRAIGHT



WINNER OF

Grand American Handicap

March 24, 1897



Used DU PONT
SMOKELESS POWDER

E. I. Du Pont De Nemours & Co., WILMINGTON, DEL.

THE ❁❁❁
 MARLIN ❁❁
 FIRE ARMS ❁
 GO. ❁❁❁
 NEW HAVEN,
 CONN. ❁❁❁



A Good Repeating Rifle

for everyday use is the Marlin Model, 1892, 32 calibre. For ordinary hunting, where a 22 calibre is a little too light, this rifle will be found thoroughly satisfactory. For shooting at a mark and for general practice it is just the thing. The ammunition costs but little and so you can shoot all day long either the  without finding the sport  or the  expensive.



you can use these two 



All four in one and the same arm. No alteration necessary, except to change the firing pin from rim fire to centre fire, and vice versa. This can be done without using a single tool. **THIS IS THE ONLY REPEATING RIFLE** made to take rim-fire cartridges larger than 22 calibre. This rifle can be taken apart without using a single tool.



THE MARLIN FIRE ARMS CO.
 NEW HAVEN, CONN.

IT STICKS TO METAL

We Guarantee Marlin Rust-Repeller

to be an absolute Rust Preventive and
a perfect lubricant.



(Exact size of 1½ ounce tube)

It is clean and we know of no preparation of which such a
small quantity will do so much work.

It is the best lubricant for

Bicycle Chains
and Bearings

as it is easy and clean to apply

{ Never gums
Never drips
Never grows rancid

Put up in	{	1½ ounce collapsible tubes	15c.
		3 ounce collapsible tubes	25c.
		1 pound cans	75c.

Put up only by THE MARLIN FIRE ARMS CO.
NEW HAVEN, CONN.

GAS ENGINE & POWER CO.

and CHARLES L. SEABURY & CO., Builders of

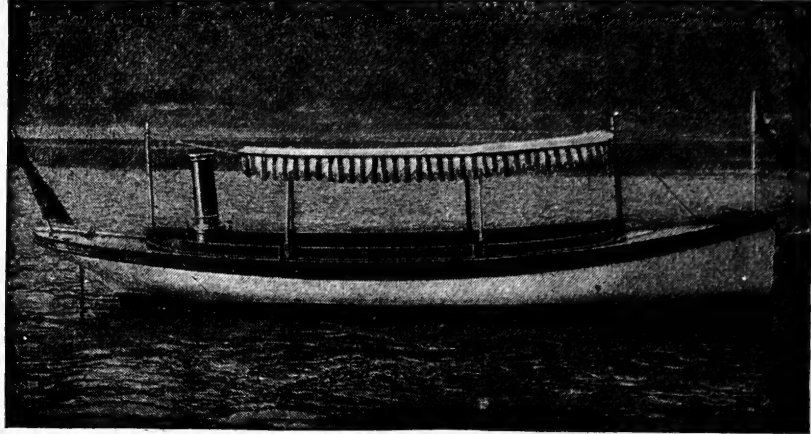

The Only Naphtha ...Launch...

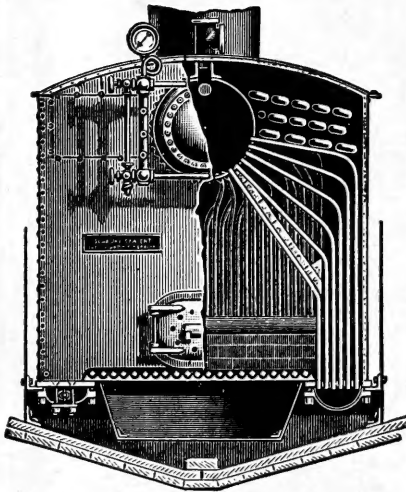

Our Patent Tubulous Boiler
for Steam Yachts

High-class Steam Yachts
Sail Yachts
Electric Launches
Dinghys
Gigs and Yacht Tenders
Seabury's Water Tube Boilers
Marine Engines

Storage Basin and Ship's ways. Overhauling of
all kinds promptly done. Charters and Insurance.
Boats bought and sold on commission

CORRESPONDENCE
SOLICITED

Send ten cents in stamps for catalogues to downtown office,
50 BROADWAY, or to factory at

MORRIS HEIGHTS, New York City

A Novel Educational Competition

COMBINES PLEASURE WITH INFORMATION AND MENTAL TRAINING

The Century Co. announces an educational competition which will arouse very general interest. Three examination papers, of fifty questions each, have been prepared; the competitors have a month to answer each set. The prizes are: \$500 for the best answer, \$100 for the second best, \$50 for the third, two of \$25 each for the fourth and fifth, and thirty of \$10 each for the next thirty in order of merit; also a further and special prize of \$500.

THE QUESTIONS impart knowledge and lead to a habit of investigation that will be of value through life. If you gain first prize, the knowledge you have acquired will be worth more to you than the \$500 you receive. But whether you win that prize or not, you learn to concentrate your mind, sharpen your wits, and secure most valuable information.

Do not cease your education when you leave school or college; keep on learning. Horace Greeley said of Lincoln that his success lay largely in the fact that he acquired new knowledge daily and therefore broadened. Get the information that is in these questions. They are not school-book kind; they deal with facts that men, women, boys and girls ought to know. No university extension lectures can help you as these questions do, because the lectures deal with theoretical knowledge, these questions with practical knowledge.

Dumb-bells and bicycles may be equally useful in physical development, yet a thousand persons ride

their wheels for one that uses dumb-bells. The reason is perfectly evident. Bicycle riding combines pleasure with exercise; the use of dumb-bells is drudgery. So with these questions; they combine pleasure with mental exercise. You cannot start work on the first one without continuing on to the last, and when you finish them you are repaid a hundred fold.

An analysis of the questions shows that they deal with a very large number of different points. That is, in answering fifty questions you investigate fifty subjects and touch upon hundreds of others. History and literature, the Bible and Homer, travel, machinery and law, operas and music, Shakspeare and Scott, Paris and Boston, art and architecture, earthquakes and the heavens, cards and the stage, Napoleon and the North American Indians, the Amazon and the Mississippi, questions of home and of business—all these and a multitude of others are included. Thus, in addition to the pleasure and the mental training, comes the new knowledge that will broaden you as Greeley said it broadened Lincoln. On request, we will forward you sample questions and full particulars of the competition.

If you do not possess a set of The Century Dictionary and Cyclopaedia, address us and we will send your name to one of the few clubs that are now being formed, each member of which secures a set at a reduction of over 40 per cent. and has the privilege of paying for it in small monthly payments.

THE CENTURY CO. (Dept. Kx) New York

Pleasure and Education Combined

University Extension Surpassed

\$500 First Prize

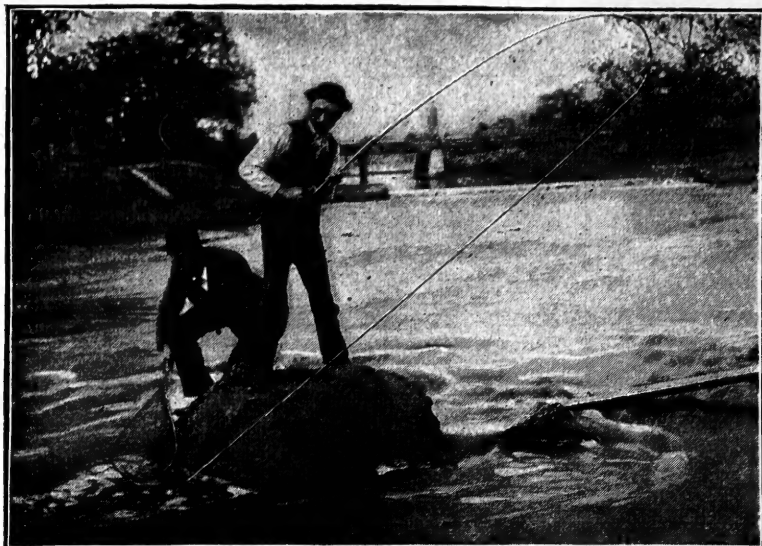

A Critical Moment



There is.....

**GOOD
FISHING**

ALONG THE

PICTURESQUE ERIE

Let Us
Suggest.....



The Delaware River

For Salmon, Bass and
Wall-Eyed Pike

Greenwood Lake

For Bass, Pike and
Pickerel

and the hundreds of trout
streams and lakes men-
tioned in our little book
on fishing, which will be
mailed on application



D. I. ROBERT'S

Gen'l Passenger Agt.
21 Cortlandt St., New York

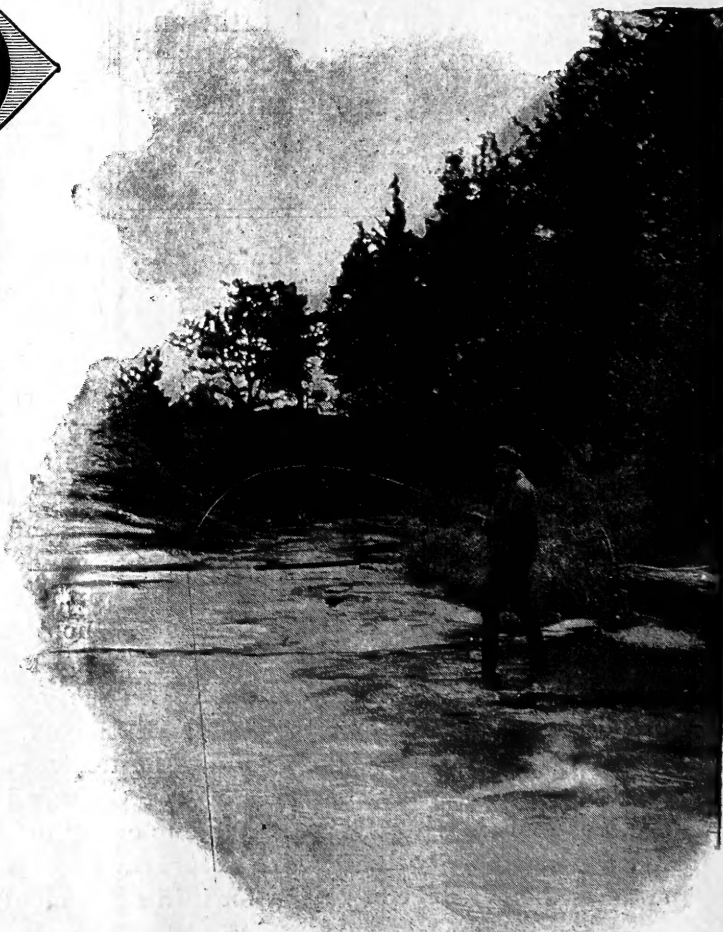

Fishing on the Picturesque Erie

THE REGAL

Canvas Oxford.

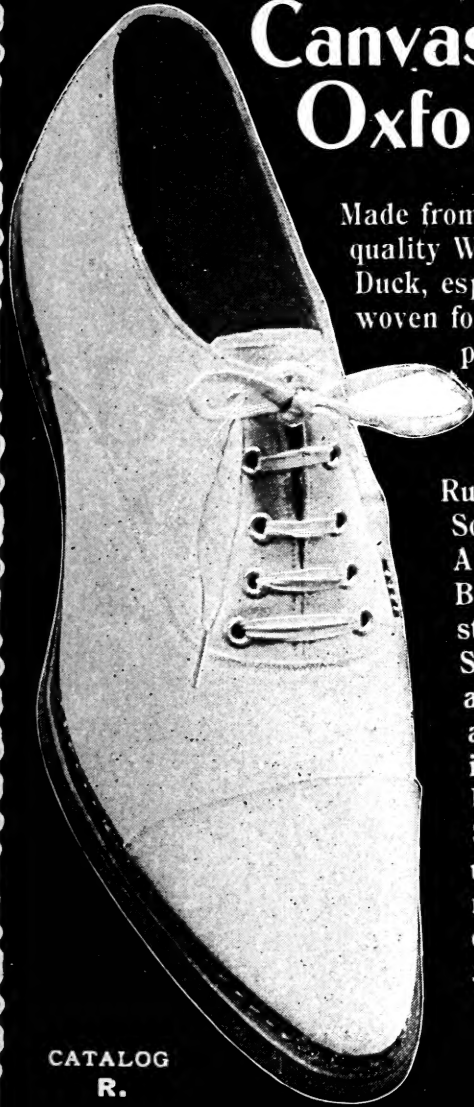

Made from best quality White Duck, especially woven for the purpose. With best quality Rubber Soles. Also in Bal. styles. Sent to any address in United States upon receipt of \$3.75.

CATALOG R.

\$3.50

L. C. BLISS & CO.,

MAIL ORDER DEPARTMENT:
109 SUMMER STREET, BOSTON.

PROVIDENCE. WASHINGTON. DENVER, COL.
NEW YORK. PITTSBURG, PA. CLEVELAND.
BROOKLYN. BALTIMORE. CHICAGO.
DETROIT.

Factory at Whitman, Mass.

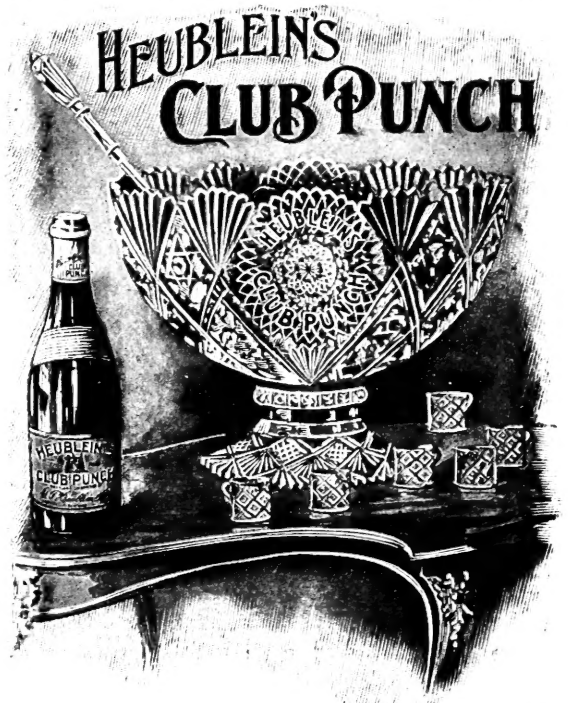

As Delightful to Drink as it's easy to make.

Fill bowl with ice, pour contents of bottle over same—it's ready for use. For a delicious Claret Cup, add one pint of good Claret to one quart of Club Punch. Fruits in season may be added. For an afternoon tea, evening party, yacht or picnic, it makes entertaining easy. For sale by dealers. Prepared and guaranteed by **G. F. HEUBLEIN & BRO., Hartford, Conn., New York, London**

A GREAT OFFER BY GERMANIA WINE CELLARS

HAMMONDSPORT and RHEIMS, N. Y.



In order to introduce our goods we make the following offer, good for the next thirty days only. Upon receipt of \$5.00 we will send to any sportsman or reader of RECREATION one case of our goods containing eleven bottles of wine and one bottle of our extra fine double-distilled Grape Brandy, all first class and put up in elegant style, assorted, as follows:

- 1 Quart Bottle Grand Imperial Sec Champagne
- 1 Quart Bottle Delaware
- 1 " " Riesling
- 1 " " Tokay
- 1 " " Sweet Catawba
- 1 " " Sherry
- 1 " " Elvira
- 1 " " Niagara
- 1 " " Angellia
- 1 " " Port
- 1 " " Sweet Isabella
- 1 " " Imperial Grape Brandy

This offer is made mainly to introduce our Grand Imperial Sec Champagne and our fine double-distilled Grape Brandy, without which no Sportsman or Hunter should start on an expedition, as it is very necessary where such exercise is taken. This case of goods is offered at about one-half its actual cost and it will please us if our friends and patrons will take advantage of this and help us introduce our goods.



Williams' Shaving Soaps

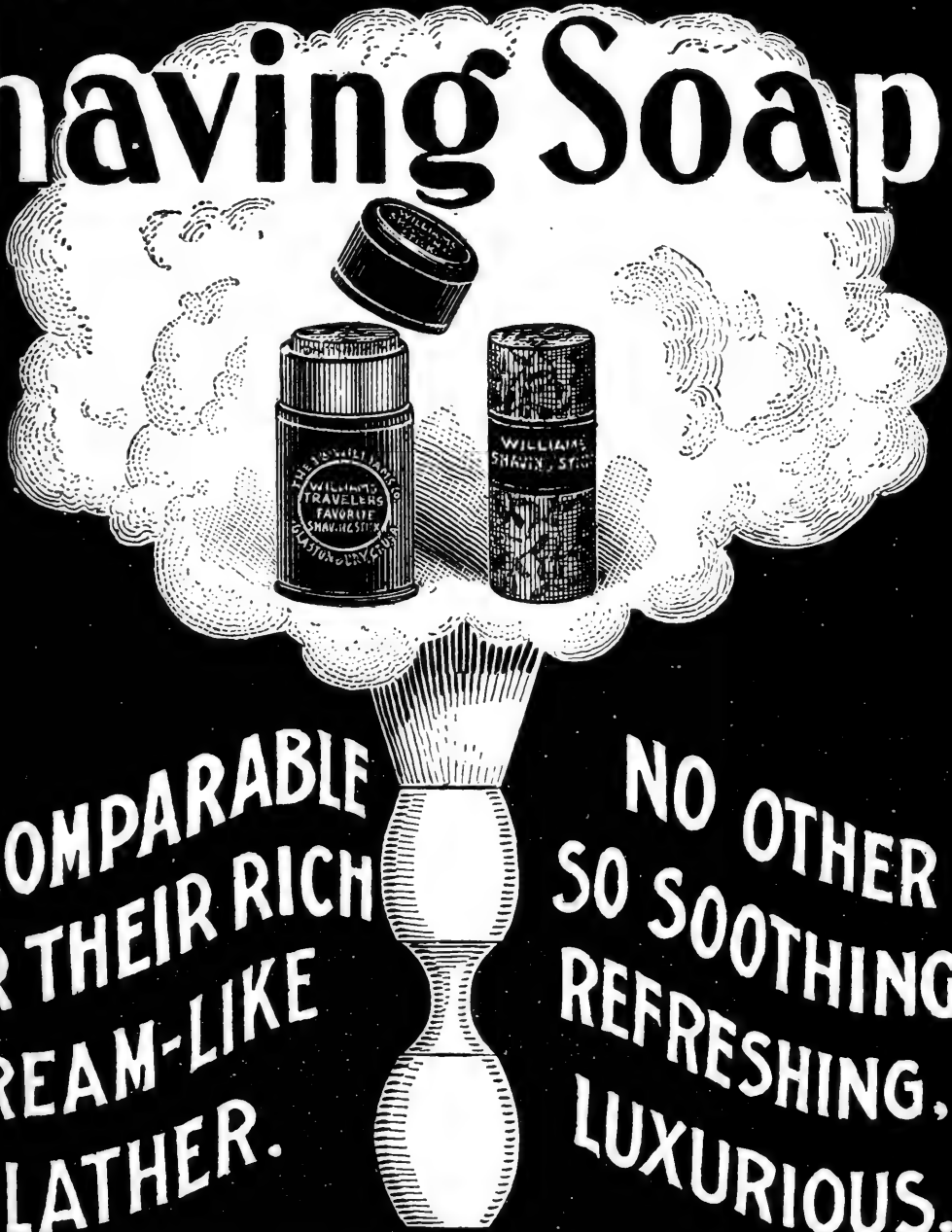

**INCOMPARABLE
FOR THEIR RICH
CREAM-LIKE
LATHER.**

**NO OTHER
SO SOOTHING
REFRESHING,
LUXURIOUS.**

WILLIAMS' SOAPS—in principal forms—sold by Dealers everywhere.



Luxury Shaving Tablet
25 cents.
Round—just fits the cup. Delicate perfume.



"Genuine Yankee" Soap
10 cents.
Oldest and most famous cake of shaving soap in the world.

Williams' Shaving Stick
25 cents



Williams' Shaving Soap
(Barbers')



This is the kind your barber should use.
Exquisite also for Toilet and Bath. Used in thousands of the best families.
Sure cure for "chapped hands."
6 cakes in a package—40 cts.
Trial sample for 2 cent stamp.

NOTE—If your dealer fails to supply you—we mail these soaps to any address—postpaid—on receipt of price.

Address **The J. B. Williams Co. Glastonbury, Ct. U.S.A.**

LONDON: 84 GREAT RUSSELL ST., N. W. SIDNEY: 161 CLARENCE ST.



Dyspepsia and Indigestion.....

There are times when the brain draws so upon our vitality that we cannot digest our food, we can get no strength from what we eat. If we let this go on, we sow the seeds of weakness which will blossom in disease. Read this letter about

**PABST MALT EXTRACT
The "Best" Tonic.**

If you are a brain worker, a woman with household worries and cares, or if you need physical strength to fight the battles of life,

act at once.



"I cannot be too grateful for the immense improvement PABST MALT EXTRACT, the "Best" Tonic, has made in my system. Two years ago I was a dyspeptic wreck of fifty, but PABST MALT EXTRACT, The "Best" Tonic, has changed all that. It has not only cured my dyspepsia, but it has braced my nerves and cured me completely of insomnia. I consider that it has saved my life. It has changed a nervous, broken down wreck of fifty-two to a strong, fresh young man of forty. When my daughter was recovering from typhoid fever, she gained nearly a pound a day for three weeks, solely by the liberal use of your decidedly "Best" Tonic.

JOHN D. HOMER, Haywards, Cal.

**ASK FOR
"PABST"**

**PERFECTION
IN BREWING
IS REACHED
IN AMERICA**

**THE FIRST
INAUGURATION**

BINNER CHICAGO

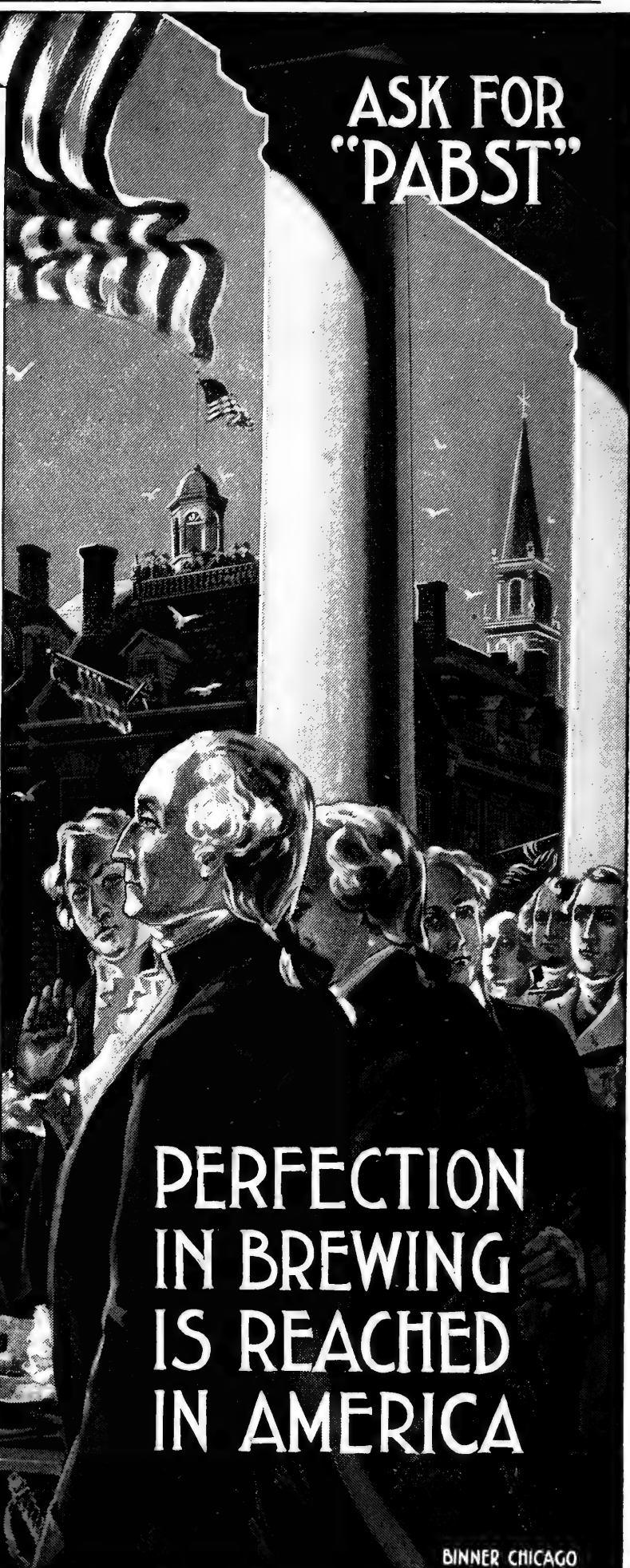

Souvenir of Grant's Tomb, FREE

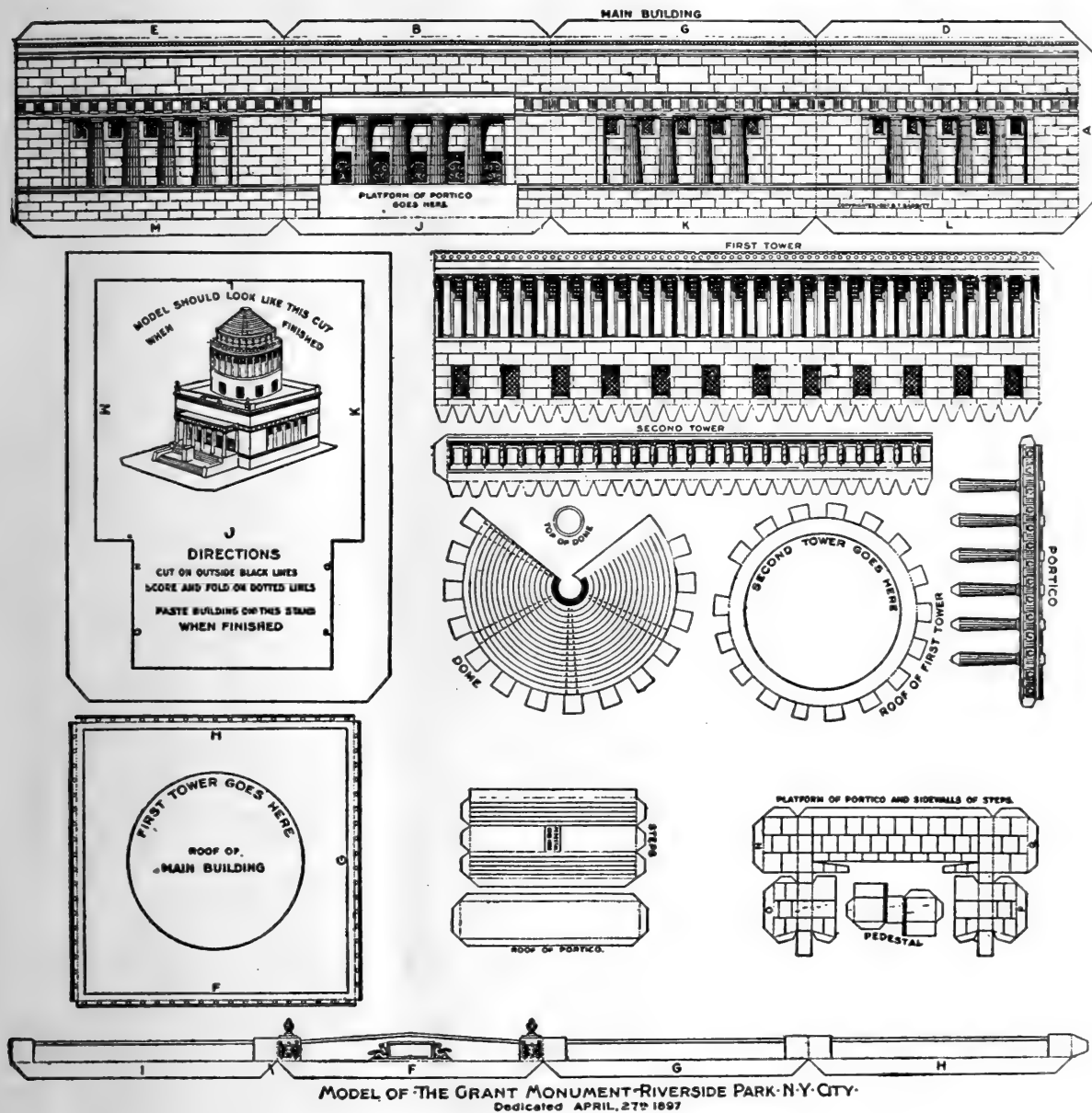

The above is a miniature reproduction of a cardboard model of Grant's Monument, size 10x15 inches, which will be sent **FREE** to any reader of RECREATION, by **B. T. Babbitt**, manufacturer of

B. T. Babbitt's Best Soap

B. T. Babbitt's 1776 Soap Powder, and

B. T. Babbitt's Best Baking Powder

upon receipt of 5 Best Soap Wrapper Trade-Marks or 5 1776 Soap Powder Trade-Marks. Be particular to use only the following address :

" Dept. LA," P. O. Box 2,917, New York City

President McKinley

WROTE A FRIEND

“ . . . Last summer I took a trip from Cleveland to Duluth on the ‘Northwest,’ and never did I have a more enjoyable vacation. The scenery is superb and the vessel a veritable floating palace. . . .”

W. McKinley

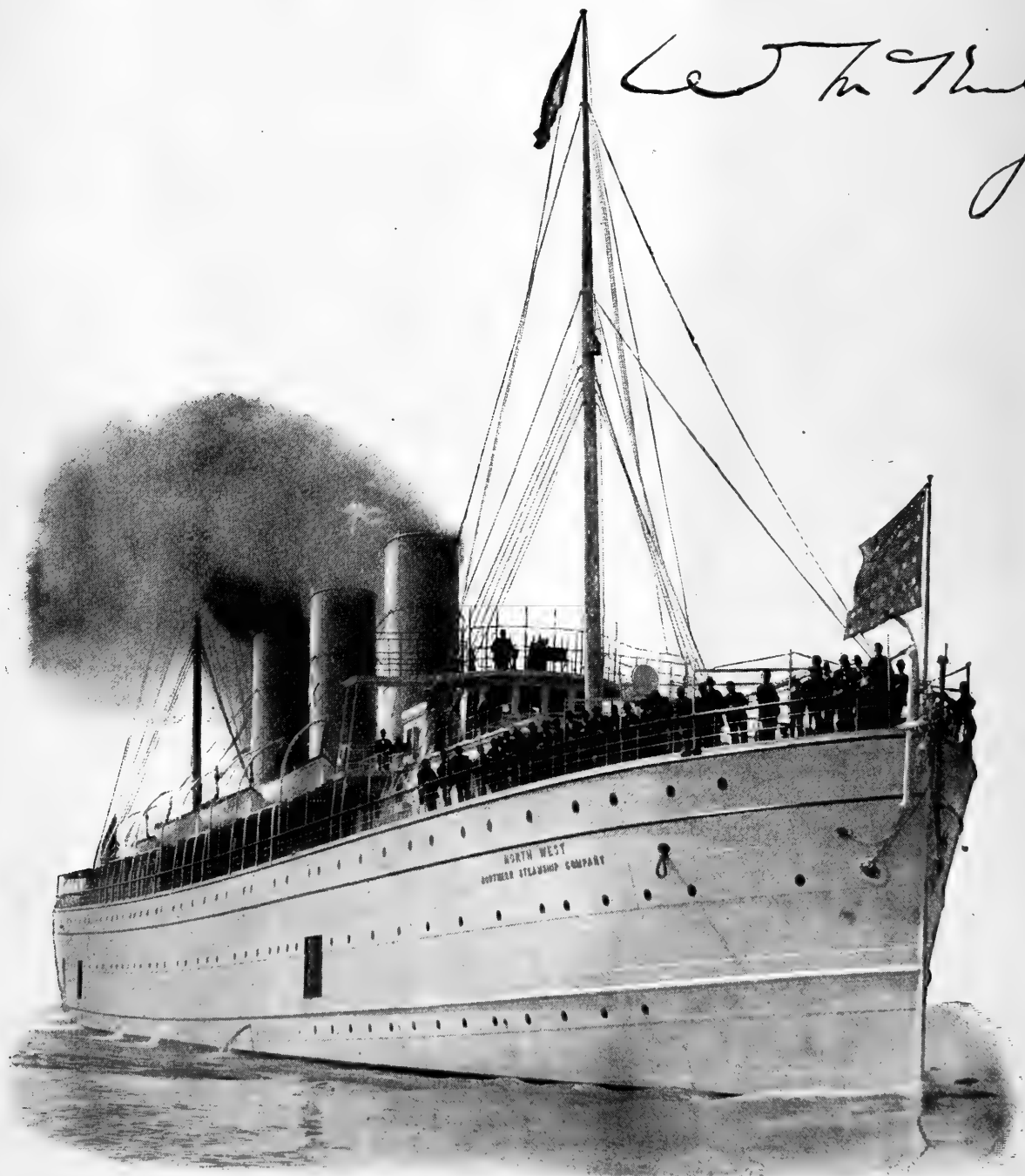

The above was written by President McKinley after a trip on the Northern Steamship Company's Line. For particulars of this line see page opposite.

"On Summer Seas"

What Makes the Tour of the Great Lakes so Incomparably Delightful

ITS NOVELTY—Combining scope of ocean travel with interest of a river trip—vastness and detail, sea views and landscapes—as by no other route.

ITS EXTENT—Two thousand miles in seven restful summer days—an ideal vacation for the weary brain or tired body.

ITS STEAMSHIPS—The Northern Steamship Company's steel twin-screw "NORTHWEST" and "NORTHLAND," each 386 feet in length, 5,000 tons, 7,000 horsepower—with ample accommodations for 500 passengers—unsurpassed in construction and equipment by anything that floats.

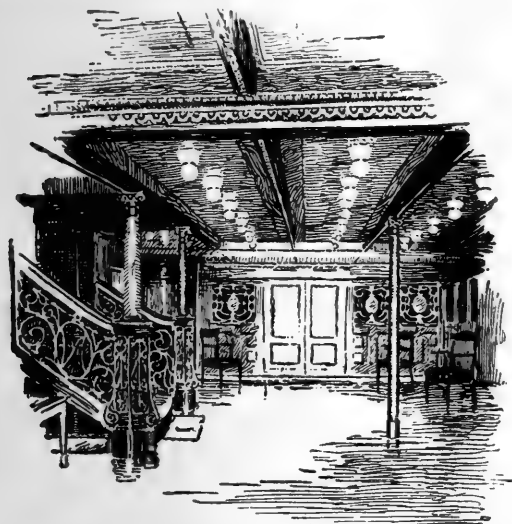

THEIR SPEED—That of the fastest ocean cruisers.

FOR PASSENGERS ONLY—No freight is carried—every conflicting interest sacrificed to safety, convenience, and enjoyment.

LUXURIOUS OUTFIT—Suites of rooms (including bath) rivaling in appointment those of the most celebrated metropolitan hotels—every element of service above reproach—superbly decorated and furnished saloons and cabins.

CUISINE—The perfection of gastronomic art applied to choicest and freshest products of land and sea—a revelation made doubly welcome by the always appetizing atmosphere.

A LA CARTE—Meals served on the European plan, at moderate prices, enabling passengers, especially when there are two or more in a party, to live economically as well as bountifully.

For Particulars Address

I. M. BORTLE, Gen'l Pass. Agent Northern Steamship Co.

W. C. FARRINGTON, Vice-President, Buffalo, N. Y.

PLACES VISITED—Buffalo, the Electric city of the Empire State—Cleveland, Queen city of the lakes—Detroit, metropolis of Michigan—historic Mackinac—Sault Ste. Marie, "the Soo," with its enormous locks, the largest in the world—Duluth, the Zenith city immortalized by Proctor Knott, and its lake-side twin, Superior.

STOP - OVER PRIVILEGES—While at most of these places time is given for a brief but satisfying carriage drive, stop-over checks are issued, good for the entire season.

SALMON AND TROUT FISHING unsurpassed anywhere, is to be enjoyed at the head of Lake Superior. Steam and Naphtha Launches for pleasure parties can be had at moderate rates.

NATURAL WONDERS, great triumphs of engineering skill, innumerable islands with their summer hotels and cottages, sleepy old Canadian towns with quaint peculiarities, Indian reservations, ancient trading posts and hunting grounds, modern mines and fisheries, the Painted Rocks and other relics of a bygone race—and always round about the varied shipping of the lakes, and over all the panorama of the Northern sky.

IT IS NOT SURPRISING that President McKinley (see opposite page) found such a trip so entirely enjoyable.



FURTHER WEST—At Duluth direct connection is made with the Great Northern Railway, and the Northern Pacific Railway to St. Paul, Minneapolis, KOOTENAI mining districts, Yellowstone Park, and the Pacific Coast.

\$25.00

Chicago to California

Is the rate that will be made by the

Santa Fé Route

for the Christian Endeavor Convention in July. It will also apply to intermediate points and in the reverse direction.

Have you wished to visit the **SOUTHWEST**; the remarkable health resorts; the irrigated farms and orchards; the new mining camps now attracting a multitude of gold-seekers; the homes of the prehistoric cliff-dwellers and the ancient villages of the Pueblo Indians; the towering Rockies; the stupendous chasm of the Grand Cañon of the Colorado River; the far-famed marvels of mountain and valley on that western shore where the blue Pacific rolls? Then take this opportunity.

You may learn all about it by addressing any agent of the Santa Fé Route, or the undersigned.

W. J. BLACK

G. P. A., A. T. & S. F. R'y

Room 136, 9th and Jackson Streets
TOPEKA, KAN.

C. A. HIGGINS

A. G. P. A.

Room 1336, Great Northern Building
CHICAGO

GOOD LOOKS . . .

How every one can be
made good looking



**Painless, Plastic Surgery Removes Wrinkles
::: and All Kinds of Facial Blemishes :::**



IF you have a birth-mark on your face or body, John H. Woodbury can take it off—no question about that, for you can see with your two eyes it's gone—and he can do it so skilfully that in a few weeks you'll be unable to find the spot where it was. No faith is necessary to get your nose straightened, for it is accomplished while you look right at the operation.

THE · CHART · OF · THE · NECKLESS · FACE

Explains a Few Operations

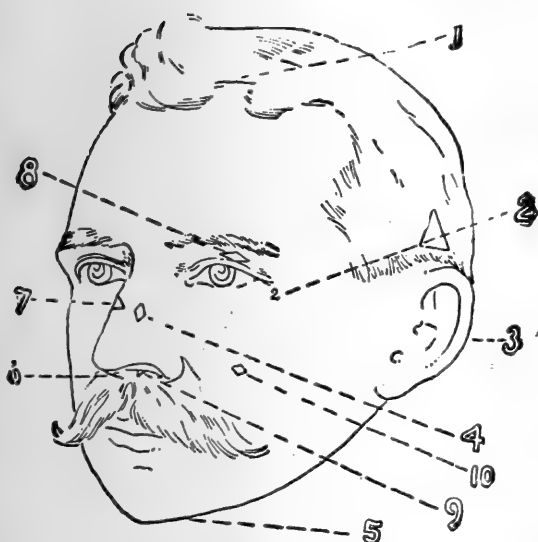

- No. 1.**—Removes wrinkles from the forehead.
- No. 2.**—Removes crow's-feet and wrinkles from beneath the eyes or around the nose.
- No. 3.**—Causes an extended ear to set closer to the head.
- No. 4.**—Is the inner operation in the nose, for catarrh ; for removing cartilage or flesh.
- No. 5.**—Reduces the bagginess which causes a double chin.
- No. 6.**—Reduces a projecting nostril partition.
- No. 7.**—Removes the humps from the nose.
- No. 8.**—Removes the slack from drooping eye-lids.
- No. 9.**—Straightens a crooked or ill-shaped nose-wall.
- No. 10.**—Produces a dimple in the cheek.

Painless Plastic Surgical Operations that make people 10 to 20 years younger looking ; also operations for the correction of projecting or ill-shaped ears, noses, and all Facial Deformities. Superfluous hair is removed with the absolute assurance that it will not return. Moles, Warts, Red Veins, etc., are quickly removed, without pain or leaving any disfigurement. Freckles, Pimples, Blackheads, and all discolorations are made to disappear in a remarkably short time at little expense. Eczema, Sycosis, Psoriasis, and all diseases of the Skin, are successfully cured by methods tested in thousands of cases. Special attention is given to the care of the complexion, the modern treatment of wrinkles, and thin, fat, or flabby faces. We also treat all diseases of the hair and scalp, eruptions, dandruff, loss of hair, etc. Persons having any imperfections or disease on, in, or under the skin, any irregularity of the nose, ears, or mouth should call and see the specialists at the

JOHN H. WOODBURY DERMATOLOGICAL INSTITUTE

Offices for the Cure of Skin and Nervous Diseases and the Removal of Facial Blemishes

New York, 127 W. 42d St.

Boston, 11 Winter St.

Philadelphia, 1306 Walnut St.

Chicago, 163 State St.

A sample of either Woodbury's Facial Soap or Woodbury's Facial Cream, with illustrated book on treatment of the skin, nervous and blood diseases, forwarded by mail on receipt of 10 cents in stamps. A large static electrical machine at each office for the treatment of Nervous Diseases, Rheumatism, etc. There is no shock or disrobing, the effect is pleasant, soothing and beneficial.

Address all letters to 127 West 42d Street, New York



THE VICTOR

OFFICIAL LEAGUE BALL

is recognized far and wide as the best league ball that money can buy

Why not
Use the
Best?

It is the only ball that conforms exactly to the specifications of the National League

It is always uniform in size and shape

It will outwear any other league ball

It is honestly made of the finest materials only

We make a specialty of Team Outfits—
Uniforms, Bats, Mitts, and Gloves

OVERMAN WHEEL CO.

Makers of Victor Bicycles and Athletic Goods

New York

Boston

Chicago

Detroit

Denver

Pacific Coast: San Francisco

Portland



Bert Cassidy
97

"HE THREW THE DOG ABOUT TEN FEET IN THE AIR."

RECREATION.

Volume VI.

JUNE, 1897.

Number 6.

G. O. SHIELDS (COQUINA), Editor and Manager.

WILL A DOG BAY A MOOSE?

ED. H. TRAFTON.

In a recent number of RECREATION I saw an inquiry about hunting moose with dogs. When I first came to the Teton Basin, 15 years ago, there were a great many moose in this country, as well as other game. During the first winter I spent here another trapper and I estimated there were about 150 head of moose in the big swamp on the river, within an area of 15 miles long by 3 wide. I had a small black dog, which we called a collie. Some of these dogs are bobtailed, and some have no tail—only a tuft of hair.* They are natural born heelers; that is, when they attack an animal, they always bite at the heel. In my experience this is the only breed of dog that can stand up a big bear, single handed, and hold him until the hunter can come up.

I had trained this dog to hunt elk. He would stop a big bull just as quick as he got to him and would hold him until I came up to within 10 or 15 yards. Then I would throw sticks or stones at the elk, and see the dog work on him. Every time the elk would make a break to run, the dog would have him by the heel; until finally the elk would get sulky and refuse to budge. It was impossible for any kind of game he could catch, to get away from him. They either could not, or would not, stand the punishment he could inflict on their heels.

The first opportunity I had to see this dog work on a moose was one day

when I was snow-shoeing up the river, through the swamp. There were lots of fresh signs and I knew I should jump a moose before I went far. I also knew I should see some fun when Bob, my dog, tackled him. I was shoving the long skis easily over the snow, and just as I slid out into a little park, bordered by thick willows, there stood a big bull moose, not more than 15 feet from me. I stopped dead still and the old bull swung his big head around toward me. I saw his eyes turn green, and the hair on his head, between his ears, rise up like a cat's tail when a strange dog comes around.

Then I felt myself getting kind of dizzy under the hat, as if I had been smoking a strong pipe too much. The next thing I knew, I heard Bob give voice, and knew I was safe. I looked in the direction the noise came from, and thanked my lucky stars that Bob appeared on the scene just as he did, for the old bull had him by the middle of the back, with his mouth, and it looked as if Bob's hide had stretched about 8 inches. Before I had time to do any more thinking, he threw the dog about 10 feet in the air, over his back.

I tell you right now, boys, I didn't hang around there to see what the next play was going to be. I just hollered, "Heel him, Bob," and slid for a bunch of willows. When I got behind these, I tore the snow-shoes off and jerked my revolver. I didn't know I had one before. Then I looked for Bob and the

* This was probably an "old English sheep dog" instead of a collie.—EDITOR.

moose, and I was not disappointed. The dog was the gamiest of the 2. He was cutting away on that moose's heels and was the maddest dog I ever saw. He was getting even with the old moose in great shape. The blood was running off the bull's hind legs, plenty.

I had gotten over that sickness, and thought I would help Bob torture the old brute a few minutes. Then I wanted to see if Bob could stop him if he tried to pull out. So I slipped out where the moose could see me, and fired a shot, which hit him in the nose. He bolted through the brush, but didn't get 40 yards till the dog stopped him. I followed and gave the moose another shot in the neck; but he just stood there and gritted his teeth and looked green eyed. Then he would make a plunge with his forefeet, at the dog, but Bob was not there. He was just behind Mr. Moose again, working on those hind legs. As soon as I saw he couldn't get away from the dog, and that Bob could stop a moose just as well as an elk, I gave the bull the finishing shot, and dressed him. Then I put on my snow-shoes and struck out up the river.

I had not gone 300 yards when I ran into 3 moose in a little opening. I put the dog after them, just to see what he would do, and they broke into a swinging trot, as if they intended to go somewhere; but the hind one was the first

the dog reached. I noticed he only went about 30 yards, when he stopped and whirled around to see what was the matter with his hind legs. He discovered they were bleeding, and no matter which way he jumped, or kicked or struck, that black, bobtailed dog was tickling his hind legs. I just imagined I could see green tears running out of that moose's eyes—he was so mad. I finally called the dog off, after the moose had raised a perfect cloud of steam from his exertions, in trying to escape from the dog.

These are only 2 of the many times I have seen my dog stop moose. He has stopped dozens of elk, mountain sheep, bear, and wounded deer; and I have the first time to see game get away from one of these bobtailed shepherd dogs.

I have 2 dogs now, half brothers to old Bob. I call them "Old Cub" and "The Pup." They are known all over Fremont and Bingham counties; and I have the first time to see an elk, or moose, or any animal they can catch, get away from them. The old dog is 10 and the pup is 5 years old, and I have killed a great many elk with them in the last 5 years. I have trained several dogs of this breed, with "Old Cub," and they all made good hunters. So there is no question as to a dog, that is a natural heeler, and trained, being able to stop a moose in any country.

TOO BAD.

YELLOW HAMMER.

Within a country home were born
Two blooming infants bright and fair;
It was a calm and quiet morn
And spring and sweetness filled the air.

It was for them the bright sun shone
Amid the green and fragrant trees,
For them the fragrance sweet is blown
Upon the balmy evening breeze.

They grow apace and yet it seems
That Nature's smile doth linger still;
They wander 'neath the sun's bright beams,
Amid the woodland, o'er the hill.

But they are grown and they must go
Into the city's sounding din,
Onward with measured tread and slow
Seeking their daily bread to win.

For them no more the humming bees
Within these walls—unhappy elves,
No more for them the rustling trees
For now they rustle for themselves.



AFTER THE HUNT.



AMATEUR PHOTOGRAPH BY GEO. M. LINCOLN.

A VIEW FROM PROSPECT ROCK, ADIRONDACKS.

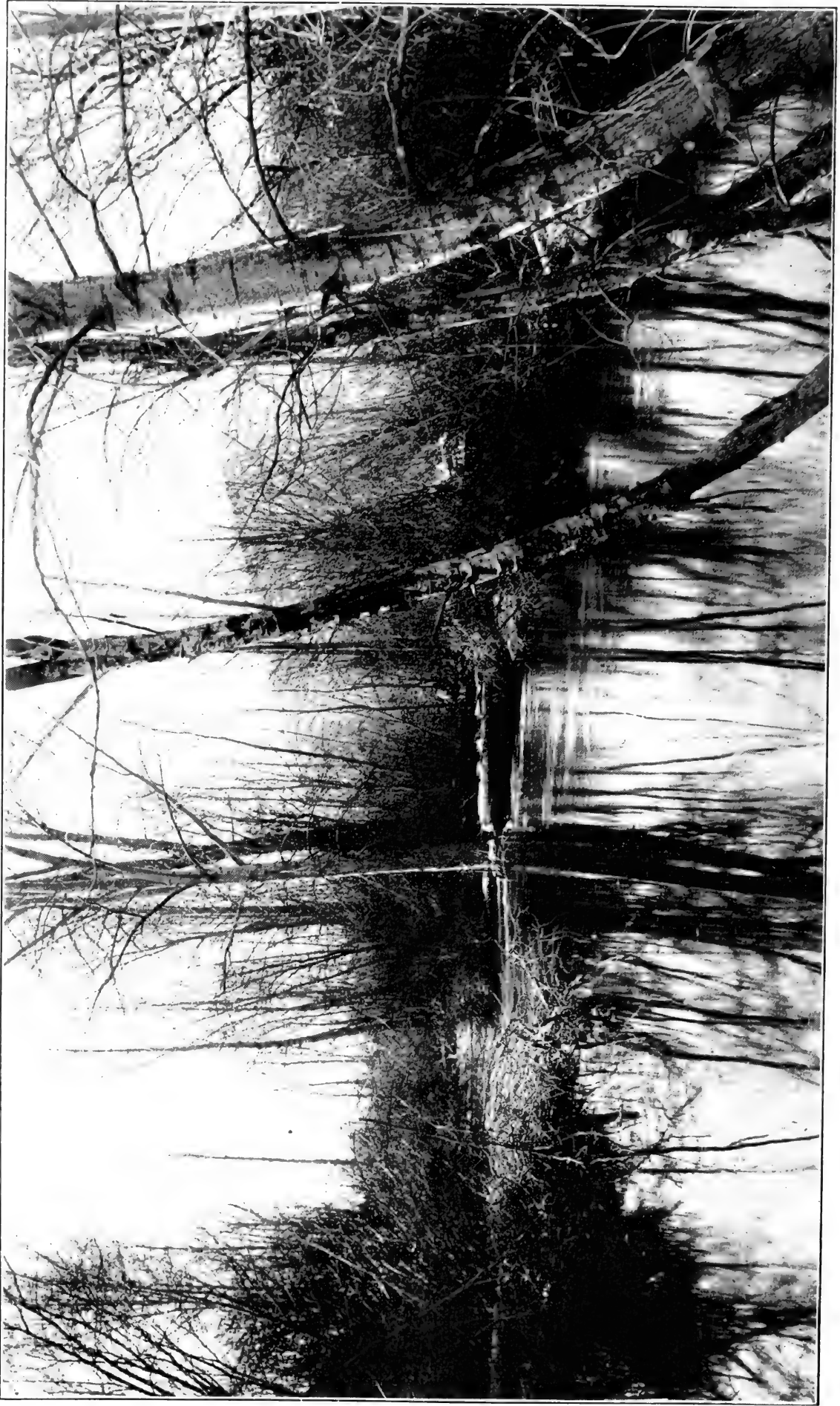

A BIT OF THE BITTER ROOT.

A REMARKABLE LANDSCAPE.

(See opposite page.)

Editor RECREATION: I enclose you photo of a bit of Western Autumn scenery—a charming nook in one of the narrow channels of the Bitter Root river—from which I have taken many a lusty trout, on the professor and the coachman. I used a Seed 26 x plate; a Turner-Reich lens, 43 stop, $\frac{3}{4}$ seconds, at 11 a.m. of a bright day; developing until the high lights are very dense; printing on Aristo-Platino, good and deep; toning, in the gold solution, to a medium sepia, and fixing in a hypo bath—1 oz. hypo to 24 oz. water—for 20 minutes. Thus I have a reproduction of my favorite trout pool, in almost its natural colors.

Rambler, Hamilton, Mont.

It is impossible to reproduce the wonder-

ful sepia tones in this photo, by any mechanical process; but the print is one of the most beautiful I have ever seen. The fine detail in the foliage, both in foreground and background—even in the outline of the distant mountain; the delicate lighting of the trees on one side; the sharp cutting of every feature in the shadows; the soft, hazy reflections in the water—all these combine to make this one of the most remarkable bits of landscape photography ever made. There are many delicate twigs shown here, some of which are scarcely larger than the lead in your pencil, yet they are all brought out with as great fidelity to Nature as are the trunks of the trees.

This is a phenomenal piece of work and Rambler may well feel proud of it.

EDITOR.

A NEW SPECIES OF MOUNTAIN SHEEP.

Dr. J. A. Allen, Curator of Mammalogy, in the American Museum of Natural History, New York, has issued, in bulletin form, the following preliminary description of the new species of mountain sheep, taken in Alaska and brought out by Mr. A. J. Stone, who is in charge of RECREATION'S Alaskan Exploring Expedition.

Through the kindness of Mr. A. J. Stone, of Missoula, Montana, the Museum has received 3 mounted specimens of a Mountain Sheep, or Bighorn, quite unlike any heretofore described. These were collected by Mr. Stone on the headwaters of the Stickeen river, British Northwest Territory, near the Alaskan boundary, at an altitude of about 6,500 feet. The species may be described as follows:

OVIS STONEI, sp. nov.

Male Adult.—Above gray, formed by an intimate mixture of whitish and blackish brown. Face, ears, and sides of neck lighter and more whitish, being much less varied with blackish brown. Whole posterior area and lower parts, from hinder part of back downward and forward, covering the posterior aspect of thighs and the abdomen, white; the white area narrowing anteriorly and terminating in a V-shaped point on the middle of the chest; also a broad sharply defined band of white on the posterior surface of both fore and hind legs, extending from the body to the hoofs, and proximally including also the inner surface. Front of neck, from base of lower jaw posteriorly to the white of the ventral surface, including the breast and greater part of the chest, and thence along the sides to the thighs, nearly black. The lateral extension along the flanks becomes narrower, posteriorly, and the neck is somewhat grizzled with white (see Pl. II.). Outer surface of both fore and hind legs blackish brown, either uniform or, in some specimens, varied with a slight mixture of whitish. Back of head with a broad area of black, narrowing posteriorly and continuing to the tail as a well-defined blackish dorsal stripe. Tail wholly deep black, except a few white hairs on the middle of its lower surface. A narrow blackish chin bar, varying in breadth and distinctness in different individuals; hoofs black; horns light brown.

Measurements (of type, ♂ ad.)—Measurements from mounted specimens (taken with a tapeline and following the curvatures of the parts measured). Tip of nose to base of tail, 1,676 mm.; tail vertebrae, 80; tail to end of hairs, 121; tip of nose to eye, 197; tip of nose to base of ear, 305; length of horn (over convexity), 762; distance between points of horns, 552; circumference of horn at base, 324; circumference of horn at middle, 216; circumference of front hoof at base, 190.

This species is based on 3 males, of the ages respectively of 2, 5 and 6 years.* The older specimen is taken as the type. On this the dark areas are blacker, and on some parts less varied with whitish tipped hairs than in the others, especially the 2-year-old.

This species differs from *Ovis dalli* in the prevailing coloration; being either dark gray or blackish brown, according to the area in question (see Pl. II.), instead of being "a nearly uniform dirty white color." In *O. stonei* the white is restricted to definite, sharply defined areas, in strong contrast with the adjoining parts. *O. stonei* and *O. dalli* apparently agree in size and in the character of the horns.

O. stonei agrees, in a general way, in pattern of coloration, with *O. cervina* (Desm.), but the "umber brown" or "wood-brown" of the latter is everywhere replaced in *O. stonei* with blackish brown or black. It is also a much smaller animal, and the horns are slenderer and have a more outward curvature at the tips.

The following table gives comparative measurements of 2 specimens of *O. dalli* (from True, in "Nelson's Report on Nat.

* These three specimens were exhibited in RECREATION'S booth at the Third Annual Sportsmen's Exposition and attracted marked attention from scientists and sportsmen alike. They were sent from the exposition to the American Museum of Natural History.—EDITOR.



OVIS STONEI.

BUL. A. M. N. H. PLATE II.

Hist. Coll. made in Alaska," 1887, p. 283), of 2 specimens of *O. stonoi* and of 2 specimens of *O. cervina*, from Montana, all from mounted adult male specimens, and therefore comparable.

	O. CERVINA. ¹	O. CERVINA. ²	O. STONEI. ²	O. STONEI. ²	O. DALLI. ¹	O. DALLI. ¹
Tip of nose to base of tail.	1,854	1,854	1,676	1,626	1,626	
Tip of nose to eye	229	228	197	194	178	
Tip of nose to base of ear.	330	340	305	318	292	
Length of horn over convexity	775	867	762	837	838	
Circumference of horn at base	444	400	324	330	293	
Circumference of hoof at base	267	205	190	190	211	

¹ From True, *l. c.*

² From specimens in Am. Mus. Nat. Hist.

Mr. Stone took measurements of the animals before skinning, but they are unfortunately not available at this writing. He also has separate skulls, which he will later forward for examination, when it will be possible to give some further particulars respecting this interesting species.

I am indebted to Mr. Stone, in whose honor the species is named, for the following observations:

"The 3 animals were killed in the Che-
on-nee Mountains, British Northwest Ter-
ritory. These mountains are a part of the
interior of the Coast Range, drained by the
headwaters of the Stickeen river, and not far
from Alaskan Territory.

"The timber line in this country extends
only to a height of about 2,500 feet, giving
the mountain ranges the appearance of be-
ing quite high, but in reality there are no
high mountains in this section of the Coast
Range.



PLATE III., FIG. 1.

"The 2 older specimens were taken August 10, about 5 miles from where the first were found and were the only ones in the bunch. I watched them an entire afternoon before killing them. They passed the time alternately nibbling at tiny bits of grass, occasionally seen peeping from crevices in the rocks, and playing or lying down on patches of snow and ice. They were very fat.

"Specimens taken 2 months later possessed the same markings, but were somewhat darker."

Mr. Stone is familiar with *Ovis dalli*, which he reports as occurring some 250 miles North of the locality where

"The only specimens of this Sheep I had an opportunity to study were the males, which I found, during the months of August and September, in the most rugged parts of the mountains, entirely above timber line. I often found them singly, and at no time did I discover more than 5 in one bunch; though one of my party reported having seen 11 together. I saw perhaps 50 head, and secured 12 specimens. I was careful in my study of these interesting animals, and found them uniformly marked, both in color and general characteristics.

"The youngest of the 3 now in the Museum, was secured Aug. 8, 1896, in a deep, rocky canyon just at the base of one of the highest peaks in this part of the mountains. At the time I discovered him he was alone, carefully making his way down the canyon, and from what I afterward learned I am inclined to believe he was then in quest of the ewes, lambs, and yearlings, in the edge of the timber, farther down the mountain side. It is likely he had not yet regularly taken up the company of the older rams.



PLATE III., FIG. 2.

he obtained the present examples of *O. stonei*.

DESCRIPTION OF PLATES II AND III.

PLATE II.—*Ovis stonei*, ♂ ad.

PLATE III.—Fig. 1, head of *Ovis stonei*, ♂ ad. (same specimen as figured in Pl. II.).

Fig. 2.—Head of *Ovis cervina*, ♂ ad., from Montana, for comparison with Fig. 1. The Montana specimen is probably somewhat older than the specimen of *Ovis stonei* shown in Fig. 1, but probably the difference in age is not great.

THERE ARE OTHER TRIMMINGS.

"What a beautiful, humane thought this birdless bonnet movement is?"

"Don't be so sure about its humanity. It is calculated to work the silk worm to death."

FRITZ.

I hand you herewith a photograph of the thoroughbred cocker-spaniel, "Fritz," owned by Joseph Boehrer, Viroqua, Wisconsin. He is not yet 2 years old, but is the pet of all the sportsmen who know him, owing to the fact that he possesses all the points of merit usually found in the blue-blooded cocker.



"FRITZ."

He is thoroughly trained in every respect, and is a natural and willing worker on ruffed grouse and woodcock, as well as a careful retriever on land or water. His excellent conduct in chicken shooting, last fall, surprised many of the local sportsmen.

He will "stand," and will do the other necessary work, in this respect, at the command of his master, whether given *viva voce*, or by whistle.

He will tree ruffed grouse to the queen's taste, and will tow the largest goose to shore, safe. Fritz is a jet black and is perfection itself in form and weight. He has the reputation of being the best general purpose dog ever brought to this city.

E. B. C., Viroqua, Wis.

LARGE MULE DEER HEADS.

I send you herewith the photo of 2 mule deer heads which I think the largest 2 and 3 point heads in America. The length of beam of the 2 point, is 22 inches; spread 22½ inches.



SPREAD, 22½ INCHES.



SPREAD, 31¼ INCHES.

The 3 point has a length of beam of 27½ inches, with the enormous spread of 31½ inches. Each head has a crown point on one horn, which is very uncommon with 2 and 3 point heads.

H. A. A., Laurin, Mont.



AMATEUR PHOTOGRAPH BY DR. G. T. PHILLIPS.

MOONLIGHT ON LAKE BOMOSEEN, VERMONT.

Enclosed please find a moonlight photo which I made in September, '95, at Lake Bomoseen, Vt.

I exposed the plate $\frac{1}{2}$ hour, at half past 9. By looking closely you will notice buildings on the opposite shore, about one mile away. The length of the moon shows the distance it traveled in 30 minutes.

The exposure was made on a number 50

Stanley dry plate, the camera being a Waterbury.

G. T. P., D.D.S., Rutland, Vt.

I send you by this mail a photo of 6 full blood English fox terrier puppies which I raised, and which we think are quite good ones. I hope to see them in RECREATION.

E. D. P., Auburn, N. Y.



FOX TERRIER PUPPIES.



NO. 3.—VIRGINIA DEER. WILD.

Editor RECREATION: Have you ever noticed the great difference in the expression, as shown in photographs, of live wild deer and of those in captivity? I send you herewith prints of 2 deer, taken in an enclosure; and of 2 others of wild deer, taken in the woods. The buck and the doe—Figs. 1 and 2—are tame deer, taken with my Turner-Reich lens, $\frac{1}{4}$ second exposure each.

The 2 does—Figs. 3 and 4—are of wild deer, taken when a heavy snow had driven them down into the Bitter Root valley. Both of these pictures were taken with a telephoto lens. No. 3 was some 60 yards from me and was given an exposure of 1 second, with open lens.

I have enlarged this negative to more than twice its original size. No. 4 is also enlarged slightly. You will notice the startled look on both of these does, caused by a whistle I had uttered to stop them; while with the tame deer no amount of noise, of any kind, caused any unusual attitude or expression.

I used Eastman's films, for these negatives, and for that of the live pine squirrel. The latter was taken at sunset with a telephoto lens, and is, I am afraid, too hopelessly undertimed for reproduction. I gave him 4 seconds, open lens, and should have prolonged exposure, but that I feared he



NO. 2.—MULE DEER. TAME.

would move, which, in fact, he did just as the shutter closed.

Rambler, Hamilton, Mont.



NO. 1.—A TAME BUCK.



NO. 4.—VIRGINIA DEER. WILD.

“What do you want to borrow my gun for? Are you going to shoot the first robin?”

“No; I’m going to shoot some men at our boarding house who are always making bets on him.”

Most tillers of the soil get in
 Their harvests in July;
 But florists reap their pile of tin
 As Easter passes by.

“Paddle your own canoe” may go
 When wintry winds are blowing;
 But summer girls should fix it so
 That men shall do the rowing.



PINE SQUIRREL.

Photograph made after sunset; 4 seconds, open lens.

THE NEST OF THE BROWN THRUSH.

ANGUS GAINES.

On the North side the creek would have found ample room to expand over the wide low bar of white sand that stretched out toward the willow thicket; but that was precisely the course which it did not choose to take. Creeping close by the high Southern bank, and half undermining the wildly tangled osage hedge, it made a final sharp turn, before losing itself in the Wabash, and spent its last strength in a dash against the high, wooded ridge.

usually I was the only human visitor. I have spent many a long summer day there, lying in the thick blue grass on the overhanging bank, or sitting on some great tree trunk that bridged the stream. Sometimes I would read, but more often I would watch the varied forms of life about me.

Harmless little snakes sported in the water or basked upon the low sand bars. Lazy turtles sunned themselves on stones and logs. In the long summer twilight I



NEST OF THE BROWN THRUSH.

On one side flashes of reflected sunlight, dancing fitfully through the dense tangle of willows, suggested the broad river beyond; but high banks, hedges and trees, in close semicircle, cut off the landward view and gave no hint of the proximity of traveled road or cultivated fields.

In this miniature wilderness nature reigned supreme. Strange birds, never seen in the fields and meadows near by, paused in their migratory flights and dropped down here as their ancestors had done before their domain was invaded by man. Truant schoolboys and juvenile sportsmen invaded the place at times, but

could see myriads of great waterbugs circling about on the surface of the stream, and muskrats frolicking on the banks or seeming to play tag in the water.

Every part of the day and night had a different attraction, and the sights and sounds also changed with the weather. On fine days a good variety of song birds made the creekside musical with their notes, and in cloudy, gloomy weather, when these songsters were mute and discouraged, when the snakes were hid and even the turtles had plunged into the water to get out of the rain, the brown thrushes poured forth their matchless bursts of song.

Slow and deliberate their melody seemed when heard at a distance. It opened with a prelude of 3 distinct notes, each followed by a pause. Then, after a brief rest, came 3 more and different notes, terminating, as it seemed, in the long drawn out syllable che-e-e. On nearing the singer, so that the elements of the melody could be more clearly distinguished the song was found more complicated and difficult to describe than it first appeared. Softer notes could be heard filling every pause until it almost seemed that the bird was singing 2 songs at once. Heard more distinctly the closing note of each burst of melody was no longer a simple che-e-e, but a most charming trill, rapidly uttered, tremulous and beyond description.

Dark days, gloomy weather and the long shadows of approaching night were the delight of the thrushes, and it was when other songsters were mute and discouraged that they most joyed in displaying their gifts. On bright clear days they fled to this sheltered spot beside the creek to escape from the glaring sunlight; and here their songs could often be heard all day.

Have I ever found their nests and seen their eggs and young? Many a time; but if I tell you where, I do so in strict confidence, and you must never reveal the spot to any naturalist; for he would rob the nest to get specimens for his cabinet. He might even think stuffed thrushes were desirable curiosities.

There were several small trees standing in the osage hedge on the high bank, and one of these, undermined by the stream and apparently crowded off by its neighbors, had lost its footing and bent low toward the water. The wild grape vines had caught it in their long arms, stayed it in its fall and had hidden its decay with their luxuriant green. Beneath the swaying sapling the tangled sprays of vines were loosely wreathed together, and in this living net the decaying twigs and fallen branches had been caught and held in jagged clusters.

On this picturesque foundation the thrush, year after year, builds her nest, of dry leaves, plastered together with mud and lined with the finest hair-like roots, and soft moss. Her 4 eggs are of a delicate light blue color, with perhaps a light shade of green, but free from all spots and markings.

Beneath this overhanging screen of swaying branches and vines I once found shelter from a sudden shower and watched the old bird sitting fearlessly on her nest, while her mate, heedless of rain and visitor, sang on undisturbed. As I emerged from this retreat the low sun peered out between the thunder clouds; a rainbow spanned the Eastern sky, its colors mimicked by the sparkling drops shaken flashing from the dripping leaves, and the tireless thrush, balanced on a swaying spray of vine, poured forth a fresh burst of song.



A GROUP OF GRIZZLIES.

Killed by W. E. Carlin and W. H. Wright, and exhibited by RECREATION, at the Third Annual Sportsmen's Exposition.

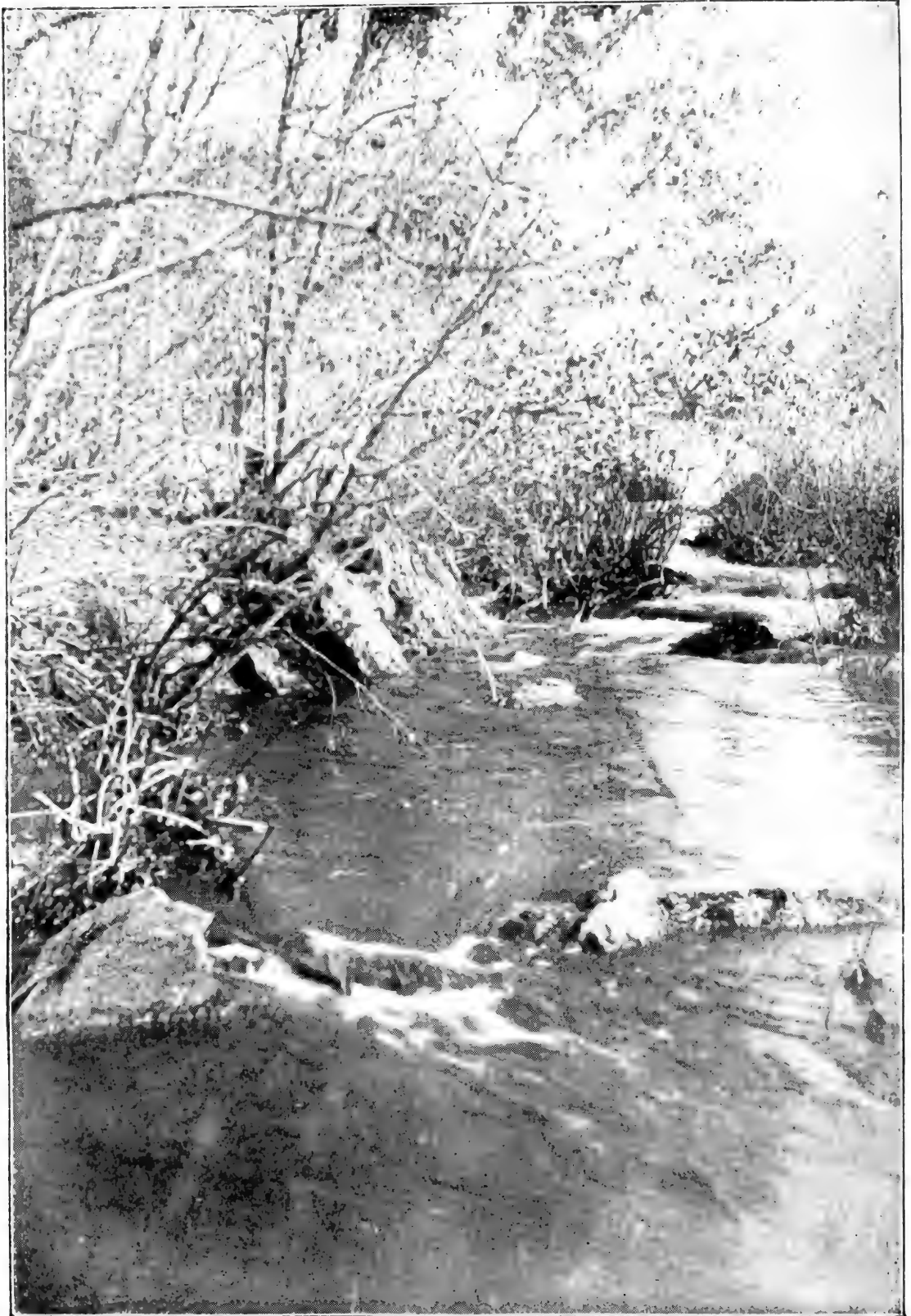

AMATEUR PHOTOGRAPH BY HENRY ALLINDER.

IN THE HAUNTS OF SALMO FONTINALIS.

THE ORIGIN OF NEGRO MINSTRELSY.

VAUGHAN KESTER.

Othello was the first negro on the English speaking stage—if Shakespeare's coffee colored savage can be justly called a negro. Then in 1696 there came Oroonoko, in the tragedy of that name. Oroonoko was a somber figure, much addicted to Grecian poses, Roman togas, and stilted blank verse.

This sable gentleman was endured for some time. Indeed such was his vogue that the negro seemed destined for a lasting place in the serious drama. When in 1768, the shackles of tradition were cast aside, and Mungo, in the comic opera of "The Padlock," stepped upon the stage, comedy succeeded tragedy, for Mungo was denied the superior privileges of blank verse, and had to content himself with doggerel of distinctly undignified tone.

These 3 characters were creations of the English stage. It remained for America to give the negro permanency, to evolve a special form of entertainment wherein he should reign supreme without the touch of contrast and dependent solely on his own abundant humor and sentiment for perpetuity.

As early as 1815 representations of negro life in the South were popular with the American public. The first sketches of this kind are said to have been given by clowns in the circus ring, but it was not until 1842, that negro minstrelsy, as we now understand the term, was inaugurated, and before this time "Jim Crow Rice" had seen his best day, as had also his numerous imitators. In short the negro seemed about exhausted as a factor in current amusements, when the chance but lucky hit of 4 stranded musicians, in negro songs and sayings, proved that there was still both fame and money to be made from our dusky brother.

Of the first band of minstrels, Dan. D. Emmett is the only surviving member, and he is now best known, where known at all, as the author of "Dixie," "Old Dan Tucker," etc.

However, in his day Emmett was a "burnt cork artist" of considerable note. He made old men his specialty and was great in this line of work. He has solemnly assured me that when he had blacked his face, and donned his wig of kinky white hair he was "the best old nigger that ever lived."

Emmett was born at Mount Vernon, Ohio, in 1815. He came of a family whose members all possessed a more than ordinary talent for music, and in his own case this talent amounted to a sort of genius.

As a boy Emmett learned the printers' trade, and when he had mastered it, drifted about the country in search of work. He finally abandoned his trade to become a

member of Oscar Brown's circus company. This was at Cincinnati in 1835.

For the succeeding 8 years his summers were spent in the South and West and his winters in Cincinnati, where a permanent circus held forth during that portion of the year when travel was impossible.

It was during these years that Emmett did his first "sketches," assisted by a fellow member of the troupe by the name of Frank Browes. They were nominally members of the band only, but it devolved upon them, as a part of their duties, to go in the ring at each performance, where they would give a short entertainment consisting of songs and dances.

The songs were mostly of Emmett's own composition. "Old Dan Tucker" was written about this time and first sung by Emmett in the ring. In its original form it was what would now be called a "topical song" as new verses, with local hits, were added whenever it was sung.

The spring of 1842, found Emmett in New York City out of an engagement and with but scant chance of securing one. Browes was with him, and no better off. As nothing offered they took to playing and singing in saloons, concert halls—any place, in fact, where crowds could congregate and a hat be passed.

One day as they were at work enlarging their repertory, at Emmett's boarding place in Catharine Street, Billy Whetlock and Dick Phelom—two friends whose condition was scarcely an improvement on their own—dropped in upon them quite by chance. It was suggested by Emmett that they give Nate Howe, who was managing a show at the old Amphitheatre, on the Bowery, a "shiverree."

The proposition meeting with the approval of all, the 4 armed themselves with various instruments and strolled down to the Amphitheatre. They surprised Howe in the hallway, and surrounding him before he could make good his escape, they gave the "Lucy Long walk 'round" in the most approved negro style.

Oddly enough Howe was charmed—"Boys," he said, "you have struck a great thing, keep it up."

Delighted at finding him so enthusiastic they continued "to keep it up" until a crowd had gathered about them. In the crowd was Bartlett, the landlord of the "Branch Hotel," a famous theatrical resort of the day. He invited them over to his place, an invitation they at once accepted, and when they had disposed of certain refreshments that he ordered for them, they gave a performance, in his billiard-room,

which, in a crude way, contained all the elements of modern minstrelsy. Their success was so great that it decided them to continue practice together.

The first appearance of the 4 on any regular stage was at the Chatham Theater, the event being Phelom's benefit. After this they played one night at the Amphitheatre, and as pay for their services were given cuts of themselves in character. They were now known as the "Virginia Minstrels."

The scene of their next triumph was a saloon called the "Cornucopia." Near this was the Park Theater, with Walshe's circus as the attraction. As they drew largely on Walshe's patrons for support, he finally offered them a week's engagement. They



DAN EMMETT, THE FATHER OF NEGRO MINSTRELSY.

were to receive \$100 and a benefit. Their profits on the week were a little over \$700.

From the Park Theater the Virginia Minstrels went to Boston, and played to large and fashionable audiences in that city. Meanwhile Phelom had become infected with the idea that riches and fame would result from a trip to England, and the other members of the troupe were so elated with their success that it was probably an easy matter for him to bring them around to his point of view.

They returned to New York and after giving Walshe a rousing benefit sailed for the other side.

Arrangements had been made for them to appear at the Adelphi Theater, London,

under the management of one Anderson, "The Wizard of the North." Anderson was a sleight of hand performer and the minstrels gave their entertainment during his rests.

They remained 6 weeks at the Adelphi, but the engagement was not a pecuniary success. Either Anderson's sleight of hand was as potent in the box office as on the stage, or else their agent was dishonest, for at the end of the run the minstrels were all but penniless.

Then followed a short but disastrous season in the provinces, and the first minstrel troupe came to an abrupt and inglorious end.

Browes and Whitlock returned home, while Emmett with Phelom secured a position in the band of the American Circus company, then touring England.

Emmett remained abroad until 1844, when he returned to New York, only to find that minstrelsy had undergone a great change; so great, in fact, that he felt himself altogether out of it.

It was not until 1858 that he again ventured upon the stage. In that year he became a member of Bryant's minstrels at 472 Broadway. He was engaged to compose songs and "Walk'rounds," but not to take part in the performance. However, Bryant soon had him on the stage once more, as banjoist and vocalist.

It was while he was a member of Bryant's company that the famous song of "Dixie" was composed. This song was hastily written, one Sunday afternoon, in response to a demand of Bryant's for a new walk'round for the following Monday's entertainment.

There have been many accounts given as to the origin of "Dixie." The one most commonly accepted is that it grew note by note of its own volition, and that Emmett simply put on paper something that already existed.

The truth is that Emmett had the single line, "I wish I was in Dixie" to start with. Now oddly enough "Dixie" or "Dixie land" originally referred to an estate on Manhattan Island, owned by a man of the name of Dixy early in the last century. Dixy was an extensive slave holder, until the spread of the anti-slavery sentiment in the North, and the constantly increasing risk that attended the ownership of this kind of property forced him either to sell or remove his slaves South; and from these slaves or their descendants came the expression "Dixie land," signifying their attachment for their old home and master.

The phrase passed into the current speech of the people, gradually losing all local reference.

But a chance allusion by John Randolph to Mason's and Dixon's line, in a speech delivered by him in 1820, revived the memory of that now famous survey, and in some way "Dixie"—doubtless from its similarity

to Dixon—was given a place in the South, for when Emmett first heard the expression as a young man, it was from the lips of circus men, who, when caught by a spell of unseasonable weather in the North, were wont to wish they were in "Dixie land."

The song of "Dixie" won instant popularity. It came just prior to the war, and the South at once appropriated it as a national anthem. Thousands, perhaps millions, of copies of the song were printed and sold in the Southern cities, each publisher giving the credit of authorship to a different composer.

Ferth & Pond, to whom Emmett had sold the rights to Dixie for \$500, very naturally wished to protect their property, but it was not until after the war was ended that they were able to do so. Then Emmett, at their request, advanced and proved his claim to the authorship of the piece.

Emmett remained with Bryant until 1865,

when he established himself with Charley White in the management of a place of amusement called "The Melodian" on the Bowery. The enterprise was attended with considerable success, but Emmett became dissatisfied, and decided to branch out by himself. He removed to St. Paul and opened a minstrel show in that city, but to poor business.

Hoping to better himself he secured a theater in Chicago, but bad luck followed him there, and after a short and very costly experience he was glad enough to retire from the field. This was about his last appearance as a "burnt cork artist."

In 1888 Emmett returned to Mount Vernon, Ohio, wishing to end his days there, and there he still lives, his few simple wants amply supplied by the Actors' Fund of America, which grants him a weekly pension.

Editor RECREATION: I have pleasure in sending you a photo of a deer, killed by an old Indian last November. It was frozen stiff and we stood its fore legs in a barrel in order to make the picture.

You will notice there are 2 hooks on the last prongs of both antlers. Counting all



the protuberances he has upward of 35 points

A great many people have called to see the head, among them several old hunters, and all declare it a marvel. I should like to hear from some of the readers of RECREATION in regard to the scarcity of such heads.

K. H. C., Leech, Minn.



ROCKY MOUNTAIN GOATS.

Killed by W. E. Carlin, and exhibited by RECREATION, at the Third Annual Sportsmen's Exposition.

"Maym, do you understand this new X-ray process?"

"Oh, yes; it's a method of curing sick people by letting them look at photographs of their bones."



ANTELOPE HEAD, SHOWING DEFORMED ANTLERS.

The subject of the inclosed photo is one of the most peculiar cases of retroverted, or drop horns, I have ever seen in the antelope tribe. This animal was killed on a high, dry ridge, between the 2 Laramie rivers, about 12 miles from the town of Laramie, Wyo., some 4 years ago.

The attention of hunters was first called to the animal by his walking backward, in a half circle, when feeding. He was very wild and avoided death for many months,

although being continuously hunted. More than 100 shots were fired at him before he met his death. He was fat and in fine condition when killed. Examination discloses the fact that on account of the peculiar shape and length of his drooping horns he could not feed satisfactorily while walking forward, so he walked backward in order to reach the grass.

W. H. R., Laramie, Wyo.

THE ARMY PACK TRAIN SERVICE.

J. A. BRECKONS.

The pack train service was, in times past, one of the most important though least heard of adjuncts of the United States Army. It performed a large share in the military movements in the West, during the past 30 years, and without it the army would have been almost useless in Indian campaigns.

The central depot and training grounds, for the pack service, are at Camp Carlin, near Cheyenne, formerly the supply depot for the Department of the Platte. Here the men and mules designed for the service were trained; and from here pack trains were organized, equipped and sent to

various army commands in Texas, Arizona and California when required.

The service was and still is in charge of Col. Thomas Moore, chief packer of the United States Army, a grizzled veteran of over 30 years army service, who can at 6 hours' notice put a pack train, equipped for a year's field service, at the disposal of any command requiring it.

Nine men, 47 or 48 mules and one horse constitute a pack train for active service. The men are the packmaster, 2 super-cargoes, or "Cargadoras," and 6 packers. Of the mules, 9 are for riding, 3 for packs and one, and sometimes 2, extras for

emergencies. The horse wears the bell and shares with the packmaster the honor of the leadership of the train. One of the packers must be a blacksmith and one a cook. Usually all of the men are qualified for the duties of both professions.

Although part of the army the men are civilians and not required to enlist. They are paid \$50 a month. It requires 6 months' training to make a fairly good packer of a green hand, and several years to make him an expert. Only able-bodied men are hired. None weighing under 170 pounds are taken, and every applicant must be able to lift 200 pounds to the level of his chin.

No uniform is required. Most of the men wear a modification of a cowboy's costume. On a campaign they are armed

for bedding for the men. On the folded blanket is placed the pack saddle, shaped like a saw buck, and technically called an "apperajo." The coronna, blanket and pack saddle constitute the "rigging." On the rigging are fastened the loads done up in two "manteaus," or 6 foot squares of heavy duck cloth. They are lashed with a $\frac{3}{8}$ inch rope, 28 to 36 feet long, called the "layer." A sling rope, of the same size and length, ties the loads across the top of the rigging. The loads and rigging are secured to the animal by a lash rope $\frac{1}{16}$ of an inch in diameter and 52 feet long. The lash rope has a broad leather cinch at one end, which is passed under the belly of the animal. A "diamond hitch" across the top of the load is the method of tying. A leather blind called "tappajo" is put over



A GROUP OF PACKERS.

with Cavalry carbines, revolvers and hunting knives. In camp, and at the Camp Carlin depot, the men feed and groom the mules, train green animals to the use of packs, and every alternate day take the train out for a practice march of from 20 to 30 miles. For drilling purposes and practice the animals carry loads of 300 pounds. In active service 275 pounds is the maximum load. This is made up of tenting, bedding, cooking utensils, rations and ammunition. One mule can carry 100 field rations. Ordinarily one half of the train carries rations, the balance carrying tenting, ammunition and miscellaneous supplies.

A pack mule's equipment is somewhat complicated. On the animal's back is first placed the "corunna," or crown, consisting of a quilted pad lined with canvas, as a sweat cloth, and numbered so that it may always be used on the same animal. On top of the coronna is placed a good heavy blanket 6 feet wide by 7 feet 6 inches long. This is folded to 6 thicknesses and serves

the animal's eyes while the rigging and load are being put on, and the first lesson taught a pack mule is to have him stand stock still while the tappajo is over his eyes.

The bell horse is the nabob of the train. He carries no load nor rider. A soft toned, tinkling bell, hung to a strap around his neck, announces every move he makes and the pack mules follow him when he walks or crowd around him when he stands. On the march the bell horse is never ridden but is led by one of the packers. When the mules are grazing the bell horse is hobbled, except when apprehensive of attack, when a man holds him by his halter. Bridles are never used on the animals. A "tie up" is made with the bell horse at the right of the line, mule number one tied to the bell horse's halter and each of the other mules tied to the rigging of his predecessor in the line. A tie up can be made by an expert train in 2 minutes.

With a nucleus of 20 well trained mules enough green mules to make up a full train

can be trained in 6 weeks to 2 months. It requires 6 months to break in a full train of all green mules. Since 1885 over 500 mules have been broken into the pack service, at Camp Carlin, and sent to do service with the various commands in Texas, Arizona and Montana. The mules are bought at St. Louis. None over 6 or under 4 years of age are taken and none under 850 pounds in weight. Animals found to be vicious are not kept in the pack service but are turned over to the tender mercies of the "mule skimmers" of the wagon trains.

The pack service has always been used to some extent in the army, but it was put

of the past 25 years. On the march the position of the trains is alongside the Cavalry, giving the troops the right of way. In a fight the pack train, with all superfluous baggage and horses, is usually placed in the centre of the command.

"The first big fight I went into with Crook," said Col. Moore, "was at the Rosebud. The battle was in the bad lands and the country was so rough the men had to do most of the fighting dismounted. Before the fight the General said to me: 'Now Moore, when we get into this fight what do you intend to do?' 'Keep in the middle of it,' I said, 'so you can defend your sup-

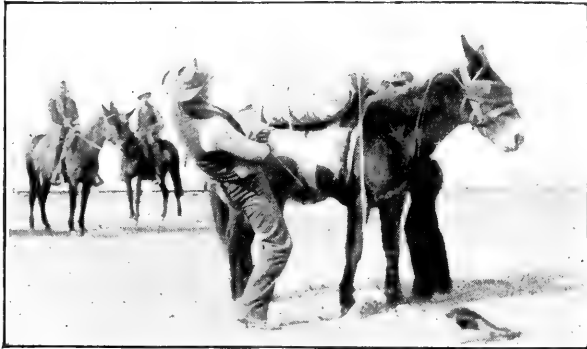

THE DIAMOND HITCH.



BUNCHING THE TRAIN.

into its present efficient state by Col. Moore, who in 1867, under orders of Gen. Crook, organized the service as it is now conducted and established a central depot for training and drilling men and mules. Col. Moore has been in all the important Indian campaigns in the West. From 1867 until 1871 he was with Gen. Crook in Idaho, California and Oregon, taking part in the subjugation of the Piutes in these States. From 1871 to 1875 he was with Crook in the Apache campaigns, and in 1875 and 1876 in the big campaign against the Sioux nation in Wyoming, Montana and Dakota. In 1877 Col. Moore and his pack train were with Gen. Merritt and Col. Hart in the memorable chase across Idaho, Wyoming and Montana after the celebrated Chief Joseph and his band of Nez Percés. In 1885 Moore had several pack trains in the Apache campaign, with Gen. Miles, and his men and mules were in the famous forced marches in Arizona which ended with Geronimo's capture. Col. Moore's last field service was in the winter of 1890 and 1891 in the Pine Ridge campaign. Eight hours after the outbreak, in response to a telegram from Gen. Brooke, Col. Moore had 2 trains ready for the field.

Col. Moore and his pack trains have shared with the troops almost every battle with the Indians in the various campaigns

plies while you are defending yourselves.' 'That's all right,' said Crook, and we went into the affair just that way and adopted the same tactics always afterward."

"Mules are not so easily stampeded as horses," continued the Colonel. "Once in Idaho, when we were moving supplies without an escort, we were surprised at night by a party of Indians who tried to run off the train. We had 3 full pack trains and 2 night herders out with each. The Indians raised a big commotion and whooped and yelled and fired into the herd, but the mules, instead of running, huddled into a bunch and crowded around the bell horses until we drove the Indians away. Seventeen mules were shot during the scrimmage but not an animal was run off."

Col. Moore is looked upon, in army circles, as an authority on army supply transportation. He has letters from Gen. Crook, Gen. Merritt and other Indian fighters endorsing and approving his views on the superiority of pack train over wagon service in army operations in the West.

He has had offers from the French government to superintend the organization of a pack train service from the French army in Algiers, and from the British to organize a like service in the Soudan; but prefers remaining in his present position.



Loneliness And Cubs.

After-Dinner Nap.

Feeding Time

CARL WINGATE '75

Mr. Murphy Is Hungry.

DRAWN FOR RECREATION BY CARL WINGATE.

IN CENTRAL PARK MENAGERIE.



IN THE GARDEN OF THE GODS, COLORADO.



BY COURTESY OF "THE PROFESSIONAL PHOTOGRAPHER."

"NOW LOOK PLEASANT, PLEASE."

WILD TURKEY SHOOTING.

CAPT. C. J. CRANE, U.S.A.

For the first hour after leaving the roost in the morning turkeys are very busy eating, and during that time the hunter can approach them more easily than in the middle of the day. Pecans, acorns, grass seeds, berries, and green grass constitute their diet in Texas and the Indian Territory. In New Mexico and Arizona they have no pecans, but are very fond of the nuts from the piñon and pine trees, which are abundant.

If at the break of day the hunter is in the vicinity of the roost, but has not seen the turkeys, he will easily discover their whereabouts from the noise they usually make before flying down. In the middle of the day the best hiding places, usually thick underbrush, will have to be searched to find them. In a prairie country the timber is nearly all concentrated along the water-courses, and pecan and cottonwood trees offer good roosts, and the underbrush gives good hiding places. In the mountains of the far Southwest, concealment is easy, the real trouble being, not for the turkey to hide, but for the hunter to find him.

When not much hunted, turkeys will sometimes fly into low trees to get something to eat. Sometimes they do so to hide, especially when suddenly disturbed by dogs or wild animals. Some hunters use dogs in hunting them, the dog being trained to rush suddenly among them, when some or all of the flock will take to the trees, and give opportunities for several shots.

The son of our post commander—a boy of about 16—one day killed 8 turkeys out of a single flock; his pointer dog treeing the birds.

I went hunting the same day, and thought I did well to kill 2 birds, but I had no dog. Dogs that have been trained to hunt quails take naturally to turkey hunting. The large bird will hide like the small one, wherever it can find concealment, and like the small bird, will fly out of cover and offer a good shot.

I was with a hunting party from Fort Sill, in December, 1887, on Deep Red creek, and one day killed 9 birds, all but one having been flushed and shot like quails.

An old turkey hen, with a brood of small ones, will make the little birds conceal themselves, and while they are escaping she will run around trying to keep attention directed to herself, in this resembling all other birds.

The senses of seeing and hearing are extremely well developed in turkeys, and they waste no time in settling the question as to whether the object just seen is a man or only a stump. A deer may stop to make

sure before running away, but the bird seems to see correctly at once, and to need no confirmation of its suspicions. Still, when advantage is taken of every cover and inequality of the ground, it is possible to get very close to a flock, close enough sometimes for the hunter to use both barrels with deadly effect.

No other bird in America can run so fast as the turkey, but when caught some distance away from thick woods they have frequently been run down and captured by a horseman. They cannot fly more than from $\frac{1}{2}$ to $\frac{3}{4}$ of a mile the first flight, even when thin, and if fat the distance will be less. The second flight will be much shorter; the same with the second run, so that many turkeys have been run down and caught after running and flying from $\frac{1}{2}$ a mile to 2 miles.

The poor things get so exhausted that they cannot fly any more and cannot run faster than a man can walk. Of course the chase would have to be pushed without any let up, in order to be successful. It is said—and I believe it—that the Indians of Arizona sometimes run down and catch turkeys, in their mountains, on foot.

While hunting, the proximity of a flock, or even of one bird, can often be detected from the signs around, such as fresh tracks, scratching, droppings, etc. The presence of anything that turkeys eat should keep the hunter always on the lookout. A good-looking piece of woods for squirrels and deer, 'possums and 'coons, will be just as good for turkeys, and more care must be taken. The hunter must be ready to shoot, for the birds will surely run or fly as soon as they see or hear him, and it is generally useless to race after them. It will be good hunting to find them again an hour after. Sunken paths, ravines, or creek-beds should be followed for short distances at a time, with frequent peering over the bank and examining of the surrounding country.

A turkey call is of great assistance at any season of the year, especially when the birds are about to mate in the Spring. If the birds are young and have not been made wild by hunting, a party of hunters could kill more of them by merely locating the roost, during the day, and shooting at night.

This requires that the hunters should all be skilled in night shooting. Usually, however, turkeys are hunted all day, and at night too, if their roost can be located.

Turkeys are usually fattest in the Spring, but it is not right to kill them then, and in most States they are protected by law.

In the open countries, Oklahoma and Indian Territories, turkey hunting, as it has

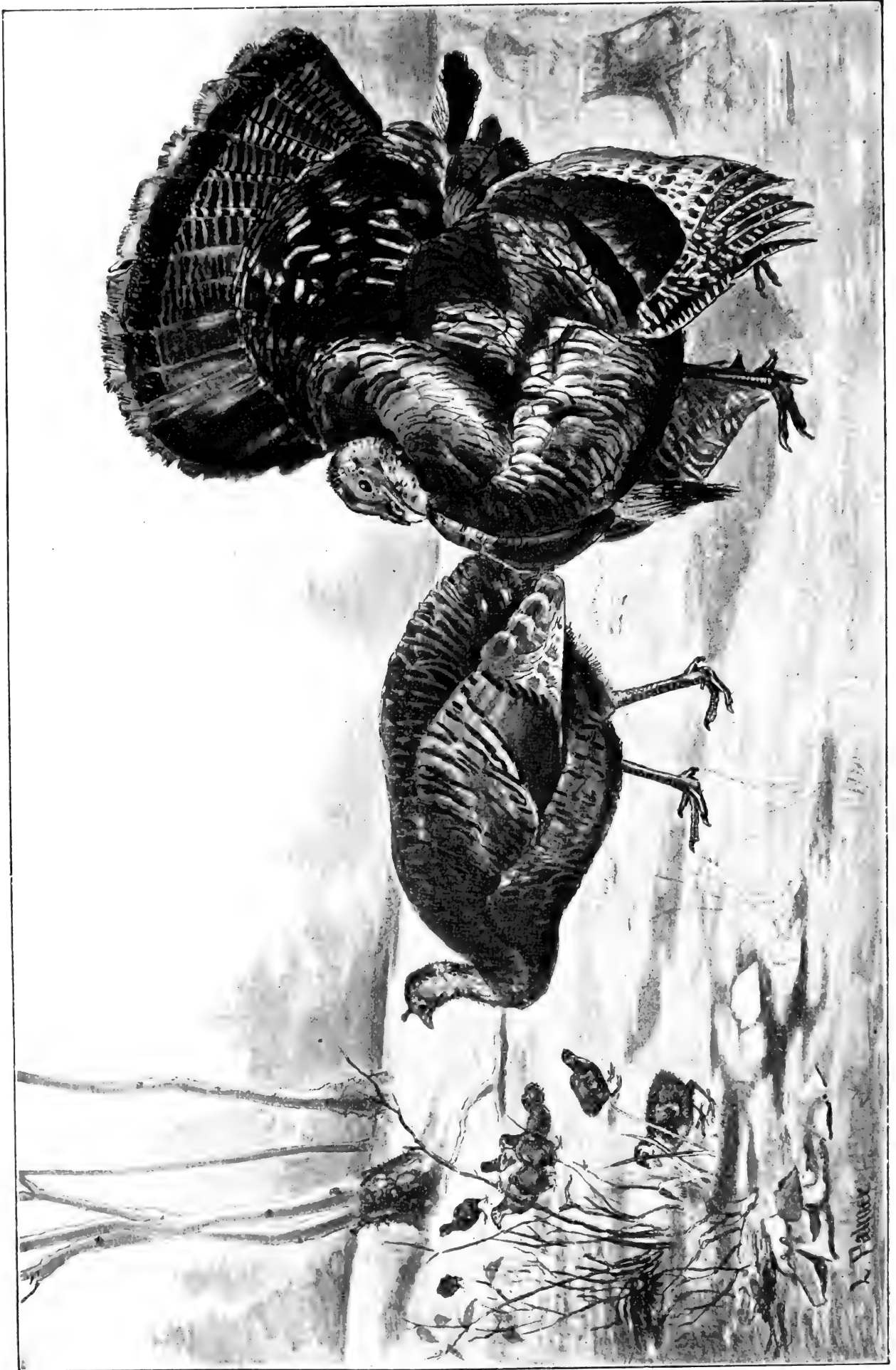

A ROYAL FAMILY.
THE WILD TURKEY (*Meleagris gallopavo*).

existed, will soon be a thing of the past. In the mountains of Arizona and New Mexico it is such hard work to hunt that game of all kinds will exist for a long time. It is not likely that those mountains will ever be thickly settled, therefore turkeys, deer, and bear will continue to find there homes secure enough to prevent their total extinction.

The numbers of turkeys killed in Texas and the old Indian Territory will never again be equalled. In the winter of '86-'87, on Deep Red creek South of Fort Sill, a hunting party of about 10 hunters killed in one night more than 80 turkeys, and about

125 in 3 days. One year from that date, another party, having in it several hunters of the year before, hunted that same creek for more than 20 miles, killing but 5 in 5 days.

The shotgun, loaded heavily with BB shot, is the best weapon to use for these birds, although smaller shot do better against a half-grown one, not tearing the flesh so badly. The rifle is often used too, and I have even killed 2 turkeys at one shot with a rifle; but a large bullet tears so badly that it almost spoils the bird. It is good shooting to kill a turkey with a rifle, and to kill 2 at one shot is always accidental.

THE PRAIRIE DOG AT HOME.

GEO. G. CANTWELL.

One of the novelties to the Eastern traveler crossing the plains is a prairie dog town. Although he may never have seen one of these rodents before, its saucy face is instantly recognized, for its fame has spread over the land. A spirit of romance hovers about this little dweller of the plains, and he is almost the last picturesque feature in the great panorama of the West, now rapidly fading away.

When our first daring pioneers pushed their way across the Kansas prairies, they found the prairie dog there, filling in the little places not occupied by buffalo or Indians. But alas, for the little dog! He has watched from the top of his mound the Indian chasing the last buffalo over his town. The buffalo has gone and the Indians have nearly all departed to the happy hunting grounds; yet the little dog is there still. The Texas steer and the cowboy have long been his companions, but they, too, are fast passing away.

Approaching civilization has served to make the dog crafty and to sharpen his wits, for it is only by persistent watchfulness, that he has been able to hold his own against a pest of enemies.

Although scattered generally throughout their range the dogs seem to court the society of man, for they are most plentiful about the outskirts of villages and along the roads among the ranches. Their colonies, or towns, as they are called, are generally on high, dry ground, sometimes on hill-sides, but never in the creek bottoms. They have a dread of water. Instinct seems to warn them of its dangers, and in later days the small boy has taught them the folly of locating under the slope of irrigating ditches.

On the high plains water is not found

running along every roadside, for the boys to dip out by the canful, and pour into the holes to drown the dogs out as they would drown a gopher.

When holes are dug in level places, the dogs pile the dirt that is taken out, about the entrance, so as to bring the opening of the tunnel a foot or more above the surrounding surface. The holes are large for the size of their owners, for 2 dogs can pass each other easily, in most of them. The hole goes almost straight down, for 3 or 4 feet; then makes a sharp turn, and continues 8 or 10 feet on a slight inclination upward, where it ends in a chamber, a foot or more in width, and 2 to 5 feet under the surface.

In an ordinary town of a few dozen dwellers, the holes are usually about 25 feet apart; but in the large colonies, where they occupy hundreds of acres, the holes are close together, and the tunnels join each other in a perfect network. This is the cause of many a family row. In this tenement style of living, fierce combats are waged between jealous males.

As a general thing the prairie dog feeds on roots, grass, alfalfa when they can get it, and almost anything that goes to make up the food of a rabbit; but unlike the rabbit, the dog eats also lizards, toads, snakes, grasshoppers and other insects. He is about the size and shape of the musk-rat; of a light golden color, darker on the back, and shading to black on the tail. This is the species that lives in Eastern Colorado. In the mountains another variety has taken up its home, in the grassy parks below the snow-capped peaks. He is similar to the plains variety, but is the proud possessor of a white tail, and is known as the white-tailed prairie dog (*Cynomys leucurus*).

We probably all remember the pictures, in our old geographies, of prairie dogs, burrowing owls, and rattlesnakes, all dwelling peacefully in the same hole, lying down together, as it were. It became such a fixed idea in our minds that it was readily taken for granted; but when stripped of its romance, we find these creatures on anything but sociable terms. The little owl is around sure enough, but more than likely the hole he inhabits was deserted before he occupied it. You may see a rattlesnake about, also; but you are just as likely to see one anywhere else; for the whole country is their habitation. A snake in a dog town is any-



thing but at home, and if he seeks a hole it is from necessity and not from choice.

I have never seen any of the alleged gray-haired patriarch dogs doing sentinel duty, while the others fed at leisure. In fact, they all appear to be sentinels, every one for himself; for the way they act on the "self preservation" principle, would lead one to believe they thought their little pelts as valuable as those of the sea otter, and that they objected seriously to allowing any of them to be placed on the market.

I remember the first dog town I ever visited. I was on the outskirts of Colorado Springs. I came suddenly over a rise of ground to a level mesa, and there, almost at my feet, scampered hundreds of fat, clumsy, prairie dogs, each one making for his mound, and immediately lowering himself into the hole, but with a pair of bright eyes just showing over the rim, and a nervous tail dusting the edge of the opposite side. Then with a hurried glance at the intruder, and with a shrill chatter, as a final

salute, down he went. In a remarkably short time every dog within 200 yards had disappeared. Now and then a timid head could be seen, peering at me over the edge of the mound, its owner giving vent to an occasional bark, much like that of a small domestic dog, but sharper. At the least suspicious movement, on my part, all in sight would immediately seek the shelter of their holes. As far as the eye could reach might be seen excited little chaps running over the uneven ground, headed for home, almost out of rifle range.

I had a small rifle with me and attempted to creep up within range of several dogs I had seen at a distance; but it was of no use. I could get no nearer than 200 yards. Then I concluded to wait for some of them to come up. I sat down in a place where burrows were numerous; but none came in view, although I waited half an hour and kept perfectly still. I was beginning to gain considerable respect for the little rascals; and to understand how it was they were able to hold their own so well in the neighborhood of a city where people were in the fields, hunting, almost daily. The dogs make a tempting mark and the man who can go out on foot and shoot a number of them is indeed a good shot. However, there is a way to get them, and that is to approach on horseback. They are not so suspicious of four-footed creatures as they are of man.

Later I managed, with a camera, to outwit this same colony. By a good deal of manœuvring, very close to the ground, I succeeded in focusing on some interesting groups.

Their location was evidently one of long standing, for almost half the holes were unoccupied, and a good many owls and cotton-tail rabbits had taken up quarters in the vacant holes.

The prairie dog can be found all over this part of the country, living as he has always lived, and whether away out on the plains, a thousand miles from nowhere, or holding down the choicest corner lots in a "busted boom" town, he is always the same independent, happy bit of Western nature.

Husband (at breakfast, opening a biscuit)—"My dear, why are you greater than the ancient Israelites?"

Wife (thoughtfully)—"I really don't know."

Husband—"They made bricks without straw; while you can make them of flour."



COMMODORE HARRY T. DEANE, AND HIS MODEL YACHT "RECREATION."

THE SHEEP EATER CAMPAIGN.

LT. M. D. HARDIN, U.S.A.

In the spring of 1879, while troop G, 1st Cavalry, in which I was then a corporal, was stationed at that delightful post, Boise Barracks, Idaho, orders were received directing the troop to take the field as soon as the snow on the mountains would permit, in search of some Indians who, during the previous winter had murdered some Chinese miners on Loon creek, Idaho. These Indians were called "Sheep Eaters." I had never heard of them before; but inquiry among pioneers brought the information that they were a small band located somewhere in the Salmon river country. They had never been on a reservation, and had been known since the early 60's when the gold fever first broke out in Idaho. Some said the band was made up of renegades from other tribes; and this is all the information, concerning the origin of the Sheep Eaters, I have ever received.

We did not get started on our hunt until about the last of May. As we were to travel with pack-mule transportation, it was necessary to go lightly equipped, with no tentage save what could be made up of the one piece of shelter-tent issued to each man. The command consisted of troop G, 1st Cavalry, about 50 men, and 2 civilian scouts, under command of Brevet Colonel R. F. Bernard, Captain 1st Cavalry—now Lieutenant Colonel 9th Cavalry, and Brevet Brigadier General U. S. Army.

On leaving Boise City we at once struck into the mountains to the Northward; passed through Idaho City, and then disappeared from the world. From that time until our return, 100 days later, we were either climbing up or sliding down mountains, making our own trail generally, and keeping within the region that in the 10th census report of Idaho is branded "Unexplored."

On examining almost any map of Idaho of that date, the reader might be persuaded that somewhere in the section traversed by us one might find a piece of level ground large enough for a football field. But the reader must not be deceived by the maps published—that is, if they are all as bad as the best I have seen.

After the first 3 or 4 days deep snows retarded the pack train, though we managed to get through, and then had to go into camp to wait for it to come up. As we were 52 hours ahead of our rations, this was called Starvation Camp.

With great difficulty we crossed another snow covered divide and reached the deserted mining town of Oro Grande, on Loon creek, the place where the Chinamen

had been killed. Just before reaching Oro Grande we had our first bit of excitement. Two men were seen, on the opposite side of the creek, making frantic efforts to escape. We gave chase, charging by file along the narrow trail, and soon came within hailing distance of the fugitives, whom we found to be white prospectors, very much frightened, having mistaken us for Indians.

The next few days we spent in trying to work our way down Loon creek, which was very high, and during this time it rained or snowed upon us without ceasing. On and on we went through beautiful mountains, until our rations were about exhausted, when we returned to Starvation Camp. Here in a beautiful little valley we rested 12 days, while the train was sent to Boise Barracks for more rations. But this was not now a camp of starvation. We killed many deer and blue grouse, and lived well.

On the return of the train with fresh supplies, we again set out on our hunt for Sheep Eaters. Circling around through the mountains, we explored all the streams known or suspected to exist, finding plenty of old, but no new, signs of Indians.

Deer were plentiful; does with fawns, in the valleys, and fat bucks on the higher ground. Occasionally a bear was killed, and we found a few mountain sheep. Streams were numerous, and we had no difficulty in catching all the trout we wanted, when we could get grasshoppers for bait. We were not provided with the approved rods and flies, but had common cotton lines and the cheapest hooks, while rods were cut from willow thickets, used for the day and thrown away. Our best arrangement for fishing was to have 2 men work together, one to catch grasshoppers, and the other to catch trout. In this way both could find plenty of work to do, and a good team of workers might easily catch a string of 80 or 100 trout in an afternoon, after the day's march.

Had we been out for pleasure only, we could not have wished for a better country; but we had lost some Indians; so instead of scouting up and down one of the forks of the Salmon river, making and breaking camps at pleasure, we were obliged to keep going as fast as our pack train could travel.

To relate all the incidents of that summer's outing would be to write a large volume, so I must confine myself to the mention of only a few. The scenery was everywhere grand. Pine timber, grass, and beautiful streams of clear, cool water everywhere. We found but one body of water that was not cool, and where there were no

fish. That was a very deep lake away up in the mountains, and the water was quite warm. To explore this lake we constructed rafts, and floated out a mile or more from the shore. We had some picket ropes with us, and with them we sounded to the depth of perhaps 100 feet, but found no bottom. We dove into it, and the temperature of the water increased with its depth. We enjoyed this lake very much, as all the other waters we found were too cool for comfortable bathing.

Among the curiosities we found, perhaps the greatest was the red fish in the head waters of Payette river. Gazing into one of the deep pools of this stream, one could see what appeared to be a red gravel bottom; but on throwing a stone into the water, this red bottom would break into a thousand pieces, and the pieces would fly in all directions. Then for the first time one could see it was fish that made the bottom of the pool red. These fish resemble the salmon in all respects save the red coloring of their backs. I have never seen or heard of them in any other place. On this stream we found a man preparing a seine for catching them. We helped him with his seine, and in return he allowed us to use it for our haul. It was all we wanted, as we secured enough fish for supper and breakfast for the entire command.*

Another curiosity was one of our own creation. One afternoon we went into camp near a mountain torrent which we were obliged to cross, but whose banks were vertical walls 30 feet in height. Forging or swimming was out of the question. We must make a bridge for men and animals. We made the bridge and that was the curiosity. First we dropped a huge pine tree across the chasm. Over this some men crept, and cut off the upper branches so that the trunk of the tree would lie snugly on the ground. Then long slender pine poles were cut and locked together so that one would hang on either side of the large log,

and with the tops of the poles about on a level with the top of the log. Pine boughs were then laid on, and over this we strewed earth. Our bridge was then complete. It was a narrow bridge, and a roaring torrent dashed under it. Many thought the animals would refuse to cross; but they did not. All crossed in a few minutes, and without much trouble. It is needless to say the horsemen did not ride across that bridge.

On July 4th we held our celebration at about noon, on a huge snow-bank on the top of a high ridge, by pelting each other with snowballs. While we were thus engaged, our officers, for safety, I presume, climbed to the top of a bare peak sticking out of the snow. From their position they discovered some bighorns down at the base of the peak, and on the side opposite us. Lieutenant P— hurried down, and taking 3 of us with him, crept around the base of the peak, where we crawled, under cover of a snowbank, to within about 25 feet of the sheep, while they were peacefully snoozing in the sunshine. We killed 3 fine fat fellows, and greatly enjoyed the feast that followed.

About the middle of July we found what we had wanted for a long time—not the Indians, but a fighting bear. All summer we had been looking for such an animal, for we had an alleged bear fighter with us, a man known as Reddy, and we wanted to see him slay a bear by his own pet method. According to his story, he was a wonderful slayer of ugly and wounded bears. The way the trick was done was to drop on his back and let the bear walk over him, when he would leisurely disembowel him. He had done the thing often in Montana, he said; but for some reason we were all a trifle skeptical and were anxious to see Reddy perform the act.

Some bear had been shot during the summer; but they had all yielded up the ghost too easily, affording Reddy no chance. One afternoon, just about time to make camp, we came to a small patch of clear ground in the middle of which was a bear, and an ugly one he proved to be. On seeing us he stopped rooting, and sat up to take a good look. The captain and scout fired at once, knocking him over; but, after rolling about a bit, he got his feet under him and scampered off into the timber.

We went into camp right there. As soon as the horses were turned out to graze, some of us found Reddy and told him we were sure of finding the wounded bear not far away, and we wanted him to show us how to kill it with a knife. Reddy did not take kindly to the scheme, arguing that the bear had only been tickled enough to make him travel well, and he was already miles away and still going. But by guying and coaxing we got him to go with us.

We soon found a trail of blood, and began to fear we should soon find a dead bear and

* Professor B. W. Evermann, ichthyologist of the U. S. Fish Commission, Washington, D. C., in reply to an inquiry as to the identity of this fish, says:

"The redfish of Big Payette lake is known in the books as *Oncorhynchus nerka* (Walbaum). It is a true salmon and runs up from the sea to spawn just as the Chinook salmon does. It is, in different places, known by different common names: in the lower Columbia it is the blueback salmon; in British Columbia, the Fraser river salmon; while in the Idaho lakes and throughout Alaska, and even to Kamchatka, redfish is its name. In Alaska it is, commercially, by far the most important species of the family. In the Columbia river it ranks next to the famous Chinook, *Oncorhynchus tshawytscha*. In 1892, the Columbia river canneries utilized 909,556 Chinook salmon, while the number of bluebacks (which is our redfish) utilized was nearly as great, it being 873,106. For canning purposes it is fully equal to the justly celebrated Chinook. These salmon do not get red until near the breeding season. They enter the Columbia in the spring, reach the Idaho lakes late in the summer, pass through the lakes into their small cold inlets in which they spawn during the early fall, and then die. It is not certain that any of those which reach these lakes ever return to the sea or live to spawn a second time. There is no evidence that they are land-locked, as many have supposed."

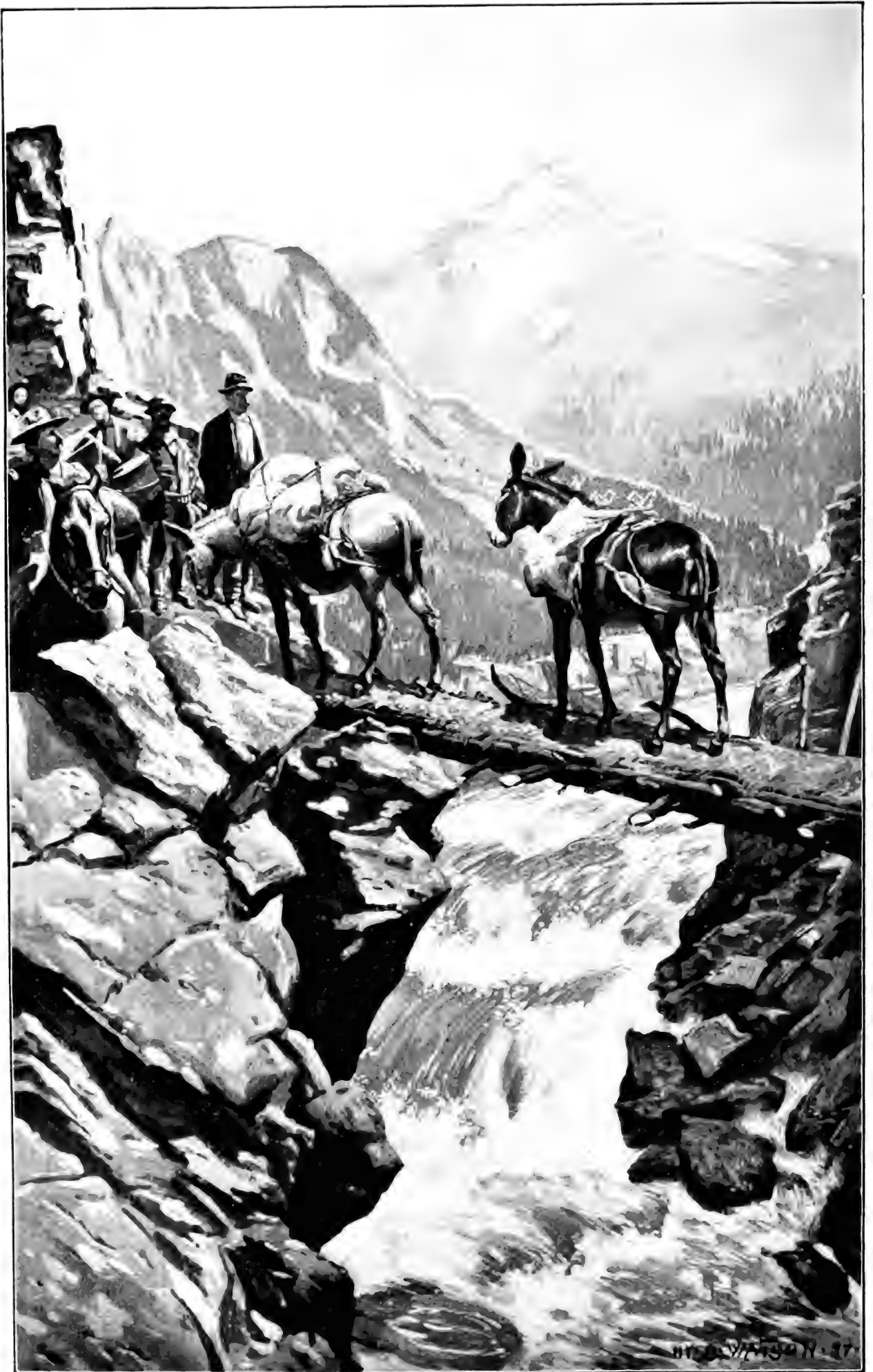

"IT WAS A NARROW BRIDGE, AND A ROARING TORRENT DASHED UNDER IT."

so be cheated of our entertainment. The more blood Reddy saw the braver he became; he was soon quite a warrior, taking the lead, partly through his own bravery, but chiefly through our courtesy. He carried his knife in his boot, his revolver under his belt in front of his body, and his carbine at the position of "ready." We had followed about half a mile, and were just about to pass a fir tree, with branches thick about the base, when suddenly these branches parted, and out sprang the bear.

Reddy promptly fired at nothing, then dropped his carbine, turned and ran, at the same time grasping at his revolver, which he also dropped. Away he flew, the bear weakly following him, paying no attention to the rest of us. Evidently the bear was willing to assist in our entertainment, but Reddy was not, and he did not stop until he had clambered to the top of a rock, about 100 yards away. In vain we yelled at him to lie down and carve him. The bear tried to climb the rock, but was too weak. Reddy shouted like a wild man, calling us to shoot, and save him; but we were having too much fun as matters stood. The bear finally concluded he could do nothing with Reddy, and turning he came lumbering toward us.

This was not exactly what we were there for, so we opened fire, finally knocking him down when within a few feet of us. He was almost gone, but got up and staggered blindly away from us a few paces; when we succeeded in getting him down to stay. He was not a very large bear, weighing probably not more than 500 pounds; but he was a vicious beast. The scouts called him a mongrel; his color was many shades of brown, slightly grizzled. I have never seen another like him.

Reddy never afterward mentioned his method of killing bear, and we never saw his wonderful knife trick performed.

Toward the middle of July we began to find fruit, and from this time to the end of our outing we were frequently treated to wild currants, huckleberries, and one other fruit that I have never heard named. The plant that bore this fruit was an annual, having a single stalk about 4 feet in height, and covered with what looked like nettles, but they were soft and harmless. The leaf was large and like the grape leaf. The fruit grew in clusters, and looked like large red raspberries, and like raspberries, left a cone on the stem when plucked. The flavor of the fruit was very delicate and delicious, resembling that of the strawberry. On first discovering this fruit we feared it was poisonous, and let it alone; but one of the men concluded to test it, and after we had seen him eat a quart or more of the berries, with evident relish, and without bad results, we followed his good example as long as any could be found.

Toward the end of July we found our first

sign of civilization. It was the residence of a Chinaman on Salmon river, not far from the town of Warrens, or Washington, as it appears on some maps. This Chinaman had a nice garden, and supplied us with the first fresh vegetables we had that season. Passing through the old mining town of Warrens, on the Warrens and Florence trail, I was detached with 2 men and sent to look for Indians at Loon lake.

My party left the trail at Secesh creek, and turning up this stream, we traveled about 15 miles over fallen timber when we discovered our lake, a body of water having an area of perhaps a little more than 2 square miles. Now, as we had been led to believe there was a strong possibility of finding Indians on this lake, and as we did not wish to be found by them, I concealed our horses, under charge of one man, and sent one man around one side of the lake, while I went round the other side. There was a dense growth of timber about the lake, and we had to proceed with some caution. We found some old signs of an Indian camp, but no fresh ones. After reconnoitring the lake, we concealed ourselves in a clump of pines and went into camp for the night, picketing our horses after dark on a clear grass plot near our thicket. Toward midnight we were aroused by the snorting of the horses. Grasping our carbines we crept to the edge of the thicket to see what was going on. There in the moonlight, not 50 yards off, stood a huge elk, quietly looking at our frightened animals. As we could not carry much meat, we refrained from shooting. The next morning we saw several elk taking their morning drinks within a quarter of a mile of us; but we did not molest them.

As we expected to find our command on the trail not far from the crossing on Secesh creek, we did not hurry our march to that point, and it was about midday when we reached it. Still thinking there was no cause for hurry, we unsaddled and picketed our horses out to graze while we smoked and rested. We were soon aroused by rifle shots, not far away, and upon investigating we found the shooters were 2 civilians, who said they had been directed to look out for me, and to tell me our commander, having learned that Lieutenant Farrow, with his scouts, was on the trail of a band of Indians who were going to Devil's mountain, would march to that mountain on that day, and I was to join him that evening. The distance I was to travel, the men said, was 60 miles.

Our horses were none too fresh, and I had my doubts about being able to comply with this order; but long experience had taught me this particular commanding officer did not take much stock in impossibilities, and I knew the effort must be made. Mounting in haste we took the trot along a good trail, and kept up the gait most of the time for more than 3 hours, when to our joy

we ran on the command in camp. It seems that later news had been received from Farrow, and his Indians were really white men driving a herd of horses. At least that was the explanation I received.

We joined Farrow the next day, and a day or so thereafter we learned that the Indians had been found by a company of mounted infantry, under Lieutenant Catley, 2d Infantry, who had been defeated with the loss of 3 men and some mules. The Indians had been found away back East of the place where we had found the Chinaman. After a hard march of 4 days we reached the Chinaman's claim on Salmon river, where we were joined by Captain Forse, 1st Cavalry, with a part of his troop, and Lieutenant Catley who had found the Indians.

From this point we started on the queerest march I have ever made. The 1st day we marched up the side of a very steep mountain, camping near the summit. It was a long march and we made our zigzag trail the whole distance. The next day we slid down the other side to Big creek, on which we camped for the night. During the next 2 days we marched down the canyon of Big creek, and so narrow and rough was this canyon that almost if not quite one half of the 2 days' march was made in the bed of the creek, in water knee deep to our horses, with enough holes to furnish plenty of amusement for those who could keep out of them.

These 2 days of wading brought us to the site of the recent "Battle of Vinegar Hill," as it was named by the soldiers. Farrow's scouts were in front, and had captured the camp of the hostiles, which they had found on a shelf of the mountain, about 500 feet above the bed of the creek, and about a mile below Vinegar hill. It was a splendid stronghold for a small band of Indians, having several acres of beautiful grass, plenty of wood, and a fine spring of cool water. Farrow's scouts must have worked nicely to capture this place without loss. I suppose the surprise was made easy through the route we came. Surely no person could have expected human enemies by that route. Farrow also recaptured some mules and rations that had been lost at Vinegar hill. We stopped for the night in the captured camp, while Farrow's men went out on the trail of the hostiles.

On August 20th, the morning after the capture, our scouting party was broken up. We were far from home and our rations were running low, so the commands of Captain Forse and Lieutenant Catley were started back to their proper station, while our troops went up the mountain in the direction taken by Farrow. It was my fortune to be left on rear guard duty that day, to travel with the pack train. The train was not ready to march with the command, and we were delayed about an hour in getting started.

When all was ready, a group of us lingered for a moment to hear the last of a yarn that was being spun. Suddenly the air was split by wild yells of Indians, and we received a rattling volley from the top of a bluff about 60 feet in height, and 100 yards from where we stood. One man and 3 horses fell, and the remainder, including all of our particular group, sprang to the nearest cover, which chanced to be a crooked pine tree about a foot in diameter. Our men were well drilled, and they dressed beautifully on that tree, following its curves exactly. One moment for reflection, and then we concluded to show fight.

The chief packer told us he could take care of the mules if we would kindly keep between him and the hostiles; and this chief packer, "Jake" Barnes, was just the man for such a situation. In a moment he had run his train to a sheltered place, and then leaving it in charge of his men, he caught the mule that carried our emergency ammunition boxes—boxes that could be opened without unloading the pack—and under a heavy fire brought that blessed mule to our position. Then after issuing ammunition to my men, he joined me, saying: "I want some of this myself."

Before this, however, we had abandoned our tree, and were well sheltered behind solid rocks. Leaving 2 men at the base of the hill, with orders to make as much noise as possible, I took 4 men and started up the mountain, under cover, intending to get above the Indians, cut them off, and then kill or capture them with ease. I had been on that bluff the previous evening, and knew the lay of the land pretty well. If I could only get directly behind them, they were my Indians. I cautioned my men not to show themselves; but unfortunately one of them became too eager, and when about on a level with the enemy's position, he ran up to a rock and took a peep at them. Then, seeing an Indian, he fired. That shot gave our scheme away. We ran across as quickly as possible, but the Indians had promptly retreated. They must then have been very near to and above us, and might have turned the tables on us nicely; but their own narrow escape from a trap had evidently "rattled" them.

Our little fight had made a tremendous noise. Down in that deep canyon the carbines had roared like field-pieces, and had of course been heard by the troops, and they were all back with us soon after the firing ceased. One of our men, a private of the 2d Infantry, had been shot through both legs. Our surgeon amputated one leg and then the poor man died. It was a blessing he was permitted to die there, for he would have suffered horribly in being carried out of that canyon, and he could not have lived to reach the nearest post.

On the morning after the fight the commands again separated. It was decided

that all the rations we could spare were to be given to Farrow, who, with his scouts, would remain in that vicinity to run down this band of Indians. Captain Forse and Lieutenant Catley were to proceed to their proper stations, and we were to march to the mouth of Loon creek, where we expected to meet rations from Boise. Our first march up the mountain, getting out of that canyon, was a terrible one, and cost us 14 mules. We soon found we had been too liberal in dividing the rations. Ours were entirely exhausted before we reached the mouth of Loon creek, and we found no train there, so we were without food for 3 days of hard marching. As ill luck would have it, just at this particular time we saw no game.

On the afternoon of the 3d day of our famine, as we were riding up Loon creek, someone shouted, "Salmon!" There they were, a fine lot of them, sunning themselves in water scarce deep enough to cover their backs. The captain and half a dozen of us dismounted at once. The Lieutenant was directed to find a camp, and in a few minutes we had shot about a dozen large fish, which were soon in camp. Salmon steaks were hastily cut, thrown on fires, and when about half cooked, they were snatched from the fires and eaten, without bread or even salt. The first swallowed would not remain down; but we persisted until we could

make it stay. I ate no more salmon for several years after that meal.

That evening our energetic chief packer, Barnes, took 2 of his best pack mules and struck out for Bonanza, a mining town supposed to be about 75 miles away. The next day we marched up Long creek to Oro Grande, and that evening Barnes rejoined with 2 loads of bacon, crackers and coffee, and we had the most enjoyable feast of my life. The following day we met Lieutenant Patten, 21st Infantry, with a pack train loaded with provisions, and our famine was ended.

A few days later we went into camp on the Payette river, where we awaited orders from General Howard, who finally directed us to return to Boise Barracks, where we arrived about the middle of September. Meanwhile, the scouts under Lieutenants Farrow, 21st Infantry, and W. C. Brown, 1st Cavalry, were pressing the Sheep Eaters and soon had them all captured. I believe there were only about 20 warriors in the band.

Thus ended our Sheep Eater campaign. The march had been a hard one, because we had been obliged to keep going; we had suffered from hunger, and were in rags; but for real pleasure and sport, for one who enjoys hunting and fishing, the country traversed by us in the summer of 1879 can hardly be equalled.

THE SHEEP EATER CAMPAIGN.

MAJOR T. E. WILCOX, U.S.A.

Oro Grande, a mining camp on Loon creek, a tributary of Salmon river, Idaho, was the scene of an Indian massacre in the winter of 1878-9, the victims being a few Chinamen who were gleaning the placers abandoned by white men. The Indians concerned belonged to that little-known band called "Sheep Eaters," together with a few renegade Bannocks who escaped capture or surrender in the Bannock war of 1877-8.

Bonneville makes mention of a band of Indians, not allied to any of the great tribes either side of the Rocky mountains, but possibly made up of renegades from all, shunning all men, Ishmaelites, who dwelt in the remotest recesses and among the loftiest peaks. The mountain sheep supplied them with food and a name.

As soon as news of the massacre reached the authorities, one company of infantry was sent in to "apprehend and if necessary destroy" the marauders.

This expedition met with disaster.

A few weeks later a courier brought to the post summons for "the field," the command being at Payette lakes, 3 days' march distant.

Preparations were hurriedly made, and on a sultry August afternoon we started upon what proved to us an eventful campaign.

Taking a trail which greatly shortened the distance to our prospective camp, for the first night, we reached Horseshoe bend of the Payette river, where a hotel afforded a lodging place and an early breakfast. From this we descended the river a short distance, crossed and proceeded up Squaw creek to the last ranch, where we took the trail up the mountain which had to be crossed. Reaching the summit and crossing it, a dense and vine-tangled thicket was entered, where our guide soon became bewildered and led us here and there until approaching darkness, when, stumbling over

rocks and briers, we suddenly emerged on the banks of a mountain stream.

Camp was made here, and although the trail was found in the morning we did not come up with the command that day nor the next. Our provisions ran low, and through hunger and fatigue from continuous hard marching, we suffered considerably before the command was overtaken on the fourth day. A cordial greeting and rich entertainment awaited us.

It was not till long after that we knew the kindly colonel and genial adjutant had saved, for 2 days, the peaches which graced the board. Soon after our arrival the rest of the command joined, and early on the following day the line of march was taken up Elk creek.

Now we were to take an unknown trail which white man never before had trod and where we might at any moment meet with the enemy. There were vague rumors of a 7-peaked mountain, of a 7-forked stream, impassable canyons and slide rock without limit. All these we found, and more.

The scouts sent ahead found the trail nearly impassable, but were assured that the rolling off of a mule or two was not to be heeded, so pushed on. Night found us near the summit and camp was made close by an Alpine lake.

Old Indian trails were found and for the most part followed. It was evident that there were usually two over the same route, one being a high-water and the other a low-water trail. Often along the line of march there would be found rocks piled up with loop-holes, affording protection to defenders of the trail.

The next day led us along ridges, across valleys, swept by winter avalanches from the mountain side, and piled in inextricable confusion. Slide rock or rock avalanches had to be crossed where each footstep of predecessor was obliterated as fast as made, and night found us ready for the bivouac.

So on day by day till signs of the Indians added to our ever increasing watchfulness. Fires were not lighted before dark and then in some nook where they were concealed as much as possible. They were extinguished before day, that no smoke might betray our approach; game, although abundant and marvelously tame, went undisturbed.

Reaching Big creek, where the last expedition had come to grief, we halted for a short rest. The blacksmith was looking at the horses and making a shoe tight here and there, when the sound of a distant rifle reached us. "Boots and saddles" was sounded, then the "trot," and the echo of a scattering shot now and then reached our ears and spurred us to greater effort. Down the valley, through chapparal where the ardent yellow jacket gave a warm reception, over boulders, and finally up a steep mountain to a bench, where we found the scouts had routed the Sheep Eaters.

They had disappeared among the rocks, leaving a rich cache of dressed skins, furs, dried marmot feet, dried salmon and salmon eggs, and great stores of service berries. No casualties attended this skirmish, and, the Indians being scattered, the main portion of the command went into camp for the rest of the day and night.

After dividing the booty, the scouts moved on in search of the trail of the fugitives, who had a small herd of ponies and some women and children, so that it was difficult for them to wholly conceal their course, which led over the divide. Farther on the ponies were abandoned and all the Indians scattered among the rocks, where their trails were lost. Securing the ponies the scouts went into camp, sending back couriers to announce their success.

The troops remained at the site of the first skirmish during the night, and in the early morning prepared to move on. Our advance was well up the mountain when the rear guard was attacked. At the first sound of a gun the command rushed down the mountain and was soon on the field, scattered among the rocks in search of the foes. The conflict was short, the Indians retreating. Now and then a glimpse of a swarthy body, or a red garment, would be had and fire opened, yet most of them made their escape, while our loss consisted of 1 man slightly wounded and 1 fatally. The coolness and quiet bravery with which this man looked upon the inevitable ending of his sufferings elicited the praise of all. To one he gave his knife, to another his tobacco-box, and then after leaving messages for those at home, said: "I am ready; go on."

While the surplus baggage, saddles, etc., were being burned, an animal left the herd, which was grazing some distance away, and coming toward the party of officers standing near the fire, dropped dead. It was found that a wound had been received during the fight and had escaped notice when the stock was inspected. After the firing ceased, no Indians were seen, but throughout the day the mocking cry of coyotes, first near, then far away, were heard; yet patient search failed to uncover the game.

Later it was learned that less than a dozen Indians were engaged in this attack. They were returning from a raid on a ranch when they saw the troops, and under cover of night crept among the rocks, hoping to stampede the pack train. They were poorly armed and had little ammunition.

The rest of the day was spent in searching for traces of Indians, and the camp of the previous night was again occupied. In the morning, resuming the march, our eyes were greeted by signal fires on many peaks, as well as along our prospective route, but we sought in vain for their builders. Now we came upon evidence of hasty flight. Here a squaw's saddle, made from 2 oblong cushions and fastened together covered

with beautifully dressed mountain sheep skins, a talma with fringe of the same material; a little farther we passed the carcass of a hapless mule which had been killed and the fore quarters cut off as the fugitives hurried along. Another peak and more canyons to climb, and cross, and we overtook the scouts in their bivouac with the captured ponies.

By this time many of the animals were worn out, "heap tired," and were shot to prevent their falling into the hands of the Indians. The Sheep Eaters' ponies were much smaller than the ordinary cayuse, probably due to their environment, but they were well formed. As they were footsore and unable to go on, they were shot.

Early the next morning the command moved on and the advance was well up the mountain when the sound of rifles recalled us to repel an attack on the rear guard.

The contest was short and sharp, the Indians escaping among the rocks. One man was killed and 1 wounded, besides a small loss in horses and mules. The next morning the march was resumed over the divide, and the scouts were overtaken, with the ponies captured from the hostiles on the previous day.

Moving on the now faint and scattered trails of the fugitives, the Middle fork of Salmon river was reached at the upper end of "Impassable canyon"—a canyon with vertical walls reaching thousands of feet in height and extending for many miles. Here an old winter camp with grass-covered and bark wickiups was found. The grand cliffs of the dark canyon, lofty mountains on every side, and the swift, rushing river, made a scene to be long remembered.

Our enemy had vanished, leaving nothing to indicate their course; but later were compelled to surrender.

LIL' JOE.

GEO. W. STEVENS.

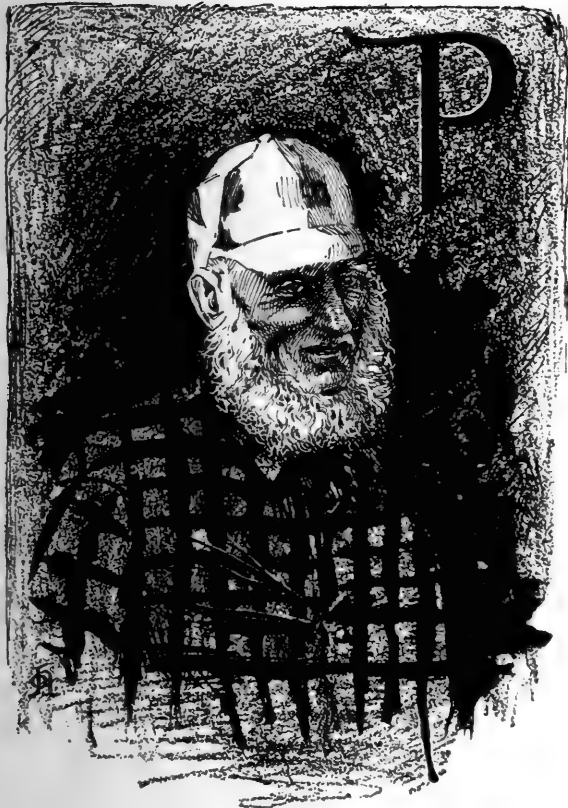

ETE'S growing ole. Sometime I feel
I ain't much good but fish for eel.
I 'member when dis marsh was lake
An' moonbeams dance in pon' boat's wake;





I 'member when no house for mile'
'Cept few ole shanty by Presque Isle.
Dat be de time when Pete be smart
And know de muskrat trick' by heart;
An' when two duck come all alone
I jes bang once; she fall lak stone.
But time is change; Pete los' her eye;
I can't shoot one duck now, I try;



I tink I go an' save some wood,
An' maybe sometin' else dat's good;
An' dat's de way I find my Joe.
He's big boy now, dat's long time 'go;



But dats all right, I got my Joe.
You hear 'bout him? What, No?
Well, one night win she blow, blow, blow—
Lak nevaire blow before, I know;
An' some big boat jes off de shore
Go down, an' don't come up no more.
She all bus' up an' den nex' day
Some t'ings be floatin' hon de bay.



De probate court try take from me,
'Cause lil' Joe have propertee.
But lil' Joe she hug me tight;
I say you tak him now you fight;

An' den de court she swear my han'
 An' guess I mak' good guardian.
 I teach him fish lak anyting;
 An' how to set de trap in spring,

An' how to hunt, an' how to row,
 An' how to mak' de pon' boat go;
 An' now two duck come all alone
 My Joe bang once—she fall lak stone.



CAMP FIRE TALES.

VII.

A VISITOR.

J. LOEFRIC.

"Do you know," said D'Auber, "I think, seriously, we ought to kill the Idiot. If we don't, he will kill us."

Old Pop grinned. "Ye kaint burn him, he's too green."

"No, I wasn't thinking of burning; that would be too mild a torture."

"Suit yourselves, gentlemen. Anyway you please. I'm always ready to sacrifice myself for my friends," interposed the Idiot, trying to assume a martyr-like air.

"I propose we hold court and try the criminal. Make Old Pop judge, I'll be prosecuting attorney, and the rest of you witnesses." Ten Gage's proposition met

with instant favor, and preparations were made at once to carry it into effect.

Our camp that night was on the banks of the famous Forest lake, then an almost unknown spot, but since become famous for its black bass fishing. Right at the edge of the woods, a sandy little beach in front, the tent looked out on the quiet lake—quiet save for the splash, now and then, of a fish leaping in the air, and falling back on the placid surface.

The hunters had turned anglers, laying aside the gun for the rod. The lake, or rather the 2 lakes, lay on the line of the St. P. & D. Ry., our camp being within a few

rods of the tracks. A camp chest, regardless of contents, was turned on end for the judge, Pop Collins, while the witnesses arranged themselves in various attitudes.

"Bring in ther pris'ner." The judge assumed a stern air.

"Guess I'll have to arrest myself, won't I?" drawled the Idiot.

"Mister Clerk! Who's ther Clerk?"

Nobody spoke. All wanted to be witnesses or spectators.

"I appint D'Auber Clerk o' this here Court." D'Auber seated himself in front of the judge, his back against the judge's seat, pencil and paper in hand.

"Mr. Clerk, fine ther pris'ner \$2 fer kin-tempt o' Court." D'Auber entered the fine.

"Pris'ner, who be ye? and what yer been doin'?"

"Please your Honor I don't know, yet."

"Mister Clerk, \$2 more. Pris'ner, be careful what yer say. Mr. Clerk, swar ther pris'ner."

Clerk: "Pris'ner, hold up your left hand. Now repeat after me. 'I solemnly swear never to tell the truth——'"

"No need to swear him to that," said the Infant.

—"to always divide my bottle with the Clerk of this honorable Court——'"

"But not the contents"—added the Idiot——

"Two dollars more," shouted the judge.

"Never to put burrs in the Hon. Joseph's blankets and—(here the Clerk stuck, but an idea came to him and he went on) so help me 4 aces in a jack pot."

His Honor: "Ther pris'ner'll hold his yap whilst ther Clerk reads ther indite-munt."

Clerk: "You, the Idiot, stand before this bar of judgment accused of—what's he accused of, Judge?"

His Honor: "Of bein' er Idjet, mostly."

Clerk: "Of being an Idiot and conspiring against the peace and good temper of this Court."

His Honor: "Are ye guilty or not guilty?"

Prisoner: "Your Honor, I have no lawyer and——"

"Yer bet yer boots, I'll defend yer, young feller."

Every one started, except his Honor, and looked in the direction the sound came from. Out of the shadows of the trees stepped the raggedest specimen of the genus hobo we had ever seen.

"Ef et's ther pleasure of his Honor and ther Pris'ner, I'll do ther defense act," said this apparition as he stepped into the fire-light.

His Honor: "I guess as how ef the Pris'ner kin stan' it, we kin. Idjit yer kin confer with Whiskers."

Whiskers: "Gentlemen, ye'll excuse my sudden ontray, but I'm er sort of modern knight of the road and kaint see ther weak

an' defenseless oppressed. I war jes' com-in' ter borray the loan of er square meal when I hears ye a railroadin' this innercent young man to prison or to death, an', as usual, I rushes ter the resqu."

Joe: "There's no flies on you, pard."

Whiskers: "'Ceptin' in summer time. Now then, as I'se ter defend yer, young feller, yer better make er clean breast of it. Did yer steal ther hoss or not?"

Prisoner: "Your Honor, may I retire and confer with my Attorney?"

His Honor: "Yer may. This here Court's a'journd fer 10 minutes."

The prisoner and his counsel disappeared in the shadows of the trees. After a few moments a peculiar sound was heard, as of some liquid running from a jug or bottle.

"Counsel's collecting his fee in advance," remarked Ten Gage.

"You're mistaken," said Joe, "that's only a retainer."

"Wall," said Pop, "did yer ever see er cheekier hobo nor that?"

"Wait till we hear the defense. I'll bet he knocks the District Attorney out, in the first round," declared the Infant.

Here the prisoner and his counsel appeared.

Whiskers: "Yer Honor, we's ready."

His Honor: "Mr. Clerk, call the Court to order."

Clerk: "The Court will come to order."

Whiskers: "Yous don't know how ter call no Court ter order."

His Honor: "Silence in ther Court! We'll now percede with ther case."

Dist. Att'y: "Your Honor and gentlemen, you have all heard the indictment. Most of you are acquainted with the prisoner and are living witnesses of the truth of the indictment. Who has caused the fair and once rotund form of our beloved brother, the Infant, to waste away, to the frail and consumptive being he is? Who, I ask, has caused the fierce, upward curl to the once meek and drooping mustache of our worthy Clerk? Who is it that has driven the Hon. Joseph off his feed by putting indigo in his smoking tobacco? Who was it drove the talented and gifted District Attorney bald headed by drawing the shot from his cartridges, so that he never bagged a bird all day? Who, I repeat, has been for the past 2 years driving the honorable gentlemen before me crazy with his idiocies? Earth and Heaven unite in denouncing the prisoner at the bar.

"Gaze on that face, your Honor, and gentlemen! Beneath that mask of guilelessness lies a depth of depravity unequalled in the annals of crime. See how he cringes beneath the accusing finger of Justice. Your Honor, in the name of humanity and the cause of justice, I demand that this infamous wretch be sentenced to be muzzled while he treats the crowd."

Whiskers: "Yer Honor, we intend ter

prove ther allegations of my worthy brother ter be false and utterly without foundation. Yer take up ther first charge. Under this head we intend to prove ther prisoner public as well as er personal benefactor. Yer Honor and gentlemen, turn yer gaze on that benign countenance." (Points to the Infant.) "Gaze on its broad expanse of adipose tissue; think how ther succulent but elusive angle worm would have preyed on its rosy hues if it had not been for the self-sacrifice of my client. He saw, with horror, the rotundity of our skeletonized friend growing larger and larger; knew that at any moment nature might burst that ere frail tenement and scatter that ere fairy form to the 4 winds. With all the noble-heartedness of that manly bosom he sprang into the breach and—yer don't need a microscope ter find ther Infant.

"My learned brother accuses us of being the cause of the upward tendency of our most worthy Clerk's mustache. We admit it. We glory in it. It's only another example of how ther truly good is mistaken in this degenerate and sinful world. My client saw that in drinkin' coffee the honorable gentleman's mustaches would steal down his epiglottis and gently tickle his thorax; that they was liable at any time to cause consternation of his chest protector. Ag'in my client sacrificed himself for a friend, and behold his reward! Excuse me, gents, while I weep.

"But a truce to this weakness while we take up the next accusation. No! No! I can't, I can't gaze on that childlike sweetness and even repeat such a monstrous accusation. In reference to the abstraction of shot from my most erudite brother's cartridges, I can only say my client is a member of the S. P. C. A., and he removed the shot so that my accomplished brother would not, in the wild frenzy of the hunt, scare the little birds.

"Your Honor and gentlemen, I ax you as men, can you look on ther sweet purity of that ere face; ther soulfulness of them ere lustrous orbs, that ere wide expanse of brow, shaded by them ere Sing-Sing locks, and for one moment entertain a doubt of their utter innocence? Can you, I ask, gaze at them ruby lips, agape with thirst, and not offer ther prisoner and his counsel a drink?

"Yer Honor, we'll rest our case here pendin' ther drink."

His Honor: "The pris'ner's discharged and ther Camp pays ther costs.

"Afore we dismiss this Court, we wants ter say that ther pris'ner don't want to be brung afore this Court ag'in, 'cause he maint git off ther next time."

"Look here, Whiskers," said Joe, "what are you, anyway?"

"Only ther Prince o' the Tin Can, travelin' incog. fer my health. Accidentally me special car war side-tracked, an' seein' the

genial glow of yer fire, an' hearin' ther sound of yer musical voices, I recognized kindred sperits."

"Yes, you got most of mine," interrupted the Idiot. Whiskers waved his hand gracefully.

"All in the cause of humanity, my dear sir."

"Your cause has great capacity, I should judge," and the Idiot gazed regretfully at his flask.

"Ah, but you must remember the Good Book says 'Ho, all ye that thirsteth,' and I hoed."

"Hey, Whiskers, come here," called Old Pop from the other side of the fire. "Here's thet squar meal yer was wantin' to borrow."

"Now, that's suthin' like. When I gets tru wid that, life'll no longer be 'an empty dream.'"

For a few minutes no one spoke, but all lay back and watched the eagerness with which the tramp stowed away the food, while D'Auber rapidly sketched the grotesque figure.

"Yer'll excuse me, pard," remarked the tramp, "but yer an old river man I see," nodding to Pop.

"How did yer know that?" questioned the old man in surprise.

"Oh, lots of ways. Yer puts saleratus in yer biskits. Now if yer'd use bakin' powder, all mixed with ther flour, yer'd improve yer cookin'."

"Wal, but yer got nerve!" was all the astounded Pop could say. Looking over to D'Auber, who had finished his sketch, Whiskers said, "Could I look at that sketch, sir?" D'Auber handed it over to him without a word. The tramp held it to the light and examined it critically. "Excuse me for my presumption," he said, "but you're a little faulty in your foreshorten. Allow me ter take your pencil. Now if you'll notice, it only needs but this—and a line here—I think we have caught the expression." He handed back the book.

D'Auber looked at it a moment, then at Whiskers. D'Auber rose to his feet.

"Gentlemen, I thought I was an artist, but I'm only an amateur. You, sir," he turned to the tramp, "are an *Artist*. Allow me"—and he held out his hand. Whiskers gazed at him a moment, then taking off his ragged tile bowed and said,

"Thank ye, sir, but I can't take your hand. I am no longer fit. You're a gentleman and I—well, I'm only er hobo—as ain't fit ter shake hands with yer. An' now, gentlemen," turning to the others, "thankin' yer fer yer kindness I'll bid yer good night." He turned to go when Ten Gage, who had been staring at the tramp, watching every expression of the be-whiskered face for the past 10 minutes without a word, said suddenly, "Dol."

Apparently the tramp did not hear. Ten Gage took a step forward and laying his hand on Whis-

kers's shoulder turned him around facing him.

"Dol," he said again. A blank look spread itself over the tramp's face.

"Guess yer made er mistake, Pard," he said in a curiously quivering voice. "Thet ain't my——" He tried to finish. "Thet ain't my——" He choked a little, his throat seemed to fill. Tears gathered in his eyes. He struggled for utterance. Finally he managed to say, in a broken voice, "Sam,

don't! I can't stand it! let me go! Dol is dead—dead this many a year—don't open old graves."

"Dol"—and Ten Gage's voice trembled; "I never gave you up." Throwing his arm over the ragged shoulders, he drew the man away, down the beach.

The Idiot was the first to break the silence. "It's his brother! Good night boys," and he disappeared in the tent where, without a word, the others followed.

A WEDDING TOUR IN THE ROCKIES.

MRS. IRA DODGE.

"Mr. Ira Dodge and Miss Sarah E. Slate were married at Bozeman on the 4th inst. Miss Slate was married in her riding habit, and after the ceremony mounted a horse to accompany her husband to Wyoming, where he has a ranch. The wedding journey will be fully 200 miles, on horseback, into a country where houses are not to be found in a day's ride."—Bozeman, Montana, Chronicle.

We had arranged to immediately take up our abode in one of the wildest spots of the Rocky mountains, where large and small game was abundant. We had directed that all our effects, household and personal, should follow us by team, and so we took little with us. We had a good camp outfit, tent, bedding, stove, plenty of provisions, good warm clothing, and 9 horses.

We left Bozeman in the afternoon, October 4, 1892, somewhat in advance of the pack-train, but Charles, our helper, soon overtook us with that, and shortly afterward the first camp was made, 8 miles from town.

Our journey the next day was through the prosperous Gallatin valley; we had not yet reached the wilderness. Charles left us at noon, going back to town. An early camp was made beside a mighty monarch of the forest which had fallen by the chopper's hand, and a pleasant place it was. A pack-train passed us, on its way down, loaded with elk meat. The elk had been killed in the basin toward which we were journeying, only a few miles farther on.

The second morning was a trying one. When we would get the horses into our improvised corral, my pet horse would break through and that would start the others. Finally we drove them several miles to a ranch and corralled them there. My horse jumped the corral and ran off, so I had to ride another that had never before been ridden by a woman, but she behaved all right; not a wrong move all day. She after-

ward became my pet mare and never deviated from her good behavior of that day.

By the time we returned to camp, got the horses packed and were ready to start, it was after 12 o'clock. We moved along briskly until we reached the Gallatin river, which was forded and the trail taken up on the other side.

It was indeed a trail! Over huge boulders, through shale or slide rock, up one steep hill and down another, across small streams that came dashing down the mountain to join the river, finally emerging for a breathing spell into open space, only to go again through similar scenes.

Night found us at the "Basin," a ranch owned by a Mr. M——. We camped in a cabin nearby and spent the evening at his house.

We did not leave camp until 11 o'clock, for good camps could be found anywhere in the next 20 miles, and the previous day's ride had been a very hard one for the horses as well as ourselves. We put a pack on one horse that had never packed before. Now, sometimes there is plenty of fun in doing something of this kind, and you are able to pick up the contents of that pack for miles around, but we took much precaution to avoid this. We blind-folded the horse, held him carefully, and when all was ready, turned him loose. He turned around a few times, tried to run, gave it up and that ended it. He was a good pack horse from that on. The day was uneventful as was also the following, and on October 9th, after an early start we reached the divide, or watershed of the Gallatin and Madison rivers. The divide is quite low, surprisingly so to me, and I scarcely realized when we crossed it.

Now came some rough riding, up steep pitches and down, crossing and recrossing streams, finally traveling along right in the water, through the brush and over fallen trees, until we came to a nice little park, or

open space, and here we pitched our camp for the night. When the regular routine of camp work was done we climbed the hill and with the glass viewed the lovely valley lying at our feet.

There are several families living here, all acquaintances of my husband, and after dinner we went calling. At the first place the family was not at home. At the next we stayed a few minutes, and at the next the family had just moved out for the winter.

When morning came the rain-clouds had vanished, and though chilly it was pleasant. Our route now lay through the forest, and by noon we reached the Yellowstone Park boundary line. That night we camped at a station called Riverside. Here 3 soldiers are stationed to protect the game. As no hunting is allowed, our guns were sealed and we had to keep them so while in the park. Toward dark the air became warmer, foreboding a storm, and in the morning it was snowing. We stayed in camp all day; but the second morning was clear and cold, with about 6 inches of snow on the ground. We moved early and followed a winding wagon road up, up, over a mountain range.

In the distance was the Pyramid range, white and glistening in the frosty air, while nearer at hand were smaller ranges and the broad basin below us. Many tracks of elk, deer, antelope, bear and mountain lions were seen, but nothing appeared in sight but one lion, which crossed the road directly in front of us. After reaching the summit, the road was quite easy; only a gradual down-hill grade, until we rounded a curve, came down the hill and then were at the Firehole Basin. Uncle Sam has spared no pains to make the roads good, and they are gradually being extended through all parts of the park.

We forded the river and traveled the road up past Hell's Half Acre, past the great Excelsior geyser, and camped for the night right among boiling springs and on the bank of the river, on the only piece of bare ground we could find. No need to heat water here. Just go out and dip up all you want and then it is too hot to use without cooling.

We moved camp as early as possible in the morning, for the vapor was rising like a fog; the bedding was damp and our clothing was becoming so. We traveled the usual road to the upper geyser basin, some 3 miles away. The geysers were steaming in all directions but we had little time to spare, for some high ranges were between us and our destination, and we had seen the park before.

Leaving the geysers, we traveled a new road which we thought would take us to Shoshone lake; but it did not. It wound around and around up the mountain, up until we could see the main range of the Rockies—the Continental divide. After

getting clear to the top of this divide we could see our destination, but that was not being there. Like a panorama the country lay at our feet; the green trees, the pure snow, and farther on the blue, shining water surrounded by mountain chains; while in the distance, just peeping above the other ranges, were the mountains I had longed so much to see, the Teton range.

We made an abrupt descent, making a trail for ourselves, through the timber and into small open spaces, running on to elk and bear sign, and finally coming out at a lovely little spot beneath tall trees and on the East shore of Shoshone lake.

Did you ever camp in a place you felt as if you never wanted to leave? This was the way I felt about leaving Shoshone lake the next day. But the morning was passing and we must leave for a long, hard ride through the timber, up and down ravines, on the shores of the lake again. We passed Lewis lake, skirted its shores some distance, then plunged into the forest again and followed a very dim trail. It was a long, tiresome ride, through "forests interminable," crossing small ravines, jumping fallen timber and over boggy, spring marshes.

Finally, we came to a small open spot on the banks of the Lewis river and rode out into the stream to admire the falls. They were more cascades than falls, for the water leaped and tumbled in feathery foam over rocks of perhaps 50 feet or more in height. Leaving this small park, we again plunged into the forest and traversed it without a break in the monotony until we found a small opening where camp could be made; but it was late, later than we had ever made camp before and we had ridden fully 25 miles, and this was the 10th day of our trip, October 14th.

It was noon when we left this camp, and came to a camp of soldiers, and after our firearms were examined and found sealed we were allowed to pass. In a short time we met a party returning from a long hunt. The hunters said while on Buffalo fork, they could hardly sleep, for the elk made such a noise whistling. You should have seen their eyes open at the sight of a woman in these wilds. One man stared at me as if I were a strange animal, or a crazy woman.

Ahead of us was a pass, and on reaching it a glorious sight met our eyes. Straight ahead, but far away, was Fremont's peak, and at its base lay our Mecca. Near at hand, on our right, were the grand Tetons. When a child at school I used to gaze longingly at a picture of Teneriffe peak, in my old geography, and thought that was the way all peaks should look; but although I had lived 7 years among the mountains my ideal had never been reality until now. When they burst upon my vision with clearness, and so near at hand, I at least had one illusion realized. Never shall

I forget the feeling that came over me when first I saw their snowy summits. Their height is nearly 15,000 feet and glaciers are found among them. On the left was a low range of wooded mountains and at our feet lay Jackson's lake, similar to Shoshone lake, but larger and dotted with a number of small islands. This valley is the famous Jackson's Hole.

It snowed on us all the way, on October 16th, to our next camping place. We saw ducks and geese a number of times, and finally I saw my first band of game animals, a bunch of antelope, about 16 in number and running at full speed. Night found us camped on the East bank of Pacific creek.

The next morning we found we had a very raw, disagreeable wind to face, with flurries of snow included. We traveled about 6 miles, when we came to a cabin, the home of a rancher. We sat by the fire and were made so welcome by the owner, who begged us to remain until after the storm, that we concluded to do so. During the day he said I was the first woman ever on that ranch. I must have been the only one his dog ever saw, for when we rode up to the house, the dog came out to meet us, but when I alighted he took one good look at me, gave a yelp, dropped his tail and made off, and during the entire stay I failed to get him near me. The cats ran out of the house, too, when I went in and the chickens scurried away in haste when I went to the barnyard.

As it was still snowing the next morning, we stayed through the day, but on October 19th, the clouds were rising and disappearing when we arose. We prepared to move on in spite of the earnest solicitations of our host to remain. Our ride led directly over the hills, and the farther we went the less snow we found. Antelope were around us everywhere all day long. Just at this season they were traveling Southward to their winter homes. In going over a hill we suddenly came on a bunch and startled them so they ran directly in front of the horses thus giving us a fine view. We did not shoot at them for we had meat enough.

The only regret I felt was that we were leaving the Tetons without having a view of their tops in a clear sky; for by night they were out of sight. We camped on a small creek where placer mining had been tried. The gold-pans, sluice-boxes, and lumber were lying around promiscuously, showing they had long been deserted.

The morning of October 20th, was beautiful, clear, yes and cold. Just across the creek from us was a huge red hill and the sun seemed to fairly set it ablaze. The first thing I saw in looking at it was a band of antelope moving along on the narrow trail. We saw a solitary man with a pack train in the distance during the day, the first human being for 2 days. Toward even-

ing we came to a high ridge and saw a bunch of antelope on the opposite one. They saw us in an instant and stopped to look; then one came on ahead. He would run some distance, then stop and look, then run on again until finally concluding the coast was clear he uttered a peculiar whistle and the whole bunch followed.

That night we camped on the site of an old Indian camp and utilized their tepee poles for firewood.

October 21.—We struck out boldly across the range this morning. The divide was low and there are game trails clear across. I took the lead and after a little difficulty we arrived in the valley below, on Green river. Antelope were still with us, everywhere, in bunches of from 2 up to hundreds. We were nearing our destination, and felt we were almost home when camp was made that night.

When we arose on the 17th day of our trip, it was with the expectation of reaching our destination that afternoon. A low range was to be crossed and on going over we had an exciting race. My husband started to rope an antelope that had its left leg broken. Although on a good horse, he could not get near enough the antelope to throw the rope. At a small rise another antelope ran in between them, and the wounded one got into a thicket.

We saw quite a number of cattle on this divide and when across it, had another antelope race. I started in it, but it was harder riding than I liked. I stayed with the pack-horses while the hunter and hunted disappeared from view. The antelope made good its escape. Soon after, we began to see some civilization and by 2 o'clock were at the Cora post office.

We spent several days looking around, riding over the country and found we had reached a game-range indeed. Elk, deer, antelope, bear, mountain sheep, and moose were here, besides trout in millions, and feathered game. Then we concluded we would go up to the mountains again and camp until our goods arrived.

We had been in camp but a few days when, on November 2d, my husband had a terrible encounter with a grizzly bear which nearly cost him his life. He was taken to the nearest house where he could be cared for, and it was 2 months before he could leave with safety.

In January we moved to our home. It is said that sometimes too great happiness is only a forerunner of sorrow and so it was in this case. My husband's hand and eye had to have medical attention, so in March we went to Salt Lake City for the necessary treatment; but he fully recovered from his fight with the grizzly, barring a missing thumb, a stiff hand and a sadly scarred face. We now have as cosy a little home—"Willowglen," on the East side of the Wind River range—as can be found anywhere.

A DAY WITH QUINAULT TROUT.

F. J. CHURCH.

Reader, have you ever had the fortune to cast a fly upon waters practically unknown to man—so thoroughly unknown that no fly had ever been cast there before—no hook ever dropped into the transparent depths of the azure pools? If so, you have enjoyed a treat given to few of us in this world; and if your success was equal to your natural anticipation, you have had a banner day in your career. If you have been thus fortunate, and have not already done so, I beg of you, in the name of all true anglers, to tell us about it, in the columns of RECREATION. I have had such an experience and here is the story of it.

During the summer of '96, 3 of us undertook a trip never before attempted, in its entirety—i.e., to cross the many ranges of the Olympic mountains, that lie in tumbled, jagged, forbidding masses in the extreme Northwestern part of our country, in the State of Washington, reaching the Quinault river within a mile or two of its source in the great Lindsley glacier; then down the river, across the beautiful lake of the same name to the sea. Then a long ocean voyage on the huge billows of the Pacific, around Cape Flattery in an Indian dug-out canoe. This journey occupied 2 months, being full of adventure of various kinds, and in future articles I hope to tell you of the most interesting features of the trip.

In this present paper, I shall tell you of the incidents of a day of days, or rather of 3 hours on such a day, when I had my first and last introduction to the Quinault trout, which appears to be a species by itself.

We had been tramping down stream for "3 suns," as the Indian would say, carrying packs of over 70 pounds each; following the elk trails when we could, or walking the gravel bars along the river, wading when necessary. The river was milky, from glacial action; but otherwise, as far as appearance went, was an ideal stream for trout. We camped each afternoon about 4 o'clock, and industriously whipped the pools and rapids; but with no success at all, not even a rise. To say we were disgusted, but mildly expresses it; for in addition to our camera, tent, provisions, blankets, rifles, etc., we had packed along 2 split bamboo rods, in their stiff cases, and if there is anything on earth that will drive a man to drink, it is trying to crawl through a vine maple jungle, on a scorching July day, with a heavy pack, above which projects, for 2 feet, a trout rod in case.

All the morning we had been working along the ridge above a superb, but forbidding canyon, the elk trail being in places as wide as an ordinary road, but very steep,

giving us much tough climbing. About 2 P.M. we reached the river bottom again, where a large stream came into the main river from the South, and at the junction, ye gods, what a pool! Fifty yards long and 30 across! Clear as crystal, with an exquisite tinge of blue and plenty of foam flecked eddys and ruffles that *must* contain trout.

With one accord we hunted up a good camping place, pitched our tent and cooked a hasty meal. We were all eager to try the unknown waters. Drawing lots for the big pool, at the forks, my companions were the fortunate ones and I took my way down the river, which, except at rare intervals, was too deep to wade. The air was cold and raw, the rocks slippery, the water literally ice-water, being nothing but melted snow and ice; yet the eager anticipation as to what the few remaining hours of daylight might bring forth, made us careless as to cold or fatigue.

For nearly a quarter of a mile below camp the stream ran swiftly between rocks and boulders, without a sign of a pool. I cast my flies right and left, as carefully as I knew how, changing them once or twice. I fished in rapid waters, and in the swirls behind the rocks, but all to no purpose; not a rise could I get. After I had almost made up my mind there were no more pools in the river I came to a beauty—grand, if possible, than the one above, where my companions were fishing. The river ran against a long rocky ledge, which turned it almost at right angles, forming a magnificent pool, with just below it another slightly smaller. With the mental comment that "if there are trout anywhere on earth, they are in there," I cautiously crept up behind a big rock and made a cast. The line straightened out, the flies settling on the water as gently as a falling snow-flake, exactly in the spot I had intended to reach. My heart was in my mouth. I must confess I fully expected a strike, and a good one at that.

But no, the foam bubbles sped merrily by. A little water ouzel bobbed up and down on a stone, chirping away in his own merry fashion; while a pair of stellar jays, in an under brush, were making all the row they could. I cast and recast in that pool. Then I tried the other one; but not a sign of a fish did I see. Then I tried a trolling spoon; then naked hooks, baited with bacon; but I might as well have been fishing in a bucket of water, as far as results were concerned.

Looking at my watch and finding it was 6 o'clock, I made up my mind to make one

more cast and quit. Some good angel must have prompted that; or, perhaps, the goddess of fate had relented. At any rate, from the moment the flies settled on the water, at the completion of the cast, until it was too dark to see, I had my hands decidedly full. The tail fly, a *Parmachene Belle*, was seized by a rainbow trout, about 6 inches long, who was promptly landed, with the exclamation, "world, I'm not skunked anyhow."

I cast again with a resulting flash of white and silver, and a churning of the waters that made the pool fairly bold. Phtw! I had something this time with a vengeance. Back and forth across the pool he flew, breaking water constantly, leaping 2 or 3 feet in the air, angrily shaking his head the while in his effort to loose the barb from his jaw. It appeared as if the fish was made of springs, and that each time he struck the water, he was projected therefrom again by some great catapult.

After some 3 minutes of this work, the steady strain of the rod, aided by the pressure of the automatic reel, began to tire him, and he sought the depths of the pool, where he doggedly held on, refusing to move, but giving queer little quick jerks on the line. From being cold, I was now bathed in perspiration, and in the battle had waded in above my waist. But what cared I provided always I could win in the end and land the prize.

Having neither landing net, nor gaff, it was a delicate proposition. In the anxiety of the moment, it seemed as if his royal highness remained in the bottom of that pool for an hour or so. It was probably not more than 3 minutes, but when he finally did make up his mind, his decision was made and acted on instantaneously. Away he went, the reel singing merrily, straight down the pool and out of it, down the stretch of river to the next. Having only 100 feet of line, I followed as best I might, floundering in holes up to my arm pits, barking my shins against unseen rocks; once falling flat and dropping the rod, to pick it up with fear and trembling. I found, to my great delight, that I still had him.

Finally, having reached the lower pool, he began to sulk again; but his struggle was nearly ended, and after the most exciting half hour I ever put in, I dragged him, panting but unconquered, out on to a gravel bar. Just as I stooped to pick up my prize, the hook slipped out of his jaw, and away he went, in frantic flops, toward the river and safety. A wild foot-ball dive, on my part, and a mixed up jumble of arms, legs, water, pebbles and trout; a lucky slipping of a finger in his gills, and I arose triumphant. Twenty inches if he was an inch! Full bellied, with absurdly small mouth for the size of the fish! The back an intense, greenish blue, while the sides were clear

silver and the belly white. Such was my prize—the *Quinault* trout. I should judge he would weigh a trifle over 3 pounds.

Wiping my brow, and making sure the brown hackle that took him was fit for another battle, I cast again, this time in the lower pool. Again a monster fish was hooked, and again every nerve in me shook with excitement until, the fight being over, he lay beside the other on the pebbly beach. At 7.30 I had 8 trout, all of a size and all of equal fighting qualities.

The sun was just dipping behind the low hills to the Westward, so I made up my mind I would try to catch one more, to make it 3 a piece, in case the other boys had been unsuccessful. A dozen casts were made without a rise, when, just as I was about to lift the fly off the water for a final attempt, I saw something long and brown come slowly up to the top fly—a *Reuben Wood*. The great jaws opened, making a cavity large enough for me to put my fist in; and when I struck it felt as if the hook had imbedded itself in the trunk of a tree.

The instant he felt the pain of the penetrating hook his sluggish movements, of the moment before, developed into those of lightning rapidity. He did not break water at all, but around, across, up and down the pool he went, the line making a hissing noise as it cut through the water. The occasional glimpses I got revealed a great brown fish with a yellow belly. Making up my mind I was fast to a salmon, and one at least 3 feet long, I yelled and howled for the other chaps to come and help me out; but the roaring of the river kept them from hearing me.

I played that fish until my wrist was so tired I could scarcely hold the rod; and finally, when his tremendous speed slackened, I seated myself on a rock and simply let the rod and reel keep a steady pressure on him, knowing that he must tire, in the end. Finally he gave up and turned on his side, and ye gods! A broad, deep red stripe ran down his side from head to tail. There, within 6 feet of me lay the grand-daddy of all the rainbow trout I ever saw or heard of. He was hooked fair in the hard muscles, at the top of his jaw, and if the tackle had been strong enough I could have hauled him bodily out on the sand. But I knew his weight alone, if unaccompanied by any jerk, would break my leader; and so I attempted to reel him in short until I could get my hand in his gills.

Carelessly I had let my reel down, neglecting to take up the last 3 feet of line, so I stripped the rod, carefully pulling the line in with my fingers. When I grabbed him, my foot slipped and down I went on my hands and knees. Away went the trout, the crashing of the stones having put new life into him. I was not at all worried, knowing I could soon reel him in again; but horror of horrors! *miserabile dictu!* In

some way unknown to man or the devil, the line had formed a half hitch over the tip of the rod. A tightly singing leader and line; a moment of agony; a sharp "snap," and all was lost! A deep, muttered, heart-felt ejaculation, far more forcible than elegant, followed by a wild plunge into the pool in the hope of grabbing something, and a wet, tired and utterly disgusted angler stood on the bank looking wofully at the rapids flowing near, and now becoming black with the shades of night. No words in the English language—or any other language—could express my feelings.

And so, gathering up my rod and string of trout, which were all I was able to lug, I wended my way campward, where I found

a cheerful fire, and a pan of smoking trout awaiting me. My chums had had equal luck and had also lost the "King of the waters." Thus ended a day the memory of which will be with me as long as life lasts.

In this blessed region there are no poisonous insects, of any description, to annoy; and all would have been perfect if—Ah! reader, how much an "if" may mean. Never again will I get a chance like that. Such things come only once in a lifetime. The loss of that trout will be a regret to my dying day. Yet why should I complain? We could not have used him if I had succeeded in landing him. Besides I had had the most exciting afternoon's fishing that fortune has ever favored me with.

THE STRATEGY OF TWO ANGLERS.

GARDNER C. TEALL.

"Well, I'm sure I don't know what we're going to do for fish," said Kent, as he sat on the steps of the old boat-house and took his rod apart.

"If there had been any we would have caught some, you may depend on that, if it's any consolation," the other replied.

"I know. But to think of our coming away out here, loaded with all sorts of tackle, to a lake several miles long and nearly as broad, with all sorts of bait under our thumbs, from a grasshopper to a hop-toad, with science and magnificent theories at our command, yet not to get a sight of a fish, dead or alive! They'll laugh at us."

Evidently it was this fear that harrowed Kent's soul. No angler likes to be laughed at, for what he has not done.

The boys maintained a meditative silence for a few minutes and then Kent spoke again:

"Say, just for the fun of it, let's try it again. What do you say? Just once more, before we pack up."

So the rods went together for, like Barkis, the other was always "willin'"; and into the boat they piled and pushed out.

Perhaps it was because the water was not wet enough. At any rate the bass would not bite, nor would the muskalonge strike.

To add to it all, the wind blew the lake surface into white caps, and "that fish" kept out of the way in the most provoking manner.

The boys always spoke of "that fish" as "he," because, after the first 4 days of their angling (which was under the most unfavorable conditions) without getting a

strike, Kent and his friend had come to the conclusion that there was but one fish in the lake. They conceded this much merely because they had been taught that the existence of that which we call "nothing" can only be demonstrated by a contrast of itself with that other extata which we call "something."

"Did you catch him?" the good people at the house asked, when the boys returned.

There was a painful silence broken only by a miserere which emanated from a tuneful mouth-organ, in the possession of John, and the party entered the house bearing Gray's Elogy expressions on their countenances, relieved by an occasional Moody and Sankey smile.

Soon the day drew to a close, and, in their last few hours, while the sun still shone, they put in their time snapping the kodak where one least expects a kodak to be. Tiring of this, Kent returned to the house and was soon engaged in perusing "The Life and Adventures of Captain McDougall, the Apollonite," written by his daughter; while the other lad sauntered down to the dam and, Svengalistic as it may appear, was, within a few minutes, actually fishing again!

Minnow hooks and black linen thread completed his outfit. He had learned to make use of toad-stools, for bait, when it came to a pinch. And now comes the strange part of it all.

No, he didn't catch any porpoises or whales. Neither did he capture a turtle on whose back could be found carved words of mysterious import, the raveling of which

mystery would have made possible the reunion of some long-lost and thought-to-be-dead lovers. Nothing of the like. No, far removed from the possibility of such romantic happenings, the boy rested content in hauling out wee sun-fish and rock bass.

Not too fast. Don't condemn him. He had a purpose—a brilliant idea.

They would have some fish to show when they returned to the city, after all. And this is how the miracle was accomplished.

Taking 8 of the smallest of this miniature catch, selecting each one a trifle larger than the one before, the young man strung the lot on a thread and fastened them up, by pins, before a small piece of cloth at the sides of which he had pinned some weeds *à l'arbe*. The success of the scheme was assured then, and all it needed was an application of the camera. By this time Kent had finished his book and had sauntered down to view the arrangement.

He laughed when he saw the fish, and grinned when he was told what they were there for.

"Here," said Kent, "I'll run and get the camera;" and he was soon back with it.

"Now we will have something to show," said he; and standing so as to get as close a focus as possible, thereby magnifying the fish greatly, and casting what afterward proved a very useful shadow—he made 2 shots; "For," said he, "it will never do to run the chance of one not coming out clear. Our reputation depends on the success of the picture."

* * * * *

"Whew!" they exclaimed, at home—and there were several fishermen present who should have known better. "What! All these black bass in 16 minutes? If you boys were not 'cherry-treers' we'd call it a whopper; but maybe you are telling the truth. At any rate it's plain to see you got the fish, and we will not quarrel as to how long it took to get them, or the weight of each." And they took another admiring glance at the photograph. And well they might admire it; for it showed a string of fish that, to all but an expert, seemed veritable black bass, of enormous size. And the fellows' mouths watered as they gazed—and continued to gaze—on the "magnificent catch."

"WHISKERS."

JAS. WEIR, JR., M.D.

When quite a small lad, one of the first lessons set down in my copy-book, after I had graduated in "pot-hooks and hangers" was the trite old saw "Cleanliness is next to godliness." My Yankee governess, a tall, angular spinster, from Maine, made the meaning of this copy clear to my infant mind, pointing her remarks by calling attention to the Kentucky real estate which had found a resting-place beneath my finger nails, and which seemed to decorate them with perpetual badges of mourning. I have never forgotten that lesson and firmly believe in its truth.

The love of cleanliness seems to be inherent in the lower animals, with but few exceptions. We have all noticed the cat, the dog, the squirrel, the monkey, and the birds at toilet-making; and we know they spend a large portion of their time in cleansing and beautifying their bodies. Some of them are dependent on their own ministrations, while others are greatly assisted by humble little servants, whose only remuneration is domicile, the cast-off clothing, or the garbage and refuse from their host's table.

For instance, the common domestic fowl is greatly assisted in its toilet by certain little animals belonging to the family *Lithoe*. These little creatures carefully scrape away and eat the scarf-skin, and other epidermal débris that would otherwise impair the health of their hosts. Some of the fish family are entirely dependent on the ministrations of mutualists, as these little hygienic servitors are called, in matters of the toilet. Notably, the gilt cat-fish, which would undoubtedly die if deprived of its mutualist—the *Gyropeltes*. This remarkable little creature does not live on the body of its host, but swims free in the water, and only seeks him when it is hungry. The skin of the gilt cat-fish secretes a thick, glairy mucous exudate, which, if left to itself would imperil the health of the fish. The *Gyropeltes*, however, regard this exudate as delicious food and rapidly remove and devour it. All insects devote some of their time to the toilet, and there is probably no one who has not, at some time or other, noticed the fly, or some other insect, at its toilet.

The greatest lover of bodily cleanliness,

in the whole insect tribe, however, is, I believe, my pet locust, "Whiskers"—so named by a little neice, on account of her long, graceful antennæ. "Whiskers" is one of the smallest of her family, and is a dainty, lovely, agile little creature; light olive-green, in color, with red legs. She was reared from the egg, and has lived in my room all her short life. She is quite tame and recognizes me as soon as I approach, often hopping 2 feet or more in order to light on my coat-sleeve, or outstretched hand.

The first thing she does, after reaching my hand, is to seek my little finger and try her jaws on a diamond ring. The diamond seems to puzzle her greatly. She sometimes spends several minutes closely examining it. She will stand off at a little distance and pass her antennæ over every portion of it. Then she will come closer and make a more minute examination; finally essaying another bite with her powerful jaws. A great water-drinker, she evidently thinks the stone is some strange kind of dewdrop, hence her persistent efforts to bite it.

"Whiskers" has developed cannibalistic tastes, for the hardened skin around my finger nails is a favorite *morceau* which she digs out with her sharp jaws and masticates with seeming delight. She nips out a piece of skin, cocks her head on one side, and, looking up at me with her clear, emerald-tinted eyes, her masticatory apparatus working like a grist-mill, she seems to say, "Well! old fellow, this is good."

She passes most of her time on a bit of turf, in a box on my table, where the sun shines bright and warm. She is fond of water, however, and makes frequent excursions to the water-pitcher across the room. How she discovered that it contained water

is more than I can tell; but she did, and she visits it often.

It is in her habits of bodily cleanliness, however, that "Whiskers" outshines all other insects. I have watched her at early dawn and have always found her at her toilet. This is her first undertaking, even before taking a bite to eat. She makes frequent toilets during the day, and it is her last occupation at night before sinking to rest on a blade of grass. Her method of procedure is very interesting. She commences by first carefully cleansing her antennæ, drawing each of them through her mouth repeatedly. Then she treats her fore-legs to a thorough scrubbing, going over every portion with her tongue and jaws. With her fore-legs, using them as hands, she then cleans her head and shoulders, if I may use the latter term. Her middle legs and her long "vaulters" are then subjected to the same careful treatment. Her back and the posterior portion of her abdomen are next rubbed down, she using the last pair of legs for this purpose. Finally, standing erect and incurvating her abdomen, between her legs, she cleans it and her ovipositor, with her jaws and tongue. Her toilet is made 20 or 30 times a day. Invariably, after one of her excursions to the water-pitcher, as soon as she returns to her box this is her first occupation.

This interesting little creature shows a high degree of intelligence, inasmuch as she evidently knows the way to and from the water-pitcher. Many of the lower animals, notably the ant, the snail, the limpet, and the flea have the sense of direction highly developed; but it remained for "Whiskers" to show that even an insect of such low organization as the locust possesses it likewise.

RECREATION.

SAM. LEVEL CROFOOT.

Is my greatest consolation,
 It gives me all the sporting news,
 And quickly cures the chronic blues.
 It tells me where to hunt for deer,
 And makes me glad, 12 times a year.
 It treats of guns and game and fish,
 And everything that one could wish.
 I read its pages o'er and o'er,
 Then sigh because there are no more.
 These modest facts I free confess,
 And wish Coquina great success.

FROM THE GAME FIELDS.

A QUAIL HUNT IN THE INDIAN TERRITORY.

LEVI LUIGO.

On December 26th we started on our annual quail hunt up in the B. I. T. Our party of 5 consisted of Maj. L. L. Maughs, Dr. W. H. Mills, H. Brooks, Ed. Pollard and me. Our destination was some 20 miles Northeast of this place. We took the M. K. & T. Railway to Cale, I. T., some 16 miles North, and then by hack 10 miles East. About the time we arrived at Cale the wind came in from the North and blew great guns. Some one suggested that we had better turn back; but the rest of us did not agree with him. Soon after we left Cale it commenced to snow, but fortunately for us the wind was to our backs.

We soon came to a farm house where we expected to stay and were told they could not take care of us, as the man who lived there had left the day before, for Texas, after a wife; that they expected him back that night and would have to celebrate. The Major said he did not want to stop where there was a bride and groom, as it always made him feel sad. They told us they thought a farmer a little farther on would take care of us; so we drove on and soon came to the place. After making known our situation the man said we could stay; so we unloaded our plunder, ate our lunch, got our guns together and started out after quail. Major Maughs and Dr. Mills went together; Pollard and I together, and Brooks alone. The Major wanted to go with me, but I was afraid of his thoroughbred dog. The Major says he (the dog) has a pedigree as long as his arm, and from the looks of him I did not doubt it. He may be pointer, setter, hound or plain cur; you can't tell anything from his looks.

We all got back to the house a little before dark, with good bags. We rushed for the fire—one of those old-fashioned fireplaces at least 6 feet wide. Soon after supper was announced and we filed out. All ate as hungry hunters always do, and then made for the fire-place again. Soon after supper the others of the family commenced dropping in around the fire, and I thought they never would stop coming. There were 6 of us, with our driver; the farmer and wife, 2 grown sons, 2 nearly grown daughters and one granddaughter, 13 in all.

The house had 2 small rooms and one small shed, that was used to cook and eat in. I never knew where they all slept.

It was getting cold, sure enough, so we piled on the wood and told yarns until nearly 11 o'clock—all dreading to go to bed.

I think we would have remained up the most of the night if the Major had not got on to his war yarns. Then we all said we believed we preferred going to a cold bed, and off we started.

Pollard and I and 2 dogs took one bed, and the others in about the same order. The candle was soon put out, but we could see all the stars, on our side of the house, through the cracks in the siding. It had been put on green and had shrunk till you could put your hand through the wall anywhere. This makes a fine summer house, but not very good for winter, especially when the mercury is hunting zero. Still we all slept the sleep of the just and got up feeling good. Yet it was cold and we had hard work to get Brooks and Mills to wash their faces before breakfast. After a late breakfast we again started after the quail and hunted until noon. Then we ate dinner and started back to town, hunting all favorable places on our way in. After getting in town we divided up, and all were well satisfied with our trip.

BIG GAME IN MAINE.

OLDTOWN, ME.

Editor RECREATION: It is interesting to note the different opinions regarding our big game. Nearly all the guides will tell one game is on the increase; while many outsiders, and some of our own citizens, say game will soon go, with the buffalo. These citizens do not consider the difference between the prairies and our Maine forests. If our game could be turned out on an open prairie, where it could find no cover, it could then be exterminated by hunters, using repeating rifles and fast horses; but the 13,000,000 acres of forest land in this State, or a great portion of it, is jungle. In many places the hunter must pull the bushes apart to get through; and in 9 cases out of 10 the game is in such thick cover that it will hear the hunter and flee.

I believe our caribou are going North. In some localities where I traveled last year, and several years previous, I saw plenty of deer, moose and caribou. In October and November, last, I traveled with sportsmen some 50 or 75 miles through the same country, and saw few signs of caribou.

I do not judge of the condition of game entirely by my own observation; but from information gathered from practical hunters and guides.

I have no fear of our game being exterminated. Our fish and game commissioners, and the legislative committee on fish and game, have worked hard to devise plans for better game protection. They have

made more stringent laws, and have licensed the guides, which I hope will have the desired effect on game and fish hogs. Our laws are severe in comparison with those of the neighboring province of New Brunswick. Their law fixes the date at which the shooting of all kinds of game shall commence as September 1st, the open season to continue until December 31st. After that no one is allowed to go in the woods with a gun without a special permit from the Surveyor General.

In Maine the shooting of big game commences on October 1st, and continues to December 1st, which is 2 months shorter than in the provinces. The sportsman over the line is limited to one moose, 2 caribou and 2 deer; but if he kills in excess of that number, he gets off by paying a much smaller fine than in Maine. Here the sportsmen can kill only one caribou, 2 deer and one moose. For killing in excess of the legal number of moose, deer and caribou, the fine in the province is not less than \$20 nor more than \$40, and in default of payment of these penalties, imprisonment for a period not exceeding one month, nor less than 15 days. No one is permitted to kill any cow or female calf moose, within the province. Penalty \$200, and not less than \$100. The province fishing laws are similar to those in Maine.

It is estimated that 50,000 persons visited Maine in 1896. The number of deer taken by them is placed at 2,245; moose 133, caribou 130.

Granville M. Gray, Oldtown, Me.

LEARNING TO SHOOT ON THE WING.

L. A.

I saw in your March number a request for advice as to how to learn to shoot on the wing. An experience of over 60 years has convinced me that every one must learn this for himself. It cannot be taught, for the following reasons:

1st. The difference in mental sight. To some people the full moon looks no larger than a quart cup; while to others it looks as big as a peck measure.

I have tried to instruct several young aspirants, with indifferent success. When I try to impress them with the need of forelaying a crossing bird 5 or 10 inches, it may look to them 5 or 10 feet. The difference of nerve and temperament, in different people, is as important as quality of powder and gun. I was once shooting in Wisconsin, with another man and was not making a good record.

"Where are you shooting?" he asked. "You were sure death on prairie chickens yesterday."

"About 6 feet ahead," I said.

"Too slow," said he, "with your slow gun, Peterson's powder and the ducks going before this high wind. You ought to forelay all of 10 feet." I did so and they died.

Another difficulty is the excess or deficiency of "decision of character." Some slow men are good shots, but they are those who never pull till they are ready, and always do pull when they are ready. They seldom make good snap shots in thick cover; while the man who can think and act almost simultaneously is not so good at open field shooting.

The boy's first gun should be a model of what he is likely to use later in life. I first shot a single barreled, 20 gauge gun, and can now do my best work with that same arm; while to men who have learned with double guns a single barrel always feels like a stick. Beginners should early form the habit of shooting in advance of the game. No moving object in space is where it looks to be. The sun and moon are miles in advance of their apparent position at the moment the rays catch our eye and brain. So a bird in flight is in advance of where we think it is. Powder and nerve are quick; but some time must elapse, and that time is well improved when a duck is going down wind at the rate of a mile a minute—and they often do it. That rate gives them a flight of 88 feet a second and a second is only about 2 winks of the eyelids.

Now suppose a flock of 20 or 30 ducks are moving at that rate. They will probably occupy a range of 60 feet and are leaving more than that space behind them every second. How can you hope to hit any of them if you do not shoot well ahead? I have been in a position to notice beach shooters; and when they shoot well ahead it is most always the rear ducks that fall, if any. In early times in California, before quail were shot at, they would take to the trees and when they came down, in a parabolic curve, it required a guessing advance of 15 or 20 feet to tell where they would land. Another factor in wing shooting is optical illusion. Let a quart cup be suspended by an invisible thread, at a fair gunshot away, with the sky for a background, and the most expert rifleman will stand but a poor show of hitting it for the reason that he can see quart cups anywhere in space.

Learn to shoot in advance of a moving object, and practice will eventually tell you how far ahead better than I can. The reason so many birds are winged, and not killed, is because they are hit by the rim of the charge, and not with the centre—a sure indication of a poor shot.

Boys, you should commence with a 12, 14 or 16 gauge and load it right. Always use the same quality as well as quantity. Make up your minds to throw away a certain amount of ammunition. Blaze away till you acquire decision and knowledge as to where

to hold. Always be sure to level your gun and not to merely point the muzzle at the object—and you will kill—if you can estimate distance, quickly and correctly. This faculty can only be acquired with practice.

D. T. R. asks for hints on learning to shoot on the wing. Liberal and persistent practice at the trap is good for this purpose. An inexpensive trap can be made in this way: Take a piece of 1 inch oak board, about 3 feet long by 1 foot wide. Take another piece $\frac{1}{2}$ inch thick and of same di-

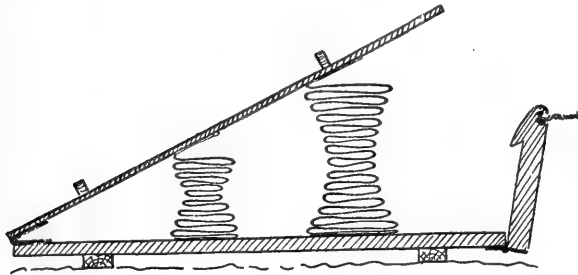

Fig. 1.

mensions. Attach the $\frac{1}{2}$ inch to the other by means of hinges at one end. Then get 2 springs such as are used in sofas, one long one and one short. Put the shorter one about 15 inches from the end of the boards, where they are attached, and the longer one about a foot behind that and the trap is finished.

Now for a trigger to hold it down, when ready to fire. Shape a piece of board into a hook and attach it by a hinge to the lower board. Then pull the upper board down

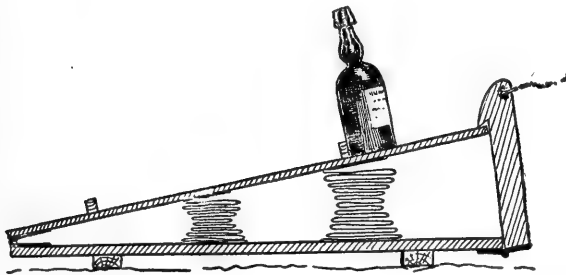

Fig. 2.

and put the projection of the trigger over it, and it is ready to fire. To throw the trap simply pull the string attached to the trigger.

This trap will throw bottles and cans far enough to afford good practice for any would-be wing shooter, and practice makes perfect.

K. C. S., West Newton, Mass.

The Bergen County Gun Club, of Hackensack, N. J., which in a year has become one of the strongest clubs in this vicinity announces that it will celebrate its first an-

niversary by holding a 2 days' shoot, at targets, June 2d and 3d. The programme follows:

June 2d: The 4th shoot for the RECREATION Cup, which represents the individual amateur championship of New Jersey gun clubs. This match is open to all amateur members of recognized gun clubs of the State. The conditions of the race are: 100 targets, 50 at known angles, and 50 at unknown angles, \$2. Entrance to cover cost of targets. The cup to the winner; \$5 to 2d high gun, and \$2 to 3d high gun. Optional sweepstakes on each 25 targets. Entries close before the completion of the first string of 25 targets. The shoot for the cup will commence at 1 P.M. sharp.

Sweepstake shooting will be started both before and after the main event, traps being ready for practice at 10.30.

June 3d: A programme of sweepstake events for this day will be arranged, the events ranging from 10 to 25 targets, with entrance fees at popular prices. The Rose System will be used in dividing purses.

A MORNING WITH THE WHITE RABBITS.

W. H. FLINT.

Early one morning in January, when the mercury was loitering in the neighborhood of zero, 5 of us started for the haunts of the white rabbit. In this part of New York State they are the largest game we have, with the exception of the red fox, and these are so scarce and such good runners that you can seldom run one to earth.

After a drive of 30 minutes we arrived at our destination. As soon as we had taken care of our team, and thawed the frost out of our ears and fingers, we let the dogs loose and started for the woods.

This piece of timber contains about 650 acres, with a large ravine running through the centre of it. On one side of this ravine, and parallel with it, runs an old log road. Up this road we all went, in single file.

About 2 inches of snow had lately fallen, which covered the old tracks, and as the sun began creeping above the tree tops, and we felt the warmth of its rays, we knew we were to have an ideal day's sport.

We had traveled about 100 rods up the road when whir-r-r from almost under our feet went a ruffed grouse. Then another, and instantly 5 guns jumped to shoulder. But that was all. The season had closed and the birds escaped.

All this time the dogs had been working but had started nothing, although there were plenty of signs. We were getting discouraged, when all at once the voice of the old dog rang out strong and clear as a bugle, mingled with the "yep—yep—yep"—of his mate. What music to a hunter's ear!

Robinson said, "Boys, I'd rather hear that than a brass band. There they go across the road above us."

Up the road some of us went, the others down. We took our stations about 500 feet apart, waiting for the game to circle and come back. Fainter and fainter grew the baying of the dogs. They went almost out of hearing—but hark! that sounded near. Yes, they have turned and are coming back. Nearer and nearer they come. Now be ready for a quick shot. They are almost here. What? Have they circled and gone back? No they have gone down the ravine. Down the road—quick—to head him off. Too late! Back in the road we go and take our stations again, satisfied bunny will cross next time.

Sure enough, in a few minutes we hear the dogs coming again. This time Mr. Cottontail comes straight for the road. Bang! Some one up the road has the first shot. Did he get him?

"All right," shouted Burdick. "I've got him." It was a long run for a rabbit—one hour and 15 minutes.

After giving the dogs a rest we sent them into the brush again. In a very short time they started a rabbit, and thinking it would be a better place down in the ravine I went there and took my stand where I had a good view of both sides of the ravine. I had been there but a short time when I heard the dogs coming. Then I saw the rabbit coming down the hill. He was making a bee line for where I stood. I said I would not shoot until he started up the hill on the other side.

He came so near I could have hit him with my gun barrel as he passed. I raised my gun, took deliberate aim and pulled—and pulled—. Then I tried the other trigger and the rabbit was over the hill out of sight. Didn't have my gun cocked!

Further remarks are unnecessary. Every shooter has been there and knows just how I felt.

As soon as the dogs had passed I went up to the road and there had the satisfaction of seeing one of the boys stop this same rabbit on his return.

It took nearly one hour to start the next game and nearly 2 hours to bag him. The woods were getting so tracked up, it was hard work for the dogs to follow a fresh track.

It was now growing late and we decided to start for home. Although we hadn't succeeded in getting as many rabbits as we had expected we were well satisfied with our day's sport.

SYRACUSE, N. Y.

Editor RECREATION: I should like to acquaint the readers of RECREATION, who are anticipating a trip to the woods, with Henry

N. Mullen, of Harrisville, Lewis Co., N. Y., who is one of the best guides and most accommodating men I have ever met. He knows the Cranberry lake region like a book. This is, without doubt, the best hunting ground in the North woods to-day, owing to St. Lawrence County being closed to hounding. The deer seem to have found this out and they flock in there from all adjoining Counties, which makes rare sport for those wishing to hunt in a legitimate way. Cranberry lake, with its many tributaries, also affords as good sport as can be found in the woods, with rod and reel.

Mr. Mullen has spent 33 years in this region and can show you a deer, or land you in a trout pond, on short notice. Last July, while fishing in Omstead pond, we saw and counted 32 deer.

Nothing affords me more solid comfort than to sit around a blazing camp fire after a long day's hunt, and listen to stories of exploits with gun and rod; then to roll up in my blankets, on a fragrant bed of balsam boughs, and, listen to the crackle of the fire, the sighing of the pines and the numerous other noises from the forest. It's a lullaby you can't enjoy in a city flat, and you awake in the morning feeling that you have really slept and rested. There is no dark brown taste in your mouth to remind you that your room was not properly ventilated, and you unroll yourself from your blanket and go about your camp duties feeling like a new man—ready for any amount of hard work.

Readers of RECREATION who have never enjoyed a taste of this life should begin now to lay their plans for a trip into the North woods. One week of camp life there will do you more good than all the medicine a doctor can pour into you in a year. I always begin making my plans for the coming year as soon as I get home; and I look forward to it, as a child does to Christmas. If one is a true lover of nature he can't help it. The North woods with their rugged mountains, their glassy lakes and sparkling trout streams, are truly a paradise, and I advise all the readers of this little magazine to buy pack baskets; pack your duffel, adorn yourselves in old clothes, shoulder your rifles and buy tickets for the Adirondacks.

E. W. G.

NEPONSET, ILL.

Editor RECREATION: I send you the following letter, written me by my brother who some months ago sought the Cascade mountains of Washington for his health. The letter is dated at Lake Chelan, and is as follows:

A month ago to-day a party of us had an experience I will never forget. It certainly reminded me of the expeditions you made while in Montana.

There were 6 of us in the party. We had 3 pack horses loaded with provisions and a camp outfit. We left Chelan on Friday, on board the steamer, for the North end of the lake and on the following morning started up the Stehkin valley. At Rainbow falls (3 miles from the head of the lake) it commenced to snow.

We made 15 miles, to Bridge creek, and camped in a hunter's cabin. Another old building served as a shelter for the cayuses.

We were wet as soaked cats, but the log fire-place, filled with cedar logs, soon dried us out. We had an exceptionally good lot of fellows and our evening—notwithstanding the wildness of the tempest—was most enjoyable.

The next morning we found the snow 3 feet deep—all of which had fallen in 15 hours. It was our intention to go to the summit of the Cascades, in search of mountain sheep and goats, which it is said abound there; but owing to the heavy snow we were compelled to retrace our steps.

We made 5 miles that day, having to break a trail in order to get our cayuses out. On our way back we saw many signs of deer but no game.

In 2 days we reached, again, the Stehkin hotel. The steamer was there, so we took our horses aboard and were soon ready for supper.

The next morning we started down the lake. The scenery is magnificent all through this country. The abruptness of the Cascade mountains is characteristic. On our upward trip we saw 5 goats, probably $\frac{3}{4}$ of a mile away. On our return 2 showed up, within range—an old billy and a kid. We had some fun shooting at them, but the lay of the country was such that it was impossible to follow them.

After leaving the steamer 2 of us took to the hills for a shot at deer, and after a tramp of 2 hours I killed a fine black tail buck, which dressed 190 pounds.

We found jack rabbits numerous in the Big Bend country, and prairie chickens were easy to get at every turn. A good many mallards are wintering on the Columbia river.

M. P. M.

Some alleged sportsmen who visited Florida put up at a little backwoods hotel and asked the proprietor to get them a guide.

"We want to put in a day or so in these parts," the shooters explained, "and want a good man for a guide. Of course there are guides to be had here?"

"Lots of 'em," answered the proprietor. "You kin git all kinds of guides here."

"Well, we want the best that can be had for money, and we don't care what it costs," said one of the hunters.

"There's 2 or 3 kinds of bests in this

business," returned the proprietor, "and it all depends on what line you want. There's Bill, f'r instance. He knows more about these here woods in a minute than anyone else does in a week. He kin take you to more onfrequented places and hustle you 'round faster than any other feller in this section."

"Just the man for us," said the spokesman. "Where is he?"

"Then there's Hank," continued the proprietor, without noticing the question. "I s'pose he knows more about the game an' the best way to get it than any man 't ever lived in these parts. He kin gin'ly scare up somethin' when nobody else kin."

"Then he's the man for us," said the spokesman. "We came from the city to make a record."

"Make a record?" repeated the proprietor.

"That's it exactly. We want to make a record in the hunting line that we can boast of when we go back."

The proprietor went over and sized up their pile of luggage, including everything that was latest in the way of hunters' equipment.

"You don't want Bill, nor Hank," he said at last. "I'll send for Jim. He's the best man for you."

"What's Jim's special qualification?" they asked.

"Wy, he's the best liar in this State," replied the proprietor. "If you can't make a record with him there ain't no use tryin' fer it with no one else. At first I thought you was jest up here fer the huntin', an' I was goin' on that basis, but I kin fit you out for best records jest as easy, if that's what you're after."

CABLE, WIS.

Editor RECREATION: We all consider yours the best magazine in its line, and look forward to the day of its arrival with much the same pleasure as the sportsman does to the opening of the deer or trout season. We have here the greatest combination of sport to be found anywhere in this State. This claim can be attested by hundreds of people who come here, every summer, to rest and recuperate.

Cable is the highest Railway point in the State, being 1,368 feet above sea level. Cable lake is about one half mile from the depot; is 3 miles long and one mile wide. Black bass and Northern pike are abundant. Both average large, the pike often weighing as high as 30 pounds.

Long lake, 2 miles from Cable, is 8 miles long, one mile wide, and affords excellent bass and pike fishing. Namakagan lake is 10 miles East of Cable. There is a beautiful driveway to the lake, over plains that abound with prairie chickens, sharp tail and ruffed grouse. The road crosses sev-

eral streams where trout may be seen by the hundreds, and leads through dense forests of hardwood where you may frequently see a noble old buck, with horns in the velvet, or a doe with her fawns grazing on the tender clover that grows by the roadside. The lake has 100 miles of coast; is delightfully picturesque; is 75 feet deep, in places, and is as clear as crystal. Black bass, pike, pickerel, perch, crappies and muskalonge are abundant. A fine trout stream empties into the head of this lake.

There are 10 or 12 other lakes near this one, all of which afford good fishing.

Should any reader of RECREATION contemplate a trip let him write me and I will gladly give him all the information he may wish.

D. Archibald.

BUFORD, COLO.

Editor RECREATION: Last winter was a remarkably easy one for all kinds of game. The elk had no trouble in going through any snow we had.

On the West of us, and only 2 miles from our camp, on the South fork, a bunch of about 50 elk wintered. To the Southeast of us, not more than 4 miles distant, one bunch of 7 and one of about 20 stayed all winter, and in the cañon there were a number of others. None of these was disturbed. They stayed in the green timber, only getting on the hillsides to feed, then going back into the timber to lie down. What little hunting is done, for elk in winter, is done entirely on snowshoes and for meat only.

The deep holes in the river, where the ice is off, afford good fishing for white fish, though no trout bite in winter. The bulk of the fish go down the river in winter, and return in the spring, but a considerable number stay here all winter.

One party that intended to come to White river for a hunt, last fall, had quite a lot of grief in New Castle. They outfitted there, and for some reason or other wished no guide, preferring, I suppose, to do their own guide work. One of the horses they had hired was a little flossy, and to be sure he would stand still, while being packed, one of the men, a prominent R. R. officer, took a turn of the hackamoon around his wrist. The horse went, and the man could not get loose; so he was dragged. A special car took his remains back to his wife, and the rest of the party, disheartened by the death of one of their number, gave up the projected hunt. It seems to me that men unaccustomed to packing and handling the "mild eyed cayuse" make a mistake in not getting someone to do it for them.

The wolves are increasing very rapidly all over this country.

J. M. Campbell.

Editor RECREATION: My trip to Wyoming and Colorado was all I could ask for. I went to Rawlins, Wyo., and from there to Dixon, where we fitted out with wagon and pack outfit; thence went up Snake river to the falls. Trout were plentiful and we soon got tired of them. We crossed the continental divide at Colombine, a new mining town, to Hahn's peak; thence up Elk river as far as we could get. Game was abundant. In some places the country looked like a tame deer park. We also found plenty of mountain grouse.

On our return we camped in Slater park. Deer and antelope were here by the hundreds and grouse by the thousands. We killed only what game we could use.

The one thing that pleased me most was the 38-55 Winchester carbine. It has a 20 inch barrel; weighs $5\frac{3}{4}$ pounds, and uses smokeless shells and soft pointed bullets. In my younger days I was an expert with the rifle, and found I had not entirely lost my grip. I could not have done better with any rifle than I did with this little carbine. I killed one of the finest and largest 5 prong mule deer bucks I ever saw. He was fully 400 yards away and in open ground. One shot got him; and that was enough for each of the deer I killed. I always shoot offhand. Those who want to use heavy guns can do so; I have no use for them. I also used a Bristol steel fishing rod, and it is the best rod I ever used, though I have been fishing and shooting over 50 years.

George Hayden.

Juneau is all right in more ways than one. Just now it is the outfitting point for the rich gold fields, and as a hunting and fishing resort it promises to become famous in later years. Game will exist in the wild and impassable country, long after it has been destroyed in the more accessible places. Deer (white tail), mountain goats and black and brown bear are plentiful and easy to get. Blue grouse and white tail ptarmigan, and occasionally ruffed grouse, are found on the hills, but just now are high up. Roads or trails are scarce and all travel is by boat.

Ducks are found in the bays and rivers in September and October, principally mallards, widgeons and green winged teal. Sea ducks, geese and cranes appear later. So will jack snipe and other beach birds.

Eagles—fine white headed old patriarchs—are conspicuous on the dead trees along the shore line, but keep a safe distance from anything human.

Many people here hunt during the winter months; some for fur and the market, others for sport. The favorite rifle among them seems to be the 30 calibre Winchester smokeless, with soft nosed bullet. A friend of mine who was out on the summit the

other day met with a small black bear and blew its head all to pieces with one of these rifles. The man also got 3 mountain goats.

I killed an eagle with a metal patched bullet and scarcely turned a feather.

Geo. G. Cantwell, Juneau, Alaska.

At the 4th annual meeting of the Adirondack Guides' Association, held at Saranac lake, N. Y., in January last, the honorary president, the Hon. Verplanck Colvin, of Albany, appointed the following named gentlemen, from the list of Associate Members, as best representing the different employers of guides, as a Board of Honorary Trustees for the year ending on the third Wednesday in January, 1898.

R. Babcock, P. O. Box 197, New York City,

A. Nelson Cheney, Glens Falls, N. Y.,

Verplanck Colvin, Albany, N. Y.,

W. West Durant, 45 Broadway, New York City,

Ulysses S. Grant, San Diego, Cal.,

Dr. A. G. Gerster, 56 East 25th St., New York City,

R. H. Kissell, Morristown, N. J.,

Senator G. R. Malby, Ogdensburgh, N. Y.,

Schuyler Merritt, Stamford, Conn.,

Warner Miller, Herkimer, N. Y.,

Col. A. G. Mills, 38 Park Row, New York City,

J. J. Broome, Room 29, 115 Broadway, New York City,

G. O. Shields, Editor RECREATION, New York City,

Samuel J. Tilden, New Lebanon, N. Y.,

W. C. Witherbee, Port Henry, N. Y.,

Wm. R. Weed, Potsdam, N. Y.

The guides are doing excellent work in the way of reporting violations of the game and fish laws and in rebuking men who would slaughter game or fish in order to be able to boast of big bags.

BELLE MEADE, N. J.

Editor RECREATION: Last fall I spent 3 months on the Allegheny river, on a Government survey, and we had a taste of life in a "semi-roughing-it" manner.

Our party of 6 men lived in a houseboat 16 ft. x 9 ft., known, locally, as a "Joe boat." It was floated down stream by the current.

We were on the shores all of every clear day, but in this boat we did our cooking, eating, sleeping, and, on rainy days, our office and draughting work.

There are some very fine bass and pike in the river, though for 50 miles below Oil City, the waste from the oil refineries covers the surface of the river and the banks, and is having its effect in decreasing the number of fish. This flood of oil should be stopped.

The scenery in the Allegheny valley is charming, in autumn. At that season you will find every possible tint on the foliage. The hills are high and abrupt, at Oil City, and gradually become lower and less rugged as one follows down the river.

The 3 natural divisions passed through are instructive and interesting. First, at the upper end, is the oil region as previously stated. Then begins the small 4 foot vein of bituminous coal, first found at the top of the hills.

The strata of all this valley are nearly horizontal, having a slight dip to the South; so that this coal vein works down to within 30 feet of the river, in the next 40 miles, and over-lapping this division commences the last, viz., that of natural gas.

One can also see the grip of the "trusts" in their respective fields. The Standard Oil Company's pipe lines are like a network, and the Philadelphia and other gas companies' pipe lines are almost as thick; dictating the price and only market for the producers.

There are many boating and fishing camps above Kittanning, that afford fresh air and good sport, during the summer, and during the fall the ruffed grouse can be heard drumming, the squirrels clattering, and the rabbits darting beneath the bushes in goodly numbers. There are few ducks in the coldest weather, and foxes a very few. These thickly wooded hills have felt but lightly the hand of civilization.

On foot, carrying heavy instruments for over 100 miles, along those banks of brush and boulder, gave us health and strength; and the wildness, together with the mode of living, proved that recreation, free from civilization, could be had in the Eastern State of Pennsylvania. Your magazine was forwarded to me every month and made life more enjoyable.

C. N.

"That was a lively hunt," said Murdock, as we were discussing some of our old experiences. It took place on Milk creek, Yakima Co. Murdock and I had discovered, the summer before, a small lake near the head of this creek, which was full of small brook trout, and which afforded us a fine camp ground. Our fire was not 20 feet from the blue water of the little pool, and it was a case of out of the water into the frying pan when we caught a trout.

At the time Murdock was speaking of we were making for this lake, and when about $\frac{1}{4}$ of a mile from it came out of a black pine thicket into a swampy opening in the timber. Near the other side, and in full view were 3 bear, 2 large ones and a cub. We were both off our horses in an instant and making it hot for the bears.

I fired first at the old female, which was black, and Murdock took charge of the

other—a big cinnamon. About 6 shots were fired before the bear made the cover of the brush. My first had brought the old one to the ground but she was up just as quickly. We turned our dog loose and followed him after the bear into the thicket. He soon had one of the cripples at bay, and Murdock, being as tall as a fence rail, outstepped me and succeeded in getting the first shot at bruin's head which was badly disfigured by a 45-90 ball.

The other 2 bears were not to be seen and all manner of coaxing would not induce the dog to leave the dead bear; so we went back after our horses which we found had scampered off when we had begun the fring. We soon secured them and started to the lake to camp. Once there we unsaddled our horses and arranged camp. The next day we got another bear and in the evening lots of trout, from the lake. On the third day we returned home bearing our spoils.

J. B. L., Clover, Wash.

Why should New England shooters go so far from home when they can get good duck shooting on the Ipswich river and its tributaries? I have shot ducks and geese at Eagle Hill for the past 18 years and have had no trouble in making a good bag when the weather permitted.

Eagle Hill is on Plumb Island river, covers perhaps 5 acres, and is owned by A. B. Clarke of Peabody, Mass. It is also an ideal location for beach bird shooting. My largest bags of black ducks, for one day's shooting, are 18, 24 and 17. My total, in '96, was 277. This season is the poorest we have had for years, owing to not having plenty of heavy ice.

Few sportsmen shoot ducks, from a boat of our model, which I claim is the best boat made for that purpose. Dimensions, 13 feet over all; only 2 laps or streaks on each side; 12 feet on bottom, 20 inches wide at after knee, on bottom; 28 inches at stern, on top; 18 inches deep between middle knees sloped from the after knee on bottom 6 inches. The rest of the bottom, forward of the after knee, should be perfectly straight to stem. Rake on stem 9 inches; plain, on lower streaks, 6 inches; top the same. Scull hole $3\frac{1}{2}$ inches up from bottom, inside, and 4 inches from the left-hand side in the stern board. This hole must be $2\frac{1}{2}$ inches in diameter; perfectly round and lined with a salt-pork skin. This prevents all noises. There should be 2 paddles—only one to be used at any given time and the other to be held in reserve in case of accident. These paddles should be 6 feet long; small enough to use in the scull hole and leave plenty of room to swing the paddle. They must also be bent down on the handle, 3 inches, and about 12 inches from the end, so that the

end of the paddle and your hands cannot be seen above the gunwale.

To trim the boat put in ballast enough to draw $2\frac{1}{2}$ inches on stern. When using in ice paint white; in summer brown, and trim with long grass. This boat will stand a lot of rough weather, if well handled, and will carry about 7 yards of sail, made in a sprit cut. T. C. W., West Lynn, Mass.

Editor RECREATION: Some of the stories of hair-breadth escapes, in RECREATION, remind me of a bear story, told me by a young sportsman who went up in Minnesota last fall, to hunt.

The party consisted of Al. Leland and 3 others. One day they started out for a bear hunt. They had a wagon and team and plenty of ammunition, in both solid and liquid forms, and they thought they would kill every bear in the country.

Arriving at the hunting grounds, the boys tied the team to the rear end of the wagon and placed a stick in the hounds, to hold the pole up out of the mud while they went after bear. Al. thumped around to start up the bears and succeeded in starting one from under a stump, with bristles up and war paint on.

Al. raised his trusty Winchester and pumped 17 bullets into the beast; then threw down his gun and ran for the wagon 4 miles distant. He ventured to look back, and Great Scott! there was the bear at his heels, with eyes dilated and mouth as wide open as a Minnesota saloon. Then Al. put his No. 8's down at the rate of a mile a minute and took another start for the wagon. By the time he reached it the bear came lumbering along, licking Al.'s heels at every jump. Putting on a double head of steam Al. made a trapeze leap for the front of the wagon and lit safe on the double-trees. Then he fainted.

The bear was under such headway, and so excited he didn't see the wagon tongue until it had run clear through him. Then one of the boys ran a stick through that little "bizness" that holds the neck yoke on. Then they all got clubs and pounded the bear to death. It weighed "nigh on to" 700 lbs.

Max.

Having just read an article in RECREATION about the game in the park I will give you some idea as to how the people of Gardiner and vicinity passed their time last fall and winter. As the snow was deep in the park the antelope came down and crossed the Gardiner river, at their old crossing, and got outside of the park, when a party of brave guides and hunters surrounded them and killed about 100 of them.

Then the elk came out and something like 100 of these were also killed.

W. V. B. says he can stand in the streets of Gardiner and see coyotes kill antelope, but doesn't say he sees or hears of the 2 legged coyotes killing elk, for their teeth and horns.

I can show you where 9 elk lay dead at one time and nothing but their teeth had been taken. Some of these men have been caught killing elk in the park. George Scott and Will Decker are among this number. They had killed 28 when caught.

When you hear of antelope being killed by coyotes you can bet the most of the killers have but 2 legs.

R. G. W., Horr, Mont.

We were killing geese in the store one night (we generally have better luck there, than in the sound), when "Uncle Ben" dropped in. After listening to several more or less veracious accounts of big kills he gave us the following:

"We wuz cummin along the edge of the ma'sh one evenin', in a cunnu—me and Tommy Dowdy—wen I heerd a goose honk.

"Sez I, 'Tommy Dowdy there's geese.' In a little while I sez, 'Tommy Dowdy honk to 'em;' an' Tommy he honked.

"Sez I, 'Tommy Dowdy them geese is a cummin;' an' he says 'they is;' but kep' a honkin.

"I riz up, frens, and fired on them geese and shot out 7 dead with one shoot an' 6 of 'em fell in the cunnu.

"Frens, it's a kind of a hard yarn, but ef you don't believe me ax Tommy Dowdy."

A. S. D., Coinjock, N. C.

Last Friday night, during the storm, a flock of wild geese became bewildered at the electric lights on the Court House, here, and circled around them for over an hour, often passing within 20 feet of the building. Next day one lone goose, resting and quietly swimming around in a muddy pool in the street, between the Court House and Boyer's drug store, apparently oblivious of its civilized surroundings, afforded an interesting sight to hundreds of people passing by. The city marshal would not allow any one to shoot at it, and just at dusk it took flight, on its journey Northward.

Doniphan, Neb., on the St. Joe and Grand Island Div. of the U. P. Ry., has been the mecca for goose shooters, on the Platte river, this spring, and the birds have been shot by hundreds. Some R. R. officers, in a special car, remained there several days and all secured large bags of geese, brant and ducks. The Canada and Hutchins geese were especially plentiful.

M. W. M., York, Neb.

On their recent goat hunt, in Liard valley, Paradise valley, and along the South shoulders of the great snow mountain, John Huggins and Herbert Bashford shot so many bears, and brought back so much bear meat, that Fort Nisqually was overstocked with it.

They mailed chunks to friends far and near, and gave a large lead to Dick Shovelhead, a near Nisqually neighbor, who was there before Columbus came.

Dick has a primitive plant for making Nisqually bacon (smoked dog-salmon), and he put the bear meat through the usual pickling and smoking process. It came out the best bacon you ever satisfied a mountain appetite on. Its fine flavor was undoubtedly due to the huckleberry and hazelnut diet, and to unstinted draughts of pure soda water at Shortmire's springs.

Puyallup (Wash.) "Commerce."

Since the snow has begun to melt, and Winter's cap on the water disappears, the ducks are beginning to light on the bald spots of Washoe lake and Carson river, also in the sloughs.

Where they come from is conjecture. Flocks of canvas-backs, a rare bird in these parts, are visiting us in large numbers. I am informed they feed on a plant that looks like cress, and tastes like wild celery.

The open season closed April 1st, and the shooters were out in large numbers during March. They had good shooting.

The grouse are coming down from their winter quarters in the pines, on the mountains, to feed on the spring buds.

The trout season opens June 1st, and the lovers of that sport are busy looking over lines, rods, reels, and preparing for—mosquitoes.

W. W. C., Carson City, Nev.

While on a hunting trip, with C. C. Jones and John Lathan, Mr. Lathan and I started out from camp, went into a patch of dead timber and sat down on a log to listen for a bull elk to whistle. While waiting we saw a calf elk coming toward us, from the West. We went into the timber from the South and the calf was going to cross South of us, about 50 yards; but when he came to our trail he stopped short, turned and came toward us. Then he turned to the East again till he struck the trail when he stopped, as before; sniffed the bushes and then came toward us again. He passed within 30 feet of us, on our West; then turned East and went out of sight.

We were in plain sight all the time but kept perfectly quiet and he did not notice us. Why is it that a little 3 month's old elk calf will not cross a man's trail in the woods?

If Mr. O. D. Wheeler ever gets in among a large bunch of cow and calf elk he will learn why they say elk whistle; although the old bull's trumpet doesn't sound much like a whistle.

S. N. Leek, Jackson, Wyo.

An Eastern man who recently went to Southern Oregon blows his horn thus in a report to his home paper:

"My desire for killing big game grows more and more. Let me tell you no man can come from the East and learn to hunt in a day. It takes a long time to learn how to pack; where to find game, and then how to shoot it. A party from California had hunted 2 weeks—6 of them—and only got 8 deer. We went by where they were camped. They said there was no game around there.

"We went on, found grass for our horses, near by, and the next day I killed 8 deer. We stayed there 11 days and got 52 deer. One day a doctor came and wanted to go out with me; so the next morning I went to their camp at 3.30 and said: 'Are you ready?' He said he had not had any breakfast yet. I told him, 'Nor I; come on.' We got 5 deer. I gave him the first shot at all of them, and he killed 2."

The report comes that this Eastern butcher was murdered, by some native of the country where he was hunting. The settler probably killed him to save the game. If so, who blames the settler?

EDITOR.

We have a woman here who can outshoot the most of us old hunters, at game, and she will hold her own with all of us in shooting at target. She uses a 40-65 Winchester, half magazine, 86 model, and handles it easily and gracefully.

She was out hunting 2 days last fall and got 3 white tail deer. She killed 2 and wounded the third, the first day, and went back the second day to get the cripple.

She dresses and rides like a man. She walks 20 miles a day, on web snow shoes, without being any worse for the trip. Two years ago she killed a bull elk. If her husband was as keen a sportsman as she is they would spend all their time in the mountains; but game is pretty safe where he is. This woman can catch fish where the rest of us won't try.

M. P. Dunham, Lyon, Mont.

Away down in Newton, Mississippi, there lives an honest colored man named Ped Williams. He is the town butcher and is reliable as to his contracts and engagements. He is a famous coon and possum hunter, and has 2 coon dogs that have an entree to his fireside, with his 6 ebony hued chaps. Ped hunts with Jack and Hunter, his 2 dogs, as the coon hunters did in ante bellum days. With a pitch pine torch he leads the party down through the deep pineries into the creek bottoms, with ax on his shoulder. It takes a good walker to keep up with him when Jack or Hunter

speaks up a tree. Many travelers and Northern visitors can testify as to Ped's prowess as a coon killer.

J. T. W., St. Louis, Mo.

I hoped to have had a deer story to send you, for RECREATION, but was disappointed. We had no tracking snow here until after the season closed.

A few years ago deer were as scarce as hens' teeth, but of late they have been coming in here. We talked deer hunt all last summer yet I did not get my hunt. The man who was to take us wanted me to go and take the chances on jumping a deer; but I declined, so he went with 2 men who came over from Meadville and they got one deer. My friend Stanley says he can take me now and show me where at least 10 or 12 deer are staying. Only 3 or 4 were shot last season so we expect a good hunt next fall.

F. A. R., South Oil City, Pa.

A writer in RECREATION asks "What game is to be found about Red lake, Minn.?" I can say, from personal knowledge, that moose, caribou, deer, bear, lynx, fishes, marten, otter, porcupine (some people might not call the *silver cat* game), ruffed and sharp-tail grouse, spruce grouse and water-fowl, can all be found in that region. There are also white fish, wall eyed pike, pickerel, suckers, bullheads and Chipewa Indians.

It must be remembered, however, that it is unlawful to kill moose and caribou until 1898; also that Red lake is Indian reservation, except the North half of the North lake.

There is a chance to visit Red lake by steamboat from Thief River falls. Some of the best hunting grounds are about the great marshes and lakes, to the N. W. of Red lake.

E. L. B., Warren, Minn.

I have been reading RECREATION 18 months and think it the best of its class. It gives more information than any book printed, in the game line.

Should like to be able to send you some game notes but am in a locality where the game hog has been, and the game had to give way. If the game laws are not enforced, to the letter, game will be extinct everywhere in a few years. James Stephens, of whom you speak in your March number, for instance. Poor hog! Did anyone say hog? Yes; hog with eyes of the asp, brains of the ant, and hands dealing death strokes. I agree with you that his funeral should have been celebrated the same day, but before he had a chance at those 26 antelope.

H. A. H., Goshen, Ind.

Enclosed find answers to the three puzzles in April number.

I also deem it a privilege to enclose 10c. for RECREATION'S fresh air fund. This is a noble charity and will meet with the response it deserves, I am sure.

The flight of geese, brant and ducks, to the North, so far, is hardly worth mentioning—very unlike 10 years ago, when, at this season the air was alive with them. The game hog, and the market hunter, have indeed been killing the bird that laid the golden egg, so far as their business, and the sport of others is concerned. I have heard but one defense of spring shooting, viz.: "Every one else does it;" and this is not true.

M. B. C., Garner, Ia.

Walter and Frank Dexter killed 2 moose, a cow and a calf, one afternoon, being only 3 hours absent from town. On the same day 2 other men struck it lucky in the Western part of the County. E. A. Bower and Peter Michael, an Indian, left Clyde at 2 P.M., tramped 10 miles in the direction of Barrington, and in the woods known as the "Musquash country," killed 3 moose, and were back at Clyde at 8 o'clock the same evening. Hugh Williamson, of the Big Meadows, shot a fine moose near Blue Hill the same week. Joseph Warrington, of Birchtown, killed 2 good sized moose at that place, about half a mile from the road.

Shelburne (Canada) "Budget."

Frank Alling, Tacoma, Wash., who is known all over the Northwest as a true friend of game birds, and a sportsman who takes more than usual interest in their propagation and care, recently received 2 coops of oriental pheasants from Canton, China, and turned them out on Fox island.

These make 92 pheasants Alling has imported and turned loose on his Fox island preserve. It is the aim to stock Washington forests with this prince of game birds, and he says if the legislature will only aid him in his work he will, in time, make that State a sportsmen's paradise.

We have as fine fly fishing here as can be found in the country. We often land fish weighing up to 8, 9 and 10 pounds, and lots of them. The country is full of deer. No trouble to get one any time, and as for ducks and grouse we have them galore, all within 5 minutes' walk from home. Bear, cougar and wolves roam our forests in large numbers.

A hunter caught a 2 year old bear, in a No. 1½ Newhouse trap the other day, which speaks well for the maker of the

traps. I see they are advertised in RECREATION, which is a welcome guest in my den. I was deeply interested in Bert Cassidy's letter on "How My Wife got Her First Elk." I gloried in the little woman's spunk in having the bull elk to shoot at.

F. C. McL., Cowichan Lake, B. C.

Some 20 years ago 16 men were hunting deer in the Turny mountains, Centre Co., Pa., and U. S. (Uncle Sam—that's me) was one of the party. It was raining—a cold, dreary morning, and the boys were enjoying themselves as best they could in the tents—most all in the large A tent. I was nearest the door. A small snake, probably warmed by our genial fire, came under the tent in front of me. I pulled my feet back to let him go by. The next man did the same. The snake made the full rounds of the tent and started out, when the darky cook saw him, and dispatched him. Holding him up one of the boy said, "I thought that looked like a snake." All of us had seen it crawl around the tent, but never a word was said till then. Why? Well, you can guess.

The sun came out by noon, and before night several nice bucks hung in camp.

U. S., Ashland, Pa.

I have taken other sportsmen's papers, but like RECREATION better than any of them. Am especially interested in the articles on "Who makes the best gun." I use a "Parker" and am well satisfied with it.

The way some people, better known as "game hogs," kill deer here is a shame. Recently the police of this city made a raid on a shed, where it was said deer were kept. They found 11 deer carcasses and the man who was in the shed, at the time of the raid, was taken to police headquarters. He was given a sentence of \$440 fine, or 330 days in jail. His partners were to shoot the deer and he was to dispose of them by shipping them to cities out of the State. I hope this will serve as a warning to others, who kill game indiscriminately, in season or out.

W. W., Superior, Wis.

The annual field trials of the Continental Field Trials Club will be held at Morris, Manitoba, Wednesday, Sept. 1, '97. In the Blue Ribbon Stake (Derby) for pointers and setters whelped on or after January 1, 1896, entries close May 15, 1897. Purses, \$125.00 to first, \$100.00 to 2d, \$75.00 to 3d, \$50.00 to 4th. The trials will be run on Chickens and under the rules of the Continental Field Trials Club.

The all ages stake will be known as "The Excelsior Stake" (all aged) and will follow the above event.

When opportunity affords I always take a peep into every corner of your magazine. In so doing I find some things of which I approve and some otherwise; some things I understand and some I do not. Note on page 148 of your March issue a picture of a boy shooter, Master Tom Metcalfe, champion, etc. That picture reminds me of how often we read of men—full grown men—who ought to know better, doing as this boy is doing. There is some excuse for a boy leaning on his gun, but none for a man. "Didn't know it was loaded," would be the proper epitaph for many a grave.
Krittick, Leadville, Colo.

I have read RECREATION for about a year and have learned several things from it. I am much interested in guns and ammunition. I always read those articles first, and would like to hear the opinion of some shooters about the Lyman sights for rifles.

Deer and antelope are thick here, as are also wolves and coyotes. In the spring there are always plenty of ducks.

Each year there are many bear and mountain lions killed in the hills near by. I always shoot with a rifle and get plenty of game, too.

P. J. M., Maxwell City, N. M.

I am very much interested in your magazine and have been a subscriber since March, 1896. My opinion of RECREATION is that it is the best sportsmen's journal published, in this or any other country.

Game is scarce here. At times we have a few ducks, geese and snipe. We have good bass fishing, in season. Rabbits and squirrels are scarce. The game laws are strictly enforced but there are lots of pot-hunters, who would kill game out of season if they were not watched.

G. W. M., Elizabeth, N. J.

Large game was rather scarcer than usual in this part of the country, last winter, and very little hunting was done. Plenty of deer could be found high up the mountains, the snow not being deep enough to drive them down. Prairie chickens are plentiful all along the Okanogan river. No trouble at all for a good shot to get 15 or 20 any morning. Also lots of grouse in the edge of the fir timber; but by most people they are not considered of good flavor when feeding on fir buds.

J. B. L., Clover, Wash.

J. L., of North Vernon, Ind., says our last Legislature passed a law prohibiting the killing of quails, in this State, for 2 years. J. L. is in error. Such a bill passed one branch, but was killed in the other. I believe that in this county (Fayette) we shall have more quails next fall than for years past. But few were killed last season on account of the heavy growth of ragweed.

Then, too, our winter was quite open—no heavy snows. C. H., Connorsville, Ind.

A meeting of the Oil City (Pa.) Gun Club was recently held, when the following officers were elected:

L. L. Graham, president.

A. Smedley, vice president.

H. C. Reeser, secretary.

H. C. Dorworth, treasurer.

Directors—F. S. Bates, C. T. McClintock, C. H. Lay, Jr.

Arrangements were made for the Pennsylvania Sportsmen's association shoot, which will take place under the auspices of this club June 22d, 23d, 24th and 25th, inclusive. The railroads have offered to give special rates to Oil City, on these dates, and it is expected that 200 to 400 shooters will attend.

A St. Louis despatch says:

"Game Warden Henry has instructed ex-Judge Claiborne to apply for warrants against 750 game-dealers and restaurant-keepers in this city, who, it is alleged, have violated the law by selling game during the close season. The managers of 10 of the principal restaurants and several game dealers have been selected to bear the brunt of the first prosecution. A similar prosecution in Illinois recently cost one dealer \$80,000."

Good! I hope each of these 750 law breakers, in St. Louis, will be equally unfortunate. I hope no one of them will have money enough left to buy a beef steak when he gets out of court.
EDITOR.

A meeting was held here, in March last, for the purpose of forming a gun club. Dr. S. D. Woods was elected temporary chairman and the Connellsville Gun Club was formed. The following officers were elected: President, Dr. J. C. Irwin; Secretary, P. H. Pendleton; Treasurer, George Balsley. The club starts off with 10 charter members, with good prospects of increasing the membership to 20 or more.

P. H. P., Connellsville, Pa.

We had good quail and rabbit shooting last fall. The open season for quail shooting is October and November. I had fine sport November 18th, with my dog and gun, killing 13 quails and 4 rabbits. On November 26th I killed 10 quails and 3 rabbits, and killed several rabbits later in the winter. I shoot a 12 gauge Parker hammerless gun, 8½ lbs., and it does fine work. I use ¾ drams Dupont smokeless powder and 1½ oz. No. 7 shot.

W. M., Woodson, Ill.

The hunting is rather poor around here. Fish and game protector Pomeroy, of Erie Co., was after 4 hunters, for shipping birds out of the county. He got 3 of the men, 2 of whom settled for about \$30. The other would not settle, but is going to stand trial. Sympathy is mostly with the hunters, but I am not.
F. E. L., Brocton, N. Y.

FISH AND FISHING.

FASTIDIOUS OUANANICHE.

F. G. NELSON.

A curious instance of the fastidiousness of ouananiche was noticed last June, during our annual visit to the Grand Discharge of Lake St. John. We were all well supplied with different sizes of the favorite flies, jock scott, silver doctor, cowdung, brown hackle and professor; but Lyme had an extra pair of silver doctors, differing slightly in appearance from his others, and from ours, which he had bought at Springfield just before starting on the trip. During the early part of our first day's fishing he noticed that one of these 2 silver doctors was taking all of his ouananiche, so he put on the other, also, in place of the brown hackle at the end of his leader. His success was constant. He fished with us, away from us and all around us. He traded places with us; he did everything but trade flies.

Along toward the middle of the afternoon, when he had 35 ouananiche, running from $\frac{3}{4}$ to 3 pounds each, and we but 8 between us, a good sized fish took one of his silver doctors and made a rush straight out toward the middle of the river.

Lyme had about 6 feet of slack line drawn off the reel which he held in his left hand, and when this was taken out by the ouananiche, and the line began to render directly from the reel, the handle thereof caught in the cuff of his sleeve and before it could be disengaged the line was snapped just above the leader. The loss of those 2 flies ended the fish catching for that day, for, although he immediately put on another leader and tried other silver doctors, and then nearly every fly in his book, neither he nor we caught another fish.

The season of 1896 appeared to be later than those of preceding years. The water did not seem higher, although it was said to be so; but the fish were nowhere nearly so plentiful as in former Junes, and when hooked were comparatively sluggish in their movements. In the 2 previous years the best fishing in the Grand Discharge was synchronous with the appearance of countless numbers of a slender brown fly, with gauzy wings, reaching 2 inches in length, which swarmed around the Island House after dark, creeping and crawling everywhere. Up to June 22d, in 1896, these flies had not appeared, and, possibly for the same reason, whatever it may have been, the ouananiche also were scarce.

Inasmuch as nobody wishes to make the trip to Lake St. John and find himself too early or too late for the best fishing, let me suggest that intending fishermen write to T. Kenna, Manager of Hotel Roberval, or

A. J. Ritchie, Manager of the Island House, about the first of June, and ask to be notified, promptly, when the ouananiche begin rising freely to the fly, in the Grand Discharge.

On our way up there, from Springfield, Mass., via Boston and Maine and Grand Trunk roads, to Quebec, and thence North via Q. & L. St. J. Ry., we stayed 3 days at Landlord Rowley's Laurentide House, at Lake Edward, spending part of the time at a camp which he maintained 10 miles down the lake. We caught, with bait, large brook trout weighing $3\frac{1}{2}$ pounds or less, and smaller ones with the fly, in the headwaters of the Batiscan river. The black flies and mosquitoes were numerous and attentive, but they are said to disappear in midsummer, while the fishing stays good all through the season. *Verbum sap.*

STATE FISH COMMISSIONERS.

Most of the States of the Union have attempted to provide for the protection of the game and fish within their borders, by the enactment of fish and game laws and the appointment of Fish and Game Commissioners.

The attention given to the matter has varied with the importance of the game, fishing and fisheries interests, and with the intelligence of the legislatures in the different States.

The amounts appropriated, annually, for carrying out the provisions of the laws vary from nothing, or from \$300 to \$800, as in Indiana and Georgia, to \$50,000, as in New York. In some States, as New York, Michigan, and California, a vast amount of good has been accomplished; while in others, scarcely less important in their fishing and fishery interests, no good has been done.

The differences in the results attained, in the different States, are not wholly due to larger appropriations in some States than in others. They are due in no small degree to the fitness or unfitness, for the work, possessed by the different Commissioners.

This brings me to the question: What constitutes fitness for the position of State Fish Commissioner? To answer this question it will be helpful to consider, briefly, the proper and legitimate purposes of a State Fish Commission.

Manifestly, the primary object of a State Fish Commission should be to maintain, at the maximum possible limit, the supply of food and game fishes of the State. This is by no means a simple nor an easy matter.

The relations and inter-relations of the different species of fishes, plants, and other animals, inhabiting any given stream or lake, are complicated in the extreme. In a state of nature any given body of water, as a lake, will be able to support only a certain maximum number of individuals of each species of animal and plant inhabiting it. Unless some agent come in as a factor, from the outside, and disturb the existing relations, the balance of forces will be maintained and the number of individuals of each species will remain approximately constant. Just as many individuals of each species will be eaten up, destroyed, or die a natural death, each year, as are born in the lake each year.

This, of course, requires that every adult animal and plant must die so soon as it has succeeded in leaving one of its kind in its place. It *must* live that long; it *cannot* live longer. The "balance of nature" can be maintained in no other way. The killing off of a larger number of individuals, of any particular species, destroys this balance; and when a state of stable equilibrium is again secured we find that certain species are less abundant than they were before; while others have become more numerous.

It is only the trained biologist—the man who has made a careful study of questions concerning the life relationships of animals and plants, adaptation to environment, geographic distribution, and the life histories of the various forms, who has any clear conception of what the results of such a disturbance will be.

Many good people think that to have plenty of fish in our streams and lakes it is only necessary to stop "illegal fishing." The poor violator may be catching nothing but bullheads or suckers; nevertheless, he is fined and his seines are destroyed. This, under the law, may be perfectly proper; but the conclusion that by so doing the important food and game fishes are being protected does not follow, by any means. Just the opposite result may follow.

The competent State Fish Commissioner will be able to consider these various questions in an intelligent and rational way. He will know not only how to punish offenders but he will also know what will be detrimental and what beneficial to the fishery and angling interests of his State. He will know a big-mouthed black bass from a small-mouthed black bass—a bit of information not possessed by all State Fish Commissioners in the upper Mississippi Valley, as shown by their illustrated official reports. He will be sufficiently trained as a zoologist to be able to identify not only the food and game fishes, but the other species of fishes which serve them as food. He must be a man of some scientific attainments, and should know something of fish-culture.

Recently I had occasion to criticise the

appointment, by Governor Mount, of Indiana, of Rev. Mr. Sweeney to the position of Fish Commissioner of that State. I have received a letter from one of my friends protesting against what, to him, seems an unjust criticism. That his ideas of what constitutes fitness for the duties of State Fish Commissioner are not my ideas is evident from the 7 reasons which he gives in justification of the appointment. They are as follows:

1. Mr. Sweeney is a splendid fly fisher.
2. He is an educated gentleman.
3. He is a man of easy fortune, and did not want the office for "what there is in it."
4. He is an author and a minister of the Gospel.
5. He is a "splendid fellow."
6. He was Consul in Constantinople, and resigned because he wished to.
7. He took this office to protect the bass in our lakes and rivers.

I frankly and freely admit each and every one of these 7 propositions, yet in my judgment these good qualities do not at all fit Mr. Sweeney for the important office of State Fish Commissioner. Must a man be a "splendid fly fisher," "of easy fortune," "an author and a minister of the Gospel," and a "good fellow" to fill this position? Seth Green and Professor Baird were not measured by any of these standards, yet they were model fish commissioners.

For Mr. Sweeney, personally, I have the highest regard; but I fail to find any evidence, even among the claims of those who approve the appointment, that it was a wise one. The duties of a State Fish Commissioner are such as require special, technical training, and I do not believe appointments should be made for any other reason.

So long as others tell of their trips in the woods and along the streams, so long shall I enjoy reading RECREATION. The pictures these writers have drawn, only help me in my enjoyment, as memory hurries each year's trip over my mind's canvas.

Years of fishing in the St. Lawrence; other years in the great woods of Northern New York and others to Champlain, all have left their charming memories.

On our last trip to Champlain the party was made up of mothers and children; old and young; some with hair of gray among the brown; others with their flowing, flaxen curls and locks; others with neither locks nor curls.

We went on the 7 A.M. train North from Albany, and in due time arrived at Plattsburgh where the men and boys did their best at carrying bundles down to the boat. Then some of us went to see our boys at the barracks. Soon all the bundles were in a heap on the cool upper deck of the Maquam. She pointed her nose East and we were off again.

After a grand sail of 28 miles we threw a line and it was caught by John Parker, our host. All our paper bags and other things were deposited on the lawn which slopes from his neat and commodious house, down to the clear waters of Champlain. What a time we had! What a place to go! What fish we caught, and what big ones got away! How the linen got splashed! How the crimps got wet! How the freckles grew! How the tan came on!

No one loves fishing better than I, in my declining years. Oh, that I had begun earlier in life! I do love to go fishing with a lot of ladies. Isn't it strange how they dislike worms? Theirs is not the kind of clinging feeling they hanker after; so we "boys" are called on to do the impaling act.

Those of your readers who are looking for good bass fishing should go to Parker's, in the first week of September.

We had a grand time there and if the mills run we shall go again. Next time we intend to take a camera.

45-90. Syracuse, N. Y.

Here are directions for cleaning and cooking bony fishes which I am sure will be appreciated by all anglers who are not already familiar with this method.

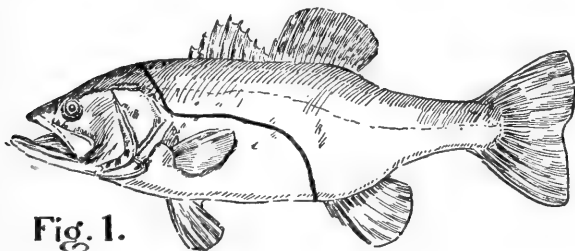

Fig. 1.

First take a sharp knife and cut, as per diagram, through the flesh to the ribs, but do not sever them. Then thrust in the knife at A and just to one side of the back bone. Cut the flesh from the skeleton, being careful to keep outside of the ribs, till you come to B, when you push the knife clear down through, as shown in diagram 2. Then slide along the back bone to the tail, C.

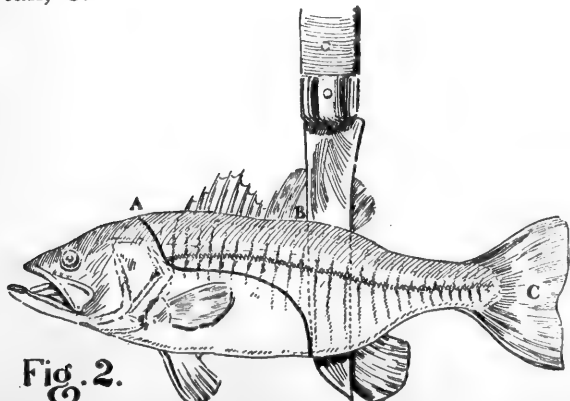

Fig. 2.

Now turn the fish over and treat the other side in the same manner, when you will have all the edible flesh, from the smallest fish, with scarcely a bone in it. The slices cut thus may be broiled crisp and brown, so that the few small bones remaining may be eaten with impunity.

S. W. B., Ann Arbor, Mich.

The salmon season at Bangor pool opened April 3d. The wet weather, in the early part of the month, was unsuitable for fly fishing; consequently the sportsmen have not visited the pool. Following is a list of sea salmon caught in the pool in 4 days:

April 3—1 salmon, weight, 14¾ lbs.

April 4—2 " " 15 and 16 lbs.

April 5—1 " " 14½ lbs.

April 7—2 " " 17 and 16½ lbs.

The pool is within the city limits, about one mile from the post office, and is one of the most famous in the country. It is being frequented by sportsmen, not only from different parts of Maine but from other States. With the approach of warm weather the salmon commence to run up the river, in abundance, and are much larger than the first, weighing up to 32 pounds. This, however, is an exceptional weight, for the fish average about 18 or 20 pounds. The fish mentioned above were caught by professional market fishermen and were sold at \$1.25 a pound.

My letter in February RECREATION seems to have displeased a certain resident of Traverse City, Mich. If "F. D. C." has fished every trout stream within 100 miles of Petoskey, he is a lucky man.

Of course every stream does not contain trout weighing 2 pounds, but there are streams that do; and they are not scarce either.

Any man who knows anything about fishing, will tell you that trout will drive grayling from a stream, in time, but it takes a considerable number of years for them to do it. In the meantime there are both grayling and trout in the same stream. I may also add that the average grayling will weigh more than the average trout. The small grayling do not seem to be taken as frequently as the small trout.

I know of the capture of 2 grayling which weighed but a few ounces under 3 pounds each.

I think there are numerous anglers in Northern Michigan who will agree with me when I say that my mere statement of facts should not be called "exaggerations."

W. G. E., Petoskey, Mich.

This makes 27 subscriptions I have sent you, and I have never gone out for one of them.

G. S. W., Scrubgrass, Pa.

Editor RECREATION: I heartily congratulate you on the noble work you are doing for game and fish protection. I am sure it will please you to know that another of these out of season fishermen has been brought to justice. The brooks here are almost fished out and for that reason a few of them are posted.

This man whom I speak of was found fishing in a posted brook, a week before the law went off. He had not noticed the signs; nor had he had a bite. That is to say, by his own confession; but when they came to search him they found his pockets filled with trout.

This same man was last spring suspected of catching trout in nets; but nothing was done with him. Now that he is caught, fair and square, he deserves the full penalty of law, and I hope will get it.

P. K. R., Washington, Conn.

A press despatch from Ashland, Wis., dated March 25th says:

Sportsmen all over the country will regret to learn that loggers have invaded the Brule river, as this may destroy the most famous trout fishing stream in the United States.

Crews of men were sent to Brule to-day and will start driving logs from Wild Cat rapids to Lake Superior, 20 miles distant. Logs have never before been driven in the Brule river. Expensive clubhouses, owned by men in St. Paul, Minneapolis, and Ashland, including ex-Mayor O'Brien of St. Paul and Senator Vilas, line the stream. The owners of these places protest against the proposed log driving, as it will ruin the trout fishing.

In these clubhouses such prominent men as Secretary Harrity, of the national democratic committee, ex-Secretary Noble, ex-Secretary Rusk and other prominent men have spent their summer vacations. An effort will be made to stop the work.

It is a great pity that not a nook nor a corner of the earth can be exempt from the greed of lumbermen, save where the strong arm of the government is raised to protect the forests.

EDITOR.

The first general bait rod casting tournament ever held in the United States took place recently, at Liberty Island, under the auspices of the Liberty Island Rod and Gun Club. E. H. Merritt won the gold medal in Class A, and James Reithel won the silver medal. Merritt's average was 127.1 feet, Reithel's 120.2. The casting was in sea coast style, with 3 ounce sinkers.

In class B, New York Bay style, W. S. Birdsall won, with an average of 73-2. A one ounce sinker was used in this match. Other prizes were won by A. H. Bear and others. W. H. Wood and A. F. Meisselbach were the judges; W. C. Harris, referee.

Reithel made the best cast of the day, 224-9½. The best record, 246, is therefore unbroken.

It may benefit readers of RECREATION to learn that Leonard Champion, Mahoopany,

Wyoming Co., Pa., will furnish bait, boats, etc., to his customers, free of charge. Bass, pickerel, and wall eyed pike are plentiful in the Susquehanna river, 100 yards from his house. Last August E. M. Yerger and I, both entire strangers to Mr. Champion, caught 68 bass, 4 pickerel and one pike—weight 11¾ pounds—in 2 days. The largest bass weighed 4 pounds 2 ounces; smallest ½ pound. Hotel rate \$1.25 a day; excellent board. We shall go there often.

I am highly pleased with RECREATION, and shall remain on your subscription list permanently." W. L. F., Easton, Pa.

Will you kindly publish an article in RECREATION on fly fishing for beginners, or submit this for the opinions of your readers. How in the name of Isaac Walton are the uninitiated to know what are the proper flies to use, in the different seasons and localities, with over 100 varieties to select from? Some information on the above would be appreciated by many of your readers. L. E. K., West Fairview, Pa.

RECREATION beats every other book, all hollow. I shall keep on taking it as long as we both live.

I am near 2 big lakes. Our town is called "Waterville" because there is so much water near it. My mother caught a 13½ pound pike last fall, and many good ones are caught here every season.

D. B., Waterville, Minn.

Great sport is afforded anglers, at present, catching the small white fish that make their annual run up the Okanogan river, at this time of year. These are beautiful fish, of a light silvery color, about 12 inches in length and averaging ½ to 3 pounds. They bite at salmon eggs readily and are quite gamey when taken.

J. B. L., Clover, Wash.

Anyone wishing some good bass fishing can get it by calling on W. H. French or L. D. Mills of this place. Good sport here in this line.

M. B., Conway Centre, N. H.

The waters in this vicinity are protected from net fishing and abound in muskalonge, black bass, and pickerel. We have good boat liveries and guides, and I should be glad to give any information brother sportsmen may desire.

L. H. Dodge, Cape Vincent, N. Y.

State Fish Commissioner Z. T. Sweeney, of Columbus, was in the city Monday. He says he is engaged in calling down the mill owners who have dammed streams and failed to construct fish ladders. Mr. Sweeney says he believes the strict enforcement of this law will afford at least a partial solution of the problem of fish protection.—Franklin (Ind.) "Star."

GUNS AND AMMUNITION.

THE 30-30-160 SMOKELESS.

W. E. CARLIN (CHELAN).

In a former paper I outlined some shooting incidents, showing the excellent killing powers of the 30-40 smokeless cartridge. That its more moderate power companion cartridge, the 30-30, is also effective on big game is evident from the many reports from the game fields, which my own experience may help to confirm.

A friend and I were climbing a broken side hill one morning, and after a straight pull of some 1,500 feet, sat down on a rock, to smoke a pipe and to discuss the situation, which we did in too loud tones. Our conversation was interrupted by the rattling of a dislodged piece of slide rock above us. Glancing up, I saw a small goat disappearing around a point of rock, some 75 yards away. Jumping to our feet we made for a point from which we could command a better view, and in so doing disturbed 3 more goats. These ran out on a ledge, 50 feet above us, and looked over to learn the cause of the disturbance. My friend, who had never killed a goat, shot at the largest one, and killed it so dead it did not even struggle sufficiently to fall over the ledge, although its head and one fore leg hung over. This goat was shot with a 30-30 Marlin rifle, using the U. M. C. flat-pointed full-jacketed bullet. The ball struck the goat fairly in the brisket, smashing the bone and making a hole in the lights that you could put your hand into; while the large arteries at the top of the heart were torn to pieces. The bullet made its exit beside the backbone, tearing a 2 inch hole, and cutting away a tuft of white hair, that was borne slowly along the mountain side by the breeze.

My next experience, with the 30-30, takes me to the high meadow country lying East of Elk Summit. Wright and I had walked over to some lakes, the larger of which I named Lake Jeannette. It is a beautiful sheet of water and we regretted not having taken a camera with us. We determined to return and photograph it, which we did 2 days later. Mrs. Carlin, Wright and I were riding through a vast meadow, where the red top grass came half way up the horses' sides, when I saw a movement among the small trees, on the side hill to our right. A moment later a young bull moose stepped out and walked rapidly across our front, without apparently noticing us.

Slipping from my saddle I drew my rifle—a 30 Winchester, model 94—from its boot; but while the moose was clearly visible from the horse's back, he appeared indistinct, through the brush, now that I was on the

ground. He had come to a stop and was listening. Firing at the only visible part, I missed him. He turned and made several steps toward us, exposing his right shoulder, diagonally, which I fired at. He turned and walked unconcernedly from us. I fired again, at his flank, and again at his neck, as he walked majestically away. So far he had not flinched nor given the slightest sign that he was hit and I started after him, shoving in a cartridge as I went. He had gone perhaps 30 yards when he stumbled and fell, stone dead! The second bullet had entered back of the shoulder, breaking a rib, passing through the lights, leaving a 3 inch hole, and had lodged under the skin on the opposite side. The 3d shot had passed through him sideways, smashing his liver to a pulp and making a 2 inch hole where the bullet went out. The last shot, fired at his neck as he walked away, had merely cut a gash in his withers.

The killing of the moose was especially fortunate as we had been out of meat for some time. We had had little time to hunt and had seen nothing but does. Of course as soon as we had meat in camp we saw plenty of game. We shot nothing more, however, until we reached the cedars, where Mrs. Carlin killed a deer. As you wished some salmon skins, we moved down about 8 miles, to where we had seen salmon. Near-by was a lick, but nothing but cow elk and does seemed to be using it, and they came only at dusk, or after dark.

On the third evening I suggested to Mrs. Carlin that she kill something, as we needed meat to last us out of the country. The next animal that came down, happened to be a barren white tail doe, which, as the shadows grew long, and the light dim, stood some 60 yards from us, with her shoulders hidden behind a tree. Mrs. Carlin shot at the exposed portion, and as the white flag waved among the trees we said it was a clean miss. She was certain, however, she had held well; so Wright followed its track. He found blood and soon came on the deer, lying dead at about 150 yards.

The bullet—a 30 caliber soft nose Winchester—had passed through the small intestines, cutting them all to pieces. All hunters have, no doubt, seen deer shot in the same place which were never gotten at all, or at best only after a long chase. I remember once, some 10 years ago, when on one hunt 11 deer were shot, too far back or too low down, by soldiers using the 45-70-500, and not one of these was saved at the time, though several were found dead, later.

The fourth animal killed with the 30-30 was a good sized black tail buck. We were

travelling down Bear creek, and were anxious to lay in a supply of meat before reaching the Clearwater. I was driving the rear horses of the pack train when I heard a shot, and saw Wright, who led, hurrying forward. He said he had fired at a mule deer that was making off through the brush.

We had taken in 4 little fox terriers, thinking to use them on bear, if we found any. At the shot, off went the quartette on the trail of the deer. We followed, and on nearing the scene of an evident combat, we walked carefully, and came upon the dogs and deer, on a little open flat. The buck was on his knees, 2 of the terriers having him by the ear and the jaw and 2 hanging to either hind leg. Right here I saw the folly of not carrying a small camera that could always be at hand and ready for use. Not wishing to delay the pack train to get out the big camera I shot from where we stood, behind the deer. The bullet entered between the hams and, ranging upward, lodged beside his backbone, killing him instantly.

Wright's shot was a good one. The 45-70-405 bullet had entered the flank, and had gone quartering through, smashing the right shoulder bone; yet the deer had gone a good half mile before the dogs brought him to bay.

THE 40-82 FOR BIG GAME.

COWANSVILLE, P. Q.

Editor RECREATION: I have read the opinions of your various correspondents, with deep interest, and hope to read of the actual experience of many other lovers of the rifle and shot gun, in your columns.

I notice the various comments as to the killing power of the 30-30. I have used a great many rifles, and was on the point of ordering a 30-30, when I received some metal-patched bullets from the Winchester R. A. Co., for my 40-82. I got 100 full-patched and 100 soft nosed bullets, in order to give them a thorough trial.

They seem to fill the bill completely. My object in ordering them was this: I load my own cartridges, and as I use a very strong powder (Hamilton Powder Co's. "Caribou" No. 4), my rifle leaded badly. I tried many alloys, but none of them was entirely satisfactory; though I found a proportion of 1 part tin to 12 lead gave the best results. These bullets, however, were not always accurate, and when used on game did altogether too much smashing.

Last fall I went to Megantic for a deer hunt, and took the 40-82, with the cartridges loaded as follows: 82 grs. No. 4 "Caribou" and split bullets, 1 to 12.

The weather was bad, but I shot one deer. It was running broadside to me and I fired twice, in less time than one could wink.

The 1st bullet passed through the body just behind the shoulder. It broke a rib on entering, tore the heart to pieces, and made a square hole about $1\frac{1}{2}$ inches in diameter on coming out. It came out in 3 pieces and smashed 2 more ribs. The 2d shot went through the lower part of the neck, and was almost a miss; owing to the stumbling of the deer, at the first shot, and to my bad holding.

The new full metal-patched bullet goes through about 20 inches of pine. The other day I shot one through 12 inches of dry hemlock and 3 inches of green maple (frozen). The soft-point bullets have more penetration than my split bullets, but mushroom quite enough to suit me. They penetrate from 9 to 10 inches of soft pine.

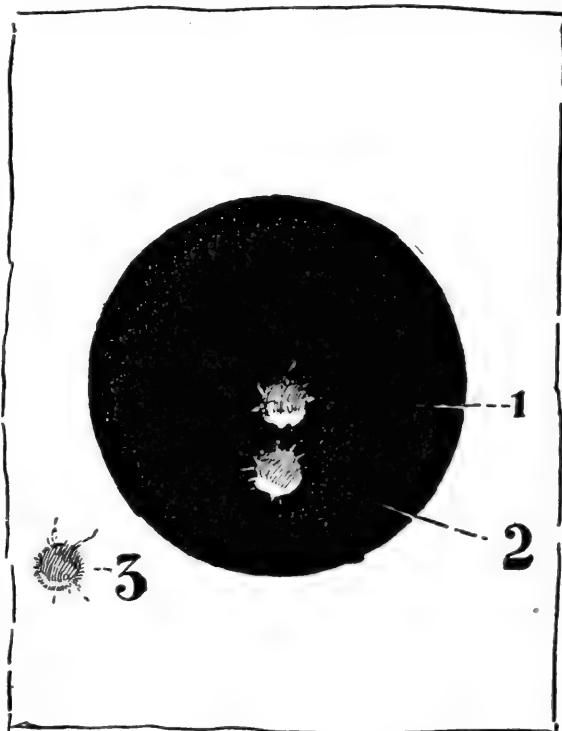

TARGET—EXACT SIZE.

I send you 2 of these bullets. As regards accuracy they are perfect. I also send you a target, made on a cold, windy day (March 13, '97).

The first 2 shots are all right; but the third is—well—blame the wind, or my cold hands.

L. D. von I.

Will you kindly tell me why shot gun nitro powder cannot be used in brass shells? Also why shot gun nitro powder will not work well in a rifle that is built for rifle nitro?

J. J. S.

I referred this question to the DuPont Powder Co., Wilmington, Del., who reply as follows:

"The reason brass shells are not suitable for nitro powder is because there is no method of crimping the shell; a crimp be-

ing necessary on nitro powder, in order to hold back the shot, an instant of time, so that full combustion may take place in the nitro powder charge.

"The reason shot gun nitro powder will not work well in a rifle is because shot gun nitro is made quicker than rifle nitro powder. Consequently, if shot gun nitro powder be placed in a rifle, the pressures would be entirely too high.

"To show you how much lower the pressures are in a shot gun, than in a rifle, we would state for instance, with respect to old black powder: If this grade of powder is fired in a shot gun a pressure will result of about 5,000 or 6,000 pounds; while if the same powder be fired in a rifle, the pressure will be anywhere from 25,000 to 30,000 pounds. You can readily see, therefore, that if a powder is made quick enough to be used in a shot gun, it will give an exceedingly high pressure if used in a rifle. Under these circumstances, nitro rifle powders have to be made especially for the work which they are required to do."

BUFFALO, N. Y.

Editor RECREATION: In your March number G. E. S. complains of 11 gauge wads swelling paper shells. This is a common complaint and can be avoided, if a loader, as shown in the enclosed sketch, be used. This sketch will give the idea, from which any machinist can make the tool. Use a heavy piece of low-grade steel. Have the inside as smooth as possible. The shells should fit so close that the larger ones will just enter the churn with light pressure. If you use a finely fitted loader you will find a slight variation in shells.

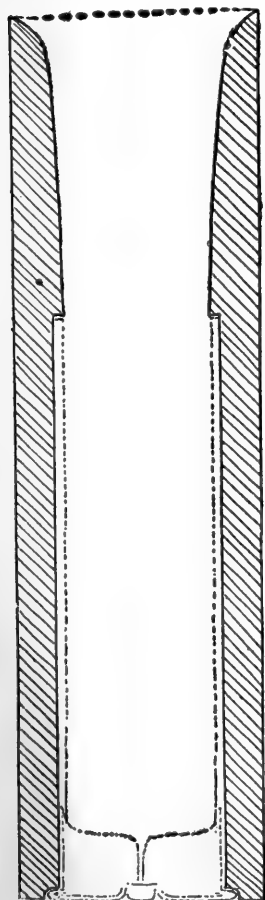

IMPROVED LOADER.

A large wad in this taper is reduced to exactly the inside diameter of shell and will not swell the shell a particle. The ram-

mer should be made of steel also, and fitted closely. The end should be cut off square and the edges only rounded off enough so as not to cut. The length of churn should be such that a $2\frac{5}{8}$ in. shell will project about $\frac{1}{16}$ inch. Any length shell can be loaded by using a little care.

As a sample of the efficiency of such a loader I send, under separate cover, a 12 gauge "Nitro" shell, in which are 3, 9 gauge $\frac{3}{8}$ inch wads, and one 11 gauge, $\frac{1}{4}$ inch black edge. You will fail to discover any swelling of shell.*

All wads are set exactly level with this tool. This loader will cost about \$3.00, as it requires a good mechanic and plenty of time and care to make a good job. It cannot be used for reloading.

II GAUGE.

BRIMFIELD, MASS.

Editor RECREATION: J. V., asks for the opinion of some of the small bore "cranks" as to the best rifle for shooting the 22 short and long cartridge. I recommend the Marlin for accuracy, style and workmanship, and am glad to see it advertised in RECREATION. I have a Marlin repeater, model '92, 32 calibre, both centre and rim fire, fitted with Lyman combination front and rear sights, and it is the most accurate shooting rifle I ever saw. I can drive nails with it at 25 yds., and at 60 yds. can hit a $1\frac{1}{2}$ inch bull's eye nearly every time. I load my own shells, with a set of Ideal reloading tools, which are as near perfect as any tools can be.

If any one wants an accurate rifle, let him get a Marlin repeater, fitted with Lyman sights, and he will have a rifle that will make him happy. For very close shooting, I clean the rifle after each shot, with a clean woolen cloth.

I have tried the square point, 32 calibre cartridge that O. J. B. speaks of, and am convinced the killing power is very much increased by cutting off the end of the bullet. The penetration is not so great, but I think the shock, to whatever the ball hits, is greater, and it makes a hole the size of a 38 calibre conical bullet.

The April number of RECREATION is very interesting, and I believe it is the best one yet. This magazine grows better every month, and I am doing all I can to increase its circulation about here.

F. E. B.

CRESWELL, ORE.

Editor RECREATION: R. D. K., in a recent number of RECREATION, favors the use of the old Winchester rifle, model 66-44 calibre, rim fire, 28 gr. powder, 200 gr. lead.

* Shell received, is loaded as above stated, and is not swollen a particle.—EDITOR.

This gun is so nearly obsolete, in the West, that one is rarely seen. One of the best hunters I ever knew used a gun of this model for several years, but discarded it because, as he said, it would not bleed a deer. This seems the principal objection advanced by those who do not favor the use of any of the smaller calibres.

M. Fenwick, of this State, who is a skilful hunter of big game, and who is said to be the best running shot in the State, nearly always uses a gun of 45 calibre. He admits that the rifles of smaller calibre are more accurate; but thinks more game can be secured by using a repeating rifle of large calibre.

B. D. Pane, Eugene, Ore., a fine shot and a successful hunter, says the Winchester or the Marlin rifle, using a 30-40 smokeless cartridge, is large enough for any game, if a soft point steel jacketed bullet is used.

Personally I have never had any experience with rifles of this class. They may be all right, but it seems to me if the men who so strongly advocate their use had to stop a grizzly bear, in open ground, they would feel better to stand behind a 45-90 Winchester.

R. D. K., in February RECREATION, says: "My idea of a good hunter is that his bullet should never hit a bone on the side of the animal on which it enters."

This reads strangely to Western hunters who kill most of their game running, at full speed, with repeating rifles. At standing game the shoulder shot is considered the best and the safest. With a rifle sighted to shoot a trifle high, to pull up the foreleg until the sight darkens full, is certainly a good shot.

I trust R. D. K. will take no exception to this criticism, as it is kindly given. In fact, I think one secret of the popularity of RECREATION, over other periodicals of its class, is owing to the simple, candid manner in which sportsmen are allowed to express their opinions through its columns.

E. L. H.

This locality is not noted as a game country; but we have fair fishing, in season. Owing to the scarcity of game, lovers of the gun and rifle must needs content themselves with shooting at inanimate targets. Since early in November we have been shooting once or twice a week, for turkeys or for jack pots.

Most of the shooting, with the rifle, has been on the Standard American target, at 50 yards. There is one little 22 calibre rifle, with 22 inch barrel, that has been winning two-thirds of all the meat and money, against a half dozen others, all of larger calibre. At first the boys derisively styled it the popgun, but lately they have learned to have more respect for it.

I am looking for a repeater that can do

as good work, with the .22 long rifle cartridge, as that same single shot. I would like to hear from some of your readers, who are expert rifle shots, as to the best sights for rest shooting, at 50 to 200 yards.

Moody, Rushville, N. Y.

Editor RECREATION: I have been using Winchester rifles for 3 years. First was a 44-40-200 with which I did good work. I killed deer, squirrels, rabbits, and one wild cat. Then I tried a 32-20-115 and find it just the thing to use here. With this I have killed deer, rabbits, squirrels, quails, coons, etc. It does good work up to 150 yds.

Many shooters claim that a 32 is too small for big game; but if they know where to hold it is large enough for here in Humboldt and Trinity Counties. The deer, coons, bears, panthers, rabbits, and game of all kinds, is easy to get within shooting distance of. If the hunter is careful he can get within 50 to 60 yards of deer.

I am now using a 92 model 32-20-115 Winchester rifle and have had good results from the first time I went out with it and think I always shall have.

W. B., Bridgeville, Cal.

I am very much interested in your wonderful magazine. It is a prize to sportsmen and the only trouble I find is in waiting from one month to another. I have it all read through long before it is time for another issue. Guns and ammunition is the first thing I strike for, and I wish there was more on that subject. Am showing your magazine to all my friends that I think have a drop of sportsmen's blood in them, and hope RECREATION will reach the millions, which it will if given justice.

G. R. R., Northfield, Vt.

I am a small bore crank, and would say to J. V. that for all-around shooting I consider the 22 Marlin best. I bought one and have never regretted it. The 22 short cartridge is about as good as the 22 long, and is cheaper; while the 22 long rifle is far better and no dearer. I should like to hear from some one who has used the 22 short, hollow point bullets.

A. H., Paterson, N. J.

Replying to J. V., I have a 22 short Marlin single shot rifle, which I have used 5 years. I have tried several other makes of same calibre, but like the Marlin best. With slight elevation, it shoots accurately at 100 yards, and point blank at 50 yards.

I use a graduated peep rear sight and a Beach combination front sight.

J. S., New York City.

NATURAL HISTORY.

COYOTE STUDIES.

During the past 10 years, our professional mammalogists have been giving the different families and genera of American quadrupeds a complete overhauling. Through the labors of Dr. C. Hart Merriam, of the Biological Survey, Dr. J. A. Allen, of the American Museum of Natural History, Dr. Edgar A. Mearns, of the Mexican Boundary Survey, and a few others, huge collections of the dry skins and skulls of the smaller quadrupeds have been gathered by trained collectors. Often 100 skins of the same species have been brought together, each one most carefully labelled as to its locality, measurements, date, etc. Dozens of trained and skilful collectors have gone over nearly every portion of the United States, gathering in everything that was so unwary as to succumb to trap or poison. It is absolutely certain that the work of the Biological Survey of our Agricultural Department is by far the most thorough and systematic of any studies of quadrupeds ever carried out in any country. As yet the public generally has not the faintest idea of its scope or its value, because thus far the results have not been ready to correlate and lay *en masse* before the public. When this is done, it is safe to predict that such reports will be a revelation to all people who are interested in animal life.

As an illustration of the startling results often reached, we may mention the case of our old friend, the coyote. And what blessed memories of sage-brush "flats," bare "divides," ragged "bad lands" and good times galore rise before the hunter at the mention of his name! We have all known him—and love him for the fun he has furnished us for lo! these many years. We have clung to him as the one animal who scientifically is the same to-day, yesterday and forever. The varieties of gray wolves and of bears may be ever so many, but we never knew *Canis latrans* to be assailed by the makers of new species until now.

At last, however, the coyote's hour has come. At last Dr. Merriam has gotten hold of him, to the extent of a large collection of skins and skulls, from all parts of coyote land, and the individuality of our old friend and occasional camp-follower has been divided by long division. Dr. Merriam recognizes as valid 3 old species, that for years had been considered harmless, and at one fell swoop he has also created and described 7 new species!

The Doctor protests that the specimens alone are to blame. He spread them all out, according to their localities, sizes, colors and teeth, and found 11 distinct

forms. To make sure his eyes did not deceive him, he called in several other mammalogists, and challenged their judgment. It was agreed that the 11 species were all there, and could not be reduced by any legitimate process known to science; whereupon, the whole 11 have been described by Dr. Merriam in a Biological Society paper, which was published on March 15.

It is impossible for the casual student, much less the average hunter, to acquire, from even the best descriptions, the ability to recognize each of the species described without missing a shot. Only a trained naturalist can do that.

As if in anticipation of this very difficulty, Dr. Merriam has arranged the 11 species in 3 groups, each of which is represented by a species which may be considered the type of its special group.

The LATRANS GROUP heads the list, and is represented by our old friend *Canis latrans*, who is accredited to "the humid prairies and bordering woodlands of the Northern Mississippi valley in Iowa and Minnesota, and follows the Northern edge of the plains Westward to the base of the Rocky mountains, in the province of Alberta." Farther West, in Colorado and Montana to Assiniboia, it is replaced by a pale species called *Canis pallidus* (new) which joins farms, still farther West, with *Canis lestes* (new), who owns Southern British Columbia, the Sierra Nevadas and the Rocky mountains, to Northern Arizona.

The FRUSTROR GROUP contains 3 species—*C. cagottis* of Central Mexico, *frustror* of Southern Texas and Indian Territory, and *peninsulæ* (new) confined to Lower California. These 3 species are of medium size, and have smaller teeth than the members of the *latrans* group.

The MICRODON GROUP contains 5 species, 2 of which hail from Mexico, one from Arizona, one from Utah, and one from the San Joaquin valley, California. These are all new save the one last named. These are still smaller animals, and have much smaller teeth than either of the other 2 groups.

Just what method will be adopted to enable other persons than half a dozen professional mammalogists to get a clear understanding of the 11 coyote species now laid before us, remains to be seen. One very important step in that direction has been omitted by the distinguished author—inadvertently, let us hope. *Not one* of the 11 species has been christened with an English name! To most people, the Latin names mean nothing, and it is therefore probable that general interest in the new forms will wait for names in the United States language—names that mean something, and that can be remembered.

W. T. H.

THE CARNEGIE MUSEUM.

Five years ago, Mr. Andrew Carnegie—who spends his wealth for the people about as fast as he accumulates it—gave to the city of Pittsburg a grand pile of buildings containing a fine library, museum, art gallery and music hall. It cost \$800,000, and all its contents are free to the public. The only condition exacted by the generous founder of what should be called "The Carnegie Institute," was that the city of Pittsburg should annually appropriate the sum of \$40,000 for the maintenance of the library and music hall.

For the maintenance of the museum and art gallery, Mr. Carnegie has given \$1,000,000, as a permanent endowment fund, the income from which amounts to \$50,000 a year, and is divided between the 2 institutions.

The museum has been the last of the 4 features to get under way, chiefly for the reason that while it is possible to buy the contents necessary to a library, or an art gallery, a really fine museum must be created from the crude materials, by careful and intelligent selection and handiwork.

For more than a year the Museum Committee of the Board of Trustees has been considering what course to adopt for the development of the museum. Nine large halls stand ready to be filled. After full investigation, the Committee has chosen Mr. Frederic S. Webster, of New York, to serve the museum as taxidermist and general preparator in zoology, and on May 1 he assumed the duties of that very responsible position.

The founder of the museum, and all the promoters of the new treasure house of zoology, are to be heartily congratulated on their choice. Mr. Webster has for years stood in the front rank of his profession, and he is, beyond question, the best man that could have been found for the place. His years of experience at Ward's Natural Science establishment, when its taxidermic department was at its best, gave him a wide and valuable experience in the mounting of birds, mammals and reptiles, of all possible degrees of difficulty. It was there he accomplished the difficult feat of mounting both the skin and skeleton of a rare New Zealand lizard (*Hatteria punctata*), a task which at first seemed impossible. In the 13 years Mr. Webster devoted to custom taxidermy in Washington, and in New York, the amount of fine work, in mammals and birds, which left his hands, both singly and in groups, was really immense. His exquisite artistic taste in the preparation of bird groups has won for him numerous prizes and general praise.

To all lovers of zoology it must be a sincere pleasure to see so capable a man, and so true an artist, chosen to produce the work which will fill the elegant halls of the

new Carnegie Museum. I understand it is the intention of the Museum authorities to give Mr. Webster as free a hand as any taxidermist could possibly expect in his work, and the public will look for good results. His first official act was the purchase, from Lieutenant Peary, of a fine series of soft skins of the Atlantic walrus, with which to create a huge group.

DESTRUCTION OF AFRICAN GAME.

About 2 years ago the rinderpest broke out in Uganda, Eastern Africa, and slowly marched Southward, sweeping down about 90 per cent. of all domestic cattle. A year ago it struck Mashonaland and Matabeleland, and spared so few oxen that traffic and travel by wagon became almost impossible. It is now going on down toward the Cape, and bids fair to completely ruin thousands of small farmers whose wealth has, until now, consisted chiefly of cattle.

One of the worst features of this awful cattle plague is that it attacks and kills off certain species of wild game, as well as domestic cattle. Even the hardy and vicious Cape buffalo cannot withstand it. A party of English hunters, who have recently returned to Buluwayo, from the Zambesi country, report that in the region where eland, sable antelope and buffalo were plentiful a year ago, scarcely any of those animals now remain; and for this reason their trip was a complete failure.

While it is hardly probable that any of the species of African antelopes will be exterminated by the rinderpest, it is fairly certain that many years must elapse before the herds increase to anything like their numbers 3 years ago, even if they ever do; for from now on hunters will be more numerous than ever before.

WHY IS IT?

I have already published an account of the way in which wolves signal across country, and shall have more to say on this subject, in a later number. I write now to inquire if any of the readers of RECREATION have noticed the habit wolves have of rolling in carrion that they would not deign to eat.

The only explanation I can offer for this strange habit is that a wolf's personal odor, or body scent, is very strong, and that all animals know and fear it; so that it must often betray him while hunting. From time to time, therefore, he "dopes up" when he finds some exceptionally stinking filth. No wild animal is frightened by the smell of carrion, and if its potent odor does not entirely overpower that of the wolf, it at least dispenses it in a measure. Thus the wolf

hides his sins under the odor of a dead animal.

Has any reader ever observed this habit? If so will he kindly report, through RECREATION as to when, where, how often, etc. Give full particulars.

Ernest Seton Thompson.

TAXIDERMISTRY WITHOUT A TEACHER?

Will you please tell me, in RECREATION, if I could learn the art of taxidermy from reading the various books on the subject, or would I have to study with some one? If so, how long?

F. H. T., Haverhill, Mass.

While it is entirely possible for a bright young man to learn the art of taxidermy from books alone, it is far better to study with a living teacher, and learn by practical demonstration as well as by precept. The latter course will—if the teacher knows his business, and teaches its principles fully and frankly—save both time and money. The best course for a beginner is to enter the service of some competent taxidermist, begin with the preparation of skins, watch everything that goes on around him, and study nature. But, in addition to that, he should get Hornaday's "Taxidermy and Zoological Collecting," and learn it by heart. It has taught many a man to mount birds, quadrupeds and heads of big game when living teachers were entirely beyond reach.

GLENWOOD SPRINGS, COLO.

Editor RECREATION: There is a most wonderful cave about 6 miles above Glenwood Springs, overlooking the Grand river. Many people visit it every year, yet it has never been fully explored. Several men have put in a whole day wandering from chamber to chamber; and it is thought there are fully 5 miles of underground passages.

The entrance is about 10 x 18 feet and is about 2,000 feet above the Grand river. The view from the entrance is wonderful. Trains passing up and down the valley look like mere toy cars.

The walls of the chambers of the cave look like polished marble. One of these chambers, nearest the entrance, the bears use for winter quarters. Others are used by mountain sheep. It is evident they were once also the hiding places of the dusky Ute, for many arrow and spear heads have been found in them.

Two years ago I found the skeleton of a large ram that had been killed by lions, the winter before. There are many bear, lions, mountain sheep, deer and grouse about

there, but not many elk on the South side of the river. When there was a bounty on bear I used to get as many as 7 in a week, with the aid of my dogs. I discovered this cave in 1892, while prospecting, and have located it as a mineral property. I have never been able to get to it in the winter, on account of the deep snow and the narrow trail around the cliffs.

W. H. Hubbard.

A reader asks how to prepare skins to keep the moth out of them.

A pelt that is to be used must first be tanned, by a professional tanner. After that has been done, the skin should be stretched on a board, skin side uppermost, sponged with lukewarm water until it is quite soft, and then it should have a coat of arsenical soap, such as taxidermists use, mixed to about the consistency of thin cream, so that it can penetrate the skin to the roots of the hair. This can be facilitated by rubbing the skin vigorously, with a bit of smooth wood to save the fingers from the soap. The soap *must* penetrate the skin to the roots of the hair, for it is there that insects work. It is impossible to poison the hair itself without making the fur dangerous to the users.

Arsenical soap is the best thing in the world to protect any skin from insects, for when dry it gives off no powder. All taxidermists, doing custom work, keep it for sale, and a pound goes a long way. Apply it with a common paint brush, the kind called a "sash tool" being the best. A skin should always be treated while fresh and soft, unless it is to be used as a fur garment, rug or robe.

Seeing your invitation to coon hunters to send in actual weights of coons, I gladly respond, as I have been hunting them 6 years, in which time I have caught 157 coons. I keep a record of the weight of every one caught. The largest one I ever took weighed 21½ pounds, though I saw one caught, by a friend, which weighed 24 pounds.

I have often heard of coons weighing 35 and 40 pounds, "guess weight," but when laid on the scales they seldom go 20 pounds. They are very deceiving as to weight and I may safely say the average weight of coons, in this section, is 10 to 15 pounds.

G. V. B., Hackensack, N. J.

As one of the court of inquiry to report on the weight of the biggest coon, I beg to report that among the many coons I have secured, while trapping and buying furs in this vicinity, the largest was one which I bought of a local hunter and which weighed 29 pounds.

E. L. R., Westville, Ind.

EDITOR'S CORNER.

THE SICK BABIES' FRESH AIR FUND.

I said in the May number of RECREATION that the responses to my appeal in behalf of the Sick Babies' Fresh Air Fund had been generous. They had been generous, up to that time, so far as some people were concerned; but during the past month the receipts have not been nearly so large as I had reason to believe they would be. In fact, I am sadly disappointed at the meagreness of the contributions. I have thus far received less than \$50, all told, while I should have had \$1,000.

Here are a few letters indicating the sentiments of certain good people, on this subject:

TITUSVILLE, PA.

Herewith please find \$1 to cover the following-named contributions to your fund for the benefit of the sick children: Miss A. M. Eckbert, Jno. C. Machale, Geo. J. Marks, F. T. Cuthbert, Mrs. F. T. Cuthbert, J. Ronald Cuthbert, Helen Iredell, Raymond Iredell, Harry Iredell, G. E. Bennett.

It is a great pleasure to be able to contribute to so worthy a cause, and the thought that some poor baby, sick and almost dying, perhaps, for the want of air and medical treatment, may be given even this little outing, and the tired mother be relieved from the worry and care of life, for one day, makes one feel good in the consciousness of having done a little for the ones needing help and sympathy. May it be a great success.

G. E. BENNETT.

WASHINGTON, D. C.

Ten readers of RECREATION send herewith \$1 in postage stamps for the "Fresh Air Fund" and wish you complete success.

C. G. GOULD.

MARION, N. J.

Editor RECREATION: Here is my mite for "The Sick Babies' Fresh Air Fund." You certainly deserve great credit for doing such good work, and I trust you will be successful in raising the amount you name, \$13,000. I don't see how any one can possibly refuse so small an amount as 10 cents for such a cause.

W. H. KELLEY.

BUFFALO, N. Y.

Enclosed please find 20 cents for your Fresh Air Fund—10 cents for myself and 10 cents for my wife, who is also a reader of RECREATION. The object is a noble one, and I wish you success in your endeavor to raise the thousands of dollars.

E. W. SMITH.

PHILADELPHIA, PA.

Enclosed find 10 cents for your Fresh Air Fund. You certainly deserve the help of every reader of RECREATION in this noble work, and I hope your efforts in that direction may be crowned with success.

WM. L. VOIGT.

LEBANON, N. H.

These 10 stamps are to be counted in your Fresh Air Fund. My 2 babies have fresh New Hampshire air 365 days in the year. It seems impossible that such a mite (20 cents) should give fresh air to 2 little "mites" for a day. It is a pleasure to contribute.

H. M. CHENEY.

I assumed that almost every reader of RECREATION would receive this appeal in the same spirit as these people have. It seems strange that any man, woman or child, who is fond of fresh air, should not be willing to spend 10 cents to give a sick baby a whole day of it; an excursion on the salt water; a salt water bath and a good wholesome meal. I hope the receipts for the next 30 days will be at least \$1,000. Who can refuse to add his or her 10 cents?

SUBSCRIPTION RECEIPTS FOR 2 YEARS AND 4 MONTHS.

Read the deadly parallel columns:

	1895.	1896.	1897
January	\$379	\$723	\$2,146
February	256	693	2,127
March.....	300	1,049	2,215
April.....	342	645	1,921
May.....	292	902	
June	307	770	
July.....	345	563	
August.....	306	601	
September.....	498	951	
October	438	969	
November.....	586	1,054	
December	652	1,853	
	<hr/>	<hr/>	<hr/>
	\$4,671	\$10,773	

Look at the figures for April '95, '96 and '97. They afford a lot of food for reflection. Think of this remarkable growth, and consider whether or not your ad. should be in RECREATION.

Are you not using other publications whose circulation is decreasing all the time? There are many of that kind on the market.

The July number of RECREATION will fully sustain the reputation this magazine has made as a storehouse of good reading and beautiful pictures.

Among the leading features of that issue will be "A Rough Ride in Oregon," by Maj. J. G. Trimble, U. S. A.; "A Linger-ing Bunch of Buffaloes," C. N. Ayers; "Doubles," W. C. Kepler; "My Last Hunt in Kansas," Gen. F. W. Benteen, U. S. A.; "Goose Shooting in Colorado," W. E. King; "How I Killed the Big Ram," T. D. C.; "My 22 Point Buck," Dr. F. D. Hulbert, etc.

The various departments will be full, to overflowing, of bright bits of news and valuable information.

I have never yet found nor heard from the 4 heads, that were stolen from my exhibits at the first and second Sportsmen's Shows, in Madison Square Garden, though the heads are undoubtedly somewhere in New York City. Who has seen an antelope head, a mule deer head (female), a Rocky mountain lamb's head (with horns about 1 inch long) or a coyote head? I would gladly pay \$25 each for the return of these, and ask no questions. Please keep a lookout for them.

Send me brief items for Cycling, Natural History and Photographic departments.

The report of the judges who awarded the prizes in the photo competition will be found on another page. Prize winning pictures in July RECREATION.

BICYCLING.

AN INTERVIEW WITH WHITMAN'S SPIRIT.

Spiritualism may be and probably is one of the biggest frauds of the day; but it has some good men among its followers, and once in a while it produces a good thing. The following pretended revelation, from the spirit of Walt Whitman might easily have come from the pen of the late poet:

ERNEST SETON THOMPSON.

"Oh, flying wheel! Oh, bicycle! skimming lightly past the lumbering horses on the crowded thoroughfare like a sucker among the ice chunks in the creek, when the spring floods are making it almighty cold and rough!

"Oh, little lacework of steel, rimmed around with rubber! I've made up my mind about you and I'm starting in to sing your praise in one of my chants.

"Not that I ever was on a wheel, or that I care about that style of exercise;

"Not because you have disproved a lot of rot that the scientists talked, about velocities, energies and ratios;

"Not because you are taking away lots of trade from the big hotel monopolies and scattering it more evenly over the country among the little wayside inns, as it should be;

"Not entirely because you are giving the poor clerks and counterjumpers a chance to see God's earth once in a while, as well as those who care nothing about it;

"But this is why I am singing your praise: Because what many great and good men and women vainly gave their lives to do, for the race, you have done in less than 10 short years.

"You have given to women the right to have legs, just as men have them; and you are building up big strong loins and thighs on those who will, in the next generation, be the mothers of the nations."

ON THE BOULEVARD.

A sparkling April morning,
A cycling maiden gay,
A happy speckled doggie
That wouldn't get out of the way.
A girlish scream of terror,
A wickedly wobbling wheel,
And then—the distant echoes
Of a vanishing canine squeal.
Alas for the speckled doggie!
None could his pace retard.
Alas for the cycling maiden!
Asphalt is very hard.

—Exchange.

AS TO WHEELS, TIRES, ETC.

SYRACUSE, N. Y.

Editor RECREATION: There are many good wheels on the market, and many poor ones that are supposed to be good; so it is well for a man, in purchasing, to use judgment, and not to depend on what the salesman says. You will find riders who ride a certain wheel because of its lines, the color of its enamel, or because a certain friend sells it, or some other cause that counts for nothing. There are few riders who select their machines solely for their superior points in mechanical construction yet these are what make a perfect riding and easy running wheel.

I have ridden ever since I was 8 years old, and am now past 30. Being a mechanical engineer, and having designed for several of the leading manufacturers, I know a well made wheel when I see it.

I favor no wheel on advertising grounds but consider all of them solely on their merits. During the past year I rode one wheel 13,226 miles and had absolutely no trouble with it. I used in all this time one pair of Vim tires and had but 3 punctures in these.

I cannot speak too highly of the Vim tires, and I sound their praises wherever I go. They have served me well, on all sorts of roads and in all sorts of weather. It is true that toward the end of the season I was forced to change my rear tire to my front wheel, on account of wear; but some friends who rode with me last season, and who were several thousand miles behind me, used 2 or 3 pairs of tires to my one.

Tires are not always to blame when they give out. Many riders are careless. They use no judgment in keeping their tires properly inflated or properly fastened to the rims. There is also the scheming repairer who does poor work and spoils tires simply to get more work, and possibly sell a new tire. If a puncture is such that you cannot fix it yourself, send it to the manufacturers, and they will work to their own credit.

My choice of a saddle is the Brooks, but a saddle is something each rider must try. A saddle that fits one person may not fit another.

In all the years I have ridden, I have never used a lamp, so cannot advise, but the Bridgeport is a fine one, and has done good service for many of my friends.

E. W. G., Syracuse, N. Y.

"Honesty is the best policy,"—especially for a man who wants to do business 2 years in the same place.

A CRY FROM THE WAR.

(Dedicated to the best Lexicographer.)

Is it bisighkel,
 Little Michael?
 Or bisickel,
 Whether nickel
 Five per cent., or fifty carbon,
 When it has its final garb on?
 Whether plain or most ornate,
 Strong and simple in its state
 Or decked with gaities?
 I say it is!

If you don't believe it
 You'll soon perceive it
 By looking up the dictionary,
 For it's—well, it's fiction, very
 Much so, to deny, brother,
 That it's either one or other.

Take a vote and there will be
 A very large majoritee
 For bisickel
 Like icicle,
 Or bisighkel, uttered, say
 Like the "cycle of Cathay."
 In either case,
 Whichever wins the race,
 I offer you surety
 That best authority
 Will be against the chosen way
 And the other method will come to stay.

BROOKLYN, N. Y.

Editor RECREATION: A study of the bearings of the '97 wheels shows a tendency against which I wish to record a protest. On nearly all the wheels the arrangement of cups, cones and ball-retainers is such as to make an enclosed case which holds the oil and anything else that may get in. This arrangement requires little care and is clean, making a good bearing for a ladies' wheel. The old style, before ball-retainers came

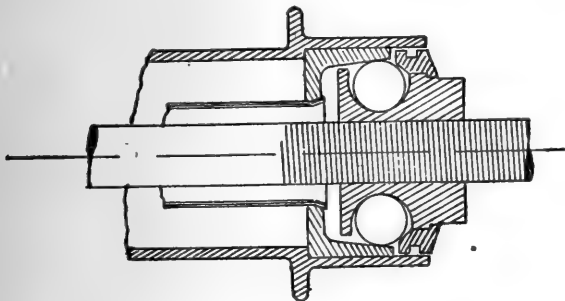

into use, was to have the cones outside and locked by the nuts on the axle ends. This was a good arrangement inasmuch as it allows the oil to drain out of the bearing, carrying with it the particles of dirt which may get in.

The great value of this natural drainage is referred to in the report of a hard tour made

by a U. S. Army officer. The oil, in draining slowly out collects dust which is easily wiped off. The point of value is that it shows at a glance the health of the bearing.

I submit a sketch of a rear wheel bearing. The axle is $\frac{3}{8}$ of an inch in diameter and the balls $\frac{5}{16}$ inch. The ball-retainer has a groove for a felt washer, as a protection from dust. The balls are held to the cone, a much better arrangement for cleaning and inspection than where they are held in the cup. The angles of the bearing surfaces are such as would make an easy running wheel, if carefully made, without the slightest tendency to wedge. B.

"Somebody has invented a machine-gun to be mounted on a bicycle."

"That won't work. The men will have so much fun riding that they will forget all about the fighting."

It was Sunday morning March 28th, that my friend Clyde and I came together and planned a ride for the afternoon. It was the first Sunday the roads had been in good shape this year, so we ventured out.

Our first objective point was DeGraff, O., $3\frac{1}{2}$ miles distant. I had been sick, for some time, and did not feel able to ride fast, but we pushed along at a fair gait.

Arriving at DeGraff, we rode over the town awhile and then stopped at a restaurant, rested and smoked.

We now ran North about 3 miles to Logansville and thence started for home. After going about a mile Southwest, the road began to grow worse, and my friend suggested a change of route; so we returned to DeGraff. There we took another rest and then rode out toward a little town called Spring Hills, Southeast from DeGraff. We found the road fair until we had gone about 3 miles when it began to get rough. The wind was in our faces, and our wheels began to push like log wagons.

It was only a $4\frac{1}{2}$ mile run to this town but it seemed like 10, the way the roads were at some places. We walked up all the steep hills and found plenty of them.

We finally found we were on the wrong road so concluded to return to DeGraff and then go home.

We reached Quincy late in the evening, thoroughly tired and convinced that March is rather early for the roads, in this country. D. W., Quincy, O.

HER HAPPY THOUGHT.

She had painted an elegant sunset—

It was lurid enough to roast her;
 But it wouldn't sell, so she dashed in an "ad"—

A wheel-girl—and called it a poster.

E. C.

TROUBLE AHEAD.

"Skorcher felt terribly about getting his face scratched in that bicycle collision."

"Yes; he said he couldn't make his wife believe he hadn't been to a lady barber."

What do you think of the Lovell Diamond bicycle, as compared with the Victor, the Stearns and other \$100 wheels?

A. E. H., New Haven, Ct.

ANSWER: The Lovell Diamond may be all right but is not so well known as the others you mention. You will always serve your own interests, and those of brother sportsmen, best, by buying goods that are advertised in RECREATION in preference to those not represented there.

"You go out on your wheels every Sunday, don't you?"

"Yes; after we come home, you know, we get a sermon and the music from our phonograph; and our vitascope shows us the people coming out of church."

SUMMER JOYS.

'Tis now the dusty time o' year—

As writ in Nature's page;

When reckless sprinklers soak the streets,
And make the cyclists rage.

The Gotham Cycle Club is in the saddle more firmly than ever, having now acquired possession of its handsome and spacious club house at 254 West 53d Street on terms, for all practical purposes, equivalent to ownership. The new President of the club, is Mr. A. Jagmetti, the well-known Superintendent of the Century Association.

Extensive alterations and improvements will be made, in the club house, at once.

"George, I heard talking after you came in late last night; were you saying your prayers?"

"Not much: I was hunting matches and put both hands flat on that fly-paper you left on the mantel."

CYCLE NOTES.

With the ground white with the dreaded snow, at late as March 15th, it looks as if Southwestern Connecticut would have at least her share of mud and slush this spring. It reminds me that '97 will be a gear case year in America, if year 'round riders are real bright; for a good gear case saves a lot of wear and muscle, not to say pointed remarks, all due to bad roads, which are too numerous all over the land. I shall try one early, and report.

* * *

There is a budding tendency toward more comfort and less agony from saddles; but several of the new kinds shown, that pretend to afford ease, are so small the rider feels that if he remains on, it will be due as much to Providence, as to his own skill.

* * *

A light, accurate, repeating rifle, that means business when fired at a vicious dog who wantonly attacks wheelmen on the road, is a good thing to carry in regions so infested. No law in this State prevents it, either, and should not in any other.

* * *

Tires wider than inch-and-a-half "will be much worn" this year by comfort lovers; and even by many of the speedy ones, who have grown weary of numb hands and aching arms due to small, hard inflated tires on rough roads. One and three-quarters and, in many cases, 2 inch tires will be ridden by those who prefer to still inhabit this vale of tears. Why not ride at ease?

* * *

A fine quality of steel wire should replace many of the flimsy dress and chain guards, of string, found on too many ladies' wheels.

Suppose wire costs ten cents more to a wheel; it would make the owner more than that much happier, and she would, with the wire lacing, as the photographer says, "look pleasant" at all times.

Stamson.

The secretary of the L. A. W. has compiled a list of membership in each State, showing the numerical standing for 1896 and 1897. There was a decrease in only two divisions—Oklahoma and Mississippi. The membership a year ago was 39,323. This year it is 75,512.

The wheelmen of Watertown, N. Y., have formulated plans for building bicycle paths along Lake Ontario, connecting with paths throughout the Northern, central and Western counties. It is expected this circuit will be completed by August.

Saratoga has been selected for the New York State division bicycle meet, which will continue 2 days, during the week beginning June 21. The local arrangements will be made by the Goods Roads Association.

Six months ago the Greater New York Wheelmen organized with 12 members. They now have nearly 200 and the club has made application for membership in the Associated Cycling Clubs of Long Island.

A party of 3 gentlemen will go from here to San Francisco, on bicycles, this spring. Will some one inform me in regard to the best route to take?

B. G. Robinson,
East End, Oneonta, N. Y.

"Some Sager Saddle Surely Suits."



CYCLE SADDLES

Come in 5 forms of 14 various dimensions, interchangeable with 7 graded springs, giving 60 styles to choose from, shown in the new Illustrated Catalogue, sent free.

The Racer pleases all fast riders.



Made of the finest materials the world produces by the

Sager

"Makers of Most of the High-Grade Saddles." ROCHESTER, N. Y.

WHY ROUGH IT IN CAMP?

WHY NOT SMOOTH IT?

WHY NOT BE COMFORTABLE?

Our forefathers used to rough it because they had to. That was before the day of DERBY, ABERCROMBIE & Co. It was before the day of their water-proof tents, clothing bags, and sleeping bags; their grub bags, ammunition bags, canvas canoe covers, awnings, folding buckets, etc.

Now, since these goods are on the market, and at prices that are easy for everyone, there's no reason why anyone should not make camp life a luxury.

Here is what one man says of our goods:

ABBOTTSTON, BALTIMORE, MD., Nov. 20, 1896.

Gentlemen: I have used your tents 6 seasons, hunting in the North and South, and find them an absolute protection against rain and dampness. The fact of their not wetting is a great feature, for they do not increase in weight. I camped in the Mississippi Delta 6 weeks during an unusually wet season, and used tent without fly, which proved a great boon to us. You may use my name to recommend your tents, and hope others will see the advantage of a light-weight, waterproof tent.

HORACE ABBOTT CATE.

Many others have spoken in equally strong terms. If you try our goods you will like them as well as others do.

Ask for catalogue and prices.

Derby, Abercrombie & Co.

Manufacturers of **WATERPROOF and PLAIN CANVAS GOODS**

36 South Street, New York City

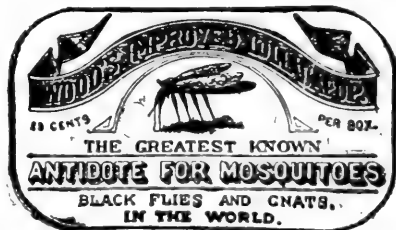

Trustiest Tackle of Tackledum

To take **TRICKY TROUT, BASS, PICKEREL, or TARPON.**

Illustrated in a book of 136 pages—FREE To the "SONS OF ISAAC WALTON" which means to those who have a love for fishing, or would like to have.

Penny, in a postal, brings it. Send for it NOW. **REUBEN WOOD'S SONS' CO., SYRACUSE, N. Y.**



Carry **"The Corker"** with you

and you need have no fear of walking home. It mends cycle tire punctures in a minute. The simplest thing in the world. Send 25c for enough to mend 25 punctures.

"Clinchit" Rubber Cement, the "stuff that sticks." Ounce tube, postpaid, 15c.

Circulars free.

The National Specialty Co. 91 Euclid Av. Cleveland, O.

Cartridge Kodaks.

\$25.⁰⁰

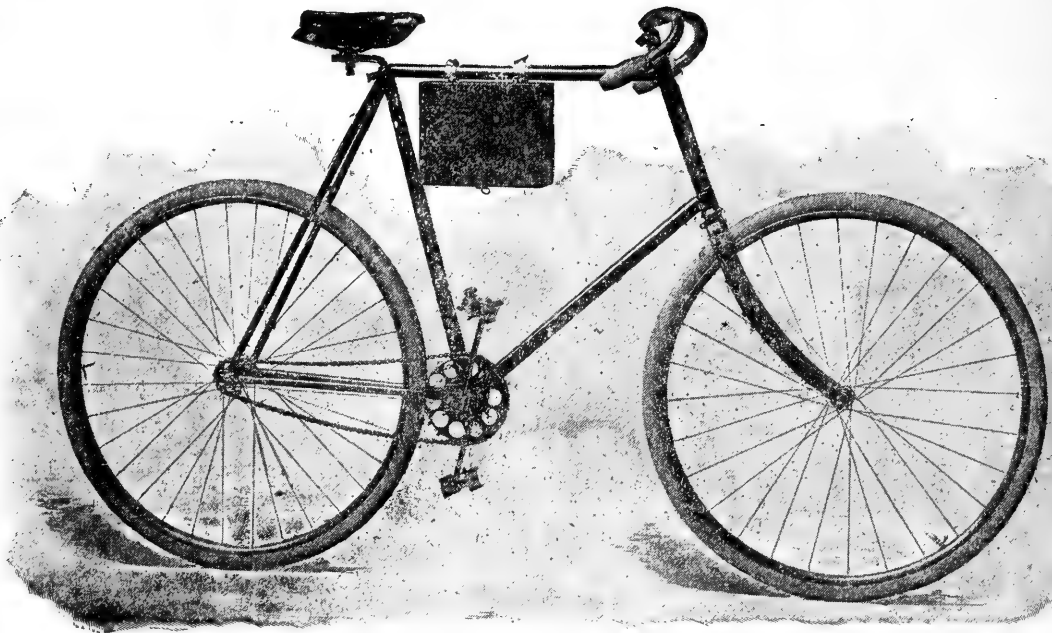

SHOWING CARTRIDGE KODAK CYCLE CASE.

In the No. 4 Cartridge Kodak we have combined our Film Cartridge System by which the camera LOADS IN DAYLIGHT with a Folding Kodak of the highest type. It embodies in an instrument $3\frac{1}{8}$ inches in thickness, every feature which the skilled amateur desires in his camera. It uses either film cartridges or glass plates and is the only 4 x 5 camera which is

**PERFECTLY ADAPTED
TO USE AWHEEL.**

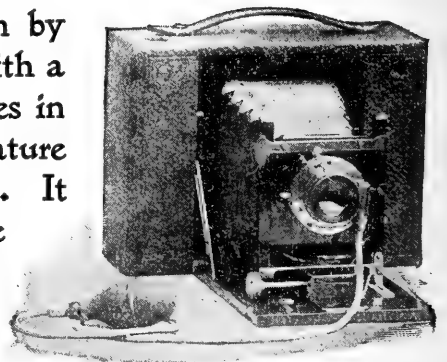

"BICYCLE KODAKS" booklet
free at agencies or by mail.

**\$2,853.00 in Prizes for
Kodak Pictures.
\$1,475.00 in Gold.**
Send for "Prize Contest"
Circular.

EASTMAN KODAK CO.

Rochester, N. Y.

AMATEUR PHOTOGRAPHY.

CLOSE OF THE CONTEST.

RECREATION'S 2d annual photographic contest closed April 30th, and the prizes were awarded Monday, May 3d. The judges selected for this important duty were Geo. H. Daniels, General Passenger Agent of the New York Central Railway; Ernest Seton Thompson, the eminent animal painter, author of "Art Anatomy," "The King of Currumpaw," etc.; and W. T. Hornaday, director of the New York Zoological Society, and author of "Taxidermy and Zoological Collecting," "Two Years in a Jungle," "A Man Who Became a Savage," etc. These men are well known to all readers. Their professions are such as to have required them to handle photographs, for years past, and they are, therefore, especially qualified to judge critically of this class of art.

They gave an entire afternoon and evening to the work of examining the 1,214 pictures which had been submitted by 607 competitors. The reader will readily understand the great responsibility placed upon these gentlemen, and the difficulties they encountered, from the start.

A number of photographs were entered by beginners, who had little idea of the high degree of excellence they would have to compete with, and whose pictures were, therefore, not of a high order. There were, however, more than 300 fine ones, to the makers of which the judges would have been glad to award substantial prizes; but this could not be done, on account of the heavy expense it would entail on the publisher of RECREATION.

Many excellent pictures must, therefore, be passed over and the makers of them will naturally feel disappointed. Even honorable mention could not, for lack of space, be accorded to all who deserve it. The honors were placed where the judges deemed they were most thoroughly deserved, and persons whose names do not appear in either of the following lists need not, for a moment, infer that their work was not appreciated by the editor, or the judges. The unfortunate ones must remember that all pictures could not be best, and that all could not win where so few prizes or so few commendations could be bestowed.

The prize winners are as follows:

- 1st, "Hunting the Big Horn".....Myra A. Wiggins.
- 2d, "In the Swim".....Wm. L. Rathbone.
- 3d, "Gee!".....F. T. Harmon.
- 4th, "A Big One at Last".....Frank C. Pearre.
- 5th, "Alone, Perhaps!".....W. H. Walters.
- 6th, "An African Hunt".....Arthur C. Mellette.
- 7th, "After the Bass in Big Swamp," D. M. Ballou.
- 8th, "On a Summer Day".....F. E. Matthewson.
- 9th, "At the Foot of the Pass".....Harry R. Christy.
- 10th, "An Anxious Moment".....Mrs. H. L. Darling.

- 11th, "A High Grade Tumble".....John Boyd.
- 12th, "Game Keeper and Antelope" Serg't Wm. Van Buskirk.
- 13th, "End of the Cruise of '89".....William Allen.
- 14th, "Pine Shack".....D. M. Ballou.
- 15th, "The Captain of the Libbey".....F. E. Matthewson.
- 16th, "A Fresh Supply of Venison" J. Howard Demarest.
- 17th, "A Fine Catch, See!".....Capt. John S. Loud, U.S.A.
- 18th, "Curse That Limb".....E. H. Ashcroft.
- 19th, "Recreation".....Frank C. Pearre.
- 20th, "Here They Come".....William Mohaupt.
- 21st, "Doubtful".....Robert Walstrom.
- 22d, "A Late Cast".....H. L. Christy.
- 23d, "In Trouble".....Wm. L. Rathbone.
- 24th, "An Early Breakfast".....B. J. Warren
- 25th, "A Few Minutes' Rest".....William Allen.
- 26th, "Looking For Trouble".....H. G. Reading.
- 27th, "A Fine Afternoon".....Eugene V.R.Thayer,
- 28th, "Bathers".....G. E. Moulthrop,
- 29th, "The Drumming of the Grouse" S. J. Power.
- 30th, "Dunbar Castle".....Fred Darrow.
- 31st, "Prairie Chickens".....J. C. Howenstein.

The following pictures are awarded high commendation:

- 1st, "Where is Our Camp?".....S. J. Power.
- 2d, "Two Coons and the Dog that Treed Them".....Samuel Randall.
- 3rd, "Now Look Pleasant, Please," E. F. Whitmore.
- 4th, "The Monarch of the Forest" Samuel F. Gaches.
- 5th, "Chips of the Old Block".....H. S. Humphrey.
- 6th, "Sugaring Off".....W. C. Sleight.
- 7th, "Scene in Ogden Canyon".....W. D. Capes.
- 8th, "Polar Bears in Lincoln Park" William Wells.
- 9th, "Orphans".....Wm. Mohaupt.
- 10th, "An Amateur".....Will D. Bowers.
- 11th, "Government Camp".....Myra A. Wiggins.
- 12th, "Are Girls a Necessity?".....A. R. Ordway.
- 13th, "Spinnaker Trying to Play Balloon".....Geo. E. Dodge.
- 14th, "Ten O'Clock and Only Thirteen".....E. H. Ashcroft.
- 15th, "Our November Camp".....Arthur C. Mellette.
- 16th, "Moonlight on Lake St. Catharine".....T. L. Davies.
- 17th, "A Noble Dog".....John H. Wheeler.
- 18th, "A Thirsty Traveller".....H. G. Reading.
- 19th, "Packing Deer to Camp".....Boyd C. Packer.
- 20th, "Days of Recreation".....E. F. Whitmore.
- 21st, "Running Fire".....Francis W. Sprague.
- 22d, "A Pleasant Camp".....F. J. Taylor.
- 23d, "The Empty Creel".....Kenneth Fowler.
- 24th, "Image Cut in Sandstone".....Robt. Walstrom.
- 25th, "In Camp".....E. H. Ashcroft.
- 26th, "Racing".....C. L. Amos.
- 27th, "Lake Monponsett".....W. E. Higbee.
- 28th, "Moose".....F. H. Holmes.
- 29th, "The Loyalhanna River".....Harry L. Christy.
- 30th, "Tramp Down the Shiawassee" C. A. Stone.
- 31st, "Scene in Ogden Canyon".....W. D. Capes.
- 32d, "Wounded Buck".....Boyd C. Packer.
- 33d, "A Tasty Meal".....A. P. Ingram.
- 34th, "Summer Recreation".....Herman Illies.
- 35th, "Fishing for Pickerel".....J. Howard Demarest.
- 36th, "Our Favorite Sport".....Wm. Mohaupt.
- 37th, "The Murial".....Jas. Wilson.
- 38th, "Not a Beauty, but Clever".....Jas. Wilson.
- 39th, "Staunch".....Arthur C. Mellette.
- 40th, "The Pretty Boys' Camp at Egg Beach".....William Allen.

A great many pictures were submitted for competition that were not admissible under the conditions published in previous issues of RECREATION. That is, the pictures did not represent any branch of sport or recreation. Among this class the following, while not entitled to prizes, are highly commended:

- 1st, "The Shepherd and His Sheep" E. J. Swetland.
 2d, "Winter Evening" Herman Illies.
 3d, "In the Shade" B. J. Warren.
 4th, "I'm Ready for My Picture," .. S. J. Power.
 5th, "Early Spring" G. L. Stone.
 6th, "A Glimpse of the Oswego
 River" Fred Darrow.
 7th, "Nature" Robt. Walstrom.
 8th, "On Guard" Fred Darrow.
 9th, "Logging Team" H. C. Eberhart.
 10th, "My First Snap Shot" Mrs. H. L. Darling.
 11th, "The Home of the Trout"..... Francis W. Sprague.

In RECREATION'S first competition, held a year ago, there were but about 100 entries; in the second, over 600. Thus it will be observed that RECREATION is reaching out in the field of amateur photography, as in everything else.

My 3d annual competition will open January 1st, '98, and close April 30th of the same year. It may be safely predicted that more than 1,000 amateur photographers will compete in that contest, and that more than 2,000 pictures will be submitted.

I had hoped to have reproduced some of the winning pictures in this issue of RECREATION, but my editions have grown so large that it is necessary to go to press at least 3 weeks before the date of issue. Several of the first forms were on the press before the contest closed. A number of winning pictures are now in the hands of the engraver, and will appear in the July number. Others will follow in August, September, October, etc. All those commended by the judges will be published, in time, as also many they were compelled to pass over without noticing in this way.

I tender my heart-felt thanks to all the amateur photographers who have so generously responded to my request for entries in this competition, and beg to assure them that their good will and their co-operation are heartily and cordially appreciated.

"The precarious nature of the supply of platinum was well shown a year or 2 ago, when a small combination was able to 'bull' the price of this metal almost to the value of gold. It will therefore be good news to photographers that a new source of supply has been discovered, of such large area that it may fairly be expected to bring down the price to a level never before reached. We read that in New South Wales a bed of platiniferous lead, over a mile long, has been discovered. It has been known for some time past that the metal was there, but it had not been properly worked. It is said the platinum is present to the large extent of 75 per cent."—British Journal of Photography.

Since this appeared many other photographic and scientific journals have published similar information, and their writings have been recently copied by some intercolonial journals. From personal inquiries, made at the Department of Mines of New South Wales, Sydney, we are in a position to state that no such extensive find of platinum has been made in the Colony, and that at the present time the value of this metal is nearly equal to gold.—"Australian Photographic Journal."

Some time ago I read of a Frenchman who had discovered a compound that would

give prints their natural color, when dipped in the solution. Do you know whether it has been placed on the market? If so please tell me the price and where it can be procured.
 J. R., Yazoo City, Miss.

ANSWER.—No such process has yet been proven effective for general use, though some remarkable results have been obtained from experiments. An account of another successful experiment, in this line, is given in this issue of RECREATION. My readers will be kept fully advised of the progress made by students.

EDITOR.

I have just finished a book of photographs, that I have taken on my hunting trips, and it lies on a stand in my den. I advise every sportsman to carry a camera with him, when going into the woods, as a number of good views and a diary bring back the joys of a hunting or fishing trip more vividly than anything else can. A camera that will take a good picture is all that is needed. This highly finished wood and beautiful grained leather is liable to injury while being kicked around a camp.
 W. H. D., Augusta, Me.

To make a phantom picture, put a sheet of ground glass behind a portrait negative and place it against a window strongly lighted. Darken all the panes except the one against which the negative is placed, then look steadily at one point of the negative for about half a minute. On then directing the eye toward the dimly illuminated ceiling of the room a beautiful positive, of a rich sepia, will be seen. By this simple method a likeness can be recognized by those who are not practised in examining negatives.—"Photographic News."

A new ink is announced, that will write on glass, and can take the place of paper labels on bottles, etc., as it is indelible. It is made by dissolving 20 grams of brown lacquer (not heated) in 150 cc. of commercial alcohol, and mixing this, a drop at a time, with a solution of 35 grams of borax, dissolved in 250 cc. of distilled water. It can then be colored as preferred; 1 gram of methylene violet, for instance, will produce a handsome ink.—"Nouveaux Remedes."

It is said that in England large photographs are being extensively used for wall paper. Here is a hint which enterprising Yankee photographers may easily turn to profit.

Send short items for this department. Fellow readers will thank you for them, as well.

THE EDITOR.

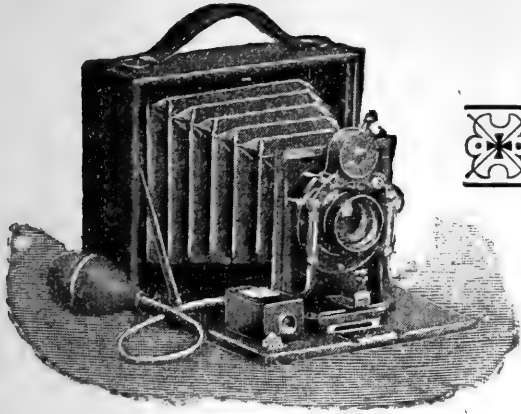

PREMOS
PRODUCE
PERFECT
PICTURES

Premo Cameras

Have achieved an enviable reputation the world over. Their PERFECT construction and ease of manipulation, combined with grace, beauty, and superb finish, have placed them in the front rank, and they are to-day the Favorite Camera with the foremost Amateur and Professional Photographers.

MADE IN

20

DIFFERENT STYLES
AND SIZES

Special Designs for the Sportsman and Tourist

CATALOGUE MAILED FREE

Rochester Optical Co., Rochester, N. Y.

CHECK LISTS OF ARTICLES CONSTITUTING CAMP OUTFITS.

With reference to the first of the following lists, it may be noted that a strong man can carry 50 pounds 10 or 15 miles a day, comfortably, when accustomed to it. If traveling by canoe, the only addition necessary to make to the loads, in case of portages, would be the canoe and paddles. If no long portages are to be made, a few other luxuries may be added to the list.

The total weight of such articles, enumerated in the second list, as are to be carried on the pack animals, is about 320 pounds, or 160 pounds to each animal. With these loads they will travel, comfortably, 20 to 35 miles a day. As the provisions and cartridges are used up, skins, heads, or other trophies may be added to the loads in their stead. No animal should be allowed to carry more than 250 pounds, and small ones not more than 150 to 200. Overloading is cruel, and is nearly sure to cause sore backs.

If more than one pack animal is provided for each man, then a folding boat, folding cots, chairs, cook stove, and even a table may be carried. For a larger or smaller party, or for a longer or shorter outing, the requisite quantity of supplies may be determined by multiplication or subtraction.

The dotted lines are intended to hold memoranda of any articles that it may be deemed necessary to add, in special cases.

SUPPLIES FOR TWO MEN FOR A TEN DAYS' TRIP ON FOOT.

10 pounds hard bread.	2 suits extra underwear, in bags.	300 matches.
14 pounds bacon.	4 pairs socks.	2 water-proof match boxes.
3 pounds dried apples or peaches.	2 rubber coats.	2 ounces insect lotion.
2 pounds salt.	2 compasses.	2 cakes soap.
3 pounds sugar.	2 watches.	2 towels.
2 pounds coffee, roasted and	1 photo camera.	2 tooth-brushes.
ground,—or,	1 camp kettle.	Supply of small change.
½ pound tea.	1 frying pan.
2 sleeping bags, or blankets.	1 wire broiler.
2 rifles or guns.	1 stew pan.
1 ax.	1 coffee pot.
100 cartridges.	2 tin plates.
2 fishing rods.	2 spoons.
hooks, lines, flies, reels, etc.	2 tin cups.
2 belts and hunting knives.	1 dish cloth.
2 pocket knives.	2 pounds tobacco.	Total weight about 100 pounds.
1 tent.	2 pipes.	It is possible to curtail this list slightly,
2 pack straps.	1 map.	but not without some sacrifice of
		comfort.

SUPPLIES FOR TWO MEN FOR TEN DAYS, TRAVELING WITH TWO SADDLE HORSES AND TWO PACK HORSES, SUMMER OR FALL.

2 saddle horses.	2 reels and lines.	2 water-proof pocket match boxes.
2 pack horses.	12 bait hooks, assorted sizes.	20 pounds flour, or
2 riding saddles.	12 flies, assorted colors.	15 pounds hard bread.
2 pack saddles.	2 sleeping bags, or	14 pounds bacon.
2 bridles.	3 pairs heavy wool blankets.	3 pounds dried apples or peaches.
4 saddle blankets.	2 pillows.	3 pounds oat or rye meal.
4 picket ropes.	1 tent.	3 pounds beans.
2 sling ropes.	2 sheets, canvas.	3 pounds rice.
2 lash ropes.	2 suits heavy woolen clothes.	2 pounds salt.
2 cinches.	4 heavy woolen undershirts.	¼ pound pepper.
2 manteaus.	4 pairs heavy woolen drawers.	3 pounds sugar.
50 feet quarter-inch rope.	4 heavy woolen outside shirts.	2 pounds roasted and ground coffee,
50 feet half-inch rope.	6 pairs heavy woolen socks.	or ½ pound tea.
2 gun slings.	2 light felt hats.	2 pounds desiccated vegetables.
2 rifles or guns.	2 pairs buckskin gloves.	2 pounds tobacco.
1 ax.	2 rubber coats.	2 pipes.
200 cartridges.	2 pairs rubber hip boots.	2 toilet cases, each containing soap,
2 cleaning outfits for guns.	2 pairs heavy leather shoes.	towels, tooth-brush, needles,
1 small can of oil.	2 bags to carry clothing in.	thread, buttons, safety-pins, and
2 belts.	4 pairs buckskin moccasins.	other small articles.
2 hunting knives.	1 camp kettle.	1 kit tools and materials for repair-
2 skinning knives.	stamped envelopes and paper.	ing camp equipage, etc.
2 pocket knives.	1 frying pan.	4 horse shoes.
2 steels.	1 wire broiler.	1 pound horse nails.
1 map.	1 stew pan.	2 pounds powdered alum, for curing
2 compasses.	1 coffee pot.	skins.
2 watches.	2 tin plates.	Supply of small change.
2 pack straps.	2 spoons.
2 pairs goggles or smoked glasses.	2 knives.
2 pairs ear muffs.	2 forks.
1 photograph camera.	2 tin cups.
3 rolls celluloid film.	2 dish cloths.
2 fishing rods.	1 box matches.

SUPPLIES FOR TWO MEN FOR TEN DAYS, TRAVELING BY TEAM, SUMMER OR FALL.

- 1 team and its equipment.
- 50 feet quarter-inch rope.
- 50 feet half-inch rope.
- 2 rifles or guns.
- 2 gun slings.
- 1 ax.
- 200 cartridges.
- 2 cleaning outfits for guns.
- 1 small can of oil for guns.
- 2 belts.
- 2 hunting knives.
- 2 skinning knives.
- 2 pocket knives.
- 2 steels.
- 2 compasses.
- 2 watches.
- 2 pack straps:
- 1 map.
- 2 pairs goggles or smoked glasses.
- stamped envelopes and paper.
- 2 pairs ear muffs.
- 1 photograph camera.
- 24 celluloid plates.
- 2 fishing rods.
- 2 reels and lines.
- 12 bait hooks, assorted sizes.
- 12 flies, assorted colors.
- 2 sleeping bags, or
- 4 pairs heavy wool blankets.
- 2 mattresses, or
- 2 folding cot beds.
- 2 pillows.
- 1 tent.
- 1 camp cooking stove.
- 2 sheets, canvas, 4 x 8 feet.
- 1 folding camp table.
- 2 folding camp chairs.
- 1 hammock.
- 2 suits heavy woolen clothes.
- 4 heavy woolen undershirts.
- 4 pairs heavy woolen drawers.
- 4 heavy woolen outside shirts.
- 6 pairs heavy woolen socks.
- 2 light felt hats.
- 2 pairs buckskin gloves.
- 2 rubber coats.
- 2 pairs rubber hip boots.
- 2 pairs heavy leather shoes.
- 4 pairs moccasins.
- 2 bags to carry clothing in.
- 1 folding canvas boat.
- 1 camp kettle.
- 1 frying pan.
- 1 wire broiler.
- 1 stew pan.
- 1 bread pan.
- 1 coffee pot.
- 1 dutch oven.
- 2 tin plates.
- 1 folding rubber bucket.
- 2 spoons.
- 2 knives.
- 2 forks.
- 2 tin cups.
- 2 dish cloths.
- 1 bar laundry soap.
- 1 box matches.
- 2 waterproof pocket match boxes.
- 20 pounds flour, or
- 15 pounds hard bread.
- 14 pounds bacon.
- 2 pounds dried apples.
- 2 pounds dried peaches.
- 2 pounds dried apricots.
- 3 pounds oat or rye meal.
- 2 pounds beans.
- 2 pounds rice.
- 5 pounds salt.
- 1/4 pound pepper.
- 3 pounds sugar.
- 2 pounds roasted and ground coffee, or
- 1/4 pound tea.
- 25 pounds potatoes.
- 2 pounds tobacco.
- 2 pipes.
- 2 toilet cases, each containing soap, towels, tooth-brush, hair-brush, needles, thread, buttons, safety pins, etc.
- 1 kit tools and materials for repairing wagon, camp equipage, etc.
- 4 horse shoes.
- 25 horse nails.
- 2 pounds powdered alum for curing skins.
- Supply of small change.

The PRESS BUTTON KNIFE can be opened with one hand by slightly pressing the button.

In Solid Silver $\frac{925}{1000}$ Fine. Sheffield Steel Blades, nothing finer made; no breaking finger nails, or removing gloves. Impossible to get out of order. Fully guaranteed. A perfect knife for ladies or gentlemen.

Sent postpaid as follows:

Sterling Silver, like cut, Bright or Antique,	\$1.75
Pearl, Plain, -	\$1.50
Ivory, Plain, -	1.25
Stag, Plain, -	1.00
Celluloid, Plain,	1.00

Handsome Stag-handle sent on receipt of \$1.00, postpaid

LOTT & SCHMITT

112-114 Walker Street
NEW YORK



FOR
**Hunting
Fishing and Camping**

our four-inch blade, Press-button Jack Knife is simply the best knife made for the purpose. Impossible to close or open until you want it to. You can't injure yourself.

SEND FOR ILLUSTRATED CATALOG

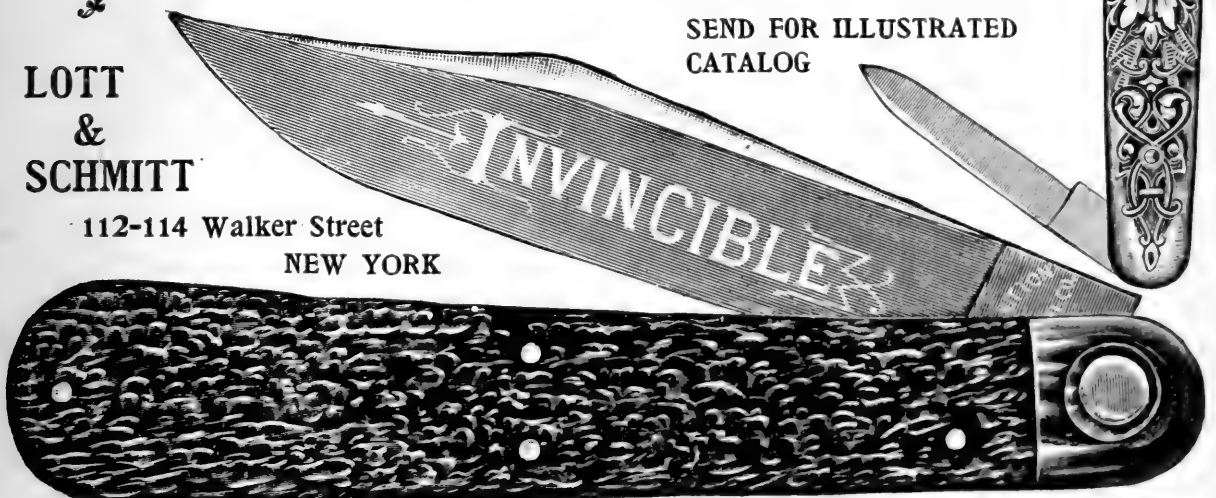

HAVE YOU SENT IN YOUR 10 CENTS FOR THE SICK BABIES' FRESH AIR FUND?

PHOTOGRAPHY IN COLORS.

Yet another process comes from France. At a recent meeting of the Société Française, M. de Saint Florent read a paper on a new process he had discovered. Celloidin (collodio-chloride) paper was used, exposed to sunlight until it had assumed a reddish-black color. After this the paper was immersed for 10 minutes in the following bath:

Alcohol (36 deg. Beaume) . . . 3 ounces.
Glycerine 2 drachms.
Tincture of iodine (24 p. c.) . . . 2 drachms.
Ammonia (.880) 6 drops.

After drying in the dark room, the paper was exposed under a colored transparency, to direct sunlight, for an hour or so, until the colors appeared. It was then fixed in a 6 to 10 per cent. solution of hyposulphite of soda. While in this bath the colors came out brilliantly and then faded to a lemon yellow color, when the print was withdrawn from the bath and washed rapidly, after which it was dried in the sun, or in front of a bright fire. This caused the colors to reappear in all their brilliancy, and to remain permanent. This sounds too good to be true, but it is easy to verify the author's statements. As will be readily seen, the process is essentially different from that of M. Graby.—"Photogram."

Quad Camera

No Separate
Parts

3½ x 3½ inch Plates

Eminently
Practical

Handsomely cov-
ered with leather



Price, \$5.00 Send 2c. stamp for sample photograph and booklet

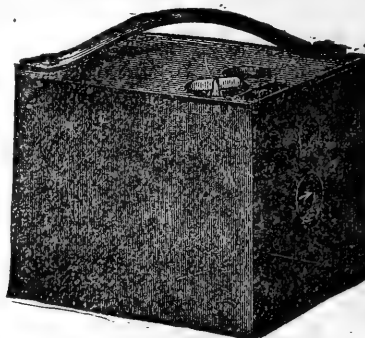

Buckeye

Twelve Expo-
sures without re-
loading. Loaded
in daylight.
Simple and ef-
ficient.

Price, \$8.00 Send for illustrated booklet.

E. & H. J. Anthony & Co.

591 Broadway New York

If you are in need of

A Camera that will produce a Perfect Picture,

obtain

The HAWK-EYE, Jr.

which will be found

a faithful friend at all times.

The simplicity of its working parts enable the novice to obtain results that will astonish old photographers. Size, 4⅜ x 4¾ x 6¼ in. Photo, 3½ x 3½ in. Weight, 20 oz.

LOADS IN DAYLIGHT, USES EITHER ROLL FILM OR GLASS PLATES.

Send for Catalogue, giving description of all kinds of
Cameras and Supplies.

PRICE, \$8.00

THE BLAIR CAMERA CO., 471 Tremont St., Boston, Mass.

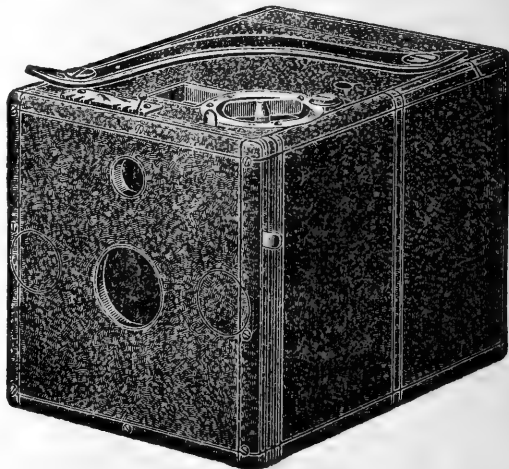

The Baby Wizard Camera

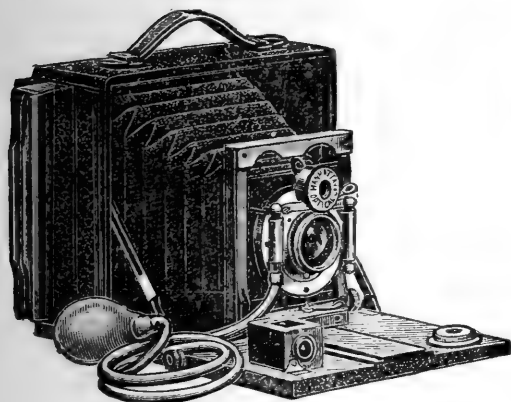

Only 2 $\frac{3}{8}$ x 5 $\frac{5}{8}$ x 6 $\frac{3}{8}$ inches]

*Is the
Ideal Camera*

FOR TOURISTS, WHEELMEN
OR SPORTSMEN GENERALLY

*Fitted with our Extra Rapid
Rectilinear Lens (unequaled in
this country), and the Bausch
and Lomb Optical Company's
Iris Diaphragm Shutter.*

Complete with Carrying Case

\$25.00



Same without rack and pinion, for focussing, and swing back

\$20.00

SEND FOR CATALOGUE

Manhattan Optical Co., Cresskill, N. J.

\$2,853.00

In Prizes for Kodakers.

THE EASTMAN
 AMATEUR
 PHOTOGRAPHIC CONTEST.

\$1,475.00 in Gold,
 \$1,308.00 in Cameras,
 \$70.00 in Lantern Slide
 Plates and Film.

130 Prizes.

The conditions are easy to comply with—the prizes valuable.

Prizes for contact prints, enlargements and lantern slides. Special classes for Pocket Kodak Prints and Pocket Kodak Enlargements. Circular giving conditions and enumerating prizes free at Kodak agencies or by mail.

EASTMAN KODAK CO.

Kodaks, }
 Kodets, } \$5.00
 Bullets, } to
 Bulls-Eyes, } \$100.00.

Rochester, N. Y.



(The Kenwood Camping Bag in use.)

“No
Sportsman
Can Do
Without It”

That's what letters received from men who have hunted, fished and camped, from Maine to California, say about the

KENWOOD CAMPING BAG

It's a comfort—a luxury—a necessity. Easily adjusted and a perfect protection from Cold, Snow, Rain, or Dew. Adapted to every condition of climate and weather. Kicking or turning will not uncover you. Stiffening of tired muscles never happens. A complete shelter in itself. Handy as a hold all. Lighter than a square blanket it adds less weight to the pack, on a carry. Made to stand the very hardest use. Many improvements. Common sense price. Write to the editor of RECREATION, or send for

FREE

Samples of materials, and illustrated pamphlet of our new Steamer Rugs, Baby Bags, and Golf, Travelling and Steamer Capes, to

The Kenwood Mills, Albany, N.Y.



"That's my Washburn!"

If you have it in mind to buy either a Guitar, Mandolin or Banjo, let us send you our "Washburn Book." It tells why Washburns are by far the best instruments made; gives portraits and testimonials of over 100 artists, and quotes to you the net cash prices at which Washburns are sold everywhere. Address Dept. T, Lyon & Healy, 199-203 Wabash Ave., Chicago.

JUST THE THING...

For Yachts and Country Homes
THE STELLA



Our new Music Box, playing any number of tunes on tune sheets, without pins or projections of any kind; surpasses all others in quality of tone and in durability; it occupies little space and compares favorably in tone with the piano. Call and see it, or send for catalogue and list of tunes to

JACOT & SON, 39 Union Square, New York

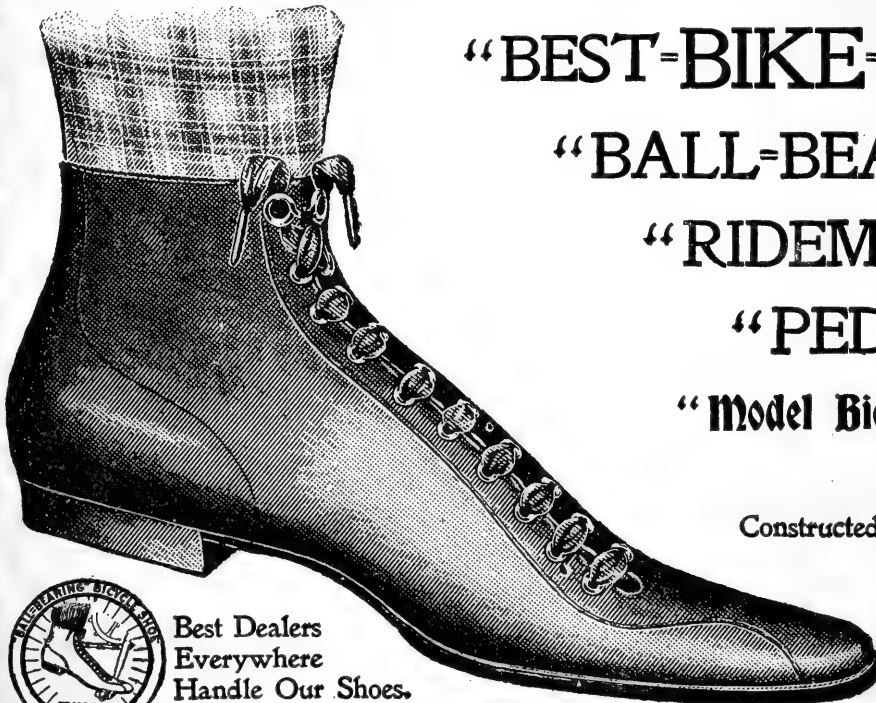

"BEST=BIKE=SHOES,"

"BALL=BEARING,"

"RIDEMPFAST,"

"PEDALSHOE,"

"Model Bicycle Shoes
of the World."

Constructed on scientific principles.

EASY TO RIDE IN—

EASY TO WALK IN.



Best Dealers
Everywhere
Handle Our Shoes.

... Pratt Fasteners Hold Laces ...

THE "B=B" SHOE MFG. CO.,

121 Duane Street,

New York.

THE FRAME TELLS THE NAME



FOWLER CYCLE MFG. CO.
CHICAGO.

• NEW-YORK • BOSTON • PROVIDENCE •
LONDON.

— Drop us a Postal Card for —
'97 Catalogue.

Camping and Camp Outfits

A MANUAL OF INSTRUCTION FOR YOUNG
AND OLD SPORTSMEN.

Edited by G. O. SHIELDS ("COQUINA")

Author of "CRUISINGS IN THE CASCADES," "RUSTLINGS IN THE ROCKIES," "HUNTING IN THE GREAT WEST," "THE BATTLE OF THE BIG HOLE," "THE BIG GAME OF NORTH AMERICA," "THE AMERICAN BOOK OF THE DOG," "AMERICAN GAME FISHES," ETC.

12mo. 200 Pages. 30 Illustrations. Cloth, \$1.25.

THIS book contains practical points on how to dress for Hunting, Fishing, or other Camping Trips; what to carry in the way of extra Clothing, Bedding, Provisions, Cooking Utensils, and all classes of Camp Equipage; how to select Camp Sites; how to make Camp Fires; how to build Temporary Shelters; what to do in case of Getting Lost, etc. It contains check lists of articles constituting Complete Camping Outfits; a list of the names and addresses of Guides, in various hunting and fishing countries, and much other information of value to Campers, and which has never before been given to the public.

The instructions given are based on an experience of twenty-five years in Camping, and in the study of Camp Lore, Woodcraft, etc., and it is believed that the work will prove of great value to thousands of men and boys, who have not had such favorable opportunities for study.

The book also contains a Chapter by

DR. CHARLES GILBERT DAVIS, on CAMP HYGIENE, MEDICINE AND SURGERY

ONE BY

COL. J. FRY LAWRENCE, on CAMP COOKERY,

AND ONE BY

FRANK F. FRISBIE on THE DIAMOND HITCH, or HOW TO LOAD A PACK HORSE

This book should be in the library of every Sportsman, and will be sent, post-paid, on receipt of price, by the Author,

G. O. Shields, 19 W. 24th St., New York.

Given as a Premium for Four Subscriptions to Recreation

CAMP COMFORT.

Next to a tent or a house, nothing can add more to the luxury of camp life than the Gold Medal Camp Furniture Co.'s folding cot beds, folding chairs and folding tables. No family should ever go into camp without a complete outfit of these goods; and, where plenty of transportation can be afforded, no man or party of men should go without them. The old theory that people, on going into camp, must learn to rough it, has become unpopular. The modern idea is to "smooth it" in camp as well as at home. Nothing can make camp life so smooth and so delightful as a good, comfortable bed to lie on, or a good chair to sit on. Write the Gold Medal Camp Furniture Co., Racine, Wis., for a catalogue; then select the goods you want and order them. I have used these goods, many years, and am sure you will make no mistake in taking my advice.

This has been a hard winter on game on account of the deep snow. Farmers report finding grouse covered with snow and frozen. Some deer are reported to have been caught alive.

In my last fall's hunt I got 7 deer and one elk.

This has been a good winter for white owls and we have received numerous fine specimens.

You might state in your list of guides, that the kind of game to be found about here is deer, geese, ducks, cranes and grouse.

E. L. B., Warren, Minn.

SUBURBAN ECSTASIES.

"Do you like living in the country, Mrs. Plankwalks?"

"Yes; our hens lay such lovely eggs; any actor in the world might be proud to have them thrown at him."

DOGS PREFERRED.

"Other people's children are charming companions."

"Yes; but when they get tiresome you can't take them by the neck and drop them out of the window."

"The Beverly's dogs behave better than their children."

"Yes; but then, you know, there are places where you can take dogs and pay to have them trained."

"Do you have to study much at these summer schools?"

"No; the brain is not active in hot weather."

"Don't the professors complain?"

"Not much; they are in the same fix."

20 BOOKS ❁ ❁

ON 20 DIFFERENT SUBJECTS,
BUT ALL RELATING TO SOME
DELIGHTFUL PHASE OF
AMERICAN TRAVEL, VIA
"AMERICA'S GREATEST RAIL-
ROAD."



ILLUSTRATED CATALOGUE SENT
FREE, POST-PAID, ON RECEIPT
OF A 1-CENT STAMP BY GEORGE
H. DANIELS, GENERAL PASSENGER
AGENT, NEW YORK CENTRAL &
HUDSON RIVER RAILROAD, GRAND
CENTRAL STATION, NEW YORK.

SANFORD
AND SANFORD

Merchant Tailors
and Importers

176 FIFTH AVENUE

Bet. 22d and 23d Sts.

NEW YORK



All the latest
London fabrics
regularly imported

PUBLISHER'S DEPARTMENT.

AN IDEAL YACHT.

The handsome steam yacht "Hiawatha," built last year for Mr. Charles Fleischmann, of Cincinnati, a member of the New York, Atlantic, Larchmont and other yacht clubs, was found too small for his requirements, so he returned to the same builders and obtained what the experience of last summer's cruising had shown him he needed. This new steam yacht was built by the consolidated firms of the Gas Engine & Power Co., and Charles L. Seabury & Co., at Morris Heights, this city, and was launched April 17th.

The new "Hiawatha," for such is her name, is of steel, and a model of comfort, luxury and elegance, in combination with those features which gladden the yachtsman's heart—beauty, speed and stability. No device imaginable to make life safe and enjoyable, has been omitted in her design. Every detail has been carefully studied, and, as a result, something like the perfection of modern marine architecture has been produced.

The "Hiawatha" is 170 feet over all, 138 feet on the water line, 21 feet beam and 8 feet draught.

The machinery consists of a Seabury safety water-tube boiler and triple-expansion engines, developing about 1,000 horse-power. A speed of 18 miles an hour is guaranteed. The new "Hiawatha" will be seen in foreign as well as in American waters during the season.

A CHANCE TO WIN \$500.

The Prize Competition which the Century Co. has planned is at once novel and instructive. Three examination papers are sent out and a month is allowed the competitors for work on each paper. For those who send the best answers there is a series of prizes running from \$500 down to \$10. The unique feature of the Competition, however, is in the further and special prize of \$500 offered to the person who answers the questions in these examination papers from any 10 works of reference, other than the Century Dictionary and Cyclopedia. In fact, the offer goes beyond this, even, for the competitors are allowed to omit 10 per cent. of the regular questions.

This offer was made to invite comparison between the Century and other works, and to prove the truth of the publishers' statement that "The Century more than takes the place of any 10 other works ever pub-

lished." In making up the list of other works any encyclopedia, or any dictionary, or any other work in any number of volumes may be used and counted as one of the 10.

Read the Century Company's ad. on page v. of this issue of RECREATION and then write for full particulars, being careful to mention this magazine.

Next fall, when you go into the woods, or mountains or on the duck marshes, you will need a sleeping bag. Now is a good time to be inquiring into the question as to which is the best one. Write F. C. Huyck & Sons, Albany, N. Y., for a descriptive circular of their bags. I have examined these carefully and have shipped out several of the bags, as premiums for clubs of subscribers. I can conscientiously say I have never seen a sleeping bag that appeared to me so nearly perfect as this one is. I devised a bag, years ago, made mainly of sheep skin, with the wool on; but the fine wool felt, of which the Kenwood bags are made, is far ahead of the sheep skin, in every way. Try one of these bags and see if you do not agree with me. Mention RECREATION when you write.

The Grand Rapids & Indiana Ry. Co. has issued a tasty little book, giving a map of the road and of the State of Michigan, with a list of trout streams reached by that system, and a synopsis of the Michigan fish laws. It is a valuable document for reference and every angler should have a copy of it. Write C. L. Lockwood, G. P. & T. A., Grand Rapids, Mich. Mention RECREATION and he will send you a copy, free.

The Marlin Rust Repeller is one of the best brands of gun grease in the market. It is indorsed by many of the most prominent sportsmen in the country. It is put up in handy collapsible tubes and sells at 10, 15, 25 and 75 cents a package, according to size. Write the Marlin Arms Co., New Haven, Conn., for a descriptive circular, mentioning RECREATION.

The Hunt Hygienic Saddle, which has become so well known by reason of its basis of pliant leather thongs, is now made with padded top and spring pommel, affording a support which delicate persons appreciate in bicycling.

DON'T FORGET TO SEND ME THAT 10 CENTS FOR RECREATION'S FRESH AIR FUND.

Send for Booklet on

SALADS



HOW TO MAKE
AND DRESS THEM.



Mailed FREE
on Application to

E. R. DURKEE & CO.

129 WATER STREET, NEW YORK

"DURKEE'S SALAD DRESSING," of which this little book is designed to show some of the innumerable uses, consists only of the very choicest ingredients which long experience and unlimited facilities in obtaining condiments from all over the world can bring together. "Nothing too good" has been the motto. Its preparation is as careful and cleanly and unvarying as is humanly possible. It is a complete sauce in itself, and may be used either hot or cold, or may be taken as a basis in making certain other sauces—as "Devilled" Paste, "Tartar Sauce," "Sauce Robert," etc., but rarely to be had in private houses, owing to the difficulty in making or procuring the necessary ingredients. Its many uses make it indispensable, not only to the *table*, but to the *kitchen*, and as well for regularly prepared meals and the impromptu chafing dish. Its value is that it is always ready, a veritable "friend in need." If it is in the house, you have a perfect mayonnaise, or a perfect sauce foundation at hand, without the labor of preparation. It is economical. You waste nothing. It is rich, nutritious, appetizing, and it may be modified to suit every palate, retaining a distinct individuality and delicacy of flavor peculiarly its own and possessed by no other sauce.

PUZZLE PAGE.

Here is one new puzzle. Try your hand at it. A package of merchandise is offered each person who solves it. This offer is good until August 31, '97.

Always state on what page the ad. is printed, which contains the involved word.

HIDDEN LETTER PUZZLE.

My first in salad you will find,
My next in sauce will be,
My third in mustard, and my fourth
In ketchup you will see.
My fifth is always found in spice,
My sixth is seen in extracts nice.
Where'er you see my whole impressed
You'll know it marks the very best.

ANOTHER HIT.

RECREATION is not the only thing that has made a hit, this year. There is one other. That is RECREATION MARCH. It was published in the April number of this magazine and already over 70,000 copies, in sheet music form, have been sold. Many of the leading bands and orchestras throughout the country are playing it, and, as a piano number, it is filling thousands of homes with delight. Sousa's band is playing it, on all occasions, and at a recent Sunday night concert, at the Broadway Theatre, responded to 3 encores before the audience—a large and fashionable one—would permit them to proceed to the next number. The 7th, 12th, 13th and 22d regiment bands played RECREATION MARCH in the Grant Memorial parade, while passing the grand stand, and the music was enthusiastically applauded.

Verily RECREATION MARCH is a great hit, as well as RECREATION MAGAZINE.

I take great pleasure in reading RECREATION and wait anxiously for it each month, always finding something up-to-date for sportsmen.

H. R. McM., D.D.S., Buffalo, N. Y.

Your columns are filled with testimonials of the worth of RECREATION, and "The half has not been spoken." May you live long and prosper.

H. C. W., Friendship, N. Y.

I read RECREATION from one end to the other, every month, and think it is the best magazine of the kind I have ever seen.

There is not much game in this locality, but we get a deer once in a while. I had the good fortune to kill 2 in October.

R. E. H., Canyon City, Colo.

THE "ONEITA"

Elastic Ribbed
Union Suits

are complete undergarments covering the entire body like an additional skin. Perfectly elastic, fitting like a glove, but softly and without pressure. No buttons down the front. Made for Men, Women, and Young People. Most convenient to put on or off, being entered at top and drawn on like trousers. With no other kind of underwear can ladies obtain such perfect fit for dresses or wear comfortably so small a corset.

Patented April 25, 1895.

Send for Illustrated Booklet

ONEITA KNITTING MILLS OFFICE
No. 1 Greene St.
New York

Golf Hose

AN OFFER TO RECREATION
READERS

No. 11. My price on this hose is \$1.00 a pair. No better can be bought in any city in the country for less money. It is made of best domestic wool, Scotch mixture, gray and dark brown checks, cuff brown. A stylish but quiet combination, will look well with any suit, suitable for either lady or gentleman. Will not show dust; in fact, in every respect I consider it the best \$1.00 hose I have.

To test RECREATION as an advertising medium I will sell a quantity of this hose to readers of RECREATION at 75 cents a pair, postpaid to any address in the United States or Canada, and I guarantee the hose to be just as represented. If not satisfactory I will return your money. Remember, the price of this hose is \$1.00 a pair and they will not be sold at one cent less except on orders received through this advertisement. Send money with order. If you wish to send me \$1.00, for

the extra 25 cents I will send you two pairs of socks, fancy color, summer weight, good value at 15 to 18 cents a pair. State size.

Remit by post-office order, currency, or postage stamps. Please do not send checks on local banks for small amounts.

I refer to Preston National Bank, John L. Harper & Co., Bankers, Detroit, Mich., or editor of RECREATION.

GEO. F. WEBBER

Dealer in all kinds of Hosiery
DETROIT, MICH.

TROUT FLIES.

The celebrated **Bradley Trout Flies** will be supplied by

Wm. Greenshields, Romeo, Michigan, at the following prices: Plain flies, 25 cents each; pure gold, embossed, 50 cents each. These flies are made to order only. Guaranteed to hold any weight of fish. Gut will neither split, break nor untie. The most successful flies ever used for trout, rainbow trout, grayling, salmon trout, Loch Leven trout, and ouananiche.

GAME PHOTOGRAPHS.

The finest series of Photographs of Live Wild Game in the world, 53 Deer, 13 Elk, 13 Antelope, 30 Mountain Lion, 7 Wild Cat, 1 Coyote, 3 Rattlesnake, 2 Sage Hens, 3 Jack Rabbit, 2 Snow Shoe Rabbit, 1 Cotton-tail Rabbit, 1 Grouse, 11 Bear, 2 Ducks, 1 Badger. 141 in the set; 53—8 x 10, Balance 5 x 8, Prices—5 x 8—\$3 a doz.—8 x 10—\$6 a doz. The set complete \$40—Unmounted \$36.

A. G. Wallihan, Lay, Routt Co., Colo.

WHERE TO GET BIG GAME.

Have you located your happy hunting ground for next fall? If not, I will agree to take you to moose, elk, deer, bear, plenty of mountain goats, fish and grouse galore, providing you wish my services as guide. Only 40 miles from the R. R. to the hunting grounds. Good pack outfits, tents, etc. Horses good and gentle. Terms reasonable. Best of references; 18 years' experience as guide.

Vic Smith, Anaconda, Mont.

Jas. L. McLaughlin:—Experienced Guide. Best references furnished. Elk, moose, deer, mountain sheep, antelope, lions, bear, sage hens and grouse. Best trout fishing in the country, within 10 minutes walk of my ranch. Would take a few boarders. Tourist outfits furnished on short notice. Address, Ishawood, Big Horn Co., Wyoming.

ANY PARTY

wanting to see the **National Park**, or to hunt in the Teton or Jackson's Hole countries, should write me.

These are the best big game ranges in the United States. Moose, elk, deer, bear, mountain sheep, mountain lions, and all kinds of small game abundant; also the best of trout fishing in the West.

Have put in 16 years hunting, trapping, and guiding in Wyoming, Idaho, and Montana, and know where to go for any kind of game you want. Write me and I will give you full particulars.

GEORGE WINEGAR, St. Anthony, Fremont Co., Idaho

For Sale.—10 gauge Lefever hammerless, 30-14-23/4, \$200 grade. Full choke; a splendid gun for ducks or for trap shooting. Good condition; \$40.00 cash. A bargain for some one. E. W. Smith,

404 D. S. Morgan Bldg., Buffalo, N. Y.

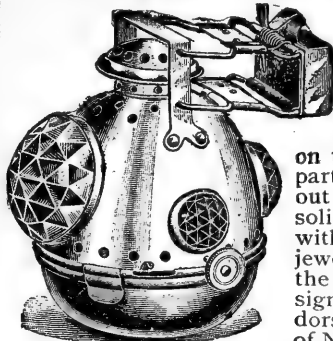
A Ball of Fire is the **FIRE BALL**

Not only a danger signal for the back of the bicycle, but the finest kind of a lamp for the front. The smallest, lightest lamp on the market. No extra parts, and nothing to get out of order. Practically a solid ball of drawn brass, with large cut-glass white jewel in front, green ones at the side, and red danger signal in the rear. Endorsed by the bicycle police of New York. Price, **\$2.00.**

By mail, prepaid, if not obtainable of your dealer.

The Cycle Danger Signal Co., 107 Chambers St., New York City

KAREZZA ETHICS OF MARRIAGE.

A bold, brave book teaching ideal marriage, rights of the unborn child, a designed and controlled maternity.

Union Signal: Thousands of women have blessed Dr. Stockham for **Tokology**, thousands of men and women will bless her for **Karezza**.

Arena: **Karezza** is worth its weight in gold.

Sample pages free. **Agents Wanted**. Prepaid \$1.00. **ALICE B. STOCKHAM & CO., 277 MADISON ST., CHICAGO.**

I have a Stevens Ideal rifle, with combination ivory front sights, Lyman combination rear sight, and with the ordinary rifle sights, in addition. It uses a cartridge of 32 calibre, containing 25 grains of powder, nitro or black, and using a bullet of 75 or 225 grains. Would trade or sell; any reasonable offer considered. Would exchange for a Winchester or Marlin, of any calibre over 45-70. The rifle cost \$28.

Dr. J. S. Kennedy, Chambersburg, Pa.

Would like to exchange a new 32 Winchester, 14 shot, for a 22 lb. bicycle, in good order. The rifle is in perfect condition, with case and shoulder straps.

C. Ballentine, Summit, N. J.

For Sale.—Marlin Repeating Rifle, 1893 model, good condition, \$10.

E. S. T., care RECREATION.

The only game we have here is reed birds, rails, partridges, a few ducks, rabbits, squirrels, smelt and eels.

F. G. S., Jr., Hackensack, N. J.

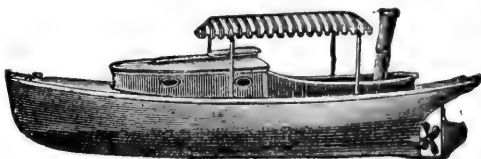

Also
Vapor
Hunting
Launch.

(The hit of the Sportsman's show.) Motor controlled from bow. Valve movement, 12 to 1. 16 to 60 ft. Launches. Twin Screws a specialty. 1, 2, 3, 5, 7, 12, 14, and 20 h. p. No licensed engineer or pilot required. Speed and Safety guaranteed. No dangerous Naphtha or Gasoline used. No disagreeable vibration. *Send Ten Cents in Stamps for 1897 Catalogue.*

MARINE VAPOR ENGINE CO., ft. Jersey Ave., Jersey City, N. J.

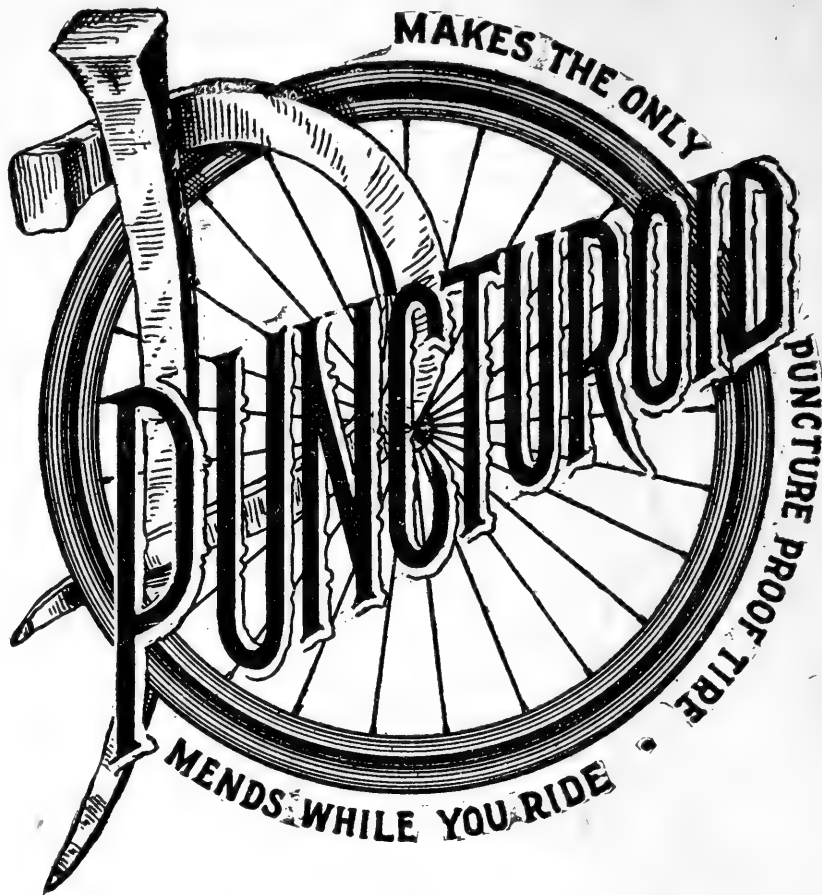

Mends While You Ride

Every puncture or leak, in any single tube tire, caused by anything from a carpet tack to a tenpenny nail, is instantly and permanently healed by

PUNCTUROID

A fluid injected into the tire, through the valve, with your bicycle pump. Guar-

anteed harmless to the tire, and we will replace, with a new tire, any that PUNCTUROID injures in any degree.

PRICE, \$1.00 A CAN, SUFFICIENT FOR BOTH TIRES

Puncturoid Manufacturing Company

482 Boylston Street, Boston or 152 Madison Street, Chicago
Factory, Chelsea, Mass.

You Get the Profits

Of Dealers, Agents, Jobbers
and Middlemen by buying di-
rect from the manufacturer.



No better wheel made than the

Acme Bicycle

Built in our own factory by
skilled workmen, using the best
material and the most improved
machinery. *We have no agents*
Sold direct from factory to the
rider, fully warranted. Shipped
anywhere for examination.

WRITE FOR

Our Interesting Offer

Acme Cycle Co., Elkhart, Ind.

The Megaphone A NOVEL DEVICE FOR TALKING AT A DISTANCE

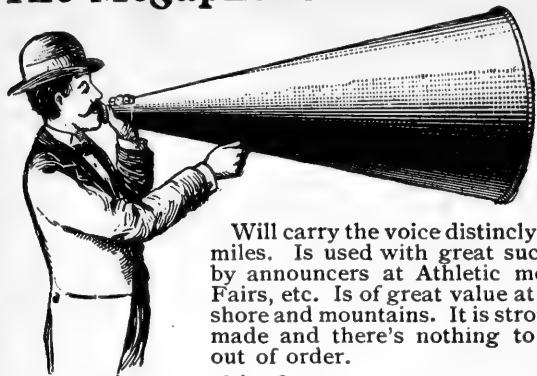

Will carry the voice distinctly two miles. Is used with great success by announcers at Athletic meets, Fairs, etc. Is of great value at seashore and mountains. It is strongly made and there's nothing to get out of order.

Prices as follows : 48 in. \$5.00
 36 in. 4.00
 30 in. 3.50
 Sent C. O. D. or on receipt of price
HARVEY & LEWIS, Opticians, HARTFORD, CONN.

I have been reading RECREATION 2 years, and it outclasses any magazine I have ever read.

The duck shooting was not first-class here last spring, but we had some good snipe shooting in April.

J. F. F., Burlington, Ia.

I let some sportsmen friends read a copy of my RECREATION, and by so doing have secured 3 subscribers. They say the temptation to subscribe was irresistible, as they enjoyed reading it better than all the other literature they had ever read.

R. R. C., Millington, Conn.

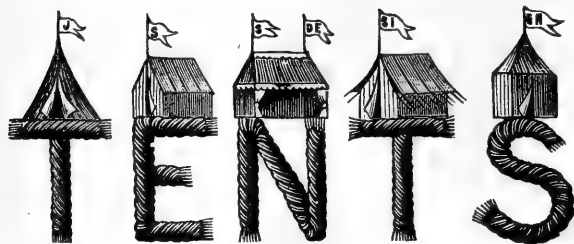

COPYRIGHT 1884

AND **CAMP
 OUTFITS**

We manufacture the largest and most complete line of tents in the country, and our goods are celebrated for their wearing and waterproof qualities.

Send 4 cents in stamps for our new 40-page illustrated catalogue showing all styles of Tents and Camp furniture.

GEO. B. CARPENTER & CO.

202 to 210 S. Water Street, CHICAGO

Established 1840.

Use **“Plugine”** TRADE MARK
 Beforehand

Then ride your wheel in safety. It absolutely prevents punctures. We guarantee tires that contain Plugine. Easy to apply. Sent postpaid on receipt of \$1.00.

The National Specialty Co.,
 91 Euclid Avenue, Cleveland, Ohio.

1897 **High Grade Bicycles**



for Men, Women, Girls & Boys. Complete line at lowest prices ever quoted.
 \$100 ‘Oakwood’ for \$45.00
 \$85 ‘Arlington’ “ \$37.50
 \$55 “ “ \$25.00
 \$20 Bicycle “ \$10.75

\$75 ‘Maywood’ Simplest, Strongest Bicycle on Earth “ \$32.00
 Fully guaranteed. Shipped anywhere C.O.D. with privilege to examine. No money in advance. Buy direct from manufacturers, save agents and dealers profits. Large illustrated catalogue free. Address (in full),
Cash Buyers’ Union, 162 W. Van Buren St. B 359 Chicago

**Tribune
 Bicycles**



The Best in the World

Send for Catalogue

THE BLACK MFG. CO.
 ERIE, PA.

Mention RECREATION.



WINNERS

THE HARTFORD RUBBER WORKS Co
HARTFORD, CONN.

BRANCHES **NEW YORK. BOSTON. CHICAGO.**
PHILADELPHIA. MINNEAPOLIS. TORONTO.

Insist on a Genuine Hunt
free with your new wheel.



Hunt

**Padded Hygienic
Saddles Excel in Ease.**

The famous saddle with leather strands, now made with padded cover, lifting rider completely above the pommel of the saddle.

Can be had of any cycle dealer or send for catalog S.
Hunt Mfg. Co., Westboro, Mass.

OREGON SHORT LINE R.R.

Operating 1,421 miles of railroad, through the thriving States of UTAH, IDAHO, WYOMING, OREGON and MONTANA.

The short line to BUTTE and HELENA, MONTANA; BOISE CITY, IDAHO; PORTLAND, OREGON, and the North Pacific Coast.

The Popular Line to all Utah Mining Districts. The only Road to Mercur, the Johannesburg of North America.

The Fastest Service, in connection with the UNION PACIFIC SYSTEM, to all points West.

Buy your Tickets to the West and Northwest via the OREGON SHORT LINE, the Fastest and Best Railroad.

General Offices, 201 S. Main St., Salt Lake City

S. W. ECCLES D. E. BURLEY
Gen'l Traffic Man. Gen'l Pass. and Ticket Agent

W. H. BANCROFT
Vice-President and General Manager

Do You Travel?

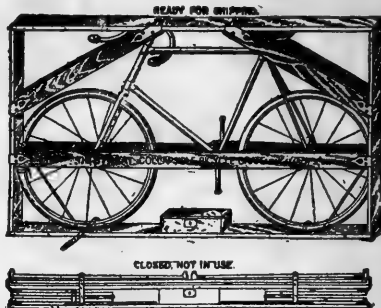

SHIP YOUR WHEEL IN THE Streat Collapsible Bicycle Crate

Always ready for use.

Can crate your wheel in less than five minutes without the aid of a single tool, with pedals and all on.

Price, \$4; with Canvas Curtains, \$6

BOOKLET FREE

HERBERT G. STREAT, Manufacturer
281 West 128th Street, New York

NOVA SCOTIA'S FULL OF FISH

Ever tried Tusket or Maitland River for trout? There's famous fishing there. Nothing in the United States compares with it. The Tusket region is just back of Yarmouth; Maitland River is a little farther in. It's a quick sail from Boston to Yarmouth—only 17 hours.

▲ PERFECT VACATION LAND

is Nova Scotia, whether you want to fish, boat, or just loaf—delightful climate, fine scenery, good roads, and there's boating everywhere, and it's

▲ DELIGHTFUL TRIP

going by the steamers "Boston" or "Yarmouth," of the Yarmouth Steamship Co., the finest and fastest steamers leaving Boston. They leave Pier 1, Lewis Wharf, Boston, every Tuesday and Friday at 12 o'clock, noon, during April, May, and June. Commencing June 24, they will leave every Monday, Tuesday, Thursday, and Friday at 12 o'clock, noon. "Beautiful Nova Scotia," our new 1897 Guide Book, handsome, entertaining, profusely illustrated, sent on receipt of 10 cents. For folders and information, write

J. F. SPINNEY, Agent

YARMOUTH STEAMSHIP CO.
43 LEWIS WHARF

THE BANNER

Is the Cycle Lamp for '97.

\$2.50

WITH RIGID BALL-SOCKET BRACKET LIKE CUT.



5½ IN. HIGH

**HANDSOME!
PRACTICAL! HONEST!**

A powerful light-thrower, having a 3-Inch Double-Convex Polished Optical Lens.

REVERSIBLE OIL POT.

POSITIVE WICK LOCK.

WON'T JOLT OR BLOW OUT.

Burns kerosene. Solid Brass, heavily nickelled; no solder. \$2.50 like cut, attachment for head or forks. \$2.50 with spring bracket. Sent, carriage paid, on receipt of price, when not kept by dealers. Send for illustrated catalogue.

New York. **PLUME & ATWOOD MFG. CO.**
Boston.
Chicago. FACTORIES: Waterbury and Thomaston, Conn.

Swift and Sure



"Get there and get back."

LEAGUEKIT

THE PUNCTURE DOCTOR,
REPAIRS TIRES. "SURE THING."
A "Tip on Tires" sent free.

Stores:

BOSTON, BALTIMORE, CHICAGO, CINCINNATI, CLEVELAND,
DENVER, DETROIT, INDIANAPOLIS, ST. LOUIS,
SAN FRANCISCO, TOLEDO.

25 Park
Place,

NEW YORK BELTING & PACKING CO. LTD

New
York.

A GEM AMONG JEWELS

In appearance a jewel may be perfect—in reality, imperfect. It is so with a bicycle. Paint covers a multitude of sins, but will not insure safety against flaws or imperfections.

**THE HOWARD
PLATE**

on a Howard Cycle is a guarantee of Howard perfection, backed by an old and honorable firm

THE HOWARD CYCLE \$100
Men's and Women's Models

THE HOWARD \$150
TANDEM

THE E. HOWARD WATCH & CLOCK Co., 383 Washington St., Boston. 41 Maiden Lane, New York

AMERICAN GAME FISHES.

Their Habits, Habitat and Peculiarities. How, When and Where to Angle for Them.

Large 8vo, 580 pages. 155 illustrations and two colored plates. Price: cloth, \$2.50; half morocco, \$4.00; full morocco, gilt edged, \$5.50.



SPECIMEN ILLUSTRATION FROM "AMERICAN GAME FISHES."

— WRITTEN BY —

A. N. Cheney, J. G. A. Creighton, W. N. Haldeman, Francis Endicott, Prof. G. Brown Goode, F. H. Thurston ("Kelpie"), Rev. W. H. H. Murray, Rev. Luther Pardee, S. C. Clarke, W. D. Tomlin, Fred. Mather, and others.

EDITED BY G. O. SHIELDS ("COQUINA"),

Author of "Cruisings in the Cascades," "Rustlings in the Rockies," "Hunting in the Great West," "The Battle of the Big Hole," "Camping and Camp Outfits," etc.

“The Excellent is the Permanent”

So says TENNYSON, and so says Nature.

Fine things are lasting things.

IRON rusts, STONE crumbles to dust, while

GOLD remains untarnished for ages.

FINE is not synonymous with FRAIL.

In its class the FINEST is always the FIRMEST,

The SOLIDEST, the STRONGEST, the most DURABLE.

DIAMOND is harder than glass because it is FINER.

A PERSIAN rug outwears a JAPANESE jute one, because it is FINER.

MAHOGANY outlasts HEMLOCK, because it is FINER.

So it is with DESKS, LIBRARY, and OFFICE FURNITURE.

Those made from poor materials are sure to be FRAIL, not FINE.

Only FINE DESKS, TABLES, CHAIRS, ETC., can be STRONG,
FIRM, and DURABLE.

They cost but little more, are worth a great deal more.

GEO. W. COBB, Jr.

Successor to TUFTS & COBB

73 NASSAU STREET, NEW YORK

“Can you ride a wheel, Joe?”

“No; but I can stick on to one while it is running away.”

The South Brooklyn Wheelmen intend moving into the house adjoining their present quarters, No. 476 Ninth Street, which is better adapted to their needs.

A wheelman has figured out that the States which are talking of seceding from the L. A. W. represent a membership of only 7,500 out of a total of 75,000.

The Quill Club wheelmen will run 2 meets during the year, one possibly early in June.

The difficulty between the Cycle Board of Trade and the Cycle Clubs, of Brooklyn, over the possession of the old Thirteenth Regiment armory, has been decided by the courts in favor of the tradesmen.

“Why do we call the bicycle the silent steed?”

“We don't—unless it belongs to a man.”



A Trial will Convince You that
GOLDEN SCEPTRE
 SMOKING TOBACCO
 Is Almost Perfection. We will send on receipt
 of 10c. a sample to any address. Prices of Golden
 Sceptre, 1 lb., \$1.30; ¼ lb., 40 cts., postage paid.

— CATALOGUE FREE. —
 SURBRUG, 159 Fulton Street, New York City.

**Built
To Sit
On
Not to
Straddle**



The Wheeler Reform Saddle

The only saddle that leaves the rider free from saddle soreness after a long ride. Will not sag out of shape after long use. Comfortable all the time. Specially recommended for ladies and endorsed by prominent physicians. Insist on having it on your wheel. Write **The Wheeler Saddle Company, 186 Larned Street, Detroit, Mich.,** for free catalogue.

Craig



Patented June 11, 1895.
AUTOMATIC, PNEUMATIC CYCLE Saddles

Are perfection in Bicycle Seats. You sit on two air-cushions which automatically adjust themselves to the rider by means of a small tube that connects the two cushions. Made in four styles. Price, \$5.00. Do not buy an imitation. Demand "THE CRAIG." Write for 1897 Catalogue BEFORE YOU PURCHASE.

CRAIG CYCLE SADDLE CO.,
Agents Wanted. 347 Essex St., Lawrence, Mass.

EMBOSSED SHEET-STEEL "GET THERE" DUCK BOATS

FOR THE MILLION

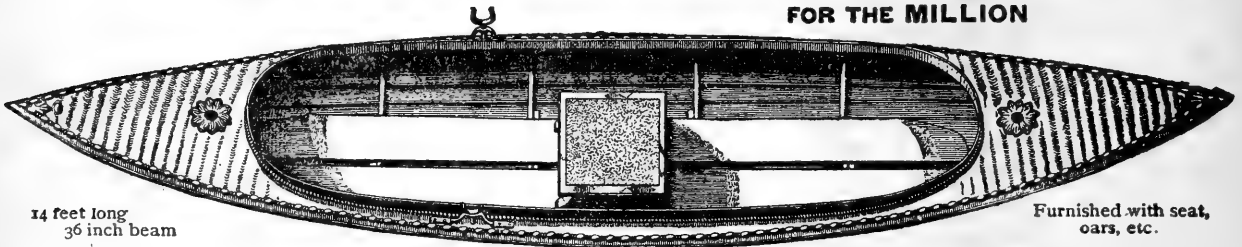

14 feet long
36 inch beam

Furnished with seat,
oars, etc.

Will not crack open. No repairs. Will safely carry two men with guns, etc. Painted a dead grass color. Guaranteed to be first-class in every way. PRICE TWENTY DOLLARS. Correspondence solicited.

W. H. MULLINS, 228 DEPOT STREET, SALEM, OHIO

Sectional View

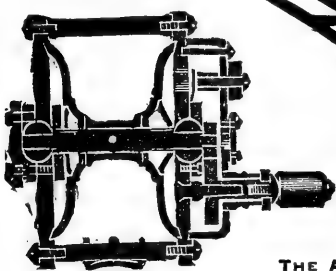

Globe Bearing.



Don't believe imitators of "**HENDRYX**" standard goods when they say their Fishing Reels "are **NOW** as good as **HENDRYX**". The fact that they imitate proves the "**HENDRYX**" is the recognized standard line of Fishing Reels. Ask your dealer for them.



THE ANDREW B. HENDRYX CO., NEW HAVEN, CONN., U. S. A.

J. B. CROOK & CO. Established 1837

1180 Broadway, Cor. 28th Street

Manufacturers and Importers of **NEW YORK CITY, U. S. A.**

HIGHEST GRADE FISHING TACKLE HIGHEST GRADE

SPECIALTIES FOR 1896

Featherweight Rods, Aluminum Reels Trout and Salmon Flies

The only Waterproof Fly Lines: The London Black or Trout, Salmon, and Black Bass. Send for catalogue. Mention RECREATION.



LYMAN'S RIFLE SIGHTS.

Send for 96 Page Catalogue of Sights and Fine Shooting Rifles. **WILLIAM LYMAN, Middlefield, Conn.**



600 SECOND HAND BICYCLES

All makes. \$5 to \$15. New High Grade '96 models, fully guaranteed, \$17 to \$25. Special Clearing Sale. Shipped anywhere on approval.

Earn a Bicycle by helping advertise us. Easy work, sure reward. Write at once for our Special Offer.

D. P. MEAD & PRENTISS, CHICAGO.



There's no more pleasurable sensation than riding along a good, smooth road at a lively clip on a bicycle in which you have perfect confidence.

The Stearns is a wheel to be trusted. On the level, it runs without an effort; the labor of an up-hill climb is lessened by its lightness and ease of running; down the hill, over stones and "thank-you-mums" its strength comes into play.

For an all 'round wheel you cannot do better than buy a Yellow Fellow; you may easily do worse.

E. C. STEARNS & COMPANY,
 SYRACUSE, N. Y. BUFFALO, N. Y.
 TORONTO, ONT. SAN FRANCISCO, CAL.

TINKHAM CYCLE COMPANY,
 New York Agents, Nos. 306-310 West 59th St.

Cut this out and save it. It will not appear again.

\$5,242.50 GIVEN AWAY

1,000 PRIZES. FOR 25 CENTS.

Who can form the greatest number of words from the letters in ENTHUSIASTIC?

Do not use any letter more times than it appears in the word. Use no language except English. Words spelled alike, but with different meaning, can be used but once. Use any dictionary. Pronouns, nouns, verbs, adverbs, prefixes, suffixes, adjectives, proper nouns allowed. Anything that is a legitimate word will be allowed. Work it out in this manner. E., Eat, Eats, Nat, Nut, Nuts, Net, Nets, Tat, Sat, Set, Hat, Hats, etc. Use these words in your list.

The publishers of WOMAN'S WORLD AND JENNESS MILLER MONTHLY will give the following presents absolutely free to those making the largest lists:

1,000 Prizes:

1 Beautiful Rosewood Upright Wing Piano, \$700.00	
1 Set Century Dictionary, 10 Vols., Half Morocco.....	130.00
1 Worcester Bicycle, High Grade, '97 Model, Ladies' or Gentlemen's.....	125.00
1 Monarch Bicycle, High Grade, '97 Model, Ladies' or Gentlemen's.....	100.00
1 White Bicycle, High Grade, '97 Model, Ladies' or Gentlemen's.....	100.00
1 Racycle, High Grade, '97 Model, Ladies' or Gentlemen's.....	100.00
1 Set Standard Dictionary, 2 Vols.....	26.00
1 Webster's Dictionary, latest edition.....	10.50
100 Cash Prizes—\$5 each.....	500.00
100 " " \$4 ".....	400.00
100 " " \$3 ".....	300.00
100 Dress Patterns, Organdies, 12 yds. each, \$5 per pattern.....	500.00
300 Dress Patterns, Grenadines, 12 yds. each, \$5 per pattern.....	1,500.00
167 Kombi Cameras, value \$3 each.....	501.00
125 Cash prizes of \$2 each.....	250.00

1,000 Prizes. Value, \$5,242.50

Why we give the rewards.—It is done to attract attention to WOMAN'S WORLD AND JENNESS MILLER MONTHLY, a beautiful, practical magazine for women and the home; edited by Mrs. B. A. Whitney, assisted by Dinah Sturgis, Sally Van Rensselaer, Helen Whitney Clark, and others; 36 pages; profusely illustrated with original matter by the ablest artists and writers in literature; three great serial stories always running. Yearly subscription price, \$1.00.

MEN OF NATIONAL REPUTATION WILL AWARD THE PRIZES. The reputation of men of sterling integrity and one of the oldest and best ladies' publications in the country is staked on the honesty of this proposition. The men who will decide who win the prizes are known to everybody throughout the world, whose ability, worth and integrity are unquestioned. The Board of Award is Rev. Joseph Sanderson, D.D., author, scholar and divine; Horatio Alger, Jr., an author whose name needs no comment, and John Habberton, equally

celebrated. Every person who enters into the contest for one of the prizes can rest assured that they will get just and impartial treatment.

Every prize in the above schedule is standard value and is now in our office and paid for, ready for delivery as soon as the judges decide the winners.

HOW TO GET A PRIZE The person sending us the largest list of words spelled from the letters in "Enthusiastic" will be awarded the Beautiful Upright

Wing Piano, valued at \$700.00. The person sending the second largest list, 1 set of Century Dictionary, 10 vols., with handsome Oak Stand. The third largest list, 1 Worcester Bicycle; the fourth, 1 Monarch Bicycle; the fifth, 1 White Bicycle; the sixth, 1 Racycle; the seventh, 1 set Standard Dictionary (2 vols.); the eighth, 1 Webster's Unabridged Dictionary, latest edition. The next 100 largest lists, \$5.00 each, and the next 100 largest lists, \$4.00 each, and the next 100 largest lists, \$3.00 each; the next 100 largest lists, a 12-yard Organdie Dress Pattern, worth \$5.00 each; the next 100 largest lists, a 12-yard Grenadine Dress Pattern, worth \$5.00 each; the next 167, each 1 Kombi Camera, \$3.00 each; the next 125 largest lists, \$2.00 each.

These prizes will be given free and without consideration. To compete for a prize you must send 25 cents in silver or stamps, and for that 25 cents we will send WOMAN'S WORLD AND JENNESS MILLER MONTHLY three months. It is a most fascinating study to make up the list of words and a source of pride to have won in a contest of this kind. This contest will close July 19. No one will be allowed to compete for a prize unless they have paid 25 cents for a three months' subscription. There are 1,000 prizes. They will be fairly and honestly awarded by the judges above named. These prizes are all exactly as represented and have an actual value of over five thousand dollars, and every prize **WILL BE GIVEN AWAY**. The names of the winners—and your name can be one of them if you try—will appear in the next number of our great paper after the awards are made. **THERE WILL BE 1,000 WHO WILL WIN.** Isn't it worth your while to try for the Piano or one of the Wheels, or the splendid Dictionaries, or one of the other premiums? In subscribing for our paper you know that you will get fair and honorable treatment. Send 25 cents to-day for a **THREE** months' subscription. An opportunity like this will not occur again. Do not miss it. Remit in stamps or silver, money order or registered letter. Address

WOMAN'S WORLD,
22, 24, 26 No. William Street, N. Y.
Dept. No. 149.

N. R.—If you prefer full rules and regulations send 25 cents **NOW** for three months' subscription, and we will send you full instructions and a coupon of Free Entry for your list when completed.

References—Any mercantile agency, any newspaper in the United States, or ask your New York friend to call and see us.

AN EXTRA FREE PRESENT. If you send at once, and mention RECREATION, we will send you free, by return mail, a charming 200-page book, "Treasure Island," by Robert Louis Stevenson.

"Do you really enjoy shooting?"
"Why, yes, of course," said the dear girl, who had lately bought a light rifle and a lovely pair of hunting bloomers. "Every time I manage to kill a rabbit or a poor little bird I have just the loveliest cry imaginable."—*"Indianapolis Journal."*

RECREATION is better every month, and I only wish it would come weekly instead of monthly.
W. A. K., New York City.



ALUMINUM Chain Guard

For Ladies' bicycles. Light, strong, ornamental. No more torn or greasy dresses. No troublesome lacing. No accidents. Infinitely superior to old style guards. Weight only 7 oz. Fits any wheel. Sent prepaid anywhere in U. S. on receipt of \$1.50. Circulars free. The Turner Brass Works, 163 Kinzie St., Chicago.

The Wing

Piano

STYLE 7



You do not have to
pay an extravagant
price for a first-
class piano

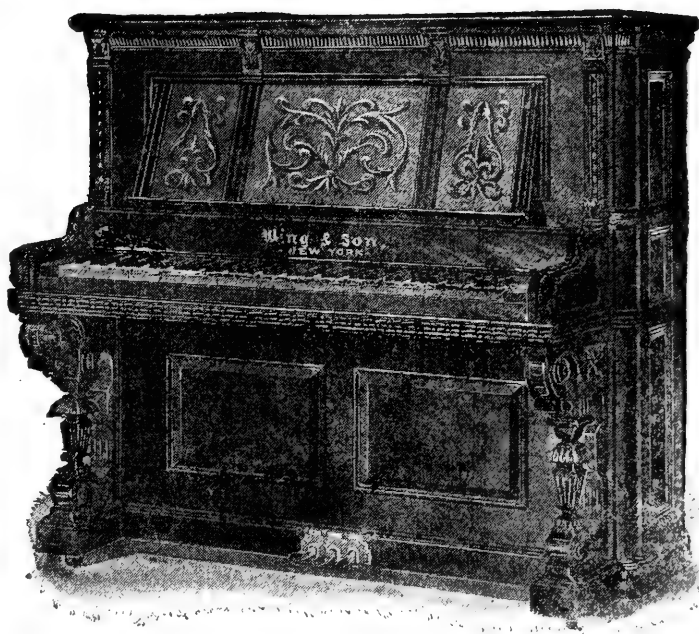

In justice to your-
self write for prices
of the Wing Piano
before you buy

The Instrumental Attachment

imitates perfectly the tone of the Mandolin, Guitar, Harp, Zither and Banjo,
giving the effect of an entire orchestra of these instruments playing in concert
with the piano

SENT ON TRIAL • We will send this piano, or your choice of four other styles,
to any part of the United States *On Trial* (all freights
paid by us), allow ample time for a thorough examination and trial in the home, and,
if the instrument is at all unsatisfactory, we will take it back at our own expense. No
conditions are attached to this trial. We ask no advance payment; no deposit. We
pay all freights in advance.

**OLD INSTRUMENTS EXCHANGED
EASY PAYMENTS**

OUR BOOK should be in the hands of every one who intends to buy a piano. It contains many
valuable hints and instructions, and tells a great many things every buyer ought to know. We will send
it free with our catalogue to any one who writes us.

WING & SON, 443 and 445 West 13th St., N. Y. City

ESTABLISHED 1868

Summer Homes and Resorts

ALONG THE

Lehigh Valley Railroad

In the Historic Valleys and Romantic Mountains of Pennsylvania or Among Picturesque Lakes of New York State.

Convenient Train Service
Delightful Climate

and everything combined conducive to the comfort and well being of the sojourner.

NEW YORK OFFICE, 375 Broadway
BUFFALO OFFICE, Cor. Main & Seneca Sts.
Send for beautifully illustrated printed matter to
CHAS. S. LEE, General Passenger Agent
Philadelphia, Pa.



.... FISHING
AND HUNTING
.... REGIONS
... OF MAINE ...

REACHED BY THE

Bangor & Aroostook Railroad

The lakes and ponds teem with the most gamy of game fish; the speckled square-tailed trout, salmon, pickerel and togue.

Visit such places as the

- MOOSEHEAD LAKE REGION
- PENOBSCOT RIVER REGION
- BIG MACHIAS LAKES
- FISH RIVER REGION
- AROOSTOOK RIVER REGION
- THE KATAHDIN PONDS

The Sportsmen's Paradise of the World!

The shipment of game by visiting sportsmen from our stations greater than from all New England put together.

Shipped in October, November and December, 1896: 2,245 Deer, 133 Moose, 130 Caribou, 15 Bears.

Through trains with Pullman Buffet Cars into the very heart of the wilderness. For an illustrated guide book, containing maps, rates of fare, etc., enclose two 2c. stamps to the General Passenger Agent.

F. W. CRAM
Vice President and General Manager
GEO. M. HOUGHTON
General Passenger and Ticket Agent

General Offices, Bangor, Me.

Vacation Days

In the lake regions of Wisconsin, Northern Michigan, Minnesota, Iowa, and South Dakota, along the lines of



are hundreds of charming localities pre-eminently fitted for summer homes, nearly all of which are on or near lakes which have not been fished out. These resorts range in variety from the "full dress for dinner" to the flannel shirt costume for every meal. If you are planning a vacation trip for the coming summer, send a two-cent stamp for a copy of "Vacation Days," giving description of the country traversed by the lines of the Chicago, Milwaukee, and St. Paul Railway, and a list of summer hotels and boarding houses, with rates for board, to

GEO. H. HEAFFORD

General Passenger Agent CHICAGO, ILL.

UNEQUALED ATTRACTIONS

ON THE LINE OF THE

Union Pacific

FOR TOURISTS

It traverses the Grandest Scenery of the Rocky Mountains, and reaches all the Health and Pleasure Resorts of the Mid-Continent.

Sportsmen

will find in scores of localities along this line game worthy of their skill, such as Bear, Mountain Lion, Coyotes, Elk, Deer, Antelope, Mountain Sheep, Feathered Game of all kinds. And everywhere are Beautiful Streams well stocked with Trout.

For Gun Club Rules, Game Laws, and any information relative to localities for Hunting, or for information in regard to the UNION PACIFIC SYSTEM, call on or address any General or Traveling Agent of this Company.

R. TENBROECK, Gen'l Eastern Agent,
287 Broadway, New York City

E. DICKINSON, Gen'l Manager,
Gen'l Pass. & Tkt. Agt.,
Omaha, Neb.

E. L. LOMAX,

Amateur Photographers

WILL FIND THAT THE

WEST-SHORE RAILROAD

PRESENTS most delightful and varied Scenery for PHOTOGRAPHING AND SKETCHING. Its Mountains, Woodlands, Streams, Lakes, and Valleys, provide subjects for an

Infinite Variety of Pictorial Gems

THE HUDSON RIVER

THE CATSKILL MOUNTAINS

THE MOHAWK VALLEY

THE NIAGARA FALLS

All contribute to make this the most desirable route for persons of artistic temperament.

Five elegant Fast Trains with through Sleeping Cars to Kingston, Albany, Utica, Syracuse, Rochester, Niagara Falls, Toronto, Cleveland, Detroit, Chicago, and St. Louis.

DIRECT ROUTE to the Adirondacks, making close connections with railways, steamers, and stages for all the choice hunting and fishing grounds of that delightful region.

FOR INFORMATION, ADDRESS

H. B. JAGOE, G.E. Pass. Agt. J. WOLFE, Gen. Agt.
363 Broadway, New York Albany, N. Y.

C. E. LAMBERT, Gen. Pass. Agent
5 Vanderbilt Avenue, New York

How a Donkey Found a Mine

The history of mine discoveries, in the West, is full of strange and amusing incidents. Many of the most celebrated mines or ledges have been found by accident. Some of these accidental discoveries are laughable in the extreme. One of them occurred in connection with the discovery of one of the richest mines in the Cœur d'Alene country, in Idaho. In this case a common donkey, or jackass, or "burro," as one chooses to term it, was credited with the finding of the mine.

The Northern Pacific Railway's finely illustrated tourist book, *Wonderland '97*, has a chapter on mining in the West, in which the incident alluded to is given. It shows how, from slight or trivial things, great results may flow. There are also articles on Yellowstone Park, Alaska, Cattle Raising, etc. By sending six cents in postage stamps to Chas. S. Fee, Gen. Pass. Agent, St. Paul, Minn., anyone can obtain a copy of this book. It is full of historical fact and descriptive narrative, and is valuable as a school text-book.

...To "the" Pleasure Resorts of...
Texas and Gulf of Mexico

TAKE



Via CHICAGO, KANSAS CITY, or
ST. LOUIS

WAGNER BUFFET SLEEPERS
FREE "KATY" CHAIR CARS

For further information, address

W. S. ST. GEORGE, Gen. East. Agt.
409 Broadway, New York

THE . . .

ADIRONDACK . . .

MOUNTAINS

Called in
Old Times

"THE GREAT NORTH WOODS."

A marvelous wilderness, abounding in beautiful lakes, rivers and brooks, filled with the greatest variety of fish.

An immense extent of primeval forest, where game of all kinds is to be found.

This wonderful region—located in Northern New York—is reached from Chicago by all lines, in connection with the New York Central; from St. Louis by all lines in connection with the New York Central; from Cincinnati by all lines in connection with the New York Central; from Montreal by the New York Central; from Boston by a through car over the Boston & Albany, in connection with the New York Central; from New York by the through car lines of the New York Central; from Buffalo and Niagara Falls by the New York Central.

A 32-page folder and map entitled "The Adirondack Mountains and How to Reach Them" sent free, post-paid, to any address, on receipt of a 1-cent stamp by George H. Daniels, General Passenger Agent, New York Central & Hudson River Railroad, Grand Central Station, New York.

You can't

make a white plume
from a crow's tail

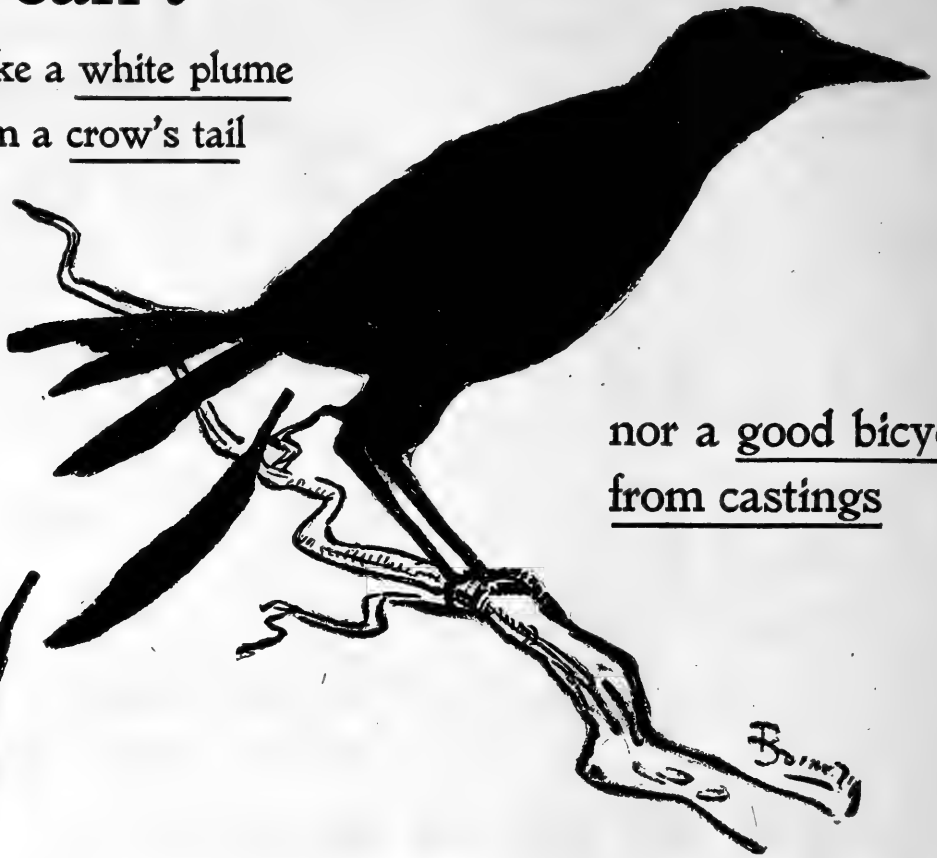

nor a good bicycle
from castings

The
Monarch
is good
all through

Look under the Enamel

MONARCH CYCLE MFG. CO.

Chicago New York London

ASHLAND HOUSE

FOURTH AVE.
and 24th ST.

Two blocks from
Madison Sq. Garden

...HEADQUARTERS FOR SPORTSMEN

American and
European Plan

RATES:

Rooms, with board,	\$2.00, \$2.50	and \$3.00	per day
Rooms, without board,		\$1.00	and upwards
Breakfast,			75 cents
Lunch,			50 "
Table d' Hote Dinner,			75 "

No Fire, Smoke, or Heat. Absolutely Safe. Send 5 Stamps for Catalogue. **\$250 and up**



TRUSCOTT BOAT MFG. CO. Drawer H, St. Joseph, Mich.

The Phillips Phonograph (Maine)

is doing more for the woods there than anybody or anything else but the fish and game.

SEND FOR A COPY—IT'S GAMY EVEN NOW.

RUPTURE ABSOLUTELY CURED

without truss, operation or confinement, on strictly scientific professional principles, based on an experience of many years.

My method of treatment is known only to myself, and I object to long letters explanatory thereof. An interview is positively necessary for those requiring information.

Complete cure effected in 6 to 8 weeks; one treatment each week, with no detention whatever from business.

SAGREDO

Care F. C. PRESTON, 98 Hudson Street, New York

GOLD MEDAL CAMP FURNITURE MANUFACTURING CO., RACINE, WIS. U. S. A.

Manufacturers of the celebrated Gold Medal Camp and Folding Furniture, and Folding Portable Bath-tubs.



Look for our GOLD MEDAL CAMP BED in this space next month.

Price \$10.00

GOLD MEDAL FOLDING BATH-TUB

AGENTS WANTED. Mention Write for Discounts. RECREATION.

None so Portable, none so Thoroughly Good and none so Comfortable.

This tub represents our Gold Medal Folding Bath-tub. These have been in use a year and have proved entirely satisfactory. The frame is constructed with our patent metal joints, in such a way that it folds in an exceedingly small space. The cover is made of very heavy, closely woven duck, coated with pure, thoroughly refined rubber, cured in such a way that it is tough and elastic. The duck is specially rubbered for us and we warrant it not to crack. This tub is made with no separate parts and is so arranged that it can be picked up and carried even when it contains water for the bath; and empties by simply raising one end, the other forming a trough through which the water is poured into a pail. It is in every way a practical bath-tub, strong enough to hold the heaviest person, and will last a generation. Folds 5 ft. by 5 in. square. Send for free Catalogue of Camp and Folding Furniture and Bath-tubs.

Wyoming...

For Antelope, Bear, Cougar, Deer, Elk, Fish, Goat, Moose, Sheep, Grouse, Duck, and Sage Chicken Shooting,

ADDRESS H. D. DEKALB, BIG PINEY, WYO.

A DIRONDACK LANDS FOR SALE in Various Parts of that Region. Suitable for GRAND PARKS. GAME PRESERVES. COTTAGE SITES. FOREST LAND CO., SYRACUSE, N. Y.

IN ANSWERING ADS, IF YOU WILL KINDLY MENTION RECREATION YOU WILL GREATLY OBLIGE THE EDITOR.

THE PROPAGATION OF GAME BIRDS

If interested therein, send postal for booklet regarding the English Ring-neck Pheasant, to

D. G. BLACK, 26 Cortlandt Street, New York

Cycle Touring in England at small expense. All about it, for 25c.

Arthur Munson, Stamford, Ct.



This is a picture of Sewell Newhouse, inventor of the celebrated

NEWHOUSE STEEL TRAPS

known the world over as the best traps made for catching fur-bearing animals. Send to

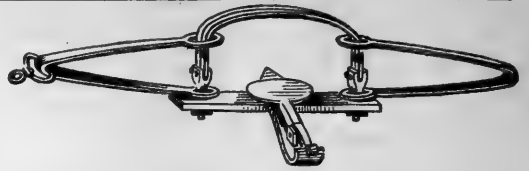

ONEIDA COMMUNITY, Ltd., Kenwood, N. Y.

for catalogs, prices and discounts.

YES, we can and do sell **SPLIT BAMBOO RODS for \$1.00,** but why should you want such stuff?



We can sell you good (none as good as ours) **Trout Flies** for 24 cents a dozen, but we are sure **your** pleasure will be best served by ordering our **turned wing gut helper Trout Flies**, at 72 cents a dozen. We want you to **send for our illustrated catalogue**, because it will tell you where you can buy **fine quality goods at CUT PRICES.** It will give you lots of information as to **Fishing Tackle, Gun Goods, Photographic Goods, and Sporting Goods** generally. (One order from us and you will continue with us.)

CORNWALL & JESPERSEN,

310 BROADWAY, NEW YORK

“MY DOG AND I”

By **H. W. Huntington, 5 W. 39th St., New York**
President National Greyhound Club of America.

Contains 66 portraits of famous dogs, with 200 original etchings.

Gives origin, uses, Specialty Club's scales of points for judging, with concise treatment of dogs in health and sickness. Price **\$1.00, post-paid.**

“Wallace's Adirondacks”

In *Elegance, Interest and Completeness, nothing on the subject has ever approached it. Contains much important information never before published.* It is more than a mere guide-book, as it tells the whole story of the *Adirondacks.* **HISTORY, LEGEND, HUMOR and DESCRIPTION** are *delightfully interwoven,* and it is so admirably written, it *engrosses the attention like a novel.* Contains about 700 pages, 12mo; 200 **HALF-TONE Engravings,** and large Map, forming a **MAGNIFICENT ART WORK.** Finely bound. Price, **\$2.00, postpaid.**

FOREST PUBLISHING CO., Syracuse, N. Y.

HYPNOTISM TAUGHT BY MAIL.



Not Difficult. Spare Moments Sufficient. Not a natural gift; anyone can use it. Latent powers developed and the otherwise impossible accomplished. Ours the most reliable secrets of the art, making all susceptible to this strange influence. Induced by contact, or at a distance by mail or telegraph. Control loved ones and save them from error. Habits, weaknesses and diseases cured. Nothing aids all classes of every age, sex and condition, in business and social life more than this knowledge. Everything private. Established twenty years. Most advanced and reliable methods. Valuable information upon request. Address, **Prof. L. H. ANDERSON, R. C. 67. Masonic Temple, Chicago, Ill. U.S.A**

THE **PETERS** BEST

 OF **NEW VICTOR** ALL
AMMUNITION

Try **.22 Peters' Short Smokeless and New Victor Shells,** Loaded with **King's Smokeless**

FOR **ACCURACY, VELOCITY, STRENGTH, PENETRATION AND CLEANLINESS.**



Taxidermists' Supplies Artificial Glass Eyes

For stuffed birds and animals

WHEN you get a good specimen of bird, fish, or mammal that you would like to have mounted send it to us. We will do it right and make the price right.

Zoologists' and Entomologists' Supplies. Send two-cent stamp for Taxidermists' Catalogue to

FRED. KAEMPFER, 217 Madison St., Chicago, Ill.

All specimens of natural history prepared and mounted true to nature in the best style of art and at reasonable prices.



INSIST ON YOUR DEALER SUPPLYING YOU
THE PETERS CARTRIDGE CO.
CINCINNATI, O.

FOR SALE EVERYWHERE

SOME GOOD GUIDES.

Following is a list of names and addresses of guides who have been recommended to me, by men who have employed them; together with data as to the species of game and fish which these guides undertake to find for sportsmen.

If anyone who may employ one of these guides finds him incompetent or unsatisfactory, I will be grateful if he will report the fact to me.

ALASKA.

William York, Juneau, moose, bear, deer, sheep, goats and small game.

CALIFORNIA.

Chris. Ringsin, Avalon, Santa Catalina Island, goats, water-fowl, and salt-water fishing.

John Meier, Sweetwater Lake, Dotsero P. O., Eagle Co., ditto

John Broder, Visalia, trout, deer, bear, grouse, and quails.

S. L. N. Ellis, Visalia. ditto

COLORADO.

J. M. Campbell, Buford, elk, bear, deer, antelope, trout and grouse.

Chas. Smith, Buford, ditto

Frank Allen, Dotsero, Eagle Co., "

Charles Allen, Dotsero, Eagle Co., "

Wells and Patterson, Meeker, "

R. W. McGee, Debeque, "

Lem Crandall, Debeque, "

Sam. T. Himes, New Castle, "

Luke Wheeler, Pinkhampton, "

Nathan Fisher, Gunnison, "

W. H. Hubbard, Glenwood Springs, "

W. L. Pattison, Glenwood Springs, "

J. E. Borah, Glenwood Springs, "

Ed. L. Stockton, 527 11th St., Greeley, "

FLORIDA.

C. L. Farnham, Avon Park, bear, deer, turkeys, quails, ducks, black bass, etc.

Oliver Tinny, Ozona, Hillsboro Co., deer, bear, turkeys, quails, ducks and salt-water fishing.

E. M. Reynolds, Fort Myers, ditto

Wm. Webb, Osprey, Manatee Co., "

Frank Guptill, Manatee Co., "

W. J. Meyer, Tarpon Springs, "

Robt. E. Hammond, Key West, "

Frank Carson, Ft. Meyers, "

E. T. Robinson, Keuka, "

T. C. Cato, Inverness, "

J. L. Sandlin, Punta Gorda, "

Oliver Archer, Clearwater, "

L. W. Scroggins, Homeland, "

Capt. Jas. Argo, Oviedo, "

F. J. Adams, Sanford, "

C. B. Bailey, Winter Haven, "

W. H. Steacy, Pt. Tampa City, "

Wm. J. Lyon, Interlachen, "

L. L. Sutton, Sutherland, "

W. D. Isler, Eagle Lake, "

George W. Hawthorn, Hawthorn, "

C. H. Hill, Maitland, "

J. E. Bowen, Laughman, "

Margan Bass, Kissimmee, "

B. C. Lanier, Leesburg, "

John Hunter, Winter Park, "

H. Shipman, Haskell, "

Robert James, Emporia, "

Alex. Brown, Martin, "

W. J. McCullough, Boardman, "

Frank Smith, St. James City, "

Jinks McCreary, Higly, "

Baldwin Cassidy, Lisbon, "

W. H. Howell, Centre Hill, "

Ed. Brown, Dunedin, "

G. B. Lawson, Lake Maitland, "

J. H. Maddox, Wauchula, "

Will Montgomery, Arcadia, "

T. E. Fielder, Calvinia, "

W. F. Hays, Webster, "

IDAHO.

W. L. Winegar, Egin, Fremont Co., elk, bear, deer, antelope, mountain sheep, trout and grouse.

Geo. Winegar, St. Anthony, Fremont Co., ditto

R. W. Rock, Lake, Fremont Co., "

Ed. Stailey, Lake, Fremont Co., "

Geo. W. Rea, Orange, Fremont Co., "

Wm. Fraser, Beaver Canyon, "

MAINE.

Wm. S. Emery, Blakesley Camps, Eustis, moose, caribou, deer, trout, grouse.

Algie Spearin, Moro, ditto

Charley Condon, Moro, "

Wm. Atkins, Oxbow, "

Miles D. Arbow, Oxbow, "

J. E. Jenkins, Oxbow, "

C. R. Peavy, Oxbow, "

John Keaten, Oxbow, "

Walter Swett, Oxbow, "

Frank Cram, Oxbow, "

Nathan B. Moore, Bingham, "

Charley Powers, Medway, "

Charley Hale, Medway, "

Walter Dacey, Medway, "

Elliott Rich, Bethel, "

John C. Lamb, Kineo, "

John H. Quelty, Kineo, "

John Kelley, Kineo, "

Winn McKenney, Patten, "

Frank McKenney, Patten, "

Orville Crommitt, Patten, "

C. C. Coburn, Patten, "

Mitchell Francis, Patten, "

Royal E. Paine, Stratton, "

Charles Hathaway, Medway, "

Victor Scott, Millinocket, "

C. O. Norton, Dover, "

Benjamin J. Woodaid, Dover, "

Benjamin Woodard, Dover, "

Col. N. D. Brown, Roach River House, "

Alonzo Davenport, Shesuncook, "

Ichabod Smith, Greenville, "

Ernest Ham, Guilford, "

Charlee Capen, Capens, "

Ed. Masterman, Moosehead, "

Marsh Carlton, Rangely, "

Freeman Tibbetts, Rangely, "

Fred Reed, Medway, "

Dan Hale, Medway, "

Will Meyer, Eustis, "

Charles Haley, Eustis, "

H. R. Horton, Eustis, "

Abner McPhiters, Norcross, "

Albert McPhiters, Norcross, "

Horace B. Cushman, Norcross, "

Irving Hunt, Norcross, "

Wm. O. Shaw, Dobby Lake, Washington Co., "

Ran. Day, Princeton, Washington Co., "

Geo. C. Jones, Carritunk, "

Geo. Douglass, Eustis, "

Andrew Douglass, Eustis, "

Gus Douglass, Eustis, "

Joe St. Ober, Eustis, "

Otis Witham, Eustis, "

John Quint, Eustis, "

David Quint, Eustis, "

Davis Moody, Stratton, "

Gus Jones, Stratton, "

Fred Viles, Stratton, "

John Darling, Lowell, "

Joe Francis, Old Town, "

Sebat Shay, Old Town, "

Louis Ketcham, Old Town, "

Granville M. Grey, Old Town, "

L. A. Orcutt, Ashland, "

MASSACHUSETTS.

Recommended by Dr. Hitchcock, Cliftondall, grouse, squirrels, salt water fishing.

MICHIGAN.

Bony Markelty, Negaunee, deer, bear, grouse, trout, black bass, and muskhalonge.

Thos. Starr, Alpena, "

MINNESOTA.

C. L. Porter, Glenwood, ducks, geese, prairie chickens, and black bass.

E. L. Brown, Warren, ditto

Jack Baldwin, Jackson, "

SOME GOOD GUIDES (Continued.)

MONTANA.

M. P. Dunham, Woodworth, elk, bear, deer, antelope, mountain sheep, trout and grouse.
 G. H. Heywood, Red Lodge, ditto
 Mr. William Jackson, Browning, Montana, "
 W. A. Hague, Fridley, "
 E. E. Van Dyke, Red Lodge, "
 James Sheehan, Butte, "
 Vic. Smith, Anaconda, "
 James Blair, Magdalen, "
 George Whitaker, Gardiner, "

NEW HAMPSHIRE.

Philip Marden, Wolfboro Falls, black bass, grouse and quails.
 Frank Britton, Wolfboro Falls, ditto
 Blake Abbott, Wolfboro Falls, "
 Ned Norton, Colebrook, moose, caribou and deer.
 John Bresette, Diamond Pond, ditto
 Henry Bresette, Diamond Pond, "

NEW JERSEY.

Billy Throckmorton, Mannahawkin, ducks, geese, brant, shore birds, grouse, salt-water fishing.
 Dory Hulse, Mannokoking, Ocean Co., ditto
 Ernest Worth, Bayville, Ocean Co., "
 James Emmans, Jr., Swartswood Lake, Swartswood, black bass, pickerel, quails and rabbits.
 Mr. Riker, Culver's Lake, Branchville, perch, black bass and pickerel.

NEW YORK.

Cal. Blanchard, Upper Jay, deer, grouse, rabbits, squirrels and trout.
 Abe Rundle, Eldred, Sullivan Co., ditto
 A. W. Rundle, Eldred, "
 Eugene Scrafford, Eighth Lake, Old Forge, "
 Ceylon Clarke, Piseco, Hamilton Co., "
 Joe White, Horseshoe Pond, Tupper Lake, Franklin Co., "
 Edson Brown, Spring Cove, Franklin Co., "
 William Boyea, Owl's Head, Franklin Co., "
 Will Simonds, Franklin Fall, Franklin Co., "
 Harry Freeman, Axton, Franklin Co., "
 Fred Reeves, Axton, Franklin Co., "
 Gean Clark, Axton, Franklin Co., "
 Geo. P. Finnegan, Smithville Flats, Chenango Co., "
 L. C. Pendell, Athol, "
 Wm. Sperry, Old Forge, "
 Geo. Goodsell, Old Forge, "
 Chris. Goodsell, Old Forge, care Rocky Point Inn, "
 Chas. Johnson, Seventh Lake, Old Forge, "
 Emil Meur, Fourth Lake, Old Forge, "
 Joe Ward, C. & A. branch, R. N. & O., Oswegatchie, "
 Martin Humes, Harrisville, "
 Myron Humes, Harrisville, "
 Raymond Norton, Glendale, Lewis Co., "
 Andrew Watson, Glendale, Lewis Co., "
 Frank Perkins, Greg, Lewis Co., "
 Henry N. Mullen, Harrisville, Lewis Co., "
 Chris. Wagner, Beaver River, "
 Peter Back, Beaver River, "
 Nelson Foster, Saranac Lake, "
 Rant Reynolds, Saranac Lake, "
 Chas. McKaffery, Saranac Inn, "
 Wess Wood, Saranac Inn, "
 Justin Farrington, Saranac Inn, "
 C. I. Stanton, Blue Mountain Lake, "
 C. L. Stanton, Blue Mountain Lake, "
 George W. Fuller, Blue Mountain Lake, "
 G. W. Fuller, Blue Mountain Lake, "
 Lawrence Sweeney, Lake Clear, "
 Ed. Oyis, Lake Clear, "
 Geo. Otis, Lake Clear, "
 Leonard Bunting, Greenfield, Ulster Co., grouse, woodcock and trout.
 Thomas Flake, Cape Vincent, pickerel, muskalonge, black bass.
 Antoine Seymour, Cape Vincent, ditto
 Wilfred Dodge, Cape Vincent, "
 Ren Dodge, Cape Vincent, "
 Warren Aldrich, Greenwood Lake, black bass, trout, grouse, squirrels, rabbits, etc.
 Charles Lane, Good Ground, L. I., ditto
 Peter Post, Seaford, L. I., "
 Harry Rogers, Eastport, L. I., "

Willet Ellison, Freeport, L. I., black bass, trout, grouse, squirrels, rabbits, etc.
 W. C. Raynor, Freeport, L. I., ditto
 W. N. Ackerley, Patchogue, L. I., ducks, baybirds, salt-water fishing.
 Hugh Smith, Moriches, L. I., quails, woodcock and grouse.
 Dan Havens, Centre Moriches, L. I., ditto
 Hugh Smith, East Moriches, L. I., "

NORTH CAROLINA.

Fenner S. Jarvis, Haslin P. O., deer, bear, turkeys and quails.
 Robert Waterfield, Knotts Island, ditto
 Jas. Tooly, Belleport, "
 W. C. Halsted, Currituck C. H., deer, turkeys, quails, ducks, salt-water fishing.
 Fred. Latham, Haslin, ditto

OREGON.

Wm. Ascher, West Fork, Douglass Co., deer, bear, elk, trout, grouse, ducks and geese.
 E. L. Howe, Creswell, Lane Co., ditto

PENNSYLVANIA.

Leonard Champion, Prop'r Lehigh Valley Hotel, Mahopany, Wyoming Co., bass, pickerel, salmon.

VERMONT.

E. Ward, Fair Haven, woodcock, grouse, black bass and trout.

VIRGINIA.

M. Corbel, Virginia Beach, geese, brant, ducks, shore birds, quails, salt-water fishing.
 Captain R. E. Miles, Machipongo, ditto
 C. A. Spencer, Buckingham, "
 James Daniel, Buckingham, "
 Fred Spencer, Buckingham, "
 M. A. Barner, Clarksville, "

WASHINGTON.

John S. Wood, Morton, Lewis Co., deer, grouse, trout, etc.

WISCONSIN.

T. R. Page, Bruce, deer, grouse, trout, black bass and muskalonge.
 Charles Johnson, care Williams, Salsich & Co., Star Lake, Vilas Co., ditto
 M. E. Monsell, Star Lake, Vilas Co., "
 H. E. Soule, South Range, "
 Judd Blaisdell, Camp Franklin, Woodruff, "
 Alexander Gillies, Camp Franklin, Woodruff, "
 C. J. Coon, Camp Franklin, Woodruff, "

WYOMING.

Mark H. Warner, Ten Sleep, elk, bear, deer, mountain sheep, antelope, grouse and trout.
 Milo Burke, Ten Sleep, ditto
 James Fullerton, Ten Sleep, "
 Nelson Yarnall, Dubois, "
 Geo. Y. Hayes, Dubois, "
 S. A. Lawson, Laramie, "
 R. C. Tregoning, Laramie, "
 A. Pache, Laramie, "
 N. E. Brown, Marquette, "
 H. D. DeKalb, Big Piney, "
 Ira Dodge, Cora, "
 S. N. Leek, Jackson, "
 W. P. Redmond, Jackson, "
 Frank L. Peterson, Jackson, "
 O. F. Bike, Jackson, "
 F. E. White, Jackson, "
 W. A. Hague, Pleasant Valley Hotel, via Mammoth Hot Springs, "

CANADA.

Christopher Bowers, Shelburne, Nova Scotia, moose, bear, grouse, black bass and trout.
 E. Thompson, Hammond Plain, Nova Scotia, ditto
 John Bowers, Shelburne, Nova Scotia, "
 Billy McCoy, "
 Frank Komondo, Desert or Maniwaki, P. Q., "
 Philamon Gashon, Three Lakes, P. Q., "
 Robert Elliott, Kennebec Road, Armstrong, County Beauce, P. Q., "
 Geo. Gillard, Little Bay, Notre Dame Bay, Newfoundland, caribou, bear, ptarmigan, ducks and geese.

The Most Elegant Folding Camera in the Market • •

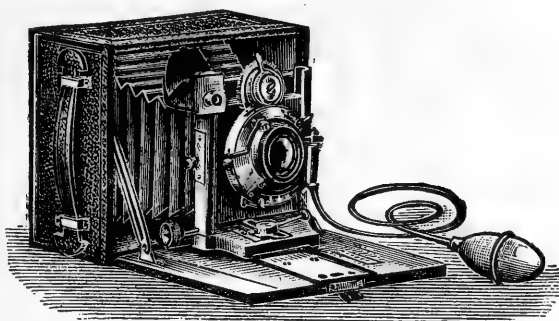

QUALITY
• • • Can't be Beaten forOR.....
PRICE ❁ ❁

Send for Circular

GUNDLACH OPTICAL CO.

761, 763, 765 South Clinton St.

∴

ROCHESTER, N. Y.

A Practical Common Sense Camp Stove.

In 6 Sizes. Patent applied for.

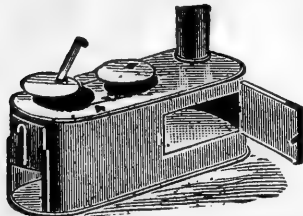

The lightest, most compact, practical camp stove made; either with or without oven. Won't get out of shape, combination cast and sheet steel top, smooth body, heavy lining, telescopic pipe carried inside the stove.

Burns largest wood, keeps fire longest of any stove made. For full particulars address

D. W. CREE, Manufacturer, Griggsville, Ill.

PHEASANTS, CALL DUCKS, ETC.

Golden, Silver, Reeves, Swinhoe, Versicolor, Ringneck, and Lady Amherst and Golden (cross) Pheasants. Also White Call and Mandarin Ducks for sale.

JAMES MORRISON, Mr. SCHIEFFELIN'S place,
P. O. BOX 48, TARRYTOWN, N. Y.

Gall & Lemcke
OPTICIANS.

21 Union Square, N. Y.

The Telescopes furnished by you to the Signal Corps, National Guard, State of New York, I find remarkable for definition and clearness of objects at long distances. Yours, etc.,

HOMER W. HEDGE,
1st Lieut. and
Ass't Signal Officer.



TYPEWRITERS ALL MAKES

All the Standard Machines for SALE or RENT at HALF manufacturers' prices. Full guarantee. Express charges prepaid if this medium mentioned. Privilege of Examination. Write for catalogue. Typewriter Emporium, 202 LaSalle St. CHICAGO.

G. CRAMER
DRY PLATE
WORKS

ST. LOUIS, MO.

Full descriptive catalogue mailed to any address on application

Dixon's Graphitoleo

Lubricates not only the chain and sprockets, but also the pins in the links of the chain, which stick Graphite cannot do and is not intended to do. For gun locks, for copying presses, and for office chairs it is unequalled. If your dealer does not keep it, mention RECREATION, and send 15 cents for sample.

JOS. DIXON CRUCIBLE CO., Jersey City, N. J.

Bright and Light ALADDIN'S LAMP The New One...



has the maximum quality at the minimum cost

NEW FEATURES: Hinged door and oil well; double springs instantly detachable; patent lighter by which wick can be ignited in the highest wind; enlarged oil reservoir. Drawn brass throughout and not a particle of solder. Price, \$2.50.

A LAMP WITH A REPUTATION THAT HAS STOOD THE TEST.

Guaranteed against any defects.

Of dealer or post-paid on receipt of price.

THE ALADDIN LAMP COMPANY

107 Chambers Street, New York. 518 Broad Street, Newark, N. J.

WANTED.—LIVE ELK, MOOSE, CARIBOU, BLACK-tail deer, wild turkey, European roebucks, fallow deer, etc., for Litchfield Park, Adirondacks. Address, with particulars, EDWARD H. LITCHFIELD, 59 Wall Street, New York.

IMPORTANT AND INTERESTING

FOR THE

HOME, CHURCH, FAIR and THEATRE.

Parents, Committees, Managers and Proprietors are cordially invited to call and see demonstrations of

THE MARVELOUS INVENTION OF THE AGE
ANIMATED PHOTOGRAPHS,
LIVING AND MOVING PICTURES.

Every Movement of Actual Life depicted on the Screen

The Wonderful Kineoptoscope

The machine takes any "Edison Standard" Films. The vibration is less than on any other machine. The films pass through quite uninjured.

Although so low in price, it is not a toy, but fully equal to any machine on the market.

Price, \$120 and up.

LIBERAL DISCOUNT FOR CASH.

Riley Bros., 16 BEEKMAN STREET.

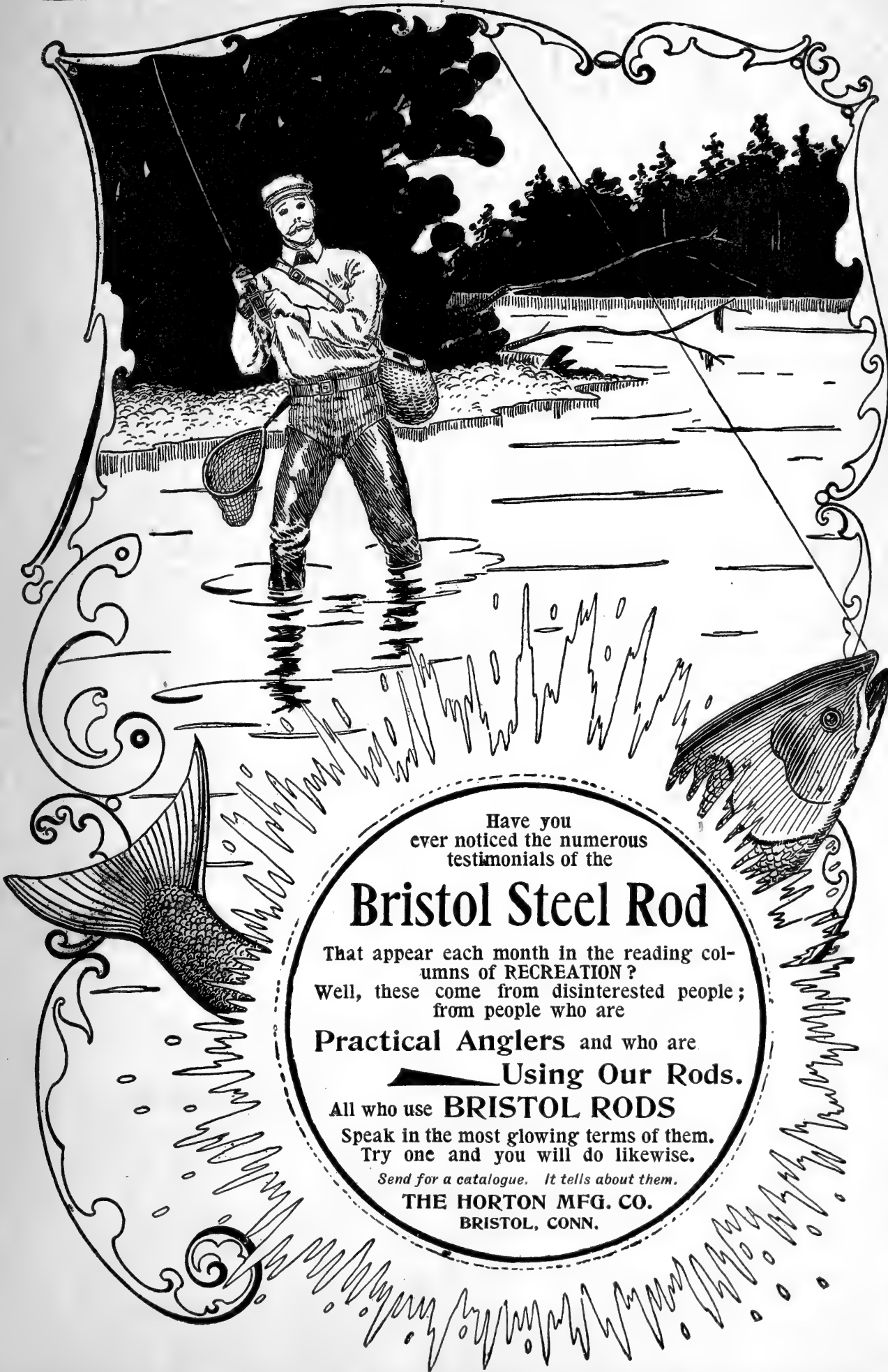

Have you
ever noticed the numerous
testimonials of the

Bristol Steel Rod

That appear each month in the reading columns of RECREATION?
Well, these come from disinterested people;
from people who are

Practical Anglers and who are
Using Our Rods.

All who use **BRISTOL RODS**

Speak in the most glowing terms of them.
Try one and you will do likewise.

Send for a catalogue. It tells about them.

THE HORTON MFG. CO.
BRISTOL, CONN.

New Ithaca Guns

Self compensating,
taking up wear
at every point

Bored
**FOR BLACK AND
NITRO POWDERS**

Close and Hard Shooting Guns
at long range a specialty



Price but a little more than one-half that of any other good gun, and warranted in the most positive terms, shooting included

ITHACA GUN COMPANY, ITHACA, N. Y.

Send for circular
Mention RECREATION

Manufacturers of fine Hammer
and Hammerless Guns



Have Your SHELLS Loaded with

**Laflin & Rand
W.-A.
Smokeless**

*ABSOLUTELY UNIFORM
IMPERVIOUS TO MOISTURE*

OR

**Orange
Sporting
Extra**

In Use Since 1808



**Laflin & Rand
Powder
Company**

Manufacturers of

**Black and Smokeless Sporting
and Military Powders**

NEW YORK	BALTIMORE	NEW ORLEANS
CHICAGO	NASHVILLE	DENVER
CINCINNATI	PITTSBURG	POTTSVILLE

For nearly 50 Years the name

"Davenport"



has been identified with the manufacture of

Guns....

and Rifles!
+++++

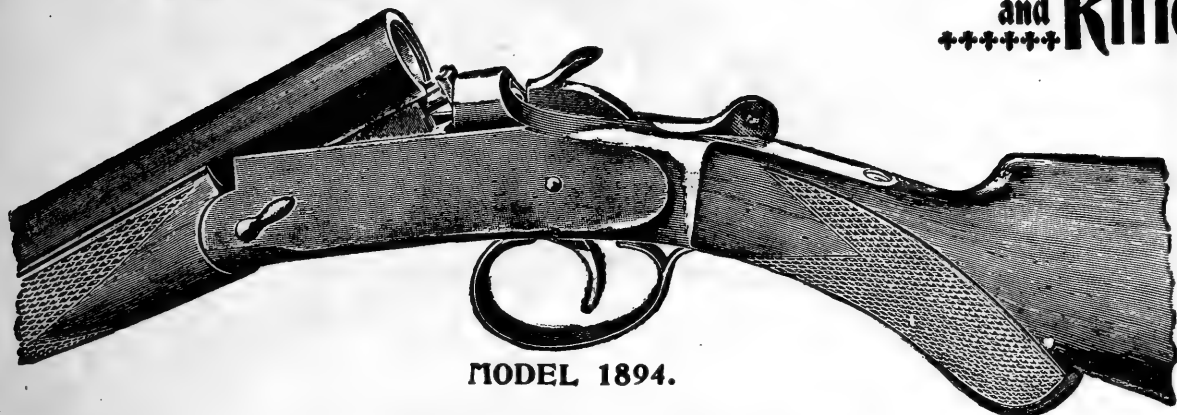

MODEL 1894.

AUTOMATIC EJECTOR

Our present line is complete and varied and shows the result of years of experience.

For catalogues and information address

THE W. H. DAVENPORT FIRE ARMS CO.

NORWICH, CONN., U. S. A.

Mention "RECREATION"

*Ejector Guns
no longer a
luxury*

Good News for Sportsmen

Lefever Automatic Ejector Guns at a price within the reach of every sportsman.

OUR NEW EJECTOR MOVEMENT

Has only two pieces: One in the Hammer, One in the Frame.

We have decided to meet the demand for *medium* price Ejectors, and are now prepared to accept orders for all grades of our hammerless guns fitted with Ejectors.



TENS OF THOUSANDS IN USE

Send for Catalogue

LEFEVER ARMS CO. - - Syracuse, N. Y.

(Mention RECREATION.)

Date,.....1897.

G. O. SHIELDS,

Editor and Manager of RECREATION, 19 West 24th St., New York:
Herewith find One Dollar, for which please send me RECREATION
for one year beginning with.....number.

Name,.....

Remit by P. O. or Express Money Order, or New York Draft.

DETACH THIS, FILL OUT, AND SEND IN.

A FINE PERFORMANCE GRAND AMERICAN HANDICAP, 1897



1st—Hon. T. A. MARSHALL,
Keithsburg, Ill., 25 kills straight.

2d—Dr. W. F. CARVER, Chicago,
24 straight, and 25th killed but
carried out of bounds by wind.

2d—Dr. J. L. WILLIAMSON, 24
ex. 25.

All
Using
Cashmore
Guns

FIRST AND TWO SECONDS OUT OF 136 COMPETITORS

TRAP GUN BUILDING A SPECIALTY

NEW LIST FREE Address, WM. CASHMORE, Gunmaker
Telegram, "Extractor, Birmingham" BIRMINGHAM, ENG.

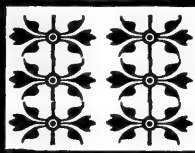

FOR FIELD OR FOR TRAP,
FOR POT HUNTING OR FUN,
NO SPORTSMAN IS EQUIPPED
WITHOUT A SYRACUSE GUN

"MORE TRUTH
THAN POETRY"

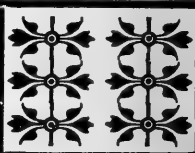

We do not say that SYRACUSE HAMMERLESS GUNS

"Are as Good" as any gun in the market.



Their simplicity of construction and superiority of finish stamp them "BETTER" for practical all-round work than any gun in the market. The "old, old story" but, nevertheless, substantiated by every man who ever drew a Syracuse to his shoulder.



SYRACUSE ARMS CO., SYRACUSE, N. Y., U. S. A.



Forehand Arms Co.'s

EJECTOR AND NON-EJECTOR
HAMMERLESS DOUBLE GUN

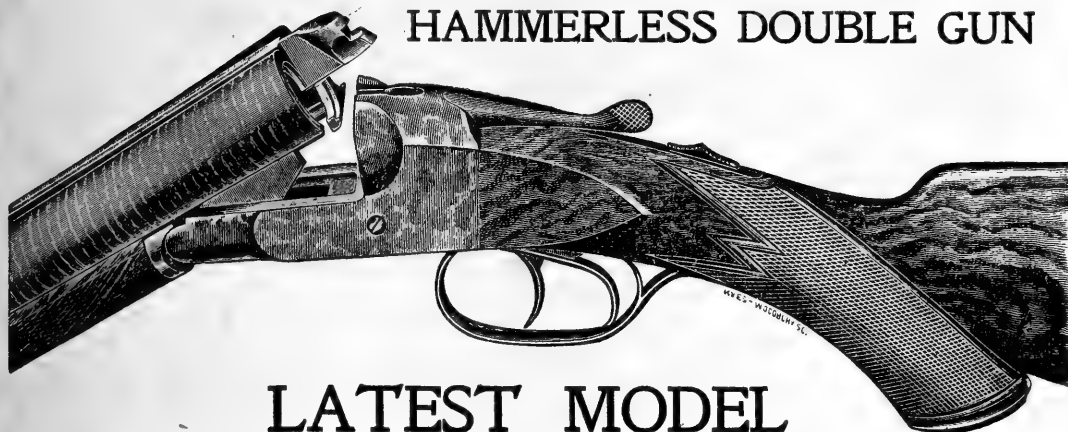

LATEST MODEL

WARREN, ILL.

The Forehand Hammerless Gun you sent me, for 35 subscriptions, has arrived. I am delighted with it, and shall recommend it highly. It is a good, close-shooting gun, simple in action, and of fine workmanship. I made two long shots with it yesterday at grouse in heavy brush, killing both birds at distances of forty to forty-five yards. I would not wish for a better gun than the Forehand for trap shooting.

DR. A. C. CZIBULKA.

READ WHAT MEN
SAY OF THE
FOREHAND, WHO
ARE USING IT.

MOLINE, ILL.

I have received from the Forehand Arms Co., of Worcester, Mass., the double-barreled, hammerless, breech-loading shot-gun as a premium for 35 subscriptions, and it is a beauty. It is light, strong, handsome, and shoots as well as any gun I know of. Got four squirrels and a rabbit yesterday—all the game I saw—and one shot at each was enough. I compared my gun with an \$85.00 gun today, of another make, and mine gained in value greatly, in my estimation.

W. B. KENT.

WE GET THOUSANDS
OF SUCH
TESTIMONIALS—
ALL UNSOLICITED

"WHAT EVERYONE SAYS MUST BE SO"

We challenge competition in Beauty, Workmanship, Simplicity of Mechanism, Shooting Qualities and Price. We target all our guns with nitro powder. For Catalogue, address

FOREHAND ARMS CO., WORCESTER, MASS.

"COMMON SENSE OF **DOG** DOCTORING"
 A CONCISE AND UP-TO-DATE POPULAR TREATISE
 PRICE (MAIL FREE), 25 CENTS

DOG AND POULTRY
 SUPPLIES

Order through your Dealer and send for catalogue to
SPRATTS PATENT LIMITED
 245 EAST 56TH STREET, NEW YORK CITY
 SAN FRANCISCO BRANCH
 1320 VALENCIA STREET

THE OLD
 RELIABLE

Parker Gun

HAS
 NO EQUAL

*Has stood the test
 of over 30 years*

"Built on Honor"

*Simplicity and dura-
 bility combined with
 handsome finish and
 perfect shooting
 qualities*



*Experience and ability have placed "The Parker" in an
 enviable and well deserved position as the best gun in the
 world. Made by the oldest shot gun manufacturers in America.
 Nearly 100,000 in use.*

SEND FOR CATALOGUE

New York Salesrooms
 96 Chambers Street

PARKER BROS., Meriden, Conn.

Genuine Siberian Moose Hunting, Golf or Walking Shoes

ABSOLUTELY WATER-PROOF TO THE TOP.

NOTHING SO GOOD EVER PRODUCED BEFORE AT ANY PRICE.

This is a **special** line of Boots and Shoes in every way. Special water-proof leather, special anhydrous soles, special lasts of new design, special stitching, special lining, in fact, every point of shoe worth has been studied to give each special value.

The result is a shoe as strong as steel, yet, pliable and soft as kid, graceful to the eye and easy on the foot, and will outwear any two ordinary shoes.

The leather is the famous Siberian Moose. Costs more than any other, and guaranteed water-proof.

The soles are of the best anhydrous oak stock, made water-proof by patented process.

The stitching will not rip. The bottoms are hand-sewed with Barbour's extra heavy water-proof flax. The uppers are stitched and then double-stitched with pure silk.

Bellows tongues of the best Moose stock are used, making the shoes water-proof to the top.

The linings are of finest russet calf-skin, adding warmth and strength.

English Backstays, extra heavy eye-lets, "Bull Dog" toes, Pratt Fasteners, etc., etc. Every approved shoe point will be found in them. **Price to all alike, \$7.50 net.**

We also make a short boot, 12 inches high, at \$8.50; a knee boot, "Hunters Style," lacing up the front, at \$10.00, and a "Cavalry Style" boot, at \$12.00, all with the same good points as the shoes.

We expect a large out-of-town trade, and to quickly introduce this line we will, on the first 100 pairs, prepay expressage to any part of the United States or Canada, as the orders are received.

**HENRY C.
SQUIRES & SON**

20 Cortlandt
Street

New York

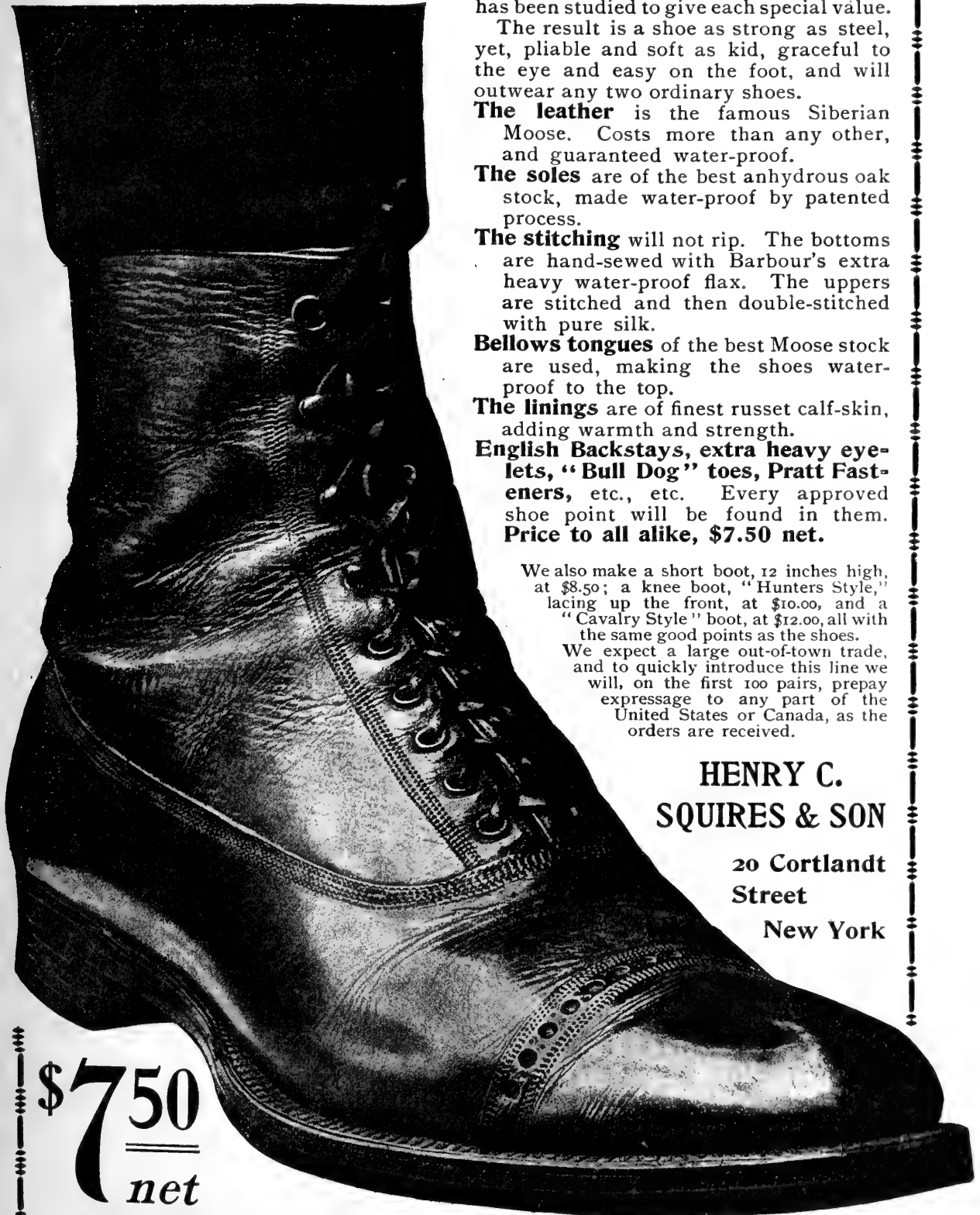

\$7.50
net

The cut is a photograph of our tan walking shoe after having been worn two months.

SPEND THE SUMMER AT

DEER PARK

*On the Crest of the Alleghanies
3000 Feet Above Tide-Water*

Season Opens June 21, 1897

THIS famous mountain hotel, situated at the summit of the Alleghanies, and directly upon the main line of the Baltimore & Ohio Railroad, has the advantage of its splendid vestibuled express train service both east and west, and is therefore readily accessible from all parts of the country. All Baltimore & Ohio trains stop at Deer Park during the season. There are also a number of furnished cottages with facilities for housekeeping.

The houses and grounds are supplied with absolutely pure water, piped from the celebrated "Boiling Spring," and are lighted by electricity. Turkish and Russian baths and large swimming pools are provided for ladies and gentlemen, and suitable grounds for lawn tennis; there are bowling alleys and billiard rooms; fine riding and driving horses, carriages, mountain wagons, tally-ho coaches, etc., are kept for hire; in short, all the necessary adjuncts for the comfort, health or pleasure of patrons.

For terms apply to D. C. JONES

B. & O. Central Building, Baltimore, Md.

A TOUR OF EUROPE FREE TO YOU

OUR PROPOSITION: We wish to introduce our HOME VISITOR into 20,000 new homes and will spend liberally in doing so.

To the three persons sending us the greatest number of words from the letters in the title "**HOME VISITOR**" we will give each a prepaid ticket on the "**Home Visitor European Tour**," embracing an eight weeks tour through England, France, Italy, Switzerland, Germany, etc., sailing July 5, 1897, including all fares, hotels, and traveling expenses in first class style, allowing same privileges as rest of our party who pay \$300 for ticket. (Full particulars, route, itinerary, etc., in this month's HOME VISITOR.) To next largest list we will give \$100, next largest list \$50, next \$25, next five lists \$10 each, next seven \$7.50 each, next ten \$5 each, and to next **One Hundred Largest Lists** we will give a complete Silver Tea Set, consisting of 23 pieces, beautifully engraved, and guaranteed to wear for five years. (In miniature as shown below.)



RULES: Use any dictionary. Make up words in this plan: Toe, hoe, met, rim, more, etc., always confining your selection to the letters that appear in the words "**Home Visitor**." You will find it a very pleasant study to produce the words and will soon succeed in getting quite a list. When you have obtained all the words that you are able, send your list to us **at once** and you may secure one of the

grand tour of Europe premiums or one of the many cash rewards. You must mail your list before midnight, June 15, and you will then be an admitted contestant. If you have tried in other contests without success **you may be successful this time.**

CONSOLATION PREMIUM: Every contestant who sends in ten or more words will receive free our **Ladies' Work Basket Companion Set**, containing darning, wool, yarn and carpet instruments, and five dozen steel needles that cannot be purchased for less than 50 cents and which makes a **DESIRABLE PRESENT TO ANY WOMAN.** We give these rewards for the purpose of attracting attention to our interesting magazine containing instructive departments to old and young, serial, short stories and articles by our leading authors. It will be necessary for each contestant to send 25 cents in stamps, money order or silver for six months subscription, as no lists will be recorded unless amount is enclosed in same letter. Names of successful contestants will be given in June number of "**HOME VISITOR**," and premiums will be fairly awarded by a committee of well-known and disinterested citizens of Philadelphia. We refer to Dunn's or Bradstreets Mercantile Agencies, Adam's or U. S. Express Co's. or any Bank in Phila. as to our reliability. Send your list at once and if you send ten words or more your companion set and this month's "**HOME VISITOR**" will be sent you immediately to show your letter was received and your solution recorded. Remember every contestant who sends ten or more words receives the Work Basket Set, a chance on the large premiums and our interesting Magazine free for six months, and the 25 cents you send barely pays for cost and transportation of premiums and expenses of contest. We believe in liberal and judicious advertising and money spent in this contest will pay us in later results. Address letter (mention this paper), to "**HOME VISITOR**" Publishing Co., 1813 No. 16th Street, Philadelphia, Pa.

"LITTLE FINGER DOES IT"

Fisherman's Automatic Reel

THE AUTOMATIC REEL

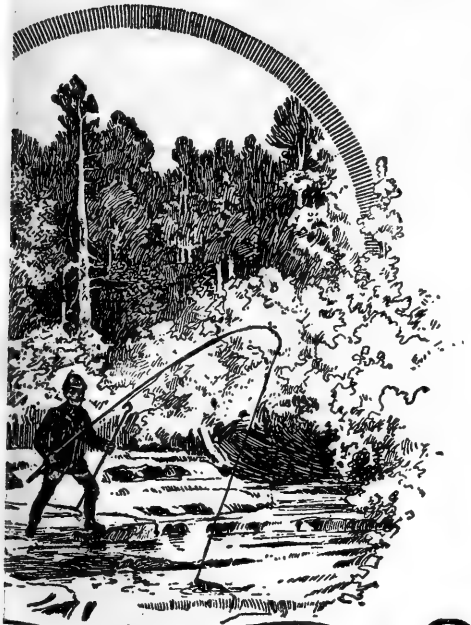
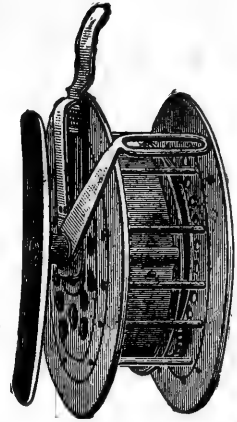

Manufactured by
MAN & ERBE
344 No. ST. PAUL Street
CHESTER, N. Y. U. S. A.



What we claim for the Automatic Reel

First—It will wind up the line a hundred times as fast as any other reel in the world.

Second—It will wind up the line slowly if the angler chooses.

Third—No fish can ever get slack line with it.

Fourth—It will save more fish than any other reel.

Fifth—It will prevent tips, lines, and snells from being broken by large fish.

Sixth—The reel is manipulated entirely by the hand that holds the rod.

Seventh—It enables the angler and makes it desirable to use lighter tips.

SEND FOR CATALOGUE

High-Grade

Bicycles

AMES
MANUFACTURING
COMPANY

CHICOPEE, MASS.

We have ready for shipment our 1897 crop of High-Grade Bicycles, both in Gent's and Ladies' patterns, at the price of a low or medium grade. We have several styles as follows:

MODEL "B" SPECIAL, Gent's Diamond Frame, large seamless tubing, with changeable sprockets, single piece cranks and axle, at \$85.00

MODEL "B" Gent's Diamond Frame, large seamless tubing, changeable sprockets, at \$75.00

MODEL "M" Ladies', with Single Reach Frame, seamless tubing, changeable sprockets, at \$75.00

MODEL "I" Ladies' Curved Double Reach Frame, changeable sprockets, . . . at \$75.00

All of the tubing in the above wheels is seamless cold drawn, the frames are enameled with three coats of first-class enamel baked on, all connections are drop steel forgings, the nickeling is done after a coat of copper is put on and the finish is as nice and fine as any wheel ever made.

We also have model "K" gent's diamond frame, large seamless tubing, with changeable sprockets, and model "L" ladies', one curved and one straight reach, seamless tubing, changeable sprockets.

The connections on the two latter machines are a fine grade of electrically welded stampings. The two latter wheels are listed at \$60.00 each.

The ball cases and cones in all of the above wheels are cut from bar, the hubs are of drop forged steel, and take them all in all they are as fine a line of wheels as are on the market.

We solicit a trial order and should be pleased to mail you on application our 1897 artistic catalog

The above firm is the old original Ames Manufacturing Company, which has been in business on the same ground since 1828



What's the Use

of walking when you
can get a first-class, high-
grade bicycle for nothing?

How?

By getting 75 subscriptions for
Recreation

If you live in a town of 3,000
or more, and if you are a hustler
you can get these in 2 days.

I can give you the names of 20
people who did this in 1896, and
who now have their wheels.

Write for particulars.

RECREATION

19 West 24th Street
New York



Sargent's

R E A D Y R E F E R E N C E R O T A R Y

Book Cases



SARGENT

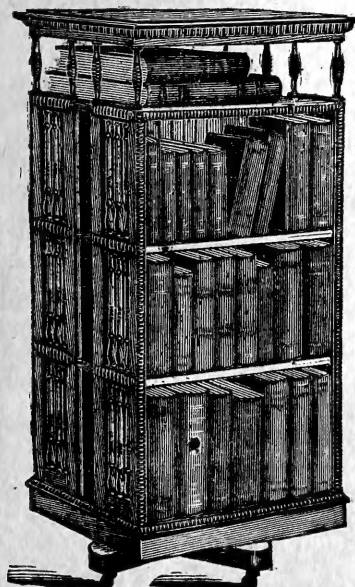

A brain worker's best
tool.

A Labor Economizer.

A Time Saver.

All kinds for all needs.

New and perfect anti-
friction Rotary prin-
ciple.

Write for **Catalogue
D, free**; postage 2c.

Our new **Catalogue C**,
48 pages of **Reclin-
ing, Easy Library
and Study Chairs
and Couches**, is just
out, and is the most
complete ever issued.

We can suit anybody.

If interested, write for
it, postage 3c.

Mention Recreation.

Geo. F. Sargent Co.

289 Fourth Ave.,

(Next 23d St. Moved
May 1 from 814 B'way)

NEW YORK.

BOOKS BY G. O. SHIELDS (COQUINA)

THE BIG GAME OF NORTH AMERICA

Its Habits, Habitat, Haunts and Characteristics.
How, When and Where to Hunt it. 8vo, 600
pages, 80 illustrations. Cloth, \$3.50; Half Mor-
occo, \$5.00; Full Morocco, \$6.50.

CRUISING IN THE CASCADES

A Narrative of Travel, Exploration, Amateur
Photography, Hunting and Fishing, with Special
Chapters on Hunting the Grizzly Bear, the Buf-
falo, Elk, Antelope, Rocky Mountain Goat, and
Deer; also on Troutling in the Rocky Mountains;
on a Montana Roundup; Life Among the Cow-
boys, etc. 12mo, 300 pages, 75 illustrations. Cloth,
\$2; Half Morocco, \$3.

AMERICAN GAME FISHES

How, When and Where to Angle for them. 8vo,
400 pages, 50 illustrations. Cloth, \$2.50; Half Mor-
occo, \$4.

HUNTING IN THE GREAT WEST

(**Rustlings in the Rockies**)
Hunting and Fishing Sketches by Mountain and
Stream. 12mo, cloth. Over 300 pages. Illustrated.
Price, 75 cents.

THE AMERICAN BOOK OF THE DOG

The Origin, Development, Special Characteristics,
Utility, Breeding, Training, Diseases and Kennel
Management of all Breeds of Dogs. 8vo, 650 pages,
100 illustrations. Cloth, \$3.50; Half Morocco, \$5;
Full Morocco, \$6.50.

CAMPING AND CAMP OUTFITS

A Manual of Instruction for Young and Old Sports-
men. 12mo, 200 pages, 30 illustrations. Cloth, \$1.25.

THE BATTLE OF THE BIG HOLE

History of General Gibbon's Engagement with
the Nez Perce Indians in the Big Hole Basin, Mon-
tana, August 9, 1877. 12mo, 150 pages. Profusely
illustrated. Cloth, \$1.

*These books will be mailed, post-paid, on receipt
of price, by the author.*

G. O. SHIELDS

19 West 24th St., New York

Some Rare Oppor- tunities

These goods are all new, and will be shipped direct from factory. Prices named are those at which manufacturers and dealers usually sell. Here is a good chance to get

- A BOOK
- A GUN
- A CAMERA
- A TYPEWRITER
- A BICYCLE

FREE OF COST

Subscriptions need not all be sent at once. They can be sent in installments as taken and credit will be given on account. When the required number is obtained the premium earned will be shipped.

"Recreation"

19 West 24th Street
New York



- To any person sending me**
- TWO yearly subscriptions to RECREATION at \$1 each, I will send a copy of *Hunting in the Great West*, paper.
 - THREE subscriptions at \$1 each, a copy of *The Battle of the Big Hole*, cloth.
 - FOUR subscriptions at \$1 each, a copy of *Camping and Camping Outfits*, cloth.
 - FIVE subscriptions at \$1 each, a copy of *Cruising in the Cascades*, cloth.
 - SIX subscriptions at \$1 each, a copy of *American Game Fishes*, cloth.
 - SEVEN subscriptions at \$1 each, a copy of *The Big Game of North America*, or of *The American Book of the Dog*, cloth.
 - EIGHT subscriptions at \$1 each, a Pocket Kodak, made by the Eastman Kodak Co., and valued at \$5.
 - TEN subscriptions at \$1 each; a single-shot Davenport Rifle; or a Bristol Steel Fishing-rod, or a Yawman and Erbe Automatic Reel, worth \$9; or a Kenwood Sleeping Bag, worth \$10.
 - TWELVE subscriptions at \$1 each, a Manhattan Improved Hand Camera, made by the Manhattan Optical Co., and valued at \$12.
 - FIFTEEN subscriptions at \$1 each, a Davenport Single-barrel, breech-loading Shotgun, worth \$15; or a Premo D Camera, worth \$6 to \$10; or a Kenwood Sleeping Bag, complete with canvas cover, worth \$16; or a No. 2 Bullet Camera, loaded, worth \$10.
 - TWENTY subscriptions at \$1 each, a 14-karat Gold Hunting-case Watch, with Elgin Movement, worth \$20; or a Marlin Repeating Rifle, listed at \$20; or an Improved Night-hawk Hand Camera, made by the Manhattan Optical Co., and valued at \$25; or a No. 4 Bullseye Camera, made by the Eastman Kodak Co., and worth \$12; or a Premo B Camera, worth \$16.
 - TWENTY-FIVE subscriptions at \$1 each, a Premo A Camera, worth \$25, or a No. 4 Bullet Camera, made by the Eastman Kodak Co., and worth \$18.
 - THIRTY-FIVE subscriptions at \$1 each, a Forehand or a Syracuse Double-barrel Hammerless Breech-loading Shotgun, worth \$35.
 - FORTY subscriptions at \$1 each, a Premo Sr. Camera, worth \$30.
 - FIFTY subscriptions at \$1 each, a Marlin Rifle, with fancy curled walnut stock, pistol grip, checkered four-end, handsomely engraved, half octagon, half magazine, with take down, listed at \$50.
 - SEVENTY-FIVE subscriptions at \$1 each, a Safety Bicycle, worth \$85 to \$100; or a Bo-peep Camera, for 5x7 plates, made by the Manhattan Optical Co., and valued at \$90.
 - EIGHTY subscriptions at \$1 each, a Premo Sr. Camera, worth \$65.
 - ONE HUNDRED subscriptions at \$1 each, a fine Lefever Hammerless Gun, worth \$85; or a Bo-peep Camera, for 6½x8½ plates, made by the Manhattan Optical Co., and valued at \$120.

"THE SURVIVAL OF THE FITTEST"

At the Grand American Handicap, held at Elkwood Park, Long Branch, N. J., March 24 and 25, 1897, U. M. C. Paper Shells took the highest honors. The *Hon. Thomas A. Marshall, of Kethsburg, Ills.*, was the only contestant out of 34 shooters facing the traps who made a clean score of 25 birds. *He used*



TRAP SHELLS

Of the remaining 33 other prize-winners, 27 used *U. M. C. Shells*. The result of this contest speaks volumes for the *quality of U. M. C. goods*.

A sample of the kind of shell used by the winner of the first prize will be sent upon application.

THE UNION METALLIC CARTRIDGE CO.
BRIDGEPORT, CONN.

Shooters Know REMINGTONS Can Be Depended Upon

THE SKILL AND SCIENTIFIC KNOWLEDGE THAT MADE REMINGTON FIREARMS FAMOUS HAS WON FOR THEM PUBLIC CONFIDENCE

Remington value
is obtained in
Remington products only.

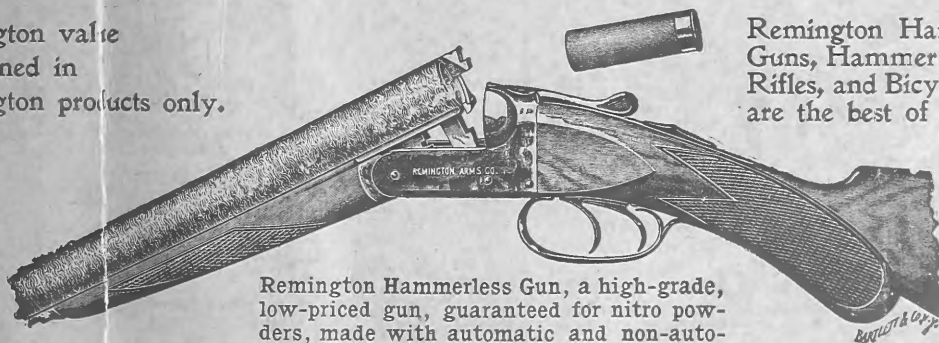

Remington Hammerless
Guns, Hammer Guns,
Rifles, and Bicycles
are the best of their kinds.

Remington Hammerless Gun, a high-grade,
low-priced gun, guaranteed for nitro pow-
ders, made with automatic and non-auto-
matic ejector, five grades.

SEND FOR ILLUSTRATED CATALOGUES

of Firearms and Bicycles. Remington Hammerless Automatic Ejector Guns are reduced in price,
\$15.00 less than the former list price.

REMINGTON ARMS COMPANY

313-315 Broadway, New York ILION, N. Y. 425-427 Market St., San Francisco, Cal.



3 2044 114 275 175



The Splendid Scores

Constantly Being Made With

WINCHESTER GALLERY AMMUNITION

Are Proof of Its Superiority.

Results Count. Winchester Ammunition Always Gives the Best Results.

AMMUNITION FOR ALL KINDS OF SHOOTING

MANUFACTURED BY THE

Winchester Repeating Arms Co., New Haven, Conn.

FREE—136-Page
Illustrated Catalogue.

STORES: 312 Broadway, New York
418-420 Market St., San Francisco, Cal.



NO DEPARTMENT STORE

can sell a bicycle at from "\$29.99" to \$37.77 if it is finished and equipped as Clippers are in Clipper enamel and Clipper decorations. Clipper finish is the result of two years' experimenting and several thousand dollars expense. Every coat of Clipper enamel is hand and water rubbed by furniture finishers, who have spent a lifetime finishing the finest furniture in the world. Every transfer used in decorating Clipper is imported from Germany. Every line of hand decoration is drawn by an expert of 20 years' experience. Every Clipper bicycle turned out is finished at an expense 3 times greater than any wheel we know of. Clipper equipment is the most expensive, and of the very highest grade, such as first quality Garford, Hunt or Brown saddles, Baldwin chains, G. & J. tires, Berkey furniture finished, cloth-lined wood rims, Hunt's highest grade tool bags, Clipper pedals, steel bars fitted with grips that don't break easily. Equipment like this is too expensive for Department Store cheap wheels.

The above equipment costs us just \$8.91 more than the best used on any Department store bicycle we ever saw, and \$12.63 more than the worst we have ever seen. Remember this difference in cost is only a small part of the bicycle. Everything else is in about the same proportion. Again we say, there is no bicycle the equal of a Clipper at the price of a Clipper.

MADE BY THE

"CLIPPER PEOPLE," Grand Rapids, Mich.

Have blue crowns

FENTON BICYCLES

are ridden by those who appreciate the refinements of a superior machine.

Send for Catalogue
Fenton Metallic
Mfg. Co.
Jamestown N. Y.

ELEGANCE
SIMPLICITY
DURABILITY