

**Report of the Proceedings**

of the

**Third Entomological Meeting**

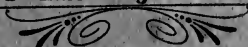

*Held at Pusa, 3rd to 15th February 1919*



LIBRARY OF

Dr. Z. P. Metcalf

1885-1956

J. Maulak  
London. 1970

---



# REPORT

OF THE

## *Proceedings of the Third Entomological Meeting*

Held at Pusa on the 3rd to 15th February 1919

In Three Volumes

Edited by

T. BAINBRIGGE FLETCHER, R.N., F.L.S., F.E.S., F.Z.S.,

*Imperial Entomologist*

---

VOLUME III



CALCUTTA  
SUPERINTENDENT GOVERNMENT PRINTING, INDIA  
1920

Price per complete set of 3 Vols. Rs. 17 As. 8.

**[ Agents for the Sale of Books Published by the  
Superintendent of Government Printing, India, Calcutta.**

**IN EUROPE.**

Constable & Co., 10, Orange Street, Leicester Square, London, W.C.  
Kegan Paul, Trench, Trubner & Co., 68-74, Carter Lane, E.C., and 25, Museum Street, London, W.C.  
Bernard Quaritch, 11, Grafton Street, New Bond Street, London, W.  
P. S. King & Sons, 2 & 4, Great Smith Street, Westminster, London, S.W.  
H. S. King & Co., 65, Cornhill, E.C., and 9, Pall Mall, London, W.  
Grindlay & Co., 54, Parliament Street, London, S.W.

Luzac & Co., 46, Great Russell Street, London, W.C.  
W. Thacker & Co., 2, Creed Lane, London, E.C.  
T. Fisher Unwin, Ltd., 1, Adelphi Terrace, London, W.C.  
Wm. Wesley & Son, 28, Essex Street, Strand, London.  
B. H. Blackwell, 50 & 51, Broad Street, Oxford.  
Deighton Bell & Co., Ltd., Cambridge.  
Oliver and Boyd, Tweeddale Court, Edinburgh.  
E. Ponsonby, Ltd., 116, Grafton Street, Dublin.  
Ernest Leroux, 28, Rue Bonaparte, Paris.  
Martius Nijhoff, The Hague, Holland.

**IN INDIA AND CEYLON.**

Thacker, Spink & Co., Calcutta and Simla.  
Newman & Co., Calcutta.  
B. Cambay & Co., Calcutta.  
S. K. Lahiri & Co., Calcutta.  
B. Banerjee & Co., Calcutta.  
The Indian School Supply Depot, 309, Bow Bazar Street, Calcutta, and 226, Nawabpur, Dacca.  
Butterworth & Co. (India), Ltd., Calcutta.  
Rai M. C. Sarcar Bahadur & Sons, 90-2A, Harrison Road, Calcutta.  
The Weldon Library, 57, Park Street, West, Calcutta.  
Standard Literature Company, Limited, Calcutta.  
Lal Chand & Sons, Calcutta.  
Higginbothams, Ltd., Madras.  
V. Kalyanarama Iyer & Co., Madras.  
G. A. Natesan & Co., Madras.  
S. Murtby & Co., Madras.  
Thompson & Co., Madras.  
Temple & Co., Madras.  
P. R. Rama Iyer & Co., Madras.  
Vas & Co., Madras.  
E. M. Gopalakrishna Kone, Madras.  
Thacker & Co., Ltd., Bombay.  
A. J. Combridge & Co., Bombay.  
D. B. Taraporevala, Sons & Co., Bombay.  
Mrs. Radhabai Atmaram Sagoon, Bombay.  
Sunder Pandurang, Bombay.  
Gopal Narayan & Co., Bombay.

Ram Chandra Govind & Son, Kalbadevi, Bombay.  
The Standard Book Stall, Karachi.  
Mangaldas Harkishendas, Surat.  
Karsandas Narandas & Sons, Surat.  
A. H. Wheeler & Co., Allahabad, Calcutta and Bombay.  
N. B. Mathur, Supdt., Nazir Kanun-i-Hind Press; Allahabad.  
Rai Sahib M. Gulab Singh & Sons, Mufid-i-Am Press, Lahore and Allahabad.  
Rama Krishna & Sons, Lahore.  
Supdt., American Baptist Mission Press, Rangoon.  
Manager, the "Hitavada" Nagpur.  
S. C. Talukdar, Proprietor, Students and Company, Cooch Behar.  
A. M. & J. Ferguson, Ceylon.  
Manager, Educational Book Depôts, Nagpur and Jabalpur.\*  
Manager of the Imperial Book Depot, 63, Chandney Chauk Street, Delhi.  
Manager, "The Agra Medical Hall and Co-operative Association, Ltd." (Successors to A. John & Co., Agra).  
Supdt., Basel Mission Book and Tract Depository, Mangalore.\*  
P. Varadachary & Co., Madras.\*  
H. Liddell, Printer, etc., 7, South Road, Allahabad.\*  
Ram Dayal Agarwala, 184, Katra, Allahabad.\*  
D. C. Anand & Sons, Peshawar.\*  
Manager, Newal Kishore Press, Lucknow.\*

\* Agents for the sale of Legislative Department publications only.

# CONTENTS.

## Papers read at the Meeting.

PAGE

47. The life history of <i>Caligula cachara</i> , by J. Henry Watson . . . . .	836
48. Life-histories of Indian Microlepidoptera ( <i>Abstract</i> ), by T. Bainbrigg Fletcher . . . . .	838
49. Exhibition of drawings, by Major F. C. Fraser, I.M.S., of early stages of Indian Butterflies . . . . .	857
50. The life-history of <i>Orthezia insignis</i> , by K. Kunhi Kannan . . . . .	857
51. The function of the chitinous plate in <i>Bruchus chinensis</i> ( <i>Abstract</i> ), by K. Kunhi Kannan . . . . .	857
— 52. Some Insect Prey of Birds in the Central Provinces, by E. A. D'Abreu . . . . .	859
53. Life-history of <i>Comocritis pieria</i> , by R. Senior-White . . . . .	872
54. Notes on rearing insects in hot countries, by T. Bainbrigg Fletcher and C. C. Ghosh . . . . .	875
55. Breeding Cages and general insectary technique for wood-borers, by C. Beeson . . . . .	892
56. Notes on night-flying dragon-flies, by Major F. C. Fraser . . . . .	895
57. Note on larva of <i>Catochrysops strabo</i> , by Major F. C. Fraser . . . . .	897
58. Spiders as checks on lepidopterous larvæ, by Major F. C. Fraser . . . . .	898
59. The comparative invisibility of <i>Papilio demoleus</i> during flight, by Dr. E. H. Hankin . . . . .	900
60. The forms of <i>Papilio polytes</i> , by Professor E. B. Poulton . . . . .	903
61. The importance of insects to fisheries in India, by Dr. Baini Prashad . . . . .	906
62. Note on a musciphagous wasp, by T. V. Ramakrishna Ayyar . . . . .	909
63. Notes on the life-history of <i>Cantao ocellatus</i> , by T. V. Ramakrishna Ayyar . . . . .	910
64. Notes on the life-history of <i>Polyptychus dentatus</i> , by T. V. Ramakrishna Ayyar . . . . .	914
65. Some observations on the life-history of an <i>Erotylid</i> breeding in Italian millet, by P. V. Isaac . . . . .	919
66. The life-history of the <i>Moringa</i> stem-borer, by T. V. Subramaniam . . . . .	922
67. Notes on the life-history of the <i>Pollu</i> flea-beetle ( <i>Longitarsus nigripennis</i> ) of pepper, by T. V. Ramakrishna Ayyar . . . . .	925
68. On some of the bionomics of Bruchide, by R. S. Kasargode . . . . .	928
— 69. On the insect parasites of some Indian crop-pests, by T. V. Ramakrishna Ayyar . . . . .	931
70. Hints on collecting and preserving insects, by T. Bainbrigg Fletcher . . . . .	936
71. A method of preserving butterflies and other insects, by Dr. E. H. Hankin . . . . .	974
72. The importance of collecting, by Dr. D. Sharp . . . . .	976
73. Note on a very curious Geometrid larva, by T. Bainbrigg Fletcher . . . . .	978
74. Indian Epipyropide, by T. Bainbrigg Fletcher . . . . .	978
— 75. Indian Fossil Insects, by T. Bainbrigg Fletcher . . . . .	982
76. The desirability and practicability of the preparation and publication of a general catalogue of all described Indian Insects, by T. Bainbrigg Fletcher . . . . .	989
77. A sketch of our present knowledge of Indian Microlepidoptera, by E. Meyrick . . . . .	999
78. The Trichonymphid parasites of some Indian Termites, by Captain Froilano de Mello . . . . .	1009
79. Genitalia of some Ceylonese Hesperiadæ, by W. Ormiston . . . . .	1022
80. On the Bollworm parasite described as <i>Rhognus lefroyi</i> by Dudgeon and Gough, by Professor C. T. Brues . . . . .	1026
81. Some recently noted South Indian Melolonthidæ of economic importance, by P. V. Isaac . . . . .	1028

*Papers read and the Meeting—contd.*

82. Notes on two Psyllid galls exhibited, with remarks on Indian Psyllidæ, by T. V. Ramakrishna Ayyar . . . . .	1030
83. Note on some swarming Fulgorid Bugs, by T. V. Ramakrishna Ayyar . . . . .	1032
84. Eumastacinæ from South India, by T. V. Ramakrishna Ayyar . . . . .	1033
85. Suggestions regarding publication of communications on Indian Insects, by C. C. Ghosh . . . . .	1034
86. The preparation and reproduction of scientific illustrations, by A. W. Slater . . . . .	1043
87. Lantern Slides ( <i>Exhibition and Discussion</i> ) . . . . .	1048
88. Note on the decimal method of subject-indexing entomological literature, by C. Beeson . . . . .	1048
89. Note on Plant Imports into India, by T. Bainbrigge Fletcher . . . . .	1052
90. Entomological Education in Agricultural Colleges ( <i>General Discussion</i> ) . . . . .	1070
91. Some aspects of Economic Entomology in India, by C. C. Ghosh . . . . .	1073
92. The Organization of Entomological Work in India ( <i>General Discussion</i> ) . . . . .	1081
Closing Speeches . . . . .	1094
List of Resolutions passed by the Meeting . . . . .	1097
INDEX . . . . .	1101



## LIST OF PLATES

	PAGE.
PLATE 130. Larva of <i>Caligula cachara</i> . . . . .	836
" 131. } . . . . .	877
" 132. } . . . . .	878
" 133. } Breeding cages of different types . . . . .	879
" 134. } . . . . .	880
" 135. } . . . . .	881
" 136. Feeding Borer larvæ ; Tile-cage for termites . . . . .	883
" 137. Pusa Insectary . . . . .	889
" 138. " " " " " " " " " . . . . .	890
" 139. Cages for wood-boring beetles . . . . .	892
" 140. " " " " " " " " " . . . . .	893
" 141. <i>Bembez lunata</i> . . . . .	909
" 142. <i>Cantao ocellatus</i> (Coloured) . . . . .	910
" 143. <i>Polyptychus dentatus</i> . . . . .	915
" 144. <i>Anadastus</i> sp. (Coloured) . . . . .	919
" 145. <i>Moringa</i> stem-borer . . . . .	922
" 146. Collecting outfit, e.g., nets, traps, etc. . . . .	943
" 147. " " " " " " " " " . . . . .	946
" 148. " " " " " " " " " . . . . .	947
" 149. " " " " " " " " " . . . . .	949
" 150. Store-box . . . . .	950
" 151. Setting and mounting insects . . . . .	951
" 152. Forceps, knives, glass-bottomed box . . . . .	952
" 153. Killing insects . . . . .	953
" 154. Pinning and setting of insects . . . . .	955
" 155. " " " " " " " " " . . . . .	957
" 156. " " " " " " " " " . . . . .	959
" 157. Storage of papered insects . . . . .	960
" 158. " " " " " " " " " . . . . .	962
" 159. " " " " " " " " " . . . . .	963
" 160. Insect-cabinet . . . . .	968
" 161. " " " " " " " " " . . . . .	969
" 162. A Geometrid larva on <i>Heptapleurum</i> . . . . .	978
" 163. <i>Epipyrops evybrachydis</i> . . . . .	981
" 164. Indian Fossil Insects . . . . .	988
" 165. " " " " " " " " " . . . . .	988
" 166. " " " " " " " " " . . . . .	988
" 167. <i>Acrocercops resplendens</i> . . . . .	1006
" 168. Trichonymphid Parasites of Termites . . . . .	1021
" 169. " " " " " " " " " . . . . .	1021
" 170. " " " " " " " " " . . . . .	1021
" 171. Genitalia of Ceylonese Hesperiadæ . . . . .	1023
" 172. " " " " " " " " " . . . . .	1024
" 173. Two Psyllids and their galls . . . . .	1030
" 174. Fulgorids . . . . .	1031

	PAGE.
PLATE 175. <i>Phyllochoreia ramakrishnai</i> , Bol . . . . .	1033
" 176. Preparation and Reproduction of Illustrations . . . . .	1043
" 177. " " " " . . . . .	1044
" 178. " " " " (Coloured) . . . . .	1045
" 179. " " " " . . . . .	1046
" 180. Fumigation box, sketch and external measurements . . . . .	1063
" 181. " " (closed up for fumigation) . . . . .	1064
" 182. " " (open) . . . . .	1065

Proceedings of the Third Entomological Meeting

VOLUME III

## 47.—THE LIFE-HISTORY OF CALIGULA CACHARA.

By J. HENRY WATSON, F.E.S.

(Plate 130.)

The following notes on the partial Life-History of *Caligula cachara* are not complete as no larvae survived longer than the middle of the fourth age. It was most disappointing as they appeared to be thriving to the end of the third age, but no doubt it was due to the food they were fed upon, the common English Hawthorn, *Crataegus oxyacantha*, which was evidently unsuitable for them: but of course that is one of the points one has to contend with in breeding exotic larvae, the natural food plant of which is unknown. The species is for the present included in *Caligula* but I think it should not be included in this genus, nor in the genus *Dictyoploca* to which *C. simla* and *C. japonica* are now referred.

Unlike *Caligula japonica*, where the ovipositing is like our British *Saturnia carpini* (that is, laid in closely-packed sheets or regularly round twigs), the ova of *C. cachara* are in little groups irregularly laid and unevenly covered with brown cement giving them a streaky appearance. The size of the egg is about  $2.5 \times 1.5$  mm.

The ova were laid from a female paired to the same male for two successive nights but which separated each night before dawn. They were laid 19th to 23rd March. Those laid on the 22nd and 23rd were without cement and quite white and were deposited at a foot away from where the female was caged, evidently by propulsion; none of these last ones hatched; the others hatched 13th to 17th April.

The larvae on first hatching are about 3.5 mm. long and are pale milk-blue on the dorsal surface shading down the sides to greenish-blue, more prominent on the first four segments and reminding one of the last two stages of *D. simla* and the last stage of some larvae of *D. japonica*. During feeding in the first stage the larvae changed from milk-blue to green, yellowish on moulting.

Head, glossy black with a few scattered forward projecting creamy hairs. Carapace yellow, kidney-shaped; with a black glossy kidney-shaped mark, on anterior edge of which on both sides of the median line a similar yellow mark; anterior edge of each having a flat spindle-shaped yellowish tubercle with forward projecting hairs similar to those on the head; on lateral posterior edge of this segment an oval black spot surrounding the first spiracle; in front of it in a line with the lower edge of black carapace, a small yellowish flat tubercle with a few hairs longest in the middle. Feet black, glossy and with very few hairs. The oval black spot and the aforementioned tubercles form the lateral

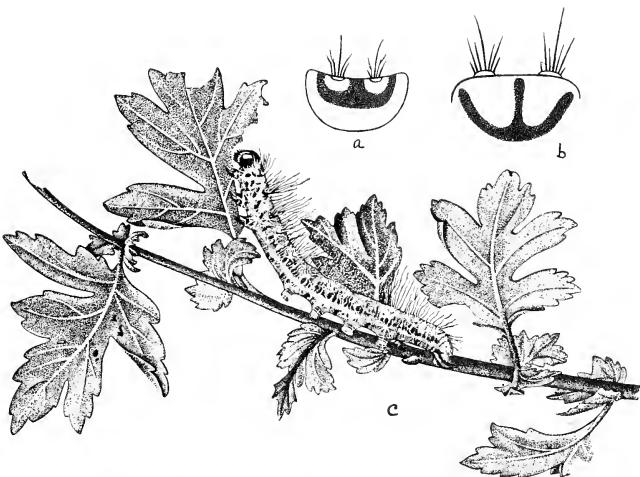

Larva of *Caligula cachava* ; a. thoracic shield, first instar ; b. thoracic shield, third instar ; c. larva in fourth instar, half-grown, magnified.



row of tubercles and spots and their relative position on the sides of the larva is nearly the same all through the first stage, except that the spots on the second and third segments are longer and obliquely set and on all other segments are behind the spiracle, as it is set on the extreme anterior edge of spot. The second and third segments have a blood crimson oval mark on each end of which is set a pale transparent yellow tubercle with slender yellowish spines curving mostly dorsally and backward, and is very noticeable. Forward and also behind in a dorsal line is a long black spot broken at the intersections; both at the fore and hinder lateral edges, other spots (the submedian row of black spots). Lateral ruga (the infrspiracular line of Packard) is more yellowish and not very pronounced. Abdominal legs greenish yellow. Suranal plate same colour with a broad heartshaped black centre and edged anteriorly with black. Anal legs with small black spot. There is a slight variation in the amount of spots and markings of these larvae.

Larvae spun up 21st April. Moulded 24th April.

Length end of first age 7 mm.

*Second Age.* The first larvae moulted 24th April, aged eleven days. Head and feet glossy black. Dorsal surface milk-white, lateral surface pale-gold. The black spots along the sides are broken up and the carapace is now only edged behind with a narrow line of black which extends in a median line to the anterior edge. Dorsal tubercles of second and third segments are larger and of the crimson colour of the oval raised spots they spring from and with short caraneous spines and a very short white hair in the centre. The rest of the dorsal and all the subdorsal tubercles have a very long white hair in the centre of each, which is wanting on the subspiracular row. Suranal plate triangular and narrowly edged black. Anal legs with curved black mark. In this stage the whole larva is covered with fine milk-blue hairs from body, longer from the tubercles, except those from carapace; last two segments and subspiracular tubercles pale maize yellow.

Comparing it with *D. japonica* and *D. simla* of same age; whilst *C. cachara* resembles *D. simla* in fourth age, but with the addition of four red tubercles, *D. japonica* is all black and the dorsal tubercle hairs of second and third segments are the longest. These in *cachara* are the shortest and spring from large red dorsal tubercles. The dorsal line of tubercles in *japonica* are relatively taller and armed with stronger spines than *cachara* where except for the two red pairs they are only papillate. Length of larva at end of second age about 10 mm.

*Third Age.* Moulded 5th May, aged 23 days. Hardly differing from last except that the black marks are more broken and scattered, ending abruptly just above the yellow lateral ruga and re-appearing faintly

below. The head has now a pale inverted V-shaped mark. Length at end of third age 19 mm. Spun up 16th May; moulted 19th May.

*Fourth Age.* Is very like third in general appearance and is shown half grown in this age in sketch the length when 43 days old being about 38 mm. The head has now a pale upper lip as well as the pale V mark. It is a pity the unsuitableness of the food showed itself by them going off one by one. I hope one day to complete the life history.

I have here [*exhibited*] some specimens of the various stages of *Caligula cachara* which Mr. Watson has sent for exhibition at this Meeting. Mr. Watson has made a special study of silk-moths for many years and probably knows more of them than anybody else. We are much indebted to him for sending this paper on the early stages of one of our Indian species.

Mr. Fletcher.

#### 48.—LIFE-HISTORIES OF INDIAN MICROLEPIDOPTERA.

By T. BAINBRIGGE FLETCHER, R.N., F.L.S., F.E.S., F.Z.S., *Imperial Entomologist.*

(ABSTRACT.\*)

This abstract gives little more than a list of names of species with their food plants so far as is known but it will perhaps serve to indicate what is known and the numerous gaps in our knowledge.

##### PTEROPHORIDÆ.

*Diacrotricha fasciola*, Zell.—Known from Ceylon and Pusa. Larva in flowers of *Averrhoa bilimbi* and *A. carambola*.

*Buckleria paludicola*, Fletcher.—Ceylon and Khasis. Larva on *Drosera burmanni*.

*Buckleria xerodes*, Meyr.—Ceylon to Nagpur. Larva on *Gynandropsis*.

*Buckleria defectalis*, Wlk.—Throughout Plains. Larva on *Boerhaavia*.

*Buckleria wahlbergi*, Zell.—Throughout India and Ceylon. Larva on *Oxalis* sp.

*Sphenarches caffer*, Zell.—Throughout India, Burma, Ceylon. Larva on *Cajanus indicus*, *Dolichos lablab*, *Lagenaria vulgaris*, *Luffa* sp., *Hibiscus mutabilis*, *Averrhoa bilimbi*, *Biophytum sensitivum* and *Mimosa pudica*.

*Oxyptilus lactuceæ*, Fletcher.—Dehra Dun. Larva on lettuce.

\* The original intention was to publish this paper *in extenso* in these Proceedings but it has run to such a length that it is considered desirable to publish an abstract only and to issue the complete paper elsewhere.



- Oxyptilus epidectes*, Meyr.—South India; Burma; Ceylon. Larva on *Biophytum sensitivum*.
- Oxyptilus chordites*, Meyr.—Colombo; Karwar. Larva on *Calycopteris floribunda*.
- Oxyptilus pelecynetes*, Meyr.—Khasis; Ceylon. Larva on *Scutellaria discolor*.
- Oxyptilus causodes*, Meyr.—Peradeniya; Pusa. Larva in fruits of *Dillenia retusa*.
- Xyoptila vaughani*, Fletcher.—Ceylon. Larva probably in fruit of *Dimorphocalyx glabellus*.
- Deuterocopus alopecodes*, Meyr.—Karwar. Larva on *Vitis* sp.
- Deuterocopus socotranus*, Rebel.—Plains of India, Burma, Ceylon. Larva on flowers of *Vitis quadrangularis* and *V. trifolia*.
- Deuterocopus planeta*, Meyr.—Ceylon: South India; Khasis; Burma. Larva on flowers of *Leea sambucina*.
- Deuterocopus ritsemæ*, Wlsm.—Ceylon; Coorg; Assam. Larva on *Leea sambucina*.
- Platyptilia citropleura*, Meyr.—Ceylon; Khasis. Larva in seed-pods of *Begonia* sp.
- Platyptilia taprobanes*, Feld.—Ceylon to Pusa; Khasis. Larva on *Scutellaria discolor*.
- Platyptilia pusillidactyla*, Wlk.—Throughout India, Burma, Ceylon. Larva in flowers of *Lantana camara*, *L. indica* and *Lippia geminata*.
- Platyptilia brachymorpha*, Meyr.—Plains from Ceylon to Pusa; Burma. Larva on *Celsia coromandeliana* and on unnamed Solanaceous plant.
- Platyptilia direptalis*, Wlk.—Hills of India and Ceylon; Pusa. Larva on *Teucrium quadrifarium* and *Scutellaria discolor*.
- Platyptilia molopias*, Meyr.—Ceylon Hills. Larva on *Teucrium tomentosum*.
- Platyptilia cacaliæ*, Fletcher.—Coimbatore. Larva in flower-head of *Cacalia coccinea*.
- Platyptilia gonodactyla*, Schiff.—Darjiling; Rawalpindi. Larva on *Tussilago farfara* in Europe.
- Stenoptilia zophodactyla*, Dup.—Throughout India and Ceylon. Larva on *Sopubia trifida* and *Blumea balsamifera*.
- Ezelastis liophanes*, Meyr.—Throughout India, Burma, Ceylon. Larva on *Oxalis*.
- Ezelastis atomosa*, Wlsm.—Plains of India. Larva on *Cajanus indicus* and *Dolichos lablab*.
- Pterophorus lieinigianus*, Zell.—Throughout India, Burma, Ceylon. Larva on *Solanum melongena* (on *Artemisia vulgaris* in Europe).

*Pterophorus monodactylus*, Linn.—North-West India; Kashmir. Larva on *Convolvulus* in Europe.

*Alucita niveodactyla*, Pag.—Hills of India and Ceylon. Larva on *Ipomœa* sp.

*Steganodactyla concursa*, Wlsm.—Ceylon; Coorg; Belgaum. Larva in unexpanded leaves of *Argyrea* sp. and *Ipomœa populifolia*.

*Agdistis tamaricis*, Zell.—Karachi; Peshawar. Larva on *Tamarix gallica*.

## CARPOSINIDÆ.

*Meridarchis scyrodcs*, Meyr.—Plains of India. Larva in fruits of *Zizyphus jujuba*.

*Meridarchis reprobata*, Meyr. MS.—Nagpur; Surat; Kashmir. Larva in fruits of *Eugenia jambolana* and cultivated olive.

## PHALONIADÆ.

*Clysia ambiguella*, Hb.—Assam; Burma. Larva in flower-buds of vine in Europe.

*Phalonia hybridella*, Hb.—Dharmasala. Larva in seed-heads of *Picris hieracioides* in Europe.

## TORTRICIDÆ.

*Capua invalidana*, Wlk.—India, Ceylon. Larva on leaves of betel-vine.

*Adoxophyes privatana*, Wlk.—India, Burma, Ceylon. Larva in flowers of *Lantana camara*.

*Homona coffearia*, Nietn.—India, Ceylon. Larva on tea, coffee, *Lantana camara*.

*Homona menciiana*, Wlk.—India. Larva on *Lantana camara*.

*Cacœcia micaceana*, Wlk.—India, Burma, Ceylon. Larva on guava and broad-bean.

*Cacœcia epicryta*, Meyr.—India, Ceylon. Larva in fruits of *Duranta* and guava, flower-heads of *Lantana camara*.

*Cacœcia isocryta*, Meyr. MS.—Pusa. Larva on lucerne.

*Cacœcia pensilis*, Meyr. MS.—Madras. Larva boring into orange fruit.

*Cacœcia compacta*, Meyr.—Pusa. Larva on leaves of *Salix* sp.

*Cacœcia dispilana*, Wlk.—India, Burma. Larva rolling leaves of honey-suckle.

*Cacœcia philippa*, Meyr.—Abbottabad. Larva on leaves of *Hedera*.

*Ulodemis trigrapha*, Meyr.—North East India (Hills). Larva on berries of *Viburnum* (?)

*Pandemis ribeana*, Hb.—Himalayas. Larva on *Cratægus*, *Rosa*, *Prunus*, *Pyrus*, *Quercus*, *Rhamnus*, *Fraxinus*, *Betula*, etc., in Europe.

- Tortrix semialbana*, Gn.—Himalayas. Larva on *Lonicera*, *Rosa*, *Chelidonium*, *Lilium*, *Urtica*, etc., in Europe.
- Tortrix dunstaniana*, Tr.—Kashmir. Larva on *Lonicera*, *Urtica*, *Hedera*, *Rubus*, *Umbelliferæ*, *Quercus*, etc., in Europe.
- Harmologa miserana*, Wlk.—Assam. Larva on *Ficus* spp. in Australia.
- Cnephasia argentana*, Cl.—Himalayas; Kashmir.
- Planostocha cumulata*, Meyr.—Ceylon, South India. Larva on *Lantana camara*.
- Eboda obstinata*, Meyr.—Ceylon; Pusa. Larva rolling leaf of *Cardiospermum* sp.
- Peronea siderota*, Meyr.—Peradeniya. Larva mining twigs of *Cinnamomum camphora*.
- Peronea epidesma*, Low.—Ceylon; Pusa. Larva on leaves of *Polyalthia longifolia*.

## EUCOSMIDÆ.

- Spilonota rhotia*, Meyr.—India, Ceylon. Larva on guava and *Eugenia jambolana*.
- Acroclita cheradota*, Meyr.—Ceylon; Pusa. Larva rolling leaves of *Ficus religiosa*.
- Acroclita narana*, Hb.—India, Ceylon. Larva on blackthorn, holly, *Vaccinia*, etc., in Europe.
- Acroclita vigescens*, Meyr. MS.—Pusa. Larva on *Cordia myxa* and *C. latifolia*.
- Ancyliis glycyphaga*, Meyr.—Pusa; Abbottabad. Larva on sugary excretion of *Phromnia marginella* (Homoptera).
- Ancyliis lutescens*, Meyr.—Hoshangabad; Pusa; Gauhati. Larva rolling leaves of *Zizyphus jujuba*.
- Ancyliis cyanostoma*, Meyr.—Pusa. Larva in spun leaves of *Zizyphus jujuba*.
- Diplonearcha insinuans*, Meyr.—Peradeniya. Reared from Psyllid gall on *Ficus*.
- Eucosma critica*, Meyr.—Plains of India. Larva on *Cajanus indicus*.
- Eucosma melanaula*, Meyr.—Plains of India; Khasi Hills. Larva on *Cajanus indicus*, *Phaseolus aconitifolius*, *P. mungo*, *P. radiatus*, Florida beggar-weed.
- Eucosma balanoptycha*, Meyr.—Plains of India, Ceylon. Larva on *Pongamia glabra*.
- Eucosma clepsidoma*, Meyr.—Coimbatore. Reared from gall on unidentified plant.
- Eucosma conciliata*, Meyr. MS.—Pusa. Larva on flowers of *Butea frondosa*.

- Eucosma fenella*, Linn.—Dharmisala. Larva in stems and roots of *Artemisia vulgaris* in Europe.
- Eucosma zelota*, Meyr.—Abbottabad. Larva spinning up rose leaves.
- Eucosma stereoma*, Meyr.—Pusa. Larva in flowers of *Pithecolobium dulce* (or *Inga dulcis*).
- Eucosma melanoneura*, Meyr.—Khasi Hills. Larva spinning up flowers of *Rhus senialata*.
- Crocidosema plebeiana*, Zell.—Pundaluooya; probably throughout India also. Larva on Malvaceæ.
- Bactra truculenta*, Meyr.—Plains of India. Larva in stems of *Cyperus rotundus*.
- Polychrosis fetalis*, Meyr. MS.—Pusa. Larva in flower-head of *Leucas* sp.
- Polychrosis cellifera*, Meyr.—Colombo; Pusa. Larva on leaves of *Eugenia jambolana*.
- Lobesia æolopa*, Meyr.—India, Ceylon, Burma. Larva on flowers of *Cajanus indicus*, *Lantana camara*, *Leucas cephalotes*.
- Lobesia genialis*, Meyr.—Ceylon, South India. Larva on flowers of *Lantana canara*.
- Argyroploce citharistis*, Meyr.—India, Burma. Larva in flower-head of *Leucas* sp.
- Argyroploce illepidæ*, Butl.—India, Ceylon. Larva in fruits of *Nephelium litchi*, *Feronia elephantum*, *Cassia fistula*, *C. occidentalis*, *Tamarindus indica*, *Ægle marmelos*, *Sesbania aculeata*, *S. grandiflora*, *Acacia arabica*, *Citrus aurantium*.
- Argyroploce aprobola*, Meyr.—India, Ceylon. Larva on leaves of mango, litchi, rose, *Cassia tora*, *Polyalthia longifolia*. *Lantana camara*, also eating rose buds and Dahlia (?) flowers.
- Argyroploce cenchropis*, Meyr. MS.—Pusa. Larva in fruits of *Cordia myxa*.
- Argyroploce cbenina*, Meyr.—Karwar. Larva on leaves of *Diospyros*.
- Argyroploce erotias*, Meyr.—India, Ceylon. Larva boring mango shoots [?], webbing leaves of mango, *Loranthus*, *Cynoglossum*, and *Lantana camara*.
- Argyroploce leucaspis*, Meyr.—India, Ceylon. Larva rolling litchi leaves.
- Argyroploce paragramma*, Meyr.—Pusa; Gauhati. Larva boring bamboo shoots.
- Argyroploce poetica*, Meyr.—Ceylon; Palnis; Pusa. Larva rolling leaves of *Polyalthia longifolia*.
- Argyroploce rhynchias*, Meyr.—Ceylon. Larva in pods of *Canavalia* in Mauritius.
- Argyroploce semiculta*, Meyr.—India, Ceylon. Larva rolling terminal leaves of *Alseodaphne semecarpifolia*.

- Argyroploce tonsoria*, Meyr.—Ceylon. Larva in fruit of *Barringtonia racemosa*.
- Laspeyresia kænigana*, Fb.—Plains of India and Burma. Larva on leaves of *Melia azadirachta*; also on *Jasminum sambac* (?)
- Laspeyresia hemidoxa*, Meyr.—Khasi Hills; Malabar. Larva boring shoots of pepper vine.
- Laspeyresia leucostoma*, Meyr.—Ceylon; South India; Assam. Larva rolling leaves of tea.
- Laspeyresia capparidana*, Zell.—Pusa. Larva boring stem of *Capparis horrida*.
- Laspeyresia mamertina*, Meyr. MS.—Pusa. Larva on leaves of *Loranthus*.
- Laspeyresia ptychora*, Meyr.—India; Ceylon. Larva in pods of *Vigna sinensis* in Rhodesia.
- Laspeyresia pyncnohra*, Meyr. MS.—Coimbatore. Larva in pods of *agathi* (*Sesbania grandiflora*).
- Laspeyresia malesana*, Meyr. MS.—Coimbatore.—Larva in pods of *Parkinsonia* and *Cassia corymbosa*.
- Laspeyresia dædalota*, Meyr.—Pusa. Larva on flowers of *Cassia fistula*.
- Laspeyresia jaculatrix*, Meyr.—Plains of India. Larva on leaves of *Dalbergia sissu*.
- Laspeyresia tricenra*, Meyr.—Plains of India and Ceylon. Larva boring shoots of *Crotalaria juncea*.
- Laspeyresia pseudonectis*, Meyr.—Plains of India. Larva boring shoots of *Crotalaria juncea*, *Phaseolus mungo* and *Dolichos lablab*.
- Laspeyresia torodelta*, Meyr.—Plains of South India. Larva boring young shoots of *Dolichos lablab*.
- Laspeyresia pomonella*, Linn. Kashmir (?). Larva in fruits of apple, pear, etc., in Europe and America.
- Laspeyresia pulverula*, Meyr.—Himalayas; Khasis; Bred from *sal* (*Shorea robusta*) logs.
- Pammene isocampta*, Meyr.—Peradeniya. Associated with *Lecanium* sp.
- Pammene theristis*, Meyr.—Ceylon; Kumaon. Larva at roots of *Sal* (*Shorea robusta*) seedlings.

CHLIDANOTIDÆ.

(No life-histories of any Indian species are known.)

GELECHIDÆ.

- Sitotroga cerealella*, Oliv.—Throughout India, Burma, Ceylon. Larva on grain, bamboo seeds.
- Telphusa melanozona*, Meyr.—Pusa. Larva mining leaves of *Euphorbia nivulia*.

- Aristotelia ingravata*, Meyr.—Pusa ; Peshawar. Larva forming gall in twig of *Tamarix*.
- Idiophantis chiridota*, Meyr.—Peradeniya. Reared from Psyllid galls on *Eugenia*.
- Istrianis crauropa*, Meyr.—Dharwar. Larva on leaves of *Butea frondosa*.
- Ephysteris chersaea*, Meyr. (*oschophora*, Meyr.).—Plains of India, Ceylon. Larva in dry vegetable refuse.
- Epitlectis studiosa*, Meyr.—Peradeniya ; North India. Larva on dried plants and on stored rice.
- Phthorimæa heliopa*, Lower.—Plains of India, Burma, Ceylon. Larva boring in stem of tobacco.
- Phthorimæa blapsigona*, Meyr.—Madras ; Central Provinces. Larva in buds of brinjal.
- Phthorimæa operculella*, Zell.—Throughout India (? except Punjab and Assam). Larva in potato tubers.
- Phthorimæa ergasima*, Meyr.—Pusa. Larva mining brinjal leaves.
- Stomopteryx nerteria*, Meyr.—India, Burma, Ceylon. Larva on ground-nut, *Cajanus indicus*, *Psoralea corylifolia*.
- Platyedra gossypiella*, Saunders.—India, Burma, Ceylon. Larva in cotton seeds, less commonly on *Hibiscus abelmoschus*, *Abutilon indicum*, hollyhock, *Thespesia populnea*, *Hibiscus esculentus* and *H. cannabinus*.
- Gelechia tamariciella*, Zell.—Plains of North India. Larva on *Tamarix*.
- Stegasta variana*, Meyr.—India, Ceylon. Larva on leaves of *Cassia tora* and *Jasminum sambac*.
- Onebala blandiella*, Wlk.—India, Burma, Ceylon. Larva rolling leaves of dead-nettle.
- Zalithia diluticornis*, Wlsm.—India, Ceylon. Larva on dry leaves and twigs.
- Thyrsostoma glaucitis*, Meyr.—India, Ceylon. Attached to mango.
- Dactylethra candida*, Stainton.—Calcutta ; South India. Larva in gall on stem of wild-indigo (? *Tephrosia purpurea*).
- Lecithocera crypsilychna*, Meyr.—Bassein Fort (Bombay). Larva on leaves of *Ipomæa arvensis*.
- Lecithocera effera*, Meyr.—Coimbatore. Larva on leaves of *Ipomæa batatas*.
- Brachmia engrapta*, Meyr.—Lahore ; Coimbatore. Larva on leaves of sweet potato (*Ipomæa batatas*).
- Brachmia arotræa*, Meyr.—India, Burma, Ceylon. Larva rolling rice leaves.
- Brachmia idiastris*, Meyr.—Pusa. Larva rolling *Panicum* leaves.

- Brachmia insulsa*, Meyr.—Plains of India. Larva on potato leaves.
- Brachmia xerophaga*, Meyr.—Madras; Orissa. Larva in nest of *Stegodyphus sarasinorum* (a social spider).
- Helcystogramma hibisci*, Stainton.—India, Ceylon. Larva rolling leaves of *Hibiscus esculentus*.
- Autosticha authæma*, Meyr.—Peradeniya. Larva in heliciform case on moss-covered rocks.
- Autosticha chernetis*, Meyr.—Peradeniya. Larva in galleries on moss-covered rocks.
- Autosticha exemplaris*, Meyr.—Coimbatore. Bred from refuse in fork of tamarind tree.
- Autosticha protypa*, Meyr.—Ceylon. Larva in galleries on lichen.
- Paraspistes palpigera*, Wlsm.—South India, Burma, Ceylon. Larva in pods of *Cassia corymbosa*, *C. flora*, *Crotalaria*, and indigo.
- Hypelictis albiscripta*, Meyr.—North Kanara. Pupa amongst *Salix* leaves.
- Strobisia amethystias*, Meyr.—Peradeniya. Larva in fungus-bed of Termites' nest.
- Trichotophe geochrota*, Meyr.—Bassein Fort (Bombay). Larva on unidentified plant.
- Dichomeris ianthes*, Meyr.—Plains of India and Ceylon. Larva on indigo, lucerne, *Cyamopsis*.
- Dichomeris evidantis*, Meyr.—Pusa. Larva rolling leaves of *Dalbergia sissu*.
- Anarsia acerata*, Meyr.—South India. Larva on *Cajanus indicus*.
- Anarsia altercata*, Meyr.—Pusa. Pupa on *Sesbania* sp.
- Anarsia didymopa*, Meyr.—Pusa. Pupa on *Capparis horrida*.
- Anarsia ephippias*, Meyr.—Plains of India. Larva on indigo, groundnut, soy-bean, moth, urid, mung, *Acacia* sp.
- Anarsia epotias*, Meyr.—Pusa. Larva on *Tamarix* twigs.
- Anarsia exallacta*, Meyr.—Pusa. Larva on *Cajanus indicus*.
- Anarsia idioptila*, Meyr.—Pusa. Larva on leaves of *Cassia fistula*.
- Anarsia melanoplecta*, Meyr.—Plains of India. Larva boring in mango shoots.
- Anarsia omoptila*, Meyr.—Coimbatore. Larva on leaves of *Cajanus indicus*.
- Anarsia sagittaria*, Meyr.—Pusa. Larva boring top-shoots of *Zizyphus jujuba*.
- Anarsia sagmatica*, Meyr.—Pusa. Larva rolling *Loranthus* leaf.
- Anarsia veruta*, Meyr.—Pusa. Pupa on *Inga dulcis* leaf.

- Chelaria phacclota*, Meyr.—Peradeniya. Bred from Psyllid galls on *Mallotus philippinensis*.  
*Chelaria rhicnota*, Meyr.—South India. Larva on mango flowers.  
*Chelaria scopulosa*, Meyr.—Karwar. Larva boring shoot of *Careya arborea*.  
*Chelaria spathota*, Meyr.—India. Larva on mango leaves.  
*Æcia æcophila*, Standinger.—India. Larva probably on domestic rubbish.

## METACHANDIDÆ.

(Nothing is known of the early stages of this Family.)

## COSMOPTERYGIDÆ.

- Anatrachyntis simplex*, Wlsm.—India, Burma. Larva in cotton seeds and dry vegetable refuse generally.  
*Anatrachyntis falcatella*, Stainton. India, Ceylon. Larva in lac, on cotton shoots infested with scales, in rotten pomegranate. Probably a refuse feeder.  
*Anataractis plumigera*, Meyr.—Pusa; Coimbatore. Larva in gall in stem of *Indigofera linifolia*.  
*Pyroderces albitineella*, van Deventer.—Ceylon; South India. Larva in pods of indigo and *Cassia corymbosa*.  
*Pyroderces semicoccinea*, Stainton.—India. Bred from stems of *Cajanus indicus* (larva a refuse-feeder?).  
*Pyroderces promacha*, Meyr.—Plains of India. Bred from stem of *Cajanus indicus* (larva a refuse-feeder?).  
*Pyroderces callistrepta*, Meyr.—North Bihar. Larva mining teak leaves.  
*Limnæcia metæcypha*, Meyr.—Peradeniya. Pupa between spun leaves.  
*Limnæcia peronodes*, Meyr.—Pusa. Larva on bamboo (? predaceous on Coccids).  
*Cosmopteryx mimetis*, Meyr.—India, Ceylon. Larva mining leaves of *Cyperus rotundus*.  
*Cosmopteryx bambusæ*, Meyr.—Pusa. Larva mining bamboo leaves.  
*Cosmopteryx phæogastra*, Meyr.—Pusa; Coimbatore. Larva mining bean leaves.  
*Cholotis crypsiloga*, Meyr.—Coimbatore. Larva on *Acacia*.  
*Cholotis pachnodes*, Meyr.—Pusa. Larva on *Tamarix* twigs.  
*Aganoptila phanarcha*, Meyr.—Ceylon. Bred from galls on undetermined tree.  
*Microcolona citropecta*, Meyr.—Coorg; Pusa. Larva on *Eugenia jambolana*?  
*Batrachedra arenosella*, Wlk.—India, Ceylon. Larva amongst seeds of *Juncus*.



*Batrachedra silvatica*, Meyr.—Almora. Bred from twigs of *Pinus longifolia* (? larva predaceous on *Ripersia*).

CECOPHORIDÆ

*Endrosia lacteella*, Schiffermüller.—India (Hills). Larva on dry vegetable refuse.

*Borkhausenia pseudopretella*, Stainton.—Hills of India and Ceylon. Larva on seeds, dried plants, skins, etc.

*Macrobathra nomæa*, Meyr.—Coimbatore. Bred from dry refuse in fork of tamarind tree.

*Tonica barrowi*, Bingham. Maymyo. Larva on *Bombax malabaricum*.

*Tonica niviferana*, Wlk.—India, Ceylon. Larva boring in shoots of *Bombax malabaricum*.

*Tonica terasella*, Wlk.—Sikkim; Karwar. Bred from pupa on bamboo leaf.

*Tonica zizyphi*, Stainton.—India, Ceylon. Larva in folded leaves of *Citrus* and *Murraya* (? also on *Zizyphus*).

*Cryptolechia arvalis*, Meyr.—South India. Larva between spun leaves of *Careya arborea*.

*Porthmologa paracina*, Meyr.—Surat; Pusa. Larva on *Zizyphus jujuba*.

*Pseudodoxia cretata*, Meyr.—Ceylon. Larva in case on lichens.

*Pseudodoxia limulus*, Rogenhofer.—Ceylon. Larva in case on lichens.

*Pseudodoxia palimpsesta*, Meyr.—Hazaribagh. Larva in case on mango twigs.

*Pseudodoxia picrophaea*, Meyr.—Ceylon (Hills). Larva in case on lichens.

*Pseudodoxia sepositella*, Wlk.—Ceylon. Larva in case on lichens.

*Promalactis cornigera*, Meyr.—Almora; Chamba. Bred from log of *Pinus longifolia*.

*Promalactis scmantris*, Meyr.—Himalayas; Assam. Bred from logs of *Shorea robusta* and *Eugenia jambolana*.

*Aristeis thwaitesii*, Meyr.—Ceylon. Larva in case on *Eugenia caryophyllæum*.

PHYSOPTILIDÆ.

*Physoptila scenica*, Meyr.—South India. Larva in shoots of *Careya arborea*.

XYLORYCTIDÆ.

*Ptochoryctis simbleuta*, Meyr.—Sylhet. Larva in case on tea, eating bark.

*Antithya vineata*, Meyr.—Peradeniya. Larva in case on lichens.

*Odites atmopa*, Meyr.—Kandy; Pusa. Larva on leaves of *Melia azadirachta*.

- Odites bambusæ*, Wlsm.—Ootacamund. Larva rolling bamboo leaves.  
*Odites hederæ*, Wlsm.—Ootacamund. Larva on ivy leaves.  
*Odites melitidis*, Meyr. MS.—Coimbatore. Pupa on field-beans.  
*Odites spoliatrix*, Meyr.—Plains of India. Larva in nest of a social spider (*Stegodyphus sarasinorum*).  
*Procometis trochala*, Meyr.—North Bihar. Larva on dry leaves and stems (once found boring sugarcane).  
*Nephantis serinopa*, Meyr.—Ceylon; Southern India; Bengal; Lower Burma. Larva on leaves of coconut and palmyra palms.

## STENOMIDÆ.

- Synchalara rhombota*, Meyr.—Assam. Larva on leaves and bark of tea.  
*Stenoma ichnaea*, Meyr.—North Kanara. Larva on leaves of *Symplocos spicata*.

## ORNEODIDÆ.

(No early stages of any Indian species are known.)

## COPROMORPHIDÆ.

(No early stages of any Indian species are known.)

## (ÆGERIADÆ.)

## HELIOZELIDÆ.

- Antispila argostoma*, Meyr.—Pusa. Larva mining leaves of *Vitis trifolia*.  
*Antispila aristarcha*, Meyr.—Karwar. Larva mining leaves of *Vitis* sp.

## HELIODINIDÆ.

- Stathmopoda hemitorna*, Meyr.—South India. Bred from refuse in fork of tamarind tree.  
*Stathmopoda theoris*, Meyr.—Plains of India and Ceylon. Larva on dry vegetable refuse; also reared from lac.  
*Stathmopoda sycophaga*, Meyr.—Pusa. Larva in fruits of *Ficus glomerata*.  
*Stathmopoda basipletra*, Meyr.—Hardwar; Siwaliks. Larva in seeds of *Albizia lebbek*; also reared from lac.  
*Stathmopoda præalbata*, Meyr.—North Bihar. Bred from fallen fruits of *Ficus bengalensis*.  
*Stathmopoda sycastis*, Meyr.—Peshawar. Larva in ripe fruits of *Ficus carica*.  
*Stathmopoda ovigera*, Meyr.—Plains of India and Ceylon. Larva predaceous on *Pulvinaria* on *Ficus glomerata*.

- Stathmopoda adulatorix*, Meyr.—Almora. Bred from twigs of *Pinus longifolia*.
- Cedematopoda venusta*, Meyr.—Jabalpur. Bred from colonies of lac insect.
- Cedematopoda cypris*, Meyr.—Kandy. Bred from colony of lac insect.
- Cedematopoda flammifera*, Meyr.—Pusa. Larva boring mango shoots.
- Cedematopoda clerodendronella*, Stainton.—Calcutta; Bihar. Larva webbing top-leaves of *Clerodendron infortunatum* and *Anisomcles ovata*.
- Eretmocera impactella*, Wlk.—Plains of India. Burma, Ceylon. Larva webbing top-leaves of *Amarantus*.

## GLYPHIPTERYGIDÆ.

- Hilarographa caminodes*, Meyr.—Ceylon. Larva in roots of cardamom and wild Zingiberaceous plants.
- Imma myliias*, Meyr.—Ceylon; South India. Reared from pupa on tamarind bark.
- Phycodes minor*, Moore.—India, Ceylon, Burma. Larva rolling leaves of *Ficus* spp.
- Phycodes radiata*, Oechsenheimer.—India, Ceylon. Larva rolling leaves of *Ficus* spp.
- Simaethis ophosema*, Lower.—India. Larva on bamboo.
- Simaethis orthogona*, Meyr.—India, Burma, Ceylon. Larva on *Streblus* sp.
- Simaethis aegyptiaca*, Zeller.—Simla; North Bihar. Larva webbing tender leaves of *Ficus glomerata*.
- Simaethis fabriciana*, Linn.—Himalayas; Kashmir. Larva on *Urtica* and *Parietaria* in Europe.
- Brenthia coronigera*, Meyr.—Pusa. Larva on leaves of *Cordia myxa*.
- Choreutis bjerkanarella*, Thunberg.—North India. Larva on *Blumea balsamifera* (?); on *Carduus*, *Inula*, etc., in Europe.

## BLASTOBASIDÆ.

- Blastobasis spermologa*, Meyr.—Ceylon; South India; Pusa. Larva in tea-seed and in fallen fruits of *Ficus glomerata*.
- Blastobasis decolor*, Meyr.—India, Ceylon. Larva in fallen fruit of *Ficus glomerata*.
- Blastobasis crassifera*, Meyr.—India, Ceylon. Larva in pods of *Crotalaria juncea*.
- Blastobasis transcripta*, Meyr.—Almora. Larva on twigs of *Pinus longifolia* (? predaceous on *Ripersia*).
- Exinotis catachlora*, Meyr.—India, Ceylon. Larva in flower-heads of *Leucas* sp.

*Prosinthis florivora*, Meyr.—Madulsima ; Pusa. Larva on flowers of mango.  
*Holococera pulverea*, Meyr.—Plains of India. Larva on lac and lac insects.

## SCYTHRIDIDÆ.

(The early stages of no Indian species are known.)

## ELACHISTIDÆ.

(The early stages of no Indian species are known.)

## HYPONOMEUTIDÆ.

*Argyresthia iopleura*, Meyr.—Almora. Larva on twigs of *Pinus longifolia* (? feeding in shoots).

*Prays citri*, Milliere.—India, Ceylon. Larva on flowers, shoots and fruits of *Citrus* spp.

*Hyponomeuta malinellus*, Zeller.—Poona (?). Larva on *Pyrus* in Europe.

*Hyponomeuta lapidella*, Wlsm.—Dharmasala. Larva on wild *Salvia*.

*Atteva fabriciella*, Swederns.—South India ; Bombay ; Central India.

Larva on *Ailanthus excelsa*.

*Atteva niveigutta*, Wlk.—North-East India. Larva on *Ailanthus excelsa*.

*Ætherastis circulata*, Meyr.—Travancore. Larva on *Eugenia jambolana*.

*Comocritis picria*, Meyr.—Ceylon ; Assam. Larva on bark of *Hevea brasiliensis* and tea.

*Ethmia assamensis*, Butler.—Himalayas ; Assam. Larva on (?) *Ehretia serrata*.

*Anticrates lucifera*, Meyr.—North Kanara. Larva on *Sideroxylon tomentosum*.

## COLEOPHORIDÆ.

(The early stages of no Indian species are known.)

## GRACILLARIADÆ.

*Lithocolletis triarcha*, Meyr.—Pusa. Larva mining cotton leaf.

*Lithocolletis virgulata*, Meyr.—Karwar ; Pusa. Larva mining leaf of *Butea frondosa*.

*Lithocolletis conista*, Meyr.—Pusa. Larva mining leaf of *Triumfetta neglecta*.

*Lithocolletis iteina*, Meyr.—Pusa. Larva mining *Salix* leaf.

*Lithocolletis clarisona*, Meyr.—Peradeniya. Larva mining leaf of *Urena lobata*.

*Lithocolletis bauhinia*, Stainton.—Calcutta. Larva mining leaf of *Bauhinia purpurea*.

*Lithocolletis dorinda*, Meyr.—Pusa. Larva mining *Desmodium* leaf.

- Lithocolletis ganodes*, Meyr.—Parachinar. Larva mining apple leaf.
- Lithocolletis incurvata*, Meyr.—Karwar. Larva mining leaf of *Strousslanthes callosus*.
- Lithocolletis neodoxa*, Meyr.—Pusa. Larva mining leaf of *Cajanus indicus*.
- Phrixosceles plexigrapha*, Meyr.—Pusa; Coimbatore. Larva mining green pods of *Cajanus indicus*.
- Epicephala chalybacma*, Meyr.—India, Burma, Ceylon. Larva in flower buds of *Casalpinia pulcherrima*.
- Epicephala albifrons*, Stainton.—India. Larva in fruits of *Phyllanthus niruri*.
- Acrocercops pentalocha*, Meyr.—Karwar. Larva mining mango leaf.
- Acrocercops ordinatella*, Meyr.—Ceylon; South India; ? Burma. Larva mining leaves of *Litsea* sp., *Alseodaphne semecarpifolia* and camphor.
- Acrocercops simplex*, Meyr.—Pusa. Larva mining leaf of *Terminalia catappa*.
- Acrocercops quadrifasciata*, Stainton.—Calcutta. Larva mining leaf of *Urena lobata*.
- Acrocercops prosacta*, Meyr.—Pusa. Larva mining sweet-potato leaf.
- Acrocercops phæospora*, Meyr.—Belgaum; Pusa. Larva mining leaf of *Eugenia jambolana*.
- Acrocercops terminaliæ*, Stainton.—Calcutta. Larva mining leaf of *Terminalia catappa*.
- Acrocercops cathedraea*, Meyr.—India. Larva mining leaf of *Achyranthes aspera*.
- Acrocercops orthostacta*, Meyr.—Pusa. Larva mining leaf of *Sida cordifolia*.
- Acrocercops austeropa*, Meyr.—North Kanara. Larva mining leaf of *Bauhinia purpurea* and *B. variegata*.
- Acrocercops resplendens*, Stainton.—North India. Apparently attached to *Ficus religiosa* (?)
- Acrocercops tricyma*, Meyr.—Pusa; Khasis. Larva mining leaf of *Blumea lacera*.
- Acrocercops amula*, Meyr.—India. Larva mining *Cynoglossum* leaf.
- Acrocercops isonoma*, Meyr.—Pusa. Larva mining mango leaf.
- Acrocercops isodelta*, Meyr.—Ceylon; South India. Larva mining leaf of *Colebrookea oppositifolia*.
- Acrocercops gemoniclla*, Stainton.—Plains of India. Larva mining leaves of *Semecarpus*, *Anacardium*, *Achras sapota* and (?) sugarcane.
- Acrocercops barringtoniella*, van Deventer.—North Kanara. Larva mining leaves of *Barringtonia spicata* and *Careya arborea*.

- Acrocercops lysibathra*, Meyr.—Pusa. Larva mining leaf of *Cordia latifolia*.
- Acrocercops phractopa*, Meyr.—Pusa. Larva mining leaf of *Ficus infectoria*.
- Acrocercops geometra*, Meyr.—Pusa; Coimbatore. Larva mining leaf of *Cordia myra*.
- Acrocercops hyphantica*, Meyr.—Pusa. Larva mining leaf of *Cesalpinia bonducella*.
- Acrocercops hierocosma*, Meyr.—Pusa. Larva mining litchi leaf.
- Acrocercops auricilla*, Stainton.—Calcutta; Pusa. Larva mining leaf of *Swietenia mahagoni*.
- Acrocercops telestis*, Meyr.—Pusa; Coimbatore; Moulmein. Larva mining leaves of *Trewia nudiflora*, *Gmelina arborea* and *Eugenia jambolana*.
- Acrocercops desiccata*, Meyr.—Peradeniya; Pusa. Larva mining leaf of *Ficus glomerata*.
- Acrocercops ustulatella*, Stainton.—Calcutta; Peradeniya. Larva mining young ebony leaves.
- Acrocercops syngramma*, Meyr.—Plains of India. Larva mining mango leaves.
- Acrocercops labyrinthica*, Meyr.—Pusa. Larva mining *Trema* leaf.
- Acrocercops allactopa*, Meyr.—Karwar. Larva mining leaf of *Eugenia jambolana*.
- Acrocercops bifrenis*, Meyr.—Belgaum. Larva mining leaves of two unidentified plants.
- Acrocercops brochogramma*, Meyr.—Peradeniya. Bred from leaves of *Hibiscus* sp.
- Acrocercops crystallopa*, Meyr.—Karwar. Larva mining leaf of *Memecylon amplexicaule*.
- Acrocercops cylicota*, Meyr.—Karwar. Larva mining leaf of *Colebrookea oppositifolia*.
- Acrocercops diatomica*, Meyr.—North Kanara. Larva mining leaf of unidentified plant.
- Acrocercops elaphopa*, Meyr.—Karwar. Bred from *Total* creeper.
- Acrocercops erioplaca*, Meyr.—Pusa. Larva mining in leaf of *Terminalia catappa*.
- Acrocercops extenuata*, Meyr.—Karwar. Larva mining leaves of unidentified shrub.
- Acrocercops hemiglypta*, Meyr.—Karwar. Larva mining leaves of unidentified plant.
- Acrocercops loxias*, Meyr.—Jodhpur. Bred from *Eugenia jambolana*.
- Acrocercops macroclina*, Meyr.—Karwar. Larva mining leaf of *Wagatea spicata*.

- Acrocercops pharopeda*, Meyr.—Karwar. Larva mining leaf of unidentified creeper.
- Acrocercops scandalota*, Meyr.—South India. Larva mining leaf of *Helicteres isora*.
- Acrocercops scenias*, Meyr.—Karwar. Larva mining leaves of *Changana* bush.
- Acrocercops scriptulata*, Meyr.—Karwar. Larva mining leaves of? *Terminalia paniculata*.
- Acrocercops tenera*, Meyr.—Peradeniya. Larva mining leaf of *Schleichera trijuga*.
- Acrocercops triscalma*, Meyr.—Karwar. Larva mining leaf of *Wagatea spicata*.
- Acrocercops vanula*, Meyr.—Karwar. Larva mining leaf of *Terminalia tomentosa*.
- Liocrobyla paraschista*, Meyr.—North Kanara ; Pusa. Larva mining leaves of *Cajanus indicus*, *Butea frondosa* and *Desmodium gangeticum*.
- Stomphastis plectica*, Meyr.—Plains of India. Larva mining leaves of *Sebastiania chamaelea* and *Jatropha gossypifolia*.
- Parectopa coccinea*, Wlsm.—Ootacamund. Larva rolling myrtle leaves.
- Parectopa labrodes*, Meyr. MS.—Pusa. Larva mining *Desmodium* leaves.
- Cyphosticha cærulea*, Meyr.—Pusa ; Coimbatore. Larva mining leaves of *Dolichos lablab* and *Cajanus indicus*.
- Gracillaria acidula*, Meyr.—Pusa. Larva mining leaf of *Phyllanthus emblica*.
- Gracillaria octopunctata*, Turner.—India. Larva rolling leaves of *Dalbergia sissu*.
- Gracillaria zachrysa*, Meyr.—North-West India to Assam. Larva mining and folding apple leaves.
- Gracillaria theivora*, Meyr.—India, Ceylon. Larva mining and rolling tea leaves.
- Gracillaria soyella*, van Deventer.—Ceylon ; Plains of India. Larva rolling leaves of *Cajanus indicus* and *Atylosia candollei* ; in leaves of *Soya hispida* in Java.
- Gracillaria iselæa*, Meyr.—Peradeniya. Larva on *Spondias mangifera*.
- Gracillaria ?? coffeifoliella*, Nietner.—Ceylon. Larva mining coffee leaves.

EPERMENIADÆ.

- Epimarpis philocoma*, Meyr.—Karwar ; Khasis. Larva in web on unidentified plant.
- Idioglossa triacma*, Meyr.—Khasis ; Pusa. Larva on leaves of *Commelina bengalensis*.

## AMPHITHERIDÆ.

(The early stages of no Indian species are known.)

## PLUTELLIDÆ.

- Acrolepia manganeutis*, Meyr.—India, Ceylon. Larva on stored yams.  
*Plutella maculipennis*, Curtis.—Throughout India, Burma, Ceylon.  
 Larva on cabbage, cauliflower, radish, mustard, candy-tuft and other cruciferous plants.

## LYONETIADÆ.

- Leucoptera sphenograptæ*, Meyr.—Plains of North India. Larva mining leaf of *Dalbergia sissu*.  
*Phyllocnistis chrysopteralma*, Meyr.—North Kanara. Larva mining leaf of *Cinnamomum zeylanicum*.  
*Phyllocnistis cirrhophanes*, Meyr.—North Kanara. Larva mining leaf of *Alseodaphne semecarpifolia*.  
*Phyllocnistis citrella*, Stainton.—India, Ceylon; ? Burma. Larva mining leaves of *Citrus* spp., *Egle marmelos*, *Murraya koenigii*, and *Jasminum sambac*.  
*Phyllocnistis habrochroa*, Meyr.—North Kanara. Larva mining leaves of "Chuli."  
*Phyllocnistis helicodes*, Meyr.—Pusa. Larva mining leaf of *Polyalthia longifolia*.  
*Phyllocnistis selcnopa*, Meyr.—Peradeniya. Larva mining leaf of *Melia azedarach*.  
*Phyllocnistis symglypta*, Meyr.—Dharwar. Larva mining leaf of small unidentified shrub.  
*Phyllocnistis toparcha*, Meyr.—Coimbatore. Larva mining leaf of grape-vine.  
*Badellia somnulentella*, Zeller.—Peshawar; North Coorg. Larva mines leaves of *Convolvulus*, *Ipomœa*, etc.  
*Crobylophora daricella*, Meyr.—India, Burma, Ceylon. Larva mining leaf of *Plumbago*.  
*Bucculatrix crateracma*, Meyr.—Pusa. Larva mining leaf of *Bombax malabaricum*.  
*Bucculatrix cœdrea*, Meyr.—India. Reared at Pusa from unidentified plant.  
*Bucculatrix leoxoptila*, Meyr.—Attur (Madras). Larva on leaves of Caravonica cotton.  
*Bucculatrix mendax*, Meyr.—Pusa. Pupa on leaf of *Dalbergia sissu*.  
*Bucculatrix verax*, Meyr.—Pusa. Larva on leaf of *Trewia nudiflora*.



- Petasobathra sirina*, Meyr.—North Bihar. Larva on top-shoots of indigo.
- Opogona chalinota*, Meyr.—India, Ceylon. Larva in dry stems of *Polypodium quercifolium*.
- Opogona flavofasciata*, Stainton.—India, Burma, Ceylon. Larva in fungus-comb of termites' nest.
- Opogona præincta*, Meyr.—Coimbatore. Associated with a termite.
- Opogona lachanitis*, Meyr.—Plains of India, Ceylon. Larva in fungus-comb of termites' nest.
- Opogona fumiceps*, Felder.—Ceylon. Larva on coconut.
- Erechthias zebрина*, Butler.—India, Ceylon. Larva probably a refuse feeder.
- Pylætis mimosa*. Stainton.—Plains of India and Ceylon. Larva in seed's of *Acacia arabica*, *Cassia fistula* and *C. corymbosa*.
- Decadarchis dissimulans*, Meyr.—Ceylon. Larva on dead bark and wood.
- Tischeria ptarmica*, Meyr.—Puri. Larva mining in leaf of *Zizyphus jujuba*.
- Opostega myxodes*, Meyr.—Pusa. Larva mining leaf of *Cordia myca*.

TINEIDÆ.

- Melasina energia*, Meyr.—Ceylon. Larva in tube in ground, feeding on dead leaves.
- Melasina granularis*, Meyr.—Peradeniya. Larva in tube, feeding on lichens.
- Melasina campestris*. Meyr.—Pusa. Larva in tube in ground, feeding on dead leaves.
- Myrmecozela leontina*, Meyr.—Kulu; North Bihar. Larva in tube in ground, feeding on dead leaves?
- Myrmecozela tincoides*, Wlsm.—Plains of India. Larva on dry tobacco leaves?
- Myrmecozela ? corticina*, Meyr.—Pusa. Larva boring bark of *Ficus bengalensis*.
- Machæroptervis halistrepta*, Meyr.—Plains of India and Ceylon. Larva in tube in ground, feeding on dead leaves?
- Hypophrictis inceptrix*, Meyr.—India, Ceylon. Larva in flat case, in nest of *Cremastogaster*.
- Hypophrictis ? plana*, Meyr. MS.—Pusa. Larva in flat case, on mango trunk.
- Hypophrictis* sp.—Pusa. Larva in flat case, in nest of *Polyrhachis*.
- Scardia sistrata*, Meyr.—India, Ceylon. Larva boring into fungus (*Polyporus* and *Fomes*).
- Eucrotala nucleata*, Meyr.—Assam. Bred from log of *Shorea robusta*.

- Hapsifera rugosella*, Stainton.—India, Ceylon. Larva boring in dead wood.
- Hapsifera seclusella*, Wlk.—India, Ceylon. Larva in farmyard manure.
- Setomorpha insectella*, Fb.—Throughout India, Ceylon, ? Burma. Larva on dead animal and vegetable matter.
- Latypica albofasciella*, Stainton.—Plains of India. Larva boring bark of *Ficus bengalensis*.
- Atabyria buccphala*, Snellen.—India. Larva boring in fungus.
- Elegistis cunicularis*, Meyr.—Ceylon. Larva tunnelling in dead wood.
- Lepidoscia globigera*, Meyr.—Ceylon (Hills). Larva in case, on lichens.
- Tinea opsigona*, Meyr.—Plains of India, Ceylon. Larva on animal horns ??
- Tinea frugivora*, Meyr.—Coimbatore ; Burma. Larva in dry fruits of *Trichosanthes*.
- Tinea pellionella*, Linn.—Throughout India, Ceylon, ? Burma. Larva in case, on woollen cloth, feathers, hair, etc.
- Tinea pachyspila*, Meyr.—Ceylon : Travancore. Larva in case, on flannel, fur, etc.
- Tinea fuscipunctella*, Haworth.—India. Larva in case, on dried fruit, in birds' nests, etc.
- Macræola inquisitrix*, Meyr.—Pusa. Larva in case, on dead insects, etc.
- Tinea bisselliella*, Hummel.—Peshawar. Larva on hair, wool, etc.
- Trichophaga abruptella*, Wollaston.—Throughout India. Larva on furs.
- Crypsithyris hypnota*, Meyr.—Peradeniya. Larva in case, on lichens.
- Crypsithyris longicornis*, Stainton.—Calcutta ; Pusa. Larva in case, feeding on lichens ?
- Crypsithyris mesodyas*, Meyr.—Peradeniya. Larva in case, on lichens.
- Monopis dicycla*, Meyr.—Ceylon ; Calcutta. Larva on woollen cloth.
- Monopis hemicitra*, Meyr.—Ceylon ; South India. Larva in Mantid egg-mass.
- Monopis monachella*, Hubner.—Throughout India, Burma, Ceylon. Larva amongst rubbish, in birds' nests, in skins, etc.

#### INCURVARIADÆ.

(There is only one doubtfully Indian species whose early stages are unknown.)

#### ADELIDÆ.

(No early stages of any Indian species are known.)

## NEPTICULIDÆ.

- Nepticula argyrodoxa*, Meyr.—Pusa. Larva mining leaf of *Desmodium* sp.  
*Nepticula isochalca*, Meyr.—Pusa. Bred from cocoons on leaves of  
*Phyllanthus emblica*.  
*Nepticula liochalca*, Meyr.—Pusa. Larva mining leaf of *Cyperus rotun-*  
 *dus*.

## MICROPTERYGIDÆ.

(Only one species of this Family has been discovered in India and its early stages are quite unknown.)

## 49.—EXHIBITION OF DRAWINGS, BY MAJOR F. C. FRASER, I.M.S., OF EARLY STAGES OF INDIAN BUTTERFLIES.

Last year Major Fraser very kindly sent me a note-book containing Mr. Fletcher  
a large number of coloured drawings of the early stages of Indian Butterflies. In some cases the complete life-history is shown and in many cases I think that we have no published information on these early stages.

50.—THE LIFE-HISTORY OF *ORTHEZIA INSIGNIS*.

(ABSTRACT.)

By K. KUNHI KANNAN, M.A., F.E.S., Senior Assistant Entomologist, Mysore.

This pest was discovered for the first time in the Nilgiris by a European planter in 1915. It was sent in for identification by Mr. Anstead. When it was determined as *Orthezia insignis*, it was decided to test the effect of its attack on *Lantana*. In the course of observations, the life-history was studied of which the following are the more important details. The insect moults three times, the interval between successive moults being roughly about two weeks. In about two to two and a half months the insect begins to reproduce, the total number of young produced varying from 80 to 110. The total period from hatching to death is about four and a half months.

The insect is not much attended by ants and the honey-dew is more of a solid nature and little in quantity. Transmission experiments on the lines described in the *Bulletin on Scale Insects of Coffee* (Dept. of Agri., Mysore) failed to induce the species of ants experimented with to carry the insect to their nests. The insect retards the growth of *Lantana* and finally kills it. One bush on which it was introduced, measuring about three feet high and four feet in diameter, was killed in three years.

There is reason to believe that when bushes are thick and adjoining, the effect will be accelerated. The insects failed repeatedly to thrive on coffee and tea-plants in pots. In more natural conditions it may catch on as it has done elsewhere.

Mr. Fletcher.

*Orthezia insignis* is not a very desirable insect to introduce even to reduce *Lantana*.

Mr. Ramakrishna Ayyar.

It is highly undesirable to bring in such insects. It is not found in India and we must be careful not to introduce it.

Mr. Kunhi Kannan.

It was not introduced.

Mr. Fletcher.

No; I know that it was not deliberately brought in to India. What I meant was that it is not desirable to spread it about in India.

Mr. Ramachandra Rao.

At Bangalore they were working out the life-history of *Orthezia*. I had the opportunity of going to Barwood Estate in the Nilgiris in 1917 and saw the planter there. He told me that in 1915 he saw that this scale had wiped out a hedge of *Lantana*. He sent specimens to Mr. Ainstead, who sent them on to Dr. Coleman at Bangalore. Dr. Coleman advised its immediate destruction, saying that it had a number of host-plants and was very dangerous. It was reported that the insect had been destroyed, but I found it still present in numbers on the *Lantana* bushes in 1917.

Mr. Ramakrishna Ayyar.

It is a very undesirable thing and even for experimental purposes it should not be introduced.

Mr. Fletcher.

It is a pity that these things are not reported at the time. Even for destruction of *Lantana* this Scale-insect is not very efficient. I remember seeing it on *Lantana* around Diyatalawa when I was in Ceylon about twelve years ago; and there it occurred in a patchy sort of way and, although it did check back the bushes actually attacked, it did not occur sufficiently generally to do any real good in checking *Lantana*.

## 51.—THE FUNCTION OF THE PROTHORACIC PLATE IN *BRUCHUS CHINENSIS*.

(ABSTRACT.)

By K. KUNHI KANNAN, M.A., F.E.S., *Senior Assistant Entomologist, Mysore.*

The function of the H-shaped chitinous plate in *Bruchus* has remained obscure ever since it was noticed first by Riley. There has been even some misapprehension that it was used by the Bruchid larva for excavation into the seed. It has, however, been proved that it has no direct share in boring. The structure stands on a movable fold on the prothorax and is thrust against the egg-shell which in *B. chinensis* is fixed on to the

seeds. This leaning of the process against the egg-shell is necessary, firstly because the larva has no functional legs and therefore cannot get a grip on the seeds to use the mandibles, secondly because the larva is so short and thick-set that it has no neck to bend the head, so that the bending of the head has to be effected by fixing the H-shaped structure at various angles. When it is fixed forward the mandibles work on the hind end of the hole. When fixed behind the head is freer and the mandibles work on the front side of the hole. For deeper excavations the process is fixed along the rim of the hole at a point from which the head works on either side. The structure appears to vary a good deal in different species of store—as well as free-living forms and, before a study of the various forms is made and correlated with the habits of the species concerned, the account of the function of the structure in the genus cannot be said to be complete. Attempts in this direction are being made in Mysore.

## 52.—SOME INSECT PREY OF BIRDS IN THE CENTRAL PROVINCES.

By E. A. D'ABREU, F.Z.S., *Curator of the Central Museum, Nagpur.*

While making a representative collection of the avifauna of the Central Provinces for the Nagpur Museum, I made it a point to record the contents of the entire alimentary canal of almost every specimen secured. Six hundred birds were thus examined and a list of the contents of their stomachs has been published in No. II of the *Records of the Nagpur Museum*. I now intend to give a list of the insects taken by the various birds and also a list of the birds examined which included insects in their dietary.

### ORTHOPTERA.

*Forficulidæ*.—Fourteen species of birds had taken these insects, namely, the Pied Myna, a flycatcher, a chat, two wagtails, the Hawk-Cuckoo, a water-hen (*A. phoenicurus*), two plovers, two sandpipers and a spoonbill. The Black Ibis and the Spotted Owlet pa took of these insects more freely. The Earwig taken from Tickell's Blue Flycatcher was *Labidura riparia*.

*Blattidæ*.—Cockroaches were noticed in the stomach of a Grey Hornbill and repeatedly in those of the Yellow-fronted Pied Woodpecker.

*Mantidæ*.—Mantids were taken from seven birds including *Dicrurus ater* and *Acrocephalus stentoreus*. Of identified species *Humbertiella indica* was taken by *Sylvia jerdoni*. *Hierodula westwood* by the Grey

Hornbill, Pied Crested Cuckoo and Jungle Owlet; and *Schizocephalus bicornis* by the Cattle Egret.

*Acrididae*.—Locusts and short-horned grass-hoppers are, as is well known, eaten by most insectivorous birds. They were taken by all or most of the species of Babblers, Warblers, Shrikes, Wagtails, smaller Owls; by some of the Drongos, Thrushes, Chats, Pipits; Cuckoos; Harriers; Herons; Egrets; Ibises; by the Roller; Bee-eater; Pitta; Buzzard Eagle and Kestrel; and to a lesser extent by a water-hen and Jungle fowl.

As a destroyer of grass-hoppers, I think the Cattle Egret would come a good first, although much of his hunting is done near tanks. A second place would perhaps be given to the Buzzard Eagle, the Harriers, the Kestrel, the Roller, the smaller Owls, the Common Myna and the Black Drongo.

*Tetriginæ*. The *Tetriginæ* were all taken by water-haunting birds, e.g., the Whistling Thrush, the Swallow, four Wagtails and two Egrets.

*Tryxalinæ*. *Tryxalis turrata* or allied forms were taken by the White-eyed Buzzard Eagle and the Cattle Egret.

*Epacromia dorsalis* by *Dissemurus paradiseus* and *Glaucidium radiatum*.

*Oedipodinæ*. *Oedaleus (Gastrimargus) marmoratus* was taken by the Roller, Jungle Owlet, Montagu's Harrier and the Black Ibis; other *Oedipodinæ* were noticed in the Swallow, Sirkeer Cuckoo and grey Jungle Fowl.

*Pyrgomorphinæ*. *Atractomorpha crenulata* and species of *Chrotogonus* were taken in quantity by the Buzzard-Eagle and Cattle Egret. *Chrotogonus trachypterus* was identified from the Roller. *Dicrurus ater* and *Petrophila cyaneus* also accounted for *Chrotogonus*.

*Acridinæ*. *Acridinæ* were observed in 21 species of birds. The genus *Catantops* was taken by the Kestrel and Jungle Owlet. The species *Cyrtacanthacris ranacea* by the Sirkeer Cuckoo, Coucal, Montagu's Harrier, Kestrel and Cattle Egret. *Teratodus monticollis* by the Coucal, and species of *Oxya* by the Common Myna and the Indian Wren Warbler.

*Locustidæ*. Locustids were taken by the Bulbul (*M. hæmorrhous*), two Warblers, two Shrikes and the Cattle Egret. *Conocephalus indicus* was found in *Lanius lahtora*.

*Gryllidæ*. Crickets, excluding mole-crickets, were eaten by the following birds:—Grey Wagtail, Grey-headed Wagtail, Indian Pitta, Crested Swift, Buzzard Eagle, Spotted Owlet, Common Sandpiper, Spoonbill, Black Ibis, Cattle Egret and Pond Heron. *Tridactylinæ* were taken by *Motacilla melanope*; *Gryllodes* sp. by the Pitta, Black Ibis, Cattle Egret and Pond Heron; *Brachytrypes* sp. by the Spotted Owlet

and Black Ibis and *Liogryllus bimaculatus* by the Black Ibis. Mole-cricket ( *Gryllotalpa africana* ) were taken by the Pied Myna, Indian Pitta, Spotted Owlet, Brown Crake, Common Sandpiper, Cattle Egret and to a great extent by the Black Ibis.

#### NEUROPTERA.

*Termitidæ*. Termites were taken by the following birds and the first four appear to be more partial to them:—*Acridotheres tristis*, *Galloperdix spadicea*, *Cursorius coromandelicus*, *Sarcogrammus indicus*, *Cyornis tickelli*, *Anthus compestris*. *Mirafra erythroptera*, *Brachypternus aurantius*, *Gallus sonnerati*, *Perdicula asiatica*, *Turnix pugnaz*, and *Dicrurus ater*. Winged individuals were only taken by the Drongo.

*Odonata*. Adult Dragon-flies were taken by but four species of birds:—the Malabar Whistling Thrush, two Bee-eaters and a Hobby. Adult Agrionids by the Black-naped Flycatcher, Grey Wagtail and Pond Heron.

Dragonfly nymphs of the family Anisoptera were taken by most water-frequenting birds as listed below, viz., Grey Wagtail, Blue-headed Wagtail, Spur-winged Plover, Wood Sandpiper, Greenshank, Ruff, Common Snipe, Pintail Snipe, White Ibis, Spoonbill, White-necked Stork, Eastern Purple Heron, Large Egret, Cattle Egret, Pond Heron, Brahminy Duck, Little Grebe.

Agrionid nymphs were taken by the following:—Wood Sandpiper, Marsh Sandpiper, Cattle Egret, Little Grebe.

*Ephemeridæ*. Ephemerid nymphs were taken by *Gallinago cælestis*

#### HEMEROBIDÆ.

*Chrysopinæ*. A species of *Chrysopa* was taken by Franklin's Nightjar and a *Chrysopa* larva by the Little Ringed Plover.

#### HYMENOPTERA.

Hymenoptera (ants excluded), chiefly of small size, were found in the stomachs of the following birds:—*Machlophus haplonotus*, *Dumetia hyperythra*, *Alcippe phæocephala*, *Dicrurus ater*, *D. longicaudatus*, *Dissemurus paradiseus*, *Hypolais rama*, *Prinia socialis*, *P. inornata*, *Lanius nigriceps*, *Tephrodornis pondicerianus*, *Graucalus macii*, *Acridotheres tristis*, *Alseonax latirostris*, *Terpsiphone paradisi*, *Rhipidura albifrontata*, *Petrophila cinclorhyncha*, *Hirundo nepalensis*, *Motacilla personata*, *M. citreola*, *Anthus rufulus*, *Merops viridis*, *Lophoceros birostris*, *Macropteryx coronata*, *Caprimulgus monticola*, *Athene brama*, *Pernis cristatus* and *Falco subbuteo*.

Ichneumons, Cuckoo Wasps (*Chrysis fuscipennis*) and Pompilids, including *Salix flavus*,\* were taken by the Racket-tailed Drongo and other Fossores by *Alcippe phaecephala*. *Polistes hebraeus* was also taken by *Dissemurus paradiseus* and *Eumenes conica* by a Grey Hornbill.

*Apidae*. Bees were taken by *Merops viridis*, *Dicrurus longicaudatus*, *Pernis cristatus* and *Macropteryx coronata*. *Apis florea*, *A. dorsata*, and *Anthophora confusa* were all taken by *Merops viridis*, and *Apis florea* by *Macropteryx coronata*.

*Formicidae*. Ants were found in the stomachs of 42 species of birds, chiefly Crows, Babblers, Warblers, Shrikes, Drongos, Wagtails, Chats, Thrushes, Swallows, Flycatchers, Larks and Pipits. They were taken to a greater extent by all the Wood-peckers, the Wryneck, the Red Spur-fowl, the Common Myna and the Pied Bush Chat.

*Ponerinae*. These ants were observed in *Hirundo nepalensis*, and *Lobopelta ocellifera* was observed in *Lanius erythronotus* and *Pavo cristatus*.

*Myrmecinae*. *Cremastogaster subnuda* was taken by *Argya caudata*, *Brachypternus aurantius*, *Lynx torquilla* and other myrmecine species by *Cyornis superciliaris*, *Dicrurus ater*, *Hirundo nepalensis*, *Alauda gulgula* and *Platalea leucorodia*.

*Camponotinae*. *Camponotus compressus* was taken by *Corvus splendens*, *Argya malcolmi*, *Crateropus canorus*, *Sylvia jerdoni*, *Tememichus pagodarum*, *Acridotheres tristis*, *Siphia parva*, *Cyornis tickelli*, *Pratincola caprata*, *Petrophila cyaneus*, *Pitta brachyura*, *Brachypternus aurantius*, *Galloperdix spadicea*, *Amaurornis phaeicurus*, *Ibis melanocephala* and *Pseudotantalus leucomelanus*; *C. irritans* was taken by *Cyornis superciliaris*, *Gecinus striolatus* and *Brachypternus aurantius*; other species of *Camponotus* were taken by *Dissemurus paradiseus* and *Sylvia affinis*.

*Ecophylla smaragdina* was taken by *Sturnia malabarica*, *Cyornis tickelli* and *Brachypternus aurantius*, and *Polyrachis* by *Dumetia hyperythra*.

#### COLEOPTERA.

Coleoptera, either in the adult, larval, or pupal stages, were found in the stomachs of 108 species of birds.

*Cicindelida*. Tiger-beetles were taken by but four birds, namely, *Aegialitis dubia*, *Inocotis papillosus*, *Ardeola grayi* and *Podiceps albipennis*.

*Carabidae*. Carabidae were found in the following birds:—*Dicrurus ater*, *Lanius erythronotus*, *Cyornis tickelli*, *Hirundo nepalensis*, *Motacilla personata*, *Anthus rufulus*, *Pitta brachyura*, *Coracias indica*, *Macropteryx coronata*, *Amaurornis akool*, *Totanus hypoleucus*, *Inocotis papillosus*, *Pseudotantalus leucocephalus* and *Podiceps albipennis*. Of identified



species *Scarites indus* was taken by *Coracias indica*; *S. semirugosus* by *Inocotis papillosus*; *Clivina striata* by *Pseudotantalus leucocephalus*; *Malenus* sp. by *Dicrurus ater* and *Coracias indica*; *Platymetopus* (?) *erebius* by *I. papillosus*; *Chlanius hamifer* by *Cyornis tickelli*; *Ch. marginifer* by *I. papillosus* and *P. leucocephalus*; *Ch. circumdatus*, *Ch. rugulosus*, *Ch. nigricans*, *Ch. chalthorax*, *Phacopsophus cardoni*, *Ph. catoirei* and *Ph. occipitalis* by *Inocotis papillosus*.

*Halipidæ*. *Haliphus angustifrons* was taken by *Nyroca ferruginea* and *Podiceps albipennis*.

*Dytiscidæ*. *Dytiscids* were taken by *Macropteryx coronata*, *Egialitis dubia*, *Totanus glareola*, *T. stagnatilis*, *Gullinago caelestis*, *Ibis melanocephala*, *Inocotis papillosus*, *Platalea leucorodia*, *Ardeola grayi*, *Pseudotantalus leucocephalus*, *Dissura episcopus* and *Podiceps albipennis*.

*Laccophilus anticatus* was taken by *T. glareola* and *P. albipennis*; *Cybister confusus* by *D. episcopus* and *P. leucocephalus*; *Cybister tripunctatus* by *Ibis melanocephala*; species of *Cybister* were also taken by *P. leucorodia* and *P. leucocephalus*; *Hypophorus ater* and *Eretes sticticus* were taken by *P. leucorodia* and the larvæ of *Hylaticus* and *Cybister* by *Ardeola grayi*.

*Staphylinidæ*. *Pæderus* sp. was taken by *Motacilla madraspatensis* and other species by *M. personata* and *Macropteryx coronata*.

*Silphidæ*. A Silphid grub was noticed in the stomach of *Motacilla melanope*.

*Cucujidæ*. A specimen was noticed in *Dissemurus paridis* us.

*Cryptophagidæ*. These beetles were taken by *Hirundo rustica*.

*Coccinellidæ*. *Chilomenes sexmaculata* was found in *Aegithina tiphia* and *Molpastes hæmorrhous*; *Thea cincta* in *Sylvia affinis*; *Scymnus* sp. in *Prinia socialis*, *Cotile sinensis* and *Macropteryx coronata*.

*Dermestidæ*. A grub was identified from the stomach of *Inocotis papillosus*.

*Byrrhidæ*. A specimen had been taken by *Liopicus maharattensis*.

*Hydrophilidæ*. *Berosus decrescens* was found in *Motacilla melanope*; *Hydrophilus olivaceus* in *Ibis melanocephala*, *Inocotis papillosus*, *Platalea leucorodia*, *Dissura episcopus*; and other Hydrophilids were seen in *Totanus hypoleucus*, *T. stagnatilis*, *Pavonilla pugnax* and *Podiceps albipennis*.

*Cantharidæ*. A firefly was found in the stomach of *Herodias alba*, but it was most probably first eaten by a frog.

*Cleridæ*. *Necrobia rufipes* was found in *Orthotomus sutorius*.

*Buprestidæ*. Buprestids had been taken by *Dendrocitta rufa*, *Argya malcomi*, *Aegithina tiphia*, *Chloropsis jerdoni*, *Lanius nigriceps*, *Graucalus*

*maei*, *Temenuchus pagodarum*, *Lophoceros birostris* and *Glaucidium radiatum*.

*Elateridae*. Click-beetles occurred in *Lanius lahtora*, *Temenuchus pagodarum*, *Rhipidura pectoralis*, *Hirundo nepalensis*, *Motacilla citreola*, *Pitta brachyura*, *Inocotis papillosus* and *Platalea leucorodia*. *Laeon* sp. occurred in *Amaurornis phaeicurus*, and Elaterid grubs were found in *Acridotheres tristis*, *Cuculus canorus*, *Centropus sinensis*, *Sarcogrammus indicus* and *Gallinago coelestis*.

*Tenebrionida*. *Platynotus perforatus* was found in *Lanius lahtora*; *Opatrum depressum* in *Oriolus kundoo* and *Thamnobbia c mbaicensis*; other species of *Opatrum* in *Petrophila cyanus*. *Pitta brachyura* and a larva in *Inocotis papillosus*. *Rhytinota impolita* was seen frequently in *Petrophila cyanus* and *Inocotis papillosus* and other Tenebrionids in *Mixornis rupricapillus*, *Lanius nigriceps*, *Motacilla melanope* and *Bubulcus coromandus*.

*Anthicida*. These small beetles were seen in *Motacilla melanope*.

*Lariada*. *Bruchus* sp. was taken by *Arachnechthra zeylonica* and *Perdicula asiatica*; *Sperophagus* sp. by *Cyanecula suecica*; other Bruchids by *Pyctorhis sinensis*, *Hypolaïs rama* and *Macropteryx coronata*.

*Chrysomelida*. These beetles were found in 22 species of birds. *Cassidinae* were noticed in the Swallow, as well as *Nodostoma* sp. and *Cocassida pardi unda*. *Scelodonta* sp. was noticed in *Dumetia hyperythra* and *Cryptocephalus schestedi* in *Prinia inornata* and *Hirundo rustica*. Flea beetles. *Chatoxema* sp. had been eaten by *Cisticola cursorans*, *Prinia socialis*, *Hypolaïs rama*, *Motacilla madagaspatensis*, *M. citreola*, *M. melanope* and *Podiceps albipennis*.

*Cerambycida*. Longicorn grubs had been taken by *Liopicus mah-rattensis* and *Iyngipicus hardwickii*, and a single small Longicorn was found in *Podiceps albipennis*.

*Curculionida*. Weevils had been eaten by 28 species of birds. Species of *Apion* alone were found in 18 stomachs, chiefly Bblers, Warblers, Swallows, Wagtails and Sandpipers.

Species of *Tanymericus* were found in *Dierurus ater*, *Graucalus maei*, *Ibis melanocphala* and *Platalea leucorodia*; *Mylloceris* in *Acrocephalus dumetorum*, and *Lixus brachyrrhinus* in *Graucalus maei*.

*Scarabaeida*. Coprids were noticed in 23 species of birds, chiefly Drongos, Shrikes, Mynas, Thrushes, Swallows, Wagtails, Bee-eaters, Nightjars, Owls, the Hobby, Plovers, Sandpipers, Water-hens, the Spoonbill and the Cattle Egret.

*Onthophagus* sp. was noticed in *Acridotheres tristis*, *Pitta brachyura*, *Caprimulgus meulicola*, *Amaurornis phaeicurus*, *Sarcogrammus indicus*, and *Platalea leucorodia*; *Gymnopleurus* sp. in *Glaucidium radiatum* and

*A. phænicurus*; *Heliocoprís* sp. in *Bubo bengalensis*; *Trox* sp. in *Caprimulgus monticola* and *Rhyssenus* sp. in *Amaurornis akool*. The Dynastid, *Heteronychus lioderes*, was taken by *Inocotis papillosus* and *Bubulcus coromandus*. Melolonthids were noticed in *Glaucidium radiatum* and Melolonthid larvæ were noticed twice in *Inocotis papillosus*; in one instance as many as 101 specimens were taken.

#### LEPIDOPTERA.

Caterpillars had been eaten by 58 species of birds. These were the Tree-pie, 2 species of Tits, 4 Babblers, the Iora, Chloropsis, one Bulbul, 2 Drongos, 6 Warblers, 1 Creeper, 6 Shrikes, 3 Mynas, an Oriole, a Flycatcher, 2 Chats, the Baya, 4 Wagtails, 2 Pipits, 3 Sunbirds, the Pitta, 4 Woodpeckers, 5 Cuckoos, 1 Owl, 1 Dove (a single instance), the Stone-curlew, Greenshank, Spoonbill, Pond Heron and Grebe. Hairy caterpillars were taken by *Lanius nigriceps*, *Cuculus canorus*, *Hierococcyx varius* and *Taccocua leschenaulti*. Of identified families Arctiade were taken by *Cuculus canorus*; Lymantriade by *Hierococcyx varius*; Pyralide by *Campophaga sykesi*, *Oriolus melanocephala*, *Cuculus canorus* and *Cisticola cursitans*; Cosside by *Liopicus mahrattensis* and *Brachypternus aurantius*; Noctuidæ by *Machlolophus haplonotus*, *Dicrurus ater*, *Cyornis tickelli*, *Graucalus macii*, *Cyanecula suecica* (*Agrotis* sp.), *Anthus rufulus*, *Pitta brachyura* and *Brachypternus aurantius*; Geometridæ by *Aleippe phæocephala*, *Dicrurus ater*, *Cisticola cursitans*, *Tephrodornis pondicerianus*, *Campophaga sykesi*, *Cuculus canorus* and *Glaucidium radiatum*. A Lycænid caterpillar was taken by *Ædicnemus scolopax*. Adult Lepidoptera were found in only a few cases. *Phylloscopus affinis* and *Caprimulgus monticola* had taken moths which could not be identified. Noctuids were noticed in *Prinia socialis* and *Caprimulgus monticola*; Pyralids in *Perecrocotus erythropygus*; Geometrids in *Campophaga sykesi*; Arctiade in *Alseonax latirostris* and Sphingidæ in *Dicrurus ater* and *Coccytes jacobinus*. A Drongo was seen taking a Tasar moth on the wing.

Pupæ had been eaten by *Chloropsis jerdoni*, *Salpornis pilonotus* and *Coccytes jacobinus*, and batches of insect eggs were found in *Parus atriceps*, *Argya malcolmi*, *Aegithina tiphia*, *Sturnopastor contra*, *Motacilla melanope*, *Anthus rufulus*, *Caprimulgus monticola* and *Taccocua leschenaulti*.

#### DIPTERA.

Diptera were taken by 34 species of birds, chiefly Warblers, Flycatchers, Swallows, Wagtails, the Bee-eater, Cattle Egret and a few others. Maggots were repeatedly found in quantity in *Corvus splendens*

and other dipterous larvæ in three Wagtails, two Thrushes and the Black Ibis.

*Mycetophilidæ*. Fungus-gnats had been taken by *Æthopyga seheriae*.  
*Stratiomyidæ*. *Sargus* sp. was taken by *Ibis melanocephala*.

*Tabanidæ*. *Chrysops dispar* was taken by *Tephrodornis pondicerianus* and *Rhipidura pectoralis*; *Tabanus rubidus* by *Bubulcus coromandus*; other Tabanids were taken by *Motacilla maderaspatensis* and *B. coromandus*.

*Chloropidæ*. These flies were taken by *Hirundo rustica*.

*Diopsidæ*. These were taken by *Podiceps albipennis*.

*Trypetidæ*. *Trypetidæ* were taken by *Copsychus saularis* and the larvæ by *Prinia socialis* and *C. saularis*.

*Ortalidæ*. These flies were noticed in *Podiceps albipennis*.

*Anthomyidæ*. *Ardcola grayi* partook of these flies freely.

*Muscidæ*. *Pyenosoma flaviceps* was taken by *Terpsiphone paradisi* and other blue-bottles by *Alseonax latirostris*, *Culicicapa ceylonensis* and *Meropis viridis*. *Musca domestica* is eaten by *Motacilla maderaspatensis* and *Bubulcus coromandus* and other Muscids were found in most of the Flycatchers (*A. latirostris*, *C. ceylonensis*, *T. paradisi*, *R. pectoralis*) and *Bubulcus coromandus*. Muscid larvæ are much taken off carrion by Crows.

*Tachinidæ*. *Tachinidæ* were taken by *Terpsiphone paradisi*.

*Hippoboscidæ*. A specimen was noticed in the stomach of *Astur badius*.

#### RHYNCHOTA.

*Pentatomidæ*. Pentatomids seem a favourite diet with birds. *Halys dentatus* was taken by *Tephrodornis pondicerianus*, *Brachypternus aurantius* and *Lophoceros birostris*; *Eusarcocoris* sp. by *Cisticola cirsitans*; *Coptosoma indicum* by *Prinia socialis*; *Cydnius* sp. by *Macropteryx coronata*; *Geotomus* sp. by *Hirundo erythropygia* and *M. coronata*, and other Pentatomids by the following birds.—*Dendrocitta rufa*, *Argya malcolmi*, *Dumetia hyperythra*, *Pyctorhis sinensis*, *Aegithina tiphia*, *Dissommus paradiscus*, *Orthotomus sutorius*, *Lanius nigriceps*, *Percorotus rosus*, *Graucalus macii*, *Sturnia malabarica*, *Temenuchus pagodarum*, *Sturnopastor contra*, *Petrophila cincloryncha*, *Motacilla maderaspatensis*, *M. melanope*, *M. borealis*, *Anthus rufulus*, *Glaucidium radiatum*, *Francoelinus pondicerianus*, *Amiavornis akool*, *Platalca leucorodia*, *Herodias alba* and *Bubulcus coromandus*.

*Coreidæ*. These bugs were noticed in *Orthotomus sutorius* and *Pitta brachyura*.

*Lygaeidæ*. *Lygatus hospes* was taken by *Francoelinus pondicerianus* and other Lygaeidæ by *Franklinia gracilis* and *Motacilla maderaspatensis*.

*Pyrrhocoridae*. *Dysdercus cingulatus* was taken by *Molpastes hæmorrhoides* and other bugs of this family by *Inocotis papillosus*.

*Hydrometridae*. *Gerris* sp. was taken by *Myiophonus horsfieldi* and *Podiceps albipennis* and other *Hydrometrids* by *Motacilla melanope*.

*Reduviidae*. *Ectomocoris cordiger* was taken by *Inocotis papillosus* and other *Reduviids* by *Anthus campestris*.

*Cimicidae*. A bed-bug was found in the stomach of *Acridotheres tristis*.

*Nepidae*. *Laccotrephes ruber* was taken by *Ibis melanocephala* and *Dissura episcopus*, and *Ranatra filiformis* by *Podiceps albipennis*.

*Naucoridae*. *Heleocoris* sp. was taken by *Inocotis papillosus*.

*Belostomidae*. *Belostoma indica* was taken by *Botaurus stellaris*, and *Sphaerodema annulatum* by *Grus antigone*.

*Notonectidae*. *Enithares* sp. was taken by *Myiophonus horsfieldi* and *Platalea leucorodia*, *Anisops* sp. by *Platalea leucorodia*; *Notonectids* were also taken by *Pseudotantalus leucocephalus*, *Ardeola grayi* and *Spatula clypeata*.

*Corixidae*. These were taken by *Motacilla citreola*.

*Fulgoridae*. Fulgorids were observed in the stomachs of *Phylloscopus affinis*, *Cotile sinensis* and *Anthus maculatus*.

*Membracidae*. Membracids were eaten by *Phylloscopus affinis*, *Prinia inornata*, *Hirundo rustica*, *H. nepalensis* and *Brachypternus aurantius*.

*Cercopidae*. Cercopids were taken by *Acanthopneuste viridanus*.

*Jassidae*. Jassids were noticed in *Maxiornis rubricapillus*, *Terpsiphone paradisi*, *Piprisoma squalidum*, and *Macropteryx coronata*.

*Aphididae*. Aphids were taken by *Pyctorhis sinensis*, *Hirundo nepalensis*, *Motacilla citreola*, *Aethopyga seheriae* and *Liopicus maharattensis*.

#### ARACHNIDA.

Spiders had been taken by 34 species of birds, a False-scorpion (*Chernetidae*) by *Salpornis spilonotus* and the mite *Trombidium grandissimum* by *Corvus macrorhynchus*. Of ticks *Hyalomma aegyptium* was found in *Corvus splendens* and *C. macrorhynchus* and *Boöphilus australis* in *Acridotheres ginginianus*.

Insectivorous or partially insectivorous birds inhabiting the Central Provinces which were examined.

1. *Corvus splendens*—Indian Crow.
2. *Dendrocitta rufa*—Indian Tree Pie.
3. *Parus atriceps*—Indian Grey Tit.
4. *Machlolophus haplonotus*—Southern Yellow Tit.

5. *Argya caudata*—Common Babbler.
6. *Argya malcolmi*—Large Grey Babbler.
7. *Crateropus canorus*—Jungle Babbler.
8. *Dumetia hyperythra*—Rufous-bellied Babbler.
9. *Pyctorhis sinensis*—Yellow-eyed Babbler.
10. *Alcippe phaeocephala*—Nilgiri Babbler.
11. *Mixornis rubricapillus*—Yellow-breasted Babbler.
12. *Myiophonus horsfieldi*—Malabar Whistling Thrush.
13. *Aegithina tiphia*—Common Iora.
14. *Chloropsis jerdoni*—Jerdon's Chloropsis.
15. *Molpastes hamorrhous*—Madras Red-vented Bulbul.
16. *Sitta castaneiventris*—Chestnut-bellied Nuthatch.
17. *Dicrurus ater*—Black Drongo.
18. *Dicrurus longicaudatus*—Indian Ashy Drongo.
19. *Dissemurus paradiseus*—Larger Racket-tailed Drongo.
20. *Salporius sponota*—Spotted-grey Creeper.
21. *Acrocephalus stentoreus*—Indian Great Reed Warbler.
22. *A. dumetorum*—Blyth's Reed Warbler.
23. *Orthotomus sutorius*—Indian Tailor Bird.
24. *Cisticola cursitans*—Rufous Fantail-Warbler.
25. *Franklinia gracilis*—Franklin's Wren-Warbler.
26. *Hypolais rama*—Sykes's Tree-Warbler.
27. *Sylvia jerdoni*—Eastern Orphean Warbler.
28. *Sylvia affinis*—Indian Lesser White-throated Warbler.
29. *Phylloscopus affinis*—Tickell's Willow-Warbler.
30. *Acanthopneuste viridanus*—Greenish Yellow-Warbler.
31. *Prinia socialis*—Ashy Wren Warbler.
32. *P. inornata*—Indian Wren Warbler.
33. *Lanius lahtora*—Indian Grey Shrike.
34. *L. nigriceps*—Black-headed Shrike.
35. *L. erythronotus*—Rufous-backed Shrike.
36. *Tephradornis pondicerianus*—Common Wood-shrike.
37. *Pericrocotus roseus*—Rosy Minivet.
38. *P. peregrinus*—Small Minivet.
39. *P. erythropygus*—White-bellied Minivet.
40. *Campophaga melanoschista*—Dark-grey Cuckoo-shrike.
41. *C. sykesi*—Black-headed Cuckoo-shrike.
42. *Graucalus macii*—Large Cuckoo-shrike.
43. *Oriolus kundoo*—Indian Oriole.
44. *O. melanocephalus*—Indian Black-headed Oriole.
45. *Sturnus menzbieri*—Common Indian Starling.
46. *Sturnia malabarica*—Grey-headed Myna.

47. *Temenuchus pagodarum*—Black-headed Myna.
48. *Acridotheres tristis*—Common Myna.
49. *Sturnopastor contra*—Pied Myna.
50. *Siphia parva*—European Red-breasted Flycatcher.
51. *Cyornis superciliaris*—White-browed Blue Flycatcher.
52. *Cyornis tickelli*—Tickell's Blue Flycatcher.
53. *Alseonax latirostris*—Brown Flycatcher.
54. *Culicicapa ceylonensis*—Grey-headed Flycatcher.
55. *Terpsiphone paradisi*—Indian Paradise Flycatcher.
56. *Hypothymis azurea*—Indian Black-naped Flycatcher.
57. *Rhipidura albifrontata*—White-browed Fantail Flycatcher.
58. *R. pectoralis*—White-spotted Fantail Flycatcher.
59. *Pratincola caprata*—Common Pied Bush Chat.
60. *P. maura*—Indian Bush Chat.
61. *Cercomela fusca*—Brown Rock Chat.
62. *Cyanecula suecica*—Indian Blue Throat.
63. *Thamnobia cambaiensis*—Brown-backed Indian Robin.
64. *Copsychus saularis*—Magpie Robin.
65. *Geocichla cyanonotus*—White-throated Ground Thrush.
66. *Petrophila cinclorhyncha*—Blue-headed Rock Thrush.
67. *P. cyaneus*—Western Blue Rock Thrush.
68. *Ploceus baya*—The Baya.
69. *Cotile sinensis*—Indian Sand Martin.
70. *Hirundo rustica*—The Swallow.
71. *H. nepalensis*—Hodgson's Striated Swallow.
72. *H. erythrogygia*—Sykes's Striated Swallow.
73. *Motacilla alba*—White Wagtail.
74. *M. personata*—Masked Wagtail.
75. *M. maderaspatensis*—Large Pied Wagtail.
76. *M. melanope*—Grey Wagtail.
77. *M. borealis*—Grey-headed Wagtail.
78. *Motacilla beema*—Indian Blue-headed Wagtail.
79. *M. citreola*—Yellow-headed Wagtail.
80. *Anthus maculatus*—Indian Tree-Pipit.
81. *A. rufulus*—Indian Pipit.
82. *A. campestris*—Tawny Pipit.
83. *Mirafra erythroptera*—Red-winged Bush Lark.
84. *Galerita deva*—Sykes's Crested Lark.
85. *Ammomanes phænicura*—Rufous-tailed Finch Lark.
86. *Aethopyga seheriae*—Himalayan Yellow-backed Sun Bird.
87. *Arachnechthra asiatica*—Purple Sun Bird.
88. *A. zeylanica*—Purple-rumped Sun Bird.

89. *Piprisoma squalidum*—Thick-billed Flower Pecker.
90. *Pitta brachyura*—Indian Pitta.
91. *Gecinus striolatus*—Little Scaly-billed Green Woodpecker.
92. *Liopicus mahrattensis*—Yellow-fronted Pied Woodpecker.
93. *Iyngipicus hardwickii*—Indian Pigmy Woodpecker.
94. *Brachypternus aurantius*—Golden-backed Woodpecker.
95. *Chrysocolaptes festivus*—Black-backed Woodpecker.
96. *Iynx torquilla*—Common Wryneck.
97. *Coracias indica*—Indian Roller.
98. *Merops viridis*—Common Indian Bee-Eater.
99. *Lophoceros birostris*—Common Grey Hornbill.
100. *Macropteryx coronata*—Indian Crested Swift.
101. *Caprimulgus monticola*—Franklin's Nightjar.
102. *Cuculus canorus*—The Cuckoo.
103. *C. poliocephalus*—Small Cuckoo.
104. *Hierococcyx varius*—Common Hawk Cuckoo.
105. *Coccyzus jacobinus*—Pied Crested Cuckoo.
106. *Taccocua leschenaulti*—Siikeer Cuckoo.
107. *Centropus sinensis*—The Coucal.
108. *Bubo bengalensis*—Rock Horned Owl.
109. *Athene brama*—Spotted Owlet.
110. *Glaucidium radiatum*—Jungle Owlet.
111. *Ninox scutulata*—Brown Hawk-Owl.
112. *Butastur teesa*—White-eyed Buzzard-Eagle.
113. *Circus cineraceus*—Montagu's Harrier.
114. *Astur badius*—The Shikra.
115. *Pernis cristatus*—Crested Honey-Buzzard.
116. *Falco subbuteo*—The Hobby.
117. *Tinnunculus alaudarius*—The Kestrel.
118. *Turtur suratensis*—Spotted Dove.
119. *Pavo cristatus*—Common Peafowl.
120. *Gallus sonnerati*—Grey Jungle Fowl.
121. *Galloperdix spadicea*—Red Spur Fowl.
122. *Perdicula asiatica*—Jungle Bush Quail.
125. *Amawornis akool*—Brown Crane.
126. *A. phœnicurus*—White-breasted Water Hen.
127. *Gallinula chloropus*—The Moorhen.
128. *Grus antigone*—The Sarus.
129. *Œdicnemus scolopax*—Stone Curlew.
130. *Cursorius coromandelicus*—Indian Courser.
131. *Sarcogrammus indicus*—Red-wattled Lapwing.
132. *Hoplopterus ventralis*—Spur-winged Plover.



133. *Ægialitis dubia*—Little Ringed Plover.
134. *Himantopus candidus*—Black-winged Stilt.
135. *Totanus hypoleucus*—Common Sandpiper.
136. *T. glareola*—Wood Sandpiper.
137. *T. ochropus*—Green Sandpiper.
138. *T. stagnatilis*—Marsh Sandpiper.
139. *T. fuscus*—Spotted Redshank.
140. *T. glottis*—Greenshank.
141. *Pavoncella pugnax*—The Ruff.
142. *Tringa temminckii*—Temminck's Stint.
143. *Gallinago caelestis*—Common Snipe.
144. *G. gallinula*—Jack Snipe.
145. *Ibis melanocephala*—White Ibis.
146. *Inocotis papillosus*—Black Ibis.
147. *Platalea leucorodia*—The Spoonbill.
148. *Dissura episcopus*—White-necked Stork.
149. *Pseudotantalus leucocephalus*—Painted Stork.
150. *Ardea manillensis*—Eastern Purple Heron.
151. *Herodias alba*—Large Egret.
152. *Bubulcus coromandus*—Cattle Egret.
153. *Ardeola grayi*—Pond Heron.
154. *Arletta cinnamomea*—Chestnut Bittern.
155. *Botaurus stellaris*—The Bittern.
156. *Casarca rutila*—Brahminy Duck.
157. *Nettion coromandelianus*—Cotton Teal.
158. *Nettion crecca*—Common Teal.
159. *Spatula clypeata*—The Shoveller.
160. *Nyroca ferruginea*—White-eyed Duck.
161. *Podiceps albipennis*—Indian Little Grebe.

In this paper Mr. D'Abreu has given us a careful enumeration of **Mr. Fletcher's** the actual insects found in all the birds which occur commonly in the Central Provinces. Work of this sort is tedious and difficult and there is a great deal of room for more work on the same lines, all over India. The only similar work done previously was that done by Mr. Mason and published in Volume III of our Entomological Memoirs. I notice that Mr. D'Abreu has found no butterflies (or at least no identifiable remains) in any of his birds. The question of the attack on butterflies by birds is one in which we require further records, especially in connection with the subject of mimicry, warning coloration, directive markings and so on. All exact records of this sort are very useful and become more so as they accumulate.

## 53.—SOME NOTES TOWARDS THE LIFE-HISTORY OF COMOCRITIS PIERIA, MEYRICK.

By R. SENIOR-WHITE, F.E.S.

*References.*

Meyrick, *J. Bom. N. H. S.*, XVII, 416, (1906); *Antram. Ind. Tea Assoc. Bull.* 5, (1907); Grèen, *Trans. III Con. Trop. Ag.* Vol. I, 631, (1914); *Rev. App. Ent.* IV, 389, (1916); *Cey. Dep. Ag. Rpt.*, 1916, p. 9; *Rev. App. Ent.* V, 497, (1917); *Ind. Tea Assoc. Q. J.* 1918, pt. I, p. 8.

*Food.*

Green originally gave the food as lichens and algæ on rubber bark, though Meyrick in his original description notes that the specimens sent him were also eating the bark itself. Antram and Andrews in North-East India record it as eating tea-bark, whilst Green in his paper before the Third Congress of Tropical Agriculture and later references refer to it as eating rubber-bark.

Myself I have found it only on rubber-bark. If in eating this a lichenous patch is met with, this also is consumed, but only in so far as this lies in the line taken, which is not diverted for the sake of the lichen.

On rubber the burrows in the bark are seldom found below 5 feet from ground-level, and continue upwards to 20-30 feet from the ground. I have not seen it eat renewed bark, though this of course is now-a-days seldom found over four feet from the ground. I have never heard of or seen it on tea in Ceylon.

The actual burrow is shallow, usually only 2 mm. or so deep, and may branch in any direction; a burrow often "peters out," (no larva being found at the head of it), without any apparent reason why it should have been abandoned.

*Egg.*

No references. Apparently nothing known. I have utterly failed to find it myself.

*Larva.*

In Ceylon the colour of the larva is nearly crimson, the yellow colour described by Antram being that of the pre-pupa only. The dark contents of the intestines often show through the crimson. The abdominal prolegs are doubtfully functional—they are not used in progressing on a smooth surface such as a table, when the abdomen is slightly arched and only the anal suckers assist the true legs. Beneath the web the larva

is very active, its movements causing a sort of wave to travel along the frass covering the burrow. Larvæ have no power of swinging by silk threads if they fall out of the burrow.

#### *Pupa.*

The pre-pupal larva is yellow, and active if disturbed. It is some considerable time, up to a month, in this stage before finally pupating, during which time it is mostly found in the pupal pit, but not always. This pupal pit is an oval depression eaten below the bottom of the burrow to a depth of 2 to 3 mm., the bottom of the pit being thus about 5 mm. from the outer surface of the bark, and very close to the lactiferous layer. The pupal pit is about 15 mm. by 5 mm. along the major and minor axes. The pupa lies free within with the last larval skin free behind it. The pit is ceiled by a stiff brown silk membrane tightly stretched across it below the main webbing of the burrow, which is usually considerably elevated at this point, making the location of the pupa easy. On younger trees (up to ten years old or so), where they are often still visible, pupation frequently occurs in the branch scars, possibly because, except at these points, the lactiferous layer is too near the surface to permit of the excavation of the pupal pit. Pupæ in these scars are more difficult of discovery as the outer webbing is not always so noticeably raised above them.

The pupa itself is 7 mm. long (male) to 9 mm. long (female) : ochreous, incompletely obdect, the wing cases somewhat free above. In the laboratory emergence usually occurs during the afternoon.

#### *Life-History.*

I have not found larvæ before January, at which time they are obviously quite young. Their growth is slow, and they mature and pupate from the third week in July onwards for about a month, being earliest (as far as this estate is concerned) in an area near the Southern boundary where the infestation is annually heavy, and latest on an outlying division two miles to the North where so far it has been slight. The middle of September sees the last imagines out. Pupal period 26 days.

I have never taken imagines save in August and September, and I have not found any hibernating pupæ. It is unlikely that so delicate a moth in large areas of pure rubber which afford no shelter can remain alive until December for oviposition, which makes the non-discovery of the egg the more remarkable, as it must be in this stage that the insect spends the four intervening months till January.

According to Antram emergence in North-East India takes place in April-May. The pupal period there would appear to be about the same, as larvæ are reported by Andrews as doing damage "towards the end of the cold weather." It would be interesting to know during what month young larvæ are first found in this area, so that the relative times in each stage in North-East India and Ceylon can be compared.

Assuming that the period September-January is passed in Ceylon in the egg stage, what is the factor controlling hatching? It cannot be rain, as that may occur, heavily, during any portion of this time, the North-East monsoon, neither can it be the cessation of rain, which does not occur until February; possibly it is cold, which only occurs in January.

#### *Imago.*

The insect on emergence can expand the wings without taking up the more or less vertical position necessary in most Lepidoptera. The pupa remains in the pupal chamber, the long axis of which is more usually parallel to the ground, thus bringing the emerging moth out on a line parallel to the ground, but this hardly seems a satisfactory explanation for so singular a power as this.

I have taken one imago at light.

All the imagines I have taken and bred have been exactly similar. The form figured by Antram on Fig. 2 of his plate is unknown to me.

#### *Enemies.*

The fairly noticeable swellings over the pupation pits are often seen torn open from one side and the larva or pupa missing. This I think is the work of squirrels, which are common among rubber, whereas birds are comparatively rare. Sometimes spiders, often with eggs, are found in the pupal pits, whilst I have also found occasionally small beetles, (? Coccinellids), and an ovate mite with large scorpoid claws, but I am not decided as to whether these are not only chance visitors to empty opened pits. Spiders certainly make use of the pits for nests long after they are empty. Of internal parasites, I have actually bred none, but have fairly frequently found the inner cover of the pupal pit pierced by a round hole in the centre as if for the exit of a Hymenopteron, the remains of the pupa being found within the pit. Lastly, at the end of October 1918 I found a pupa which contained a white soft-bodied maggot, completely filling the pupal skin, which shelled off whilst I was removing it, thus preventing the rearing of the parasite.

*Status.*

I am of the opinion that on rubber the insect is more important mycologically than entomologically. During the North-East monsoon the old webs are almost completely stripped from the trees, leaving exposed the inner cortical tissues, whilst the pupal pits collect water and form good nidi for fungal spores.

*Rearing.*

This is extraordinarily troublesome. It is with the greatest difficulty I have ascertained the exact pupal period. If the inner lid of the pupal chamber is lifted to ascertain the state of the contained insect and this is found to be still pre-pupal, it is almost a certainty that the next visit will reveal an empty chamber, the larva having left or fallen a victim to a predator, whilst pre-pupal larvæ removed to the laboratory nearly always fail to turn. However, if within 24 hours or so of turning, the change can sometimes be successfully accomplished, and the imagines bred.

*Points on which further information is required.*

1. There appears to be nothing whatever known of the egg stage.
2. Where is the insect from September to December ?
3. Is Antram's figure 2 the same or another species ?
4. A mycological investigation of the wounds caused in the bark.

This is quite an interesting account of a Microlepidopteron of which Mr. Fletcher personally I have no first-hand knowledge. As regards Mr. Senior-White's third question, however, I can say something, as I have examined the specimen (unique in the Indian Tea Association's Collection) from which was drawn the second figure in Mr. Antram's Bulletin on the Bark-eating Borers of Tea. Mr. Antram states that it is a variety of *Comocritis pieria*. The specimen is now in very poor condition but it seems to me quite distinct from *C. pieria* and seems to belong to an undescribed species.

## 54.—NOTES ON REARING INSECTS IN HOT CLIMATES.

By T. BAINBRIGGE FLETCHER, R.N., F.L.S., F.E.S., F.Z.S. *Imperial Entomologist*, and C. C. GHOSH, B.A., *Assistant to the Imperial Entomologist*.

(Plates 131—138).

The importance of rearing insects needs little emphasis here. The identification of insects being based as a rule on adult characters, in the case of an immature form found doing damage it is usually necessary

to rear it into an adult in order to know what it is. And a knowledge of early stages and life-histories (in the fullest sense of the word) of any insect pest is a necessity in any consideration of control methods.

The necessity for such knowledge, however, is by no means equivalent to its acquisition, and those who have attempted the rearing of large numbers of insects under tropical conditions will doubtless agree that such rearing is decidedly an art only to be acquired by dint of much trouble and patience, often accompanied by numerous set-backs and disappointments.

In order to assist those who wish to rear insects in India, therefore, we have in the following paper jotted down a few notes based on our own experience in the hope that it may be of some use to others.

*The main condition of success* in rearing all insects is to provide them as far as possible with absolutely natural conditions of life. A caterpillar, for example, under natural conditions lives in the open air on a growing plant, whose leaves remain constantly fresh; when it is full-fed it may burrow into the ground and pupate under the soil which remains at an optimum degree of moisture. If we catch that caterpillar and shut it up in a cardboard box or glass bottle with some leaves of its food-plant, the leaves will wither and dry up, or their contained moisture may be condensed on the sides of the glass bottle, and the caterpillar is at once placed under unhealthy and unnatural conditions of existence and food; similarly, if it pupates in earth in a box, the earth may dry up or become too moist, with the result that the pupa dries up also or is killed off by mould. The above may be an exceptional case. It is really wonderful under what adverse conditions many caterpillars will live and (apparently) thrive. But in any case it is necessary as a first condition of success that, to ensure successful rearing, insects should be provided with:—

- (1) fresh food,
- (2) fresh air, or at least sufficient air,
- (3) correct conditions of moisture,
- (4) sanitary surroundings.

*Growing plants*, if they can be utilized in this way, provide the most natural and therefore most satisfactory means of rearing all insects feeding on such plants. The plants may be grown in pots or other receptacles containing earth and the potted plants with the insects living on them may be enclosed in cages. Or the plants may be grown in large cages provided with a sufficiency of soil. Or, in the case of plants growing out of doors, the plants themselves may be covered over with a cage pressed down into the soil around them, or they may be "sleeved," i.e., the plant or a branch is covered with a single or double-ended bag



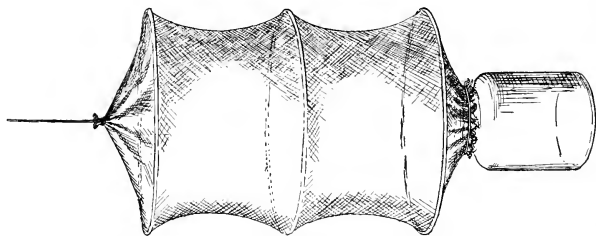

Fig. 1.—A meat-safe used as a rearing-cage.

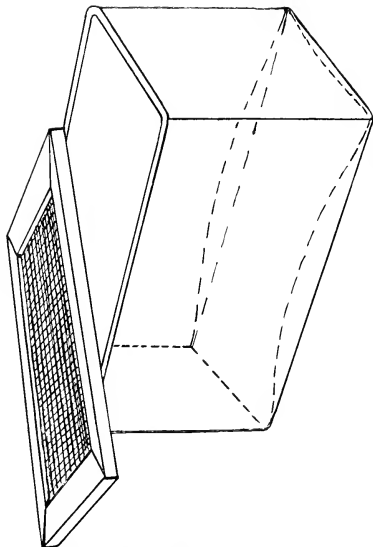

Fig. 2.—Glass Trough with wire-gauze cover.



made of muslin or mosquito-netting whose open end is tied around the stem of the plant (or whose ends are tied around a branch on either side of the place where the insects are feeding) so that the insect under rearing is allowed to feed under fairly natural conditions but cannot escape outside of the "sleeve." "Sleeving," however, is not very satisfactory in a country such as India, as such "sleeves" quickly rot and are very liable to tear or may be torn open by birds or other animals or even removed altogether by human bipeds.

Generally, therefore, it is necessary to rear insects such as caterpillars on cut portions of their foodplants placed within closed receptacles and in such cases the effect of a hot climate at once makes itself felt. Cut portions of plants, which in a cool climate would remain tolerably fresh for a day or more, wilt almost immediately in the hot weather whilst during the monsoon the plant-food and excrement of the insects under rearing form very favourable media for the rapid growth of moulds. Especial care therefore is required to keep the breeding cages (of whatever construction) quite clean by removing all excreta and uneaten leaves at least once a day, if not oftener. Otherwise, mould will quickly appear on these and the insects are likely to be affected.

For casual rearing on a small scale a small meat-safe makes a convenient cage, the necessary foodplant being kept fresh by having its stalk inserted in a jar of water. Or a collapsible meat-safe (of the type made of mosquito-netting stretched over bamboo rings) may be placed over the jar or bottle containing the foodplant and tied securely around the neck of the jar, the upper end being suspended by a string from any convenient support. If the stalk of the foodplant does not fill the neck of the jar, the latter should be packed with a thick wad of cotton-wool, otherwise caterpillars are very liable to crawl down and drown themselves in the water. (Pl. 131, fig. 1.)

For more regular rearing of insects, however, it is necessary to provide proper apparatus, which comprises:—

Glass jars and troughs.

Zinc cages.

Zinc cylinders.

Muslin cages.

*Glass jars.* At Pusa we use glass dishes and glass battery jars (as illustrated in Pl. 132) in different sizes, from small to large. For covers of these cages we use either glass plates with one side ground or brass plates (Pl. 132). In dry weather leaves kept in cages retain moisture for several days and remain fit to serve as food to the insects to which they are supplied. In moist weather in the rains, however, whole covers

are unsuitable and we use brass plates with a large hole in the middle, the hole being protected with fine brass wire gauze soldered on to the plate (see figure). In these cages the moisture can be regulated almost to perfection by the use of these perforated brass covers, the holes in them being left, when necessary, either entirely open or partly covered by glass or brass sheets placed on the top. As a result we have hardly any trouble from mould in the rearing cages. For those insects which pupate underground, such as Noctuid larvæ, a layer of moist earth is provided at the bottom of the cage and they can without further attention go into the earth and pupate there. The earth keeps moist for very long periods. Therefore it is not necessary to disturb the insects at all.

The glass dishes and jars are used as small aquaria for insects which feed on aquatic leaves, for example, *Nonagria pallida* and *Nymphula* whose caterpillars feed on floating leaves of *Nelumbium*, or *Galerucella singhara* feeding on floating leaves of *Trapa*. When used as aquaria the cages are covered with muslin. For larger aquaria we use glass troughs shown in figure 2. on Plate 131.

There are some insects which can be included among the leaf eaters but which live underground as a rule, only coming up, usually at night, to collect food, such as caterpillars of *Agrotis* and nymphs of the Large Brown Cricket (*Brachytrypes portentosus*). For them the glass jars are filled with moist earth and leaves or cut plants placed on the surface of the earth.

There is another class of insects which form silken tubes underground, the tubes serving as galleries in which they live. For them also the glass jars and troughs are used with success. The caterpillars of *Ancylolomia chryso-graphella* not only require earth to form galleries but also living plants, rice or grasses, on the leaves of which they feed. The caterpillars of *Melasma*, *Lamoria*, *Myrmecozela*, *Macharopterus* and others require earth in which they can form galleries and are fed with leaves and grasses placed on the surface of the earth.

*Zinc Cages.* Grasshoppers have been reared successfully in these glass jars. But on account of their saltatorial habits they are somewhat cramped for space in these cages. They are best placed on potted plants in the large zinc breeding cages illustrated in Pl. 133. fig. 1. These cages measure 24 inches in height and 12 inches across each side and are provided with a hinged door. The door and the wall opposite to it are of wire gauze with about 16 meshes to the inch. The other two walls are of glass. The entire framework and the roof and floor are made out of galvanized iron sheet. We also use similar cages of a smaller size measuring 12 inches in height about 8 inches across each

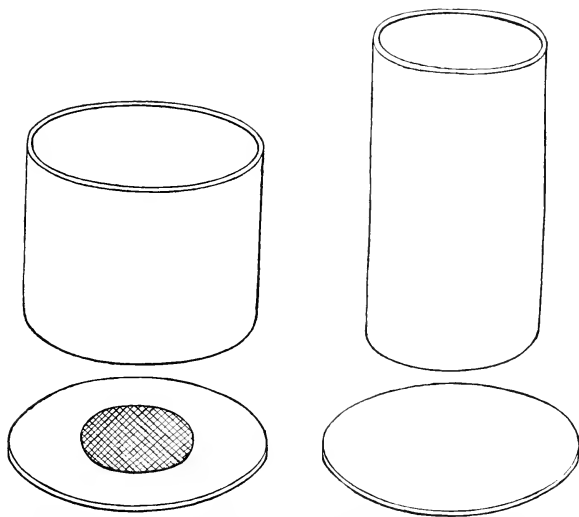

**Glass Dish (left) and Battery Jar (right) with whole (right) and perforated (left) metal covers.**





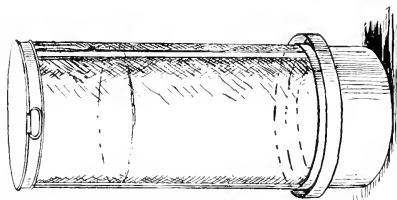

Fig. 2.—Gauze Cylinder.

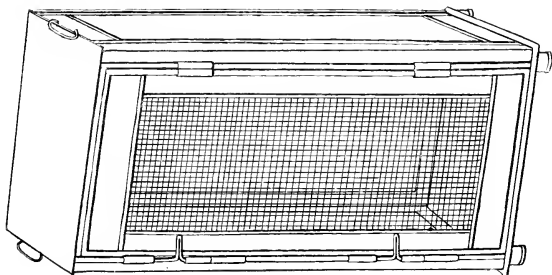

Fig. 1.—Zinc Breeding Cage.

side. When required for small parasites, etc., thin muslin or silk gauze is gummed over the wire gauze.

*Zinc Cylinders.* For *Nymphula depunctalis* the glass jars proved too small. The caterpillars require rice plants growing in water, so that they can float and swim in water and crawl upon the plants. For them the zinc cylinder illustrated in Pl. 134, fig. 1 was used. These cylinders are either with or without a bottom. Those with a bottom can be used as aquaria. In the case of *Nymphula depunctalis* caterpillars, one with a bottom was used. Living rice plants were transferred into it with a quantity of earth and it was partly filled with water. A long stick, stood in the middle, supported the muslin which formed the covering. The zinc cylinders without a bottom can be pressed into the ground over living plants and when the plants are low the wire gauze cover illustrated in figure 2 serves the purpose well. For taller plants the covers shown in Pl. 133, fig. 2 are used. The cylinders are made out of thin galvanized iron sheets and are 2 feet in diameter. All round the top on the outside there is a channel about an inch in depth and breadth which can be filled with kerosenized water to prevent access of ants or escape of creeping insects. On the inside the top is provided with a sloping piece intended to prevent escape of insects. This can, however, be done away with.

The cage illustrated in Pl. 135, fig. 1 is made by pinning thin muslin on a wooden frame. The bottom is made of wooden board. The door is on one side and is fitted with a long muslin sleeve. This is a very useful cage and serves many purposes better than the zinc breeding cages. Moths and flies kept in it do not dash against hard surfaces as in cages having glass or wire gauze sides in their flight or attempts at escape. Therefore in such cases the risk of injury to them is very small. Also the sleeved door is more advantageous than the hinged door of zinc cages. There is hardly any possibility of insects escaping through it during manipulation.

Having provided ourselves with the principal apparatus required, we can now proceed to consider the various groups into which insects may be classified according to their feeding habits and hence according to the manner in which it is necessary to rear them. In this way insects may be classified as:—

- (1) Scavengers of dead—
  - (a) animal matter.
  - (b) vegetable matter.
- (2) Predators on other animals.

- (3) Parasites of other animals—
  - (a) external parasites,
  - (b) internal parasites.
- (4) Feeders on living plants :—
  - (a) leaf-eaters,
  - (b) leaf-miners,
  - (c) gall-makers—
    - (1) in leaves,
    - (2) in petioles,
    - (3) in stems ;
  - (d) borers—
    - (1) in stems,
    - (2) in roots,
    - (3) in flowers,
    - (4) in fruits,
    - (5) in seeds ;
  - (e) root-feeders,
  - (f) sap-suckers.
- (5) Aquatic insects.

*Scavengers of dead animal matter*, such as many Sarcophagids, Muscids, Phorids and other Diptera, and Scarabæids, Silphids and other Coleoptera, require moist conditions and should be provided with moist food and moist earth. They are easily reared as a rule if their appropriate food is placed on a little earth.

A few Lepidopterous and Coleopterous feeders on dead animal matter (such as *Trichophaga* on furs, *Tinea* and *Anthrenus* on woollens, and *Necrobia* on dried meat) are also easily reared in the presence of their particular food, but require fairly dry conditions.

*Scavengers of dead vegetable matter*, such as those beetles which live in dry grain or wood, depend little on external conditions and can be reared out easily. But those which feed in rotting vegetable matter, such as Nitidulids, require to be kept under moist conditions.

*Predators*. Among the predators which bite, the Mantids, Carabids, Coccinellids, as also the Phorids and Syrphids and those which suck, the Myrmeleonids, Ascalaphids, Chrysopids, Pentatomids and Reduviids, require an ample supply of food and are indifferent to dry or moist conditions. The Carabids, however, pupate underground and require a supply of moist earth. The larvæ of stinging predators, Eumenids, Sphegids, etc., and in fact all Hymenopterous larvæ except, probably those of Tenthredinids which behave like caterpillars, require a good deal of





Fig. 1.—Zinc cylinder.

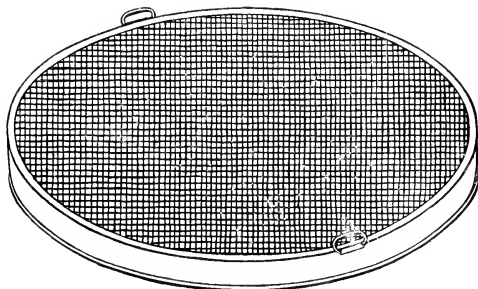

Fig. 2.—Cover for zinc cylinder.





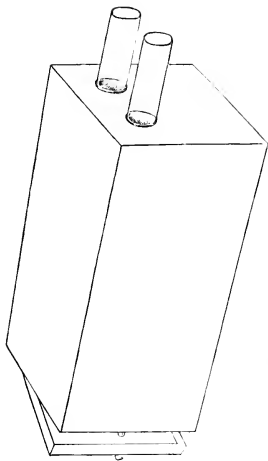

Fig. 2.—Breeding box for parasites.

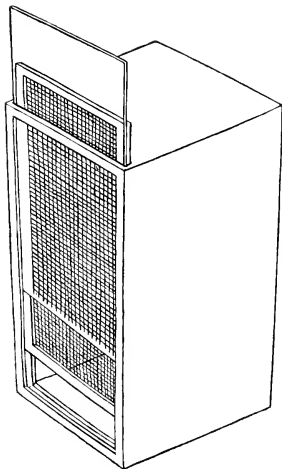

Fig. 3.—Parasite Cage.

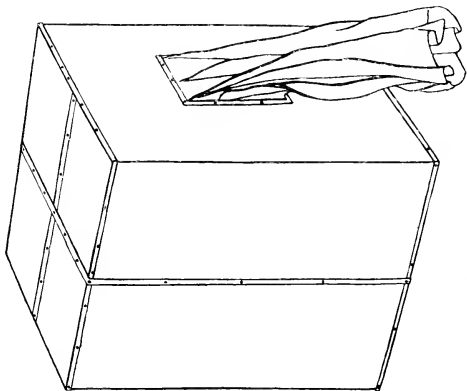

Fig. 1.—Muslin cage, with sleeve at one side.

care and delicate handling although they are not affected very much by a little dryness or moistness of conditions in which they are kept.

*External Parasites* on other animals, such as the lice and bugs found on vertebrate and the dipterous parasites of birds and bats, require to be reared on their special hosts as a rule. Fleas, however, do not undergo their transformations on their hosts and are easily reared under dry conditions.

*Internal Parasites* of vertebrates, such as *Cestrids*, when full-fed larvæ are obtained on expulsion from their hosts, can be reared easily if they are kept in moist earth and not allowed to dry up. The same procedure is followed with Tachinid parasites of insects.

When internal parasites emerge from eggs, larvæ or pupæ which happen to be under rearing in the glass jars, they are easily observed and collected. When perforated covers are used for the jars in which minute parasites are expected the wire gauze of the covers should either be very fine or be protected with silk gauze or muslin.

When it is intended to rear out parasites especially we use the cage shown in Pl. 135. fig. 2. It is made of wood. Parasites appear in the tubes when they can be collected. The door is on the end opposite to that in which tubes are fitted. Another pattern is the one shown in figure 3 and this kind of cage has been largely used for the introduction of the bollworm parasite in the Punjab. It is made of wood and has two covers, one of wire gauze and the other of glass or wood. The glass remains above the wire gauze. When parasites come up through the wire gauze they are visible through the glass. When too much green stuff is placed inside the box, a quantity of moisture collects under the glass. The parasites are caught in the drops of moisture and are drowned. Without the glass cover the box works fairly well when it is intended to let out the parasites, a wooden cover being used in this case.

*The leaf-eaters* form the most numerous group of those insects which feed upon living plants. Some of them feed openly on leaves, biting them from the top or margin, or gnawing holes in their surface. It is unnecessary to quote examples as this form of feeding is quite common. Some roll individual leaves and feed while living inside the rolled leaves, for instance, *Sylepta* on cotton, *Eublemma* on brinjal and *Margarodes* (*Glyphodes*) *indica* on cucurbitaceous plants. There are others which bind several leaves together and feed similarly while living inside them, for instance, *Chapra mathias* on rice, *Phycita infusella* on cotton and *Eucosma critica* on *Cajanus indicus*. Among the leaf-eaters we can include those which nibble the leaf surface like the *Epilachna* grubs. All these require a supply of fresh leaves. The ideal condition would be to keep them on living plants growing in soil and covered with cage or

on plants growing in pots which can be introduced into breeding cages when necessary. This however is only possible when one deals with a few kinds of insects and with only a few specimens of each kind. Even then some are such voracious eaters, for instance, the Sphingid caterpillars, that it is difficult to keep only a few individuals supplied with sufficient potted plants. Besides it is not always possible to foresee what insects may require to be fed and to have sufficient plants ready for them beforehand. Therefore it is absolutely necessary to use some kind of handy cages in which the insects can be kept confined and fed with leaves. Such cages are essential when we want to study individual larvæ very closely.

Leaf-feeders kept in cages require to be given a constant and regular supply of fresh leaves, which should be fresh and neither dried up nor wet when given. If leaves are of necessity gathered in a wet condition, they are best dried by placing them in the centre of a dry towel or cloth and whirling this around by the corners, so that the moisture is driven out by centrifugal action without bruising the leaves.

Care must also be taken that no predaceous insects or other animals are introduced with the leaves.

When only a few insects are under rearing in one cage, it is well to count them when fresh food is given, to make sure that none are removed and thrown away with the old food when it is removed.

Young caterpillars especially are very delicate animals and should not be handled if it can be avoided. They also require tender leaves of their foodplant as a rule.

*Leaf-miners*, among which can be included also those which mine under the epidermis of the green bark like that of cotton. For a few examples we can name *Acrocercops*, *Rhynchonius* and *Eugnamptus* on mango leaves, *Phyllocnistis* on lemon leaves, *Hispia* on rice leaves and *Trachys* on jute leaves. It should be remembered that in the case of all these, as in the case of the majority of miners of this description, the larvæ complete their larval life in the same mine and cannot form a fresh one even when they are provided with suitable leaves. They live inside and feed on moist tissue. Therefore it is essential that when the leaves containing them are plucked from the plants they should be kept moist as long as possible. For this purpose the glass dishes and jars are invaluable. In some cases the use of wet blotting paper is necessary or a layer of moist earth may be placed at the bottom of the cage. There are a few miners which can migrate to fresh leaves and form fresh mines in them, for instance, the caterpillars of *Phthorimæa cingalis* and the grubs of *Platypria andrewesi*. Rearing them is easy, as they can be supplied with fresh leaves as long as necessary.



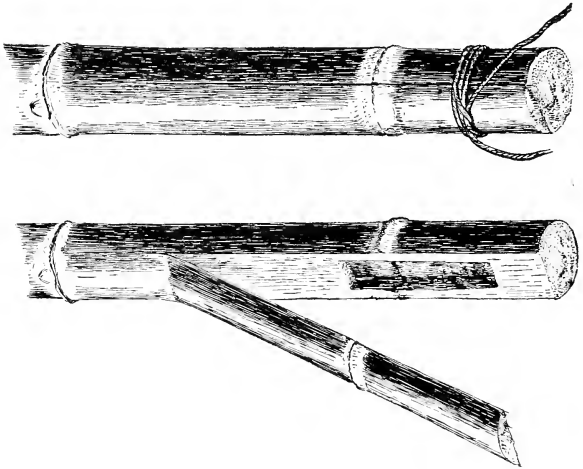

Fig. 1.—Method of feeding borer larvae.

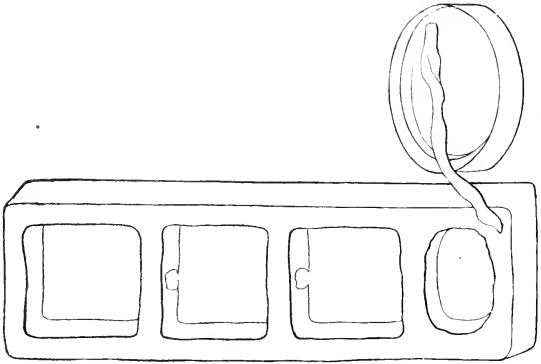

Fig. 2.—Tile cage for Termites.



*Gall-formers on leaves*, for instance, Psyllids and Cecidomyiads, require the same care and treatment as leaf-miners.

*Gall-formers in the petioles of leaves*, like *Clitea picta* on *Egle marmelos*. The petioles should be prevented from drying. The use of glass dishes is essential. If necessary, moist earth or wet blotting paper should be used and by the use of perforated brass covers growth of mould can be entirely checked.

*Gall-formers in stems*, such as the Cecidomyiads in Cucurbitaceous plants and Buprestids and Curculionids. In order to be able to rear them the galls should be kept moist. Like the leaf-miners they cannot be transferred into fresh stems.

*Borers in twigs and green stems*, for instance, the larvæ of *Chlumetia transversa* and *Alcides frenatus* in mango twigs. *Chilo* and *Sesamia* in maize, rice and allied plants, *Scirpophaga* in sugarcane. *Nupserha* in soybean and *Phaseolus* stems. Many examples can be quoted from among the Buprestids, Cerambycids, Curculionids, Noctuids, Pyralids and Flies which are among the worst pests of plants. Among them some like *Scirpophaga* and most Buprestids do not fare well if transferred to fresh stems and they are better reared in the stems in which they occur. Of course the stems should be prevented from drying and glass jars are useful for the purpose. The others can easily be transferred into fresh stems and the best method is to bore holes at the ends of the pieces of stems intended to be given as food with the pointed end of a pair of forceps or with a gimlet. The larvæ are put into these holes and they bore in well. In some cases however the larvæ leave these holes and cannot find their way back and in order to make them stay there, the following plan may be adopted. A longitudinal slice is cut but not detached from the stem and a portion of the interior of the stem below this slice is scooped out with a knife to afford enough room for the larva to be put in. The larva is placed there and the slice closed and secured with thread. (Pl. 136, fig. 1.)

For larger borers in woody stems or dry wood, such as the longicorn grubs we find in mango, orange, jak and many other trees, large pieces of stems should be taken and holes bored in them with augers. The larvæ are put in these holes, the mouths of which are best plugged with a piece of wood or cork. In the case of those which work in fresh moist stems it is desirable to keep the stems moist as long as possible. We do this by keeping the pieces of stems covered with moist saw-dust. Besides keeping the stems moist the sawdust serves another useful purpose. When the larvæ happen to bore out of the stems they find themselves among sawdust and are not at all inconvenienced even if immediate attention is not forthcoming. In some cases they are actually observed

to bore through the layer of sawdust. Apparently the sawdust serves partly as food. These borers are such slow growers that they tax the rearers' patience sometimes. There is hardly a case in which one has to wait for less than a year before the adult is obtained. Two or three years are not uncommon. Examination of the stems in which the borer larvæ are placed should be made with great discretion. Frequent examination causes disturbance which the larvæ cannot endure. Then during examination the stems should be split or opened with the greatest care and patience as the exact whereabouts of the insect is unknown and it is likely to be injured. It may have formed its pupal cell and may be pupating or may have pupated. Disturbance at this time is often injurious and in the majority of cases leads to the death of the insect. Some of the borers in drywood, especially the Buprestids, cannot endure transference and have to be reared in the wood in which they occur.

*Root-borers*, such as Hepialids, require the same treatment as stem-borers. Among this class may be included borers such as *Cylas formicarius* in sweet potato tubers; such can be reared out easily.

*Borers into flower-buds* or larvæ which eat petals of flowers, require a supply of fresh flower-buds and flowers and can be reared easily.

Of the *insects affecting fruits*, the fruitfly larvæ require a supply of moist earth to pupate in and, as in the case of all Diptera, the pupæ should be kept moist and not allowed to dry up. A layer of moist earth should be kept at the bottom of the glass jars or troughs and the fruits containing the maggots should be placed on the earth. The maggots when full-fed will go into the earth and pupate there. When the fruits are succulent like pumpkin and give out a large quantity of water on decomposition it is better to use an extra large quantity of dry (not moist) earth. The dry earth absorbs the water and becomes moist. Otherwise the excess of moisture may cause the pupæ to rot. In rearing these flies it may be necessary to dispense with glass or metal covers for the jars and keep them covered with muslin.

Many larvæ bore into fruits for the seeds which they eat. Common examples are *Etiella* boring *Khesari* (*Lathyrus sativus*) and other pods, *Heliothis armigera*, *Evelastis* and *Catochrysops* boring *arhar* pods, and *Virachola* boring pomegranates. Such larvæ require a supply of green pods and fruits and are easily reared. *Bruchids* do not require any fresh food to be supplied and are reared in the pods or rather seeds in which they occur.

*Root-eaters*, e.g., Melolonthid, Elaterid, Curculionid and Chrysomelid larvæ, live underground and are best kept in glass jars with ample moist earth and provided with roots, principally of grasses. The roots supplied must be fresh.

Although called root-eaters the food of many of these insects is not definitely known. Many Melolonthid grubs, for instance those of *Anomala polita*, have been reared wholly on farmyard manure, while others are known definitely to attack living plants, e.g., *Anomala bengalensis* on sugarcane. Probably many of them depend on a variety of food. In the case of caterpillars and termites of course there is no cause for doubt. The food of Tipulids and Asilid larvæ, which are ordinarily taken to be root-eaters, is not definitely known in India. *Gryllotalpa africana* is definitely known to be both herbivorous and predacious. Of the Elaterid larvæ some are certainly predaceous, e.g., *Agrypnus fuscipes*, others may be both predaceous and herbivorous.

Whatever their food the larvæ which live underground in nature must be kept in moist earth, and as the larval life of most of them is very long, it is an advantage if the earth in the rearing cage can be kept moist for long periods without being required to be changed. Numerous Melolonthid grubs are reared at Pusa every year. They live for about a year and are kept in glass jars and dishes and, if glass covers are used, it becomes hardly necessary to change the earth even once. Metal covers are unsuitable for the purpose as they allow evaporation to go on. When it is not necessary to change the earth there is very little disturbance of the insects.

As the food of most of these underground larvæ is unknown, attempts to rear them from their young stage frequently fail. It is therefore advisable to collect the larvæ in the advanced state of growth and then their rearing is almost always successful. When the food is known and a supply of it can be kept up, they can be reared without much difficulty provided the earth in which they are made to live remains always moist. One *Agrypnus fuscipes* larva lived in the Insectary for over two years. It was fed with caterpillars and Melolonthid and Scarabæid grubs. Similarly *Gryllotalpa africana* was reared from the egg stage, being fed with live fly maggots only for about 5½ months.

*Sucking insects*, which live by sucking the sap from living plants—the plant—sucking Heteroptera, Homoptera and Phytophthires—require living plants. We usually grow plants in pots and, when convenient, keep the potted plants on which the insects feed in zinc breeding cages (Pl. 133, fig. 1) or cover the plants with muslin or silk gauze. Some of them are however amenable to feeding in glass jars with portions of their foodplants from which they can obtain enough juice. *Leptocoris varicornis* has been reared on ears of *Setaria italica*, *Riptortus* on pods of *Cajanus indicus*, *Nezara viridula* on pods of *Cajanus indicus* and *Phaseolus radiatus* and *Aspongopus* on succulent stems of pumpkin. When they get abundant juice they can be reared in this manner. In fact some of

them in nature have adapted themselves to this habit, for instance, mealy-bugs (*Pseudococcus nipæ*) and Tingid bugs (*Recaredus* sp.) on seed potatoes in store.

*Inducing oviposition.* In order to observe and note details of life-history it is often necessary to rear out adults or collect them from the fields and make them lay eggs in confinement. All insects will not oviposit easily under such conditions. They require the conditions in which they lay eggs in nature or at least conditions as far as possible similar. Almost all plant-feeding insects require living plants in order to oviposit. Sometimes when gravid females are obtained from outside they deposit eggs even when kept confined in a small pill-box, because then egg-laying is a necessity with them. Special means have to be adopted to get eggs from different insects. It is not possible to give here our whole experience. We can only refer to a few cases.

It is generally difficult to induce butterflies to oviposit in confinement. They require living plants and a large amount of space to fly about in and may have to be fed with sugar or honey syrup. We keep them in the side-cages of the Insectary which give them sufficient room to fly about. Potted plants are supplied. Feeding is done according to the following method. The syrup is placed in a glass crucible or watch-glass. The butterfly is held in one hand between the thumb and forefinger with the wings turned over its back and with a pin in the other hand the proboscis is stretched out and its end dipped in the syrup.

For moths the large-sized zinc breeding cages (Pl. 133, fig. 1) are used, potted plants being placed in them when necessary. These cages also serve for bugs, sawflies and many kinds of beetles. Ant-lions can be made to oviposit in these cages on a layer of fine dry sand placed on the bottom.

For grasshoppers we use the side-cages of the Insectary. Into one of these cages one pair of *Hieroglyphus banian* was introduced in 1905. Since then we have been carrying on the progeny of this pair. Every year young nymphs hatch out about June. They are fed and develop, deposit eggs in the earth of the cage in October and November and then die. The eggs in due course hatch about June again.

In order to be able to observe the details of oviposition in the case of grasshoppers and other insects which thrust their eggs into the ground, they should be placed in a cage with four glass sides and provided on the bottom with a block of wood two or three inches high and in size about half-an-inch less in breadth and width than the internal breadth and width of the cage. This wooden block is covered with a very thin layer of earth which however fills the quarter-inch space left all around between the block and the glass sides of the cage. The grasshoppers,

finding insufficient depth of soil on top of the block for oviposition, are then forced to oviposit against the glass through which their motions may be watched. The space between glass and wooden block may be varied with the size of the grasshopper under rearing.

For *Heliocoprís bucephalus* a small cage is unsuitable. The beetles were therefore placed in a large side cage in the Insectary. They at once bored into the earth. Fresh cowdung was placed on the surface of the earth and was taken down by the beetles through tortuous galleries up to a depth of about 4 feet. Oviposition was successful and a brood was reared out.

It is easy to get soil-living termites to establish colonies in glass jars. The jars are filled with moist earth which is somewhat pressed down and an artificial hole is made in the earth by forcing a pencil or stick into it. From among the winged termites which appear at the time of their annual flight a pair, consisting of a male and a female, is picked out and placed in this hole. Very soon they lay eggs and workers and soldiers appear in due course and are observed to form tunnels. Many colonies of *Odontotermes assmuthi* were established in this manner in the course of the last five years. In the jars the development of the colonies cannot be properly traced. For this purpose the tile cage illustrated in Pl. 136, fig. 2 was devised. It was made by a local potter. It has three chambers with two partition walls in the middle. But the chambers communicate with one another by means of holes in the partition walls. Besides these chambers there is a cavity at one end meant to serve as a reservoir for water. The idea was that the water kept in this reservoir would slowly soak and keep the tile moist. In actual practice however it was found that the water from this reservoir soaked so rapidly and so much that the chambers became too damp for the termites. Therefore water is kept in a separate vessel and a wetted wick of cotton lint is used so that one end of the wick is dipped in the water and the other end rests on the tile. By this means just sufficient water is soaked up by the tile to keep it moist. The face of the tile is well smoothed by being rubbed on a flat stone. The chambers are covered by glass plates through which the insects inside are visible. In order to produce darkness in the chambers, on top of the glass plates are placed other glass plates on which black paper has been pasted. When it is necessary to observe the insects the upper plates are lifted up. A pair of the winged termites, usually those which have shed their wings, are placed in one chamber in the tile and are allowed to occupy whichever chamber they prefer. The majority of those tried established colonies in the first chamber, *i.e.*, the one next to the source of water and none selected the third chamber. Colonies of *Odontotermes assmuthi* have lived in these tiled cages for about

four months and have then dwindled and died. Some of the colonies in glass jars were buried underground in the compound inside the jars; one of these lived for a year. The tile cages we use measure about 12 inches in length and about 4 inches in breadth. The thickness from face to back is about one inch. The inside dimensions of the chambers are about  $3 \times 3 \times \frac{1}{2}$  inches.

Colonies of *Microtermes obesi* were similarly established in glass jars and also in the tile cages. But they seemed to be more delicate than *Odontotermes assumathi* and died quickly.

*Some general hints on rearing.* It is advisable to examine the cages every day in the morning or better still, both morning and evening and take out the insects which have emerged. Butterflies and moths are better taken out as soon as their wings have hardened or they may spoil the scales on the wings by fluttering in the cage. Flies are better left for a day or two; if killed too soon their wings collapse and shrivel. Beetles should be left for two or three days or their colour does not develop properly. Bugs and grasshoppers should also be left in the cages for two or three days to allow them to harden their wings and develop colour.

In the case of large specimens, for instance, SpHINGID moths, Saturniid moths, larger butterflies, etc., it may be necessary to transfer the pupæ from small rearing cages to zinc breeding cages so that the imagines on emergence may crawl up the wire gauze wall and hang and develop their wings properly. Otherwise the result is a specimen with crumpled undeveloped wings. If the rearing cage be large a few long sticks stuck into the earth or stood against the walls may serve the purpose.

*Cannibals.* The rearer will find by experience that some insects, which are normally plant-feeders, develop into voracious cannibals when kept in close proximity to their fellows under conditions of confinement. If, on counting them, caterpillars are found to have disappeared without visible reason, cannibalism may reasonably be suspected. Such larvae must of course be reared separately.

*Records.* A very important part of rearing is the proper recording of full descriptions and accounts of all the stages of all insects under rearing. These may either be Cage-slips kept on separate uniformly-sized sheets of paper placed under, or at least with, each cage or may be kept in a register or note-book. In any case, each separate lot of insects reared should be provided with a separate number corresponding to the Cage-slip or entry in the register, and the reared specimens should have this number entered on their labels, so that, in after time, there is no possible doubt as to the actual specimens to which the records refer.



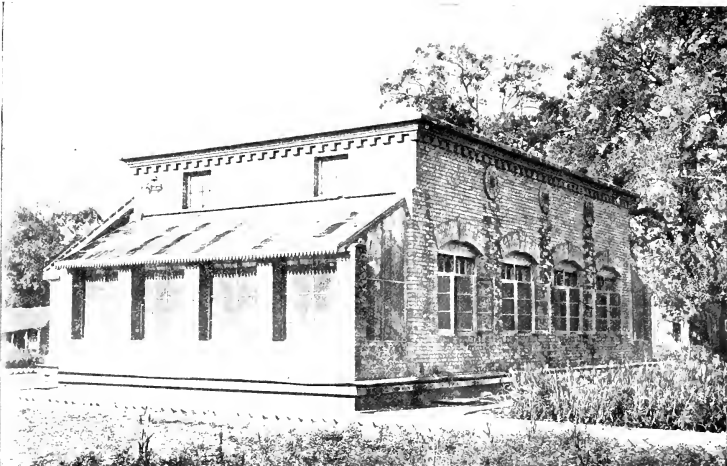

Fig. 1.—The Pusa Insectary.

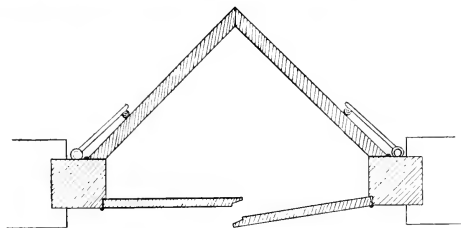

Fig. 2.—Details of double door to Insectary.



No time or trouble that can be taken to make these records complete and accurate in all respects can possibly be wasted.

If drawings of the various stages, and of any details of them, can be made, so much the better; and all such drawings also should be fully identified with the number of the Cage-slip or entry in the register.

*Preservation of Early Stages.* Another important point in rearing is the preservation of material of the early stages. Caterpillars may be blown and most other larvæ preserved in spirit. Empty pupa-cases and cocoons should be preserved pinned with the individual specimens which have emerged from them. Pupæ, even of the same species, often vary considerably in the two sexes and therefore it is important to see that the pupal shell of each *individual* imago is correctly paired off with it. How often one sees series of bred specimens in collections and how seldom are they accompanied with even their empty pupa-cases. Yet it is certain that a close study of pupal structure will often throw very valuable light on the affinities of the insects concerned; and, to carry out work on these lines in India, it is essential to preserve all the material possible in order that it may be available for study.

*Quality and Quantity.* One advantage of rearing insects is the obtaining of perfect specimens of the adults for the collection. Another advantage, which is often lost sight of in India, is the ease with which not only good but long series of an insect may be obtained. Especially when an unknown insect, found doing damage in its larval stage, is under rearing, endeavour should be made to rear and preserve a long series of adults in order that amply sufficient material may be available for determination of the species concerned.

*Insectaries.* The foregoing remarks have been made more especially for the general collector who has no special facilities for rearing other than those afforded by an ordinary room or verandah.

It may, however, be useful to add here a description of an Insectary, or building specially designed for and devoted to the rearing of insects, such as we have at Pusa.

The Pusa Insectary (Pl. 137. fig. 1) is a masonry building having one large hall 40 feet long, 24 feet broad and 16 feet high. On the south side it has a verandah about 40 feet long and 10 feet wide with a tiled roof. Against the walls on the east and west there are four cages on each side. These side cages measure 6 feet  $\times$  5 feet each and have brick walls up to a height of about  $5\frac{1}{2}$  feet from the bottom. Above the brick walls right up to the roof wire gauze is fitted into wooden frames and encloses the cage completely. The roof slopes from the wall of the main building outwards and is made of glass which is protected from hail by wire-netting over it. Each cage

is filled with earth up to the height of the brick walls. The earth is watered as necessary and remains moist throughout the year. At first only two of these cages had cemented bottoms. Termites, crickets and even beetles often appeared in the other cages which had no cemented bottom and therefore communicated with the soil below. All the cages have now been provided with cemented bottoms. They do not communicate with one another but each has a panelled door fitted with glass panes and opening into the hall.

Insects are sent in to Pusa from various places in India and as some of them may not occur in the neighbourhood of Pusa or in Northern India, the Pusa Insectary, in which they are intended to be reared, is built on a plan which prevents their escape from confinement even if they escape from the rearing cages. The doors and windows are protected with wire-screen having about 12 meshes to the inch. This is not fine enough for very small insects. But no case of introduction of an undesirable insect into the locality has happened during the last fourteen years. With the same object in view the outer doors are provided with double flaps, the outer pair of which is of wire gauze (Pl. 137, fig. 2); one pair of these flaps can be shut before the other pair is opened; thus the entrance of any insect from outside or the escape of any from inside can be checked. This is satisfactory so far as flying insects or large creeping ones are concerned but is no protection against small creeping ones. In fact, ants are a trouble throughout the hot weather and the rains. In order to prevent them an ant-channel of re-inforced concrete was added all round the wall at a height of about a foot from the ground. The channel is about one inch deep and is kept filled with water mixed with phenyle or crude oil emulsion. In order to prevent leaves and grasses being blown into the channel and affording bridges for ants to cross over it was necessary to have a shade of galvanized zinc sheet (see Pl. 137, fig. 1) over it. The ant-channel works satisfactorily. But as the floor was of bricks set on edge and not of concrete, ants were able to come up anywhere in the floor from below the foundation. In order to prevent this the floor has recently been concreted. Still, however, we have not been able to get rid of ants altogether. The walls, not being plastered from outside, ants have found enough room to establish nests in them.

When future insectaries are built, in order to make them really ant-proof the following arrangements illustrated in Pl. 135, fig. 1 might be tried. All round the building at about the ground level there should be a cemented *pucca* drain which may be a shallow one. This will prevent water settling at the foundation and also ants from establishing nests

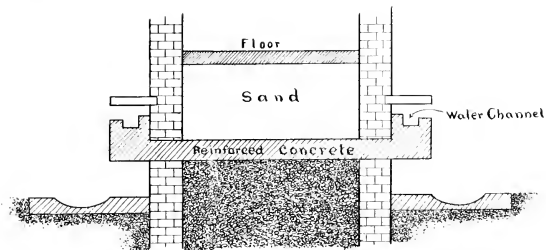

Fig. 1.—Plan for foundation of an Insectary in order to make it ant-proof.

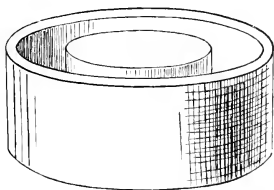

Fig. 2.—Ant-preventing stand.



there. At a height of about six inches from the ground-level the entire floor including the walls should have in one complete sheet a layer of reinforced concrete not less than two inches thick. This will prevent termites as well as ants from coming up from below. Above the layer of cement concrete all round the wall on the outside there should be an ant-channel of reinforced concrete, the channel being about  $1\frac{1}{2}$  inches deep and about 2 inches wide. About 2 inches above the channel a brick should project out of the wall and act as a shade over the channel. The walls of the insectary should be plastered both inside and outside, thus leaving no room for flying queen ants to establish nests in them.

The plinth of the building may be about 3 feet from the ground-level. The floor should be cemented. The space between the floor and the layer of concrete below may be filled with dry sand. This will afford additional protection against ants and termites and make the floor proof against damp.

Inside the building the furniture should be plain tables and shelves for rearing cages, etc. It is desirable to have removable tables and shelves which can be taken out and cleaned if silver fish get access and prove troublesome. If water-troughs etc., are required, they should be of reinforced concrete or at least with cemented walls. If brick walls are left unplastered and with *surki* or cement pointing dust settles in the chinks and converts them into favourite breeding places of *Macraola inquisitrix*. Chinks in the walls and tables afford hiding places for the silver fish also. Therefore they should be avoided as much as possible.

Ants and silver fish are really pests of the insectary. The former get into rearing cages and attack the insects. The latter nibble away dates and records from the cage-slips. Therefore it is necessary to keep both away from the insectary as far as possible.

As regards the structure of the building, there should be large windows and as many of them as possible. They should all be protected with wire gauze, say of not less than 16 meshes to the inch and provided with flaps on the outside which can be shut when necessary, for instance, against driving rain. When ample ventilation is ensured by the provision of as many large windows as possible—a condition which is present in the Pusa insectary—the temperature inside the insectary does not vary to a great extent from that prevailing outside. Therefore the insects kept in the insectary are not affected to a great extent by the artificial conditions incident to rearing indoors. When this condition is secured the observations recorded in the insectary approximate very closely to those recorded outside. This has been verified in the case of numerous hibernating and aestivating insects and all stages of them, *viz.*, eggs,

larvæ, pupæ and adults, which have been kept under observation both in the insectary and outside in the fields. In the Plains of India it is not necessary to have the conditions of a green-house or glass-house for rearing insects. Nor should there be any discrepancy between observations carried on in the insectary and those under actual field conditions.

When however no separate insectary is built it is preferable to carry on rearing in the verandah of a house. The verandah can be enclosed with wire gauze and in order to prevent ants the legs of rearing tables can be placed on ant-proof stands as shown in Pl. 138. fig. 2. The stands may be of wood or stone and the channels in them should be kept filled with water or phenyle water to prevent ants crossing the water or mosquitos breeding in it.

#### 55.—BREEDING CAGES AND GENERAL INSECTARY TECHNIQUE FOR WOOD-BORERS.

By C. F. C. BEESON, M.A., I.F.S., *Forest Zoologist.*

(Pls. 139—140.)

When the study of the wood-borers of valuable forest trees was commenced a few years ago at Dehra Dun, it soon became evident that one could not isolate the important species and investigate their life histories as separate items of research. The borer fauna of a forest tree is a complex association of species from several families of Coleoptera, e.g., Anthribidæ, Scolytidæ and Platypodidæ, Curculionidæ, Cerambycidæ, Lamiadæ, Buprestidæ and Bostrychidæ, with occasional species of Cossidæ, Arbelidæ and Hepialidæ. The proportions in which the species occur in a particular tree are influenced primarily by the time of year at which the tree dies and the time of occurrence of the swarming periods of the beetles, that breed in it. It is possible, for example, for the available bark space of a dying or recently dead tree to be occupied by surface breeders such as bark beetles, Buprestids, small Longicorns, etc., to such an extent that heartwood borers and shothole borers are unable to effect an entrance and establish their galleries. Or it is possible for a large Longicorn to arrive first on the scene and monopolize the sapwood to the exclusion of small shothole and pinhole borers, etc.

As a check on field work it was decided to breed out the borer fauna on a large scale in the insectary at Dehra Dun, and to correlate the emergence records so obtained. The usual procedure followed is to fell selected trees in forest divisions at intervals throughout the year, and to cut off lengths from the felled trees at one month or two month intervals and rail the logs to Dehra.



Types of breeding cages used for wood-borers in the Forest Zoologist's Insectary.







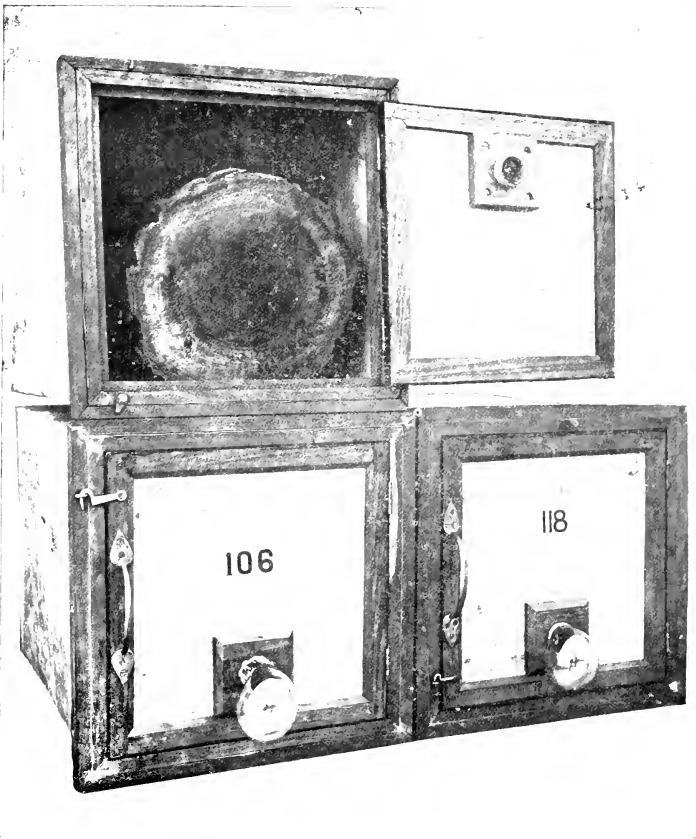

Galvanized iron cages in which the air and wood humidity can be regulated.

The first year's work showed that the breeding cages used were unsuitable for the purpose. At that time the only cages available were of the usual cubical shape with glass and wire gauze sides and a large door at one side. Their principal defects were the rapid desiccation produced in the log and the difficulty of preventing the escape of minute insects when manipulating the emerged material through the large side-doors.

Special patterns of cages were therefore devised for this purpose. Plate 139 shows various types of cages tested before satisfactory results were obtained. The cages in the two upper rows are of deodar wood with a square of wire gauze let into the roof and a hinged door forming one side. The cages in the fourth and fifth rows are of *toon* wood with a square of wire gauze in the roof, a sliding door at one end, and a small hinged door in front. The cages in the bottom row are similar in principle but of different design and dimensions to accommodate logs of different sizes. In all these types the capture of the emerged insects is effected by attraction to light. At first large test-tubes and glass bottomed boxes were used, but it was found that, although insects readily entered these traps, they were also able to leave them and return to the cage. Glass retort-shaped bulbs were therefore substituted for tubes and have been used ever since with complete success.

The wooden cages used, however, did not eliminate the difficulty of desiccation resulting from the long periods (one to two years) for which the logs must be kept. Even with logs 4 feet long and 3 or 4 feet girth much more heartwood moisture was lost in the insectary than would be lost by the tree lying in the shade of the forest and exposed to rainfall. Waxing the ends reduced the loss, but insufficiently. The evaporation of moisture also caused considerable warping and cracking of the wood work of the cages (some of the cages in the photograph show this).

We have therefore adopted galvanized iron cages as the standard design. These are illustrated in the 3rd row of Plate 139 and on a larger scale in Plate 140. The dimensions vary. Those shown are  $18 \times 12 \times 12$  inches but we also use larger sizes capable of holding fairly representative sections of the tree trunk. The door frame is made of seasoned *shisham* and all the contact joints of the door and the frame are lined with felt or velvet. The neck of the attraction bulb is held in a velvet lined cylinder in wooden blocks screwed on either side of the iron sheet forming the door. These cages are quite satisfactory, as they allow the regulation of the rate of evaporation by means of desiccators and humectators to suit all classes of timber, and conditions of atmospheric humidity. Some have recently been fitted with hygrometers.

No trouble is experienced from moulds. In any case mould grows only on the cut surfaces of the log just as it does on felled logs in the forest.

For work on a larger scale outdoor cages are available ( $11' \times 6\frac{1}{2}' \times 11'$  and  $6\frac{1}{2}' \times 6\frac{1}{2}' \times 11'$ ); these are constructed of wire gauze  $\frac{1}{16}"$  mesh and angle-iron frame-work. Cages with brick walls and glass roofs are also used. They are fitted with automatic emergence traps on the principle of the window screen for house flies.

The cages of the types described give only emergence records.

The exact length of the life-cycle is obtained by direct inoculation of logs with eggs of the borer under investigation. In order to determine the lengths of the various stages, full-fed larvæ of known ages are extracted from infested logs and transferred to tubes with moistened wood dust. The atmosphere of the pupal chamber is saturated and these conditions are easily reproduced in the tubes and maintained by waxing the corks. The tubes are kept in the dark at temperatures corresponding to insectary or outdoor conditions and the changes of the insects observed. No saprophytic moulds grow in these tubes, but parasitic fungi such as *Botrytis bassiana* readily develop and permit one to eliminate the diseased larvæ at an early date. From experimental observation in tubes one can determine the length of the pre-pupal period, date of pupation, date of transformation, and length of the immature beetle period. When the beetle is mature it emerges by eating its way through the cork.

#### *Interpretation of Emergence records.*

The correlation of the emergence records of wood-borers is obviously best conducted by graphical methods but before one can construct curves it is necessary to eliminate certain errors.

Theoretically the daily emergences recorded in the breeding cage notes are correct; in practice errors arise from careless examination or unavoidable neglect of the cages and other sources. Plotting the daily emergence figures as recorded may therefore give misleading results. Two methods of correction are employed, geometrical and mathematical.

The first method may be used for smoothing off accidental irregularities in the curves of a single series of observations. The accumulated daily totals are plotted and a curve drawn with reference to the points; the curve values are substituted for the observed values and the theoretical daily values calculated by difference.

In comparing the *data* for different series (of the same species) of the same quality but of different weight, the observed values are reduced to a common standard by the method of the weighted mean. A clearer comparison is obtained by combining the daily values in groups of 5 or 7;

it is found that this method of grouping also facilitates comparison with rainfall and temperature values.

*Description of plates.*

Plate 139. Various types of cages used for wood borers.

Plate 140. Galvanised iron cages in which the air and wood humidity can be regulated.

56.—NOTES ON NIGHT-FLYING DRAGONFLIES.

*By* MAJOR F. C. FRASER, I.M.S.

Dragonflies are so obviously sun-loving insects that it comes as a surprise to find that there are certain species which adopt nocturnal habits.

Mr. Morton, writing to me from Edinburgh in 1917 mentioned that some of the Odonata, more especially the larger Aeshnines only appeared on the wing after dusk, when as a rule, they flew for quite a short period, usually for about 15 to 20 minutes. A similar habit is commonly adopted by some of the Sphingidæ but until the receipt of the letter quoted I was not aware that it was applicable to dragonflies, my experience being that these insects usually retire fairly early in the day and that few are found on the wing after 3 p.m.

Mr. Morton's letter induced me to make a few trial excursions at dusk in the hope of securing some night-flying Indian species and as a result I was able to take five of such, three of which may be said to be purely night-flyers, whilst the other two, although seen on the wing throughout the day, continue their activities until long after dusk, in fact until they are no longer discernible in the darkness.

Four of the species belong to the subfamily Libellulinae whilst the fifth is a *Gynacantha*. All thus belong to the suborder Anisoptera and I know of no Zygopterous species which adopts such habits.

The following are some notes made on the five species mentioned above :—

1. *Brachythemis contaminata*.

This is one of our commonest Indian dragonflies and is seen on the wing from dawn until long after dusk, apparently employing the later hours for pairing as well as feeding. Both sexes may be seen hawking for food throughout the day apparently oblivious to one another's presence, the females usually being in excess of the males, a quite contrary fact as compared with most other dragonflies; but after dark several males may be seen mobbing solitary females.

### 2. *Bradinopyga geminata*.

This insect is about the only true example of cryptic colouring in Indian dragonflies. Itself the colour of stone or cement, it usually selects such materials to rest upon during the day. In Madras I have seen it settled on the plastered sides of wells, in Elephanta Island and Poona it is often seen resting on granite rocks in which places it is well-nigh invisible. At dusk it leaves these situations and hawks freely in the open. Before dusk it may commonly be seen hunting for mosquitos in the darkened verandahs of bungalows. In the latter situations they have a habit of coming to rest in large numbers on the ropes of chicks, 20 to 30 sitting in close alignment and sleeping there throughout the night.

### 3. *Tholymis tillarga*.

In Bombay *tillarga* appears on the wing soon after 6 p.m. and from then onward till long after dusk a continuous stream of the insects may be seen pursuing each other round the borders of tanks. The males are the first on the wing and by reason of the opalescent patch on the hind-wings, which has a distinctly luminous effect not unlike phosphorescent paint, it is easily distinguished.

The females appear later and, as they have not the same distinctive mark as the male, they are seen with difficulty. The luminous mark is obviously a recognition mark of sexual importance and is the only example I know of among the Order although it has a close analogy in the white recognition marks found in the males of several species of jungle-haunting Zygoptera.

### 4. *Zyromma petiolatum*.

This dragonfly resembles one of the New World Aeshnines in that it limits its flight to a very short period during the 24 hours. The duration of this is usually for about 20 minutes after sundown. In Poona I have seen it first appear at any time between 6-30 and 7 p.m. and as suddenly disappear shortly after 7 p.m. I have taken it after dark by striking at its shadow as seen silhouetted against the light reflected from the surface of water. The insect may be beaten up from dense jungle during the day and then taken by tracking it to its next resting place. Usually it flies only a few yards and then comes to rest. Sometimes it may be seen flying during the day over densely-shaded pools in deep jungle or not uncommonly it is seen hawking mosquitos in the depths of a deep well. There is one such well in the Empress Gardens, Poona, where *petiolatum* may almost invariably be seen during the day but it must be noted that it never leaves these fastnesses until after dusk. (I have

noticed *T. tillarga* flying in similar spots during the day and it is well known that night-flying butterflies will take to the wing during the day in dark, shady jungles).

#### 5. *Gynacantha bayalera*.

This very local insect appears on the wing only after night has set in for good. At such times specimens may only be taken by watching for their silhouette against the evening sky and as they have a rapid, skipping flight, this is done with difficulty. It is more easily captured by beating it up during the day from its resting-places in deep jungle and then observing where it comes to rest again. Usually its flight then is but for a short distance, some 20 yards or so, but on account of the invisibility of its wings and the foliage-green colouring of its body, it is not easily recognizable amongst the foliage. The wings of the last three species are remarkable for the fineness of their venation and delicacy of structure and I note that other *Gynacantha* resemble them in this respect so that it may well be that the species of this genus are all night-fliers.

The food of all consists of mosquitos although I have occasionally seen them making a meal off the smaller moths. If the mouth of any one be examined directly after capture it will be found stuffed with an immense number of mosquitos; very probably the insect makes the most of its time and then retires to finish the meal at leisure.

Major Fraser's observations are not only interesting but economically **Mr. Fletcher.** important because, as he notes, these night-flying dragonflies seem to feed principally on mosquitos. I expect that most of us have seen dragonflies on the wing at dusk but have merely put them down as belated individuals capturing their suppers. These species are not at all easy to catch as a rule but I have no doubt that, now that attention has been directed to them, we shall be able to make considerable increases to the list of night-flying species. Certainly we have several at Pusa including at least one large species, which I have as yet been unable to catch.

#### 57.—NOTE ON THE LARVÆ OF *CATOCHRYSOPS STRABO* FEEDING ON *CYCAS*.

By MAJOR F. C. FRASER, I.M.S.

In Madras it would probably be impossible to examine any single plant of *Cycas* which has not suffered from the depredations of a small caterpillar, the larva of a Lycænid, *Catochrysops strabo*. In the Horticultural Gardens, Mount Road, I noticed that every plant was eaten and at one time of the year when *Cycas* throws up its young crown of leaves,

the ova and larvæ of this pest may be seen in hundreds, eating their way into the foliage.

In 1911 I made some interesting micro-photographs of these insects at work but regret that they are not at hand, having been packed away for the "duration of the war."

Apparently two species of *Catochrysope* feed upon *Cycas*, as de Niceville mentions that he fed *C. pandava* on it in Calcutta, but my own observations have only been on *strabo*.

I cannot give, with reliability, from memory, the dates when the plant puts on its new crown of leaves, but in Madras this takes place twice annually and one of these periods happens to coincide with one of the broods of *strabo*. At such a time several of the butterflies may be seen hovering around any of the plants and if the young, tender leaves be examined, they will be found swarming with ova and young larvæ. The latter eat their way rapidly into the substance of the juicy stems and many are quite hidden in the cavities so formed.

If the larvæ are in great numbers, as they usually are, the whole of the crown of the plant is entirely destroyed and as *strabo* will or can only feed on the young parts, only the first-comers reach maturity, the last perishing from starvation; they are literally eaten out of house and home, the adults not being above making a meal off the smaller ones, as the supply of food runs out.

In Madras, the crown of leaves which coincides with the advent of *strabo* is entirely destroyed, only a few shrivelled and stunted stems remaining which look as if they had been blasted with fire and, were it not for the fortunate circumstance that it throws up a second crown and thus dodges the parasite, the whole of the plants would be wiped out in a single generation. As it is, the growth of the plant annually is exactly halved and I have found it possible by examining a plant in my own compound to trace the alternate attacked and unattacked crowns, the history of which is written on the trunk of the plant.

*C. strabo* has at least two or three broods in the year, the food of the odd broods being several species of leguminous plants, but I believe the main brood depends for its livelihood on *Cycas* and it ought to be possible by protecting this plant during the period it is putting on its new foliage to check the spread of the pest.

#### 58.—SPIDERS AS CHECKS ON LEPIDOPTEROUS LARVÆ.

By MAJOR F. C. FRASER, I.M.S.

The important economic part played by spiders as checks on the multiplication of Lepidopterous larvæ is well illustrated by the following notes made on the larvæ of *Acherontia styx* in 1907 and again in 1910.



Several full-grown larvæ were found feeding on jasmine, all being detected by searching for their droppings on the ground beneath the bushes, a method of detection of great utility when applied to the larger larvæ. This led to a search for more juvenile specimens on the foliage and, whilst doing so, the presence of a very large number of empty egg-shells was noticed. Over a hundred were counted in a short space of time and when some of these were examined under a powerful lens, they were seen to present a minute ragged hole, about the borders of which was a small collection of dried *debris*.

Now, the larvæ of most of the Sphingidæ invariably make their first meal off the empty egg-shell, so that it was obvious that an early and untimely fate had met the former occupants of the eggs.

A further search revealed another interesting fact, *viz.*, that there were a large number of leaves which bore the basal portion of an egg or eggs still adhering to their surface and each of these presented a small hole somewhere in the neighbourhood of its centre. This was easily explained by the fact that, when the newly hatched larva has finished all the egg-shell it can manage (it rarely manages to nibble off the base of the shell, as this lies flush with the surface of the leaf and so is difficult for the larva to negotiate), it proceeds to make the following meal from the middle of the leaf. These tell-tale punctures in the foliage are an easily-seen guide for detecting the young larvæ but in the present case although some fifty consecutive leaves were examined, all of which were holed and on nearly all of which the basal portion of an egg was found, only seven young larvæ were detected, most of which were only two or three days old.

Whilst searching for the ova and larvæ, an interesting phenomenon was observed which served to explain the presence of the derelict egg-shells. A small spider was observed standing over an egg which from its bright green and translucent colour was evidently occupied by a developing larva. The spider stood motionless facing the egg as if it were crystal-gazing but on approaching it carefully so as not to disturb and frighten it away, and making an examination of the egg with a powerful lens, it was observed that the larva was quickening and could be seen moving within the egg-shell. It was actually eating its way out and the minute jaws could be seen enlarging the hole of exit. It was obviously these movements which had attracted the spider which now stood waiting until such time as the hole would become large enough for it to extract the larva from the egg. Some five minutes later it suddenly sprang upon the egg and in a short space of time seized and dragged the mangled corpse of the larva from the egg and thereafter departed with its prey. On examining the empty egg, a little moist *debris* was seen

clinging around the hole through which the caterpillar had been dragged and this accounted for the collection of *debris* seen in the previous shells. This incident was not an isolated one, for it was seen repeated on several occasions and at other times spiders were detected in the act of devouring larvæ a few days old. The destruction of the Sphingid larvæ therefore, before even they leave the ova, works out at 86 per cent. and probably another 10 per cent. are destroyed by the same agency in the first week or two of larval life. I do not think the larger larvæ suffer much from the attacks of spiders but as their number is still further reduced by preying Hymenoptera and birds, not much more than one or two per cent. can come to maturity. The above-mentioned larvæ are not the only species which are attacked in the egg stage for I have noticed that the Papilioninæ are also checked in a similar way, *P. polytes* for instance. For some time I was under the mistaken impression that the empty eggs were sterile ones but the above observations furnished the key to the truth. The deposition of sterile eggs in nature I imagine must be very rare.

It may be noted here that spiders never attack those larvæ which are protected by ants and if one be placed on a bush inhabited by such, it will beat a hasty and ignominious retreat, always provided that it is able to escape the furious onslaught of the protecting hordes.

#### 59.—THE COMPARATIVE INVISIBILITY OF *PAPILIO DEMOLEUS* DURING FLIGHT.

By E. H. HANKIN, M.A., Sc.D., *Chemical Examiner to Government, United Provinces.*

It is possible that the following remarks on the colouration of a butterfly, *Papilio demoleus*, may be of interest from the point of view of the application of colours for use in camouflage, with especial reference to the painting of military aeroplanes so as to secure invisibility when seen from below.

Since it was proved, some years ago, that the decoration of butterflies has nothing to do with sexual attraction, no satisfactory explanation has been put forward as to its nature. In some cases there can be no doubt that it serves the purpose of concealment. In other instances it warns enemies of the unpalatability of its possessor. Neither of these explanations will apply to *P. demoleus*.

This butterfly in size and colouring has a superficial resemblance to the English Swallow-tail butterfly. In freshly-hatched specimens the upper surface of the wing has a chequer pattern of black and primrose

yellow. At the inner margin of the hind wing is a spot of dull reddish brown. When settled on a flower it keeps its wings fully expanded, slightly dihedrally-up and often in quivering movement. It makes no attempt, in my experience, to hide its red spot by covering it with the hind wings. Hence in this position it is an extremely conspicuous object, and in the absence of other evidence, one would be inclined to suspect that its colour-pattern was meant to serve as a warning to enemies.

If its colouring is meant as a warning then this butterfly must either be unpalatable or must be regarded as being unpalatable by its enemies. But the frequency with which damaged specimens are seen makes it very unlikely that it bears this character among the birds in Agra.

On examining the underside of this butterfly facts are found that militate strongly against the idea that its colour-pattern serves as a warning. Underneath, the ground colour is not black but dark brown. Most of the yellow areas are larger than those of the upper surface. Hence the general effect is that the colouring is lighter below than above. It may be suggested that this difference is a compensation for the underside being in shadow; such an explanation would be satisfactory if the purpose of the colouring was concealment but has very little meaning if, as has been suggested, its purpose is display. Further, the hind-wing, on its underside, possesses six more or less rectangular areas and an eyespot all of dark ochre-yellow bordered with blue and black. Why, it may be asked, should this butterfly have evolved this elaborate pattern on the underside of its wings where it is invisible to birds when the insect is at rest?

Let us now consider the appearance of the insect when in flight. When flying slowly it is conspicuous, perhaps as conspicuous as when settled. But when in fast flight it is extraordinarily difficult to see. It appears to me merely as a grey flash. I have had a good deal of practice in observing insects in flight and I know of no other insect that so completely loses its distinctive appearance when flying fast. I have noticed this peculiarity of *P. demoleus* both in the present season and last year, I have seen it when I was making no attempt to catch the butterfly and when therefore my attention was not distracted by movements of the net.

From the point of view of inconspicuousness when in flight the underside of the wing of *P. demoleus* is perhaps more important than its upper surface because when disturbed it flies off with gain of height and travels at ten or more feet above the ground. A bird that had swooped down to attack a settled *demoleus* would therefore, as a rule, be below the escaping insect and would see the underside of its wings perhaps a little more than their upper surfaces.

Experts in camouflage will probably be able to form an opinion as to how far the inconspicuousness of *demoleus* when in fast flight is due to its colouring and how far it is due to its speed. It is in fact a fast-flying butterfly. If it is considered possible that the pattern is one that makes for invisibility, experiments with low-flying aeroplanes similarly coloured might give results of scientific interest and possibly of practical utility.

A singular change in the colouring of *demoleus* takes place with age. At the beginning of the monsoon season the only specimens seen flying are survivors from the previous season. In two or three specimens that I have examined in this condition the dark ochre-yellow of the under-surface has faded to a tint not markedly different from the yellow of the rest of the wing. But, as though in compensation, the yellow of the upper surface has greatly deepened. The red spot had faded on the under surface but not on the upper side. It seems probable that the fading of the under surface tends to reduce conspicuousness when the insect is hidden and at rest during the cold and dry seasons of the year. The hind wings of these old specimens are very frequently damaged as though from the attacks of birds.

A second butterfly is found in Agra that is somewhat markedly inconspicuous when in flight. Its name is *Junonia lemonias*. It differs in its flying habits from *P. demoleus* in that it generally flies at a height of about a foot or two above the ground. A bird that was chasing it would probably keep on a higher level and would therefore see more of the upper surface of its wings, especially as when flying it often makes short glides with its wings in the horizontal position. It is of interest to notice that the upper surface of each wing of this butterfly has a large eye-spot of blue, black and orange brown that recalls the colouring of the spots on the underside of *P. demoleus*.

NOTE.—The substance of the above remarks was communicated to the Comptroller of Munitions Inventions, who forwarded my letter to the Camouflage School in Kensington. A report received therefrom stated that the upper wing of the insect (*Papilio demoleus*) was photographed. The pattern was cut out of the resulting print and the parts weighed. The weights thus obtained gave the proportions of the component colours. The colours were then exactly matched and painted on a spinning wheel in the same proportion as occurs in the wing of the butterfly. Both surfaces of the wing were treated in this way. On spinning the wheel the resulting colours were for the upper surface a moderately dark olive green and for the lower an earth colour. Spinning these two colours together, as would occur when the insects wings are blurred in flying, was found to result in a khaki colour.

"It is also noteworthy," the report states, "that this colour almost exactly matches one of the colours found most useful in the concealment of low-flying aeroplanes from overhead observation."

Mr. Fletcher.

Dr. Hankin's paper is an excellent example of the fact that even the commonest of insects repay study. *Papilio demoleus* is an abundant

species, indeed a pest, in most parts of India. When disturbed, its flight is extremely swift, as you all know, and it certainly is difficult to follow with the eye then. How far that is due to the mere rapidity of the flight and how far it is due to the blending of the colours of the wings, I should not like to say. Possibly some of us may be able to make observations on it in the near future.

Another point brought out by Dr. Hankin's paper is the manner in which entomological observations may prove of great utility in other fields. In the present case it has been suggested that, if the colours of the underside, especially of the hind-wing, in *Papilio demoleus* make for invisibility during rapid flight, such a scheme of colour might be applied to military aeroplanes in order to reduce their visibility when flying low. How far such a thing is practicable and how far a colour-scheme which might reduce visibility against a glaring Indian sky would produce the same result under European conditions, I cannot say, but Dr. Hankin's remarks are certainly suggestive.

60.—THE PROPORTIONS OF THE FEMALE FORMS OF *PAPILIO POLYTES*, L., IN THE DIFFERENT PARTS OF ITS GEOGRAPHICAL RANGE.

By EDWARD B. POULTON, D.Sc., F.R.S., *Fellow of Jesus College, Oxford, and Hope Professor of Zoology in the University.*

The investigation here suggested is of great interest and importance and at the same time very easy to carry out. All that is required is to breed the butterflies from indiscriminately collected larvæ in each locality and send the specimens to me at the University Museum, Oxford, so that they may be sexed and recorded. Additional value will be given to the investigation by obtaining as full and accurate a record as possible of the relative proportions to each other and to their mimics in the same locality of the two models, *Papilio hector*, L., and *P. aristolochia*, F. If it be found impossible to breed the forms of *polytes*, interesting results may be gained, although of much less value, by the indiscriminate collection of the butterflies, particularly if all or as nearly as possible all the specimens seen on any given occasion are taken.

A short abstract of the results already obtained will show the great need for further investigations.

*Ceylon.* Mr. J. C. F. Fryer has recorded in *Phil. Trans. Roy. Soc., Lond.*, Series B. Vol. 204 (14th November 1913), p. 249, the results of breeding from 155 indiscriminately collected wild larvæ, viz., 66 males, 40 male-like females (*cyrus*, Hubn.), 24 *romulus*, F., females mimicking *P. hector*, and 25 *polytes*, L. females mimicking *P. aristolochia*. It is suggested that these results may be significant.

"In Ceylon, therefore, if the above statistics are reliable, the ratio between the mimetic and non-mimetic females is one which might be expected if it be assumed that there is no selection in favour of either of these forms of female; under these conditions the population is stable in composition and may remain so indefinitely.

"On the whole question, however, no final conclusions can yet be drawn, for, in the first place, the numbers obtained from the statistics may quite possibly be a coincidence, while in the second the effects of the phenomena discovered in connection with the fertility and mating of the species are quite unknown. Possibly the conclusion which can be drawn with the greatest confidence is that the extraordinary mimicry in the female sex is at present of little importance to the population of the butterfly in Ceylon. (*Ibid.*, p. 250)."

I have not at present been able to set beside Mr. Fryer's ratios those derived from breeding in other areas but the following evidence, quoted in all cases from the *Proc. Ent. Soc. Lond.*, goes far to disprove the general application of the conclusions set forth in the above-quoted paragraphs.

*West slopes of Ashambo Hills, North-West of Cape Comorin.* In this locality in the extreme south of India, J. Williams Hockin collected (1905-16) 30 males, 1 *cyrus* female, 12 *polytes* females, 21 *romulus* female, 1 female intermediate between the last two. Of the 12 *polytes*, 4 were *stichius* with no white in the hindwing cell, 4 *polytes* with conspicuous white, and 4 intermediate. The female intermediate between *polytes* and *romulus* was an interesting form, indistinguishable from some of the forms of *theseus*, Cramer, from Borneo. As regards the models Mr. Hockin considered *hector* decidedly commoner than *aristolochiæ* and indeed the commonest *Papilio* in the district, *aristolochiæ* being second, and *polytes* third "but several lengths behind." (1917, lxxx-lxxxiii.)

The Ceylonese *polytes* females, although in a closely adjacent area, are very different in that the *stichius* form is almost unknown while the hind-wing cell of the great majority is conspicuously white-marked, a fact which, it can hardly be doubted, is related to the abundance in Ceylon as compared with India of forms of *aristolochiæ* with a white cellular spot in the hind wings (Rothsd. and Jord., *Nor. Zool.*, II, 1895, p. 248).

*North Kanara.* According to the extensive experience of T. R. Bell, largely derived from breeding, the *cyrus* form is excessively rare; it was in fact only once obtained and then by capture. Of the two mimetic forms, both abundant, *romulus* was perhaps the commoner. (1914, xcix-c.)

*Neighbourhood of Madras City.* Out of 45 females taken on two days in 1915 by Prof. and Mrs. Fyson, 23 were *polytes* and 22 *romulus*;

34 males were also captured. Twelve *hector* were taken and, on another day, one *aristolochiæ*. (1915, xcii-xciv.)

*Singapore Island.* In 1916 Dr. R. Hanitsch collected 27 males, 8 of the *cyrus* female and 9 of the *polytes* female together with 5 of the models of the latter. (1916, lxxvi-lxxviii.) Later in the same year he collected 34 males, 5 *cyrus* and 9 *polytes* (1917, xxx-xxxiv.)

*The mainland (Johore) opposite Singapore Island.* Dr. R. Hanitsch received from his collector 12 males, 3 *polytes* female and 1 *cyrus* female (March 1917), and a second example of the *cyrus* female (July 1917) together with 3 males taken on the same day and 8 males somewhat earlier. (1917, xxx-xxxii, lxxxiii-lxxxiv.)

These results from Singapore and mainland are very different from those recorded by Dr. Seitz who only remembers the *polytes* female in this locality. (1913, p. xxxii.)

*The Hongkong and Macao Districts.* The male-like female *cyrus* is, on the evidence of most naturalists, much the commonest form of the mimetic forms; *romulus* is unknown and the *polytes* female rare, as is its model, *aristolochiæ*. Of 10 examples from Stonecutter's Island in Hongkong Harbour 4 were males and 6 *cyrus* females. (1913, xxxi-xxxiii.)

I think it will be agreed that the results summarized above are sufficient to show how important it is to obtain evidence on a more extensive scale, and especially to carry out, in as many localities as possible, Mr. Fryer's method of breeding from indiscriminately collected larvæ.

I suppose that you all know that *Papilio polytes* is remarkable in having three forms of female, all different from one another. There is firstly the form *cyrus*, which is like the male, secondly the form *polytes* which resembles *Papilio aristolochiæ*, and thirdly the form *romulus*, which mimicks the female of *Papilio hector*. I have here specimens [exhibited] of these forms of females and of the two other *Papilios*, *P. aristolochiæ* and *P. hector*, which they mimick. Mr. Fletcher.

We at Pusa have tried some breeding experiments with *Papilio polytes* and I have here [exhibited] specimens of two generations reared from a captured female. As you will see, the females reared in this lot belong to the forms *cyrus* and *polytes*. We have not bred any *romulus* here as yet, although *romulus* does occur rarely at Pusa. In this connection I may note that *Papilio hector*, the model for the *romulus* form, does not occur at Pusa; I have seen it from Nagpur, where it is rare, but from nowhere north of that.

It will be of considerable scientific interest if any of you can assist by rearing *Papilio polytes* in numbers from known parents and sending

the resulting specimens either to Pusa or direct to Professor Poulton. It is not easy to rear them in numbers; at least, we have not found it possible at Pusa to rear more than two generations, so far.

If you will collect specimens of *P. polytes*, taking indiscriminately all the examples seen at one time in any one place of *P. polytes*, *P. hector* and *P. aristolochiae*, that will also be useful, as giving us an idea of the relative proportions of occurrence of the different female forms and of the species which they resemble.

Another *Papilio* which would well repay breeding in numbers is *Papilio memnon* which has numerous distinct forms of females, some tailed and some tail-less. In Java both tailed and tail-less forms have been bred from one batch of eggs, but I do not think that *P. memnon* has ever been reared on any scale in India.

I am sure that I am endorsing the feelings of this Meeting in saying how grateful we are to Professor Poulton for sending us this paper.

#### 61.—THE IMPORTANCE OF INSECTS TO FISHERIES.

By B. PRASHAD, D.Sc., *Officiating Director of Fisheries, Bengal and Bihar and Orissa.*

Most people are quite unaware of the influence of insects on fisheries and fishes and to them the title of this short paper would certainly sound very strange but it should be distinctly understood that the insect fauna of a given area of water exerts not only a potential but a real influence on the fishes living in it. For a pisciculturist, therefore the knowledge of the insect life of his fisheries is of as great an importance as that of the vegetation of these waters. From these facts it is quite apparent that the problems involved in fisheries are neither simple nor one-sided, and require for their solution a very serious research into all types of aquatic plants and animals, besides a thorough understanding of the general biological conditions of the fisheries in question. In this paper I have considered in a general way the relations of insects to fisheries. Scarcity of information on the various heads does not allow of a more detailed treatment and it is with great diffidence that this incomplete paper is presented before the Entomological Conference. But then the object of the paper is to show our ignorance of the various problems, and if possible, to enlist by so doing the sympathies of the entomologists and others for helping us in the solution of these problems. The total number of scientific workers in India is very small and it is only through co-operation with one another that any real progress can be made under the existing circumstances. It will not be out of place to point out here that the importance of the investigations like the present one is as great to



the entomologist, the sanitary departments and the general public as to the pisciculturist. Every one agrees that the question of public health in the tropics, more so than anywhere else, is very seriously involved in the discovery of efficient means for the destruction of mosquito larvæ. Several species of fish have been credited as being efficient agents in this connection, but I am sorry to have to say that the most unsystematic way in which this work has been carried on, has resulted in making the problems more obscure and involved. However, we will have something more to say about it further on.

To a layman the word insect essentially conveys the idea of small terrestrial six-legged animals that can fly by means of specially developed structures—the wings. Undoubtedly insects are most numerous on land, but then all of them cannot fly as indeed all are not terrestrial. A large number are permanently aquatic and a still larger number pass the earlier stages of their life-history in water. The very keen struggle for existence on land has probably resulted in these insects taking to the aquatic medium, where food in the form of plankton and aquatic vegetation is most plentiful and though hosts of enemies exist to devour the helpless eggs, larvæ, pupæ and even the adult insects, yet the chances of escape are far greater in water than on land. The question as to whether the ancestors of insects were terrestrial or aquatic crops up, but a discussion of it would be quite out of place here. A point that deserves mention in connection with insects that pass the earlier stages of their life in water, is that the time spent in the water is comparatively short, as indeed is the whole life-cycle. This is largely to be explained by the abundance of food resulting in rapid growth and prolific breeding but there are exceptions, for cases of hibernation for long periods in the larval stage are quite well known in the case of large numbers of insects. The direct bearing of many of the above detailed factors is very little on the fish-life; still, insects, like plankton, exercise at all times a very great influence on the fishes in any area.

The relations of insects, as indeed of most influences in the sphere of life, have to be considered from two different points of view, whether they are of any use or they are in any way injurious? We will consider these two sides separately.

*Useful insects.* In the distribution of fishes food acts as a very important factor, and according to the effects of this ecological factor fishes are divided into various groups; of these groups we are here concerned with the pelagic and littoral fishes only. Both these types of fishes depend largely on the plankton or insects, for their food, and in accordance with it show special modifications of the mouth and the alimentary tract. They frequent only those parts of the streams, lakes or ponds

where such food is most plentiful. Indeed, the names of the groups themselves are given according to the habitat rather than the food eaten by the different kinds of fish. As is evident, the fish very seldom could get hold of the adult insects owing to the latter flying above the surface of water, but cases are known where fairly large fishes remain swimming near the surface in the evenings and jump out of water to pounce on the insects flying near the surface. An important use of this habit is made by the anglers who use artificial and fresh flies as baits for these fishes and the fish rising to these attractive but deceptive baits get hooked and supply the anglers with a nice form of sport. Some of the beetles, bugs and other insects that live permanently in the water are either too active for the fish or have a very hard chitin and are, therefore, usually avoided by fish. Some interesting observations on this latter head have been recorded. The fish were found to learn gradually by experience the futility of securing such undesirable types of food and later avoided them altogether. The most important part of the food of fish from amongst the insects are the larval stages of some orders of insects. These larvæ abound in most waters, subsisting on the vegetation, the protozoan animals and the small crustacea, and are in turn eaten in large quantities by the fish. The chitinous covering of these larvæ is very thin and poorly developed, and the comparatively large quantity of fleshy substance of their body is very important as food to the fishes when compared to the quantities of small crustacea that must be eaten to get an equal quantity of nourishment. Whereas for obtaining enough plankton fish have to take in large quantities of water and to strain the plankton from it; they have only to dart a number of times at the comparatively large insect-larvæ and very soon to obtain equal quantities of food. Our information in India regarding most of these points is most scanty. In Europe and America where systematic experiments have been carried on, larvæ of the may-flies (*Ephemeroidea*), dragon-flies (*Odonata*), some of the *Neuroptera*, and amongst the two winged-flies (*Diptera*) those of the families of crane-flies (*Tipulidae*), mosquitos (*Culicidae*) phantom-larvæ (*Corethra*), harlequin-flies (*Chironomidae*), *Dixidae* and others, have been shown to form a large quantity of the food of some fishes. In fact, a celebrated Carp-culturist suggested the desirability of increasing the mosquito larvæ in the carp-ponds by specially devised means for increasing this source of the food supply of the fish; he was naturally ignorant of the harm that would accrue if larvæ escaped from the fish and developed into the adult mosquitos. All the same the fishes are important agents in keeping down the numbers of these objectionable insects.

A very important economic use has been claimed from the sanitary point of view for utilising the fish as destroyers of mosquito larvæ. Un-



*Page 909.*

**PLATE 141.**

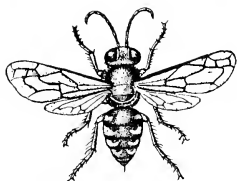

*Bembex lunata* ( $\times \frac{1}{2}$ ).

fortunately the habits of the various indigenous fishes have not been studied in this connection, and without ascertaining the suitability or otherwise of the various fishes for this work, they have been indiscriminately used for this purpose; very large sums of money have thus been wasted. If the whole problem were scientifically tackled and the most useful species in this connection discovered, the gain would be immense. This is, truly, considered to be work for pure science, though the fact is quite ignored that the work of applied science has very often failed owing to lack of information on the various points from the pure scientific side. For example, in connection with this problem the habits of the more hardy type of small surface-feeding fishes, the structure of their mouth, the quality and quantity of the food of these fishes under natural conditions, besides the question of their acclimatisation to new surroundings should be thoroughly inquired into, before they are used for destroying mosquito larvæ.

2. *Harmful insects.* Some of the insects have been shown to be of immense use to fish, but others are equally injurious. The large aquatic beetles (*Coleoptera*), some of the beetle larvæ, the bugs (*Hemiptera*) and some dragon-fly larvæ consume large quantities of the plankton, which as has been stated already forms the greater part of the food of some fish, and thus these insects stand out as very strong competitors with the fishes. They are injurious in another way also, in that they destroy large numbers of otherwise healthy fry of various fishes by gnawing and eating away their opercula, thus hindering the processes of respiration. They may exert some other influences also but then our information about all these is so very meagre. The Fisheries Department is trying its best towards the solution of all these problems and would be very grateful for any help that it may receive at the hands of entomologists and others.

#### 62.—NOTE ON A MUSCIPHAGOUS WASP (*BEMBEX LUNATA*).

By T. V. RAMAKRISHNA AYYAR, B.A., F.E.S., F.Z.S., *Ag. Government Entomologist, Madras.*

(Plate 141.)

It is well known that species of the Bembecine wasp genus *Bembex* are in the habit of collecting flies and storing them in their nests. There are also interesting accounts of these by observers like Peckham in America and Fabre in Europe. But, being the first time I noted an Indian species (*Bembex lunata*) doing this, I have brought this to your notice just to know whether any others have seen this in this or any other species of *Bembex*.

The first time I saw this was at Hillgrove (2,000 feet) on the Nilgiris where this wasp was very actively collecting flies of sorts attacking the body of a cow. The flies happened to be species of *Stomoxys*, *Lyperosia*, and *Philæmatomyia*—all biting flies.

I again noted this phenomenon at Tanjore in the Plains where the flies were collected from cart bullocks. I was not able in this case to identify the flies. I am sorry I was not able to follow the wasps in both cases to their nests.

I believe this appears to be interesting from a veterinary point of view also.

Does the reader of this paper know whether the wasps stupefy the flies?

I am sorry to say that I could not observe this point.

Species of *Bembex* are usually found in sandy places but they are so quick on the wing that it is generally very difficult to observe them. Bingham, in his *Fauna* volume, notes that they prey on Diptera and states that some Indian species do not close their burrows but keep them open and supply their larvæ with fresh food. I am not aware, however, that the species of Diptera so taken have been definitely determined before.

### 63.—NOTES ON THE LIFE-HISTORY OF *CANTAO OCELLATUS*, TH.

By T. V. RAMAKRISHNA AYYAR, B.A., F.E.S., F.Z.S., *Ag. Government Entomologist, Madras.*

(Plate 142.)

During the months from May to July this gay-coloured Pentatomid is found in numbers on *Trewia nudifolia*, an Euphorbiaceous tree growing abundantly along the banks of the big tanks adjoining the Agricultural College, Coimbatore, South India. Due to the striking colouration and its habit of feeding quite exposed on the tender leaves and succulent fruits of the tree, this bug many a time attracts the attention even of the layman.

So far as I am aware, very little is on record regarding the early stages and habits of this bug although the insect has been known to science for over a hundred years past. According to Dixon this insect is sparingly found in the Borghat (Bombay) in April-May and appears to play an important part in the pollination of the Moon tree (*Macaranga roxburghii*). Green states that in Ceylon this species is found gregariously twenty or thirty together on single branches of trees. Lefroy in his *Indian Insect Life* has a word about the insect's habit of sitting on its eggmass.

Mrs. Hutchinson.

Mr. Ramakrishna  
Ayyar.  
Mr. Fletcher.



## EXPLANATION OF PLATE 142.

### *Cantao ocellatus.*

- Fig. 1. Branch of *Trewia nudiflora* with bugs on it, natural size.  
Fig. 2. Female bug brooding over egg-mass, natural size.  
Fig. 3. Eggs, newly-laid (on left) and ready to hatch (on right), magnified. The natural sizes are shown by the smaller figures within the dotted circles.  
Fig. 4. Parasite on eggs, magnified.  
Fig. 5. Larva, first instar, magnified.  
Fig. 6. Larva, second instar, magnified.  
Fig. 7. Larva, third instar, magnified.  
Fig. 8. Larva, fourth instar, magnified.  
Fig. 9. Larva, fifth instar, magnified.  
(In figures 4-9 the natural sizes are shown in the smaller figures alongside each of the magnified illustrations.)



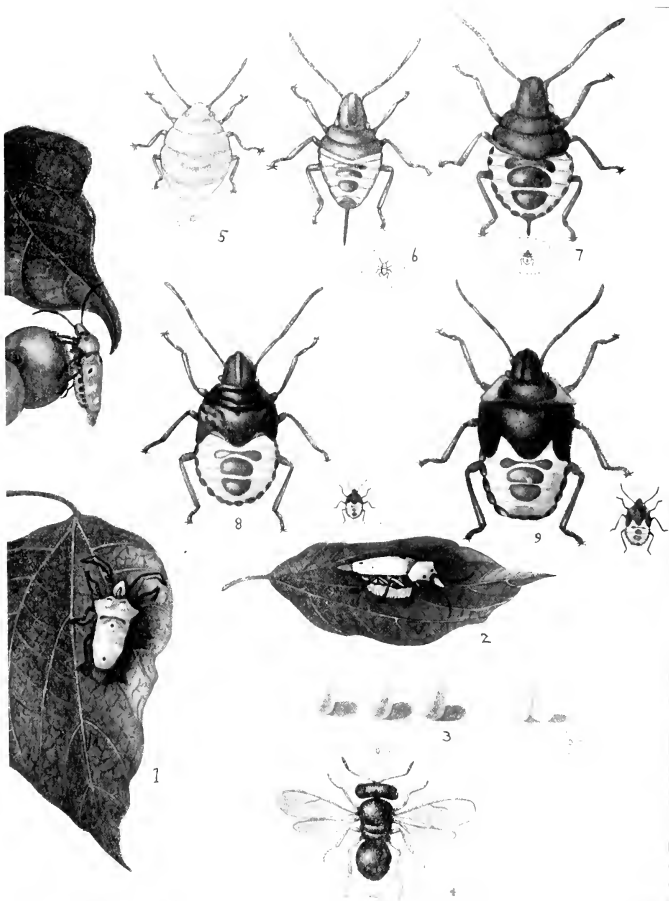

CANTAO OCELLATUS.



The following notes form a summary of the observations I have been able to make on the life-history and habits of this insect in South India.

*Distribution.* I have noted this insect in Coimbatore, the Mysore uplands, the Bababudins and on the Western Ghats, commonly in summer. Besides *Trewia* I have found this insect occasionally breeding on *Kigelia pinnata* in company with another conspicuous bug, *Catantus incarnatus*, Dr., in the Western ghats and on the Mysore uplands.

*Life-history.* As is usual with most bugs, the method of coupling is in opposition. The sexes remain united for a long time—even as long as 36 hours sometimes—and numerous couples are seen in May-June, which appears to be the breeding season.

*Egg.* Egg-laying does not occur soon after the sexes separate but it generally takes place from two to four days afterwards; at any rate, this was the case in captivity. The eggs are generally laid on the lower surface of tender leaves, though they are also found at times deposited on fruit clusters. In captivity the act of egg-laying was never noticed during the day time. The eggs are laid in groups, the number in each group varying from 10 to as many as 150. The eggs in each group are closely packed together in parallel rows and each of them is cemented to the plant surface. In shape each egg is cylindrical and attached to the plant surface by one of the poles of the cylinder; the height of the egg is 1.5 mm. while each measures 0.875 mm. across transversely. The egg surface is smooth and, unlike that of many other Pentatomids, there is no separately marked lid or sculptured operculum provided; but the region of the egg cap can be made out as a transparent shining circular area on the top pole of the egg. In colour the just-laid egg-cluster is glistening yellow-white; especially the upper pole through which the future larva emerges is very glossy; this colour gradually changes to a deep orange as the hatching time approaches. At this latter stage the pink eyes of the future nymph are seen through the transparent egg-shell as two bright spots.

This insect is one of the few and interesting examples of insects exhibiting what may be called 'parental care.' The mother-bug sits on the eggmass and continues to do so from the time the eggs are deposited until after they hatch out into young ones. In some cases I have observed the mother remain in the same position some time even after all the young larvæ have moved away from beneath her body. All this time the parent insect does not take any food and while in this posture the slightest disturbance makes it vibrate the antennæ in a characteristic manner as though in defence, and bring its body closer to that side of the eggmass

where the disturbance is felt. The egg mass in some cases is fairly big and the parent is not able to cover the whole mass while it sits over it. In one case where I got a group of eggs collected from a tree with the mother mounting guard over them, I observed that, while those eggs well covered by the parent's body retained their normal colour, those at the edge and away from the mother's reach developed a dark tinge and eventually in about two days minute black wasps\* emerged from the eggs instead of bug larvæ. Evidently the parent resting on the egg-mass serves to some extent as a preventive against the eggs getting parasitized.† A similar case of parental care is described in the Transactions of the Entomological Society for 1904 by Dodd in the case of another Pentatomid, *Tectocoris lincola*, var. *banksi*, Don.

In from five to seven days the eggs hatch; all the young ones do not emerge together. An interval of several hours intervenes between the hatching out of the first nymph and the opening of the last few eggs of a group.

*First instar.* Length 1.5 mm. The tiny larva has at this stage a roughly oval shape with the upper surface convex from above. The antennæ and limbs are comparatively well developed; the distal joint of the antenna is slightly swollen. The rostrum extends almost to the tip of the abdomen along the ventral side. The general colour is orange; eyes bright scarlet; antennæ, rostrum and legs transparent brown. In about half an hour after emergence the colour of the limbs, thorax and the dorsal region of the abdomen changes to a paler hue. Two fairly distinct and one faint dark patches appear on the abdomen. All the larvæ coming out of one egg-batch remain feeding gregariously on the fruit or the leaf surface for a pretty long time—in some cases even up to the second or third moult. During the first stage the creature is quite helpless, the slightest external disturbance often affecting it very much.

*Second instar.* Length 3 mm. Head, antennæ, legs, rostrum, connexival spots and transverse bands across abdomen get a shiny bluish brown colour. The head and thorax get a metallic greenish tinge, the abdomen becomes pinkish; the antennal joints are pinkish proximally, connexivum bluish black. Three transverse patches of blue black colour are found across the abdomen dorsally; of these two one is dumb-bell-shaped. The general shape of the body becomes changed due to a tendency on the part of the anterior portion of the body to be drawn forward.

---

\* This parasite appears to be same as *Trichonomus indii*, Girault, found on Pentatomid eggs.

† This fact has also been mentioned by Fletcher in his *South Indian Insects*, page 34, figure 17.

The rostrum now extends slightly beyond the abdomen and can be seen from above; the distal joint of the antenna is slightly swollen.

At this stage also the larvæ are gregarious and not very active; but they often manage to remain together hidden either under a leaf or on the unexposed surface of a fruit.

The second moult takes place after four days.

*Third instar.* Length 5 mm. At this stage the posterior end of the thorax shows a tendency to become pointed backwards to form the future scutellum. Soon after the second moult the larva has a uniform pinkish colour and the rostrum has a whitish tinge. After an hour or more the ground-colour now becomes changed to a reddish ochre and the metallic spots at the connexivum appear clearly. The rostrum reaches beyond the abdomen. The scutellum appears pointed posteriorly at the median line. The larvæ still feed gregariously but in hiding. In another four days the third moult occurs.

*Fourth instar.* Length 8 mm. At this stage the rostrum is slightly shorter and just reaches the tip of the abdomen. Head, thorax, legs and rostrum metallic blue; abdomen above and below reddish ochraceous with two transverse and one dumb-bell-shaped patches of dark brown on the dorsal surface of the abdomen. The head is drawn forwards and the three regions in it are clear; the rudiments of the wings appear on each side of the body as blunt processes of a metallic hue. The scutellum is found gradually moving backwards over the abdomen. The larvæ at this stage begin to separate and remain feeding hiding under leaves. In another four days the next stage is assumed after another moult.

*Fifth instar.* Length 12 mm. The rostrum at present reaches only the third abdominal segment. The wing-pads and scutellum are distinct and have moved backwards well over the abdomen. The latter is bluntly pointed behind and reaches the first dumb-bell-shaped transverse band on the abdomen; the wing-pads extend a little beyond. The prothoracic spines now appear and though small are distinct, sharp and pointed backwards. In colour the antennæ and rostrum are dark, the region of the legs from coxa to tibia reddish; the tibiae and tarsi of a shining metallic green colour. Head, thorax and scutellum shining metallic green. The lateral margins of the prothorax orange. The metallic bands on the abdomen are broader and prominent. The abdomen below gets a darker ringe especially at the midventral region.

In a week's time the last moult takes place and the adult condition is assumed. The following table of rearing in captivity show the approxi-

mate period occupied by each stage in the development of the insect in two cases.

No.	Eggs laid on	Hatched 1st stage	2nd stage	3rd stage	4th stage	5th stage	Adult	TOTAL
1	14th May	19th May	23rd May	27th May	31st May	4th June	12th June	28 days.
2	20th May	24th May	28th May	2nd June	5th June	9th June	16th June	27 days.

Thus the adult condition is reached in about a month's time from the date of egg-laying.

*The sexes.*—There is a good deal of individual variation in the adults, nor can males and females be easily distinguished by any definite colour markings. The male is generally smaller in size and has, so far as I have observed, a more pronounced colouration. In a number of specimens of the adults examined I found that the bluish-black spots on the ventral side of the abdomen are generally more in number in the females than in the males.

One very interesting thing about this bug is that it is an annual visitor to the locality, coming about May and disappearing in July. For the rest of the year I have never found a single specimen anywhere in the vicinity of the College. And the season between May-June is the shooting and fruiting season of the food plant *Trewia*.

#### 64.—NOTES ON THE LIFE-HISTORY OF *POLYPTYCHUS DENTATUS*.

By T. V. RAMAKRISHNA AYYAR, B.A., F.E.S., F.Z.S., *Acting Government Entomologist, Madras.*

(Plate 143.)

Rothschild and Jordan in their classical memoir on the Spingidae of the World record only two species of the genus *Polyptychus* as found in India, the rest of the species, about thirty in number, being recorded as African. Of the two *P. dentatus* is the subject of this paper. Although there are two or three previous references to this insect, whatever is on record regarding the earlier stages of this insect is very meagre and imperfect. Harsey has devoted a couple of lines to the larva of this insect as found at Barrackpur and he calls it *Smerinthus denticulatus* in the *Proceedings of the Entomological Society* (1864) Vol. III, p. 100. Forsayeth in his paper on the Lepidoptera of Mhow in the *Transactions of the Entomological Society* for 1884, p. 395, refers to this insect and gives a very brief and meagre description of a fairly well-grown larva. These



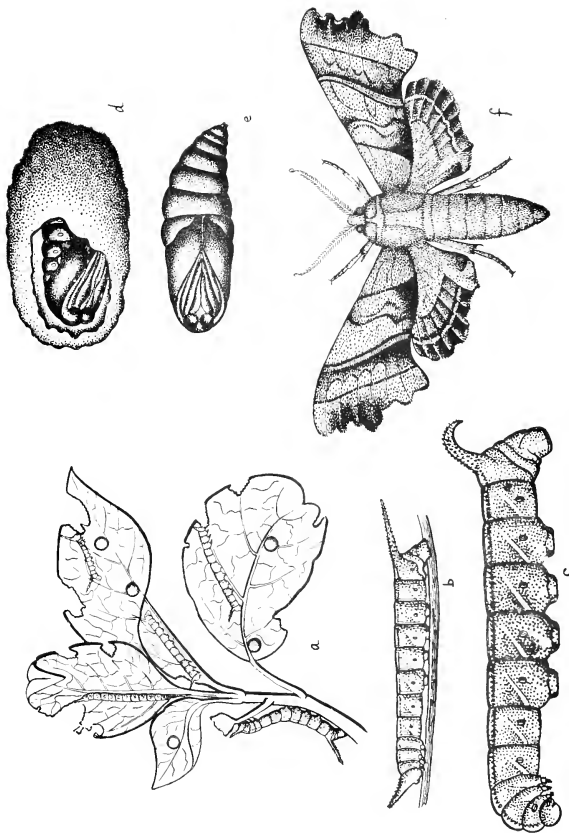

*Polyptychus dentatus*; a, *Cordia* shoot showing eggs and young larvae; b, half-grown larva; c, full-grown larva; d, cocoon, partly broken open to show pupa; e, pupa; f, moth.



are the only references to the early stages of this insect. Rothschild and Jordan, speaking of the larval stages of these Ambulicine hawk-moths, say that the first stage is not known of any of these larvæ. I believe therefore that the early stages of this insect will probably be of interest. The following is a brief summary of the different stages in the life-history of this Sphingid.

*Food-plant.* The early stages of this moth are spent exclusively on *Cardia subcordata*, a plant which appears to be a native of the Asiatic Archipelago and not common in India, only being grown here and there in gardens. In Coimbatore on a solitary plant of this kind in the estate I have found the early stages of this insect, almost all through the year—especially from July to March. It is not generally seen during the summer months.

*Egg.* The eggs are of the usual Sphingid type, fairly big, spherical and seedlike in shape. They are found deposited singly both on the upper and under surface of the leaves. In captivity the eggs laid by one moth numbered over thirty. The egg-surface is smooth and in colour it is glistening yellowish white; it measures 2 mm. across. Very often the egg is parasitized by a small dark Chalcidid wasp which has been found to be a new species by Girault who has given it the name *Anastatus coimbatorensis*. The egg takes from five to ten days to hatch. Soon after hatching the larva often feeds on the egg-shell.

*The first stage.* The just-hatched larva measures 9.5 mm. The head is very slender and elongated, spherical, smooth, made up of two hemispheres with a median ventral groove. The prothorax is slightly swollen. The usual posterior horn on the anal segment is present, measuring 1.25 mm. It is very slender and directed straight up vertically; the tip of the horn is forked. Just behind the horn are two small sharp tubercles which are only clearly seen when observed carefully. The general colour of the body is a uniform pale greenish-yellow; ocelli dark, the horn pinkish. The legs and prolegs have the colour of the body. The whole body is fringed with numerous minute white tubercles. Within a short period of two days the first moult takes place, and the second stage is reached. Very little of the moulted skin is found in the cage in captivity; probably the larva feeds on it.

*The second stage.* Length 11 mm. Body is still slender and elongate. The striking feature of this stage is the appearance of a vertical cephalic process not generally seen in most caterpillars. No trace of it is found in the caterpillars when it hatches out of the egg and it appears only after the first moult. This head-process, when closely observed, is made up of two elongated pieces very closely approximated together and made

to appear as one; it measures 2 mm.; each of these is fringed with minute sharp tubercles. The head is wedge-shaped and with the cephalic process appears more or less like that of a goat. The tail-process is prominent (3.5 mm. long) and kept almost upright. The whole body is fringed with minute tubercles. Those along the mid-dorsal line form a sort of median dorsal ridge. The general colour of the body is a pale green. The head process is transparent greenish-white and the tail process is pinkish-brown. Head pale greenish; rest of body yellowish-green. Spiracles are seen as minute dark spots. There is a median dorsal small dark brown patch on the prothorax.

During these earlier stages the caterpillar exactly resembles the ribs of the backside of the *Cardia* leaf, so much so that it is difficult to make out the presence of the larva on the leaf unless closely observed. Before the next moult the larva grows to 16 mm. At this stage marked changes in the form and colour take place. The head and tail horns elongate with the body. The former becomes distinctly differentiated from the body by its peculiar triangular shape with the dorsal horn. The general colour of the body, although still pale yellowish-green, brown and purple colour markings appear all over the dorsal surface. The dorsal region of the head around the base of the horn is dark; the rest of the head light yellowish-green. The whole of the head process has a dark brown colour. The head and the process are covered with numerous minute tubercles. The dorsal region of the prothorax has a pinkish median stripe which at the posterior boundary of this segment expands into a prominent black spot. From behind this area, *viz.*, from the mesothorax backwards to the posterior horn on the last abdominal segment, there is a series of pinkish-brown spots arranged in pairs along the mid-dorsal region. The thoracic legs are purple-brown and the prolegs whitish-green. The posterior horn is purplish-brown, 5.5 mm. long, straight and covered with minute tubercles. The posterior two or three pairs of spiracles are distinctly seen as dark brown spots. At this stage the larva moults a second time and assumes the third stage. One week is spent in the second stage.

*Third stage.* Length 18 mm. There is no change in the general appearance and colour. In front of the head are found two bluish-black streaks, one on each side of the clypeus, beginning from the ocellar region and extending backwards, both these meeting at the foot of the cephalic horn, ocelli and mouth parts olive brown. The spiracles appear clearer. When the larva moves about the cephalic process is kept erect and not directed forwards. At this stage the larva exactly resembles the central main rib of the back of a *Cardia* leaf.

Within another week the third skin is thrown off.

*Fourth stage.* Length 20 mm. Tail process 8 mm., head process 5.5 mm. The anal process at this stage is comparatively very long, deep bluish-black, and fringed with tubercles. General colour of the body is light yellowish-green above and pale green at the sides and below. Head-process vertical and dark brown. Along the dorsal region wedge-shaped brownish marks appear along middorsal region bounded on each lateral side by a long row of prominent yellowish-brown tubercles. The body as a whole is fringed with minute white tubercles. At this stage the head and tail processes look almost similar in form and colour and it is often difficult to say which is head and which is the tail of the larva when casually observed.

In another six days the next moult takes place.

*Fifth stage.* Length 30 mm. Tail horn 10 mm., head process 5 mm. The tail horn is horizontal and the cephalic process vertical. General colour pale yellowish-green with the wedge-shaped brown spots along the dorsal region; each of these gives out a short lateral streak. Spiracles brown; legs purple brown. Head and tail process bluish-black.

The next moult takes place in another week's time.

*Sixth stage.* Length 40 mm.—Tail horn 10 mm., extending 8 mm. beyond the body. The head-process is short though prominent. No marked changes in form and colour are noticed. The larva grows stouter, larger and more cylindrical in shape. It also becomes voracious, feeding on the foliage. Tail process bluish-black; facial streaks, legs and spiracles purple-brown. In seven or eight days more another skin is thrown off.

*Seventh stage.* Length 46 mm. At this stage of the life of the larva the head process is *finally lost*. The posterior horn is still present. It is pointed and somewhat curved and extends a little beyond the anal segment. The whole body has a light greyish-green colour. Middorsal region along the whole length of the body is divided off from the two lateral regions by a longitudinal row of prominent tubercles on each side of this region. These two rows of tubercles begin at the prothoracic region and meet at the base of the horn on the anal segment. These tubercles have a pinkish colour. In this mid-dorsal region, which is of a yellowish-green colour, there is an interrupted transverse band of purple on each segment. There is a continuation of each of these bars at the sides drawn antero-posteriorly in a tangential manner. The anal horn is greyish fringed with numerous small pink tubercles. Spiracles brown. Head and prothorax greyish-green; legs purple-brown. The claspers are edged with purple.

During this last stage the larva feeds voraciously and grows in size rapidly. At the same time colour changes also occur. Just before pupation a well-fed larva reaches 80 mm. The body becomes long, cylindrical

and stout. The anterior region is thinner than the abdominal end, which is stouter. The head is more or less triangular. The anal horn is prominent and curved. The whole body is fringed with minute whitish tubercles. The two longitudinal rows of tubercles on the dorsal surface are prominent and the individual tubercles are bigger and really made up of two or three smaller tubercles around a bigger one. The general colour is green with the difference that the region on the dorsal surface between the two longitudinal rows of spiracles is bright green while the sides and ventral portion of the body have a bluish tinge. Each row of tubercles appears as a pinkish line from the prothorax to the anal horn; the latter is pale green and studded with tubercles. Mouth parts brown; legs purplish-brown. Prolegs and claspers with purple edges. There are six clear and one or two faint whitish tangent stripes at the sides; the last one meeting the horn is clearer than the rest.

This stage lasts from twelve to fourteen days. At the end of this period the larva stops feeding and descends into the soil to pupate.

*Pupa.* The larva goes three or four inches into the soil and more if the soil is not hard and easily penetrated; there it makes a cell of earth, and after this it changes into the pupa. The pupa inside the earthen cocoon is 36 mm. long. It is thick anteriorly, and bluntly pointed behind and chocolate brown in colour. There is a short forked spine at the anal end:—

The pupal period lasts twelve to fourteen days. The following is a table showing period of pupation in different cases.

Date of pupation	Date of emergence
7th December . . . . .	29th December.
30th July . . . . .	13th August.
24th February . . . . .	9th March.
21st October . . . . .	2nd November.
21st November . . . . .	3rd December.

The development period thus takes in all about nine to ten weeks, the period being occupied as below:—eggs a week, larva 48 to 50 days, pupa 12 to 14 days. The period of each stage is found to differ slightly according to seasonal variations.

*General remarks.* The larva is easy to rear. I have never caught the adults in nature. As stated before, the most interesting feature in this caterpillar is the presence of a head-horn in the early stages of the caterpillar, a character which is not common in most Spingidæ.



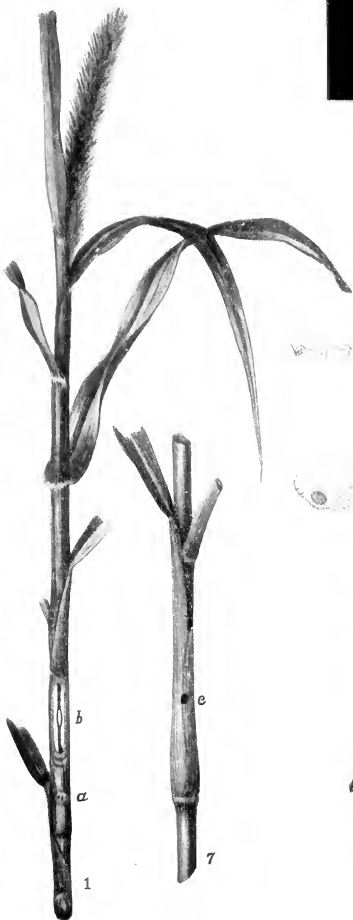

2



3



4



5

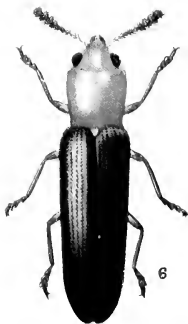

6

ANADASTUS SP.

## EXPLANATION OF PLATE 144.

### *Anadastus* sp.

- Fig. 1 Stem of Italian millet showing (a) mark left by oviposition, and (b) egg in situation
- Fig. 2. Egg ; magnified ( $\times 20$ ).
- Fig. 3. Young larva ; magnified ( $\times 20$ ).
- Fig. 4. Full-grown larva ; magnified ( $\times 8$ ).
- Fig. 5. Pupa ; magnified ( $\times 8$ ).
- Fig. 6. Beetle ; magnified ( $\times 8$ ).
- Fig. 7. Stem from which imago has emerged, showing (c) exit.

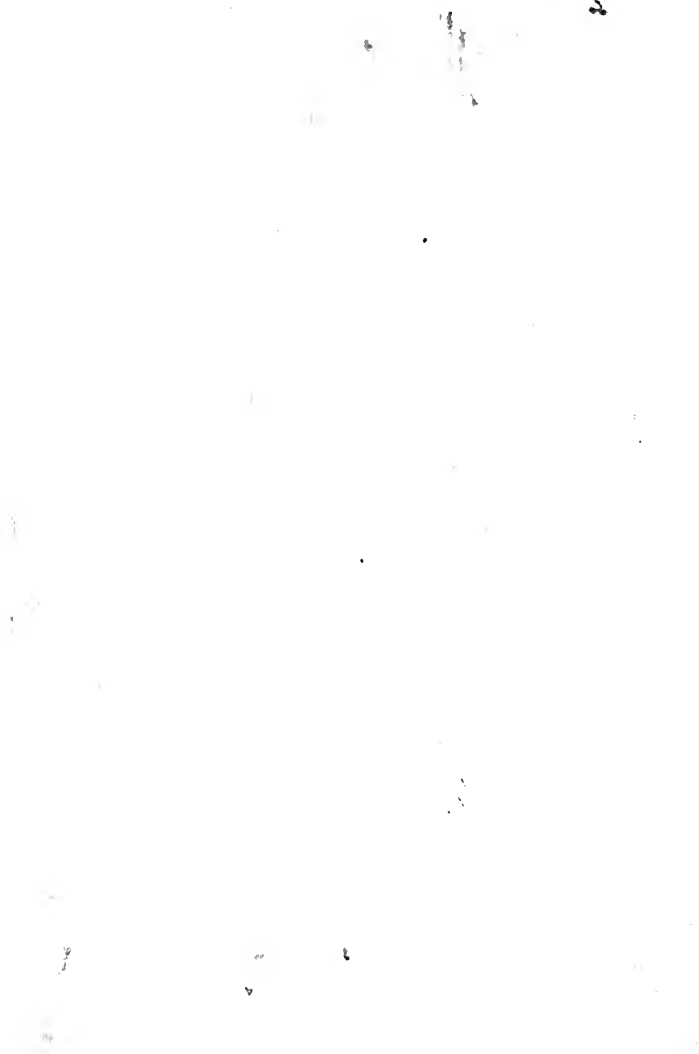



## 5.—SOME OBSERVATIONS ON THE LIFE-HISTORY OF AN EROTYLID BREEDING IN ITALIAN MILLET.

By P. V. ISAAC, B.A., *Entomological Assistant, Agricultural Department, Madras.*

(Plate 144.)

*I. Introduction.*

Recently a small Erotylid beetle, a species of *Languria*,\* attracted considerable attention to itself as a pest of Italian millet [*Setaria italica*]. Without exaggeration it may be said that during certain seasons the beetle did more damage to the crop on the College farm, Coimbatore, than all other insects combined.

Apparently the insect has not been noticed elsewhere although on the above farm they were numerous enough, and found in almost every field, the worst infestation being in certain small plots attached to the Insectary.

*II. General Observations.*

A summary of the general observations is as follows :—

- (1) The first sign of injury is a withering earhead, the stalk of which when pulled smartly breaks at a ring a few inches above the ground.
- (2) The damage is done by a grub which neatly rings the stem from inside. The cut, which extends almost up to the epidermis, not only causes the flow of plant sap to discontinue, but also makes the stem liable to break in a strong wind.
- (3) The grubs were not found in the stout central stem of every clump, nor were they seen to attack certain thick-stemmed strains of Italian millet.
- (4) A good number of stalks having snapped yielded nothing, while others with very little or no sap passing up the ring yielded more chaff and less grain or no grain at all.

*III. Life cycle.*

Considering the amount of damage this pest was responsible for, it was decided to make a study of its life-history.

*The egg.* The egg is 1.75 mm. long, cigar-shaped, smooth, shiny, and cream-coloured. In about two days, except at the tips, it becomes orange.

---

\* Since determined as a species of *Ana lastus* (see *ante*, page 316).—Editor.

*Just-hatched larva.* 2 mm. long, yellow. Head large and provided with strong mandibles, and short antennæ. Close to the base of each antenna and just posterior to it is a group of four small eye-spots, one below the other. The ultimate segment bears a pair of fleshy pseudopods.

*Mature larva.* 8 mm. long; legs very small; abdominal segments large and distinct. There is a pair of short chitinous spines on the dorsal surface of the last segment, directed cephalad. The anal pseudopods are prominent.

*Pupa.* 7 mm. The newly transformed pupa is yellow but later on it becomes darker and tinged with reddish-brown at the tips of the appendages. The eyes at first present the appearance of a group of light brown specks but finally form into large black dots. A transverse row of spines is present on the dorsal aspect of every abdominal segment except the last one, which has instead a pair of very strong spines occupying a terminal position and curved slightly towards the anterior. The dorsal spines become larger and more pronounced as they approach the posterior end. A pair of spines directed caudad are present on the ventral surface of the seventh abdominal segment. Hairs are found on the vertex, on the anterior and posterior margins of the large prothoracic shield and also interspersed with the dorsal spines.

The total life cycle is:—egg 5 to 6 days, larva 25 days, and pupa 14 days. About four days have to elapse after emergence for the beetle to leave the shelter of the stem.

#### IV. Habits.

The eggs are laid singly in the stems at some point from one to six inches above the soil. This takes place during the second month of the crop when the stalks are rapidly elongating and the ears are being put out, and eggs are laid only in stems in which the central hollow has begun to appear. The egg is thrust in at some spot just within an inch above a node. As elongation of the internode in grasses is confined to the portion just above the node this region is softer and more vulnerable than the portion farther up and is therefore selected for oviposition.

Oviposition always leaves a mark: though it is often impossible to trace it on the stem itself. But on the outer leaf-sheath it remains distinct as a small dry oval patch, bearing three punctures in a horizontal row. The side ones seem to be caused by some lateral supporting structures on the ovipositor. The egg is passed in through the central one and this is therefore the only puncture that extends into the stem.

There is only one egg laid in an internode and it has its long axis in a line with that of the stem. Though the egg is laid within an inch above a node, due to the rapid elongation of the stem as mentioned above it

may be seen closer to the upper node than to the lower and also far above the level of the impression left by the oviposition on the outer sheath.

The grub as soon as out of the shell travels about in the hollow and on reaching the base feeds a little on the pithy lining of the inner wall. It next attends to the ringing of the stem, which is begun on the second or third day after hatching and is accomplished in a few hours. The cut goes completely round and is so deep that it almost reaches the epidermis.

The question that arises is "what purpose does this ring serve?" The labour bestowed and the skill displayed premise something more than an effort to supply with humble toil the modest wants of the day. In all probability it is intended to prevent the plant-sap from rising up.

From now the grub is to be found above the ring. It is a moderate feeder and does not go about in search of a palatable morsel. Remaining above the ring and content with the adjacent tissue, as it grows it finds itself in an enlarging chamber. If the grub gets moist it is sure to die. This calamity is prevented by the ring which prevents plant-sap from rising up and by the accumulation of frass at the ring.

It may be noted here that a single stem may be infested with more than one grub. There may at times be as many as four. But always there is only one grub in an internode and it never bores through into an adjacent one.

When full-grown the grub pupates within the stem. If the stem now snaps at the ring, as occasionally happens, the mass of frass accumulated there, as mentioned before, acts as a plug and keeps the pupal chamber closed and the pupa safe.

The beetle on emergence has the exoskeleton soft and of an amber colour. But very soon the normal hardness and hue is gained and within five days after emergence the full-fledged adult cuts a small hole in the wall of the stem and creeps out.

The beetles are shy creatures, but a close observer can locate them, moving up and down the leaves or stems. They seldom take to flight, a habit which makes hand-picking easy when control methods are necessary.

#### V. *Conclusion.*

It may be stated in conclusion that the beetle has habits well calculated to ensure success. Eggs are laid during the second month of the crop and they grow into adults in a month and a half. A generation is therefore produced before it is time to harvest the crop.

66.—THE LIFE-HISTORY OF THE *MORINGA* STEM-BORER.

By T. V. SUBRAMANYAM, B.A., *Assistant to the Government Entomologist, Madras.*

(Plate 145.)

This paper deals with the life-history of a longicorn beetle boring into the branches of the *moringa* plant (*Moringa pterygosperma*), the drumstick plant of South India. This plant is economically very important, at least in the Madras Presidency, where its long sticklike fruits are largely used in the preparation of vegetable curries and are considered to be extremely nutritious. The leaves and flowers are also extensively used. The insect has not been identified correctly and has been sent to experts for identification. A stray grub was seen one day boring inside a *moringa* twig and the adult when reared out at the Insectary was found to be this beetle. Afterwards a pair of these beetles were caught during copulation and made to lay eggs in captivity and the life-history was completely studied. The insect is not a serious pest but it is seen occasionally scraping away the bark of the plant when an adult and boring in *moringa* twigs during its larval stage.

The insect, the larva of which is found boring inside the branches of the plant, is one of the Lamiadae, a Family of comparatively large-sized beetles, generally recognized by their hard and robust bodies and long filamentous antennae. The beetle has not been identified yet; I believe it is a species of *Monohammus*. The adult beetle is half to three-fourths of an inch long and an eighth of an inch in breadth. The prothorax and the wings, which cover the whole body on the dorsal side, are brown in colour with dark grey patches here and there. The under-side of the body, the vertex of the head, the labrum and the basal segment of the mandibles are covered with thick grey pubescence. The head is bent down under the prothorax. The mouth-parts are well developed and adapted to the bark-eating habits of the insect; the labrum is orange in colour and the mandibles hard and black; maxillae are well developed. The antennae are long and filamentous, arising from the inner curvatures of the large black eyes. Each antenna consists of twelve segments covered by short, soft, grey hairs: the basal segment is short and stumpy and the first few segments have a row of long black hairs along the inner side. The prothorax is long and cylindrical. There are four visible abdominal segments. The legs are yellowish brown covered by grey pubescence and end in two claws.

The insect has not been noted as a serious pest. But just before I left for Bombay I found a whole tree attacked. The injury is recognized

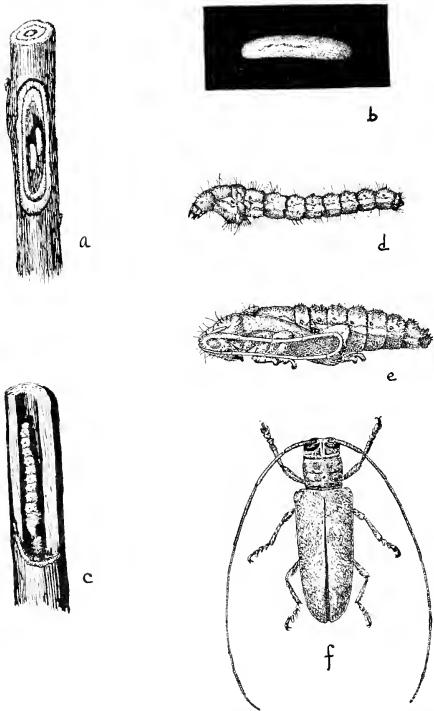

*Moringa* stem-borer. a, eggs *in situ* in stem; b, egg magnified  $\times 7$ ; c, larva in tunnel in stem; d, larva magnified  $\times 4$ ; e, pupa, magnified  $\times 4$ ; f, beetle magnified  $\times 2\frac{1}{2}$ .



by the twigs drying at the tip and absence of leaves on them. The attack begins at the tip and the grub bores towards the main stem. Only a few beetles have been collected and a few grubs found boring into the stem. No alternative food-plant has been noted. The beetles were once supplied with *agathi* branches; but they never took to this food and began eating only when *moringa* twigs were given.

*Life-History.* There is no sexual difference in the beetles excepting that the males are a little smaller than the females in size. The female lays its eggs inside the stem of the food-plant. In two or three days the egg hatches into a tiny grub which begins at once to bore into the stem at its centre; it remains inside the stem until it becomes full-grown when it leaves the stem and pupates outside. In about a week or ten days the adult comes out of the pupa.

*Egg.* Eggs are laid in hollow cavities, excavated by the mother, in the stem. The place in the stem, where the eggs are, is indicated by a small mark on the stem where the bark has been scraped off by the mother beetle. In the centre of this patch is a small hole which leads into the cavity in which the eggs are laid. This cavity is oval in outline and generally contains two eggs, although occasionally there may be only one. Though only two or at the utmost three eggs are laid by an individual at a time, the total number laid by it will be large as the beetle goes on laying eggs for a number of days. The beetle that was under observation at the Insectary laid about fifty eggs during the time it was in captivity—who knows how many it may have laid before it was caught? The eggs are long, cylindrical, and whitish in colour; they have a slight curvature on one side and measure 1 mm. in length.

On the second day after the eggs are laid the grubs inside are clearly seen through the egg-shells and on the third or fourth day the eggs hatch into tiny little grubs, so that the egg-period may be roughly said to last only two or three days.

No.	Eggs laid on	Eggs hatched on	Egg period
			Days
1	1st May 1917 . . . .	2nd May 1917 . . . .	1
2	5th May 1917 . . . .	7th May 1917 . . . .	2
3	7th, 8th May 1918 . . . .	9th, 10th May 1917 . . . .	2
4	10th, 11th June 1917 . . . .	12th, 13th June 1917 . . . .	2
5	12th, 13th June 1917 . . . .	15th, 16th June 1917 . . . .	3
6	13th, 14th June 1917 . . . .	16th, 17th June 1917 . . . .	3

The grub comes out of the egg-shell by bursting it open at one end by its hard mandibles and wriggling out. A peculiarity noticed was that in most cases two eggs were laid at a time side by side in a cavity but only one grub was to be found in the cavity afterwards and the other egg or the grub hatched out of it was missing. In one instance only the egg-shell of the missing grub was to be found. This leads to the suspicion that the more vigorous of the newly-hatched grubs eats its less fortunate neighbour.

*Larva.* The newly-hatched grub is about 2 mm. long and is whitish in colour with brown well-developed mandibles. The thoracic region has a swelling on the ventral side. The abdomen is made up of ten segments each of which has a short projection on the dorsal side with the help of which the segments may be counted. The whole body has a slight curvature on the ventral side. Small short brownish hairs are scattered all over the ventral side of the body and round the last two segments. The grub has neither thoracic nor abdominal appendages and locomotion is effected entirely by means of the wriggling movements brought about by the contractions and relaxations of the muscles of the body-wall. As soon as the grub comes out of the egg it begins to bore into the stem; it makes a straight tunnel in the centre of the stem, blocking up its entrance and a short distance inside it with excrement.

The full-grown larva is a little over thirty-two millimetres in length and has the ventral thoracic lump well developed. The segments of the body have the dorsal surface convex and the ventral surface plain. The body has a gli-tening appearance and is covered all over by short hairs which are yellow on the dorsal side and brown on the ventral. The anal segment of the body is flattened at its hind end and has a circle of brown hairs along its edges.

The duration of the larval period is variable. Of the four grubs that completed their life-history in captivity one pupated two months and five days after hatching from the egg, another two months and 26 days, a third three months and 16 days and the last three months and 24 days.

No.	Hatched on	Pupated on	Larval period
1	2nd May 1917 . . .	7th August 1917 . . .	2 months 5 days.
2	9th, 10th May 1917 . . .	5th, 6th August 1917 . . .	3 months 26 days.
3	16th, 17th June 1917 . . .	3rd October 1917 . . .	3 months 16 days.
4	12th, 13th June 1917 . . .	7th October 1917 . . .	3 months 24 days.



The larval period may thus be put roughly to be from two to four months. Pupation has not been observed in nature; probably it is in the soil or some other place outside the stem because all the grubs reared in captivity came out of the stem when they were full-grown and pupated outside.

*Pupa.* This is of the typical Lamiad type. It is yellow in colour and 20-25 mm. long. The appendages of the head and the thorax are folded together on the ventral side inside the exceedingly thin and transparent pupal skin. A day or two after pupation the eyes get dark. The colour of the pupa changes gradually from yellow to brown and after a week the pupal skin is cast off and the adult emerges.

No.	Pupated on	Emerged on	Pupal period
1	7th July 1917 . . .	14th July 1917 . . .	Days 7
2	6th August 1917 . . .	14th August 1917 . . .	8
3	3rd October 1917 . . .	13th October 1917 . . .	10
4	7th October 1917 . . .	15th October 1917 . . .	8

On emerging from the pupal skin the beetle is dull and soft to the touch. In a day or two the body gets hard and the beetle begins to move about and feed on the bark of the *moringa* stem.

These observations were made by me at the Insectary of the Agricultural College, Coimbatore, under the guidance of M. R. Ry. T. V. Ramakrishna Ayyar Avargal, the Acting Government Entomologist of Madras, and I take this opportunity of tendering him my heart-felt thanks for the valuable suggestions he gave me during my investigations.

The habit of emergence from the stem to pupate elsewhere, at the conclusion of the larval period, is most unusual in a Lamiad beetle. Further observations on this point, under natural conditions, appear desirable. Mr. Fletcher.

67.—NOTES ON THE LIFE-HISTORY OF THE *POLLU* FLEA-BEETLE (*LONGITARSUS NIGRIPENNIS*, MOTS.) OF PEPPER.

By T. V. RAMAKRISHNA AYYAR, B.A., F.E.S., F.Z.S., Acting Government Entomologist, Madras.

The subject of this paper is a flea-beetle which is found causing some damage to cultivated black pepper (*Piper nigrum*) in the pepper-growing tracts of North Malabar.

Since there is no previous record of this insect as a pest and since there is nothing also regarding the life-history or habits of the insect, I believe the following notes may be of some use in adding to our knowledge of this beetle.

So far as I know, sixteen species of this genus, *Longitarsus*, have till now been recorded from different parts of India, and of these *Longitarsus nigripennis* is one. The previous record of its locality in his description of the species by Motschulsky is simply "India" with no mention of the exact locality. Jacoby has described some species latterly and these are from Pondicherry, Madura, Calcutta, North Kanara and Belgaum.

The species of this genus are comparatively small in size, not more than 3 mm. in length, and are extremely active in habits. Their hind femora are very much thickened, thus showing the great saltatorial powers these insects possess. I have very rarely found them flying; they commonly leap or hop from place to place and cover great distances in such a way. This species (*L. nigripennis*) is 2.5 mm. in length. The head is comparatively very small and more or less covered by the fairly prominent prothorax. The antennæ are long and the eyes prominent. The hind femora are extraordinarily stout compared with the size of the insect. The head and prothorax are of a pale fulvous-yellow colour when fresh; in dry specimens this appears reddish-brown; the elytra bluish-black. The antennæ and legs are of a pale brownish colour; but the hind femora have a shining bluish-brown colour; the eyes are dark.

*Damage done by the insect.* You will find from the title of this paper that I have called this the "*Pollu* flea beetle of pepper." This means that the insect is associated with a disease of pepper called "*Pollu*" which really means 'hollow' or empty. The turning hollow of the growing pepper-berry is often caused by this beetle. There are, of course, other causes which bring about this '*Pollu*' condition but I shall confine myself only to the insect side of it. The small cream-white grub of this beetle burrows into the ripening green berries of pepper and eats away the inner contents, which causes the seedlessness or hollowness of the berry called '*Pollu*.' The external indication of such an attack on the growing pepper-vine is generally the presence of a group of two to four darkish berries in a spike of pepper, the rest of the spike being healthy and green. Infested berries are commonly found in groups of two, three or four. An examination of the inside of one of these blackened berries will disclose a short stout pale white grub. Generally only one of these three or four berries shows the grub and this is explained by the fact that this one grub is responsible for the damage of all the three or four berries in the group, the larva feeding on the inner contents

of the berries one after the other. Not more than four berries are attacked by one grub before it is full-fed. At the initial stages of infestation one has to examine the spikes more carefully to find berries that are just getting attacked, since, at the beginning, the berry that is first attacked simply shows a pale sickly yellowish surface and a minute hole through which excrement might be seen thrown out; the characteristic dark group of berries begins to show itself only when the grub has finished with one berry and has entered the second. In certain cases another phenomenon is noted in infested pepper-berries and that is the darkening of the whole distal portion of a spike. This happens when the grub in tunnelling through one berry to another encroaches on the main stem of the spike and scoops out a good portion of it; this damage to the stalk at the middle arrests the flow of nutrition to the distal portion and the berries beyond this spot turn black and do not ripen, although they remain attached to the spike almost throughout the season.

*Life-history.* Observations made in the field go to show that the eggs are laid singly. Each egg is carefully thrust and glued to the tissue just underneath the skin of the green pepper-berry, commonly near the attachment of the berry to the spike; only one egg is generally deposited in each berry. To find out the egg one has to open the berry skin very carefully in very thin slices. The egg is ovoid in shape and measures 1.5 mm. in length; it has a pale brownish colour. It has not yet been possible to get the eggs hatched out in captivity although several methods were tried. The grub is pale to cream-white in colour with the head and prothorax dark; it is comparatively short and stout in build.

The grub goes on growing by feeding on the inner contents of two or three berries for about forty or fifty days, after which it stops feeding and drops down into the soil to pupate. It goes down into the soil two to three inches and before the final moult to assume the pupal stage builds an oval cocoon of soil around itself. The pupa is pale white in colour. In this condition it remains for ten days—the period noted in captivity.

After this period, the adult form is assumed, but the beetle remains in that condition for a day or two in the soil and comes out only after these one or two days which are apparently necessary for the insect to get its body hard and become active itself.

The adult insect readily and voraciously feeds on the tender pepper-leaves, biting numerous small holes in them.

*Seasonal history.* The investigations with regard to the habits, etc., of this insect are still incomplete. But, so far as work has been done, it appears that there are two clear broods in the year, one generation of beetles emerging in October and another in January. It is thought that

the insect aestivates in the adult condition through the summer months, March to June. But whether this is so or whether there is another brood during this period of the year will be definitely known next season.

*Natural enemies.* So far no natural enemies of any kind either predatory or parasitic have been noted.

*Other host plants.* Besides pepper no other plant has been found till now wherein the pest breeds. This point can be verified during the off-season, when the pepper-vines are dormant.

*Extent and distribution of the 'Pollu' caused by the insect.* The pest is not noted in two of the three pepper tracts, viz., the coastal region and the Ghat region, but is prevalent only in the sub-montane jungly tracts below the Ghats. The insect is more commonly found in shady, damp and very cool plots. Even in the same place those plots, which are somewhat open and not full of shade-trees, are less infested with the beetle pest. With regard to the extent of damage the actual injury done by the insect in causing 'Pollu' is very little compared to the extent of actual 'Pollu' caused by all causes combined. We have reckoned it roughly as between 5 and 8 per cent. of the total damage.

*Control-methods.* Looking at the life habits of the insect it appears to me that the most vulnerable stage in the life of the insect is the pupa, and I think measures to destroy these in the soil at the proper season will go a great way in checking the multiplication of the pest. Hoeing the soil under the vines in September-October and December-January, the seasons when the pupæ are found under the soil, might do good. Nothing could be done to tackle the borer which is an internal feeder. Then, coming to the methods whereby the adult could be checked and prevented from laying eggs, one method is spraying: our attempts in this direction have shown that it is rather difficult to get the pepper vines satisfactorily sprayed, although in some plots where we tried some deterrents like lead arsenate and Bordeaux mixture the pest did not appear. Investigations are still continued in this direction.

#### 68.—ON SOME OF THE BIONOMICS OF BRUCHIDÆ (LARIADÆ).

By RAMRAO S. KASERCODE, Assistant Professor of Entomology, Poona.

The seed-testing Department of Bombay has for some years past been engaged in trying to find out the germinating capacity of most seeds used by the cultivator during the sowing season. The results show that most of the seed, besides being mouldy, is destroyed by insects and does not germinate satisfactorily. Mouldiness is preventible by preserving the seed in dry conditions, and admixture of weed-seeds can

be remedied by careful field selection, but the insect attack is more difficult to check even if the cultivator would try to depend upon his own seed without going to a *Mawari* for it. It is therefore necessary to investigate the nature and extent of injury by insects alone, and pulse-seeds were first taken in hand as being likely to be solved easier than most other store-house pests.

In the year 1914 Farm-grown pulse-seed was collected under careful supervision of the following five varieties, (1) peas, (2) *wal* (*Lolichos lablab*), (3) *tur* (*Cajanus indicus*), (4) *kulthi* (*Lolichos biflorus*), (5) gram (*Cicer arietinum*).

They were fully dried and kept in sealed kerosine tins to prevent external infection. The tins, when opened at the end of the year, showed that gram and *kulthi* escaped attack from Bruchids totally but the *tur*, *wal* and peas were attacked, the peas least of all. This helped to show that the infection need not necessarily come from old infested seeds of previous years but may also come from the field direct. In the year 1915 a large number of plants of each kind were kept under close observation from the time of their flowering. Eggs of all insects known to lay their eggs on the pods were carefully brushed away daily, but all efforts during the whole year to isolate the eggs of Bruchids proved useless. A variety of different adult Bruchids were however caught in the flowers of *tur*, *wal* and peas. These were identified by the Imperial Entomologist as belonging to three different species, *B. affinis*, *B. theobromæ* and *B. chinensis* (*Pachymelus chinensis*). The dry pods on several plants other than those under observation showed clean-cut round holes on them very much like those found upon stored pulse-seeds. There was therefore no doubt that the Bruchids did breed on the green pods on the plants in the fields. Seeds of these plants kept in glass-topped boxes developed some more Bruchids during the summer of 1915.

During the following season Bruchids reared from stored seeds were enclosed in paper bags along with growing pods on potted plants. The Bruchids laid their eggs freely. The pea Bruchid, *B. affinis*, laid its eggs anywhere about on the outside of the pods singly, but the *tur* Bruchid, *B. theobromæ*, restricts itself solely to the depressions found on the *tur* pod. *B. chinensis* would not lay eggs on any of the common pulses. The Bruchids reared from these eggs fitted very well with the identified specimens from Pusa. The shape and size of the eggs of these Bruchids made it possible for me to search for similar eggs in the field and to my great satisfaction I was able to find similar eggs in the field. In both these cases the adults have been caught in the flowers. The same have now been reared from eggs in the field. The eggs are from two to two and a half millimetres long, round at the end and slightly bent on one

side. In colour the eggs of *affinis* are lighter than those of *B. theobromæ* which have a slight tinge of yellow in them. It is difficult to follow the life-history of these small beetles inside the pods or seeds but better means for rearing may make it possible to find out the details of the life stages of these beetles.

It was only in 1917 that eggs of the *val* Bruchid were isolated. This Bruchid is different from any of the three identified Bruchids and it lays its eggs in small masses of three to five eggs in each cluster and each green pod may have from two to six such masses laid on it. The eggs are white, of the same shape and colour as of *B. affinis*. All the eggs are capable of developing into fully-formed adults even although there may be only three to five seeds in each pod. It is probably explained by each seed being larger than most other pulse-seeds and capable of sustaining more than one grub. As many as six of these beetles have been bred from each seed.

*B. affinis* is also in the habit of laying more eggs than the pods are likely to contain seeds and although as many as seventeen eggs have been counted on each pod the seeds inside always regulate the number of beetles that would breed out of the pod. The rest probably die.

Further breedings of the beetles in the laboratory have shown that *Bruchus affinis* is not capable of breeding in dry seeds and that it has only one generation in a year. The other two Bruchids, *B. theobromæ* and the *val* Bruchid, do breed successfully to the total destruction of dry seeds in the store.

At the time these investigations were carried out a fat grub of a beetle was seen to breed in the pods of *Crotalaria juncea*. On breeding, it proved to be a Bruchid of a new type as yet unidentified, of which specimens are exhibited. This beetle passes through only a single generation in a year and the eggs and larvæ are found in green pods in plentiful numbers to the total destruction of the seeds in them. The larvæ have the habit of spinning a tortuous long silken cocoon inside the pods wherein they pupate. The eggs are laid, one on each pod, just in the manner of other Bruchids.

The recognition of the fact that many of our common Bruchids are found breeding in the field brings us a little nearer to the solution of the problems of control-measures. It is helpful at least to know that mere care to exclude external infection is not in itself sufficient to prevent destruction of pulse-seeds and it may therefore be necessary to fumigate the seed directly after harvest.

Unless the pods in the field dry and open up, the Bruchids do not breed on them.

In my experiments I enclosed green pods in paper bags and even then they were attacked. **Mr. Ramrao.**

Our experience at Pusa supports that of Mr. Ramrao. **Mr. Fletcher.**

The question of the identity of these Bruchids, and of the distinctions between the various species, seems at present to be in considerable confusion. Last year we sent a number to Dr. Marshall for determination but we have not yet received the identifications.

#### 69.—ON THE INSECT PARASITES OF SOME INDIAN CROP-PESTS.

*By T. V. RAMAKRISHNA AYYAR, B.A., F.E.S., F.Z.S., Acting Government Entomologist, Madras.*

It need hardly be stated that the study of insect parasites—especially of those which are natural enemies of some of our important crop-pests—offers a very wide and almost unexplored field in India. Besides being very fascinating from a purely scientific point of view, this study is of the greatest importance in connection with some of the problems of Agricultural Entomology connected with the various control-measures against insect pests.

Among the various insect parasites we know of, the representatives of the Order Hymenoptera are by far the most numerous and important. There is little doubt that there is a considerable amount of material of these insects which have been collected or reared out, not only at Pusa but at the different centres in India where any entomological work is done. But unfortunately very little appears to have been done in the way of getting this material worked out and the economic importance of the different forms recorded or estimated. Systematists like Cameron, Szepilgetti, Ashmead, Viereck, Crawford, Morley, etc., have recorded sundry Indian species of parasitic Hymenoptera in different scientific periodicals; but all of these are systematic papers and there is very little in these descriptions to show the economic aspect of these parasites. In spite of this drawback such papers are really useful because of the fact that, in order to properly appreciate the real importance or otherwise of these different forms, the correct identification of each species is a very essential factor.

I therefore venture to believe, that the little information contained in this paper regarding some of our reared parasites which I have managed to get identified within the past year or two, may be of some use in adding to our knowledge of Indian parasitic Hymenoptera in relation to their hosts. The paper is certainly imperfect, but is only prepared to point

out the importance of the study of Indian parasitic wasps many of which are very good friends of the Indian farmer. The information in my list is very little compared to what we might be able to get when all the accumulated material all over India is worked out, but perhaps this may be of some use as a preliminary list.

I have arranged the information in a tabular form showing the hosts and the parasites so that it will facilitate easy reference.

The parasites noted in the above table are those whose host relations have been definitely known. I have, however, come across records of other Indian parasites by authors like Crawford, Viereck and others and although I have not been able to peruse the papers to see whether anything is said of the host relations of these parasites, the names of these parasites appear to give some hint in that direction. Such are the following.—

Viereck has described in the *Proceedings of the United States National Museum* 1912, the Indian species, *Apanteles creatonoti*, *A. stauropi*, *A. papilionis*, *A. plusia*, *A. phycodis*, and *Meteorus arcticida*. These evidently look like parasites on Lepidoptera which are more or less familiar to us. Similarly Cameron's *Apanteles tachardiæ*, *Ectadiophtinus tachardiæ* and *Chalcis tachardiæ* in the *Indian Forest Records* certainly show some relation to the "Lac insect." The following described by Crawford in the *Proceedings of the United States National Museum*, 1912-13, also suggest that they have parasitic relations with insect pests, viz., *Tetrastichus ophiuxæ*, *Bruchocida orientalis*.

- Mr. Fletcher. Some records of parasites reared at Pusa are being published in the Bulletin of the Second Hundred Notes, now in the press. Some of the insects included in this paper are new. Who is describing them?
- Mr. Ramakrishna Ayyar. Some are being described by Dr. Howard and others by Mr. Girault.
- Mr. Fletcher. Where are the descriptions being published?
- Mr. Ramakrishna Ayyar. In some journals not accessible to us.
- Mr. Fletcher. That is rather unfortunate.
- Mr. Beeson. The descriptions of the parasites that we send out for determination are coming out in the *Indian Forest Records*.
- Mr. Ramakrishna Ayyar. We sent specimens of grasshoppers to Mr. Bolivar but I have not heard from him.
- Mr. Fletcher. I think that specialists should be asked to send descriptions for publication in India. It is very difficult for workers in India to obtain access to some of these scattered papers.



Host Insect	Order or family of Host	Parasitic Insect	Group or family of Parasite	Remarks regarding distribution, etc.
<b>LEPIDOPTERA.</b>				
<i>Parava nathias</i> (Rice skipper)	Hesperiidae	<i>Xanthopimpla immaculata</i> , Mor.	Ichneumonidae	Palur (South Arcot).
Ditto	Do.	<i>Ctenocentrus</i> sp.	Braconidae.	Do.
<i>Cholam</i> leaf skipper	Do.	<i>Apanctes</i> sp.	Do.	Do.
<i>Taragama siva</i> (on <i>Alacra</i> )	Lasiocampidae	<i>Hemiospitis</i> sp.	Ichneumonidae	Coimbatore.
<i>Trubala vishnu</i>	Do.	<i>Microdus lamipennis</i> , Bingham	Braconidae.	Coimbatore.
<i>Parasa lepada</i> (on castor)	Limacodidae	<i>Ctenocentrus</i> sp.	Do.	Do.
<i>Natala nararia</i> (on <i>Pithecolobium</i> )	Do.	<i>Protopanctes</i> sp.	Do.	Do.
<i>Euprodia fraterna</i> (on castor)	Lymantriidae	<i>Hemiospitis (reticulatus?)</i>	Ichneumonidae	Do.
<i>Euproctis scintillans</i> (on gogu)	Do.	<i>Protopanctes</i> sp.	Braconidae	Do.
<i>Psalis securis</i> (on paddy)	Do.	Ditto	Do.	Do.
<i>Polyptychus dentatus</i> (on <i>Cardui</i> )	Sphingidae	<i>Anastatus coimbatorensis</i> , Gir.	Chalcididae	Coimbatore (egg parasite).
<i>Cirphis allistipna</i> (on paddy)	Noctuidae	<i>Xanthopimpla</i> sp.	Ichneumonidae	Palur (South Arcot).
<i>Achea metecerte</i> (on castor)	Do.	<i>Paniseia occidaris</i>	Do.	Coimbatore.
Ditto	Do.	<i>Hemiospitis</i> sp.	Do.	Do.
<i>Perigea capensis</i> (on safflower)	Do.	<i>Protopanctes</i> sp.	Braconidae	Do.
Ditto	Do.	<i>Heriogramus</i> sp.	Do.	Do.
<i>Adisura adkinsoni</i> (on <i>Tab. tab.</i> )	Do.	<i>M. obarcon</i> sp.	Do.	Do.
<i>Plusia agrarum</i> (on snake gourd)	Do.	<i>Cerapron abdensis</i> , Gir.	Proctotrypidae	Do.
<i>Carca subtilis</i> (on <i>Eugenia</i> )	Do.	<i>Tamitacrocoides jambarana</i> , Gir.	Chalcididae	Do.
<i>Chilo simplex</i> (on <i>Sorghum</i> )	Do.	<i>Xanthopimpla pedator</i> , F.	Ichneumonidae	Do.
Borers on maize, <i>Sorghum</i> and sugarcane.	Pyralidae	<i>Stenopilegna</i> sp.	Braconidae	Coimbatore, Kurnul, etc.
<i>Crociodomia bipunctis</i> (on radish)	Do.	<i>Microbracon</i> sp.	Do.	Attur, Chingleput, Coimbatore.
<i>Encyrtipira peticella</i> (on brinjil)	Do.	<i>Prisomorax testaceus</i> , Morley	Ichneumonidae	Do.
<i>Antigaster catalanatis</i> (on gingelly)	Do.	<i>Cycnastus</i> sp.	Do.	Do.
<i>Ezelastis atomosa</i> (on red-gram)	Pterophoridae	<i>Protopanctes</i> sp.	Braconidae	Do.
<i>Pithorinaca blapsigena</i> (on brinjil-bud).	Gelechiidae	<i>Microbracon</i> sp.	Do.	Do.

Host Insect	Order or family of Host	Parasitic Insect	Group or family of Parasite	Remarks regarding distribution, etc.
<b>LEPIDOPTERA.</b>				
<i>Phthorimaca heliopa</i> (on tobacco-stem).	Cicelchiadae .	<i>Chelonia</i> sp. . . . .	Braconidae	
<i>Nephantis sericeopa</i> (on palms)	Xyloryctidae .	<i>Stomatocerus sublaesicollis</i> , Gir.	Chalcididae	
<i>Gracillaria soqella</i> (on red-gram)	Gracillariidae .	<i>Asya piceella indica</i> , Gir. . . . .	Do.	
<b>COLEOPTERA.</b>				
<i>Alcidis babo</i> (on <i>agathi</i> ) . . . . .	Curculionidae .	<i>Metastomomyia jalinai</i> , Gir. . . . .	Do.	
Ditto . . . . .	Do.	<i>Euclyptus pipra</i> , Gir. . . . .	Do.	
<i>Aspidomorpha militaris</i> . . . . .	Cassididae .	<i>Cassidocida aspidomorpha</i> , Craw. . . . .	Do.	
<i>Sphenoptera</i> sp. (on red-gram stem)	Buprestidae .	<i>Glyptomorphia</i> sp. . . . .	Braconidae	Hagari.
<i>Dinoderus</i> sp. (in dry bamboo)	Bostrichidae .	<i>Metapalpa indica</i> , Gir. . . . .	Chalcididae	

NOTE.—Of the Braconids in the list I have only received the generic determinations up till now. I hope to prepare a more detailed list as soon as some more of our material is got worked out.

Host	Family of host	Parasite	Family of parasite	REMARKS
<b>HYMENOPTERA.</b>				
<i>Eurytoma indi</i> , Gir. (on <i>dhalaincha</i> pod).	Chalcididae	<i>Megastigmus indi</i> , Gir.	Chalcididae.	
Ditto	Do.	<i>Eridontomeroidella gibboni</i> , Gir.	Do.	
<b>DIPTERA.</b>				
<i>Pachydiplaxis oryza</i> (on paddy)	Cecidomyiidae	<i>Polygnathus livii</i> , Gir.	Proctotrypidae.	
<i>Chaetodacus encruidae</i> (on gourds)	Trypanetidae	<i>I. pubraeus</i> sp.	Braconidae	Coimbatore.
<i>Dacus longistylus</i> (on <i>L. adropis</i> )	Do.	<i>A. strepitus</i> sp.	Do.	Bangalore.
<i>Chaetodacus zonatus</i> (on mango)	Do.	Ditto	Do.	Anantapur District.
<i>Dacus</i> sp. (on <i>Alangium</i> fruits)	Do.	<i>Euthyalaeus</i> sp.	Do.	
<b>RHYSCHNOA.</b>				
<i>Coptosoma cribraria</i> (on <i>lab-lab</i> )	Pentatomidae	<i>T. leonurus indi</i> , Gir.	Proctotrypidae	(On eggs).
<i>Saissetia nigra</i> (Stål)	Coccidae	<i>Scutellista cyanea</i> ?	Chalcididae	Coimbatore.
<i>Pseudotropa simplicata</i> (on <i>cholan</i> )	Fulgoridae	<i>Paracampoplex opabilis</i> , Perk.	Chalcididae	(On eggs).
Ditto	Do.	<i>Ooetradicticus indicus</i> , Gir.	Do.	Do.
<b>ORTHOPTERA.</b>				
<i>Mantis</i> sp. (Eggs)	Mantidae	<i>Podagrion indicum</i> , Gir.	Do.	Do.
<i>Heteroglyphus basanus</i> (on paddy)	Acrididae	<i>Scelto heteroglyphi</i> , Gir.	Proctotrypidae	Do.
		<i>Scelto oryza</i> , Gir.	Do.	Do.
		<i>Tumidiscapus oophagus</i> , Gir.	Chalcididae	Do.
<i>Oryza vector</i> (Eggs)	Do.	<i>Angustatus coimbatorensis</i> , Gir.	Do.	} All on <i>Oryza</i> eggs.
		<i>Aetropis ori</i> , Gir.	...	

NOTE.—Of the Braconids in the list I have only received the generic determinations up till now. I hope to prepare a more detailed list as soon as some more of our material is got worked out.

Mr. Ramakrishna  
Ayyar.

May not these descriptions be contained in the Departmental publications, Bulletins and Memoirs? Will the Report of this Meeting be a suitable place for the publication of these results?

Mr. Misra.

It is very difficult to get our parasites identified and we are handicapped for want of these identifications. Our work could be carried much further if we could get these insects identified quickly. We had a large collection of parasites of cotton boll-worms but lost it all on its way to a specialist, as it was sunk by enemy action. At present we have a large collection of parasitic Hymenoptera and Diptera that we cannot get identified. We sent a large collection to Dr. Howard in 1914 and we have not heard any more of it since. One American Entomologist came to India from Florida to get parasites of Aleurodids, but we in India know practically nothing of these parasites. At present the identification of Chalcidids is our chief trouble and, unless they can be identified, we cannot proceed with our work.

Mr. Fletcher.

I quite agree with what Mr. Misra has said. One of our crying needs is for good systematic workers on our parasitic Hymenoptera and Diptera to let us know what the different species are, and, until we get this, we cannot proceed with the control of crop-pests by means of parasites.

#### 70.—HINTS ON COLLECTING AND PRESERVING INSECTS.

By T. BAINBRIGGE FLETCHER, R.N., F.L.S., F.E.S., F.Z.S., *Imperial Entomologist*.

##### COLLECTING.

Plates 146-161.

*Localities.* Insects of some sort are present in practically every locality within the Tropics, although it is obvious that some localities support a richer insect-fauna than others. Particular insects of course favour special localities but, for general collecting in India, the Hill tracts, especially between the heights of about two and six thousand feet, will be found to produce a more varied fauna than any area of similar size in the Plains. This is due mainly to the fact that the flora of these Hill tracts is much richer than that of the Plains. Many species of insects are only found in the Hills and other species only occur in the Plains, but there is of course no definite Hill insect-fauna as wholly distinct from that of the Plains, many species being equally abundant in both sorts of locality, nor are the insects found in one Hill tract necessarily the same as those found in others. Briefly speaking, the insect-fauna of the North-Western Himalayas has a decidedly European *facies* whilst that of the Eastern Himalayas is decidedly Oriental with a slight tinge of the palæartic element partly derived from the

North-West and partly through Northern China (*e.g.*, *Vanessa antiopa*); the Khasi Hills (and probably the other little-known Hill tracts of Assam) have a strictly Oriental fauna and form a sub-region closely related to that formed by the Burma Hill Tracts; the South Indian Hills, except the Nilgiris, are very little known as regards their insect-fauna, which is however very distinct from that of the North-Indian Hills, and a line drawn East and West through the Palghat Gap, between the Nilgiris and the Anamalais, seems to form a definite demarcation between two faunal sub-regions, whilst the Ceylon Hills form a third such sub-region.

The Khasi Hills seem to be the richest locality for insects within Indian limits and doubtless this remark might be extended to include the Hill districts of Assam generally, but it must be confessed that the surface of the ground has scarcely been scratched in any of these Hill tracts, or indeed in any locality in India whether in the Hills or Plains, so far as our knowledge of the insect population is concerned. In a country where it is possible to discover some new and undescribed insect on most days of any week in the year, and where our knowledge of the insect-fauna is so scanty even in the best-worked localities, no keen collector or student of insects need ever be at a loss for occupation. Hill or Plain, wet or dry, cultivated area or jungle, all alike will furnish a wealth of novelty. The Hills, however, as a whole will supply a greater wealth of material, both of beautiful species and of those interesting from the entomological view-point, and the collector in such localities will daily come across the most interesting and at times bizarre forms of insect life. Nor, in his appreciation of the individual forms, should he neglect to notice more general facts, such as the great prevalence of green-coloured insects in localities with a heavy rainfall and consequent very verdant vegetation.

Desert tracts form the very antithesis of Hills but these also have an interesting, though necessarily scanty, insect-fauna, of which practically nothing is known in India,\* and an investigation of desert-living forms of insect-life and a comparison of the different forms found in the various desert tracts would be of considerable interest.

Many insects are aquatic during the whole or only a part of their existence and every more or less permanent body of water supports a considerable insect-fauna, which comprises members of all the principal Orders, and the aquatic insects of India as a whole form a complex of which we know remarkably little as yet, although special attention

---

\* See "Fauna of a Desert Tract in Southern India" by Annandale and Wroughton in *Mem. A. S. B.* Vol. I, No. 10 (1906).

has been paid to them of late by the Zoological Survey and, of course, very special attention has been paid to one group, the mosquitos, by numerous workers.

In any locality, therefore, the collector will find ample material for observation and collection, and he will find further that close observation will as a rule develop a trained eyesight which will reveal innumerable insects which would never be noticed at all by the untrained eye.

In any case, it will be found that it pays better to work thoroughly one good, if circumscribed, locality rather than to spend time in moving on to some other, perhaps less favourable, place. "If you know a better place, go to it—and stop there" is not a bad entomological motto. It is bad policy to try to combine collecting with a walking tour. It is best to survey a locality briefly, note down one or two likely places for the particular insects required, and to work this or these thoroughly. The following remarks deal with special localities or methods of collecting.

*Insect Pests* usually obtrude themselves upon notice and, where an insect is in sufficient numbers to constitute itself a pest, little difficulty usually occurs in obtaining specimens. In the case of crops, the crop affected should be examined and also any adjacent likely food-plants. Insect pests of sann-hemp for example, are likely to be found also on wild species of *Crotalaria*, and pests of sugarcane and cereals on wild grasses. It is often important to know what are the alternative food-plants, either cultivated or wild, of pests because this knowledge may be of considerable importance in devising control measures. This paper deals with collecting insects generally and not with control of pests and therefore it seems unnecessary to say much about insect pests here, beyond pointing out that every item of information regarding the occurrence, life-history, and so on, of insect pests is of importance in devising control-measures. Accurate records of the occurrence of all pests are very desirable, as it is possible that the accumulation of records of this sort will eventually throw a good deal of light on the reasons for the occurrence of such outbreaks and will perhaps enable us to forecast them and take preventive measures in due time. On all occasions, therefore, when insects are found present in destructive numbers, the collector will assist the progress of economic entomology considerably by taking some specimens and forwarding them to an entomological centre with any information about the outbreak, instead of merely passing them over as common things of no interest to anybody.

*Bright, sunny, open places* such as open glades near or in wooded areas, gardens, and, generally speaking, any places containing flowering plants, sunshine, and shelter from wind, will be found good localities

for the collection of such insects as butterflies, dragon-flies and dayflying insects generally. Roadside hedges, covered with flowers, are also very attractive, especially in the early morning, when insects are feeding.

*For shade-lovers*, such as most moths, shaded tunnels in woods, roadside bushes, and any localities providing leafy shade will yield an ample supply of specimens, which will usually require to be beaten out during the daytime.

*Caves*, if sufficiently deep to be in permanent darkness, often have a peculiar insect-fauna of their own composed of small moths, crickets and beetles, which are sometimes blind and often have their antennæ enormously developed. Very little is known as yet of the cavernicolous insects of India and collectors who have an opportunity of exploring deep caves will doubtless come across many new and interesting forms.

*Under stones or logs* will be found a favourite habitat of numerous insects and when collecting such it is as well to have the forceps, killing-bottle and a supply of tubes of spirit in readiness, as many of these insects scuttle away as soon as they are exposed to the light. Beneath large stones will be found *Thysanura*, *Collembola*, earwigs, cockroaches, crickets, beetles (especially Carabids and Tenebrionids), Reduviid and other bugs, ants, termites (especially *Capritermes*) and numerous other insects, some of which live in colonies under such shelter, the same stone in some cases sheltering several colonies which tend to get mixed up together when the stone is overturned; some care is therefore necessary in securing specimens in such cases, as it need scarcely be pointed out that individuals from different colonies of such insects as ants and termites should never be placed into one tube. Logs (which term covers the case of all large pieces of wood lying on the ground) also give shelter to many of the insects enumerated above and in addition the dead wood itself provides food and shelter for a large number of insects and their predators. Rotten palm-stems, whether fallen or standing, generally harbour *Oryctes* larvæ and rotting logs in the Hill districts will be found to contain Passalid beetles in all stages. A stout knife or small axe is usually required for successful grubbing in logs. Many insects (*e.g.*, Aradid bugs and Brentid beetles) often occur in numbers under the bark of dead trees, and the bark requires to be ripped off to find them.

*Felled or fallen trees*, which are still green, attract many insects which feed on dying or dead wood and these will generally be found on the under-side of the felled trunk. In some cases, indeed, trees may be felled on purpose to serve as traps for some beetles attacking dying trees.

*Wood-borers* will be found both in dying, dead, and decaying trees, as noted above, and also in living trees, where their presence is often indicated by the extrusion of their sawdust-like excrement or by the dying back of the bored branch or stems. The adults are comparatively rarely met with but may sometimes be found resting on the attacked trees, although best obtained by collection and breeding of the immature stages. In special cases, attacked stems may be enclosed in wire gauze in order to trap the adults on their emergence.

*Root-borers*, such as Hepialids, are usually captured by accident and are also best obtained by breeding.

*Streams and ponds* furnish many insects which live in the water either as larvæ or adults. For purely aquatic insects a water-net will be required but many of these fly by night and may be caught at light. There are also many groups of insects, whose larval existence is aquatic and the imaginal life aerial, and these may be caught along the edges of streams and ponds, although some range far afield from water, which they only approach to oviposit. It is only possible to search comparatively shallow areas with a water-net and a drag-hook may be used to bring up weeds, sunken branches, etc., from greater depths. These, if searched, will be found to yield a rich harvest, especially of immature stages: Ranatrid bugs, for example, will be found amongst weeds, whilst fresh-water sponges contain the larvæ of *Sisyra*.

Different kinds of streams often have quite different types of insect-fauna; thus, some species of dragon-flies affect rapid, rocky-bedded streams, whilst others prefer more sluggish streams with muddy bottoms and banks. Similarly, some insects prefer small accumulations of water whilst others live only in large ponds, lakes, or rivers.

*Holes in trees*, which accumulate dead leaves or hold water after rain, are favourite hiding and breeding places for some insects and will often repay examination. Many beetles and mosquitos and the Tabanid fly, *Gastroxides ater*, habitually live and breed in such situations.

*Hot Springs* in other parts of the World have been recorded as containing many insects which live habitually in water at a temperature usually fatal to insect-life. I am not aware that any insects have been noted in hot springs in India but it is probable that such may occur. Similarly, in the United States the larva of an Ephydrid fly (*Psilopa petrolei*, Coq.)\* has been found living, feeding, and swimming about in the pools of crude petroleum which are so numerous in the various oil-

---

\* "The Petroleum Fly in California." by D. L. Crawford, *Pomona Coll. Journ. Ent.* IV, 687-697, figs. (May 1912).



fields of California—another example of hardy constitution to which we have as yet no parallel in India.

*Wet places*, especially wet sandy patches in beds of streams or muddy patches along roadsides, are often very attractive to butterflies in dry weather and may sometimes be seen literally carpeted with these insects sucking up the moisture. In such cases, it is often noticeable that each species keeps to itself.

*Marshy places* have a special flora to which some insects are attached. For example, the larva of *Buckleria paludicola* feeds on *Drosera* ("sun-dew") and the imago of this little Plume-moth may be taken in the evening in and around marshy places where *Drosera* is growing abundantly.

*Dry, sandy places*, such as the beds of rivers during the dry season, yield many insects, amongst which species of *Cicindela* are conspicuously plentiful. The sandy seashore also has its special fauna, and *Cicindela biramosa*, for example, is never found at any distance from a sandy beach.

*The presence of ants* in numbers on plants is generally a sure sign of the presence of other insects which they are attending, such insects including Lycenid larvæ, Coccids, Aleyrodids, Membracids, etc. Many insects also are predacious or parasitic on Coccids, etc., and these also should not be overlooked.

*Ants' nests* contain numerous myrmecophilous insects (principally beetles) rarely found except by searching these nests. Termites' nests also contain termitophilous Collembola, Coleoptera, Lepidoptera and other insects amongst which may be mentioned the curious wingless Phorid flies belonging to the genus *Termitoxenia*. The nests of the social spiders of the genus *Stegodyphus* harbour small Gelechiid moths, and nests of vertebrate animals often contain fleas and other parasites of such animals and also insects feeding on the substance of the nests themselves, from which they may be collected or bred out.

*Spiders' webs* often repay examination as they are sometimes found to contain undamaged specimens of uncommon insects. At least one bug lives normally in spiders' webs, being predaceous on the eggmasses, and spiders' eggs also have insect parasites.

*Bats* have a peculiar insect-fauna of which little is known in India. Flying-foxes are infested with peculiar wingless Nycteribiid flies of the genus *Cyclopodia*, and *Lyroderma* carries small winged Streblid flies and the rare and abnormal bug, *Polyctenes lyra*. Other vertebrate animals have of course their special parasitic insects, but those of bats are of especial interest from a scientific view-point.

*Dead animals and animal droppings* attract many insects, principally beetles and flies, whose early stages are passed in dead animal matter, and examination of animal carcasses and droppings and of the ground beneath them will yield many insects rarely found in any other way. In the case of animal droppings these may be placed in a bucket of water, when the contained insects will float up. The insect-fauna of human excrement is of considerable importance in connection with the transmission of many diseases but it cannot be said that this subject has as yet received adequate entomological investigation in India.

Besides those insects which breed in such situations, carrion and animal droppings often attract butterflies and may sometimes be used as baits to bring within reach species which normally fly high up.

*Attraction by other scents* may also be turned to advantage in the capture of insects. Newly-turned earth exercises potent attraction for some flies, whilst the males of some species of fruit-flies are attracted by the smell of citronella oil, or kerosine.

*Assembling* is a special form of attraction by smell, by which the males of some insects congregate attracted by the smell of a newly-emerged virgin female of the same species. Advantage may be taken of this, in such cases, by exposing a bred or captured newly-emerged female and catching the males as they are attracted to her. The female should be isolated in a gauze cage as, once junction with a male is effected, the attraction ceases. This method of capture may be adopted in the case of wild silk moths and some other groups.

*Sugaring* is another method of attraction by smell, used especially for the capture of night-flying moths, although little adopted in India, apparently because of the prevalence of ants. The usual procedure is to prepare a mixture of coarse treacle and sugar boiled or mixed together, which is thinned with beer and a little coarse rum added just before application; but almost any sweet mixture containing a little alcohol, such as treacle with a little methylated spirits, will prove attractive. The mixture is painted at dusk on to tree-trunks, palings, flower-heads or any suitable surface and it is best to apply it in long vertical streaks well worked into the bark. After dark the prepared patches are examined by means of a lantern, and the insects, attracted to the sugar and rendered stupid by the alcohol, are picked off as required either in boxes or direct into the killing-bottle. The beam of the lamp should be directed from below upwards, not neglecting to examine any drops or trickles of the mixture which may have dropped down, as insects will often drop off when the light falls on them and are then liable to knock off any others below them. A still, warm, dark, sultry night is usually best and the cumulative effect of sugaring is



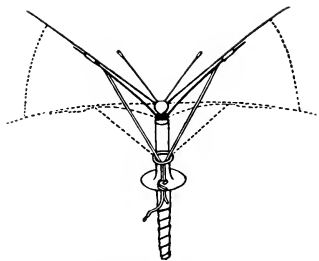

Fig. 1.—Knaggs Butterfly Decoy (front view).

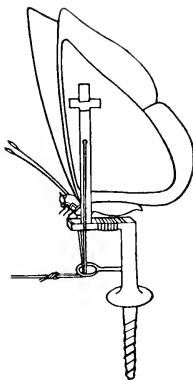

Fig. 2.—Knaggs Butterfly Decoy (side view).

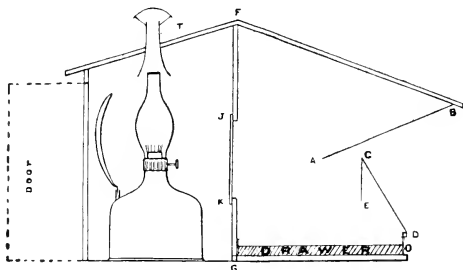

Fig. 3.—Light trap in section.

very marked—those patches which have been painted on regularly for a long time proving much more attractive than new patches. Cold, windy, or moonlight nights are usually less productive.

The Andres-Maire trap, used for the control of *Agrotis ypsilon* in India is a special form of sugaring, which otherwise seems scarcely to have been tried in India, although it seems worth a trial in suitable localities.

*Attraction by sight* may be used for the capture of some insects, such as some butterflies which normally fly high up out of reach. *Hebomoia glaucippe*, for example, may be attracted by pinning a roughly-coloured paper model in a convenient situation below the trees affected by this butterfly and, as soon as a specimen has been caught in this way, it may be substituted for the paper model in order to attract further examples.

Some years ago, Dr. H. G. Knaggs described in the *Entomologist* (Vol. XXVI, pp. 154-157, 180-182, 207-210 (1893)) a working model of an artificial decoy butterfly, of which the main idea can be grasped from the two figures reproduced here. (Plate 146, figs. 1, 2). An imitation butterfly, or the wings of a real one, is glued on to two pieces of card cut roughly to the shape of the wings and these cards are worked up and down by pulling on strings attached to a piece of watch-spring fastened under each card, so that an imitation of a butterfly's action in opening and shutting its wings when at rest is thus secured. The model is fastened to a screw which can be secured into a wooden stake driven into the ground in any convenient situation. Any butterflies attracted may either be caught in an ordinary net or the decoy may be supplemented by a spring net, on the lines of a bird-catching net, worked by a second string from the same distance as the decoy.

*Light* exercises a very powerful attraction in the case of many night-flying insects, a fact which is only too well-known to all dwellers in India, and which may be taken advantage of to increase the collection. Many insects, which fly in to the ordinary house lights, will form welcome additions to the collection and special methods can be adopted to increase these numbers by the use of a powerful lamp with a white screen placed behind it in order to increase its attractive power and to provide a suitable resting-place for the insects so attracted. Or an unused room may be used as a trap, a light being left burning in it all night and suitable precautions taken to exclude toads, bats and other insectivorous animals.

Special light-traps, which can be placed anywhere, may also be used. Some of these require the attention of the collector and some

are self-acting. The former have been used with great success in Ceylon especially and are generally composed of an acetylene lamp surrounded by a mosquito-net framework to prevent the insects flying into the lamp, the back of the framework covered with white cloth to act as a reflector, and the whole apparatus packing into a box for convenience of transport. A lamp of this type can be taken and set up in any convenient place, such as the edge of a clearing overlooking a good expanse of jungle, the operator standing by and picking off the required insects as they fly in to the light. As in the case of sugaring, dull, cloudy still, warm, sultry nights are usually the best, and comparatively little comes in on cold, windy, or bright nights, although nights of heavy rain are often very productive. Very few insects are attracted on bright moonlight nights, as a rule, and the period from about the fourth to tenth days after a full moon is usually the best.

Self-acting light-traps may be put up and left out all night, the catch being examined next morning. They are so arranged that insects can fly in to the light but are unable to find their way out again. One drawback to their use in India lies in the number of large insects (beetles, grasshoppers, etc.) which may be attracted and do damage to the more delicate specimens, and also to the prevalence of geckos; it is therefore necessary to adopt some means of killing all entrants into the trap. A self-acting light-trap may be made out of an old packing case of any suitable size, but about 2 feet 6 inches in height answers best. The construction is shown in Plate 116, fig. 3, which shows a section through the trap. AB, CD, CE are pieces of glass fitting right across the box and are fixed by narrow strips of wood nailed to the sides. FG is a wooden partition with a hole (JK) 6 inches square cut out of it opposite the flame of the lamp, this hole being closed with a pane of glass fixed behind it with putty or nails. The lamp is an ordinary wall-lamp provided with a reflector. The chimney passes inside a tin tube (T) which in its turn passes through the top of the box; where this tube passes through, the top of the box must be well puttied, or wet will get through and crack the chimney. The lamp is put in and removed through a door at the back. In the bottom of the front of the box is a drawer which contains a shallow dish filled with potassium cyanide and covered with muslin. The glass sheet AB overlaps the sheet CD, and insects climbing up CD towards the opening are diverted by the glass strip CE and fall into the drawer. To work this trap, it is placed in a favourable position, the lamp lighted and left overnight.

*Smoking* may be used for disturbing insects from thick herbage whence they are often difficult to dislodge by beating, the smoke being

puffed into the herbage with the mouth (tobacco smoke) or a bee-smoker or a smudge being used. Large numbers of small insects are often to be collected in this way.

*Beating* bushes or herbage with a stick will dislodge numerous insects which may be caught as they fly out or when settled again. The beating or shaking of trees, bushes, flowers, etc., over an inverted umbrella, piece of white cloth or large sheet of paper, will also result in the dropping of large numbers of miscellaneous insects, which can be picked out as required; or the whole mass can be placed in a tight bag for subsequent examination at leisure.

*Flowers, moss, termites' fungus-combs, etc.*, may similarly be collected in a tight bag and turned out for subsequent examination over a clean sheet of paper or cloth. *Termitoxenia* may thus be collected from the fungus-combs, and especially the "nursery combs" of mound-building termites.

*The time of day* when collecting is done, will determine to a large extent the material collected in the case of many groups and, conversely, if it is intended to collect particular groups, it is important to select the appropriate time of day for their collection.

The early part of the forenoon, when the sun begins to warm the air, is the feeding-time of many butterflies, such as Ornithoptera and strong-flying Papilionids, which then descend to feed on such flowers as *Lantana*, but later on in the day fly high up or at such a pace that capture becomes very difficult.

The morning is also the best time to catch dragon-flies, partly because their intestines are then less likely to be replete with insect prey, since specimens taken with empty alimentary canals are more likely to keep their colours than examples which are full of insect prey, and partly because many dragon-flies are to be found in numbers near water in the morning but in the afternoon seem to disperse and are often not to be found in places where earlier in the day they were abundant.

The early evening is the best time for the collection of Microlepidoptera which may then be beaten out of bushes and herbage or taken on the wing.

Twilight brings forth a few butterflies (*e.g.*, *Melanitis*) most Sphingids and Melolonthids. Sphingids and the curious nightflying bee (*Xylocopa rufescens*) may then be caught attracted to flowers, and Melolonthids may be found feeding or clustered on leaves or may be attracted to a white sheet.

After dark, most moths and night-flying insects generally are on the wing and may be taken at light or at sugar.

A few insects fly late at night, but it will be noticed that very few seem to be on the wing after about 10 p.m.

Some insects fly at special and irregular times. Amongst such are termites, whose flight usually takes place on a still evening after the first heavy rains, but may take place (in the same species) at other times of the day. Thus at Pusa the flight of *Odontotermes assmuthi* usually occurs in the late afternoon, but may take place in the early morning or at almost any time during the day, that of *Microtermes obesi* always occurs between 7 and 8 p.m., that of *Eremotermes paradoxalis* in the late afternoon, and that of *Coptotermes heimi* at dusk, whilst, on the only occasion at Coimbatore that I have noticed the flight of *Hodotermes viarum*, it occurred late at night after 10 p.m. When such flights occur, it is important to trace the place whence the emergence is taking place, in order to secure specimens of the soldiers and workers which belong to the winged adults. This is often difficult to do, especially in cases where the adults issue singly from small holes or slits in the ground, but, by bending down as near ground-level as possible and watching carefully, it is often possible to find the holes of emergence and, by digging up the ground beneath these, the soldiers and workers may be found and definitely associated with the winged forms. The winged adults of *Eremotermes*, for example, emerge from minute slits in the ground, which are very difficult to discover, and the soldiers and workers, which are rarely seen otherwise, may be turned up from the soil beneath the hole of exit. *Odontotermes*, on the contrary, usually streams up from a mound or hole or holes of exit, whose entrance is thickly surrounded with soldiers and workers running around on the surface of the soil.

“*Carpe diem.*” In the case of the occurrence of termites’ swarms, as in all other cases of collecting insects, the entomologist’s motto should be “*Carpe diem.*” When an insect, of which specimens are required, is found commonly, the opportunity should be taken to take a sufficient series at the time; otherwise, if this is not done, the chances are that the species will not be found again later on when required, or an opportunity of taking examples (such as revisiting a particular locality) may not recur. It is better to take a good long series of any uncommon insect when met with rather than to take only a few; it should be remembered that duplicates or excess specimens will often be *desiderata* to other brethren of the net and he who has such specimens to spare to others is most likely to be remembered when they have specimens to dispose of.



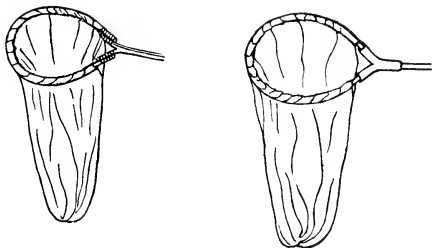

Fig. 1.—Nets made with Y-pieces of wood (left) and metal tubing (right).

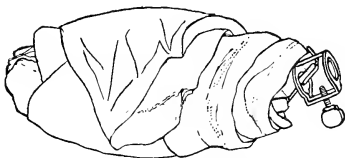
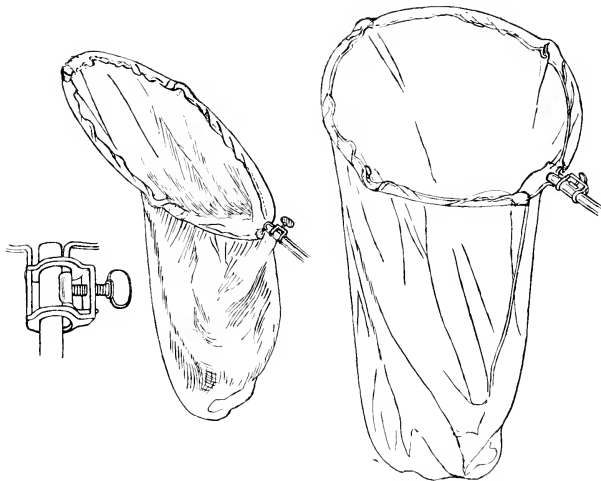

Fig. 2.—Folding Net in folded position.







**Folding Net.** On the right it is shown open ; in the centre it is shown folded over to prevent the escape of an insect caught in it ; and to the left is shown the screw attachment to the stick.

## APPARATUS.

Turning now to the apparatus required for collecting insects the absolutely necessary items include net, store-box, pins, forceps, lens, killing bottle, tubes, spirit, and note-book, to which various other items may be added.

*Nets.* A net for general collecting may be made at a pinch from a piece of old mosquito-netting or muslin sewn on to a ring made from a slip of bamboo fastened to a forked stick or joined to a straight stick by a metal Y-piece. (Plate 147, fig. 1). Such a net is quite a useful weapon to keep handy for use within a limited area, such as a bungalow compound, but for convenience of transport a more portable form is better, and a wire-framed folding net (Plate 147, fig. 2, and Plate 148), adjustable to any stick as a handle, will fulfil all ordinary purposes. One obvious advantage of an adjustable net is that it may be fitted on to any ordinary walking-stick or umbrella or on to a long bamboo if it is desired to catch an insect settled or flying high up. The size of the net may be made to suit individual requirements, but personally I like a moderately small net, about 12 to 15 inches in diameter across the mouth and about 18 to 20 inches deep. This size is big enough to catch the largest-sized insects and at the same time is sufficiently light to ensure the quick stroke necessary to secure rapid flyers. The bottom of the net should be cut square with the corners rounded off; and the depth of the bag should suffice to enable the net to be closed by turning the rim over, whilst it should not be so deep as to cause any difficulty in securing specimens at its bottom. As regards material, a silk gauze is the best, being at once light, strong and transparent—three qualities indispensable to a good net-bag. Cotton materials, such as mosquito-netting, may also be used but are less satisfactory in use and less durable than silk. Purchased nets are usually dyed green, presumably on the supposition that the intended victims are less likely to take notice of the waving of a green object, but this seems to be a fallacy and in actual practice it will be found that it is the movement, much less than the colour, of an object which is apt to frighten insects. It is, moreover, more difficult to see the enclosed insect in a green net than in a white one. It seems, therefore, that no end is gained by the use of green-dyed material, more especially as the dye tends to rot it, and a white net appears preferable on every ground.

The successful capture of insects, especially of very strong-flyers, is an art only to be acquired by practice. It must be remembered, as noted above, that insects are keenly perceptive of motion and the

would-be capturer must therefore creep up very cautiously, or take up a favourable position and remain motionless, until the occurrence of a suitable opportunity for a quick sharp stroke with the net. If this fails, it is generally useless to pursue the startled insect. The best thing to do is to keep quiet in the hope that it may return. Some butterflies, such as *Vanessids*, often have a favourite spot to which they return again and again, and hawk-moths will frequently return to the flowers from which they have been startled, whereas a stern chase in either case is more likely to drive the insect away than to achieve its capture.

A wary insect, such as a butterfly or *Fulgorid*, settled on a tree-trunk or on any solid object above ground-level, calls for the most difficult side-sweep of the net. A case of this sort proves the truth of the saying that "practice makes perfect"; too distant a stroke will probably wreck the net against the tree-trunk and too near a one will miss the insect, and it is only the collector who knows by constant practice the exact reach of his net who will achieve the happy medium and secure the prize in nine cases out of ten.

To catch an active insect resting on the ground is also not easy, the best method as a rule being to creep up very cautiously to within easy striking distance, raise the net very slowly until it occupies a convenient position for the stroke and then strike it downwards over the insect taking care that the rim strikes the ground evenly all round and not with too much violence. Butterflies will usually fly upwards into the bag but tiger-beetles will often run around on the ground inside the net and escape if any hole is available under the rim, which should therefore be kept pressed tight against the ground.

When netting an insect, endeavour should be made to follow its motions with the eye. An insect which is supposed to be safely in the net often proves, on examination of this, to have been missed; but, if its flight has been followed with the eyes, a second chance of capture may be afforded. Some sluggish insects when at rest will remain clinging to their resting-places even when struck at with a net but will drop or fly off immediately afterwards. The collector therefore should not look at once at the net, for, if the insect has been netted, it will remain safely there; he will do better to keep his eye fixed on the position of the insect, so as not to lose sight of it if perchance it has not got into the net.

Similarly, when seeing an insect at rest and being unprepared for its capture, it is always as well to endeavour to keep one's eye on the insect when getting ready the net or killing-bottle or whatever is to be



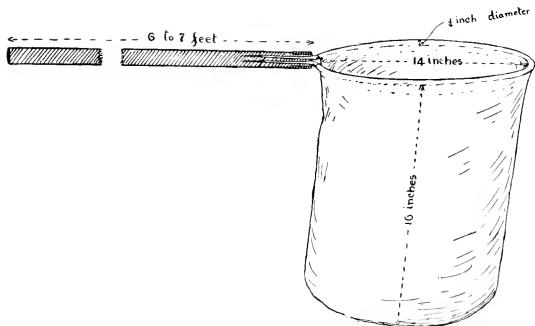

Fig. 1.—Details of Water Net.

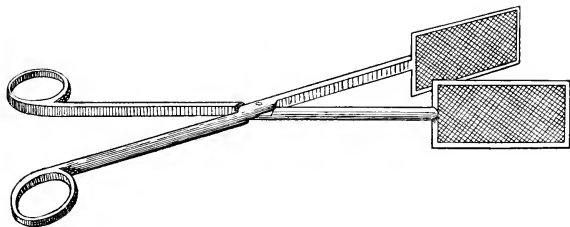

Fig. 2.—Scissors Net.



used. An active insect may change its position whilst the eye is taken off it and then be frightened away for ever when endeavouring to locate it anew, and many apparently inactive insects are nevertheless acutely conscious of discovery and move or drop off immediately they perceive that observation has been removed from them, even momentarily.

When approaching an active insect, which is to be netted, it is important to approach it from the side opposite to that from which the sun is shining, as a shadow may easily startle it away.

Besides the ordinary "general service" net, the collector may use other nets for special purposes. Such nets are Micro-nets for the collection of minute insects, sweep-nets for collecting insects from herbage, water-nets for securing aquatic insects and scissors nets for the capture of Hymenoptera off flowers, etc.

Micro-nets are simply small-sized nets of the ordinary pattern but made of very fine silk gauze or chiffon. They are extremely useful for the capture of small and delicate Lepidoptera, Diptera, etc., but require careful use as the material of the bag is necessarily very thin and easily torn.

Sweep-nets on the contrary are larger editions of the ordinary pattern, with a stoutly-built rim (preferably of metal) and stout bag made of cheese-cloth or similar material. They are used to drag over and through herbage and vegetation generally, especially for the collection of Coleoptera, Ephemera, and Orthoptera, and are therefore necessarily of stout construction to withstand wear and tear under such conditions. In use, frequent examination of small lots of contents is better than less frequent examination of large masses of material.

Water-nets, as their name implies, are used for the capture of aquatic insects on and in water. The ordinary "general service" net may be used for this (as also for sweeping) at a pinch, but rough use of this sort will not tend to its longevity. Water-nets may be of the folding pattern, adjustable to any stick (in which case it is as well to secure the net securely to the stick with a length of cord also in case the clamp should slip whilst the net is in use) or they may be made simply of a stout ring of round metal rod fastened securely into a permanent stout handle which should be six or seven feet long for effective use. The metal rim is best made of galvanized iron. The bag, made of light canvas or similar material, should be comparatively shallow, as it is not required to be closed over to prevent the escape of captures, as is a land-net, and it is uncomfortable to remove specimens from the bottom of a deep bag when it is wet. (Plate 149, fig. 1).

Scissors-nets are made on the principle of a pair of scissors whose blades are replaced by flat areas of net supported on diamond-shaped or oblong frames which can be separated or brought together by the action of the handles (Plate 149. fig. 2). They are intended for capturing Aculeate Hymenoptera resting on flowers, leaves, etc. I have never used one myself, or met anyone who has, and imagine that their utility is not great.

*Store-boxes* are used for the temporary or permanent preservation of pinned specimens and should be light-and air-tight, lined with some material which will hold the pins firmly, and of a convenient size and weight for storage and handling. As further information about store-boxes is given further on under the heading of "Preserving," it only seems necessary to say here that the most convenient store-box for general purposes is one made of good deal, with top and bottom of three-ply wood, external dimensions 17½ long by 12 inches broad by 4 inches deep, lined on both sides with cork covered with white paper and provided with a naphthaline-cell. (Plate 150 fig. 1).

For general collecting purposes, when travelling, it is useful to rule light pencil lines across the paper lining so as to form squares about two inches each way, as specimens from one locality can then be placed in one or more squares with a small label pinned into the lower right-hand corner, and there is then no difficulty later on, when permanent labels are to be affixed to the specimens, in knowing which particular locality any specimen came from. Specimens with any particular *data* may also be isolated with ease in this way. Another method of isolating groups of specimens is to draw a line around them with pencil; but this looks untidy and, after a little use, the lines are liable to be confused together, whereas the squares may be used indefinitely and, if they are fairly small, little space is wasted owing to incompletely filled squares.

One of the worst enemies of the collection in India is mould and it is often difficult to avoid mould developing on newly-caught and imperfectly dried specimens, especially when collecting in a damp climate and having to open the collecting-box constantly to add fresh specimens. Before starting, therefore, it is a good plan to treat the store-box with a saturated solution of naphthaline in benzine or any similar solvent, pouring the solution all over the inside of the box and allowing the solvent to evaporate, when a thin film of naphthaline is left over the interior: this, while it lasts, will effectually prevent the development of mould and, when the naphthaline has evaporated, there will generally be room to pour in a little more of the solution over unoccupied portions of the lining. The amount of naphthaline contained in

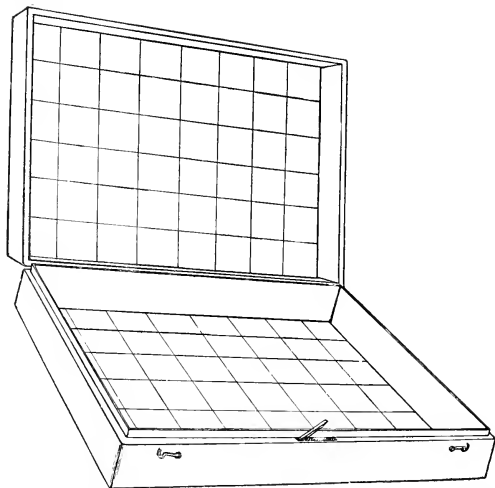

Fig. 1.—Store-box ruled into squares for collecting. Lid of camphor cell (in near side) is shown raised up.

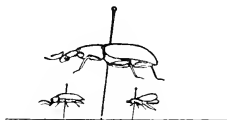
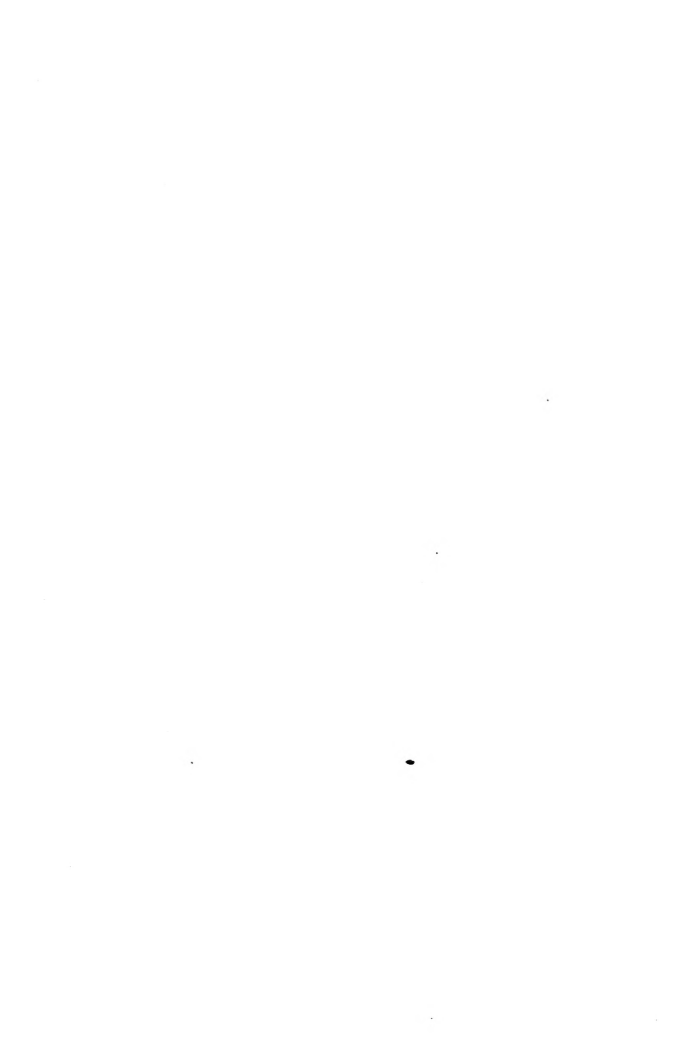

Fig. 2.—Pinning insects into store-box to economize space.





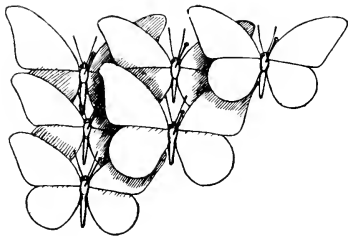

Fig. 1.—"Shingling" set butterflies for close packing.

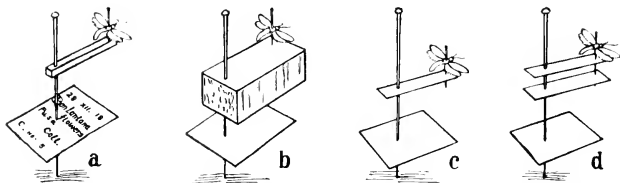

Fig. 2.—Mounting small insects ; (a) on polyporus pith, (b) on sola pith, (c) on single card stages, and (d) on double card stages.

the ordinary cell inside the box is quite insufficient to prevent the growth of mould in such cases.

When collecting, space in the store-box is often a consideration and considerable economy can be effected by pinning in the small specimens (on small pins) first, when it will be found that a good many of the larger specimens (on big pins) can be pinned in between and over the smaller ones (Plate 150, fig. 2). In the case of large specimens set out with their wings flat (*e.g.*, butterflies, dragon-flies, etc.), considerable economy of space can be effected by "shingling" them, *i.e.*, pinning them into the box at an angle so that their wings overlap one another. (Plate 151, fig. 1).

*Pins* are made in various sizes and of various materials, the main requisites being that they should be made of a hard, non-corrosive metal, have sharp points and small heads, and be of slender diameter and suitable length. Ordinary brass pins corrode sooner or later, the body-juices of the pinned specimens attacking the metal with the formation of the so-called "verdigris," which is not verdigris at all but copper butyrate. Silver pins are sometimes used for minute insects, but are too soft and blunt and do not seem safe from corrosion. The most satisfactory pins are those made from pure nickel wire. We always use Messrs. D. F. Tayler's pure nickel pins, sizes 16 and 20, the former being a stout pin 35 mm. long suitable for all large insects and the latter a fine pin 15 mm. long suitable for all small insects. These two sizes of pins are suitable for all general collecting work.

*Staging* is a method of mounting small insects, pinned with small pins, to raise them above the level of the cork surface of the store-box or cabinet drawer and to avoid injury when moving the specimens. The small pin of the specimen is driven into one end of the stage, through the other end of which is passed a stout pin which bears the label and is secured into the cork surface. The stage may be made of various materials, of which pith and card are generally used. Polyporus pith is very suitable as it keeps beautifully white and may be obtained in square slips. *Sola* pith is obtainable locally and makes satisfactory stages. Card is readily obtainable and may be cut to any size or shape required and makes a good stage for permanent mounting. Double-card stages are sometimes used in Europe, two similar card-stages being used, one about an eighth of an inch below the other, and both large and small pins being passed through each stage; but there seems to be no special advantage gained by this method. Mica also is sometimes used for staging, especially in the case of small Coleoptera, but I have had no experience of it. Photographic film may also be used if a transparent mount is desired (Plate 151, fig. 2).

Small Coleoptera may also be gummed onto card stages, with legs and antennæ outspread, and in such cases it is as well to mount some specimens upside-down for ease of examination.

*Forceps* (Plate 152, fig. 1) are of absolute necessity for any collecting work and a good pair of forceps is as useful as a third hand to the entomologist. A pair of forceps is invaluable when collecting, in picking up all sorts of odd specimens, and is absolutely necessary for handling pinned specimens, when the pin should be grasped *below* the specimen in order to avoid bending it when pushing it into the cork. Forceps are made in various sizes and shapes and are sometimes provided on the inside of one leg with a short pin which fits into a hole of the opposite leg. Tastes differ, but personally I prefer a moderately small pair of forceps without a pin.

*Knives* of various patterns are often useful when collecting, those most frequently required being a field-knife, which may either be a large pruning-knife with a curved tip or a stout pocket-knife, and a medium-sized scalpel for delicate work. (Plate 152, fig. 2).

*Scissors* are not often required for field-work but are a necessity for cutting labels, setting-strips, and sometimes for trimming specimens. Any ordinary small scissors are suitable.

*A lens* is a prime necessity both in the field and for examining, pinning and setting small specimens. A platyscopic lens, magnifying ten diameters, by any good maker, is sufficient for ordinary work. Lenses with higher magnification are less suitable for field-work.

*Glass-bottomed Boxes* (Plate 152, fig. 3) are extremely useful for collecting small insects which are required to be kept alive. They are usually made of card board and sold in nests of seven boxes, one fitting inside the other. The larger boxes are used for collecting caterpillars and large insects generally, and the smaller ones are very useful for small moths and so on. Care should be taken that only one moth or similar insect is placed in each box; if several are imprisoned together, they are sure to disturb one another and all are likely to be spoiled. Glass-bottomed boxes made of metal are also available but are not satisfactory for use in hot climates, as they get overheated and the contained insects die and dry up.

*Killing* an insect is the natural sequence to catching it in cases where it is desired as a specimen. In the case of many slender-bodied insects, such as butterflies, this can be done whilst the insect is in the net by pinching it with the forceps or between the thumb and first finger; the wings are held over the back and a smart pinch is given to the thorax, at the base of the legs (not to the head, as the non-entomologist usually imagines). This will kill most Lepidoptera outright but a few (*Danaïnes*,





Fig. 1.—Pinning Forceps.

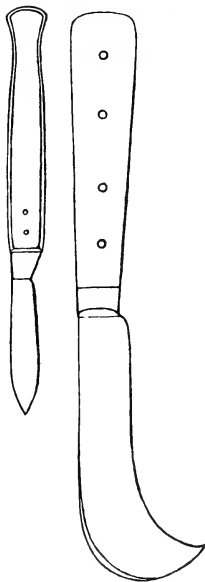

Fig. 2.—Knives ; scalpel (above) and field-knife (below).

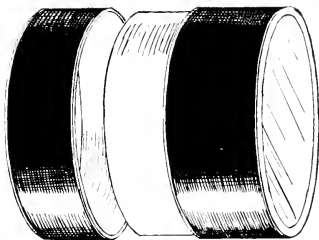

Fig. 3.—Glass-bottomed box.







Fig. 1.—To kill a butterfly it should be pinched at the place shown by the arrow-head.

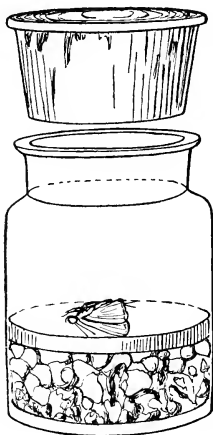

Fig. 2. Cyanide killing-bottle.

Zygæids, etc.) are very tenacious of life and will fly off again gaily after a really hard pinch (Plate 153. fig. 1).

For most insects a killing-bottle is used, made of any tightly-stoppered wide-mouthed glass jar which is usually charged with potassium cyanide. The jar should have a cork stopper, as a glass stopper is very liable to break either itself or the bottle when clapped to smartly, as is necessary when shaking specimens into the bottle out of glass-bottomed boxes; and it is more convenient if the cork stopper is fitted into a wooden top (Plate 153. fig. 2). The jar is charged by filling in small lumps of potassium cyanide to a depth of an inch or more (according to the size of the jar) and then filling the chinks between the lumps with dry plaster of paris; a thick mixture of plaster of paris is now made up with a minimum of water and poured over the cyanide to form a smooth layer, which sets hard and keeps it in place. There is always a considerable condensation of water on the inside of a newly-charged bottle and this water requires to be wiped off several times. In damp weather also the cyanide picks up a good deal of water from the air and the surface of the plaster is liable to get very wet. It is as well, therefore, to cover the surface of the plaster with several layers of thick white blotting-paper, which should be renewed when it becomes wet or dirty.

Some collectors powder the cyanide and mix it with the plaster. But a bottle prepared with lump cyanide and a minimum of water in the plaster, as described above, will last longer.

For general collecting, it is useful to have at least two bottles, one of which may be reserved for more delicate specimens which are liable to be broken if mixed up with larger ones.

Killing-tubes, made from a corked glass tube prepared in the same way as a bottle, are also useful for small specimens, and can be carried in one's coat-pocket when a bottle would be unnecessarily cumbersome.

Besides potassium cyanide, various other killing materials may be used, such as chloroform, benzene, ammonia, etc. In the case of specimens collected in glass-bottomed boxes, for example, one end of a strip of paper dipped in chloroform may be introduced into the box, when the insect is speedily stupefied. Benzene may be used in a similar way and is sometimes used mixed with chloroform. Killing bottles or tubes may also be extemporized by stuffing a wad of tissue paper into the bottom of a suitable bottle or jar and pouring on to it a few drops of chloroform or benzene or a mixture of both; a glass tube charged in this manner will remain effective for two or three hours if not left opened too long.

Insects killed in a bottle or tube become very stiff after death, as *rigor mortis* sets in: this passes off after some hours. If insects are to be set, therefore, they should be left in the bottle overnight when they will usually be found in proper condition for setting the next morning.

Tobacco smoke makes an effective temporary stupefying agent, very useful in the case of Microlepidoptera which have been collected in glass-bottomed boxes. The lid of the box is raised very slightly on one side and a puff of smoke blown into the box; in a few seconds the moth is stupefied, when it can be shaken out, pinned, given a nip on the thorax with the forceps and will then be in beautiful condition for setting forthwith.

After using chloroform, benzine, tobacco smoke or any similar agent to stupefy or kill insects in collecting-boxes, care should be taken that the boxes are left open and thoroughly aired afterwards as, if any trace of the killing agent lingers inside the box, any insects subsequently placed in the box are likely to be made very restless and knock about until they spoil themselves.

Occasionally a specimen will be found which is too large to go into any ordinary killing-bottle. Such insects as large Coleoptera, Phasmids, etc., may be dropped into a basin of boiling water, which kills them immediately: they should, of course, be well dried before putting them away. Larger moths, such as *Attacus atlas*, may be killed by holding them with the wings over the back and thrusting into the side of the thorax a pen or stout pin dipped in a saturated solution of oxalic acid; if no such killing agent is available, a red-hot needle thrust into the lower part of the thorax is a barbarous but effective method.

Dragon-flies, especially large ones, should not be killed at once if it can be helped, as the subsequent putrefaction of the intestinal contents will spoil the colour of the bodies. It is better to place them alive each in a separate box or dry glass tube plugged with a wad of crumpled paper and to leave them until next day before killing in order to give them time to empty their alimentary canals.

The intestinal contents of large dragon-flies may also be removed, after killing them in the cyanide bottle, by slitting up the underside of the abdomen with a pair of scissors and pulling out the stomach and intestines with a pair of forceps. A blunt-pointed pair of scissors is better than a fine-pointed pair, as the latter is more likely to penetrate the skin of the back. In the case of male dragon-flies, care must be taken to make the slit *around* the secondary sexual apparatus found beneath the anterior end of the abdomen so as not to spoil these organs, which are of importance for systematic discrimination of the species.

A stout bristle may be passed in through the front of the thorax

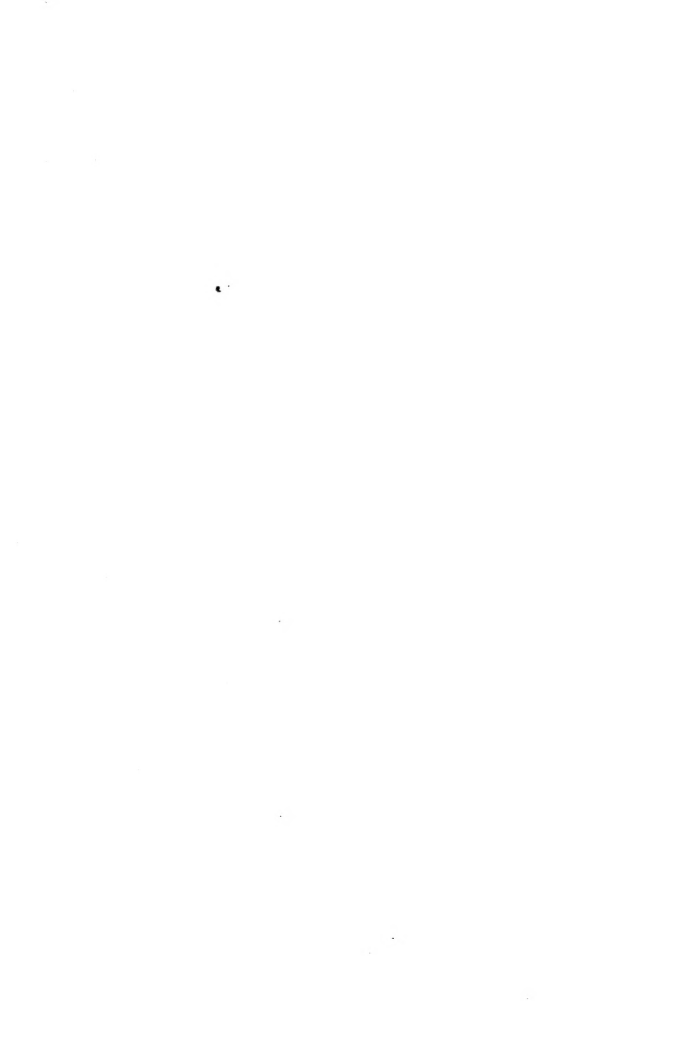

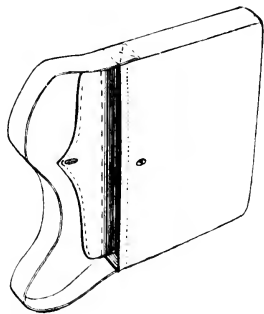

Fig. 1.—Collecting bag.

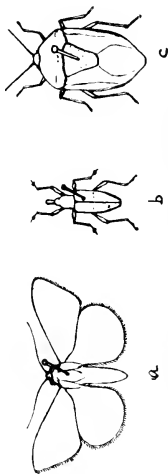

Fig. 2.—Where to pin insects ; a, moth ; b, beetle ; c, bug.

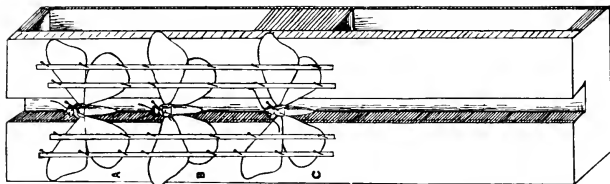

Fig. 3.—Setting board, showing (A) butterfly set correctly, and (B, C) incorrectly. In (B) the fore wings are not raised sufficiently forward, and in (C) the wings and antennae are not arranged symmetrically.



and down the inside of the abdomen, to prevent the latter from breaking off, as dragon-flies when dried are peculiarly brittle objects.

*Wet material.* Many insects are not easily preserved dry, either because they are too small to pin or because they shrivel up. Minute insects (such as small Chalcidids), which in any case require to be mounted as microscopic objects for satisfactory study, are best preserved in spirit. Spirit is also the best medium for the collection and preservation of insects such as Aptera generally, termites, Embiads, Thysanoptera, and Aphids, which shrivel up too much to make satisfactory dry specimens: and it is also as well to preserve in spirit some duplicate specimens of most other groups which are ordinarily pinned, in order that both wet and dry examples may be available for study, this remark applying especially to such groups as Psocids, earwigs and dragon-flies. Some insects whose brilliant colours in life are due to a thin film of liquid within the chitinous epidermis, such as many Cassidine beetles, lose these brilliant colours entirely when dry, but the brilliancy is retained in the case of specimens kept in spirit or formalin and in such cases a few duplicate examples may be kept wet. Immature stages are also best placed into spirit.

The best preservative agent for general use is ordinary spirits of wine at a strength of about 70, reduced to about 50 in the case of immature and very soft-bodied insects so as to avoid distortion. Formalin is also used sometimes but is not very satisfactory; the ordinary commercial formalin is of about 40 per cent. strength and this is diluted to about 4 per cent. for preserving purposes.

For collecting, therefore, a supply of corked tubes of various sizes and filled with spirit is required, and a pencil and paper should also be at hand in order that a temporary label may be placed in each tube as it is filled. These temporary labels should be replaced or supplemented by permanent labels, giving full *data* and written on good paper with a moderately soft pencil, and placed *inside* each tube. Labels stuck onto the outside of tubes are liable to fall off or be obliterated.

A *collecting-bag* is a useful accessory in which to carry the apparatus required for fieldwork. It may be of any convenient size or material. A very useful bag is easily and cheaply made from stout cloth or light canvas about sixteen inches broad and twelve deep and three wide, with slightly rounded corners, and provided with a flap secured by a button and also with a wide strap to pass over the shoulder. The bag may be divided into two or more compartments in order to avoid mixing full and empty boxes, tubes, etc. Such a bag will hold killing-bottle, folding-net, field-knife, and a supply of boxes and tubes. (Plate 154. fig. 1).

*The clothes* when collecting may be selected with due regard to their suitability for the purpose. A loose coat, with pockets ample both in size and number and capable of being buttoned up, provides stowage for a large amount of material. The forceps and lens will of course be carried in one pocket, the latter attached to a button-hole by a string if considered necessary. A supply of small empty boxes may also be carried in one side pocket and transferred as filled to the corresponding pocket on the opposite side; for ordinary right-handed people, it is more convenient to carry empty boxes in the right-hand coat pocket. The left-hand coat pocket, besides filled boxes, will hold a killing-tube ready charged. An inside breast-pocket will accommodate the folding net if a bag is not carried, and an outside breast-pocket securely buttoned, will hold a supply of tubes with pencil and paper for labelling. Finally, a few pins may be stuck into the lining of the *topi* and specimens such as butterflies, which can be killed by pinching, pinned sideways and stuck into it, several specimens on one pin if necessary to economize space; such specimens can be relaxed and moved off the pin later on and either set or placed in papers.

*A note-book* should be an indispensable part of the field-apparatus. It should be of a convenient size, of good plain paper bound in stout boards and provided with its pencil. If carried in the collecting-bag it will be at hand when required to make a note on habits or any point observed concerning insect or to make a sketch on the spot of any peculiar attitude, etc. It is useful, in connection with such notes to number them consecutively, either with a series of figures or letters, and to label the specimens to which they refer with corresponding numbers; on looking over the notes afterwards it is then possible to pick out in the collection the particular specimen referred to, and similarly, when a numbered specimen is named up, the name can be entered in the note-book, which in this way becomes a valuable record.

*Setting* is the name applied to the process of spreading out insects partly for display in a collection and partly for convenience of proper examination of their structure, the latter requirement being important in the case of all collections made (as all should be) for scientific purposes. When collecting in the field, it is not necessary as a rule to set large insects, as it is nearly always possible to relax these afterwards and they occupy a smaller amount of space if carried unset, but it is desirable to set small specimens (such as Microlepidoptera) when fresh, as it is often difficult to set them satisfactorily afterwards. Some collectors of special groups, *e.g.*, butterflies, also prefer to set their captures when fresh.



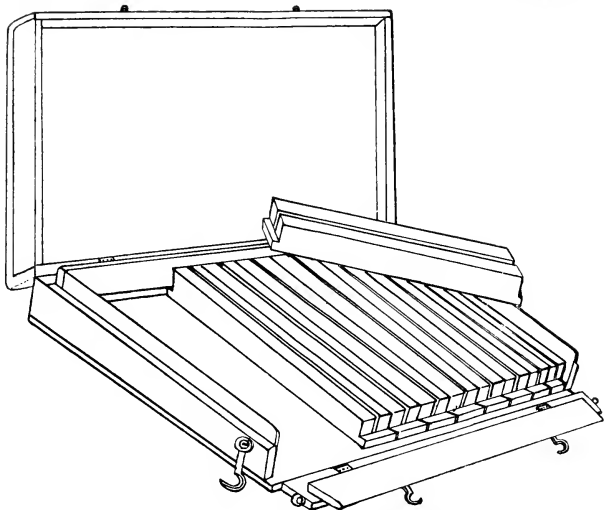

Fig. 1.—Travelling case for setting-boards.

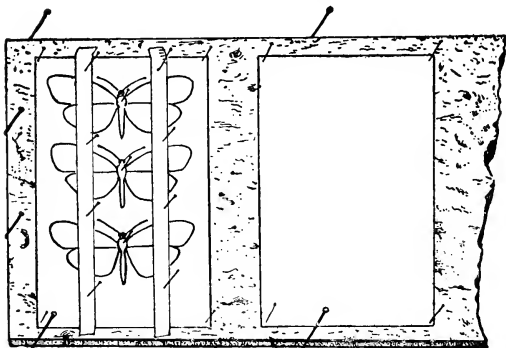

Fig. 2.—Setting small moths on flat cork sheet.

In the case of specimens such as large Lepidoptera, Neuroptera generally and others whose wings are to be spread out, it is usual to do this on special setting-boards, which are usually made of parallel strips of wood covered with papered cork sheet and with a space between to receive the bodies of the insects. (Plate 154, fig. 3). Setting-boards are sometimes made with the corked side-pieces sloping slightly upwards or curved downwards, but the best boards are flat and raised about one inch above the bottom of the board to give plenty of room to grasp the pin with the forceps below the insect when set. The specimen to be set is first pinned through the middle of the thorax, the pin being placed upright or sloping forward very slightly, and then pinned into the groove of the board so that the bases of the wings are just above the level of the board. Two strips of moderately-thin glazed paper are then cut of a width and length proportional to the size of the board and one end of each strip is pinned onto the end of the board in front of the insect whose wings are then stretched downwards and forwards until the hinder-margins of the forewings are at right angles with the axis of the body; the strip of paper is then passed down over the fore-wings, the hindwings drawn up as necessary, and the strip of paper pinned down to fix the wings in position. The antennæ (and legs, if necessary) should also be fastened into symmetrical positions with pins, and the body fixed with pins into a position parallel with the head and thorax. Both for the sake of display in a collection and for structural examination it is important that the wings be spread out symmetrically and sufficiently; a very common error is to draw the forewings, especially in Lepidoptera, insufficiently far forward, so that they are overlapped by the front portion of the hindwings, with the result that it is impossible to examine satisfactorily the structure of either pair of wings. As a general rule, the forewings should be so placed that their hinder-margins are in a straight line and the hind wings should be drawn up only so far as not to overlap the forewings. (Plate 154, fig. 3).

Most insects are pinned through the thorax, except Coleoptera (beetles) which are pinned through the right elytron (wing-case) and Rhynchota (bugs) which are usually pinned through the scutellum. (Plate 154, fig. 2). In cases where the thorax or scutellum bears special characters (*e.g.*, Chalcidids, many Rhynchota) the pin should be so placed as not to destroy these characters; in pinning a series of any small insect, therefore, it is as well to pin a few specimens sideways through the thorax, so as to retain the thoracic characters unimpaired.

Earwigs, cockroaches, beetles, flies and bugs are usually left unset although the wings and antennæ may be displayed symmetrically

Grasshoppers and other winged Orthoptera usually have the wings spread out on one side only, and this is done for economy of space in the storage of these large insects.

Setting-boards may be carried and kept in any convenient tight-shutting box, but when travelling a setting-case is often convenient. This may take the form of a large box, somewhat after the style of a small meat-safe, with shelves to hold the boards, or a more compact travelling case may be made of the size of a store-box with soft-wood setting-boards fitted in. (Plate 155, fig. 1). Specimens can then be set when fresh and carried on the boards.

As noted above, however, there is no real need to set large specimens at the time of capture, as they can nearly always be relaxed and set at any subsequent times and for small specimens, which require immediate setting, there is no need to carry special boards when travelling, as such small specimens can be set quite satisfactorily on small sheets of cork, pith or compressed peat which can be pinned into the store-box. The procedure is as follows:—a strip of paper slightly wider than the expanse of wings of the insect to be set and as long as the width of the cork sheet is cut and pinned onto the sheet and two narrow slips of paper are pinned onto this at a suitable distance apart, the insects being then set on this paper-covered cork in the ordinary way. (Plate 155, fig. 2). *Data* can be written on the paper. Any ordinary fairly-thin glazed paper is satisfactory; thin "squared" paper is very useful as the cross-lines give a good guide to the proper position of the wings.

Improvised setting can also be done without boards in many cases, by pinning the insect onto a small card to which the wings, legs, etc., may be secured by small pins. When dry, these pins and cards can be removed. (Plate 156, fig. 2).

No definite time can be given during which insects can be left under setting. It depends entirely on the humidity of the surrounding air and the size of the insect. In dry weather small insects may be ready to take off the boards even after a few hours and in damp weather they may take a week, whilst large insects may take four or five days to two or three weeks. By gently testing with a pin to see whether the body is quite firm and hard, it is possible to see whether the insect is ready in any case of doubt, as if the body is quite firm, it may be assumed that the insect is ready to remove from the boards, but if the body is at all soft it should be left longer. In damp weather or when rapid removal is required drying may be expedited by placing the boards in a drying chamber, or in a box over a lamp or in front of a fire; but, in cases where artificial heat is used, care must be taken to see that the



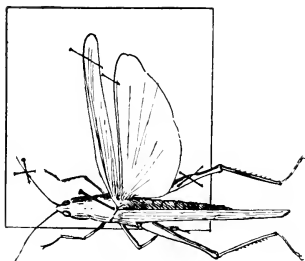

Fig. 2.—Temporary setting on cards for grass-hoppers, etc.

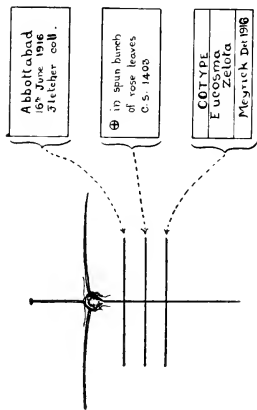

Fig. 1.—Diagram showing how several labels may be attached to one specimen. Note that the locality label is always uppermost.

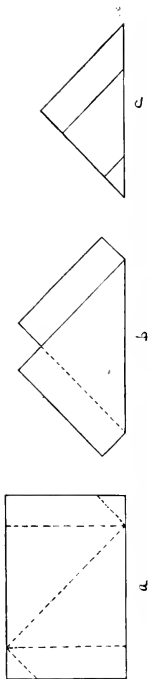

Fig. 3.—Folding an envelope to take papered insects: "a", rectangular piece of paper showing (dotted lines) where folds come; "b", the same, folded diagonally; "c", the envelope closed with corners folded over.



wings are properly fastened down or they will tend to cockle up at the tips. In any case of doubt or when there is no hurry for removal it is as well to leave the insects on the boards as long as possible, provided of course that the boards are kept in a safe place. After relaxation, set insects require to be kept on the boards for a longer period than do fresh specimens of similar size, as they are very liable to "spring" if removed too soon.

Dragon-flies require to be dried as rapidly as possible in order to retain their colours, and in damp weather the process of drying generally requires to be hastened artificially to avoid decomposition and mould.

*Labelling* is a most important item in the art of collecting. Every single specimen in a collection, to be of any scientific value at all, must carry a label or labels showing at least where and when it was obtained, and any further particulars concerning it, such particulars usually including the name of the person who collected it. Other particulars should include references to note-book or other record, foodplant or any particulars regarding place of occurrence, habits, colour in life, etc. Finally, if the specimen has been identified by a specialist it should bear a label showing its name as given and the name of the identifier and date (at least the year). The labels should be as small as possible, as it is a waste of space in the store-box and a decided eyecore to attach enormous placards to the specimens, as one often sees done, especially in Government Collections in India. If there is not room to write all particulars on one small label, it is better to use two or more labels, one placed below the other, but the uppermost should always be that showing the locality and date of capture, and these particulars at least should be legible without removal of the pinned specimen. Then may follow particulars of foodplant, etc., references to any records of rearing or habits, etc., and finally a separate label showing identification. (Plate 156, fig. 1).

When large numbers of insects from one locality are dealt with, it is convenient to use labels printed in small type, as printed labels are more compact, neater and more legible. When the locality is in the Hills, its height above sea-level should be stated and, except in the case of well-known localities (*e.g.*, Calcutta), it is as well to add the Province; thus:—

Assam; Khasi Hills.  
 Shillong (5,000 feet)  
 (date)  
 (Collectors name.)

The spelling of place-names should conform as far as possible to the rule that consonants are pronounced as in English and vowels as

in Italian, the only exceptions being in the cases of very well-known names of erroneous spelling (*e.g.*, Lucknow, Calcutta). Thus, it is preferable to write Darjiling, Karachi, Muzaffarpur, rather than Darjeeling, Kurrachee, Mozufferpore.

Vague indications, such as "on cotton" should be avoided, as such labels give no real information. Full particulars (*e.g.*, "imago eating cotton flowers," "imago resting on cotton leaf," "larva rolling and eating cotton leaf") give definite information and are preferable. The correct botanical names of foodplants should also be ascertained and used as far as possible, as popular or local names are often incapable of exact identification.

*Dry, unpinned material.* Some specimens are best collected and kept dry and unpinned and may either be preserved permanently in this state or be relaxed and set at any subsequent time.

Such insects as butterflies, dragon-flies, ant-lions, and, generally speaking, any broad-winged insects, may be placed inside paper envelopes with their wings folded over their backs and in this way a large number can be packed in a comparatively small space. Envelopes are best made of a moderately thin slightly glazed paper, rectangular pieces rather longer than broad being folded over to form a triangular envelope, on the outside flap of which should be written full *data* (place and date of capture, collector's name, and any remarks). (Plate 156, fig. 3.) These envelopes can be stowed in any tight box, together with some powdered naphthaline, and may be kept for years if required. Special boxes for storing such envelopes, and useful either in the case of a collection kept in papers or of duplicates kept for exchange or preservation, have been designed and described by Mr. E. Ernest Green, whose account of them is as follows:—

"Triangular paper envelopes have been employed by travelling entomologists for the temporary storage of butterflies, for many years. But it has been usual to lay these envelopes haphazard in plain boxes, in such a manner that it is impossible to find any particular specimen without turning over the whole contents of the box.

"By the use of the special boxes here described the envelopes occupy very much less space, the contents are less liable to damage, and any individual specimen can be found and removed with the greatest ease without disturbing the remainder.

"The boxes are made of tin plate, with partitions dividing them into trough-shaped spaces. The envelopes rest edgewise in the troughs.

The boxes are fitted with two lids, above and below—

"Plate 157, fig. 1, shows a box with the upper lid removed and the lower one in place. The box measures 9 in. by 6 in. by 3 inches.

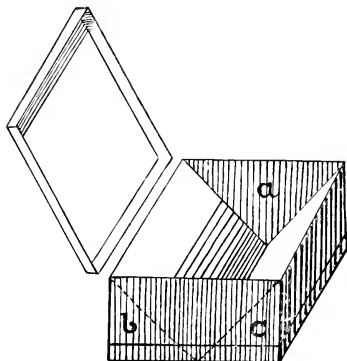

Fig. 1.—Design 1 (with lids).

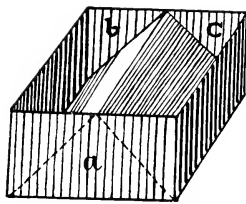

Fig. 2.—Design 1 (under side).

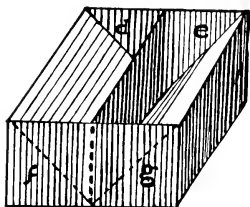

Fig. 3.—Design 2.

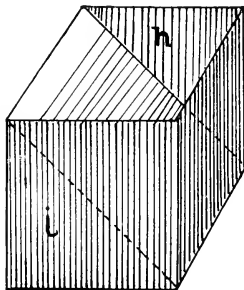

Fig. 4.—Design 3.

Green's boxes for storage of papered insects in envelopes.



The upper space contains a single trough (*a*) and carries envelopes with a base of  $5\frac{1}{2}$  inches.

"Figure 2 represents the reverse of the same box, with two smaller troughs (*b*, *c*) to contain envelopes of half the size.

"Figure 3 shows a box of the same size, but designed for the smaller-sized envelopes alone, and containing four troughs (*d*, *e*, *f*, *g*).

"Figure 4 is a larger box, of just double the depth of the others, measuring 9 in. by 6 in. by 6 in. with a diagonal partition forming a single trough above and below (*h*, *i*), capable of carrying envelopes of a larger size.

"(In figures 2, 3, and 4 the two lids have been omitted for the sake of clearness.)

"These boxes are designed for three sizes of envelopes, which gives a sufficient range for butterflies of any size. Size 1 is made from a rectangle 8 in. by 5 in., size 2 from a rectangle 6 in. by 4 in., size 3 from a rectangle measuring 4 in. by  $2\frac{3}{4}$  in.

"It is found in practice that a box made according to figure 1 will carry, without overcrowding, from 100 to 130 full envelopes in the larger trough, and from 175 to 200 in each of the two smaller spaces. Design 2 will hold in each of the four spaces 225 *Lycænidaë*, making a total of 900 insects. Design 3 will hold 75 or more filled envelopes in each of the two spaces.

"For convenience of examination the insects should be arranged in families; the genera alphabetically in each family, and the species alphabetically in each genus. Subsequent additions can be slipped into their places without disturbing those already in position. To keep the envelopes in place when the troughs are only partly occupied, triangular blocks of cork about  $\frac{3}{4}$  inch thick can be employed. For use as collecting boxes the troughs can be charged with empty envelopes, and the cork triangles will serve as markers to separate the unused envelopes as they are filled.

"The boxes illustrated are of the simplest design, as made by a local tinsmith in Ceylon. They can be improved by a coating of black japan on the outside.

"Messrs. Watkins and Doncaster have adopted this design, and are turning out boxes (to suit their special-sized envelopes) in stout japanned zinc, with perforated partitions at the end of each trough for the reception of naphthaline or camphor." (*Spolia Zeylanica*, VII. pp. 164-166 (May 1911)).

Or the envelopes may be packed in stout paper packets as described by Major H. D. Peile in the *Journal of the Bombay Natural History Society*, Vol. XXV, pp. 309-312 (September 1917), as follows:—

“Standard sizes of paper-triangles should be used. For small and medium-sized butterflies semi-transparent butter-paper is best, as it enables the contents to be seen through the paper at a glance, and guards against spread of any grease that may form. For large triangles use stronger glazed paper such as that of English illustrated weeklies, as glazed paper does not rub the scales off the wings.

“Place the newly-captured butterfly with the antennæ close against the forewings and at the fold of the paper, so that they dry in that position safe from injury (*see* sketch 3). Do not place it with body against the fold (*see* sketch 4) as in this position the antennæ almost always dry sticking out and eventually get broken off in handling the paper or specimens.

“If papered butterflies be massed together in a box any particular specimen cannot be got at without many being handled, resulting in damage to some sooner or later.

“The paper triangles should be kept in packets of corresponding standard sizes, so that these packets, fitting closely in an ordinary biscuit-tin, economize space and enable any one packet to be easily taken out without disturbing its contents.

“The paper triangles should be so placed in a packet that the bodies of the specimens are alternately to right and left and so lie evenly; if not so placed they form a lopsided pile, and space is wasted and pressure is all on one side.

“All packets should be of uniform height—1 inch—so forming two or three tiers in the tin according to the kind of biscuit-tin used and each packet should contain just so many specimens as not to be loose in it, and then the vertical sides of the packets take any weight or pressure.

“A medium-sized packet has its longest side about  $3\frac{1}{2}$  inches; larger packets can be made double, or smaller ones half the size of this one. Stout paper such as parchment-note answers best.

“Attached is an outline pattern (reduced half-size) for making such a packet (Plate 159, fig. 1). Cut along the outside continuous lines, and fold backwards at the dotted lines. This pattern may be used for outlining others with a pencil, keeping the centre portion of the pattern fixed with the fingers of the left hand, and turning up each portion after outlining as one works inwards. Paste A to underside of B so that C is between the two; then paste underside of D onto E with F between them. To close the packet insert the flap between

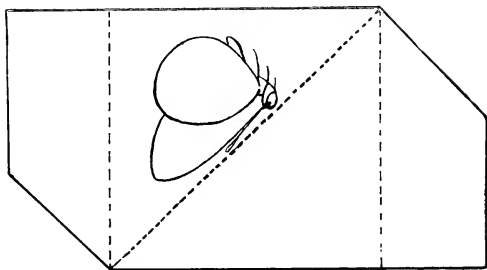

3. Paper for Medium Paper Triangle.  
Fold at dotted lines.  
Butterfly placed with antennae safe.

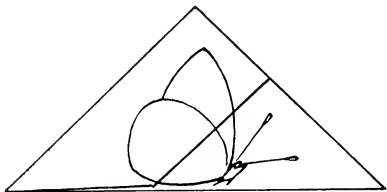

4. Paper triangle closed.  
Butterfly unsafely placed.

Major Peile's envelopes for butterflies.







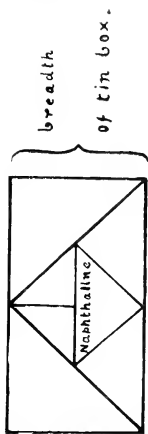
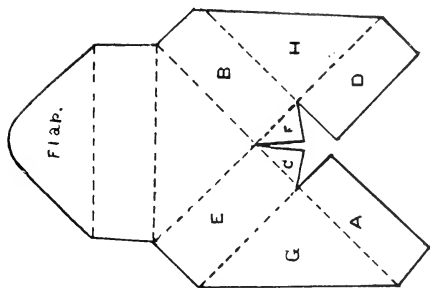

5. Arrangement of  
Packets in Tin box.

Fig. 3. Major Peile's packets for envelopes packed in biscuit tin.

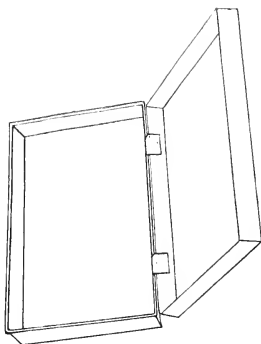
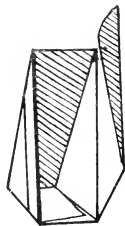

Fig. 4.—Zinc Relaxing Box.



Figs. 1 and 2.—Major Peile's packets for papered insects in envelopes.

G and H. A number of these outlined and cut out for packets, but not folded, can be kept ready to be made up into packets as they are wanted.

"The pattern for packets should be of rough paper so that it will last a long time, and if some coloured paper be used for it the pattern will not get pasted together for a packet in mistake for one outlined from it.

"The lower sketch [fig. 2] shows an open completed packet.

"Diagram 5 shows an arrangement of three sizes of packets, say in the uppermost tier in a small biscuit-tin, a space in the middle being conveniently left for naphthaline.

"Each packet is numbered and a list of contents pasted on the outside of the tin. Finally the tin is closed against damp and insects by a strip of 1-inch adhesive plaster all round the edge of the closed cover."

Many insects, however, are not suitable for storage in ordinary envelopes, grasshoppers and stick-insects, for example, and these may be wrapped in tissue-paper rolled in ordinary unglazed paper. Large beetles may be packed in dry saw-dust in which a little powdered naphthaline has been mixed, or they may be made up in little packets of thin paper and kept in a box with naphthaline. When saw-dust is used, it should not be that obtained from any resinous wood.

The same procedure may be adopted with large bugs and, generally speaking, when accommodation in the collecting store-box becomes or is likely to be cramped, space in it can be reserved for small and delicate specimens, all large insects being disposed of in papers or saw-dust.

Scale-insects may be collected and kept as dry specimens, according to the size of the foodplant, in envelopes or boxes. In such cases a parallel series in spirit is useful.

Insects kept dry in glass tubes should have the inside of the cork naphthalined before being closed up, to prevent development of mould.

*Relaxing* is the process of softening dried insects for the purpose of manipulating them at some interval after they have stiffened subsequent to the vanishing of *rigor mortis*. It is usually effected by exposing them to a damp atmosphere, by placing them in a closed box (Plate 159, fig. 4) on damp sand or blotting-paper, a few drops of carbolic acid being added to prevent the growth of mould. The time taken to relax an insect in this way varies with the size of the insect and the temperature, the time being extended directly by the size of the insect and lowness of the temperature. In warm weather small

insects may be relaxed in twenty-four hours and large ones in two or three days. The process may be hastened by using warm water, over which the insects are suspended or floated on a piece of cork. Care must be taken that the insect is sufficiently softened to permit of easy setting and, conversely, that it is not left in the relaxing-tin so long that it becomes too decomposed. As already noted, relaxed insects are peculiarly liable to "spring" (*i.e.*, the wings fail to retain their positions) if removed too soon from the setting-board; extra time on the boards should therefore be given in the case of all relaxed specimens and, in any obstinate cases, the wings may be fixed with a small drop of cement applied to the base of the lower surface of each wing.

Green insects, especially moths, are very liable to fade when relaxed and should therefore be set when fresh as far as possible.

*Cement*, by the way, should also form part of the collector's apparatus, as it is often required for mending broken specimens. Special Insect Cement is prepared, obtainable in small bottles, and only a very minute quantity is required to be applied. If it becomes too thick, it may be softened by adding a little vinegar or acetic acid solution.

#### PRESERVATION.

Assuming that an insect is pinned and labelled and (whether set or not) is ready to be placed in the collection, it still remains to take all necessary precautions to preserve it effectively. To do this it is necessary to keep it free from fungal and animal pests and from the action of light.

*Mould* is the worst enemy of insect collections in damp climates such as are found in most parts of India, either all the year round or at certain seasons, and constant vigilance is required to prevent its development and spread on specimens. Large insects when badly attacked may often be cleaned with a small brush moistened with benzine but small and delicate specimens, such as Microlepidoptera, are ruined once and for all when badly moulded. As in so many other cases, prevention is much better than cure, and every effort should be made to prevent the entry and growth of mould on the specimens. The best preventive is (1) to see that all new acquisitions are thoroughly dried and free from mould before putting them away in the collection and (2) to keep the atmosphere inside the store-boxes, cabinet-drawers or other receptacles thoroughly impregnated with naphthaline vapour, in which mould is unable to develop from any spores which obtain admittance from the air when the receptacles are opened. A plenti-

ful supply of powdered naphthaline should therefore be kept in all store-boxes, cabinet-drawers, etc. It is of comparatively little use to pin a large lump of solid naphthaline in one corner, as the evaporation from a limited surface is too small to exercise any really beneficial effect. In the case of cabinets, there is ample space provided as a rule around each drawer and, if this space is kept filled with powdered naphthaline, the collection will remain quite safe; should excessive evaporation take place and naphthaline be deposited on the specimens, a little airing will speedily free them without damage. In the case of store-boxes, a "camphor-cell" is usually provided and this should be filled with powdered naphthaline, but it is often too small and in such cases the inside of the box may be painted over with naphthaline dissolved in benzine. It is best to keep store-boxes in tightly-fitting almirahs which can be given a plentiful supply of naphthaline in crystals or small lumps so that the boxes are kept in an atmosphere impregnated with naphthaline vapour.

*Extreme dryness* is also injurious to insect specimens, as they become very brittle and are apt to break at the least touch. Moderately dry conditions of storage should be aimed at as far as possible.

*Insect Pests*, especially Psocids (the so-called "mites"), Dermestid beetles, *Tribolium*, and Tineid moths attack and ruin specimens to which they have access, but are easily kept at bay by the use of tightly-fitting receptacles well impregnated with naphthaline. In case pests such as Dermestids gain access to the collection, however, it takes more than naphthaline to destroy them. In such cases a mixture may be used composed of naphthaline dissolved in carbon bisulphide and mixed with beech-wood creosote, in the proportion of about one-third of each constituent, and a little of this poured into the boxes; this acts equally well for insect pests and mould and at Pusa we use this to a considerable extent, especially during the Rains.

Care must be taken that insect pests do not attack specimens when on the setting-boards and be subsequently introduced into the collection with the set specimens. The boards should therefore be kept in a tightly-fitting drawer or similar place with plenty of naphthaline and carbolic acid. Major Fraser mentions a small fly which attacks insects (especially dragon-flies) on the setting-boards at Poona, but I have never come across this.

Larger animals, such as mice, will devour the bodies of dried specimens, and of course ruin them, but the access of such large animals can only be due to gross carelessness. And, generally speaking, damage to a collection by animal pests of any sort is only possible when there is a certain amount of neglect exhibited.

*Light* is injurious to the colours of most insect specimens, especially in the case of moths and green-coloured insects, which rapidly fade when exposed to light. Glass-topped cases are therefore very unsuitable receptacles for the permanent storage of a collection of any value and are usually only seen in public museums, where it is necessary to exhibit specimens; and in such cases they should be so placed as not to receive direct sunlight at any time and should be kept efficiently screened when not actually in use. The dire combined effects of light, mould, insect pests and neglect generally are perhaps nowhere more evident than in the case of the insect-cases displayed to the public view in many museums throughout India.

*Store-boxes* are necessary for the collection of specimens and are convenient for their preservation, at least temporarily, especially in the case of small collections, as it is always easy to interpolate boxes when expansion is necessary.

Various patterns have been tried at Pusa during the last fourteen years, all teak-wood boxes  $17\frac{1}{2} \times 12 \times 3$  inches. The first pattern was lined with pith and provided at one end with a partitioned compartment to hold naphthaline balls. A second pattern was lined, top and bottom, with cork sheets covered with white paper. A third pattern had no cork at all but was lined with two sheets of paper stretched over thin slips of wood screwed to the inner sides of the boxes, these screws being adjustable to secure proper tension of the paper. A fourth pattern was lined on the bottom with cork linoleum painted white and fixed in with a mixture of paraffin wax and naphthaline, a further supply of this mixture being also placed in the lid of the box. A modification of this last pattern had a white-painted sheet of cork linoleum embedded in a thick layer of paraffin wax and naphthaline poured into the bottom of the box and allowed to set, the lid of the box being simply varnished.

The last pattern was in use for a long time and the majority of the collections at Pusa are still kept in such boxes, but they are not satisfactory in use, as the wax makes them very heavy to handle and is liable to melt in really hot weather whilst the naphthaline soon evaporates and exercises no preventive action on insect pests or mould after a year or so. The linoleum sheet also is liable to buckle upwards at times, the specimens being pressed against the lid of the box and often ruined in this way. We are therefore no longer recommending this paraffin-lined box for general use.

Storeboxes are usually made in standard sizes ( $8 \times 6$ ,  $10 \times 8$ ,  $13 \times 9$ ,  $14 \times 10$ ,  $16 \times 11$ , and  $17\frac{1}{2} \times 12$  inches) and 3 inches deep, these measurements being external dimensions. Small boxes are useful to transmission of specimens but for a collection the largest size ( $17\frac{1}{2} \times 12$ ) is

preferable, and in any case it will be found most convenient to have all the boxes of a uniform size, at least as regards length and breadth. As regards depth, the ordinary depth of 3 inches is too shallow to admit of placing large or high-set insects on both sides of the box without risk of damage and an external depth of four inches is best. A four-inch box is not only more economical of space (as three four-inch boxes filled on both sides hold as many specimens as six three-inch boxes which can only be filled on one side, and also occupy on a shelf only the space required by four three-inch boxes) but is also more easily placed upright on an almirah shelf as it does not tend to topple over as a three-inch box does.

As regards material, imported store-boxes, as supplied by dealers in entomological requisites, have until comparatively recently been made of deal, the top and bottom often only glued to the sides, with the result that these come unstuck in damp weather. The tops and bottoms also crack and split in the dry weather, so that glued deal-wood boxes are unsatisfactory under Indian conditions. In any case, the tops and bottoms should be screwed onto the sides in addition to being glued.

Locally-made boxes are made of various kinds of wood, of which teak is that most frequently used. A well-made box of good, seasoned teak should last well, but has the disadvantage of being heavy and is by no means immune from, the top especially, splitting in hot, dry weather, with the result that insect pests and mould play havoc with the collection during the ensuing Rains. Another disadvantage of locally-made boxes is that it is extremely difficult to secure exact standardization in size, with the result, if the boxes are kept in racks, that some boxes will be found not to fit in properly.

Three-ply store-boxes, *i.e.*, boxes whose tops and bottoms are made of a "three-ply" wood, such as "Venesta" boarding, and whose sides are usually made of deal, have come into use of late years and our experience of them has shown that they are thoroughly satisfactory in use. A box of this pattern,  $17\frac{1}{2} \times 12 \times 4$  inches, holds a large number of insects whilst being sufficiently light for easy handling. The tops and bottoms should be screwed on and the whole of the outside varnished. The inside is fitted with a large cell for naphthaline and the top and bottom lined with sheet cork covered with white paper.

The first requirement of a good store-box is that it must remain tight, without cracking or shrinking under any climatic conditions in India, and this requirement has only been fulfilled so far in the case of three-ply boxes. We have had no experience of metal boxes in India.

Small label-holders, made of thin sheet brass, may be attached to the front of the box to hold card labels to indicate the contents of each box. If these labels are rubbed over with paraffin wax, after being written on, they are less liable to be eaten by fish-insects.

*Storage.* For a collection of any size, some definite system of storage is required. At Pusa and most of the Agricultural Colleges, teak-wood boxes, lined with paraffin-wax and naphthaline, have been stored in open wooden racks, the boxes sliding on horizontal wooden or iron slats. This method has been given a thorough trial at Pusa during the last thirteen years and has proved thoroughly defective, as:—

- (1) every box is exposed to dust and atmospheric conditions, the result being that the tops of the boxes frequently split in the hot, dry months of March-May so that there is free access to light, insect pests and spores of mould, the last especially proving very troublesome during the Rains (June-September) when the saturated air penetrates into the boxes through such cracks ;
- (2) it is impossible to keep the boxes in an atmosphere impregnated with naphthaline vapour, so that when all the available naphthaline added with the paraffin wax has evaporated there is no further protection by this means against insect pests and mould ;
- (3) the system of storage in open racks gives very poor economy in space, as not more than about twenty boxes can conveniently be kept in one rack.

Almirahs are preferable to open racks as the store-boxes are kept free from dust and it is possible to surround them with an atmosphere impregnated with naphthaline vapour, so that, if a box should crack or be left improperly shut or spring open (as sometimes happens), its contents incur far less risk of damage by insect pests, mould, or light. If store-boxes four inches in depth are used, they will stand upright on shelves quite securely ; but if boxes only three inches in depth are used they are unsteady if kept upright and will require thin battens to keep them in place. For heavy insects there is some risk of displacement if the boxes are kept vertical and this is one objection to storage in almirahs, but, on the other hand, if the boxes are placed horizontally there is a great deal of waste of space as each box requires to be provided with a separate pigeon-hole. Boxes of four inches in depth placed upright on shelves in almirahs are much preferable to boxes three inches in depth kept either vertically or horizontally as far as economy of space is concerned.



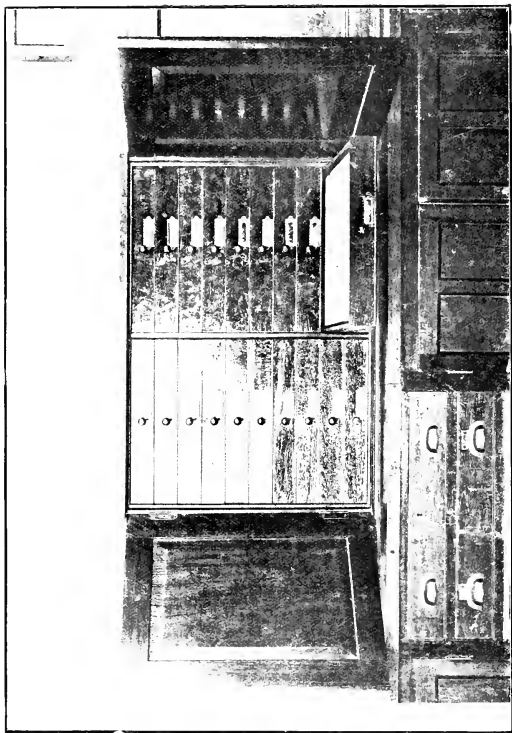

Insect Cabinet of twenty drawers in two tiers.





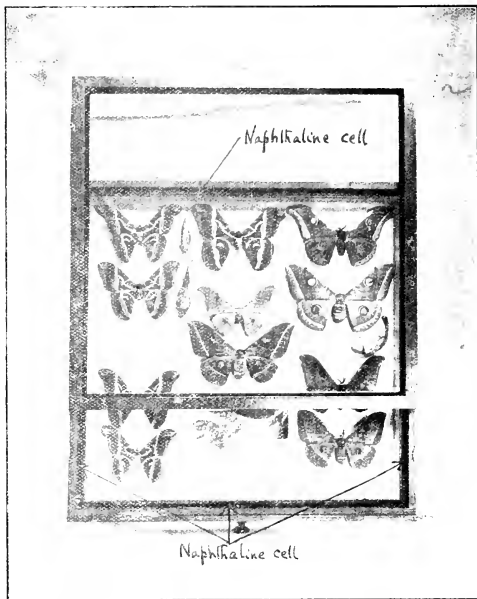

Cabinet drawer with glass partially removed, showing naphthaline cell running all around the four sides.

Cabinets (Plate 160) seem to have been little used in India hitherto but provide by far the best means of storage for the permanent preservation of insects as all the specimens are kept free from mould, pests, and light, provided, of course, that the cabinets are thoroughly well made of properly seasoned wood and that the drawers are kept supplied with naphthaline, which, however, evaporates comparatively slowly under closed conditions. A great advantage in cabinets is the very large economy of space yielded by their use instead of store-boxes, whether these are kept in racks or almirahs, as three or four twenty-drawer cabinets may be placed on top of one another, so that eighty drawers (equivalent in storage space to one hundred and twenty three-inch store-boxes or to sixty four-inch boxes) only occupy about the same floor-space as one rack holding only twenty three-inch boxes.

The most convenient size for a cabinet is one of twenty drawers, in two tiers of ten drawers each. It should be made of thoroughly-seasoned, best quality mahogany or teak. Inferior woods will warp in the dry weather and swell in the rains, with the result that the sides may crack and the drawers will stick. Under no circumstances should resinous wood, such as cedar or pine, be used, as the resin contained in such wood is sure to exude sooner or later and condense in little blebs on the glass and inside of the drawers and even on the specimens themselves. It is thoroughly bad economy to have any but the very best quality of wood and workmanship in a cabinet. It should be provided with double wooden doors, to lock in the centre and lined with velvet along the hinge-edges to exclude dust. No fancy-work in the top or bottom is required if it is intended to stand cabinets one upon another.

The drawers may be made of any size but a convenient size is  $18 \times 18 \times 2\frac{1}{2}$  inches externally, giving internal dimensions of about  $16 \times 16$  inches of corked space and at least  $1\frac{1}{2}$  inches from surface of cork to lower surface of glass. In any case the drawers should be made interchangeable, not only in their own cabinet, but in all the cabinets containing one collection. By this means it is possible to expand and rearrange the collection without moving all the specimens. The drawers should be fitted with glass frames to drop in and with a space all around about  $\frac{3}{8}$  inch wide, under the edges of the frame, for naphthaline (Plate 161). They should be lined with sheet cork over which unglazed white paper is pasted. The cost of a well-made cabinet, in the above dimensions, landed in the laboratory, may be put at about Rs. 15 per drawer.

*Preservation of Larvæ.* Caterpillars may be preserved dry after having been "blown." The process is as follows:--Select a well-

coloured specimen, preferably a day or two after a moult, and kill it either in the cyanide bottle, with chloroform or other agent or, in the case of a non-hairy caterpillar, by dropping it into spirit or boiling water. If wet, it is then dried on blotting-paper, on which it is laid. A small slit is then cut in the anus with a fine-pointed pair of scissors and the contents of the body are carefully squeezed out through the vent with the help of a small rounded piece of wood, such as a pencil, which is rolled lightly over the body, commencing near the anus and gradually working up towards the head. In this way, all the contents of the body can be removed, leaving only the empty skin. Care should be taken not to press too hard, especially at first, or the skin may burst. The skin being emptied of its contents, the point of a fine blow-pipe, either of metal or of glass tubing drawn out to a point, is inserted into the hole through which the body-contents have been removed and the skin is gently inflated either with the mouth or by means of a small rubber bulb or bellows attached to the blow-pipe. If the skin slips off the blow-pipe it may be secured either with a twist of cotton or by means of a piece of watch-spring lashed onto the blow-pipe and with its free end pressing against the end of the blow-pipe. The inflated skin is then dried moderately rapidly over a piece of wire-gauze placed over a spirit lamp. When thoroughly dry, the skin will retain its shape without collapsing and may be removed from the blow-pipe and mounted with glue onto an artificial spray of its foodplant or onto a strip of pith or a piece of silk-covered wire and then, after labelling, pinned into the collection.

Many caterpillars keep their natural colours very well under this process, but green larvæ nearly always lose all colour. Such may either be left as they are or may be painted by hand or a little dry green paint may be distributed over the inside of the dried skin.

*Another method*, known as "popping," is sometimes used for the preservation of small non-hairy caterpillars and possesses the advantages of simplicity and quickness. The only requisite is a glass-tube or piece of tin or anything that will stand heat. The caterpillar is killed with chloroform or benzine or in the cyanide bottle and placed in the tube which is heated over a flame. The caterpillar will first contract and then expand and burst and dry in this expanded state. It may be allowed to cool in the tube and can then be removed and mounted. As a rough-and-ready method for the preservation of small larvæ, the process of "popping" often gives satisfactory results under conditions, such as touring, in which regular inflation is not practicable.

*Dried unpinned material*, such as Coccids, may be kept either in envelopes or boxes (according to size) placed in drawers and kept

supplied with plenty of naphthaline. No general rules can be given for the preservation of more bulky material such as wasps' nests. In any case it is best to keep all such material away from light as far as possible and to protect it with naphthaline.

*Spirit material* may be kept in tubes or jars according to size, but in any case should be properly labelled with full information written with pencil or waterproof ink on labels placed *inside* the tubes or jars. Labels gummed onto the outside of containers are very apt to drop off or become illegible on account of fading or attacks of fish-insects. Corked tubes are best kept on their sides if the corks are good, as they should be; if placed upright, the corks are apt to dry and shrink, so that the spirit evaporates. Loss of spirit by leakage and evaporation is always a trouble in the case of corked tubes and the best method of storage is to remove the corks altogether, plug each tube with a wad of tissue-paper (*not* cotton-wool), and place the tubes in a jar filled with spirit. A layer of cotton-wool should be placed at the bottom of the jar to prevent the tubes breaking. By this means all the specimens of one species or group may be kept together so that they are readily accessible when required, a large label placed *inside* the jar indicating its contents at a glance. By this means also the spoiling of specimens by loss of spirit is reduced to a minimum, as it is much easier to see when the jars require refilling and less trouble to fill a few jars than many separate tubes. It is as well to go over the jars at regular intervals to see whether any renewal of spirit is required. For a working collection, it is impracticable to seal up specimens hermetically, and there will always be some loss of spirit even in the best-fitting jars. Tops that fit very well are apt to stick especially if the jars have not been opened for some time; to obviate this and reduce evaporation of spirit in the case of less well-fitting jars, a little thick vaseline may be smeared around the edge of the cover. All spirit specimens should be kept in dark almirahs and not be exposed to light.

#### TRANSMISSION OF SPECIMENS.

A paper on collecting and preserving insects would not be complete without a few words regarding the transmission of insect specimens, as every collector, especially in a country such as India, is sure at some time to require to send specimens away for identification, and it is extremely annoying and unsatisfactory to find that cherished specimens, possibly unique and irreplaceable, have been destroyed in transmission. At Pusa we send out hundreds, sometimes thousands, of specimens in the course of a year to correspondents in India, Europe,

America and practically all parts of the World and receive back specimens after determination by specialists, and rarely suffer loss in transmission (except owing to the Germans' piracy during the War). But it is far otherwise with the specimens we receive from correspondents in India. Frequently we receive a box of pinned insects, sent through the post wrapped only in a sheet of paper; the inevitable result being that the box of "specimens" on being opened is found to consist of a tangled mass of pins, labels, and broken insects. Such a result is due solely to gross carelessness or stupidity or both and may be avoided by a realization of the jolting to which a parcel of insects is liable when going through the post and by adoption of precautions accordingly.

*Pinned specimens* should be *firmly* pinned into postal boxes or small store-boxes lined with good cork previously prepared with naphthaline solution (in benzine) to prevent mould or insect attack *en route*. Lumps of naphthaline should *not* be pinned into the corners of the box, whether enclosed in muslin or not. A wad of cotton-wool may, however, be pinned in one or more corners to catch any stray legs, bodies, etc., which may be jarred off the specimens. Large specimens should be secured with cross-pins or strips of paper firmly pinned down over them. If the box is sufficiently deep to take specimens pinned into both sides (top and bottom), a sheet of thin paper should be placed between the two sides, and secured by all four edges of the box when it is shut, to isolate any specimens which may become loose. Then wrap the box in clean paper and pack it into an outer packing-case with *at least* two inches of good resilient packing *all around* between the insect-box and the outer packing-case. Tow, balls of crumpled paper, or excelsior, all make excellent packing material; cotton-wool may be used for the *light* packages. Ordinary wood-shavings, cut paper or straw should not be used for packing material, as they are not sufficiently resilient. Sprinkle a little powdered naphthaline onto the packing material as it is filled in, and make sure that there is plenty of packing material below and above the specimen box as well as all around it. The lid of the packing-case should be screwed down and not nailed, as nailing down is apt to jar the specimens and a nailed lid is also more liable to be damaged in opening the box. When any quantity of specimens are to be sent away, it is as well to have packing-boxes made specially of light wood. *Bombax* wood makes very good packing cases which are light and yet sufficiently strong to stand the postal journey to Europe and back. In sending insects abroad for identification, it is as well to declare them as "of no commercial value" on the Customs Declaration form; if they get broken or lost on the way, no compensation from the Post Office will replace them whilst,



if you declare their value at a fancy figure, your correspondent (in some so-called civilized countries at least) will be called on to pay Customs Duty on them at a correspondingly inflated rate.

*With unpinned, dry material* the main object is to prevent rattling about in transit. Do not send specimens loose in a tube; pack them sufficiently tightly with a wad of tissue-paper, *not* cotton-wool. Butterflies and similar specimens in paper envelopes should not be allowed to rattle about. Pack in a light but sufficiently strong box and, if it is not quite full, fill it up with tissue-paper or balls of crumpled paper, adding a little powdered naphthaline.

*Spirit material* is best sent in tubes fitted with good corks. Specimens must not be sent loose in a tube. Place a wad of tissue-paper at the bottom of the tube, then fill in the specimens, then another wad of tissue-paper pressed gently against the specimens to prevent their moving and then, if necessary, more tissue-paper up to the cork. Do not use cotton-wool inside the tubes, as the specimens get entangled in the fibres. See the tube is filled with spirit and that the cork is tight. If the cork tends to come out, place a piece of thin string in the tube, then ram home the cork and withdraw the string. If the tube cracks or the spirit leaks out *en route*, the moistened wads of tissue-paper will help to keep the specimens in condition until their journey's end. See that each tube contains its proper label. Wrap each tube separately in paper and then in a wrapping of tow or wool and pack in a stout wooden box with plenty of packing around each tube and an extra quantity lining the bottom, sides, and top of the box. As in the case of pinned specimens, it is best to use screw-down lids to the packing boxes.

*Living material* should be sent as a rule in light wooden boxes—not in tight tins or boxes punched with large holes, as insects are usually asphyxiated in air-tight tins and living insects often escape if holes are provided for this purpose.

Eggs of insects may be sent wrapped in tissue-paper or thin muslin placed in small boxes or a piece of bamboo so that they will not rattle about or be exposed to pressure in the post.

Larvæ are generally best sent in wooden boxes. Caterpillars may be packed with dry leaves, as wet leaves placed with them usually ferment and they are often killed by the conditions so resulting. If food for the caterpillars is to be sent, it should be sent separately and might be wrapped in slightly damped muslin and sent in an airy wooden box.

Subterranean larvæ are best sent packed in crumpled paper pressed moderately tightly together; if sent in earth, they are usually crushed or asphyxiated.

Pupæ should be wrapped carefully in tissue-paper or cotton-wool and packed carefully in cotton-wool.

Finally, the great art of successful transmission of insect specimens by post is to use *plenty* of good packing material. It is far better to pay a little extra in postage and make sure that plenty of packing material surrounds the insects sent than to skimp the packing and find that the specimens have arrived broken to pieces on account of defective packing.

**Mr. Senior-White.** May I say a few words as regards labelling insects? I put down details of each specimen on a card and on the label I have only a number referring to this card.

**Mr. Fletcher.** That means that your specimens are incomplete in themselves and if you send them out it is very difficult to know what the *data* are.

**Mr. Senior-White.** You could make out a list and send it with the specimens.

**Mr. Fletcher.** That is not an easy matter when you have to send out thousands of specimens as we do.

**Mr. Beeson.** A card index is certainly a valuable accessory. You really require a clerk to deal with the writing work in the case of a large collection.

Do you prefer cork for lining the boxes? We use pith and it answers very well with us.

**Mr. Fletcher.** I think that cork is better to work with and more permanent. I certainly prefer cork for cabinets.

**Mr. Senior-White.** I use asbestos sheets, but these are too hard to take ordinary pins.

#### 71.—A METHOD OF PRESERVING BUTTERFLIES AND OTHER INSECTS.

*By* DR. E. H. HANKIN, M.A., Sc.D., Chemical Examiner to Government, Agra.

The ordinary method of preserving butterflies is not without its disadvantages from the point of view of the ordinary collector. In a cork-lined store-box about a quarter of an inch of vertical space is occupied by the butterfly and nearly two inches of vertical space by its pin.

My attempts at an improvement on an ordinary store-box have led to a method which may perhaps be of use in special cases. Each butterfly is mounted in an air-tight box having a glass top and bottom. The sides of the box are made of a strip of bent tin electroplated. I submit specimens of butterflies mounted in this way [*exhibited*].

I have used three sizes of boxes. The largest takes ordinary quarter-plates as used in photography. The next size is fitted with these plates

cut in two and the smallest size has these plates cut in four. The advantages of using photographic quarter-plates is that the glass is of very good quality and is practically a waste product. The tin frame is made of such a size that the distance between the two plates is sufficient to accommodate the legs and body of the insect.

The butterfly is attached to one of the glasses by a cement made of four parts of resin and one of beeswax. The glasses are attached to the frame by a cement containing four parts of resin, four parts of sealing-wax and one part of beeswax. The constituents are melted together and sufficient lamp-black is stirred in to give it a black colour if black sealing-wax is not available.

In mounting the butterfly, the glass to which it is to be attached is first fixed in position in the frame. Marks are made on the outside of the glass with a grease-pencil to indicate points to which the adhesive composition is to be applied. The composition is melted over a flame and small drops of it are put on at the points indicated by means of a thin pointed glass rod. The butterfly is set on a flat piece of cork upper side downwards. A pin may be used to attach it in position while the wings are being set but must be removed as soon as this is done. It is advisable to allow the set butterfly to dry in the presence of carbide which is a most efficient desiccating agent. When thoroughly dry the butterfly is removed from the sheet of cork and placed with its back upwards over the mouth of a bottle of suitable size. The glass in the frame is warmed so that the spots of composition are properly melted. It is then lowered into position over the butterfly until the latter adheres. The frame is then laid on the table and some of the black composition is placed along the ledge on which the second glass is to rest. It is warmed with the help of a Bunsen burner and the glass is dropped into position. It is advisable to cool the edges of the frame rapidly with the help of water so that the composition sets before the air in the box has had time to cool. Otherwise the cooling of the air may result in a decrease of pressure and air from the outside may be drawn in through the layer of composition under the edge of the glass and the box may not be airtight.

It is not difficult to mount the butterfly in an atmosphere of carbonic acid gas in these boxes. To do this I made a glass-walled box whose bottom was a little larger than the frame of my container. Carbonic acid gas was led into this from a tube provided at the bottom and replaced the air by displacement. The box containing the butterfly was lowered into the glass case. Gas was allowed to enter during a few minutes. The glass lid was then lowered into position. For this

purpose it was attached to the end of a rod by means of a piece of plasticine. The composition on the edge had previously been put into place and heated. It remains adhesive sufficiently long for the glass firmly to adhere to it.

The great objection to this method is that it is expensive. It is not every tinsmith who has sufficient skill to make the frames. If they were made of aluminium they might be produced cheaply and would not need electroplating. Such frames might be of use for preserving specimens of other insects than butterflies or for seeds or other natural history specimens. Mounting the insect in the box takes up so much time that the method could scarcely be suitable for ordinary museum purposes. But it might be useful in special cases in which it was desired to preserve the original colours. The method has the advantage that the heads, abdomens, etc., can be cemented either to the glass or to each other and hence are not likely to come loose.

**Mr. Fletcher.**

I have here some specimens of butterflies, mounted in this way, which Dr. Hankin has sent for exhibition in illustration of his paper. In an accompanying letter he says :—"Some time ago I met an aluminium manufacturer and showed him these boxes. He told me he would be ready to consider the question of making them in quantity if there was any prospect of a demand. I should be glad to hear what entomologists say on that point. Some sent up to Simla were rapidly sold for charitable purposes." It seems to me that, whilst such boxes might find a small sale as curiosities, such a method of preservation would be quite unsuitable for an entomological collection on account of the time taken in preparation and the inaccessibility and difficulty of storing the specimens themselves. If kept in a damp climate the specimens would be sure to go mouldy sooner or later.

## 72.—THE IMPORTANCE OF COLLECTING.

*By* DAVID SHARP, M.A., F.R.S.

Many who have a taste for entomology begin collecting with enthusiasm, but after a time diminish their efforts or even altogether abandon them. There are numerous reasons that account for this fact, but as this brief communication is of a practical rather than of a philosophical nature, I need allude to but one of them, and that is a belief that collections are more advanced and nearer completion than the other branches of entomology are. This I believe to be a great error. Those who have inspected a large collection of insects and have recognized its great extent may be pardoned for entertaining the idea that

collections are large enough ; although really, in comparison with the condition of Nature they are intended to exemplify and to make us understand, they are painfully incomplete.

The great Sociologist Herbert Spencer held that it was amongst the very first duties of a civilized community to make itself thoroughly acquainted with the environment among which it lives.

Alas, to think how very far we are from this. There is not a single square mile of the earth's surface of which we know thoroughly the fauna and flora. Hence the number of existing forms with which we are totally unacquainted is very great, and I feel that I need not insist on this for I believe all entomologists will admit it. I think I may say with probable truth that not more than one-fourth of the insects existing in India are represented in any collection, or even in all collections if they could be united or brought together as one.

But to get together a collection of all the insects of a limited region is merely to lay one of the foundation-stones of the science of entomology in that region. For we have not only to recognize that the creatures exist, but also to become acquainted with their variation, their distribution and their habits : to study the anatomy and the development of each species, and (as many at least among us recognize) their evolution, *i.e.*, the relation of their generations. And what a huge number of specimens is required for all these purposes, of this huge number of kinds that we believe to be in existence.

I say then, do not discontinue collecting but go on with it with the greater knowledge and discretion that your experience may suggest.

I urge this because entomology is the science of many generations. In a hundred years (I might say a thousand with almost equal truth) entomology will still be in a rudimentary state ; but in that period many of the species of animals now existing will have become extinct. This constant extinction of other animals by the extension of civilization is one of the saddest facts that the naturalist is forced to recognize, and we should at least endeavour to preserve some record of them for the instruction of posterity. It is frequently said nowadays that posterity can take care of itself, but it cannot do so in the matter of a knowledge of the animals that we have caused to cease to exist.

I trust these few considerations, which must be familiar to many if not to all of you, may tend to promote the habit and art of collecting. This period ought in the history of entomology to be marked as the age of collections.

These very imperfect remarks on an important subject should naturally be followed by others on the preservation and distribution of the specimens collected. But this would take me too far for a Meeting

of this kind, and I can merely add that in my opinion the advancement of collections should be attained by international combination. For want of this the extremely limited resources of entomology are much wasted, and the admirable enthusiasm of collectors is smothered if not entirely extinguished.

**Fletcher.**

Dr. Sharp is familiar to all of you as the author of the two volumes on Insects in the Cambridge Natural History, to mention only one work with which you are all familiar. He is absolutely correct in drawing our attention to the vast amount of work still to be done in collecting and studying insects and we are all much obliged to him for his kindness in sending us this paper.

### 73.—NOTE ON A VERY CURIOUS GEOMETRID LARVA.

By T. BAINBRIGGE FLETCHER, R.N., F.L.S., F.E.S., F.Z.S., *Imperial Entomologist.*

(Plate 162.)

The Geometrid larva shown in the accompanying photographs and coloured sketch\* was found by me at Shillong on 29th June 1918 feeding on a small plant of *Heptapleurum hypoleucum* (Araliacee).

As you will see from the figures, it provided a very good imitation of a small piece of dead stick covered with a thick growth of green moss. It was in the evening when I found it and I did not examine it very closely at the time, but supposed it was probably an "Emerald" caterpillar which had applied pieces of moss to its back, in the same way as is done with lichen in the case of another small Geometrid larva which is very common at Shillong. On examining the larva next morning, however, I was surprised to find that the supposed fragments of moss were really outgrowths from the skin itself. As you will see from the figures, the resemblance to moss was exact both in shape and colour, the detailed exactitude of the protective resemblance in this caterpillar being very striking.

The larva fed on *Heptapleurum* leaves, usually remaining motionless by day, and ultimately pupated on 12th July. The pupa is shown in the coloured sketch. It was brought to Pusa when I returned there at the end of July but the journey and change of climate proved too much for it and it failed to emerge. It is therefore not possible to say definitely what species this caterpillar belonged to, until further examples

---

\* Not reproduced.

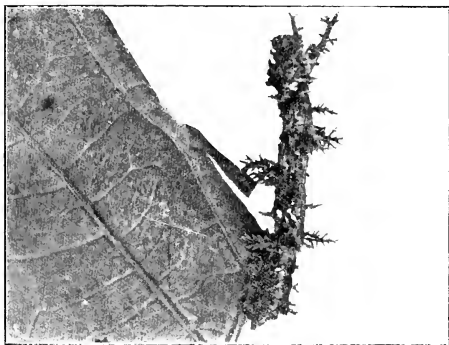

Fig. 1.—Geometrid larva on *Heptapleurum* at Shillong.



Fig. 2.—Geometrid larva on *Heptapleurum* at Shillong.





may be found and reared out. The caterpillar, however, does not seem common and further repeated search for other examples failed to discover any.

#### 74.—INDIAN EPIPYROPIDÆ.

By T. BAINBRIGGE FLETCHER, R.N., F.L.S., F.E.S., F.Z.S., *Imperial Entomologist.*

(Plate 163.)

The genus *Epipyrops*, with type *anomala*, was first described by Westwood in *Trans. Entom. Soc. London*, 1876, p. 522, tab. 7, from examples reared at Hongkong by J. C. Bowring from larvæ found upon *Fulgora candalaria*. In the *Transactions* for 1877, pp. 434-435, Professor Westwood mentions an *Epipyrops* larva found by Lieut-Colonel Godwin-Austen on the body of a species of *Aphaena* (Fulgoridæ) in the Dillrang Valley, and also figures (Tab. X, C.) another larva found upon *Eurybrachys spinosa*, presumably somewhere in Madras, as the specimen belonged to the Madras Museum. It is, however, no longer in existence there, as Dr. Henderson informs me. Nevertheless, these records are of interest as indicating that species of *Epipyrops* had been observed to occur in India more than forty years ago, although apparently the moths were never reared from the larvæ.

Epipyropidæ, however, are by no means confined to the Oriental Region. In 1883 G. C. Champion noted (*Proc. Ent. Soc. London*, 1883, p. xx) that he had often observed larvæ attached to some of the smaller Fulgoridæ in Central America, but apparently in this case also no moths were bred out. In 1902 H. G. Dyar described (*Proc. Ent. Soc. Wash.*, V. 43-45) *Epipyrops barberiana* reared from a larva attached to a Fulgorid in New Mexico, and two years later W. J. Holland recorded (*Entl. News*, XV 344-345) this same species from Texas on another species of Fulgorid. Finally, in 1905 R. C. L. Perkins described (*Hawaii Sugar Planters' Assocn.*, *Entl. Bull.* No. 1, pt. 2, pp. 75-84, figs. ) three new genera and seven new species of Epipyropidæ from Fulgorids, Jassids and Delphacids in Queensland and New South Wales.

The first definitely described species of *Epipyrops* recorded from the Indian Region was *E. poliographa*, from Mankulam and Yatiyantota in Ceylon, described by Sir George Hampson in the *Bombay Natural History Society's Journal* in 1910. In the following year I took a single specimen, apparently belonging to an undescribed species, at light at

Hoshangabad in September. In October 1914 P. Susainathan bred several examples from *Eurybrachys tomentosa* at Coimbatore. In November 1915 I found larvæ, probably of *E. poliographa*, on the same insect at Pollibetta in South Coorg, and in December 1917 numerous larvæ of *E. eurybrachydis*, again on *E. tomentosa*, at Coimbatore. Epipyropids are therefore widely distributed in the Indian Region, being known to occur in Ceylon, Coorg, Coimbatore, Hoshangabad and the Dilrang Valley. At our last Meeting Mr. Kunhi Kannan also exhibited some specimens found on *Idiocerus* at Bangalore, but I have not had an opportunity of examining these. It is probable therefore that search on Fulgorids and other Homoptera in India would reveal a large number of species of this interesting group of moths.

The systematic position of *Epipyrops* has been a matter of doubt. Westwood placed the genus in Arctiadae, from which it is excluded by the neuration, 8 of hindwing being free from base and not coincident at all with upper margin of cell. Sir George Hampson, as recently as 1910, has placed *Epipyrops* in Limacodidae, but the reason for this is not evident, as the hindwing has not vein 8 anastomosing with the cell as is required for Limacodidae by his table in *Cat. Lep. Phal.* (Vol. I, p. 19). S. B. Fracker, in his classification of lepidopterous larvæ (*Illinois Biol. Monogr.* II p. 96 (1915)) includes *Epipyrops* as a distinct family Epipyropidae under the superfamily Zygaenoidea between the American families Pyromorphidae and Megalopygidae and together with the Cochliidiidae (Limacodidae). Perkins in 1905 had already considered that these insects should form a distinct family most nearly related to *Fumea* and *Talæporia* of the Tineidae and to the Psychidae of the Psychina. It seems best to retain them as a distinct family.

The known genera may be tabulated as follows :—

1	{	Cell of hind wing emitting only 4 veins (4 absent), 7 free to base . . . . .	<i>Palaeopsyche</i> .
		Cell of hind wing emitting 5 veins (4 present), 7 absent . . . . .	2
		Cell of hind wing emitting 6 veins (4 and 7 present) . . . . .	<i>Epipyrops</i> .
2	{	Fw. with 7 out of 8 bear apex . . . . .	<i>Agamopsyche</i> .
		Fw. with 7 and 8 basally approximated but distinct . . . . .	<i>Heteropsyche</i> .

Of these, all but *Epipyrops* are only known from the Australian Region as yet.

Turning to the Indian species, we have at least three, *E. poliographa*, Hmps., *E. eurybrachydis*, n. sp., and a third undescribed species from Hoshangabad.



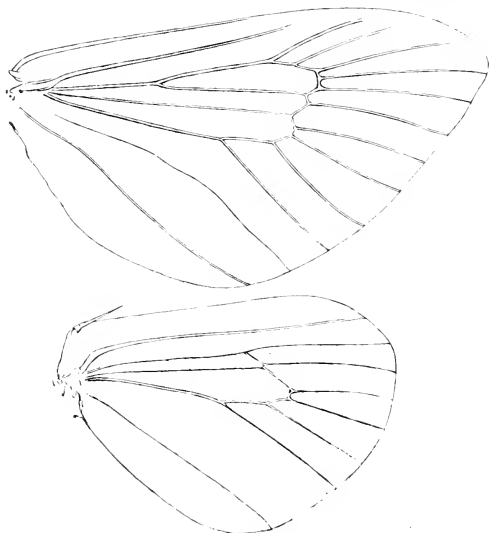

Fig. 1.—Neuration of *Epipyrops eurbrachydis*.

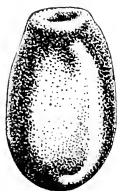

Fig. 2.—Egg of *Epipyrops polio-grapha*, Hmps. (magnified).



Fig. 3.—*Epipyrops eurbrachydis*.  
*a*, larval leg (right leg of first pair) (. 35); *b*, arrangement of crochets on larval proleg (. 75).

*Epipyrops poliographa*, Hmps. n.

In the *Journal of the Bombay Natural History Society*, Vol. XX, p. 109 (June 1910) Sir George Hampson described *Epipyrops poliographa*, as follows:—

“*Female*.—Head, thorax and abdomen very dark olive-brown mixed with grey. Forewing very dark olive-brown thickly and evenly reticulated with indistinct silvery-grey markings. Hindwing uniform very dark olive-brown.

*Habitat*. Ceylon; Mankulam (Mackwood), Yatiyantota (Green).

*Exp.* 16-26 mill.

*Type* in B. M.”

This species is also figured on Plate F, figure 12, of the same volume (opposite p. 1047).

The description is short and unsatisfactory and it is unfortunate that Hampson's species was described from females and the great difference in wing-expanse possibly indicates that more than one species is included under name of *poliographa*, but the description and figure given seem to refer best to specimens bred by me from larvæ found on *Eurybrachys tomentosa* at Pollibetta, in South Coorg, in November 1915, and I conclude that these specimens are *E. poliographa*, Hmps. n.

*Epipyrops eurybrachydis*, n. sp.

*Male*. Expanse 11-12.5 mm. Antenna with twelve to fourteen branches, pectinations whitish, shaft and branches streaked with pale brown. Head and thorax greyish-fuscous. Abdomen short and rather stout, not exceeding hindwing, dark fuscous narrowly ringed with greyish at apices of segments, anal tuft pale greyish; underside of abdomen whitish. Legs brownish, irrorated with whitish.

Forewing broadly triangular, apex moderately acute, tornus slightly rounded, violet grey-brown thickly suffused on basal two-thirds of wing with dark olive-brown, which tends to form a recurved fascia from costa to lower edge of cell at  $\frac{2}{3}$ ; a narrow indistinct antemarginal olive brown fascia from costa to near dorsum. (In other specimens the markings are more obscure and the wing may be described as dark olive-brown irregularly sprinkled with greyish scales tending to form indistinct transverse markings, especially towards termen, and spots along the costal region). Cilia white, brown at apex and brownish around tornus.

Hindwing fuscous, irrorated with whitish on costal area. Cilia white sometimes brownish around apex and tornus.

*Female.* Expanse 14-19 mm. Much as in male, but in the forewing there is a greater tendency to form irregular undulating transverse lines in outer half of wing. Cilia brown intermixed with a few greyish scales. Sometimes there are two or three irregular pale-yellowish blotches slightly before  $\frac{2}{3}$  in lower portion of disc below cell tending to form a short oblique undulating line.

Hindwing uniform fuscous-brown, paler than in male. Cilia brown intermixed with a few greyish scales; dorsal cilia sometimes whitish.

The neuration is shown in the figures. (Plate 163, fig. 1.)

The full-grown larva of *E. eurybrachydīs* has a strong posteriorly curved claw on the extremity of each thoracic leg (figure 3a). The abdominal prolegs with crochets arranged in a single row forming a complete circle, but the posterior crochets are much longer and stouter than the anterior ones (figure 3b). The anal prolegs have apparently a single row of crochets on the anterior edge only.

The pupa emerges from a horizontal slit in the cocoon, the anterior half, which is more highly chitinized than the posterior, being thrust out on emergence.

*Locality.* Coimbatore. Larva on *Eurybrachys tomentosa*. Fb. I am by no means certain whether the Coimbatore material does not include two species; if so, *eurybrachydīs* will be restricted to that with more variegated markings and 14 antennal branches in the male. The markings are, however, so obscure in all the specimens that it seems unsafe to differentiate them only on this.

Mr. Fletcher.

I may say that this paper is not intended as a detailed monograph on our Indian Epipyropidæ, but merely to call attention of Indian collectors to the occurrence of these little moths in the hope that, if attention is directed to them, further observations may be made on their habits and occurrence within the Indian Empire. We do not know where the eggs are laid, whether they are actually laid on the host-bug or whether they are laid on the plants on which these bugs feed, the larvæ subsequently crawling onto their hosts; the latter supposition appears the more probable. We do not know exactly what is the larval food, whether it feeds on the flocculent waxy excretion of the host or whether it actually sucks the juices of the bug. The larval mouth-parts are very peculiar, the mandibles being very long and slender, and from this it certainly looks as if the larva is truly parasitic and sucks the juices of its host. Unfortunately, *Eurybrachys* does not occur at Pusa. It is, however, common in many parts of India and I therefore bring these facts to your notice in order that any of you, who have the opportunity, may investigate further.

## 75.—INDIAN FOSSIL INSECTS.

By T. BAINBRIGGE FLETCHER, R.N., F.L.S., F.E.S., F.Z.S., *Imperial Entomologist.*

(Plates 164-166.)

In his Annual Address\* some years ago a President of the Entomological Society of London remarked (I do not pretend to quote the exact words) that one of the most interesting chapters of the great book of Nature, could we but read it, would be that dealing with the various forms of insect life which have disappeared from the World without Man having ever been even aware of their very existence. This remark applied more particularly to those present-day forms of insect life which are being rendered extinct by the advance of civilization in almost all regions of the Earth. But how much more true is such a remark when applied to the innumerable species of insects which have had their existence in the past before such a study as Entomology was even adumbrated. Innumerable as seems the number of forms of insect life living at the present day, easily outnumbering in species all the other terrestrial animals added together, this number is yet but a small fraction of those which have lived in the past and become extinct. Most of these extinct species have passed away without leaving any direct trace save in the very rare cases in which they have been preserved in a fossil state.

In Europe and America and other parts of the World thousands of species of fossil insects have been found and described, although comparatively little attention has been paid to this branch of Entomology by either entomologists or geologists; but from India, until within the last two or three years, practically no fossil insects had been described at all. Indeed, in my book on *South Indian Insects*, I stated (page 18) that no fossil insects appeared to be as yet known from India. That statement, however, was not quite accurate, as at the time I was unaware of a paper on fossil insects from Nagpur † and of a few scattered notes in Medicott and Blanford's *Manual of the Geology of India*. And since then numerous fossil insects from Burmese amber have been described by Professor T. D. A. Cockerell in five papers.‡ so that quite

\* *Proc. Ent. Soc. London* 1887, pp. lxxiv-lxxv.

† Notes on some Fossil Insects from Nagpur, by Andrew Murray (*Qrly. Journ. Geol. Soc.* XVI (1860), pp. 182-185, t. 10, ff. 66-70).

‡ (1) Insects in Burmese Amber; *Amer. Journ. Science* XLII, 135-138 (Aug. 1916).

(2) Fossil Insects; *Ann. Ent. Soc. Amer.* X 1-22 (1917).

(3) Arthropods in Burmese Amber; *Psyche* XXIV 40-45 (April 1917).

(4) Insects in Burmese Amber; *Ann. Ent. Soc. Amer.* X 323-329 (1917).

(5) Descriptions of Fossil Insects; *Proc. Biol. Soc. Wash.* XXX 79-81 (May 1917).

a small fauna of fossil insects is now known from India. All these insects flourished in Tertiary times, those described from Nagpur being found in the inter-trappean beds which are found near the base of the volcanic formations, and those described from Burmese amber being found in lumps of Burmite which occur in clay beds of Miocene age.

The inter-trappean beds, in which insect remains were found at Nagpur by Hislop, are found interstratified with the lower trap rocks almost throughout the great trap area, and especially in parts of the Central Provinces, Northern Hyderabad, Berar, and the States north of the Narbada Valley. They consist of thin bands, rarely more than a few feet and often only a few inches in thickness, of chert, limestone, shale or clay, which apparently formed the beds of shallow fresh-water lakes and which contain fresh-water shells, the bones and teeth of animals, and fossil plants. It was amongst the fossil seeds and fruits found at Takli, about 2½ miles west of the old town of Nagpur, that the greater part of the Coleoptera described by Murray were discovered.

Fossil insects have also been found in shaly beds associated with limestones and clays at a small village called Kota, on the left bank of the Pranhita or Wainganga, about eight miles above its junction with the Godavari. These formations belong to the Upper Gondwana groups, which are said \* to be newer than the liassic and certainly of greater age than the trias. No insects appear to have been described definitely from Kota, but in a letter dated 24th July 1857, Hislop mentions † a Blattid forewing with "deep chestnut brown patches, now represented by the dark stains," which came from Kota.

Further undescribed insect remains have been found in the Bombay intertrappean beds, which belong to a very different horizon from that to which the intertrappeans of Nagpur and the Narbada Valley must be assigned.‡ As the remains are only fragmentary and are found associated with the skeletons of large numbers of frogs, it is probable that they represent the excreted food of these animals, as the general conditions seem to show that these beds formed part of a shallow marsh.

No fossil insects appear to have been found in India hitherto in rock formations other than those of the Kota-Maleri group and of the Nagpur and Bombay inter-trappean beds, as noted above. It seems probable, however, that a search would result in further discoveries of insect remains in such formations as the plant beds at Ratnagiri and in the Rajmahal Hills.

\* *Manual of the Geology of India*, p. xxxiv.

† "Stephen Hislop, Pioneer Missionary and Naturalist in Central India," by G. Smith (London: J. Murray: 1888), p. 256.

‡ "A Manual of the Geology of India," by H. B. Medlicott and W. T. Blanford (Calcutta: 1879), p. 320.



As regards the insects found in Burmese amber, Professor Cockereil has stated that "it is evident that the amber was washed into them [clay beds of Miocene age] from higher levels, and it is not impossible that it is much older." Dr. Noetling's paper § about this amber is not available in the Pusa Library, but Dr. E. H. Pascoe, of the Geological Survey, kindly informs me (*in litt.*, 28 May 1917) that the amber mines are situated in the Hukong Valley in the extreme north of Burma near Maingkhwan (Lat. 26°15', Long. 96°25' approximately) and that nine amber localities are reported in this neighbourhood. The amber occurs in a blue clay of Tertiary age, which Dr. Noetling is inclined to think is Lower Miocene in age. The amber is found in irregularly distributed pockets as flattish pebbles. This evidence of wear and tear, however, Dr. Pascoe adds, would not necessarily in his opinion denote a much older age for such an easily corroded substance as amber, nor does he know of any other evidence of a greater age.

This Burmese amber, which has been called Burmite by Dr. O. Helm,|| differs from ordinary Baltic amber by the absence of succinic acid, the presence of which distinguishes true Baltic amber, which is therefore known more precisely as Succinite. There appears to be no evidence regarding the trees whose resinous exudations have come down to us as Burmite. Succinite is a product of coniferous trees and the New Zealand kauri gum, which is obtained in a sub-fossil condition, is also the product of a conifer (*Agathis australis*) but the East African Copal, which is another recent and sub-fossil resin, is an exudation from a leguminous tree. Burmite is usually transparent or semi-transparent and brownish red or dark-brown in colour, but may be ruby-red or yellow.

Fossil resins have also been found in other localities, such as in the lignite beds near Varkalay, twelve or fourteen miles south of Quilon, in Travancore, and it is probable that search in such resins would yield insect remains. I can merely indicate the possibilities to anyone who has opportunity of investigation in such localities.

Turning now to the insects which have been actually recorded so far in a fossil condition from India, the following have been noted :—

*From the Inter-trappean tertiaries at Nagpur.*

Thirteen Coleoptera, four Buprestidæ, of which one was named by Murray as *Lomatus hislopi* and the other three were left unnamed and are doubtfully Buprestids, and nine Curculionidæ, of which one

§ *Rec. Geol. Surv. India*, XXVI, p. 31.

|| *Rec. Geol. Surv. India*, XXVI, pt. 2, pp. 61-64 (1893).

was called *Meristos hunteri* by Murray, and of the others, which were left unnamed, some are doubtfully Curculionids.

*From Burmite.*

The Hymenoptera are represented by a *Trigonalys*, two species of Bethyridæ, and several genera of Evaniadæ. Curiously enough, not a single Formicid has as yet come to light.

The Diptera include two Empididæ, a Cecidomyiad, a Psychodid, and two Mycetophilidæ.

Single species of Trichoptera and Psocidæ are included.

The Coleoptera include a Rhipiphorid, a Pedilid, an Elaterid, a Buprestid, a Dermestid, Ipidæ and others not yet studied.

The Hemiptera are represented by two genera and four species of Hemiccephalidæ, of which only one has been described as yet, and the Homoptera by a *Liburnia*.

The Isoptera include a *Hodotermes* and a *Termopsis*, both primitive genera.

Blattidæ are also said to occur commonly, but only young or fragmentary specimens have been noted.

There is also a Lepismatid, doubtfully referred to *Lampropholis*, but undescribed as yet.

The following is a bibliographical catalogue of the species actually described, showing the origin of each:—

HYMENOPTERA.

*Trigonalidæ.*

<i>Trigonalys pervetus</i> , Ckll., Proc. Biol. Soc. Wash. XXX p. 79, ff. 1. (May 1917)	Burmite.
--	----------

*Bethyridæ.*

<i>Apnesia electriphila</i> , Ckll., Psyche XXIV 44-45 ff. 6 A-E (April 1917)	Burmite.
<i>Scleroderma ? quadridentatum</i> , Ckll., Psyche XXIV 43-44, ff. 5 A-C (April 1917)	Do.

*Evanidæ.*

<i>Protosenus swinhosi</i> , Ckll., Ann. Ent. Soc. Am. X 19 ff. 1 A-F (March 1917)	Burmite.
<i>Hyptiognathites electrinus</i> , Ckll., Ann. Ent. Soc. Am., X 20, ff. 2 (March 1917)	Do.

DIPTERA.

*Empididæ.*

<i>Electrocyrtoma burmanica</i> , Ckll., Ann. Ent. Soc. Am. X 22, ff. 5 (March 1917)	Burmite.
<i>Burmitempis halteralis</i> , Ckll., Ann. Ent. Soc. Am. X 326, ff. 6 (1917) ( <i>sine descr.</i> )	Do.

*Cecidomyiidae.*

*Winnertzola burmitica*, Ckll., Psyche XXIV 42 ff. 3 A-G  
(April 1917) . . . . . Burmite.

*Psychodidae.*

*Trichomyia swinhoei*, Ckll., Ann. Ent. Soc. Am. X ff. 4 A-C  
(March 1917) . . . . . Burmite.

*Mycetophilidae.*

*Burmacrocera petiolata*, Ckll., Ann. Ent. Soc. Am. X 326-327  
ff. 5 C-E (1917) . . . . . Burmite.  
*Sciara burmitina*, Ckll., Ann. Ent. Soc. Am. X 20-21 ff. 3 A-E  
(March 1917) . . . . . Do.

TRICHOPTERA.

*Odontoceridae?*

*Plecopteryx nebulosus*, Ckll., Ann. Ent. Soc. Am. X 327, f. 7  
(1917) . . . . . Burmite.

PSOCINA.

*Psocidae.*

*Phyllipsocus? banksi*, Ckll., Amer. Jl. Sci. XLII 136-138,  
ff. 2 A-B 3 C-D (August 1916) . . . . . Burmite.

COLEOPTERA.

*Curculionidae.*

*Meristos lauteri*, Murray, Qly., Journ. Geol. Soc. XVI 184,  
t. 10 f. 67 (1860) . . . . . *Inter-tropican  
Tertiaries (Nag-  
pur).*

*Rhipiphoridae.*

*Myodites burmiticus*, Ckll., Ann. Ent. Soc. Am. X 22, f. 6  
[antenna] (March 1917) . . . . . Burmite.

*Pellidae.*

*Eurygenius vickhami*, Ckll., Ann. Ent. Soc. Am. X 324-325,  
ff. 2 A-D (1917) . . . . . Do.

*Elatericidae.*

*Elater burmiticus*, Ckll., Ann. Ent. Soc. Am. X 325, f. 3  
(1917) . . . . . Do.

*Buprestidae.*

*Acmacodera burmitina*, Ckll., Ann. Ent. Soc. Am. X 323, ff. 1  
A-G (1917) . . . . . Do.

*Lomatius hislopi*, Murray, Qly. Journ. Geol. Soc. XVI 183,  
t. 10, f. 66 (1860) . . . . . *Inter-tropican  
Tertiaries (Nag-  
pur).*

*Dermestidae.*

<i>Dermestes lurcalis</i> , Ckll., Psyche XXIV 43, ff. 4 A-D (April 1917)	Burmite.
---	----------

## RHYNCHOTA.

*Henicocephalidae.*

<i>Henicocephalus fossilis</i> , Ckll., Amer. Jl. Sci. XLII 135-136, ff. 1 A-C (August 1916)	Do
--	----

*Fulgoridae.*

<i>Liburnia burmitina</i> , Ckll., Ann. Ent. Soc. Am. X 329, ff. 8, 9 (1917)	Do
--	----

## ISOPTERA.

*Protermittidae.*

<i>Termopsis swinhoii</i> , Ckll., Amer. Jl. Sci. XLII 138, ff. 4 A-C (August 1916)	Do.
<i>Holotermes tristis</i> , Ckll., Ann. Ent. Soc. Am. X 329, f. 10 [wing] (1917)	Do.

*Explanation of Plates 164-166.*

- Trigonalya perovctus*.
- Apenesia electriphila*. A, stigma and adjacent parts; B, base of antenna; C, labial palpus; D, anterior basitarsus; E, posterior femur.
- Scleroderma quadridentatum*. A, prothorax; B, base of antenna; C, hind femur.
- Protocus swinhoii*. A, anterior wing; B, abdomen; C, hind leg; D, head; E, base of antenna; F, mandibles.
- Hyptiognathites electrius*. Anterior wing, abdomen, and hind-leg.
- Electrocyrtoma burmanica*. Wing, antenna, and dorsal profile of head and thorax.
- Burmitempis halteralis*. Wing, halter, and hind-leg.
- Winnertzola burmitica*. A, wing; B, halter; C, claws; D, palpus; E, basal part of antenna; F, end of antenna; G, caudal appendages.
- Trichomyia swinhoii*. A, wing; B, head and thorax; C, end of abdomen.
- Burmacrocera petiolata*. A, wing; B, halter; C, abdomen; D, tibia; E, antenna.
- Sciara burmitina*. A, wing; B, palpus; C, leg; D, abdomen; E, end of antenna.
- Plecoptlebus nebulosus*. Anterior wing.
13. 14. *Psyllipsocus banksi*. A, anterior wing; B, anterior leg; C, hind wings of both sides; D, antenna.
- Myodites burmiticus*.
- Eurygenius wickhami*. A, entire insect; B, maxillary palpus; C, end of anterior leg.
- Elatr burmitinus*. Posterior angle of thorax.
- Acmacodera burmitina*. A, entire insect; B, thoracic puncturation; C, maxillary palpus; D, antenna; E, elytral sculpture; F, margin of elytron towards apex; G, middle leg.
- Dermestes lurcalis*. A, hind leg; B, end of front leg; C, mandible; D, hair.
- Henicocephalus fossilis*. A, anterior tibia, tarsus and claw; B, antenna; C, end of wing.
- 21, 22. *Liburnia burmitina*. 21, forewing; 22, fore and hind wing, profile of head and hind tibia.

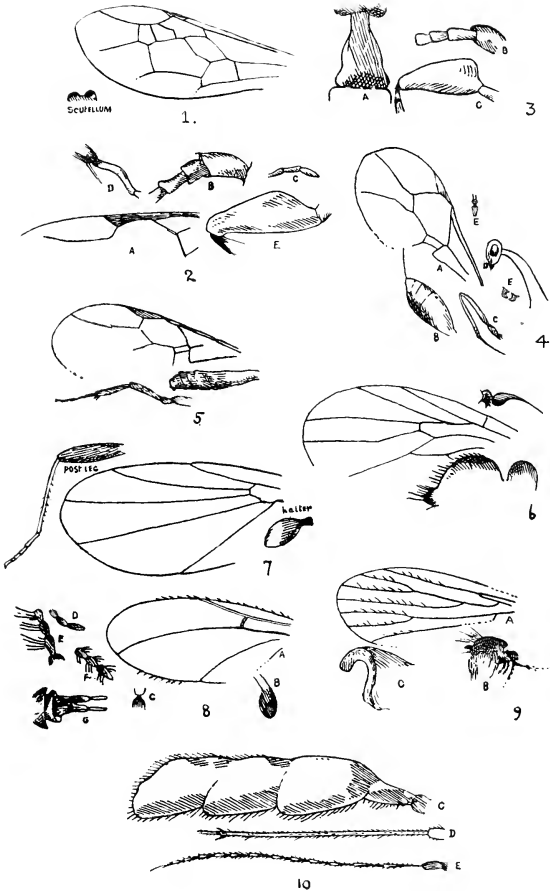

INDIAN FOSSIL INSECTS.

(Copied from the figures referred to in text.)



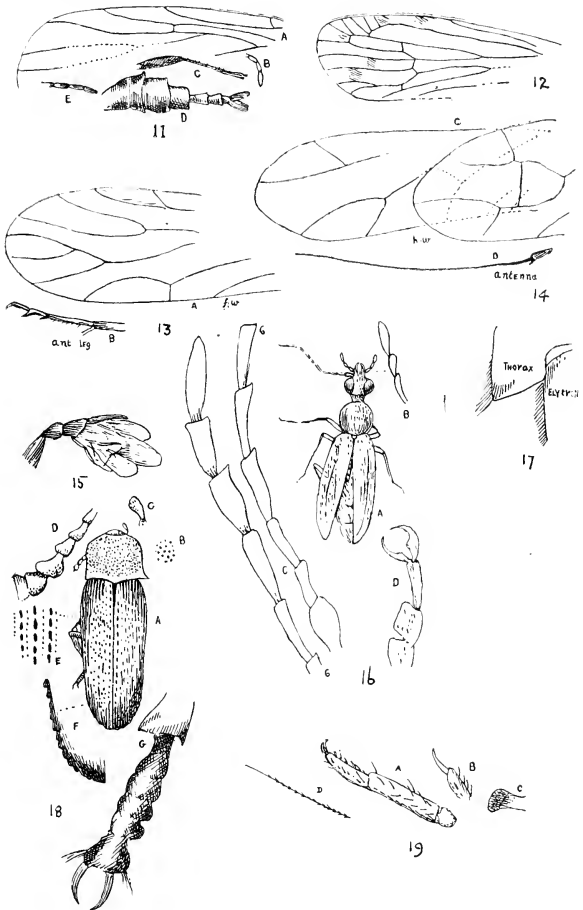

INDIAN FOSSIL INSECTS.

(Copied from the figures referred to in the text.)







20

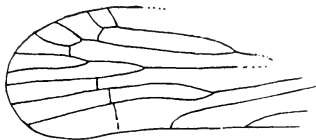

21

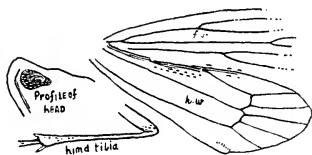

22



23



24

INDIAN FOSSIL INSECTS.

(Copied from the figures referred to in the text.)



23. *Termopsis swinhoi*. A, costapical part of wing; B, side view of head; C, joints of apical half of antenna.

24. *Hodotermes tristis*. Wing.

[*Note*.—All of the foregoing figures have been copied from the papers quoted above.]

This paper is intended to draw your attention to the occurrence **Mr. Fletcher** in India of insects in a fossilized condition so that any of you, who have an opportunity of so doing, may perhaps be able to procure further material. I need hardly point out the extreme interest of the study of fossil insects, more especially from the point of view of the light which they throw upon the evolution of insects in the past. I can only regret that I have as yet failed entirely to obtain any specimens of fossil insects in India and therefore I have no specimens to exhibit to you. During a recent visit to Nagpur, I made a search in the inter-trappean limestones but entirely without success so far as insects were concerned, although it was in this locality that Hislop obtained numerous specimens some sixty years ago.

The consideration of fossilized specimens of insects leads us to consider how insects are being preserved at the present day under natural conditions in such a way that in the course of ages they may, under favourable chances, become fossilized. Insects such as those now found fossil in amber must have become enclosed in the amber whilst this was still soft, presumably whilst it was oozing from the tree in the form of a gum. Now, if we examine present-day gums as they exude from the tree, we frequently find that this gum contains small insects. I have here [*exhibited*] some pieces of *Kadaii* (*Sterculia urens*) gum from the Dohad Hills forests and, if you examine them, you will see that they contain small ants of existing species which are normally found running about on tree-trunks and which have been caught in this gum whilst it was still liquid, although it has now hardened. Under natural conditions in an undisturbed forest, this gum might finally get buried in the ground and in the course of ages would become fossilized along with the included insects.

When I was at Minbu in Lower Burma a few years ago I saw some of the so-called "mud volcanoes" there. These are small hillocks built up of mud by the action of a stream of mud which flows up from underground. This mud is extremely fine and, when freshly exuded, insects, even minute gnats, which fall onto it, are caught by the sticky surface of the mud. I have here some specimens [*exhibited*] of insects found half-imbedded in this mud and you will see that they have every appearance of fossil specimens, now that the mud has hardened. If this mud were preserved so as to form rock in the course of time, it

would be found to contain numerous beautifully preserved fossil insects in due course. It has occurred to me that possibly some of the remarkably well-preserved fossil insects that have been described as from supposed fresh-water deposits may have been really entrapped in "mud-volcanoes" of this sort. Besides insects, this mud contains leaves, seeds, and twigs blown onto it by the wind and also snail-shells.

76.—THE DESIRABILITY AND PRACTICABILITY OF THE PREPARATION AND PUBLICATION OF A GENERAL CATALOGUE OF ALL DESCRIBED INDIAN INSECTS.

By T. BAINBRIGGE FLETCHER, R.N., F.L.S., F.E.S., F.Z.S., *Imperial Entomologist*.

The desirability of the preparation and issue of a complete catalogue of Indian insects is self-evident and requires little argument. Every serious worker on Indian insects, with whatever group he is occupied, continually finds the need for some index to the published literature, which is so scattered that it is extremely difficult for any one worker to be sure that he has seen everything or nearly everything that has been published even on a small group. Even a worker on such a popular group as the butterflies has no accessible guide to the published literature on this comparatively small group. "Lepidoptera Indica" is out of reach of the ordinary worker on account of its price and both de Niceville's and Bingham's books are unfinished and incomplete even as regards the published portion, for there is a considerable amount of literature which is not quoted either by de Niceville or Bingham or has been published since the issue of these two books: and Evan's list (*B. J.* XXI 553-584, 969-1008) is little more than a list of names and localities, without references. Even in cases where monographs on particular groups have been issued, such as the "Fauna of British India" series, these books are quickly rendered very incomplete, as the mere fact of their issue often stirs up interest in the groups treated of, so that more attention is paid to these groups, the result being that a mass of supplementary published information is soon accumulated. Anyone who attempts to compare the "Fauna" volumes on moths with the issued volumes of the "Catalogue of Lepidoptera Phalænæ" will begin to realize how quickly these "Fauna" volumes have become out of date owing to the vast accessions to knowledge since their publication. And, if this is so in groups on which "Fauna" volumes have been issued, it may be imagined what is the case in other groups. The student, for example, of groups such as the Isoptera, the Odonata, or the Microlepidoptera, finds no guide to the published information on

such groups and has to compile, as best he can, a bibliographical catalogue on each subject before he is in a position to start work on any group. Such a compilation entails a great deal of labour and is only possible if there is access to a good entomological library on the subject. It may be possible to prepare the skeleton of such a catalogue from the "Zoological Record," but this publication only deals (for the most part, at all events) with new genera and species and catalogues formed in this way will be very incomplete as regards such items as localities, habits, foodplants and synonymy. More time may thus be spent in finding out what has been published on an insect or group of insects than can be given to the study of the insects themselves. And, as matters are at present in India, with a number of scattered workers in different appointments and Departments, every such scattered worker has to compile his sources of information as best he can with very occasional help in the case of monographs on a comparatively few groups, and even in these cases he has to keep his information up to date as best he can from the literature issued year by year. If he does this it means considerable labour and time, each of these items being multiplied by the number of workers; if he does not do it, it simply means that his information is incomplete and, when he requires it, is not available.

I will ask you to consider for a moment what is the present procedure with regard to the identification of any Indian Insect, which we capture ourselves or which is sent in to us for naming. It may be something that we know and can name off-hand, or it may be something that we do not know or are not certain of. In such cases we can usually place it approximately in a family, or sometimes in a genus or group of species, and compare it with the already named specimens in our collection; if it agrees exactly, it is presumed to be the same; if it does not agree exactly and there is a "Fauna" volume or other monograph on that group, we look up the literature and try to run it down. But what happens in the large majority of cases, under present conditions, when we have neither similar identified specimens nor available monograph? The usual thing is that the specimen is regarded as unidentifiable and is put away in a box of "unidentified so-and-so's," where it probably remains for years until some specialist is found to work on that particular group; and in the meantime any information connected with the specimen is valueless in the absence of a definite identification. In rare cases, some of us may have gone over the literature of a group and listed the various genera and species with references, so that it is possible to look up an unknown insect; but this is decidedly the exception rather than the rule.

What is required, in my opinion, is a thorough revision and abstracting of all useful information which has been published to date on all Indian Insects, the term "Indian" including the whole of the Indian Empire from Baluchistan to Madras and including Burma, Ceylon, Andamans and Nicobars, Maldives and Laccadives, and such adjacent territories as Kashmir, Bhutan, Tibet and Yunnan, *i.e.*, entomogeographical India. This information would best take the form of a General Catalogue of Indian Insects, issued in parts which might be devoted to groups (*e.g.*, Isoptera, Odonata) or families (*e.g.*, Gelechiadæ). Once issued this could easily be kept up to date, by the insertion of addenda and corrigenda as new information became available, either the whole catalogue being kept up to date at one Entomological Institute, or different Institutes being responsible for special sections. It would probably facilitate matters if this Institute (or Institutes) kept their corrected up-to-date catalogue(s) in the form of card catalogues, additional information being issued either in the form of annual supplements or of revised sections of the General Catalogue as requisite.

What information should such a General Catalogue contain? The ideal catalogue would contain a general sketch and diagnosis of the group treated of, with lists of literature and general remarks on distribution, habits and life-histories; if the group treated of were an Order, it should contain keys to the Families contained in it (if more than one) and under each Family there should be a key to the Genera, which would follow in systematic order; under each Genus would be given references to the original description and any subsequent redescriptions, and similarly with synonyms, the type-species of each generic name being indicated: the species contained in each genus would follow in systematic order, under each species being quoted the full reference to the original description and any subsequent re-descriptions, and similarly with synonyms and varietal names, then would follow references to occurrence, life-histories, habits, foodplants or any other relevant information, a brief note being given in square brackets after each reference regarding the information contained in it; and in a separate column against each species would be given its distribution, the information given under this heading being connected with the references under the specific name by small arabic numerals, so that it could be seen exactly what was the authority for the distribution given.

With the help of such a Catalogue, the student should be able, by means of the keys, to run any unknown insect (provided of course, that it was a described species) down to a genus and could then compare it with the published descriptions of a comparatively few species. Such

a Catalogue could not be a determinator for all unknown insects but would provide a very ready help in their determination.

Such is the ideal Catalogue. It remains to be seen how nearly we can approach such an ideal. It will be by no means easy as things are at present, for no one of us has the time or knowledge required for the production of such a Catalogue. But I venture to think that, if we can enlist the help of specialists who have worked on particular groups of Indian insects, and add their help to our own efforts, we can at least make a start in such an undertaking.

A certain amount of work in this direction has already been done by myself.

The Orthoptera were listed by me in 1912, the list being based on Kirby's Catalogue with additions to that date. This list is at Coimbatore and a little work would bring it up to date.

Up-to-date card catalogues of the Blattidæ, Dermaptera, Isoptera, Odonata, and all Neuroptera (*sensu antiquo*), prepared by myself, are at Pusa.

We have also at Pusa a card-catalogue of addenda to the "Fauna" volumes on Hymenoptera (also listed by Mr. Ramakrishna Ayyar in the *Bombay Journal*; but many of Cameron's names are synonyms and the whole requires careful check) and also lists of other Indian Hymenoptera.

The Coleoptera have been partly listed recently in Junk's "Catalogus Coleopterorum" and the parts of "Genera Insectorum" and we have a rather incomplete card-catalogue of Indian species. The Coleoptera form one of the largest and most difficult groups for the preparation of a complete catalogue.

The Macrolepidoptera have been listed in the "Fauna" volumes on moths and the supplementary papers in the *Bombay Journal*, but numerous additional species have been described in the *Ann. Mag. Nat. Hist., Novitates Zoologicae* and other publications and some groups have been thoroughly revised (*e.g.*, the Sphingidæ by Rothschild and Jordan and part of the Noctuidæ in the *Cat. Lep. Phal.*). My own copy of the "Fauna" volumes is partly corrected up to date but requires a good deal of additions to make it complete.

The Butterflies have been listed in *Lepidoptera Indica*, but numerous additions have been made since then. There should not, however, be any great difficulty in making a complete list of these.

The Microlepidoptera have been listed by myself in a catalogue corrected up to date.

The Diptera were listed by myself in 1910 and the card catalogue made then is presumably still in the Imperial Pathological Entomo-

logist's Section. I understand that Mr. Brunetti is publishing a catalogue of the Nematocera and it should not require a great deal of work to complete a general list of Diptera.

The Rhynchota, so far as dealt with in the "Fauna" volumes, have been corrected up to Vol. VI in my copy of the "Fauna" volumes. Vol. VII has to be added.

The Aleyrodidæ, Psyllidæ, and Coccidæ have not been listed.

It will be seen, therefore, that a good deal of the work has been done already, more or less completely, and only requires a little more to be done to bring it up to date.

The Coleoptera compose the most formidable group whose listing remains to be done, both because of the large numbers of families, genera and species concerned and because of the extremely scattered literature on this Order.

Most of the other groups can be done, to some extent at least, with our present resources.

What I suggest is that we should, as far as possible, invoke the aid of specialists in various groups to prepare catalogues of those groups not listed already and, as regards other groups, endeavour to list these ourselves to the best of our ability. Such a catalogue could take any one of the following forms, viz :—

*Form 1.*—A mere list of Indian genera and species without references or localities but with synonyms.

*Form 2.*—A list of genera and species with references, localities and synonyms.

*Form 3.*—A more complete list, as outlined above, with diagnoses of groups, families and genera, citations of generic types, and full references with synonyms and localities.

I give brief examples of these three Forms. Personally I think that the third Form is the best and if we are to undertake the work of preparing and issuing such a catalogue it would be most satisfactory to do it really well and to put it in the most useful form.

#### FORM I.—PTEROPHORI.

##### *Pterophoridae* Zell.

*Agdistis*, Hb.

*bennetii*, Curt.

*Cnæmidophorus*, Wallngr.

*rhododactylus*, Fb.

(Extract from R. South's "Entomologist" synonymic List of British Lepidoptera.)



FORM II.—PTEROPHORIDÆ.

207. *Trichoptilus*, Wlsglm. 1880.

- 1310.—*Paludum* Z. Is. 1841, 866 ; L. E. VI. 400 ; Stt. . Germ.(s)? ;  
 Cat. Suppl. 13 ; HS. 19, V p. 382 ; Hein.— Austr. inf ;  
 Wck. 810 ; Snell. II, 2, p. 1057 ; Leech Helv ; Angl ;  
 Pteroph t. 18, f. 8 ; Meyl. 431 ; Hofm Bat ; Fen ;  
 Pteroph 122 . . . . . Liv ; Gal.  
 alp ; Cat.

(*Extract from Staudinger and Rebel's "Catalog der Lepidopteren des Palæarctischen Faunengebietes."*)

FORM III.—PTEROPHORIDÆ.

Head often with forked scales, forehead smooth or with conical horny prominence or tuft of scales, ocelli usually obsolete. Tongue developed. Maxillary palpi obsolete. Forewing with 5 remote from 4, neuration often much degraded, usually cleft into two (rarely three or four) segments. Hindwing with 5 remote from 4, 7 remote from 6 ; lower surface with a more or less developed double row of dark spine-like scales on lower margin of cell ; wing usually cleft into three segments. Cilia containing ramified hair-scales.

This is one of the two groups of Microlepidoptera covered by the popular term "Plume-moths," the wings being cut by longitudinal clefts into indistinct segments which in some genera have a feathery appearance. On this account the members of this group are generally easy to recognize, but there is one section (the Agdistinæ) in which the wings are not cleft, although even here there is some diminution of scaling on the areas which are developed into clefts in the other sub-families.

The Pterophoridae are easily separated from all other Lepidoptera, however, by the series of spine-like scales on the lower surface of the hindwing.

The family is usually considered as belonging to the Pyralidina and has some Pyralid affinities, but it is very isolated and it is probably better to treat it as a separate entity.

Larva rather short, usually with well developed fascicles of hairs in the free-living forms, but these are necessarily much reduced in the case of internal feeders. As a rule the larvæ seem attached to composite plants, feeding on the flowers and fruits but in a few cases they tunnel in stems or fleshy fruits. Pupa usually hairy, attached by the tail by

means of a double cremaster; there is occasionally a very slight cocoon but generally the pupa is freely exposed.

*Literature.* The literature on this group is very scattered but the following list contains the principal papers requisite for its study:—

*	*	*	*	*	*	*	*
<i>Key to Genera.</i>							
1.	Wings not fissured . . . . .	2					
	Wings fissured . . . . .	3					
2.	Termen of f. w. not falcate; f. w. 8 and 9 separate . . . . .	<i>Agdistis.</i>					
	Termen of f. w. strongly falcate; f. w. 8 and 9 stalked . . . . .	<i>Steganodactyla.</i>					
*	*	*	*	*	*	*	*
17.	F. w. with 10 out of 7 . . . . .	<i>Pselnophorus.</i>					
	F. w. with 10 separate . . . . .	<i>Pterophorus.</i>					
*	*	*	*	*	*	*	*

COSMOCLOSTIS, MEYR. (1886).

<i>Cosmoclostis</i> , Meyr. T. E. S. 1886. 7 <sup>(1)</sup>	. . . . .	Type: <i>aglaodesma</i> , Meyr.
<i>aglaodesma</i> , Meyr., T. E. S. 1886. 12 <sup>(1)</sup> . B. J. XVII. 134 (1906) <sup>(2)</sup>	Ceylon (dry low Fletcher, Spol. Zeylan. VI 32 (1909) [ <i>Diacrotricha</i> ] <sup>(3)</sup> ; country) <sup>(2)</sup>	
Meyr., Gen. Ins. Pteroph. p. 4, tab. f. 1 (1910) [ <i>Diacrotricha</i> ] <sup>(4)</sup>	Puttalan <sup>(3)</sup> Solomon Isds <sup>(4)</sup> E. Australia. <sup>(1)</sup>	

To conclude, I consider that it is highly desirable and within the bounds of practicability to prepare such a general catalogue in order to gather together the results of past work and to form a foundation for future work; that its preparation should be a matter for combined action of the various Institutes interested in Entomology in India; and that, if these various Institutes are prepared to combine in this matter, such a catalogue should be prepared and edited by an inter-departmental committee and published by Government.

Mr. Fletcher.

With regard to this matter of the preparation of a catalogue. I have written to various specialists in different groups and have received replies from nearly all of them promising help in their special groups. Mr. Bagnall, for example, writes that he is willing to undertake the Thysanoptera, Dr. Cameron the Staphylinide, Dr. Gravelly the Passalidae, and so on. Mr. Prout writes as follows:—

“There is certainly a demand for an up-to-date catalogue of Indian Insects and I should like to collaborate so far as limited time and opportunity may render possible. I could at any rate do the sub-families

*Enochrominae*, *Hemithaina* and *Sterrhinæ* (= *Acidaliina*) and probably the *Larentiinae*. The unwieldy sub-family "*Boarmiina*" I unfortunately have not yet so well in hand, though I have of course hosts of notes and references, so that if no one better could be found, I might find myself able to do fairly well with them by the time the list was required."

Mr. H. E. Andrewes, who is working on Indian Carabidæ, sends quite a useful note on this subject, which I will read to you. He says:—

"Having quite recently prepared a Catalogue of Oriental Carabidæ, I mention a few of the considerations which have presented themselves to me, as a Coleopterist, in the course of that work.

"(1) My first idea had been to confine myself to species recorded from India, Ceylon and Burma, but I soon found that I must abandon this scheme, and before long decided to take in the whole of South East Asia, including Japan in the North, and the entire Malay region in the South. The fact is that our knowledge of the fauna of India is at present so imperfect that species described from China, Indo-China, Siam, and Malay Archipelago, etc., are continually reappearing in India, so that a catalogue of species recorded at present from India only would give quite a false impression, and inevitably lead to the redescription of known insects, and a consequent augmentation of the already superabundant synonymy. It would also limit the opportunities for the comparison of Indian species with allied forms in adjacent areas, which has always seemed to me so great a help to Entomologists. If I may slightly modify Kipling I would say "what should they know of India, who only India know!" It may surprise some to learn that even among ground-beetles (quite apart from those inhabiting the desert tract from Egypt to Sind), there is at least one species common to India and Africa, and quite a number are spread over large tracts of South East Asia, and the adjacent islands. My first point therefore is that, in the present state of our knowledge, a catalogue should aim at covering a wide area.

"(2) Of existing catalogues of the Coleoptera—all that I am competent to say anything about—the only complete one extant is that of Gemminger and Harold, commenced in 1868, a monument of painstaking labour, which must have proved of inestimable value to Coleopterists during the past fifty years. During that period, however, the number of described species has probably doubled, so that it is now quite out of date. Before the war a new World-catalogue was in course of preparation under the auspices of the firm of Junk in Berlin, and some parts had already appeared in 1914; I have, however, no details at hand about it.

"In 1890 E. T. Atkinson published in a supplement to the *Journal of the Asiatic Society of Bengal* his catalogue of Oriental Carabidæ, an excellent piece of book-work, but necessarily suffering, as such work must always do, from his lack of special knowledge of the subject. He himself only claims "to give a list of recorded species," and that he did very well.

"My own investigations have shown me (a) what an immense number of changes and corrections result from a study of the material to be catalogued. (b) How very far short I still am of arriving at anything like finality in regard to already existing species. My second point is, therefore, the importance of getting a subject catalogued, wherever possible, by someone who has studied or is studying it. This I fear is to some extent a Counsel of Perfection, but a general interest in Entomology seems to be increasing, as its economic importance becomes more widely known, and it ought not to be very difficult to induce more of those who have the taste for it to make themselves experts in a small group rather than remain amateurs in a more extended field. Where it is impossible to get a catalogue on these lines, one of the Atkinson type is most desirable, and sure of a cordial reception from entomological workers.

"(3) It may be suggested that the existence of the now numerous volumes of the "Fauna of India" series render catalogues more or less unnecessary. Writing as a Coleopterist only, I hardly think this view will have much weight for another five and twenty—perhaps fifty—years, for, although half a dozen volumes on Coleoptera have already been published, not a single large family has yet been completed, and catalogues are likely therefore to be as necessary as ever for many years to come. On their extreme importance to all workers in entomology I need hardly insist, and progress during the coming years should be materially increased by any stimulus which can be imparted to this branch of the subject."

This subject has, of course, been considered by the Committee appointed to deal with this subject, so I will only now read the following report of the Committee on this Cataloguing question:—

*"Report of Committee on Catalogue of Indian Insects.*

"The Committee considers that it is very desirable that a General Catalogue of all described Indian insects should be prepared and issued and makes the following proposals to this end:—

- (1) That a Standing Committee of the Entomological Meeting be appointed, with power to add to their number, to take the

necessary steps for the preparation of such a Catalogue, which should include references not only to descriptions but to the natural history (in its widest sense) of the insects concerned, and that the Standing Committee should report progress to the next Entomological Meeting.

- (2) That the area to be covered should include the whole area included in the "Fauna" volumes with the addition of Tibet and Yunnan.
- (3) That the aid of specialists in the various groups of insects be invoked to help in this matter, and, where such special aid is not available, the Standing Committee should make the best arrangements possible in each case.
- (4) That Government be approached with a view to sanctioning the preparation and issue of such a Catalogue which might be printed at the Government Press and published under authority of the Government of India as an interdepartmental publication of the Entomological Meetings."

I propose a formal Resolution to the effect **that the Report of the Committee appointed to consider the question of the preparation and publication of a catalogue of Indian Insects be approved.** Mr. Fletcher.  
Resolution 3.

I beg to second that Resolution.

Mr. Ramrao.

*[The Resolution was put to the Meeting and carried unanimously.]*

The next thing is to appoint a Standing Committee to take action and report progress to the next Meeting. I shall be glad of the names of any volunteers who feel that they can assist in this matter. Mr. Fletcher.

I shall be glad to assist.

Mr. Beeson.

I will do what I can to help.

Mr. Andrews.

I should like to see Ceylon represented on the Committee and will gladly assist as far as possible. Mr. Senior-White.

Then the Committee will consist of Messrs. Beeson, Andrews, Senior-White and myself and we will meet together before we separate and discuss details. Mr. Fletcher.

#### 77.—A SKETCH OF OUR PRESENT KNOWLEDGE OF INDIAN MICROLEPIDOPTERA.

By EDWARD MEYRICK, B.A., F.R.S.

(Plate 167.)

My friend Mr. Fletcher has suggested to me that it might be useful if I would contribute a few remarks summarizing the present state of

our knowledge of the *Microlepidoptera* of India, and I should be showing little gratitude for his generous and valuable help towards their study, if I failed to comply with so reasonable a request.

When in 1905 I commenced a series of papers on the subject in the *Journal of the Bombay Natural History Society*, only about 100 species had been authentically recorded from the whole of India, and a large proportion of these were incorrectly classified or otherwise very inadequately known. The difficulty of collecting and preserving these fragile and delicate insects in good condition in the climate and surroundings of India is great but not insuperable, as has since been proved by the skill and energy of my correspondents, and the backward condition of our knowledge was hard to justify, the Indian species being at that time less known than those of any other considerable geographical area. From Australia I had already classified about 2,500 species, sufficient to give a good idea of the character of the fauna, which is a rich one. If Burma is included with India, I daresay the probable number of species occurring within these regions may be estimated at 10,000. I proceed to indicate how far our acquaintance with these already extends.

Looking at the subject from a geographical point of view, it appears that even now only a small part of the vast area included has been investigated, and that very inadequately. The southern portion of the peninsula is the best known; Mr. Fletcher has sent many species from Coimbatore and some from other southern localities; several collectors have visited the Nilgiris; Mr. L. Newcome has made considerable collections in Coorg, and Mr. R. Maxwell in Kanara. Moreover the fauna of this region has much affinity with that of Ceylon, from which I have received copious material, and many species will probably prove to be common to both regions. From Pusa representative collections have been sent by the Imperial Entomologist and his predecessor, but presumably this locality has not an extensive fauna. I obtained a large number of specimens, forming the captures of a year, from a native collector in the Khasis; this man was an expert collector, but without scientific knowledge. A few species only have been received from other parts of India, including the neighbourhoods of Bombay and Calcutta, and certain points in the Himalayas; and Dr. Annandale and Mr. Fletcher have contributed a few from Burma. I cannot accurately state the number of species, described and undescribed, which I possess at the present time, but estimate it roughly at about 2,300.\*

---

\* The number of described species on my list is 2,425.—T. B. F.

This leaves us (conjecturally) 8,000 more to be discovered, and the question arises, where are they? In the first place it is obvious that they are not equally distributed over the land, but on the contrary very unequally. Large stretches of wide plain or cultivated fields may probably be little productive, but even these are liable to contain many more species than might be supposed possible; the insects may occur in very limited nooks of only a few square yards, they may be obtainable only for a few days in the year, only in certain weather or at a certain time of day, only by certain means of capture, or only by unusually sharp-sighted collectors. Even of experienced Microlepidopterists only a few can perceive a *Nepticula* on the wing, and some of the *Micropterygidae*, when flying in their favourite conditions of mixed sunlight and shade, although relatively larger, are almost invisible. *Limnæcia phragmitella* is a species of not inconsiderable size (20 mm. expanse); it was described in 1851 from two wasted English examples, having eluded all earlier collectors, and was thought to be of extreme rarity; later a chance discovery was made of the larva, which feeds in the seedheads of *Typha*, causing the down to hang out in masses (which however hardly attract attention, being attributed to natural decay), and it was found to be extremely easy to collect and rear; the imago is excessively sluggish, resting on the foodplant, which it closely resembles in colour, whilst the *Typha*, growing in water, is little liable to be disturbed. Special search presently showed the insect to be common not only in England but in Europe; I discovered it in North Africa, in Australia, and New Zealand, and have obtained it from South Africa and North America; so that it now appears that this supposed rare and local species is really one of the commonest and most widely distributed of insects; but it is still hardly ever taken except by those who know how to look for it. This distribution is believed to be quite natural, the *Typha* being a cosmopolitan plant; the insect might be looked for in India. Even where insects seem plentiful, it is wise to believe that we are passing over as many species as we find.

The most favourable localities for number and diversity of *Microlepidoptera* are forest-clad ranges, at elevations of from 3,000 to 7,000 feet; these will always repay prolonged and careful collecting. Such ranges, if they form isolated blocks, have probably been islands at some earlier period, and are likely to possess numerous peculiar species. The vegetation naturally gives good indications; if the trees and plants are varied and peculiar, the *Microlepidoptera* are sure to be so likewise. At the same time it must be remembered that a large number of species feed on lichens, dead wood, refuse, fungi, and probably on dead leaves, thus making themselves independent of the flora. From mountains

situated near the equator (Mt. Kilimanjaro in East Africa, and the Andes of South America) I have received species found at heights of 13,000 feet, and they probably attain 14,000 feet; in the Himalayas I anticipate they will be found up to 12,000 feet at least, but I have none yet from anything like this. Coast sand-hills and saltmarshes, carrying a peculiar vegetation, are usually very productive of interesting species, quite different from those of other regions; these have not yet been touched, apparently.

The larvæ of *Microlepidoptera* are probably almost invariably edible (not protected by distastefulness or irritating hairs, as many larger *Lepidoptera* are), and when one considers the multitude of their enemies in the active life of a tropical forest, ants (one species of ant alone, introduced into the Hawaiian Islands, has exterminated there most of the *Microlepidoptera* in those districts over which it has spread), spiders, ichneumons, birds, lizards, and many other insect-eating creatures, it seems extraordinary that so many species still maintain their existence. Under this violent pressure it is certain that a variety of ingenious expedients for concealment and protection will have been evolved, offering a succession of interesting riddles to the acute collector. Alexander the Great, putting hard questions to the Indian sages, inquired which was the most crafty of animals, and was answered "That which has not yet been discovered." Many will be found to be internal feeders in flower-heads, seed-vessels, berries, shoots, stems, or roots; others feed underground amongst roots, and these are difficult to find or to obtain uninjured, except in sand. Those which feed on dead leaves or ground-refuse (often in portable cases of leaf-fragments) are also difficult to observe, and have been much neglected. Some have adopted the courageous but effective method of sheltering within the nests of termites, ants, or spiders, apparently sometimes tolerated by the owners as useful scavengers, and protected by them against external enemies, securing at the same time a supply of food and defence against drought or rain. An Australian species (*Cyclotorna*) is at first parasitic on certain *Homoptera* (*Jassida*), to whose bodies the larva adheres; it then goes through a kind of pupal stage in a cocoon, and emerges as a larva of quite different form and colouring, which lives in ants' nests, feeding on the ant-larvæ, and ingratiating itself with the ants by excreting an agreeable liquor for their consumption. Some very interesting forms feed on scale-insects (*Coccida*), sheltering themselves amongst the fragments of their victims. Probably many curious kinds of parasitism remain to be discovered.

I will now review the families in order, indicating how our knowledge of them stands at present.



The *Carposinidæ* may be known by the combination of obtuse palpi, scaletufts on forewings, and absence of vein 6 of hindwings; I have ten Indian species, a number which will no doubt be considerably increased. The larvæ are believed to feed usually in berries, and should be easy to collect; it would seem however to be a disadvantageous habit, as they must be liable to wholesale destruction by berry-eating birds.

The *Phaloniadæ* are *Tortricina* which have vein 2 of forewings rather approximated to angle of cell, instead of widely remote as in the following families; they are principally interesting in India through their absence. Only three or four species being known. Yet the family is largely developed in Europe, especially throughout the Mediterranean region, and extends thence all down North and South America; its abrupt termination on the frontier of India is a very striking feature.

The *Tortricidæ* proper are distinguished (not quite absolutely) from the *Eucosmidæ* by the absence of the cubital pecten of hairs on hindwings. Over 100 are known already, and they are probably most numerous in the Himalayan region, where they will be largely increased. The larvæ are mostly leaf-rollers, and as they are often not at all particular as to foodplant, they are liable to be very destructive pests of cultivated trees and shrubs. Owing to their versatility of habit, species that have never hitherto been noticed as injurions are capable of becoming suddenly dangerous.

The *Eucosmidæ* are very numerous and diversified in India, which is probably the original centre of distribution of the family. I have already about 250 forms. The larvæ are very miscellaneous in habit, some feeding on leaves, others in fruits, stems, or roots. The considerable genus *Laspeyresia* has a strong leaning to the pods of *Leguminosæ*, which offer a large and promising field for larval research.

The small family *Chlidanotidæ* is intermediate in characters between the preceding and the *Glyphipterygidæ*; it appears to be mainly characteristic of Ceylon, but there is one species from Assam.

Coming now to the *Tineina*, the first four families are marked by the sickle-shaped pointed palpi, smooth head, and stalking (or coincidence) of 7 and 8 of forewings, and are distinguished from one another by the hindwings, which in the *Gelechiadæ* are trapezoidal with termen more or less sinuate, 6 and 7 usually diverging; in the *Æcophoridæ* elongate-ovate or ovate-lanceolate, 6 and 7 parallel; in the *Cosmopterygidæ* lanceolate or linear, 6 and 7 diverging; and in the *Metachandidæ* are subtrapezoidal, with vein 6 absent. The pecten on the basal joint of antenna is theoretically present, but in the *Gelechiadæ* is generally absent. The *Gelechiadæ* are abundantly developed in India (which

is their place of origin), and I have nearly 700 species; moreover as they are often small, obscurely coloured, retired in habit, and difficult to find in the imago state, it is probable that they will be largely increased by careful rearing from the larvæ. The large genus *Gelechia*, however, so numerous and omnipresent in Europe and North America, stops abruptly on the confines of the Indian region, in the same curious manner as the *Phaloniada*. Its place is taken by the more primitive genus *Brachmia*, with its derivative *Lecithocera* and allies. The larvæ mostly feed on low plants and shrubs, displaying an interesting variety of habit; few have yet been discovered.

The *Metachandida* are an interesting family specially characteristic of the Mascarene region, of which a few stragglers extend into Africa on one side and India on the other. I have about 15 Indian species; the larval habits are unknown.

The *Cosmopterygidae* are usually small and slender-winged, and readily escape notice, but under a lens are often very attractive; the species of *Cosmopteryx*, decorated in black, orange, and metallic gold, are hardly surpassed for elegance. About 120 species of the family have been found. The larval habits are very various, but are usually fixed for each genus. The larvæ of *Cosmopteryx* mine blotches in leaves, with a preference for *Gramineæ*. Other genera feed in shoots, or on seeds and dry refuse, or on scale-insects. Much work remains to be done in this family, which is often neglected.

The *Oecophorida* are principally represented by the *Depressariid* group, though the large genus *Depressaria* itself follows exactly the main lines of distribution of *Gelechia*, and stops short at the border. The other three groups of the family are each represented by a few species only. Altogether there are about 150 species. Amongst the most curious and peculiar are the gigantic forms of *Lactistica*, which are amongst the largest of the *Tineina*, with extraordinarily elongated posterior legs; and the still larger *Binsitta barrowi*, whose pupa imitates a snake's head. In several genera of this family the pupa is naked and sits erect upon its tail, imitating a leaf or other object. The larvæ of *Pseudodoxia* feed in singular long acute cases on lichens; those of the elegant genus *Macrobathra* on leaves of *Leguminosæ*, especially *Acacia*; other genera sometimes on dead leaves, or in decayed wood or bark.

The *Physoptilidae* at present consist of a single peculiar species only.

The *Xyloryctidae* resemble broad-winged *Oecophorida*, but in the hindwings 6 and 7 are usually basally approximated or stalked, the antennal pecten invariably absent, and in the *Stenomid* group 7 and 8 of forewings are separate. They are generally of fair size, and the

larvæ habitually protect themselves with some sort of shelter or tent-like covering, which in some Australian forms is developed into a tunnel in wood closed by a movable barricade, the larva carrying in leaves for food. I have about 70 species, but these insects are often retired in habit, and careful search for larvæ will reveal unexpected novelties.

I now include the *Orneodidae* at this point. These easily recognized insects, with the wings divided each into six (or rarely seven) plumes, are represented by 14 species, but I anticipate considerable additions from the Himalayan region.

I pass over the *Sesiidae* (or *Aegeriidae*), which belong here but are commonly appropriated by the collectors of the larger Lepidoptera without any justification.

The *Heliozelidae* are at present only known by two species of *Antispila*, small but elegantly marked insects whose larvæ mine in vine-leaves cutting out cases for pupation; I have no doubt that *Heliozela* should be fairly represented, but these very small and obscure-looking moths have probably been overlooked.

The *Heliodinidae* are narrow-winged insects with smooth heads, no antennal pecten, and the curious habit of erecting the posterior legs over the back, the tarsal joints of these being always more or less spinose at apex. There are about 60 species. The principal genus is *Stathmopoda*, which will be found very numerous when the larvæ have been sufficiently investigated; these are various and interesting in habit with a preference for the pods of *Leguminosae* and figs, some being gall-producers. The larvæ of other genera feed in the fructification of ferns, or on scale insects. I recommend this family for special study.

The *Glyphipterygidae* are allied to the preceding but very different in appearance, their development having taken place in the direction of broader wings instead of narrower: the antennal pecten is always absent. I have about 90 species, but the representation is probably very incomplete; *Glyphipteryx* in particular, of which the species usually frequent *Carex* or *Juncus* in open or swampy places, has probably not been sufficiently looked for, as it should not be less numerous than in Australia, where it is plentiful. Several of the principal genera (*Simaethis*, *Imma*, *Phycodes*) are closely associated with the various species of *Ficus* and its allies, and have probably been developed with them from the same place of origin.

The *Blastobasidae* possess a stigmatium (thickened costal space between 11 and 12 of forewings) as in the *Hyponomeutidae*, veins 6-10 being characteristically approximated whilst 11 is remote, and a strong antennal pecten. For obscurity and similarity they are unsurpassed

by any *Lepidoptera*; but the males generally offer tangible sexual characters. Hence those who collect these insects should take care to obtain good series of both sexes under the same circumstances to ensure identification. Only a few species have been definitely ascertained so far, for lack of adequate material. The main development of the family is in America. The larvæ feed on seeds and dry vegetable matter, or on scale-insects, and may be of much economic importance.

The *Scythridæ* are represented by about 20 species of *Scythris*; collection in open flowery spaces by sweeping-net would probably largely increase these, especially perhaps in the Himalayas; the larvæ usually feed on low plants.

The *Elachistidæ* are few in number at present, and although these small and obscure insects (chiefly grass-feeders) are easily overlooked, I think it probable that they are much less numerous here than in Europe.

The *Hyponomeutidæ* have a general resemblance in character to the *Cecophoridæ*, but with shorter and simpler palpi, less specialized neurulation, and are distinguished by the presence of a stigmatium. I have about 50 species. The gigantic speckled species of *Nosymna*, the large spotted forms of *Atteva* and *Ethmia*, and the gaudy crimson and yellow *Anticrates* would attract attention anywhere. The larvæ are mostly leaf-feeders, sometimes living gregariously in a web and easy to observe; that of *Comocritis* feeds on lichens and bark of trees; those of *Argyresthia* in shoots of trees.

The *Coleophoridæ* are narrow-winged insects usually recognisable by the antennæ being held forward in repose. Only about a dozen species are to hand at present, but none have yet been bred, and the species of this family are notoriously very retired in the perfect state, though often obtainable in abundance as larvæ. The larvæ are case-feeders, either mining (from within the case) characteristic small blotches in leaves, or often feeding on seedheads and flowers, when the case (itself constructed of seed-husks) is hard to detect. I anticipate however, that the family is here not very numerous; it abounds in Europe, and is common also in Africa and North America.

The interesting family *Gracilariadæ* contains delicate and elegant insects, whose larvæ are mostly leaf-miners. Their peculiar habit of resting with the forepart raised and the anterior legs rather widely separated and displayed (Plate 167) usually causes them to be easily recognisable, and the filiform porrected maxillary palpi are very characteristic. I have about 150 species and fresh ones are being continually discovered by rearing from the larvæ, principally of the

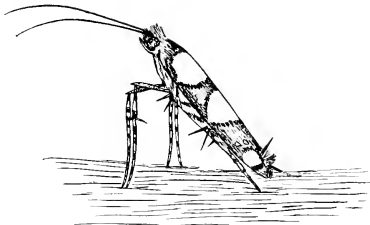

Resting attitude of a Gracillariad (*Aerocercops resplendens*.)



genus *Acrocercops*, which though cosmopolitan is at its maximum in India.

The *Epermeniadae* are everywhere a scanty group, represented by a dozen species. The curious *Idioglossa* has gilt markings on both fore and hindwings, an unexplained eccentricity. The typical forms of *Epermenia* have scale-teeth on dorsum of forewings. The larvæ are external feeders on leaves, protecting themselves by a slight web.

The *Amphitheride* are another small group of narrow-winged insects, with long antennæ, and the eyes usually curiously divided by a line of scales; I have 6 species.

The *Plutellidæ* nearly resemble the *Hyponomeutidæ*, from which they are distinguished by the distinct short porrected maxillary palpi. They are an ancient family, not now numerous anywhere, though *Plutella maculipennis* is the most universally distributed of all the *Microlepidoptera*; there are about 20 species. The known larvæ are leaf-feeders.

The *Lyonetiadæ* are typically rough-headed, with folded maxillary palpi like the *Tineidæ*, but advanced forms have suffered much degradation, and may have lost these structures; the distinguishing mark of the family is the upturned (or sometimes down-turned) apex of forewing in repose, sometimes very strongly marked and striking, looking like a deformity, and the basal joint of the antenna often forms an eyecap. I have nearly 100 species. Some of these insects are amongst the smallest and most delicately marked of the *Lepidoptera*, such as *Phyllocnistis*, which is probably rather numerous, requiring close study; its larvæ mine flat blotches in leaves. *Opostega*, which is probably also numerous, has the most degraded neuration of all *Lepidoptera*; its larvæ are scarcely known. The larvæ of *Bucculatrix*, although of very small size, feed externally on leaves, and have a peculiar ribbed cocoon. The earlier genera usually have larvæ feeding on dry vegetable matter; those of *Opogona* are often resident in the nests of Termites. The family as a whole is very interesting for study.

The *Tineidæ* are an extensive group, with normally rough head and often folded maxillary palpi, the neuration well-developed and simple, the veins of hindwings usually separate. I have over 200 species, but some genera are very obscure and need much more study to discriminate the different forms. The species of *Melasma* are especially difficult, and good series should be taken, but even then two or three species may occur commonly together. The larvæ usually feed on dead or dry vegetable (or sometimes excremental) matter, fungi, bark, dead leaves, roots, etc., but in other countries are occasionally leaf-

miners. Some are attached to the nests of Termites or ants. Not infrequently they are case-bearers.

The *Adelidæ* may be known at once by the very long antennæ, only paralleled in certain *Trichoptera*; their brilliant ornamentation of purple, gold, and other metallic hues renders them very attractive. Over 20 species are known. The larvæ are case-bearers, often feeding habitually on dead leaves, yet attached to certain plants in their primary stages.

The *Nepticulidæ* are an ancient group of much interest with quite peculiar neuration, rough heads, large eyecaps, and folded maxillary palpi; they are usually very small, and are naturally difficult of observation, but occur all over the world. The larvæ are leaf-miners, and in hot countries pass very rapidly through all their stages; hence with proper precautions they are not difficult to breed. About 8 species are known so far, but very possibly they run into hundreds. Effective collections of these tiny creatures can only be made by those who specialize in them, disregarding the attractions of larger insects.

The *Hepialidæ* should be mentioned at this point, but owing to their size are usually mistaken for *Macrolepidoptera*.

Finally, the *Micropterygidae* are (like the *Hepialidæ*) distinguished from all the preceding by the 12-veined hindwings, and from the *Hepialidæ* by the folded maxillary palpi. They are at present represented by a single specimen (*Neopseustis*) from the Khasis, a highly peculiar and remarkable insect which argues the existence of other species, probably even more remarkable. Some at least of these should be looked for at high elevations in the Hima'ayas, in spring-time, especially in Conifer forests, but actually attached either to catkin-bearing trees and shrubs or to mosses, frequenting mingled sunshine and shade; not improbably they might be of Trichopterous appearance, and might be overlooked on this account. These insects are so important and interesting from their bearing on the origin of the *Lepidoptera* that no pains should be spared to discover them.

Mr. Fletcher.

The *Microlepidoptera* in India are probably not less numerous than the *Macrolepidoptera* but have attracted the attention of very few collectors, partly on account of their small size and partly (probably mostly) because there has been no regular guide to the study of these small moths. The descriptions of the species and genera are extremely scattered. Many have been described in the *Bombay Natural History Society's Journal* and in *Exotic Microlepidoptera*, a few in the *Indian Museum Records* and others in scattered publications issued outside



of India, and these descriptions have included odd species of various families as they came to light. There has been so far no general *resumé* of our knowledge of the group as a whole, so that Mr. Meyrick's paper will, I hope, be of value to the general lepidopterist in India by giving him at least some idea of the characteristics of the various families. In his sketch I note that Mr. Meyrick has omitted the Pterophoridae, perhaps by oversight, and I have therefore included a brief account of this Family in my note on the proposed catalogue of Indian Insects in order to supplement his paper. The student of Indian Microlepidoptera should therefore be able now to place his specimens at least into their proper families with some certainty. The time for a *Fauna* volume, or series of *Fauna* volumes, on the Microlepidoptera has not yet come. As you see from Mr. Meyrick's paper, he thinks that we know at present only about one quarter of the existing species and I agree that his figure of ten thousand species is not below the mark; certainly I find that about forty per cent. of my captures are novelties, in whatever part of India they are made. But I hope that sometime we may have at least a small guide to the study of Indian Microlepidoptera, as such a publication could not fail to stimulate interest in these small but neglected insects. In their variety of habits and structure and beauty, as also in their economic importance, the Microlepidoptera scarcely yield in importance to the Macrolepidoptera, and the elegance of the adult insects themselves in such groups as *Cosmopteryx*, *Acroccrocs*, *Leucoptera*, and *Nemotois* cannot but forcibly remind one that *Natura maxime in minimis miranda*. At Pusa I have got together a tolerably good collection of Indian Microlepidoptera, which comprises many of the commoner species and I shall be glad to receive material from all parts of India and to help in identification of specimens as far as possible.

We are all, I am sure, much indebted to Mr. Meyrick for sending in this interesting and valuable paper.

#### 78.—THE TRICHONYMPHID PARASITES OF SOME INDIAN TERMITES.

By CAPTAIN FROILANO DE MELLO (*Instituto de Analises e Vaccina, Nova-Goa*).

(Plates 168—170.)

It is with a feeling of pride that I come to this Entomological Conference to expose before its learned members the results of my researches on Indian Trichonymphids. I dare say that my audacity will find some just excuses in the hope I have been cherishing that this work

is a kind of introduction which will contribute to a certain extent to fill the gap left in this branch of the, nowadays so important, biological literature in India.

But I feel that the time has come for rectifying what I have just now said: the priority of these studies in India does not belong to me. In 1912 one of our colleagues, who gives us the honour of presiding at this Conference, was the first to discover in the rectum of *Hodotermes viarum* from Coimbatore, the existence of a very abundant Trichonymphid fauna. This distinguished Entomologist, whose preparations I have lately studied and to whom I owe so much of learned advice, is Mr. Bainbrigge Fletcher. To him my best thanks are due.

The relations between Trichonymphids and Termites are explained by the three following theories:—

- (a) the first one admits the fact as a mere case of accidental parasitism;
- (b) the second finds in these relations a certain influence on the differentiation of the termites, . . . . . castes;
- (c) the third finds in these conditions a symbiotic relationship in which the parasites, forming their own bodies by the consumption of the wood ingested by the termite, would help the nutrition of its host.

I will quote on this subject the words of Bugnion:—"Reproducing daily in prodigious quantities, dying every day by millions, these parasites would be digested and would in this way contribute to the nutrition of the termite."

The most important argument on which the theory of Bugnion is founded, is not only that the Trichonymphids are harmless to the termite, but that the larvæ of *Calotermes greeni* harbour an abundant Trichonymphid fauna during the most part of their life in which they feed on wood. It happens however that these larvæ cease eating wood some days before moulting and the Trichonymphids disappear at the same time.

In fact, one can see that the termites kept in captivity and without wood for nourishment lose their parasites rapidly. But I cannot induce you to believe this pretended conclusion of Bugnion, not only for the reason that the death can be explained by want of food, but especially because I have studied some species of *Odontotermes* and *Microtermes* that feed on wood without harbouring Trichonymphid parasites in their digestive tract.

Trichonymphids are not found in all kinds of Termites. Some of them never contain such parasites: the genus *Termes*, for example.

Many species from Nova-Goa, Daman, Pragana, Baroda, and Pusa, feeding on wood, are also without Trichonymphids.

The genera that up to this date have been found to harbour these parasites are: *Leucotermes* in France, Philadelphia, Italy, Portugal and Portuguese India; *Calotermes* in Italy and Ceylon; *Hodotermes* at Coimbatore in India (I have already referred to the slides of Mr. Bainbrigge Fletcher); *Coptotermes* in Brazil, Ceylon and Portuguese India; *Glyptotermes*, *Arrhinotermes* and *Tecmitogeton* in Ceylon; *Ncotermes* in our island of S. Thome in Africa according to the studies of my colleague Carlos França, published in the last year, and, I believe, *Eutermes* with their Trichonymphids belonging to the genus *Leidomella* in the Argentine.

I know that the termites from Chili show also Trichonymphids but I am sorry I was not able to consult and compare the papers on this subject. If you find this work worthy of any interest, I pray you will be pleased to overlook its deficiencies.

What are Trichonymphids? The common meaning of this word does not correspond to the zoological classification. It is generally used *sensu lato*. Some authors consider the Trichonymphids as belonging to the Mastigophora and others to the Infusoria. I prefer to call them the multiciliate protozoal parasites of the intestine of white ants. You will see that the meaning is merely etymological (*tric.* hair; *nympha*, nymph). At the end of this paper I will try to establish a classification of true Trichonymphids which, I may already remark, belong to the class of Mastigophora and can be easily separated from the Infusoria which also are found as parasites of the white ants.

Since 1860, everyone knows that a curious Trichonymphid, called *Lophomonas blattarum*, has been described in the intestine of *Stylopyga orientalis*, but I have not yet specially studied the parasites of Indian Cockroaches and for the present I will consider *Lophomonas blattarum* as an additional species of the group of Trichonymphids.

And as I have spoken of the Mastigophora and Infusoria, it will not be out of place to draw your attention to the fact that transitional forms are to be found between these classes, represented in the Infusoria by the genus *Monomastix* of Roux and in the Mastigophora by the genus *Caduceia* of Carlos França.

My researches refer specially to the parasites of *Leucotermes indicola*, Wasm., the identification of this termite being due to the kindness of Mr. Bainbrigge Fletcher. The intestine of *Leucotermes indicola* is full of an abundant protozoal fauna to which I can apply the following

words of Leidy. I cite them with due homage to the memory of that American Scientist:—

“The brownish matter proved to be semifluid, but my astonishment was great to find it swarming with myriads of parasites which indeed actually predominated over the real food in quantity. Repeated examinations showed that all individuals harbour the same world of parasites, wonderful in number, variety and form.”

Figures 1-6 on Plate 168 show the different forms of *Tr. agilis*. This protozoon is composed of a kind of *head*, hyaline and in shape like the head of a mushroom, a kind of *neck* consisting of two parts, one internal, of the form of an *hourglass* but with the constriction at the level of the union of its anterior and middle third, and one external ectosarc, enveloping and protecting the *hourglass-like formation*. The neck is inserted above in the middle of the head protruding into its interior and seems like the neck of an open bottle, and below it is attached to the body by its convexity, this articulation being very thin and extremely mobile. The third portion is the *body*, oval, globulous, susceptible of a very great polymorphism and containing a large nucleus, sometimes hyaline, sometimes full of more or less abundant chromatic granules, and surrounded by a very distinct nuclear membrane. The constitution of the body is thinly granulous and the endoplasm is full of wooden particles, irregularly placed.

*Tr. agilis* is covered with flagella, which are disposed in three series: the first one composed of short and immobile flagella, inserted in the ectosarc layer around the neck, the second emerging around the inferior articulation of the neck, and formed by long flagella, covering the anterior part of the body like a surplice; the third with the flagella shorter than the former, inserted on the whole body and endowed with a limited mobility.

The *flagella* of the second series are extremely mobile and this mobility, added to that of the inferior articulation of the neck and to the sarcodic contractions of the body, gives the parasite the most extraordinary forms and is the cause of its extreme polymorphism. The flagella of the third series have been considered by some authors as the longest, of a fantastic length. It is an optical mistake against which I must protest. At first sight these flagella seem really very long, because they are numerous and following one another. Sometimes they cross one another and the best places to determine their length are the lateral borders of the parasite.

Should they be so extraordinarily long, they would seem still longer when the *Trichonympha* shortens: this is never the case and the

distance from the ectosarc to the free extremity of the flagella is always the same, whatever may be the form of the parasite.

The movements of *Trichonympha* are very interesting. It advances majestically as if searching its way, moving its anterior portion to the right and the left, forwards and backwards and throwing away by means of the flagella of the second series all the animated and inanimated particles that are to be found in its march and when a stronger obstacle is obstructing its way, the protoplasm shows a sarcodic contraction, the body becomes narrow and elongated and the animal, changing its way, progresses again.

I will draw your kind attention to figure 5 representing the parasite seen on its vertical axis. The four concentric circles are: the first the summit of the hourglass-like formation, the second the outline of the hyaline head, the third the periphery of the *flagellated surplice*, the fourth the circumference of the body, more or less irregular.

I was able to study the division of *Trichonympha*, these forms being very rare in the intestines of Termites kept in captivity. My studies confirm the observations of Foa in Italy. As you see, figure 6 shows the division of the *hourglass-like* formation before the nuclear division. I have seen all the stages of their division and I can definitely affirm that the division commences by the *hourglass-like* formation which is followed by that of the nucleus and body. The hourglass-like formation is therefore a blepharoplast that at the moment of division assumes the function of a centrosome.

I will now compare my description with those of other authors. Plate 168, figures 7-15, represent some figures from Plate 51 of Leidy, but only those which correspond to *Tr. agilis*. You will easily perceive that their general configuration is very similar to mine. His description however is erroneous and the figures incorrect. Leidy thought that the constriction, sometimes found in the body of *Trichonympha*, divides this protozoon into two parts, head and body, and some of his figures show a line marking this division. Leidy continues: "a large spherical nucleus is constantly to be observed situated centrally at the conjunction of the two divisions of *Trichonympha* as seen in figures 1-10." It is unnecessary to prove that Leidy has included in this so-called head a part of the body. Secondly Leidy does not describe either the *hourglass-like* formation, or the head of mushroom and these parts are wanting in his figures. He thinks that the anterior portion is acuminate "and the base abruptly terminating on the line of conjunction of the head and body." Concerning the flagella he described four series: the first immediately behind the pointed summit of the "head, are the shortest, extend upon sides and wave incessantly." These are the

flagella of my first series, but Leidy was not right from the point of view of their mobility. The second series of Leidy comes "from a circle behind the former, extend backward and outward and wave like those of the first rank." They are the flagella of my *surplice*. The third series of Leidy starts from the head beneath the former, and spreads over the body to its posterior extremity or beyond it to an extent proportionate with the shortening of the animal. Leidy's fourth series, "the longest of all the series springing from the head, fold backward in a special direction, clearly envelop the body and extend beyond its extremity in a twisted fasciculus with divergent ends."

The mistakes of Leidy have been copied in the various text-books of Protozoology. As you see, the figure given in Ray Lankester's book (Plate 168, figure 17), for example, is a reproduction from the figure 10 of Leidy's original paper (Plate 168, figure 16).

The figure 18 of my Plate 168 represents the *Trichonympha* of Grassi's description. He has well described the *hourglass-like* formation and the mushroom-like head, but believes that the first is like the neck of a bottle, whose very large but not very distinct base, would be situated in the body of *Trichonympha*, constituting the line of separation of his so-called striate and non-striate zones. This base would harbour the nucleus of *Trichonympha* surrounded by some rodlets, forming his *cestello*. I have never seen this *cestello*, and it is not true that the *hourglass-like* formation has any connection with the body endoplasm, unless by its articulation. Finally for Grassi all the flagella, short and long, come from the anterior striated zone, which is evidently a mistake.

The description of C. França is very much like mine. I must however, note the following two points: (1) the distinction that França establishes in the body protoplasm in *preanuclear* and *postnuclear* segments, with a granular structure in the first and alveolar in the second, I never found in my specimens. Moreover, it can be easily seen that this distinction cannot take place because the position of the nucleus is very variable. França's series of flagella are three, but the first comes from the line of conjunction of the two first segments, the second (my *surplice*) from the borders of the second segment and the third from the anterior part of the third segment. These are the longest for him and envelop the whole body. I think that the mistakes are mostly due to the study of these parasites in dry stained preparations. Studying the slides of Mr. Bainbrigg Fletcher I have seen that the flagella of the third series seem to be the longest. My researches have been done in *hanging drops* and vital coloration. I have examined thousands of *Tr. agilis* and you may safely believe my description. By this I have found out

the mistakes of others. But I think that it would be desirable to commence any new researches on this subject by a study of the parasites of the American *Leucotermes flavipes*. It is quite possible that under the name of *Tr. agilis* a number of different species or varieties have been described and therefore each description might be perfectly correct in itself.

In the remaining figures (19-30) of this Plate you will find the reproduction of the parasites that Leidy considered as young forms or immature stages of *Tr. agilis*. Please give this subject your kind attention. Excepting perhaps figure 30, which seems to me to constitute the *Microjoenia hexamitoides* of Grassi, all the others present an almost identical constitution, well pictured in his figure 11 (my figure 19). Grassi, Bütschli, Délage rejected the conception of Leidy, and C. França created in 1914 the genus *Leidya* for his *L. metchnikowi*.

The genus *Leidya* has the following characteristics: nucleus situated in the anterior third of the body of the parasite, flagella inserted on a double spiral band, starting from the anterior extremity and crossing the body in opposite directions. Keeping these fundamental characteristics I was obliged to introduce a small modification, that is to say, that the flagella envelop the body in the whole or part of its extension.

You will easily see in Plate 169, figures 31-40, the reason of this modification. Four species of *Leidya* parasitize the intestine of *Leucotermes indicola*: *L. metchnikowi* of França, and *L. annandalei*, *L. kempi* and *L. campanula* all of which I have studied. With two of them I associated the names of the distinguished zoologists Annandale and Stanley Kemp. All these parasites present a vivid progressive movement and their anterior part is more mobile; the first three easily take circular forms and all present also an interesting helicoidal movement following the direction of their spiral turns. Their anterior flagella are shorter but it seems that they have all an identical disposition and there is no place to describe the siderophile formation giving insertion to the anterior flagella of *L. metchnikowi* of França. In stained preparations one can easily distinguish the basal granules giving origin to the flagella. They are situated in the inferior face of the spiral band, excepting on the anterior part, which, when it is elongated, changes the situation of these granules from inferior to interior. My last three species, and specially *L. campanula*, show a curious contractile movement, beginning in the basal insertion of the spira and permitting the elongation of the longitudinal axis of the parasite. The animal progresses thus in a shaky way.

You can easily see the differences between these four species. *L. metchnikowi* (figures 31-33) with the whole body covered with spira and flagella, *L. annandalei* (figures 34-36) with its posterior glabrous part, *L. kempi* (figures 37-38) with a tuft of cilia, in this glabrous part, which are immobile and are more easily tinged with vital stains than the other flagella, and *L. campanula*, (figures 39-40) a species I have characterized by the constancy of its morphology which remains always the same in all stages of life of this protozoon.

Plate 169 gives place to some interesting remarks. One of the figures of Leidy shows some spherical bodies that the American author considered to be *masses of spores*. He makes also reference to the fact of wood particles being sometimes surrounded in the body of *Trichonympha* by a hyaline substance, and the protoplasm is in other cases stuffed with round hyaline bodies.

I have tried to study the constitution of the bodies contained in the protoplasm of *Trichonympha* and arrived at these conclusions—

- (1) all the circular bodies found in the endoplasm of *Trichonympha* are identical with the circular bodies found free in the intestine of the Termite :
- (2) the circular bodies with an internal substance of more or less irregular form are wood particles surrounded by a kind of hyaline secretion :
- (3) circular bodies with an internal substance more or less nucleiform are Termite leucocytes or nuclei of *Leidyia* that I have seen being phagocyted on more than one occasion by the *Trichonympha* ;
- (4) the circular hyaline bodies resembling fat drops which sometimes fill the endoplasm of *Trichonympha* seem to me to be fat drops or divisional masses of the protoplasm of cells and protozoa phagocyted by *Trichonympha* ;
- (5) some of the circular bodies that Leidy considered to be masses of spores are alimentary masses, well divided. Others . . . . .  
. . . .—but I must firstly tell what I have observed.

Three times only, in more than 100,000 parasites, once in the body of a *Trichonympha*, twice in that of *Leidyia*, I have seen small spheres, formed by a kind of rolled up thread (chromatic ?) and animated by such a vertiginous circular movement that their parasitic nature could easily be recognised. I saw nothing more than the vermicular stage and the spheric stage, following one another and the divisional phenomena that are represented in the Plate. The vermicular form pierces the body of its host and moves freely in the ground under the microscope. I cannot say if this *Trichonympha*'s parasite may constitute the evolutive



stage of some sporozoon and if what I observed belongs only to the sexual (male) element of this sporozoon. But as these elements are so discouragingly rare, I believe it will not be devoid of interest to call the attention of protozoologists to them, creating a new provisional genus *Enchelyspheroides*, whose etymology comprises both the stages I have observed. I will be glad if others are more fortunate than myself in being able to study the whole evolution of the parasite. I must add that these bodies have nothing to do with the trichocysts of Infusorians.

In protozoological literature I have found only three parasitic genera of Protozoa: *Metchnikowella*, Caull and Mesn. 1897, a parasite of Gregarines; *Hyalosaccus*, Keppene 1899, a parasite of Dinoflagellates; and *Chitridyopsis*, Aim. Schn., a parasite of the intestinal cells and of the Gregarine of *Blaps mortisaga*. My parasite has no similarity with these genera and has been provisionally named *Enchelyspheroides trichonympharum* (figure 41). This plate shows also three new\* species of parasites of *Leucotermes indicola*, belonging to the Infusoria: *Opalina termitis* and its divisions (figures 45-47), *Balantidium termitis* (figure 42) and *Nyctotherus fletcheri* (figures 48-49), well known genera upon which I will not make further remarks: I must only say that Dobell was in 1910 the first to describe his *N. termitis* (figure 50) in *Calotermes militaris* from Ceylon and my species of *Nyctotherus* to which I have associated the name of Bainbriggé Fletcher differs from that of Dobell not only by its size but also by the form of the meganucleus and the situation of the micronucleus.

You see in the same plate two figures more, about which I must give some explanations: one is my *Pyrsonympha grassii*, n. sp.\* (figure 43) of *Leucotermes indicola*, the other is Grassi's *P. flagellata* (figure 44), parasite of *L. lucifugus* of Italy, reproduced for comparison. There is nowadays a tendency to consider the genus *Pyrsonympha* as synonymous with *Dinynympha* and this comes from the fact that Leidy described under the name *P. vertens* not only this species but also some stages of *Dinynympha gracilis*. In 1893 Grassi created the family Pyrsonymphidæ with the following characteristics: flagella disposed in spiral lines, nucleus on the anterior extremity, no micronucleus, mouth or contractile vacuoles, ellipsoidal monaxomic body, asymmetric poles, locomotion by helicoidal movements.

---

\* Although referred to as new species in this paper, Captain Froilano de Mello has published descriptions of these novelties in a paper entitled "Os parasitas multiciliados do caria na Índia Portuguesa" in *Boletim de Agricultura*, Ano I, No. 2, pp. 131-147 (Nova Goa; April 1919) and this publication has precedence of the present paper.—  
*Editor.*

By these characteristics the family Pyrsonymphidae seems similar to that of Holomastigidae of França: but I think that the family Pyrsonymphidae must subsist with the following addition: axial filament, single or multiple.

Really, when we study the two species of *Pyrsonympha* described before me, we will see that in *P. vertens* Leidy describes "in addition to the undulatory lines of the surface of the body or the ciliary investment, another accessory to movement...usually seen more or less distinctly as a cord, narrow fold or doubly contoured line extending from one end to the other." On Plate 170, figure 79, I have reproduced the *P. vertens* of Porter, a figure extracted from Ray Lankester's Treatise on Zoology. This figure shows a "specialised (muscular?) band running through the whole length of the medulla." This apparatus I consider to be an axostyle.

In *P. flagellata* you see easily the axostyle apparatus, under the form of a curved cone, with the base turned to the inferior pole.

My *P. grassii* has all the characteristics of a *Leidya* but possesses an axostyle, whose disposition is quite contrary to that of *P. flagellata* and ending apparently near the nucleus to which the base of the axostyle seems to form a kind of cradle.

But in the family Pyrsonymphidae, Grassi included his genus *Holomastigotes*, which seems to me a doubtful genus and in every respect must belong to the family Holomastigidae; you will soon see the figures of *H. elongatum* of Grassi, a parasite of the Italian *Leucotermes lucifugus*.

In Plate 169, figures 51-56, are seen the figures of different positions of a new Infusorian for which I was obliged to create a new genus. I have gladly associated with it the name of França. Figure 51 represents the dorsal view, figures 52 and 53 the side views with the right lip very developed. Figure 54 shows the parasite seen with its mouth in a moment of dilatation, figure 55 the ventral face, and figure 56 the view from the inferior pole. The micronucleus is situated inside the meganucleus, the endoplasm is full of particles of wood and minute vacuoles. There is no anus. All the cilia are of the same length, excepting those of the mouth, which are longer. The striation of the body is helicoidal and the centre of this striation seems to be the nuclear region. I have named this parasite *Franciella termitis* and it belongs to the order of Heterotricha, suborder Polytricha, group Bursarina. The genus most closely allied to it is the genus *Bursaria*, whose typical species is *B. truncatella* of Fr. Muller.

Plate 170, figures 57-60, show the Trichonymphids of *Coptotermes travians* from Ceylon, briefly described by Professor Bugnion. You will see that numbers 57 and 58 are *Leidya metchnikowi*, number 60

*Tr. agilis*, number 59 seems also a *Tr. agilis* with the anterior extremity bent on a superior plane. As you know, Professor Bugnion did not identify any of the parasites from Ceylon Termites.

Trichonymphids have also been recorded by Professor Bugnion as found in the intestine of Termites of the genera *Glyptotermes* and *Termitogeton*. The five figures given by Professor Bugnion in his paper illustrating the description of *Termitogeton umbilicatus*, Hag., in the *Annales de la Societe Entomologique de France*. Volume LXXXIII (1914), belong to *Trichonympha agilis*.

Plate 170, figures 61-68, represent the parasites of *Arrhinotermes flavus* from Ceylon according to the figures of Professor Bugnion. You see also here *Tr. agilis* and *L. metchnikowi*. I cannot say to what species figure 66 may belong.

I will now show (Plate 170, figures 69-74) the parasites of *H. viarum* of Coimbatore from the slides prepared by Mr. Bainbrigge Fletcher. I could easily identify the species *Tr. agilis* and *L. metchnikowi*. But *H. viarum* contains numerous other species which can only be classified by a study *in loco*. I hope that one of the colleagues that honours me by hearing this lecture will apply himself to this task whose interest is recognized everywhere.

I have also reproduced (Plate 170, figures 80-87) the Trichonymphids of *Calotermes greeni*, as given by Professor Bugnion. I cannot identify them. These are certainly new genera to be described. But Professor Bugnion's figures have not the necessary neatness to encourage a classification. His descriptions are also too short. I must however, say that the circular form is common to all Trichonymphids *en état de souffrance* and it is not only on this morphology that an identification can be based.

Finally I must tell you that I have studied the parasites of two species of *Coptotermes* collected at Daman and Pragana, our possessions near Bombay. These species of *Coptotermes* have not yet been identified. That of Daman has the following fauna:—*Tr. agilis*, *Leidyia metchnikowi*, *L. annandalei*, *Opalina termitis*, and the common Spirochæte of white ants or *Treponema termitis*. The termite of Pragana has *Tr. agilis*, *Leidyia metchnikowi*, *L. annandalei*, *L. kempfi*, *Franciella termitis* and the same spirochæte that I have also found in two other species of Termites.

I am quite glad to see that *Tr. agilis* of both these species of Termites is just the same as the *Trichonympha* of *Leucotermes indicola* and I dare say that this protozoon in India and Ceylon has the same characteristics that I have already described.

True Trichonymphids belong to the class of *Mastigophora*. The absence of a micronucleus in some of them, the existence of basal granules

in the origin of the flagella, the absence of vacuoles, cirri or membranella, prove this assertion. The parasites that I have described—excepting the Infusoria that I specified—belong to the order of Hypermastigina of Grassi and Foa: forms usually large, with numerous flagella whose disposition is variable.

To render the systematization more comprehensible and less arid I have figured on Plate 170 the illustrations of different genera. You have there (figure 93) a *Stephanonympha* of Janicki, belonging to the family Calonymphidæ: large multinucleate forms, axial filaments present. To every nucleus corresponds one blepharoplast giving rise to one or more flagella.

You see also the *Jania annectens* of Grassi (figure 88), the *Lophomonas blattarum* of Stein (figures 91-92), single and in divisional stage, and *Caduceia theobromæ* (figure 94), a species described in the last year by França. They are all mononucleate forms, with an axial rod and a well developed basal apparatus—characteristics of the family Lophomonadidæ of Grassi.

You also see (figure 90) the *Gymnonympha zeylanica* of Dobell which, with *Tr. agilis*, belongs to the family Trichonymphidæ of Leidy: large mononucleate forms. No axial filaments.

The small figure you see, is a *Microjania hexamitoides* of Grassi, a flagellate of the family Octomitidæ (Plate 170, figure 89).

The family Holomastigidæ comprises mononucleate forms, without axial filaments, and numerous flagella inserted on spiral lines. The genera *Leidya* and *Holomastigotes* have been included in this family.

Finally the family Pyronymphidæ has been modified in this manner: mononucleate forms, with flagella inserted in spiral lines, simple or multiple axial filaments, no basal apparatus.

## ORDER HYPERMASTIGINA Grassi and Foa 1911.

## Families.

Calonymphidæ, Grassi	Lophomonadidæ, Grassi 1911	Trichonymphidæ, Leidy 1877	Pyronymphidæ, Grassi 1893	Holomastigidæ, França 1914
<i>Genera.</i>				
<i>Calonympha</i> , Foa 1905.	<i>Lophomonas</i> , Stein 1866.	<i>Trichonympha</i> , Leidy 1877.	<i>Pyronympha</i> , Leidy 1877 (pro parte).	<i>Pseudotrichonympha</i> , Grassi and Foa 1911.
<i>Stephanonympha</i> , Janicki 1911.	<i>Jania</i> , Grassi 1885.	<i>Gymnonympha</i> , Dobell 1910.	..	<i>Holomastigotoides</i> , Grassi and Foa 1911.
	<i>Caduceia</i> , França 1913. <i>? Leydonella</i> , Frenzel 1891.	..	..	? <i>Holomastigotes</i> , Grassi 1893. <i>Leidya</i> França 1914.



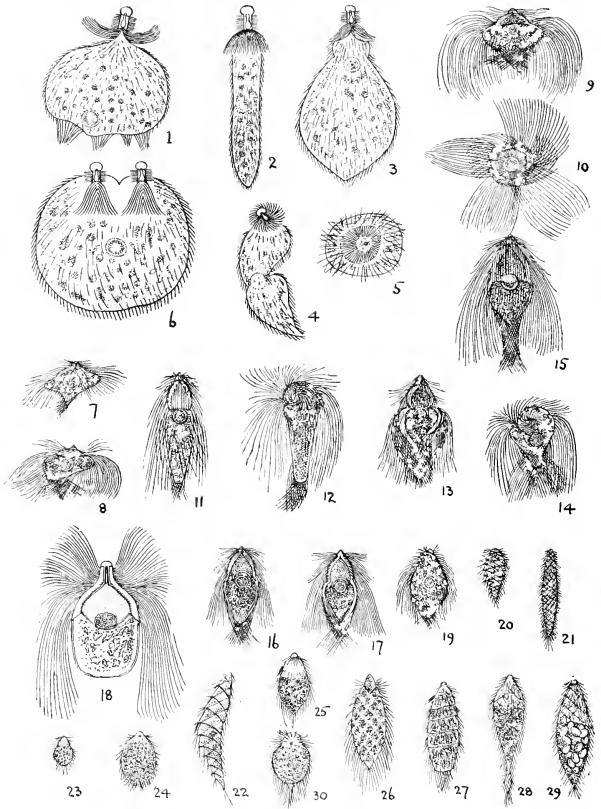

TRICHONYMPHID PARASITES OF TERMITES.



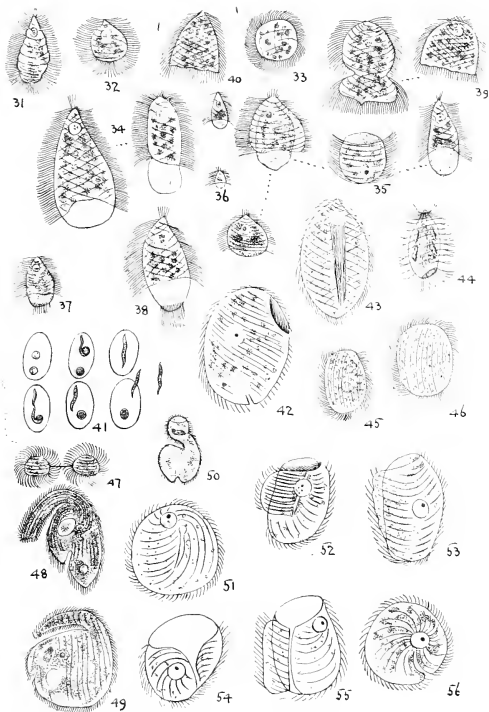

TRICHONYMPHID PARASITES OF TERMITES.





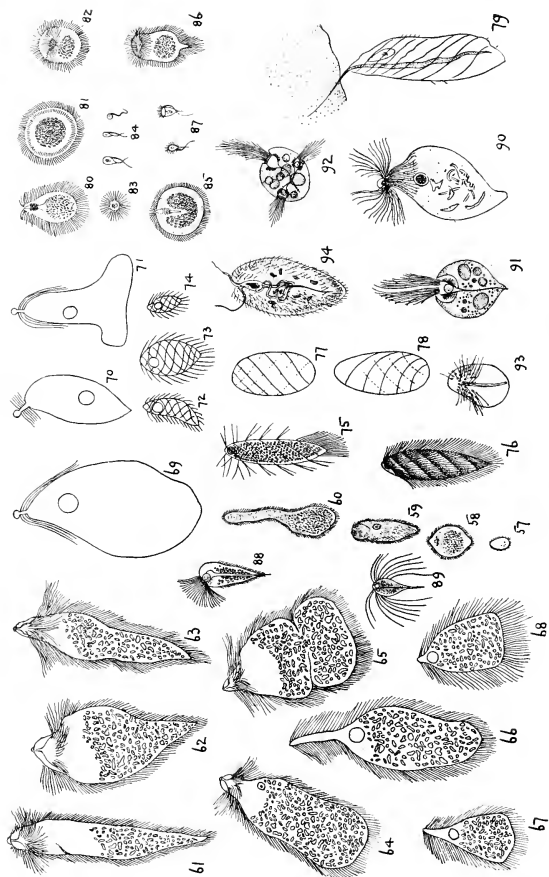

TRICHONYMPHID PARASITES OF TERMITES.

Ladies and Gentlemen, I must conclude. My great disadvantage comes from the fact that I am speaking a language that is not mine. But I know that you will pardon my mistakes.

Ladies and Gentlemen, I bring you the hearty salutations of the Nation, your oldest Ally, that since the first moment, when all was obscure and doubtful in the horizon, sided with you firmly decided to triumph or die with you. I bring you particularly the hearty greetings of the Portuguese Scientists and my personal feelings could be well expressed by the words of the Indian Poet :—

“*I was a foreigner and you have received me as a brother.*” And to reply to this courtesy I will now repeat the words of the great Shakespeare.

“*I speak as my understanding instructs me, and as mine honesty puts it to utterance.*”

We are much indebted to Captain Froilano de Mello for his interesting lecture and we all appreciate and reciprocate the complimentary allusions with which he has concluded. Mr. Fletcher.

It may be considered by some that the study of Protozoa, such as the Trichonymphid parasites of Termites, comes rather outside the scope of Entomology but in my opening Address at the beginning of this Meeting I pointed out how the study of such parasites may throw some light on the evolutionary history of the Termites themselves, and from this point of view we may take a just interest in such studies. This paper is important as being the first attempt to study these parasites in India, and I can only hope that it will lead to further researches along a most interesting line of work.

*Explanations of the Plates illustrating Captain Froilano de Mello's paper on the Trichonymphid parasites of some Indian Termites.*

PLATE 168.

- 1—4. *Trichonympha agilis*, different forms.
- 5. *T. agilis*, viewed anteriorly.
- 6. *T. agilis*, division process.
- 7—15. *T. agilis* (after Leidy, *Journ. Acad. Nat. Sci. Philad.* (2) VIII, t. 51, ff. 1—9)
- 16. *T. agilis* (after Leidy).
- 17. *T. agilis* (after Lankester, copied from Leidy).
- 18. *T. agilis* (after Grassi and Sandias, *Cost. Soc. Termitidi*, t. 5, f. 1).
- 19—30. The so-called young forms of *T. agilis* (after Leidy, *l.c.* t. 51, ff. 11—22).

PLATE 169.

- 31—33. *Leidyia metschnikowi*.
- 34—36. *Leidyia annandalei*.
- 37—38. *Leidyia kempii*.

*Explanations of the Plates illustrating Captain Frevilano de Mell's paper on the Trichonymphid parasites of some Indian Termites—contd.*

- 39—40. *Leidyia campanula*.  
 41. *Enchelyspheroides trichonympharum*.  
 42. *Bolantidium termitis*, n. sp.  
 43. *Pyrsonympha grassii*, n. sp.  
 44. *Pyrsonympha flagellata* (after Grassi).  
 45—47. *Opalina termitis*, n. sp.  
 48—49. *Nyctotherus fletcheri*, n. sp.  
 50. *Nyctotherus termitis* (after Dobell).  
 51—56. *Fraciella termitis*, n. g., n. sp.

## PLATE 170.

- 57—60. Trichonymphids from posterior intestine of *Coptotermes* (after Bugnion, *Mem. Soc. Zool. France* 1910, p. 114, fig. 1).  
 61—68. Trichonymphids from *Arrhinotermes flavus* (after Bugnion, *Mem. Soc. Zool. France* 1911, t. 3, ff. 6—13).  
 69—74. *Trichonympha agilis* from *Hodotermes viarum*.  
 75—78. *Holomastigotes elongatum* (after Grassi and Sandias, *l.c.*, t. 5, ff. 21—24).  
 79. *Pyrsonympha vertens* (after Ray Lankester).  
 80—87. Trichonymphids from *Calotermes greeni* (after Bugnion and Popoff, *Mem. Soc. Zool. France* 1910, t. 5).  
 88. *Jovnia annectens* (after Grassi and Sandias, t. 5, f. 6).  
 89. *Microjovnia hexamitoides* (after Grassi and Sandias, t. 5, f. 10).  
 90. *Gymnonympha zeylanica* (after Dobell, *Spolia Zeylan*, VII, t. 2, f. 1).  
 91. *Lophomonas blattarum* (after Minchin, *Introd. Study Protozoa* fig. 45a).  
 92. *L. blattarum*, dividing stage (after Minchin, *l.c.*, fig. 45c).  
 93. *Stephanonympha* (after Franca, *Soc. Port. Sci. Nat.* VIII, p. 8, fig. D1).  
 94. *Caduceia theobromæ* (after Franca, *l.c.*, t. 2, f. 1).

## 79.—GENITALIA OF SOME CEYLONESE HESPERIADÆ.

By W. ORMISTON, F.E.S.

(Plates 171—172.)

The leading work on this Family is still "A revision of the Oriental Hesperidiæ" by Messrs. Elwes and Edwards. Unfortunately the authors had apparently few Ceylon specimens to examine and so I fear that several of our species will require renaming.

Their work mainly decides questions of specific identity by an examination of the prehensorés of the males, and the authors point out "that a very considerable practice in making this examination and great experience in estimating the value of the characters observed, are necessary to form an opinion on the subject." I confess that I have



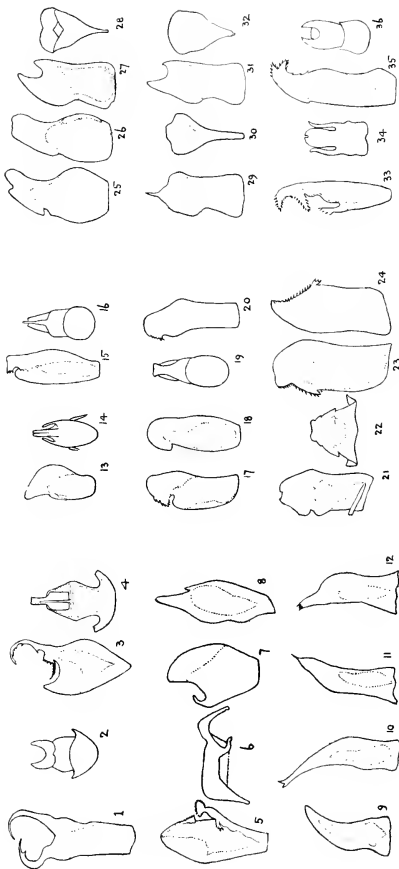

GENITALIA OF CEYLONESE HESPERIIDÆ.

had no previous experience, but the sketches in the Plates exhibited herewith are, in nearly every case, the result of the examination of a large number of specimens. In no case was the sketch made from a single specimen. I am sending a set of my slides to the Colombo Museum where anyone interested can examine them. They include all the Ceylon Hesperidae with the exception of *C. spilothyrus* and *G. albofasciata*. When removed from the body of the insect and dried, the clasps almost invariably shrivel and curl up, thus entirely altering their outlines as seen under a microscope. I have, therefore whenever possible, used perfectly fresh undried specimens for my sketches. In cases where there are only slight differences between the prehensores of two forms it is necessary to examine a large number of each, to ascertain if these differences are permanent or only casual variations. For instance, with regard to *Padraona dara*, Messrs. Elwes and Edwards write that Mr. Edwards dissected "fifteen specimens from different localities, and found considerable variation in degree, but no differences which can be regarded as specific." Lieutenant-Colonel Evans in his notes on Indian butterflies (*Journal of the Bombay Nat. Hist. Socy.*) says that he examined 23 males in his collection and found he had five species. I have dissected over 100 Ceylon specimens, and I find two very distinct forms which show no signs of grading and extremely slight internal variation. (See Pl. 171, figs. 27-31.) I believe there is also a third but I have been unable, so far, to obtain sufficient specimens to prove that it is not merely a variety or seasonal form. (See Pl. 171, figs. 31, 32.) By the courtesy of Mr. F. Hannyngton, I.C.S., I have been able to dissect a few specimens from Coorg and found two forms among them which are very distinct from anything I have seen in Ceylon. Apparently this group is split up into numerous local races, and, so far as my experience goes, the prehensores will be found a more constant and reliable means of separating them than the colouration of the wings. I believe that similar local races also occur in the *philippina* and *kumara* groups of the genus *Parnara*. A question which arises is whether differences in colour caused by climatic influences are accompanied by changes in the prehensores. This of course can only be settled by breeding experiments. For instance, Indian writers treat *Caprona saraya* as a seasonal form of *C. ransonnetti*, although Messrs. Elwes and Edwards point out that their clasps differ considerably.

In Ceylon *C. siamica* shows an almost similar divergence from *C. ransonnetti* and would therefore, I presume, be treated as a seasonal form. I have examined about a dozen specimens of *C. siamica* and have, so far, found no signs of grading in the clasps and am therefore inclined to regard it as distinct. (See Pl. 171, figs. 9, 10, 11 and 12.)

To satisfactorily settle the status of our Ceylon species and races it will be necessary to examine a large number of allied Indian forms, especially from South India, and I shall be very grateful to any Indian collectors who will send me specimens for dissection.

Mr. Fletcher.

In this paper we come again on the question, which arose several times during the discussion of several Lepidopterous pests during the earlier part of this Meeting, of the separation of superficially-similar forms by means of distinct differences in the male genitalia. The Hesperiadæ form an especially difficult group for the discrimination of species in the ordinary way and we must welcome Mr. Ormiston's work on the separation of the Sinhalese species as a solid contribution to the subject. I would therefore call your particular attention to his appeal for specimens of Hesperiadæ from Southern India especially, and would ask you to send him for examination any specimens that you can spare, as further comparison of the forms occurring in India and Ceylon cannot but improve our knowledge on this subject.

*Explanation of Plates 171—172 illustrating "Genitalia of some Ceylonese Hesperiadæ."*

1. <i>Hantana infernus</i>	. . .	Inner face of clasp.
2. Ditto	. . .	Dorsal aspect of tegumen.
3. <i>Tapena thuraitesi</i>	. . .	Inner face of clasp.
4. Ditto	. . .	Dorsal aspect of tegumen.
5. <i>Coladenia tissa</i>	. . .	Inner face of clasp.
6. Ditto	. . .	Lateral aspect of tegumen.
7. <i>Tagiades distans</i>	. . .	Inner face of clasp.
8. <i>Tagiades atticus</i>	. . .	Ditto.
9 & 10. <i>Caprona ransonnetti</i>	. . .	Inner face of clasps.
11 & 12. <i>Caprona siamica</i>	. . .	Ditto.
13. <i>Sarangesa albicilia</i>	. . .	Inner face of clasp.
14. Ditto	. . .	Dorsal aspect of tegumen.
15. <i>Baracus vittatus</i>	. . .	Inner face of clasp.
16. Ditto	. . .	Dorsal aspect of tegumen.
17. <i>Suastus gremius</i>	. . .	Inner face of clasp.
18. <i>Suastus minuta</i>	. . .	Ditto.
19. Ditto	. . .	Dorsal aspect of tegumen.
20. <i>Hyarotis adrastus</i>	. . .	Inner face of clasp.
21. <i>Matapa aria</i>	. . .	Ditto.
22. Ditto	. . .	Dorsal aspect of tegumen.
23. <i>Paduka lebaeu</i>	. . .	Inner face of clasp.
24. <i>Gangara thyrasis</i>	. . .	Ditto.
25. <i>Telicota bambuse</i>	. . .	Ditto.
26. <i>Telicota augias</i>	. . .	Ditto.
27. <i>Padraona pseudomorsu</i>	. . .	Ditto.



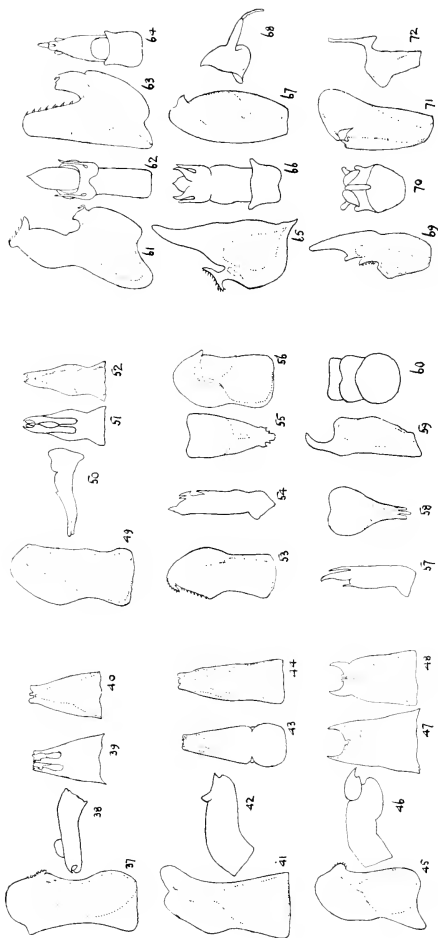

GENITALIA OF CEYLONESE HESPERIIDÆ.



*Explanation of Plates 171—172 illustrating "Genitalia of some Ceylonese Hesperidae"—contd.*

28.	<i>Padraona pseudomæsa</i>	. . . . .	Dorsal aspect of tegumen.
29.	<i>Padraona mesioides</i>	. . . . .	Inner face of clasp.
30.	Ditto	. . . . .	Dorsal aspect of tegumen.
31.	<i>Padraona dara?</i>	. . . . .	Inner face of clasp.
32.	Ditto	. . . . .	Dorsal aspect of tegumen.
33.	<i>Halpe ceylonica (or egea)</i>	. . . . .	Lateral aspect of tegumen.
34.	Ditto	. . . . .	Dorsal aspect of tegumen.
35.	<i>Halpe decorata</i>	. . . . .	Inner face of clasp.
36.	Ditto	. . . . .	Dorsal aspect of tegumen.
37.	<i>Bauris pencillata</i>	. . . . .	Inner face of clasp.
38.	Ditto	. . . . .	Lateral aspect of tegumen.
39.	Ditto	. . . . .	Dorsal aspect of tegumen.
40.	Ditto	. . . . .	Ventral aspect of tegumen.
41.	<i>Parnara kunara</i>	. . . . .	Inner face of clasp.
42.	Ditto	. . . . .	Lateral aspect of tegumen.
43.	Ditto	. . . . .	Dorsal aspect of tegumen.
44.	Ditto	. . . . .	Ventral aspect of tegumen.
45.	<i>Parnara seriata</i>	. . . . .	Inner face of clasp.
46.	Ditto	. . . . .	Lateral aspect of tegumen.
47.	Ditto	. . . . .	Dorsal aspect of tegumen.
48.	Ditto	. . . . .	Ventral aspect of tegumen.
49.	<i>Parnara narcom</i>	. . . . .	Inner face of clasp.
50.	Ditto	. . . . .	Lateral aspect of tegumen.
51.	Ditto	. . . . .	Dorsal aspect of tegumen.
52.	Ditto	. . . . .	Ventral aspect of tegumen.
53.	<i>Parnara bolia</i>	. . . . .	Inner face of clasp.
54.	Ditto	. . . . .	Lateral aspect of tegumen.
55.	Ditto	. . . . .	Dorsal aspect of tegumen.
56.	<i>Parnara cingala</i>	. . . . .	Inner face of clasp.
57.	Ditto	. . . . .	Lateral aspect of tegumen.
58.	Ditto	. . . . .	Dorsal aspect of tegumen.
59.	<i>Ismen ataphus</i>	. . . . .	Inner face of clasp.
60.	Ditto	. . . . .	Dorsal aspect of tegumen.
61.	<i>Parata bulleri</i>	. . . . .	Inner face of clasp.
62.	Ditto	. . . . .	Dorsal aspect of tegumen.
63.	<i>Parata alexis</i>	. . . . .	Inner face of clasp.
64.	Ditto	. . . . .	Dorsal aspect of tegumen.
65.	<i>Hasara badra</i>	. . . . .	Inner face of clasp.
66.	Ditto	. . . . .	Dorsal aspect of tegumen.
67.	<i>Rhoplocampta benjamini</i>	. . . . .	Inner face of clasp.
68.	Ditto	. . . . .	Lateral aspect of tegumen.
69.	<i>Bibasis sena</i>	. . . . .	Inner face of clasp.
70.	Ditto	. . . . .	Dorsal aspect of tegumen.
71.	<i>Bulamia exclamationis</i>	. . . . .	Inner face of clasp.
72.	Ditto	. . . . .	Lateral aspect of tegumen.

80.—ON THE BOLLWORM PARASITE DESCRIBED AS *RHOGLAS LEFROYI* BY DUDGEON AND GOUGH.

By PROFESSOR CHARLES T. BRUES (*Harvard University*).

In the *Agricultural Journal of Egypt* for 1914 (Vol. 3, part 2, pp. 108-110) Dudgeon and Gough described two Braconid parasites of the Egyptian bollworm (*Earias insulana*) which they referred to the genus *Rhogas*. Specimens presumed to be *R. lefroyi* had been given this manuscript name previously by Ashmead.

Recently, T. Bainbrigg Fletcher, Esq., the Imperial Entomologist of India, sent me a number of specimens bred from the bollworm in India asking me if I thought all were of the same species and whether they were *Rhogas lefroyi*. A comparison of the specimens with the short description of *R. lefroyi* and the photograph of the wings which accompany it, show them to agree very well, and they seem unquestionably to be the species described by Dudgeon and Gough. They do not, however, belong to the genus *Rhogas*, but are referable to *Microbracon*. It is evident from Dudgeon and Gough's original figure also that they cannot belong to *Rhogas* as the submedian cell in the hind wing is very short and in the front wing is the same length as the median, while the basal vein is almost perpendicular to the costa and not strongly oblique as in *Rhogas*. From the description the antennæ also are of a different conformation from those of *Rhogas*.

It appears therefore that this insect must be known as *Microbracon lefroyi* and that the other species described in the same publication as *Rhogas kitcheneri* is probably also a *Microbracon*. There is of course a possibility that the species may have previously been described, although I have not been able to find that this is the case. In order to make the species more easily recognizable I have drawn up the following description from the specimens forwarded by Professor Fletcher.

*Microbracon lefroyi*, Dudgeon and Gough.

*Agric. Journ. Egypt*, vol. 3, pt. 2, p. 109 (1914) (*Rhogas*).

*Female*. Length 2.3 mm.; ovipositor slightly longer than the abdomen, but not quite so long as the abdomen and propodeum together. Body honey-yellow, varied with black and piceous, legs usually somewhat lighter and the sides of the abdomen often much paler. Black markings variable; in melanic specimens they include spot on front above base of antennæ, ocellar space, occiput, antennæ, stripe on each of the three lobes of mesonotum, scutellum, propodeum irregular marks on pleuræ, abdominal segments three to five, except narrow lateral

border, and sheaths of ovipositor; in light specimens the entire body is pale honey-yellow with only the flagellum of antennæ, tips of mandibles, ocellar triangle, clouds on the second and third segments, and ovipositor black, piceous or brown. Wings faintly to distinctly tinged with brown, the stigma and veins fuscous. Antennæ 25- to 27-jointed, the joints slightly decreasing in length to apex, the basal ones barely twice as long as thick. Mesonotum shagreened, scutellum shining; propodeum distinctly shagreened, but often more nearly smooth basally toward the middle, without median carina except at extreme apex which is finely areolate; mesopleura finely shagreened, with a narrow polished strip along its posterior margin. Abdomen broadly oval or nearly circular in outline; first segment twice as wide at apex as at base, posterior corners separated by deep grooves, median field triangular; second segment four times as broad as long, with an obsolete median carina; third segment a little longer than the second; following shorter; entire abdomen except corners of first segment finely roughened, without distinct punctures or reticulations, except sometimes on the second and third segments near the middle; second suture finely crenulate. Wings as figured by Dudgeon and Gough (*loc. cit.*).

*Male.* Length 2 mm. Similar to the female with the antennæ 24-25-jointed and the head and thorax generally darker; the abdomen has the sixth segment black and lacks almost all the yellow at the sides although the first two segments are yellow and usually paler than in the female.

There is an enormous amount of colour variation in the large number of specimens examined, a slight variation in the number of antennal joints and in the sculpture of the propodeum and abdomen but none of these seem to be in any way definite or correlated.

*Microbracon* sp.

In the lot of bollworm parasites are two males from Pusa (3 XII. 15; T. Ram), easily distinguishable from the foregoing. The head is pale yellow with black markings, the antennæ 29-jointed, the propodeum bears a median carina and the abdomen is coarsely somewhat irregularly longitudinally striate. In the absence of the female, it would be hazardous to attempt to identify it.

This redescription of *Microbracon lefroyi* will be useful to Indian workers, but I may add that we at Pusa are not quite ready to agree that all the specimens of *Microbracon* parasitic on *Earias* belong to *M. lefroyi*. Indeed, as you will see, Professor Brues considered two specimens to represent a distinct species. When this redescription

Mr. Fletcher.

came to hand, we went over all our material and made out that we had at least four or five species of *Microbracon*, differing in habits as well as in appearance and structure, and all reared from *Earias*, as well as several other doubtfully distinct species reared from hosts other than *Earias*. I may remark here that it is important for us to know in what other hosts the *Earias*-infesting species are capable to breeding. All this material, representing the collections made from rearing during many years, was sent to Professor Brues with a letter pointing out the differences which we believed to exist; but unfortunately this parcel was lost by submarine action and the whole of our collection was lost. I mention this because, if he had received this second collection, it is just possible that Professor Brues might have modified this paper to some extent. As it is, we must wait until we can secure more extensive material from known hosts.

#### 81.—SOME RECENTLY NOTED SOUTH INDIAN MELOLONTHIDÆ OF ECONOMIC IMPORTANCE.

By P. V. ISAAC, Assistant to the Government Entomologist, Madras.

Under the term *Melolonthidæ* there are included for the purposes of this paper the four important sub-families of *pleurostictæ* *Scarabæidæ*, namely:—

- (1) *Cetonianæ*.
- (2) *Dynastinæ*.
- (3) *Rutelinae*.
- (4) *Melolonthinæ*.

When in the summer of 1916 reports were received of damage to cinchona seedlings by white grubs in the Government cinchona plantations at Dodabetta (8,000 feet) in the Nilgiris, the study of *Melolonthidæ* received fresh importance; and the appearance in 1917 of the volume on *Rutelinae* in the *Fauna of India Series*, has been of much help in sustaining the interest in the group.

The species which have in recent times come into prominence are:—

##### *Cetonianæ*.

(1) *Anthracophora crucifera*, Oliv. This beautiful insect has been found commonly on *Lantana* flowers and *cholam* inflorescence in Coimbatore.

(2) *Protætia aurichalcea*, F. This also has been found at Coimbatore both on *Lantana* and *cholam* flowers.

*Rutelina.*

*Popillia chlorion*, Newm. This little shining green insect is a pest in its larval stage on cinchona roots in Dodabetta.

*Melolonthinæ.*

(1) *Holotrichia repetita*, Sharp. This was found in large numbers in the soil in the cinchona plantations at Dodabetta. The grubs injure the roots of young cinchona plants.

(2) *Holotrichia* sp. This is of the same general appearance as *H. repetita* but is slightly smaller. This was found in great abundance in the cinchona plantations at Dodabetta, in the ground, awaiting the South-West-Monsoon to fly out. These are injurious to cinchona seedlings in the larval stage.

Both these species of *Holotrichia* were caught in large numbers in light traps.

From individuals of both species confined in cages it was found that they lay small white eggs singly and that each female can lay about 100 eggs.

(3) *Holotrichia rufoflava*, Brs. This was taken near roots of orange plants at Coimbatore. It is believed that the grubs of the species ate off the bark, just below ground level, from orange plants and caused their death.

(4) *Serica nilgirensis*, Shp. The larvæ of these were found in company with those of the two *Holotrichias* mentioned above at roots of cinchona seedlings.

It is hoped to do more work on the group, now that it is safe to transmit specimens to, and receive communications from, experts abroad.

This paper might have been taken earlier when we were discussing **Mr. Fletcher.** crop-pests. There does not seem to be much systematic work in it, although the title was communicated for inclusion in the programme under the head of Systematic Entomology.

In Sylhet I found the bark of orange-trees eaten away near the **Mr. Ghosh.** ground by something. I could not associate this with an insect. It might have been due to some bacterial or fungal disease.

At Coimbatore we were able to observe fresh cuts from day to day **Mr. Isaac.** and the only thing found near these were the Melolonthid grubs.

Species of *Holotrichia* are common girdlers and are also accompanied **Mr. Beeson.** by *Adoretus* and one cannot differentiate their work. I am not, however, in a position to add any definite observations.

## 82.—NOTES ON TWO PSYLLID GALLS EXHIBITED, WITH REMARKS ON INDIAN PSYLLIDÆ.

By T. V. RAMAKRISHNA AYYAR, B.A., F.E.S., F.Z.S., *Acting Government Entomologist, Madras.*

(Plate 173.)

Unlike other minor groups of insects it is gratifying to note that the group of jumping plant-lice or Psyllidæ has been studied to some extent in India. The previous records are chiefly by Buckton and Kieffer and latterly by Dr. Crawford. I am sorry I have not been able to see Kieffer's "Monograph of Gall-making Psyllids" published in the *Annals of the Brussels Entomological Society* in 1905, which would certainly have helped in preparing this note, and also given us information as to whether these galls are recorded by him. The early records of Indian Psyllids to which we have easy access are in the pages of *Indian Museum Notes* by Buckton and latterly in the pages of the *Records of the Indian Museum* by Crawford.

The following species have so far been noted :—

- (1) *Psylla cistellata*, Buckt., on mango shoots; Dehra Dun (*I. M. N.* III, 1, p. 13).
- (2) *Pemphigus ædificator*, Buckt., on *Pistacia terebinthus*; Baluchistan (*I. M. N.* III, 1, p. 71).
- (3) *Phacopteron lentiginosum*, Buckt., on *Garuga pinnata*; Poona and Dehra Dun (*I. M. N.* III, 5, pp. 18-19).
- (4) *Psylla obsoleta*, Buckt., on *Diospyros melanoxylon*; Bombay (*I. M. N.* V, 2, p. 35).

In Lefroy's *Indian Insect Life*, Plate LXXX, we have figures of two other undescribed species making galls on *Alstonia scholaris* and *Ficus glomerata*. There is another species of Psyllid we have in Coimbatore, a pretty bad pest of a species of garden *Cardia*; it does not however make any prominent gall-like structure on the plant. This Crawford has named *Euphalerus citri* (probably it is the same as found on *Citrus* plants elsewhere).

The two kinds of galls just before you are :—

- (1) That of *Phacopteron lentiginosum* on *Garuga pinnata* from pepper gardens in North Malabar. As you see, the leaves are very badly galled and in the worst cases the plants show nothing but these cylindrical, ovoid or finger-like galls which often give the appearance of a cluster of



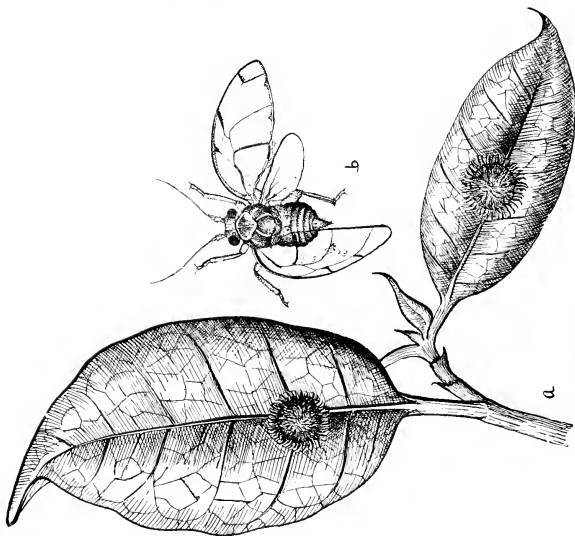

Fig. 1.—Psyllid galls on *Ficus nebrota*: a, twig with two leaves each bearing a gall ( $\times \frac{3}{4}$ ); b, adult Psyllid, magnified ( $\times 6$ ).

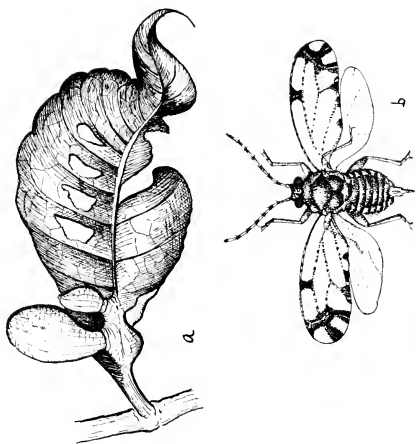

Fig. 2.—*Phacopteris lentiginosum*: a, galls on leaf of *Garriga pinnata* ( $\times \frac{3}{4}$ ); b, adult ( $\times 7$ ).





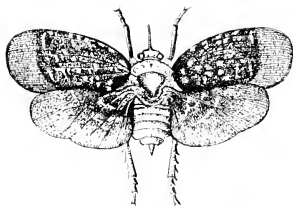

Fig. 1.—*Kalidasa sanguivalis*.

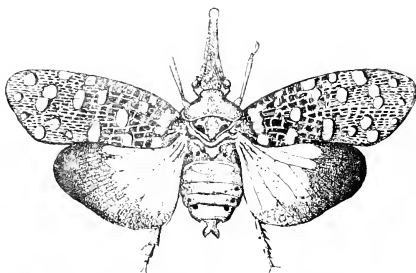

Fig. 2.—*Falyora candelaria*. Natural size.



Fig. 3.—*Ricania bicolorata*. Twice natural size.

fruits (*see* fig. 2). The galls in nature have a pale yellowish-green appearance with a tinge of reddish-brown. Often the plant, which is occasionally used as a standard to train the pepper vine on, suffers very much from this Psyllid.

- (2) The other is the gall caused by an undetermined species; and although I have consulted Crawford's "Monograph of American Psyllidæ" I have not been able to find any figures or descriptions that would apply to this interesting species. I have sent it on to Dr. Crawford for correct identification. The gall made by this insect is very curious and beautiful (*see* fig. 1). It was found on a wild shrub, *Ficus nervosa*, in the Taliparamba forest in North Malabar. Any casual observer will surely mistake the gall for some natural outgrowth of the plant. The galls are attached to the mid-rib of each leaf and commonly on the upper surface. In structure it is oval covered over with hairy and villose processes of plant tissue. In nature it is greenish in colour with a mixture of light yellow. The galls are not very unlike that shown in plate 5 of *Ind. Mus. Notes*, V. 2, caused by *Psylla isitis*, but certainly shows differences.

The object of this note is simply to create if possible an interest in this very interesting study of insect galls in India.

*Phacopteron lentiginosum* is common in all forest areas, not only in **Mr. Beeson**.  
Dehra Dun and Poona.

In Travancore *Garuga pinnata* is popularly called the Mosquito- **Mr. Isaac**.  
tree as it is believed to give birth to mosquitos from its limbs.

This tree is of no economic importance. On account of this Psyllid **Mr. Ramakrishna**  
only galls are found and we do not see any leaves on it when it is attacked **Ayyar**.  
in this way.

The whole subject of galls and gall-makers in India is one which **Mr. Fletcher**  
requires investigation. It is a very wide subject which is at present  
awaiting workers to take it up. One comes across the most curious  
galls at times. I have here [*exhibited*] a photograph of a gall which  
occurs commonly on *Quercus griffithii* at Shillong; as you will see, it  
forms a curious sort of rosette something like an unexpanded thistle-  
flower. Another gall which I found at Shillong last year was on leaves  
of *Rubus assamensis* and resembled a small spiny sea-urchin; from  
this I bred a Cecidomyiad fly.

## 83.—NOTE ON SOME SWARMING FULGORID BUGS.

By T. V. RAMAKRISHNA AYYAR, B.A., F.E.S., F.Z.S. *Acting Government Entomologist, Madras.*

(Plate 174.)

Though it is a common sight to find swarms of small bugs like species of *Idiocerus*, *Helopeltis*, *Calocoris*, *Empoasca* and other minute forms, I have not seen bugs of fairly large size as the ones I am referring to in this note appearing in such numbers, and it is to know from you whether any one else has noted these insects in such numbers that I speak about these to-day.

The three Fulgorid bugs are :—

1. *Fulgora delesserti*. Guer. Species of this genus of large beautiful bugs are regarded as more or less rarities. In October 1917, while out on a collecting trip to the foot of the Nilgiris, I accidentally came across this insect in large numbers. About twenty or thirty of them were always found perched on the bark of the stem of huge trees, chiefly *Ailanthus excelsa* and *Terminalia bellerica*. The peculiar colouration of the tegmina and the head protects them easily and it is very difficult to find them on these tree stems even when they are in numbers. Once disturbed, all fly away and it was found rather difficult to catch them unless very carefully netted.

2. The other bug, also a Fulgorid, is *Kalidasa sanguinalis*, Westw. (fig. 91 of Dist. Vol. III). This is a smaller form and has more or less sanguineous colour. Numbers of this bug were also found always in the same situations as the *Fulgora*. (Plate 174. fig. 1.)

The same thing—these two bugs found in company—was observed later on in Ganjam. In this case the species of *Fulgora* was *F. candidaria*, Linn. (fig. 82 of Distant, Vol. III). (Plate 174. fig. 2.)

3. The third one is a species of *Ricania*—those bugs which have fairly large dark wings with pale white transparent blotches on them. The species concerned here is *R. bicolorata*. (Pl. 174. fig. 3.) In the months of April and May this bug is found in thousands on almost every plant along the mountain railway line running from the foot of the Ghats up to Hillgrove or Coonoor. I believe Mr. Dutt has seen this when he came down to Madras last time.

[*Specimens of the bugs were exhibited.*]

Mr. Fletcher.  
Mr. Ramakrishna  
Ayyar.

Did you find any Epipyropidae on these Fulgorid bugs ?

I am sorry to say I did not look for them.



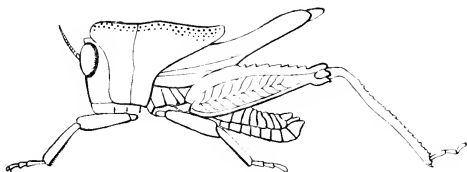

*Phyllochoreta ramakrishnai*, Bol. ( $\times 3$ ).



*Fulgora candalaria* does not seem to be a very common species as a rule. I have not come across it myself in India although I found it in Hongkong twenty years ago. Did you observe any special function of the cephalic prolongation?

Mr. Fletcher.

Mr. Ramakrishna Ayyar.

No.

Fulgorids are known to transmit fungal or bacterial diseases to plants. Work is being done in the sandalwood areas on the spike disease of sandal in this connection.

Mr. Beeson.

Another point of interest about these Fulgorid bugs is their supposed luminosity. *Fulgora candalaria* was so called because it was supposed to be luminous. I think it was Madame Merian in Surinam about two hundred years ago who recorded that some of these bugs were found to be luminous when the box containing them was opened in the dark, but since then no authentic corroboration of this statement seems to have been obtained. I made inquiries at Hongkong but was unable to obtain any confirmation of this supposed luminosity. The luminosity, if it does really occur, may be the result of bacterial disease and not to the action of photogenic organs.

Mr. Fletcher.

#### 84.—EUMASTACINÆ FROM SOUTH INDIA.

By T. V. RAMAKRISHNA AYYAR, B.A., F.E.S., F.Z.S., *Acting Government Entomologist, Madras.*

(Plate 175.)

In exhibiting herewith some specimens of these curious insects collected from South India I would add a few remarks.

The group Eumastacinae is, as most of you know, a sub-family of the well-known Orthopterous family Acridiidae. The insects included in this sub-family are all very curious and abnormal in structure as compared with other grasshoppers (*see figure*).

The striking features of these insects are the extreme shortness of the antennae, the curious posture and structure of the wings (some are apterous) and the peculiar leaflike projected formation of the prothorax in some forms. Almost all of them are comparatively small in size, ranging from half an inch to not more than a couple of inches in length. Almost all the Indian species recorded are from the Hills of Burma, Kashmir and South India.

Mr. Kirby in his Fauna Volume on *Acridiidae* has described all the forms known up to 1914. Since then Candido Bolivar has described three new South Indian forms, from some material we sent from Madras,

in the Spanish journal *Trab. Del Museo Nac. de Cienc. Nat.* (Ser. Zoológica, Num. 16) (1914). These three species are *Phyllocoreia ramakrishnai* and *Bennia burri* from the Western Ghats, South Kanara, and *Mastacides nilgirisicus* from the Nilgiris.

Extremely little is known of the bionomics of these extraordinary creatures. I found them in damp localities on hill-sides and on low-growing brushes. Their peculiar slow and sudden movements often reminded me of the chameleon. I have not seen any of these in flight, but they hop about very effectively. Some of them have very good protective colouration—green, brown or speckled to suit the surroundings. I believe they are plant feeders, since I found one or two species feeding on *Terminalia* leaves.

Though these do not appear to be of any economic importance so far noted, this is a group of insects worth studying, as almost nothing is on record regarding the life-history or habits of these insects.

Mr. Ramakrishna  
Ayyar.

I have here [*exhibited*] some specimens of Eumastacinae.

Incidentally I would plead for a catalogue of our own as the figures of this group in the Fauna volume are not reliable on account of their being ascribed to the wrong species.

Mr. Fletcher.

We have very few specimens of these grasshoppers in the Pusa collection. I got a few when I was in Burma and Ramachandra Rao has collected a few during the course of his *Lantana* deputation.

Mr. Ramakrishna  
Ayyar.

The description of these species was published in a Spanish journal. It took me three years to get it translated.

Mr. Fletcher.

You say that almost all the species recorded from India are from the Hills of Burma, Kashmir and Southern India. I do not know about Kashmir, but my Burmese specimens were taken at a comparatively low elevation on the railway-line between Maymyo and Lashio, and I note that two of your species were taken at Taliparamba and Tamarasseri, neither of which are at any height above sea-level. When I was in Ceylon I remember finding one species at Trincomali also and that is at sea-level.

#### 85.—SUGGESTIONS REGARDING PUBLICATION OF COMMUNICATIONS ON ENTOMOLOGICAL SUBJECTS.

By C. C. GUOSH, B.A., *Assistant to the Imperial Entomologist.*

It is intended in this paper to deal with a few points regarding the existing facilities for publication of communications on entomological

subjects, to point out how far the existing publications satisfy the needs of different classes of readers and to discuss whether there is room for a publication solely devoted to entomology in India.

Readers of entomological publications may be placed under two categories:—(1) entomologists and (2) non-entomologists, *i.e.*, the lay public. In the first category are included the workers in as well as outside India. The departmental Memoirs and Bulletins, and the journals dealing with zoological matters generally, such as the *Journals* of the Asiatic Society and the Bombay Natural History Society and *Records* of the Indian Museum at Calcutta are accessible to this class. All these publications afford ample facilities for publishing all communications on entomology, but as none of them, except the Departmental Memoirs and Bulletins, is solely devoted to entomology, the comparatively small entomological contributions are buried among the more voluminous matters dealing with general zoology. Besides, these publications are hardly available to the Provincial Entomological Assistants working in the mofussil. The Departmental Memoirs and Bulletins are meant to be records of work which is more or less complete and which is either of too popular or too technical a nature. The time has therefore arrived to consider whether it will be useful to have a periodical publication solely devoted to Entomology, in which reports of observations and investigations, of trials of preventive and remedial experiments, notes on life-history and similar matters, which cannot by themselves form the subjects for separate Bulletins and Memoirs, can be published. Such matters are extremely important and in fact form the bricks with which the edifice of Economic Entomology in India has to be built up. At present only a very small proportion of such observations, etc., is actually recorded. Out of this recorded matter again only a small proportion is actually published and that too in such a scattered manner, in Departmental leaflets, annual administration reports, provincial year-books, and the pages of the Asiatic Society and Bombay Natural History Society's *Journals* in India as well as of various journals outside India, that it is hardly accessible to all workers. Even if a worker is enthusiastic enough to collect this scattered information from all these various and not easily accessible sources, much of it is necessarily brief and incomplete and not as valuable as it may be and ought to be, because in administration reports and even in the annual reports of the Entomological Department much room cannot be provided for detailed treatment.

Mere records of catches are useful; descriptions of the methods used in collecting are highly interesting; observations of habits in actual field conditions in nature are extremely valuable; and the workers

engaged in field investigations throughout the country have ample opportunities of contributing to our knowledge in these matters. But for want of facilities for publication either such things are not recorded nowadays or even if recorded they are consigned to files. After a time the interest due to freshness of the observation becomes stale even to the observer himself and he gradually loses the stimulus of recording his observations. If he knows that there is an organ which is his own and in which all things, interesting and useful, however small and described however briefly, will find a corner under his own name, he is not likely to let slip any opportunity for observations and recording them. A person not in the habit of recording them will be tempted to do so when he sees his fellow workers doing it and getting the credit for it. The healthy rivalry which will thus be evoked will be of immense benefit to Economic Entomology in India. This will also improve the quality of the work. When one is going to put down a thing in black and white for publication, under all the chastening influences of the prospect of criticism, one is naturally compelled to go deeper into it.

A publication of the nature suggested here will be of very great use to the working entomologists as it will be a sort of a meeting ground for them and serve the purpose of a perpetual conference of the kind in which we have been partaking at present. A record of observation on a particular insect in a particular aspect in one Province will evoke interest in it and lead to observations on that aspect in the other Provinces. Besides it frequently happens that more than one of us are engaged on the same problem in different Provinces. We follow our own lines in complete ignorance of what others are doing or what progress has been made. The suggested journal will remedy this defect. It may be argued that we may co-operate through correspondence. But this is only possible when we know what others are doing and at present there is no means of distribution of this knowledge. Besides some workers may justly look forward to recognition. Recognition of one's efforts however insignificant always acts as a stimulus and the proposed journal will give an incentive to young entomologists when they see that their efforts are being recognized. In this manner many things will come to light, which although probably small in themselves, may form important links for work another may be doing. We therefore see that a journal solely devoted to the subject of entomology is not only desirable but will serve a very useful purpose in furthering the work of the economic entomologists in this country. To begin with, it may form a part of the *Agricultural Journal of India* or can be issued as a separate publication under a distinctive name such as the "*Indian Entomologist*." A separate publication would of course

be preferable even though it be of a small size and issued as a quarterly or even a half-yearly magazine. There will be no want of materials for it. The following among other sources can be mentioned here :—

- (1) Records of observations of the kind pointed out above and which all entomological workers have the opportunity of making but very few of them at present make.
- (2) Reports of investigational tours undertaken by all workers with regard to particular insects or problems.
- (3) At present rearing is not done in all the Provinces. For want of rearing the work remains defective. It is hoped that this defect will be remedied at an early date. The records of rearing and notes on life-history thus made in different Provinces under different climatic conditions will supply ample and extremely useful materials.
- (4) Life-histories which are fully worked out.
- (5) The Conference in which we have met is now a permanent function. The Proceedings and at least some of the papers read in these conferences can most fittingly be included in this journal.
- (6) In order to enhance its educative value, useful communications on Indian Insects appearing in other journals may be reprinted in it.

Now we turn our attention to the non-entomological readers, including the large body of the agricultural public. The educated professional classes also fall under this category as practically all of them possess lands which they or their relations cultivate. The prevalent ignorance of even the elementary facts of insect life has been dealt with in my paper on "Some aspects of Economic Entomology in India," in which the necessity has been indicated of the compilation of simple elementary books on entomology in all the Indian vernaculars and of the introduction of entomology as a subject for nature study in the primary schools.

It will not be an exaggeration to say that the publications of the Agricultural Department, however highly applauded and valued here and abroad, are not of much practical importance and use to the great body of the Indian agriculturists. In order to make my point clear it is only necessary to remind you of the small percentage of English-knowing people in the country. The publications, being in the English language, can be expected to be read only by this small percentage. It would be interesting to find out how many do actually read them. I for one would be inclined to regard their number to be very small. At any rate it may safely be asserted that in the case of technical Memoirs, etc., this number is practically *nil*. Unfortunately it has to

be admitted that the Agricultural Department has not yet been successful in reaching the public in most cases and as members of a Service intended to help the agricultural public, it is our duty to find out why and in what respects we fail to reach them. Many of the officers of this Department have peculiar notions about bringing the results of agricultural research to the notice of the public. One recorded it as his opinion that those who did not know English could not be said to be educated and the matters in which this Department dealt were so abstruse that they would not be intelligible to the so-called "uneducated" people even if presented to them in their own vernaculars. This reveals a want of knowledge of the actual conditions. Without going too far it will be sufficient if we inquire how many of the coolies we engage in the Pusa Farm know how to read and write their own vernacular. From my experience of Bengal and Bihar it can be said that it is a common practice with all cultivators to read or hear read the epics of *Ramayana* and *Mahabharata*, both written in not very simple verses. Therefore the fault is with us if we cannot present our subjects in a simple, clear and intelligible manner, and not with the cultivators whom we wish to inform. They know their agricultural problems thoroughly, although they may not be able to express them in the manner in which we can. All important matters relating to agriculture can hardly fail to interest them. The public can be reached through various available agencies.

Although newspapers and magazines are not yet as widely read in India as in some of the Western countries, from my experience of Bengal I can say that the vernacular weekly papers are most widely circulated and they find their way to remote villages. Any information intended to be spread quickly cannot be better done than through the medium of these weekly papers. Four weekly papers of Calcutta can be named which together can carry the information throughout the whole of Bengal. It depends on us to supply them with the information. Otherwise wrong information or correct information awfully distorted is likely to be spread. As an instance the following incident may be mentioned. A vernacular monthly magazine on one occasion published the information that damage to stored rice could be prevented by the application of carbon bisulphide and gave the direction that carbon bisulphide was to be tied in a piece of cloth and kept in the midst of the stored rice. This information was quoted in many papers, and necessarily widely circulated, with what result you can imagine. It seems therefore highly necessary that instead of remaining contented with giving useful information on Economic Entomology in books which seldom find their way to the remote villages, we should frequently

communicate such information to the daily and weekly and especially the weekly vernacular papers. This will go a great way in popularizing Economic Entomology. We therefore come to the following conclusions :—

- (1) For the great body of non-entomological readers in India there are means of diffusion of useful information and we should make more use of these means than we have been doing in the past.
- (2) At present there is not sufficient means of satisfying the needs of the working entomologists for whom a journal solely devoted to the subject of Entomology has become a necessity.

There is no objection to sending communications to the vernacular papers. But, as regards this proposed Journal, the first question is the material and money required to run it. Is there any likelihood of getting help from the Government? Considering its usefulness, Government ought to help. **Mr. Ramakrishna Ayyar.**

I agree with what Mr. Ghosh has said regarding the scattered material and the scattered methods of publication adopted at present and I have already referred to this point in my note on the expansion of entomological work in India, printed as Appendix K to the Report of the Indian Industrial Commission. I consider that all entomological work should be published in one set of publications issued by Government. But I really do not see the necessity just at present for a Journal as proposed by Mr. Ghosh. A Journal might start off well but would soon break down from want of material. As things are at present it is difficult to get material for publication. Some of us are too busy on every-day routine and new investigations to have spare time to write. In 1916 I issued a Bulletin of one hundred short notes on Indian Insects and appealed for material for a second hundred such notes. Very few came in in response to my appeal and, after waiting for about two years, I had to sit down and complete the second hundred notes myself by writing up various life-histories and so on to complete the Bulletin, which has now gone to the press. Material of the nature indicated by Mr. Ghosh, as to be published in the proposed Journal, can in nearly all cases be included in such Bulletins and in this way we have a collected mass of material which is accessible to everyone. **Mr. Fletcher.**

Such Bulletins are published at such long intervals as to prevent their utility. **Mr. Ramakrishna Ayyar.**

Not necessarily; the frequency of publication depends entirely on the material available. If each of you would send in only one note **Mr. Fletcher.**

each month we could get out three or four such Bulletins every year without any difficulty.

**Mr. Ramakrishna Ayyar.** The difficulty about these Bulletins, each containing one hundred Notes, is that you have to wait to complete the hundred Notes each time. How will these Notes appear ?

**Mr. Fletcher.** The Second Hundred Notes are appearing under no definite authorship. Those Notes which have been contributed from outside have the contributors' names appended to them.

Another question that arises in connection with this proposed Journal is, who would run a paper of the nature suggested ?

**Mr. Kunhi Kannan.** I think that the question of such a publication might well be postponed until the question of an entomological Bureau has been decided.

**Mr. Ghosh.** It is important that we should reach the general public and now we cannot do so. As I have said, the vernacular papers do not publish anything, or if they do publish it is usually wrong.

**Mr. Fletcher.** I do not see that this proposed Journal would improve things in that respect. At present our Agricultural Department Bulletins and Memoirs and Reports have a very large circulation and are sent to all the principal newspapers in India but many of these publications are never even noticed in the newspapers.

**Mr. Senior-White.** It is dangerous to send Bulletins, etc., to be abstracted by editors of newspapers. We should send them ready-prepared articles. There are other difficulties as regards running such organs as Mr. Ghosh suggests. The subscription list of *Spolia Zeylanica* is not more than 120. If a paper, as suggested by Mr. Ghosh, is decided upon, then it should be obligatory for all the members to send their contributions only to this paper and nowhere else, and all systematists should be asked to be prepared to publish the work done on Indian material in this Journal.

**Mr. Fletcher.** I am afraid that there are serious practical difficulties about that proposal so long as the entomological workers in India are scattered about in different Departments and Services as they are at present. Probably the systematists would not object as a rule to have their work published in India and I think this should be done wherever possible. But, as a matter of fact, to give an instance, when I put up Dr. Hancock's paper on Tetriginæ from the Pusa Collection for publication in our series of Memoirs, there were objections raised to its inclusion on the ground that it was systematic work.

**Mr. Ramakrishna Ayyar.** What is the difference between a Memoir and a Bulletin ?

**Mr. Fletcher.** We have always refrained from attempting a definition of either, but, roughly speaking, the series of Memoirs is intended to take in



completed or advanced work, whilst the Bulletins include incomplete or preliminary work.

But I know of cases where one part of a Memoir has been published in one year and a second part has appeared three years later. I sent a paper of mine to be published as a Memoir and I was told that it could only be published as a Bulletin. **Mr. Ramakrishna Ayyar.**

I presume that you are referring to the paper on the Coccidæ of Southern India. That seemed to me to be a collection of short notes on different species rather than an intensive study of one or more species, and therefore it was a Bulletin. I am sorry if we offend on occasion but we try to do our best. **Mr. Fletcher.**

Bulletins do not supply our needs and this Journal, that I have proposed, should be a common ground for the discussion of entomological matter. I know that there is no real difficulty in contributing to the vernacular papers, although this has to be done with permission; yet it has not been done so far, and we ought to do it regularly. These Bulletins of one hundred Notes should be replaced by a Journal such as I propose. **Mr. Ghosh.**

We could start it as a part of the *Agricultural Journal of India*, quarterly or half-yearly in separate parts. We could send in notes of general interest such as a discussion on the value of topping cotton-plants against bollworms. Or a portion of the *Agricultural Journal of India* should be set apart for Entomology. **Mr. Misra.**

Would it not be better to bring forward a definite proposal on the subject of this Journal? **Mr. Afzal Husain.**

I will bring forward a Resolution.

**Mr. Ghosh.**

I do not see the necessity for setting apart a portion of the *Agricultural Journal*. I am sure that the Editor is always pleased to receive and insert any contributions on entomological subjects without being necessarily tied down to setting aside a portion for entomological articles. **Mr. Fletcher.**

I suppose that any contributions could be sent to the *Agricultural Journal*. **Mr. Ramakrishna Ayyar.**

Mr. Andrews, how can one get the publications of the Indian Tea Association? On applying to the ordinary booksellers one is usually told that these publications are not in stock. **Mr. Senior-White.**

Our publications are obtainable from the Secretary of the Indian Tea Association. **Mr. Andrews.**

Mr. Ghosh.

I beg to propose the following Resolution :—

Resolution 4.

“The Third Entomological Meeting is of opinion that it would be desirable to have a Journal solely devoted to Entomology and Government should undertake publication of it. Definite proposals regarding its size and time of publication will be decided by a Committee.”

Mr. Ramrao.

I second that Resolution.

[*The Resolution, on being put to the Meeting, was declared carried by 12 votes against 6.*]

Mr. Ghosh.

I propose the following Committee be appointed in accordance with the terms of the Resolution just carried, *viz.*, the Imperial Entomologist, the Forest Zoologist, the Government Entomologist, Madras, and Mr. Andrews.

Mr. Kunhi  
Kannan.

We need not hurry on with this matter. We had better wait for the decision as regards the centralization scheme.

The Chairman.

I am afraid that is rather out of order now as the Resolution has been carried. We can only now consider the appointment of the Committee proposed in it.

Mr. Beeson.

Whilst thanking the gentleman who proposed my name for this Committee, I beg leave to decline on personal and official grounds, as I have already voted against the scheme.

Mr. Fletcher.

Whilst quite prepared to give any assistance that I can to such a Journal if and when it is started, I must also decline to serve on the Committee, as I have already opposed the scheme and the acceptance of a place on the Committee would stultify my attitude regarding this proposed Journal.

Mr. Ramakrishna  
Ayyar.

When the Heads of Sections do not agree with this scheme, it would not be possible to run the Journal. I therefore propose the following Resolution :—

Resolution 5.

“The Resolution last passed may be recorded but action on it may be postponed until something definite has been decided about the organization of the Central Entomological Institute.”

Mr. Gosb.

I second this Resolution.

[*The Resolution, on being put before the meeting, was declared carried, only one vote being recorded against it.*]



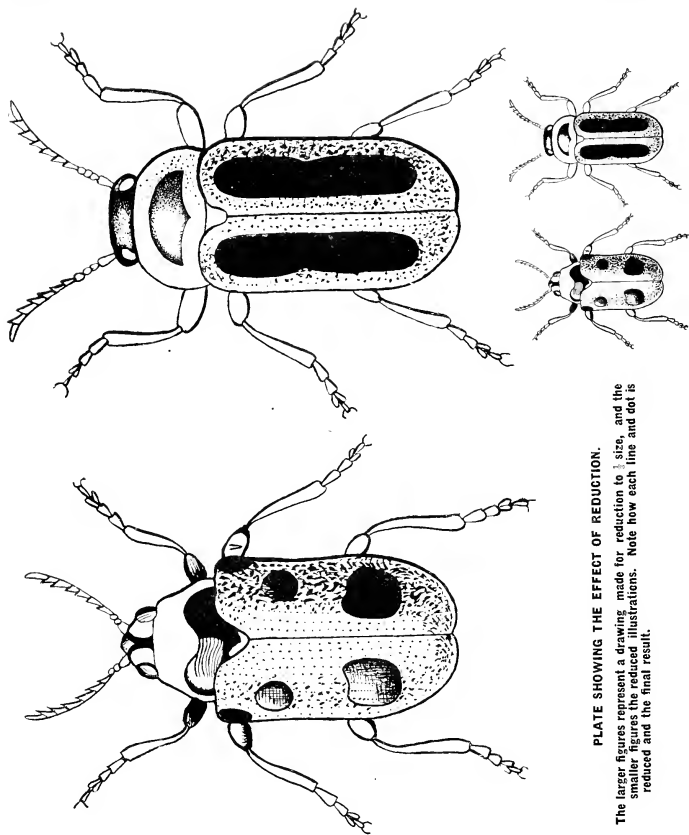

PLATE SHOWING THE EFFECT OF REDUCTION.

The larger figures represent a drawing made for reduction to  $\frac{1}{2}$  size, and the smaller figures the reduced illustrations. Note how each line and dot is reduced and the final result.

## 86.—THE PREPARATION AND REPRODUCTION OF SCIENTIFIC ILLUSTRATIONS.

By A. W. SLATER (*Manager, Calcutta Phototype Company*).

(Plates 176—179.)

There are many processes used in reproduction for printing, but in the present day photo or process engraving has quite superseded all other methods, and it is quite rare to find any publication in which the illustrations are produced other than by a photographic process.

It is not intended in this article to give a history of the art of reproduction or a detailed treatise on every stage of each process but just a general outline of the procedure in the principal processes used and to point out from the engraver's side little points that should be thought of in preparing originals or in the choice of the process to be employed.

Nearly all illustrations are in these days produced by either Line engraving, Half-tone engraving or Three-colour engraving.

These all come under the heading of process engraving which is the process by which drawings or photographs are, by the aid of photography, transferred to metal, afterwards being etched by chemical action, the result being a block from which a very large number of copies can be printed.

The choice of the process to be used must of necessity depend on the nature of the drawing, photo or picture to be reproduced.

*Line Blocks.*

Line engravings or line blocks are made from pen and ink sketches, *i.e.*, black and white drawings in line, without any shading except that obtained by the varying thickness of the line of the drawing. Before considering the points which go to make a good original a brief description of the process will be interesting.

In the first place a negative is made somewhat similar to an ordinary photographic negative except that the wet plate process, in which the operator prepares his own plate, is used.

This negative must be perfectly black and white with clear white lines on a black ground. It is at this stage that the attempt to reproduce the grey or faint lines, described later, affects the result as, in the endeavour to clear the negative by chemical action, all the lines are liable to lose their true value and thicken up.

The negative is then printed, a piece of sensitized metal (usually zinc) being placed into contact with the negative in a printing frame and exposed to the action of the light. The effect of the light passing through the clear parts of the negative is to make the coating on the plate insoluble in water. When sufficiently exposed the plate is covered

with a coating of greasy ink and then placed in water, it is then wiped carefully with cotton wool and the coating which has not been acted on by light, being soluble, washes away, taking the ink with it, leaving the ink on the parts which have been acted on by light. The ink image on the zinc plate should now be a true representation of the original copy.

The thin film of ink is next reinforced by very fine powdered asphaltum and is now ready for etching. After examining the plate to see if the lines are all correct the plate is now placed in a weak solution of acid which etches the parts not covered by the ink image. Considerable care and skill are required at this stage as a little carelessness means the loss of fine lines.

After a short etch the image on the plate is again strengthened to enable it to stand a stronger solution of acid, this process of etching being repeated till the white spaces are deep enough to make it impossible for them to take ink from the printing machine roller.

After trimming away the superfluous metal and mounting on wood the block is ready for the printer, each line of the drawing which has been reproduced standing in relief from the rest of the metal,

The following are the points to be observed in preparing originals for line work. All drawings should be made with clear black lines on white paper or card. Rough paper should be avoided. Care should be taken that all the lines are drawn firmly; scratchy or grey lines, produced by the ink being thinned down, are not permissible.

Drawings for the line process are better if made larger than the required size, reduction giving sharper and clearer results. It should be borne in mind that each line reduces in breadth as well as in length. All lettering should be neatly and clearly put in, care being taken to make all lettering sufficiently large to stand reduction. This point is often lost sight of, the result being that lettering which appears perfect on the original is unreadable when reduced. All lettering and in fact every line of the original should be perfect and complete, as alterations on the finished block are extremely difficult.

The most suitable scales of reduction are one half or two-thirds the size of the original.

#### *Half-tone process.*

The Half-tone process is used when it is desired to show the gradations from black to white with the intervening tones. This is also a photographic process but to obtain the desired effect it is necessary to make a special negative which is broken up into dots varying in size.



Plate showing comparison between a half-tone from a wash drawing, and a line block of the same subject.





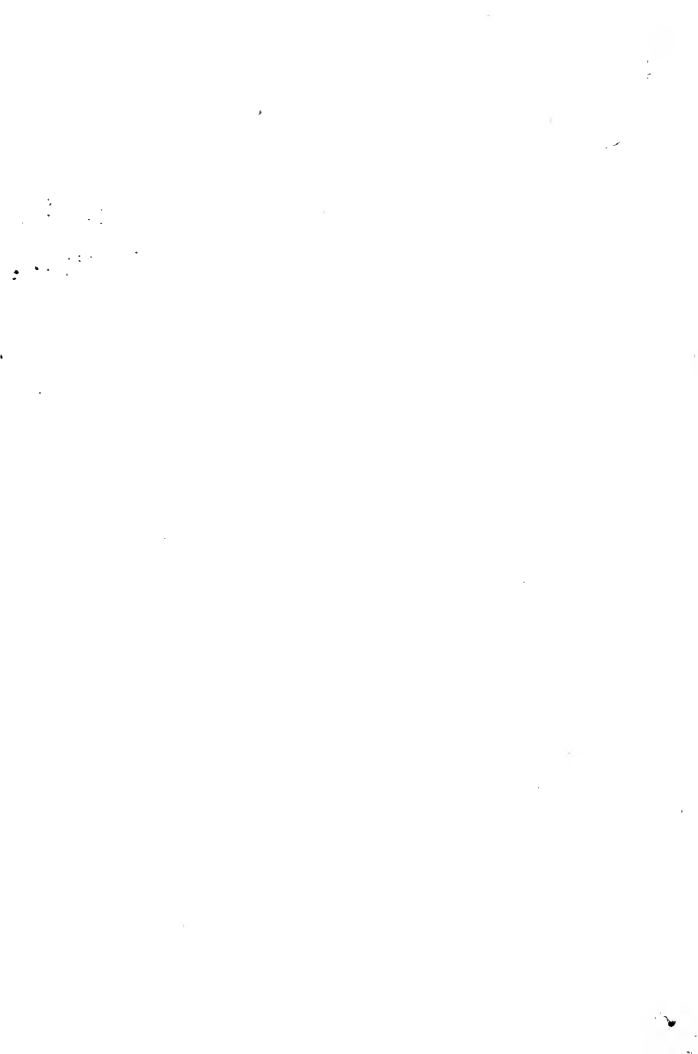

RED.

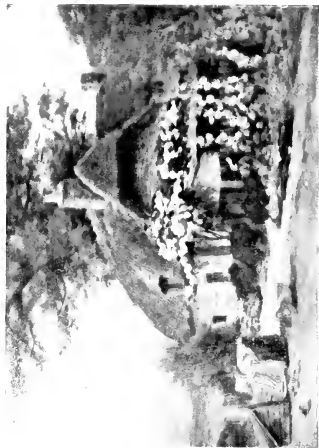

3 COLOURS SUPERIMPOSED

YELLOW.



BLUE.

These dots in the negative are obtained by placing in the camera, between the lens and sensitive plate, a screen consisting of two pieces of glass which are engraved with parallel lines and joined together so that the lines cross at right angles.

There are various rulings varying from 50 to 200 or more lines per inch and the finer the screen the finer the illustration, provided the conditions for printing the block are perfect.

It is however seldom desirable to use a screen finer than 150 lines, especially in India, as owing to climatic and other conditions it is difficult to print blocks made with an extremely fine screen. From the negative a print is made on a sensitized piece of copper or zinc by exposure to light.

The light passing through the dots of the negative renders the solution on the metal insoluble so that it is covered with a mass of dots the reverse of the negative.

These dots form the printing surface after the metal between them has etched away.

The etching requires considerable skill, as to obtain the real tone value it is necessary to stop out various parts during etching; otherwise, except from a very bright and brilliant picture, the result would be flat and lifeless.

It should be explained that a half-tone block must receive from the printing roller an even coat of ink all over and that it is impossible to ink one part lightly and other parts with a thick layer of ink.

The effect is obtained by varied sizes of dots; the very fine dots in the high lights impress only a small dot on the paper, while in the darker tones and shades the dots are larger and in a given area more ink is impressed on the paper than when the dots are smaller.

A reference to the diagram illustrated on Plate 177 will make this clear.

After the plate has been etched it is mounted on wood and is now ready for the printer.

We will now consider what to avoid in preparing originals for reproduction by the half-tone process.

Wash drawings or photographs should be of the best possible. A bright clear original with all the detail clear and distinct will give the best result.

With skill good results can be obtained from flat photographs but, if possible, they should be avoided, as they create difficulties at every

stage of the process and it is almost impossible for a workman to keep details which are only slightly discernable on the copy.

Photographs of subjects with a lot of fine detail should be taken in a good light and a white background used, care being taken to avoid shadows. A good well-diffused light is preferable to sunlight. Avoid unnecessary reduction in the case of originals with a lot of fine detail; on the other hand, a good bold subject will be improved by reduction.

Photographs should be packed flat and should not be roughly pasted on paper. Negatives are not necessary if good clear prints are available.

#### *Three-Colour Engraving.*

The three-colour process is an adaptation of the half-tone process and the procedure is the same except that special colour-sensitive plates are used and greater skill is needed at all stages.

The principle of the three-colour process is based on the theory that all colours are composed of yellow, red and blue, which, while not scientifically true as applied to light, is nearly correct when applied to inks.

Three-colour negatives are, briefly, made as follows:—Each negative retains only those rays of the desired colour. Thus the negative showing the yellow values excludes the blue and red rays. The yellow rays are excluded from the red and from the blue negatives. The rays not wanted are cut off by means of light filters. The etching of three-colour illustrations is similar to half-tone etching.

Three colour work, as the name implies, requires three printings. First the yellow plate, then the red, lastly the blue, each colour "registering" on the previous impressions, thus completing the picture in its natural colours.

To print three-colour illustrations is an exceedingly delicate task. The amount and colour of the ink must be carefully regulated and, as many impressions are usually taken, the printer must be cautious to maintain uniformity. As the colours fit exactly on top of one another the merest stretching or shrinkage of the paper will be disastrous to fine work.

Originals for this process should be in colours and complete in all detail and should be made on smooth card. The degree of reduction depends entirely on the original. A very well drawn original with a lot of fine detail should be reproduced to the same size but as a rule it is best to make the copy for reduction to two-thirds.

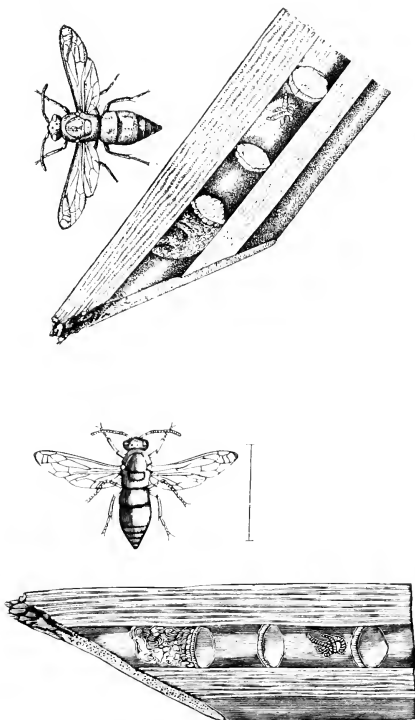

Fig. 1.—Woodcut.

Fig. 2.—Line block.

PLATE SHOWING A COMPARISON BETWEEN A LINE BLOCK AND A WOOD CUT.



*Hints on the making of originals.*

The following brief remarks are common to all processes :

All originals should be as perfect as possible. When giving instructions for reduction linear measurements are understood ; thus, " half size " means reduce to half the length and breadth, not half the area.

Originals can be enlarged if necessary but this should be avoided if possible.

It is advisable to indicate by a short note if any particular point in a scientific illustration requires special attention so that the engravers can obtain the best result.

*Other methods of reproduction.*

Having considered the processes which are most commonly in use at the present time we will briefly refer to other methods of reproduction which are available.

*Photozincography* is the process which is the most useful for large work such as the reproduction of maps and can be carried out in black and white or in colours.

A good drawing or sketch in black ink on white paper or tracing paper can be enlarged or reduced by photography and a printing plate prepared. This process is more economical in large size than the line block process.

Colours are introduced by different printings, each colour having to be printed separately.

Originals should show all the required lettering and detail and a separate rough sketch showing the colours required should be supplied, or a proof in black can be supplied by the printer which can be coloured by hand as a guide.

*Wood Cuts* or wood engraving are, as the name implies, blocks made of wood. This is purely a hand process the quality of the work depending entirely on the engraver. It is not recommended as it is very difficult to obtain good work in India owing to the scarcity of good workmen. Briefly, a drawing is made on a piece of box-wood and all the parts which are not required to print are cut away from the wood by hand.

*Photogravure* is a most artistic process but it is slow and expensive. This is also a photographic process but differs from others in so much that, instead of the printing surface being in relief, the plate is prepared so that the image is etched into the copper plate to varying depths according to the original. Printing ink is forced into the etched portions and naturally the places which are deeply etched take up more ink

The plate when inked is passed through a machine with a sheet of paper, the result being that all the ink is taken up by the paper.

## 87.—LANTERN SLIDES.

**Mr. Fletcher.** We gave an exhibition of lantern-slides of Indian Insects the other night. Has anybody anything to say on this subject? Our main difficulty at present is to get them coloured. The arrangement which we used to have has broken down and we have great difficulty in getting this work done satisfactorily.

Cannot your artists do it?

**Mr. Kunhi Kannan.**  
**Mr. Fletcher.** They could only do it in their spare time. We always have more work for the artists than they can get through. After our own arrangement fell through I arranged with the Calcutta Phototype Company to have this work done in Calcutta so that the finished coloured slides could be supplied by them and Mr. Slater got hold of a man who said he could do them; after about three months this man only produced about half-a-dozen slides and, on inquiry, it was found that he had sent these to Japan to be done. So we did not progress much as regards getting them done locally. If any of you know of anyone who would be prepared to colour these slides, we should be glad to be informed.

What do you pay for colouring a slide?

**Mr. Kunhi Kannan.**  
**Mr. Fletcher.** One rupee and eight annas. It takes time and care but the materials are not costly.

## 88.—NOTE ON THE DECIMAL METHOD OF SUBJECT INDEXING ENTOMOLOGICAL LITERATURE.

*By C. F. C. BEESON, M.A., I.F.S., Forest Zoologist.*

Everyone who has to deal seriously with entomological literature adopts some method of recording references to the subjects in which he is interested or expects to be interested. Each of us has apparently evolved a system that suits his own immediate requirements, and in consequence there is considerable variety in the systems now in use; *e.g.*, some use a card catalogue with a dichotomous or numerical index; some prefer entries in specific and general ledger files; some use loose-leaf notebooks and others interleaved publications.

It seems to me that if entomological work in this country is to be centralized or co-ordinated it is also desirable to centralize or standardize methods of recording references to literature. It would be of immediate



assistance to the individual worker if a standard system of classifying references were available, and it would also prepare the way for the introduction of an official catalogue of literature on Indian entomology which will have to be maintained by a Central Institute.

For entomological literature numerous skeleton schemes are already in existence based on the well-known Dewey decimal system of classifying literature. It is hardly necessary to point out the merits of a decimal system, but it may be repeated that it is :—(1) less expensive, (2) most easily understood, remembered and used, (3) practical rather than theoretical, (4) capable of almost unlimited expansion, and admirably adapted for the needs of the student or specialist.

Examples of decimal methods that have been used successfully are the *Bibliographia Zoologica*, *Concilium Bibliographicum*, the *International Catalogue of Scientific Literature*, and the *Zoological Record*.

As to the relative merits of the existing systems I can offer no remarks; on the contrary, it is hoped that this note may produce an expression of opinion by those who have had occasion to test one or more systems. I attach a statement showing the scheme of classification used for literature on Forest Zoology at the Forest Research Institute. It resembles very closely that used in the *International Catalogue of Scientific Literature*, i.e., a binomial association of decimal groups combined with phylogenetic classification. While it works satisfactorily for present requirements I do not think it will do so permanently. A scheme to be entirely comprehensive must provide for all possible contingencies, which may arise in future. The specialist or professional user of a specialized library can usually find the material for which he is searching, without the aid of a logical or completely comprehensive scheme, provided the index is elaborately cross-referenced. But, since the subject indexing of libraries must be carried out in this country by a clerical staff of moderate intellectual attainments, a more or less mechanical method is essential.

I suggest that it is desirable to adopt a standard classification of entomological literature in India,\* and that a phylogenetic system on a decimal basis is likely to prove the most efficient. As to the details of the subject heads and the numerical notation, expert opinion is necessary, and it is therefore desirable to consider the catalogue of the Bureau of Entomology and the London Library Subject-Index as possible models and to invite the opinion of their librarians.

---

\* Attention is drawn to the report of the Proceedings of the All-India Conference of Librarians held in January 1918, at which was considered the possibility of introducing a uniform system of subject-indexing in libraries in India.

## CLASSIFICATION OF LITERATURE ON FOREST ZOOLOGY

*Main subjects.*

- 01 General Zoology.
- 03 Protozoa.
- 05 Metazoa excluding  
Arthropoda and Vertebrata.
- 07 Arthropoda general.
- 09 Crustacea.
- 11 Arachnida, Myriopoda, etc.
- 13 Insecta general.
- 15 Aptaera, Thysanoptera.
- 17 Anoplura, Siphonaptera.  
Mallophaga.
- 19 Coleoptera.
- 21 Diptera.
- 23 Hemiptera [Rhynchota].
- 25 Hymenoptera.
- 27 Lepidoptera.
- 29 Neuroptera.
- 30 Isoptera.
- 31 Orthoptera.
- 33 Vertebrata general.
- 35 Pisces.
- 37 Amphibia, Reptilia.
- 39 Aves.
- 41 Mammalia.

*Subheads of main subjects.*

- 01 Treatises, Text-books, Manuals.
- 03 Bibliographies, Catalogues, Lists,  
Dictionaries.
- 05 Reports of Institutions, Departments,  
Congresses, Museums.
- 07 Philosophy, History, Biography.
- 09 Technique, Methods of Research.
- 10 Nomenclature.
- 11 Systematics, Monographs, Faunæ.
- 13 Anatomy, Morphology, Physiology,  
Development.
- 15 Ethology, Ecology, General  
Bionomics, Life histories.
- 17 Aetiology, Variation, Evolution.
- 19 General Economics.
- 21 Geography, Travel.
- 23 Control Measures, Insecticides.

**Mr. Beeson.**

This paper cannot be of much use to this productive Meeting but I put it forward with the idea of eliciting information.

**Mr. Fletcher.**

I am rather doubtful myself as regards the present necessity for the introduction of such a scheme. One difficulty is the fact that a publication may fall under several distinct heads at the same time. Another difficulty, so far at least as concerns the main subjects of the classification of literature on Forest Zoology as given by Mr. Beeson, is that this classification does not go far enough. Neuroptera for example includes very diverse groups which are usually regarded nowadays as Orders and will undoubtedly be given ordinal rank by general consent in the near future. This system therefore presupposes the permanency of our classification, which is far from being the case.

**Mr. Beeson.**

I do not suggest this for general adoption. A modification of the system is essential. You must have cross-references, letter-files, and so on, to complete it.

**Mr. Andrews.**

I keep a card index also and started it by Families and put all the information for a particular species under that species. I number

according to the sections suggested by Mr. Beeson. If a genus is split up, you have simply to remove your card and change your guide card.

Our experience is that cards are not satisfactory except (1) when the work of a Section or Department is comparatively in its infancy and (2) for purely systematic references. All our economic work is recorded on the File system, the Files being kept arranged in systematic order, and each species having its File, which includes all the information we have on it, whether published or unpublished, and including correspondence about it and any illustrations that have been done. On turning up a File we have at once the whole information we have on the subject of the insect concerned. Systematic work is entered on card-catalogues or interleaved copies of "Fauna" volumes, and general notes are entered into interleaved copies of *Indian Insect Life* and *South Indian Insects*. It is very rarely that any publication fails to fit into one of these systems but, for the few that do not, a general alphabetical card-catalogue is quite sufficient.

The main difference between Mr. Beeson's scheme and that adopted at Pusa seems to be that he considers that subject-indexing of entomological literature can be carried out by a clerical staff, whilst we act on the assumption that this is technical work that must be done by a properly trained man. I should be very sorry to have to rely on references as extracted by merely clerical labour. Recently in our own library I found a monograph on dragon-flies put away by the librarian under the heading of Diptera and that sort of thing is bound to happen constantly when merely clerical labour is devoted to classification of entomological literature.

I beg to propose the following resolution:—

Mr. Beeson.

"That this Meeting considers it desirable to adopt a standard classification of Entomological Literature for India. Resolution 5.

"That, if such a scheme be adopted, it would be of considerable advantage that it should, if possible, conform with the scheme in use at the Imperial Bureau of Entomology, London, and that the Director of that Bureau be approached for information on the matter.

"That such information be circulated to those interested in the subject in India, and that the matter be brought up for discussion at the next Entomological Meeting."

I second this Resolution.

Mr. Andrews.

[This Resolution, on being put to the Meeting, was carried unanimously.]

## 89.—NOTE ON PLANT IMPORTS INTO INDIA.

By T. BAINBRIGGE FLETCHER, R.N., F.L.S. F.E.S., F.Z.S., *Imperial Entomologist.*

(Plates 18—182.)\*

Until about a year ago India was a free dumping-ground for the plant-feeding pests of the whole world, and that we have not received more of them than we actually have done is probably only one more example of the good luck attendant on the usual "muddle-through" policy of the British Empire as a whole. Anybody was at liberty to bring into India any living plants of any kind—fruit-trees, ornamental plants, rubber-stumps, sugarcane-setts, etc.—and to bring with them any insects which happened to be living on or in them, so that there was every chance of our receiving, not only insects already known to be bad pests in other countries but also the many insects which were liable to develop into bad pests under novel conditions of climate, food and absence of enemies which they found awaiting them in India. Here we may remark that it is almost always the insects which have been introduced into a new country that become the worst pests of that country even in cases when they did, and still do, comparatively little harm in the countries from which they were brought. In its own country, in which it has lived for innumerable thousands of generations, the numbers of any insect tend to remain constant on the whole, as any undue increase is checked by natural causes of which parasites and predators form a considerable proportion. But an insect introduced into a new country providing sufficient food and a climate to its liking is introduced, more frequently than not, without the parasites and predators which keep it in check in its old home, with the result that it increases disproportionately and becomes a serious pest. The same tendency is of course true of animals other than insects and of plants.

We in India know of at least three bad pests which have been introduced of comparatively late years. One is *Phthorimæa operculella* which was originally brought into Bombay about 1905 or 1906 with seed potatoes from Italy and spread all along the Western Ghats and then southward into Madras and northward into the Central and United Provinces and Bihar and which now causes damage amounting in the aggregate to *laks* yearly. Another is *Eriosoma (Schizoneura) lanigera* which has been brought into all the fruit-growing districts on imported apple-trees and which has done serious damage already and is likely to do more in the future as fruit-culture extends in India. *Coccus viridis* is another example. These three insects have all become bad pests in India and there is no doubt but that all were introduced.

What other insects may have been introduced and may turn up as pests we do not know, but it is to be hoped that there will be none in this category.

As showing the frequency and ease with which pests may have been introduced into India with plants, I can quote a few cases which have come under my personal notice :—

- (1) A parcel of sugarcane setts received from Antigua was found to contain two living larvæ and a cocoon of *Sphenophorus sacchari*, a weevil which is well-known as destructive to cane in the West Indies and Guiana.
- (2) Another parcel of sugarcane setts received from Java contained a living example of a beetle which was apparently *Holaniara picescens*, described by Van Deventer as a cane-pest in Java.
- (3) Apple-trees imported from England and guaranteed free from *Eriosoma lanigera* by the exporters were found on arrival to be badly affected with this Aphid.
- (4) Young coconut trees imported from Ceylon were badly affected with an Aphid not otherwise known from India and almost certainly imported with the plants (see *South Indian Insects*, pp. 506-507).

These are only a few cases, but you will realize that they are cases which only came under notice more or less accidentally and that they formed a very small proportion of the total imports. It is impossible to imagine what insects may not have been brought into India in the past on the innumerable parcels of crop- and garden-plants imported by Government Departments and private individuals.

This danger was perceived many years ago and the first action taken was in 1906 when, owing to the special danger of importation of the Mexican Cotton-boll Weevil, orders were issued by Government directing that all cotton-seed imported from the New World should only be admitted into India after fumigation with carbon bisulphide at the port of entry, and this regulation was in force until superseded by later legislation. The regulation, however, was not very effectively carried out, as at least one case came to my notice in which an Agricultural Officer imported cotton-seed from America through the post without its being fumigated.

Further action as regards plant imports other than cotton-seed was initiated in December 1906 by the Bombay Chamber of Commerce, which addressed to the Bombay Government a letter pointing out the

danger of the introduction into India of insect pests, more particularly through the importation of plants from foreign countries, and requesting Government to take the matter into serious consideration and to adopt early measures for the protection of the staple agricultural products of India. The Government of Bombay thereupon referred the matter to their local Agricultural Department and to the Inspector General of Agriculture and obtained from Ceylon information regarding the measures adopted there. Correspondence then followed between the Inspector General of Agriculture and the Imperial Mycologist and Imperial Entomologist regarding the pests and diseases likely to be introduced and the best means of preventing their introduction into India, and the two latter Officers in July 1910 prepared a combined schedule of dangerous plants the importation of which into India should be controlled, and this combined schedule with the previous correspondence was circulated by the Government of India to Local Governments and Administrations for their opinions on the proposals made. These opinions were on the whole favourable and it is interesting, on reading over them, to note the cases in which examples are given of practical experience of receiving insect pests on imported fruit-trees. A Committee was then appointed by the Government of India to consider the whole subject and to make recommendations. It met at Pusa in November 1911 and consisted of Messrs. B. Coventry (Inspector-General of Agriculture), E. J. Butler (Imperial Mycologist), A. Howard (Imperial Economic Botanist), T. Bainbrigge Fletcher (Imperial Entomologist), A. T. Gage (Director, Botanical Survey), R. F. L. Whitty (Customs Department, Bombay), and R. D. Anstead (Planting Expert, South India). This Committee recommended (1) that plant imports likely to introduce insect pests should be fumigated, (2) that importation of plants from foreign countries should be permitted at the seven principal ports only, (3) that all living plants, excepting only culinary vegetables or fruits intended for consumption and seeds and a few other specified exceptions, should be fumigated with hydrocyanic acid gas at the place of entry, (4) that the Government of India should address Foreign Governments and Native States owning sea-ports in India on the subject of introducing restrictions similar to those applied in British India, and (5) that no action need be taken with regard to the land frontiers of British India other than those of Foreign Governments and Native States owning sea-ports in India.

It was supposed that the importation of plants could be regulated under Section 19 of the Sea Customs Act (VIII of 1878), but it was found that the Sea Customs Act could not be used in the manner proposed

and that separate legislation to deal with the matter was necessary, and a " Bill to prevent the introduction into British India of any insect, fungus or other pest which is or may be destructive to crops " was published in the *Gazette of India* of 13th September 1913 and considered by a Select Committee whose Report was presented to the Council of the Governor General of India on 16th January 1914 and passed into law, as Act II of 1914, on 3rd February 1914, as follows :—

ACT NO. II OF 1914.

*" An Act to prevent the introduction into British India of any insect, fungus or other pest, which is or may be destructive to crops.*

" Whereas it is expedient to make provision for preventing the introduction into British India of any insect, fungus or other pest which is or may be destructive to crops ; It is hereby enacted as follows :—

" 1. This Act may be called the Destructive Insects and Pests Act,  
Short title. 1914.

" 2. In this Act, unless there is anything repugnant in the subject,  
Definitions. or context :—

(a) " crops " includes all agricultural or horticultural crops  
and trees or bushes ;

(b) " import " means the bringing or taking by sea or land ; and

(c) " infection " means infection by any insect, fungus or  
other pest injurious to a crop.

" 3. (1) The Governor-General in Council may, by notification in the  
*Gazette of India*, prohibit or regulate, subject to  
such restrictions and conditions as he may  
impose, the import into British India, or any  
part thereof, or any specified place therein,  
of any article or class of articles likely to cause infection to any crop.

Power of Governor-General in Council to regulate or prohibit the import of articles likely to infect.

"(2) A notification under this section may specify any article or class of articles, either generally or in any particular manner, whether with reference to the country of origin, or the route by which imported or otherwise.

" 4. A notification under section 3 shall operate as if it had been issued under section 19 of Sea Customs Act 1878, and the officers of the Customs at every port shall have the same powers in respect

Operation of notification under section 3.

of any article with regard to the importation of which such a notification has been issued as they have for the time being in respect of any article the importation of which is regulated, restricted or prohibited by the law relating to Sea Customs, and the law for the time being in force relating to Sea Customs or any such article shall apply accordingly.

“ 5. (1) The Local Government may, subject to the control of the Governor General in Council, make rules for the detention, inspection, disinfection or destruction of any article or class of articles in respect of which a notification has been issued under section 3 or of any article which may have been in contact or proximity thereto, and foregulating the powers and duties of the officers whom it may appoint in this behalf

Power of Local Government to make rules.

“ (2) In making any rule under this section the Local Government may direct that a breach thereof shall be punishable with fine, which may extend to one thousand rupees.

“ 6. No suit, prosecution or other legal proceeding shall lie against any person for anything in good faith done or intended to be done under this Act.”

A Notification of certain draft rules proposed to be made under this Act was published in the *Gazette of India* dated 21st March 1914, but these rules did not provide for fumigation and, so far as insect pests were concerned, dealt only with sugarcane, cotton seed, and living rubber and coffee plants.

Then followed over three years of correspondence regarding various details before there was issued on 7th November 1917, nearly eleven years after the subject was first mooted, a Government Order under this Act, which, with subsequent small amendments, reads as follows:—

“ No. 13-C.

## GOVERNMENT OF INDIA.

DEPARTMENT OF REVENUE AND AGRICULTURE.

*Agriculture.*

Delhi, the 7th November 1917.

“ In exercise of the powers conferred by section 3, sub-section (i) of the Destructive Insects and Pests Act, 1914 (II of 1914), the Governor



General in Council is pleased to issue the following order for the purpose of prohibiting, regulating and restricting the import into British India of the articles hereinafter specified.

1. In this order :—

(i) "official certificate" means a certificate granted by the proper officer or authority in the country of origin; and the officers and authorities named in the third column of the Schedule are the proper officers and authorities to grant in the countries named in the second column the certificates required by the provisions referred to in the first column thereof;

"plant" means a living plant or part thereof but does not include seeds; and

"prescribed port" means any of the following ports, namely Bombay, Calcutta, Dhanshodhi, Karachi, Madras, Negapatam, Rangoon and Tuticorin;

(ii) all provisions referring to plants or seeds shall apply to all packing material used in packing or wrapping such plants or seeds.

2. No plant shall be imported into British India by land or sea by means of the letter or sample post, provided that sugarcane for planting intended to be grown under personal supervision of the Government Sugarcane Expert may be imported by him by such post. [*Gazette of India*, Pt. I, p. 155, 9th February 1918].

3. No plants other than fruits and vegetables intended for consumption, potatoes and sugarcane shall be imported into British India by sea except after fumigation with Hydrocyanic Acid Gas and at a prescribed port:

Provided that plants which are infested with living parasitized insects and are intended for the introduction of such parasites may be imported without such fumigation if they are accompanied by a special certificate from the Imperial Entomologist to the Government of India that such plants are imported for the purpose of introducing such parasites.

4. Potatoes shall not be imported into British India by sea, unless they are accompanied by—

(i) a certificate from the consignor stating fully in what country and in what district of such country the potatoes were

- grown and guaranteeing that warty disease was not known to exist on the farms where the potatoes were grown; and
- (ii) an official certificate that no case of warty disease of potatoes has been known during the twelve months preceding the date of the certificate within five miles of the place where the potatoes were grown.

“ 5. Rubber plants shall not be imported into British India by sea unless they are accompanied by an official certificate that the estate from which the plants have originated or the individual plants are free from *Fomes semitostus* and *Sphaerostilbe repens*.

“ 6. Sugarcane shall not be imported into British India by sea unless it is accompanied by an official certificate that it has been examined and found free from cane borers, scale insects, Aleyrodes, root disease (any form), pine apple disease (*Thielaviopsis Ethacetica*), “Sereh” and cane gummosis :

Provided that canes for planting intended to be grown under the personal supervision of the Government Sugarcane Expert may be imported direct by such expert without such certificate.

“ 7. Coffee plants shall not be imported into British India by sea from America (including the West Indies) except by the Madras Department of Agriculture.

“ 8. Seeds of coffee, flax, *bersim* and cotton shall not be imported by land or by sea by letter or sample post.

“ 9. Coffee seeds shall not be imported into British India by sea from America (including the West Indies) except by the Madras Department of Agriculture.

“ 10. Flax seeds and *bersim* (Egyptian clover) seeds shall not be imported into British India by sea, unless the consignee produces before the Collector of Customs a license from a Department of Agriculture in India in that behalf.

“ 11. Cotton seeds shall not be imported by sea except after fumigation with carbon bisulphide and at a prescribed port.

“ 12. Nothing in these rules shall be deemed to apply to any article brought by sea from one port in British India to another. [No. 520-232 of 13th June 1919.]

R. A. MANT,

*Secretary to the Government of India.*

“ THE SCHEDULE.”

[Paragraph 1 (i).]

Paragraph	Country of Origin	Authority	
1	2	3	
4 (ii)	Great Britain and Ireland	The Board of Agriculture and Fisheries, England. The Board of Agriculture for Scotland. The Department of Agriculture and Technical Instruction for Ireland.	
	Sweden . . . . .	The Ministry of Agriculture.	
	Norway . . . . .	The Norwegian Board of Agriculture.	
	Denmark . . . . .	The Ministry of Agriculture.	
	France . . . . .	Ditto.	
	Japan (including Formosa)	The Department of Agriculture and Commerce.	
	Italy . . . . .	The Ministry of Agriculture.	
	British East Africa . . . . .	The Department of Agriculture.	
	Australia . . . . .	The Departments of Agriculture, Victoria, South Australia, New South Wales, Queensland, Tasmania and Western Australia.	
	5	Ceylon . . . . .	The Department of Agriculture.
		Malay Peninsula . . . . .	The Department of Agriculture, Federated Malay States.
Dutch Indies . . . . .		The Department of Agriculture, Industry and Commerce.	
Belgian Congo . . . . .		The Department of Agriculture,	
British East Africa . . . . .		Ditto.	
Uganda Protectorate . . . . .		Ditto.	
Nyasaland . . . . .		Ditto.	
South Africa . . . . .		The Union of South Africa Department of Agriculture.	
6		Dutch Indies . . . . .	The Department of Agriculture, Industry and Commerce.
		Mauritius . . . . .	The Department of Agriculture.
	Philippine Islands . . . . .	The Bureau of Agriculture.	
	Japan (including Formosa)	The Department of Agriculture and Commerce.	
	South Africa . . . . .	The Union of South Africa Department of Agriculture.	
	Egypt . . . . .	The Ministry of Agriculture.	
	West Indies . . . . .	The Imperial Department of Agriculture, Barbados.	
	British Guiana . . . . .	The Department of Science and Agriculture.	
	Trinidad . . . . .	The Department of Agriculture.	
	Jamaica . . . . .	Ditto.	
	United States . . . . .	Ditto.	
	Ceylon . . . . .	Ditto.	
	Malay Peninsula . . . . .	The Department of Agriculture, Federated Malay States.	
	British East Africa . . . . .	The Department of Agriculturs.	
	Queensland . . . . .	The Department of Agriculture and Stock.	

The effect of this Order on the various classes of Plant Imports is shown in the Table on next page.

Roughly speaking, so far as insect pests are concerned, the regulation amount to this :—

- (1) There is no restriction on the importation by land or sea of seeds other than seeds of coffee, flax, *bersim* and cotton.
- (2) There is no restriction on the importation of any plants whatever through the land frontiers of India except through the letter or sample post. It is not considered that there is any great danger of new pests being brought in along the ordinary trade routes across the frontiers of Northern India and Burma.
- (3) No plants, except seeds other than those specified above, may be sent into India by letter or sample post. This regulation is enforced because the contents of letters and sample packets are not declared by the senders and there is therefore no regular means of checking their contents.
- (4) Fruits and vegetables (except potatoes) intended for consumption are admitted without restriction except by letter or sample post.
- (5) Potatoes, sugarcane, rubber plants, coffee-plants and seeds, flax seed, *bersim* seed and cotton seed are only admitted subject to special restrictions.
- (6) All other living plants are only admitted through specified ports of entry after fumigation.
- (7) Plants merely sent from one port to another, both being in British India (*e.g.* from Calcutta to Rangoon) are not subject to any restrictions.

As regards the land frontiers and Foreign Governments and Native States owning sea-ports in India, the French and Portuguese possessions and the Travancore, Cochin, Baroda and other States have expressed their willingness to cooperate by introducing the necessary restrictions on plant imports from overseas. In the case of Portuguese India such articles will not be despatched from the Portuguese Customs House until they have been examined by an expert officer of the Agricultural Inspecting Department, such preventive measures being taken as may be considered necessary. The French ports, I understand, propose to adopt restrictions similar to our own. Travancore proposes to confine the importation of plants to the port of Alleppey. Junagadh State issued an Order in May 1918 on the same lines as the British India Notification, fumigation to be at the port of entry. Cambay, Sachin,

Statement showing the restrictions, prohibitions, etc., imposed on the importation of plants, seeds, etc., into British India.

Kind of Plant	IS IMPORTATION RESTRICTED BY		If restricted is the importation absolutely prohibited.	IF NOT ABSOLUTELY PROHIBITED.			Is it subject to the production of special certificates. If so, what certificates.	Is importation by letter or sample post prohibited.	REMARKS
	Land	Sea		Is importation restricted to certain ports	Is it subject to quarantine	7			
1. Potatoes	No. except through the letter or sample post.	Yes	No	No	No	Yes (i) A certificate from the consignor stating fully in what country and district of that country the potatoes were grown and guaranteed to be free from disease. That disease was not known to exist on the Farms where the potatoes were grown; and (ii) A certificate from an officer of the Board or Ministry of Agriculture or other Government Department of the country, to the effect that no case of wart disease of potatoes has been confirmed during the 12 months preceding the date of the certificate within 5 miles of the place in which the potatoes were grown.	Yes.	Causes for planting imported direct by the consignor in the Sugar Act, 1900. Expert and in- tended to be grown under his personal supervision are	
2. Sugarcane	Ditto	Yes	No	No	No	Yes. A certificate from an officer of the Board or Ministry of Agriculture or other Government Department of the country of the origin that it has been examined and found free from cane borers, scale insects, etc.	Yes	Causes for planting imported direct by the consignor in the Sugar Act, 1900. Expert and in- tended to be grown under his personal supervision are	

Statement showing the restrictions, prohibitions, etc., imposed on the importation of plants, seeds, etc., into British India—  
continued.

Kind of Plant	IS IMPORTATION RESTRICTED BY		If restricted is the importation absolutely prohibited	IS NOT ABSOLUTELY PROHIBITED			Is importation by letter or sample post prohibited	REMARKS
	Land	Sea		Is importation restricted to certain ports	Is it subject to Fumigation	Is it subject to the production of special certificates. If so, what certificates		
1 *	2	3	4	5	6	7	8	9
3. Fruits and vegetables imported or consigned in sample (except potatoes)	No. Except through letter or sample post.	No. Except through letter or sample post.	No . . .	No . . .	No . . .	red rot disease (any form), Ring rot disease ( <i>Phytophthora ethacensis</i> ) "Scorch" and cane gummosis.	Yes.	exempted from the conditions in columns 6 and 7.
4. Living rubber plants and parts thereof (except seeds).	Ditto . . .	Yes . . .	No . . .	Yes, Bombay, Calcutta, Madras, Karachi, Tuticorin, Dhanshikholi, Negapatam and Bangalore.	Yes, with Hydrocyanic Acid Gas.	Yes. A certificate from the Government Mycologist of the country of origin that the plants have originated from the individual plants and that they are free from pests, nematodes and Spine-rosellidæ repens.	Yes.	
5. Coffee plants and any living parts thereof.	Ditto . . .	Yes . . .	No . . .	Ditto . . .	Ditto . . .	No . . .	Yes . . .	The imports of these from the New World (including South America and West Indies) can only be made by the Madras Department of Agriculture.
6. Coffee Seeds	Ditto . . .	Yes . . .	No . . .	No . . .	No . . .	No . . .	Yes . . .	Ditto.



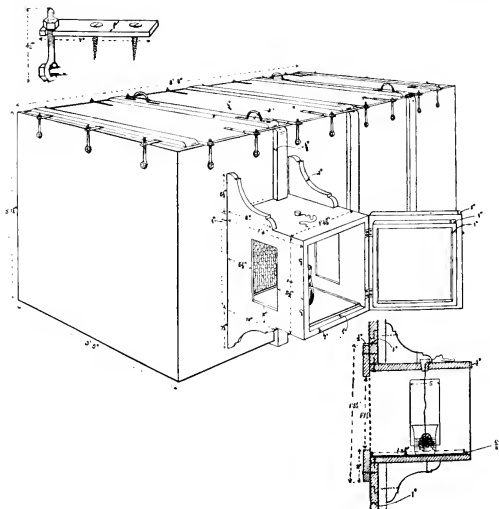

Fumigation Box. Sketch showing construction and external measurements.



7. Flax seed and 8. Berato (Egyptian clover) seed.	Ditto	Yes	No	No	No	Yes.
9. Cotton seed	No. Except through letter or sample post.	Yes	No	Yes, Bombay, Calcutta, Madras, Karachi, Tuticori, Dhansakhodi, Secapattam and Rangoon.	Yes, with carbon bisulphide.	Yes.
10. Seeds other than Nos. 6-9 above.	No	No	No	No	No	No.
11. Plants which may be infested with parasitized insects and which are intended for the introduction of such parasites.	No. Except through letter or sample post.	Yes	No	No	No	Yes.
12. All living plants and all portions thereof including all packing materials used in wrapping and living materials and all portions thereof (with the exceptions noted in 1 to 11 above).	Ditto	Yes	No	Yes, Bombay, Calcutta, Madras, Karachi, Tuticori, Dhansakhodi, Secapattam and Rangoon.	Yes, with Hydrocyanic Acid Gas.	Yes.

Yes. A license from one of the Departments of Agriculture in India which must be produced to the Collector of Customs by the consignee. This license will be granted on the report of the Inspector that the seed has been obtained through well known and reliable seed merchants and has been guaranteed free from dodder seeds.

A special certificate signed by the Imperial Entomologist to the Government of India to the effect that the plants are intended for the introduction of the parasites with which the plants may be infested.

Janjira, Nawanagar, Porbandar, Morvi, Jafrabad, and Bhavnagar States have not considered it necessary to introduce restrictions, as living plants are usually imported through Bombay. The danger of importation of pests through sea-ports other than the principal ones in British India is comparatively small and it is to be hoped that no such cases will arise. As regards other land frontiers, no serious danger is anticipated at present and therefore no restrictions have been imposed.

In the case of plants received from overseas, they arrive either (1) on freight, (2) by post or (3) brought in by passengers.

Packages brought in on freight are necessarily landed through the Customs Department to whom the necessary statements of contents have to be made. It is probable therefore that all such cases of importation are dealt with as a matter of routine. In the case of living plants which are to be fumigated, the packages containing them are opened and placed, with all packing materials, in a fumigation box, the lid of which is then fastened down securely and a charge of gas given by means of the small box attached to the side of the large one. The construction of the fumigation box is shown in (Plates 180—182. The internal measurements are :—

(i) Main Box, 8'6" long, 3'6" high, 3'3" broad=96.6875 c. ft.

(ii) Generating Chamber.—1'3" long, 1'3" broad, 1'3" high=1.9531 c. ft.

the internal capacity of the two boxes being therefore 98.6406 c. ft.

The construction will, I think, appear sufficiently plain from the photographs. The planks are joined with a  to secure gas-tightness (see section of generating chamber, where part of side of main box is shown). If any cracks appear, they can be closed with putty, caulked or pasted over with stout paper. All that is required is a gas-tight box. The lid fits on to a ledge on inner edge of the sides, a gas-tight joint being secured by a strip of felt or other similar material secured onto this ledge. The main and generating chambers are separated by a sheet of perforated zinc to prevent any parcels under fumigation falling into the generating chamber; wooden or metal bars would do equally well. The generating chamber is provided with a lead tray to catch any acid that may be spilled; its lid is bored with a small hole fitted with a cork.

For convenience of transport, the perforated zinc sheet, generating chamber and lead tray are best removed and packed inside the main box which may be strengthened for transport by additional wooden battens.

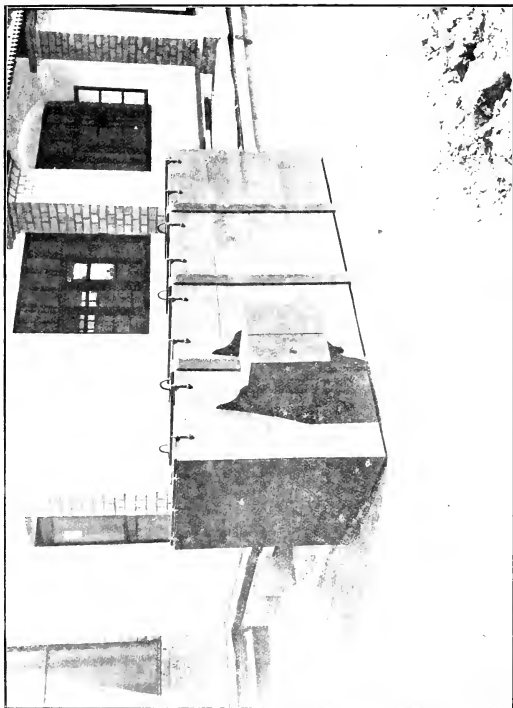

Fumigation Box (closed up for fumigation).





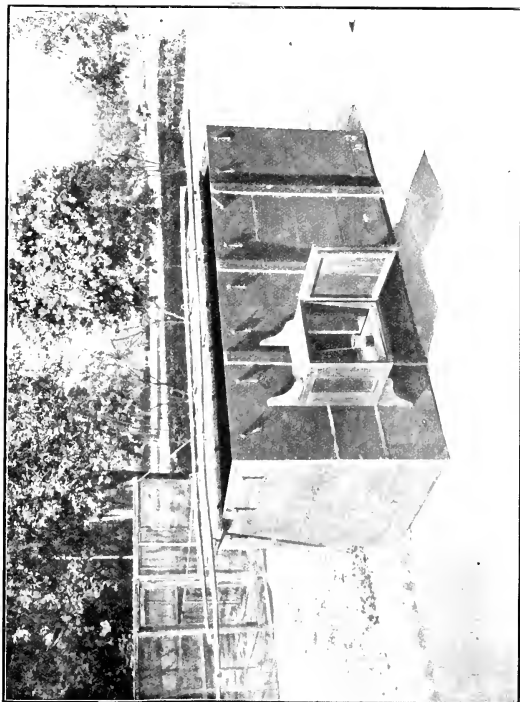

Fumigation Box (open).

For use, the parcels to be fumigated are placed in the main chamber and its lid tightly fastened down. The weighed quantity of sulphuric acid and water is placed in a glass beaker or earthenware jar in the fumigating chamber and the weighed quantity of potassium cyanide is wrapped loosely in a piece of thin paper tied by a string of which one end is passed through the hole in the top of the fumigation-chamber, which is then closed up. All being ready, the packet of cyanide is easily pulled up by means of the string and dropped into the vessel of acid, a glass strip being provided on either side of the fumigation-chamber through which it can be seen that the packet reaches the acid and that the gas is properly evolved in the form of bubbles. The cork is of course replaced as soon as the packet has been dropped in.

The gas evolved (Hydrocyanic Acid Gas) is colourless and non-explosive.

On completion of the time required for the fumigation process, the nuts holding down the lid of the main box may be slacked off and turned back. If the lid is properly tight, practically no gas should escape during this process and no danger should therefore be run by the operator. The lid can then be lifted, which is best done by raising it from some little distance by means of a rope attached to the handles of the lid and passing through a block attached above the Fumigation Box.

Fumigation should not be done in a closed room but in an open shed or verandah where the gas liberated from the Fumigation Chamber will be rapidly dissipated without any danger to any one in the vicinity. If reasonable care is taken in opening up the box after fumigation, no danger can ensue, but of course if the operator (or others) deliberately inhales the gas, the consequences may be serious. With the help of a block and long lead to raise the lid whilst keeping at a reasonable distance, and of course to windward if there is any breeze, and with care not to approach the box until all the gas has been dissipated, and with due regard to selection of a locality so placed that the released gas will not blow into any offices, etc. (it is very quickly dissipated and rendered harmless in the open air), there is not likely to be any danger.

The following directions for fumigating plants embody the necessary information :

1. Remove the covers of the cases, wrappings of packages, etc., and spread the plants out in the trays together with all moss, wrappings, etc., in or with which they have been packed, taking care that the contents of each package are kept separate. The plants should be spread out loosely so that the gas will be able to penetrate between the plants.
2. Close up the plant-chamber, wedging the door or lid securely.

3. Place the vessel containing the requisite quantity of water in the small external gas-generating chamber. Add the acid to the water; never pour the water into the acid, or it will react violently and spatter about. Take the weighed quantity of cyanide, wrap it loosely in a piece of thin paper tied by a string of which one end is passed through the hole in the top of the fumigation-chamber which is then closed up. All being ready, the packet of cyanide is easily pulled up by means of the string and dropped into the vessel of acid, and the hole on top of fumigation-chamber corked up. Note the time.

*Quantities of chemicals required.*

For each Fumigation Box (100 cubic feet):—

Water . . . . .	1 fluid ounce.
Sulphuric Acid . . . . .	1 „ „
Potassium Cyanide (98 per cent.) . . . . .	½ ounce

For larger Chambers:—

According to size, at the rate of—

Water . . . . .	1 fluid ounce.	} Per 100 cubic feet of internal capacity.
Sulphuric Acid . . . . .	1 „ „	
Potassium Cyanide (98 per cent.) . . . . .	½ ounce	

4. After three-quarters of an hour open the door or lid of the plant and fumigating chambers, taking care not to breathe any of the gas whilst doing so, and leaving them open for at least a quarter of an hour before making any attempt to remove the plants. The trays may then be removed and the plants exposed to a current of air for another quarter of an hour, after which they may be repacked.

NOTE.—In all cases when an agent of the consignee is in attendance, the unpacking and repacking of the plants will be done by such agent.

*Cautions.*

1. Living plants must not be watered immediately before fumigation as wet foliage is liable to be injured by gas. If received wet, they should be allowed to dry before fumigation.

2. After fumigation plants should be protected from the sun for several hours, preferably until the following morning. Do not therefore spread plants out in the sun's rays after fumigation to dissipate the gas. It is better to carry out fumigation at night if possible.

3. Sulphuric Acid is strongly corrosive and will burn into the skin, flesh or clothing. If acid should accidentally be spilt on to the hands, plunge them *immediately* into a bucket full of water. If acid should be



splashed on to the clothes, pour liquid ammonia on to the spot to neutralize the acid.

4. Potassium Cyanide is a deadly poison if taken into the system, either if swallowed or introduced through any cut or wound in the skin. It is better therefore not to touch it with the bare hands but to wear gloves or to handle it with forceps.

5. Hydrocyanic Acid Gas, produced by the action of Sulphuric Acid on Potassium Cyanide, is extremely poisonous if inhaled. It is colourless, non-inflammable, and has a faint smell something like that of peach-kernels or of some metals when these are struck together. Great care must be taken to avoid breathing in any of the gas before it has all escaped. Should symptoms of poisoning be noticed the patient should be immediately removed and placed in the open air.

In the case of plants received from overseas by post, under a Government of India Notification dated 15th December 1917, the Chief Post Office Officials at the specified ports of entry are empowered to search or cause search to be made amongst all articles in course of transmission by post to any place in British India for all plant imports whose entry is regulated under the Pest Act and to deliver to the Customs Department all postal articles reasonably believed or found to contain such goods. Parcels from abroad are of course accompanied by a declaration stating their contents, and the entry of plant imports (except non-specified seeds) by letter or sample post is prohibited. Any plant imports, whose entry is regulated under the Pest Act and which are found in the Foreign Mails, are therefore handed over to the Customs Staff for necessary action.

Living plants brought in by passengers are subject to the same restrictions as if they come in on freight, and are required to be fumigated or to be accompanied by the certificates required under the Act. It is probable that the regulations are not very strictly enforced in all cases and that there is still some danger of pests being brought into India in this way.

Turning now to the actual working of these regulations, it was originally proposed to erect a regular fumigatorium at each port of entry and to have a special man, belonging to the Agricultural Department, at each such port to carry out the work. In view, however, of the small quantity of plant imports at all ports except Bombay, it was decided that the fumigation could be done by the Customs Staff in special boxes designed for this purpose, and on issuing the Notification under the Act Government directed that the work of fumigation should be entrusted to the Customs Staff as an experimental measure for a

period of one year in the first instance. This period has now elapsed and presumably the Customs Staff will continue the work, as no practical difficulties seem to have arisen in doing it.

A few unforeseen contingencies which have arisen may be mentioned here. A case occurred in which a parcel of water-lilies was brought into Calcutta; as it was not possible to fumigate wet plants of this sort and as there seemed no danger of their introducing pests, they were allowed in without fumigation. A trade in sugarcane from the Persian Gulf to Karachi was also reported; as the cane was intended for eating purposes in Karachi and as it seemed unlikely that any new pests or diseases would be introduced, this was also allowed to be landed. A more serious case occurred in Bombay in June 1918 when some ten thousand maunds of cotton seed from Mombasa was brought to Bombay; it was not possible to fumigate this large quantity with carbon bisulphide in accordance with the regulations, as the apparatus at hand was insufficiently small, and it was passed to the consignees without fumigation on their giving a bond that it would be used for oil-making in Bombay. A report was also received that unginmed cotton, amounting to 50,000 Bengal maunds during the past year, is received at the port of Porbandar (Porbandar State) from the ports of Gwadar and Chobar in the Persian Gulf, but no action seemed necessary in this case as we are not likely to receive from the Persian Gulf any pests that we have not got already. I have also come across one case where plants were fumigated and proved to have living insect pests on them on receipt by the consignee; in this case, the packing material had not been fumigated and the plants were consequently reinfested; steps have been taken to prevent a recurrence of this.

Penalties for infringement of the regulations governing the importation of plants into India are provided as follows:—

- (i) Section 4 of the Pest Act (II of 1914) prescribes that a Notification issued under Section 3 of the Act shall operate as if it had been issued under Section 19 of the Sea Customs Act.
- (ii) Under Chapter XVI, Section 167 (a) of the Sea Customs Act goods which are landed at ports other than those prescribed for the landing of such goods are liable to confiscation. Plant imports, therefore, which are landed otherwise than at Bombay, Calcutta, Dhaneshkhodi, Karachi, Madras, Negapatam, Rangoon or Tuticorin are liable to confiscation.
- (iii) Under Chapter 167 (8) of the Sea Customs Act, the importation of prohibited goods may involve confiscation and the imposition of a fine not exceeding thrice the value of the goods or one thousand Rupees.

- (iv) Section 5 (2) of the Pest Act (II of 1914) empowers Local Governments to punish breach of any rule made under Section 5 by a fine which may extend to one thousand Rupees.

With reference to the importation of insect pests I may mention **Dr. Gough**, that the scale-insect that we are fighting in Egypt was found by me on some oranges that I had at the Taj Mahal Hotel in Bombay. It would be best for the Government of India to take measures against the importation of fruit from Egypt. Our importation laws are administered by the Entomological Department and not by the Customs Department.

What is the name of this scale ?

**Mr. Ramakrishna Ayyar.**  
**Dr. Gough.**

*Aspidiotus ficus*.

But we already have that in India and it is widely distributed and **Mr. Fletcher**, has been found in Calcutta on palms.

I might say that it is not possible to avoid all insects coming in. **Dr. Gough**, Samples without value do get in without our knowledge. With us the matter is simplified as our only ports of entry for fruit are Port Said, Alexandria and Suez.

With us the ports of entry are so scattered and at such enormous **Mr. Fletcher**, distances apart and the importations of plants at some ports are so small and infrequent that it is at once uneconomic to keep an entomological staff at each port to do the fumigation and impossible to supervise the work properly in the absence of a proper Entomological Service. That is our difficulty at present. If we can only get a properly organized Entomological Service with a sufficiently large staff it should be possible to arrange for at least the proper supervision of this work if not for doing it entirely. An Entomological Supervisor, for example, in going his rounds to inspect the work of the Provincial Entomological Assistants, could take in these ports on his rounds and see that the work was being done properly.

I should like to draw the attention of the Meeting to a paper read **Mr. Ramakrishna Ayyar**, by me at the last Science Congress at Bombay on "Some Foreign Insect Pests not required in India."

One point about a paper of this sort is that it is comparatively easy **Mr. Fletcher**, to make a list of foreign pests that we have not got and do not want to get, but we do not know in all cases whether what is a pest in one country will actually be a pest in another country. As I have pointed out in my paper, an insect which is more or less harmless in its own native home often becomes a bad pest when introduced into a new country, and probably the opposite is sometimes the case. As regards foreign

pests likely to be brought into India, I have often wondered why we have not got *Plodia interpunctella* into India, but we do not seem to have it.

In this connection one thing that we want is a regular insect-survey of the various plant-nurseries in India. Probably such a survey would reveal a number of hitherto unknown and unsuspected pests which have been introduced with plants and are being distributed throughout the country. But, until we get a proper-sized entomological staff, it is hopeless to try to start work of this sort.

Mr. Senior-White.

Coolies travelling between Ceylon and India may bring in pests. The Customs Department cannot stop that.

Mr. Fletcher.

The Act covers all plants whether brought in by hand or otherwise. I know that these coolies do sometimes bring plants with them but the Customs Department should deal with that under the Act.

#### 90.—ENTOMOLOGICAL EDUCATION IN AGRICULTURAL COLLEGES.

Mr. Fletcher.

This subject is down on the programme for general discussion and has been considered by a Committee under the chairmanship of Mr. Higginbottom and composed of all those present at this Meeting who are engaged in teaching work at the various Colleges. As I explained to the Committee, my idea in including this subject amongst the Agenda was that some of those engaged in teaching might benefit by discussing with other teachers the syllabus of the course in Entomology and also by seeing the various diagrams and models used in teaching at other Colleges and brought to this Meeting, at my suggestion, for exhibition. As most of those who are most interested in the subject have already discussed this question in Committee, and in the absence of Mr. Higginbottom. I will now read the—

#### *Report of the Committee on Entomological Education in Agricultural Colleges.*

“Considering the great economic importance of insect pests to Indian Agriculture, we recommend that all Agricultural Colleges should make provision for the teaching of Entomology.

“The aim of the teaching of Entomology in Provincial Agricultural Colleges should be to give the students a sufficient knowledge of entomology to be able (1) to recognize the common pests and to know something of their life-history and the control measures applicable to each, and (2) to be in a position to report intelligently regarding the occurrence of any unusual pests.

“ To this end we recommend that the course should include, in addition to the lecture and laboratory work, a sufficient amount of practical work in the field to acquire a knowledge of the insects under field conditions and of the actual methods adopted to control them.

“ In view of the demand for coloured plates showing the life-histories of Indian insects for the use of their classes of students, we recommend that all Agricultural Colleges requiring such plates should make an annual estimate in anticipation of their demands and that such estimates should be forwarded to Pusa by 1st January in each year to be consolidated into one indent in order to reduce cost and expedite delivery of these plates.”

This Report is now before the Meeting. Has anyone any remarks **Mr. Fletcher.** to make on it ?

What is the cost of these coloured plates, supposing that we require **Mr. D'Abreu.** only one copy of each ?

That is the difficulty which we sought to avoid in the last paragraph **Mr. Fletcher.** of the Report. It is as much trouble to the printer to get the blocks in register to print off a single copy as it is to print off a thousand, and he would probably charge you at least one rupee each for single copies. If we can know the demand, we can get a number printed at one time.

The lines suggested by the Committee seem to meet the requirements. **Mr. Ghosh.**

In the Agricultural Colleges the aim is to train farmers and fruit-growers and not entomologists. We want to give these students a training which will be of real practical value to them, for example, they should be able to distinguish a pest from a non-pest ; any insect biting off a few leaves does not become a pest. If the student cannot make a distinction in this direction he is likely to magnify small things and to adopt preventive and remedial measures which are not at all called for.

Secondly, they should be able, at least in all ordinary cases, to trace the real culprit when they observe any injury to their crop or orchard ; for instance, when they see the top-shoot of a *brinjal* plant droop they should have sufficient knowledge to see that the ladybird-beetle grub feeding on the Aphids on the leaves is not responsible for it.

Thirdly, they should be able to distinguish the beneficial from the injurious.

Fourthly, they should have just a general knowledge of the external anatomy of insects so as to be able to place the insects at least in their Orders. This amount of systematic work is quite sufficient for them.

In order to make them familiar with common insects, their mode of feeding and causing damage, merely telling them of these insects or giving a description of their damage, however elaborate the description

may be, or showing them figures and illustrations or dry specimens in the cabinet, does not do. On the other hand, when once the student is shown the Aphids, the mealybugs and scales or caterpillars in the field, no student of average intelligence will make mistakes about them.

The laboratory work required of the students would be confined to the insects collected by the students themselves. They should be expected to rear those which can be reared and as the rearing goes on they should be made to make notes on life-history. This is the place where they can easily be taught the differences between a bug and a moth and those between a moth and a beetle or those between a fly and a beetle.

All measures of control are based on life-history and habits and the students' attention should be particularly drawn to those points.

If it is thought that entomology does not warrant so much time to be devoted by the students, in answer I may say that by the method which I advocate, *viz.*, studying entomology mostly in the fields, the students while engaged in entomological observations, unconsciously make very valuable observations on the crops themselves. The observation concentrates their attention on the crop. Or, to put it inversely, while carrying on their work in the fields the students should be encouraged to make observations on the insect and fungal pests. They should collect those insects which should be under rearing so that the students may have an opportunity of following the insects in their course of life-history. Rearing can be done in batches, *e.g.*, six boys rear the leaf-roller, another batch of six may rear the stem-borers and so on, while all can see the insects being reared by the whole body of boys. The staff to help the students should be a demonstrator and a laboratory keeper. The rearing will be done under the supervision of the demonstrator. The students should be required to visit the rearing place compulsorily once every day to see how the insects progress. If they cannot spare the time to feed the insects and clean the cages, the laboratory keeper can do that for them.

Mr. Fletcher.

I propose a Resolution :—

Resolution 7.

“That the Report of the Committee appointed to consider the question of Entomological Education in Agricultural Colleges be approved.”

Sardar Harchand Singh.

I second this Resolution.

[*The Resolution, on being put to the Meeting, was carried unanimously.*]

Mr. Kunhi Kannan.

I suggest that cabinets of the various insect-pests and the life-histories of the insects of particular localities be prepared for use in schools. In Mysore we circulated such cabinets and they created very great interest.

Stories of insects in simple language and illustrated by coloured plates **Harchand Singh**, should be prepared for use in our schools and also be inserted in the elementary text-books. They are sure to interest the children.

The ignorance of the facts of insect life is really very great and some-  
thing must be done. **Mr. Kunhi Kannan.**

It is no use making cabinets and having books if there are no teachers **Mr. Afzal Husain** to explain them. In all school primers there are chapters on animals and insects, but the teachers find them useful only for dictation as they contain some difficult technical words that children cannot spell correctly. We must first train the teachers.

In Baroda we have village museums. **Mr. Patel.**

[*The general opinion of the Meeting was that theoretical lectures are of no use.*]

As a member of the Ceylon Board of Agriculture I have to deal **Mr. Senior-White.** with the *raiyyat* in connection with insect pests and my experience shows that it is little use to have coloured plates and books; you must show the actual insect. The best thing is to teach general entomology and agriculture in the training colleges for teachers.

I have dealt with this subject in my paper on "Some aspects of **Mr. Ghosh.** Economic Entomology in India."

In the Central Provinces we have been keeping show-cases in villages. **Mr. Khare.**

What about that reader for use in the Central Provinces and for **Mr. Fletcher.** which I wrote some chapters on insects?

I do not know anything about it. **Mr. Khare.**

## 91.—SOME ASPECTS OF ECONOMIC ENTOMOLOGY IN INDIA.

*By C. C. GHOSH, B.A., Assistant to the Imperial Entomologist.*

In this paper it is proposed to deal with a few ideas which have occurred to the writer with regard to Economic Entomology in relation to Agriculture in India. The question is dealt with from the viewpoint of the Indian cultivators. The aim of the Agricultural Economic Entomologist is to protect the crops against insect pests. The success of his work depends on the adoption of proper and efficacious methods of control or prevention. The efficacy of the methods depends on the thoroughness of the study of the pests in all their relations, including proper experiments and verification of the preventive and remedial measures suggested by the life-history and behaviour of the insects concerned. Even when the methods recommended to deal with them are based on such study, another essential condition of success is their proper application. This presupposes on the part of the constituents

of the entomologist capacity to understand and to carry out the recommendations.

Measures of control and prevention against insects may be broadly placed under two categories. In one, definite results can be expected by the adoption of certain definite measures. If the Scales, Mealybugs and Aleurodids, etc., are sprayed with certain spray-fluids, we can see the results at once. The insects are killed and the plants saved. Great progress has been made in this respect in America and other countries. Although similar results can be expected and are obtained in India, a good deal of work has yet to be done to test the fumigants and sprays under Indian conditions of temperature and moisture and especially to find out simple things which the Indian cultivator can make up and use with small expenses within his means. In the other category such definite results can hardly be expected and under it are included the majority of the pests, caterpillars, grubs, bugs and the whole host of insects affecting garden, vegetable and field crops. In their case, the measures of control and prevention, however carefully and accurately they may have been worked out, can only approximate to certainty in their results. With regard to most of these, although the Agricultural Department with a recognized entomological staff has now been in existence in India for about a decade and a half, Economic Entomology may be said to be still in its infancy. It has not yet been possible to make out a complete survey of the pests, although most of the principal ones have been discovered. Of the known ones again, on account of the paucity of workers, it has not been possible to carry out the intensive study necessary to understand them in all their aspects, *viz.*, in relation to the agricultural practices followed for cultivating the crop or crops concerned, the climate, presence and absence of alternative foodplants and various other conditions, a correct study of which is necessary to grasp their real nature. Insects like all other living creatures are influenced by varying conditions of early or late rainfall, drought, scarcity or abundance of food and presence or absence of enemies. Therefore, unless we are able to keep them under careful observation for a series of years our knowledge of their real behaviour is extremely defective. It has not yet been possible to devote such study to them and in fact no attempts at the study of most of them have yet been made. Our recommendations to combat them are therefore in most cases based on general observations and deductive inferences. For instance, borers in sugarcane cause "dead heart." On the principle of "catch and kill," to diminish the number of borers, recommendations have been made to cut out the shoots with "dead heart." Similar measures are recommended for borers in rice which cause dry ear.



Although the principle of "catch and kill" is applicable in many cases with successful results, recent experiments have proved that it is hardly of use in the case of sugarcane and rice just mentioned. In sugarcane "dead hearts" have been found to be caused by various agents which are not got rid of simply by the removal of the shoots with "dead hearts," and in fact this remedial operation has a retarding effect on the crop. Similarly removal of rice plants with dry ears has been found to be hardly helpful to the standing and of doubtful utility to the future crop. When we come to verify our own recommendations we find that they do not always possess the merits we claim for them. Recommendations based on general impressions and imperfect knowledge of the pest are bound to be vague and even useless and not applicable to all cases and localities. These remarks apply to most of the insects we have to deal with. This defect is due to imperfect study which again is ascribable not to inefficiency of the experts who have made the recommendations but to want of facilities.

The constituents of the Agricultural Economic Entomologist in India have absolutely no knowledge of insect life. To them a caterpillar is an insect which is born and dies as such. The moth or the butterfly resulting from the same caterpillar is a separate insect taken to be born and to die as the moth or the butterfly. This ignorance of insect life is not simply confined to the uneducated classes, but is equally prevalent among the educated classes also. Moreover, the majority of the cultivators own only a few acres of land which is scattered in small plots, often half or even one-third of an acre in area or even less. And in addition to this, they are proverbially poor. Any measure of insect control involving an outlay of expenditure is either inexpedient on account of the scattered nature of the plots under cultivation or beyond the means of the cultivator. But although totally ignorant of the elements of insect life, the Indian cultivators owing to the accumulated experience of ages have in many cases evolved methods of cultivation best adapted to the successful growth of the crops which are liable to be seriously affected by insects or fungal diseases. Take for instance the "wilt disease" of tobacco at Rangpur, which the writer had the opportunity of investigating from the entomological point of view. The soil is turned over frequently with the hand plough. The cultivators believe that they are removing the extra moisture from the soil by this operation, but really they conserve moisture by preparing a sort of a surface mulch. Scientific investigation corroborated the same process to be efficacious to a great extent against the disease as the germs are frequently exposed to the sun and are thus killed. Similarly in the "*Koleroga*" disease of betel-nuts in Mysore, the people

have a method of covering the bunches of the nuts by tying over them the broad leaf-sheaths locally called *Kottes*. Scientific investigation revealed the fact that the spores of the disease are spread by rainwater and *kotte*-tying is efficacious against it. In Gujarat, against the caterpillars which bore the tobacco stem and cause a swelling in it, the cultivators follow the method of making an incision in the swollen part which in many cases cures the disease and enables the plants to grow normally, the plants remaining stunted if not cured. The entomologist cannot yet suggest a better method. In the case of the plant (*Orobanche*) parasitic on roots of tobacco in Bihar, scientific investigation recommended the stoppage of the ratoon crop. In spite of the root parasites the cultivators make a profit out of the ratoon crop and therefore they are not prepared to give it up. But they have a method of evading the parasites by not growing tobacco for consecutive years in the same place. In extreme cases cultivation of particular crops, which they have not been able to protect, has been given up. The writer knows of a locality in the Raniganj Subdivision of Bengal where no *aus* paddy is cultivated, although it grows well there, as it cannot be protected against the rice bug, *Leptocorisa varicornis*.

The agricultural practices followed by the cultivators are usually suited to the local conditions. Although with regard to many pests we are not in a position to suggest really efficacious measures, whatever recommendations to deal with an insect are made, they must take into account the local conditions and the current agricultural practices or they become not only impracticable and useless but make the cultivators lose confidence in the entomologist. What would one think of drowning rice plants in order to kill caterpillars of *Chapra mathias* feeding on their leaves by raising a high mound all round the field and filling it with water? Ridiculous is too mild an adjective for this recommendation. Yet it has been made by an entomologist who probably never saw the conditions under which rice is cultivated. It also illustrates the fault of making recommendations on the strength of general impressions and imperfect study, which are likely to magnify small things beyond proportion. The *Chapra mathias* caterpillars are a very minor pest, hardly requiring any treatment in most cases. While in the case of most of the injurious insects we have not yet been able to find out practical methods of prevention or control, in the case of some of the pests at least, simple measures, quite within the means of the cultivators, are efficient. For instance, removal and destruction of eggclusters or congregated young caterpillars of *Diacrisia* on jute or of the white butterfly (*P. brassica*) on cabbage will check their increase. The Red Cotton Bug may be shaken off into a pan of kerosinized water. Timely

destruction of the top-shoot borers of *brinjal* may diminish future damage. The surface caterpillars among vegetable crops or in the field may be picked off by children by turning over the surface of the soil. Enough time and labour can almost always be spared by the members of the cultivator's family for such measures. Many wonder why he does not adopt them. He does not adopt them because he does not understand the reason of the thing. He cannot comprehend how the destruction of the caterpillars feeding to-day will ensure safety of the new crop or to the crop at a later stage. He does not understand that insects like all other living creatures are born of parents and not out of air or water and are endowed with a power of rapid development and growth, and a fecundity not commonly met with among animals, beasts or birds he ordinarily sees. When he will understand that ten caterpillars feeding to-day have the power of giving rise to about five thousand a month later, he will of his own accord and without any advice from the entomologist, seek out the ten or even two and destroy them. Therefore the best service the entomologist can at present render to the cultivator is to acquaint him with the elements of insect life. The attitude of apathy, indifference or resignation, at present so common on his part, can be dispelled only by this knowledge, and his co-operation secured, without which the entomologist however much backed he may be otherwise, cannot be successful in his work of checking the pests. While it is true in many cases that no reforms can be safely or widely introduced into the agricultural system without the willing and intelligent co-operation of the farmer, which can only be expected from him if his education has been directed in that line, it is hardly so in entomology. Even small children without education can see and grasp the elementary things of insect life as they do of cattle. Only the things have to be pointed out to them. In this respect the entomologist is much more favourably situated than the mycologist or the bacteriologist and need not requisition the services of a microscope.

Insects have a charm both for the young and the old. It will not be easy to approach the old people at once, but they can be approached through the children. As an instance of how children can quickly grasp the elements of insect life, the writer mentions here his experience with a child about eight years old. This child one day found a golden-coloured glistening chrysalis of the common butterfly *Euplaea core*, hanging on a leaf of oleander. She was asked to keep it in a tumbler and she saw how the butterfly emerged from it. She was further asked to search the oleander bush and she found eggs and caterpillars of the same butterfly. She saw the caterpillars hatching from the eggs and was made to feed and rear them in a tumbler. She saw the connection

between the egg, the caterpillar, the pupa and the butterfly. This aroused her interest in insects and she collects them from all sorts of plants. Soon after her experience with the above butterfly one day she found two pupæ of the oleander hawk-moth (*Deilephila nerii*) under cover of old leaves lying on the road side. She brought them to the writer and accurately described them as the pupæ of some large caterpillars although she had not seen such pupæ before. As against this method of teaching, the writer remembers while reading in his undergraduate days that the word "caterpillar" in a text book was explained as referring to an unknown creature living on the surface of the earth and he had not had the opportunity of recognising it in the ubiquitous "*shua poka*" until he joined the Agricultural Department.

In India insects are present everywhere and they form the best subjects for Nature Study for small children. But the instruction should be on proper lines. In Bengal villages and almost everywhere in the country most of the cultivators' boys attend the village *pathshalas* (primary schools) for shorter or longer periods according to the means of the family. All families make an attempt to teach the boys at least how to read and make small calculations. While attending the *pathshalas* the boys can be shown the common insects by the *Guru* (teacher). For this purpose the *Guru* himself has to be taught when he attends the *Guru* training-schools. Elementary text books written in the plainest language in the vernaculars will be of help in this direction.

When the cultivators will understand insect life they will know the complexity of the problem and the difficulties of the entomologist and will not expect wonders from him. The writer has heard the Entomological Assistants in the Provinces being styled by the people as "doctors." The people expect that plant-diseases due to insects are capable of being cured by these entomological "doctors" with the application of medicines, if not by incantations and *mantras*, as they see human diseases cured by medical men and more recently cattle diseases by veterinary surgeons. In this connection it may be pointed out that most of the provinces have an Entomological Assistant, whose time is wholly taken up and he himself spent up, in moving from place to place, under orders to check insect outbreaks wherever they occur throughout the Province.

The position of the Entomologist in India is at present this. In the case of most of the pests he cannot suggest really efficacious measures on account of not having facilities for proper study. In the case of some insects, for instance, Aphides, Scales, etc., the efficacious measures either involve an outlay not within the means of the cultivator or lack facilities for adoption. The results of preventive measures are not

apparent at once and preventive measures do not appeal to the people as, to quote one example, they do not see the connection between the hibernating caterpillars in *juar* stalks and the brood of the same insect in the crop of the next spring. In some cases the entomologist cannot do more than recommend the methods which the cultivators themselves follow. Frequently again for want of facilities for local investigation the advice given through correspondence has no reference to actual conditions and therefore turns out to be impracticable. All these difficulties in the way of the entomologist are not apparent to the ordinary people. In some quarters therefore there is a tendency to belittle the importance of the entomologist in the economy of the Agricultural Department. This is hardly justifiable as the entomologist is judged before he is given facilities for equipping himself for the work he is expected to be able to do.

In Agricultural Economic Entomology in India there are two distinct lines on which progress is urgently needed, first investigational and the second educational. We have to push on vigorously the investigational part which can be carried on without the co-operation of the people. The investigation of a pest must be carried on in its natural environment in the locality where it occurs, in order to enable the investigator to see it in its real perspective. The mango fruit weevil (*Cryptorhynchus gravis*) or the Rice *Hispa* which occur and cause extensive damage in Eastern Bengal and Assam cannot be investigated with imported individuals at Pusa, where they do not occur or occur only as curiosities. It will be years before the investigational part can make much progress even if we proceed at a much faster rate than we are doing at present. But in the educational part we can have very good results in the course of a short time, if only we can utilize the agency indicated above. If with the co-operation of the Educational Department Nature Study with insects be made a compulsory subject in primary schools, the knowledge of insect life will spread quickly. Through the boys attending the *pathshalas* it will spread into their families and those of their neighbours. If a proper beginning on these or similar lines be made, progress is expected to be very rapid and this will help the Economic Entomologist immensely in his work of checking the ravages of insects.

Mr. Ghosh's paper contains many facts which are obviously true. **Mr. Fletcher.** We require, in the first place, very detailed work on the natural history (in its widest sense) of the innumerable insect pests which cause in the aggregate money losses amounting to hundreds of millions of rupees every year in India alone. For that we require a very large increase of staff, and, in my opinion, such an investigational staff should be

centralized in order to obtain the best economy and efficiency. That is the first thing we want—a thorough knowledge of the insects concerned—and it is not a bit of good to recommend control measures before we have this thorough knowledge. We can of course recommend what Mr. Ghosh calls the “catch and kill” policy, as in the case of bagging of grasshoppers, but measures of that sort are mere temporary palliatives and are not control-measures as I regard the word “control.” In the second place, there is room for a considerable amount of education on the part of the *raiyat* as regards the life-histories and methods of life of the commoner insects. That is in some respects simple work, only requiring organization, but it is rather outside the scope of the investigational staff and could well be left to Provincial activities provided that it was done in close co-operation with the entomological side of the work in order to ensure accuracy. But I think strongly that the investigational work must come first. Otherwise, if you start to tell the *raiyat* this and that about insects, the first thing he will want to know will be the practical question of control. If your investigational work has got far enough to have elucidated definite lines of control, the *raiyat* will then be willing to listen to what you have to say, if you can tell him not only about the life-history but also about the control; but, if your information stops short at the life-history and you cannot answer his questions about control, I doubt whether he will see the practical value of what you have to tell him. As far as Nature Study is concerned I quite agree that insects form a suitable subject for use in India but many of the lessons on insects in text-books in use in India are, I think, founded on insects which are not Indian and this point requires amending and the text-books checked by competent entomological workers.

I think that we might have a Resolution on this subject. I have drafted one and, if it meets with general approval, perhaps Mr. Ghosh would like to propose it.

Mr. Ghosh.

I propose the following Resolution:—

“This Meeting—

Resolution 8.

- (1) considers, in view of the great importance of a knowledge of insects and insect life-histories to the peoples of India, that readers for use in the primary schools in India should, as far as possible, contain simply written accounts of some of the insects commonly found in the Provinces concerned.
- (2) suggests that entomology should figure prominently in all courses of Nature Study, and

- (3) recommends that the educational authorities should enlist the help of entomological workers in the preparation of such accounts in their readers or text-books."

I second this Resolution.

Mr. Kunhi  
Kannan.

*[The Resolution was put to the Meeting and carried unanimously.]*

## 92.—THE ORGANIZATION OF ENTOMOLOGICAL WORK IN INDIA.

We now come to the last subject on our Agenda-paper, the organization of entomological work in India and in the first place I may perhaps explain why this subject was placed on the list of Agenda after the programme was printed. When Sir Claude Hill, the Hon'ble Member in charge of the Revenue and Agriculture Department, was at Pusa last month I showed him the programme of subjects for discussion at this Meeting and he asked me whether we would not discuss my organization scheme, to which I replied that my scheme had already gone up to Government officially and that subsequent proceedings seemed to me more a matter for executive action. Sir Claude Hill however said that Government would welcome any discussion on it at this Meeting, at which so many entomological interests would be represented, and it was therefore included in the programme.

Mr. Fletcher.

The question of the means of improvement of entomological work, and particularly of entomological research, has been in my mind for many years and you must not think that this proposal of mine is a hasty or ill-considered one. Since taking over the duties of Imperial Entomologist in 1913 I have visited all the Provinces with a view to acquiring a first-hand knowledge of their requirements and of how these may best be met and I may remind you that I have myself served as Government Entomologist in the only Province that has yet created such a post. I have been able therefore to regard this question not only from the point of view of what is best for the Indian Empire as a whole but from the Provincial aspect also. One's first idea is, perhaps naturally, the creation of Provincial Staffs, but more mature consideration convinced me that better progress would be made by an equal number of men working together rather than by the same number of men working separately—in other words, by a strong Imperial Staff rather than by numerically equal but much less efficient Provincial

Staffs ; and some three years ago I had the details more or less worked out in my own mind. Two years ago the Government of India called for proposals for an expansion of the Pusa Research Institute and I then drafted my proposals for the centralization of all the varied entomological work being done in India, as I considered that the question should be considered as a whole and not only as regards Pusa alone. These proposals were submitted to Government and were considered by a Committee which met in Simla in May 1918 and reported favourably on them. They were also printed in the Report of the Indian Industrial Commission which also endorsed them. It is now for this Meeting to consider them and make any criticisms on them. I may say that for my part I shall welcome any criticisms that you may have to offer. I will now read the Report of the Committee appointed to consider this subject.

*“ Report of Committee on organization of entomological work in India.*

“ No alternative proposals having been received, the Committee has considered the proposals contained in Mr. Bainbrigge Fletcher's scheme (Appendix K to Report of Indian Industrial Commission) on which they offer the following remarks :—

- (1) The Committee considers that the centralization of entomological research work in India is very desirable.
- (2) As regards the Agricultural and Forest Departments, the Committee considers that the dimensions of the Service proposed are not large enough to commence the work satisfactorily, in view of the importance of entomology in India, and that an increase in the numbers proposed is necessary and that an increase in the rates of pay proposed for the lower grades is also necessary. The Committee offers no remarks as regards other Departments.
- (3) The Committee considers that the staff of the central entomological institute should be imperial (*i.e.*, employed directly under the Government of India).
- (4) Provincial staffs will be required, in addition to the staff of the central entomological institute, and we consider that they should work under the local Agricultural or Forest or other Departments, as the case may be, reporting to the central institute through such local Departments.



- (5) As regards the location of the entomological institute, we consider that Coimbatore is the most suitable locality that has yet been suggested.

E. A. ANDREWS,  
 C. BEESON,  
 SAM HIGGINBOTTOM,  
 LEWIS H. GOUGH,  
 T. BAINBRIDGE FLETCHER,  
 C. S. MISRA,\*  
 T. V. RAMAKRISHNA AYYAR,†  
 K. KUNHIKANNAN.†  
 Y. RAMACHANDRA RAO.†

“As a representative of the Forest Department I wish to record my opinion on the suitability of Dehra Dun as an alternative locality after Coimbatore. Dehra Dun compared with Coimbatore is equally accessible and habitable, and is rapidly becoming a scientific centre of great importance. As regards the preservation of an insect collection climatic conditions are not prohibitive although they are far less suitable than those of Coimbatore. Improved methods of storing would nullify disadvantages arising from high humidity. As regards facilities for experimental breeding of insects Coimbatore appears to epitomise various soil and locality conditions better than Dehra Dun, although the qualifications of the latter are high. In my opinion facilities for this work are not essential at a Central Institute, as seasonal history investigations require to be carried out in experimental stations in the field.

(Sd.) C. BEESON.

“I feel that Coimbatore is too far South to be central, but I cannot suggest any other place that offers so many advantages with so few disadvantages. I feel that the neighbourhoods of Poona, Indore or Rutlam, Bangalore and Jubbulpore are worth considering.

(Sd.) SAM HIGGINBOTTOM.

“In view of the function that the Central Entomological Bureau is expected to fulfil in the future it is desirable that it should be located in or near a central place easy of access to all workers in Entomology from different parts of India. Its proximity to an Institute dealing with cognate subjects of Agricultural Bacteriology, Chemistry, Botany,

\* Subject to note appended.

† Subject to the note appended.

Mycology, etc., from a broad or Imperial point of view is also desirable. In my opinion these conditions are fulfilled at Pusa. If, however, adequate provisions are made, it will be possible to keep the specimens in as good a condition as it will be possible to do elsewhere.

(Sd.) C. S. MISRA.

“ We consider that as far as the Agricultural side of the Scheme is concerned, the work of the Entomological Assistants in the Provinces is better controlled and directed through a Provincial Entomologist than through a Deputy Director of Agriculture, necessarily preoccupied with his own work. We consider also that no provision has been made in the scheme for the training of Indians for posts in the Superior Service.\* As regards officers coming under Class II of Mr. Fletcher's scheme, we consider that any grade less than Rs. 100—150—15—300, 300—25—500, will fail to attract the best men required for efficient work in the Provinces as well as for final recruitment into the Imperial Service on attainment of the maximum of the grade.

We also consider that unless the Provincial Entomological Staff is also made Imperial, it would seriously detract from the merits of a Centralised Entomological Research Institute.

(Sd.) T. V. RAMAKRISHNA AYYAR,

(Sd.) K. KUNHIKANNAN,

(Sd.) Y. RAMACHANDRA RAO.”

With regard to this Committee Report, no alternative scheme was submitted to the Committee and I take it that no one has any other scheme to propose.

The Committee is unanimous regarding the desirability of the centralization of research work in entomology in India, and when one considers the demand for investigational work in entomology in connection with Agriculture, Forestry, and Medical and Veterinary Science in India and with the more systematic side of the subject, as well as the enormous extent of the subject of entomology generally, which renders it quite impossible for any one worker to be really a master of more than one small section of the whole science, and when one further commences to multiply the various workers in these sections by the number of Provinces into which the Indian Empire is divided for purely adminis-

---

\* This sentence was amended at the General Meeting to read as follows :—Provision should be made at the Central Entomological Institute for the reception of a limited number of post-graduate students desirous of acquiring a knowledge of the methods employed in entomological research work.

trative purposes, you will find that, if expansion is to take place on the present decentralized lines, we shall have thirty or forty or more entomologists all working separately, each provided with expensive laboratories and libraries and collections, which are necessary if any good work is to be done, and each man with his work diffused, incomplete and often redundant. To me there seems no question but that an equal number of men all belonging to one Central Institute would accomplish far more and far better work, because each man could be employed on a particular line of work, and at far less cost to the State on account of the centralization of laboratories, libraries, collections and records generally. Such items as recruiting would be greatly facilitated by the establishment of a centralized service on account of the more regular occurrence of vacancies and because a centralized Service with a high reputation would attract a better class of candidates than odd vacancies in various Services occurring at infrequent intervals. There are numerous other advantages of centralization and practically no disadvantages, but I do not propose to say any more on this subject now because these points have been dealt with in my Note which you have had an opportunity of seeing.

As regards the numbers required to commence with, this point was also endorsed by the Simla Committee. As regards the dimensions proposed originally in my scheme it should be remembered that those numbers represented a bare minimum to commence with and were largely influenced by the practical difficulty of recruiting larger numbers of really competent men, but if the various Departments require more workers (as apparently they do, the Forest Department for example, having now asked for five men instead of the three allowed for in my scheme) than this minimum must be increased accordingly. No remarks have been offered regarding the numbers proposed for work on the special problems of Departments other than the Agricultural and Forest Departments, not because the Committee considered the proposed numbers sufficient but simply because no representatives of such other Departments were present at this Meeting. As regards the rates of pay proposed in the lower grades, we shall probably all agree that they err on the low side, particularly in these days, and that some increase is necessary.

There is no difference of opinion as regards the necessity for the employment of the staff of the Central Entomological Institute directly under the Government of India. There are very few insects which are respecters of Provincial boundaries and it is obvious that, to get the best results, problems must be studied in as broad and imperial a manner as possible.

I do not think there is any difference of opinion regarding the necessity for permanent Provincial Staffs in addition to the Staff of the Central Entomological Institute, but there is a sharp difference of opinion, clearly shown in the note of dissent appended to the Committee Report by Messrs. Ramakrishna Ayyar, Kunhi Kannan and Ramachandra Rao, regarding the employment of those Provincial workers. The majority of the Committee consider that such Provincial Staffs must work under the Provincial Officers (Agricultural, Forest, or others, as the case may be) whilst the minority consider that these men, although permanently stationed in the Provinces, should work directly under the Central Institute without any direct subordination to the local authorities. This latter scheme would not work in practice in my opinion, because it would lead to constant friction with the Provincial authorities and because it would be extremely difficult for the Central Institute to keep in sufficiently close touch with the various local workers scattered all over India and Burma.

As regards the location of the proposed Entomological Institute, there is also considerable difference of opinion, which again is clearly shown in the various notes appended to the Report of the Committee. My own view is that Coimbatore is the most suitable locality that has yet been suggested. It is not ideal altogether, but it approaches the ideal more closely than any other locality that I know of. If a more central place could be found, climatically and otherwise equally or more advantageous than Coimbatore, such a place would undoubtedly be preferable, but I do not know of any such place nor has anyone else as yet made any really useful suggestion regarding this. The main objection which is usually raised regarding Coimbatore is its supposed inaccessibility but I think that this bugbear of inaccessibility has been greatly exaggerated and this will be minimized in the near future when air transport has come in as a regular method of travel and despatch of mails. I just ask you to consider for a moment the facilities for transport in India one hundred, or even fifty, years ago and compare them with the present day and I will further ask you to try and look ahead another twenty or fifty or a hundred years and try to imagine the way in which distances will be reduced by improvement in means of transport. It would be folly to my mind to put up large and expensive buildings in any locality which we are not absolutely satisfied will be thoroughly suitable. We have found that out by bitter experience at Pusa and have no wish to repeat an experiment of that sort. I hold no special brief for Coimbatore and, if anyone can satisfy me that another locality will be more suitable, I am quite willing to be convinced.

The Committee Report is now before you for consideration.

May I know if the whole of my note of dissent will be printed? I **Mr. Misra.** should like to see the whole of it printed.

There was no desire to curtail this note but, as I read it, I understood **Mr. Fletcher.** that only the concluding paragraph was intended to be added. The following is the full note appended by Mr. Misra to the Report of the Committee :—

“ The Committee appointed to consider the question of reorganization of the Entomological work in India consisted of the following besides myself :—

Mr. T. Bainbrigge Fletcher, Imperial Entomologist.

Mr. C. F. C. Beeson, Forest Zoologist.

Mr. E. A. Andrews, Entomologist Indian Tea Association, Tocklai.

Dr. L. H. Gough, Director of Entomology, Egypt.

Mr. Kunhi Kannan, Senior Assistant Entomologist, Mysore.

Mr. T. V. R. Ayyar, Acting Government Entomologist, Coimbatore.

Mr. Y. R. Ramachandra Rao, Assistant to Government Entomologist, Coimbatore, on Special Deputation on Lantana work.

“ In my opinion the localization of the Central Entomological Bureau in a Central place would have far reaching effects on the future development of Entomological work in India and I think shifting the work from Pusa to extreme south would not secure this object. By locating the Central Bureau at Coimbatore the inconvenience felt by entomological workers in the North, East, and West of India would be so great that they might hereafter bring to the notice of the Provincial Governments concerned the necessity of having a separate Bureau for the North of India, and as a number of workers in Entomology are here, I hope you would be pleased to obtain their views by announcing the minutes of the Committee and then making a suggestion to the Government, who will no doubt obtain the views of the Local Government before deciding upon the localisation of the Bureau. As suggested by the majority of the members in the Committee, I think, Coimbatore would not meet the situation. Pusa is in one extreme and Coimbatore is in the other. I think, if proper provisions are made, it is possible to keep the specimens in good condition at Pusa. The conditions of storage of specimens at Pusa in the past have been rather peculiar and it is to these causes more or less that they have not remained so good as they should have been. I also think, if it is at all decided to shift from Pusa, Jubbulpur would meet the requirements much better than Coimbatore. It is central from all parts of India, it commands access to the neighbouring rice, wheat, sugarcane, cotton tracts and other important crops, and access to the neighbouring Pachmarhi Hills, the

summer Head quarters of the Chief Commissioner of the Central Provinces, is also easy by rail. As for provision for special investigations on tea, coffee, cinchona in South India, Assam and Burma, I think, the requirements would be amply met with, by the establishment of field laboratories of special workers on the subjects as considered by the Committee. Besides this, I think, the proximity of the Bureau to a Central Institute like Pusa dealing in cognate branches of Agriculture, Chemistry, Bacteriology, Botany, Mycology, etc., from a broad or Imperial point of view would be found desirable. A future worker on insecticides or chemotropism of insects would like to be in frequent personal touch with the head or workers in the Central Chemical Bureau.

"In view of the above, I beg to submit the following to be appended to the minutes of the Committee regarding the localization of the future Central Bureau of Entomology in India :—

"In view of the function that the Central Entomological Bureau is expected to fulfil in the future it is desirable that it should be located in or near a central place easy of access to all workers in entomology from different parts of India. Its proximity to an Institute dealing with cognate subjects of Agricultural Bacteriology, Chemistry, Botany, Mycology, etc., from a broad or Imperial point of view is also desirable. In my opinion these conditions are fulfilled at Pusa. If, however, adequate provisions are made, it will be possible to keep the specimens in as good a condition as it will be possible to do elsewhere."

Mr. Fletcher.

In their note to the Committee Report Messrs. Ramakrishna Ayyar, Kunhi Kannan and Ramachandra Rao have also raised the question of the provision of training for Indians. This point was not raised in Committee or we might have said something about it. As it was, we were considering the question of centralization more from the point of view of research. I do not know at present how this question of training can best be provided for. I feel strongly that to make a really first-class entomologist you must at least start with a man who has an innate keenness for the subject and that it is useless to put classes of students, who have not got this aptitude inborn in them, through courses of instruction and expect to turn out uniform and first-class results. We may be able to pick up a few really keen men from here and there and give them special training, but that is quite a different thing from regular teaching courses. Another thing is that the proposed Central Institute is intended to be primarily a Research Institute and the first thing we want at present is to find out information before talking of imparting it to others.

Mr. Ramakrishna  
Ayyar.

At least facilities should be afforded for attracting research students.

Any students desirous of knowledge for its own sake would always be welcome and, the Director would keep his eyes open and be eager to secure any really promising man for the Entomological Service. But I maintain that you cannot make a man an entomologist by merely passing him through a course of training. Such a man will never be more than a routine worker unless he has real keenness in him to start with. **Mr. Fletcher.**

That means that you are going against the whole system of education. It must be admitted that a centralized Institute of the kind suggested is very desirable. During this Meeting we have constantly been reminded of the very great difficulty of getting our specimens identified. We have lost a large collection through enemy action and boxes full of our insects have been with specialists outside India for years. We do want a central place for India, an Institute such as the British Museum (Natural History) is for the whole Empire, where specialists can work and our insects be identified. But this scheme does not take into account the pure side of the Science, I mean research in physiological and embryological problems of Entomology. These problems may have no immediate application but are very interesting and important. Without pure science we cannot go very far with our applied science. **Mr. Afzal Husain.**

I do not know whence Mr. Husain has derived this idea. The Central Institute would of course deal with the class of problems he mentions, provided that the staff could tackle them. In cases where particular problems concerned sciences outside of entomology, such as the transmission of fungal disease by insects or work in which the co-operation of a chemist was necessary, my idea is that we should either send an entomologist to work with the mycologist or chemist, or borrow a mycologist or chemist to work at the Entomological Institute. The exact arrangements to be followed in any particular case would have to be arranged at the time. My scheme allows for complete mutual collaboration with other Departments and for work on every aspect of entomology, pure and applied, and I cannot understand the idea prevalent in some quarters, that the Entomologists want a Central Institute merely to go inside and lock the doors and pore over specimens of insects and shut themselves off from zoological and other work. Entomology is a branch of Zoology just in the same way as Zoology is a branch of the Natural History of a hundred and fifty years ago. Yet we do not hear nowadays of a botanist or a mineralogist claiming that Zoology is a part of his work because he is equally a student of Natural History. We Entomologists merely claim that we are specialists in a science, which is big enough nowadays to stand on its own legs as a science separate from Zoology, and that we know what is required to be done and we prefer to do it in our own way. **Mr. Fletcher.**

**Mr. Afzal Husain.**

As has been already pointed out by the Committee which considered this scheme at Simla, this proposed Institute does not provide facilities for the teaching of Entomology. I have been through a complete course of training in Zoology in this country, but we did extremely little of Entomology. If we want a large staff, we must train the men. I do not agree with Mr. Fletcher when he says that ordinary graduates of the Indian Universities can teach Entomology in the Agricultural Colleges. We must have really capable people to teach, men who can stimulate their pupils. I might refer to my own teacher, Lieutenant-Colonel J. Stephenson. His influence and teaching have been responsible for the development of Biology in the Punjab. Now we find his pupils going to England for specialization in the subject in which he instructed them. All the Zoological posts in Northern India are held by his pupils. This demonstrates how a teacher can influence his pupils. We want men like him to be teachers in these Agricultural Colleges. In England, which is not an agricultural country, the Universities are erecting special chairs for Entomology. Entomology is a vast subject and cannot be taught by giving a short course of lectures. At Cambridge we have a course of lectures extending over two terms and that is only for pure Entomology. There is another course of applied Entomology extending over three terms. Professor Lefroy's course is a one-year course; he does morphology during the first term, systematic entomology during the second term, and applied entomology in the third term. If we want to help the growth of entomology in this country, we must start with the teaching of entomology. It is not essential that an Institute like the one suggested should only be for research work. Teaching keeps the mind young.

**Mr. Andrews.**

The comparison of the proposed Institute with Cambridge and Oxford is not applicable. Cambridge and Oxford are primarily education bodies and keep up research as a secondary thing. The proposed Institute may better be compared with Rothamsted and many American institutions which are primarily for research.

**Mr. Afzal Husain.**

It is strange to hear that the Universities in England are merely educative; they are as much for research work as they are teaching institutions, if not more so.

**Mr. Andrews.**

I do not believe in the system of education in this country. Educational institutions should be private concerns and based on competitive principles so that we get better education.

**Mr. Kunhi Kannan.**

This scheme, that aims at preventing unnecessary expenditure, should have a teaching side. It should give the benefit of research work to students and this can be done best in the Central Institute; of course, the research should be of an advanced nature.



Some of the Provincial Agricultural Colleges have served as a rather awful warning not to lay too much stress on the teaching side too early. Many of them were started in a hurry and commenced to give courses before they had any knowledge of what to teach as regarded local conditions. Teaching will come later on. **Mr. Fletcher.**

The demand for entomologists was created in England and these chairs of Entomology were established to meet that demand. First let us have a well-organized Research Institute and create a demand and then in the near future education will have to be provided for. **Mr. Andrews.**

Surely teaching was done before the Research Institutes were started. **Mr. Afzal Husain.**

The first thing is to have specialists and, if they find time, they can give courses of lectures. Mr. Lefroy's course was started as a temporary measure and it was afterwards made permanent when it was found successful. **Mr. Andrews.**

We should have a provision that if a body of well-qualified candidates not more than about half-a-dozen, come forward, the specialists may give courses of lectures. They cannot be expected to sit down and teach elementary things. **Mr. Senior-White.**

If it is in order, we should like to amend the sentence in the Committee's Report, *i.e.*, "We consider also that no provision has been made in the scheme for the training of Indians for posts in the Superior Service," so as to read as follows:—"Provision should be made at the Central Entomological Institute for the reception of a limited number of postgraduate students desirous of acquiring a knowledge of the methods employed in entomological research work." **Mr. Ramakrishna Ayyar.**

If you all three, who signed this Note, are agreed to amend it in this way, I am quite prepared to accept the amendment. **Mr. Fletcher.**

This amendment exactly expresses what we want. In the Tata Research Institute, the professors do research work and also guide the research work of students. **Mr. Kunhi Kannan.**

Mr. Andrews has taken the case of a few men who have to give a long course of lectures. There are men who do research work but also give a short course of lectures in their own subject. **Mr. Afzal Husain.**

Training in entomology requires more than lectures. The Central Institute should be modelled more after the lines of the very successful Bureau of Entomology in the United States of America, which does no teaching work as such. **Mr. Fletcher.**

There is another aspect. Entomologists become experts after a long period of work when they are practically old men. Where are the experts to be got for this Institute? This point has been brought forward in the Report of the Industrial Commission. **Mr. Afzal Husain.**

**Mr. Fletcher.** There certainly will be difficulty in getting together a body of experts in various lines and it will necessarily be a gradual process.

**Mr. Afzal Husain.** Therefore it is best that we start training men in this country.

**Mr. Andrews.** In an Institute of this kind men fresh from College are better drafted on to special subjects so that they come without a bias and specialize in that subject in the course of time.

**Mr. Isaac.** The doors of the Institute should be open to all.

**Mr. Fletcher.** There must be some limit to the number of students to be admitted.

**Mr. Ghosh.** Some of us have drafted another note dealing with the points that concern most of us and especially the Provincial Assistants. In a discussion that we had before this General Meeting we came to certain conclusions which we have incorporated in this note, which we should like to have included in the Proceedings.

**Mr. Fletcher.** Provided that the note is signed by its supporters, there is no objection to its inclusion in the Proceedings, as it comes to the same thing whether you each speak on the subject or whether you read a note.

**Mr. Ghosh.** The following is the note :—

“ In our opinion that part of the scheme which contemplates investigations of special crops and problems by the appointment of Special Experts who will include in their sphere of investigations the crops or problems as they affect the country as a whole is good. By such investigations, the experts will be able to investigate problems as they affect different parts of the country and will thus be able to make efficient recommendations. But in our opinion the success of such organization is indissolubly connected with the appointment of Provincial Entomologists who will keep themselves in touch with the Special Experts and will also attend to the adoption and carrying out of the measures recommended by them. This will do away with the extra burden which would otherwise have fallen on the shoulders of the Deputy Directors of Agriculture, who having no expert knowledge of the subject take only a half-hearted interest in the recommendations and give a step-motherly treatment to the Entomological Staff entrusted with the execution of the recommendations.

“ The scheme as outlined in the recommendations of the committee appointed during the present session contemplates continuation of the present system whereby the Entomological Assistants do not get opportunities and encouragement for work but are at times even employed to do non-entomological work.

“ By the appointment of a Provincial Entomologist the question of dual control will be avoided ; and the Special Expert dealing with a problem affecting different Provinces will not be expected to become conversant with the language, habits and agricultural practices of the

people of different Provinces. In our opinion recognisance of the above factors is essential to the success or otherwise of the suggestions of the Special Expert. By the presence of a Provincial Entomologist the Special Expert will have the advantage of a local organization and will be left free to deal with research and the consideration of the subject or subjects from a broad or Imperial point of view.

“ In our opinion the requirements of Entomology will be amply met with if the Special Experts were attached to the Imperial Agricultural Research Institute. Pusa, where they would remain in touch with other experts in Botany, Chemistry, Bacteriology, Mycology, etc. In our opinion close intimacy between experts dealing with Imperial or broad questions is essential for the special subjects being investigated in all their bearings, so as to yield substantial results.

“ The difficulties experienced in the past with regard to the preservation of insect specimens due to humidity can be overcome by the improved methods of storing at present introduced at Pusa.

“ In our opinion, special investigations for the following are required and we suggest these for immediate consideration on the strength of our experience gained during the last decade or more.

- (1) Cereals.
- (2) Sugarcane.
- (3) Cotton.
- (4) Store Pests.
- (5) Fruit Pests.
- (6) Termites.
- (7) Parasites.
- (8) Lac.
- (9) Bees.

“ In our opinion any scheme which does not provide for the adequate training of the Indians for the Indian Agricultural Service cannot be considered satisfactory. Hitherto the conditions of service in the Department have not at all been attractive to the best graduates of the Indian Universities. Therefore, in any future scheme of development in Entomology the aim should be to attract such students as would after necessary training in research be able to carry out research work on their own initiative.

“ We further think that in order to attract the best Indian graduates in Class II of the scheme it is necessary to start them on an initial salary of not less than Rs. 200 and after a probationary period of a year to confirm them on Rs. 250. Thereafter they should go up to Rs. 500 after a reasonable period of service.

“The opinions embodied in this note relate exclusively to Agricultural Economic Entomology.

RAMRAO S. KASARGODE.  
R. MADHAVAN PILLAI.  
E. S. DAVID.  
J. L. KHARE.  
C. U. PATEL.  
T. N. JHAVERI.  
P. C. SEN.  
P. V. ISAAC.\*  
V. G. DESHPANDE.  
C. C. GHOSH.  
HARCHAND SINGH.  
G. R. DUTT.”

Mr. Fletcher.

Many of the points referred to in this note have already been discussed and it scarcely seems necessary to go over all that ground again. I need only remark that the unsuitability of Pusa as an entomological centre is not based solely on the difficulty of preservation of specimens, as seems to be implied in this note.

We have had a long discussion on this Committee Report and, as you have seen, there are differences of opinion on certain points, such as the question of Provincial staffs and the location of the proposed Central Institute, but those differences of opinion are clearly shown in the Report itself and I have no doubt will be fully considered by Government before any final action is taken. I now propose :—

Resolution 9.

“That the Report of the Committee on organization of Entomological work in India, as amended, be accepted.”

Mr. Ramachandra Rao.

I second that Resolution.

[*The Resolution was put to the Meeting and carried unanimously.*]

Mr. Fletcher.

That is the last item on our programme and it now only remains to close this Meeting. In my Opening Address I asked you to give me your views regarding the next Meeting, its duration and the date and place at which it should be held, but I have not received any suggestions. Its duration must depend largely on the business to be got through and a fortnight has been none too long for this Meeting. As regards date, the end of the cold weather is the most suitable time for most of us. As Pusa is at present the central entomological station and many of

\* Excepting that I am in favour of Coimbatore as the locality for the Institute, I agree with what is said herein.

you require to consult collections and records, the next Meeting will probably be at Pusa in the beginning of February 1921.

It has given me very great pleasure to have seen so many people here attending this Meeting. We have got through a good deal of hard work together and I hope that the visitors have enjoyed their stay here. Many have come from great distances, not without inconvenience to themselves. We thank them for the share they have taken in making this Meeting a success. I shall look forward to the next Meeting, when we hope to have a larger gathering still.

I am voicing the opinion of all present and also of those who have come and gone when I say how much we are indebted to Mr. Fletcher and in expressing our opinion that such Meetings are productive of various new ideas, as we get to know what other workers are doing and what is left undone. We shall go away in a state of mental exhilaration. At this Meeting, considerable importance has been given to subjects beyond merely Economic Entomology, such as methods of breeding, etc. One of the main advantages of centralizing Entomology would be the privilege of collaborating. We are alive to the tremendous amount of work entailed in the preparation of these Meetings. On behalf of the Meeting I propose a vote of sincere thanks to Mr. Fletcher.

I should like to second this vote of thanks with very great pleasure. I have had the privilege of attending all three of these Meetings. The first was a success, the second was a greater success, and the third has been a greater success still. These conferences are an indication of what might be attained by centralization. I think that the increasing success of these conferences shows what centralization can do. I thank Mr. Fletcher very cordially for the trouble he has taken in making this Meeting a success and in giving us all so much help.

I should like to thank Mr. Fletcher not only for help in the Meeting but also for various kinds of help during our stay here.

In addition I beg to thank Mr. Fletcher for helping us in the identification of our specimens. And we also owe thanks to the Heads of the other Sections at Pusa for their kindness in giving us the opportunity of seeing something of the work of their Sections.

I wish to thank Mr. Fletcher and the British Government for giving me the opportunity of coming to attend this Meeting.

On behalf of the Indian States we join with the others in thanking Mr. Fletcher for the help he has given us. Although we have not been able to contribute much, yet we have learnt a great deal. I hope that the practice of inviting us will be continued.

**Mr. Fletcher.**

I feel that you have rather overwhelmed me with thanks for the little that I have been able to do. I am very glad to hear that you consider that the Meeting has been a success and, for making it so, you must remember that the help given me by my staff has contributed not a little to this end, besides the numerous contributions that you yourselves have made. We have been very glad to have you all here and hope that you will all be able to attend two years hence. It now only remains for me to declare this Meeting closed.

## APPENDIX.

### LIST OF RESOLUTIONS PASSED BY THE THIRD ENTOMOLOGICAL MEETING.

#### *Resolution 1* (page 7).

The Entomological workers assembled at this Meeting desire to express their sense of the loss to Entomological Science sustained by the untimely deaths of their former co-workers in India, the late Edward John Woodhouse and Charles William Mason.

#### *Resolution 2* (page 782).

This Meeting considers that there is considerable danger of the introduction into India of bee-diseases by the unrestricted importation of bees, beeswax, and honey from countries infected with such diseases, and that such importation should therefore only be permitted under necessary restrictions.

Proposed by Mr. T. Bainbrigge Fletcher, Imperial Entomologist, Pusa.

Seconded by Mr. C. C. Ghosh, Assistant to the Imperial Entomologist, Pusa.

Carried unanimously.

#### *Resolution 3* (page 998).

That the Report of the Committee appointed to consider the question of the preparation and publication of a catalogue of Indian Insects be approved.

Proposed by Mr. T. Bainbrigge Fletcher, Imperial Entomologist, Pusa.

Seconded by Mr. Ram Rao S. Kasergode, Assistant Professor of Entomology, Poona.

Carried unanimously.

#### *Resolution 4*, (page 1041).

The Third Entomological Meeting is of opinion that it would be desirable to have a Journal solely devoted to Entomology and Government should undertake publication of it. Definite proposals regarding its size and time of publication will be decided by a Committee.

Proposed by Mr. C. C. Ghosh, Assistant to Imperial Entomologist, Pusa.

Seconded by Mr. Ram Rao S. Kasergode, Assistant Professor of Entomology, Poona.  
Carried by a majority of twelve against six.

*Resolution 5* (page 1041).

The Resolution last passed may be recorded but action on it may be postponed until something definite has been decided about the organization of the Central Entomological Institute.

Proposed by Mr. T. V. Ramakrishna Ayyar, Officiating Entomologist to the Government of Madras.

Seconded by Mr. C. C. Ghosh, Assistant to the Imperial Entomologist, Pusa.

Carried by majority—1 vote against it.

*Resolution 6* (page 1050).

That this Meeting considers it desirable to adopt a standard classification of Entomological literature for India.

That, if such a scheme be adopted, it would be of considerable advantage that it should, if possible, conform with the scheme in use at the Imperial Bureau of Entomology, London, and that the Director of that Bureau be approached for information on the matter.

That such information be circulated to those interested in the subject in India, and that the matter be brought up for discussion at the next Entomological Meeting.

Proposed by Mr. C. Beeson, Forest Zoologist.

Seconded by Mr. E. A. Andrews, Entomologist to the Tea Association.

Carried unanimously.

*Resolution 7* page 1071).

That the Report of the Committee appointed to consider the question of Entomological Education in Agricultural Colleges be approved.

Proposed by Mr. T. Bainbrigge Fletcher, Imperial Entomologist, Pusa.

Seconded by Sardar Harchand Singh, Superintendent of Dairy Farms, Patiala State.

Carried unanimously.

*Resolution 8* (page 1079).

This Meeting (1) considers in view of the great importance of a knowledge of insects and insect life-histories to the peoples of India,



that readers for use in the primary schools in India should as far as possible contain simply written accounts of some of the insects commonly found in the Provinces concerned,

(2) suggests that entomology should figure prominently in all courses of Nature Study, and

(3) recommends that the educational authorities should enlist the help of entomological workers in the preparation of such accounts in their readers or text books.

Proposed by Mr. C. C. Ghosh, Assistant to the Imperial Entomologist, Pusa.

Seconded by Mr. K. Kunhi Kannan, Senior Assistant Entomologist, Mysore State.

Carried unanimously.

*Resolution 9 (page 1093).*

That the Report of the Committee on Organization of Entomological Work in India, as amended, be accepted.

Proposed by Mr. T. Bainbrigge Fletcher, Imperial Entomologist, Pusa.

Seconded by Y. Ramachandra Rao.

Carried unanimously.



# INDEX

All scientific names of insects are indexed under both specific and generic names, but page references are only given under the latter.

All names in italics are treated as synonyms and should be looked up in this Index under the names given in roman letters.

An asterisk indicates that a figure of the insect referred to is given on the page cited.

Names of plants have not been indexed nor have those of the birds quoted in Mr. D'Abreu's paper.

## A

- abdominalis, *Aulacophora*.  
 „ *Scrinetha*.  
 aberrans, *Pyrilla*.  
*Abidama producta*, 272, 354.  
 ablutella, *Raphimetopus (Anerastia)*.  
 abruptalis, *Syngamia*.  
 abruptella, *Trichophaga*.  
 abyssinia, *Spodoptera*.  
 acaciaria, *Boarmia*.  
*Acanthophorus serraticornis*, 587.  
*Acanthopsyche bipars*, 138; *A. cana*, 334, 338; *A. punctimarginalis*, 334; *A. subteralbata*, 138.  
*Acanthopsyche (Mahasena) theivora*.  
*acerata*, *Anarsia*.  
*Achæa janata*, 80, 335, 340, 347, 933.  
*achatinus* (portentus), *Brachytrypes*.  
*Acherontia lachesis*, 95, 333, 339, 340; *A. styx*, 95, 333, 340, 347, 898.  
*acidula*, *Gracillaria*.  
*Aclees cribratus*, 204, 577.  
*Aclerda japonica*, 295.  
*Acmeodera burmitina*, 987\*.  
 acocephaloides, *Neodurtus*.  
*Acontia graellsii*, 80; *A. intersepta*, 79; *A. malvæ*, 79; *A. transversa*, 79, 335, 339.  
*Acria gossypiella*, 636.  
*Acrida turrita*, 305.  
 Acridiidae as crop-pests, 304; eaten by birds, 860.  
 Acridinae eaten by birds, 860.  
*Acrocerops æmula*, 851; *A. allactopa*, 852; *A. auricilla*, 162, 852; *A. austeropa*, 851; *A. barringtoniella*, 851; *A. bifrenis*, 852; *A. brochogramma*, 852; *A. cathedræa*, 162, 585, 851; *A. crystallopa*, 852; *A. cyclocota*, 852; *A. desiccata*, 852; *A. diatonica*, 852; *A. elaphopa*, 852; *A. erioplaca*, 852; *A. extenuata*, 852; *A. gemoniella*, 162, 594, 851; *A. geometra*, 852; *A. hemiglypta*, 852; *A. hierocosma*, 162, 582, 852; *A. hyphantica*, 852; *A. isodelta*, 851; *A. isonoma*, 162, 585, 851; *A. labyrinthica*, 852; *A. loxias*, 852; *A. lysibathra*, 852; *A. macroclina*, 852; *A. ordinatella*, 161, 851; *A. orthostaeta*, 851; *A. pentalocha*, 585, 851; *A. phæospora*, 162, 580, 851; *A. pharopeda*, 853; *A. phractopa*, 852; *A. prosaeta*, 162, 851; *A. quadrifasciata*, 851; *A. resplendens*, 851, 1006\*; *A. scandalota*, 853; *A. scenias*, 853; *A. scriptulata*, 853; *A. supplex*, 564, 851; *A. syngamma*, 162, 323, 584, 852; *A. telestis*, 162, 580, 852; *A. tenera*, 853; *A. terminalia*, 161, 564, 851; *A. tricyma*, 851; *A. triscalma*, 853; *A. ustulatella*, 852; *A. vanula*, 853.  
*Acroclita cheradota*, 841; *A. naryana*, 841; *A. vigescens*, 842.  
*Aerolepia manganautis*, 854.  
*Aerotylus inficita*, 306.  
*actæa* (acteus), *Rhyncolaba (Theretra)*.  
 actæon, *Lytta*.  
 acteus, *Rhyncolaba*.  
*Actias selene*, 99\*, 323.  
 actiniformis, *Ceroplastes*.  
*acuta*, *Chiloloba*.  
 „ *Leptocoris*.  
*acutissimus*, *Coccus*.  
*acutissimum*, *Lecanium*.  
*acutus*, *Agrius*.  
 „ *Gelasimus*.  
*Acythopeus citrulli*, 206, 320, 595.  
*Adelida*, 856, 1007.  
 adersi, *Lecanium*.  
*Adisura atkinsoni*, 61, 323, 344, 453, 933.  
*adonidum* (longispinus), *Pseudococcus*.  
*Adoretus bicaudatus*, 175; *A. bicolor*, 176; *A. caliginosus*, 177, 361\*; *A. duvauceli*, 175, 566, 576, 578, 591, 593; *A. horticola*, 176, 566, 576, 578, 591, 593; *A. lasiopygus*,

- 176, 578, 582; *A. lobiceps*, 175; *A. nitidus*, 598; *A. ovalis*, 176; *A. versutus*, 176, 361, 566, 576, 578, 591, 593.
- Adoxophyes fasciata*, 639; *A. privatana*, 336, 337, 338, 339, 341, 840.
- adrastus*, Hyarotris.
- adulatrix*, Stathmopoda.
- adusta* (maidis), Aphis.
- advena*, Silvanus.
- ædia*, Heterusia.
- ædificator*, Pemphigus.
- Ægeria ommatiaeformis*, 159.
- Ægeriadae*, 159, 1004.
- ægrotalis* (*bipunctalis*), *Psara* (*Pachyzancla*).
- egyptia*, Orthacanthacris.
- egyptiaca*, *Teerya*, 287.
- " *Simaethis*.
- egyptium*, Hyalomma.
- æmula*, Acrocercops.
- ænescens* (armigera), Hispa.
- Æolesthes holosericea*, 222, 580; *Æ. induta*, 668.
- æolopa*, Lobesia.
- Æolopus* (Aiolopus).
- Æoloscelis* (Stathmopoda) *theoris*.
- Ætherastis circulata*, 160, 580, 550.
- affaber*, Alcides.
- affinis*, Aiolopus (*Æolopus*).
- " *Bruchus*.
- " *Oides*.
- " *Pempheres*.
- " *Podontia*.
- africana*, Gryllotalpa.
- agamemnon*, Papilio.
- Agamopsyche*, 980.
- Aganoptila phanarcha*, 846.
- Agathia visenda*, 570.
- Agdistis tamaricis*, 840.
- Agestrata orichalcea*, 180.
- agilis*, Trichonympha.
- aglea*, Delias.
- Agonoseclis nubila*, 252.
- agramma* (peponis), Plusia.
- Agrilus acutus*, 247; *A. grisator*, 574.
- Agriophara* (Synchalara) *rhombota*.
- Agromyzidae*, 47—49, 344.
- Agrotis c-nigrum*, 63; *A. flammatra*, 63; *A. sp.*, 64; *A. ypsilon*, 62, 349, 350, 580, 622—625, 704.
- Aiolopus affinis*, 305; *A. tamulus*, 305, 342, 562, 860.
- albicilia*, Sarangesa.
- albifrons*, Epiccephala.
- albineclla*, Pyroderces.
- albiscripta*, Hypelictia.
- albigigma*, Cirphis.
- albigriga*, Amsacta.
- albocaudata*, Gymnoscelis.
- albofasciella*, Latypica.
- alboguttata*, Protactia.
- albo maculata*, Thomsoniella.
- albo marginatus*, Rhagastis.
- albo punctata*, Oxycetonia.
- " Panilla.
- albo striata*, Plusia.
- Alcides affaber*, 199, 321; *A. bubo*, 198, 321\*, 934; *A. collaris*, 199; *A. fabricii*, 199; *A. frenatus*, 200, 585; *A. leopardus*, 199, 453; *A. mahi*, 200, 567; *A. pictus*, 319\*, *A. sp.*, 563.
- alciphron*, Hypsa.
- alcemene*, Chloridolum.
- alecto*, Theretra.
- Aleurocanthus nubilans*, 277; *A. piperis*, 277
- A. spiniferus*, 277, 431\*, 574.
- Aleurolobus barodensis*, 277, 418\*.
- alexis*, Parata.
- Aleyrodes cotessii*, 278; *A. ricini*, 347; *A. sp.*, 278.
- Aleyrodidae* as crop-pests, 277, 574, 587.
- algira*, Parallela (*Ophiusa*).
- alisonotum piceum*, 183, 361; *A. simile*, 183, 361.
- alitalis* (bivitalis), Margarona (*Glyphodes*).
- allactopa*, Acrocercops.
- almana*, Junonia.
- alope*, Lacera.
- alopecodes*, Deuterocopus.
- altercata*, Anarsia.
- altermus*, Stauropus.
- Altha lacteola*, 333, 337; *A. nivea*, 104.
- Alucita niveodactyla*, 840.
- amabilis*, Eulemma.
- Amaranth Pyraustina*, 134.
- Amata cyssea*, 333, 338; *A. passalis*, 52, 333, 337, 338, 339; *A. perixanthia*, 661.
- Amatidae*, 52.
- ambiguella*, Clysia.
- Amblyrrhinus poricollis*, 194, 564, 568, 569, 582, 583, 585.
- amethystias*, Strobisia.
- Amphipyra magna*, 71; *A. pyramidea*, 71; *A. surnia*, 71; *A. yama*, 71.
- Amphitheridae*, 854, 1006.
- amphix*, Lyncestis.
- Ampittia dioscorides*, 114
- ampla*, Lymantria.
- amplum*, Apion.
- Ampullaria sp.*, 694.

- Amsacta albistriga*, 57; *A. lineola*, 55; *A. moorei*, 56, 71; *A. moorei sara*, 56, 71.  
*Amya octo*, 74; *A. punctum*, 74, 335, 338;  
*A. selenampha* (*punctum*), 74.  
*anacardi*, Phytocotrips.  
*Anadastus sp.*, 316, 919\*.  
*analis*, Bruchus.  
 " *Parallelia* (*Ophiusa*).  
*Anarsia acerata*, 155, 845; *A. altercata*, 845;  
*A. didymopa*, 845; *A. ephippias*, 155, 845;  
*A. eptias*, 845; *A. exallacta*, 155, 845;  
*A. idiopitla*, 845; *A. melanoplecta*, 155,  
 453, 585, 845; *A. omoptila*, 155, 845; *A.*  
*sagittaria*, 155, 570, 845; *A. sagmatica*,  
 845; *A. veruta*, 845.  
*Anastatus coimbatorensis*, 933, 935.  
*anastomosalis*, Omphisa.  
*Anataractis plumigera*, 149, 846.  
*Anatona stillata*, 178.  
*Anatrachyntis coriaccella* (*simplex*); *A. falca-*  
*tella*, 149, 846; *A. simplex*, 149, 846.  
*Ancyliis cyanostoma*, 841; *A. glycyphaga*,  
 841; *A. lutescens*, 144, 569, 841.  
*Ancylolomia chryso-graphella*, 120, 341.  
*andersonianum*, Potamon.  
*Andraca bipunctata*, 100, 666.  
*Andrallus spinidens*, 69.  
*Andres Maire trap*, 943.  
*andrewesi*, Platypria.  
*Anerastia* (*Raphimetopus*) *ablutella*.  
*angustatus*, Calocoris.  
*angustifrons*, Haliphus.  
*Anisops sp.*, 867.  
*annandalei*, Leidy.  
*annectens*, Jænia.  
*annulatum*, Sphaerodema.  
*Anobium sp.*, 723\*.  
*Anomala antiqua*, 173, 347; *A. aurora*, 173,  
 590, 597; *A. bengalensis*, 171, 361; *A.*  
*biharensis*, 172, 361\*; *A. decorata*, 173,  
 590; *A. dimidiata*, 174, 566, 570, 579;  
*A. dorsalis*, 170; *A. dussumieri*, 174, 582;  
*A. elata*, 171; *A. ignicollis*, 173; *A.*  
*lineatopennis*, 173, 593; *A. olivieri*, 171;  
*A. pallidospila*, 173, 590, 598; *A. polita*,  
 171, 361, 568, 579; *A. regina*, 175; *A.*  
*rufiventris*, 174, 566; *A. transversa*, 571;  
*A. varicolor*, 172, 593; *A. variivestis*, 172,  
 566.  
*anomala*, Epipyrops.  
*Anomalococcus indicus*, 316, 326.  
*Anoplocnemis phasianana*, 256.  
*Anoplomus flexuosus*, 589.  
*Antestia cruciata*, 252, 574, 586, 590.  
*Antheræa paphia*, 569; *A. roylei*, 100\*.  
*Anthicidæ* eaten by birds, 864.  
*Anthomyiadæ*, 39-40, 324, 370\*, 414, 573  
 eaten by birds, 866.  
*Anthophora confusa*, 862.  
*anthracina*, Megachile.  
*Anthracophora crucifera*, 177, 1028.  
*Anthrenus fasciatus*, 317; *A. pimpinellæ*,  
 317.  
*anticeatus*, Laccophilus.  
*Anticrates lucifera*, 850.  
*Anticyra* (*Dinara*) *combusta*.  
*Antigastra catalaunnalis*, 134, 347, 933.  
*antiopa*, Vanessa.  
*antiqua*, Anomala.  
*Antispila argotoma*, 848; *A. aristarcha*, 848.  
*Antithyra vineata*, 847.  
*antonii*, Helopeltis.  
*antrami*, Clamia.  
*Ants as pests*, 33.  
 " indicating presence of insects, 941.  
 " nests, Insects in, 941.  
*Anua coronata*, 80, 335, 337.  
*aonidium*, Chrysomphalus.  
*Apanteles creatonoti*, 932; *A. papilionis*, 932;  
*A. phycodis*, 932; *A. plusiæ*, 932; *A. sp.*,  
 933; *A. stauropi*, 932; *A. tachardæ*, 932.  
*Apenesia electriphila*, 986\*.  
*Aphanus sordidus*, 262, 347, 348, 762.  
*Aphidide* as crop-pests, 279, 325, 343, 344,  
 345, 346, 348, 349, 350, 351, 592, 598, 763;  
 eaten by birds, 867.  
*Aphis durranti*, 283; *A. gossypii*, 284, 561,  
 562; *A. maidis*, 283; *A. malvæ*, 283; *A.*  
*malvoides*, 283; *A. medicaginis*, 282; *A.*  
*nasturtii*, 284; *A. nerii*, 282; *A. rumicis*,  
 282; *A. sacchari*, 282.  
*Aphis* (*Brevicoryne*) *brassicæ*.  
 " (*Siphocoryne*) *indobrassicæ*.  
*apicalis*, Hindsiana.  
 " *Nephotettix*.  
*Apidæ*, 35; eaten by birds, 862.  
*Apines concinna*, 252.  
*Apion sp.*, 198, 344, ; *A. amplum*, 320.  
 " spp. eaten by birds, 864.  
*Apis dorsata*, 772\*, 862; *A. fasciata*, 779;  
*A. florea*, 772, 862; *A. indica*, 772.  
*Apoderus tranquebaricus*, 196, 321, 564, 583.  
*Apogonia ferruginea*, 167; *A. proxima*, 167;  
*A. sp.*, 361.  
*Apollodotus præfectus*, 264.  
*Apomecyna histrio*, 217; *A. perotteti*, 211  
 321\*; *A. pertigera*, 217, 350.  
*Apparatus for collecting*, 946.  
*Apple-borer*, 597.  
 " *Gracillariad* (see *G. zachrysa*).

- Apple Limacodid, 105\*.  
 „ Notodontid, 101\*.  
 „ Tortricid, 148.  
 approximator, Aristobia.  
 Apriona cinerea, 213, 577, 589; *A. germari*, 213, 589; *A. sp.*, 213.  
*Apocrea* (Stomopteryx) nerteria.  
 aprobola, Argyropele.  
 Apsylla cistellat, 277, 585, 1029.  
 Aptinotrips ruficornis, 619.  
 Aquatic Insects, 937.  
 arachidis, Sphenoptera.  
 Arachnida eaten by birds, 867.  
 "Arhela" dea, 141; *A. quadrinotata*, 141, 573; *A. tetraonis*, 141, 570, 574; *A. theivora*, 142, 587, 581, 587, 592.  
*Arbelida* (Teragruidae).  
*archesia* (undata), Pelamnia (*Remigia*).  
 Arctiadae, 53; eaten by birds, 865.  
 arctiida, Meteorus.  
 aretotania, Ophiura.  
 arenosella, Batrachedra.  
 argentana, Cnephasia.  
 Argina argus, 94; *A. cribraria*, 94, 563; *A. syringa*, 94, 563.  
 argostoma, Antispila.  
 argus, Argina.  
 Argynnis hyperbius, 107, 590.  
 Argyrethia iopleura, 850.  
 Argyria tumidicostalis, 119, 388\*.  
 argyrodoxa, Nepticula.  
 Argyropele aprobola, 146, 582, 584, 842; *A. coachropis*, 842; *A. citharistis*, 842; *A. ebenina*, 842; *A. erotias*, 146, 584, 585, 842; *A. illepida*, 146, 568, 582, 595, 842; *A. leucaspis*, 146, 582, 842; *A. paragramma*, 147, 394\*, 842; *A. poetica*, 842; *A. rhynchias*, 842; *A. semiculta*, 842; *A. tonsoria*, 843.  
 aria, Matapa.  
 aristarcha, Antispila.  
 Aristeis thwaitesii, 847.  
 Aristobia approximator, 215, 517, 599.  
 aristolochiae, Papilio.  
 Aristotelia ingravata, 844.  
 armigera, Hispa.  
 atrotrae, Brachmia.  
 Arrhenothrips ramakrishnae, 327, 619\*.  
 Arrhinotermes flavus, 1918.  
 articulatus, Aspidiotus (*Selanaspilus*).  
 artocarpi, Parlatoria.  
 arvalis, Cryptolochia.  
 Arynina isitis, 276.  
 asellus, Blosyrus.  
 Asopus malabariensis, 255.  
 asperulus, Centhorrhynchus.  
 Asphondylia sesami, 49.  
 Aspidiotus articulatus, 299; *A. camelliae*, 300, 330; *A. curcumae*, 300, 326; *A. cyanophylli*, 300, 605; *A. cydoniae*, 300, 606, 607; *A. destructor*, 300, 583, 607; *A. dictyospermi*, 301; *A. hartii*, 301, 326; *A. lataniae*, 301, 574, 607; *A. orientalis*, 301, 568, 605; *A. tamarindi*, 302, 326.  
*Aspidiotus* (Chrysomphalus) aurantii.  
 aspidistire, Hemichionaspis.  
 aspidomorphae, Cassidocida.  
 Aspidomorpha foveata, 234; *A. indica*, 234, 351; *A. miliaris*, 234, 934.  
 Aspongopus brunneus, 256; *A. janus*, 255.  
 assamensis, Ethmia.  
 assamensis, Serica.  
 Assamia moesta, 268, 354.  
 Assembling, 942.  
 assulta, Heliothis.  
 Asterolecanium pustulans, 588.  
 Astroöpius sp., 934.  
 Astycus lateralis, 188, 562, 589.  
 Aswatthamanus cylindricus, 305.  
 Asympiesiella indica, 934.  
 Atabyria bucephala, 856.  
 Atactogaster finitimus, 195.  
 ataphus, Ismene.  
 ater, Hypophorus.  
 Athalia leucostoma, 38; *Athalia proxima*, 37, 348.  
 athanasii, Ceraphron.  
 Athysanus fusconervosus, 441; *A. indicus*, 431.  
 atkinsoni, Adisura, 61.  
 „ Idiocerus.  
 „ Julodis.  
 Atmetonychus peregrinus, 187.  
 atmopa, Odites.  
 atomosa, Exelastis.  
 Atractomorpha crenulata, 307, 860; *A. scabra*, 307.  
 atripennis, Aulacophora.  
*atromaculata* (crucifera), Anthracophora.  
 Attagenus piceus, 719\*.  
 Atteva fabriciella, 160, 850; *A. niveigutta*, 160, 850.  
 atticus, Tagiades.  
 augias, Telicota.  
 augur, Serinetha.  
 Aulacophora abdominalis, 229, 350, 588; *A. atripennis*, 229; 350; *A. excavata* (atri-pennis); *A. foveicollis* (abdominalis); *A. stevensi*, 228.

Aularches miliaris, 307, 347, 562, 575; A.  
punctatus, 307; A. scabiosa, 307.  
aurantii, Chrysomphalus.  
    "    Dialeurodes eugeniæ.  
    "    Toxoptera.  
aurichalcea, Protætia.  
auricilla, Diatraea.  
auricilla, Acrocercops  
auripua (xanthogastrella), Scirpophaga.  
aurora, Anomala.  
austeropa, Acrocercops.  
australis, Boöphilus.  
authæma, Autosticha.  
Autoserica sp., 163, 361\*, 574.  
Autosticha authæma, 845; A. chernetis, 845;  
A. exemplaris, 845; A. protypa, 845.  
arenæ (padi) Siphocoryne.  
Aximopsis ovi, 934.  
Azazia rubricans, 86, 345.  
Azygophleps scalaris, 140.

## B

Bactra truncata, 394\*, 842  
Bactrocera (See Chatodacus).  
bada, Parnara.  
Badamia exclamationis, 1025.\*  
badgleyi, Epicauta hirticornis.  
badra, Hasora.  
Bael flea-beetle, 318.  
Bag for collecting, 955\*.  
Bagnallia (Thrips) oryza.  
Bagraa picta, 253, 348, 350.  
Bakla stem-fly, 48.  
Balaninus c-album, 196, 581; B. sp., 197.  
balanoptycha, Eucosma.  
Balantidium termitis, 1016\*.  
ballardi, Phenacoccus.  
ballardi, Tylopholis.  
balsamina, Metialma.  
Bamboo Woolly Aphid, 325.\*  
bambucivora, Pyrausta.  
bambuse, Cosmopteryx.  
    "    Odites.  
    "    Oregma.  
bangalorensis, Odontotermes.  
banian, Hieroglyphus.  
banksi, Phyllipocus.  
Baoris penicillata, 1024\*.  
Baracus vittatus, 1023\*.  
barbatum, Stomatium.  
barberi, Diaspis. :  
    "    Melasericæ.  
barberiana, Epipyrops.  
barcalis, Pilocrocis.  
barodensis, Aleurolobus.  
barringtoniella, Acrocercops.  
barrowi, Tonica.  
basalis, Chactocœna.  
    "    Vespa.  
basipleetra, Stathmopoda.  
Bats, Insects living on, 941.  
Bathyaulex sp., 935.  
Batocœra rubus, 212, 577, 587; B. sp., 577.  
Batrachedra arenosella, 846; B. silvatica,  
    847.  
baubiniæ, Lithocolletis.  
bayadera, Gynacantha.  
Beara dichromelle, 79, 335, 339, 569.  
Beating out insects, 945.  
beatrice, Lymantria.  
beckii, Lepidosaphes (Mytilaspis).  
Bed-bug eaten by bird, 867.  
Bedellia sommulentella, 851.  
Bee-diseases, 779.  
Bees in Egypt, 779—781.  
Beeswax, Production of, in India, 775, 777.  
Belionota prasina, 245, 580, 587.  
Belippa lalœana, 105\*, 565, 592, 595.  
belli, Idgia.  
Belostoma indica, 867.  
Belostomidae eaten by birds, 867.  
Bembex lunata, 909\*.  
Bemisia leakei, 278.  
bengalica, Heteroglyphis.  
bengalense, Pentodon.  
bengalensis, Anomala.  
benjamini, Rhopalocampa.  
Bennia burri, 1033.  
bergii, Neomaskellia.  
Berosus decrescens, 863.  
Berytidae as crop-pests, 259.  
Bethylid parasite of Platyedra gossypiella,  
    446\*.  
bettoni (nigrorepletus), Hieroglyphus.  
bhurmitra, Boarmia.  
Bibasis sena, 1025\*.  
bicaudatus, Adoretus.  
biclavus, Howardia.  
bicolor, Adoretus.  
    "    Meranophilus.  
    "    Nupserlia.  
    "    Stauroderus.  
    "    Trachys.  
bicolorata, Ricania.  
bicornis, Schizocephalus.  
bidentulus, Corigetus.  
bifrenis, Acrocercops.  
biharensis, Anomala.

- Lilinea*, *Canea*.  
*bilinealis*, *Marasmia*.  
*bilineatus*, *Hieroglyphus*.  
*bilobus*, *Olenecampylus*.  
*bimaculatus*, *Ligyryllus*.  
*bimaculatus*, *Miopristis*.  
*binotalis*, *Crocidolomia*.  
*Binsitta* (See *Tonica*).  
*bioculalis*, *Rivula*.  
*bioculatus*, *Tetranychus*.  
*bipars*, *Acanthopsyche*.  
*bipunctalis*, *Psara* (*Pachyzancla*).  
*bipunctata*, *Andraca*.  
*bipunctatus*, *Cletus*.  
 „ *Nephotettix*.  
*bipunctifer*, *Schenobius*.  
 Birds, Insects eaten by, 859—871.  
*bispinifrons*, *Pentodon*.  
*bisselliella*, *Tineola*.  
*Biston marginata*, 662.  
*Biston suppressaria*, 101.  
 Bitter-gourd gall-fly, 324\*.  
*bivalvata*, *Inglisia*.  
*bivitratis*, *Margaronia* (*Glyphodes*).  
*bjerkandrella*, *Choreutis*.  
*blandiatrix*, *Eutelia*.  
*blandiella*, *Onebala*.  
*blandus*, *Myllocerus*.  
*blapsigona*, *Phthorimæa*.  
*Blastobasidae*, 158, 849, 1005.  
*Blastobasis crassiflora*, 158, 849; *B. decolor*, 849; *B. spermologa*, 849; *B. transcripta*, 849.  
*blattarum*, *Lophomonas*.  
*Blattidæ* eaten by birds, 859.  
*Blissus gibbus*, 261.  
*blitealis*, *Noorda*.  
*Blosyrus asellus*, 185; *B. inæqualis*, 186.  
*Boarmia acaciaria*, 335, 339; *B. lbhuruitra*, 335, 340.  
*Boarmiæ*, 101, 565.  
*Boarmiæ* No. 2, 101\*, 565.  
*bochus*, *Jamides*.  
*boerhavia*, *Hippotion*.  
*bœticus*, *Polyommatus*.  
*bolina*, *Hypolimnas*.  
*Bombotelia jocosatrix*, 75, 581; *B. sp.*, 76.  
*Bombycidae*, 100.  
*Boöphilus australis*, 867.  
 Borers, Rearing of, 883\*.  
*Borkhausenia pseudospretella*, 847.  
*Borolia venalba*, 67.  
*brachelytra*, *Gonocephalum*.  
*Brachmia arotrea*, 153, 844; *B. efferata*, 154, 323, 844; *B. engrapta*, 154, 844; *B. idiastis*, 153, 844; *B. insulsa*, 153, 844; *B. xerophana*, 845.  
*Brachmia* (*Helcytogramma*) *hibisci*.  
*Brachycaudus pruni*, 284.  
*Brachycyrtarus* (*Acanthopsyche*) *subteralbata*.  
*brachymorpha*, *Platyptilia*.  
*Brachyplatys patuper*, 249; *B. subaeneus*, 249; *B. vahliei*, 325.  
*brachyrrhinus*, *Lixus*.  
*Brachytes* sp., 256.  
*Brachythemis contaminata*, 895.  
*Brachytrypes portentosus* (*achatinus*), 312, 349, 562, 585, 596, 634; *B. sp.*, 860.  
*Brachyunguis earthami*, 285.  
*Braconid* parasite of *Platyedra gossypiella*, 447.  
*Bradinopyga geminata*, 896.  
*Brahmina coriacea*, 167, 556, 576, 578, 591, 593.  
*brassicæ*, *Brevicoryne*.  
 „ *Phædon*.  
 „ *Pieris*.  
*Brenthia coronigera*, 849.  
*bretinghami*, *Pachnephorus*.  
*breviceps*, *Phoxothrips*.  
*Brevicoryne brassicæ*, 280; *B. chenopodii*, 280; *B. coriandri*, 280.  
*brevistylus*, *Dacus*.  
*breviuseula*, *Nanaguna*.  
*Brinjal Sarrothripine*, 77.  
*Brithys crini*, 64, 334, 337.  
*brochogramma*, *Acrocercops*.  
*bromelia*, *Pseudococcus*.  
*Bruchidæ*, 239, 720.  
*Bruchus analis*, 321, 762; *B. affinis*, 239, 721\*, 929; *chinensis*, 239, 322, 721\*, 762, 858, 929; *B. sp.*, 722\*, 762, 864; *B. theobromæ*, 239, 322, 762, 929.  
*Bruchocida orientalis*, 932.  
*brunnea*, *Myrmecaria*.  
*brunneicornis*, *Physothrips*.  
*brunneus*, *Aspongopus*.  
*bubo*, *Aleides*.  
*Bucculatrix crateracma*, 854; *B. exedra*, 854; *B. loxoptila*, 164, 854; *B. mendax*, 854; *B. verax*, 854.  
*bucephala*, *Atabyria*.  
*bucephalus*, *Heliocopris*.  
*Buckleria defectalis*, 838; *B. paludicola*, 838; *B. wahlbergi*, 838; *B. xerodes*, 838.  
*Buprestidæ* as crop-pests, 244, 571; eaten by birds, 863.  
*burkilli*, *Pulvinaria*.  
*Burmacrocera petiolata*, 986\*.  
*burmanica*, *Electrocyrtoma*.



*Burmitempis halteralis*, 986\*.

*burmitica*, Winnertzia.

*burmiticus*, Myodites.

*burmitina*, Acmaeodera.

„ *Liburnia*.

„ *Sciara*.

*burmitinus*, Elater.

*burri*, Bennis.

*Butea* Limacodid, 322.

*butleri*, Parata.

Butterflies, Decoy for, 943\*.

„ eaten by birds, 871.

Byrrhidae eaten by birds, 863.

## C

Cabinets, Insect, 968\*.

*cacalia*, Platyptilia.

*cachara*, Caligula.

*Caecocia compacta*, 840; *C. dispilana*, 840;

*C. epicyrta*, 144, 571, 580, 840; *C. isocyta*,

840; *C. micaceana*, 144, 344, 345, 579, 596,

598, 840; *C. pensilis*, 840; *C. philippa*,

840.

*cadambæ*, Cossus.

*Cadamustus* (Stephanitis).

*Cadmitos* (Galeatus).

*Caduceia theobromæ*, 1019\*.

*cæsalis*, Margaronia.

„ *Margaronia* (*Glyphodes*).

*caffer*, Sphenarches.

Cages for rearing in-bets, 878\*, 892\*.

*cajani*, Ceroplastodes.

*Calandra linearis*, 595; *C. oryzae*, 715\*, 735,

741, 762; *C. rugicollis*, 320; *C. stigmati-*

*collis*, 208, 576.

*c-album*, Balaminus.

*calcuttæ*, Serica.

*calianthina*, Parlatoria.

*caliginosus*, Adoretus.

*Caligula cachara*, 836\*.

*Callipterus trifolii*, 285.

*callistrepta*, Pyroderces.

*Callitettix versicolor*, 272, 354.

*Calobata* sp., 47.

*Calocoris angustatus*, 266.

*Calotermes greeni*, 1018; *C. militaris*, 20.

*Calpe ophideroides*, 87, 590.

*Caltris bevani*, 116; *C. colaca*, 116.

*calvum*, Potamon.

*calyptroides* (echinocacti), Diaspis.

*camellia*, Aspidiotus.

*caminodes*, Hilarographa.

*Camouflage*, 14, 900.

*campanula*, Leidya.

*campestris*, Melasina.

*Camponotinae* eaten by birds, 862.

*Camponotus compressus*, 316, 862; *C. irritans*, 862.

*cana*, Acanthopsyche.

„ *Thosea*.

*candelaria*, Fulgora.

*candida*, Dactylethra.

*Canea bilinea*, 659.

*canidia*, Picris.

*Cannibal caterpillars*, 888.

*Cantao ocellatus*, 910\*.

*Cantharidae* eaten by birds, 863.

*Cantharidæ* (Meloïdæ).

*Cantharis* (Lytta).

*canthusalis*, Margaronia (*Glyphodes*).

*capensis*, Heteracris.

*capensis*, Perigea.

*capitata*, Ceratitis.

*capitata*, Dilinia.

*Cappea taprobanensis*, 251, 574.

*capparidana*, Laspeyresia.

*caprææ*, Eulecanium.

*Caprimia conchylalis*, 128.

*Capsidæ* as crop-pests, 264.

*Caprona ransomettii*, 1023\*; *C. siamioa*, 1023\*.

*Capua invalidana*, 143, 840.

*Carabidae* eaten by birds, 862.

*cardoni*, Idgia.

*cardoni*, Pheropsophus.

*cardui* (medicaginis), Aphis.

*Caræa subtilis*, 79, 322\*, 933.

*carpalina*, Myiopardalis.

*Carpocapsa* (Laspeyresia) pomonella.

*Carpomyia vesuviana*, 45, 324, 453, 570

*Carposinidæ*, 143, 840, 1002.

*cartbami*, Brachyunguis.

*Caryoborus gonagra*, 763.

*Cassidinae* eaten by birds, 864.

*Cassidocida aspidomorpha*, 934.

*castanea*, Thosea.

*castaneum*, Tribolium.

*castor*, Psychid, 139.

„ *Semi-looper* (see *Achæa janata*)

*catachloa*, Exinotis.

*Catalogue of Indian Insects*, 989.

*Catantops* sp., 310, 860.

*catalaunalis*, Antigastra.

*Catephia inquieta*, 86.

*Caterpillars* eaten by birds, 865.

*cathedræa*, Acrocercops.

*Catochrysops* (Euchrysops) cnejus.

*Catochrysops pandava*, 112; *C. strabo*, 897.

- catoirei, *Pheropsophus*.  
*Catopsilia pyranthe*, 110.  
*caudata*, *Elymnias*.  
*caudatus*, *Chaetodacus*.  
*caudularia*, *Thalera*.  
*causodes*, *Oxyptilus*.  
*cautella*, *Ephestia*.  
 Cave Insects, 939.  
*Cecidomyiade*, 49, 324, 554, 678.  
*Celama internella*, 53, 344; *C. squalida*, 54.  
*celerio*, *Hippotion*.  
*cephalonica*, *Corycra*.  
*Cephalosporium Icanii*, 328.  
*Cephonodes picus*, 96.  
*Cerataphis lataniae*, 326.  
*ceratitina*, *Stictaspis*.  
*Ceratitis capitata*, 46.  
*ceriferus*, *Ceroplastes*.  
*Cerococcus hibisci*, 287, 561, 562.  
*Ceronema koebchi*, 291.  
*cervina*, *Thosea*.  
*Ceroplastes actiniformis*, 292; *C. ceriferus*, 292, 632; *C. floridensis*, 292, 588, 608, 632; *C. rubens*, 292, 603, 609, 632.  
*Ceroplastodes cajani*, 293, 326, 600; *C. chiton*, 293.  
*cellifera*, *Polychrosis*.  
*celtis*, *Selepa (Plotheia)*.  
*cenchropis*, *Argyroloce*.  
*Cerambycidae*, 220, 587; eaten by birds, 864.  
*ceramicus*, *Duomitus*.  
*Ceraphron athanasii*, 933.  
*Ceropide* as crop-pests, 272; eaten by birds, 867.  
*cerealella*, *Sitotroga*.  
*Ceropia induta*, 341.  
*Ceroplastes actiniformis*, 603.  
*Cerostoma (Dasyses) rugosellus*.  
*Cetoniade*, 177.  
*Ceuthorrhynchus asperulus*, 201.  
*Ceylonia theowala (Toxoptera aurantii)*.  
*ceylonica*, *Halpe*.  
*Chirocampa (Hippotion) echeucus (eson)*.  
*Chirocampa theylia*, 333, 338.  
*Chaetocnema basalis*, 233; *C. sp.*, eaten by birds, 864.  
*Chaetodacus caudatus*, 44, 324, 351, 572, 589; *C. correctus*, 43, 586; *C. cucurbitae*, 19, 44, 351, 589, 592, 595, 625—629, 935; *C. diversus*, 43, 572, 586, 592, 600; *C. dorsalis*, 41, 572, 580, 581, 587, 591, 592, 598, 763; *C. duplicatus*, 43; *C. ferrugineus*, 41, 572, 580, 581, 591, 597, 598; *C. hageni*, 45; *C. incisus*, 41, 324, 580, 581, 586; *C. tuberculatus*, 42, 598; *C. versicolor*, 42, 580, 586, 594; *C. zonatus*, 42, 568, 577, 586, 591, 594, 935.  
*Chafer grubs*, 343, 345, 563.  
*Chaitophorus maculatus (Callipterus trifolii)*.  
*Chalcnosoma metallicum*, 232.  
*Chalcididae* as crop-pests, 36.  
*Chalciopce hypaspia*, 81.  
*Chalcis tachardiae*, 932.  
*chalciothorax*, *Chkenius*.  
*chalcytes*, *Plusia*.  
*chalinota*, *Opogona*.  
*chalybacma*, *Epiccephala*.  
*Chapra mathias*, 116, 341, 342, 354, 442, 933.  
*Chauliops fallax*, 261.  
*Chelaria phacelota*, 846; *C. rhicnota*, 156, 586, 846; *C. scopulosa*, 846; *C. spathota*, 156, 584, 846.  
*Chelidonium cinctum*, 223, 317\*, 331, 573.  
*Chelonella sp.*, 933.  
*chenopodii*, *Brevicoryne*.  
*cheradota*, *Ancylis*.  
*Chernetidae* eaten by birds, 867.  
*chernetis*, *Autosticha*.  
*chersaea (oschophora)*, *Ephysteris*.  
*Chilades laius*, 111, 322, 333, 340; *C. trochilus putli*, 111, 572.  
*Chilo oryzae*, 120, 390\*, 410; *C. simplex*, 120, 354, 385\*, 410, 414, 416, 546, 933; *C. sp. (C. S. 1769)*, 391\*; *C. sp. (C. S. 1835)*, 392\*; *C. sp. (C. S. 1795)*, 120, 391\*; *C. sp. (C. S. 1831)*, 120, 392\*.  
*Chiloloba acuta*, 179.  
*Chilomenes sexmaculatus*, 32, 863.  
*China Stemfly*, 48.  
*chinensis (Bruchus) Pachymerus*.  
*Chionaspis decurvata*, 295; *C. dilatata*, 295, 588; *C. graminis divergens*, 295; *C. miami*, 295; *C. megaloba*, 296; *C. nilgirica*, 296; *C. sp. 571*; *C. theae*, 632; *C. varicosa*, 296; *C. vitis*, 296, 588, 602.  
*chiridota*, *Idiophantias*.  
*chiton*, *Ceroplastodes*.  
*Chkenius chalciothorax*, 863; *C. circumdatus*, 863; *C. hamifer*, 863; *C. marginifer*, 863; *C. nigricans*, 863; *C. rugulosus*, 863.  
*Chlidanotide*, 843, 1003.  
*chlora*, *Pseudoterpna*.  
*Chloridea (See Heliothis)*.  
*Chloridolum alemene*, 222, 574.  
*chlorion*, *Popillia*.  
*Chloropide*, 47; eaten by birds, 866.  
*Chlumetia transversa*, 76, 453, 582, 585.  
*Cholam Cecidomyiad*, 50.  
*Cholam Fly*, 39.  
*Cholotis crypsiloga*, 846; *C. pachnodes*, 846.

- chordites, Oxyptilus.  
 Choreutis hjerkanrella, 849.  
 chotanica, Phyllostreta.  
*chromataria* (cupreoviridis), Earias.  
 Chrotogonus sp., 306, 860.  
 Chrysanthemum Pyralid, 136.  
 Chrysis fuscipennis, 862.  
 Chrysochroa sp., 246.  
 chrysographella, Ancyloleomia.  
 Chrysomela democratica, 598.  
 Chrysomelidae as crop-pests, 224, 563, 565, 568, 572, 578, 579, 593; eaten by birds, 864.  
 Chrysomphalus aonidum, 302, 574, 602, 604, 607, 1068; *C. rossi*, 303, 602; *C. aurantii*, 302, 326, 574; *C. triglandulosus*, 303, 608.  
 chrysophthalma, Phyllocnistis.  
 Chrysopidae eaten by birds, 861.  
 Chrysops dispar, 866.  
 cichorii, Zonabris.  
 Cicindelidae as crop-pests, 249; eaten by birds, 862.  
 Cidaria cingala, 336, 338.  
     *cincta*, Thea.  
     *cinctalis*, Phlaeoba.  
     *cinctum*, Chebidonium.  
     *cinerea*, Apriona.  
     *cinerea*, Walkeriana.  
     *cingala*, Cidaria.  
         ,, Paruara.  
     *cingulatus*, Dysdercus.  
     *circulata*, Ætherastis.  
     *circumdata*, Metriona.  
     *circumdatus*, Chlenius.  
 Cirphis albig stigma, 65, 323\*, 933; *C. compta*, 65; *C. fragilis*, 66; *C. insularis*, 65; *C. loreyi*, 65, 342; *C. unipuncta*, 66, 341.  
 cirrhophanes, Phyllocnistis.  
 cistellata, Apsylla.  
 citharistis, Argyploce.  
 citrella, Phyllocnistis.  
 citri, Dialeurodes.  
     ,, Euphalerus.  
     ,, Prays.  
     ,, Pseudococcus.  
 citrifolia, Toxoptera.  
 citrinella, Olegores.  
 citroplecta, Microceclona.  
 citropleura, platyptilia.  
 citrulli, Acythopeus.  
     ,, (*gossypii*), Aphis.  
 Clania antrami, 138; *C. crameri*, 138, 334, 339; *C. destructor*, 138, 642; *C. variegata*, 640.  
 clarisona, Lithocolletis.  
 Clavigralla gibbosa, 257, 344, 346; *C. horrens*, 257.  
 clepsidoma, Eucosma.  
 Cleridae eaten by birds, 863.  
 clerodendronella, (Edematopoda).  
*Clethara* (Giaura) septicata.  
     ,, *valida* (see *Nanaguna breviscula*).  
 Cletus bipunctatus, 352.  
 clientella, Phycita.  
 Clinocentrus sp., 933.  
 Clitea picta, 232, 568.  
 Clivina striata, 863.  
 Clothes for collecting, 955.  
 Clovia lineaticollis, 325\*; *C. punctata*, 442.  
     *clypealis*, Idioceus.  
     *clypeata*, Serica.  
 Clysia ambiguella, 143, 579, 840.  
 Cnaphalocrois medinalis, 127, 341, 442.  
 cnejus, Euchrysops.  
 c-nigrum, Agrotis.  
 Coccidae as crop-pests, 286, 596, 598, 599.  
 coccinea, Parectopa.  
 Coccinellidae as crop-pests, 248; eaten by birds, 863.  
 Coccus acutissimus, 293; *C. colemani*, 328; *C. hesperidum*, 293, 605; *C. longulus*, 293; *C. mangiferae*, 293, 588; *C. viridis*, 294, 328, 605.  
 coecalis, Pyrausta.  
 Cocoon Scolytid, 320.  
 cocotis, Pseudococcus.  
 Codophila maculicollis, 251.  
 Coelosterna scabrator, 215, 570; *C. sp.*, 214, 589; *C. spinator*, 215.  
 coerulea, Cyphosticha.  
*cofea*, *Lecanium* (*Saissetia hemisphaerica*).  
     ,, Zenzera.  
 coffearia, Homona.  
 Coffee Borer (see *Xylotrechus quadripes*)  
     ,, Pests in South India, 328.  
 coffeifoliella, Gracillaria.  
 cognata, Hypena.  
 coimbatorensis, Anastatus.  
 Coladenia tissa, 1023\*.  
 Colasposoma semicostatum, 227, 572.  
 colemani, Coccus.  
 Colemania splenarioides, 308.  
 Coleophoridae, 850, 1006.  
 Coleoptera as crop-pests, 165; eaten by birds, 862.  
 Colias croceus fieldi, 110; *C. hyale*, 110.  
 collaris, Alcides.  
 Collecting insects, Hints on, 936; Localities for —, 936, 1001; time for —, 945; apparatus for —, 946; importance of —, 976.

- Collyris* sp., 249, 331.  
*combusta*, Dinara.  
 Committees, 22.  
*Comocritis pieria*, 160, 336, 338, 850, 872.  
*compacta*, Caeocia.  
*complana*, Hypsa.  
*complanata*, Popillia.  
*compressus*, Cauponotus.  
*compta*, Cirphis.  
*Conarthrus jansonii*, 319.  
*conchylalis*, Caprinia.  
*concihiata*, Eucosma.  
*concinna*, Apines.  
*concolor*, Hieroglyphus.  
   „ Lymantria.  
   „ Suana.  
*concurra*, Steganodactyla.  
*Cnephasia argentana*, 841.  
*conferta*, Holotrichia.  
*confusa*, Anthophora.  
*confusus*, Cybister.  
*coniotalis*, Metasia.  
*conista*, Lithocolletis.  
*conviticornis*, Aptinotrips ruficornis.  
*Conocephalus indicus*, 860.  
*Conosia irrorata*, 51.  
*consanguis*, Polia.  
*conspersa*, Euproctis.  
*conspersa*, Lawana.  
*contaminata*, Brachythemis.  
*Contheyla rotunda*, 104, 322, 331, 575.  
 Control of Insect Pests, 15, 18, 23, 27.  
*convolvuli*, Herse.  
 Copromorphidae, 848.  
*Coptosoma cribraria*, 249, 344, 345, 346, 937;  
   *C. indicum*, 866; *C. nazirae*, 250, 325\*; *C.*  
   *ostensum*, 325; *C. sp.*, 250, 344, 345.  
*Coptotermes* sp., 1018.  
*Coreyra cephalonica*, 323, 762.  
*cordiger*, Ectomocoris.  
*Coreidae* as crop-pests, 256; eaten by birds,  
   866.  
*coriacea*, Brahmina.  
*coriaceella* (simplex), *Anatrachyntis (Pyro-*  
*derces)*.  
*coriandri*, Brevicoryne.  
*Corigetis bidentulus*, 211.  
*Corixid* eaten by birds, 867.  
*Corizus rubicundus*, 259.  
*cornifrons*, Mudaria.  
*cornigera*, Promalactis.  
*coronata*, Anna (*Ophiusa*).  
*coronata*, Ophiusa.  
*cornigera*, Brentbia.  
*correctus*, Chaetodacus.  
*corticina*, Myrmecozela.  
*corymbatus*, Pseudococcus.  
*Cosmophila crasa* (indica); *C. fulvida*, 85;  
   *C. indica*, 85, 335, 339; *C. sabulifera*, 85.  
*Cosmopolites sordidus*, 208, 593.  
*Cosmopterygidae*, 149, 846, 1003.  
*Cosmopteryx bambuse*, 150, 486; *C. mimetis*,  
   486; *C. phaeogastra*, 150, 486.  
*Cosmoscarta funeralis*, 273; *C. relata*, 273,  
   581.  
*Cossidae*, 142; eaten by birds, 865.  
*Cossus cadambae*, 142.  
*cotesii*, Aleyrodes.  
*Cowpea Agromyza*, 48.  
*Crabs*, 327, 680—694.  
*crameri*, Clania.  
*Craspedia defamataria*, 102; *C. fibulata*, 335,  
   337, 338, 340, 341; *C. remotata*, 335, 337,  
   338.  
*crassicornis*, Gallobelicus.  
*crassifica*, Blastobasis.  
*crateracma*, Bucculatrix.  
*cranuopa*, Istrianis.  
*creatonoti*, Apanteles.  
*Cretonotus hagdii*, 59.  
*Cremastogaster hodgsoni*, 34; *C. sp.*, 328;  
   *C. subnuda*, 862.  
*Cremastus* sp., 933.  
*crenulata*, Atractomorpha.  
*cretaceus*, Sympiezomias.  
*cretata*, Pseudodoxia.  
*Cretonia vegeta*, 73.  
*cretosus*, Spilophorus.  
*cribraria*, Argina.  
   „ *Coptosoma*.  
*cribratus*, Aleces.  
*Criocla trifenestrata*, 100, 569, 570, 581, 582,  
   584, 597.  
*crini*, Brithys.  
*crinitus*, Sitones.  
*critica*, Eucosma (*Eucelis*).  
*Crobylophora daricella*, 854.  
*crocata*, Tarache.  
*croceus fieldi*, Colias.  
*Crocidolomia binotalis*, 132, 336, 338, 340, 349,  
   933.  
*Crocidophora ptyophora*, 133.  
*Crocidosema plebeiana*, 842.  
*Crossotarsus* sp., 185.  
*crotonis*, Pseudococcus.  
*crucifera*, Anthracophora.  
*Cruciferous Leaf-miner*, 47.  
*cruciata*, Antestia.  
*cruentatum*, Rhipiphorothrips.  
*crypsiloga*, Cholotis.

crypsilychna, *Lecithocera*.  
*Crypsithyris hypnota*, 856; *C. longicornis*, 856; *C. mesodyas*, 856.  
*Cryptoblabes ephestialis*, 125.  
*Cryptocephalus dodecapilus*, 225.  
*Cryptolechia arvalis*, 847.  
*Cryptophagidae* eaten by birds, 863.  
*Cryptorrhynchus gravis*, 204, 587, 597; *C. mangiferae*, 204, 586; *C. poricollis*, 205, 587.  
*crystallopa*, *Acroceroops*.  
*Cucujidae* eaten by birds, 863.  
*cucumeris* (*gossypii*), *Aphis*.  
*cucurbita*, *Chaetodacus*.  
*cucurbiti* (*malvae*), *Aphis*.  
*Cumbu Ceeidomyiad*, 50, 324.  
*Cumbu Fly*, 39.  
*cumulata*, *Planotrocha*.  
*cunicularis*, *Elegistis*.  
*cupreoviridis*, *Earias*.  
*cupricollis*, *Popillia*.  
*Curculionidae*, 185, 570; eaten by birds, 864.  
*Curculionids*, undetermined, 200—210, 211.  
*curcuma*, *Aspidiotus*.  
*Curry Leaf-hopper*, 325.  
*cyanea*, *Haetica*.  
 „ *Mimastra*.  
 „ *Redoa*.  
 „ *Scutellista*.  
*cyanophylli*, *Aspidiotus*.  
*cyanostoma*, *An'yliis*.  
*Cyblister confusus*, 863; *C. tripunctatus*, 863.  
*Cylopelta obscura*, 344.  
*Cydus* sp., 866.  
*cydonia*, *Aspidiotus*.  
*Cylas formicarius*, 196, 351.  
*cylicota*, *Acroceroops*.  
*Cylinders*, *Zinc*, for rearing, 879\*.  
*cylindricus*, *Aswatthamanus*.  
*Cyphosticha coerulea*, 163, 323, 853.  
*cypris*, *Edeematopoda*.  
*Cyrtacanthacris ranacea*, 310, 562, 860.  
*Cyrtotrachelus dux*, 207; *C. longipes*, 207.  
*cysea*, *Amata*.

## D

*Dactylethra candida*, 844.  
*Dactylopius* (*Pseudococcus*).  
 „ *indicus*, 288.  
*Dacus*, (see also *Chaetodacus*).  
 „ *brevistylus*, 40, 324, 588, 595; *D. longistylus*, 40, 324, 935; *D. oleae*, 17, 41, 590.  
*daedala*, *Laspeyresia*.

*daksha*, *Papilio*.  
*Danaus plexippus*, 332, 337.  
*danica*, *Locusta*.  
*dara*, *Padraona*.  
*daricella*, *Crobylophora*.  
*Dasychira divisa*, 334, 337; *D. dudgeoni*, 654; *D. fusiformis*, 334, 337, 338, 339, 340, 344; *D. horsfieldi*, 89, 334, 339, 566; *D. mendosa*, 89, 334, 338, 339, 340, 344, 566, 583, 590, 653, 677; *D. securis*, 90, 341, 342, 343, 354, 933; *D. sp.*, 90, 590.  
*Dasyneura gossypii*, 49.  
*daubei*, *Plusia*.  
*dayanum*, *Potamon*.  
*dea*, "Arbela."  
*Dead animals*, *Insect fauna* of, 942.  
*Decadarchis dissimulans*, 855.  
*decipiens*, *Sympiezomias*.  
*decolor*, *Blastobasis*.  
*decorata*, *Anomala*.  
 „ *Halpe*.  
*Decoy for butterflies*, 943\*.  
*decreseens*, *Berosus*.  
*decurvata*, *Chionaspis*.  
*defamataria*, *Craspedia*.  
*defectalis*, *Buckleria*.  
*defoliator*, *Emperorrhinus*.  
*Deilephila hypothous*, 97; *D. nana*, 96, 333, 337.  
*Deiradoleus* sp., 209, 566, 589, 591.  
*delesserti*, *Fulgora*.  
*Delias aglea*, 117.  
*democratia*, *Chrysomela*.  
*demoleus*, *Papilio*.  
*dentatus*, *Halys*.  
 „ *Polyptychus*.  
*dentifer*, *Myllocerus*.  
*dentipes*, *Metaplex*.  
*depressa*, *Saissetia*.  
*depressella*, *Emmalocera* (*Papua*).  
*depressum*, *Gonocephalum*.  
*depunctalis*, *Nymphula*.  
*Dereodius pollinosus*, 188, 566; *D. sparsus*, 352, 362, 596.  
*Dermestes larvalis*, 987\*.  
*Dermestidae* eaten by birds, 863.  
*derogata*, *Sylepta*.  
*deschampsii*, *Phymatostetha*.  
*Desert Insects*, 937.  
*desiccata*, *Acroceroops*.  
*Desmidophorus hebes*, 206.  
*destructor*, *Aspidiotus*.  
 „ *Clania*.  
 „ (*psis*), *Nectarophora* (*Macrosiphum*).  
*Deudorix epijarbas*, 113, 594.

- Deuteroecopus *alopecodes*, 839; *D. planeta*, 839; *D. ritsemæ*, 839; *D. socotranus*, 839.  
*devestita*, *Empoasca*.  
*devestita*, *Lælia*.  
*Diabasis* sp., 645.  
*Diacrisia eximia*, 677; *D. montana (suffusa)*, 55; *D. nigrifrons*, 54; *D. obliqua*, 54, 324, 345, 347, 348, 562, 563; *D. sp.*, 55.  
*Diacrotricha fasciola*, 136, 565, 838.  
*Diadiplosis indica*, 554, 617.  
*Dialeurodes citri*, 278, 574; *D. eugeniæ*, *aurantii*, 278.  
*D. eugeniæ*, 325.  
*dianthi*, *Rhopalosiphum (Myzus persicæ)*.  
*Diapromorpha melanopus*, 225.  
*Diaspis barberi*, 297, 602; *D. echinocacti*, 297; *D. mangiferae*, 298, 602; *D. rosæ*, 298, 602; *D. sp.*, 574.  
*diatonica*, *Aerocerops*.  
*Diatrea auricifolia*, 119, 387\*, 416; *D. saccharalis*, 118; *D. sacchariphagus*, 119; *D. sp. (C. S. 1610)*, 119, 388\*; *D. sp. (C. S. 1674)*, 119, 389\*; *D. sp. (C. S. 1769)*, 119; *D. sp. (C. S. 1835)*, 119; *D. venosata (striatella)*, 118, 388\*, 414, 416.  
*Dichocrois punctiferus*, 128, 324, 336, 338, 347, 580, 586, 587, 589, 591.  
*Dichomeris evidantis*, 845; *D. ianthes*, 154, 845.  
*dichromella*, *Beara*.  
*Dictyophora pallida*, 268.  
*dictyospermi*, *Aspidiotus*.  
*dicycla*, *Monopis*.  
*didyma*, *Nephele*.  
*didymopa*, *Auarsia*.  
*diemenalis*, *Lamprosema (Nacoleia)*.  
*diffusa*, *Naranja*.  
*Dihammus fistulator*, 216.  
*dilatata*, *Chionaspis*.  
 „ *Phenacaspis*.  
*Difilia capitata*, 569; *D. medardaria*, 569.  
*diluticornis*, *Zalithia*.  
*dimidialis*, *Eublema*.  
*dimidiata*, *Anomala*.  
*Dinara combusta*, 100.  
*Dinoderus* sp., 934.  
*dionysius*, *Phyllognathus*.  
*Diopsidæ* eaten by birds, 866.  
*dioscorides*, *Ampittia (Hesperia)*.  
*Diplonearcha insinuans*, 841.  
*Diptera* as crop-pests, 39; eaten by birds, 865.  
*Dirades theclata*, 590.  
*direptalis*, *Platyptilia*.  
*discolor*, *Mylocerus*.  
*discrepans*, *Lecanium*.  
*disjuncta*, *Megachile*.  
*dispar*, *Chrysops*.  
*Disphinctus humeralis*, 265; *D. politus*, 266.  
*dispilana*, *Cacecia*.  
*dissimilis*, *Phytosephus*.  
*dissimulans*, *Decadarchis*.  
*distans*, *Tagiades*.  
*distincta*, *Sogata*.  
*distinctissima*, *Geisha*.  
*divergens*, *Chionaspis graminis*.  
*diversus*, (*Bactrocera*) *Chaetodacus*.  
*divisa*, *Dasychira*.  
*dodceaspilus*, *Cryptoccephalus*.  
*dodceastigma*, *Epilachna*.  
*Dolycoris indicus*, 251, 343, 562.  
*dominica*, *Glottula (see Brithys erini)*.  
*dominica*, *Rhizopertha*.  
*dorinda*, *Lithocolletis*.  
*dorsalis*, *Anomala*.  
*dorsalis*, *Chaetodacus*.  
 „ *Epaeromia (Aiolopus tamulus)*.  
 „ *Scirtothrips*.  
*dorsata*, *Apis*.  
*dorsatus*, *Mylocerus*.  
*Dorylus labiatus*, 35; *D. orientalis*, 35, 349, 354, 361.  
*downsi*, *Lema*.  
*dracænæ*, *Hemichionaspis*.  
*Dragonflies*, Preparation of, 954.  
*Dragonflies* (see *Odonata*).  
*Drasterius* sp., 244, 361\*.  
*Dry* specimens, 960.  
*dudgeoni*, *Dasychira*.  
*dumetana*, *Tortrix*.  
*Duomitus ceramicus*, 142, 699; *D. leuconotus*, 142; *D. mineus*, 142; *D. sp.*, 142.  
*duplicatus*, *Chaetodacus*.  
*durante* (*durranti*), *Aphis*.  
*durranti*, *Aphis*.  
*dussumieri*, *Anomala*.  
*duvauchéi*, *Adoretus*.  
*dux*, *Cyrtotracheus*.  
*Dynastidæ*, 181.  
*Dyscerus fletcheri*, 210\*, 567; *D. malignus*, 210\*, 567.  
*Dysdercus cingulatus*, 262, 351, 562, 867.  
*Dysodia ignita*, 333, 338.  
*Dytiscidæ* eaten by birds, 863.

## E

*Earias cupreoviridis (chromataria)*, 78, 335, 339, 448, 562; *E. fabia*, 78, 335, 339, 361,

- 443, 448, 451, 470, 562; *E. insulana*, 78, 443, 448, 470, 503, 562.
- ebenina*, *Argyropluce*.
- Eboda obstinata*, 841.
- eburifera*, *Gnatholea*.
- echeclus*, *Hippotion*.
- echidna*, *Platypria*.
- echinoaceti*, *Diarsma*.
- echinus*, *Urentius*.
- Economic Entomology, Some aspects of, 1072.
- Ectadiophtanus tachardiæ*, 932.
- Ectomocoris cordiger*, 867.
- edocla*, *Heterusia*.
- Education, Entomological, in Agricultural Colleges, 1069.
- edwardsi*, *Sesarma*.
- Eelworms, 327.
- effera*, *Brachmia*.
- „ *Lecithocera*.
- egena*, *Halpe*.
- egialealis*, *Terastia*.
- Egypt, Entomological Service in, 511—513.
- Egypt, Bee-keeping in, 779.
- Elachistidæ, 850, 1005.
- elaphopa*, *Acrocerops*.
- Elasmoscelis platypoda*, 268, 354.
- elata*, *Anomala*.
- Elater burmitinus*, 987\*.
- Elateridæ* as crop-pests, 244, 317; eaten by birds, 864.
- electrinus*, *Hyptiogastries*.
- electriphila*, *Apenesia*.
- Electrocyrtoma burmanica*, 986\*.
- elegans*, *Heteracris*.
- „ *Heterorhina*.
- Elegistis cunicularis*, 856.
- Eligma narcissus*, 78.
- elongatum*, *Gonocephalum*.
- elongella*, *Stenachroia*.
- elpis*, *Lampides*.
- Elymnias caudata*, 575; *E. undularis*, 105.
- Emmalocera (Papua) (Polyocha) depressella (saccharella)*, 123, 379\*.
- Emmalocera sp.*, 377\*.
- emolus*, *Lycænesthes*.
- Emperorrhinus defoliator*, 190, 566, 568, 590, 591.
- Empoasca devastans*, 276; *E. flavescens*, 275, 633; *E. sp.*, 276; *E. thea*, 276.
- Empusa lecanii*, 328.
- Endrosis lacteella*, 847.
- Enchelyspheroides trichonympharum*, 1016\*.
- enega*, *Melasina*.
- engrapta*, *Brachmia*.
- Enithares sp.*, 867.
- Entomological Education in Agricultural Colleges, 1069.
- Entomological Journal Suggested, 1035, 1041.
- Entomological Literature, Subject indexing of, 1047.
- Entomological Publications, Proposals regarding, 10—13, 1034.
- Entomological Society, Proposed Indian, 7—9.
- Entomological work, Organization of, 1080.
- Entomology, Some Aspects of economic, 1072.
- Envelopes for Specimens, 960\*.
- Eophileurus perforatus*, 576.
- Epacromia (Aiolopus) tannius (dorsalis)*.
- Epepeotes uncinatus*, 215, 577.
- Epermeniadæ*, 853, 1006.
- Ephemeridæ* eaten by birds, 861; eaten by fish, 908½.
- Ephestia cautella*, 323.
- ephestialis*, *Cryptoblabes*.
- ephippias*, *Anarsia*.
- Ephysteris chersæa (oschophora)*, 844.
- Epicauta hirticornis badgleyi*, 240; *E. sp.*, 240.
- Epicephala albifrons*, 851; *E. chalybaena*, 453, 851.
- Epicometis squalida*, 180.
- Epicrocis lateritialis*, 336, 337.
- epicyrta*, *Cacæcia*.
- epidectes*, *Oxyptilus*.
- epidesma*, *Peronea*.
- epijarbas*, *Deudorix*.
- Epilachna dodecastigma*, 248, 345, 351; *E. viginti-octo-punctata*, 248; *E. sp.*, 350.
- Epimarpis philocoma*, 853.
- Epipyropidæ*, Indian, 978\*.
- Epipyrops anomala*, 978; *E. barberiana*, 979; *E. eurybrachydis*, 981\*.; *E. polio-grapha*, 980; *E. sp.*, 979.
- Episomus lacerta*, 189.
- Epithectis studiosa*, 844.
- epius*, *Spalgis*.
- epotias*, *Anarsia*.
- erebius*, *Platymetopus*.
- Erechthias zebrina*, 855.
- Eretes sticticus*, 863.
- Eretmocera impactella*, 158, 849.
- ergasima*, *Phthorimæa*.
- Ergolis merione*, 107, 347; *E. taprobana*, 107.
- Eridontomeroidella gibboni*, 935.
- Eriosoma lanigera*, 285, 597.
- eriosoma (chalyctes)*, *Plusia*.

- Eriophyes gossypii, 559; E. sp., 581, 582.  
 erioplaca, Acrocercops.  
 erithonius (demoleus), Papilio.  
 erosa (indica), Cosmophila.  
 erotias, Argropyloce.  
 Erotylidae as crop-pests, 249.  
 erythrina, Lepidosaphes.  
 eson (echeclus), Hippotion (*terrocampa*).  
 Estigmene lactinea, 55, 334, 337, 338, 339, 347.  
 Ethmia assamensis, 850.  
 Etiella zinckenella, 126, 344, 346.  
 Eublemma amabilis, 453, 797; E. dimidialis, 73; E. *hemirhoda* (dimidialis), 73; E. olivacea, 73, 335, 340, 350; E. quadrilineata 453, 554, 617; E. scitula, 335; E. *secta* (dimidialis), 73; E. silicula, 73, 585, 586.  
*Euedis* (Eucosma) critica.  
 Euchromia polymena, 52.  
 Euechrysops enejus, 112, 333, 339, 344.  
 Eucoptaera premorsa, 310.  
 Eucosma balanoptycha, 841; E. clepsidoma, 841; E. conciliata, 841; E. critica, 145, 841; E. foenella, 842; E. melanaula, 145, 841; E. melanoneura, 842; E. steroma, 842; E. zelota, 145, 842.  
 Eucosma *ludera* (critica).  
 Eucosma *trichocrossa* (critica).  
 Eucosmide, 114, 841-1003.  
 Eucrotala nucleata, 855.  
 eugeniae aurantii, Dialeurodes.  
 eugeniae, Dialeurodes.  
 Eugnamptus marginatus, 197, 584, 597.  
 eugraphella, Nephopteryx.  
 Eulocanium capree, 294; E. persiae, 294.  
 Eumastacinae, 1032-1033.  
 eumenoides, Melleis.  
 Eupatorus hardwickii, 181.  
 Euphalerus citri, 276, 574.  
 Euplexia opposita, 335, 337, 341.  
 Euproctis conspersa, 646; E. flava, 567, 578, 583, 591, 593, 594; E. fraterna, 91, 324, 334, 338, 339, 340, 344, 593, 596, 933; E. latifascia, 91; E. lunata, 91, 569, 583, 584, 589; E. semisignata, 334, 337; E. scintillans, 92, 334, 338, 339, 340, 344, 565, 583, 586, 594, 677, 933; E. sub-fasciata, 91; E. varians, 648.  
 Eupterote geminata, 99, 333, 339, 340; E. mollifera, 99.  
 Eupterotidae, 99.  
 eurybrachydis, Epipyrops.  
 Eurybrachys tomentosa, 267.  
 Eurydema pulchrum, 348, 350.  
 Eurygenius wickhami, 987\*.  
 eurynome, Neptis.  
 eurytion, Melittia.  
 Eurytoma indl, 37, 315\*, 935; E. pigra, 934.  
 Eurytomine, 36, 37.  
 Eusareocoris guttiger, 252; E. ventralis, 251; E. sp., 266.  
 Eutelia blandiatrice, 587.  
 Euthalia garuda, 106, 584.  
 Euxoa segetum, 61, 349; E. spinifera, 61.  
 Euzophera pericella, 123, 336, 340, 933; E. plumbeifasciella, 124, 323, 568, 595; E. puniceella, 124, 594.  
 evidantis, Dichomeris.  
 exallaeta, Anarsia.  
 excavata (atripennis), Aulacophora.  
 excavatus, Macropes.  
 exclamationis, Badamia.  
 exclamationis, Lælia.  
 Excrement, Insect fauna of, 942.  
 exedra, Bucculatrix.  
 Exelastis atomosa 137, 839, 933; E. liophanes, 839.  
 exemplaris, Autosticha.  
 exigua, Laphygma.  
 eximia, Diaerisia.  
 Exinotis catachlorea, 849.  
 expansum, Paralecanium.  
 extenuata, Acrocercops.  
 externalis, Nodaria.
- F**
- fabia, Farias.  
 fabriciana, Simaethis.  
 fabriciella, Atteva.  
 fabricii, Alcides.  
 falcata, Anatrachyntis (*Gracilaria* ?).  
 fallax, Chauliops.  
 farinalis, Pyralis.  
 farinosus, Paramecops.  
 fascialis, Hymenia.  
 fasciata, Adoxophyes.  
 „ Apis.  
 fasciatus, Anthrenus.  
 „ Hapalochrus.  
 fasciola, Diacroticha.  
 fastuosa, Psiloptera.  
 Fatua longicornis, 317.  
 faunus, Xanthotrachelus.  
 feæ, Popillia.  
 Feeding habits of insects, 879.  
 femorata, Sagra.  
 ferrugalis, Hapalia (*Pionea*).  
 ferruginea, Apogonia.



- ferruginea, Tettigoniella.  
 ferrugineus, Chætodacus.  
   " Rhynchophorus.  
 fetialis, Polychrosis.  
 fibulata, Craspedia.  
 fici, Hemichionaspis.  
 ficus (aonidium), Chrysomphalus.  
   " Hypsa.  
 Fig, Borer in, 577.  
 filiformis, Ranatra.  
 finitimus, Atactogaster.  
 Fiorinia proboscidea, 299; F. there, 299.  
 Fisheries, Importance of insects to, 906.  
 fistulator, Dihammus.  
 flagellata, Pyrsonympha.  
 flammatra, Agrotis.  
 flammifera, Edematopoda.  
 flava, Euproctis.  
*flavescens* (camellie), Aspidiotus.  
   " Empoasca.  
   " Orthacanthacris.  
 flaviceps, Pycnosoma.  
 flavo-asciata, Opogona.  
 flavus, Arrhinotermes.  
   " Salius.  
 Flea-beetles, 343, 563.  
 fletcheri, Dyscerus.  
   " Nyctotherus.  
   " Opilus.  
   " Stylotermes.  
 flexuosus, Anoplomus.  
 florea, Apis.  
 floridensis, Ceroplastes.  
 florivora, Prosintis.  
 fluctuosalis, Nymphula.  
 fœnella, Eucosma.  
 folus, Udaspes.  
 Forceps, 951\*.  
 Forest Insects, 669—704.  
 Forficulide eaten by birds, 859.  
 formicarius, Cylas.  
 Formicidae, 33; eaten by birds, 862.  
 Formicomus sp., 361.  
 formosana, Lecithocera.  
 formosanus, Odontotermes.  
 fornicatus, Xyleborus.  
 Fossil Insects, Indian, 982\*.  
 fossilis, Henicocephalus.  
 foveata, Aspidomorpha.  
*foveicollis* (abdominalis), Aulacophora.  
 fragilis, Cirphis.  
 Franciella termitis, 1018\*, 1019.  
 frater, Sympiezomia.  
 fraterna, Euproctis.  
 frenatus, Alcides.  
 fructicassiaella, Trachylepidia.  
 frugalis, Pelamia (*Remigia*).  
 frugivora, Tinea.  
 Fruit Insects, Rearing of, 884.  
 Fulgora candelaria, 1031\*; F. delesserti, 1031.  
 Fulgoridæ as crop-pests, 267; eaten by birds, 867.  
 fullonica, Ophiusa (*Othrcis*).  
 fulvida, Cosmophila.  
 funiceps, Opogona.  
 Fumigation of imported plants, 1064\*.  
 fumipennis, Microdus.  
 funeralis, Cosmoscarta.  
 Fungal diseases of Coccus viridis, 328.  
*furcifer* (banian), Hieroglyphus.  
 furcifera, Megamelus, 270, 271.  
 fusca, Protetia.  
 fuscipennis, Chrysis.  
 fuscipunctella, Tinea.  
 fuscicornosus, Athysanus.  
 fuscus, Riptortus.  
 fusiformis, Dasychira.
- G**
- gaika, Zizera.  
 galba, Spialia.  
 Galeatus retarius, 263.  
 Galerucella singhara, 229, 595; G. sp. 230, 581.  
 Galerucines, undetermined, 231.  
 Gall-making insects, Rearing of, 882.  
 Gallobelicus crassicornis, 266, 349.  
 Gangara thyrasis, 115, 575, 600, 1024\*.  
 gangis, Creatonotus.  
 ganodes, Lithocolletis.  
 garuda, Euthalia.  
 Gastrimargus transversus, 306.  
 Geisha distinctissima, 634.  
 Gelasimus acutus, 693.  
 Gelatine grubs, 30.  
*Gelechia* (Helcystogramma) hibisci.  
   " (Platyedra) gossypiella.  
   " tamariciella, 844.  
 Gelechiidæ, 150, 843, 1003.  
 geminata, Bradinopyga.  
 geminata, Eupterote.  
 geminata, Solenopsis.  
 gemoniella, Acrocercops.  
 genialis, Lobesia.  
 geochrota, Trichotaphe.  
 geometra, Acrocercops.  
 geometralis, Lepyrodes.  
 geometrica, Grammodes.  
 Geometrid larva, A very curious, 978\*.

Geometridæ, 101.  
 Geotomus sp., 866.  
 germari, Apriona.  
 Gerris sp., 867.  
 Gaura sceptica, 77.  
 Gibbium scotias, 719\*.  
 gibboni, Eri lontomeroidella.  
 gibbosa, Clavigralla.  
 gibbus, Blissus.  
 gidcon, Xylotrupes.  
 gilviberbis, Scirpophaga.  
 Gitonides perspicax, 555\*.  
 glaucitidis, Thyrsostoma.  
 (glass-bottomed boxes, 952\*.  
 Glass jars for rearing, 877\*.  
 glaucinans, Pericyma (*Homoptera*).  
 globigera, Lepidoseia.  
 globosa, Xystroera.  
 globulifera, Monanthia.  
 gloriose, Polytela.  
*Glottula dominica* (see *Brithys crini*).  
 glycyphaga, Anechis.  
 Glyptopterygidae, 159, 849, 1005.  
*Glyphodes* (see *Margaronia*).  
 Glyptomorpha sp., 934.  
 Gnatholea eburifera, 221, 573, 596.  
 Gnathospastoides rouxi, 242.  
 gnoma, Theretra.  
*Gnorinoschema* (*Phthorimæa*) heliopa.  
 gonagra, Caryohorus.  
 Gonocephalum brachelytra, 242; *G. depressum*, 243, 578, 864; *G. elongatum*, 243;  
*G. hofmaunseggi*, 243, 578; *G. sp.*, 244, 864.  
 gonodaetyla, Platyptilia.  
 gossypiella, Acria.  
 gossypiella, Platyptera (*Gelechia*) (*Pectinophora*).  
 gossypii, Aphis.  
 „ Dasyneura.  
 „ Eriophyes.  
 „ Sphenoptera.  
 Graecillariadæ, 161, 850, 1006.  
 Graecillaria acidula, 853; *G. coffeifoliella*,  
 853; *G. ischea*, 853; *G. octopunctata*, 853;  
*G. soyella*, 163, 853, 934; *G. theivora*, 163,  
 853; *G. zachrysa*, 17, 163, 566, 853.  
 gracilli, Acontia.  
 graminea, Nezara.  
 graminis divergens, Chionaspis.  
 graminum, Toxoptera.  
 graminivora, Mahasena.  
 Grammodes geometrica, 81; *G. stolidia*, 81.  
 granarium, Macrosiphum.  
 grandissimum, Trombidium.  
 granularis, Melasina.

Graptostethus servus, 260, 344, 346, 562.  
 Grasshoppers, Observation of oviposition of,  
 886.  
 grassii, Pyrsonympha.  
 gravis, Cryptorrhynchus.  
 Green potato leaf-beetle, 319.  
 greeni, Calotermes.  
 gremius, Suastus.  
 grigator, Agrilus.  
 „ Sthenias.  
 Gryllidæ as crop-pests, 311, ; eaten by birds,  
 860.  
 Gryllodes sp., 860.  
 Gryllotalpa africana, 311, 359\*, 861.  
 Gryllus viator (*melanocephalus*), 313, 588.  
 guttiger, Eusareocoris.  
 Gymnonympa zeylanica, 1019\*.  
 Gymuoplcurus sp., 864.  
 Gymnoseelis albocaudata, 335, 339.  
 Gynaeantha bayadera, 896.  
 Gynaikothrips karnyi, 619.

## H

habrochroa, Phyllocnistis.  
 hageni, Chaetodacus.  
 halidayi, Idolothrips.  
 Haliphidæ eaten by birds, 863.  
 Haliphus angustifrons, 863.  
 halistrepta, Machæropteris.  
 Halpe ceylonica, 1024\*; *H. decorata*, 1024\*.  
*H. egena*, 1024\*.  
 halteralis, Burmittempis.  
 Haltica cyanea, 232.  
 Halticines, unidentified, 233, 234.  
 Halticus minutus, 267.  
 Halys dentatus, 866.  
 hamifer, Chlenius.  
 Hantana infernus, 1023\*.  
 Hapalis ferrugalis, 135.  
 Hapalochrus fasciatus, 248.  
 Haplosynx trifasciatus, 566.  
 Haplothrips tenuipennis, 27, 619, 621.  
 Hapsifera (*Dasyseles*) rugosella, 165, 395\*, 590,  
 856; *H. seclusella*, 856.  
 hardwickei, Eupatorus.  
 Harmologa miserana, 841.  
 hartii, Aspidiotus.  
 Hasora badra, 1024\*.  
 hebes, Desmidophorus.  
 hecabe, Terias.  
 hederæ, Odites.  
 Helcystogramma hibisci, 154, 845.  
 helcenus, Papilio.

- Heleocoris* sp., 867.  
*helicodes*, Phyllocnistis.  
*Heleocopris bucephalus*, 887; *H.* sp., 865.  
*Heliodinide*, 158, 848, 1004.  
*hebiopa*, Phthorimæa.  
*Heliolithia assulta*, 61, 335, 340, 349, 578; *H.* *obsolata*, 60, 335, 338, 340, 344, 345, 394\*, 573, 578.  
*Heliolithrips indicus*, 618, 619.  
*Heliozclidae*, 848, 1004.  
*Hellula undalis*, 132, 336, 338.  
*Helopeltis antonii*, 265, 325, 330; *H.* *theivora*, 24—26, 30, 265, 325, 669—671.  
*Hemichionaspis aspidistræ*, 298, 326, 608; *H.* *dracæne*, 298; *H.* *fici*, 298; *H.* *minima*, 298; *H.* *minor*, 299; *H.* *these*, 299, 606.  
*hemicitra*, Monopis.  
*hemidoxa*, Laspeyresia.  
*hemiglypta*, Acrocercops.  
Hemiptera as crop-pests, 249; eaten by birds, 866.  
*hemirhoda* (dimidialis), Eublemma.  
*hemisphærica*, Saissetia (*Lecanium*).  
*hemitorna*, Statimopoda.  
*Hemicocephalus fossilis*, 987\*.  
*Hemicospilus reticulatus*, 933; *H.* sp., 933.  
Hepialidae, 1007, 1018.  
*heringi*, Rhodophæa.  
*Herse convolvuli*, 95, 333, 339.  
*hespera* (didyma), Nephela.  
*Hesperia* (*Ampittia*) *dioscorides* (maro).  
 „ (*Spialia*) *galba*.  
Hesperiidae, 114.  
 „ Ceylonese, Genitalia of, 1021\*.  
*hesperidum*, Coccus.  
*Heteracris capensis*, 311; *H.* *elegans*, 311; *H.* *illustris*, 311; *H.* sp., 311.  
*Heterogamus* sp., 933.  
*Heterographis bengalella*, 125, 323, 576.  
*Heteronychus lioderes*, 865; *H.* *sacchawi*, 182.  
*Heteropsyche*, 980.  
*Heteropternis respoudens*, 306.  
*Heterorrhina elegans*, 177.  
*Heterusia ædia*, 664; *H.* *edocla*, 140; *H.* *magnifica*, 139; *H.* *virescens*, 140.  
*hexamitoides*, Microgænia.  
*hibisci*, Cerococcus.  
 „ *Helcystogramma*.  
*hierocosma*, Acrocercops.  
*Hierodula westwoodi*, 859.  
*hieroglyphi*, Scelio.  
*Hieroglyphus banian*, 309, 935; *H.* *bilineatus*, 309; *H.* *concolor*, 309; *H.* *nigrorepletus*, 308.  
*Hilarographa caminodes*, 159, 849.  
*Hindsiana apicalis*, 618.  
Hippoboscidae eaten by birds, 866.  
*Hippotiou bochraviæ*, 333; *H.* *rafflesi*, 333, 338.  
*Hippotion celerio*, 97, 578; *H.* *cecheilus* (*esou*), 97.  
*hirsutus*, Phenacoccus.  
*hirticornis*, Epicauta.  
*hislopi*, Lomatus.  
*Hispia armigera*, 237, 342.  
*hispidus*, Tanymeceus.  
Hispine beetle on plantain, 593.  
*histeroides*, Tetroda.  
*histeroidea*, Popillia.  
*histrio*, Apomecyna.  
*histrio*, Menida.  
*hodgsoni*, Cremastogaster.  
*Hodotermes tristis*, 987\*; *H.* *viarum*, 314, 1009.  
*hofmannseggii*, Gonocephalum.  
*Holocera pulverea*, 797, 850.  
*Holcomyrmex scabriceps*, 33.  
*holosericea*, Eollesthes.  
*Holotrichia conferta*, 167, 329; *H.* *repetita*, 168, 1028; *H.* sp., 1028; *H.* *rufoflava*, 1028.  
*Homona coffearia*, 30, 143, 840; *H.* *menciana*, 637, 840.  
*Homoptera* (*Pericyma*) glaucinans.  
*honesta*, Lagoptera.  
 „ *Ropica*.  
Honey, Uses of, in India, 773.  
*Hopatroides seriatoporus*, 242.  
*Hoplocerambyx spinicornis*, 696, 703.  
*horrens*, Clavigralla.  
*horsfieldi*, Dasychira.  
*horticola*, Adoretus.  
*hospes*, Lygæus.  
Hot Springs, Insects in, 940.  
*Howardia biclavus*, 297.  
*hugelii*, Lophosternus.  
*Humbertiella indica*, 859.  
*humeralis*, Disphinctus.  
 „ *Rhynchocoris*.  
*hunteri*, Meristos.  
*hyale*, Colias.  
*Hyalomma ægyptium*, 167.  
*Hyalopterus pruni*, 215.  
*Hyarotis adrastus*, 1024\*.  
*Hyblea puera*, 88, 324, 701.  
*hybridella*, Phalonia.  
*Hydaticus* larvæ eaten by birds, 863.  
*Hydrodromus*, Paratelphusa.  
*Hydrometridæ* eaten by birds, 867.

Hydrophilidae eaten by birds, 863.  
 Hydrophilus olivaceus, 863.  
 Hyelopsis (Lithacodia) signifera.  
 Hymenia fascialis, 127, 336, 337.  
 Hymenoptera as crop-peats, 33, 315; eaten  
 by birds, 861.  
 Hypargyria sp., 323.  
 Hypelictis albiscripta, 845.  
 Hypena cognata, 335, 341.  
 Hypera medicaginis, 194; H. variabilis, 194.  
 hyperbius, Argynnis.  
 Hypermastigina. Families of, 1020.  
 hyphantica, Acrocereops.  
 hypnota, Crypsithyris.  
 Hypolimnas bolina, 332.  
 Hypomeces squamosus, 187, 572, 668.  
 Hyponomeutidae, 160, 850, 1005.  
 Hyponomeuta lapidella, 850; H. mahnellus,  
 850.  
 Hypophorus ater, 863.  
 Hypophrictis ineptrix, 855; H. plana, 855;  
 H. sp., 855.  
 Hyposidra talaca, 335, 338, 339, 340.  
 hypothous, Deilephila.  
 hypypasia, Chalciopie (*Trigonodes*).  
 Hypsa alciphron, 93, 577; H. complana, 93;  
 H. ficus, 93, 576, 577.  
 Hypsipyla robusta, 700.  
 Hyptiogastrites electrinus, 986\*.  
 hyrtaca, Metanastria.  
 hystriellus, Tingis.  
 hystrix, Platyptria.

## I

ianthes, Dichomeris.  
 Icerya purchasi, 633.  
 iceryoides, Phenacoccus.  
 ichnaea, Stenoma.  
 Ichneumonidae eaten by birds, 862.  
 Idgia belli, 248; I. cardoni, 247; I. melanura,  
 247.  
 idiaastis, Brachmia.  
 Idioceris atkinsoni, 273, 586, 597; I. clypealis,  
 273, 586; I. niveosparus, 273; I. sp., 274.  
 Idioglossa triacma, 853.  
 Idiophantis chiridota, 844.  
 idioptila, Anarsia.  
 Idolothrips halidayi, 618.  
 ignicollis, Anomala.  
 ignita, Dysodia.  
 illepidia, Argyroploce.  
 Illustrations, Preparation and Reproduction  
 of scientific, 1042.

illustris, Heteracris.  
 imbricans, Lecanium.  
 Imma myllias, 849.  
 immaculata, Xanthopimpla.  
 immeritalis, Sclerobius.  
 impaetella, Eretmocera.  
 impolita, Rhytinota.  
 Importation of insects on plants, 1052.  
 importunitas, Ragnus.  
 impressus, Pachnophorus.  
 inachus, Kallima.  
 inaequalis, Blosyrus.  
 ineptrix, Hypophrictis.  
 incisus, Chetodacus.  
 inconspicuus, Nysius.  
 Incurvariade, 856.  
 incurvata, Lithocolletis.  
 indi, Eurytoma.  
 ,, Megastigmus.  
 ,, Telenomus.  
 indica, Apis.  
 ,, Aspidomorpha.  
 ,, Asympiesiella.  
 ,, Belostoma.  
 ,, Cosmophila.  
 ,, Diadiplosis.  
 ,, Humbertiella.  
 ,, Leucaspis.  
 ,, Margaronia (*Glyphodes*).  
 ,, Meta pelma.  
 ,, Neohegeria.  
 ,, Tinda.  
 indicata, Lamproscma (*Nacoleia*).  
 indicola, Leucotermes.  
 indicum, Coptosoma.  
 ,, Podagrion.  
 ,, Syntomosphyrum.  
 ,, Anomalococcus.  
 ,, Athysanus.  
 ,, Conocephalus.  
 ,, Dactylopius.  
 ,, Dolycoris.  
 ,, Heliothrips.  
 ,, Leeuwenia.  
 ,, Oötetrastichus.  
 ,, Panchætothrips.  
 ,, Taumecus.  
 indobrassicae, Siphocoryne.  
 indus, Scarites.  
 induta, Aelosthes.  
 ,, Ceropia.  
 inferens, Sesamia.  
 infernus, Hantana.  
 inficita, Acrotylus.  
 ,, Saluria.

infusella, Phycita.  
 Inglisia bivalvata, 293.  
 ingravata, Aristotelia.  
 inquieta, Catephia.  
 inquisitrix, Macræola.  
 Insectaries, Construction of, 889\*.  
 Insectary Technique for wood-borers, 892\*.  
 insectellæ, Setomorpha.  
 Insecticides, 25.  
 insignis, Orthezia.  
 insinuans, Diplonearcha.  
 insolitus, Phenacoccus.  
 insulsa, Brachmia.  
     ,, Earias.  
 insularis, Cirphis.  
 integranota, Nemoria.  
 internella, Celama.  
 interpunctella, Plodia.  
 intersepta, Acontia.  
 invalidana, Capua.  
 iopleura, Argyresthia.  
 Ipobracon sp., 935.  
 Ips longifolia, 702.  
 irritans, Camponotus.  
 irrorata, Conosia.  
 isekka, Gracillaria.  
 isitis, Arytaina (*Psylla*).  
 Ismene ataphus, 1024\*.  
 ismene, Melanitis.  
 isocampta, Pammene.  
 isochalca, Nepticula.  
 isocrates, Virachola.  
 isocyrta, Cacoecia.  
 isodelta, Acrocercops.  
 isonoma, Acrocercops.  
 Isoptera as crop-pests, 313.  
 Istrianis crauropa, 844.  
 iteina, Lithocolletis.  
 itysalis, Margaronia (*Glyphodes*).

## J

jaculatrix, Laspeyresia.  
 Jak-fruit weevil, 320\*.  
 jambulaua, Tumidicoxoides.  
 Jamides bochus, 333, 339.  
 janata, Achæa.  
 jansoni, Conarthrus.  
 janus, Aspongopus.  
 japonica, Aclerda.  
 Jasside as crop-pests, 273, 563; eaten by  
     birds, 867.  
 Jivatma sp., 268.  
 jocosatrix, Bombotelia

Jœnia annectens, 1019\*.  
 Juar Cecidomyiad, 50.  
     ,, stemfly, 51.  
 juliani, Metastenomyia.  
 Julodis atkinsoni, 246, 588.  
 Junonia almana, 106; J. lemonias, 106, 902;  
     J. orithyia, 106.  
 Jute Apion, 198.  
     ,, Trachys, 246.

## K

Kalidasa sanguinalis, 1031\*.  
 Kallima inachus, 106, 591.  
 karnyi, Gynaikothrips.  
 kempi, Leidyia.  
 khapra, Trogoderma.  
 Killing-bottle, 952\*.  
     ,, specimens, 952\*.  
 Knives, 952\*.  
 kœbeli, Ceronema.  
 kœnigana, Laspeyresia.  
 kœnigi (viarum), Hodotermes.  
 Kōlingi pod beetle, 318\*.  
 Kolla mimica, 275; K. sp., 442.  
 kumara, Parnara.

## L

Labelling insects, 959\*, 973.  
 labiatus, Dorylus.  
 Labidura riparia, 859.  
 labrodes, Parectopa.  
 labyrinthica, Acrocercops.  
 lacca, Tachardia.  
 Laccophilus anticatus, 863.  
 Laccotrepes ruber, 867.  
 Lac-dye, Production of, 786  
 Lacera alope, 335, 339.  
 lacerta, Episomus.  
 lachanitis, Opogona.  
 lachesis, Acherontia.  
 Lachnus pyri, 284.  
 Lac insects, 795\*.  
 Lacon sp., 864.  
 lacteella, Endrosia  
 lacteola, Altha.  
     ,, Amsacta.  
 lacticina, Nyctemera.  
 lactinea, Estigmene.  
 lactuceæ, Oxyptilus  
 Lælia devestita, 89; L. exclamationis, 334,  
     340.

- lætus*, *Oxycaenus*.  
*Lagoptera honesta*, 590.  
*lahorensis*, *Stephensonia*.  
*lains*, *Chilades*.  
*laleana*, *Belippa*.  
*Lamiad cane-borer*, 372\*.  
*Lamiadæ*, 212.  
*Lamiads*, unidentified, 220, 572.  
*Lampides elpis*, 112.  
*Lamprosema diemenalis*, 129; *L. indicata*, 129, 336, 337, 345.  
*Langia zenzeroides*, 98\*, 565, 592.  
 Languages, Proposed restriction of, 12.  
*Languria* sp., 249 (see also *Anadastus*).  
*lanigera*, *Eriosoma*.  
*Lantana Agromyzid*, 675.  
*Lantern Slides*, 1047.  
*Laphygma exigua*, 70, 71, 324, 342, 347, 349.  
*lapidella*, *Hyponomeuta*.  
*Lariadæ*, 239, 720; eaten by birds, 864.  
*Lariadæ*, *Bionomics of*, 928.  
*Larvæ*, Preservation of, 969.  
*larvalis*, *Dermestes*.  
*lasianthi*, *Lepidosaphes*.  
*Lasiocampidæ*, 102.  
*Lasioderma serriecorne*, 722\*, 762, 763  
*lasiopygus*, *Adoretus*.  
*Laspeyresia epparidana*, 843; *L. dædalota*, 843; *L. hemidoxa*, 147, 843; *L. jaculatrix*, 843; *L. koenigana*, 843; *L. leucostoma*, 147, 323, 843; *L. malesana*, 843; *L. mamertina*, 843; *L. pomonella*, 148, 567, 843; *L. pseudonectis*, 147, 843; *L. ptychora*, 149, 843; *L. pulverula*, 843; *L. pycnoehra*, 843; *L. torodelta*, 148, 843; *L. tricentra*, 147, 843.  
*Laspeyresia (Eucosma) trichocrossa* (critica).  
*latania*, *Aspidiotus*.  
 " *Cerataphis*.  
*lateralis*, *Astyceus*.  
*lateritalis*, *Epicrocis*.  
*Latheticus oryzæ*, 714\*.  
*latifascia*, *Euproctis*.  
*latus*, *Pœcilocoris*.  
*Latypica albofasciella*, 856.  
*Lawana conspersa*, 574.  
 Leaf-eating insects, Rearing of, 881.  
 Leaf-mining insects, Rearing of, 882.  
*lebadca*, *Paduka*.  
*lecanii*, *Cephalosporium*.  
 " *Empusa*.  
*Lecanium* (see also *Coccus*).  
 " *a-utissimum*; 603.  
 " *adersi*, 295, 603; *L. discrepans*, 295, 603, 605; *L. imbricans*, 295;  
*L. marsupiale*, 296; *L. marcaræ*, 296; *L. signiferum*, 296, 605.  
*Lecithocera erypsilychna*, 844; *L. effera*, 844; *L. formosana*, 637.  
*Leeuwenia indiensis*, 618.  
*lefroyi*, *Microbracon (Rhogys)*.  
*lefroyi*, *Physothrips*.  
 Legislation against pests in Mysore, 57—59.  
 " in Egypt against cotton bollworms, 503—509.  
 " regarding Plant Imports, 1054.  
*Leidyia annandalei*, 1014\*, 1015, 1019; *L. campanula*, 1014\*, 1015; *L. kempfi*, 1014\*, 1015, 1019; *L. metchnikowi*, 1014\*, 1015, 1018\*.  
*Lema downesi*, 224.  
*lemonias*, *Junonia*.  
*Lens*, 952.  
*lentiginosum*, *Phaeopteron*.  
*leontina*, *Myrmecozela*.  
*leopardus*, *Aleclides*.  
*lepida*, *Parasa*.  
*Lepidoptera* as crop-pests, 52, 322; eaten by birds, 865.  
*Lepidosaphes beckii*, 303; *L. erythrina*, 303; *L. lasianthi*, 303; *L. pallida*, 303; *L. piperis*, 303.  
*Lepidoscia globigera*, 856.  
*leptalina*, *Soritia*.  
*Leptispa pygmæa*, 235.  
*Leptocoris acuta*, 258; *L. varicornis*, 257, 342.  
*Leptoglossus membranaceus*, 257.  
*Leptoxyda (Dacus) longistylus*.  
*Lepyrodes geometralis*, 336, 340.  
*leucaspis*, *Argyroplöce*.  
*Leucaspis indica*, 299, 588.  
*Leucinodes orbonalis*, 132, 336, 340, 350.  
*Leucephlebia lineata*, 96.  
*leuconotus*, *Dnomitus*.  
*Leucoptera sphenograpta*, 854.  
*leucostoma*, *Laspeyresia*.  
*Leucotermes indieola*, 1011, 1014, 1016, 1019.  
 " *speratus*, 631.  
*Liburnia burmitina*, 987\*; *L. psylloides*, 271; *L. sp.*, 271.  
*lienigianus*, *Pterophorus*.  
 Light, Effect of, on specimens, 965.  
 " traps, 943\*.  
*Limacodid*, 105\*.  
*Limacodidæ*, 103, 365.  
*limbirena*, *Plusia*.  
*Limnecia metacypba*, 846; *L. peronodes*, 846; *L. phragmitella*, 1000.

limulus, Pseudodoxia.  
 Linda nigroscutata, 216\*, 567.  
 linearis, Calandra.  
 linearis, Riptortus.  
 lineata, Leucophlebia.  
 lineaticollis, Clovia.  
 lineaticollis, Paramesus.  
 lineatopennis, Anomala.  
 liochalca, Nepticula.  
 Liocrobyla parashista, 163, 853.  
 lioderes, Heteronychus.  
 Liogryllus bimaculatus, 312, 349, 861.  
 liophanes, Exelastis.  
 Litchi Eriophyes, 581, 582.  
 Literature, Subject indexing of entomological, 1047.  
 Lithacodia signifera, 74.  
 Lithocolletis bauginiae, 850; L. clarisona, 850; L. conista, 850; L. dorinda, 850; L. ganodes, 161, 851; L. incurvata, 851; L. itema, 850; L. neodoxa, 851; L. triarcha, 161, 850; L. virgulata, 850.  
 litterata, Varuna.  
 littoralis (litura) Prodenia.  
 litura, Prodenia.  
 livii, Polygnatus.  
 Lixus brachyrrhinus, 195, 352, 569.  
 Lobesia æolopa, 145, 842; L. genialis, 842.  
 lobiceps, Adoretus.  
 Lobopelta ocellifera, 862.  
 Locusta danica, 306.  
 Locustidæ (Phasgonuridæ).  
 Locusts, 15.  
 Læmophilæus pusillus, 714\*.  
 Lomatus hislopi, 987.  
 longiceps, Physothrips.  
 longicollis, Odoiporus.  
 longicornis, Crypsithyris.  
 " Fatua.  
 longifolia, Ips.  
 longipes, Cyrtotrachelus.  
 longipes, Plagiolepis.  
 longispinus, Pseudococcus.  
 longistylus, Dacus.  
 Longitarsus nigripennis, 318, 925.  
 longulus, Coccus.  
 Lophomonas blattarum, 1019\*.  
 Lophosternus hugelii, 220, 567.  
 loreyi, Girphis.  
 loxias, Acrocercops.  
 loxoptila, Bucculatrix.  
 Loxostege massalis, 134.  
 Lucanidæ, 184.  
 Lucanus lunifer, 184, 591.  
 Lucerne stemfly, 49.

lucidalis, Pisara.  
 lucifera, Antierates.  
 Ludicra (critica), Eucosma.  
 lugubris, Oxycaenus.  
 lunalis, Sylepta.  
 lunata, Bembex.  
 lunata, Euproctis.  
 lunifer, Lucanus.  
 lutescens, Ancylos.  
 Lymantriadæ, 88; eaten by birds, 865.  
 Lycænesthes emolus, 112, 582, 583.  
 Lycenidæ, as crop-pests, 111; eaten by birds, 865.  
 Lygæidæ as crop-pests, 260; eaten by birds, 866.  
 Lygæus hospes, 260, 866; L. pandurus, 260, 591.  
 Lygropia quaternalis, 336.  
 Lymantria ampla, 334, 337, 338, 339, 340; L. beatrix, 90, 584; L. concolor, 91; L. obfusca, 90; 568.  
 Lyncestis amphix, 86.  
 Lyonetiadæ, 164, 854, 1006.  
 lysibathra, Acrocercops.  
 lysimon, Zizera.  
 Lytta actæon, 240; L. picta, 240; L. ruficollis, 240; L. tenuicollis, 240

## M

Macalla monocusalis, 126, 583, 584, 597.  
 Machæropteris halistrepta, 855.  
 Machærota planitia, 272, 556\*; M. sp., 272, 592.  
 machæralis, Pyrausta.  
 machaon, Papilio.  
 Macræola inquisitrix, 856.  
 Macrobatra nomæa, 847.  
 macroclina, Acrocercops.  
 Macroma melanopus, 181.  
 Macropes excavatus, 261; M. raja, 261.  
 Macrosiphum granarium, 279; 343; M. pisti, 279; M. roseiformis, 279; M. sanborni, 279; M. sonchi, 279, 348.  
 maculatus, Chaitophorus (Callipterus trifolii)  
 maculicollis, Codophila.  
 maculipennis, Plutella.  
 maculosa, Serica.  
 madurensis, Nisotra.  
 mæsioides, Padraona.  
 magna, Amphipyra.  
 magnifica, Heterusia.  
 Mahasena (Clania) destructor  
 " graminivora, 137; M. theivora,

- Mabasena* sp., 644.  
*maidis*, Aphis.  
*major*, Tæniothrips.  
*malabarius*, Aposus.  
     "    Phassus.  
*Malenus* sp., 863.  
*malesana*, Laspeyresia.  
*mali*, Alcides.  
*malignus*, Dyscerus.  
*maliellus*, Hyponomeuta.  
*malvæ*, Acontia.  
     "    Aphis.  
*malvoides*, Aphis.  
*mamertina*, Laspeyresia.  
*Manatha* scotoepepla, 139.  
*manganentis*, Acrolepia.  
*mangifera*, Coccus.  
     "    Cryptorrhynchus.  
     "    *Dacus* (see *Chaetodacus zonatus*).  
     "    Diaspis.  
     "    Parlatoria.  
     "    Phenacoccus.  
     "    Rhynchænus.  
Mango-hoppers (see *Idiocerus*).  
Mango-leaf Cecidomyiad, 50, 583.  
*mauni*, Chionaspis.  
Mantidæ eaten by birds, 859.  
Mantis sp., Parasite on eggs of, 935.  
*Marasnia* *lilinealis*, 127; *M. trapezalis*, 127, 342, 354; *M. venialis*, 127.  
*Margaronia alitalis* (*bivitalis*); *M. bivitalis*, 131, 336, 341; *M. cæsalis*, 17, 131, 581; *M. canthusalis*, 131; *M. judica*, 131, 336, 338, 351; *M. itysalis*, 576; *M. marginata*, 130; *M. negatalis*, 130; *M. stolalis*, 130; *M. vertumnalis*, 130.  
*Margaronia* (*Glyphodes*) *pyloalis*, 599.  
*marginata*, Biston.  
     "    *Margaronia* (*Glyphodes*).  
*marginatus*, Eugnaptus.  
*marginella*, Serica.  
*marginifer*, Chlænius.  
*marmoralis*, Tarache.  
*marmoratus*, *Edaleus*.  
*maro* (*dioscorides*), *Ampittia* (*Hesperia*).  
Marsh Insects, 941.  
*marsupiale*, Lecanium.  
*martensi*, Potamon.  
*Maruca testulalis*, 133, 336, 339, 344, 345, 346.  
Mason, C. W., 7.  
*massalis*, *Loxostege* (*Phlyctænodes*).  
*Mastacides nilgiricus*, 1033.  
*Matapa aria*, 115, 1024 \*  
*mathias*, *Chapra* (*Parnara*).  
*mauritanicus*, *Tenebroides*.  
*mauritica*, Spodoptera.  
*maxima*, *Pulvinaria*.  
Mealy-bugs, 350, 351, 561, 563, 597, 598, 599.  
*medardaria*, *Dilinia*.  
*medicaginis*, Aphis.  
     "    Hypera.  
*medinalis*, *Cnaphalocrocis*.  
*Megachile anthracina*, 35; *M. disjuncta*, 36.  
*Megacœlum stramineum*, 264. \*  
*megaloba*, *Chionaspis*.  
*Megamelus furcifera*, 270, 271.  
*Megastigmus indi*, 37, 935.  
*melanaula*, *Eucosma*.  
*Melanitis ismene*, 105, 332, 338, 341.  
*melanocephalus*, *Gryllus*, 313.  
*melanoneura*, *Eucosma*.  
*melanoplecta*, *Anarsia*.  
*melanopus*, *Diapromorpha*.  
*melanopus*, *Macroma*.  
*melanozona*, *Telphusa*.  
*melanura*, *Idgia*.  
*Melaserica barberi*, 167.  
*Melasia canpestris*, 855; *M. energea*, 855; *M. granularis*, 855.  
*melicerta* (*janata*), *Achæa* (*Ophiusa*).  
*melititus*, *Oditis*.  
*Melittia eurytion*, 159.  
*mellerborgii*, *Polytus*.  
*Mellesis eumenoides*, 45, 351.  
Meloïdæ as crop-pests, 240, 348.  
Melolonthid Beetles, control of, 28, 30.  
Melolonthidæ, 165, 1027; eaten by birds, 865.  
Melyridæ as crop-pests, 247.  
Membracidæ as crop-pests, 271; eaten by birds, 867.  
membranaceus, *Leptoglossus*.  
*memnou*, *Papilio*.  
*menciana*, *Homona*.  
*mendax*, *Bucculatrix*.  
*mendosa*, *Dasychira*.  
*Menida histrio*, 245, 342.  
*Meranopus bicolor*, 34, 344.  
*mercara*, *Lecanium*.  
*Meridarchis reprobata*, 143, 581, 840; *M. scyrodes*, 143, 570, 840.  
*merione*, *Ergolis*.  
*Meristos hunteri*, 987.  
*mesodyas*, *Crypsithyrus*.  
*Metacanthus pulchellus*, 259.  
*Metachandidæ*, 846, 1003.  
*metacypha*, *Limnœcia*.  
*metallicum*, *Chalænosoma*.  
*Metanastria hyrtaca*, 103, 564, 580, 594.



- Metapelma indica*, 934.  
*Metaplex dentipes*, 692.  
*Metasia coniotalis*, 135.  
*Metastenomyia juliani*, 934.  
*metelnikowi*, Leidya.  
*Meteorus arcticida*, 932.  
*Metialma balsaminæ*, 201.  
*meticulosalis*, Terastia.  
*Melisa* (Mahasna) *thivora*.  
*Metriona circumdata*, 235, 351.  
*micaceana*, Cacœcia.  
*Microbracon lefroyi*, 446, 450, 452, 453;  
 redescribed, 1025—1026.  
*Microbracon* sp., 933, 1026.  
*Microcolona citroplecta*, 846.  
*Microdus fumipennis*, 933.  
*Microjonia hexamitoides*, 1019\*.  
*Microlepidoptera*, Life-histories of, 838;  
 Sketch of knowledge of —, 999.  
*Micropezidae*, 47.  
*Micropterygidae*, 857, 1007.  
*Microtermes obesi* (*anandi*), 313, 711.  
*miliaris*, *Aspidomorpha*.  
 „ *Aularches*.  
 „ *Calotermes*.  
 „ (*pandurus*), *Lygæus*.  
*Mimastra cyanea*, 230, 567, 568, 571, 578, 579,  
 589, 592.  
*mimetis*, *Cosmopteryx*.  
*mimica*, Kolla.  
*mimosæ*, *Pyletis*.  
*minutus*, *Duomitus*.  
 „ *Mycalesis*.  
*minima*, *Hemichionaspis*.  
*minor*, *Hemichionaspis*.  
 „ *Icerya*.  
 „ *Phycodes*.  
*minuta*, *Suaetus*.  
*minutella*, *Nephopteryx*.  
*minutus*, *Halticus*.  
*Miopristis bimaculata*, 225.  
*miserana*, *Harmologa*.  
*Mites*, 327, 559, 581, 582.  
*modesta*, *Phidodonta*.  
*mœsta*, *Assamia*.  
*Mole-crickets* (see *Gryllotalpa*).  
*mollifera*, *Eupterote*.  
*molopias*, *Platyptilia*.  
*Monanthis globulifera*, 264.  
*monachella*, *Monopis*.  
*moncusalis*, *Macalla*.  
*monodactylus*, *Pterophorus*, 840.  
*Monohammus* (*Dihammus*) *fistulator*; *M.*  
*nivosus*, 215; *M. versteegi*, 216, 573.  
*Monolepta signata*, 230, 345, 347, 348, 361, 578.  
*Monopis diceyla*, 856; *M. hemicitra*, 856; *M.*  
*monachella*, 856.  
*Monophlebus stebbingi octocaudata*, 286, 587;  
*M. sp.*, 287, 589; *M. tamarindus*, 286.  
*monostigma*, *Scirpophaga*.  
*montana*, *Diacrisia*.  
 „ *Ochrophara*.  
*monticollis*, *Teratodes*.  
*montis*, *Porthesia*.  
*moorei*, *Amsacta*.  
*Morinda* shoot-borer, 318.  
*Moringa* stem-borer, 317, 922\*.  
 Mosquitos eaten by fish, 908.  
 Mosquito, Tea (see *Helopeltis thivora*).  
 Mould on specimens, 964.  
*Mucialla* (see *Tirathaba*).  
*Mudaria cornifrons*.  
*mungonis*, *Pachytychius*.  
*Muscida*, 39; eaten by birds, 866.  
*Mycalesis mineus*, 105; *M. perseus*, 105.  
*Mycetophilidæ* eaten by birds, 865.  
*Myelois pectinicornella*, 124, 336, 340.  
*Myiopardalis carpalina*, 45, 589, 592.  
*wyllis*, *Inma*.  
*Myllocerus* spp. eaten by birds, 864.  
 „ *blandus*, 191, 361, 594; *M. dentifer*,  
 192, 319; *M. discolor*, 192, 319,  
 361, 568, 569, 579, 581, 583; *M.*  
*dorsatus*, 190; *M. sabulosus*,  
 191, 570, 583, 593; *S. setulifer*,  
 190; *M. sub fasciatus*, 191,  
 319; *M. transmarinus*, 191,  
 570; *M. viridanus*, 190, 319,  
 579; *M. undecim-pustulatus*,  
 192, 361, 566, 569, 579, 583, 594.  
*Myodites burmiticus*, 897\*.  
*myrica* (*rubens*), *Ceroplastes*.  
*Myrmicaria brunnea*, 34.  
*Myrmecinae* eaten by birds, 862.  
*Myrmecocela corticina*, 855; *M. leontina*, 855.  
*M. tineoides*, 855.  
*myrsensalis*, *Rhodoneura*.  
 Mysore, Pest Act in, 57—59.  
*mytilaspiformis*, *Parlatoria proteus*.  
*Mytilaspis* (*Lepidoſaphes*).  
*Mytilaspis pallida*, 604.  
*myxodes*, *Opostega*.  
*Myzus persicæ*, 280.

## N

- Nacoleia* (*Pilocrocis*) *barcalis*.  
 „ (*Lamprosema*) *diemalis*; *N.* (*L.*)  
*indicata*.

- nævana, Ancyli.  
 Nagoda nigricans, 660.  
 Nanaguna breviscula, 76, 585.  
 napæa, Paratelpusa.  
 Naranga diffusa, 74, 341.  
 nararia, Natada.  
 narcissus, Eligma.  
 narooa, Pamara.  
 Narosa conspersa, 333, 340; *N. nitobei*, 660.  
 nasicornis, Oryctes.  
 nasturtii, Aphis.  
 Natada nararia, 103, 322, 933; *N. velutina*, 103, 584.  
 Naucoridae eaten by birds, 867.  
 nazira, Coptosoma.  
 nebulosa, Raparna.  
 nebulosus, Plecophlebus.  
 Necrobia rufipes, 863.  
*Nectarophora destructor* (Macrosiphum pisi).  
 negatalis, Margaronia (Glyphodes).  
 Nemoria integranota, 336, 339.  
 neodaxa, Lithocolletis.  
 Neodurtus acocephaloides, 596.  
 Neohegeria indica, 619.  
 Neomaskellia bergii, 278, 427\*.  
 Nephantis serinopa, 157, 575, 600, 848, 934.  
 Nephela didyma (*hespera*), 333, 337, 570.  
 nephelotis, Plothoia.  
 Nephopteryx eugraphella, 124, 594; *N. minutella*, 124, 336, 340, 350; *N. semirubella*, 124.  
 Nephottix apicalis, 275, 433; *N. bipunctatus*, 275, 342, 433\*.  
 Nepidae eaten by birds, 867.  
 Nepticula argyrodoxa, 857; *N. isochalca*, 857; *N. isochalca*, 857.  
 Nepticulidæ, 857, 1007.  
 Neptis eurynome, 332, 339.  
 nerii, Aphis.  
 nerii, Deilephila.  
 Nerius sp., 47.  
 nerteria, *Aproærema* (Stomopteryx).  
 Nets, 947\*.  
 Nezara graminea, 254; *N. viridula*, 254, 563.  
 ni, Plusia.  
 nigra, Saissetia (*Lecanium*).  
 nigricans, Chlenius.  
 nigricans, Nagoda.  
 nigrifrons, Diacrisia.  
 nigripennis, Longitarsus.  
 nigrisigna, Plusia.  
 nigrita, Sagra.  
 nigrofasciatus, (E)daleus.  
 nigrorepletus, Hieroglyphus.  
 nigroscutata, Linda.  
 nilgirica, Chiouaspis.  
 nilgiriensis, Serica.  
 nilgirisicus, Mastacides.  
 nipe, Pseudococcus.  
 Nisaga simplex, 99.  
 Nisotra madurensis, 231, 351.  
 nitidula, Tarache.  
 nitidus, Adoretus.  
 nitobei, Narosa.  
 nivea, Altha.  
 niveigutta, Atteva.  
 niveodactyla, Alucita, 840.  
 niveosparsus, Idiocerus.  
 niviferana, Tonica (*Binsitta*).  
 nivosus, Monohammus.  
 nobilis, Scutellera.  
 Noctuid cane-borer, 377\*.  
 Noctuidæ, 60; eaten by birds, 865.  
*Nodaria externalis*, 88.  
*Nodina rufipes*, 226, 590, 598.  
*Nodostoma subcostatum*, 226, 578, 592.  
 nolalala, Nympha.  
 nomæa, Macrobathra.  
*nonagrioides* (vateria), Sesamia.  
 Noorda blitelis, 134.  
 notabilis, Tarache.  
 Notiobiella sp., 555.  
 Notodontid, 101\*, 565.  
 Notodontidæ, 100.  
 Notonectidæ eaten by birds, 867.  
 nubila, Agonoscelis.  
 nubilalis, Pyrausta.  
 nubilans, Aleurocanthus.  
 nubilans, Scymnus.  
 nucleata, Eucrotala.  
 nuda, Perina.  
*Nupserha bicolor*, 218.  
*Nyctemera lacticinea*, 334.  
*Nyctotherus fletcheri*, 1016\*; *N. termitis*, 20.  
 nymphææ, Siphocoryne.  
 Nymphalidæ, 105.  
*Nymphula depunctalis*, 126, 341, 352; *N. fluctuosalis*, 126, 341.  
*Nysius inconspicuus*, 260, 325.

## O

- Oberea sesami, 219; *O. sp.*, 219.  
 obesi (*anandi*), Microtermes.  
 obesus, Odontotermes.  
 obesus, Plocæderus.  
 obfuscata, Lymantria.  
 obliqua, Diacrisia.  
 obscura, Cyclopelta.

- obsoleta, *Heliopsis*.  
 „ *Psylla*.  
 obstinata, *Eboda*.  
 obtusisigna, *Plusia*.  
 ocellaris, *Panicus*.  
 ocellatus, *Cantao*.  
 ocellifera, *Lobopelta*.  
*Ocma* varians, 100, 577.  
 occipitalis, *Pheropsophus*.  
*Ochrochira* sp., 256.  
*Ochrophara montana*, 251.  
 octo, *Amyra*.  
 octocaudata, *Monophlebus stebbingi*.  
 octopunctata, *Gracillaria*.  
*Odites atmopa*, 847; *O. bambusæ*, 848; *O. hederae*, 848; *O. melitidis*, 848; *O. spoliatrix*, 848.  
*Odoiporus longicollis*, 208, 503, 600.  
 Odonata eaten by birds, 861; night-flying —, 895; eaten by fish, 908.  
*Odontotermes bangalorensis*, 314; *O. formosanus*, 630; *O. obesus*, 314, 711; *O. parvidens*, 313.  
*Oecia oecophila*, 846.  
*oecophila*, *Oecia*.  
*Oecophylla smaragdina*, 33, 316, 561, 582, 583, 862.  
*Oecophoridae*, 156, 847, 1003, 1004.  
*Edalcaus marmoratus*, 860.  
 „ *nigrofasciatus*, 306.  
*Edeinatopoda clerodendronella*, 849.  
*E. cypris*, 849; *E. flammifera*, 849; *E. venusta*.  
*Edipodinae* eaten by birds, 860.  
*Oides affinis*, 228.  
*oldenlandiæ*, *Theretra*.  
*oleæ*, *Dacus*.  
 „ *Saissetia (Lecanium)*.  
*Olegores citrinella*, 636.  
*Oleocampptus bilobus*, 218, 321\*, 577, 581.  
*Oliarus* sp., 268.  
*olivacea*, *Eublemma*.  
*olivaceus*, *Hydrophilus*.  
 Olive Fruitfly (see *Dacus oleæ*).  
*ommatieformis*, *Egeria*.  
*omoptila*, *Anarsia*.  
*Omphis anastomosalis*, 133.  
*Oncocephala tuberculata*, 236.  
*Onebala blandiella*, 844.  
*Onthophagus* sp., 864.  
*oöphagus*, *Tumidiscapus*.  
*Oötetrastichus indicus*, 935.  
*Opalina termitis*, 1016\*, 1019.  
*opalinoides*, *Tarache*.  
*Opatrum (Gonocephalum)*.  
*operculella*, *Phthorimæa*.  
*Ophideres fullonica*, 86, 573.  
*ophideroides*, *Calpe*.  
*ophiosema*, *Simacthis*.  
*Ophiusa (Parallelia) algira*.  
 „ (*Parallelia*) *analis*.  
 „ *aretotænia*, 594.  
 „ (*Anna*) *coronata*.  
 „ (*Achæa*) *melicerta (janata)*.  
*ophiusa*, *Tetrastichus*.  
*Opius fletcheri*, 19, 628.  
*Opogona chalinota*, 855; *O. flavofasciata*, 855; *O. fumiceps*, 855; *O. lachanitis*, 855; *O. præincta*, 855.  
*Opostega myxodes*, 855.  
*opposita*, *Euplexia*.  
*opsigona*, *Tinea*.  
*optabilis*, *Paranagrus*.  
 "Orange beetle," 225.  
 „ *Psychid*, 139.  
*orbinalis*, *Leucinodes*.  
*ordinatella*, *Acroceroops*.  
*Oregma bambusæ*, 286.  
*Orgyia postica*, 88, 324\*, 334, 338, 339, 340, 651.  
*orichalcea*, *Agestrata*.  
*orichalcea*, *Plusia*.  
*orientalis*, *Aspidiotus*.  
 „ *Bruchocida*.  
 „ *Dorylus*.  
 „ *Stylopyga*.  
 „ *Vespa*.  
 „ *Vitellus*.  
*orithyia*, *Junonia*.  
*Ornecodidæ*, 848, 1004.  
*Ortalidæ* eaten by birds, 866.  
*Orthacris* sp., 308, 326.  
*Orthacanthaeris ægyptia*, 309; *O. havescens*, 309; *O. succincta*, 310.  
*Orthezia insignis*, 676, 857.  
*Orthocraspeda trima*, 658.  
*orthogona*, *Simacthis*.  
*Orthoptera* as crop-pests, 304, 326.  
*orthostacta*, *Acroceroops*.  
*Oryctes nascicornis*, 181; *O. rhinoceros*, 182, 575, 600.  
*oryzæ*, *Calandra*.  
 „ *Latheticus*.  
 „ *Pachydiplosis*.  
 „ *Ripersia sacchari*.  
 „ *Thrips*.  
*oschophora (chersæa)*, *Ephysteria*.  
*Oscinis theæ*, 47, 668.  
*ostensum*, *Coptosoma*.  
*Othreis (Ophideres) fullonica*.  
*ovalis*, *Adoretus*.

- ovi, Aximopsis.  
 ovigera, Stathmopoda.  
 Oviposition, Inducing, 886.  
 Oxya velox, 308, 342, 935; *O. sp.*, 860.  
 oxyæ, Scelio.  
 Oxyambulyx sericeipennis, 96\*, 595.  
 Oxyarcenus hyalinipennis, 502, 561; *O. lætus*, 261, 562; *O. lugubris*, 262.  
 Oxycoenia albopunctata, 179, 572; *O. versicolor*, 179.  
 Oxyptilus caudodes, 839; *O. chordites*, 839; *O. epidectes*, 839; *O. lactuceæ*, 136, 838; *O. polecyntes*, 839.  
 Oxyrhachis tarandus, 271.
- P**
- Pachydiplosis oryzae, 49, 324, 371\*, 442, 935.  
 Pachnophorus bretinghami, 227; *P. impressus*, 227; *P. sp.*, 361.  
 pachnodes, Choluta.  
 Pachymerus chinensis, 239, 721\*, 762.  
 Pachyonyx quadridens, 206.  
 pachyspila, Tinea.  
 Pachytychius mungonis, 201, 321.  
*Pachyzancla* (*Psara*) bipunctalis (*agrotalis*).  
 Paddy stem-fly, 342.  
 padi, Siphocoryne (*Siphonaphis*).  
 Padraona dara, 1022, 1024\*; *P. mæsioides*, 1024\*; *P. pseudomæsa*, 1024\*.  
 Paduka lebadea, 1024.  
 Pagnia signata, 226.  
 Palæopsyche, 980.  
 palimpsesta, Pseudodoxia.  
 pallescens, Sogata.  
 pallicosta, Theretra.  
 pallida, Dietyophora.  
 „ *Lepidosaphes*.  
 „ *Mytilaspis*.  
 pallidospila, Anomala.  
 Palm Psychid, 139.  
 paludicola, Buckleria.  
 palpigera, Paraspistes.  
 Pammene isocampta, 843; *P. theristis*, 843.  
*pammon* (polytes), Papilio.  
 Panchatothrips indicus, 327\*, 618.  
 pandava, Catochrysops.  
 Pandemis ribeana, 480.  
 pandurus, Lygæus.  
 Panilla albopunctata, 335, 341.  
 Paniscus ocellaris, 933.  
*Panivaragu* flea-beetle, 318.  
 Paper, Wood-fibre for making, 14.  
 paphia, Anthæra.
- Papilionidae, 107.  
 Papilio agamennon, 108, 332, 337; *P. aristolochiæ*, 332, 337, 903; *P. daksha*, 108, 571; *P. demoleus*, 107, 332, 340, 568, 571, 596, 900; *P. erithonius* (*demoleus*); *P. helenus*, 108; *P. hector*, 903; *P. machaon*, 107; *P. memnon*, 108, 571, 906; *P. paranda*, 108, 332, 340; *P. polymnestor*, 108, 571; *P. polytes*, 109, 332, 340, 571, 900, 903.  
 papilionis, Apanteles.  
 papillosa, Parlatoria.  
*Papua* (*Emmalocera*) depressella.  
 paraclina, Porthmologa.  
 paragramma, Argyroploce.  
 Paralecanium expansum, 294.  
 Parallela algira, 81; *P. analis*, 80, 592.  
 Paramecops farinosus, 195.  
 Paranesus lineaticollis, 442.  
 Paranagrus optabilis, 935.  
 Parasa lepida, 104, 575, 583, 587, 592, 594, 595, 933.  
 paraschiata, Liocrobyla.  
 Parasites, control by, 30, 62; *P. of crop-pests*, 931; *P. Rearing of*, 880\*.  
 Paraspistes palpigera, 154, 845.  
 Parata alexis, 114, 322, 1024\*; *P. butleri*, 1024\*.  
 Paratophlusa hydrodromus, 686, 688; *P. napæa*, 681; *P. spinigera*, 683, 684; *P. sp.*, 681.  
 Parectopa coccinea, 853; *P. labrodes*, 853.  
 parinda, Papilio.  
 Parlatoria artocarpus, 608; *P. calianthina*, 304; *P. mangiferae*, 304; *P. papillosa*, 609, *P. pergandii*, 304, 583; *P. proteus mytilaspiformis*, 304; *P. zizyphus*, 304, 604.  
 Parnara bada, 117, 1024\*; *P. cingala*, 1024\*; *P. kumara*, 1022, 1024\*; *P. narooa*, 1024\*; *P. philippina*, 1022; *P. seriata*, 1024\*.  
*Parnara* (*Caltoris*) colaca.  
 „ (*Chapra*) mathias.  
 parviceps, Perissothrips.  
 parvidens, Odontotermes.  
 passalis, Amata (*Syntomis*).  
 pauper, Brachyplatys.  
 pealianum, Potamon.  
 Pebrine, 805, 808, 809.  
 pecten, Spodoptera.  
 pectinicornella, Myeloida.  
*Pectinophora* (*Platyedra*) gossypiella.  
 peculiaris, Physothrips.  
 pedator, Xanthopimpla.  
 pedestris, Plocæderus.  
 „ Riptortus.

- Pelamia frugalis*, 81, 335, 338; *P. undata*, 82.  
 pelicyntes, *Oxyptilus*.  
 pellionella, *Tinea*.  
*Peltotrachelus puber*, 193, 321, 569, 571.  
*Pempheres affinis*, 202, 320.  
*Pemphigus ædificator*, 1029.  
*pencilata*, *Baoris*.  
*pensilis*, *Cacoecia*.  
*pentalocha*, *Acrocercops*.  
 Pentatomide as crop-pests, 249; eaten by birds, 866.  
*Pentodon bengalense*, 183; *P. hispinifrons*, 183.  
 peponis, *Plusia*.  
 peregrinus, *Atmectonychus*.  
 perforatus, *Eophleurus*.  
     "    *Platynotus*.  
 pergandii, *Parlatoria*.  
*Pericallia ricini*, 59, 334, 338, 339, 340, 592.  
*Pericyma glaucinans*, 82.  
*Perigea capensis*, 67, 933.  
*Perina nuda*, 93, 576, 581, 583.  
*Perissotrips parviceps*, 619.  
 perixanthia, *Anata*.  
 perlatus, *Xanthotrachelus*.  
*Perlidæ* as pests, 18.  
*Peronea epidemia*, 841; *P. siderota*, 841.  
 peronodes, *Limnœcia*.  
 perotteti, *Apomecyna*.  
 perpusilla, *Pyrilla*.  
 perseus, *Mycælesis*.  
*persica*, *Dacus* (see *Chaetodacus zonatus*)  
 persica, *Eulecanium*.  
     "    *Myzus*.  
     "    *Tuberodyobius*.  
 perspicax, *Gitonides*.  
 perticella, *Euzophera*.  
 pertigera, *Apomecyna*.  
 pervetus, *Trigonallys*.  
 Pest Act in Mysore, 57—59.  
 Pests, Collecting specimens of, 938.  
*Petasothra sirina*, 165, 855.  
 petiolata, *Burmacroera*.  
 petiolatum, *Zygomma*.  
 petrolei, *Psilopa*.  
 phacelota, *Chelaria*.  
*Phacopteron lentiginosum*, 1029, 1030\*.  
*Phædon brassicae*, 228.  
 phæospora, *Acrocercops*.  
 phalerata, *Zonabris*.  
*Phalonia ambigua*, 840.  
*Phaloniade*, 143, 840, 1002.  
 phanarcha, *Aganoptila*.  
 Phasgonuride as crop-pests, 354, 574; eaten by birds, 860.  
 phasiana, *Anoplocnemis*.  
 pharopeda, *Acrocercops*.  
*Phassus malabaricus*, 165.  
*Phenacaspis dilatata*, 588.  
*Phenacoccus ballardi*, 288, 603; *P. hirsutus*, 288, 549, 550, 610\*, 618; *P. iceryoides*, 288, 326, 603, 605; *P. insolitus*, 288, 326; *P. mangiferæ*, 288, 603.  
*Phenice* (*Assamia*) *moesta*.  
*Pheropsochus cardoni*, 863; *Ph. catoitei*, 863; *Ph. occipitalis*, 863.  
*Philanthus ramakrishnæ*, 315.  
 philippa, *Cacoecia*.  
 philippina, *Parura*.  
*Phidodonta modesta*, 238.  
*Philocoma*, *Epimarpis*.  
*Philaoba cinctalis*, 305.  
*Phlyctanodes* (*Loxostege*) *massalis*.  
*Phoxothrips breviceps*, 618.  
 phractopa, *Acrocercops*.  
 phragmitella, *Limnœcia*.  
*Phragmatocœcia* sp., 140.  
*Phrixosceles plexigrapha*, 161, 851.  
*Phthorimea blaspigona*, 152, 323, 844, 933; *Ph. ergasima*, 152, 844; *Ph. heliopa*, 150, 349, 844, 939; *Ph. operculella*, 152, 350, 764—770, 844.  
*Phytocithrips anacardiæ*, 618.  
*Phycita clientella*, 125; *P. infusella*, 125, 453.  
*Phycitid* cane-borers, 378\*.  
*Phycodes minor*, 159, 599, 849; *P. radiata*, 159, 577, 849.  
 phycodis, *Apanteles*.  
*Phyllipsocus banksi*, 897\*.  
*Phyllocnistis chrysophthalma*, 854; *P. cirrhophanes*, 854; *P. citrella*, 164, 568, 572, 854; *P. habrochroa*, 854; *P. helicodes*, 854; *P. selenopa*, 854; *P. synglypta*, 854; *P. toparcha*, 164, 323, 578, 854.  
*Phyllocoreia ramakrishnæ*, 1033\*.  
*Phyllognathus dionysius*, 183.  
*Phyllotreta chotanica*, 232, 348, 349, 350; *P. vittata*, 232, 349.  
*Phymatostetha deschampsii*, 272.  
*Physomeris* sp., 257.  
 Physoptilia *scœnica*, 847.  
 Physoptilidæ, 847, 1004.  
*Physothrips brunneicornis*, 619; *P. lefroyi*, 618; *P. longiceps*, 619; *P. peculiaris*, 619; *P. setiventris*, 619, 621; *P. usitatus*, 618.  
*Phytometra* (see *Plusia*).  
*Phytosecapus dissimilis*, 194; *P. triangularis*, 193, 569, 591.

- piceus, Attagenus.  
 picrophaea, Pseudodoxia.  
 picta, Bagrada.  
   " Clitea.  
   " Lytta.  
 pietalis, Pyralis.  
 pictus, Alcides.  
   " Pœcilocerus.  
   " Cephonodes.  
 pieria, Comocritis.  
 Pieride, 109.  
 Pieris brassicæ, 109, 349, 352; *P. caudia*,  
   109, 352.  
 Piezodorus rubrofasciatus, 254  
 pigna, Eurytoma.  
 Pilemostoma trilineata, 235.  
 Pilocrocis borealis, 128.  
 pilula, Serica.  
 pimpinelle, Antlirenus.  
 Pinning insects, 957\*.  
 Pins, 951.  
*Pionæ* (Hapalia) fœturalis.  
 pipens, Lepidosaphes.  
   " Aleurocanthus.  
 Pisara lucidalis, 334, 337.  
 pisi, Macrosiphium.  
 plagiata, Tiracola.  
 plagiatus, Rhynchochoris.  
 plagiola, Selca.  
 Plagiolepis longipes, 328.  
 plana, Hypophricis.  
 planeta, Deuterocepus.  
 planitie, Machærota.  
 Planostocha cumulata, 841.  
 Plantain stem-boring beetle, 353.  
 Plant Imports into India, 1051—1068.  
 Platyedra gossypiella, 153, 336, 339, 443, 445,  
   453, 472—547, 562, 844.  
 Platyedra gossypiella, Parasites on, 416\*, 447.  
 Platymetopus erebius, 863.  
 Platymycterus sjøstedti, 193, 569, 583.  
 Platynotus perforatus, 864.  
 platypoda, Elasmoseelis.  
 Platypodidæ, 185.  
 Platypria andrewesi, 236, 569; *P. echidna*,  
   237; *P. hystrix*, 237.  
 Platyptilia brachymorpha, 839; *P. calalie*,  
   839; *P. citroplœura*, 839; *P. direptalis*,  
   839; *P. gonodactyla*, 839; *P. molopias*,  
   839; *P. pusillidactyla*, 677, 839; *P.*<sup>2</sup>  
   *taprobanes*, 839.  
 plebeiana, Crocidosema.  
 Plecophlebus nebulosus, 986\*.  
 plectica, Stomphastis.  
 plexigrapha, Phrixosecles.  
 plexippus, Danais.  
 Plodia interpunctella, 1069.  
 Plocæderus obesus, 222; *P. pedestris*, 222.  
*Plotheia* (Selcpa) celtis.  
   " nephelotis, 77, 335, 340.  
 plumbeifasciella, Euzophera.  
 plumigera, Anataractis.  
*Plusia agranma* (peponis); *P. albostrata*,  
   83; *P. chalytes*, 83, 335, 338, 339; 340;  
   *P. daubei*, 83; *P. eriosoma* (chalytes);  
   *P. limbirena*, 82, 334, 337; *P. ni*, 82; *P.*  
   *nigrisigna*, 84; *P. obtusisigna*, 335, 339;  
   *P. orichalcea*, 84, 335, 338, 341; *P. peponis*,  
   84, 335, 338, 933; *P. signata*, 83.  
 plusiæ, Apanteles.  
 Plutella maculipennis, 164, 336, 338, 349, 854,  
   1006.  
 Plutellidæ, 164, 854, 1006.  
 Podagrion indicum, 935.  
 Podontia affinis, 597; *P. 14-punctata*, 233.  
*Pœcilocerus pictus*, 307, 577.  
*Pœcilocoris latus*, 250.  
*Pæderus* sp., 863.  
 poetica, Argyroploce.  
 Polia consanguis, 64.  
 poliographa, Epipyrops.  
 pollinosus, Dereodius.  
 politus, Disphinctus.  
 polita, Anomala.  
 Polychrosis cellifera, 581, 842; *P. fetalis*, 842.  
 Polygnotus livii, 935.  
 polymena, Euehromia.  
 polymnestor, Papilio.  
*Polyocha* (Enmalocera) depressella (*saccha-*  
   *rella*).  
 Polyommatus baticeus, 113.  
 Polytychus dentatus, 96, 914\*, 933.  
 Polyraichis sp., 862.  
 polytes, Papilio.  
 Polytela gloriosa, 64, 334, 337.  
 Polytus mellerborgii, 207, 593.  
 pomonella, Laspeyresia (*Carpocapsa*).  
 Ponerinæ eaten by birds, 862.  
 Popillia chlorion, 170, 316\*, 1028; *P. com-*  
   *planata*, 598; *P. cupricollis*, 169; *P. fœæ*,  
   169, 598; *P. histeroidea*, 170, 590, 598.  
 " Popping " larvæ, 970.  
 poricollis, Amblyrhinus.  
   " Cryptorrhynchus.  
 portentosus, Erachtyrpes.  
 Porthesia montis, 649; *P. xanthorrhœa*, 92.  
 Porthmologa paraclina, 156, 569, 847.  
 postica, Orgyia.  
   " Thiacidæ.

- Potamon andersonianum*, 689; *P. calvum*, 689; *P. dayanum*, 689; *P. martensi*, 682, 683, 684; *P. pealianum*, 689; *P. sp.*, 683.  
*prealbata*, *Stathmopoda*.  
*præcincta*, *Otogona*.  
*præfectus*, *Apollodotus*.  
*præmorsa*, *Eucoptera*.  
*prasina*, *Bellionota*.  
*prasiniferum*, *Spathosternum*.  
*Prays citri*, 160, 572, 850.  
*Predators*, Rearing of, 880.  
*Preservation of early stages*, 889; — of specimens, 964; — of larvæ, 699; — by Dr. Hankin's method, 974.  
*princeps*, *Tanyneus*.  
*Pristomerus testaceus*, 933.  
*privatana*, *Adoxophyes*.  
*proboscidiaria*, *Florinia*.  
*Procometis trochala*, 157, 384, 848.  
*Prodenia litura*, 68, 71, 324, 335, 337, 338, 339, 340, 341, 345, 347, 348, 349, 566, 567, 576, 589.  
*producta*, *Abidama*.  
*Promalactis cornigera*, 847; *P. semantris*, 847.  
*prosecta*, *Acroceroops*.  
*Prostintia florivora*, 158, 586, 850.  
*Protactia alboguttata*, 178; *P. aurichalcea*, 1028; *P. fusca*, 178.  
*Protapanteles sp.*, 933.  
*Protermitidæ* as crop-pests, 314.  
*proteus mytilasipiformis*, *Parlatotia*.  
*Protogenus swinhoei*, 986\*.  
*protypa*, *Autosticha*.  
*proxima*, *Apogonia*.  
*proxima*, *Athalia*.  
*pruinosa*, *Serica*.  
*pruni*, *Brachycaudus*.  
 .. *Hyalopterus*.  
*prunicola theæ (manni)*, *Chionaspis*.  
*Psalis (Dasychira) securis*.  
*Psara bipunctalis*, 134, 336, 340, 350.  
*Pseudonidia trilobitiformis*, 302, 583, 602.  
*pseudobrassicæ (indobrassicæ)*, *Siphocoryne*.  
*Pseudococcus bromeliae*, 337, 608; *P. citri*, 289, 329; *P. coccois*, 289; *P. corymbatus*, 289, 326, 549, 550, 551\*—553\*, 561, 605, 609; *P. crotonis*, 606, 607; *P. longispinus*, 289, 326; *P. nipæ*, 289; *P. sacchari*, 290, 326; *P. saccharifolii*, 290; *P. theæcola*, 290; *P. virgatus*, 290, 549, 550, 551\*, 607, 613.  
*Pseudodoxia cretata*, 847; *P. limulus*, 847; *P. palimpsesta*, 847; *P. picrophæa*, 847; *P. sepositella*, 847.  
*pseudomæsa*, *Padraona*.  
*pseudonectis*, *Laspeyresia*.  
*pseudopretella*, *Borkhausenia*.  
*Pseudoterpsia chlora*, 336, 339.  
*psidii*, *Pulvinaria*.  
*Psila sp.*, 46.  
*Psilidæ*, 46.  
*Psilopa petrolei*, 940.  
*Psiloptera fastuosa*, 245.  
*Psyche vitrea*, 138, 322, 583.  
*Psychid* on palms, 139; — on orange, 139, 571; — on rose, 139; — on sapota, 139, 322; — on castor, 139.  
*Psychidæ*, 137, 322, 592.  
*Psylla (Arytaina) isitis*.  
 .. *obsoleta*, 1029.  
*Psyllid* on *Ficus nervosa*, 1030\*.  
*Psyllidæ* as crop-pests, 276.  
*Psylliodes tenebrosus*, 231.  
*psyllioides*, *Liburnia*.  
*Psyllopa (Arytaina) punctipennis (isitis)*.  
*ptarmica*, *Tischeria*.  
*Pterophoridae*, 136, 838, 994.  
*Pterophorus lienigianus*, 137, 839; *P. monodactylus*, 840.  
*Ptochoryctis simbleuta*, 157, 847.  
*ptychora*, *Laspeyresia*.  
*ptyphora*, *Crocidaphora*.  
*pubes*, *Peltotrachelus*.  
*Publications, Entomological. Proposals regarding*, 10—13, 1034.  
*puera*, *Hyblæa*.  
*pulchella*, *Utetheisa*.  
*pulchellus*, *Metacanthus*.  
*pulehrum*, *Eurydema*.  
*pulverea*, *Holocera*.  
*pulverula*, *Laspeyresia*.  
*Pulvinaria burkilli*, 291; *P. maxima*, 291, 316, 326, 561, 609; *P. psidii*, 291, 329, 583, 588, 602, 604; *P. sp.*, 291, 606.  
*puncta*, *Clovia*.  
*punctatus*, *Aularches*.  
*punctiferalis*, *Dichocrocis*.  
*punctimarginalis*, *Acanthopsyche*.  
*punctipennis (isitis)*, *Psyllopa (Arytaina)*.  
*punctum*, *Amyna*.  
*Pundaluoja simplicia*, 270, 935.  
*punicæolla*, *Euzophera*.  
*punjabipyri*, *Toxoptera*.  
*Pupæ, Lepidopterous*, eaten by birds, 865.  
*purchasi*, *Icerya*.  
*Purohita sp.*, 325\*.  
*pusana*, *Pyrilla*.  
*pusana*, *Sogata*.  
*pusillidactyla*, *Platyptilia*.  
*pusillus*, *Læmophilæus*.

- pustulans, *Asterolecanium*.  
 pustulata, *Zonabris*.  
 putli, *Chilades*.  
 pycnochra, *Laspeyresia*.  
*Pycnosoma flaviceps*, 39, 866.  
 pygmaea, *Leptispa*.  
 pyloalis, *Margaronia*.  
*Pyloetis mimosae*, 855.  
*Pyralid cane-borers*, 393\*.  
 " on *Chrysanthemum*, 136.  
*Pyralidae*, 117; eaten by birds, 865.  
*Pyralia farinalis*, 715; *P. pictalis*, 715.  
 pyramidea, *Amphipyra*.  
 pyranthe, *Catopsilia*.  
*Pyrausta bambucivora*, 136; *P. codesalis*, 135; *P. macheralis*, 135, 701; *P. nubilalis*, 135.  
*Pyrastine* on *Amaranthus*, 134.  
*Pyrgomorphinae* eaten by birds, 860.  
 pyri, *Lachnus*.  
*Pyrilla aberrans*, 269; *P. perpusilla*, 269; *P. pusana*, 269.  
*Pyroderes albilineella*, 150, 846; *P. callistrepta*, 846; *P. promacha*, 150, 846; *P. semicoccinea*, 150, 846.  
*Pyroderes* (*Anatrachyntis*) *falcatella* (*spodochtha*).  
*Pyrrhocoridae* as crop-pests, 262; eaten by birds, 867.  
*Pyrsonympha flagellata*, 1016\*; *P. grassii*, 1016\*; *P. vertons*, 1017\*.  
*Pyrsonymphidae*, 1017.
- Q**
- quadraria, *Thalassodes*.  
 quadrata, *Tessarotoma*.  
 quadridens, *Pachyonyx*.  
 quadridentatum, *Scleroderma*.  
 quadrifasciata, *Acrocercops*.  
 quadrilineata, *Eublemma*.  
 quadripes, *Xylotrechus*.  
 quadripunctata, "Arbela."  
 quaternalis, *Lygropia*.  
 quatuordecim-punctata, *Podontia*.
- R**
- radiata, *Phycodes*.  
 Radish flea-beetle, 319.  
*rafflesi*, *Hippotion*.  
*Ragi* ear-head worm, 323.
- Ragnus importunitas*, 267.  
 raja, *Macropes*.  
 ramakrishnae, *Arrhenothrips*.  
 ramakrishnae, *Philanthus*.  
 ramakrishnai, *Phyllocoreia*.  
*Ramila raficostalis*, 394\*.  
 ranacea, *Cyrtacanthacris*.  
*Ranatra filiformis*, 867.  
*ransonettii*, *Caprona*.  
*Raparna nebulosa*, 88.  
*Raphimetopus abutella*, 122, 385\*.  
 Rearing insects, Notes on, 875—892.  
*Recaeredus* sp., 263.  
 Records, Keeping, of, 888, 956.  
 Red-gram *Agronomyza*, 47.  
*Redoa cyanca*, 656.  
 Red Spider (see also *Tetranychus*), 32.  
*Reduviidae* eaten by birds, 867.  
 regina, *Anomala*.  
 relata, *Cosmoscarta*.  
 Relaxing Specimens, 963\*.  
*Remigia* (*Pelamija*) *frugalis*; *R. (P.) undata* (*archesia*).  
 remotata, *Craspedia*.  
 repetita, *Holotrichia*.  
 reprobata, *Meridarchis*.  
 resinophila, *Riperies*.  
 resplendens, *Acrocercops*.  
 respondens, *Heteropternis*.  
 retiaris, *Galeatus* (*Cadmitos*).  
 reticulatus, *Hemicospilus*.  
*Rhagastis albomarginatus*, 98.  
 rhienota, *Chelaria*.  
 rhinoceros, *Oryctes*.  
*Rhipiphorothrips cruentatum*, 327, 619.  
*Rhizopertha dominica*, 322, 716\*, 762.  
*Rhizotrogus rufus*, 316\*.  
*Rhodoneura myrseusalis*, 593.  
*Rhodophæa heringi*, 125.  
*Rhogas* (*Microbracon*) *lefoyi*, 1025.  
 rhombota, *Synehalara* (*Agriophara*).  
*Rhopalocampta benjamini*, 1025\*.  
*Rhopalosiphum dianthi* (*Myzus persicae*).  
*Rhopalosiphum* (*Siphocoryne*) *nymphæae*.  
 rhotia, *Spilonota*.  
*Rhynchaenus mangifera*, 202, 583, 584.  
 rhynchias, *Argyroplöce*.  
*Rhynchosoris humeralis*, 253, 573, 574, 596; *R. plagiatus*, 253.  
*Rhynchophorus ferrugineus*, 207, 576, 600.  
 Rhynchotal crop-pests, 249.  
*Rhyncolaba acteus*, 98, 333, 337.  
*Rhyssomus* sp., 864.  
*Rhytidodera robusta*, 222, 597, 599.  
*Rhytinota impolita*, 864.



- ribeana, Pandemis.  
*Ricania bicolorata*, 1031; \* *R. sp.*, 269; *R. speculum*.  
*ricini*, Alecyrodes.  
 „ *Pericallia*.  
*riparia*, Labidura.  
*Ripersia resinophila*, 290; *R. sacchari*, 290, 326, 354; *R. sacchari oryzae*, 291, 342, 353,  
*Riptortus fuscus*, 259; *R. linearis*, 259, 345, 346; *R. pedestris*, 258.  
*ritsemæ*, Deuterocopus.  
*Rivula bioculalis*, 85.  
*robusta*, Hyppsiopyla.  
 „ *Rhytidodera*.  
*robustalis*, Simplicia.  
 Root-eating Insects, Rearing of, 884.  
*ropica honesta*, 347.  
*rosæ*, Diaspis.  
*roseformis*, Macrosiphum.  
*Rose Psycid*, 139.  
 „ *Sawflies*, 33—39.  
*rossi*, Chrysomphalus.  
*rotunda*, Contheyla.  
*roylei*, *Antheræa*.  
*Rubber Platypodid*, 320\*.  
 „ *Scolytid*, 320\*.  
*rubens*, Ceroplastes.  
*ruber*, Laccotrefhes.  
*rubicundus*, Corizus.  
*rubidus*, *Tabanus*.  
*rubricans*, *Azazia*.  
*rubrofasciatus*, *Piezodorus*.  
*rubus*, *Batocera*.  
*ruficollis*, *Lytta*.  
*ruficornis*, *Aptinothrips*.  
*ruficostalis*, *Ranula*.  
*rufipes*, *Neerobia*.  
*rufipes*, *Nodiua*.  
*rufiventris*, *Anomala*.  
*rufiflava*, *Holotrichia*.  
*rufus*, *Rhizotrogus*.  
*rugicollis*, *Calandra*.  
*rugosella*, *Hapsifora (Dasyses)*.  
*rugulosus*, *Chlenius*.  
*rumicis*, *Aphis*.  
*Rutelidae*, 169.
- S
- sabulifera*, *Cosmophila*.  
*sabulosus*, *Myllocerus*.  
*saccharalis*, *Diatraea*.  
*saccharella* (*depressella*), *Emmalocera (Polycha)*.  
*sacchari*, *Aphis*.  
 „ *Heteronychus*.  
 „ *oryzae*, *Ripersia*.  
 „ *Pseudococcus*.  
 „ *Ripersia*.  
*saccharifolii*, *Pseudococcus*.  
*sacchariphagus*, *Diatraea*.  
*saccharia*, *Sterrrha*.  
*Safflower seed-fly*, 51; — shoot-fly, 51, 348;  
 — stem-fly, 51, 348.  
*sagittaria*, *Anarsia*.  
*sagmatica*, *Anarsia*.  
*Sagra femorata*, 224; *S. nigrita*, 224.  
*Saissetia depressa*, 294, 605; *S. hemisphaerica*, 294, 329, 574, 604, 632; *S. nigra*, 295, 560, 561, 606, 608, 609, 935; *S. oleæ*, 295.  
*Salix flavus*, 862.  
*Saluria inficita*, 122.  
*sanborni*, *Macrosiphum*.  
*sanguinalis*, *Kalidasa*.  
*Sapota Psychid*, 139.  
*sara*, *Amsacta*.  
*Sarangesa albiellia*, 1023\*.  
*sarasinorum*, *Stegodyphus*.  
*Sarrothripine*, *Brijjal*, 77.  
*Sathrophyllia sp.*, 574.  
*Saturnia (Caligula) simla*, 595.  
*Saturniade*, 99.  
*scabiosæ*, *Aularches*.  
*scabra*, *Attractomorpha*.  
*scabrator*, *Cœlostomera*.  
*scabriceps*, *Holcomyrmex*.  
*scalaris*, *Azygophleps*.  
*scandalota*, *Acrocercops*.  
*Scarabæide* eaten by birds, 864.  
*Scardia sistrata*, 855.  
*Scarites indus*, 863; *S. semirugosus*, 863.  
*Scavengers*, Rearing of, 880.  
*Scelio hieroglyphi*, 935; *S. oxyæ*, 935.  
*Scelodonta sp.*, 864; *S. strigicollis*, 226, 578, 585.  
*seenias*, *Acrocercops*.  
*scenica*, *Physoptila*.  
*sceptica*, *Giaura (Cletthara)*.  
*Schistocerca tatarica*, 310.  
*Schizocephalus bicornis*, 860.  
*Schizozeura (Eriosoma) lanigera*.  
*Schenobius bipunctifer*, 121, 342, 383\*, 410, 442; *S. immeritalis*, 121, *S. sp.*, 384.  
*Sciara burmitina*, 986\*.  
*scintillans*, *Euproctis*.  
*Scirpophaga auriflua (xanthogastrella)*; *S. gilviberbis*, 121, 342; *S. monostigma*, 121, 382\*; *S. sp.*, 354; *S. santhogastrella*, 120, 381\*.

- Scirtothrips dorsalis, 619.  
 scitula, Eublemma.  
 sciurus, Tanymercus.  
 Scleroderma quadridentatum, 986\*.  
 Scolytidae, 184.  
 scopulosa, Chelaria.  
 scotias, Gibbium.  
 scothepepla, Manatha.  
 scriptulata, Acrocerops.  
 Scutellera nobilis, 250.  
 Scutellista cyanea, 935.  
 Scyannus nubilans, 553; S. sp., 863.  
 scyroides, Meridarchis.  
 Seythrididae, 850, 1005.  
 seclusella, Hapsifera.  
 secta (dimidialis), Eublemma.  
 Sectional Meetings of Board of Agriculture, 5.  
 securis, Dasycheira.  
 segetum, Euxoa.  
 Selea plagiola, 334, 340.  
 Selenampha (punctum), Amaryna.  
 Selanaspidus (Aspidiotus).  
 selene, Actias.  
 Selenocephalus virescens, 442.  
 selenopa, Phyllocnistis.  
 Selepa (*Plathea*) costis, 564, 582, 584, 585.  
 semantris, Promalactis.  
 semialbana, Tortrix.  
 semicoccinea, Pyroderces (*Cosmopteryx*?).  
 semicostatum, Colasposoma.  
 semiculta, Argyroproctea.  
 semirubella, Nephopteryx.  
 semirugosus, Scarites.  
 semisignata, Euproctis.  
 sena, Bibasis.  
 sepositella, Pseudodoxia.  
 seriata, Parnara.  
 seriatorporus, Hopatroides.  
 Serica assamensis, 166; S. calcutta, 166;  
 S. clypeata, 166, 571; S. maculosa, 166,  
 571; S. marginella, 166, 571; S. nilgiriensis,  
 166, 1028; S. pilula, 166; S. pruinosa, 166.  
 sericeipennis, Oxyambulyx.  
 Serinetha abdominalis, 259; S. angur, 259.  
 serinopa, Nephantis.  
 serraticornis, Acanthophorus.  
 serricorne, Lasioderma.  
 servus, Graptostethus.  
 sesami, Asphondylia.  
 .. Oberca.  
 Sesamia inferens, 72, 342, 375\*, 410; S.  
 nonagrioides, (vutera), 72; S. uniformis,  
 72, 377\*; S. vutera, 72.  
 Sesarma edwardsi, 692.  
 setiventris, Physothrips.  
 Setomorpha insectella, 856.  
 Setting insects, 956\*.  
 setalifer, Myllocerus.  
 sexmaculata, Chilomenes.  
 sexpunctalis, Talanga.  
 seychellarum, Icerya.  
 Shellac, Production of in India, 784.  
 .. Shingling "specimens, 951\*.  
 siamica, Caprona.  
 siccifolia, Cyclopelta.  
 siderota, Peronea.  
 signata, Monolepta.  
 .. Pagria.  
 .. Plusia.  
 signifera, Lithacodia (*Hycleopsis*).  
 signiferum, Lecanium.  
 silhetana, Terias.  
 silicula, Eublemma.  
 Silkworms, 800, 808, 809, 835, 836.  
 Silphide eaten by birds, 863.  
 Silvanus advena, 324.  
 silvatia, Batrachedra.  
 Simaethis aegyptica, 849;  
 S. ophiocoma, 849; S. orthogona, 849.  
 simbleuta, Ptochoryctis.  
 simla, Saturnia (Caligula).  
 simplex, Chilo.  
 .. Nisaga.  
 simplicia, Pandaluoya.  
 .. robustalis, 88.  
 sinensis, Thosca.  
 singhara, Galerucella.  
 Siphocoryne indobrassicæ, 280; S. nymphaeæ,  
 281; S. padi, 281.  
 Siphonaphis (Siphocoryne) padi.  
 (*Siphonophora*) Macrosiphum pist.  
 sirina, Petasobathra.  
 sistrata, Scardia.  
 Sitones cernitus, 193.  
 Sitotroga cerealella, 343, 720\*, 762, 843.  
 siva, Taragama.  
 sjöstedti, Platymyeterus.  
 "Sleeving" plants, 876.  
 smaragdina, Ecophylla.  
 Smoking out insects, 944.  
 Snails, 694.  
 Society, Proposed Indian Entomological, 7-9.  
 socotranus, Deuterocoelus.  
 Sogata distincta, 270; S. pallescens, 271; S.  
 pusana, 270.  
 Solenopsis geminata, 34, 343, 576.  
 somnulentella, Bedellia.  
 sonchi, Macrosiphum.  
 sordidus, Aphanus.  
 sordidus, Cosmopolites.

- sorghii* (maidis), *Aphis*.  
*Soritia leptalina*, 140, 565.  
*soyella*, *Gracillaria*.  
*Spalangia*-sp., 628.  
*Spalpis epius*, 333, 613, 617.  
*sparsus*, *Dereodius*.  
*Spathosternum prasiniferum*, 309  
*spathota*, *Chelaria*.  
*spectra*, *Tettigoniella*.  
*speculum*, *Ricania*.  
 Spelling of place-names, 959.  
*speratus*, *Leucotermes*.  
*spermologa*, *Blastobasis*.  
*Spermophagus* sp., 864.  
*Sphærodema annulatum*, 867.  
*Sphenarches caffer*, 136, 336, 338, 340, 344,  
 346, 351, 838.  
*sphenarioides*, *Colemania*.  
*sphenograpta*, *Leucoptera*.  
*Sphenoptera arachidis*, 245; *S. gossypii*, 244.  
*Sphenoptera* sp., 934.  
*Sphingidæ*, 95.  
*Spialia galba*, 114, 333, 339.  
 Spiders attacking caterpillars, 898.  
 Spider's webs, Insects living in, 941.  
*Spilonota rhotbia*, 144, 580, 582, 841.  
*Spilophorus cretosus*, 180.  
*spinator*, *Cuclosterna*.  
*spinicornis*, *Hoplocerambyx*.  
*spinidens*, *Andrallus*.  
*spinifera*, *Euxoa*.  
*spiniferus*, *Aleurocanthus*.  
*spinigera*, *Paratelpusa*.  
*spodochtha* (falcateella), *Anatrachyntis* (*Pyro-  
 deres*).  
*Spodoptera abyssinica*, 69; *S. mauritia*, 69,  
 341; *S. pecten*, 68.  
*spoliatrix*, *Odites*.  
*squalida*, *Celama*.  
*squalida*, *Epicometis*.  
*squalidus*, *Dacus* (see *Chaetodacus zonatus*).  
*squamosus*, *Hypomeces*.  
 Staging small specimens, 951\*.  
*Staphylinidæ* eaten by birds, 863.  
*Stathmopoda adalatrix*, 849; *S. basiplectra*,  
 848; *S. hemitorna*, 848; *S. ovigera*, 848;  
*S. prealbata*, 848; *S. sycastis*, 158, 577,  
 848; *S. sycophaga*, 848; *S. theoris*, 158,  
 848.  
*Stauroderus bicolor*, 305.  
*stauropi*, *Apanteles*.  
*Stauropus alternus*, 101, 333, 339, 595.  
*stebbingi octocaudatus*, *Monophlebus*.  
*Steganodactyla concursa*, 336, 341, 840.  
*Stegasta variana*, 844!  
*Stegodyphus sarasinorum*, 331.  
*stellifera*, *Vinsonia*.  
*Stenachroia elongella*, 117, 343.  
*Stenoma ichnæa*, 848.  
*Stenomidæ*, 157, 848, 1004.  
*Stenoplenga* sp., 933.  
*Stenoptilia zophodactyla*, 839.  
*Stephanitis* sp., 263; *S. typicus*, 263, 592.  
*Stephanouympha*, 1019\*.  
*Stephensonia lahorensis*, 280.  
*stereoma*, *Eucosma*.  
*Sterria sacaria*, 102.  
*stevensi*, *Aulacophora*.  
*Sthenias grisator*, 217, 579, 589.  
*Stictaspis ceratitina*, 45, 371\*; *S. striata*, 45.  
*sticticus*, *Eretes*.  
*stigmaticollis*, *Calandra*.  
*stillata*, *Anatona*.  
*stolalis*, *Margarotia* (*Glyphodes*).  
*stolida*, *Grammodes*.  
*Stomatocerus sulcatiscutellum*, 935.  
*Stomopteryx nerteria*, 152, 844.  
*Stomphastis plectica*, 853.  
 Storage of specimens, 967.  
 Store-boxes, 950, 965.  
*strabo*, *Chaetochrysops*.  
*stramineum*, *Megacælum*.  
*Stratiomyidæ* eaten by birds, 866.  
 Streams, Insects in, 940.  
*striata*, *Clivina*.  
*striata*, *Stictaspis*.  
*striatalis* (venosata), *Diatræa*.  
*strigicollis*, *Scelodonta*.  
*Strobisia amethystias*, 845.  
*Stromatium barbatum*, 221, 574.  
*studiosa*, *Epitheetis*.  
*Stylopyga orientalis*, 20.  
*Stylotermes fletcheri*, 314, 587.  
*styx*, *Acherontia*.  
*Suana concolor*, 333, 339.  
*Suastus gremius*, 115, 575, 1023\*; *S. minuta*,  
 1023\*.  
*subæneus*, *Brachyplatys*.  
*subcostatum*, *Nodostoma*.  
*subfasciata*, *Euproctis*.  
*subfasciatus*, *Myllocerus*.  
*subnuda*, *Cremastogaster*.  
*subteralbata*, *Acanthopsyche*.  
*subtilis*, *Carea*.  
*succincta*, *Orthacanthacris*.  
 Sucking Insects, Rearing of, 885.  
*suffusa* (montana), *Diacrisia*.  
 Sugaring, 942.  
*sulcatiscutellum*, *Stomatocerus*.  
*supercliviosus*, *Xanthotrachelus*.

- supplex, *Aceroceroops*.  
 suppressaria, *Biston*.  
 surmia, *Amphipyra*.  
 swinhoi, *Protolenus*.  
   .. *Trichomyia*.  
   .. *Termopsis*.  
 syncastis, *Stathmopoda*.  
 sycophaga, *Stathmopoda*.  
*Sylepta derogata*, 129, 336, 339, 351, 453, 562;  
   *S. lunalis*, 130, 323.  
*Symitha nolalella*, 76.  
*Sympiezomias cretaceus*, 189, 319, 589; *S.*  
*decepiens*, 189, 319; *S. frater*, 189, 319.  
*Synchalara rhombota*, 157, 848.  
*Syngamia abruptalis*, 763.  
 synglypta, *Phyllocnistis*.  
 syngramma, *Aceroceroops*.  
*Syntomis* (*Amatidae*).  
*Syntomis* (*Amata*).  
*Syntomosphyrum indicum*, 628.  
*syringa*, *Argina*.
- T**
- Tabanidae*, eaten by birds, 866.  
*Tabanus rubidus*, 866.  
*Tachardia lacca*, 604, 799.  
*tachardiae*, *Apanteles*.  
   .. *Chalcis*.  
   .. *Ectadiophtanus*.  
*Tachinidae* eaten by birds, 866.  
*Teniothrips major*, 691.  
*Tagiades atticus*, 1023\*; *T. distans*, 1023\*.  
*talaca*, *Hyposidra*.  
*Talanga sexpunctalis*, 576.  
*tamariciella*, *Gelechia*.  
*tamaricis*, *Agdistis*.  
*tamarindi*, *Aspidiosus*.  
*tamarindus*, *Monophlebus*.  
*tamulus*, *Aiolopus* (*Eolopus*).  
*Tanyneucus hispidus*, 186, 570; *T. indicus*,  
   187; *T. princeps*, 186; *T. sciurus*, 186.  
*Tanyneucus* spp. eaten by birds, 864.  
*Tapena thwaitesi*, 1023\*.  
*taprobana*, *Ergolis*.  
*taprobancusis*, *Cappaea*.  
*taprobanes*, *Platyptilia*.  
*Tarache crocata*, 75, 562; *T. marmoralis*, 75;  
   *T. nitidula*, 75; *T. notabilis*, 75; *T. opali-*  
   *noides*, 75.  
*Taragama siva*, 102, 569, 933.  
*tarandus*, *Oxyrhachis*.
- Tarucus theopastus*, 113, 569.  
*tatarica*, *Schistocera*.  
 Tea borer in *Formosa*, 668  
 Tea Mosquito (see *Helopeltis theivora*).  
   .. Pests in South India, 330.  
   .. Red Spider (see *Tetranychus bioculatus*).  
   .. Tortricid (see *Homona coffearia*).  
 Teak leaf-gall, 324.  
*Telchinia viola*, 107, 332, 340.  
*Telenomus indi*, 912, 935.  
*telestis*, *Aceroceroops*.  
*Telicota angias*, 116, 1024\*; *T. hambusse*, 342,  
   1024\*.  
*Telphusa melanozona*, 843.  
*Tenebrionidae* as crop-pests, 242; eaten by  
   birds, 864.  
*Tenebroides mauritanicus*, 718\*.  
*tenebrosus*, *Psylliodes*.  
*tenera*, *Aceroceroops*.  
*Tenthredinidae*, 37—39.  
*tenuicollis*, *Lytta*.  
*tenipennis*, *Haplotrips*.  
*teniscapa*, *Xylocopa*.  
*terasella*, *Tonica*.  
*Terastia egialealis*, 133; *T. meticulosalis*, 133,  
   336, 339.  
*Teratodes monticollis*, 310, 579, 860.  
*Terias hecabe*, 110, 332, 339; *T. silhetana*,  
   111.  
*terminalia*, *Lithocolletis*.  
*Termites*, 27, 32.  
   .. nests, *Insects* in, 941.  
   .. *Trichonymphid* parasites of, 1009.  
*Termitidae*, 313, 343, 345, 347, 354, 356—359,  
   587, 588, 705—712; eaten by birds, 861;  
   rearing of —, 887\*.  
*termitis*, *Balanitidum*.  
   .. *Franciella*.  
   .. *Nyctotherus*.  
   .. *Opalina*.  
   .. *Treponema*.  
*Termopsis swinhoi*, 897\*.  
*Tessarotoma quadraria*, 255.  
*testaceum* (*serricornis*) *Lasioderma*.  
*testulalis*, *Maruca*.  
*Tetranychus bioculatus*, 26, 29, 612, 668.  
*tetraonis*, "Arbela."  
*Tetrastichus ophiuse*, 932.  
*Tetriginæ*, eaten by birds, 860.  
*Tetroda histeroides*, 256.  
*Tettigid*, 304.  
*Tettigoniella ferruginea*, 597, 634; *T. spectra*,  
   274, 342, 442.  
*Thalassodes quadraria*, 102, 584; *T. veraria*,  
   102, 336, 340, 582.

- Thalera caudularia*, 335, 340.  
*Thea cincta*, 612, 863.  
*thea*, *Empoasca*.  
*these*, *Chionaspis*.  
*theæ*, *Chionaspis prunicola* (manni).  
 ,, *Fiorinia*.  
 ,, *Hemichionaspis*.  
 ,, *Oscinis*.  
*theacola*, *Ceylonia* (*Toxoptera aurantii*).  
*theacola*, *Pseudococcus*.  
*theclata*, *Dirades*.  
*theivora*, "Arbela."  
 ,, *Gracillaria*.  
 ,, *Helopeltis*.  
 ,, *Mahasena*.  
*theobromæ*, *Bruchus*.  
 ,, *Caduceia*.  
*theophrastus*, *Tarucus*.  
*theoris*, *Stathmopoda*.  
*Theretra* *alecto*, 97, 579, 596; *T. gnoma*, 97, 579, 596; *T. oldenlandiæ*, 98, 596; *T. pallicosta*, 98, 579.  
*Theretra* (*Rhyncolaba*) (*acteus*) *actæa*.  
*theristis*, *Pammene*.  
*theylia*, *Chærocampa*.  
*Thiacidas postica*, 89, 569.  
*Tholymis tillarga*, 896.  
*Thomsoniella albomaculata*, 442.  
*Thosea cana*, 333, 340; *T. castanea*, 657; *T. cervina*, 330; *T. sineasis*, 657.  
*Thrips*, 27; control of, 620, 621.  
 ,, *oryzæ*, 327, 619.  
 ,, spp., 343, 344.  
*thwaitesi*, *Tapena*.  
*thwaitesii*, *Aristeis*.  
*thyrsis*, *Gangara*.  
*Thyrsostoma glaucitis*, 844.  
*Thysanoptera*, 304, 327, 618—622.  
*Ticks*, eaten by birds, 867.  
*Tinda indica*, 593.  
*Tineidae*, 165, 855, 1007.  
*tineoides*, *Myrmecozela*.  
*Tineola bisselliella*, 856.  
*Tingidide* as crop-pests, 263.  
*Tingis hystericellus*, 264.  
*Til Root Fly*, 46.  
*tillarga*, *Tholymis*.  
*Tinea frugivora*, 856; *T. fuscipunctella*, 856; *T. opsigona*, 856; *T. pachyspila*, 856; *T. pellionella*, 856.  
*Tipulide*, 51; eaten by fish, 908.  
*Tiracola plagiata*, 64, 567, 665.  
*Tirathaba* sp., 118, 575.  
*Tischeria ptarmica*, 165, 569, 855.  
*Tischeriade*, 165.  
*tissa*, *Coladenia*.  
*tomentosa*, *Eurybrachys*.  
*Tonica barrowi*, 847; *T. niviferana*, 156, 847; *T. terasella*, 847; *T. zizyphi*, 156, 572, 847.  
*tonsoria*, *Argyroplöce*.  
*toparcha*, *Phyllocnistis*.  
*torodelta*, *Laspeyresia*.  
*Tortricid* boring apple fruits, 148.  
*Tortricide*, 143, 336, 840, 1002.  
*Tortrix dumetana*, 841; *T. semialbana*, 841.  
*Toxoptera aurantii*, 281, 574; *T. citrifolia*, 631; *T. graminum*, 281; *T. punjabipyri*, 281.  
*Trabala vishnu*, 103, 564, 580, 598, 933.  
*Trachylepidia fructicassella*, 117.  
*Trachys bicolor*, 246, 317\*; *T. sp.*, 246.  
*tranquebaricus*, *Apoderus*.  
*transcripta*, *Blastobasis*.  
*transmarinus*, *Myloccerus*.  
*Transmission of Specimens*, 971.  
*transversa*, *Acontia*.  
*transversa*, *Anomala*.  
*transversa*, *Chlumetia*.<sup>7</sup>  
*transversus*, *Gastrimargus*.  
*Treponema termitis*, 1019.  
*trapezalis*, *Marasmia*.  
*triaema*, *Idioglossa*.  
*triangularis*, *Phytosephus*.  
*triarcha*, *Lithocolletis*.  
*Tribolium castaneum*, 717\*, 762, 763.  
*tricentra*, *Laspeyresia*.  
*trichocrossa* (*critica*), *Eucosma* (*Laspeyresia*).  
*Trichomyia swinhoei*, 986\*.  
*Trichonympha agilis*, 1011—1014, 1018, 1019\*.  
*trichonympharum*, *Enchelyspheroides*.  
*Trichonymphid* parasites of Termites, 10, 1009.  
*Trichophaga abruptella*, 856.  
*Trichotaphæ geochrota*, 845.  
*tricyma*, *Acroceroops*.  
*Tridactylinae* eaten by birds, 860.  
*trifasciatus*, *Haplosonyx*.  
*trifenestrata*, *Cricula*.  
*trifolii*, *Callipterus*.  
*triglandulosus*, *Chrysomphalus*.  
*Trigonalys pervetus*, 986\*.  
*Trigonodes* (*Chalciope*) *hyppasia*.  
*trigrapha*, *Ulodemis*.  
*trilineata*, *Pilemostoma*.  
*trilobitiformis*, *Pseudanoidia*.  
*trima*, *Orthocraspeda*.  
*tripunctatus*, *Cybister*.  
*triscalma*, *Acroceroops*.  
*tristis*, *Hodotermes*.  
*trochala*, *Procometis*.

trochilus putli, Chilades.  
 Trogoderma khapra, 717\*, 752, 759.  
 Trombidium grandissimum, 867.  
 Trox sp., 864.  
 truculenta, Bactra.  
 Trypaneidae, 40.  
 Trypetidae eaten by birds, 866.  
 Tryxalinæ eaten by birds, 860.  
 tuberculata, Oncocephala.  
 tuberculatus, Chætodacus.  
 Tuberdryobius persicæ, 285.  
 tubmidicostalis, Argyria.  
 Tumidicoxoides jambulana, 933.  
 Tumidiscapus oöphagus, 935.  
 turrita, Aerida.  
 Tylopholis ballardi, 189, 322.  
 Tylotropidius varicornis, 311.  
 typicus, Stephanitis.

## U

Udaspes folus, 115.  
 Ulodemis trigrapha, 480.  
 uncinatus, Epepeotes.  
 undalis, Hellula.  
 undecim-pustulatus, Myllocerus.  
 undularis, Elymnias.  
 unipuncta, Cirphis.  
 Urentius echinus, 263, 350.  
 usitatus, Physothrips.  
 ustulatella, Acroceroeps.  
 Utetheisa pulchella, 60, 563.

## V

valida, Clettbara.  
 vahlhi, Brachyplatys.  
 Vanessa antiopa, 937.  
 vanula, Acroceroeps.  
 variabilis, Hypera.  
 variana, Stegasta.  
 varians, Euproctis.  
 „ Ocina.  
 varicolor, Anomala.  
 varicornis, Leptocorisa.  
 „ Tylotropidius.  
 varicosa, Chionaspis.  
 variegata, Clania.  
 Varuna litterata, 690.  
 variivestis, Anomala.  
 vaughani, Xyrophtila.  
 vegeta, Cretonia.  
 velox, Oxya

velutina, Natada.  
 venalba, Borolia.  
 venosata, Diatrea.  
 veniliialis, Marasmia.  
 ventralis, Eusarcocoris.  
 venusta, Gædematopoda.  
 veraria, Thalassodes.  
 verax, Bucculatrix.  
 versicolor, Callitettix.  
 „ Chætodacus.  
 „ Oxyctonia.  
 versteeqi, Monohammus.  
 versutus, Adoretus.  
 vertens, Pyrsonympha.  
 vertumnalis, Margaronia (Glyphodes).  
 veruta, Anarsia.  
 Vespa basalis, 36; V. orientalis, 780.  
 Vespidae, 36.  
 vesuviana, Carpomyia.  
 viator, Gryllus.  
 vigescens, Ancyliis.  
 vigintiocto-punctata, Epilachna.  
 vineata, Antithyra.  
 Vinsonia stellifera, 292, 588, 603, 607.  
 violæ, Telechinia.  
 Virachola isocrates, 113, 565, 573, 580, 581,  
 593, 594, 595.  
 virescens, Heterusia.  
 „ Selenocephalus.  
 virgatus, Pseudococcus.  
 virgulata, Lithocolletis.  
 viridanus, Myllocerus.  
 viridis, Coccus (*Lecanium*).  
 viridula, Nezara.  
 visenda, Agathia.  
 vishnu, Trabala.  
 Vitellus orientalis, 253, 325\*, 573  
 vitis, Chionaspis.  
 vitrea, Psyche.  
 vittata, Phyllotreta.  
 vittatus, Baracus.  
 vulgaris, Nacoleia (Lamprosema indicata).  
 vuteria, Sesamia.

## W

wahlbergi, Buckleria.  
 Walkeriana cinerea, 287; W. sp., 287.  
 Wallacea sp., 236, 576.  
 War, Effects of, 10, 13.  
 Wasps as enemies of bees, 780  
 Wax Moth, 780, 782.  
 Websteriella (see Parlatoria).  
 Weeds in India, 679.  
 Weevil cane-borers, 372\*, 373\*.

westwoodi, Hierodula.  
 Wet specimens, Preservation of, 954, 970.  
 White Flies (see Aleyrodidae).  
 wickhami, Eurygenis.  
 Winnertziola burmitica, 986\*.  
 Wood-borers, Breeding Cage for, 892\*;  
 Collecting —, 940.  
 Woodhouse, E. J., 6—7.  
 Worms, 694

## X

xanthogastrella, Scirpophaga.  
 Xanthopimpla immaculata, 933; X. pedator,  
 933; X. sp., 933.  
 xanthorrhœa, Porthesia.  
 Xanthotrachelus fannus, 194, 569; X. per-  
 latus, 194; X. superciliosus, 195, 569.  
 xerodes, Buckleria.  
 xerophaga, Brachmia.  
 Xyleborus fornicatus, 184, 322\*; X. sp., 184.  
 Xylocopa tenniscapa, 316.  
 Xyloryctidae, 157, 847, 1004.  
 Xylotrechus quadripes, 15, 223, 330.  
 Xylotrupes gideon, 181.  
 Xyryptila vaughani, 839.  
 Xystrocera globosa, 221.

## Y

yama, Amphipyra.  
 ypsilon, Agrotis.

## Z

zachrysa, Gracillaria.  
 Zalithia diluticornis, 844.  
 Zamilia (Pyrilla).  
 zebrina, Erechthias.  
 zelota, Eucosma.  
 zenzeroides, Langia.  
 Zenzera coffea, 140, 563, 599, 646.  
 Zeuzerid cane-borers, 373\*, 374\*, 416.  
 Zenzeridae, 140.  
 zeylanica, Gymnonympba.  
 zinckenella, Etiella.  
 Zizera gaika, 678; Z. lysimon, 111.  
 zizyphi, Tonicia.  
 zizyphus, Parlatoria.  
 Zonabris cichorii, 345; Z. phalcrata, 240;  
 Z. pastulata, 240, 344, 345, 346.  
 zonatus, Chætodæus.  
 zophodactyla, Stenoptilia.  
 Zygenidae, 139.  
 Zyxomma petiolatum, 896.

CALCUTTA  
SUPERINTENDENT GOVERNMENT PRINTING, INDIA  
8, HASTINGS STREET







