

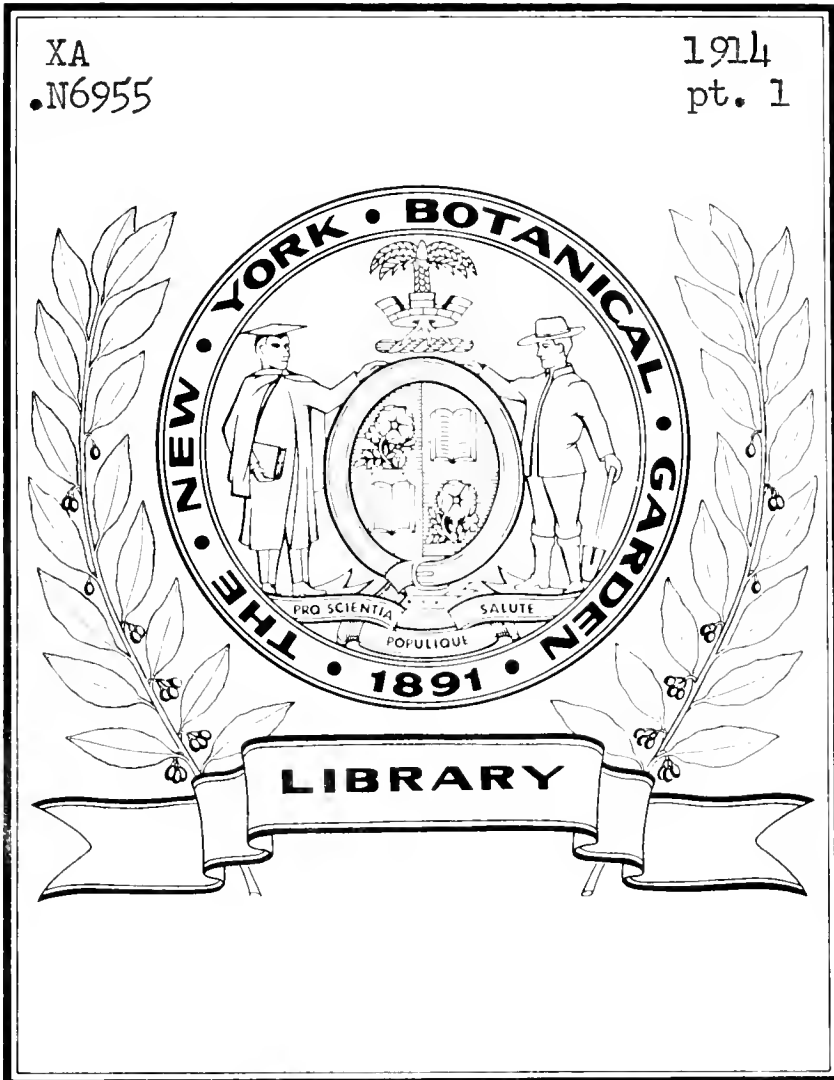

XA
•N6955

1914
pt. 1



EXPERIMENTAL FARMS

REPORTS FROM THE
DIRECTOR
DIVISION OF CHEMISTRY
DIVISION OF FIELD HUSBANDRY
DIVISION OF ANIMAL HUSBANDRY

FOR THE YEAR ENDING MARCH 31, 1914.

PRINTED BY ORDER OF PARLIAMENT.



OTTAWA
PRINTED BY J. DE L. TACHÉ, PRINTER TO THE KING'S MOST
EXCELLENT MAJESTY

1915

XA
N6955
1914
pt. 1

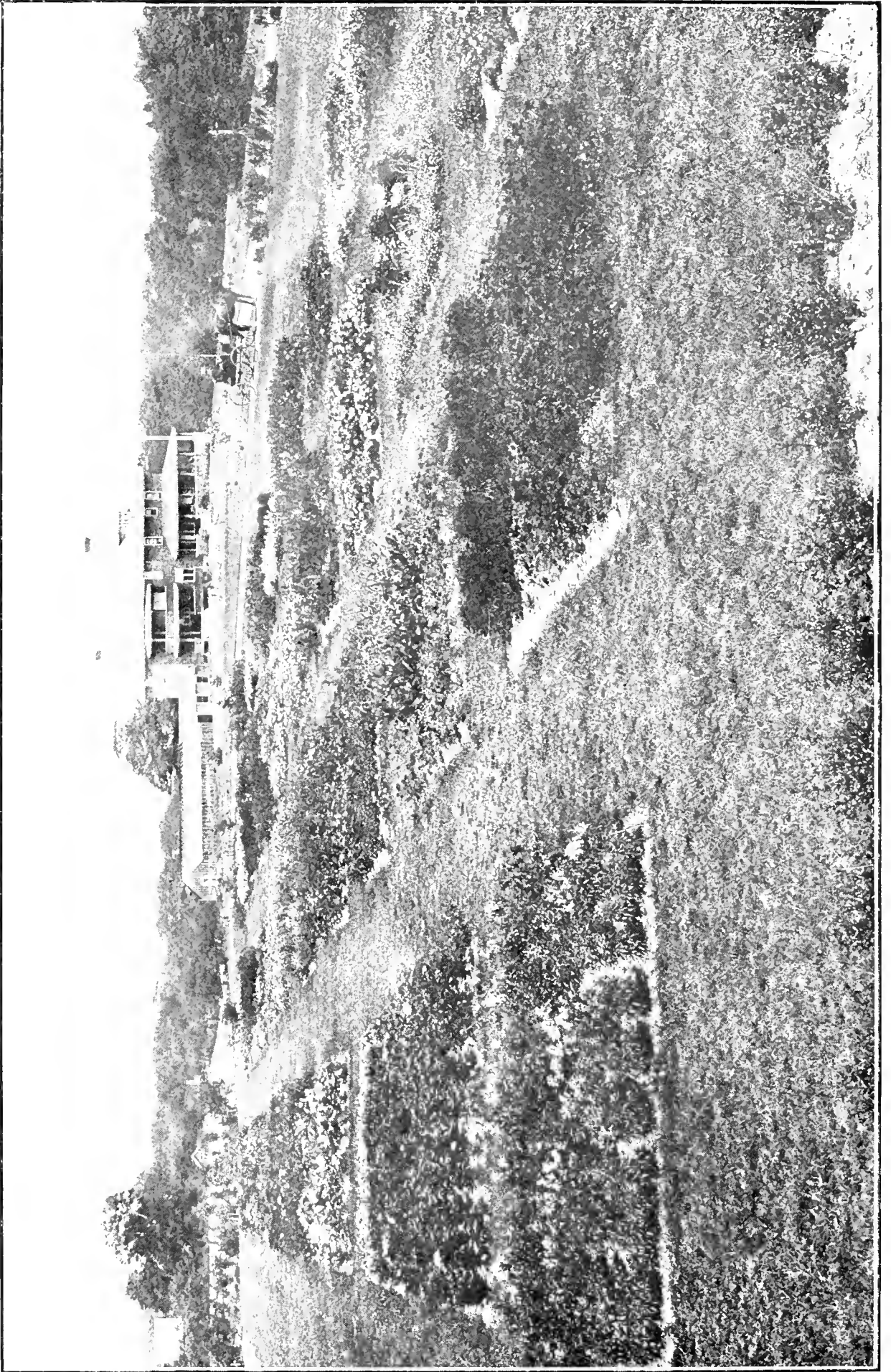

Flower Garden and Superintendent's House, Kentville, N.S.

APPENDIX TO THE REPORT OF THE MINISTER OF AGRICULTURE

EXPERIMENTAL FARMS

REPORTS FROM THE
DIRECTOR
DIVISION OF CHEMISTRY
DIVISION OF FIELD HUSBANDRY
DIVISION OF ANIMAL HUSBANDRY

FOR THE YEAR ENDING MARCH 31, 1914.

PRINTED BY ORDER OF PARLIAMENT.

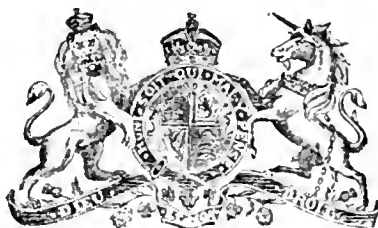

OTTAWA

PRINTED BY J. DE L. TACHÉ, PRINTER TO THE KING'S MOST
EXCELLENT MAJESTY

1915

A P P E N D I X

TO THE

REPORT OF THE MINISTER OF AGRICULTURE

ON

EXPERIMENTAL FARMS

OTTAWA, March 31, 1914.

SIR, I have the honour to submit herewith, for your approval, the twenty-seventh annual report of the work carried on at the several Dominion Experimental Farms and Stations.

Following the plan put into operation last year, the present report is divided into two sections, the first containing my report as Director and giving a summary of the year's results in the various Divisions on the Central Experimental Farm and on the branch Experimental Farms, Stations, and Substations. For the preparation of these Divisional and Branch Farm notes, I am indebted to the chief officers of the Divisions here and the Superintendents of the Branches.

Section B contains detailed reports on the various lines of experimental work under way throughout the Dominion Experimental Farms system during the year. These have been prepared by the Dominion officers having supervision of such work on the Central and branch Farms, in collaboration with the Superintendents of the latter.

These detailed reports fall under the heads of Animal Husbandry, Agrostology, Botany, Cereal Breeding and Variety Testing, Chemistry, Entomology, Field Husbandry, Horticulture (including Vegetable Gardening and Flowers), Poultry Husbandry, and Tobacco Husbandry.

Section A, which provides a concise, yet comprehensive, account of the work, is designed especially for those desirous of obtaining general information as to what is being done on the Experimental Farms system.

Section B is intended more immediately to aid the farmer in the various details of his work.

5 GEORGE V., A. 1915

The favour with which this arrangement of the matter contained in the annual report has been received would seem to indicate that it presents the data of the year's operations in a much more acceptable and convenient form than that previously followed.

I have the honour to be, sir,

Your obedient servant.

J. H. GRISDALE,

Director, Dominion Experimental Farms.

To the Honourable
The Minister of Agriculture,
Ottawa.

CONTENTS

VOLUME I

SECTION A.

	Pages.
DIRECTOR'S REPORT—J. H. GRISDALE, B. Agr.	
Including general notes, and synopses of the work of the various Divisions, Branch Farms, Stations and Sub-stations.	1-83

SECTION B.

Prepared by

CHEMISTRY, Report from—		
Ottawa, Ont.	Frank T. Shutt, M.A.	85-135
FIELD HUSBANDRY, Report from—		
Ottawa, Ont.	O. C. White, B.S.A.	141-163
Charlottetown, P.E.I.	J. A. Clark, B.S.A.	164-173
Nappan, N.S.	W. W. Baird, B.S.A.	174-178
Kentville, N.S.	W. Saxby Blair.	179-181
Fredericton, N.B.	W. W. Hubbard.	182-184
Ste. Anne de la Pocatière, Que.	Jos. Begin.	185-187
Cap Rouge, Que.	Gus. A. Langelier	188-198
Brandon, Man.	W. C. McKillican, B.S.A.	199-225
Indian Head, Sask.	T. J. Harrison, B.S.A.	226-247
Rosthern, Sask.	Wm. A. Munro, B.A., B.S.A.	248-257
Scott, Sask.	R. E. Everest, B.S.A.	258-267
Lethbridge, Alta.	W. H. Fairfield, M.S.	268-282
Lacombe, Alta.	G. H. Hutton, B.S.A.	283-289
Agassiz, B.C.	P. H. Moore, B.S.A.	290-292

ANIMAL HUSBANDRY—

(1.) Beef Cattle, Report from—

Ottawa, Ont.	E. S. Archibald, B.A., B.S.A.	297
Charlottetown, P.E.I.	J. A. Clark, B.S.A.	298-300
Nappan, N.S.	W. W. Baird, B.S.A.	301-307
Kentville, N.S.	W. Saxby Blair.	308-310
Fredericton, N.B.	W. W. Hubbard.	311
Brandon, Man.	W. C. McKillican, B.S.A.	312-314
Indian Head, Sask.	T. J. Harrison, B.S.A.	315-318
Scott, Sask.	R. E. Everest, B.S.A.	319
Rosthern, Sask.	Wm. A. Munro, B.A., B.S.A.	320-323
Lacombe, Alta.	G. H. Hutton, B.S.A.	324-326
Lethbridge, Alta.	W. H. Fairfield, M.S.	327-328

(2.) Dairy Cattle and Dairying, Report from—

Ottawa, Ont.	E. S. Archibald, B.A., B.S.A.	329-359
Charlottetown, P.E.I.	J. A. Clark, B.S.A.	360
Nappan, N.S.	W. W. Baird, B.S.A.	361-364
Kentville, N.S.	W. Saxby Blair.	365
Fredericton, N.B.	W. W. Hubbard.	366-368
Cap Rouge, Que.	Gus. A. Langelier.	369-374
Ste. Anne de la Pocatière, Que.	Jos. Begin.	375-379
Brandon, Man.	W. C. McKillican, B.S.A.	380-382
Indian Head, Sask.	T. J. Harrison, B.S.A.	383
Lacombe, Alta.	G. H. Hutton, B.S.A.	384-386
Agassiz, B.C.	P. H. Moore, B.S.A.	387-399

(3.) Horses, Report from—

Ottawa, Ont.	E. S. Archibald, B.A., B.S.A.	400-403
Charlottetown, P.E.I.	J. A. Clark, B.S.A.	404
Nappan, N.S.	W. W. Baird, B.S.A.	405
Kentville, N.S.	W. Saxby Blair.	406
Fredericton, N.B.	W. W. Hubbard.	407-409
Cap Rouge, Que.	Gus. A. Langelier.	410-412
Ste. Anne de la Pocatière, Que.	Jos. Begin.	413-414
Brandon, Man.	W. C. McKillican, B.S.A.	415
Indian Head, Sask.	T. J. Harrison, B.S.A.	416-418
Scott, Sask.	R. E. Everest, B.S.A.	419
Lacombe, Alta.	G. H. Hutton, B.S.A.	420
Agassiz, B.C.	P. H. Moore, B.S.A.	421

(4.) Sheep, Report from—

Ottawa, Ont.	E. S. Archibald, B.A., B.S.A.	422-425
Charlottetown, P.E.I.	J. A. Clark, B.S.A.	426-428
Nappan, N.S.	W. W. Baird, B.S.A.	429-432
Cap Rouge, Que.	Gus. A. Langelier.	433
Brandon, Man.	W. C. McKillican, B.S.A.	434-435
Indian Head, Sask.	T. J. Harrison, B.S.A.	436-437
Lacombe, Alta.	G. H. Hutton, B.S.A.	438
Lethbridge, Alta.	W. H. Fairfield, M.S.	439-441
Agassiz, B.C.	P. H. Moore, B.S.A.	442

(5.) Swine, Report from—

Ottawa, Ont.	E. S. Archibald, B.A., B.S.A.	443-446
Nappan, N.S.	W. W. Baird, B.S.A.	447-448
Cap Rouge, Que.	Gus. A. Langelier.	449
Ste. Anne de la Pocatière, Que.	Jos. Begin	450
Brandon, Man.	W. C. McKillican, B.S.A.	451-456
Indian Head, Sask.	T. J. Harrison, B.S.A.	457
Lacombe, Alta.	G. H. Hutton, B.S.A.	458
Agassiz, B.C.	P. H. Moore, B.S.A.	459-475

NOTE.—In Volume II will be found the Reports from the Divisions of Horticulture, Cereals, Botany, Entomology, Forage Plants, Poultry and Tobacco.

ANNUAL REPORT OF THE EXPERIMENTAL FARMS

FOR THE YEAR ENDING MARCH 31, 1914.

REPORT OF THE DIRECTOR

J. H. GRISDALE, B.Agr.

CROP RETURNS AND LIVE STOCK CONDITIONS IN 1913.

The following tables may prove of interest, as showing the average and total yields of the main field crops of the Dominion for the years 1912 and 1913, and the average yields and prices received therefor. In table II the average yields and prices for the above years are compared for the eastern provinces, the prairie provinces and British Columbia.

In table III, the numbers of the various classes of live stock are given for the five years 1909-1913, the Dominion being again divided for this purpose into the eastern, prairie and western sections.

A total estimated area under field crops of 35,375,000 acres produced returns valued at \$552,771,500 as compared with 35,750,000 acres under field crops in 1912 with a total yield valued at \$556,344,100.

The tables and other data given in this connection are compiled from figures given by the Census and Statistics Monthly, issued by the Department of Trade and Commerce.

TABLE I.—COMPARISON of Yields and Prices obtained for the years 1912 and 1913.

Crop.	Average Yield per acre.		Average Price per Bush.		Total Production.	
	1912	1913	1912	1913	1912	1913
	bush.	bush.	\$	\$		
Fall wheat.....	20.99	23.29	.84	.80	20,387,000	22,592,000
Spring wheat.....	20.32	20.81	.60	.66	203,772,000	209,125,000
All wheat.....	20.38	21.04	.62	.67	224,159,000	231,717,000
Oats.....	39.29	38.78	.32	.32	391,629,000	404,669,000
Barley.....	31.24	29.96	.45	.42	49,398,000	48,319,000
Rye.....	19.11	19.28	.72	.66	2,428,000	2,300,000
Peas.....	15.07	18.05	1.26	1.11	3,913,000	3,951,800
Beans.....	17.51	17.19	2.18	1.88	920,500	800,900
Buckwheat.....	26.38	21.99	.62	.64	10,517,000	8,372,000
Mixed grains.....	34.64	33.33	.58	.55	17,198,000	15,792,000
Flax.....	12.92	11.30	.90	.97	26,130,000	17,539,000
Corn for husking.....	56.84	60.30	.62	.64	16,949,700	16,772,600
Potatoes.....	175.38	165.88	.44	.49	84,885,000	78,544,000
Turnips, etc.....	403.71	358.30	.24	.28	80,016,000	66,788,000
	tons.	tons.	per ton.	per ton.	tons.	tons.
Hay and clover.....	1.46	1.33	11.09	11.48	12,117,000	10,859,000
Fodder corn.....	10.15	8.62	4.93	4.78	3,037,500	2,616,300
Sugar beets.....	10.63	8.71	5.00	6.12	201,000	148,000
Alfalfa.....	2.84	2.54	12.00	11.85	285,700	237,770

5 GEORGE V., A. 1915

TABLE II.—COMPARISON of Eastern Canada, Prairie Provinces and British Columbia as to Yields and Prices Obtained.

CROP.	EASTERN PROVINCES.				PRAIRIE PROVINCES.				BRITISH COLUMBIA.			
	Aver. Yield per Acre.		Aver. Prices obtained.		Aver. Yield per Acre.		Aver. Prices obtained.		Aver. Yield per Acre.		Aver. Prices obtained.	
	1912	1913	1912	1913	1912	1913	1912	1913	1912	1913	1912	1913
	Bush.	Bush.	\$	\$	Bush.	Bush.	\$	\$	Bush.	Bush.	\$	\$
Fall wheat.....	20.63	23.91	.92	.85	21.87	21.67	.67	.67	33.00	33.14	1.03	1.01
Spring wheat.....	18.21	19.73	.98	1.07	20.96	21.12	.59	.65	30.33	26.67	.93	.99
Oats.....	32.56	32.87	.49	.45	44.90	41.92	.25	.26	56.00	55.50	.51	.53
Barley.....	27.97	27.95	.70	.67	32.95	30.79	.31	.32	45.33	35.25	.64	.68
Peas.....	18.81	22.04	1.54	1.60	23.83	17.25	1.14	.85	30.66	26.67	1.38	1.50
Rye.....	16.74	20.34	.84	.91	22.52	22.73	.57	.48				
Flax.....	13.18	17.11	1.62	1.39	12.75	10.98	.95	1.06				
Potatoes.....	192.12	180.47	.42	.47	217.63	176.66	.38	.41	233.15	207.30	.49	.66
Turnips, etc.....	377.78	385.25	.27	.31	306.55	217.94	.46	.47	415.90	584.35	.53	.60
	Tons.											
Hay and clover.....	1.44	1.44	11.20	11.28	1.70	1.63	8.73	8.24	2.28	2.11	17.45	17.00
Sugar beets.....	11.16	9.23	5.00	5.20	7.00	5.00	5.00	5.00				
Fodder corn.....	7.99	8.97	4.75	4.03	3.73	6.26	9.27	8.50	8.00	7.66	9.00	12.00
Alfalfa.....	2.73	2.84	10.55	11.47	2.49	2.62	10.52	10.39	4.20	4.60	17.00	14.66

TABLE III.—Farm Live Stock, 1909-13.

	1909	1910	1911	1912	1913
Eastern Provinces—					
Horses.....	1,352,552	1,341,065	1,343,570	1,335,628	1,436,207
Milch Cows.....	2,441,306	2,426,280	2,076,056	2,079,188	2,183,824
Other cattle.....	2,748,691	2,577,867	2,509,622	2,410,671	2,479,406
Sheep.....	2,375,264	2,253,777	1,850,900	1,750,994	1,747,108
Swine.....	2,469,108	2,342,304	2,864,603	2,638,410	2,491,564
Western Provinces—					
Horses.....	779,937	872,134	1,194,927	1,296,994	1,369,283
Milch cows.....	407,999	417,671	484,170	491,239	516,011
Other cattle.....	1,636,088	1,673,096	1,324,405	1,315,681	1,336,098
Sheep.....	330,126	344,693	285,130	290,685	336,423
Swine.....	443,401	411,660	712,221	806,415	922,221
British Columbia—					
Horses.....			57,415	59,735	60,518
Milch cows.....			33,953	34,011	35,599
Other cattle.....			105,236	101,021	100,183
Sheep.....			39,272	40,702	45,000
Swine.....			33,604	32,485	34,541

NOTE.—Figures for 1909 and 1910 from British Columbia not available.

SESSIONAL PAPER No. 16

METEOROLOGICAL RECORDS AT OTTAWA.

TABLE of Meteorological Observations taken at the Central Experimental Farm, Ottawa, from April 1, 1913, to March 31, 1914, giving maximum, minimum and mean temperature for each month, with date of occurrence; also the rainfall, snowfall and total precipitation.

Month.	Maximum.	Minimum.	Range.	Mean.	Highest.	Date.	Lowest.	Date.	Rainfall.	Snowfall.	Total Precipitation.	Number of days Precipitation.	Date.	
	°	°	°	°	°		°		In.	In.	In.	In.		
April.....	56.39	34.19	22.30	45.34	86.5	26th....	21.0	20th....	2.00	S.	2.00	10 0.78	4th.	
May.....	64.96	42.52	22.43	53.73	89.0	4th....	28.8	10th....	2.33	2.33	9 0.76	28th.	
June.....	77.77	59.67	27.09	64.21	93.2	27th....	35.0	9th....	0.82	0.82	10 0.25	26th.	
July.....	82.61	57.50	25.11	70.05	100.	4th....	44.8	12th....	2.30	2.30	8 0.98	12th.	
August.....	79.02	55.10	23.91	67.05	97.2	17th....	38.0	25th....	3.13	3.13	12 1.70	22nd.	
September....	67.77	45.90	21.87	56.83	88.0	2nd....	30.0	15th....	2.69	2.69	8 0.91	21st.	
October.....	58.78	42.37	16.08	50.41	78.2	6th & 10th...	22.0	31st....	4.08	S.	4.08	14 1.02	2nd.	
November....	45.20	30.62	14.57	37.90	63.2	22nd....	17.2	28th....	2.48	2.00	2.68	12 0.92	19th	
December....	30.11	16.84	13.27	23.47	42.6	5th....	—	5.0	27th & 28th...	0.58	17.00	2.28	13 0.76	8th.
January.....	20.84	2.08	18.76	11.46	41.0	29th & 30th	—30.0	13th....	0.64	30.50	3.68	17 0.90	21st.	
February.....	16.89	—4.62	21.51	6.13	42.0	3rd....	—30.2	11th....	11.00	1.10	6 0.55	7th.	
March.....	33.07	17.24	15.82	25.15	48.0	26th....	—	2.0	12th & 20th...	0.40	9.75	1.36	14 0.40	30th.
.....	21.51	70.25	28.51	133	

Rain or snow fell on 133 days during the 12 months.

Heaviest rainfall in 24 hours, 1.70 inches on August 22.

Heaviest snowfall in 24 hours, 9.00 inches on January 21.

The highest temperature during the 12 months was 100.0° on July 4.

The lowest temperature during the 12 months was —32.2° on February 11.

During the growing season rain fell 10 days in April, 9 days in May, 10 days in June, 8 days in July, 12 days in August, and 8 days in September.

February shows the lowest number of days with precipitation, viz., 6.

Total precipitation during the 12 months, 28.51 inches, as compared with 43.18 inches during 1912-13

5 GEORGE V., A. 1915

RAINFALL, Snowfall and Total Precipitation from 1890 to 1913-14; also the average annual amount that has fallen.

Years.	Rainfall.	Snowfall.	Total. Precipitation.
1890.....	24.73	64.85	31.22
1891.....	30.19	73.50	37.54
1892.....	23.78	105.00	34.28
1893.....	31.79	72.50	39.04
1894.....	23.05	71.50	30.20
1895.....	27.01	87.50	35.76
1896.....	21.53	99.75	31.50
1897.....	24.18	89.00	33.08
1898.....	24.75	112.25	35.97
1899.....	33.86	77.25	41.63
1900.....	29.18	108.00	40.72
1901.....	29.21	97.25	38.91
1902.....	25.94	101.75	36.10
1903.....	26.43	85.00	34.92
1904.....	25.95	108.75	36.79
1905.....	23.71	87.25	32.42
1906 January 1 to March 31.....	1.90	24.50	4.34
1906-07.....	21.73	72.50	28.94
1907-08.....	24.70	134.75	38.18
1908-09.....	22.13	107.90	32.91
1909-10.....	28.40	61.25	34.51
1910-11.....	18.94	88.25	27.72
1911-12.....	20.12	98.50	29.95
1912-13.....	32.54	106.50	43.18
1913-14.....	21.51	70.25	28.51
Total for 24 years and 3 months.....	617.56	2,205.50	838.32
Average for 24 years.....	25.73	91.89	34.93

RECORD of Sunshine at the Central Experimental Farm, Ottawa, from April 1, 1913, to March 31, 1914.

Months.	Number of days with Sunshine.	Number of days without Sunshine.	Total hours Sunshine.	Average Sunshine per day.
April.....	28	2	219.8	7.32
May.....	27	4	244.8	7.89
June.....	30	0	309.0	10.30
July.....	31	0	278.9	8.99
August.....	29	2	258.6	8.34
September.....	27	3	222.5	7.41
October.....	23	8	134.3	4.33
November.....	22	8	106.7	3.55
December.....	19	12	77.6	2.50
January.....	19	12	98.6	3.18
February.....	28	0	188.0	6.71
March.....	23	8	150.3	4.84

WILLIAM T. ELLIS,
Observer.

SESSIONAL PAPER No. 16

PUBLICATIONS ISSUED DURING THE YEAR.

During the year ending March 31, 1914, the following publications have been issued or are in the press at its close:—

The Annual Report of the Dominion Experimental Farms for the year 1912-13.

In the Regular Series of bulletins:—

No. 73, *Smut Diseases of Cultivated Plants, their Cause and Control*, by the Dominion Botanist, Mr. H. T. Güssow. This bulletin treats of the smuts of barley, corn, oats, wheat, millet, and broom corn, suggests treatments to prevent the sowing of infected seed, methods of cleaning and disinfecting separators used in the threshing of smutty grain, etc., etc.

Nos. 74, 75, 76 and 77 give, in a summarized form, the results of the season's work in cereals, field husbandry, forage plants and horticulture, respectively. These bulletins were prepared by the officers in charge of those divisions of the work at the Central Farm, in collaboration with the Superintendents of the branch Farms and Stations.

It is planned to continue this series of crop bulletins year by year in the endeavour to place in the farmer's hands, in time to be of use to him in his next year's operations, the results of the season's work throughout the Experimental Farms system.

In the Second Series of bulletins, there were issued:—

No. 15, on *Preparing Land for Grain Crops on the Prairies*. This was compiled by myself from data furnished by the Superintendents of our western Farms and Stations. It is primarily intended to be an aid to the new settler, and special arrangements have been made to render it available to those taking up our western lands.

No. 16, *How to tell the Age of Hens and Pigeons*, by Mr. Victor Fortier, of the Poultry Division, explains the details of a system for the above purpose, discovered by the author, and practised by him for some years with success in his work of judging poultry at exhibitions.

No. 17, entitled *Forest Insect Conditions in British Columbia: A preliminary Survey*, by Mr. J. M. Swaine, M.Sc., B.S.A., Assistant Entomologist for Forest Insects, gives some results of the author's investigations into forest conditions and the depredations of forest insects in British Columbia. This work was undertaken at the request of the Provincial Government of that province, and will be continued during the coming year.

No. 18, on the *Strawberry Root Weevil in British Columbia*, was prepared by Mr. R. C. Treherne, B.S.A., Field Officer of the Division of Entomology. The author has been stationed in British Columbia for some time and has had an excellent opportunity of studying at first hand some of its injurious insects.

Of Circulars, two have been issued by the Division of Botany and one by the Division of Entomology.

No. 4, of the first-named Division, was prepared by the Dominion Botanist, Mr. H. T. Güssow, assisted by Mr. A. E. Kellett, artist in the Division of Entomology, and is entitled *Potato Diseases transmitted by the use of Unsound Seed Potatoes*. It was brought out as a poster in colours, giving finely executed illustrations of potatoes affected with the diseases treated of, and was designed especially for hanging up in public places, such as schools and post offices, throughout the country.

Circular No. 5, by Mr. J. W. Eastham, Assistant Dominion Botanist, treats of the *Powdery Scab of Potatoes*.

Circular No. 3 of the Division of Entomology, entitled the *Chinch Bug in Ontario*, gives the results of an examination of the infested areas in that province, carried on by Mr. H. F. Hudson, Field Officer in the above Division.

5 GEORGE V., A. 1915

In addition to the above-mentioned publications, prepared in their entirety by the officers of the Experimental Farms system, they have contributed special articles to each issue of the *Agricultural Gazette*, the official organ of the Federal Department of Agriculture.

CORRESPONDENCE.

The totals of the letters received by, and sent out from, the various Divisions at the Central Experimental Farm and the branch Experimental Farms and Stations, are tabulated below. The figures given indicate a steady growth in the appreciation of the work of the Experimental Farms, on the part of the farming community.

The total given for reports and bulletins sent out covers only such special applications as are received at the Central Farm. The Experimental Farms mailing list and the greater number of special applicants are supplied from the Publications Branch, Department of Agriculture, Ottawa.

CENTRAL EXPERIMENTAL FARM.

Division.	Letters Received.	Letters Sent.
Director.....	19,959	12,546
Field Husbandry.....	2,000	1,754
Chemistry.....	3,013	3,025
Horticulture.....	6,426	6,747
Cereals.....	13,131	3,505
Botany.....	1,937	2,251
Entomology.....	6,384	7,814
Animal Husbandry.....	3,641	5,213
Agrostology.....	587	873
Poultry.....	5,405	6,174
*Tobacco.....
French Correspondence.....	6,261	3,746
Miscellaneous.....	15,515	5,190
Totals.....	84,289	58,838

*Figures not available.

REPORTS, BULLETINS, AND CIRCULARS.

Reports and Bulletins mailed.....	12,010
Circulars re Distribution Seed Grain.....	23,538

SESSIONAL PAPER No. 16

BRANCH FARMS AND STATIONS.

Farm or Station.	Letters Received.	Letters Sent.
Charlottetown.....	1,538	1,421
Fredericton.....	1,621	1,950
Nappan.....	1,958	1,634
Kentville.....	2,557	2,623
Ste. Anne de la Pocatière.....	684	521
Cap Rouge.....	2,318	2,793
Brandon.....	4,215	4,081
Indian Head.....	13,157	12,917
Rosthern.....	1,610	1,556
Scott.....	1,088	1,069
Lethbridge.....	4,282	3,972
Lacombe.....	4,877	4,487
Agassiz.....	4,040	4,069
Invermere.....	662	558
Sidney.....	1,248	936
Totals.....	45,855	44,587

The totals for the branch Farms and Stations are exclusive of reports, bulletins and circulars sent out.

By adding the totals for the Central and branch Farms, the total number of letters received at all points is seen to be 130,144, and of those sent out 103,425.

DISTRIBUTION OF SAMPLES.

The annual distribution of samples of seed grain and potatoes was carried on under similar regulations to those followed last year, all applications for grain samples being filled at Ottawa, as well as those for potatoes from Ontario and Quebec.

The details of the distribution made from Ottawa will be found in the report from the Division of Cereals. The total number of samples sent out from Ottawa was 9,238. In addition to these, there were distributed from the branch Experimental Farms and Stations the following numbers of samples of potatoes:—

Charlottetown	13
Fredericton	55
Nappan	345
Brandon	392
Indian Head	1,266
Rosthern	434
Scott	71
Lethbridge	1,891
Lacombe	627
Agassiz	314

making a total sent out from all farms, of 14,646 samples.

Other distributions of material, more limited in scope, or of a special character, were also made, such as that of tobacco seed, some 3,640 samples of which were sent out, of inoculated soil for the growth of alfalfa, chiefly sent out from the western Experimental Farms, as well as a distribution of sweet corn to applicants from Quebec, carried on from the Cap Rouge Station, and of tree seeds, etc., from the Prairie Farms.

BUILDINGS AND IMPROVEMENTS.

BUILDINGS.

Four new greenhouses were erected this year at the Central Farm, giving about 7,500 square feet of glass. Their construction was sufficiently advanced at the close of the year to permit of experimental work being begun.

In October last, the main barn at the Central Farm was destroyed by fire. The cattle were all saved, but the machinery and equipment, together with a large supply of feed, were lost. Work was commenced at once on the erection of a new building, it being necessary to provide shelter for the cattle as soon as possible. Fortunately, the autumn was a favourable one, and the two wings of the new barn were got ready for the stock before cold weather set in. Construction has been continued throughout the winter, and the building will be completed during the coming summer.

In the Poultry Division, there were built an experiment and feed house, a cockerel house and an experimental breeding house.

More detailed descriptions of the above buildings will be found in the reports of the Divisions of Horticulture, Poultry and Animal Husbandry, respectively.

ROADS.

The main roads through the Central Farm were treated with Tarvia during the past summer, with satisfactory results. The surface was first covered with broken stone, which was thoroughly compacted by a steam roller. Tarvia was then applied hot and more stone somewhat more finely crushed spread thereon and again rolled. After rolling the second layer of stone another light coating of Tarvia was applied and stone dust scattered thickly thereon. The road was then considered ready for use.

On the branch Farms and Stations, notably at Kentville, N.S., Ste. Anne de la Pocatière, Que., and Indian Head, Sask., extensive building operations were carried on. These will be treated of in greater detail in the notes of the work at the branches.

VISITORS TO THE FARM.

In addition to the numbers visiting the Farm either singly or in small groups, there were numerous organized excursions during the summer months.

In this connection, the Auditorium proved most useful in affording facilities for the preparation and serving of lunch, the giving of addresses, etc. Several congresses and conventions were held in the city during the year, and a visit to the Farm was, as a rule, made part of the programme.

In co-operation with the Ontario Department of Agriculture, a short course in judging was given the judges chosen for the fall fairs in the eastern part of the province.

ADDITIONS TO AND CHANGES IN THE STAFF.

Mr. M. B. Davis, B.S.A., Assistant to the Dominion Horticulturist, was appointed in December last.

He was born at Yarmouth, N.S., and received his public and high school training at the Yarmouth County Academy. He graduated from the Nova Scotia Agricultural College in 1910, and continued his studies at Macdonald College, from which institution he graduated in 1912.

SESSIONAL PAPER No. 16

During this period of training, he worked on several farms, including a year on the Government Farm at Truro, N.S., and a season under Professor Blair at Macdonald College.

After graduating, he returned to Nova Scotia as manager of the Sunnyside farm and orchards, and also had charge of the Demonstration Orchard work for the Annapolis valley, carried on by the Dominion Government. During this time he acted as secretary of the Bridgetown Fruit Co., Ltd., and of the United Fruit Companies of Nova Scotia, Ltd.

In his present position, he is chiefly engaged in pomological work.

Mr. A. J. Logsdail, B.S.A., Assistant to the Dominion Horticulturist, received his early education in England. Coming to Canada, he took his degree at the Ontario Agricultural College, after which, returning to the Old Country, he spent two years as apprentice with James G. Sweet, V.M.H., F.R.H.S., proprietor of one of the largest establishments under glass in Great Britain. The following eighteen months were passed as Student Gardener at the Royal Botanic Gardens, Kew, where he was attached to the Landscape, Decorative and Tropical Departments, and secured a certificate for courses taken in economic and systematic botany, physics and chemistry.

Returning to America, he took a postgraduate course in Plant Genetics at Cornell University, and then took a position under the Ontario Department of Agriculture as Assistant Horticulturist and Expert in Plant Genetics at the Horticultural Experiment Station, Jordan Harbour. For eight months he was Acting Director of the Station.

He left this post to take his present position, in which he has plant breeding for his special field of work.

Mr. W. Dreher, B.S.A., Assistant to the Dominion Horticulturist, devotes his attention principally to vegetable gardening.

Mr. Dreher, after spending two years in the Agricultural School of the Canton of Neuchâtel, Switzerland, came to Canada, and took the four-year course at Macdonald College, graduating in 1912. In addition to his college training, he has had considerable practical experience in farming and market gardening.

He took his present position soon after graduation.

Mr. Walter L. Graham, B.S.A., Assistant to the Dominion Field Husbandman, was born at Britannia Bay, near Ottawa. He received his early training at the rural public school, the Ottawa Collegiate Institute and at his father's stock and dairy farm. He entered the Ontario Agricultural College in 1909, taking the agricultural option. Graduating in 1912, he returned home and continued farming in partnership with his brother until he took the position he now holds.

Mr. R. W. Nichols, F.C.S. (England), Assistant in Milling and Baking to the Dominion Cerealists, received his early education at the King Alfred's grammar school, Wantage, England. He then attended the City of Dublin Technical School, taking the complete seven-year course in science.

In 1901, he was appointed Assistant to F. Escombe, B. Sc. F.L.S., in the Guinness Research Laboratory, retaining the position during the three years the institution was maintained. He was then employed in the Scientific Department of the Guinness Brewery, Dublin, until 1911, being engaged in experimental work on the cultivation of barley and on the analysis of cereals, in connection with the Irish Department of Agriculture.

In 1912, he came to Canada and took a special course in milling and baking technology in Chicago the same year, after which he took his present position. His work consists in the testing of the milling and baking qualities of varieties of wheat and in testing for the public samples of bad and suspicious flour. He has also been conducting researches in breadmaking methods, and during the summer months does work on the experimental plots of the Cereal Division.

Mr. George Robertson, Assistant to the Dominion Poultry Husbandman, received his public and high school training in the city of Ottawa, and in 1894 went to the Ontario Agricultural College, where he spent two years, specializing in poultry culture in the second year.

After leaving college, he took up mixed farming at Galetta, Ont., paying special attention to poultry in its various branches. In 1904, he moved to the vicinity of Ottawa and took up poultry breeding exclusively, with most of the leading varieties of land and waterfowl.

During the latter period a considerable portion of his time has been occupied in judging, lecturing and editorial work, being widely and favourably known in all these lines.

He has been an executive officer of many of the Specialty Clubs and Poultry Associations and at the time of his appointment was serving his fifth term as President of the Eastern Ontario Poultry Association.

Mr. A. E. Kellett, Artist in the Division of Entomology, was born at Keswick, Cumberland county, England.

After receiving his public school education, he studied at Armstrong University, Newcastle-on-Tyne, and served five years' apprenticeship to process engraving and illustrating.

In 1910, he came to Canada and spent three years in Winnipeg with the leading engraving houses, as artist and designer. He was appointed to his present position in August, 1913.

Mr. W. W. Baird, B.S.A., Superintendent of the Experimental Farm, Nappan, N.S., is a native of Nova Scotia, and received his public and high school training in that province. In 1907, he entered Macdonald College, taking the four-year course and specializing in Animal Husbandry.

During his college course he gained considerable practical experience, being engaged during the summer in the Horticultural and Animal Husbandry Departments at the College, and also with the Agricultural Survey of the Province of Quebec by the Commission of Conservation, and judging field crops for the Seed Branch of the Dominion Department of Agriculture.

After graduation in 1912, he took the position of manager of a large estate in the Maritime Provinces, remaining therein until appointed Superintendent of the Nappan Farm, upon the resignation of Mr. R. Robertson, former Superintendent.

Mr. Elzear Montreuil, B.S.A., Assistant to the Superintendent, Experimental Station, Cap Rouge, Que., was born at Ancienne Lorette, in that province.

After his early training in the country school, and practical experience gained on his father's farm, he entered the Quebec Seminary, from which he proceeded to Laval University, where he took his arts degree.

Studying for two and a half years at the Agricultural Institute at Oka, he took his degree of B.S.A., in 1912. He then accepted the post of lecturer for the Provincial Department of Agriculture, resigning to take his present position.

Mr. T. J. Harrison, B.S.A., Superintendent of the Experimental Farm at Indian Head, Sask., was born near Carman, Man., and received his early education there, working during the summer on the farm.

After leaving high school, he took a five-year course at the Manitoba Agricultural College, and on graduation was made Assistant to the Professor of Field Husbandry, and later on was made assistant professor of that department, which position he was filling at the time of appointment as Superintendent of the Indian Head Farm.

Mr. K. MacBean, B.S.A., Assistant to the Superintendent, Experimental Farm, Indian Head, Sask., was born in Islay, in the highlands of Scotland, where he received his public and high school training.

After five years spent in commercial life he came to Canada and having acquired some practical experience of our farming methods by working on farms in Ontario

SESSIONAL PAPER No. 16

and Quebec, he entered Macdonald College, specializing in Animal Husbandry in his final year. He graduated in 1913, and was appointed to the position he now holds, made vacant by the resignation of Mr. R. Whiteman.

Mr. Victor Matthews, B.S.A., Assistant to the Superintendent, Experimental Station, Lethbridge, Alta., was born in Newfoundland, where he received his early education and agricultural training, receiving an A A certificate from the St. John's Methodist College.

In 1908, he came to Canada and farmed in Ontario until the autumn of 1909, when he entered Macdonald College. He specialized in Animal Husbandry during his course there and, graduating in 1913, was soon after appointed to his present position.

Mr. G. E. Parham, Superintendent of the Experimental Station at Invermere, B.C., was born at Melton Farm, Gillingham, Dorset, England, and received his early agricultural training at his home, a large sheep and dairy farm.

He then took a four-years' course at Reading College, and received the diploma of agriculture, specializing in horticulture and dairying. He managed an experimental farm for the late Sir W. Palmer, M.P., in connection with the Reading College, and published in book form the results obtained. He was then appointed Agricultural Lecturer and Demonstrator to the Bucks County Council, resigning this position to take that of manager of the experimental farm and lecturer in agriculture at the Reading College. In 1908, he came to Canada and joined his brother in a fruit farm in the Okanagan valley, British Columbia, where he remained until appointed Superintendent of the Invermere Station.

Mr. Angus Mackay, Superintendent of the Experimental Farm at Indian Head, Sask., since its establishment in 1887, was this year made Inspector of Western Experimental Farms.

Mr. Mackay's long experience in Experimental Farm work, his familiarity with agricultural conditions in general in the west, and his recognized position as an authority on good farming make his appointment as Inspector an excellent one.

The worth of his work as Superintendent of the Experimental Farm at Indian Head in furthering the agricultural interests of the prairie provinces, and those of Saskatchewan more particularly, can scarcely be overestimated.

He undertook the task of managing the Indian Head Farm in 1887, when settlers on the prairies were few and correct cultural methods for the region undetermined, and hence the crop-producing value of the prairie lands very problematical. His faith in the country was perfect, and he has shown wonderful devotion to the tasks set him of working out methods of crop production suitable to local soil and climatic conditions, of testing for suitability and productiveness the infinite variety of cereals, legumes, forage crops, fruits, trees, etc., possible of cultivation in Saskatchewan. His judgment in these matters has been most excellent, and his courageous and concise advocacy of what experience has shown him to be right have combined to make his name and his opinions honoured and respected by farmer and town-dweller alike, throughout his adopted province and far afield.

The Experimental Farms system and the poultry interests of the Dominion at large, suffered a great loss in September last through the death of Mr. A. G. Gilbert, Poultry Manager at the Central Farm since its establishment in 1887 until the winter of 1912-13, when ill health compelled him to give up active work as head of the Poultry Division.

Mr. Gilbert was one of the pioneers in poultry improvement in Canada, having made it a study for years before entering the Government service, and his work has laid a firm foundation for future experiment along these lines.

In his capacity of poultry manager, his efforts were untiring in educating the Canadian farmer in profitable poultry keeping. His interest and work were directed to aid the farmer rather than the fancier and to establish poultry raising as a profitable part of our farm industries.

As a speaker, his services were in constant demand, and his practical advice, bright personality and Scotch humour won him a host of ready listeners and warm friends.

In his reports and bulletins on poultry matters he covered the whole ground of farm poultry management. His evidence, as given before committees of the Senate and House of Commons from time to time, has been printed and distributed in large editions. These, with his numerous articles in the agricultural press, have made his name familiar to poultrymen throughout the Dominion.

Outside of his official duties, his interests were varied. He was closely identified with church, society and philanthropic work, and all who had the good fortune to know him in any of his activities, will always remember his geniality, simplicity and helpfulness.

MEETINGS ATTENDED.

My duties as Director permit of my attending but few meetings to speak on agricultural or other subjects. I was able, however, to be present at certain of the more important agricultural meetings and functions during the year, among which might be mentioned more particularly the winter fairs for Ontario at Guelph and Ottawa, the Manitoba Winter Fair at Brandon, the opening of the Manitoba Agricultural College at Winnipeg, the Dry-Farming Congress at Tulsa, Oklahoma, U.S.A., where I had the honour to be one of the Canadian delegates and give two addresses, the one on "Live Stock for Dry-Farming Districts," and the other on "Some Experimental Work in Cultural Methods on the Dominion Experimental Farms in Dry-Farming Districts," the Eastern Ontario Dairymen's Convention, the Western Ontario Dairymen's Convention, the Quebec Dairymen's Convention, the Quebec Live Stock Association at Montreal, the Ontario Live Stock Association at Toronto, the Macdonald Agricultural College Commencement exercises at Ste. Anne de Bellevue, Que., as well as a considerable number of Farmers' Club meetings and annual meetings of agricultural associations of different kinds.

JOURNEYS MADE.

As usual, the various Experimental Farms and Stations constituting this system were visited by me during the year. In some cases, several visits were made. This was done where work under way or other circumstance seemed to require a visit for inspection or to decide on lines of action to be followed.

In addition to these journeys made in connection with the Experimental Farms, I made a number of other trips into various parts of Canada, the most notable of which was the journey made by Mr. G. H. Clark, Seed Commissioner, and myself, from North Bay to Winnipeg by way of the Northern Ontario railroad to Cochrane, and thence over the right-of-way of the Transcontinental to Transcona, near Winnipeg. The object of the trip was to obtain at first hand what information we could as to the agricultural value of the so-called "clay belt," said to extend from some 150 miles within the province of Quebec on the east to nearly Superior Junction on the west, and from New Liskeard or Haileybury on the south to near James or Hudson Bay on the north.

We left Ottawa via Canadian Pacific on the night of Thursday, June 26. Next morning, we left North Bay on the Timiskaming and Northern Ontario. The first hundred miles or thereabouts traversed by this line of railway is most unpromising for agriculture. The ground is broken, hilly and rocky. Lumbering and mining were proceeding actively, the latter reaching its climax at Cobalt.

From Cobalt, we proceeded to New Liskeard at the northern end of lake Timiskaming, and next morning went over the most southerly part of the "clay belt" in

SESSIONAL PAPER No. 16

company with Mr. Galbraith, District Representative of the Provincial Department of Agriculture, who drove with us through the best parts of the local farming area. The soil is a heavy clay, apparently fertile, but rather difficult to handle. There were many signs of late spring frosts; in fact there had been 8 degrees of frost on June 23.

On the morning of the 28th, we took train again for farther north. The country passed through is well-suited for agriculture, but will, of course, require great expenditure for roads, clearing and draining before it can be expected to prove very profitable. The last two operations will apparently prove rather difficult.

About 50 miles north of New Liskeard, we crossed the divide, and after that the streams flow north into James bay. Some 30 miles short of Cochrane is Monteith, where the Provincial Government has a demonstration farm supervised by Mr. Galbraith, who had accompanied us. The soil here was quite similar to that farther south and, while crops were somewhat more backward than those at Ottawa, they were quite as promising.

Sunday was spent at Cochrane, where soil and crops appeared much the same as in the more southern portions visited. On Monday, after some local inspections, some 7 miles westward, we went by motor speeder along the railway eastward, crossing the Abitibi river and going almost to the northern extremity of Abitibi lake. The country is very uniform in appearance. The surface is slightly undulating. The higher parts are covered with strong growths of fir, spruce and poplar, the clay coming practically to the surface. The lower or really level parts are covered with from 6 inches to 2 feet of black muck or Sphagnum moss, with a fairly strong growth of spruce thereon, while the lowest parts are waterlogged and covered deep with muck and moss, forming what is called muskeg. This is the character of the country, we were informed, from 150 to 160 miles east of Cochrane, or for some miles into the province of Quebec.

On Tuesday we started from Cochrane westward, along the railway, crossing Frederick House river, Conception creek and Driftwood river. At Mattagami river, 31 miles from Cochrane, two townships have been ceded to an American company. This company agrees to bring in and locate on this land at least twenty-five settlers a year. The company gets all the wood but owns no land, and has cleared about 150 acres, built a large saw-mill and is building a large pulp mill on Poplar rapids.

From this point to Ground Hog river is 19 miles. The first 31 miles from Cochrane to Jacksonboro on the Mattagami was similar to east of Cochrane. The next 19 miles was hardly as good on the average.

From Ground Hog to Kapuskasing river, 20 miles, was again quite similar in character. The highest parts seldom or never rose over 10 feet above the grade level, while practically never did the grade level stand more than 6 or 8 feet above the lowest stretches.

From Kapuskasing to Echo lake is 9 miles, to Apazatika is 11 miles farther, to Crow creek is 10 miles farther still, and Missinaibi, the greatest river of them all, is 10 miles beyond. From Missinaibi to Hearst, 21 miles, completes the first stretch of 130 miles, west of Cochrane, Hearst being a divisional point.

From Kapuskasing to Hearst was over a most remarkably uniform stretch of country, drained by numerous rivers and small streams, well wooded and yet easily cleared. In fact, it is a region of great agricultural possibilities. Of the whole stretch from 20 miles east of Cochrane to Hearst, or 150 miles, one might safely say that from 20 to 25 per cent would be easily cleared, from 30 to 40 per cent fairly easily cleared, some burning of muck and some drainage being necessary, and from 20 to 25 per cent more possible of being cleared but, being a little more difficult of drainage, would come under cultivation later and so cost more. That is, probably 80 to 85 per cent of the country could be brought under the plough.

At Hearst, we were fortunate in meeting Mr Wilgar, District Engineer of the N.T.R., and obtained from him much information about the country and assistance in our journey.

The next morning, Wednesday, July 2, we started on the second lap of 125 miles to Grant, the second divisional point west of Cochrane. The country west of Hearst is like that east of it, drained by numerous streams flowing north. In the stretch from Hearst to English river, some 97 miles, the railway crosses the Kakabenakagami, White river, Skunk river, Negagami river, the Negagami branch, Bad river, the Pegachouan, Flint river and English river. From Hearst to the latter point is probably the best part of the clay belt. I should judge that from 25 to 30 per cent would be easily cleared, from 40 to 45 per cent would need no great effort to clear, and from 25 to 30 per cent more could be cleared, but would require more work to do so. It promises to be a splendid agricultural country. From English river to Grant, while still in the clay belt, is likely to be of but small value agriculturally, being as it is, rather low where level, with the higher parts rocky.

From Grant to Armstrong, the next divisional point, the country is of very small agricultural value if one may judge by what one sees along the right of way on the N.T.R., rocky rises, quaking muskegs, shallow black lakes, and sluggish rivers, with a very rare stretch of decent soil making up the district through which the railway runs, for a distance of about 130 miles between the above points. The road on this division crosses a number of rivers, some running south and some north. Of the latter, the most notable was the Kowkashagami, and of the former the Ombabika, Jack Fish, Seymour, Mud, Rapid creek and Whitesand may be mentioned.

We spent the night at Summit, some 30 miles from Armstrong.

From Summit to Armstrong the character of the country changes for several miles; barren sand dunes struggle for the mastery with stunted jack pine and dwarf poplar. This gradually changes near Armstrong, and spots of quite fertile soil show up both east and west of this divisional point.

From Armstrong to Superior Junction, the country is, for the most part, of small agricultural value. Lakes, rocks, rivers, muskegs, sand hills, gravelly knolls, with here and there small clay pockets make up the district as traversed by the N.T.R. It will no doubt, in time, be brought under agriculture, in part at least, as the good parts seem to be fertile and the climate appears to be favourable. It would, however, on the whole appear to be more suitable for a forest reserve or a park than for agricultural development. The same may be said of the country to the west of Superior Junction to Reddit, the first divisional point east out of Winnipeg on the N.T.R. From Graham to Reddit the country is exceedingly picturesque. Lakes are almost always in sight. It is the prettiest part of the whole N.T.R. From Reddit to Transcona some good country is traversed.

We reached Transcona at 2.30 a.m. Sunday and the next morning an automobile bus took us the rest of the way into Winnipeg.

Another trip taken was that to visit certain of the more important Experiment Stations and Agricultural Colleges in the central part of the United States. Among the institutions visited were Manhattan, Kansas, Agricultural College and Experiment Station; Ames, Iowa, Agricultural College and Experiment Station; Urbana, Ill., Experiment Station and Agricultural College, and Lansing, Mich., Agricultural College and Experiment Station.

In November, I attended the meeting of the Directors of Agricultural Colleges and Experiment Stations, held in Washington, D.C., U.S.A.

SESSIONAL PAPER No. 16

EXPERIMENTS AT FORT VERMILION, PEACE RIVER DISTRICT,
ALBERTA.

ROBERT JONES, EXPERIMENTALIST.

In the spring of 1913, work on the land was possible about April 17, harrowing was commenced on the 19th and the first wheat was sown on the 21st. May weather was fine and warm, with frequent showers. The grain germinated and grew well, but was retarded later by the dry, hot weather of June and early July. After July 10, showers were frequent and growth remarkably rapid. All wheat headed out by July 6. Haying commenced on the 18th of that month. The first wheat was cut on August 2, and harvest was general by the 18th.

September was rainy, delaying harvesting and threshing.

Wheat yields throughout the Fort Vermilion district averaged about 21 bushels per acre, oats 50 bushels, and barley 45 bushels per acre.

On the Experimental Station, nine varieties of spring wheat were tested, the highest yield $59\frac{1}{2}$ bushels per acre, being given by Bishop. Prelude wheat was the first to ripen, on August 2, yielding at the rate of 48 bushels per acre. The lowest yield was $39\frac{1}{2}$ bushels per acre.

Five varieties of oats were tested with yields from 84 bushels 24 pounds to 42 bushels 12 pounds per acre.

Two varieties of two-row barley yielded 48 bushels 36 pounds and 30 bushels 20 pounds respectively, while of four varieties of six-row, the highest was obtained from Champion, 65 bushels per acre, and the lowest 60 bushels from Success.

One variety of peas tested, the Arthur, gave 42 bushels per acre.

New and, it is hoped, hardier varieties of alfalfa have been tried this year, those formerly under test having been winter-killed.

Canary grass gave a yield of 2 tons 513 pounds per acre. Timothy, tall fescue, western rye and awnless brome failed to grow well, owing to entering the previous winter in poor condition.

Most of the apple and plum trees made good growth, although none fruited this year. Raspberries and currants did well.

The ornamental trees and shrubs grew well, and the display of annuals was very fine.

The following sorts of vegetables were grown successfully this year. Asparagus, rhubarb, celery, onions, beets, carrots, squash, cucumbers, citrons, tomatoes, beans, lettuce, garden peas, cabbage, and cauliflower.

Five varieties of potatoes were grown: Rochester Rose, Gold Coin, Carman No. 1, Early Rose and Irish Cobbler. The first-named gave the highest yield, 404 bushels per acre, and the Irish Cobbler the lowest, $308\frac{1}{2}$ bushels.

METEOROLOGICAL RECORDS.

The following records of temperatures, precipitation and sunshine were taken by Mr. Robert Jones, Experimentalist at Fort Vermilion, and arranged in tabular form by Mr. W. T. Ellis, Weather Observer at the Central Farm, who has also prepared tables comparing the Fort Vermilion records with those at Ottawa.

TABLE of Meteorological Observations taken at Fort Vermilion, Peace River District, Alberta, from April 1, 1913, to March 31, 1914, showing maximum, minimum and mean temperature, the highest and lowest for each month with date of occurrence; also rainfall, snowfall, and total precipitation.

Months.	Maximum.	Minimum.	Range.	Mean.	Highest.	Date.	Lowest.	Date.	Rainfall.	Snowfall.	Total Precipitation.	Number of days Precipitation.	Heaviest in 24 hours.	Date.
	°	°	°	°	°		°							
April.....	48.88	21.14	27.74	35.01	78.0	20th..	1.5	8th..	0.38	3.00	0.68	3	0.34	22nd.
May.....	59.72	31.55	28.16	45.63	74.0	26th..	14.5	7th..	0.91	0.91	5	0.45	9th.
June.....	73.13	33.54	34.59	55.83	88.5	4th..	26.0	2nd..	0.98	0.98	3	0.86	14th.
July.....	74.56	43.55	31.00	59.05	84.0	23rd..	32.9	25th& 28th..	1.57	1.57	7	0.64	13th.
August.....	72.07	44.93	27.14	58.50	84.8	6th..	28.2	30th..	1.81	1.81	4	1.00	31st.
September.....	53.75	31.89	21.86	42.82	69.0	27th..	23.9	11th..	3.08	3.08	9	1.07	1st.
October.....	38.73	19.10	19.62	28.91	69.6	2nd..	-2.5	28th..	0.72	0.50	0.77	6	0.30	20th.
November.....	25.72	3.36	22.36	14.54	46.0	5th..	-19.5	22nd..	0.17	1.50	0.32	3	0.17	15th.
December.....	19.16	-4.38	23.55	7.39	65.0	4th..	-39.0	24th..	4.25	0.42	5	0.20	20th.
January.....	-1.58	-20.41	18.83	-11.00	12.5	14th..	-54.0	29th..	7.00	0.70	4	0.40	18th.
February.....	-2.07	-26.46	24.38	-14.17	16.2	25th..	-56.5	2nd..	4.75	0.47	3	0.30	27th.
March.....	23.70	-10.47	37.40	-8.13	40.0	10th..	-40.5	25th..	7.00	0.70	3	0.50	31st.
									9.62	28.00	12.41	55

SESSIONAL PAPER No. 16

SOME Weather Observations taken at Central Experimental Farm, Ottawa, as compared with those taken at Fort Vermilion, Peace River District, Alberta.

APRIL.

	Mean Tempera- ture.	Highest Tempera- ture.	Lowest Tempera- ture.	Total Precipi- tation.	Heaviest in 24 hours.	Total hours Sunshine.	Average Sunshine per day.
Ottawa.....	45.34	86.5	21.0	2.00	0.78	219.8	7.32
Fort Vermilion.....	35.01	78.0	1.5	0.68	0.34	206.3	6.87

MAY.

Ottawa.....	53.73	89.0	28.8	2.39	0.76	244.8	7.89
Fort Vermilion.....	45.63	74.0	14.5	0.91	0.45	242.1	7.80

JUNE.

Ottawa.....	64.21	93.2	35.0	0.82	0.25	309.0	10.30
Fort Vermilion.....	55.83	88.5	26.0	0.98	0.86	351.9	11.73

JULY.

Ottawa.....	70.05	100.0	44.8	2.30	0.98	278.9	8.99
Fort Vermilion.....	59.05	84.0	32.9	1.57	0.64	294.7	9.50

AUGUST.

Ottawa.....	67.05	97.2	38.0	3.13	1.70	258.6	8.34
Fort Vermilion.....	58.50	84.8	28.2	1.81	1.00	252.9	8.15

SEPTEMBER.

Ottawa.....	56.83	88.0	30.0	2.69	0.91	222.5	7.41
Fort Vermilion.....	42.82	69.0	23.9	3.08	1.07	142.7	4.75

OCTOBER.

Ottawa.....	50.41	78.2	22.0	4.08	1.02	131.3	4.33
Fort Vermilion.....	28.91	69.6	-2.5	0.77	0.30	89.9	2.90

5 GEORGE V., A. 1915

SOME Weather Observations taken at Experimental Farm, Ottawa.—Continued.

NOVEMBER.

	Mean Tempera- ture.	Highest Tempera- ture.	Lowest Tempera- ture.	Total Precipi- tation.	Heaviest in 24 hours.	Total hours Sunshine.	Average Sunshine per day.
Ottawa.....	37.90	63.2	17.2	2.68	0.92	106.7	3.55
Fort Vermilion.....	14.54	46.0	-19.5	0.32	0.17	67.0	2.23

DECEMBER.

Ottawa.....	23.47	42.6	-5.0	2.28	0.76	77.6	2.50
Fort Vermilion.....	7.39	65.0	39.0	0.42	0.20	42.7	1.37

JANUARY.

Ottawa.....	11.46	41.0	-30.0	3.68	0.90	98.6	3.18
Fort Vermilion.....	-11.00	12.5	-54.0	0.70	0.40	71.7	2.31

FEBRUARY.

Ottawa.....	6.13	42.0	-30.2	1.10	0.55	188.0	6.71
Fort Vermilion.....	-14.17	16.2	-56.5	0.47	0.30	94.7	3.38

MARCH.

Ottawa.....	25.15	48.0	-2.0	1.36	0.40	150.3	4.84
Fort Vermilion.....	-8.13	40.0	-40.5	0.70	0.50	188.7	6.08

SESSIONAL PAPER No. 16

RECORD of Sunshine at Fort Vermilion, Peace River District, Alberta, from April 1, 1913, to March 31, 1914.

Month.	Number of days with Sunshine.	Number of days without Sunshine.	Total hours Sunshine.	Average Sunshine per day.
April.....	26	4	206.3	6.87
May.....	30	1	242.1	7.80
June.....	29	1	351.9	11.73
July.....	28	3	294.7	9.50
August.....	26	5	252.9	8.15
September.....	19	11	142.7	4.75
October.....	24	7	89.9	2.90
November.....	18	12	67.0	2.23
December.....	17	14	42.7	1.37
January.....	15	16	71.7	2.31
February.....	19	9	94.7	3.33
March.....	27	4	188.7	6.08

WILLIAM T. ELLIS,
Observer.

EXPERIMENTS AT GROUARD, LESSER SLAVE LAKE, ALBERTA.

The work at this point was again carried on under the supervision of Brother Laurent, of the Indian Mission.

The growing season of 1913 was wet and the temperatures low. Only three hot days occurred, the highest temperature being 94 degrees.

In spite of this, grains grew well. Barley was ripe on August 10, Early Red Fife wheat and Banner oats on September 1.

Threshing was completed on October 9. The yields were as follows:—

Wheat: Early Fife, 23 bushels per acre; Preston, 22 bushels; Marquis, 18 bushels. The yield of the last two was reduced from their being on heavy clay soil.

Ligowo oats yielded 45 bushels per acre, and Banner 40 bushels. Odessa barley gave 35 bushels per acre, and Manchurian, 34 bushels per acre.

In horticulture, while the cool, wet season was injurious to some of the plants tested, the results as a whole were satisfactory.

The fall planting of garden seeds has been practised at Grouard for years, with success.

Onions, carrots and parsnips were sown in the fall of 1912. The seedlings came up soon after snow disappeared in the spring and kept in good condition, being undamaged by the late spring frosts and heavy winds.

Soon after the middle of June, vegetables started in hot-beds, were transplanted into the open. These comprised cabbage, cauliflower, tomatoes, celery and squash. The yields from all were satisfactory in quantity and quality.

Late in April and early in May, the following varieties were sown in the open: Carrots, table beets, beans, peas, turnips (table), lettuce, onions, table corn, radish, rhubarb. These all did well except onions, which were destroyed by the onion worm.

More than fifty varieties of flowers were grown successfully.

Currants and strawberries gave good yields.

5 GEORGE V., A. 1915

EXPERIMENTS AT GRANDE PRAIRIE, ALBERTA.

Experimental work was continued by Mr. S. J. Webb at this point. The spring opened early, seeding commencing on April 12. The season as a whole was favourable, although wet, delaying haying and harvesting. On October 13, most of the grain was still in stook.

Potatoes and all kinds of vegetables were an excellent crop.

In cereals, Marquis and Preston wheats gave yields of 40 bushels and 35 bushels per acre, respectively. Banner and Thousand Dollar oats gave 70 bushels and 62 bushels per acre, and Arthur peas 45 bushels per acre.

Two varieties of mangels yielded 4 tons 1,100 pounds and 4 tons 800 pounds per acre, respectively, and two of turnips gave a return of 4 tons 1,200 pounds and 4 tons 500 pounds.

Alfalfa, Alsike, Mammoth Red and White Dutch clovers were sown with and without nurse crops, a good catch being obtained in each case. Equally good results were obtained with Red Top, Timothy and Orchard grass.

The following vegetables produced well: Peas, beets, carrots, lettuce, onions, beans and potatoes.

The display of flowers sown in the open was a very fine one.

EXPERIMENTS AT FORTS RESOLUTION AND PROVIDENCE, MAC-KENZIE DISTRICT.

Experiments were continued this year at the above points under the supervision of Father Dupont, at Fort Resolution, and of Father Giroux at Fort Providence.

At Fort Resolution, seeding was completed about the middle of May under fairly favourable conditions, but dry weather following, much of the grain did not germinate. The latter half of May and all June were exceptionally cold. On June 25 there was a severe frost, the cabbage, peas and turnips suffering especially. In late July and early August, there was a good rainfall, but rather too late to have much effect on the yield of grain. The grain plots were attacked and destroyed just before the harvest by large flocks of small birds, which visit that region each year so that the yields could not be obtained.

Vegetables which survived the frost of June 25 did very well. Those grown included carrots, beets, peas, turnips, onions, cauliflower and cabbage.

As giving some indication of the shortness of the season, the following general notes may be of interest: Snow disappeared the third week in April; on May 19 the bay was still full of ice; it became clear on the 21st but was again blocked by ice coming in from the lake (Lesser Slave) on June 8. The first boat arrived on June 5, and the first steamboat on June 13.

On September 10 four inches of snow fell. Ice was formed along the shores of the bay on September 21 and, a month later, the ice on the bay would bear skaters.

The soil at the beginning of winter was full of moisture, which should give the 1914 crops a good start.

EXPERIMENT AT FORT PROVIDENCE.

The dryness of the season was most abnormal. No rain fell until June 10, and none after that during the remainder of the growing season. Even the native prairie hay was almost a total failure. There was a frost on July 8 which damaged the wheat considerably. Early in August the crows attacked the fields, destroying some of the varieties of cereals under test and damaging others.

Four varieties of wheat were tested: Bishop, Red Fife, Marquis and Preston. All matured on August 23.

SESSIONAL PAPER No. 16

Manchurian barley was ripe on August 19.

Five varieties of oats were grown: Banner, Gold Rain, Pioneer, Sixty Day and Thousand Dollar. The first four matured on August 10, and the last on August 23. Spring rye was ripe on September 4, and four varieties of peas, Arthur Selected, Golden Vine, Prussian Blue and White Marrowfat, on the same date.

The following vegetables were grown successfully: Lettuce, cabbage, beets, carrots and turnips. Tomatoes did not ripen, and table corn did not form ears.

The first fall frost occurred on September 5, and the ground froze for the winter on the 22nd. The ground has been covered with snow since the beginning of October.

EXPERIMENTS AT KAMLOOPS, B.C.

The possibilities of crop production in a region of sparse rainfall were again made the subject of experiment in 1913, on the Harper Ranch at Kamloops, under the supervision of Mr. L. F. Stobart.

The snowfall during the winter of 1912-13 was an average one, 18 inches falling in January. The weather throughout February was cold—17 degrees being the lowest registered.

Spring opened late, ploughing commencing on April 7. Fall wheat seemed to come through the winter well.

The fall wheat land was harrowed on April 16, and from then on a 'dust blanket' was kept on the surface to conserve moisture.

On April 28, barley was sown. The germination was good and, by preserving the soil mulch, and hence the moisture, through frequent cross-harrowings, a good crop was harvested.

The yield of wheat was very low.

The fruit plantation was kept cultivated throughout the season. The growth was very slow in most cases.

Ten pounds of each of the following varieties of potatoes were sown on May 15, and were harvested on September 25, with yields as stated: Clyde, 73 pounds; Table Talk, 73 pounds; Up-to-date, 61 pounds; Eureka, 60 pounds; Green Mountain, 90 pounds; Carman No. 1, 78 pounds; Early Hebron, 65 pounds.

EXPERIMENTS AT SALMON ARM, B.C.

Mr. Thomas A. Sharpe continued, during 1913, his experimental work for the department.

The cool, dry weather of spring, continuing until early June, delayed germination and early growth. June was also dry, though warmer. When rains finally came, the season was well advanced and vegetables could not recover. Fruit was also a light crop. Potatoes were very light.

Additional varieties of apples, plums and cherries were set out and made good growth.

The bush and tree fruits under test comprise a number of varieties of the following: Apples, pears, plums, damsons, cherries, grapes, strawberries, raspberries, loganberry, blackberries, red, white and black currants and gooseberries.

The meteorological data for the year were as follows:—

SALMON ARM.—Meteorological Record for 1913.

Month.	Highest Temperature.		Lowest Temperature.		Rainfall.	Snowfall.	Sunshine.
	Date.	Degree.	Date.	Degree.			
1913.					Inches.	Inches.	H. M.
April.....	11	74	1	19	0.52	290-4
May.....	31	80	3	24	1.26	220-36
June.....	7	88	13-16	40	2.27	237-12
July.....	20-24	92	8	44	1.83	287-12
August.....	1-2-5	92	18-19-26	43	0.78	226-54
September.....	12-17	77	18	31	1.74	208-48
October.....	1	73	30	21	1.84	108-36
November.....	10	51	12-20	20	1.0	4 $\frac{1}{4}$	49-06
December.....	7	44	22-24	14	7 $\frac{3}{4}$	38-48
January.....	6	45	27	1	1.84	15 $\frac{3}{4}$	30-48
February.....	27	-48	4	-5	0.40	10 $\frac{1}{2}$	56-54
March.....	23	-56	25	12	0.89	1	121-48
Totals.....					14.37	39 $\frac{1}{4}$	1,874-42

THE DIVISION OF FIELD HUSBANDRY.

The operations of the Field Husbandry Division are very practical in nature. The scope of its work may be said to include:—

1. Soil management.
2. Crop management.
3. Agricultural engineering.

In addition to the conduct of experimental work along the above lines it is the duty of this Division to supply grain and fodder for the up-keep of the live stock on the Farm. A very limited amount of land suitable for experimental tests is available, and for that reason those reported upon herein do not by any means cover the field of work that the Division naturally includes.

In this report the following lines of work are dealt with:—

WEATHER CONDITIONS AND CROP YIELDS.

For field crops, the season of 1913 was one of the worst in the history of the Farm. Clovers, as a rule, were badly winter and spring-killed, and the hay crop at the outset promised poorly. June and July were very dry. Hay made little growth, and in many cases was a failure. Corn suffered severely and yielded below the average. Straw was light, but the oats filled fairly well and harvested an average crop of grain. Mangels were greatly retarded at first, but made a good late-autumn growth and produced a medium crop.

COST OF PRODUCTION OF FIELD CROPS.

Because of the comparatively low yields in 1913, the cost of production per unit was high. The following table summarizes the costs of producing mangels, corn, oats and hay.

SESSIONAL PAPER No. 16

COST OF PRODUCTION of Field Crops, Central Farm, 1913.

Crop.	Area.	YIELD PER ACRE.		COST TO PRODUCE.		
		Tons.	Bushels.	Per acre.	Per ton.	Perbushel
	Acres.			\$ cts.	\$ cts.	Cents.
Mangels.....	2.00	17	584	36 35	2 14	6.22
Ensilage corn.....	18.00	12		22 03	1 84	
Oats.....	35.00		52	15 96		24.3
Oat straw.....		1.16				
Hay.....	33.5	2		11 78	5 89	

ROTATIONS OF CROPS.

The value of suitable rotations of crops is too often underestimated by our farmers. The results of our experiments in this connection would indicate that in the management of crops the order in which they are grown is of great importance. There are now in operation, for various purposes, fifteen rotations. For ordinary farm purposes any one of the following will likely be found satisfactory:—

Rotation 'A' (five years' duration).

Hoed crop, manured.—Grain, seeded down with clovers and grass. Clover hay, top dressed with manure in autumn. Timothy hay, field ploughed in August, top worked and ribbed up in October. Grain, seeded down with red clover to be ploughed under the following spring when the succeeding hoed crop is corn.

Rotation 'B' (five years' duration).

Hoed crop, manured.—Grain seeded down with clovers and grass, seeds top dressed with manure in autumn. Clover hay, ploughed in autumn. Grain seeded down with clovers and grass. Clover hay.

Soiling Crop Rotation 'R' (three years' duration).

Hoed crop, manured.—Grain, seeded down with clover and grass. Clover hay, timothy hay, field ploughed in August, top worked and ribbed up in October.

Soiling Crop Rotation 'R' (three years' duration).

Hoed crop, manured.—Grain, seeded down with clovers and grass. Clover hay.

Soiling Crop Rotation 'R' (three years' duration).

Corn for early fall feed, manured.—Peas and oats to cut green, seeded down with clovers and grass. Clover hay, to cut green.

Some characteristics of the above rotations, desirable under almost any conditions, are as follows:—

1. Grain fields are always seeded down with clover, even though it be used only as a fertilizer, as in the case of the fifth year of rotation 'A.'

2. Grass and clover seedings are heavy. Increased crops of hay and rare failures of a catch have justified them.

5 GEORGE V., A. 1915

3. Hoed crops form a large proportion of every rotation. An attempt to farm a small area without a hoed crop was not successful. Weeds could not readily be kept in check.

4. No field is left in hay for more than two successive years. Our records show that the second crop almost always costs more per ton than the first, and that succeeding crops are very liable to be grown at a loss.

5. Barnyard manure is applied frequently in comparatively small quantities, rather than at long intervals in large quantities.

The following record shows the comparison of the chief items in connection with these rotations:—

COSTS, RETURNS AND NET PROFITS of Rotations "A," "B," "C," "D" and "R."

Rotation.	Cost to operate per acre.		Value of returns per acre.		Profit or loss per acre, 1913.		Profit, average of 8 years, 1904-11.	
	\$	cts.	\$	cts.	\$	cts.	\$	cts.
A (Five years' duration).....	17	55	19	40	1	85	8	78
B (Five years' duration).....	21	83	21	47	-0	36	9	03
C (Four years' duration).....	17	08	16	97	-0	11	8	15
D (Three years' duration).....	19	35	17	80	-1	55	10	08
¹ R (Three years' duration).....	19	14	19	50	0	36

¹ Records kept for 1912-13 only.

SHALLOW PLOUGHING AND SUBSOILING VERSUS DEEP PLOUGHING.

This experiment has now been under way for ten years. Two four-year rotations differing only in the above-mentioned autumn preparation for hoed crop of mangels and corn were laid down in 1904.

The average returns for the ten years show a very slight advantage in favour of the deep ploughing. If there is taken into consideration the fact that where subsoiling is practised a single plough must be used, whereas a two-furrow riding plough may be operated under the deep-ploughing method, the higher cost of operation in the former method would reduce the actual net profits still more. This experiment will be continued, as the results have not as yet shown any decided advantage in favour of either method.

COMMERCIAL FERTILIZERS AS A PART SUBSTITUTE FOR BARNYARD MANURE.

In 1913 there were completed five years of experiments designed to supply information concerning the relative fertilizing merits, in regular farm rotation of:—

1. No manure or fertilizer of any kind, but pastured one year in four (records kept in 1913 only).

2. Barnyard manure.

3. Complete commercial fertilizer.

4. Barnyard manure, together with commercial fertilizer.

The results show a distinct advantage in barnyard manure alone over commercial fertilizer alone for this soil, but point to the possibility of combining the two to good advantage when barnyard manure is scarce or high in price.

SESSIONAL PAPER No. 16

DIVISION OF CHEMISTRY.

The work carried on by the Division of Chemistry has been similar in character to that of past years, though in several of its branches there has been a widening of its scope and a very considerable increase in the amount accomplished. This has been rendered possible by additional chemical assistance and the better accommodation and facilities offered by the recent extension of the chemical building.

Research work upon the solution of problems affecting Canadian agriculture has first attention, but no less important is the educational and advisory work for the individual farmer. This latter has increased very considerably, both as to correspondence and the number of samples received for examination. It has from the first been the policy to encourage this phase of the work, and it is therefore gratifying to note that farmers throughout the Dominion are more and more realizing that the Division of Chemistry can be of real assistance to them in the difficulties that present themselves in their everyday work. As a bureau of information on subjects relating to the chemistry of agriculture, this Division is doing an important and valuable work, one which is appreciated and one which must make for the improvement of farming throughout the length and breadth of the land. This consulting work necessarily consumes a large amount of time, both in the office and in the laboratory, but it is believed to be time well spent in the country's interests.

SOILS.

The work on soils, in so far as complete chemical and physical examination is concerned, is chiefly confined to representative samples of the uncropped, unmanured soils from newly-settled districts in the Dominion and, naturally, the larger number of these have been sent in by the north-western provinces and British Columbia. The results have furnished sufficient data for a report on their general character and suitability for various crops, to indicate their deficiencies, if such have been noted, and the methods of culture, etc., whereby fertility may be maintained or increased.

In the case of cultivated soils sent in by farmers, complete analysis is not as a rule made, the character and extent of the examination being determined by the nature of the inquiry in the light of the information furnished respecting the past cropping and treatment of the soil.

Difficulties having arisen, it is alleged, in the successful cultivation of certain of the lands in the western section of the Canadian Pacific Railway Irrigation tract, east of Calgary, through rise of alkali and other causes, a number of soils carefully collected in this district have been under critical examination. This investigation is still in progress and will continue probably throughout the whole of next year. The results, it is hoped, will be of value in determining the suitability of these lands for cultivation under irrigation, and in outlining the means to be taken against injury from alkali, where such are deemed necessary.

The experiments in connection with the investigation on the conservation of soil moisture as influenced by cultural methods and cropping have been continued. The field operations are being conducted on several of the branch Farms and Stations in the northwestern provinces. This work was commenced three years ago and may be continued for another three years or more before a final report is made, but the results have already emphasized the value of early and deep ploughing before the rains are over, and of the preservation of an earth mulch and the destruction of weeds by harrowing as means for this conservation of moisture. The benefit of sub-soil packing for this purpose has not been marked in all cases, though on the lighter soils it is undoubtedly of value. It is expected that this work will eventually permit of the outlining of systems of soil management suitable for lands in districts of sparse and irregular rainfall.

NATURALLY-OCCURRING FERTILIZERS AND AMENDMENTS.

A number of the more abundant seaweeds occurring on both the Pacific and Atlantic coasts have been analysed, thus adding to our knowledge of their relative manurial value. Very considerable differences in composition have been found, notably in potash and nitrogen.

Many soils are sour or unproductive through a deficiency of lime, and there is an awakened interest throughout Eastern Canada in the matter of liming as a means of increasing fertility. In this connection a number of marls and limestones—the latter to be applied to the soil in a finely ground condition—have been analysed and reported on.

FEEDING STUFFS.

The most important work in this connection has been the analysis of a series of products from the elevators, commonly classed as screenings, and consisting chiefly of various weed seeds. Concurrently with the analytical work, feeding experiments with poultry have been carried on, and these are still in progress.

FARM ROOTS.

The feeding value, as determined by chemical analysis, of many varieties of mangels, carrots and turnips, has been ascertained. This is a continuation of an investigation begun several years ago, and it is one that has yielded valuable results for the guidance of the stock raiser.

SUGAR BEETS.

As in past years, several of the more important of the factory varieties of sugar beets, as grown on the branch Farms and Stations, have been analysed. The data give ample proof that suitable beets for sugar extraction can be grown in many parts of the Dominion.

FERTILIZERS.

Experiments with commercial fertilizers have been carried on at Fredericton, N.B., and at Kentville, N.S. The crop employed at each Station was potatoes. The work was more or less of a preliminary character, but certain conclusions may be drawn therefrom which will be found of value to potato growers in these provinces. In this work the field operations were under the charge of the Superintendents of the respective Stations.

MEAT INSPECTION DIVISION.

The number of samples received for examination has very considerably increased during the past year. The materials analysed include the products of packing houses and canneries and the various chemical and other compounds employed in their manufacture.

WELL WATERS FROM FARM HOMESTEADS.

From the increasing number of samples sent in for analysis, one may judge that this useful work is awakening throughout our rural districts a keener interest in the wholesomeness of the farm water supply—an interest that must result in better health to the farmer's family and better thrift in his live stock.

SESSIONAL PAPER No. 16

HORTICULTURAL DIVISION.

During this year, perhaps the chief feature of interest in the Horticultural Division was the erection at Ottawa of the new greenhouses which had been badly needed. Four houses have been erected of the Pierson U-Bar, flat iron frame construction with curved eaves, and giving about 7,500 square feet of glass. Experiments were begun in these houses before the close of the year with tomatoes, cucumbers, melons, grapes, and many kinds of flowers, and it is expected that valuable experimental work will be done in the future.

The work of the Horticultural Division is subdivided under the heads of pomology, vegetable gardening, ornamental gardening, and plant breeding, and the office work as in the other Divisions. Space will allow for a few facts only in regard to each.

POMOLOGY.

Although the season was not a very favourable one for fruits, on the whole the apple crop at the Central Farm was fair. Owing to the manner in which the greater part of the orchard was originally laid out, by which only a few trees of each sort are grown, variety tests have been more prominent than cultural experiments in these orchards, but the amount of information gathered in regard to a large number of varieties has been very great and varied, and the Central Farm is looked to more and more each year for information in regard to apples. At the newer Farms, more attention is being given to cultural work. The outstanding features in the pomological work for 1913-14 were the appointment of an Assistant to the Dominion Horticulturist to devote most of his time to this work; and the promising character of some of the newer varieties of apples and strawberries originated at the Central Farm, such as Melba, Joyce, Thurso, Glenton, Rocket, Bingo, and Niobe among apples, and Cassandra, Cordelia, Desdemona, Ophelia and Portia among strawberries.

VEGETABLE GARDENING.

More attention is being paid each year to vegetable gardening in the Horticultural Division, and at the Central Farm a specialist is now in charge of this work. The same varieties are being tested at Ottawa as at practically all the branch Farms and Stations, and the average results from these tests should prove of great value to vegetable growers in different parts of Canada. The desirability of using home-grown seed where good strains are available, was particularly noticeable in 1913. The germination is usually better from home-grown seeds, and where earliness is important, as it is where vegetables are sold, the advantage of having seed that one can rely on is apparent. The Early Malcolm corn and Alacrity tomato, two varieties selected in the Horticultural Division, gave very satisfactory results.

ORNAMENTAL GARDENING.

At all the Experimental Farms and Stations, a strong effort is being made to make the grounds attractive, as there is great need for improvement in the surroundings of the rural homes of Canada. These demonstrations of what can be done under the various climatic conditions in the Dominion should be an inspiration to Canadians. In conjunction with the endeavour for pleasing effects is, of course, the experimental work with ornamental trees, shrubs and herbaceous plants, both as to varieties and methods of culture. One of the most striking things at most of the Farms in 1913 was the fine display of bulbs which, at the Prairie Farms especially, were much admired.

PLANT BREEDING.

Believing that there is a great opportunity in Canada for the development of fruits, vegetables and ornamental plants especially suited to Canadian conditions, more attention is being paid to plant breeding in the Horticultural Division. In 1913, breeding work was carried on with apples, pears, grapes, gooseberries, strawberries, corn, tomatoes, peas, beans and among flowers, with geraniums, sweet peas, and columbine. A specialty is being made of the development of early strains of vegetables, and some very promising ones were grown in 1913. Many new apples, originated in the Horticultural Division, fruited and descriptions were made of them, and some of the best named. Some good new plums of the Americana type were also described.

Work on the central card index system by which a record is kept of the experiments in horticulture and lists of varieties at all the Farms and Stations was continued during the past year and is proving a ready means of reference. A bulletin on Plum Culture was published during the year. Visits to the branch Farms and Stations were made as usual. A number of important meetings were attended and addresses given.

CEREAL DIVISION.

In spite of serious drawbacks in some sections of Canada the past season was, on the whole, unusually favourable for cereals.

In the Maritime Provinces, nearly all early-sown grain gave good results, and the crops were harvested without difficulty, but late-sown grain was badly damaged, and in some cases quite ruined, by a prolonged period of wet weather in the early autumn.

A large area in Quebec and Ontario suffered from drought during the greater part of the summer. The yield was materially lessened, especially on such fields as were sown late, but the quality of the grain was unusually good. It is doubtful whether such bright, hard kernels of spring wheat have ever before been obtained on the Central Experimental Farm and in the Ottawa valley generally.

While conditions varied somewhat in different parts of Central and Western Canada they were favourable on the whole, and the crops harvested were rather above the average in yield and quality.

NEW VARIETIES OF CEREALS.

The work with spring wheat is being given special attention by the Dominion Cerealists, who has a large number of new cross-bred varieties under observation. Many new varieties of oats, barley, peas, and flax are also being tested, but the study of most of these has not yet advanced far enough to warrant their introduction to the public. Great care has to be exercised to avoid the premature introduction of varieties which may prove disappointing when thoroughly tested. Attention may be called to three of the Dominion Cerealists' new early maturing sorts of spring wheat.

Prelude—This variety is in a class by itself. Its extraordinary earliness in ripening makes it extremely valuable for high latitudes or high altitudes where Marquis cannot be depended upon to ripen before there is danger of autumn frosts. Prelude generally ripens about two weeks before Marquis. It does not generally give a very large yield, and it is seriously affected by drought in May or June; but even with these limitations it is likely to be very valuable over large tracts of country, especially in northern Saskatchewan and northern and central Alberta.

SESSIONAL PAPER No. 16

Pioneer.—This is a new wheat introduced this winter for test in those districts where Marquis is too late in ripening and where there is not sufficient rainfall for Prelude. Pioneer ripens between Marquis and Prelude, and has shown superior ability to resist drought. The kernels of this wheat are red and very hard. It yields flour of excellent colour and strength.

Marquis.—This remarkable variety has again won the highest award in international competition. At Tulsa, Oklahoma, last autumn the first prize at the International Dry Farming Congress was won by an exhibit of this variety grown by Mr. Paul Gerlach, of Allan, Sask. This is the third international triumph in succession for Marquis wheat.

MILLING AND BAKING TESTS.

The appointment of a special assistant for milling and baking researches has made possible the enlargement of this branch of the work. Tests can now be made, as often as is necessary, of the new varieties of wheat which are being produced here, as well as those obtained from outside sources. Baking tests of flour of doubtful quality are also being made for the public whenever such samples are submitted.

DISTRIBUTION OF SAMPLES OF SEED GRAIN AND POTATOES.

The annual free distribution of samples of seed grain and potatoes has been conducted as usual, and is now drawing to a close. The total number of samples distributed this year will be over 9,200, about a thousand in excess of last year. The principal varieties sent out are Banner and Ligowo oats, Marquis and Prelude wheats, Manchurian barley, Arthur peas and Gold Coin potatoes. The great decrease in the number of applications for Red Fife during the last three years has been a very striking feature of the distribution. This year less than 200 samples of this variety are being sent out. The largest number of samples distributed this season to one province will be over 3,100 to Quebec. Ontario is receiving the next largest number, nearly 2,000.

DIVISION OF BOTANY.

The work of the Division of Botany includes two main groups, viz., Plant Pathology and Economic Botany. In addition, the Dominion Botanist has charge of the Botanic Gardens and that part in the administration of the Destructive Insect and Pest Act dealing with diseases of plants due to fungi and bacteria.

THE ADMINISTRATION OF THE DESTRUCTIVE INSECT AND PEST ACT.

As indicated in the last report, the efforts of the officers and inspectors appointed under this Act were mainly directed against the introduction or spread of malignant potato diseases. The discovery of Powdery Scab (*Spongospora subterranea*) in the eastern provinces of Canada, particularly in shipments made to the United States, prompted that country to place an embargo upon all Canadian potatoes. The Dominion Botanist is able to report that while powdery scab exists in the affected areas, it has not actually shown itself destructive. The infections are slight and the market

value of the tubers is but little impaired. The embargo placed upon Canadian potatoes alarmed the growers and shippers who claimed that it would be most difficult to find another market for the potato crop; their fears proved to be ungrounded, however, as the price of potatoes did not drop to any appreciable extent. Towards the end of the year of report, potatoes were almost scarce.

In order to instruct the farmers, the Division issued two new farmers' circulars: No. 4, entitled 'Potato Diseases transmitted by the use of Unsound Seed Potatoes,' a most useful representation of the most common potato diseases in natural colours, and with a brief and instructive text; and Circular No. 5 on 'Powdery Scab of Potatoes,' which publication briefly treats of this disease which was until recently unsuspected in the Dominion. These two circulars were most widely distributed and instructions by letter and public lectures have enabled this Division to reach many farmers. It is hoped that the persistent efforts to prevent potato diseases from being propagated by the careless use of unsound seed tubers will show good results. In fall and spring the inspection service was directed towards certifying seed potatoes to be free from disease. This will be followed by inspection of the fields and later of the crops, so that this disease should most quickly come under control.

PLANT PATHOLOGICAL WORK.

The work done in this section includes the advice by letter or demonstration on the control of plant diseases already known, and research on a large number of obscure diseases affecting specific vegetation of all kinds. The importance of clearing up diseases hitherto little understood must be fully realized. We only need refer to such obscure diseases as 'Little Peach' and 'Peach Yellows,' the last-named disease being most destructive in the Niagara peninsula, and about the cause of which absolutely nothing has been discovered since it was first reported in scientific literature. As the disease is at present unknown in the western peach orchards of Canada, this appears a sufficient reason for specializing in the investigation of one disease alone.

There are numerous problems of a physiological nature which have persistently defied solution. Of these 'Bitter Pit' of fruit is one of the most prominent, and is regarded as the most troublesome and economically important fruit disease. Then reference may be made to the perplexing phenomenon 'black heart' of fruit trees, which is viewed with suspicion by fruit growers, but for which belief, in our opinion, there is no real foundation. In some provinces this trouble is regarded with much concern and accurate information is greatly needed.

Furthermore, the relation of soil organisms to plant diseases is another problem urgently requiring attention.

Our experience with common potato scab would indicate that the organism either lives directly in the soil, or its growth is favoured by the chemical condition of the soil, brought about by the use of various manures or fertilizers. Thus the Dominion Botanist was able to prove that the organism of potato scab commonly referred to as *Oospora scabies*, really belonged to the group of most widely-distributed soil organisms of the genus *Actinomyces*. The biology of the soil is a study which increases in importance every year, and, if followed by special research, will no doubt lead to important discoveries in the control of many plant diseases which are carried in the soil. The discovery of relationship of the potato organism to the group of soil organisms of the genus *Actinomyces* opens up a further field of inquiry, viz., its relation to 'lump jaw' disease in cattle caused by another member of the same group (*Actinomyces bovis*). A number of diseases of the skin and hair of men and animals, like ringworm, favus, etc., may be more closely related to this group

SESSIONAL PAPER No. 16

of organisms than may appear from previous researches. This is one field of investigation entered into more recently by the laboratories of this Division.

Owing to the recent discovery of powdery scab in Canada and to the apparent difficulty of finding means of checking it, experiments have been undertaken and will be continued for such time as may be necessary to show whether control measures are possible or not.

Another disease hitherto recorded from Europe and the United States of America, known as Silver Scurf of potatoes has been observed during the year, an account of which will be found in the report of the Dominion Botanist.

The disease 'Silver Leaf' of fruit trees has engaged the attention of this Division; it has been ascertained that this disease may be produced at will by inoculation with a particular fungus (*Stereum purpureum*), but it has also been found that there are other agents producing the same symptoms. These must be investigated before one can be in a position to suggest methods for the control of the disease.

The St. Catharines laboratory of plant pathology is continuing its good work among the fruit farmers in the Niagara peninsula. Mr. McCubbin, the assistant in charge, by his careful work and by his desire to give advice and demonstrate methods of treatment, has gained the confidence of the fruit growers.

In the section for the eradication of weeds and the identification of plants poisonous to live stock, and other wild plants harmless or injurious, the assistant, Miss Faith Fyles, has a splendid opportunity to demonstrate to the farmer what plants to avoid and how to exterminate weeds.

The weed question is ever prominent. The routine necessary for their extermination often does not suit the practice of farming followed by some farmers; others permit little weed patches to become large and spread until their eradication is by no means easy. In most instances where advice is requested one feels that a little early attention might have saved considerable trouble. Of weeds it may be said correctly 'a stich in time saves nine.' There is no better weed eradicator than a spade, and the sooner it is used the quicker will the weeds disappear. Ploughing up large patches of veined dock, Canada thistle, couch grass, etc., will only make them larger in the coming season.

The Dominion Botanist was absent on official business in the western provinces and towards the end of the fiscal year he was appointed to represent the Dominion of Canada at the first international phytopathological conference at Rome, Italy. While in Europe he was authorized to pursue certain investigations in connection with the utilization of any potatoes that may not be sold and heretofore were left to spoil. He is preparing a report on the question of evaporating potatoes for use as stock food at a time when fresh herbage is not available, and the possible introduction of the industry into Canada.

This is the age of specialization, and the work of the Division of Botany includes many phases in which special researches will become necessary, when the work done by the officers in this Division will become of still greater value because of its application to the special needs of all who require information and help along these lines of work.

THE DIVISION OF ENTOMOLOGY.

THE ADMINISTRATION OF THE DESTRUCTIVE INSECT AND PEST ACT.

This work includes the inspection and fumigation of imported nursery stock and the Brown-tail Moth control work. In order to facilitate the importation of trees and other plants into the western provinces, an additional port of entry was declared at North Portal, Sask., by Order in Council, and a fumigation station has been erected there. This will enable importers in Saskatchewan and Alberta to

secure their shipments without great delay, an essential condition for successful planting. As insuperable difficulties had been encountered in regard to the interception for the purposes of inspection and fumigation of shipments of nursery stock sent through the mails, the importation through the mails of those classes of nursery stock which required inspection or fumigation was prohibited by Order in Council, and the regulation came into effect on March 1. The entry of European nursery stock via the port of St. John, N.B., during the period December 8 to March 4, was also made possible by amending regulation 6. Owing to the repeated discovery of potatoes imported into British Columbia from California which were infested with the Potato Tuber Moth, one of the most serious insect pests affecting the potato, this insect was scheduled under section 12 of the regulations. Further, as a result of an inquiry made in California by the Dominion Entomologist, the importation of potatoes from California was prohibited.

In the addition to the new fumigation station at North Portal, Sask., new stations and additions to our accommodation for dealing with imported nursery stock have been erected at St. John, N.B., and Niagara Falls. During the importation season of 1912-13, which closed in May, 1913, over four million trees and plants were inspected.

The Brown-tail Moth control work includes the scouting work during the winter months, a study of the bionomics of the insect and the importation of parasites and their colonization during the summer. In New Brunswick the scouting work was carried on by a field force of nine men, four of whom were employed by the Provincial Government. The work for the season 1912-13 was concluded in February, and only eighty-one winter webs of the Brown-tail Moth, as compared with 2,452 in 1911-12, were collected in the seven counties at present infested. This decrease was largely due to the absence of any invasion of the moths from Maine during the flying season in July, 1912. In Nova Scotia a field force of nine men, four of whom were employed by the Provincial Government, collected over 11,000 winter webs, both the infested territory and the number of webs being greater than in the previous year.

The investigations on the bionomics of the Brown-tail Moth, particularly on the effect of temperature and the dropping of the webs during the winter, were continued with useful results.

The importation of the parasites of the Brown-tail and Gipsy Moths from Massachusetts was continued through the courteous co-operation of Dr. L. O. Howard, Chief of the Bureau of Entomology of the United States Department of Agriculture, and his assistants. An officer was stationed at the Gipsy Moth Parasite Laboratory, Melrose Highlands, Mass., to collect parasitized caterpillars, rear them and breed out the parasites. The parasites were then shipped to the Entomological Laboratory at Fredericton, N.B., and distributed from there to various selected localities. Altogether 46,548 cocoons of the hymenopterous parasite, *Apanteles lacteicolor*, 5,738 puparia of the parasitic fly *Compsilura concinnata*, and 475 cocoons of the hymenopterous parasite *Meteorus versicolor* were secured and shipped. In addition, 200 adults of the imported European predaceous beetle *Calosoma sycophanta* were collected and shipped to New Brunswick, and 975 larvæ were collected, fed and allowed to hibernate.

In addition to the importation and colonization of these native parasites of the Gipsy and Brown-tail Moths, imported originally by the United States Government from Europe and Asia, a careful study of the native parasites of certain of our commoner insects, such as the Tent Caterpillar (*Malacosoma disstria*), and the Fall Web-worm (*Ilyphantria cunea*) was begun, such an investigation being very necessary in connection with the work on the natural control of lepidopterous insects.

SESSIONAL PAPER No. 16

INSECTS AFFECTING FIELD CROPS.

As complete an investigation as possible was made of the outbreak of the Cut-worm, *Porosagrotis orthogonia*, which had proved so injurious to wheat and oats in southern Alberta in 1912, and to which reference was made in the last annual report. Mr. Arthur Gibson, Chief Assistant Entomologist, spent some time in the infested district in the spring, and Mr. E. H. Strickland, Field Officer, was stationed at the Experimental Farm at Lethbridge, where an entomological laboratory was established for the purpose of studying this insect and other similar troubles. Control experiments were carried out, but the feeding habits of the larvæ rendered most of them valueless. Fortunately, natural causes were responsible for a very marked decrease in the abundance of the insect.

The Army Worm, *Leucania unipuncta*, reappeared and Mr. Norman Criddle reported its occurrence in southern Manitoba.

Experiments were carried out at the Entomological Laboratory, Covey Hill, Que., and at Bowesville, Ont., on the control of locusts by the bacterial disease caused by *Coccobacillus acidiorum* d'Herelle, a culture of which was obtained from the Pasteur Institute, Paris (France).

In co-operation with the Bureau of Entomology of the United States Department of Agriculture, an investigation on the White Grubs (*Lachnosterna* spp.) was begun. Field laboratories were established at Aweme, Man., and Strathroy, Ont., where the local species of *Lachnosterna* were studied. The lengthy life-cycle of the insects will necessitate an inquiry extending over several years. Observations on various insects affecting cereals and other field crops were also made.

A special inquiry was undertaken regarding extensive injuries to winter wheat in southern Alberta. The occurrence of Eelworms (*Nematodes*) in injured plants suggested a possible cause, but further investigation does not appear to place entire responsibility upon these pests.

INSECTS AFFECTING FRUIT CROPS.

In Nova Scotia the investigations on the Bud Moth of apple, which is one of the worst apple pests in the fruit-growing sections, and on the Green Fruit-worms (*Xylina*, spp.) were continued by Mr. G. E. Saunders. Our work on the former insect, both in the laboratory and in the experimental orchards, where spraying experiments have been carried on, has enabled us to determine the correct time to spray and the materials to use to prevent bud-worm injuries.

At the Entomological Laboratory at Covey Hill, Que., Mr. C. E. Petch continued his work on the Apple and Plum Curculios, but progress was seriously affected by the almost complete failure of the apple and plum crops in that region.

Mr. W. A. Ross completed a third season's work on the Apple Maggot (*Rhagoletis pomonella*) in the Niagara fruit district, and has now tried out most of the methods of control usually recommended, including soil insecticides, spraying, poisoning and cultural methods. He also commenced a study of the Aphides of the region.

In British Columbia, Mr. R. C. Treherne completed his studies of the Strawberry Root Weevil (*Otiorhynchus ovalus*) and a bulletin on the insect and its control is now in the press. Studies were also made on the Lesser Apple Worm and Bud Moth. Mr. Tom Wilson continued the work of assisting the Indians in fruit culture, with increasing success.

INSECTS AFFECTING FOREST AND SHADE TREES.

At the request of the Provincial Government an investigation of the insects destroying merchantable timber in British Columbia was begun by Mr. J. M. Swaine, who spent some time in the southern part of the province. A preliminary survey

indicated that an immense amount of valuable timber is being destroyed by various injurious insects which were studied. A preliminary account of this investigation, in which control measures are recommended, has been prepared and is now in the press.

Serious insect damage was discovered in Stanley Park, Vancouver, B.C., and the control of the responsible species is now being studied with a view to advising the Parks Board in regard to the conservation of this valuable piece of virgin forest.

The Forest Tent Caterpillar again defoliated large areas of poplar, birch, maple and other deciduous trees in Eastern Canada, particularly in Quebec and New Brunswick. It was found that bacterial disease destroyed large numbers. The spruce Budworm and Larch Sawfly continue to spread; the former being very prevalent in the New Brunswick forests.

INSECTS AFFECTING DOMESTIC ANIMALS AND MAN.

An investigation was undertaken with a view to testing the value of various substances as insecticides in the destruction of house-fly larvæ in manure piles, as the control of the house-fly under rural conditions is an important question. Of the various insecticides used, chloride of lime scattered over the manure as it is piled gave the best results.

Further inquiries were made concerning the obscure disease known as 'tick paralysis' in children in British Columbia.

MISCELLANEOUS WORK.

Experiments have been made on the destruction of mill-infesting insects by super-heating as a substitute for fumigation, with gratifying results. The study of insects affecting greenhouses has been continued, chiefly in Toronto greenhouses, by Mr. Ross.

APICULTURE.

During the year a beginning has been made in the organization of the apicultural work on the different Experimental Farms with a view to giving the subject the attention it deserves, and which is now rendered possible by the appointment of Mr. Sladen. He has continued his work on queen-rearing and varietal tests, a number of queens having been imported from European countries. Bees have also been shipped successfully in wire 'combless' cages from Ottawa to Indian Head, a distance of over 1,600 miles.

GENERAL.

One of the outstanding features of the year's work has been the demonstration of the value of the policy which has been extended during the year of establishing field or regional laboratories. The direct contact with the farmers and fruit-growers, and with their problems, has increased the value of the work, and the opportunities of rendering immediate assistance to a degree more in keeping with the requirements; as a result great satisfaction and appreciation have been expressed by those in whose interests we are working.

During the year the Dominion Entomologist has visited the different parts of the Dominion, and also visited Oregon, California and Utah, where the entomological conditions, particularly in regard to the Potato Tuber Moth and the Alfalfa Weevil were studied. Messrs. Gibson, Swaine and Sladen, in addition to their other duties, attended meetings and delivered addresses.

SESSIONAL PAPER No. 16

DIVISION OF ANIMAL HUSBANDRY.

The scope of work of this Division includes directly the care, breeding, feeding, housing and marketing of horses, cattle, sheep and swine and their products on the Central Experimental Farm, together with the testing of food stuffs and the testing of methods in care and management and of all machinery pertaining thereto. In consultation with the branch Farm Superintendents, this Division also assists largely in these various operations on all the branch Farms where live stock is maintained, thus systematizing and consolidating all the live stock experimental work on the Dominion Experimental Farms.

For the past year the animal husbandry work on the Central Experimental Farm has been fairly interesting, considering the numerous and varied difficulties encountered. The summer feeding of live stock was carried on under most adverse conditions. The pasture area allowed to each class of stock is exceedingly small, only a little over 19 acres being available for this purpose. Owing to the early spring frosts which killed out the clover, followed by the severe drought of mid-summer, not only were these small pastures severely checked in their growth, but the soiling crops supplied by the Field Husbandry Division were also very limited. However, the copious fall rains and the late open season largely assisted in putting all live stock in good condition before the winter months.

On October 11, this Division suffered a severe setback in the loss by fire of the main dairy barn, calf barn, bull barn and steer barn. This necessitated the temporary discontinuance of most of the experimental work on this Farm, not only with dairy and beef cattle, but also with horses, sheep, and swine, since the buildings in which these latter classes were housed were of necessity utilized in some measure for the housing of cattle. With the completion of the new buildings, now under construction, all such postponed work will be again taken up.

There are 465 head of live stock at present in the stables, made up as follows: 140 cattle, 27 horses, 81 sheep, and 217 swine.

HORSES.

Although the horses on the Central Experimental Farm are still expected to do all the labour connected with the various Divisions, yet the numbers now include six pure-bred Clydesdale mares and four grade Clydesdale mares, all of a uniform type and exceptionally good quality and breeding, with which experimental breeding work is being started. A number of these mares are in foal, and experimental work along the lines of feeding, care, management and housing of pregnant mares and foals is being planned.

The horse labour supplied to the various Divisions on the Central Experimental Farm amounted to 6,889 days, which, at the conservative valuation of 70 cents per day, gives a total return of \$4,822.30.

No experimental horse feeding work was conducted during the past year.

DAIRY CATTLE.

The pure-bred dairy herds now in the stables are Ayrshire, Canadian, Holstein, Guernsey and Jersey. All these herds have made normal growth during the past year and have given satisfactory returns.

Aside from the pure-bred herds, there are two excellent grade herds—Holstein and Ayrshire—which have given an excellent account of themselves, both in their production and in their breeding qualities. These grade herds have also been utilized quite largely in dairy cattle feeding experiments.

DAIRY CATTLE FEEDING EXPERIMENTS.

The investigational work along the lines of the greatest number of cattle which may be profitably fed on a 200-acre farm is being continued, and with most interesting results.

A continuation and expansion of experimental feeding work, as reported in the year 1913, has been conducted during the past year. A complete summary of this investigational work to determine the feeding values of molasses and molasses meals may be found in the detailed report of the Dominion Animal Husbandman.

MILKING MACHINES.

As previously reported, a Sharples Mechanical Milker was installed on the Central Experimental Farm in July, 1912. This machine has given fairly good satisfaction. In order to get further data as to the value of milking machines, a Burrell-Lawrence-Kennedy machine was installed in September, 1913. The purpose of these milking machine tests was to compare each machine with the other and also with good hand milking as to thoroughness, to determine their effect upon the cows, to examine into the purity of the milk drawn in this way, to compare the machines with hand milking for cost and to get some information as to the durability of the machines. Unfortunately, both these machines were destroyed when the barns were burned. However, it is proposed to continue these tests as soon as the new buildings are completed.

DAIRY COW RETURNS.

It will again be noted that the quality of the dairy cattle on the Central Experimental Farm has made a marked improvement. The following is a brief summary showing the returns of some of the cows in the various herds, the profits being based on the following valuations: Butter, 30 cents per pound; skim-milk, 20 cents per hundred pounds; pasture, \$1 per head per month; hay, \$7; straw, \$4; green feed, \$3; and meal, \$25 per ton.

No. of Head.	Age.	Breed.	Average Days in Milk.	Average Pounds Milk produced.	Average per cent Fat.	Average Profit over Feed between calvings (labour, manure and calf not included.)
	Years.			Lb.	p.c.	\$
67	3 and over..	All breeds and grades...	348	7,333	4.25	60.30
11	2.....	Five breeds.....	396	5,535	5.13	50.31
5	3 and over..	Ayrshire.....	326	8,518	4.06	73.55
5	3 " "	Canadian.....	295	4,885	4.90	44.79
5	3 " "	Guernsey.....	541	7,520	5.16	74.05
5	3 " "	Grade Ayrshire.....	422	8,672	4.08	82.86
5	3 " "	Grade Holstein.....	328	10,808	3.44	86.54
5	3 " "	Holstein.....	315	11,221	3.54	85.53
5	3 " "	Jersey.....	400	6,272	5.45	71.54

In the above valuation, butter at 30 cents per pound is equivalent to milk at only \$1.65 per hundred pounds, yet, in reality, the manufacture and sale of cream cheese, Coulommier cheese and certified milk, with a large part of the milk, has netted \$3 per hundred pounds. However, the above valuations are useful for the comparison of these productions with the average herd throughout Canada.

SESSIONAL PAPER No. 16

The possibilities of opening up fancy cheese markets by the average farmer in the vicinity of the larger Canadian cities has been well demonstrated. The increased profits from the same may be readily seen.

BEEF PRODUCTION.

Steer feeding investigational work, comparing rations and food stuffs, was again under way on the Central Experimental Farm, but was of necessity discontinued owing to the loss of buildings. The steers purchased for this work were forwarded to the Experimental Farm, Nappan, N.S., for similar purposes.

SHEEP.

The conducting of investigations with sheep on the Central Farm is continued under the same difficulty, namely, the great shortage of available land. Breeding work, on a small scale, with Shropshires and Leicesters, has, however, been most successful during the past year, and these small flocks are now in excellent condition. Lamb feeding experimental work anticipated for the winter of 1913-14 was of necessity postponed, as the sheep buildings were largely utilized for the housing of cattle. A special lamb feeding shed was constructed during the past year, in which further studies in lamb feeding are to be conducted.

SWINE.

Considering the shortage of pasture, another successful year is to be reported for swine husbandry. With the exception of one line of experimental feeding work with brood sows continued on a small scale throughout the winter, no special work was under way. Further investigational work along the lines of feeding of tankage to brood sows and litters is being taken up upon a large scale.

Three breeds of swine are kept, Yorkshire, Tamworth and Berkshire, and a fairly successful breeding season may be reported.

LIVE STOCK BUILDINGS.

The Animal Husbandry Division has during the past year prepared or assisted in the preparation of plans and specifications for a large number of live stock buildings erected on branch Farms and Stations. The new barns at the Central Experimental Farm, Ottawa, are also being planned and constructed under the immediate supervision of the Animal Husbandry Division. Many plans of farm buildings and specifications for the same have also been sent out during the year, free of charge, to individual farmers who requested assistance along such lines. Such inquiries are being encouraged as much as possible.

MISCELLANEOUS.

The correspondence of this Division, pertaining to feeding, breeding, care and management, and housing of animals, together with the prevention and treatment of many of the minor ailments of all classes of stock, has largely increased during the past year.

The Dominion Animal Husbandman, in attending to his duties outside the Central Experimental Farm, has officially visited many of the branch Farms on which live stock work is being conducted. In addition to such official trips, both the Dominion Animal Husbandman and the Assistant Dominion Animal Husbandman have made many trips attending meetings in various parts of Canada, judging at numerous exhibitions, and studying live stock conditions and the needs for experimental work and demonstrational work relating to live stock.

DIVISION OF FORAGE PLANTS.

The work of the Division of Forage Plants is in general of an entirely scientific nature, the aim being:—

1. To produce superior varieties and strains of forage crops.
2. To ascertain the value of the different varieties for the different environments of Canadian soils and climate.
3. To investigate thoroughly the value of both native and foreign plants that are or may be used for fodder.

Owing to the fact that the Division has only completed the second year of its existence, the breeding work is not very far advanced, and definite results cannot be expected within the next two or three years.

The breeding work which at present demands the greater amount of attention is that with leguminous forage plants and grasses. Among these two classes of plants the species with which work on as large a scale as possible is being conducted are: Alfalfa, red clover, alsike clover, timothy and orchard grass.

CLOVERS AND ALFALFA.

In the breeding of leguminous forage plants, including alfalfa and clovers, two main objects are kept in view, namely, breeding for increased hardiness and breeding for increased yield and superior quality.

At present all the various commercial varieties of alfalfa and clovers are composed of numerous radically different types, a few of which possess the desired characters, and many that do not. This fact was very clearly demonstrated on the alfalfa plots growing at the Central Experimental Farm during the early spring of 1913 when they were put to a very severe test by the extreme freezing and thawing. This test was so severe that some of the plots that had previously withstood several winters were almost entirely killed out. The remaining plants, however, may be said to represent hardy types, and the most desirable of them have been used as a basis of material for further breeding work, and were either self-fertilized or crossed by hand. The resulting seed will be used next year to obtain individuals for pedigree breeding.

A similar course of procedure is also well under way with red clover and alsike, the only difference being that, as the different individual plants of these two clovers are sterile to their own pollen, the pedigree breeding must be accomplished by the crossing of specially selected mother plants.

In order to secure a strain of variegated alfalfa of known origin, crosses were made between the true alfalfa (*Medicago sativa*) and yellow lucerne (*Medicago falcata*). The individual plants obtained from the seed resulting from this cross will be self-fertilized, and subsequent desirable segregations fixed by repeated self-fertilization.

As a source of material for further breeding work, 1,200 individual plants of alfalfa of varied type were transplanted into the field, and it is hoped that next year many desirable types will appear that will be fixed by either self-fertilization or crossing.

A corresponding number of individual plants of red clover were also transplanted to the field during July, and will be used as a source of material for the selection of suitable mother plants for crossing.

In addition to this, a line of experiments for the production by mass selection of hardy strains of red clover and alsike, was started this season at several of the branch Farms and at Ottawa. Seed was obtained from several private growers and seedsmen in different parts of Canada. Each lot of seed has been used for two plots

SESSIONAL PAPER No. 16

at the branch Farms and three at Ottawa, and it is hoped that it will be possible to show, by actual figures, the comparative hardiness and value of these different regional strains. By conducting similar experiments during succeeding years from the seed that will be obtained from these and following plots, it is only reasonable to suppose that a gradual elimination of the undesirable and less hardy individuals will take place, and a more hardy strain be finally produced.

GRASSES.

Timothy.—During 1912, forty-two lots of individual timothy plants were each obtained from the seed of a single wild plant, and in 1913 the entire lot amply demonstrated the polymorphous character of the species. Also the fact that many of the lots were very similar in general character, showed that the morphological characters of these plants are in general hereditary.

Seventeen of the most vigorous and desirable plants among those lots were isolated and self-fertilized. From the resulting seed, individuals will be obtained next year, which will be tested for characters that would make them worthy of further investigation.

From the year's experience it is a moderate estimate to state that it will be possible to produce a uniform strain of timothy within the next few years, having a yielding capacity 25 per cent greater than any timothy now obtainable commercially.

As further material for future breeding work, 2,400 individual timothy plants obtained from lots of seed produced chiefly in western Canada, were transplanted into the field during the summer.

Orchard grass.—Work similar to that with timothy was also started in 1912 with orchard grass. In this species the range of type is even greater, while the morphological characters seem to be as readily transmissible.

From the 200 individual plants transplanted into the field in 1912, ten of the most desirable were selected and self-fertilized. From the seed obtained from these plants, individuals will be obtained and subjected to a test similar to that for timothy.

Other grasses.—For the season of 1914, work similar to that with timothy and orchard grass will be started with western rye grass, meadow fescue and one or more of the, at present, uncultivated species of *Agropyrum*.

FIELD ROOTS AND INDIAN CORN.

During the season of 1913 the usual variety tests with field roots and Indian corn were conducted at the Central Experimental Farm and at the various branch Farms, a total of 27 varieties of turnips, 19 of mangels, 6 of sugar beets and 15 of corn being tested.

Previous to 1913 each variety was grown in a single plot and the yield per acre calculated from the same. For the season of 1913, however, the tests were conducted in duplicate plots, situated in different parts of the field, thus eliminating in some measure the disturbing influence of varying soil conditions upon the comparative yield of the varieties, by averaging the results from both plots. The results for the season from this method of variety testing were very instructive, and it will be continued in the future.

For the coming season, several apparently inferior varieties have been dropped from the tests, while, on the other hand, a few new ones have been introduced. Among the introductions into this line of experiment are several promising Swedish and Danish varieties of turnips, mangels and carrots.

Root breeding.—From several of the varieties of mangels, carrots and turnips that have averaged highest in dry matter per acre for the past ten years, 200 seed roots were selected in the fall of 1913. These roots have been carefully stored and will be planted in the spring of 1914, thus making a start in systematic root breeding.

HERBARIUM.

The collection of Canadian grasses and sedges started in 1912 has been increased during the past year to the extent of several hundred species.

Arrangements have also been completed with the Botanic Garden, Lund, Sweden, to exchange collections of Canadian flora for grasses and sedges from Sweden, Norway, Finland and Denmark. In accordance with this arrangement a duplicate collection of 1,000 sheets has been exchanged for an equally large collection of grasses and sedges from northern Europe.

BROOM CORN.

The experiments with broom corn have so far shown that an early seeding is essential in the vicinity of Ottawa. In 1913, a small quantity of marketable brush was produced, but whether the crop will prove profitable cannot, as yet, be determined from the results at the Central Experimental Farm.

POULTRY DIVISION.

The work of this Division is to investigate all poultry problems that are of interest to farmers and poultrymen. This experimental work includes breeding, incubation, brooding, rearing, feeding, housing, the production of flesh and eggs, diseases, etc., and to carry out this work turkeys, geese, ducks, guineas and ordinary fowl are utilized.

The major portion of the experimental work is conducted at the Central plant at Ottawa, where special equipment and assistance are maintained. The Experimental Farms and Stations at which poultry plants are being installed are used more in the nature of demonstrations, though experiments having a local value are also conducted there.

The plant at the Central Farm, Ottawa, consists of about 5 acres, upon which the main buildings are erected, and 12 to 14 acres of park and water at a short distance away, where the experiments in turkeys and waterfowl are being conducted. This latter portion has been but lately added to the plant, and the buildings as yet are not complete.

During the past year several new buildings have been added to the plant on the Central Experimental Farm; these consist of a feed and storehouse; an experimental breeding house, and a cockerel house, which is also used as a brooder house.

As a rule, about 300 laying hens are kept on the Central plant, including the most popular utility breeds and varieties. This year two breeds of turkeys, five of ducks, three of geese, and one of guinea fowl are being introduced.

The incubators are one Mammoth of 1,200-egg capacity and eight or ten small lamp machines of the recognized standard varieties. The brooders consist of individual electric hovers placed in one wing of the cockerel house, one room brooder stove and a number of individual hovers, portable and otherwise.

Poultry work has not as yet started at all of the branch Farms and Experimental Stations. This year, however, work was started at Agassiz, B.C., Invermere, B.C., Lethbridge, Alta., Lacombe, Alta., Indian Head, Sask., Brandon, Man., Cap Rouge, Que., Nappan, N.S., Kentville, N.S., Fredericton, N.B., and Charlottetown, P.E.I. A start on the other Farms will in all probability be made next year. This work is more in the nature of 'farm poultry' than 'poultry farms.' The extent of the

SESSIONAL PAPER No. 16

stock which is being kept at these Farms is enough for one man to look after. At some of the Farms only one breed is kept but never more than three. It is not the intention to recommend to the farmer the keeping of several varieties, but rather the proper choice of a suitable variety followed by judicious selection, year after year.

At all of the plants it is the intention to have both portable and permanent houses; the portable house is small enough to be moved easily from place to place, the permanent house large enough to hold about 100 hens, which is the size of the flock recommended for the average farmer. At several of the Stations, notably Cap Rouge and Lacombe, turkeys, geese and ducks are being experimented with, and at Invermere, B.C., a speciality is being made of turkeys.

One of the main experiments which are being conducted is the production of a laying strain in several of the utility varieties. Just as soon as such a strain is established at the Central Experimental Farm, cockerels from this strain will be supplied to the Branch Farms for breeding purposes. The cockerels from subsequent matings will be available to the farmers and for those wishing breeding stock from the branch Farms. Practically no stock or eggs will be sold from the Central plant, as the surplus stock will be distributed to the outlying Farms and the eggs used for incubation and experimental work.

As the male is recognized as exerting more influence than the female on the high production of eggs, this system of supplying cockerels from high egg-producers should result, in time, in good laying strains on the branch Farms and they in turn, will distribute the cockerels raised to the farmers. The final results in the farmer's flock can mean only a higher average egg production.

Experiments in cotton front houses are being continued, and among the new experiments are: Breeding, to determine how far the male and the female are responsible for stamina, vitality, fertility, production of egg and meat, colour of plumage, type, sex, etc.; incubator and fertility tests that cover numerous phases of the subjects; brooding to discover cause and remedy of mortality among chicks; confined runs versus free range to determine effect on breeding stock and reproduction; feeding screenings from Port Arthur elevators to determine their value for poultry; the shipping of eggs by parcel post versus express; the practicability of shipping breeding eggs that are partially hatched, and from which the infertile eggs have been removed; ducks, Indian Runners for egg production and Pekins for market purposes; geese as a farm crop, best method of management, feeding and rearing turkeys; artificial versus natural methods; study of Blackhead, etc.

TOBACCO DIVISION.

The experimental work of this Division, as distinguished from the supplying of information to the public through the medium of reports, bulletins, correspondence and samples, is conducted at the Central Farm, Ottawa, and at the Tobacco Stations at St. Jacques l'Achigan and Farnham, in Quebec, and Harrow in Ontario.

RESULTS IN 1913.

CENTRAL FARM.

Fermentation.—The fermentation of the 1912 tobacco crop was finished by the end of May, 1913, on which date the packing was commenced. At the present time, the tobaccos are finishing the ripening process in the boxes.

Crop.—The seed sown germinated well and furnished an abundance of good material for transplanting early in June. The plantation specially devoted to the growing of tobacco for seed gave an abundant yield.

Among the new varieties tried, certain Italian hybrids gave results which encourage the hope that they may be used in the production of the yellow tobaccos in southern Ontario.

FARNHAM, QUE.

Crop.—Sowing was very successful and the seedlings were fit for transplantation late in May. This work was, however, hindered by rainy weather and injuries by insects.

One cannot obtain at once, on land freshly broken from old meadow, tobacco of an elastic texture, but the yield in weight was satisfactory, except on one plot which could not be manured, and received only one application of artificial fertilizer.

The principal varieties grown were the Comstock Spanish, Havana Seed Leaf, Yamaska and Big Ohio X Sumatra. They gave tobacco of a fair quality with the exception of Big Ohio X Sumatra, the product of which was somewhat lacking in elasticity.

Improvements made.—Among the principal ones may be mentioned new fencing, the drainage of some 15 arpents of land, and the building of a dam to control the brook running across the Station.

HARROW.

Sowing.—This was, as a whole, successful and an abundance of good plants was obtained. The conclusions from the experimental work of the year may be summarized as follows: Sow early, replace the cotton covers by glass, sow thinly, renew the soil in the seed bed often, and disinfect it either by formalin or steam.

Brown rust of the seedlings was frequently noticed. Not only is the yield insufficient from attacked plants, but each time a diseased specimen is used in transplanting, the evil is increased by spreading it over the whole field.

This disease was made the subject of communications to the press, giving the nature of the disease and the methods of fighting it. These methods will be proved by experiment.

Plantations.—These suffered at first from drought. Rains later brought on a normal growth when on August 3, a very violent hail storm destroyed all hope of a crop.

EXPERIMENTAL STATION FOR PRINCE EDWARD ISLAND.

CHARLOTTETOWN, P.E.I.

CHARACTER OF SEASON AND GENERAL CROP NOTES.

The winter of 1912-13 was exceptional in character. There was severe frost which entered the ground to a great depth owing to the long periods when the ground was bare. Snow lay on the ground very little more than one month, or from the middle of February to the middle of March. Much injury was done by the sudden changes of March, which caused great freshets washing out huge trenches and gullies in unlooked-for places. The very warm weather of April brought the grass and trees forward about two weeks ahead of previous years. May was so cool that growth almost remained at a standstill. June was similar to May. The weather was favourable to the thorough working of the land and the transplanting of vegetables and flowers. The grasses and clovers thickened up in the bottom but made but little growth. Corn remained at a standstill. July was favourable for all crops, and during August a good hay crop was saved in splendid condition. There was good harvest weather in September. The rainfall of October was excessive and almost continuous. The warm, moist weather was ideal for the growth of the roots, but sprouted the late grain very badly, the greater part of which was not saved in good condition until the drying winds of November came. A light frost occurred Sep-

SESSIONAL PAPER No. 16

tember 30 which only touched plants on low lands. No frost occurred in October. The weather conditions favoured the late annual and perennial flowers so that there was wonderful autumn bloom. The lawns remained green throughout November. The very heavy snowfalls and severe frosts made the winter of 1913-14 one long to be remembered.

NEW AREAS.

The areas of land acquired just previous to the commencement of the fiscal year were cleared of unnecessary trees, fences and rubbish. New fences were constructed around them and the posts painted.

BUILDINGS.

Two colony houses, a Simplex brooder house and a few small rearing buildings were added to the poultry plant. Some repair work was done, including the putting of a foundation under the kitchen of the Superintendent's residence.

UNDERDRAINAGE.

Thirty thousand feet of drain tile was purchased for the new areas, and tile was laid on most of the Conolly property before winter set in. The remainder will be laid early in the spring of 1914.

HORSES.

A team of draft mares was purchased locally in the fall for farm work. The six horses at the Station on March 31, 1914, have been healthy throughout the year and are ready for the spring work.

BEES.

Two colonies of Italian bees were purchased locally. Five colonies of black bees were ordered for this section by the Dominion Entomologist from Bridgetown, N.S., in the spring of 1913.

The bees from Bridgetown arrived in very bad condition, the hives and combs being broken and the bees killed so that the express company paid two-thirds of the first cost of the colonies. There was left of this shipment of black bees one fairly strong colony and two very weak ones. The weak ones were built up by transferring combs of brood from the Italian colonies. Italian queens were also introduced into those colonies.

The bees produced a good quantity of honey which was extracted. They refused to fill any comb sections. On November 7, 1913, thirty-one pounds of sugar syrup was fed to them. The five colonies came through the winter in good condition.

CO-OPERATIVE WORK.

Co-operative work was continued with cereals on a number of farms. The results of these and of the experimental plot work with cereals will be found in the detailed section of this report.

FARMERS' PICNICS AND VISITORS.

Nineteen Farmers' Institutes came to the Farm during the summer. The leading men of the province and many distinguished visitors added much to the educational value of these pleasant picnics by giving instruction and delivering addresses that were appreciated by the farmers and their wives. The attendance increased

greatly over the previous year, reaching the 400 mark on August 21, when four Institutes arrived on the same day. The number of visitors recorded during the year was 6,906.

EXHIBITIONS AND SEED FAIRS.

The Station exhibits at the county fairs and the provincial exhibition were much larger than on previous years and attracted much favourable comment. A display was made at the first Annual Flower Show on August 28 and 29. This show proved to be a great success. It was held by the Floral Association of Prince Edward Island, and the interest in improving the residences and parks of the towns and the homesteads in the country is quite marked. The Superintendent judged at the fall exhibitions and the seed fairs held during the winter.

AGRICULTURAL MEETINGS.

The Superintendent gave addresses at the fall exhibitions and at the seed fairs and at as many institute meetings as time permitted. Many farmers were visited personally in different sections of the province, and farm work discussed.

Instruction was given in Field Husbandry to the students taking the Short Course in Agriculture held at Charlottetown during the first part of January, 1914, and at the several Short Courses in Household Science on the 'Improvement of the Farm Home.'

At the request of the different Boards of Trade, the Superintendent gave illustrated lectures in Charlottetown and Summerside on 'Landscape Gardening' and the 'Improvement of the Home Grounds.'

CONVENTIONS AND ASSOCIATIONS.

The Superintendent attended the various agricultural conventions and association meetings in the province; the Nova Scotia Fruit Growers' Association at Kentville, N.S., and the associations held in connection with the Maritime Winter Fair at Amherst, N.S.

DISTRIBUTION OF SEED POTATOES AND SALE OF SEED GRAIN.

Thirteen samples of potatoes were sent out in April; ten lots of Banner oats and three lots of barley were sold to farmers for seed purposes in the spring of 1913. A quantity of Banner oats has been registered with the Canadian Seed Growers' Association and sealed by their inspector and will be sold to the farmers in the spring of 1914.

SESSIONAL PAPER No. 16

METEOROLOGICAL RECORDS.

MONTHS.	TEMPERATURE FAHR.				PRECIPITATION.					
	Maximum.		Minimum.		Rainfall.		Snowfall.		Total Pre.	Bright Sunshine.
	Date.	Degrees.	Date.	Degrees.	Days.	Ins.	Days.	Ins.		
April.....	26	78 ³ / ₄	8	17.5	12	3.09	5	7.75	3.86	148.8
May.....	6	68 ³ / ₄	9	28.5	20	2.9	1	1	3.	195.6
June.....	11	73	1	33.5	14	1.27			1.27	255.5
July.....	4	83.5	1	44	14	4.01			4.01	222.2
August.....	16	79.5	21	43	10	2.89			2.89	251.2
September.....	2	75	30	39	13	3.98			3.98	182.3
October.....	7	70	1 & 31	33	17	7.71			7.71	66.3
November.....	10 & 11	61	29	18	10	1.65	4	4.4	2.09	101.6
December.....	8	56	16 & 17	7	6	2.11	10	16.5	3.76	62.5
1914.										
January.....	25	45	21 & 23	- 6	2	.73	11	32	3.93	79.6
February.....	8	43	22	-21	3	.08	6	35.5	3.63	138.3
March.....	17	44	21	8	7	3.46	5	14.85	4.94	128.5
Total Annual..					128	33.88	42	112.00	45.07	1,832.4

NOTE.—One inch of rain is figured as equivalent to ten inches of snowfall.

EXPERIMENTAL FARM FOR NOVA SCOTIA.

NAPPAN, N.S.

THE SEASON.

During the winter of 1912-13, the snowfall was light, with no severe frosts in the latter part of the season. Over 2 inches of rain fell on March 27, doing considerable damage by washing, especially on the ploughed sidehills.

The weather in April was variable and broken, with a very warm wave from the 21st to the 26th. Seeding started on May 6 and was general by the 10th. It was retarded by wet, cold weather, frost being recorded on nine nights between the 1st and the 18th. Seed sown germinated very slowly.

June was cooler than usual and the rainfall was lighter. Seeding and planting were fairly through by the 21st. Growth was slow until the latter part of the month. July was dull and wet, but growth was rapid. Haying was delayed but most of the clover hay was secured in good condition.

August was brighter and most of the grain was ready to cut by the end of the month. September was, on the whole, suitable for harvesting operations and the greater part of the early-sown grain was harvested without damage, but that sown late was unfit to cut until October and was greatly injured by the frequent rains of that month.

November gave seasonable weather, but the heavy October rains had made the land so wet that the root harvest was carried on under great difficulties and ploughing could not be done to any advantage. Cold winter weather set in on December 27.

NOTES ON THE WORK.

Live stock.—The experiment of grading up the common cows of the district by the use of a pure-bred sire, commenced in 1911, was continued successfully this year and further data of interest gathered, though conclusive results cannot be expected for some time to come.

Up to date, all progeny give strong indications of being superior to the foundation stock.

The experiment in feeding steers was very successful, both in data gathered and profit made. The steers were divided into two main groups, on a basis of type, into good butchers and good stockers. These were each subdivided into heavy-fed and light-fed groups, each of which was further subdivided into lots fed different rations. Details of the experiment will be found in the report of the Division of Animal Husbandry.

A sheep feeding experiment similar to that conducted in 1912-13 was carried on. Fifty-six grade wethers were purchased for the test. These were divided into four lots and fed on different rations. Lots 1 and 2 received clover hay and meal; lots 3 and 4 timothy hay and meal; lots 1 and 3 also received roots in addition to the meal ration. The average net profit per head in each lot was: Lot 1, \$2.51; lot 2, \$2.53; lot 3, \$2.26; and lot 4, \$1.95.

Owing to the limited accommodation for swine, little work was done in experimental feeding. New colony houses were built and all swine were wintered in them. While they took just a little more attention and feed when wintered in this way, their healthy condition more than compensated for it.

A new flock of pure-bred Shropshire sheep has been established. These animals are more typical of the breed than were the former flock. The Leicester flock formerly at this Farm was transferred to the Experimental Station, Charlotte-town, P.E.I.

A number of new colony houses for poultry were built. These are of different styles in order to study the relative suitability to the district. Three breeds of fowl are now kept, Barred Rock, White Wyandotte and White Leghorn.

Cereals, Corn for Ensilage and Roots.—In cereals, twelve varieties of wheat ranged from 24 bushels to 42 bushels per acre. Twelve varieties of oats ran from 48 bushels 8 pounds to 61 bushels 26 pounds; six varieties of two-row barley from 33 bushels 16 pounds to 50 bushels and six varieties of six-row barley from 29 bushels 3 pounds to 45 bushels 40 pounds.

The buckwheat plots did not do as well as they might, owing to the presence of couch grass. Five varieties were sown with yields from 32 bushels 24 pounds to 44 bushels 8 pounds.

Peas were very late and the returns, owing to the injury from heavy rains, were not worth reporting.

Five varieties of ensilage corn ranged in yield from 12 tons 1,500 pounds to 16 tons 700 pounds per acre.

Sugar beets did fairly well, the three varieties tested yielding from 13 tons 1,000 pounds to 13 tons 1,500 pounds. Twelve varieties of turnips gave yields of from 30 tons 1,000 pounds to 42 tons 1,000 pounds per acre; eleven sorts of mangels from 16 tons 500 pounds to 32 tons 1,200 pounds; six varieties of carrots from 16 tons 1,000 pounds to 23 tons 1,000 pounds. Twenty varieties of potatoes gave from 173 bushels 20 pounds to 556 bushels 40 pounds.

Fruits and vegetables.—The apple crop was hardly up to the average, and scab was much in evidence. On the Farm, the small commercial orchard made very vigorous growth during the season, and some of the early varieties, such as Duchess and Wealthy, produced some fruit.

The season was not favourable to bush fruits, the yield was only medium and the growth fair. Strawberries were below the average in yield owing to the previous

SESSIONAL PAPER No. 16

wet autumn preventing their being properly cleaned out. There was also some winter-killing.

The vegetable garden was placed in a piece of ground naturally wet, which, with the heavy rains and the fact that the drains became plugged up with tree roots, kept the ground very heavy throughout the season.

Both annual and perennial flowers did exceptionally well.

An exhibit of farm produce was made at Halifax, September 2 to 12, and also a honey exhibit at the Maritime Winter Fair.

During the year, the Superintendent gave a number of addresses at various points throughout the province.

The number of visitors during the year was about 1,369.

METEOROLOGICAL RECORDS, NAPPAN, N.S.

MONTH.	TEMPERATURE F.			PRECIPITATION.			Total Sunshine.
	Mean.	Highest.	Lowest.	Rainfall.	Snowfall.	Total.	
1913.		°	°	Inches.	Inches.	Inches.	Hours.
April.....	40.03	71	14	3.01	4.5	3.46	132.70
May.....	47.75	67	26	2.38	2.38	169.15
June.....	54.56	74	31	1.97	1.97	265.90
July.....	62.33	82	41	4.98	4.98	226.05
August.....	61.00	80	33	3.76	3.76	238.10
September.....	54.59	78	31	2.70	2.70	165.95
October.....	55.28	72	28	7.83	7.83	71.30
November.....	38.09	65	10	1.63	4.0	2.03	115.45
December.....	27.50	55	0	2.65	16.0	4.25	80.20
1914.							
January.....	13.5	46	19	1.80	12	3.00	92.40
February.....	7.5	42	27	.30	23	2.60	133.50
March.....	30.17	46	8	1.93	2	2.13	107.85

EXPERIMENTAL STATION FOR THE ANNAPOLIS VALLEY,

KENTVILLE, N.S.

THE SEASON.

April, on the average, was about 3 degrees higher in temperature than the average of previous seasons, and May on the other hand averaged 3 degrees lower than previous seasons. The result was that apples started to leaf out toward the latter part of April, but made little growth until the latter part of May. This gave an excellent opportunity for apple scab to obtain a start on the partially-opened leaves. Where the trees were not sprayed early to protect the partially-grown foliage, scab developed rapidly, and from this infection a great loss resulted to the growers from spotted fruit and destroyed foliage. The following months to October were, on the average, 1 degree in temperature lower than the average of previous

years. October was abnormally high in temperature and the average was nine degrees above that of former seasons. November and December were seasonable months. January during the first two weeks was very cold, the thermometer registering to 5 degrees below zero. This was followed by a warm spell and the ground completely thawed out. From the 10th to the last of February the coldest weather ever experienced in the valley is reported, the temperature going below zero on eight different days and falling to as low as 17 degrees below zero. There was little snow on the ground, and the frost entered to a great depth. High winds accompanied the cold, and cellars supposed to be frost proof were penetrated.

The rainfall was light during June and August, and crops suffered, the potato crop especially being much reduced in yield. October was an unusually wet month and rain is recorded on twenty days with a total of 9.60 inches, or about 20 per cent greater than the average. This, with the warm weather, favoured the forage crops; roots especially made good growth during the month. The first fall frost of 1 degree was recorded on October 1. The only other frost recorded for the month was on the 23rd, when the temperature fell to 32 degrees. During the first week in November, frost occurred every night and 11 and 10 degrees were recorded on the 3rd and 4th respectively.

There was a short period of sleighing during Christmas week, and fair sleighing from the 19th to the 24th of January; again from the 15th to the end of February, and for a week in March. Brooks and streams thawed out early in March, but the weather remained cold and dull for the most part.

METEOROLOGICAL RECORDS.

MONTH.	TEMPERATURE F.			PRECIPITATION.			Total Sunshine. Hours.
	Mean.	Highest.	Lowest.	Rainfall.	Snowfall.	Total.	
1913.	°	°	°	Inches.	Inches.	Inches.	
April.....	41.9	77	19	4.29	4.29	137.1
May.....	46.2	70	27	3.17	3.17	178.2
June.....	56.7	78	33	1.23	1.23	270.1
July.....	65.4	87	44	3.72	3.72	252.1
August.....	63.3	86	36	1.70	1.70	238.4
September.....	54.3	84	35	2.55	2.55	156.6
October.....	56.5	74	31	9.60	9.60	57.8
November.....	38.4	65	21	1.97	1.97	111.5
December.....	23.44	55	6	3.02	13.75	4.39	74.65
1914.							
January.....	19.68	53	5 below	1.18	16.25	2.80	91.6
February.....	14.19	43	17 below	.79	18	2.59	118.7
March.....	30.72	50	11	3.13	6	3.73	118.2
Total for year.....				36.35	54.00	41.74	1,804.95

SESSIONAL PAPER No. 16

CROPS GROWN.

Thirteen acres were planted to potatoes. Nine acres were sown besides the experimental plots, but the yield per acre was only $117\frac{1}{2}$ bushels, the light crop being due to the dry weather and the poor land on which they were grown. Ten acres of corn planted gave 82 tons of ensilage for the silo. It was fairly well matured when cut. Ten acres of oats averaged 38.6 bushels per acre. Other than the turnip test plots there were 4 acres in turnips which yielded 2,362 bushels. One-half of these were grown on a piece of land that had been cleared of green stumps the previous season, and commercial fertilizers only were used. The soil was very poor and light.

The hay crop was small owing to the area in grass being limited, consisting of 8 acres of dyke land and 3 acres in the ravine south of the main road; 23 tons were harvested. Fifteen acres were sown to buckwheat and ploughed under on the newly-broken land.

FRUITS PLANTED.

Two trees each of 314 varieties of apples, pears, cherries, peaches, plums, quinces and apricots were planted. In addition to this, several larger experimental blocks were set to apples, plums, cherries and pears, making a total of 1,590 trees planted, consisting of 800 apple, 336 plum, 16 pear, 134 cherry, 75 peach, 10 apricot and 10 quince. There are 33 acres now planted with young fruit trees. Thirty-one varieties of grapes, nine of gooseberries, thirty of currants, sixteen of blackberries, eight of raspberries, ten of strawberries, making a total of 1,972 plants of small fruits, were set. The fruits have, with a few exceptions, made good growth.

LAWNS AND PLANTING OF SHRUBS AND TREES.

About five acres around the buildings at the front of the farm are too rough and broken to be of any value except for ornamental purposes; accordingly this has been graded and planted in part with shrubs and trees. This area is very poor and owing to the dry season the grass made a very feeble start, but gained somewhat at the end of the season with the favourable fall rains. The shrubs and trees have done well with the exception of the evergreens which were largely a failure and which it will be necessary to replant. An avenue of sugar maples planted along the principal road through the centre of the farm has made an excellent growth; a grass plot 10 feet wide has been left at each side of the road.

ROADS.

The roads have been greatly improved by grading where necessary and new roads have been constructed to the back of the farm. An approach was made to the ravine half-way toward the south end. This was difficult to construct owing to the abrupt character of the bank and to the fact that the sandstone lies near the surface, which made it necessary to do considerable blasting with dynamite.

FENCING.

Nearly $2\frac{1}{2}$ miles of fence were constructed around the farm. Cedar posts were set a rod apart and wire was used. The east fence was particularly difficult to construct owing to the rough nature of the land along the upper edge of the ravine, and also because of rock near the surface, which had to be blasted.

CLEARING LAND.

In addition to freeing land, already broken, of roots and stone, 17 acres in green stumps were cleared and ploughed. This land for the most part is covered with hardwood stumps and large hemlock and spruce stumps. The hardwood has made a thick sprout growth which keeps the roots green and renders the task of clearing doubly difficult. It is necessary to use considerable dynamite, and hand stumping machines are also employed. An effort was made to have the work, or part of it at least, done by contract, but no one could be got to undertake it. The large-size Manitoba brush breaker is used to plough the land, and three pair of oxen are necessary to break the thick network of roots. One 10-acre area cost \$218.75 per acre. The other seven acres cost \$282.40 per acre.

Ten acres were brushed over during the summer at a cost of \$20 per acre. This will be burned over next spring and it is thought that by cutting in the summer and burning it about the middle of June, the stumps will not make sprout growth and will rot rather than remain alive as at present on the acres being cleared.

DYKING.

Dykes to the extent of 2,525 feet were constructed around the marsh area during the summer. It is proposed to put the 8 acres enclosed by this dyke into good shape next season by draining and ploughing.

OVERFLOW WATER.

Since the areas at the rear have been cleared up, trouble is caused in the spring and after much rain by the heavy flow of water from the fields which damages the crops and carries the top soil from the upper to the lower areas. Three hundred feet of 15-inch drain was put in at one point to carry off this water, and much time has been spent in constructing surface stone drains and catch basins. It is hoped that these may in part overcome this trouble.

APIARY.

An apiary has been started and four colonies of black bees were carried over the winter.

BUILDINGS CONSTRUCTED.

An ice-house 16 by 20 feet was put up during the summer. Seven poultry colony houses 8 by 12 feet each were also built. A building 8 by 12 feet was erected near the apiary for apiary supplies and a workroom.

STOCK.

In addition to the six working horses and one driver, three pair of oxen are kept during the summer for breaking land. The ox teams are better than horses for this work as they are much more steady on the uneven ground. Eleven Short-horn cows and one bull were purchased; four have given heifer calves and one a bull calf. This stock is all in excellent condition. Eighteen steers were bought in November at a cost of 5½ cents per pound, live weight, and were sold the last of March at 7¼ cents per pound live weight. They weighed at the start 18,905 pounds, and, when sold, 22,910 pounds, a total gain of 4,005 pounds.

SESSIONAL PAPER No. 16

EXPERIMENTAL ORCHARDS.

Experimental orchard work has been conducted at Falmouth, Hants county; Berwick, Kings county; and Bridgetown, Annapolis county. The object is to determine what materials are best for the control of orchard insects and diseases, and the most profitable for the fruit grower. The time and method of application and problems relating to cultivation and fertilization are being studied at these stations. The work of Berwick and Falmouth has, during the past season, been in the charge of Mr. J. M. Robinson, B.S.A., assistant at the Kentville Station, and at Bridgetown, Mr. M. B. Davis, B.S.A. has had charge. The work so far proves conclusively that even in seasons favourable for scab development, such as the one just past, thorough applications in season of lime sulphur or Bordeaux will give practically clean fruit. Experiments in thinning of fruit have also been conducted and much data of value secured.

FERTILIZER EXPERIMENTS.

A series of fertilizer experiments combining orchard trees and agricultural crops between the trees in the young orchards was started. The crop during the past season was potatoes, which will be followed with grain seeded to clover.

EXPERIMENTS IN GREENHOUSE.

The greenhouse was used during the winter to conduct soil tests with various fertilizers, and tomatoes, lettuce and spinach were the principal crops grown.

CEREAL PLOTS.

Two plots, each of one-quarter acre, of Daubeney and Banner oats, Canadian Thorpe and Manchurian barley, Red Fife and Marquis wheat were sown. These made fair growth, but the ground came up thick with buckwheat from a crop turned down late the fall previous, and, as a result, the returns were not of a reliable nature. One bushel of each of these has been hand-picked for seeding in the spring.

FLOWERS AND VEGETABLES.

Tests were made of fifty varieties of potatoes, and 200 varieties of vegetables. All of the principal annual flowering plants were grown in many varieties, and seeds of fifty-five perennial flowering plants were started in shaded frames and will be permanently set in the perennial border next spring.

MEETINGS ATTENDED.

Addresses were given by the Superintendent at a series of meetings in Kings and Annapolis counties early in April, 1913, and in February and March, 1914. On August 27 and 28, lawns and flowers were judged for the Prince Edward Island Floral Exhibition, Charlottetown, P.E.I. Fruit was judged at the Nova Scotia Provincial Exhibition, Halifax, N.S., September 3 and 4; Hants, Kings and Annapolis Exhibition, Windsor, N.S., October 8 and 9; Cumberland County Exhibition, Parrsboro, N.S., October 16; and Maritime Winter Fair, December 9.

Meetings of the Nova Scotia Fruit Growers, Kentville, N.S., January 20 and 25; Maritime Winter Fair, Amherst, N.S., December 10; Nova Scotia Farmers' Association, Bridgewater, January 29; Dartmouth Agricultural Society, February 13, were also addressed. A series of five lectures in fruit culture was delivered to the students in attendance at the Nova Scotia Agricultural College, Truro, N.S., during February and March.

The New England apple show, Boston, was attended November 14, and also the meetings of the American Pomological Society and Society for the Promotion of Horticultural Science, November 15 to 20.

The Assistant, Mr. Robinson, also addressed a series of meetings in Kings and Annapolis counties during March and April.

EXPERIMENTAL STATION FOR NEW BRUNSWICK.

FREDERICTON, N.B.

This Station, the establishment of which in October, 1912, was noted in the report for that year, has been developed during 1913, until now there are good barns built, and good progress has been made in clearing land, fencing and draining. As there was only a comparatively small portion of the area of the station land cleared and most of this cleared land was so weedy as to be unfit for research work, but little experimental work was undertaken this year.

The weather conditions were somewhat abnormal during the season. Following a winter milder and with much less snow than the average, April was cool with a very few warm days. May was both wet and cold, and June was also wet. As much of the land was very wet naturally, this weather made it almost impossible to get any crop in the ground early. On the sod ground where it was desired to put grain, no ploughing could be done till the first of June. Rain continued until July 15, and there was but little warmth. From the 15th July till the 1st October sufficient rain fell to keep all crops growing well, but the weather might be classed as dry. Through October, the total precipitation showed 7.4 inches for the month, while 4.8 inches is the average for the last thirty-nine years. The wet weather was so continuous as seriously to interfere with all harvesting operations, and a great deal of late grain throughout the southern part of the province was spoiled, as well as serious damage done to the potato crop.

There was a good deal of frost through May, and on the 23rd June there was quite a heavy frost on the lower-lying parts of the farm. The first frost again noticed on the farm was on the 16th September, which just touched some tender plants, and there was no more till the 28th September, when most of the potatoes were blackened and the upper part of the corn plants whitened. There was no further frost till the 21st October, and there were only three days on which the sun shone in that period. The balance of the month was much brighter, though the precipitation in the ten days was 2.25 inches. There was 4 degrees of frost on the 31st, 10 degrees on the 1st November, and 17 degrees frost on the 2nd. This cold spell froze a great many potatoes in the fields and in transit.

Throughout November the weather was delightfully mild and bright, the rainfall for that month only totalling 1.14 inches.

SESSIONAL PAPER No. 16

RECORD OF TEMPERATURE, Precipitation and Sunshine at Fredericton for the year 1913.

MONTHS.	TEMPERATURES.			Precipitation.	Hours of Bright Sunshine.
	Highest.	Lowest.	Mean.		
1913.	°	°	°	Inches.	
April.....	83	15	42	2.2	160
May.....	83	27	47	4.0	181
June.....	83	34	58	1.9	257
July.....	91	47	64	5.1	213
August.....	87	36	63	4.0	244
September.....	85	29	55	2.1	192
October.....	76	26	53	7.4	57
November.....	62	4	36	1.5	107
December.....	47	-13	24	2.7	112
1914.					
January.....	51	-11	22	4.1	81
February.....	38	-20	12	2.9	123
March.....	60	-9	30	6.0	124
Total.....				43.9	1,851

BUILDINGS.

Two houses already on the place were repaired. One was fitted up for the use of the Superintendent until a residence can be built, and one for the foreman. A herdsman's house was also erected, a well drilled for water supply, and a house built over it, and pumping machinery, a pneumatic tank and air compressor installed. The various houses and barns were connected with the tank by service pipes.

A main cattle barn 50 by 100 feet, a dairy barn connected to it, 41 by 102 feet, together to house 100 head of cattle, a horse barn 30 by 90 feet, and a dairy building with cold storage attached, were erected, the cattle barn being occupied in January and the other buildings at the end of the fiscal year.

FENCING AND DRAINING.

Between 2 and 3 miles of woven wire fencing was erected, and 17 acres of land tile drained as well as over half a mile of heavy open ditch dug.

CLEARING LAND.

One hundred and fifty acres were cut over, wood removed, brush burned, small bushes cut and approximately 50 acres stumped and ploughed.

ROADMAKING.

Four thousand and thirty feet of farm road was constructed with stone foundation and gravel surface through the centre of the farm, connecting the highway on the river bank with Doak station on the Canadian Pacific railway, and the high-

way across the front of the station land was turnpiked, stone-filled in places and all gravelled. A half mile of road ditch was dug along the Wilsey road where it passes through the Station.

LIVE STOCK.

Seven draught mares, two draught geldings ranging in weight from 1,530 to 1,900 pounds, and one driving mare were purchased, making with the four grade Clyde mares already on the farm, six two-horse teams and one horse for single farm work. Eight mares were bred, but only four have proved pregnant.

Two grade cows were purchased and their milk sold to families of officers and men working on the Station.

During the winter thirty-nine cattle were bought for feeding. Feeders were very high at time of purchase and the quality of those available very poor. They will be carried along for the early summer market.

POULTRY.

Three small flocks of Rhode Island Reds, Barred Plymouth Rocks and White Wyandottes were started. Ninety-four chickens were raised and the best kept to make up three laying flocks which were wintered in colony houses. Preparations were made to conduct poultry work on a more extensive scale in 1914.

CROPS.

Six and one-seventh acres of potatoes, twelve and a half acres of Indian corn and five acres of turnips comprised the field hoed crops. As the drier land on the farm was so full of mustard, only one and a quarter acres of oats were sown there. To pull the mustard from this cost \$36. The yield was 60 bushels. Some oats and barley sown late on very wet land were a failure.

HORTICULTURE.

One and one-third acres of land were devoted to garden vegetables and flowers, etc., and twelve thousand shrubs, seedling trees, etc., were set in a nursery for future ornamental trees.

Tests were made of varieties of vegetables as to yield and characteristics and distance apart for thinning beets, carrots, etc.

POTATOES.

A variety test of 154 samples was made in rows of 66 hills each. Yields varied from 13 bushels per acre to 631 bushels, over forty varieties yielding at the rate of 400 bushels or over per acre.

Eighteen fertilizer plots to test different chemicals and combinations of chemicals were planted with potatoes. The average yield for the six and one-seventh acres, including plots where no fertilizer was used, was 288 bushels and 51 pounds per acre. The commercial plot of $1\frac{3}{4}$ acres yielded at the rate of 337 bushels and 25 pounds per acre.

Fifty-five pound samples of seed potatoes of Irish Cobbler, Green Mountain, Delaware and Carman varieties, were distributed to applicants in New Brunswick.

SESSIONAL PAPER No. 16

MEETINGS AND ADDRESSES.

The sessions of the Annual Meeting of the Farmers' and Dairymen's Association at Fredericton were attended by the Superintendent and an address given by him on the growing of Indian Corn for Silage, and the comparative results in food value from the crops of Indian corn and turnips per acre as grown at the Station.

Ten horses and four cattle were also furnished for the judging classes in connection with the same meeting.

Lectures on live stock feeding and the agricultural capabilities of New Brunswick were given before the Short Course students at the Agricultural School at Woodstock in March.

EXPERIMENTAL STATION FOR EASTERN QUEBEC.

ST. ANNE DE LA POCAITIÈRE, QUE.

CHARACTER OF SEASON.

With the exception of 1912, the season of 1913 was probably the most unfavourable for field work and yield of crops experienced for many years.

The snowfall during the winter of 1912-13 was very light, but there was an exceptional amount of rain, and the soil was covered all winter with a heavy coat of ice. This damaged grass land very much, and the clover meadows were completely destroyed.

The ice and snow were practically all gone by March 22. April, though bright, was windy and cold. It was the driest month of the season, and at its close the soil was powdery on the surface while the subsoil was still frozen.

May opened warm and dry, but became colder on the 7th, continuing cold and rainy to the end of the month. This was very unfavourable to growth.

Temperatures in June were variable and there were frequent light rains. July was rainy and cool, most unfavourable weather for haying, which was in consequence delayed in this district until August, with the exception of the hay crop on the Experimental Station, which was saved in July.

August and September gave the best growing weather of the year and the grain crops were harvested in excellent condition.

October was rainy and cold. During the month, much of the grain in this district, which had been sown in June, was harvested. In a section like eastern Quebec, where the growing season is so short and the weather so uncertain, more attention to fall cultivation is very desirable. It would avoid, to a great extent, the late harvesting of the crops and would double the chance of profitable returns.

Fall work on the land was possible up to November 20. The first snow fell on December 7. January and February were marked by extremely cold weather and frequent snowfalls, though none of them was heavy. March was a cold month, although no extremely low temperatures were registered. The snow and ice disappeared during the last days of the month.

It might be stated that the snowfall in those parts of the counties of L'Islet and Kamouraska bordering on the river and surrounding the Experimental Station is lighter than in other sections in the same latitude. This is probably caused by the low altitude and the proximity of the St. Lawrence.

ENLARGEMENT OF THE STATION.

One hundred and twenty-five arpents of land were added to the Station in the fall of 1913.

LINES OF WORK.

Twelve head of Ayrshires were sent to the Station from the Central Experimental Farm at Ottawa. These will form the nucleus of a herd.

A boar and two sows of the Yorkshire breed were received from the Experimental Station, Cap Rouge, Que. These will serve as foundation breeding stock and it is hoped to give the work with swine a prominent place in the programme of the Station.

Six colonies of bees were purchased to start an apiary. The results of the season, both in honey and in new colonies, were excellent. The district around Ste. Anne de la Pocatière should prove suitable for apiculture, and the demand for honey is good, although few farmers keep bees. It is hoped to enlarge the scope of this work, taking up both the commercial and the experimental sides of bee-keeping.

Poultry work will be commenced as soon as the poultry buildings can be erected.

IMPROVEMENTS MADE.

This work has taken up most of the time and attention during the year.

Over nine thousand feet of drain tile have been laid. This drainage work has already proved its utility and value. Larger drains have been laid from the barn yards and mains to carry off the water from the laterals.

Some one thousand loads of stone have been gathered from the fields and most of it used in the construction of foundations of the farm buildings.

NEW BUILDINGS.

A cow barn and a horse barn have been built during the year. These have been erected and fitted up in the most modern way, pleasing appearance being united as far as possible to convenience of interior arrangement, ventilation, light, ease of access and economy of construction.

METEOROLOGICAL RECORDS.

MONTHS.	TEMPERATURE F.					PRECIPITATION.			Sunshine. Hours.
	Date.	Maxi- mum. °	Date.	Mini- mum. °	Mean. °	Rain. Inches.	Snow. Inches.	Total. Inches.	
1913.									
April.....	25	82.2	8	8.6	39.4	.12	6	.72	200.6
May.....	6	87.8	7	22.0	49.2	2.69		2.69	187.7
June.....	27	82.2	22	33.8	57.9	1.53		1.53	241.5
July.....	1	83.2	30	44.0	63.4	3.64		3.64	226.8
August.....	16	81.2	25	39.2	62.4	1.34		1.34	246.8
September.....	7	81.8	13	33.2	54.3	2.81		2.91	199.8
October.....	8	75.4	31	24.2	47.5	3.42		3.42	80.2
November.....	8	63.2	27	3.8	36.5	.77		.77	89.9
December.....	9	32.2	31	-20.0	17.2	.13	10	1.13	66.8
1914.									
January.....	28	38.4	13	-30.6	12.9	.30	19	2.10	92.2
February.....	28	36.2	11	-32.6	5.9		13	1.30	104.3
March.....	17	47.0	12	-3.0	24.4	.08	12	1.28	139.8
Total.....						16.83	60	22.83	1,876.4

SESSIONAL PAPER No. 16

EXPERIMENTAL STATION FOR CENTRAL QUEBEC.
CAP ROUGE, QUE.

CHARACTER OF SEASON.

For the farmer of central Quebec, 1913 was a very good year. The spring was exceedingly early and the only drawback was the drought which lasted throughout August. Those who sowed early, cultivated their hood crops well, and attended to their work in time, did not suffer materially from this dry period.

Hay.—The mild winter of 1912-13 left bare many meadows and pastures, and there was not much clover. Still, the crop of hay was a fair one, due to the splendid growing weather of June. At the Station, it averaged over two tons per acre.

Grain.—The crop of grain was the heaviest seen in central Quebec for years. There was just enough precipitation to hasten germination, also to force vegetation, and all which was sown before May 15 escaped the bad effects of the drought of August. At the Station, oats for the trial plots were put in on the last two days of April; the main crop averaged over 78 bushels per acre.

Corn.—The drought of August was detrimental to Indian corn, and a rather early frost, on the night of September 14, cut down the yield in tons.

Roots.—Though momentarily stopped by the dry weather of August, roots recuperated under the beneficial effects of the cool nights of September and October.

Fruit.—The temperature was just right for fruit, with the exception of a frost during the middle of May. This hurt the early flowering trees.

Vegetables.—The season was as good as could be wished for. Vegetables and peppers, as well as egg plants, matured their fruit for the first time at this Station. A lot of tomato seed was saved, which shows that temperatures were favourable.

Flowers.—There was enough heat and precipitation, at the right time, for flowers.

LIVE STOCK.

All the live stock did well during the year.

Horses.—There are now seventeen horses at the Station: twelve French Canadians—nine mares, two yearling fillies, one colt; two teams of from 2,600 to 2,900 pounds weight, and a driver of about 1,000 pounds.

Experiment—Wintering a horse at low cost.—This experiment was continued for the third year.

Cost of raising horses.—Very few people have an idea of what it costs to raise a horse until he is fit to work or to sell. To throw light on this subject, it is intended to weigh the feed given to young animals. A colt dropped on May 31, 1913, had eaten food amounting to \$27.51 by April 1, 1914. On the latter date, when he was ten months old, he weighed 735 pounds. The average weight of the sire and dam of this weanling is about 1,075 pounds.

Dairy cattle.—The herd now comprises fifty-three head of pure-bred and grade French Canadians. There are one aged and three yearling bulls, twenty-seven cows, nine yearling heifers and thirteen calves. Out of this number, there are sixteen grade cows and heifers. These grades are kept to see if a profitable herd can be developed from them by using pure-bred bulls as sires. The profits given by eighteen cows which completed a lactation period during the year, were from \$107.10 down to \$24.22, neglecting the labour item.

Sheep.—There are on the Station, one ram, six breeding ewes, and eight ewe lambs, all pure-bred Leicesters. The flock is small, but the individuals very good, having character and weight. No experiment has been started yet on account of lack of accommodation. Twelve fine lambs were raised from six ewes, four rams bringing over \$40 each at the public sale held during October at Quebec.

Swine.—There are only three pure-bred Yorkshire sows. The piggery was used for horses during the erection of a new barn and there was no room for hogs. A boar bred at this Station made the highest price at the auction sale of the Provincial Government, at Quebec, in the fall of 1913.

Poultry.—A small beginning has been made in poultry keeping.

Bees.—Ten colonies were bought on June 20, a little too late for best results. The average production of honey was 31.9 pounds, and eleven colonies were put, on November 10, in a cellar especially fixed for them.

FIELD HUSBANDRY.

Yield of crops under field conditions.—The following table shows that, in 1913, swedes gave by far the most digestible dry matter per acre.

Kind of crop.	Variety.	Yield.	Digestible dry matter per acre.
Swedes.....	Good Luck.....	39,290 lb. or 654 bush. 50 lb.	3,654 lb.
Corn.....	Longfellow.....	14,524 lb. or 7 tons 524 lb.	2,367 lb.
Carrots.....	White Belgian.....	26,699 lb. or 444 bush. 59 lb.	2,350 lb.
Hay.....	Timothy and clover.....	4,118 lb. or 2 tons 118 lb.	1,919 lb.
Oats.....	Banner.....	2,659 lb. or 78 bush. 7 lb.	1,723 lb.

Cost of production of crops.—The exact cost of production was kept for 18 acres of swedes, oats and hay, with the following results:—

Kind of Crop.	Cost of 1 ton.	Cost of 1 bushel.	Cost of 100 pounds digestible dry matter.
Swedes.....	\$1.94	\$1.04
Oats.....	\$0.31	1.40
Hay (timothy and clover).....	3.8641

As the crop of clover was an exceedingly large one, it is probable that, for an average number of years, the cost to produce 100 pounds digestible dry matter in hay would be much higher than it was this year.

Rotations.—One 3, one 4 and one 6-year rotation have been compared for profit since 1911 inclusive. It is yet too early to give definite results, but the following table shows that it is advantageous to rotate crops:—

	3-year rotation.	4-year rotation.	6-year rotation.
Value per acre, 1913.....	\$28.03	\$23.14	\$22.51
Value per acre, 1911.....	16.80	12.67	15.58
Increase in 3 years.....	\$11.26	\$10.47	\$6.93
Percentage of increase.....	67	83	31

SESSIONAL PAPER No. 16

Rates of seeding corn for silage.—All the corn grown for silage for three years has been weighed, and the following figures are interesting:—

In rows 42 inches apart, plants 8 inches in row, 9 tons 1,094 pounds per acre.
 In rows 48 inches apart, plants 8 inches in row, 8 tons 1,754 pounds per acre.
 In hills 33 inches in every direction, 5 tons 1,398 pounds per acre.
 In hills 42 inches in every direction, 5 tons 1,364 pounds per acre.

VARIETY TESTS.

The trial plots are now permanently located on a piece of uniform soil where a three-year rotation is used: Roots and Indian corn for the Agrostologist, grain for the Cerealist, and hay for the experiment with different quantities of seed and to find the best nurse crop.

Roots.—Fourteen varieties of turnips (swedes), eleven of mangels, three of sugar beets, and six of carrots were tried on duplicate plots of one-fiftieth acre each. There were two check rows at the ends and also between each kind of root, so that no variety had more room or light than any other one.

Indian corn.—The three best yielding varieties for silage were, this year: Ninety Day, Salzer's North Dakota, and White Cap Yellow Dent.

Cereals.—Fourteen varieties of spring wheat, four of 2-row barley, seven of 6-row barley, ten of oats, and six of peas were sown on one-sixtieth acre plots.

Vegetables.—Three hundred and sixty-four varieties of vegetables were tested in 1913.

Seed growing.—We have grown seed from many varieties of beans, corn, cucumber, lettuce, musk melon, peas, peppers, radish, squash, tomatoes, water melon, and there seems to be no reason why we cannot grow seed of nearly all the vegetables used in this district.

Ornamental gardening.—Twenty-five varieties of conifers, 109 of deciduous trees and shrubs, 47 of roses, and over 600 of perennials, annuals and bulbs were grown in 1913, and notes were taken of each variety. We distributed over 1,400 packages of seed and as many plants of perennials. At Quebec Exhibition, we made a display of flowers and were awarded a diploma and gold medal for same.

IMPROVEMENTS.

Clearing of land.—About 15 acres were stumped and ploughed during 1913 ready to put under crop in 1914.

Drainage.—Over 32,000 feet or more than 6 miles in length, of tiles were laid in 1913. Nothing smaller than 3-inch is used, as it has been found that the 2-inch will clog very easily. The ditching machine was used, and with a careful man to run it better work can be done with it than by hand.

Horse barn.—What is probably the best horse barn in Eastern Canada was built during the autumn and early winter. It is 102 feet by 32 feet with an L 26 feet by 20 feet. The foundations and floor are concrete, it has a plank frame, and the roof is metal. There are sixteen tie and eight box-stalls, with different floorings of clay, cork, brick, wood and concrete to see which suits our conditions best. The system of ventilation is the Rutherford. Hay is brought down to each manger in chutes, whilst bedding comes through the ventilating shafts. There are twenty-eight windows, and those of the ground floor are placed at 7 feet, so that whilst the stable is very well lighted, there is no direct glare to hurt the horses' eyes. A hay fork serves to bring in the hay, and a carrier to take out manure. There is a good harness room, a feed room, and a granary above these.

With nine paddocks of from one to one and a half acres each having a neat, well-painted shed, and a stud of the best French Canadian mares which could be

bought, we have what may be considered one of the best horse-breeding plants in Quebec.

SOME WEATHER OBSERVATIONS taken at Cap Rouge Experimental Station, 1913-1914.

	TEMPERATURE F.			PRECIPITATION.				Total Sunshine.
	Mean.	Highest.	Lowest.	Rainfall.	Snowfall.	Total.	Heaviest in 24 hrs.	Hours.
	°	°	°	Inches.	Inches.	Inches.	Inches.	
1913.								
April.....	39.35	83	15.2	2.14	1.2	2.26	.83	199.8
May.....	48.95	85	25.2	3.27	3.27	1.05	207.4
June.....	57.30	84	36.2	2.53	2.53	.68	233.7
July.....	65.19	88	45.2	5.36	5.36	1.22	215.4
August.....	61.58	83	40.2	1.97	1.97	.58	230.7
September.....	56.60	82	28.2	4.01	4.01	1.95	209.3
October.....	48.96	73	24.2	4.11	4.11	.81	76.3
November.....	33.42	61	13.2	1.75	2.6	2.01	.88	61.1
December.....	21.23	37	- 1.1	.40	29.5	3.35	.80	43.4
1914.								
January.....	7.07	43	-24.8	.03	34.0	3.43	.60	57.5
February.....	.84	33	-30.7	32.6	3.26	.80	106.1
March.....	23.70	45	- 2.1	.35	26.3	2.98	.70	125.4
Total for year.....				25.92	126.2	38.54	1,766.1
Average for two years.....				33.18	131.2	46.30	1,593.7
Total for six months, May to October.....				21.25	21.25	1,172.8
Average of two years for six growing months, May to October.....				24.77	24.77	1,059.8

EXPERIMENTAL FARM FOR MANITOBA.

BRANDON, MAN.

WEATHER CONDITIONS.

The spring of 1913 opened up with favourable weather. Winter had continued late, but when warm weather came, the change was rapid. Seeding began on April 16. On the higher parts of the Farm, conditions for seeding were ideal, and it was finished early. About two hundred acres of the land along the Assiniboine river were flooded for most of the month of May, and, as a result, seeding was late and crops unsatisfactory.

The weather was very dry for the growing part of the season, the total rainfall up to the end of July being only 5.53 inches. This affected the crops on the unflooded land and prevented yields from being as heavy as are expected in a normal season.

August was a month of moderate rainfall. The autumn months were dry and the winter snowfall was light. The total precipitation for the year was less than 13 inches.

TESTS OF CEREALS.

Duplicate plots were used in the testing of varieties of grain this year, in order that the possibility of error might be lessened. Four named varieties of wheat were tested and also ten new varieties produced by the Dominion Cerealists, and known by numbers only, were given a trial. Marquis as usual gave the best results; Red Fife also showed its value for Manitoba. None of the new varieties was at all

SESSIONAL PAPER No. 16

a serious contender against these two. Of the seventeen varieties of oats tested this year, Banner was found to be the most satisfactory for general use. Ten varieties of six-row barley and seven of two-row were tested. The six-row varieties are the better for Manitoba, and of these Manchurian and O.A.C. No. 21 are recommended. Of ten varieties of field peas, Mackay is the heaviest yielder, and Arthur the earliest.

CULTURAL WORK.

The extensive system of cultural experiments inaugurated in 1911 has been continued according to the detailed plan decided upon. A great mass of figures giving yields obtained under different treatments is being gathered. It is rather early as yet for definite results from this work, but in the course of a few years more, some valuable information should be available on the different questions which are being investigated.

The experiments with rotations made rather poor progress on account of the overflowing of the Assiniboine river. Most of the land that is used for the rotations is on the lower portions of the Farm. The flood made such unusual conditions on these fields that the season's results are not of much value.

FORAGE CROPS.

Experiments with different varieties of grasses, clovers, alfalfa and mixtures of the same, gave interesting results. Alfalfa shows itself to be decidedly the most productive hay crop, no matter whether alone or in mixtures. Western Rye grass also gave very good results. Notes taken on plots of grass and clover mixtures showed that alfalfa and Western Rye grass were dominant and gradually increased their proportion of the crop.

Field crops of hay were heavy on the flooded land, but rather below average on the higher part of the Farm.

Thirteen varieties of fodder corn, twenty-two varieties of turnips, eleven varieties of mangels, three varieties of sugar beets and nine varieties of carrots were included in the tests of field roots. The dry weather affected the crop of roots and it was hardly up to average.

HORTICULTURE.

Twenty-eight varieties of potatoes were tested in uniform test rows, and were also subjected to a cooking test. A test of fertilizers applied to potatoes was also made. The usual tests of varieties of all the kinds of garden vegetables were made. Notes were taken on the appearance and table quality of these vegetables as well as on the yield and date of being ready for use.

The usual display of flowers was made, and was greatly admired by many visitors. Tulips planted in the previous fall made an especially fine showing in the spring of 1913.

Numerous sorts of trees and shrubs continue to thrive on the grounds around the Superintendent's house. Notes were taken on the growth and comparative hardiness of each.

A large crop of plums was harvested from the native Manitoba plum trees, some of which produced fruit of very good quality. Smaller quantities of Cheney, Aitken and other named varieties were also produced.

The 3,000 young seedlings of standard apples which were set out the previous year have done very well. Nearly all have wintered well and are alive to the tip.

LIVE STOCK.

The milking Shorthorn cows have done better than in previous years. One cow made a record of 11,334 pounds of milk in one yielding period. Records are being kept of the amount of feed consumed by each animal every day, and information will be available on the cost of milk production and the cost of raising calves and heifers.

An experiment in feeding steers out-of-doors was completed in the spring of 1913. In the fall an experiment was started in which dry corn fodder cured in stooks is compared with ensilage as a feed for fattening steers. The lot fed ensilage are making decidedly the better gains.

The flock of breeding ewes was used for an experiment in wintering sheep. One lot was fed in an open shed and one lot in a good barn; the ones in the shed wintered equally as well as the others. A comparison was also made between grass hay and alfalfa as a winter feed for breeding ewes, with results in favour of alfalfa. Data on the cost of feeding sheep are also being collected.

Experiments in feeding pigs showed that barley had a slight advantage over oats as a winter feed for half-grown pigs and that both were decidedly preferable to shorts. Feeding three times a day showed no advantage over twice a day for pigs of one to two hundred pounds weight. The breeding sows were increased in number and reasonably good success was attained in raising young pigs.

POULTRY AND BEES.

A man with special training in these two lines of work was engaged and began work in May, 1913. The flock of Barred Rocks was increased, and a small flock of White Wyandottes was obtained. Experimental work with cotton front colony houses showed that this type of building is quite satisfactory in this climate.

The season was not very favourable for bees as the amount of bloom was below average. However, a fair amount of honey was produced and the number of colonies doubled.

BUILDINGS.

A new horse barn was built this season, and is found to be very satisfactory. It will allow more room for cattle in the old building. A new piggery 82 feet long was also constructed. It is a good example of the best and most modern ideas in piggery construction.

Six colony houses for poultry were also built. Variations in construction were used in order to find out the best type.

A new office, 20 feet by 30 feet in size, has been built and is found to be a great help in handling the ever-growing office work in connection with the Farm.

A cottage for the herdsman was also erected and fills a much-felt want.

EXHIBITIONS.

Exhibits showing the products of the Experimental Farm, and illustrating some of the lines of experimental work being followed were made at the Dominion Fair at Brandon in July, 1913, and at the annual exhibition of the Brandon Horticultural Society in August, 1913.

MEETINGS.

The Superintendent addressed farmers' meetings at the following points in Manitoba: Deloraine, Cartwright, Morden, Manitou, Fannystelle, Culross, St. Claude, Rathwell, Cypress River, Treesbank, Methven, Carroll, Douglas, Sidney and Macgregor; judged seed fairs at the first four points above named; acted as judge

SESSIONAL PAPER No. 16

at the Manitoba Provincial Seed Fair at Winnipeg, and at the Hartney Ploughing Match.

The Assistant Superintendent addressed farmers' meetings at the following points in Manitoba: Hartney, Neepawa, Lyleton, Waskada, Whitewater, Ninga, Killarney, Cartwright, Crystal City, Lariviere, Darlingford, Morden, Plum Coulee, Rosenfeld, Kirkella, McAuley, Macdonald, Keyes, Arden, Franklin and Newdale; and judged seed fairs at the first two above named.

A wide range of agricultural topics was covered in the subjects taken up at these meetings. Among the subjects most frequently discussed were the following: 'The Work of the Experimental Farms,' 'Rotation of Crops,' 'Corn Growing in Manitoba,' 'Alfalfa Growing,' 'Mixed Farming.'

DISTRIBUTION.

During the year the following distribution was made: 392 samples of potatoes, 1 bundle of Manitoba maples, 2,200 pounds of inoculated soil for alfalfa, 500 pounds of inoculated soil for red clover.

VISITORS.

The number of visitors who inspected the Farm during the year was approximately 11,000.

METEOROLOGICAL RECORDS.

Months.	Highest Temperature.	Lowest Temperature.	Total Rainfall.	Total Snowfall.	Hours Bright Sunshine.
	°	°	Inches.	Inches.	
1913.					
April.....	82.7	18.1	.25	1	226.4
May.....	88	18	1.04	199.8
June.....	90	32	2.34	218.8
July.....	95.3	41	1.70	228.8
August.....	94	41	3.56	235.6
September.....	87.3	23	.68	199.1
October.....	81.3	- 3	.73	137.5
November.....	59.7	- 3	.04	3	93.1
December.....	41.1	-19.8	1	112.2
1914.					
January.....	38	-37.6	16	73.5
February.....	37.9	-46.4	3	134.2
March.....	44.9	-20.8	1	114
			10.34	25	1973

Reckoning 10 inches of snowfall as equivalent to 1 inch of rainfall, the total precipitation for the year ending March 31, 1914, was 12.84 inches.

EXPERIMENTAL FARM FOR SOUTHERN SASKATCHEWAN.
INDIAN HEAD, SASK.

WEATHER CONDITIONS.

On the whole, the weather conditions during the summer of 1913 were excellent for both cereal and fodder crops. Seeding commenced about the 15th of April, and the latter part of April and the first part of May were comparatively dry, which facilitated early sowing.

During the growing period of June and July, 8.3 inches of rain fell, resulting in a luxuriant growth of stem and leaf. A large crop of hay was harvested, but was somewhat difficult to cure because of the rains during July. The cereal crop ripened comparatively early and was all harvested before any frost appeared. The winter of 1913-14 was comparatively mild and stock wintered outside in good condition.

INVESTIGATIONS IN PROGRESS.

Cereals.—Four named varieties of wheat were tested on the Farm in 1913. Of the named sorts the Marquis and Red Fife seem best adapted to the climatic and soil conditions of southern Saskatchewan. The Prelude, while maturing much earlier than either of these sorts, seems unlikely to become a commercial wheat in this portion of the province because of its inferior yield.

Of twelve varieties of oats, the Banner seems to give best results. This is very noticeable when the average for five or ten years is taken. It yields high and produces an oat of good quality both for milling and feed. Another promising sort is the Victory. This has not been under test long enough, however, to enable its being recommended as highly as the Banner.

Among the six-row barley, Manchurian and O.A.C. No. 21 are the highest yielders and among the earliest maturers.

The two-row sorts are not giving as good result as are the six. They are usually weaker in the straw and do not yield so well.

It is only recently that varieties of flax have been isolated, but last season there were about ten varieties tested and among these the Premost was both the highest yielder and the earliest maturer.

In the introduction of peas in the west, early maturity is one of the most important points. For this reason, the Arthur pea is recommended. Another promising sort is the Solo. The Solo is an importation from Sweden and has not been under test long enough for final conclusion as to its value.

Forage crops.—Of the forage crops, grass is one of the most important. The results of a test made with different sorts on this Farm seem to indicate that, for hay, Western rye will give best results in this district. Brome is an excellent pasture grass but has two objections. The first is, it is hard to eradicate when the land is broken up, and the second is that it has a tendency to spread into adjoining fields and especially into hedges and windbreaks where it will eventually kill out the trees. This is more noticeable on heavy soils and where precipitation is over twenty inches per annum. Where these conditions prevail English Blue grass will make a good substitute.

The clovers are not well adapted to the light rainfalls of southern Saskatchewan. Among the different kinds, the common red clover seems to give best results.

Alfalfa is probably the best suited to western conditions of any of the legumes. It is drouth-resistant and if northern grown sorts are obtained, it proves to be perfectly hardy. Among the sorts giving best results on the Indian Head Farm are the Grimm and the Baltic.

Fodder corn is a crop that should not be neglected on any stock farm. It gives a large yield of succulent fodder. Last season a large quantity of corn ensilage was fed on this Farm and proved very valuable for both milch cows and fattening steers. Among the varieties best adapted to conditions here are Northwestern Dent and Longfellow. The former is usually the better because of its early-maturing character.

Varieties of turnips, mangels, sugar beets and carrots are grown each season on this Farm. In all about five acres of land is devoted to the purpose, as a large quantity of roots is required for winter feeding. Swedes are proving very satisfactory for conditions here.



Avenue leading to Farms, Indian Head, Kasz.

SESSIONAL PAPER No. 16

Horticulture.—A large number of varieties of the different kinds of vegetables are being tested each season and as soon as they have been in the test for five years, the five-year average will be published.

Many sorts of perennial flowers prove hardy in the west. They possibly require less attention than any other flower and give a large bloom in the early season. They also give a magnificent bloom during August and part of September.

Annual flowers are planted in smaller beds and among these asters flowered profusely.

Some of the old orchards and hedges were cut out last season and the land prepared for lawns. These were sown in early July and a good stand of grass secured. The lawn grass was a mixture of Kentucky blue grass and White Dutch clover.

Besides the trees on the avenues and windbreaks, a comparatively large arboretum is maintained. Many of the plants being tried out are proving hardy while a few are evidently too tender for conditions in the West. Of the trees that are giving best results, the Manitoba maple and Green ash are proving most satisfactory. Of the conifers some of the spruce and Scotch pine seem to be quite hardy. Among the flowering shrubs the caragana and lilac both produce an abundance of bloom early in the spring. In the orchards the crabs and hybrids gave a profusion of bloom and a heavy crop. These are proving perfectly hardy. Last year a shipment of two-year-old seedlings of those standard sorts proving to be hardy at Dunstan, Man., were received. Nearly all these lived through the winter.

A number of selected and hybrid sorts of plums were received from the South Dakota Agricultural College. These were planted and the Assiniboia, a selection of native plum, has proven most satisfactory.

A large number of the small fruits can be grown. Of these, the raspberry and currant seem most hardy.

Field Husbandry.—One of the most important lines of work under this head is the rotation tests. In this experiment, the object is not only to note the effect of each rotation on the fertility of the soil but also to find the cost of production of the various crops in each. The rotation that seems best suited to a mixed-farming district is one which includes: First year, summer-fallow; second year, wheat; third year, wheat; fourth year, oats seeded down; fifth year, hay; sixth year, pasture.

A large portion of the Farm is divided into small plots for the purpose of studying different methods of cultivation and crop management. Such questions as different systems of summer-fallowing, treating stubble, depth of ploughing, methods of harrowing, etc., are being studied.

Live Stock.—Until recently, horses were kept on the Farm for work only. The policy, however, is now changed and a start has been made to establish a stud of breeding mares.

At this Farm only Shorthorn cattle are kept. The herd has been handled until recently as a beef herd but as the demand of our farmers is for a dual-purpose cow the poor milkers are being culled out and a dual-purpose herd thus developed. With this end in view, a bull from a good milking strain was secured last fall. In addition to this work, steers are fattened on the Farm each winter. Last season twenty-eight steers were fed.

Shropshire sheep are kept on the Farm for the purpose of supplying breeding stock to farmers in the district, also to produce stock on which to calculate the cost of producing sheep in the West. In conjunction with this work, a flock of range ewes were bought some years ago and crossed with a pure-bred Shropshire ram, the idea being to see what improvement could be made in the mutton and wool qualities of range stock by the use of pure-bred top crosses. In the winter one hundred lambs were used in a feeding experiment. These were bought in the fall at 6½ cents a pound. They were divided into four lots of twenty-five each and fed

different rations. The ration that proved most economical was mixed hay, and oats and barley fed whole. No profit was made in this experiment because of the fact that the lambs were bought in the fall at a "lamb price" while they were sold in the spring with no margin at a "sheep price."

Two breeds of swine are kept at this Farm, namely, Yorkshire and Berkshire. No experimental work has been carried on with the exception of a test of wintering the sows in single-board cabins, outside, and in the piggery. The results from this test would seem to indicate that sows can be wintered to good advantage outside, one of the sows outside having already given birth to a small but very vigorous litter.

Poultry were only kept at this Farm in recent years for the purpose of supplying eggs and fowl for the table. In October, the Dominion Poultry Husbandman prepared plans of cotton-front houses. Three of these were built and eighty birds secured. These were wintered in the cotton-front houses and came through in fine condition. No freezing of combs or feet was noticed. This seems to indicate that poultry can be wintered in this type of house in southern Saskatchewan quite satisfactorily.

BUILDING.

During the year extensive building operations went on at this Farm. A new barn was built to take the place of the one burned in 1912. This is an excellent structure with a large loft overhead that will hold sufficient feed for one season. The stable proper is fitted with iron stanchions and will accommodate about seventy-five head of cattle and twenty horses in a wing of the main barn. At one end of the main barn there is a large milk room. At the other end there are three well-built bull pens. Along one side are three root houses, large enough to hold about 125 tons of roots.

Three cotton-front portable poultry houses were built in October. Two of these were 12 feet by 14 feet without a floor, large enough for forty birds each. The other was 10 feet by 12 feet with a floor. The idea in building this type of house was to ascertain the cheapest suitable house that could be used by farmers in this district.

In the fall a herdsman's cottage was built. It is 30 feet by 33 feet, with a small back kitchen 9 feet by 10 feet. It includes seven rooms, with an unfinished attic. It is a very pleasing little building of a style that could be used to good advantage by many of our farmers.

EXTENSION WORK.

Since his appointment in August, the Superintendent has found time to do considerable extension work. An address on cultivated grasses was given on October 22, at the Dry Farming Congress, Tulsa, Oklahoma. On December 15 he attended a farmers' convention at North Battleford under the auspices of the Agricultural Society and Board of Trade, delivering three lectures, one on Alfalfa Culture, one on the Problems on the Grain Farm and their Solution, and one on the Results Obtained in Field Husbandry on the Indian Head Experimental Farm.

He assisted in judging the grain at the provincial seed grain fairs at Saskatoon, Saskatchewan, and Winnipeg, Manitoba, and also at the inter-provincial seed grain fair and stock show at Brandon.

EXCURSIONS.

On July 24, an excursion was run to the Farm, including all towns on the main line from Moosejaw on the west to Mocsomin on the east. A large number of people took advantage of the excursion and visited the Farm.

SESSIONAL PAPER No. 16

VISITORS.

The total number of visitors to the Farm during the year was about 2 655.

DISTRIBUTION OF SAMPLES.

While the distribution of all cereal samples is made from Ottawa, a large amount of potatoes, vegetable and flower seeds and tree and shrub seedlings and cuttings are distributed from this Farm to applicants in southern Saskatchewan each season. Last year the distribution amounted to: Potatoes, 1,266 packages; flower seeds, 184 packages; vegetable seeds, 144 packages; maple, ash and caragana seedlings, 1,217 packages, 75 in a bundle.

SALES OF SEED GRAIN.

Last year an endeavour was made to supply a large number of applicants with good seed grain. Wheat, oats, barley, flax and peas were sold in lots ranging from 1 bushel to 6 bushels, with the result that the following grain was sold: Wheat, 238½ bushels; oats, 47 bushels; barley, 96 bushels; flax, 14 bushels; peas, 30 bushels; fall rye, 35 bushels.

METEOROLOGICAL RECORDS.

MONTH.	TEMPERATURE F.					Rainfall.	Snowfall.	Sunshine	
	Maximum.	Minimum.	Mean.						
1913.	Date.	°	Date.	°	°	Days.	Inches.	Inches.	Hours.
April.....	14	89	25	12	42.63	1	.13	166.5
May.....	27	90	7	23	48.39	6	1.20	7.	174.6
June.....	11	88	2	33	61.30	10	4.37	224.9
July.....	25	84	26	38	61.16	8	4.13	285.3
August.....	1	84	5	41	61.61	6	2.35	245.5
September.....	5	88	24	26	53.33	4	.55	209.9
October.....	2	73	28	5	33.22	2	4.87	16.	107.2
November.....	5	53	13	3	27.03	7.50	99.2
December.....	11	43	25	-12	17.1050	123.2
1914.									
January.....	5	44	24	-34	7.19	12.50	83.2
February.....	27	45	5	-38	-4.83	4.	113.2
March.....	14	47	27	-19	21.93	10.	111.6
						37	17.60	57.59	1,935.3

Reckoning 10 inches of snowfall as equivalent to 1 inch of rainfall, the total precipitation for the year ending March 31, 1914, was 23.35 inches.

EXPERIMENTAL STATION FOR CENTRAL SASKATCHEWAN.
ROSTHERN, SASK.

CHARACTER OF THE SEASON.

The precipitation was lower in 1913 than in 1912 or 1911, but was more evenly distributed throughout the season, which developed a much more even growth in the grain crops than occurred in 1912. Coupled with this was the fact that in 1913 there

5 GEORGE V., A. 1915

were no severe frosts until September 20, which allowed the grain to mature fully. The grain of 1913 was therefore of a superior grade.

There was the least snowfall in 1913-14 of any season since the establishment of the Station in 1909.

A severe hailstorm, damaging an area 2 miles wide and more than 30 miles long, passed within half a mile of the Station on the north side on July 25. The crops within the area of this storm were a total loss. On September 5 lightning struck and burned a shock of oats at a distance of 400 feet from the Superintendent's residence. Following is the weather record for the year:—

METEOROLOGICAL RECORDS.

MONTH.	TEMPERATURE F.				Pre- cipitation.	Hours of Sunshine.
	Maximum.	Date.	Minimum.	Date.		
1913.					Inches.	
April.....	72.2	16	14.8	2	.26	203.0
May.....	78.7	7	22.1	13	1.26	227.9
June.....	85.7	11	35.0	6	1.87	234.7
July.....	84.1	29	39.7	27	3.80	289.2
August.....	82.1	30	39.7	17	3.59	248.7
September.....	84.1	5	29.7	20	2.89	231.5
October.....	69.0	2	0.7	29	0.29	126.4
November.....	52.9	5	- 3.9	19	0.34	109.9
December.....	33.0	10	-21.8	24	0	109.5
1914.						
January.....	35.5	7	-32.3	30	0.65	97.9
February.....	38.8	28	-42.8	6	0	146.9
March.....	38.0	12	-15.9	6	0.55	149.1
Total.....					15.50	2,174.7

FIELD HUSBANDRY,

The work in the rotations carried on since 1911 is attracting more general interest each year, and demonstrating the great importance of the effect of humus in the soil as furnished by hay crops, and the increase of grain yields due to the inclusion of both grass and roots in the rotation, as well as to the greater quantity of manure supplied by a rotation involving crops which necessitate the keeping of a large number of live stock. Another marked effect of a rotation involving a variety of crops is the eradication of weeds. No attempt is made to handpull weeds from the grain crops on any of the rotations, and it is found that with good cultivation in a rotation involving summer-fallow, followed by roots, followed by grain seeded down, there are practically no weeds left in the succeeding crop. This applies particularly to wild oats, which are such a menace to agriculture in the West.

The work in cultural investigation, begun in 1911, has not been continued sufficiently long to give definite conclusions. The most notable feature in any of the experiments, is the good effect on wheat and a succeeding crop of oats of an application of manure on summer-fallow. Unfortunately a number of these experiments have been interfered with on account of their location on ground affected by "alkali." An effort will be made to begin some of these experiments again on more uniform plots.

SESSIONAL PAPER No. 16

CEREALS.

A number of varieties of wheat, oats, and barley, that had been under trial for some time, were discarded in 1913, and a number of new varieties were added, particularly some new hybrid wheats bred by Dr. Chas. Saunders. None of the new wheats proved in the one year of trial to be so satisfactory in every way as Marquis. The Prelude wheat, although much earlier than the Marquis, and of apparently as good quality, does not yield sufficiently to warrant its adoption in a district similar to this.

FORAGE CROPS.

Ten strains of red clover were sown on summer-fallowed land in the spring of 1913 and made good growth during the season. They were not cut, so that their own growth served as a winter mulch for the roots. In the spring of 1914 the plants were almost totally killed. Whether the injury came from winter-killing or from being smothered by too much mulch can not be determined. A further attempt will be made to find out whether the crop is adaptable to the winter in this district.

The red clover sown with rye grass and alfalfa for mixed hay in the rotation came through the winter in good condition, and has done so for the three past seasons.

Alfalfa.—Not a great deal of work has been done yet in alfalfa, but enough has been done to demonstrate that it can be grown successfully in this district. One acre of Grimms' alfalfa, sown in 1910, yielded, in 1913, 3,102 pounds, and 1 acre of Turkestan sown at the same time yielded in 1913, 2,470 pounds. In August, a plot was sown to alfalfa and cut once in the autumn to check weed growth. This plot came through the winter in excellent condition.

HORTICULTURE.

Horticulture at the Station received new impetus in the spring of 1913 by the employment of a qualified gardener. This, together with the fact that the hedges planted for windbreaks in 1910 and 1911 are now large enough to be of some effect, has caused the horticultural feature of the farm work to draw considerably more attention. The bush fruits planted in 1910 came into good bearing in 1913, and yielded for the first time. The strawberry plants had been mulched in the autumn of every year since the farm was started, but in the spring of 1913 it was not removed until nearly the end of May. It is thought that this is the reason why we had a good yield of strawberries in 1913; by the mulch having been left on, the buds were protected from the late spring frosts.

Some of the apple trees planted in 1909 began to yield in 1913. One tree yielded twenty-seven fair-sized apples.

Flowers.—Over a quarter of a mile of flower border around the lawn laid out in 1912 and partly planted, gave a magnificent display in 1913. The asters made a particularly brilliant showing towards autumn, while the tulips were the prominent feature in the beginning of the season. The shrubs, particularly the *lonicera*, *syringa* and *spirea* made a good showing. Most of those planted in 1910 flowered for the first time in 1913.

Vegetables.—Owing to the increased protection afforded by the greater growth of the windbreaks, the vegetables were more satisfactory than previously. This was the first season tomatoes, squash, cucumbers and corn ripened.

The cultural experiments in potatoes of 1912 were repeated in 1913. Some of the results were not so marked, but on the whole were quite satisfactory.

ANIMAL HUSBANDRY.

The first attempt made here at a systematic experiment in animal husbandry was begun in November by the purchase of eleven steers for experimental feeding. The attempt is quite justified by the results.

Horses.—There are five work horses and two drivers at the Station which are quite sufficient to do the work.

Live Stock Demonstration.—On March 23, upwards of forty farmers assembled at the Station for a demonstration in judging and feeding steers. The driveway of the new barn was fitted up with special lighting and seats, and the steers used in the feeding experiment were used for demonstration purposes.

The appreciation expressed by the visitors warrants the repetition of such meetings.

BUILDINGS.

The new barn which was begun in the autumn of 1912 but which was delayed because of inclement weather, was completed in 1913. It is 40 feet by 70 feet with 18-foot walls, and has accommodation for ten horses and five cattle, besides a grain room 20 feet square, and a drive way 30 feet wide, the full width of the barn.

Adjoining the barn and opening into the feed alley of the cow stable is a root cellar of solid cement 40 feet by 30 feet and 7 feet 6 inches high at one side and 7 feet at the other.

An old building 90 feet long and 20 feet wide that had served as a granary and workshop was remodelled, placed on a brick foundation and sheeted outside and inside. A granary occupies one end and the remainder is made sufficiently warm to serve as a workshop. By means of this, much work such as cleaning seeds and repairing implements and tools can be done during the winter that heretofore had to be delayed until spring.

GROUNDS.

The lawns and bordering shrubs and trees are sufficiently established and developed now to afford a fair idea of the plan in view in the laying out of the grounds.

EXHIBITION.

With the assistance of the Superintendent of the Indian Head Experimental Farm, a display of material grown on the Experimental Farms was made at the Prince Albert Exhibition, which elicited much favourable comment, both from the Exhibition Board and from visitors. The display consisted chiefly of sheaves of grains and grasses, preserved fruits, vegetables, shrubs and young trees.

DISTRIBUTION OF SEEDS.

* In the spring of 1913 there were 434 samples of potatoes sent out, besides a number of bundles of maple, ash, and caragana plants.

EXPERIMENTAL STATION FOR NORTHWEST SASKATCHEWAN.

SCOTT, SASK.

The growing season of 1913 opened early in April with bright, warm weather. Work on the land commenced on the 7th, and the first seed was sown the next day. By the 21st, grain was appearing above the ground. The weather then changed to

SESSIONAL PAPER No. 16

cool and cloudy, although there was very little rainfall. This continued until the middle of May. The ample supply of moisture in the soil at seeding time and the warm weather at that time assisted germination and growth proceeded evenly and well. The weather from the middle of May on was favourable; bright, warm weather prevailing, with frequent showers.

The harvest was, in general, an early one, a good proportion of the grain crop being in stook in August. Weather conditions were not such as to produce an unusually heavy yield, but rather a fair one and a safe and early harvest, which was carried on under favourable conditions, and before the close of the season, on October 27, threshing and fall work on the land had been completed.

BUILDINGS AND IMPROVEMENTS.

The Superintendent's house, the barns, etc., were wired for electric light, which is obtained from the town of Scott lighting plant.

An experimental building was erected during the year. This is a two-story building; the lower floor contains bins for the storage of large quantities of seed grain, space for cleaning grain, a well-lighted room for use in handpicking seed and a room for samples and display purposes. The second floor is for use in storing the crops from the test plots, etc. The basement is divided into two rooms, one for use in storing roots and the other for a winter work room, cooking feed, etc. Part of one of these basement rooms can be partitioned off for the winter storage of bees.

The main entrance to the Station was changed and a driveway opened up through the lawns. This, with the erection of a lawn fence along the road, adds materially to the appearance of the Station.

CEREAL CROPS.

The regular work with cereals was carried on and satisfactory results were obtained in most of the tests made. Marquis led in yield among the wheats, and Victory in oats. Barley was an exception in that only light yields were obtained.

ROTATIONS.

The five rotations under trial here have all shown a margin of profit for the year's work. Rotation A, one year's duration, gave a profit per acre of \$8.79; rotation C, three years' duration, profit per acre, \$4.73; rotation J, six years' duration, profit per acre, \$5.95; rotation P, eight years' duration, profit per acre, \$4.40; rotation R, nine years' duration, profit per acre, \$6.63.

CULTURAL EXPERIMENTS.

Four out of the thirteen cultural experiments arranged for the western Experimental Farms are at present laid down. From these four, data of value should soon be obtained. In experiment 5, Methods of Seeding to Grass and Clover, the 1913 figures indicate the advantage of seeding without a nurse crop and of seeding on summer-fallow or root ground, to obtain the largest yield.

In experiment 11, Depths of Seeding for Wheat and Oats, the results are this year, as last, favourable to seeding at a depth of three inches.

HORTICULTURE.

The work in horticulture was more successful than in previous years. Tomatoes ripened on the vine, cucumbers grew in the open, celery came to the table stage and corn was practically in use. Additional stocks of ornamental trees and shrubs, apple seedlings and small fruits, were received and set out. Strawberries, raspberries and currants of good quality were gathered.

LIVE STOCK.

During the year a driving mare was purchased, and a colt was obtained from one of the work mares, bringing the total number of horses to eleven head.

In October, 1913, seventeen steers were purchased for an outside feeding experiment. They were pastured until December 2, when they were put into the corral and started on a light meal ration. This was gradually increased until the animals were on practically full feed. The gains made were fair but, owing to the low price at which the animals were sold, the work was conducted at a loss.

VISITORS.

Nearly 800 visited the Station during the year, most of them in July and August. On July 17, an excursion was held at the Station under the charge of the Scott Board of Trade, which was well attended.

METEOROLOGICAL RECORDS.

MONTHS.	HIGHEST TEMPERATURE F.		LOWEST TEMPERATURE F.		Mean Temperature.	Total Precipitation.	Hours Bright Sunshine.
	—	—	—	—			
	Day.	Deg.	Day.	Deg.			
1913.					Deg.	Inches.	Hours.
April.....	13	79.0	25	14.1	43.23	.15	238.1
May.....	26	84.9	6	18.2	45.61	.95	247.3
June.....	10	90.1	14	28.7	56.72	1.28	220.1
July.....	20	87.4	31	35.2	59.85	2.98	282.3
August.....	29	86.1	17	34.3	59.89	2.62	238.8
September.....	4	86.0	24	20.1	57.24	1.24	234.5
October.....	1	72.0	28	- 5.4	32.99	.46	137.0
November.....	4	54.8	21	- 8.8	23.90	.25	103.8
December.....	4	40.5	25	-12.8	15.57	.08	101.1
1914.							
January.....	5	38.0	24	-40.1	1.91	.65	96.6
February.....	27	37.2	3	-46.6	5.70	.03	128.5
March.....	14	44.0	26	-21.9	19.37	.20	157.9
						10.89	2,191.0

EXPERIMENTAL STATION FOR SOUTHERN ALBERTA.

LETHBRIDGE, ALBERTA.

THE SEASON.

The season of 1913 opened at about the usual time for the district. Winter grain, however, suffered, many areas in the winter wheat fields being badly injured owing to the high, dry winds that prevailed. Spring seeding commenced early in April, germination was rapid and a good stand was obtained in all cases. The rainfall during the spring was scant, especially during late May and early June. Crops of all kinds suffered acutely, particularly early-sown grain. The rainfall, from late June on, was reasonably satisfactory. The late rain, however, stimulated

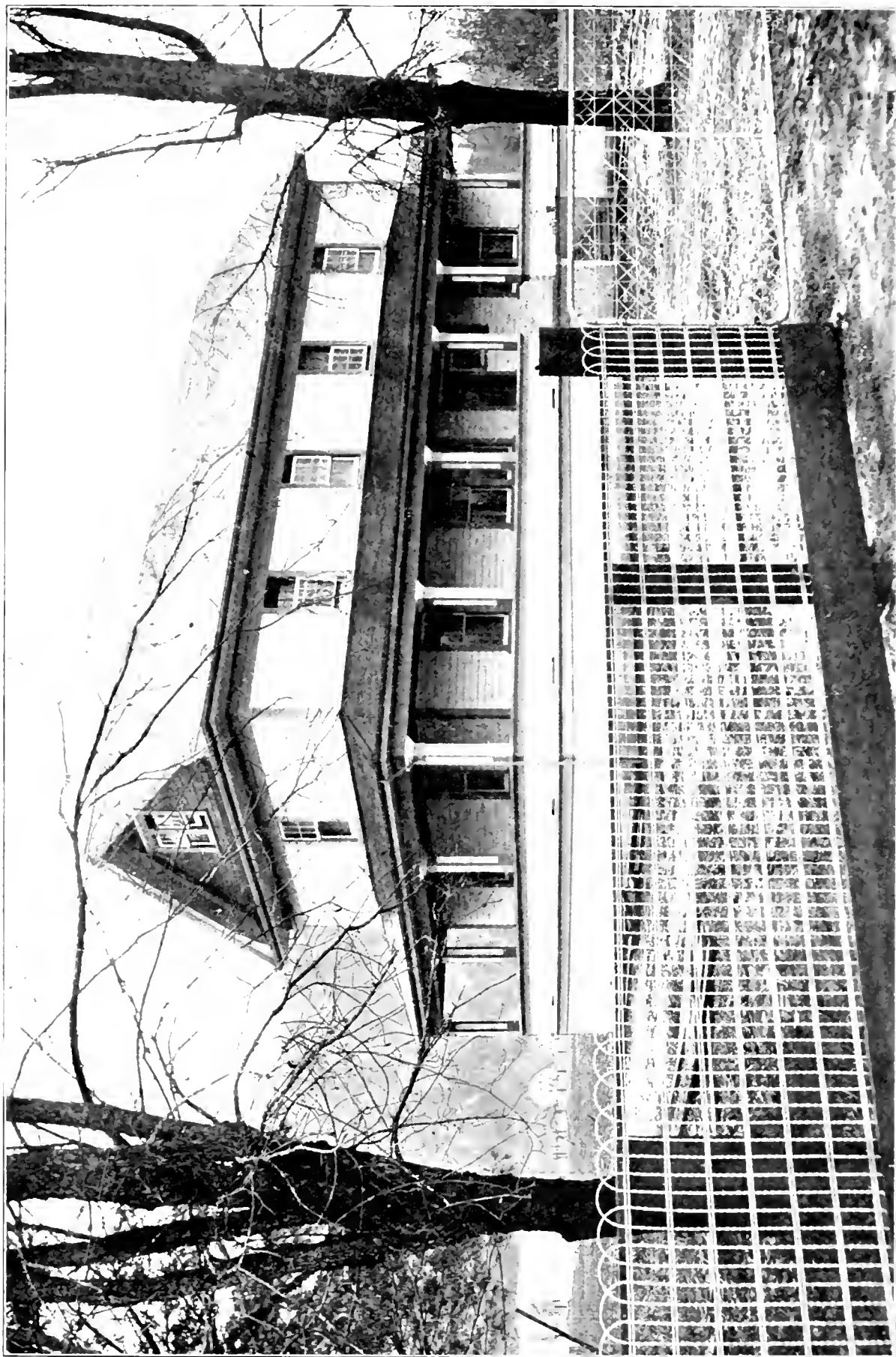

The Farm Boarding House, Agassiz, B.C.

SESSIONAL PAPER No. 16

a second growth which caused uneven ripening and thus materially reduced the yield and quality of both wheat and barley. The result with oats was better, the second growth being so strong and vigorous that it reached maturity before any serious loss was suffered from the shelling of the first growth.

METEOROLOGICAL TABLE.

MONTH.	TEMPERATURE F.			Precipitation.	Sunshine.
	Maximum.	Minimum.	Mean.		
1913.	Degrees.	Degrees.	Degrees.	Inches.	Hours.
April.....	81.2	17.0	43.8	0.52	223.4
May.....	83.3	19.2	48.45	1.70	244.8
June.....	86.6	39.9	60.96	4.70	281.8
July.....	89.2	38.0	61.89	1.29	345.0
August.....	92.8	35.8	54.21	1.93	321.2
September.....	89.3	26.2	59.9	1.65	276.5
October.....	78.2	12.3	39.2	0.50	152.7
November.....	58.0	9.0	35.1	0.36	121.8
December.....	60.0	- 7.0	29.57	0.00	156.0
1914.					
January.....	55.1	-27.0	17.05	1.55	104.1
February.....	48.1	-40.0	11.05	0.96	129.4
March.....	64.0	-15.9	29.42	1.12	207.4
				16.28	2,555.1

ROTATION OF CROPS.

Among some of the interesting points brought out in the rotations for the season are:—

On Non-irrigated Land.—1. Wheat following corn yielded as well as wheat after summer-fallow, and much better than wheat following turnips. The latter difference is no doubt due to the fact that the roots made considerable growth in the fall, thereby using up moisture, whereas the corn ceased growth with the first frost.

2. A good profit was obtained from alfalfa seed when the crop was planted in rows and intertilled.

3. Heavy yields of oats and peas, grown for feed, were obtained when sown on summer fallow.

On Irrigated Land.—1. The yield of spring wheat was over 52 bushels per acre following potatoes.

2. Potatoes planted on alfalfa sod gave a yield of 635 bushels 30 pounds per acre.

RATES OF SEEDING.

Tests to determine the correct quantity of wheat, oats and barley to sow have now been conducted for five and, in some cases, six years. Each of the above grains has been seeded at the rates of 15, 30, 45, 60, 75, 90, 105, and 120 pounds per acre. The preparation of the land in nearly all cases, each year, was summer-fallow.

5 GEORGE V., A. 1915

The results in 1913 correspond closely to the average of past years. Without exception, the smallest amounts of each gave the lowest yields. The crops obtained increased quite rapidly with the amounts of seed used up to a certain point, after which the increase was small and irregular. It is the point at which this change takes place that appears to be the most profitable quantity of seed to use. Our results to date indicate the following rates of seed to be the best:—

- Winter wheat, non-irrigated, 60 pounds per acre.
- Spring wheat, non-irrigated, 75 pounds per acre.
- Oats, non-irrigated, about 75 pounds per acre.
- Barley, non-irrigated, 75 to 90 pounds per acre.
- Spring wheat, irrigated, 90 to 105 pounds per acre.
- Oats, irrigated, about 90 pounds per acre.

The results with barley on the irrigated plots have not been uniform, and it is therefore difficult to draw definite conclusions. From the data to hand, however, 75 to 90 pounds per acre may be recommended.

SOIL CULTURAL EXPERIMENTS.

The dry-land soil cultivation investigations incepted in 1911 were carried out successfully, but as yet few of the experiments have shown any marked results. Some interesting points, however, have been brought out, which may be briefly mentioned.

Prairie Breaking.—In this experiment, the results have brought out nothing that has not before been fairly well demonstrated. They strongly support the contention that sowing crops immediately after breaking is unprofitable, and point out that the most advisable and practical method of procedure on new land is to break the sod in the spring and allow it to lie till the following season before cropping.

Depth of ploughing.—The plots ploughed 3 and 4 inches deep appeared to suffer from drouth before those ploughed 6 and 7 inches deep. Ploughing beyond the latter depth, however, seemed of no advantage.

Time of Ploughing.—One of the most striking results observed, because it happened almost without exception, was the fact that land ploughed in the fall gave poorer returns than that which was ploughed in the spring. Similar results have been obtained in previous years, but the difference has never been so marked as was the case this year. No doubt the dry winter with its scanty rainfall was, in a great measure, responsible for these results.

CEREALS.

The usual variety tests of wheat, oats, barley and peas were carried out on both the irrigated and non-irrigated land. There was nothing striking in the season's results in these investigations that would warrant special mention.

FORAGE CROPS.

Corn has done much better than usual this season. Some varieties, such as Northwestern Dent, Canada Yellow and Longfellow, ripened a few ears. The heaviest yielding sort in the variety test on the dry land was the Ninety Day, which yielded at the rate of 11 tons 1,064 pounds of green feed per acre. The best yielding variety on the irrigated land was Compton's Early, which gave a yield of 15 tons and 1,278 pounds per acre.

SESSIONAL PAPER No. 16

Turnips, mangels and carrots did reasonably well.

On the dry land, the yields of hay were very light. Brome grass produced only 1,580 pounds and Western Rye 1,160 pounds per acre. Alfalfa sown broadcast yielded only 1,481 pounds per acre, whereas alfalfa sown in rows yielded about double this amount. It would appear, therefore, that for hay as well as for seed purposes, it will pay to sow this crop in rows far enough apart to permit of cultivation.

On the irrigated land, the average yield of hay was between four and five tons per acre, this being slightly below the average for the past five or six years.

HORTICULTURE.

The season has been a particularly favourable one for horticultural work. Trees and shrubs came through the winter with slight injury, and appeared, with few exceptions, to be in a strong, vigorous condition in the spring. A large number of apples bore fruit for the first time. The yield of small fruit was quite satisfactory. On account of the late fall, the more tender vegetables such as tomatoes, corn, squash, etc., matured somewhat better than usual.

STOCK.

No breeding stock is kept on the farm up to the present time.

A steer-feeding experiment was conducted during the winter. Nineteen head were divided into three lots.

Lot I.—Fed on alfalfa hay, roots and meal made a net profit of \$10.81 per head.

Lot II.—Fed on alfalfa hay, oat sheaves, meal, and roots made a net profit per steer of \$16.04.

Lot III.—In which were included the culls, and were fed similarly to lot II made a net profit of 57 cents per head.

The average net profit per head of all the steers in the three lots was \$8.68.

A sheep-feeding experiment was conducted consisting of 250 range lambs and 50 range yearlings, divided into six lots of fifty each.

Group I.—Yearlings, fed alfalfa hay, meal, and roots made a net profit per head of \$1.31.

Group II.—Lambs, fed alfalfa hay, meal, and roots made a net profit of \$1.16 per head.

Group III.—Lambs on a longer feeding period and sheared before being sold, fed on alfalfa hay and roots, made a net profit of \$1.37 per head. (This group received meal after other groups were sold).

Group IV.—Lambs, fed alfalfa hay and meal made a net profit of \$1.15 per head.

Group V.—Lambs, fed alfalfa hay and screenings made a net profit of \$1.90 per head.

Group VI.—Lambs, on a longer feeding period and sheared before being sold, fed on alfalfa hay alone made a net profit of \$1.42 per head. (This group received meal after the other groups were sold.)

MEETINGS AND CONVENTIONS ATTENDED.

The Superintendent attended and addressed a number of farmers' meetings in this part of the province, also the Western Canada Irrigation Association Convention held at Lethbridge. He attended the International Dry Farming Congress held at Tulsa, Oklahoma, and acted in the capacity of Chairman of Jury of Awards at the International Dry Farming Soil Products Exposition which was held in conjunction with the Congress.

VISITORS.

The number of visitors to the Station during the year that were actually counted was 2,108. No doubt many more than this came.

DISTRIBUTION OF SAMPLES.

3-pound bags of potatoes sent out..	1,891
Packets of cuttings (willow and poplar)..	90
5-pound bags of winter wheat..	12
150-pound bags of inoculated alfalfa soil..	33

EXPERIMENTAL STATION FOR CENTRAL ALBERTA.

LACOMBE, ALBERTA.

With the exception of a frost on May 18 the weather during the spring and summer of 1913 was favourable for the production of all crops commonly grown in this district. While there was sufficient rain at the time crops required moisture to produce a satisfactory crop, yet the precipitation for the entire season was the least of any year recorded at this Station, except 1910. The total precipitation for the year was 14.115 inches.

This Station now has 20 head of horses, 101 head of cattle, 20 head of sheep and 24 hogs of various ages. All this stock appears to be thriving, and many of the dairy cows have made satisfactory records during the year. The Holstein heifer "Lawncrest Lee Beets," 2 years old, has produced 8,166 pounds of milk, while "Lawncrest Rosa Echo," whose lactation period is not completed at this date, has given 11,143 pounds during the year.

The first apples of any kind to be produced at this Station were ripened last season and were satisfactory as to size and quality for the variety. Many seedlings are being grown with the hope of securing a variety that will prove hardier than anything being tested at present. A satisfactory crop of currants and raspberries was produced last season.

A splendid range of varieties of trees and shrubs for ornamental purposes are proving hardy in central Alberta, and it is certain that the home grounds may be made very attractive by any farmers willing to give the required time and attention.

A large amount of new woven wire fence (six and one-half miles in all) was erected during the year. This new fence, together with that planned to be erected the coming season, will complete the fencing on the new farm recently acquired, and all fields will be fenced for all classes of stock.

The Superintendent was one of the representatives of the Department of Agriculture at the Dry Farming Congress at Tulsa, Oklahoma, in October. He acted as judge of sheep and swine at the Winnipeg Industrial Exhibition and judge of dairy cattle at the Regina Summer Fair, and also acted as judge of sheep and swine at the Regina Winter Fair. He addressed institute meetings at Consort and Hazelmere, and gave addresses before the Farmers' Convention at North Battleford, Saskatchewan. He was also a representative of the Department of Agriculture at the banquet tendered J. C. Hill & Sons by the Board of Trade of Lloydminster, Sask.

DISTRIBUTION.

A total of 627 samples of potatoes and 13,175 Manitoba maple and 5,300 Caragana seedlings were distributed to farmers living in central Alberta during the spring of 1913.

SESSIONAL PAPER No. 16

METEOROLOGICAL RECORDS.

	TEMPERATURE.				Precipitation.	Sunshine.
	Maximum.	Date.	Minimum.	Date.		
1913.	Degrees.		Degrees.		Inches.	Hours.
April.....	77.8	12	17.4	23	.15	260.8
May.....	77.4	25 & 30	18.1	5	.48	277.1
June.....	81.8	9	36.2	17	2.98	271.9
July.....	84.8	24	31.9	25	3.43	336.3
August.....	84.0	26	35.5	19	2.43	311.1
September.....	80.0	8 & 27	24.4	23	.59	240.4
October.....	81.5	1	9.7	30	.68	141.7
November.....	59.8	3	— .5	23	.05	146.2
December.....	57.8	10	—13.3	25	.07	136.7
1914.						
January.....	53.6	6	—36.1	24	1.45	73.5
February.....	48.6	24	—41.6	5	1.00	120.1
March.....	64.0	12	—23.6	26	.80	153.8
					14.11	2,469.6

EXPERIMENTAL FARM FOR BRITISH COLUMBIA.

AGASSIZ, B.C.

On the whole the weather conditions were more favourable this year than last, though the spring was wetter than that of 1912. The rain in April retarded seeding operations to some extent, and May and June were also wet, but, since there were alternate rainy and fine spells, the work was not materially affected. July was reasonably warm and dry, and August also, though occasional heavy showers fell in the latter month.

In the latter part of September there was a spell of fine weather; but October and November were wet, a condition which rather interfered with the root and corn harvest. No frosts were experienced before November 14. December and January were mild until the end of the latter month, when the first snow fell. The cold spell lasted until February 5, after which it was very mild and warm till towards the end of March, when there were 10 degrees of frost, very cold winds and snow. Coming as it did after the mild weather, this cold spell did considerable damage.

The meteorological data are given below:—

METEOROLOGICAL RECORDS.

MONTHS.	MAXIMUM TEMPERATURE.		MINIMUM TEMPERATURE.		Mean Temp. Deg.	TOTAL PRECIPITATION.		SUNSHINE.		
	Date.	Deg.	Date.	Deg.		Rain.	Snow.	Days.	Hours.	Mins.
1913.						in.	in.			
April.....	19	75	28	33	51.27	4.72	21	125	48
May.....	31	78	5	33	52.22	6.08	16	120	6
June.....	1	84	6, 17, 20	40	58.31	7.33	24	147	6
July.....	22	91	16	45	52.45	3.71	25	189	48
August.....	1	91	17, 19, 20	46	64.47	2.71	26	202	30
September.....	13	78	15	40	56.51	7.68	23	170	42
October.....	1	66	6, 28, 29	33	47.77	8.84	15	73	22
November.....	2	61	14, 20	25	45.23	12.29	9	39	30
December.....	2, 3, 6, 7, 11	50	23	29	40.22	3.36	11	55	12
1914.										
January.....	4, 6, 11	49	28	12	38.00	13.33	27	5	12	36
February.....	26	60	5	12	39.56	3.43	7	11	66	54
March.....	19	73	26	22	45.02	3.12	2	17	98	30
Total.....						76.60	36	203	1,302	4

In spite of the showery weather, the farm crops made a very satisfactory showing, with the one exception of the wheat crop, of which mention is made later. All were harvested in good condition. The following crops were grown to feed the live stock:—

Clover hay.....	116 tons	960 pounds.
Corn silage.....	284 "	1,770 "
Mangels.....	136 "	110 "
Carrots.....	9 "	1,980 "
Sugar beets.....	6 "	100 "
Turnips.....	10 "	800 "
Potatoes.....	16 "	1,500 "
Mixed grains.....	968 bushels.	
Barley.....	100 "	
Peas.....	45 "	

Different kinds of fertilizers and manures were tried with mangels. It is impossible, however, with but one year's work on these trials, to draw conclusions of any definite value.

This year, 205 rods of permanent fence has been erected. In addition to the replacing of old fencing on the boundaries, it has been found necessary to divide the Farm into four sections, so as to be able to change the pasture in accordance with the system of rotation followed. Also, with the advent of the new dairy herd, a greater number of lanes and yards have been constructed, and the grounds and gardens have had to be protected.

A good deal of labour has been expended on the farm roads. The new roads have borders 8 feet wide sown to a grass mixture, and being fenced in are capable of being used as paddocks when need arises. Both the avenue leading from the highway and the central farm road have been gravelled to a depth of 6 to 18 inches, and gravel has also been spread in the exercising yards for the cattle. A cement footpath has been laid from the main building to the highway.

The horses being kept entirely for working purposes, there is no experimental work to be reported. Some useful figures have been collected, however, on the cost

SESSIONAL PAPER No. 16

of food and care. One new team has been added to the force, a pair of three-year pure-bred Clydesdale fillies. These were bought at the close of the year. The horses were kept busy throughout the entire year with the various improvements, roadmaking, etc., and are in good condition at the present time.

With the herd of grade Holstein-Friesian cattle, breeding work has been continued, and at the same time a careful testing of each individual has been kept up, with the object of obtaining uniform groups for experimental work.

The whole herd shows a better average performance than last year. Of the calves born, 50 per cent were heifers, and all these have been raised. The total number of animals now in the herd is sixty. This year figures were collected on the cost of raising yearling heifers and some work was done to find the cost of vealing dairy bull calves. Some bacteriological testing was done by Mr. G. H. Unwin, of the Health of Animals Branch. The results show the important part played by air-borne organisms in milk contamination. This is more particularly the case where care and cleanliness are observed in handling the milk and utensils; since a dust-laden air is shown to be capable of producing a dirty sample of milk, even with the most careful handling and the cleanest of milk pails.

With hogs, the work in breeding and feeding has been very successful. The breeding stock at present consists of twenty-seven head; one aged boar, two young boars, eight sows over one year, and sixteen sows under one year. The breeding stock was kept in the "A" shaped cots. This method of housing has proved very satisfactory, both in the number of pigs farrowed and the number raised.

Some useful information has been gathered on the cost of raising a litter of young pigs. A record was kept of the cost of the sow's maintenance during the winter, and during the period from farrowing to weaning time. It was found that the cost of food per pig raised, during the whole period, was \$1.55.

A great deal of work has been done to ascertain the value of rice-meal for fattening hogs, and the results are important. Though the accommodation for this work was limited, over one hundred pigs have been put through these trials. It has been proved conclusively that rice-meal is not a profitable food for fattening hogs. It has been proved, moreover, that it is injurious. In every case where the rice-meal was fed either exclusively or in a half-and-half mixture with other grains, it produced a diseased condition, strongly resembling beri-beri in man. The diseased pigs were examined by Dr. Hawden, Health of Animals Branch. His post-mortem findings determined the specific nature of the disease.

In the flock of Dorset Horned sheep no experimental work was done owing to lack of accommodation. The winter being mild the sheep were pasturing the whole year, with the exception of one week.

It is pleasing to be able to report an advance in the poultry work, which was reorganized at the beginning of the year. Mr. V. Kuhn has been placed in charge of the details of the work and has collected a great deal of information which forms a good foundation for future experiments. The entire flock, for laying and breeding, numbers 342 birds, of which 66 are Barred Plymouth Rocks, the remainder White Leghorns.

The farm dairy since June has been in the charge of Miss R. Keene. The work has been, first, the handling of the product of the dairy herd in the form of sweet cream, butter, soft cheese, and a limited amount of high-class bottled milk, sold locally. A considerable amount of milk-testing has been done. In addition to the regular testing of the herd individuals, there have been some special tests for the pure-bred cows. Also, a number of samples have been sent in for testing from the surrounding district. Experiments were made with corrosive sublimate and formalin as preservatives of milk for testing.

In the making of soft cheese fair success can be reported, though the dairy is too small and the equipment too limited for any extensive work.

Of the cereals, the wheat crop was a complete failure. The entire crop was badly infested with the wheat midge, and nothing was harvested.

Twelve varieties of oats were grown from selected heads. Of these the earliest variety was Eighty Day, the latest Danish Island. The Lincoln gave the highest yield. Four varieties were grown for hay of which Swedish Select gave the best results.

Of the fifteen varieties of barley, the earliest was Success, which matured in 100 days, and which gave the lightest yield. Danish Chevalier matured in 115 days and gave the largest yield of the varieties grown.

As forage crops, there were grown eleven varieties of mangels, eight varieties of Indian corn, nine varieties of carrots, ten varieties of turnips, and three varieties of sugar beets. All these were grown in the double-plot system, which has given better satisfaction than the single plots. There being plenty of moisture throughout the season, all root crops gave reasonably good results. The turnips were badly infested with the cabbage maggot, and, though they were given thorough treatment, the crop necessarily suffered. Figuring from the gross yield per acre of the mangels, Danish Sludstrup stands first with 36 tons, 1,700 pounds. Prize Mammoth Long Red was second in yield.

With the varieties of Indian corn, Compton's Early and Early Longfellow again head the list.

Of the carrots, Improved Short White was again best, and with sugar beets the largest gross yield was obtained from Klein Wanzleben.

The principal horticultural work was the testing of vegetables, of which 105 varieties were grown with varying success. Next in importance was the variety testing of flowers and bulbs. Considerable work was also expended on the grounds and in the handling of the young orchard of 4 acres, containing apples, pears, plums, cherries, blackberries, gooseberries, black, white and red currants and strawberries.

During the year, 314 samples of potatoes were distributed.

EXPERIMENTAL STATION FOR THE UPPER COLUMBIA VALLEY.

INVERMERE, B.C.

The present Superintendent, Mr. G. E. Parham, took up his duties early in April, 1913.

During the previous season, much of the land had been cleared, a barn had been built and general preparatory work done, under the supervision of Mr. Duncan Anderson. In 1913, the Superintendent's house was erected, as well as a cottage for the farm foreman.

NOTES ON THE WEATHER.

The spring of 1913 was backward, frosty nights occurring until the end of April. There was also a frost on the night of June 5. In general, however, the weather conditions during the summer and autumn were favourable to farming operations. The rainfall was about the average (9 inches) and fell at such times as to save a great deal of irrigation. The winter of 1913-14 has been exceptionally mild; sleighing commenced on January 21 and the snow disappeared during the first week in March.

As horticulture is to be a main feature of the work at this Station, a special effort was made this year to get the orchards set out and experimental work with fruits, vegetables and flowers under way. Planting was commenced in April of many varieties received and heeled in the previous autumn. Five hundred and thirty-seven apple trees of different varieties were set out. Some of these have been winter-killed, but the hardier sorts seem to have stood the winter well.

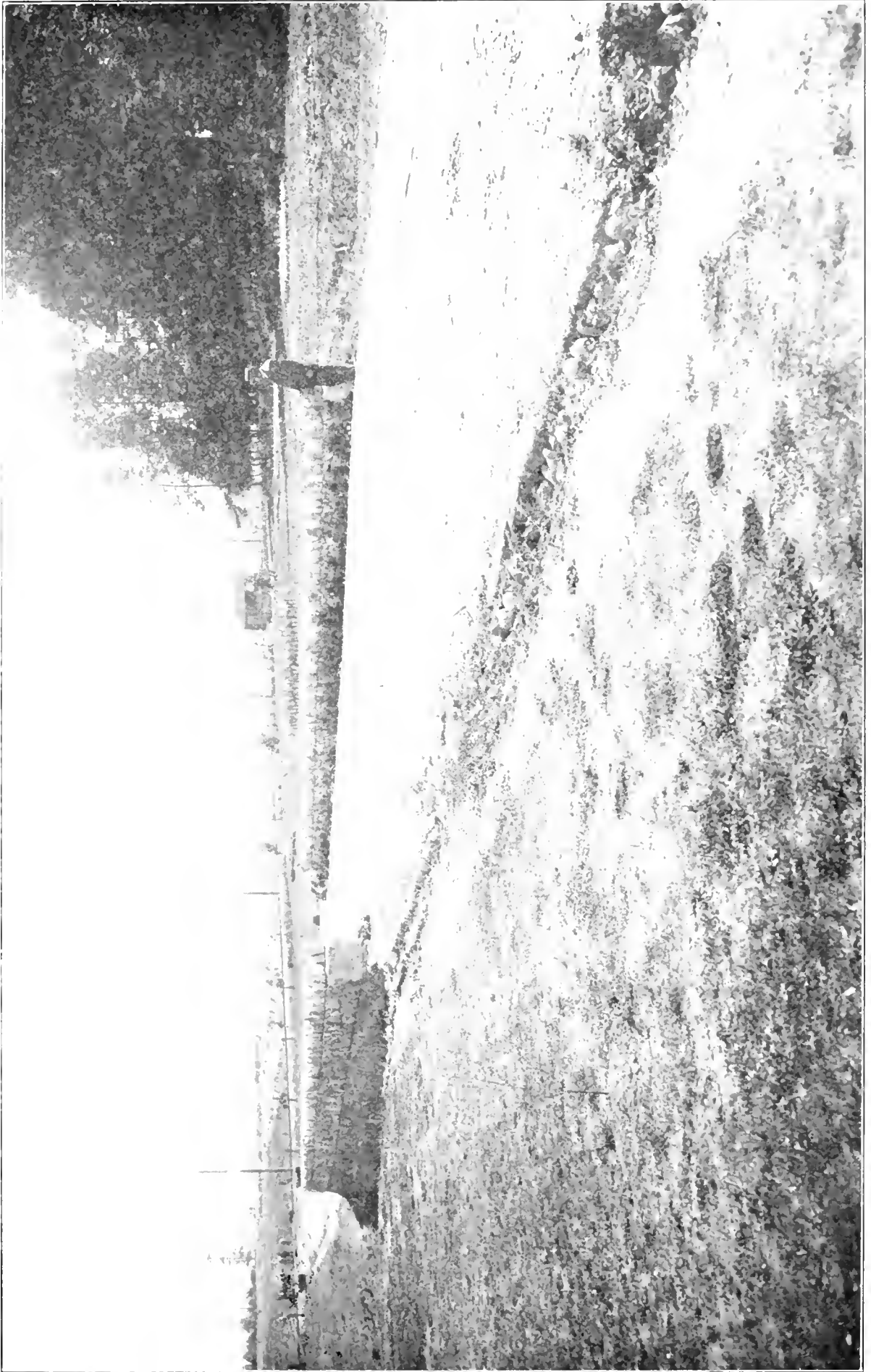

Driveway, Experimental Station, Sidney, B.C.

SESSIONAL PAPER No. 16

Winter-killing was severe among the cherries, plums, pears, and peaches set out. Bush fruits did well, except the blackberries and some varieties of gooseberries. Grapevines were winter-killed.

All the above are being grown under irrigation, and experimental work will be carried on in different methods of cultivation, with varying amounts of water and times of application.

Vegetables were also grown under irrigation. With the exception of cabbages and peas, which were irrigated twice, only one application of water was required, owing to timely rains. Experiments as to amount of water and times of application will be carried on with vegetables also.

Forty varieties of vegetables were tested under similar conditions as to cultivation and irrigation.

The success obtained with flowers was marked, and the season of bloom prolonged.

Some field crops were grown, but no experimental work with cereals, roots, or grasses was attempted. Outside of horticulture, the work done was preparatory in nature, such as clearing and grading for irrigation. Seventeen acres on the west side of the Station were enclosed with a strong poultry and cattle fence, and 2 acres of the low land has been cleared and got ready to sow with clover and alfalfa.

Work with live stock has not yet been commenced. Three horses have so far done the work of the Station. A beginning has been made with poultry, and it is planned to make poultry keeping a special feature of the work at this Station.

The Superintendent has addressed various farmers' meetings during the year and has rendered considerable assistance to ranchers in the vicinity by personal visits and advice. He has also taken part in the formation of a co-operative society in connection with the Farmers' Institute of the Windermere district.

Under his supervision, an exhibit was made of the products of the Station at the Athalmer Fair, got up by the Windermere District Agricultural Association.

METEOROLOGICAL RECORDS.

MONTH.	TEMPERATURE F.			PRECIPITATION.			Total.	Sunshine.
	Date.	Max.	Min.	Date.	Rainfall.	Snowfall.		
1913.		°	°		Inches.	Inches.	Inches.	Hours.
July.....	21	93	Not kept.		1.74		1.74	Not kept.
August.....	2	90			1.55		1.55	
September.....	18	76			1.89		1.89	193.8
October.....	2	63			.42		.42	117.6
November.....	2	45			.63	2	.63	60.5
December.....	15	40	- 6	23	0	0	0	41.4
1914.								
January.....	6	46	-11	23	.75	10.5	2.25	54.5
February.....	27	46	-27	4	0	.5	.5	73.6
March.....	17	54	- 5	25	.07	3.25	.39	144.8

*Ten inches of snow equals 1 inch of rain.

The recording apparatus set up at this Station was not complete until December.

EXPERIMENTAL STATION FOR THE SAANICH PENINSULA

SIDNEY, B.C.

The climate of this part of Vancouver island is very mild and equable, extremes of temperature being rarely met with. While the precipitation during most of the growing season of 1913 was very light, only .05 inch falling from April 26 to August 16, the atmosphere was humid, and the crop yields satisfactory.

WORK CARRIED ON.

Clearing operations were vigorously pursued on 78 acres partly cleared and reported on last year, and also on the 47 acres left uncleared on March 31, 1913.

The roots, windfalls and logs were piled by a donkey engine in several piles 100 feet high, with a base 60 feet in diameter. The bottom of each pile was closely packed with logs of from 2 to 8 feet diameter. In these, 150 holes were bored and 150 sticks of stumping powder put in singly. These were fired simultaneously. The vibration packed the whole mass and shook the dirt from the roots. The heaps were then fired, leaving only some 7 per cent to repile. This clearing operation cost \$220 per acre.

After the piles were burned out, clearing the land of rocks and roots was commenced. Dynamite was used to break up the large boulders, some of which weighed over 10 tons. The amount of rock removed averaged 50 tons to the acre and its removal cost \$105 per acre. The material was used to bed new roads, make railway and road crossings, bridges and retaining walls on the sea beach.

A general survey was then made and levels taken for ditching, grading, road-making, fencing, etc. This work was then proceeded with, the labour connected with the various items costing as follows:—

	Per rod.
Ditching (after being cleared and stoned).....	\$1 00
Draining with 3, 6, and 8-inch tile.....	1 00
Roadmaking for farm purposes	1 10
Roadmaking for transportation (team, grader, and labour).....	3 00
Fencing, including cedar posts	1 08

AGRICULTURE AND HORTICULTURE.

As soon as the land was cleared and drained, the breaking plough was put in, further clearing of rocks and roots was done and the disc harrow, leveller, grader and roller applied. These were followed by the walking plough, spring-tooth harrow and smoothing harrow, after which the soil was ready for the disc seeder. The cost varied according to the nature of the soil, which comprises good loam, quicksand, turf, and bog, with seams of strong clay containing iron oxide. This thorough preparation cleaned the ground well and got the soil into good condition for after-cultivation.

ROADS.

The 66-foot wide East Saanich road running through the centre of the Experimental Station has been prepared to make a boulevard; tulip trees have been planted 40 feet apart on each side. These will be protected by a border of Kentucky Blue grass.

In July, the service road was made through to the sea beach, giving ready access to the British Columbia Electric and the Canadian Northern stations. These are named "Bazan Bay" and are situated in the centre of the Experimental Station.

The 2½ miles of new roads now on the Station are well crowned, both sides are channelled to take away surface water and they are in good condition for transportation purposes.

SESSIONAL PAPER No. 16

A great change has been made in the appearance of the Station since clearing operations began eighteen months ago. Then giant cedars and Douglas firs grew 200 feet high, 8 feet diameter at the base and, being deep-rooted took 40 sticks of stumping powder to uproot them; windfalls and twisted logs were cross-piled amongst second growth, treacherous places of quicksand and bog were found, where, if a horse got in, cables were required to get him out. Now automobiles travel over the same ground down to the two railway stations and the sea beach, through avenues planted with shrubs and trees, and fields of fall wheat and rye are growing. There remains, however, much to be done before the plans for this Station may be said to be well under way.

On account of the difficulty and amount of the clearing to be done, the season was too advanced for experimental crop growing, so 30 acres were sown to oats for fodder, white clover, which was ploughed under in the fall, and roots for the stock. These all gave satisfactory crops.

The 30 acres set aside for horticulture has been planted with British Columbia shrubs and plants and fruit trees imported from Japan, France, Germany, the United States and Eastern Canada.

The nursery, orchards, avenue, and arboretum look well, and the lawn sown with Kentucky Blue grass is a good catch.

The five general purpose horses have been fully employed the whole year and are in excellent condition.

METEOROLOGICAL RECORDS.

MONTH.	TEMPERATURE F.			Precipitation.	Sunshine.
	Highest.	Lowest.	Mean.		
	Degrees.	Degrees.	Degrees.	Inches.	Hours.
1913.					
April.....	65	42	50	0.62	127.48
May.....	65	40	51	0.80	166.00
June.....	69	42	57	1.05	167.42
July.....	82	53	64	0.45	274.48
August.....	80	50	62.50	0.84	237.18
September.....	71	46	58.50	1.95	198.06
October.....	60	36	49.50	3.63	91.30
November.....	55	41	47	4.70	56.36
December.....	50	35	44	1.35	33.42
1914.					
January.....	45	33	39.50	0.47	35.06
February.....	51	26	44	1.56	65.54
March.....	67	29	46	2.05	117.24
Totals.....				19.47	1,569.54

NOTE.—As the meteorological instruments were not installed at the Sidney Station until February 14, 1914, the above records up to that date were obtained from other observers in the Saanich peninsula. There may be some difference between the temperatures and rainfall at these points and at the Experimental Station, but the above will give a good idea of the weather conditions of the district.

DOMINION OF CANADA
DEPARTMENT OF AGRICULTURE
DOMINION EXPERIMENTAL FARMS

REPORT

FROM

THE DIVISION OF CHEMISTRY

For the Year ending March 31, 1914

PREPARED BY

Dominion Chemist. Frank T. Shutt, M.A., F.I.C.

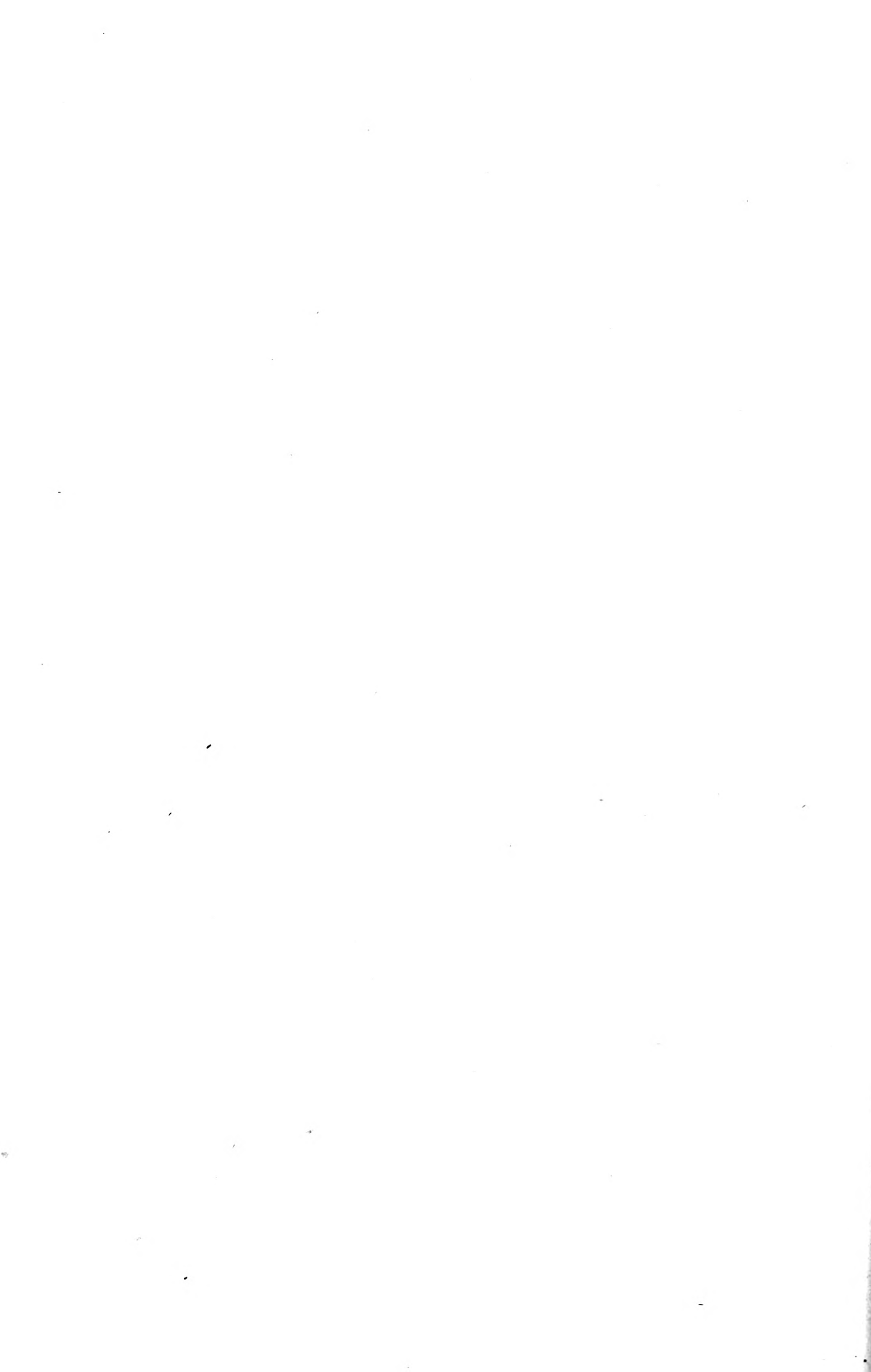

REPORT OF THE DIVISION OF CHEMISTRY.

FRANK T. SHUTT, M.A., F.I.C., F.R.S.C.,
DOMINION CHEMIST.

OTTAWA, March 31, 1914.

J. H. GRISDALE, Esq., B. Agr.,
Director, Dominion Experimental Farms,
Ottawa, Ont.

SIR,—I have the honour to submit herewith the twenty-seventh Annual Report of the Division of Chemistry of the Dominion Experimental Farms.

For the most part the work of the Division during the year now closing has been a continuation of the various researches, investigations and experiments which have occupied our attention for a number of years past, though several new problems of very considerable importance to Canadian agriculture have been attacked.

Very satisfactory progress, we believe, has been made in all the branches of the Division's activities, the increased laboratory accommodation made possible by the extension of the Chemical Building and the appointment of additional assistants on the staff having very greatly facilitated the purely analytical work.

The correspondence continues to increase and the requests of farmers for the examination of soils and other matters of an agricultural nature, become more numerous. This phase of the work, which may be considered as directly educational and advisory, has been encouraged from the first, for the information thus sent out instructs and assists the man on the farm in his difficulties and everyday work. Valuable and important as are the published reports and bulletins, this direct communication with the individual farmer who is honestly seeking for help has had a special influence and value, as our experience of many years has amply proven. It has shown itself to be not only the best and most direct means of reaching the individual, but one that has proved of very considerable service in the neighbourhood or district of the individual, since every farmer, more or less, acts as a centre in the wider dissemination of the knowledge. We have sought to make this Division a bureau of information for the Dominion on subjects relating generally to the chemistry of agriculture, to which all may apply with their questions regarding the nature, composition and properties of soils, manures and fertilizers, forage plants and feeding stuffs, insecticides, the requirements of stock and crops, etc., etc., and the farmers, we are pleased to record, are more and more recognizing that we are able, in supplying the desired information, to assist them very materially.

The samples received for analysis or examination during the past year are classified in the subjoined table, the provinces from which they were forwarded being indicated. Many of these samples have been taken in connection with the several investigations carried on by the Division, but a very large proportion of them have been sent in by farmers.

SAMPLES received for Examination and Report for the twelve months ending
March 31, 1914.

Sample.	British Columbia.	Alberta.	Saskatchewan.	Manitoba.	Ontario.	Quebec.	New Brunswick.	Nova Scotia.	P. E. Island.	Total.
Soils	46	573	494	372	51	78	25	17	2	1,658
Muds, mucks and marls....	5	5	6	1	9	14	9	13	7	69
Manures and fertilizers	13	1	0	1	7	24	16	6	0	68
Forage plants, fodders and feeding stuffs.....	5	18	13	8	104	36	7	16	6	213
Waters.....	24	15	12	12	178	23	8	272
Miscellaneous.....	6	7	2	4	585	24	3	5	635
										2,915

The 'waters' include 84 samples of rain and snow analysed in our investigation to ascertain the fertilizing value of these forms of precipitation, and the 'miscellaneous' include dairy products, fungicides and insecticides and some 500 samples from the Meat Inspection Division, Health of Animals Branch.

Soils.—We now publish fairly complete chemical and physical data respecting a series of soils typical of well defined geological areas in Nova Scotia. These were collected and forwarded by the Secretary of Agriculture for Nova Scotia and our report on them will serve as a beginning to a more exact knowledge of the soils of the more important agricultural areas or districts of that province. Our deductions will furnish information that will be valuable in the economic upkeep and improvement of the soils in question.

The analysis of many soils from virgin or unoccupied areas in Manitoba, Saskatchewan, and British Columbia has also been undertaken, but the results will be held over for future publication, pending a more complete examination of the soils of the districts involved.

There has also been in progress an examination of a large series of soils collected over the area of the Canadian Pacific Railway irrigation tract east of Calgary. The investigation includes a careful search for 'alkali' compounds and their quantitative determination, if found. The publication of these results will also be deferred until the work is completed.

Conservation of Soil Moisture.—The work begun some years ago on certain of the western Experimental Farms and Stations to ascertain the influence of subsoiling, depth and time of ploughing, frequency and depth of cultivation, sub-surface packing, etc., on the moisture content of the soil, has been continued. As this investigation progresses we accumulate proof of the value of early and fairly deep ploughing, of sub-surface packing on light soils and of frequent stirring of the surface crust by cultivation, to conserve moisture.

The Composition of Wheat as influenced by Climatic Conditions.—A continuation of this research has afforded further proof of our contention that the protein content of the cereals may be very considerably influenced by the character of the season, or to state the case somewhat more fully, that the amount of available moisture in the soil and the temperatures prevailing during the filling out of the kernel and its period of maturing, markedly affect its composition. If there is a sufficiency of moisture in the soil during the early part of the season to bring the crop to a good growth, then a fairly dry soil and high temperatures during the later summer months, hasten

SESSIONAL PAPER No. 16

maturity and conduce to a hard berry with a high protein (gluten) content. On the other hand when the vegetative period is lengthened and ripening deferred, as by cool and damp weather, the tendency will be towards the production of a soft and starchy grain.

Fodders and Feeding Stuffs.—This chapter deals with the analysis and nutritive value of a number of forage plants and concentrated feeding stuffs. These include by-products of the distillery, brewery, starch factory, and linseed oil mill. Several molasses feeds are also reported on.

We have during the year analysed a large series of samples of elevator screenings and of weed seeds separated therefrom, to determine their food value. The publication of these data, however, is deferred for the present, pending the completion of our inquiry as to the practical usefulness of these screenings in stock feeding.

Fertilizer Experiments with Potatoes.—Information is furnished on the profitable use of fertilizers on the potato crop, as gathered from experimental work carried on at the Experimental Station at Kentville, N.S., and at the Experimental Station, Fredericton, N.B. In this investigation the usual forms of nitrogen, phosphoric acid and potash found in the fertilizer market were used, and the tables of data given show the profits obtained from the various mixtures employed. The largest profits followed in the majority of instances the application of mixtures containing all three elements of plant food, and a further consideration of the data clearly shows that moderate, rather than very large, dressings were the more profitable.

The Relative Value of Field Roots.—This is a continuation of an investigation that has been carried on for some years. The series includes mangels, turnips and carrots, the analysis being made from roots grown on the Central Farm, Ottawa.

The influence of heredity in mangels has been further studied, using the Gate Post and Giant Yellow Globe. The former variety has for the past fourteen years, during which the subject has been under investigation, proved invariably the better root, both as to dry matter and sugar.

Sugar Beets.—Three of the leading varieties of sugar beets, Vilmorin's Improved A., Vilmorin's Improved B., and Klein Wenzleben, have been grown at fourteen of the Dominion Experimental Farms and Stations and representative roots therefrom have been submitted to analysis. The data, as a whole, are very satisfactory, indicating that beets rich in sugar and eminently suitable for factory purposes, may be grown in widely distant parts of the Dominion.

Naturally-occurring Fertilizers.—This chapter includes the analysis of marls, limestones, and other materials of fertilizing value sent in during the year. It also furnishes information as to the use of lime and its compounds in practical agriculture.

Insecticides and Fungicides.—A series of thirteen samples of arsenate of lead, representing the more important brands on the market, has been examined. The detailed analyses are given in tabular form and notes added as to the more salient properties of this valuable insecticide.

Several insecticides and sprays recently put upon the market, have also been analyzed and are here reported on as to their probable value.

Fertilizing Value of Rain and Snow.—The data for the seventh year of this investigation are here presented. During the past year there were furnished from these sources for the enrichment of the soil, 6,208 pounds of available nitrogen per acre. The average amount, per annum, for the past seven years, is 6.182 pounds per acre.

Meat Inspection Division.—This work consists in the analysis of samples collected by the Inspectors of the Meat Inspection Division, Health of Animals Branch

Department of Agriculture, at the various packing houses and fruit and vegetable canneries throughout the Dominion.

During the year April 1, 1913—March 31, 1914, 510 samples have been critically examined as to nature and purity, as follows:—

Lards, tallow, oils and butters.....	55
Preserved meats—sausages, mince meat, etc.....	76
Colouring and dye stuffs	56
Preservatives	67
Pickling solutions	33
Spices and condiments	19
Evaporated apples and apple waste.....	201
Miscellaneous	3
Total	<hr/> 510 <hr/>

The increase in late years in this branch of work will be apparent when it is stated that for the preceding year the samples examined numbered 185, and for the year ending March 31, 1912, 86. The reports on these materials are submitted to the Veterinary Director General.

The Water Supply of Farm Homesteads.—During the year, 272 samples of water were entered for examination. Of these 84 were from the rain and snow investigation, which has already been referred to. The remainder, 168, were from wells and other sources of water supply on Canadian farms. Of these we reported 62 as pure and wholesome, 44 as highly suspicious, 25 as seriously polluted and 37 as non-potable by reason of high salinity.

We have from the first urged with all the emphasis at our command the desirability of an ample supply of pure water for the health of the farmer and his family, the thrift of his stock and the wholesomeness of his dairy produce. In too many instances, we regret to say, farmers are still using water from barnyard and back-door wells that are seriously contaminated with drainage matter. But we can also record, and with much satisfaction, that there is an ever increasing number who are abandoning these shallow and badly-placed wells for a deep seated source—the bored or driven well—so situated as to be beyond the possibility of local pollution.

Staff: Acknowledgments.—I would acknowledge with thanks the valuable assistance rendered during the year by the staff. Mr. A. T. Charron, M.A., has continued in the general oversight and conduct of the work as First Assistant Chemist, and has been more especially helpful in connection with the correspondence and lectures in French on agricultural subjects. Mr. C. H. Robinson, B.A., has had entire charge of the analytical work in connection with the samples sent in by the Meat Inspection Division, and the analysis of Insecticides and Fungicides. To Mr. A. T. Stuart, B.A., has been assigned the water analyses, the work in connection with the rain and snow investigation, and the large number of nitrogen determinations necessary in so many researches. Mr. J. T. Janson, B.Sc., and Mr. J. M. Scott, M.Sc., have been chiefly engaged in the analysis of soils, fertilizing materials and feeding stuffs.

I have the honour to be, sir,

Your obedient servant,

FRANK T. SHUTT,

Dominion Chemist.

SESSIONAL PAPER No. 16

NOVA SCOTIA SOILS.

The four soil samples now reported were collected and forwarded, with notes, by Mr. L. C. Harlow at the instance of Principal Cumming of Truro, N.S., Secretary of Agriculture for Nova Scotia.

Laby. No. 8758.—Labelled No. 4N. 'From farm of Mr. Cook, New Annan, Col. Co.; cultivated area, for many years in grass, but not manured; in river valley which is frequently overflowed; only surface drained; soil probably about 2 feet deep. Typical of many miles, as the river valley broadens.' A coarse and very loose gravelly loam of a deep brown colour and showing an abundance of root fibre.

Laby. No. 8759.—Labelled No. 6N. 'From farm Jno. Cunningham, Bay Head, Col. Co.; virgin soil but used for pasture, covered with laurel and dry upland grass; no drainage. The north shore of Colchester county has much soil of this nature.' A light yellowish-grey soil, containing some gravel and of a generally poor, thin appearance.

Laby. No. 8760.—Labelled No. 7S. 'From Otter Brook, Stewiack, Col. Co.; virgin soil, covered with laurel, blueberry, low ground grasses. No drainage, ground low. Depth of soil without apparent change 18 inches. The north side of Stewiack valley has extensive flats of similar soil.' A brownish-red clay loam, without stones or gravel and fairly friable.

Laby. No. 8761.—Labelled No. 18S. 'From property of Mr. M. L. Tupper, Middle Musquodoboit, Halifax Co. Virgin soil, scattered over with small spruce, blueberry, arbutus. No underdrainage, but needs it. With heavy clay subsoil. Typical of west side of valley of Musquodoboit River.' A light-red, loose, gravelly loam, with a fair amount of stones and rock fragments.

The results of the physical examination of these soils are given in the subjoined table, and their study will afford much useful information as to the general nature of the loams, their culture and treatment and their suitability for specific crops.

APPROXIMATE Physical Analysis of Soils from Nova Scotia.

Laboratory No.	Stones and gravel.	Fine gravel and very coarse sand.	Coarse and fine sand.	Silt, fine silt and clay, (by difference).	Organic matter. (Loss on ignition.)
	per cent	per cent	per cent	per cent	per cent
8,758	34.6	16.0	30.8	.82	17.78
8,759	10.6	8.8	52.4	24.56	3.64
8,760	59.9	32.35	7.75
8,761	35.2	11.7	31.6	11.55	6.95

Laby No. 8758.—This is essentially gravelly, the proportion of rock fragments being quite large. The greater part of the fine soil (less than 5 mm. diam.) is sand, much of which is quite coarse. The percentage of clay and silt is very small, practically negligible. For a soil of this character the amount of organic matter is very high; it should be remarked, however, that the larger part of this is not humified, but exists as root fibre that has undergone little or no decomposition as yet.

The absence of clay and the coarseness of a large proportion of the sand explain the lack of cohesiveness of this soil and indicate that its crops might suffer very considerably in seasons of drought. The very liberal amount of vegetable matter present would no doubt do much to offset the tendency of this soil to dry out rapidly. In soils

of this type, cultivation leads to the dissipation of organic matter and, therefore, for the maintenance of fertility it will be essential to supply continually humus-forming material as with farm manures and the turning under of green crops. By this means the soil may be made more retentive of moisture and of such plant food as may be supplied in the form of commercial fertilizers.

If the water table is not too high, this soil would readily drain, allowing an easy and complete aeration. This soil should rapidly warm up in spring and respond well in favourable seasons to high manuring. It is not, from the physical standpoint, to be considered a good general farming soil, but it has characters which make it suitable for some crops, prominent among which we might place potatoes, and similar garden crops.

Laby. No. 8759.—This soil differs essentially from the preceding in its smaller percentages of gravel and very coarse sand and its much larger proportion of silt and clay. Though it might be characterized as a clay loam, it contains sufficient coarse material to make it friable and to permit of its being easily worked. From the physical standpoint the exceedingly small organic content is its most unfavourable feature, and it is undoubtedly in the addition of humus-forming material that improvement, first as to tilth and then 'life' of the soil, is to be chiefly looked for.

Laby. No. 8760.—This is a clay or heavy clay loam. With good drainage and careful, rational tillage it should prove a strong, productive soil. With an increased organic matter content, the probability is that the texture would be considerably improved, and hence the desirability of stable manures and the adoption of a rotation which would from time to time add to the soil's store of humus. Besides its valuable influence on the texture, humus may always be considered as an economical source of plant food.

Laby. No. 8761.—This is a gravelly loam, but probably contains sufficient silt and clay to give it 'strength' and make it fairly retentive of moisture. From the viewpoint of texture it should prove very fairly satisfactory for a large range of crops, but the value of organic matter as an amendment, as well as for the purpose of enrichment, may, as in the preceding instance, be again emphasized.

The composition of the soils as revealed by chemical analysis is set forth in the following table. In addition to the amounts of the essential mineral elements of plant food (phosphoric acid, potash and lime) obtained by the use of a strong acid solvent, the percentages of these constituents soluble in a dilute solution of an organic acid have been obtained. These latter may be regarded as representing more or less closely the proportions available for crop use, and hence in a certain degree may serve to indicate the need or non-need of specific fertilizers.

In considering these analytical data with the view of deducing the relative fertility of the soils, it must not be lost sight of that it is impossible to establish rigid standards as regards the minimum amounts of plant food that must be present in order that a soil may be classed as economically productive. Again, it must be borne in mind that the climatic conditions of the district, the drainage and the texture of the soil, play a most important part in maintaining fertility. Further, the amount of humus-forming material and its condition are potent factors, not only in determining the water-holding capacity of a soil, but also in affording nourishment for the micro-organisms of the soil, the role of which is largely to prepare the plant food constituents for the use of farm crops. Especially is this true as regards nitrification—probably the most important of all the conversions into available forms within the soil. These matters, here so briefly discussed, will be found more fully considered in the Report of the Chemist, Experimental Farms, 1897, but possibly sufficient has been said to show that percentages of the more important elements, useful as they are, must not be taken as the sole guide in the valuation of a soil. Its

SESSIONAL PAPER No. 16

future culture, drainage, the character of the crops grown and several other factors may profoundly modify the deductions made simply from analytical data.

ANALYSIS of (air-dried) Soils.

Laby. No.	Moisture.	Organic and Volatile Matter.	Insoluble Mineral Matter (sand and clay.)	Oxide of iron and alumina.	Lime.	Magnesia.	Phosphoric Acid.	Potash.	Total	Nitrogen.	AVAILABLE CONSTITUENTS.		
											Lime.	Phosphoric Acid.	Potash.
	p.c.	p.c.	p.c.	p.c.	p.c.	p.c.	p.c.	p.c.	p.c.	p.c.	p.c.	p.c.	p.c.
8758	3.52	17.78	57.71	15.97	1.64	1.33	.23	.27	98.45	.54	.39	.087	.048
8759	.45	3.61	91.00	3.92	.04	.35	.026	.145	99.57	.107	Nil	.011	.015
8760	1.23	7.75	80.07	9.38	.36	.91	.11	.37	100.18	.23	.15	.023	.019
8761	1.00	6.95	80.73	10.31	.11	.68	.064	.42	100.26	.204	.02	.023	.018

Laby. No. 8758.—A large amount of vegetable matter usually betokens richness in nitrogen, and it is not surprising, therefore, to find this soil characterized by a high percentage of this element. The crude condition of much of this organic matter, however, leads us to conclude that but a small portion of this nitrogen is in a form readily convertible into plant food; we must rather consider this as a store of nitrogen to be gradually made available by good methods of culture. It is quite probable also, for the same reason, that in spite of this apparent abundance of nitrogen, a good response might be obtained from applications of manure, since such furnish readily convertible, nitrifiable nitrogen for the immediate feeding of our crops.

In the mineral elements of fertility—potash and phosphoric acid—this soil appears to be fairly well supplied, the amounts comparing favourably with those obtained from many of our good soils, *i.e.*, of average fertility. The proportions which may be considered as more or less available are, we think, quite satisfactory, indicating no especial or immediate necessity for fertilizers furnishing these elements in soluble forms.

For a soil of a sandy or gravelly character, the lime content is by no means low; we should judge there was sufficient at present both for crop use and for the promotion of nitrification.

Laby. No. 8759.—The very small amount of humus-forming material present in this soil has already been commented on and emphasis has been laid on the desirability of adding to its store, on both chemical and physical grounds. The percentage of nitrogen, as might be expected under the circumstances, is quite low and the aim should be towards increasing it through organic forms (manure, the turning under of green crops, fish waste, etc.), rather than by application of the more soluble forms, such as nitrate of soda or sulphate of ammonia.

The phosphoric acid percentages—both 'total' and 'available'—are very small and a favourable response to phosphate fertilizers might well be expected. Among such fertilizers we should consider basic slag the most desirable for soils of this type.

The potash is similarly low and we have in consequence to emphasize the desirability of including special potassic fertilizers *e.g.*, wood ashes, sulphate and muriate of potash, in any scheme for the general improvement of the soil.

The amount of lime extracted with strong acid is exceedingly small and that which would be available for crop use is practically negligible. Lime may be furnished in one or more of many forms, but it would not be wise to use large amounts of quicklime unless the soil were well manured or following the turning under of a good growth of some green crop. Wood ashes, in addition to it being a valuable potassic fertilizer

is one of the most acceptable forms for supplying this element. If basic slag were used, as suggested in a preceding paragraph, there would be no need possibly for a special application of lime, as this fertilizer contains a fair quantity in a state or combination that is very useful agriculturally. Marl and ground limestone also suggest themselves as sources of lime useful on such soils.

A word of caution must be given with respect to the use of quicklime on poor soils. Though a response may be obtained at the outset, the continued or excessive employment of this material will bring disappointment unless at the same time the soil is generally enriched, as through manuring and the adoption of a rational rotation. These soils stand in need of lime, but they are also otherwise poor, and if lime only is used, the immediate return is at the expense of the soil's fertility and impoverishment rather than enrichment results.

Laby. No. 8760.—Although in certain particulars this soil is not equal to No. 8758, notably in containing less nitrogen and phosphoric acid, it is on the whole to be regarded as distinctly superior for many farm crops. Its organic matter is more humified and more intimately incorporated with the mineral components and it is in consequence more homogeneous and better adapted to the retention of moisture and to the favourable extension and development of the root system. The absence of such a large proportion of stone and rock fragments as characterizes No. 8758, and the larger clay content of this sample are in its favour. It is a soil that should prove very satisfactory under intelligent cultivation.

There are not any marked or particular deficiencies, so far as can be learned from the chemical data, though with improvement by manures and the increase of its organic content, the rational use of fertilizers would in all probability prove profitable. As a source of phosphoric acid the indications are that basic slag would be suitable. The desirability of organic manure was mentioned in discussing the physical data, and such manures would no doubt be the best forms to introduce nitrogen.

For a soil of this type we should consider the lime content too low for the best returns. An occasional liming might therefore, be recommended, as tending to the improvement of tilth, the promotion of nitrification and the supplying of plant food, directly and indirectly. Any of the forms of this amendment previously mentioned could be used.

Laby. No. 8761.—In colour and general appearance this soil is not unlike No. 8760; closer examination, however, shows it to contain a considerable proportion of gravel absent in the sample just discussed. In many of the chemical data—as in organic matter, nitrogen, insoluble mineral matter, oxide of iron and the amounts of 'available' phosphoric acid and potash, these two soils show a very strong similarity. It however proves to be much poorer in 'total' phosphoric acid, indicating that the stores of this element will require replenishing at an earlier date. A further feature in which it differs from No. 8760, is its greater poverty in lime and hence the greater improvement that may be expected from liming, provided this is judiciously accomplished.

SOILS FROM WARD I, CORNWALLIS, KINGS CO., N.S.

No. 1. Woodside Farm.—From centre of big orchard, south of big barn. In the air-dried condition this sample was of a dull or chocolate-red colour. It is essentially a coarse-grained sand, with some pebbles and small quartz fragments. The masses of agglutinated sand particles are quite friable, being readily crushed between thumb and finger. The proportion of clay and silt is very small. There is but little evidence of vegetable debris. Reaction: very slightly acid.

No. 2. Woodside Farm.—From directly northwest of big barn. Very similar in colour and general structure to No. 1, but a somewhat coarser soil with apparently a large proportion of gravel. Reaction: very faintly acid.

SESSIONAL PAPER No. 16

No. 3. Woodside Farm.—From directly northeast of big barn. A coarse-grained, reddish sandy loam with some large pebbles or rock fragments. Very little clay or silt. Reaction: very faintly acid.

No. 4. Blomidon Farm.—From northeast orchard. A comparatively fine-grained, reddish, sandy loam, with no pebbles. Very friable, with very little clay or silt. Some little root fibre present. Reaction: very slightly acid.

No. 5. Habitant Farm.—From field south of railway track. A reddish, coarse-grained sandy loam, with some lumps of grey sand and a few pebbles and rock fragments. Friable. Very little root fibre present. Reaction: distinctly acid.

No. 6. Habitant Farm.—From Lee Kinsmen's field north of road. A reddish sandy loam. Sand both coarse and fine-grained, but no gravel or pebbles. Apparently no root fibre. Not quite so friable as preceding samples, possibly owing to presence of slightly more clay. Reaction: distinctly acid.

No. 7. Habitant Farm.—From orchard south of big barn.—Light chocolate-red sandy loam with some pebbles. Lumps or masses not quite so friable as in many of the other samples, probably owing to slightly more clay. Little evidence of organic debris. Reaction: distinctly acid.

The air-dried soils were prepared by first removing pebbles and rock fragments and then gently crushing and sifting the remainder, the fine portion (less than .5 mm.) being submitted to analysis.

ANALYSIS of (air-dried) Soils from Ward 1, Cornwallis, Kings Co., N.S.

No.	Laby. No.	Moisture.	Organic and Volatile Matter.	Nitrogen.	AVAILABLE CONSTITUENTS.		
					Phosphoric Acid.	Potash.	Lime.
		per cent	per cent	per cent	per cent	per cent	per cent
1	13267	.88	4.60	.112	.043	.0158	.015
2	13268	.90	4.20	.105	.053	.0135	.021
3	13269	.72	3.24	.077	.030	.0125	.009
4	13270	1.03	5.05	.137	.013	.0048	.007
5	13271	1.40	5.46	.119	.024	.0056	.021
6	13272	1.13	5.58	.150	.021	.0063	.091
7	13273	1.12	5.12	.141	.047	.0094	.058

Physical characters and analytical data alike indicate that all these soils are of the same type or class, and that the differences between them are rather those of degree than of kind. They are sandy loams, the sand for the most part being coarse. Though many contain pebbles and rock fragments, none of the samples could be termed gravelly. Clay and silt are present only in very small proportions and in consequence the soils are free working, open and friable. No doubt in the many years of cultivation the finer particles have washed and worked down into the subsoil.

The amount of vegetable matter (humus) might with advantage be increased in all the soils, both for improving tilth and moisture-holding capacity as well as to form a storehouse for organic nitrogen, a very important element in which these loams are only moderately rich. Organic manures would be the first desideratum towards the permanent improvement of these soils. If barnyard manure is not available in sufficient quantities, the humus-forming material must be furnished by practising a comparatively short rotation, putting the land in grass with clover for, say, two years out of five. If the land is in orchard, leguminous cover crops must be

grown, which will enrich the soil not only in organic matter but in the equally needed nitrogen.

Secondly, the very low lime-content leads to the conclusion that an application of lime or finely ground limestone would be beneficial, and we should strongly advise one or other as an economical means of raising the productiveness of these soils.

Judging from the amount of 'available' phosphoric acid present, there does not seem to be any immediate need of a phosphatic fertilizer. If, however, it is decided to use such we would recommend a trial with basic slag, which, considering the nature of these soils, would appear to be the most suitable form in which to apply this element. The percentages of 'available' potash are not so satisfactory as those of phosphoric acid and indicate that a remunerative response might be obtained from an application of a potassic fertilizer for fruit and root crops.

With respect to soluble nitrogen (nitrate of soda, sulphate of ammonia) an application of, say, 100 to 150 lbs. per acre, in the spring, would probably be advantageous for grain and garden crops, but for orchard work we should consider bone meal (which also furnishes phosphoric acid) a more desirable form.

FERTILIZING MATERIALS.

The official examination of commercial fertilizers sold in Canada is undertaken by the Inland Revenue Department and the Chemical Division of the Experimental Farms does not, therefore, make any analyses of the various brands upon the market, nor engage in any investigation in cases of alleged adulteration of these goods. There are, however, here and there throughout the Dominion, many materials occurring naturally that are of considerable fertilizing value and which, more or less easily obtained, may be used to advantage by our farmers to improve and enrich their lands. These materials comprise certain muds, mucks, marls, sea-weed, fish refuse, etc., etc. It has been our custom from the first to examine into their value and to advise farmers respecting their economic use, and past reports of this Division contain much information on this important matter.

In the following paragraphs an account is given of a number of these fertilizing materials analysed during the past year, many of them having been sent in by farmers for examination while others have been collected by the Division.

MARL AND LIMESTONE.

That many farmers, especially in the Eastern Provinces of the Dominion, are awakening to the fact that there are soils that can be improved by liming, marling or the application of ground limestone, has been noted in our recent reports. The demands for information on this phase of agricultural practice continue to be received and many samples of marl and of rocks supposed to be rich in carbonate of lime have been sent in for examination. To make generally accessible information on the function and uses of lime and its compounds in agriculture an article treating of the subject in its various phases was written for the 1913 report of this Division. As copies of this report are still available, it will be unnecessary to repeat, *in extenso*, our recommendations and advice in this matter. The following paragraphs, however, have been specially written to present succinctly the salient points, and they may give sufficient information to meet ordinary cases. We shall always be pleased, however, on application, to supplement, as far as may be practicable, the particulars therein given and to make suggestions for specific cases.

Lime compounds.—Quicklime, slaked lime and carbonate of lime, though not classed as fertilizers, perform certain useful functions in the soil, the chief of which

SESSIONAL PAPER No. 16

may be summarized as follows: They furnish lime (which is an element of plant food) in a more or less available form and consequently are valuable for soils, naturally deficient in this constituent, as well as for soils that have lost their lime by long-continued cropping. They neutralize the acidity of low-lying, ill-drained soils and soils over-rich in organic matter, such as peat and muck soils; few farm crops thrive in an acid or sour soil. They promote nitrification of the humus of the soil and thus increase the amount of available nitrogen, the dominant element in crop growth. They act on the inert potash compounds of the soil, setting free this element and thus encouraging clover and other potash-loving plants. They also exert an influence on the insoluble phosphates of the soil, especially those of iron and alumina, converting them into forms more readily utilized by crops. They improve the texture of heavy clay soils, making them mellow.

The compounds, quicklime, slaked lime and carbonate of lime differ in their composition and hence in their agricultural value. On the basis of an equal purity, 100 lbs. quicklime is the equivalent of 130 lbs. slaked lime and of 180 lbs. carbonate of lime. In other words, it would require 2,600 lbs. slaked lime or 3,600 lbs. of carbonate of lime (marl, ground limestone) to furnish the lime and do the same chemical work in the soil as 2,000 lbs. of quicklime.

The rate of application per acre will depend on several factors—the character of soil, degree of its acidity, etc., but it may be stated as a general principle that on light and poor sandy loams the dressings should be small, say from 500 lbs. to 1,500 lbs. per acre of quicklime—the equivalent of (about) 900 lbs. to 2,700 lbs. of carbonate. On heavy clay loams and on soils rich in vegetable matter heavier applications may be made, say from 1,000 lbs. to 4,000 lbs. quicklime—the equivalent of 1,800 lbs. to 7,000 lbs. carbonate of lime. In considering the amount, the frequency of the application must be borne in mind. It is undoubtedly better to give small and frequent dressings than large ones at long intervals. Under ordinary conditions even when a soil responds well to liming, from 5 to 10 years should be allowed to elapse between dressings.

While excessive amounts of quicklime, or its too frequent application, may do positive harm, no danger to soil or crops need be apprehended from large dressings of marl or ground limestone. Quicklime and slaked lime are probably best applied in the autumn, marl and ground limestone may be put on the land at any season.

Quick lime, known commonly as stone lime, is somewhat inconvenient and disagreeable to apply unless it can be bought in a ground condition and distributed with a fertilizer drill or lime spreader. Without special means for distribution the best plan is to put the lumps of lime in small heaps, say of 50 to 75 lbs. each, placed at intervals, according to the rate of application, on the ploughed soil. Over each heap pour slowly a little water, say 2 to 3 gallons, and cover with soil. When the lime is thoroughly slaked, the fine powder may be mixed with more soil, scattered and at once well harrowed in. Crushed marl and ground limestone offer no difficulties in their application. Uniformity in the distribution of all these lime compounds is desirable and since there is a tendency for the lime to wash down, they should not be ploughed under but spread on the surface and harrowed in, as already described.

The use of lime entails the constant supplying of organic humus-forming matter to the soil if fertility is to be maintained.

Lime alone must lead to a soil's impoverishment and in time to its exhaustion below the point of profitable cultivation. In a system that is periodically adding to the soil's store of vegetable matter, as by the regular application of farm manures and the adoption of a rational rotation whereby plant residues are returned, the occasional application of lime in one or other of these forms may be found desirable and profitable.

Laboratory No. 11213.—From Mount Carmel, Antigonish Co., N.S.; occurs as a large bed or deposit; moderately soft and of a reddish-grey or yellowish colour and

5 GEORGE V. A. 1915

in appearance like a semi-disintegrated limestone or other calcareous rock; in powder and lumps.

Analysis.

Moisture23
Mineral matter insoluble in acid.....	13.10
Carbonate of lime	81.73
Sulphate of lime58
Organic and volatile matter*.....	1.02
Undetermined	3.34
	100.00
* Containing nitrogen05

This material is essentially carbonate of lime, and if crushed or powdered, could be used effectively as an amendment for all soils in need of lime. It should prove of particular value for the heavy soils mentioned by our correspondent as occurring in the neighbourhood.

Laboratory Nos. 12351-2.—These are samples of crushed limestone from English quarries, submitted for analysis by a Canadian correspondent who states that these limestones could be purchased for export at about 50 cents per cask of 400 lbs. and that the ocean rate would be about \$3.50 per ton.

Analysis.

	No. 12351 "B" Monks Park.	No. 12352 "C" Portland Quar- ries.
Carbonate of Lime.....	96.07	96.52
Mineral matter insoluble in acid.....	50	3.30
Undetermined	3.43	.18
	100.00	100.00

As regards lime content there is little difference between these samples; both are of excellent quality. As an agricultural source of lime, however, their use would be prohibited by reason of their high cost to Canadian farmers.

Laboratory No. 13753.—Marl from bed at Lower West River, Antigonish Co., N. S., in powder and lumps of rock fragments and has the appearance of weathered and disintegrated limestone.

Analysis.

Moisture ..	.17
Carbonate of Lime.....	81.00
Mineral matter insoluble in acid.	14.94
Loss on ignition (organic matter)69
Undetermined	3.20
	100.00

It is essentially carbonate of lime, and if reduced to powder would assuredly prove a valuable amendment on soils requiring lime.

SESSIONAL PAPER No. 16

Laboratory No. 14102.—From Clydesdale, Antigonish Co., N.S. In powder and lumps of considerable hardness; resulting probably from disintegration of rock.

Analysis.

Moisture	3.81
Carbonate of lime.	85.00
Mineral matter insoluble in acid.	8.54
Loss on ignition (organic matter, etc.)18
Undetermined.	2.47
	<hr/>
	100.00
	<hr/>

This is a calcareous deposit of fair quality. For its greater efficiency, however, crushing the whole to a condition of coarse powder is necessary.

Laboratory No. 16278.—Marl from Muldoon, Que.; stated to exist in very large quantities as a bed in an old lake bottom. Received as a putty-like substance of a light-grey colour and showing a large number of shells. It dries to an easily crumbled mass of a dark-grey, earthy appearance. It is almost entirely soluble in dilute hydrochloric acid, with brisk effervescence. This examination shows it to be marl of very good quality; it contains very little foreign matter. It would undoubtedly prove an effective source of lime for all classes of soils.

Laboratory No. 16523.—From Armstrong, B.C. Greyish-white, granular, almost completely soluble with brisk effervescence in dilute acid. This is a calcareous deposit of very considerable agricultural value. It consists essentially of carbonate of lime and is probably derived by deposition from waters rich in that constituent. The percentage of foreign matter in the deposit is very small.

Laboratory No. 16525.—Also from the neighbourhood of Armstrong, B.C. This, though containing a fair percentage of carbonate of lime, is distinctly inferior to No. 16523, there being present a large proportion—approximately fifty per cent—of inert mineral matter.

Laboratory No. 16534.—From Shuswap, B.C. This material, described as a 'white sandy deposit' occurs as a bed near a pond and is covered with about a foot of soil. As received it was of greyish-white colour, of earthy appearance and quite friable. It dissolves completely and readily in dilute acid with brisk effervescence, and furnishes evidence of being essentially carbonate of lime. It is to be considered a marl of excellent quality.

Laboratory No. 16904.—From Enderby, B.C., stated to occur as a deposit resulting from the evaporation of seepage water passing through strata of calcareous rock.

Analysis.

Moisture	7.75
Organic and volatile water.	2.03
Mineral matter insoluble in acid.	32.07
Oxide of iron and alumina	1.76
Carbonate of lime	55.46
Sulphate of lime25
Phosphoric acid	traces.
Undetermined	1.48
	<hr/>
	100.00
	<hr/>

This material, air-dried, it will be seen, contains only a little more than half its weight of carbonate of lime and therefore cannot be classed as a marl of high quality.

5 GEORGE V., A. 1915

It could, however, be used to advantage on sour soils and those naturally deficient in lime—indeed on all soils needing that element—provided it were cheaply obtained.

Laboratory No. 14481.—A 'calcareous clay' from Vittoria, Ontario. The correspondent writes 'There is a deposit of this material of about 18 inches covering about 20 acres at the foot of a hill and through which runs a small stream of water. It has evidently been a swamp.'

Analysis.

Carbonate of lime	62.25
Clay, sands, etc. (insoluble in acid).....	32.22
Oxide of iron, etc., by difference	5.53
	100.00

We might predict that this 'clay' would be useful to sour soils and those deficient in lime; it is not, however, of first quality, considered as a source of lime.

Laboratory No. 13969.—A 'calcareous deposit' from Hedley, B.C., and forwarded for information as to its use and value in agriculture.

Analysis.

Carbonate of lime	14.02
Sulphate of lime	77.27
Clay, sand, etc. (insoluble in acid)	32.22
Undetermined	5.31
	100.00

This deposit is a mixture of sulphate and carbonate of lime, the former predominating. Sulphate of lime or gypsum has an agricultural value, chiefly, probably, in liberating potash from its inert stores in the soil, and has been found of especial value for clover, a potash-loving crop. Though the percentage of carbonate of lime is not large, it is sufficient to make the deposit of value for the correcting of sourness of poorly drained soils. The application might be from 1,000 to 3,000 lbs. per acre.

Laboratory No. 15051.—Described as 'rock deposit' from Saanich Peninsula, B.C., and occurring as a bed or deposit of decomposed material overlying limestone.

Analysis.

	Per cent.
Mineral matter insoluble in acid.....	57.84
Oxide of iron and alumina	24.92
Lime	2.41
Magnesia	2.84
Potash	trace.
Phosphoric acid.....	"

This deposit cannot be considered of any agricultural value, the lime content being too small to make the material of use as an amendment for sour soils, and the potash and phosphoric acid being present in traces only.

Laboratory No. 14195.—'Grey limestone' from J. F. H., Buckingham, Que. Received in the form of a fine powder, with a request for information as to its value for agricultural purposes.

Analysis.

Carbonate of lime	91.30
Mineral matter insoluble in acid.....	1.70
Oxide of iron, alumina, etc. (undetermined).....	7.00
	100.00

This is a limestone of good quality and the degree of fineness to which it has been ground enhances its agricultural value from the standpoint of availability.

SESSIONAL PAPER No. 16

Laboratory No. 16888.—'Ground limestone' from E. L. Co., Sydney, Cape Breton, N.S., and forwarded for report as to composition and fineness.

Analysis.

Carbonate of lime	92.00
Mineral matter insoluble in acid.....	6.15
Oxide of iron and alumina	1.56
Undetermined29
	100.00

These results indicate a limestone of excellent quality. The mechanical separation gave the following data:—

20.05 p.c. passes through sieve having 80 meshes to linear inch.
27.10 p.c. " " " " 40 " "
35.81 p.c. " " " " 20 " "
48.93 p.c. " " " " 10 " "
72.16 p.c. " " " " 5 " "

Apparently this is coarser than much of the ground limestone used in the United States. We may conclude that the finer the grinding the more immediate will be the action of the limestone in the soil; on the other hand, it seems probable that a fairly coarse powder has an advantage in the majority of cases, for though slower, it will remain active in the soil for a longer period of years.

Laboratory No. 16146.—W. McD., Sussex. Limestone from Havelock, Kings Co., N.B., forwarded with an inquiry as to its value for grinding and use in agriculture.

Analysis.

Carbonate of lime	94.92
Oxide of iron and alumina60
Mineral matter insoluble in acid.....	2.24
Carbonate of magnesia, etc. (by difference).....	2.24
	100.00

A limestone of excellent quality and, in pulverized form, one eminently suitable for agricultural purposes.

Laboratory Nos. 14155-6.—Two samples of 'waste lime' from Randolph, N.B., and forwarded by W. W. H., Fredericton, with an enquiry as to their respective values for use on the land; probably occurring as refuse from lime kilns.

Analysis.

	No. 14155. "Blue Rock." Per cent.	No. 14156. "Magnesia." Per cent.
Carbonate of lime	34.23	25.73
Caustic and slaked lime.....	43.45	30.67
Mineral matter insoluble in acid.....	1.50	.19
In fine powder (passing through .5mm. mesh).....	58.60	48.22
In coarse powder and lumps	41.40	51.78

Both samples would be valuable for agricultural purposes but No. 14155 is the better by reason of its larger lime-content and its finer condition.

5 GEORGE V., A. 1915

Laboratory No. 14177.—‘Agricultural Lime.’ V-V, L., and B. Co., Victoria, B. C. In the form of a very fine white powder and specially recommended for agricultural use. Occurring probably as a waste product in the burning of lime.

Analysis.

Carbonate of lime	67.34
Caustic and slaked lime.....	21.73
Mineral matter insoluble in acid.....	4.97
Oxide of iron, etc. (undetermined).....	5.96
	<hr/>
	100.00

It is, undoubtedly, a useful source of lime for the treatment of soils and one from which good results might be expected.

Laboratory No. 16845.—‘Agricultural Lime.’ E. H., Agassiz, B.C. A very fine and fluffy powder. Its source of manufacture could not be learned, but it is probably the waste lime from kilns.

Analysis.

Carbonate of lime	48.75
Caustic and slaked lime	44.60
Mineral matter insoluble in acid.....	.22
Oxide of iron, alumina, magnesia, etc. (by difference).....	6.43
	<hr/>
	100.00

From its composition as well as its physical condition, this should prove an excellent lime for agricultural purposes.

SUPERPHOSPHATE OF LIME.

Laboratory No. 16794.—Sample forwarded from the Agricultural College, Truro, N.S., and labelled ‘Superphosphate of Lime containing soluble phosphates 36 per cent.’ From the United Alkali Co., Ltd., Pilkington Works.

Our analysis showed total phosphoric acid 19.13 per cent, water-soluble phosphoric acid, 16.09 per cent.

If all the phosphoric acid in a material containing 36 per cent phosphate of lime were made soluble, the percentage of water-soluble phosphoric acid so produced would be 16.99 per cent. It seems evident, therefore, that the manufacturers statement on the label is to be construed as meaning that the superphosphate contains water-soluble phosphoric acid equivalent to 36 per cent bone or rock phosphate.

WOOD ASHES.

Laboratory No. 13175.—J. McC., Valcartier, Que. Purchased in the vicinity and forwarded for examination as to fertilizing value. Received in air-dried condition.

Analysis.

Moisture	1.04
Mineral matter insoluble in acid (sand, clay, etc.).....	41.43
Organic and volatile matter (charcoal, etc.).....	17.80
Oxide of iron and alumina	20.96
Lime	10.14
Magnesia77
Potash	2.76
Soda	1.08
Phosphoric acid	1.10
Carbonic acid, etc. (undetermined).....	2.92
	<hr/>
	100.00

SESSIONAL PAPER No. 16

These ashes are decidedly low in potash, the chief fertilizing element in materials of this character. In commercial wood ashes of fair quality, the potash is usually between 5 per cent and 6 per cent. It therefore would seem that these ashes have been partially leached or mixed with a good deal of sand, etc.

Laboratory No. 16648.—‘Soft Maple Ashes’ from C. P. M., Sardis, B.C. Sample consists of powder and a number of vitrified masses or clinkers.

Analysis.

	Per Cent.
Potash	19.19
Phosphoric acid	2.71
Lime (existing chiefly as carbonate)	35.76
Mineral matter insoluble in acid	3.16

These ashes contain an unusually high percentage of potash and are, in consequence, of very considerable fertilizing value. They are practically free from sand or other foreign material and are to be regarded rather as the ‘pure ash’ of the maple than as a commercial article.

SEWAGE SLUDGE OR POUURETTE.

This sample (*Laboratory No. 16273*) was submitted to analysis at the request of the Commission of Conservation, it having been obtained from Manchester, England.

In various systems of sewage purification by precipitation, a product is obtained from the settling vats or reservoirs, which is generally known as sludge. The composition of this material will, naturally, vary with the concentration of the sewage, the nature and amount of the precipitant (lime, alum, etc.), and the degree to which it is subsequently dried; hence the fertilizing value is a matter of close inquiry.

Analysis.

	Per Cent.
Moisture	3.18
Organic and volatile matter	33.06
Mineral matter	63.76
	100.00
Clay, sand, etc., insoluble in acid.....	45.12
Oxide of iron and alumina	9.81
Lime	2.03
Phosphoric acid	1.22
Potash08
Nitrogen, in organic matter	1.45

For the purpose of comparison, analyses of sludge from Hamilton and Toronto, made in the Farm laboratories some years ago, are appended.

Analyses of Sludge.

	Hamilton. Per Cent	Toronto. Per Cent.
Moisture	31.75	3.94
Organic and volatile matter	39.05	40.91
Mineral matter	39.20	55.15
	100.00	100.00
Clay, sand, etc., insoluble in acid.....	9.66	34.05
Oxide of iron and alumina.....	4.74	13.65
Lime	9.23	2.07
Magnesia	10.40	.33
Phosphoric acid69	1.24
Potash19	.21
Nitrogen, in organic matter84	2.04

Their chief element of fertilizing value is nitrogen; of the other essential constituents of plant food, the percentages are quite small. It will be evident from a study of these data that this material cannot be ranked with commercial fertilizers, though it undoubtedly possesses a manurial value. It may be questioned if its plant food content would warrant its carriage for long distances, but as supplemental to other manures it could be used locally to advantage.

Sludge and peudrette, it is claimed, have a value from the biological standpoint. They are said to be rich in the nitrifying organisms necessary for the conversion of soil nitrogen into nitrates, the form in which farm crops obtain their nitrogenous food. It is probable, therefore, that the beneficial results obtained from the use of these materials may in part be due to the presence of these micro-organisms.

FLUE ASHES.

Laboratory No. 16806.—From B. M. S., Louisburg, C. B., N.S. Though labelled 'Soot,' an examination shows clearly that this material is rather of the nature of flue ashes—a conclusion confirmed by the analytical data.

Analysis.

	Per Cent.
Moisture	1.75
Organic and volatile matter	8.95
Mineral matter ¹	89.30
	<hr/>
	100.00
	<hr/>
Nitrogen20
Phosphoric acid14
Potash ²13

¹ Containing 46.83 per cent insoluble in acid.

² Containing .032 per cent soluble in water.

The fertilizing value of this material is very small, practically negligible. Though not furnishing much plant food, it is possible that it might be found helpful for heavy soils, making them mellow and more easily worked.

PULP MILL REFUSE.

Laboratory No. 16836.—From Pont St. Maurice, Que., and stated to be the refuse or waste in the manufacture of pulp by the sulphite process.

As received, it was a dark-grey, jelly-like substance, smelling strongly of sulphuretted hydrogen and very strongly alkaline. On standing there was a separation into two layers, the upper a pale-yellow fluid, the lower a dark-grey, semi-solid mass. An examination of the sample as a whole showed that potash was present in traces only, and that the lime, which was abundant, was chiefly as sulphide and therefore could not be utilized for the treatment of soils in need of that element. The caustic character of the refuse entirely precluded its employment on the land.

FERTILIZER EXPERIMENTS WITH POTATOES.

The use of fertilizers in the Maritime Provinces has been steadily increasing for some years past, especially for the potato crop. Though some farmers have done a little experimental work to ascertain the forms and amounts of the fertilizers most likely to prove profitable, the larger number are practically working in the dark, knowing little as to the deficiencies of their soil, the requirements of their crop or the cheap-

SESSIONAL PAPER No. 16

est and most available forms in which to furnish plant food as fertilizers. In order to investigate the relative merits of various forms and applications of fertilizers for the potato crop under the particular conditions of soil, climate, etc., obtaining at Fredericton, N.B., and Kentville, N.S., land was set aside, in the spring of 1913, at the Experimental Stations at these respective places, and a more or less comprehensive plan, including the use of the various forms of nitrogen, phosphoric acid and potash commonly found in fertilizers, inaugurated. The field work has been under the control of Mr. W. W. Hubbard, Superintendent at Fredericton and Mr. W. Saxby Blair, Superintendent at Kentville, to whom I am indebted for the data and records given in this report.

EXPERIMENTS AT FREDERICTON, N.B.

Fifteen plots of one-tenth acre (A to O) and three of one-half acre each (P, Q, and R.) were measured off. The series included three check plots, upon which no fertilizer was applied.

The soil was rather light sandy loam, fairly uniform in character and apparently well drained naturally. For many years it had been in hay and the last previous manuring had been two or three years prior to this experiment. In October, 1912, it had been ploughed and during the first week of May, 1913, it was thoroughly worked with the disc harrow. This was followed by cultivation continued every ten days until the time of planting. Shallow furrows were then opened up 30 inches apart and to a depth of $3\frac{1}{2}$ inches.

The fertilizer was distributed by hand as evenly as possible along the bottom of the furrows and lightly covered with soil. Commercial New Brunswick White Stock potatoes were used as seed and planting was done on June 19th.

Throughout the season due attention was given to the proper cultivation of the crop, which was twice sprayed with Bordeaux mixture and Arsenoid. The vines were killed by frost on September 28th, but digging had to be deferred until October 23rd, owing to continued wet weather, which, however, did not adversely affect the crop.

In Table I the various fertilizers and the amounts applied per acre are given, together with the total and marketable yields of potatoes obtained. Net results after deducting the cost of fertilizer have been calculated, valuing the marketable tuber at 44 cents and the culls at 20 cents, per bushel, thus showing the gains and losses per acre from the use of fertilizers throughout the series.

EXPERIMENTS AT KENTVILLE, N.S.

This series comprised twenty-four plots of $\frac{1}{20}$ acre each and included four to which no fertilizer was applied, to serve as checks.

The land had never been cropped and was only cleared of stumps the previous season, many roots still remaining. The soil was a sandy loam of medium to poor quality, but fairly level and uniform.

The fertilizer was broadcasted evenly by hand and harrowed in just before planting. A uniform strain of Green Mountain potatoes was used for seed. The rows were 33 inches apart. Planting was on June 6. Cultivation was given as necessary and the crop was twice sprayed with Bordeaux mixture and Paris green. At the close of the season the 'stand' appeared to be exceptionally even. The crop was dug September 30. The data and calculations therefrom, similar to those given for Fredericton, are presented in Table II.

TABLE 1.—Fertilizer Experiments on Potatoes at Frederickton, N.B.

Plot.	Nitrate of Soda.	Sulphate of Ammonia.	Bone Meal.	Superphosphate.	Basic Slag.	Sulphate of Potash.	Total Yield.	Market-able.	At 44 cts. Bushel.	Cost of Fertilizer.	NO ALLOWANCE FOR CULLS.		INCLUDING CULLS VALUED AT 20 CTS. BUSHEL.		
											Net Receipts.	Profit Over no Fertilizer (\$61.60).	Net Receipts.	Profit Over no Fertilizer (\$37.07).	
						Bush.	Bush.	\$	cts.	\$	cts.	\$	cts.	\$	cts.
A	75	75	250	250	500	150	322	304	133 76	14 78	118 98	57 38	122 58	55 51	
B	75	75	500	500	500	150	311	291	128 04	12 53	115 51	53 91	119 51	52 44	
C	150	120	500	500	500	150	200	172	75 68	4 88	70 80	9 20	76 40	9 33	
D	150	120	500	500	500	150	224	192	84 48	3 90	80 58	18 98	86 98	19 91	
E	150	120	500	500	500	150	176	144	63 36	3 50	63 36	Loss.	64 50	Loss.	
F	150	120	500	500	500	150	172	140	61 60	3 75	58 10	Loss.	63 76	Loss.	
G	150	120	500	500	500	150	148	116	51 04	3 90	47 29	Loss.	53 69	Loss.	
H	150	120	500	500	500	150	220	196	86 24	3 90	82 34	20 74	87 14	20 07	
I	75	75	500	500	500	150	172	132	58 08	8 38	49 70	Loss.	57 70	Loss.	
J	75	75	500	500	500	150	160	120	52 80	8 63	44 17	Loss.	52 17	Loss.	
K	75	75	500	500	500	150	134	108	47 52	8 78	47 52	Loss.	52 72	Loss.	
L	75	75	500	500	500	150	241	220	96 80	7 40	88 02	26 42	92 22	25 16	
M	75	75	500	500	500	150	227	198	87 12	7 40	79 72	18 12	85 52	18 45	
N	75	75	500	500	500	150	195	179	78 76	7 65	71 11	9 51	74 31	7 24	
O	75	75	500	500	500	150	192	171	75 24	12 00	63 24	1 64	67 44	0 37	
P	75	75	500	500	500	150	315	294	129 36	8 67	120 69	59 09	124 89	57 82	
Q	75	75	500	500	500	150	330	300	132 00	7 63	124 37	62 77	128 37	61 30	
R	75	75	500	500	500	150	239	265	116 60	6 85	109 75	48 15	116 55	49 48	
S	75	75	500	500	500	150	192	168	73 92	Loss.	73 92	Loss.	78 72	Loss.	

NOTE.—The check plots (no fertilizer) are E, K, and S.

TABLE II.—Fertilizer Experiments on Potatoes at Kentville, N.S.

Plot.	Nitrate of Soda.	Sulphate of Ammonia.	Bone Meal.	Superphosphate.	Basic Slag.	Sulphate of Potash.	Total Yield.	Market-able.	At 44 cts. Bushel.	Cost of Fertilizer.	No ALLOWANCE FOR CULLS.		INCLUDING CULLS VALUED AT 20c. BUSHEL.	
											Net Receipts.	Profit over no Fertilizer (\$58.14).	Net Receipts.	Profit over no Fertilizer (\$63.91).
1	150	350	150	Bush.	179.5	78 98	12 28	66 71	73 51	9 60	
2	150	150	169	74 36	12 53	61 84	68 44	4 53	
3	150	500	150	221.5	97 46	15 78	91 69	98 19	25 28	
4	150	350	150	259.5	114 18	12 28	101 91	108 91	45 00	
5	150	350	100	209.5	75 90	10 98	64 93	72 33	8 42	
6	151	122	53 68	53 68	59 48	
*7	150	350	150	250.5	97 46	7 56	89 91	95 51	31 60	
+8	150	350	150	263	104 50	11 33	93 17	98 27	34 86	
9	150	350	60	233.5	93 72	9 33	83 79	91 89	27 98	
10	150	215	182	80 52	4 88	75 65	82 05	18 14	
11	151.5	123	54 12	54 12	59 82	
+12	150	350	150	252.5	111 10	15 11	94 99	101 49	37 58	
13	150	350	30	197.5	72 16	9 16	63 01	69 71	5 80	
14	154.5	122	53 68	53 68	66 18	
15	150	162.5	60 06	3 90	56 16	61 36	
/16	150	350	150	265.5	104 28	11 75	92 53	98 23	Loss.	
17	350	150	186.5	66 22	3 10	62 72	69 92	34 32	
18	500	234	202.5	89 10	7 40	82 10	88 40	6 01	
19	187	161.5	71 06	71 06	76 16	24 49	
20	350	150	155.5	71 28	7 40	63 88	70 58	6 67	
21	500	194.5	160	70 40	3 75	66 65	73 55	9 64	
22	150	232	196.5	86 46	8 61	77 83	84 93	21 02	
23	150	150	195	85 80	8 73	77 03	82 73	18 82	
24	150	350	200.5	165.6	72 32	8 38	64 45	71 45	7 54	

*(Mixed and applied at rate of 400 lb. per acre.) †(Mixed and applied at rate of 690 lb. per acre.) ‡(Mixed and applied at rate of 800 lb. per acre.)
/(Potash as Muriate.)

NOTE.—The check plots (no fertilizer) are Nos. 6, 11, 14 and 19.

It would not be wise to draw hard and fast conclusions from one year's work, but a careful consideration of the data in the foregoing tables shows that there are a few inferences, broad and fundamental in character, that may be safely and legitimately made. To present these deductions in a form that may be readily grasped, Table III has been prepared. It gives for each series, the data for the plot showing the net maximum cash receipt, from which is subtracted the average value of the crop without fertilizers. The table allows of deductions respecting the increases in profit from the use of fertilizers in general. It also furnishes interesting and valuable figures representing the respective profits and losses from the employment of any one element, any two elements and from the use of all three elements in the formula.

TABLE III.—PROFIT AND LOSSES FROM USE OF FERTILIZERS.

	FREDERICTON, N.B.		KENTVILLE, N.S.	
	Marketable.	Total.	Marketable.	Total.
	\$ cts.	\$ cts.	\$ cts.	\$ cts.
Maximum net receipts	124 37	128 37	101 91	108 91
Average from check plots without fertilizer..	61 60	67 07	58 14	63 91
Maximum net increase (\$) due to fertilizer..	62 77	61 30	43 77	45 00
Maximum net increase (p.c.) " " ..	101·9	91·40	75·3	70·41
	Profits*	Losses*	Profits*	Losses*
	p. c.	p. c.	p. c.	p. c.
<i>Using any one element.</i>				
Nitrogen alone	15·0		30·1	
Phosphoric acid alone.....	30·8	5·7	7·9	
		23·2	14·7	
Potash alone	33·7		41·2	
Lime alone	2·7			3·4
<i>Using any two elements.</i>				
Nitrogen with phosphoric acid.....		19·3	10·85	
		28·3	33·9	
Nitrogen with potash.....	42 9		32·5	
Phosphoric acid with potash	15·4		9·9	
	29·4			
<i>Using any three elements.</i>				
Nitrogen with phosphoric acid and potash	78·15		6·4	
	87·5		8·4	
	93·15		11·7	
	96·0		14·8	
	101·6		40·5	
			45·0	
			54·7	
			59·2	
			60·3	
			63·4	
			75·3	

* Profits and losses have been calculated from the marketable crop only.

Though in the series at Kentville but one case of actual loss from the application of fertilizer occurred there are several instances in which the margin of profit from its use is exceedingly small. At Fredericton four fertilized plots gave no profit, yet on the same area, on apparently similar soil we find several plots upon which

SESSIONAL PAPER No. 16

the application of fertilizer has given splendid returns. The profits from the use of fertilizer range from 1 per cent to 101.9 per cent, reckoned on the total value of the crop. This latter gain means a crop worth twice as much as the average from the unfertilized plots, and yet this immense gain, found after deducting the cost of the fertilizer, does not necessarily mark the limits of possibility. It must not be inferred from this that the profit to be derived from the application of fertilizers is a matter of mere chance—it is not—but it will be evident that there is here a problem that must be rationally attacked. In a large number of instances there is a profit to be reaped from the use of fertilizers, the problem is to find out those special forms and their amounts which will yield the maximum profit. There are few other means whereby the intelligent, observant farmer can so readily increase his income; on the other hand, without care and thoroughness and patient investigation the use of fertilizers is fraught with uncertainty. To double a total income from a crop might easily mean to increase four or five fold the net profits from the year's work. The results here recorded, it must be remembered, apply simply to the potato crop, but they show that the study of the rational use of fertilizers fully merits the attention of farmers and particularly of those who are without a sufficiency of manure to maintain fertility and thus unable to obtain maximum yields.

Table III brings out in a striking manner that the largest profits and the largest number of cases giving a profit followed the application of *all three elements of plant food*. Further, where one or two of the elements only were furnished, a moderate profit of only about one-half of that otherwise obtained, is shown, the stand was not so good and the percentage of culls was much higher than when a complete fertilizer was used. As regards healthiness, field notes showed the plants on the complete fertilizer plots were the freer from rust and had in appearance the greater vigor.

A consideration of the detailed data of tables I and II shows that as to forms of plant food, nitrogen gave much the better results when applied, at least in part, as sulphate of ammonia. Phosphoric acid would seem to be equally effective either as superphosphate or basic slag, while applied as bone meal it has proved, apparently, somewhat more valuable. Potash may be applied in either form, muriate or sulphate, with equal results as regards yield.

A further study of the details will make it very apparent that the largest profits do not necessarily follow the application of the largest amounts of fertilizer. It is strikingly noticeable that the largest increase in net profits (\$62.77 or 101.9 per cent) was effected by one of the smallest applications in the list,—a total of 435 pounds, at a cost of \$6.85—and it is quite possible that these applications might be still further reduced.

FODDERS AND FEEDING STUFFS.

Attention was directed in our last report to the working of the Commercial Feeding Stuffs Act under the operation of the Department of Inland Revenue. This Act requires that certain classes of feeds, more especially those occurring as by-products in manufacturing processes, shall be duly registered and shall bear a label or statement attached to the package giving the registration number and a guaranteed analysis in terms of its minimum content of protein and fat and its maximum content of fibre. Its enforcement has undoubtedly been of considerable protective value to the farmer and incidentally has very considerably reduced the number of miscellaneous samples of feeding stuffs that we have been accustomed to receive from farmers for examination and report.

The accompanying table contains the analytical data of certain fodders and feeding stuffs examined in the Experimental Farm laboratories during the past year. The greater number of these samples are of materials used in feeding experiments at one or other of the Experimental Farms or Stations, but there are several forwarded by farmers, respecting which there did not appear to be any exact knowledge on record.

ANALYSIS OF FEEDING STUFFS 1913-14.

Laboratory Number.	Name.	Particulars.	Water.	Crude Protein.	Oil or fat.	Carbo-hydrates.	Fibre.	Ash.
			P. C.	P. C.	P. C.	P. C.	P. C.	P. C.
14664	Cotton seed meal.....	Owl Brand, Memphis, Tenn	7.16	37.77	7.56	29.93	10.81	6.77
16505	"	Am. Cotton Oil Co., Jacksonville Fla.	8.56	37.15	7.16			
16506	"	" Toledo, Fla.	10.45	40.41	7.38			
14224	Distillery grains	Melcher's Gin & Spirits Distillery Co. Ltd. Montreal	5.29	19.51	4.39	50.95	17.74	2.21
14670	"	"	7.82	19.16	3.60	50.98	16.45	2.69
15022	"	"	7.38	18.57	6.40	46.48	18.43	2.74
16253	"	"	8.65	19.43	6.30	44.94	17.58	3.10
14653	Brewers	"	9.26	22.67	5.66	42.20	16.43	3.78
16968	Dried distillery slop	Farmer's Feed Co., Toronto.	11.01	17.44	9.55	48.84	5.17	7.99
14 62	Oil cake	H. Walker & Son, Walkerville, Ont.	6.68	31.60	2.01	37.11	17.80	4.80
14665	Gluten meal.....	Livingstone Co. Baden, Ont.	13.20	30.63	4.04	49.71	1.95	0.47
14974	Barley germ meal.....	Edwardsburg Starch Co.	11.22	25.98	2.10	43.50	11.47	5.73
15672	Venus pea hay.....	Charlesburg, Que.	5.08	22.24	4.11	35.90	25.93	6.64
15673	Am. vetch hay.....	Birch Hills, Sask	7.17	19.11	3.04	40.57	23.37	6.74
16311	Cocoa bean husks.....	"	6.41	16.89	11.02	43.33	15.10	8.22
16961	Mixed concentrates	Agassiz, B. C.	7.85	14.53	9.61	54.12	7.73	6.16
14706	Wheat middlings.....	New Westminster, B. C.	10.76	15.81	4.29	58.04	6.62	4.48
16891	"	Pollyhurst, N. B.	6.83	17.74				
16892	"	Maple Leaf Milling Co., Kenora.	7.35	16.46				
16 10	Golden flax	"		21.23	41.80			
14661	Bran	Lethbridge, Alta.	11.32	14.84	3.95	53.74	9.68	5.47
14183	Hullless oats.....	Maple Leaf Milling Co., Kenora.	10.84	15.89	5.00	63.68	2.32	2.27
14660	Molasses.....	Central Experimental Farm.	28.70	4.94				
15053	" feed.....	From Louisiana, U. S. A.	22.04	4.89	0.46	58.22	7.03	7.36
15054	Molassine meal.....	Caldwell's Molasses Feed Co., Dundas	17.06	6.34	0.68	58.38	10.55	6.99
16442	Corn fodder.....	Molassine Co., E. Greenwich, Eng.	48.51	5.38	0.17	21.48	20.03	4.43
16443	" ensilage.....	Brandon, Man.	77.84	2.29	0.06	9.54	8.31	1.96

SESSIONAL PAPER No. 16

Cotton-seed Meal, Laboratory Nos. 14664, 16505, 16506.—This product as found on the market, is very variable. The highest grades contain in the neighbourhood of 40 per cent protein and as much as 13 per cent oil. Many grades may fall considerably below these figures and may also contain an excess of fibre, and thus it is evident that cotton-seed meal should only be purchased on guaranteed analysis.

Sample No. 14664, Owl Brand, was bought locally at Ottawa and was manufactured at Memphis, Tenn., U.S.A. Nos. 16505, 16506, forwarded from Truro, N.S., were from Jacksonville and Toledo respectively. All three are genuine and of good quality, but No. 16506, by reason of its somewhat higher protein content is the best of the series.

Distillers' Grains, Laboratory Nos. 14224, 14670, 15022, 16253.—These dried grains from the distillery are stated to result from the use of malted barley, rye and corn in equal proportions. This is a product of very considerable feeding value, containing nearly 20 per cent of protein and from 4 to 6 per cent of oil or fat. The fibre content is rather high when compared with concentrates such as oil cake and cotton seed meal. The samples reported on were drawn at intervals of several months apart, and, therefore, the close accord of the analyses would indicate a very fair uniformity in the composition of this product throughout the year.

Laboratory No. 16968.—Respecting this sample the manufacturers write 'In the process of drying out ordinary mashes, containing corn, rye, barley, malt and oats, the 'slop', as it leaves the still, is run over a strainer and hitherto only the part which did not go through has been saved. That which passed through has been allowed to run off without any use being made of it. It is this 'thin slop' dried that we now send you a sample of, to ascertain its feeding value.' It would appear to be an excellent feeding stuff, containing between 17 and 18 per cent protein and between 9 and 10 per cent fat, with a low fibre content, 5 per cent. In all probability it has a high digestibility, but we cannot speak as to its palatability or keeping qualities.

In addition to the tabulated data, this dried distillery slop was found to contain 3.37 per cent reducing sugars and .98 per cent non-reducing sugars. It had an acidity equivalent to 9.8 per cent in terms of lactic acid.

Brewers' Grains, Laboratory No. 14663.—This was purchased from the Farmer's Feed Co., Toronto.

This sample conforms to the standard or average for dried brewers' grains. It is considered a valuable feeding stuff in the ration for dairy cows, chiefly in supplying protein in a digestible form.

Oil Cake, Laboratory No. 14662.—This is evidently manufactured by the new process, which means that a larger proportion of the oil is extracted from the flax seed, leaving the cake poorer in this constituent, than by the old process. The average protein and fat content for the new process meal would be 33.0 per cent and 3 per cent respectively, and for the old process 28.1 to 30.0 protein and 9.0 to 10.0 per cent oil.

Oil cake is a highly concentrated feeding stuff, presenting its protein and oil in readily digestible forms. When fed judiciously it can be employed profitably, both in milk and beef production.

Gluten Meal, Laboratory No. 14665.—The product of the Edwardsburg Starch Company, Cardinal, Ont., is in all essential features similar in composition to samples of gluten meal from this company analyzed by us in recent years. The protein content is very satisfactory, but the meal does not contain as much oil as in the product put out some years ago.

This by-product, fed with other grain feeds, and in judicious quantities, has a high nutritive value, more especially for increasing the digestible protein in the ration.

Barley Germ Meal, Laboratory No. 14974.—The manufacturer is stated by our correspondent to be the 'Brassiere Champlain de Quebec.' The analysis shows it to be somewhat richer in protein and poorer in fat than dried brewers' grains, with a lower fibre content than is usually found in this latter feeding stuff and its general feeding value, we presume, would be found slightly superior.

Veiny Pea Hay, Laboratory No. 15672.—Commonly known as Veiny Pea (*Lathyrus venosus* Muhl). This fodder plant was forwarded from Birch Hills, Sask. Our correspondent writes 'this forage plant, with the Pea Vine vetch (Laboratory No. 15672) grows in abundance on newly cleared land, continuing to grow for some years in grain fields. They also grow on bluffs, climbing trees. These vines grow with many wild grasses and are cured for hay. They furnish the first green stuff in the spring and are the last to freeze in the fall. They are relished by all classes of stock. I know of one man, living in the bush, who raises hogs chiefly on these vines.'

The sample as received (September 9), was in the late flowering or fruiting stage, but contained no pods; the length of the vines was about 20 inches. The Dominion Botanist reports it as of doubtful value for economic growth.

The crude protein content is high, even for a leguminous hay, and the fibre is not at all excessive for a roughage of this character. Provided, therefore, that it is found to be palatable it should prove a highly nutritious feed.

American Vetch Hay, Laboratory No. 15673.—Commonly known as Pea Vine (*Vicia Americana* Muhl). This was forwarded with the preceding sample. It was in the late flowering or fruiting stage, with stems about 18 inches long. It is reported by the Dominion Botanist as of doubtful economic value.

In composition it appears to be slightly inferior to the sample of Veiny Pea, but is nevertheless a rich fodder and in practical feeding work there is probably not much difference in their values.

Cocoa-bean Husks, Laboratory No. 16311.—This sample of cocoa shell or husks was forwarded from the Experimental Farm, Agassiz, B.C., where it was proposed, if found of satisfactory composition, to use this material in a feeding trial with cattle and swine. It is apparently a by-product of the cocoa and chocolate factory. A sample forwarded from Halifax, N.S., in 1898, furnished on analysis figures very similar to those now obtained.

We have no reliable information as to the digestibility of this product as a whole, but we do know that cocoa butter fat is readily assimilated. It is possible, therefore, that this by-product has a high feeding value. If found fairly digestible and palatable it might serve, if finely ground, as an important constituent of the ration, furnishing protein and fat. Its palatability is a point upon which more information is needed, but it would seem probable that 2 pounds or so might be fed daily per head to dairy cows.

Attention may be directed to the richness of this material in fertilizing constituents, the following being the data obtained on this sample. Nitrogen 2.54 per cent; phosphoric acid 1.01 per cent and potash 2.80 per cent. These for the most part would be recovered in the solid and liquid excreta.

'*Mixed Concentrates*', *Laboratory No. 16961.*—This feeding stuff was forwarded from New Westminster, B.C., where it could be purchased at \$28 per ton, 'oat chop' being sold at \$30 per ton. It is stated that the cows relish the feed and seemingly do well on it.

It would seem to be an acceptable feeding stuff, comparing well with bran of good quality as to protein and fibre and decidedly richer in fat than this feeding stuff. As compared with ground or crushed oats, it contains higher percentages of protein and fat and has a lower fibre content, so that it should prove the superior feed.

SESSIONAL PAPER No. 16

Middlings, Laboratory No. 14703.—This is stated by our correspondent to have been bought from the T. H. Taylor Company, Chatham, Ont. Its analysis indicates it to be genuine and of good quality.

Laboratory No. 16891-2.—These are wheat middlings, stated to be the output of the Maple Leaf Milling Company, Kenora, Ont. No. 16891 has the somewhat higher protein content and is, therefore, the more valuable, but both would appear to be of excellent quality. The average protein content of middlings as generally found on the market is between 15.5 and 16 per cent.

Golden Flax, Laboratory No. 16010.—Regarding this sample our correspondent at Lethbridge, Alta., writes 'This Golden Flax originated no doubt by accident. I have been growing it for three years, starting with a small handful of seed. Planted this year in the middle of May, it matured 10 days ahead of a field of common flax adjacent. The common flax has a blue flower, this variety has a white flower. It is not as tall but it is a heavier yielder than the common flax. On my field I threshed an average of over 19 bushels to the acre.'

Several years ago 20 samples, representing as many strains, of flax seed grown on the Experimental Farm at Ottawa, were analysed and the following averages were obtained. Protein 24.77 per cent; oil 37.10 per cent. If these figures may be taken as representative of the flax generally grown we may conclude that this Golden Flax, while somewhat low in protein, is very considerably richer in oil than the commercial flax seed on the market.

Bran, Laboratory No. 14661.—This was from the mills of the Maple Leaf Milling Company, Kenora, Ont.

The average composition of bran as obtained from analyses made a few years ago, of samples from the principal milling companies of Canada, is as follows:—

Moisture	11.07
Protein	14.52
Fat	4.37
Carbohydrates	54.19
Fibre	10.14
Ash	5.71
	100.00

This sample, therefore, with 14.84 per cent protein and 3.95 per cent fat, is genuine and of good quality.

Hulless Oats, Laboratory No. 14483.—This sample was from a strain of hulless oats grown on the Experimental Farm, Ottawa. By comparing the data with those from a well-ripened sample of Banner oats, it will be seen that the chief points are a higher protein content and a lower percentage of fibre in the hulless variety.

	Hulless Oats.	Banner Oats.
Moisture	10.84	12.74
Protein	15.89	11.22
Fat	5.00	4.82
Carbohydrates	63.68	58.84
Fibre	2.32	9.47
Ash	2.27	2.91
	100.00	100.00

Molasses, Laboratory No. 14660.—This is a by-product from the refining of cane sugar and imported from Louisiana, U.S.A. Cane molasses differs chiefly from beet root molasses in its lower ash content and in being more palatable.

Further data as to its sugar content were found as follows:—

	Per Cent.
Cane sugar	38.21
Glucose and other directly reducing sugars.....	22.36
	<hr/>
Total sugars	60.57
	<hr/>

It is on the percentage of sugar present that molasses may be valued: the other constituents may be considered of insignificant feeding value. Samples of molasses analysed in previous years have shown a total sugar content varying from 45 per cent to 67 per cent. The present sample, therefore, ranks among the best examined in this laboratory.

When molasses, and especially that from the beet root, is fed in large quantities, looseness of the bowels is induced; fed judiciously, as a part of a well-balanced ration, molasses has given excellent results.

Molasses Feed, Laboratory No. 15053.—This was obtained direct from the manufacturers, The Caldwell's Feed Company, Dundas, Ont. Additional data as to sugar content are as follows:—

	Per Cent.
Cane sugar	28.92
Glucose and other reducing sugars	15.94
	<hr/>
Total sugars	44.86
	<hr/>

Molassine Meal, Laboratory No. 15054.—This was purchased locally (Ottawa), but was manufactured by the Molassine Co., East Greenwich, England.

Supplementing the tabulated data, we obtained:

	Per Cent.
Cane sugar	26.91
Glucose and other reducing sugars.....	8.41
	<hr/>
Total sugars	35.32
	<hr/>

Apart from their direct food value, depending practically on their sugar content, these molasses feeds may be considered to act beneficially in increasing the appetite, stimulating the digestion and in keeping the animal in a thrifty condition.

Corn Fodder and Ensilage, Laboratory Nos. 16442-3.—These were used at the Experimental Farm, Brandon, Man., in a steer-feeding experiment, the object being, in a comparative test with the fodder and ensilage, to supply the same amount of dry matter to the animals. On the basis of dry matter one part of the fodder would be equivalent of $2\frac{1}{2}$ parts of ensilage, approximately.

Both are of excellent quality, the protein content of each being somewhat higher than the average for these roughages. It would seem probable from their percentages of fibre that the corn was rather more mature than it usually is in Eastern Canada when cut for the silo.

THE RELATIVE VALUE OF FIELD ROOTS.

The importance of field roots in the ration of nearly all classes of stock is well and widely recognized, even in districts favourable to the successful growth of ensilage corn. Experienced stockmen agree that roots, altogether apart from their high digestibility and palatability, have a value in maintaining health and thrift in the farm animal, and this medicinal property, if so it may be called, appears to be due in large measure to their potash and soda compounds which are somewhat cooling and slightly purgative in their action. Obviously, therefore, there are several good reasons why

SESSIONAL PAPER No. 16

roots should find a place in the ration and why they should be regarded, in judicious quantities, as highly beneficial to the animal.

The absolute feeding value of roots compared with many other classes of feeding stuffs and as reckoned from their percentages of protein and fat must be regarded as low. The percentage of dry matter present is not high—it seldom exceeds 12 per cent—and this is made up chiefly of starch, sugar, pectin and other carb. hydrates. The amount of fibre is, as a rule, very low, which no doubt is a factor making for the easy and practically complete digestion of the root.

It is a fairly safe assumption to make that from the nutritive standpoint the relative value of any sample or class of roots will depend chiefly upon the percentages of 'dry matter' and sugar contained—the larger the percentages the greater the value of the root—and it was with this in view that some years ago an investigation was inaugurated in this Division to learn what differences might exist in this regard among the various classes of roots, mangels, carrots, turnips, etc., and among the several varieties, as offered for sale, of each class. This work, carried on from season to season since 1903, has given some very interesting results, in that it has shown wide differences in dry matter and sugar-content between the varieties examined, differences in some cases that amounted to practically 100 per cent. It is the data from a continuation of this investigation on the Central Farm, Ottawa, in 1913, that are presented in the following tables.

MANGELS.

The series comprises thirteen varieties, the larger number of which have been grown and examined in previous years. They are arranged in the order of their richness of dry matter. Data are also given for the percentage of sugar—the most important food constituent in roots—and the average weight per root.

ANALYSIS of Mangels, Central Experimental Farm, Ottawa, Ont., 1913.

Variety.	Water.	Dry Matter.	Sugar in Juice.	Average Weight of One Root.	
	p. c.	p. c.	p. c.	Lb.	Oz.
Mammoth Long Red.....	87.81	12.19	5.76	2	14
Golden Tankard.....	88.41	11.59	6.56	2	8
Giant Yellow Intermediate.....	88.51	11.49	6.89	3	12
Perfection Mammoth Red.....	88.57	11.43	6.51	2	5
Prize Mammoth Long Red.....	88.95	11.05	6.76	2	13
Gate Post.....	89.02	10.98	6.27	3	5
Giant Half Sugar White.....	89.62	10.38	5.55	3	2
Yellow Leviathan.....	90.21	9.79	5.07	2	14
Mammoth Yellow Intermediate.....	90.74	9.26	5.24	2	5
Giant Yellow Globe.....	91.10	8.90	5.18	2	15
Eckendorfer Red.....	91.30	8.70	4.44	2	3
Select d Yellow Globe.....	91.42	8.58	5.07	3	2
Danish Sludstrup.....	92.39	7.61	3.85	3	3

The results as a whole, compared with those of previous records, show that the mangels of the 1913 crop are quite the equal in dry matter and sugar to those produced at Ottawa in the most favourable seasons. They, however, will bring out the object of this investigation, in making evident that large differences in nutritive value exist among the varieties. Between the richest and the poorest there is a difference of 4.58 per cent dry matter and 1.91 per cent sugar, which means that the former contains 60 per cent more dry matter and 59 per cent more sugar than the latter. Ref-

erence to previous reports on this subject will show that mangels of the following Mammoth Long Red Half Sugar and Giant Yellow Intermediate have been placed at or near the head of the list and are therefrom to be considered as superior in feeding value, and are in consequence, from this point of view, the most desirable to grow.

The character of the season, as well as the richness of the soil, influences the composition and size of root and it will, therefore, be of interest to compare the averages from the results of the past eight years.

MANGELS.—Yield and Average Composition, 1904-1913.

Year.	Number of Varieties Analysed.	Average Weight of One Root.		Yield per Acre.		Dry Matter.	Sugar.
		Lb.	Oz.	Tons	Lb.	p. c.	p. c.
1904.....	10	2	11	30	1,277	11.69	6.62
1905.....	17	3	9	39	369	10.04	4.67
1906.....	16	2	7	31	159	11.63	5.93
1907.....	10	2	11	27	680	12.64	7.46
1908.....	12	2	2	23	690	11.87	5.33
1909.....	14	3	5	28	920	11.21	6.21
1910.....	8	5	10	56	57	10.04	4.46
1911.....	23	2	9	29	61	9.51	6.43
1912.....	13	2	14	10.51	5.63
Average for 9 years	10.96	5.88

INFLUENCE OF HEREDITY IN MANGELS.

It will be evident from what has been said respecting the differences in dry matter and sugar of the several varieties of mangels that heredity may be a factor of some importance in influencing the composition of roots. To obtain more direct evidence on this point we have, for the past fourteen years, grown side by side and analysed the Gate Post and Giant Yellow Globe, varieties representing two distinct types of mangels. The roots were grown, as far as was practicable, under identically the same conditions and consequently any differences in composition exhibited by them might be attributed to transmitted qualities.

The fact that the Gate Post variety has each season for fourteen years without a single exception proved the richer both in dry matter and sugar, affords fairly good evidence that the composition of mangels is influenced by the factor of heredity and, as has been remarked in previous reports, indicates that improvement, as regards nutritive value, might be brought about by well-directed breeding experiments.

SESSIONAL PAPER No. 16

DRY MATTER AND SUGAR in Gate Post and Giant Yellow Globe Mangels.

SEASON OF GROWTH.	GATE POST.				GIANT YELLOW GLOBE.			
	Average Weight of One Root.		Dry Matter.	Sugar in Juice.	Average Weight of One Root.		Dry Matter.	Sugar in Juice.
	Lb.	Oz.	Per cent.	Per cent.	Lb.	Oz.	Per cent.	Per cent.
1900.....	11.14	6.15	8.19	2.64
1901.....	2	9	9.41	4.15	3	3	9.10	4.08
1902.....	3	2	13.90	9.39	3	9	10.24	5.24
1903.....	3	3	12.93	7.38	3	13	10.89	6.17
1904.....	2	14	12.64	7.62	2	13	9.24	5.26
1905.....	2	13	12.07	6.83	3	12	8.64	3.55
1906.....	2	2	12.90	6.59	1	8	12.73	6.45
1907.....	3	10	12.53	7.25	2	7	10.78	6.34
1908.....	1	11	12.02	4.94	2	4	10.66	4.47
1909.....	3	14	11.82	6.64	3	7	10.95	5.82
1910.....	6	8	9.59	4.26	6	13	7.80	2.74
1911.....	2	11	10.04	3.86	3	1	6.66	1.85
1912.....	3	5	8.98	5.05	3	2	7.87	4.75
1913.....	3	5	10.98	6.27	2	15	8.90	5.18
Average for 14 years.....	11.49	6.17	9.47	4.60

TURNIPS.

This series comprises nineteen varieties and the following table gives the results of their examination in the order of their dry matter content.

ANALYSIS of Turnips, Central Experimental Farm, Ottawa, Ont., 1913.

Variety.	Water.	Dry Matter.	Sugar in Juice.	Average Weight of One Root.	
	Per cent.	Per cent.	Per cent.	Lb.	Oz.
Elephant.....	88.39	11.61	1.44	2	9
Lapland.....	89.56	10.44	1.73	3	2
Hartley's Bronze Top.....	89.84	10.16	1.32	2	6
Perfection.....	89.96	10.04	1.52	2	5
Hazard's Improved.....	90.14	9.86	1.52	3	8
Kangaroo.....	90.15	9.85	1.42	3	10
Skirvings.....	90.19	9.81	1.63	4	0
Canadian Gem.....	90.24	9.76	1.83	4	1
Hall's Westbury.....	90.34	9.66	1.53	2	4
Mammoth Clyde.....	90.35	9.65	1.83	1	15
Good Luck.....	90.44	9.56	1.42	2	13
Bangholm.....	90.49	9.51	1.42	2	2
Jumbo.....	90.50	9.50	1.42	2	9
Halewood's Bronze Top.....	90.55	9.45	1.62	2	8
Magnum Bonum.....	90.61	9.39	1.42	3	4
New Century.....	91.10	8.90	1.52	2	15
Stubb.....	91.24	8.76	1.83	2	2
Best of All.....	91.90	8.10	1.42	3	7
Destersundom.....	91.95	8.05	1.42	3	8

5 GEORGE V., A. 1915

Between the best and the poorest there is a difference of 3.56 per cent dry matter, which means that 2,000 lbs. of the former has a feeding value equivalent to 2,884 lbs. of the latter. These figures are significant and taken into consideration with similar results from previous seasons, give emphasis to the statement that, in the choice of the variety to sow, this question of composition may well be regarded.

The averages for the past eight years are presented in the following table:—

TURNIPS.—Yield and Average Composition, 1905-1913.

Year.	Number of Varieties Analysed.	Average Weight of One Root.		Yield per Acre.		Dry Matter.	Sugar.
		Lb.	Oz.	Tons.	Lb.	Per cent.	Per cent.
1905.....	20	2	13	30	1,060	10.09	1.10
1906.....	20	1	10	15	1,890	12.18	1.78
1907.....	14	3	5	33	142	10.14	1.11
1908.....	13	3	12	27	1,033	9.87	1.52
1909.....	13	2	10	29	512	11.30	1.43
1910.....	10	3	11	31	565	10.87	1.07
1912.....	19	3	12	33	155	8.65	1.10
1913.....	19	2	14	24	1,271	9.58	1.54
Average for 8 years.....						10.33	1.33

As in the case of mangels, the turnips of 1913 are somewhat better than those of 1912, but they have not given an average quite equal to that for the eight years that this experiment has been in progress.

The yearly averages show that considerable fluctuations may occur from season to season as regards dry matter, but that in respect to sugar content the figure remains fairly constant, or at all events that the range lies within narrow limits.

CARROTS.

This series includes six of the best known varieties. The results on the whole are not quite so good as those of last year, though the percentage of sugar was not affected to the same degree as that of the dry matter. Further, the records, show that certain apparent irregularities have occurred, the explanation of which it is not easy to find. Thus the White Belgian, which for several years has been closely associated with the Mammoth White Intermediate at the bottom of the list, is this year the best of all.

ANALYSIS OF CARROTS, Central Experimental Farm, Ottawa, Ont., 1913.

Variety.	Water.	Dry Matter.	Sugar in Juice.	Average Weight of One Root.	
	Per cent.	Per cent.	Per cent.	Lb.	Oz.
White Belgian.....	89.84	10.16	2.57	1	6
Giant White Vosges.....	90.35	9.65	2.03	1	14
Ontario Champion.....	90.79	9.21	2.04	1	3
Half Long Chantenay.....	90.79	9.21	2.58	1	10
Improved Short White.....	91.30	8.70	1.70	1	5
Mammoth White Intermediate.....	92.24	7.76	1.73	1	13

In sugar content, the turnip seldom exceeds 1.5 per cent; carrots as a class are richer in this constituent, though not possessing more dry matter. The sugar in carrots

SESSIONAL PAPER No. 16

has throughout the investigation, that is, since 1905, always averaged above 2.0 per cent and in four years of the eight the average has been above 3.0 per cent.

CARROTS.—Yield and Average Composition 1905-1913.

Year.	Number of Varieties Analysed.	Average Weight of One Root.		Yield per Acre.		Dry Matter.	Sugar.
		Lb.	Oz.	Tons.	Lb.	per cent.	per cent.
1905	11	1	3	25	1,510	10.25	2.52
1906	10	1	2	19	1,605	10.59	3.36
1907	6	1	1	24	1,517	10.30	3.02
1908	6	1	3	22	133	10.89	3.34
1909	6	1	0	17	1,680	10.40	2.30
1910	5	1	9	34	1,640	10.17	3.23
1912	6	1	1	18	545	10.50	2.54
1913	6	1	8	24	1,100	9.11	2.11
Average for 8 years.						10.27	2.80

There would appear to be less variation from year to year in the composition of carrots than in the case of mangels or turnips, and from this it may be concluded that they are not influenced to the same degree by environmental conditions as the latter roots. It is possible also that the varieties examined are more closely related to one another than the varieties of mangels and turnips. The annual averages, it will be noted, very closely approximate that for the eight-year period.

SUGAR BEETS FOR FACTORY PURPOSES.

The sugar beet, like other farm roots, is susceptible to conditions of season, soil and culture and in order to learn the suitability of different parts of the Dominion for the production of a crop that could be used for the profitable extraction of sugar certain leading varieties have been grown for several years past on the larger number of the Dominion Experimental Farms and Stations. The seed of the three varieties used, Vilmorin's Improved A, Vilmorin's Improved B and Klein Wanzleben was obtained from Messrs. Vilmorin, Andrieux et Cie, Paris, France, the noted breeders of beets with a high percentage of sugar.

The localities at which these beets were grown are widely distributed throughout Canada, from Charlottetown, P.E.I., on the east to Agassiz, B.C., on the west and the results of this investigation therefore, should well indicate the suitability or otherwise of the various provinces for beets of a satisfactory character.

In the following table the beets have been arranged according to variety and the locality where grown from east to west. The data include all the more important determinations necessary for an opinion as to the value of the crop for sugar extraction.

SUGAR BEETS grown on the Dominion Experimental Farms, 1913.

Variety.	Locality.	Percentage of Sugar in Juice.	Percentage of Solids in Juice.	Coefficient of Purity.	Average weight of One Root.		Yield per Acre.	
					Lb.	Oz.	Tons.	Lb.
Vilmorin's Improved A.....	Charlottetown, P.E.I.....	14.45	16.11	89.6	2	9	14	1,436
	Kentville, N.S.....	17.91	18.37	97.5	0	11	14	512
	Nappan, N.S.....	19.79	20.90	94.7	1	2	16	500
	Cap Rouge, Que.....	19.55	22.37	87.4	0	13	0	592
	Ottawa, Ont.....	15.64	17.46	89.5	0	15	14	850
	Brandon, Man.....	13.65	16.27	83.9	2	1	14	1,700
	Rosthern, Sask.....	15.80	18.46	85.5	1	14	16	1,060
	Indian Head, Sask.....	20.42	21.97	92.9	1	6	14	1,760
	Lethbridge, Alta., (irrigated)...	19.47	21.26	91.6	1	10	15	674
	" (non-irrigated)	19.85	21.46	92.5	1	1	9	743
	Lacombe, Alta.....	13.45	15.51	86.7	1	4	2	1,550
	Agassiz, B.C.....	12.64	15.06	83.9	1	4	23	1,100
Vilmorin's Improved B.....	Charlottetown, P.E.I.....	15.90	17.66	90.0	2	10	15	1,152
	Kentville, N.S.....	16.61	17.11	97.0	0	14	12	1,872
	Nappan, N.S.....	19.27	20.82	92.6	0	14	14	1,000
	Cap Rouge, Que.....	20.22	23.60	85.7	1	1	0	855
	Ottawa, Ont.....	16.34	17.66	92.5	1	0	15	1,750
	Brandon, Man.....	14.17	17.63	80.4	1	10	16	1,220
	Rosthern, Sask.....	14.94	17.86	83.7	2	5	12	1,010
	Indian Head, Sask.....	20.75	21.57	96.2	1	4	12	1,200
	Lethbridge, Alta., (irrigated)...	19.54	20.66	94.5	1	8	14	861
	" (non-irrigated)	19.93	21.66	92.9	0	13	12	499
	Lacombe, Alta.....	12.59	14.26	88.2	1	1	2	800
	Agassiz, B.C.....	19.96	21.63	92.3	1	7	24	1,250
Klein Wanzleben.	Charlottetown, P.E.I.....	16.55	17.46	94.8	2	11	15	1,029
	Kentville, N.S.....	16.98	17.31	98.1	0	13	11	176
	Nappan, N.S.....	18.44	19.42	94.9	0	13	10	1,000
	Cap Rouge, Que.....	20.04	22.30	89.9	0	15	0	435
	Ottawa, Ont.....	17.47	18.46	94.6	1	3	15	1,250
	Brandon, Man.....	13.93	17.03	81.7	2	4	19	1,160
	Rosthern, Sask.....	16.08	18.46	87.1	2	2	12	348
	Indian Head, Sask.....	21.01	22.10	95.0	1	3	12	1,200
	Lethbridge, Alta., (irrigated)...	19.60	22.26	88.0	1	12	13	166
	" (non-irrigated)	18.82	21.46	87.7	1	4	10	1,144
	Lacombe, Alta.....	11.97	13.66	87.6	1	6	2	850
	Agassiz, B.C.....	21.65	22.63	95.6	1	6	24	
Raymond No. 2358	Lethbridge, Alta., (irrigated)...	17.83	20.26	88.0	1	9	12	1,735
	" (non-irrigated)	19.09	20.66	92.4	1	8	12	1,505

Very considerable fluctuations will be observed as to richness in sugar in the same variety, due to conditions of season, etc., as obtaining at the several points of growth. These conditions, as taken from the field notes of the several Superintendents, may be briefly given and will be found of interest when making a study of the analytical data:

Charlottetown, P.E.I.—The soil is a friable, sandy loam, in good condition. The season was favourable to a heavy yield, but the actual sunshine as recorded was, during the ripening period, much below the average for a number of years past.

The results indicate a crop of fair quality only, due in part probably to lack of sunshine when ripening and in part to the large size of the roots. The average percentage of sugar in juice for the three varieties is very close to that of 1912, but decidedly lower than that obtained in 1911.

SESSIONAL PAPER No. 16

Kentville, N.S.—The soil is a sandy loam of rather poor quality. The season was fair for root crops in general, and an average yield was obtained.

Both as to sugar content and purity the beets from this Station are of excellent quality, indicating a crop eminently suitable for factory purposes.

Nappan, N.S.—A clay loam of good quality. The first part of the season was cold and backward, continuing cool until the middle of June, when weather became more promising. There was an unusual rainfall both in the earlier and later part of season, but the crop made a satisfactory growth.

The sugar percentages of all three varieties are excellent, and in this respect similar to those of previous seasons at this point. Since 1902, the first record for sugar beets at this farm, the annual average, almost without exception, has been high.

Cap Rouge, Que.—As a crop, the sugar beets were, for the third season in succession, a failure. This was probably in a large measure due to poor germination of the seed, owing to lack of moisture in the soil. The yields, it will be noticed, are exceedingly low. It has been found, in an examination of the soil recently made in the Farm laboratories, that the land is deficient in lime and slightly sour. An experiment will be carried on this year, applying lime, to learn how far the failure of this crop has been due to lime deficiency. The soil is described as a sandy loam with a shaly subsoil at 15 to 25 inches.

The sugar content of such beets as were obtained, was quite satisfactory, indeed decidedly above the average, indicating that, in spite of untoward conditions for a good yield, the conditions were favourable for a rich beet. The spring opened early and the temperatures almost ideal until August, when dry weather, which checked the growth of the roots, set in and continued until September 22nd.

Ottawa, Ont.—The soil is a sandy loam in fairly good condition. The yield was an average one and the beets of excellent quality, both as regards sugar content and purity.

Brandon, Man.—The soil is a rich, black, clay loam, characterized by a large humus and nitrogen content. The season as a whole was dry. The results as regards sugar percentages are only fair, with a rather low co-efficient of purity. Occasionally, beets with a satisfactory sugar content are obtained at this Farm, but as a rule the data do not indicate high quality, either as regards sugar or purity.

Rosthern, Sask.—The soil is a loam, rather light and rich in organic matter; it is slightly affected with alkali. The growth was not satisfactory and the yield was light. The season though not ideal for roots was not, on the whole, unfavourable. As in 1911 and 1912, however, analytical data do not indicate a very rich or a very pure beet.

Indian Head, Sask.—The soil is a rich clay loam. There was an ample precipitation during the growing season, especially June, July and August. The results are decidedly better than those of last year, or indeed of any previous season at this Farm. The average percentage of sugar in juice for the three varieties is 20.73 and is the highest average obtained this year, though at four other points an average of over 19 per cent is recorded.

Lethbridge, Alta.—A sandy to clay loam. During the latter part of May and early part of June the weather was very dry. Beginning the latter part of June and all through July and the greater part of August, there was a reasonable amount of rain but not enough to bring the yield of the beets on the dry land to equal that from the irrigated area. The weather during the month of September was generally dry and windy, and should have been favourable to the proper ripening of the beets.

The percentages of sugar as found in the irrigated and non-irrigated beets are remarkably close, and this is true for all three varieties. All the beets are of excellent quality, the averages for sugar in juice exceeding 19 per cent, and the co-efficient of purity of two of the varieties exceeding 90. In that the analytical

5 GEORGE V., A. 1915

data do not show any marked differences in quality between the crops grown on irrigated and non-irrigated land, the results are similar to those of 1912. In very dry seasons we have found the non-irrigated beets somewhat the richer.

The yields on the irrigated land, as usual, were larger than those from the non-irrigated area, the differences for the past season being more marked than for several years.

Seed supplied by the sugar factory at Raymond, Alta., was also sown on irrigated and non-irrigated land. While the data for sugar and purity from both areas were highly satisfactory, the beets grown on the non-irrigated were somewhat the richer.

Lacombe, Alta.—The results have been unsatisfactory at this farm, both as to quality and yield, ever since the beginning of the inquiry in 1907, presumably due chiefly to unfavourable weather conditions. This season they are the lowest in the series. The soil is a heavy, black clay loam well supplied with plant food.

A study of the following meteorological observations at Lacombe will reveal, we think, the reasons for the lack of growth and the conclusion that the roots did not properly mature.

METEOROLOGICAL OBSERVATIONS for Lacombe, Alta., Season of 1913.

Month.	Maximum	Date.	Minimum.	Date.	Mean temperature.	Precipitation.	Sunshine.
April.....	77·8	12th	17·4	23rd	42·2	·15	260·8
May.....	77·4	25th and 30th	18·1	5th	46·81	·48	277·1
June..	81·8	9th	36·2	17th	56·97	2·98	271·9
July.....	84·8	24th	31·9	25th	57·65	3·43	336·3
August.....	81·0	26th	35·5	19th	57·6	2·435	311·1
September.....	80·0	8th and 27th	24·4	23rd	50·9	·59	240·4

The beets were sown on May 26, and pulled September 23.

Agassiz, B.C.—In both yield and quality two of the varieties gave excellent returns; the third, for some reason not apparent, was much below the average in sugar content.

The soil is a sandy loam and the season, as in 1912, was somewhat cool and wet.

In the following table we present the averages as regards sugar content in juice for the period 1902-1913, obtained at the several localities included in this investigation.

AVERAGE Percentage of Sugar in Juice in Sugar Beets grown on the Dominion Experimental Farms, 1902-1913.

Locality.	1902.	1903.	1904.	1905.	1906.	1907.	1908.	1909.	1910.	1911.	1912.	1913.
Charlottetown, P.E.I.....									14·25	17·23	15·31	15·63
Kentville, N.S.												17·17
Nappan, N.S.....	15·87	15·33	14·41	16·52	17·08		17·53	16·74	16·43	17·56	16·68	19·17
Cap Rouge, Que.....										16·16	14·92	19·94
Ottawa, Ont.....	16·77	15·34	16·91	12·45	14·37	15·44	16·30	14·84	16·44		17·59	16·48
Brandon, Man.....		11·36	16·62	11·09	15·50	16·99	15·82	18·83	18·40	13·50	13·40	13·92
Indian Head, Sask.....	15·15	16·54	15·24	14·94	14·91	15·92	15·66	17·16		14·48	15·78	20·73
Rosthern, Sask.....										13·30	14·53	15·61
Lethbridge, Alta., Irrigated.....							16·09	17·91		17·02	17·41	19·54
" " Non-irrigated..							16·73	18·36		14·05	17·68	19·33
Lacombe, Alta.....						13·34	11·21	12·77	12·69			12·67
Agassiz, B.C.....		17·44	8·10	17·32	14·28	17·65	17·15	18·30	19·18	16·95	17·53	18·08

SESSIONAL PAPER No. 16

When it is remembered that it is seed of the same stock that is sown throughout the series, the results will be of interest in showing the degree to which the quality of the beet may be modified by weather and cultural conditions. From the same seed, beets were grown which yielded averages differing as much as 6.8 per cent sugar.

It will be further apparent from these data that beets of excellent quality for sugar extraction may be grown in many widely distant portions of the Dominion.

INSECTICIDES AND FUNGICIDES.

ARSENATE OF LEAD.

The reader is referred to the annual report of this Division for 1912 for a general discussion of this insecticide, its composition, nature and use. It may, therefore, be only necessary here to insert its more salient properties and enumerate the essential features which will enable the orchardist to judge of the relative merits of the various brands upon the market.

This insecticide, it may be recorded, is steadily growing in popularity with fruit-growers and for the spraying of shade and forest trees. In many districts, it has completely supplanted Paris green, the poison that was, until a few years ago, almost universally employed against 'biting' insects. The reasons for this are, chiefly, the greater adhesiveness of the arsenate of lead to the foliage—thus lengthening the period of efficiency of the spray—that it is practically non-injurious to foliage, even in comparatively strong sprays and that the fine state of division in which this compound exists prevents it from readily settling out of the spray, thus contributing towards a uniform application of the poison on the foliage.

The larger number of well known brands of the arsenate of lead paste—the form in which it finds most favour with orchardists—contain in the neighbourhood of 50 per cent water, and less than .5 per cent of soluble arsenic oxide—the constituent that burns the foliage. Some few years ago, this Division proposed, tentatively, a standard as follows:—

'That any arsenate of lead paste to be accounted genuine shall contain at least 50 per cent arsenate of lead; that the arsenic oxide in such combination shall not be less than 12.5 per cent; that the water soluble forms of arsenic should not exceed one per cent calculated as arsenic oxide, and that there should be no admixture with foreign materials to reduce or affect its strength.'

Arsenate of lead is also sold as a dry powder, but its use in this form, either as a 'dust' spray or in the making of a liquid spray, has not found general favour.

During the past year, thirteen samples have been analysed and the data are presented in the following table. These brands, representing those found on the Canadian market and one or two specially imported for experimental purposes, were submitted by the Horticultural Division, which, during the past two seasons, has been carrying on an extensive investigation in the Farm's orchards and fruit plantations with this insecticide. The samples for analysis were taken from the original containers.

ANALYSIS of Arsenate of Lead, 1913-14.

Lab'y. No.	Brand and Manufacturer.	Water.	Total Arsenic Oxide As ₂ O ₅	Total Lead Oxide PbO.	Soluble Impurities other than As ₂ O ₅ and PbO.	Insoluble Impurities (by difference.)	Total.	Soluble Arsenic Oxide	Soluble Lead Oxide.
		p. c.	p. c.	p. o.	p. c.	p. c.	p. c.	p. c.	p. o.
13820	"Berger's Lead Arsenate" Lewis Bergers & Sons, Ltd., Homerton, London, N. E., England.	49.03	10.88	37.73	.51	1.54	100.00	.17	.14
17053	Bowker's Lead Arsenate, Bowker Insecticide Co., Baltimore.	38.33	19.88	38.67	1.88	1.24	100.00	.15	Traces.
17054	"Grasselli's," The Grasselli Chemical Co., Cleveland, Ohio.	40.00	16.44	41.47	1.46	.63	100.00	.46	"
17055	"Swifts," Merrimac Chemical Co., Boston, Mass.	51.45	15.10	30.00	1.13	2.32	100.00	.37	Nil
17056	"Dry," Canadian Paint Co., Toronto	.50	32.18	60.77	4.23	2.32	100.00	.77	Traces.
17058	"Dry," Sherwin-Williams Co.	.42	31.31	62.43	4.11	1.73	100.00	.89	"
17059	"Neutral," Canada Paint Co., Toronto.	48.41	14.35	34.96	1.01	1.27	100.00	.59	"
17060	"Dry," Thomson Chemical Co.	.23	30.76	63.48	1.49	4.04	100.00	.51	"
17061	"Electro," Vreeland Chemical Co., N. Y.	46.48	17.15	33.65	.80	1.92	100.00	.27	"
17063	"Dry," Vreeland Chemical Co., N. Y.	.20	31.62	61.80	1.42	4.94	100.00	.18	"
17064	"Triplumbic," Thomson Chemical Co., Baltimore	46.66	12.25	37.64	.15	3.29	100.00	.53	"
17065	"Standard," Thomson Chemical Co.	48.08	18.19	31.25	2.17	.31	100.00	.53	"
17066	New process, Sherwin-Williams Paint Co., Toronto.	45.94	15.21	36.34	.92	1.59	100.00	.48	Nil.

SESSIONAL PAPER No. 16

Detailed comment on these data is unnecessary, but it may be pointed out that those pastes containing the least water and the smallest percentages of soluble arsenic oxide are, other things being equal, of the best quality.

We may be permitted to repeat that the practice followed by some manufacturers of putting a guarantee on the label, stating the percentage of arsenate of lead and particulars as to soluble impurities, is to be commended. It would allow the purchaser to judge of the relative merits of the various brands offered on the market.

FORMALDEHYDE.

From time to time, samples of formaldehyde are sent in by farmers and agricultural organizations in the northwest, for examination. Occasionally we have found a sample below standard strength but these, as a rule, have been taken at retail stores, from bulk; those drawn from the original containers have almost invariably conformed to the guarantee. We have no evidence, therefore, that the manufacturers are putting out a product below the standard though, as might be expected, all brands are not identical in the percentage of formaldehyde they contain.

<i>Laboratory No.</i>	Formaldehyde by weight. Per Cent.
14030 contains.	37.17
14286 "	38.21
14287 "	37.51

It is evident from these data that there had been no adulteration, the standard strength calling for 40 per cent by volume which is, approximately, 37.3 per cent by weight. They all conform with the guarantee.

The turbidity or milkiness observed in some samples is due to a slight 'polymerization' or the conversion of a part of the formaldehyde into a solid form. We have no data that would allow us to make any definite or final statement regarding the effect of slight polymerization on the value of the solution for destruction of smut in grain but such experience as we have had has not shown that there is any marked falling-off in fungicidal value.

PINE SPRAY INSECTICIDE.

Laboratory No. 15042, submitted by the Horticultural Division and forwarded for trial by Robinson Bros., Ltd., W. Bromwich, Staffs, England. It had the appearance of a strong soap solution and possessed a markedly alkaline reaction.

Analysis.

	Per Cent.
Moisture and loss at 100 degrees C.	70.4
Total oil or fat	25.7
Total alkali, all potash	2.45
By distillation—	
Water	62.0
Light oils	8.

This is evidently an aqueous solution of a potash soap containing a certain percentage of light oils.

It may be noted that emulsions and sprays made with a potash soap possess better spraying qualities than those made with a soda soap.

WORM KILLER.

Laboratory No. 15043.—Submitted by Horticultural Division and also forwarded by Robinson Bros., Ltd. It is a clear, magenta colored liquid, with a slight deposit.

Analysis.

Total solids at 100 degrees C., 26.58 grams per 100 c.c. containing
Mercuric chloride, 26.18 grams per 100 c.c.

This is a solution of mercuric chloride (corrosive sublimate), in an acid solution, the normality of which is .93. The colouring matter is evidently added as a precautionary measure, corrosive sublimate being an active and virulent poison to man and beast.

VELVAS LAWN SANDWEED KILLER AND FERTILIZER.

Laboratory No. 15045.—Submitted by Horticultural Division; forwarded for trial by Robinson Bros., Ltd. It is in the form of a powder, of grayish-white appearance.

Analysis.

	Per Cent.
Sulphate of iron	11.40
Sulphate of ammonia ¹	26.60
Mineral matter insoluble in acid, sand, etc.....	60.30
¹ Equivalent to nitrogen	5.6

Free from arsenic.

This is a mixture of sulphate of iron and sulphate of ammonia with about 60 per cent of sand. Sulphate of iron is used for the destruction of dandelions in lawns, but with somewhat doubtful success. Sulphate of ammonia is valuable as a fertilizer for supplying available nitrogen.

TOBACCO DECOCTION.

Laboratory No. 16866.—Submitted by the Division of Entomology, as a decoction made in the course of experimental work for the destruction of aphides. The decoction was made by boiling one pound of tobacco 'stem butts' in two gallons of water, allowing the preparation to simmer for one hour. Water from time to time was added to replace that lost by evaporation. It was of the colour of fairly strong tea.

Analysis.

Nicotine45 per cent.
----------------	---------------

The following report was written on this sample: 'We can find but little evidence in such literature as we have access to, as to the "strength" of the tobacco decoction necessary to be effective in the destruction of aphides, that is, interpreting strength as percentage of nicotine present. It has always seemed probable that the insecticidal value of the decoction might depend in some measure on other compounds present—tannin, bitter principles, etc. The nicotine present in tobacco stems is stated to be about 0.5 per cent and the directions for making the decoction usually call for 1 to 2 lbs. to 2 gallons (20 lbs.) of water, the water while still boiling being poured over the stems and the mass allowed to steep overnight. Whether this extracts all the nicotine we have no evidence.

'The Kentucky Experiment Station reports on a tobacco extract prepared in St. Louis, U.S.A. (evidently by concentration) that contains 3.0 per cent nicotine, stating that the experiments showed that this extract diluted in the proportion of 1 part to 70 parts of water, was effective as a spray for aphides. If we assume that the nicotine present measures the insecticidal value of the spray, then the decoction under discussion would bear considerable dilution, say 1 part to 10 parts water. There is, however, considerable doubt as to such diluted decoction being effective. Careful experimental work is evidently needed, with the analysis of such sprays as may be found effective.'

SESSIONAL PAPER No. 16

THE FERTILIZING VALUE OF RAIN AND SNOW.

The data for the seventh year of this investigation, the chief object of which is to determine the possible enrichment of the soil, per acre, from the nitrogen compounds furnished by the precipitation, are here recorded. It will not be necessary to discuss in any detail the plan of the work, nor the factors that have been found to influence the nitrogen-content of the rain and snow, as these matters were more or less fully dealt with in our report for 1913, to which the interested reader may be referred for further particulars of this research and its relation to practical agriculture.

The seventh year closed February 28th, 1914, and during the preceding twelve months 84 samples were analysed, 61 of rain and 23 of snow, representing a total precipitation of 31.78 inches.

In table I the data are given for the monthly totals of precipitation, the monthly average nitrogen-content of the precipitation present as free and albuminoid ammonia and as nitrates and nitrites and for the pounds of nitrogen so furnished, per acre.

The total precipitation 31.78 inches, is 8.18 inches less than that of the previous year and, as we shall see from a subsequent table, 2.56 inches less than the average at Ottawa for the past 23 years. In both rain and snow the amounts are below the averages, though the reduction is chiefly in the snowfall.

Ottawa as a rule is favoured with a fairly equable precipitation throughout the year and the records for the year ending February 28, 1914, show but one summer month, June—and one winter month—February—when the precipitation fell below 2 inches. June was exceptionally dry, with less than an inch of rain. March and October were the only months in which the precipitation exceeded 4 inches.

TABLE I.—Rain and Snow at Ottawa for the Year ending February 28, 1914.

MONTH AND YEAR.	PRECIPITATION IN INCHES.			NITROGEN.				Pounds of Nitrogen per acre.
	Rain.	Snow.	Total in Inches of Rain.	In Free Ammonia.	In Albuminoid Ammonia.	In Nitrates & Nitrites.	Total.	
				p.p.m.	p.p.m.	p.p.m.	p.p.m.	
1913.								
March	2.20	24.25	4.62	.17	.12	.16	.45	.471
April	2.00	2.00	.63	.17	.34	1.14	.517
May	2.39	2.39	.40	.09	.19	.68	.368
June8282	.60	.13	.65	1.38	.256
July	2.30	2.30	.37	.12	.41	.90	.469
August	3.13	3.13	.93	.16	.49	1.58	1.121
September	2.69	2.69	.68	.07	.23	.98	.597
October	4.08	4.08	.54	.19	.20	.93	.860
November	2.48	2.00	2.68	.82	.04	.02	.88	.535
December58	17.00	2.28	.58	.08	.16	.81	.419
1914.								
January64	30.50	3.69	.26	.08	.17	.51	.426
February	11.00	1.10	.32	.14	.21	.68	.169
Total	23.31	84.75	31.78	6.208

The total nitrogen for the year amounted to 6.208 pounds, per acre—an amount practically identical with the results obtained for the two preceding years. A comparison of the annual precipitation and amount of nitrogen furnished per acre for the

past seven years is allowed by the data set forth in table II, and it is interesting to note how very close the figures for the last mentioned datum are to the average for the whole period of seven years during which this examination has been carried on.

TABLE II.—Precipitation and Amount of Nitrogen per Acre, Ottawa, Ont., 1908-1914.

	Rain in inches.	Snow in inches.	Total precipitation in inches.	Pounds of nitrogen per acre.
Year ending February 29, 1908.....	24·05	133·00	37·35	4·322
" " 28, 1909.....	22·99	96·25	32·63	8·364
" " 28, 1910.....	28·79	80·75	36·87	6·869
" " 28, 1911.....	19·67	73·00	26·97	5·271
" " 29, 1912.....	20·33	104·25	30·76	6·100
" " 28, 1913.....	30·34	96·25	39·96	6·144
" " 28, 1914.....	23·31	84·75	31·78	6·208
Average for 23 years.....	25·14	92·03	34·34	6·182
" " 7 ".....				6·182

In table III the weights and proportions of the total nitrogen furnished by the rain and snow respectively are presented for the year and for the experimental period 1908-1914. Of the total amount of nitrogen per acre, for the past year, 6·208 pounds, the data indicate that 5·192 pounds or 84 per cent of the whole was furnished by the rain, and 1·016 pounds, or 16 per cent, by the snow. It will be observed that for the past 5 years the proportions so supplied are remarkably constant, leading to the conclusion that for the precipitation at Ottawa practically 85 per cent of the total nitrogen is found in the rain.

TABLE III.—Amounts of Nitrogen furnished by Rain and Snow.

	TOTAL.	BY RAIN.		BY SNOW.	
		Pounds.	Proportion.	Pounds.	Proportion.
		Lbs.	Per cent.		Per cent.
Year ending February 29, 1908..	4·322	3·243	75	1·080	25*
" " 28, 1909.....	8·364	7·528	90†	·836	10
" " 28, 1910.....	6·869	5·830	85	1·040	15
" " 28, 1911.....	5·271	4·424	84	·847	16
" " 29, 1912.....	6·100	5·075	83	1·025	17
" " 28, 1913.....	6·144	5·113	83	1·031	17
" " 28, 1914.....	6·208	5·192	84	1·016	16

* Snowfall exceptionally heavy.

† Rain abnormally rich in ammonia due to bush fires.

The data of table IV are of interest in showing the distribution or proportion of the various nitrogen compounds in the rain and snow. Of the total nitrogen, 6·208 pounds, there are 4·471 pounds, or 72 per cent of the whole present as free and organic ammonia and 1·737 pounds, or 28 per cent as nitrates and nitrites. These ratios are identical with those of last year and in close accord with those obtained throughout the period of investigation.

The greater richness of the rain in nitrogen compounds is also brought out by the tabulated figures.

SESSIONAL PAPER No. 16

TABLE IV.—AVERAGE Nitrogen-content of Rain and Snow.

(Amount of Nitrogen per acre as Free and Albuminoid Ammonia and as Nitrates and Nitrites, 1913-1914.)

	Number of Samples Analysed.	Precipitation in Inches.	NITROGEN.								
			Parts per Million.				Percentage of Total.			Pounds per Acre.	
			In Free Ammonia.	In Albuminoid Ammonia.	In Nitrates and Nitrites.	Total.	In Free Ammonia.	In Albuminoid Ammonia.	In Nitrates and Nitrites.	As Free and Albuminoid Ammonia.	As Nitrates and Nitrites.
Rain....	61	23.31	.327	.145	.328	1.212	61	12	27	3.790	1.402
Snow ...	23	84.75	.265	.090	.174	.529	50	17	33	.681	.335

Although the amount of nitrogen furnished by the rain and snow is not very large when considering the up-keep of the soil in this element—in the neighbourhood of 6 pounds, per acre, per annum—it is worthy of note that this nitrogen presents itself in forms immediately and directly available for crop use and that the larger amount falls at a season when vegetation is active. It is therefore, a warrantable assumption that the rain, apart from its solvent action in the soil and its many physiological functions, plays an important role in directly assisting the growth of crops by supplying them with a part of their needed nitrogen.

THE WATER SUPPLY OF FARM HOMESTEADS.

Since the establishment of the Dominion Experimental Farms the question of the water supplies of farm homesteads, creameries and cheese factories, and, to a more limited degree, those of rural schools, has received the attention of the Division of Chemistry. Through the various means taken we are aware that an interest has been awakened in the rural water supply, and much good accomplished, but we also feel convinced that there is a necessity to continue the campaign for better water. The evidence at hand supports us in this view, for of the waters sent in for examination a very large proportion, even in these later years of our propaganda, must be adjudged as impure, chiefly through the presence of excretal drainage matter. We have reason to believe that farmers as a class are not yet fully alive to the importance of a pure water supply, for the health of themselves and their families, for the thrift of their stock and for the quality and wholesomeness of their dairy produce.

The source of the supply on the larger number of farms is the shallow well, say from 5 to 30 feet deep, which merely collects 'ground water,' the soakage from the surrounding soil. Unless the location is beyond reproach from the sanitary standpoint, this shallow well is a menace—its waters may at any time become a source of danger. When, as is only too frequently the case, we find these wells sunk in the barnyard, or under the barn or stable, or not far from the privy (a most crude and unsanitary affair, as a rule), or near the back door, out of which the household slops may be thrown and near which the garbage heap with all sorts of refuse may be found, then contamination of the water is inevitable and unavoidable. It is quite true that most soils, and more particularly those which are porous and well aerated (gravels and sands), possess filtering and purifying properties, but the soil surround-

5 GEORGE V., A. 1915

ing the wells located as we have described, must in time become saturated with organic filth of a most objectionable character. Such soil is then no longer able to purify the water passing through it, but rather serves to contaminate it more seriously.

We strongly advocate the bored or drilled well, tapping a deep-seated source. It cannot be stated that such a well will necessarily yield a good drinking water, but nevertheless it is the source of supply to be generally recommended for the isolated household. If there are no fissures in the overlying strata and there is no opportunity for water to flow downwards between the piping and the sides of the boring, a good water will in all probability be obtained.

To those, who for one reason or another, must rely on the shallow well, we would say that the area around the well, say for a radius of at least 50 yards, be kept free from manure and all filth. It may preferably be kept in sod. Another precaution of considerable value towards the protection of the well water from organic filth, is to line the well to a depth of say 10 to 12 feet and to a thickness of say 6 inches with concrete or puddled clay. This lining should project some 6 to 12 inches above the mouth of the well. This will prevent the direct inflow of wash and of water from the surface soil and will in all probability ensure a certain amount of filtration through clean layers of soil.

During the year 168 samples were submitted to analysis. The analytical data and a summarized report as to quality are given in the appended table. Sixty-two were pronounced as pure and wholesome, forty-four as suspicious and probably dangerous and twenty-five as very seriously contaminated. Thirty-four samples were too saline for potable use.

Farmers desiring an examination of their water supply are invited to send for a copy of the directions to be followed in the collection and shipment of the sample. Samples are constantly being received at the laboratories which, owing to insufficiency in quantity, dirty containers or corks, or through other causes cannot be submitted to analysis; trouble and expense to the farmer will, therefore, be saved if these instructions are first obtained and faithfully carried out.

ANALYSES OF WELL WATERS, 1913-14.—Results stated in Parts per Million.

Number.	Locality.	Marks.	Date.	Free Ammonia	Albuminoid Ammonia	Nitrogen in Nitrates and Nitrites.	Chlorine	Total Solids at 105° C.	Solids after Ignition.	Loss on Ignition.	Phosphates.	Report.
1	Ottawa, Ont.	A.C.	April 1	.02	.04	1.22	3.5	273.6	197.2	76.4	Free	Contaminated.
2	"	"	"	.02	.02	1.22	3.5	276.0	200.0	76.0	"	"
3	Maxville, Ont.	Dr. Mc.	"	.68	.08	.066	.5	283.2	225.4	56.8	Faint.	Suspicious.
4	"	J.A.	"	.07	.16	Free.	10.0	352.2	255.2	97.6	Heavy.	Polluted.
5	Ottawa, Ont.	C.E.F.	"	.01	.06	.75	8.0	335.2	208.8	126.4	Free.	Wholesome.
6	Sault Ste. Marie, Ont.	A.P.E.	"	.02	.10	2.62	17.0	378.4	316.8	61.6	"	Free from pollution.
7	Ottawa, Ont.	H.H.C.	"	.05	.04	.058	Free.	393.6	274.6	119.0	F. trace.	Suspicious.
8	Coxitlam, B.C.	No. 98	"	.04	.06	.058	"	22.0	12.0	10.0	Free.	Wholesome.
9	"	No. 99	"	.04	.06	.058	"	22.0	8.6	11.4	"	"
10	Maymont, Sask.	L.C.C.	"	.16	.04	Free.	25.0	1316.0	900.0	416.0	"	Saline.
11	Ottawa, Ont.	J.O.	"	.65	.06	2.35	6.5	288.0	245.2	42.8	F. trace.	Suspicious.
12	Portsmouth, Ont.	W.E.B.	"	.65	.06	2.35	1750.0	3702.4	2693.6	1008.8	"	"
13	Tracy Station, N.B.	E.B.	"	.01	.06	.09	330.0	712.0	687.2	21.8	Free.	Wholesome.
14	McKinnon, Man.	T.E.	"	.04	.14	16.50	130.0	1402.0	891.2	510.8	F. trace.	Suspicious.
15	"	T.E.	"	3.32	.28	Free.	180.0	930.8	802.8	128.0	Trace.	"
16	Kentville, N.S.	W.S.	"	.08	.09	3.43	53.0	231.2	172.8	58.4	F. trace.	"
17	Gatineau Point, Que.	C.P.	"	.04	.09	2.05	5.5	282.8	204.0	78.8	Trace.	Seriously polluted.
18	Beauce, Que.	E.W.B.	"	.84	.04	Free.	17.0	356.8	258.0	98.8	"	"
19	Ottawa, Ont.	A.G.	"	Free.	.20	1.82	17.0	290.0	185.6	104.4	"	Suspicious.
20	Des-routo, Ont.	C.A.M.	May 2	"	.04	1.49	17.0	322.8	200.0	122.8	F. trace.	Polluted.
21	Linden Terrace, Ont.	W.D.H.	"	.66	.04	Free.	87.0	1936.0	1868.0	68.0	Trace.	Suspicious.
22	Bradwell, Sask.	E.W.	"	3.10	.73	"	310.0	7635.0	6240.0	1395.0	Free.	Saline.
23	Coxitlam, B.C.	No. 100	"	Trace.	.13	.099	.5	16.8	4.6	12.2	"	Wholesome.
24	"	No. 101	"	.04	.06	Free.	.5	13.4	6.2	7.2	"	"
25	"	No. 102	"	Trace.	.01	.016	Free.	12.8	3.8	9.0	"	"
26	"	No. 103	"	Trace.	.02	Free.	"	14.6	6.0	8.6	"	"
27	Cochrane, Alta.	G.W.F.	"	Trace.	.27	Free.	50	420.0	305.0	115.0	"	Unpolluted.
28	Calgary, Alta.	R. McB.	"	.10	.12	Free.	Free.	470.0	280.0	190.0	Free.	"
29	Nipisiquit River, N.B.	E.P.	"	.02	.12	3.96	11.5	408.0	325.2	21.6	"	Free from contamination.
30	Ottawa, Ont.	R.B.	"	1.64	.06	.63	10.0	206.4	165.2	82.8	Trace.	Contaminated.
31	"	H.S.L.	"	Trace.	.12	1.02	54.0	773.6	592.0	49.2	"	Suspicious.
32	Winchester, Ont.	H.S.	"	.34	.06	Free.	13.0	220.0	138.0	82.0	Trace.	Free from organic pollution.
33	Ottawa, Ont.	J. McC.	"	.92	2.76	"	120.0	12410.8	7618.8	4792.0	Free.	Non-potable.
34	Mezpah, Alta.	D. McC.	"	17.44	.28	"	6250.0	10370.8	9126.8	1244.0	Trace.	"
35	Clarence, Ont.	J.G.	"	28	.28	"	6250.0	10272.0	9052.0	1220.0	"	"
36	"	J.G.	"	28	.28	"	6250.0	10272.0	9052.0	1220.0	"	"
37	Sault Ste. Marie, Ont.	D.N.S.	"	.20	.56	.86	35.0	168.0	103.0	65.0	"	Contaminated.

RESULTS OF WELL WATERS, 1913-14—Results Stated in Parts per Million—Continued.

Number	Locality	Marks	Date	Free Ammonia	Albunoid Ammonia	Nitrogen in Nitrates and Nitrates	Chlorine	Total Solids at 100° C.	Solid after Ignition	Loss on Ignition	Phosphates	Report
38	Selina, Sask.	H.J.J.	28	Trace.	1064.0	Free from pollution.
39	Navan, Ont.	J.M.	"	Trace.	290.0	"
40	Capl, Ont.	A.H.	30	Free.	.14	9.90	64.0	689.2	508.0	161.2	Free.	Polluted.
41	Ewart, Man.	J.S.	31	8.66	.08	Free.	3500.0	6676.0	5480.0	1196.0	"	Saline.
42	Dunrobin, Ont.	H.S.K.	June 4	Free.	.88	1.45	17.5	240.0	114.0	126.0	"	Contaminated.
43	Ottawa, Ont.	A.G.	"	.02	.19	2.64	13.5	268.0	152.0	116.0	Trace.	Suspicious.
44	Coquitlam, B.C.	No. 104.	9	.04	.12	Free.	.7	9.0	7.2	1.8	Free.	Wholesome.
45	"	No. 105.	11	.04	.065	"	.5	15.4	3.4	12.0	"	"
46	"	No. 106.	11	.04	.05	"	.5	13.0	4.8	8.2	"	"
47	"	No. 107.	11	Trace.	.025	.033	.5	14.0	6.0	8.0	"	"
48	Ottawa, Ont.	R.C.	12	.17	.06	.69	7.5	371.2	294.0	77.2	"	Gravely suspicious.
49	Dirl-ton, Ont.	J. McL.	17	Free.	.04	Free.	5.5	326.0	186.0	140.0	"	Wholesome.
50	Oak Bank, Man.	C.E.D.	19	100.0	Saline.
51	Ottawa, Ont.	D.A.B.	21	Free.	.10	8.30	23.5	436.0	242.8	193.2	F. trace	Suspicious.
52	Deseronto, Ont.	C.A.M.	23	"	.033	2.64	18.0	314.0	264.0	50.0	Free.	"
53	Upper Keswick, N.B.	O.E.M.	23	Trace.	.02	.53	Free.	116.0	83.2	32.8	Trace.	Free from pollution.
54	"	O.E.M.	230125	Trace.	1.5	34.0	20.0	14.0	Free.	"
55	Pettapiece, Man.	F.W.B.	23	2.80	.18	Free.	215.0	3030.0	2522.0	508.0	Saline.
56	Ottawa, Ont.	C.E.F.	27	.012	.029	.98	8.5	307.2	276.0	91.2	Free.	Wholesome.
57	Forget, Sask.	J.L.	28	F. trace.	770.0	580.0	190.0	Suspicious.
58	Durham Centre, N.B.	McM. Co.	28	Free.	.088	.59	12.0	125.2	72.0	53.0	Free.	Excellent.
59	Grondines, Que.	W.H.G.	28	.084	.264	.018	.6	234.0	160.0	64.0	"	Wholesome.
60	Banff, Alta.	D.P.B.	July 2	Free.	.028	.10	Free.	19.6	126.0	70.0	"	Slightly saline.
61	Salmon Arm, B.C.	R.S.	2	8.0	1025.0	725.0	350.0	Gravely suspicious.
62	Covey Hill, Que.	T.E.	2	.07	.12	8.46	100.0	688.0	418.0	290.0	F. trace	Seriously polluted.
63	"	T.E.	2	.20	.10	6.57	58.0	660.0	335.0	325.0	Free.	Polluted.
64	Armprior, Ont.	D. McP.	4	Free.	.05	2.71	34.5	440.0	276.0	164.0	Trace.	Wholesome.
65	Coquitlam, B.C.	No. 108.	12	.015	.05	.087	Free.	14.0	6.6	7.4	Free.	Wholesome.
66	"	No. 109.	July 7	.02	.03	Free.	Free.	18.0	7.4	10.6	Free.	"
67	"	No. 110.	7	Trace.	.02	"	"	13.0	5.0	8.0	"	"
68	"	No. 111.	7	.015	.03	"	"	88.0	6.6	2.2	"	Saline.
69	Ottawa, Ont.	E.A.S.	14	3.16	.14	"	3400.0	6200.0	5704.0	496.0	"	Fairly saline.
70	Granum, Alta.	J.B.N.	15	144.0	774.0	644.0	130.0	Wholesome.
71	Ottawa, Ont.	C.E.F.	21	Free.	.016	.86	7.8	329.6	233.6	96.0	Free.	Free from pollution.
72	Sturgeon Creek, Man.	D.A.D.	22	"	.030	1.17	37.1	1372.2	1034.4	337.8	"	Pure and wholesome.
73	Banff, Alta.	D.P.B.	24	Trace.	Trace.	.052	Free.	180.0	115.0	65.0	"	Gravely suspicious.
74	Nairn Centre, Ont.	J.B.H.	25	"	.23	1.33	10.4	296.0	98.0	198.0	"	"

SESSIONAL PAPER No. 16

No.	Locality	Analyst	Date	Result	Quantity	Remarks		
75	Carrol, Man.	E.G.S.	"	14.2	868.0	618.0	250.0	Slightly saline.
76	Wellington, Ont.	C.A.P.	"	11.700	19906.0	17006.0	2900.0	Strongly saline.
77	Hull, Que.	G.P.W.	"	8.0	174.5	80.5	940.0	Suspicious.
78	Westboro, Ont.	W.H.H.	"	81.0	600.0	348.0	252.0	Seriously polluted.
79	Grand View, Ont.	J.A.	Aug.	5.0	170.4	124.4	46.0	Free from pollution.
80	Fredericton, N.B.	E.F.	"	2.0	114.0	74.0	40.0	Wholesome.
81	Isle Bizard, Que.	F.D.M.	"	10.0	604.0	420.0	184.0	Gravely suspicious.
82	Nicolet, Que.	S. de la.	"	2550.0	5352.0	4936.0	396.0	Highly saline.
83	Coquitlam, B.C.	No. 112.	"	Free.	16.8	6.4	10.4	Wholesome.
84	"	No. 113.	"	"	14.4	5.8	8.6	"
85	"	No. 114.	"	"	13.6	6.2	7.0	"
86	"	No. 115.	"	"	14.4	8.4	6.0	"
87	Waseca, Sask.	M.M.	"	13.5	332.0	164.0	16.80	Non-potable.
88	Ancienne Lovette, Que.	J.H.H.	"	14.5	181.2	81.2	100.0	Suspicious.
89	Banff, Alta.	D.P.B.	"	Free.	191.6	138.0	53.6	Pure and wholesome.
90	Woodroffe, Ont.	G.J.F.	"	32.5	42.4	268.0	156.0	Suspicious.
91	Kerwood, Ont.	W.D.	"	103.0	736.0	336.0	400.0	Gravely suspicious.
92	Gilpin, Alta.	R.D. McL.	"	14.0	1522.0	1155.0	387.0	Suspicious.
93	Hazledean, Ont.	R.H.G.	"	10.0	262.0	190.0	72.0	Pure and wholesome.
94	Saltcoats, Sask.	G.W.	Sept.	Heavy.	8140.0	6010.0	2130.0	Saline.
95	Black Creek, Ont.	G.S.G.	"	150.0	3664.0	2824.0	840.0	Suspicious.
96	Jasper Park, Alta.	D.P.B.	"	Free.	138.0	96.0	42.0	Pure and wholesome.
97	Ottawa, Ont.	C.E.F.	"	8.0	336.0	212.0	124.0	"
98	City View, Ont.	J.S.	"	45.0	338.0	170.0	168.0	Suspicious.
99	Kakmak, Man.	M. de M.	"	1030.0	2912.0	2722.0	190.0	Saline.
100	Val des Bois, Que.	J.L.	"	2050.0	4286.0	3086.0	1200.0	"
101	Sidney, B.C.	P. McC.	"	2650.0	5630.0	4135.0	1495.0	Fairly saline.
102	Maxville, Ont.	E. McE.	"	285.0	2054.0	1312.0	742.0	Suspicious.
103	"	A.W. McE.	"	180.0	860.0	545.2	314.8	Polluted.
104	"	J.T.D.	"	5.5	366.4	214.4	152.0	Suspicious.
105	Bow. Is., Alta.	C.A.	"	18.5	3180.0	2916.0	264.0	Saline.
106	Coleman, Ita.	P.L.G.	"	Free.	2.2.0	140.0	92.0	Wholesome.
107	Britannia, Ont.	J.H.	"	26.0	220.0	144.0	76.0	Contaminated.
108	Lloydminster, B.C.	A.E.H.	"	340.0	6316.0	5242.0	1024.0	Saline.
109	Ottawa, Ont.	W.F.B.	Oct.	40.0	1166.0	998.0	168.0	Suspicious.
110	Laroy, Alta.	P.W.	"	Free.	1775.0	1580.0	215.0	Wholesome.
111	"	P.W.	"	7.5	1675.0	1560.0	215.0	Wholesome.
112	Lockvale, Ont.	P.H.	"	38.0	352.0	252.0	100.0	Seriously polluted.
113	"	P.H.	"	79.0	912.0	552.0	360.0	Suspicious.
114	"	P.H.	"	23.0	600.0	384.0	216.0	Polluted.
115	Ottawa, Ont.	L.C.	"	33.0	880.0	490.0	390.0	Non-potable.
116	Beaucharnois, Que.	M.K.	"	42.0	528.0	352.0	176.0	Suspicious.
117	Wakefield, Que.	F.E.	"	Free.	70.0	42.0	28.0	Pure and wholesome.
118	"	F.E.	"	97.5	752.0	424.0	328.0	Seriously polluted.
119	Westboro, Ont.	J.H.	"	3.5	257.6	125.6	132.0	Free from pollution.
120	Grand Maun, N.B.	A.B.C.	"	16.0	104.0	44.0	60.0	Satisfactory.
121	Ottawa, Ont.	C.E.F.	"	8.0	315.2	200.0	115.2	Wholesome.
122	Ardoek, Ont.	N.A.W.	"	17.0	506.0	328.0	178.0	Seriously polluted.
123	Fredericton, N.B.	E.F.	"	1.7	80.0	48.0	32.0	Free from pollution.
124	Grandin J. Que.	L.T.	"	1.0	202.0	132.0	70.0	Pure and wholesome.

RESULTS OF WELL WATERS, 1913-14.—Results Stated in Parts per Million.—Continued.

Number.	Locality.	Marks.	Date.	Free Ammonia.	Albuminoid Ammonia.	Nitrogen in Nitrates and Nitrites.	Chlorine.	Total Solids at 100° C.	Solid after Ignition.	Loss on Ignition.	Phosphates.	Report.
125	Penkill, Sask.	A. T. H.	Nov. 7	54.0	4320.0	3280.0	1040.0	Saline.
126	Wakefield, Que.	G. P.	" 11	.08	.17	4.03	24.5	300.0	256.0	44.0	Free.	Contaminated.
127	Saltcoats, Sask.	J. W.	" 13	22.0	6944.0	5592.0	1352.0	Saline.
128	Finch, Ont.	G. H. B.	" 18	130.0	641.6	423.6	218.0	Fairly saline.
129	Vernon, Ont.	F. R. J.	" 20	24.5	744.0	464.0	280.0	Hard.
130	Black Harbor, N. B.	C. B's	" 21	.20	.02	.165	35.0	340.0	318.0	22.0	Trace	Suspicious.
131	Meaford, Ont.	E. A.	" 26	1.76	.32	Free.	24.5	1506.0	1222.0	284.0	H. trace	"
132	Ottawa, Ont.	R. O. G. C.	" 27	.075	.06	5.94	6.5	105.6	37.6	68.0	Free.	Wholesome.
133	"	G. E. F.	" 29	F. trace	.045	.89	8.0	314.0	213.6	100.4	"	Suspicious.
134	East View, Ont.	W. J.	" 25	.25	.085	.22	36.0	472.0	356.0	116.0	"	Saline.
135	Walpole, Sask.	D. J. D.	Dec. 1	4.58	.11	Free.	2200.0	4013.6	3887.6	126.0	Trace	Seriously polluted.
136	Finch, Ont.	G. H. B.	" 1	135.0	648.8	385.6	263.2	"
137	Fallowfield, Ont.	C. McK.	" 6	1.44	.40	5.25	70.0	516.0	411.4	104.6	Free.	Saline.
138	"	C. McK.	" 6	.05	.44	14.49	84.0	902.0	620.0	282.0	F. trace	Pure and wholesome.
139	Benlay, Man.	H. D. F.	" 9	7.40	.22	Free.	1008.0	3468.0	3174.4	293.6	Free.	Gravely suspicious.
140	Westboro, Ont.	L. C.	" 9	.02	.04	.049	3.0	250.0	150.0	100.0	"	"
141	Mortlach, Sask.	J. L.	" 12	250.0	2160.0	1840.0	320.0	Saline.
142	Kelowna, B. C.	G. H. D.	" 15	.06	.10	.0825	Free.	112.0	72.0	40.0	Free.	Pure and wholesome.
143	Metcalfe, Ont.	G. A. W.	" 20	.01	.14	3.40	74.0	856.0	520.0	336.0	"	Gravely suspicious.
144	"	G. A. W.	" 20	4.80	.20	Free.	74.0	666.0	448.0	218.0	"	"
145	Sonyja, Ont.	A. G. McK.	" 22	.03	.04	.074	Free.	256.0	170.0	86.0	"	Excellent.
146	Southey, Sask.	W. H.	" 26	2.52	4.52	.76	132.0	17350.0	13749.0	4210.0	Seriously polluted.
147	Cap Rouge, Que.	E. F.	" 27	.22	.23	Free.	.5	214.0	188.0	26.0	"	Suspicious.
148	Sault Ste. Marie, Ont.	M. W. S.	" 30	.18	.18	2.56	19.5	228.0	156.0	72.0	"	Free from organic pollution.
149	Holland, Man.	D. G. S.	Jan. 3	.86	.26	.68	102.0	3280.0	2840.0	440.0	V. heavy.	Wholesome.
150	Ottawa, Ont.	C. E. F.	" 2	.04	.04	.95	6.50	316.0	210.0	106.0	Free.	Wholesome.
151	Asquit, Sask.	J. W.	" 17	.01	.23	Free.	26.0	3880.0	3552.0	328.0	"	Saline.
152	Meadows, Man.	E. L. R.	" 7	.88	.23	Free.	2850.0	7284.0	5824.0	1460.0	"	Highly saline.
153	Champion, Alta.	H. McN.	" 20	Free.	.075	11.55	24.0	2966.0	2588.0	378.0	"	"
154	City View, Ont.	R. McE.	" 23	.08	.03	.066	.75	196.0	172.0	24.0	"	Free from organic pollution.
155	Canford, B. C.	J. W.	" 28	Free.	.08	Free.	Free.	410.0	310.0	100.0	"	Excellent.
156	Ottawa, Ont.	D' A. S.	Feb. 7	.05	.07	8.91	11.5	305.0	105.0	200.0	"	Suspicious.
157	"	D' A. S.	" 7	.62	.44	.94	6.5	90.0	28.0	62.0	"	Seriously polluted.
158	"	D' A. S.	" 7	Free.	.033	1.39	Free.	105.0	60.0	45.0	"	Pure and wholesome.
159	Cap Rouge, Que.	E. F.	" 10	.04	.05	.33	Free.	248.0	213.0	35.0	"	Wholesome.

SESSIONAL PAPER No. 16

160	Southey, Sask	A.H.	27	Trace.	.17	Free.	2.00	376.0	248.0	128.0	"	"
161	South Ft. George, B. C.	C.M.	9	.06	.09	2.64	4	188.0	130.0	58.0	"	Contaminated.
162	Ottawa, Ont	C.E.F.	9	.02	.06	1.15	7.5	336.0	231.0	102.0	"	Wholesome.
163	Howell, Sask	J.V.	12				120.0	7885.0	6185.0	1700.0	"	Saline.
164	Bow Island, Alta.	R.W.C.	16	.16	.07	Free.	.5	232.0	158.0	74.0	Free.	Suspicious.
165	Cochrane, Alta.	E.H.	17	.86	.26	Free.	.8	7520.0	6080.0	1440.0	"	Highly saline.
166	Big Valley, Alta.	H.S.	20					1913.0			Free.	Fairly "
167	Carp, Ont.	E.McC.	24	.01	.16	.025	115.0	724.0	532.0	192.0	Free.	Contaminated.
168	Enderby, B. C.	P.W.C.	30					122.0	93.0	29.0		

DOMINION OF CANADA
DEPARTMENT OF AGRICULTURE
EXPERIMENTAL FARMS

REPORT

FROM THE

DIVISION OF FIELD HUSBANDRY

For the Year ending March 31, 1914.

PREPARED BY

Assistant Dominion Field Husbandman, Central Farm, Ottawa. O. C. White, B.S.A.

Superintendent—

Experimental Station, Charlottetown, P.E.I. - - - - -	J. A. Clark, B.S.A.
Experimental Farm, Nappan, N.S. - - - - -	W. W. Baird, B.S.A.
Experimental Station, Kentville, N.S. - - - - -	W. Saxby Blair.
Experimental Station, Fredericton, N.B. - - - - -	W. W. Hubbard.
Experimental Station, Ste. Anne de la Pocatière, Que. -	Joseph Bégin.
Experimental Station, Cap Rouge, Que. - - - - -	Gus. A. Langelier.
Experimental Farm, Brandon, Man. - - - - -	W. C. McKillican, B.S.A.
Experimental Farm, Indian Head, Sask. - - - - -	T. J. Harrison, B.S.A.
Experimental Station, Rosthern, Sask. - - - - -	Wm. A. Munro, B.A..B.S.A.
Experimental Station, Scott, Sask. - - - - -	R. E. Everest, B.S.A.
Experimental Station, Lethbridge, Alta. - - - - -	W. H. Fairfield, M.S.
Experimental Station, Lacombe, Alta. - - - - -	G. H. Hutton, B.S.A.
Experimental Farm, Agassiz, B.C. - - - - -	P. H. Moore, B.S.A.

REPORT

FROM THE

DIVISION OF FIELD HUSBANDRY.

CENTRAL EXPERIMENTAL FARM,

OTTAWA, March 31, 1914.

J. H. GRISDALE, Esq., B.Agr.,
Director of Experimental Farms,
Ottawa.

SIR.—I have the honour to submit herewith reports of the work conducted by the Division of Field Husbandry at the Central Experimental Farm and the branch Experimental Farms and Stations during the year 1913.

As pointed out in the report for 1912 the work of this Division is of a very practical nature. Briefly, it may be said to consist of soil and crop management and agricultural engineering. Its scope is very well indicated in the following review of the main features dealt with in these reports:—

- Weather conditions.
- Crop yields.
- Rotation of crops.
- Cost of production of field crops.
- Weed eradication.
- Soil cultivation.
- Use of barnyard manure and commercial fertilizers.
- Irrigation and underdrainage.
- Clearing land, fencing, etc.

In explanation of the comparatively small number of field experiments at the Central Experimental Farm, attention may be drawn again to the present lack of sufficient land suitable for such purposes. The soil, other than that devoted to experiments herein reported upon, is so variable in composition that satisfactory field tests are practically impossible. The agriculture of the districts we serve is sufficient evidence of the need for conducting soil cultivation tests and more comprehensive rotation investigations. Such lines of work require to be under investigation for a long series of years, and at the present price of land in the vicinity of Ottawa would no doubt involve considerable expense, but if the Division is to render the best service possible more land of suitable quality must be made available.

I have the honour to be, sir,
Your obedient servant,

O. C. WHITE,
Assistant Dominion Field Husbandman.

CENTRAL EXPERIMENTAL FARM, OTTAWA.

REPORT OF THE ASSISTANT DOMINION FIELD HUSBANDMAN— O. C. WHITE, B.S.A.

WEATHER CONDITIONS AND CROP NOTES, 1913.

The season of 1913 will be recorded as one of the worst in the history of the Ottawa valley. Clovers, as a rule, came through the winter in a weakened condition, and were in many cases completely killed out during the alternate freezing and thawing of the early part of April. Seeding was commenced on the average date for the previous ten years, namely, the twenty-third day of April, and was continued under favourable conditions until its completion. Mangels, potatoes and corn were practically all sown by the end of May, though the weather became colder and rather more unfavourable towards the latter part of the month, and on farms where drainage was not good seeding of corn was delayed into June. The drought of this month materially reduced the yields of all field crops. Late-sown roots, especially turnips, germinated poorly, hay made very slow growth, and pastures became badly burned up towards the end of the month. July continued comparatively dry and very hot. Corn, roots and potatoes suffered greatly, oats made scarcely any growth, and hay, a great deal of which was left standing in the hope that rain would ultimately come and improve it, was literally burned up. Our average yield of two tons per acre cannot be taken as a criterion of yields throughout the district. 'Not half a crop' was the general comment of farmers in the vicinity. Temperatures in August continued high, and while more rain fell than in July, comparatively dry weather obtained until near the end of the month. These rains helped the root and corn crop considerably, but were too late to ensure any material growth of straw. Grain filled fairly well, however, and both yield and quality were much better than was promised early in the season. At the Farm here approximately 55 acres of oats were harvested, the average yield being 50 bushels per acre. September was exceptionally fine, but frosts on the 15th and 16th did much damage to corn, which yielded considerably below the average here, and very much below throughout the locality. On the Farm, cutting began on the 20th of the month and the corn was practically all ensiled by the 30th. October was a splendid month for the growth and harvesting of roots, which, in spite of their poor beginning, yielded almost up to the average returns for this Farm. The weather continued very open and mild until late November, final freezing up occurring on the 28th of the month.

The following records regarding field operations and the weather may be of interest:—

First date of sowing field grain, 1913.....	April 23.
First date of sowing field grain, average of eleven years....	April 23.
Earliest date of sowing field grain, 1903 to 1913.....	April 10 (1910).
Latest date of commencing seeding field grain, 1903 to 1913..	May 4 (1904).
First date of sowing mangels, 1913.....	April 26.
Date of sowing potatoes, 1913.....	May 15.
First date of sowing corn, 1913.....	May 23.
Date of commencing hay harvest, 1913.....	July 7.
Date of commencing grain harvest, 1913.....	August 2.
Date of commencing corn cutting, 1913.....	September 20.
Date of harvesting mangels, 1913.....	October 27.
Date of freezing up, 1913.....	November 28.
Average date of freezing up, 1903-1913.....	November 23.
Earliest date of freezing up, 1903-1913.....	Nov. 15 (1911).
Latest date of freezing up, 1903-1913.....	Dec. 1 (1905).

5 GEORGE V., A. 1915

SOME WEATHER OBSERVATIONS taken at Central Experimental Farm, Ottawa, 1913.

MONTH.	TEMPERATURE F.			PRECIPITATION.				Total Sunshine. Hours.
	Mean.	Highest.	Lowest.	Rainfall.	Snowfall.	Total.	Heaviest in 24 hours	
	°	°	°	Inches.	Inches.	Inches.	Inches.	
January.....	20.90	42.0	-16.0	2.17	23.75	4.54	0.92	94.4
February.....	10.60	37.8	-18.0	23.50	2.35	0.70	124.2
March.....	26.18	58.8	-14.2	2.20	24.25	4.62	0.60	107.7
April.....	45.34	86.5	21.0	2.00	S.	2.00	0.78	219.8
May.....	53.73	89.0	28.8	2.39	2.39	0.76	244.8
June.....	64.21	93.2	35.0	0.82	0.82	0.25	309.0
July.....	70.05	100.0	44.8	2.30	2.30	0.98	278.9
August.....	67.05	97.2	38.0	3.13	3.13	1.70	258.6
September.....	56.83	88.0	30.0	2.69	2.69	0.91	222.5
October.....	59.41	78.2	22.0	4.08	S.	4.08	1.02	134.3
November.....	37.90	63.2	17.2	2.48	2.00	2.68	0.92	166.7
December.....	23.47	42.6	- 5.0	0.58	17.00	2.28	0.76	77.6
Total for year.....				24.84	90.50	33.88		
Average for eleven years.....						33.29		
Total for six growing months, April to September, 1913.....						13.33		
Average of eleven years for six growing months, April to September.....						17.43		

FIELD CROP YIELDS.

The following table summarizes the yields of field crops at the Central Farm in 1913. As pointed out above, they are considerably below the average of past years.

YIELDS of Field Crops, Central Farm, 1913.

Crop.	Area.	Total yield.		Average yield per acre.	
		Tons. Lb.	Bush. Lb.	Tons. Lb.	Bush. Lb.
	Acres.				
Oats.....	50.00		2,500.....		50.....
Oat straw.....	50.00	54 680		1 173	
Corn.....	43.00	516		12	
Roots (mangels).....	3.00	48	1,600.....	16	533 20
Potatoes.....	4.00	25 1,994	866 34	6 998	216 38
Hay.....	60.00	120		2	

SESSIONAL PAPER No. 16

COST OF PRODUCTION OF FIELD CROPS.

Because of the comparatively low yields in 1913 the cost of production per unit was high. Figures are given herewith for corn, mangels, hay, and oats grown in large lots under ordinary field conditions.

COST OF PRODUCTION OF MANGELS.

Two acres of mangels were grown in a four-year rotation of mangels, grain, clover hay, timothy hay. The timothy hay field was ploughed shallow early August, top worked and ribbed up late autumn in part preparation for the mangels.

Number of acres: 2.

Rent of land at \$3 per acre.....	\$6 00
Use of machinery at 60 cents per acre.....	1 20
Quarter share of manure, at rate of 15 tons per acre, at \$1 per ton.....	7 50
Ploughing in autumn, 8 hours 3-horse team at 41 cents.....	3 28
Discing in autumn, 6 hours 4-horse team at 48 cents.....	2 88
Ribbing in autumn, 2 hours 2-horse team at 34 cents.....	68
Discing in spring, 3 hours 4-horse team at 48 cents.....	1 44
Discing, 4 hours 3-horse team at 41 cents.....	1 61
Harrowing, 1 hour 2-horse team at 34 cents.....	34
Rolling, 2 hours 2-horse team at 34 cents.....	68
Drilling, 4 hours 2-horse team at 34 cents.....	1 36
Seed, 20 pounds at 25 cents.....	5 00
Sowing, 12 hours manual labour at 17 cents.....	2 04
Hoeing, 60 hours manual labour at 17 cents.....	10 20
Cultivating, 7½ hours 2-horse team at 34 cents.....	2 55
Cultivating, 4 hours single horse at 27 cents.....	1 08
Pulling, loading and unloading, 118 hours manual labour at 17 cents.....	20 06
Hauling, 14 hours 2-horse team at 34 cents.....	4 76
<hr/>	
Total cost for 2 acres.....	\$72 69
Cost per acre.....	36 35
Yield per acre.....bush.	566
" ".....tons.	17
Cost per bushel.....cents.	6.22
Cost per ton.....	\$2.14

COST OF PRODUCTION OF ENSILAGE CORN.

Eighteen acres of ensilage corn were grown in a three-year rotation of corn, grain, clover hay. The land was manured at the rate of 18 tons per acre and spring ploughed for corn, turning under the manure and the growth of clover.

Number of acres: 18.

Rent of land at \$3 per acre.....	\$54 00
Use of machinery at 60 cents per acre.....	10 80
Third share of manure, at rate of 18 tons per acre, at \$1 per ton.....	108 00
Ploughing, 71 hours 3-horse team at 41 cents.....	29 11
Discing, 25 hours 4-horse team at 48 cents.....	12 00
Discing, 7 hours 3-horse team at 41 cents.....	2 87
Seed, 9 bushels at \$2 per bushel.....	18 00
Seeding, 9½ hours 2-horse team at 34 cents.....	3 23
Rolling, 9½ hours 2-horse team at 34 cents.....	3 23
Cultivating (three times), 54 hours 2-horse team at 34 cents....	18 36
Cultivating, 36 hours single horse at 27 cents.....	9 72
Hoeing, 144 hours manual labour at 17 cents.....	24 48
Cutting, 30 hours 3-horse team at 41 cents.....	12 30
Hauling, 102 hours 2-horse team at 34 cents.....	34 68
Loading, unloading, tramping, etc., 298 hours manual labour at 17c.	50 66
Man at engine, 30 hours manual labour at 17 cents.....	5 10
<hr/>	
Total cost for 18 acres.....	\$396 54
Cost per acre.....	22 03
Yield per acre.....tons.	12
Cost per ton.....	\$1 84

COST OF PRODUCTION OF OATS.

Thirty-five acres of oats were grown in a three-year rotation of corn, oats, clover hay. The corn ground was shallow ploughed in the autumn. With the oats there was seeded a heavy mixture of timothy and clovers.

Number of acres: 35.	
Rent of land at \$3 per acre.....	\$105 00
Use of machinery at 60 cents per acre.....	21 00
Third share of manure, at rate of 18 tons per acre, at \$1 per ton..	210 00
Ploughing in autumn, 56 hours 3-horse team at 41 cents.....	22 96
Discing in autumn, 43 hours 4-horse team at 48 cents.....	20 64
Discing in spring, 56 hours 4-horse team at 48 cents.....	26 88
Harrowing, 12 hours 3-horse team at 41 cents.....	4 92
Seed, at \$1 per acre.....	35 00
Seeding, 20 hours 3-horse team at 41 cents.....	8 20
Cutting, 25 hours 3-horse team at 41 cents.....	10 25
Twine, 105 pounds at 12 cents.....	12 60
Stooking, 61 hours manual labour at 17 cents.....	10 37
Loading, 52 hours manual labour at 17 cents.....	8 84
Hauling, 39 hours 2-horse team at 34 cents.....	13 26
Raking, 12 hours single horse at 27 cents.....	3 24
Threshing, 1,820 bushels at 2½ cents per bushel.....	45 50
	<hr/>
Total cost for 35 acres	\$558 66
Cost per acre	15 96
Yield of grain per acrebush.	52
Yield of straw per acretons.	1.16
Cost per bushel of grain (grain valued at 34 cents per bushel and straw at \$4 per ton).....cents	24.31
Cost per ton of grain \$	14 30
Cost per ton of straw	2 86

NOTE.—The relative costs of grain and straw are estimated in the following manner:—

Total revenue per acre from grain and straw is [52 bushels at 34 cents] + (1.16 tons at \$4) = \$22.32.

When revenue is \$22.32 cost to produce is \$15.96.

When revenue (from 52 bushels grain) is \$17.68, cost to produce 1 bushel is $\frac{17.68 \times 15.96}{22.32 \times 52} = 24.31$ cents.

When revenue (from 1.16 tons straw) is \$4.64, cost to produce

per ton is $\frac{4.64 \times 15.96}{22.32 \times 1.16} = \$2.86.$

COST OF PRODUCTION OF HAY.

Thirty-three and one-half acres of hay were grown in a three-year rotation of corn, oats, clover hay. Owing to the winter killing of the clover and to the excessive drought during the growing season the yield was low, and in consequence the cost of production per ton was comparatively high.

Number of acres: 33.5.	
Rent of land at \$3 per acre.....	\$100 50
Use of machinery at 60 cents per acre.....	20 10
Third share of manure, at rate of 18 tons per acre, at \$1 per ton..	201 00
Seed:—10 pounds red clover at 28 cents; 2 pounds alsike at 30 cents; 6 pounds alfalfa at 22 cents; 6 pounds timothy at 7½ cents	5 17
Cutting, 26 hours 2-horse team at 34 cents	8 84
Raking, 25 hours single horse at 27 cents.....	6 75
Coiling, 60 hours manual labour at 17 cents.....	10 20
Loading and unloading, 117 hours manual labour at 17 cents....	19 89
Hauling, 65 hours 2-horse team at 34 cents.....	22 10
	<hr/>
Total cost for 33.5 acres	\$394 55
Cost per acre	11 78
Yield per acretons.	2
Cost per ton	\$5 89

SESS ONAL PAPER No. 16

The following table summarizes in a form convenient for reference, the cost of production of mangels, corn, oats and hay as given in detail above:—

Cost of Production of Field Crops, Central Farm, 1913.

Crop.	Area.	Yield per acre.		COST TO PRODUCE.		
				Per acre.	Per ton.	Per bushel.
	Acres.	Tons.	Bush.	\$ cts.	\$ cts.	Cents.
Mangels.....	2.00	17	584	36 35	2 14	6.22
Ensilage corn.....	18.00	12	22 03	1 84
Oats.....	35.00	52	15 96	14 30	21.3
Oat straw.....	1.16
Hay.....	33.5	2	11 78	5 89

ROTATION OF CROPS.

That certain crops do better when following after certain other crops, has long been known. Farm practice, however, seldom keeps pace with knowledge in such matters, and to this particular phase of crop management work especially, too little consideration is usually given.

For the past ten years experiments have been carried on at this Farm to determine the relative value of different rotations suitable for live stock purposes. Before presenting the results of this work in detail we may briefly answer the following questions that naturally arise in a consideration of this subject:—

What is meant by a systematic rotation of crops?

It is a certain regular succession of crops so arranged that, after each, the land is left in the best possible condition to receive the crop which follows.

Why does the order in which crops follow each other make a great difference in the yields from year to year?

1. Because different plants have different manurial requirements.
2. Because plants vary in their power to abstract certain foods from the soil.
3. Because all plants do not feed to the same depth in the soil.
4. Because all plants are not alike in the residues they leave behind.
5. Because some plants tend to produce better tilth than others.
6. Because plants vary in their resistance power to bacterial and fungus diseases and to insect enemies.

What are the requirements of any rotation before it may be considered suitable?

1. It must supply the crops needed in the proper proportions.
2. It must be so constituted that weeds can be kept under control.
3. It must yield a reasonable net profit.
4. It must, under properly regulated treatment, maintain soil fertility.

Why should every farmer place his farm under some definite system of cropping, or, in other words, adopt a rotation of crops?

- 1. Because it will increase crop yields and net profits.
2. Because the cost of fencing, on farms where live stock is kept, would be materially reduced, since it would be necessary to fence off only three, four or five fields instead of ten or twelve, as is often done.

3. Because larger machinery could be used. Where fields are fewer they must be larger, and large fields lend themselves better than small ones to the use of large machinery which lowers cost of production.

4. Because all cultural operations of one kind would be in one field, thus lowering the cost by reducing the travelling necessary from one small field to another.

5. Because every field would receive, at regular intervals, its fair proportion of manure. No field would therefore be favoured to the disadvantage of the rest of the farm, and the whole farm would always be kept up to its highest producing possibilities.

The line of farming engaged in must, however, determine to a great extent the kind and relative amounts of crops that shall be grown, and may, in some cases, prevent following to the letter the rotation that would provide the largest returns. In any case it may be said that a good rotation will include: (1) meadow or pasture, (2) roots, corn, or other hoed crop, and (3) some cereal crop. The results of our experiments go to show that for greatest profits these crops should follow each other in the order named.

The following rotations have been devised to meet different requirements. One or the other of them is likely to be found suitable for conditions that obtain on the average live stock farm in Eastern Ontario and Quebec.

ROTATION "A" (FIVE YEARS' DURATION).

First year.—Hoed crop. When corn is the hoed crop used, manure is applied in spring at rate of 15 tons per acre and shallow ploughed shortly before planting time, turning under clover and manure. After the hoed crop is harvested, land is shallow ploughed or cultivated.

Second year.—Grain. Seeded down with 8 pounds red clover, 2 pounds alsike and 10 pounds timothy per acre.

Third year.—Clover hay. Two crops expected. Top dressed in fall with manure at rate of 15 tons per acre.

Fourth year.—Timothy hay. Field ploughed in August, top worked and ribbed up in October.

Fifth year.—Grain. Seeded down with 10 pounds red clover, which is allowed to grow to be turned under following spring when the hoed crop is corn.

This rotation has proven an excellent one here. When carefully followed, and when cultural operations were well performed, weeds have been kept under fair control, and crop yields have been maintained. One-fifth of the land is in hoed crop, two-fifths in grain, one-fifth in clover hay, and one-fifth in timothy hay or pasture. It supplies a relatively larger proportion of grain to roots and hay than the ordinary three or four-course rotation, and for that reason would be preferable where considerable grain is called for.

ROTATION "B" (FIVE YEARS' DURATION).

First year.—Hoed crop. When corn is the hoed crop used, manure is applied in spring at rate of 15 tons per acre, and shallow ploughed shortly before planting time, turning under both clover and manure.

Second year.—Grain. Seeded down with 10 pounds red clover, 2 pounds alsike and 5 pounds timothy per acre. New seeding top dressed in fall with 15 tons barnyard manure per acre.

Third year.—Hay. Two crops expected. Ploughed late fall.

Fourth year.—Grain. Seeded down with 10 pounds red clover, 2 pounds alsike and 5 pounds timothy per acre.

Fifth year.—Clover hay. Two crops expected.

SESSIONAL PAPER No. 16

Though the arrangement is different, this rotation is very similar to "A" in the relative amounts of the different crops it supplies. In "A" both clover and timothy hay are provided, whereas in "B" clover hay only is grown. "B" has maintained crop yields, and has given profits equal to "A" in the tests so far conducted, but, as indicated, does not answer the purpose where a certain proportion of timothy hay is called for. It can, however, be very easily extended into a six or seven-year rotation to include timothy hay or pasture. As a seven-year rotation the crops would succeed each other in the following order:—

Hoed crop; grain, seeded down with clover and timothy; clover hay; timothy hay or pasture; grain, seeded down with clover and timothy; clover hay; timothy hay or pasture.

ROTATION "C" (FOUR YEARS' DURATION.)

First year.—Hoed crops.

Second year.—Grain. Seeded down with 10 pounds red clover and 12 pounds timothy per acre.

Third year.—Clover hay. Two crops expected.

Fourth year.—Timothy hay. Field ploughed in August, manured at rate of 24 tons per acre, worked at intervals and ridged up in late fall in preparation for hoed crops.

This rotation is most satisfactory from all standpoints, except that it supplies a rather smaller proportion of grain than is often desired. Where live stock is the mainstay of the farm, this is, however, a very minor fault. The turning of a shallow furrow when ploughing sod in preparation for grain or corn has been found to be good practice here. In preparing for roots, deeper ploughing or the regular plough with subsoiler is to be advised.

ROTATION "D" (THREE YEARS' DURATION.)

First year.—Hoed crop. For corn, manure is applied in spring at rate of 18 tons per acre, and shallow ploughed shortly before corn planting time, turning under both clover and manure. For roots, land should be ploughed previous fall.

Second year.—Grain. Seeded down with 10 pounds red clover, 2 pounds alsike, 6 pounds alfalfa and 6 pounds timothy per acre.

Third year.—Clover hay. Two crops expected.

This would be a most excellent rotation to put into practice where sufficient rough land is available to serve as pasturage. It is the rotation that would supply the greatest amount of forage of the best description for dairying or beef production. It is better for heavy than for light soils.

ROTATION "E" (THREE YEARS' DURATION.)

First year.—Corn. Manure applied in spring at rate of 18 tons per acre. Shallow ploughed shortly before corn planting time, turning under both clover and manure.

Second year.—Peas and oats mixed. Cut green for cattle. Seeded down with 10 pounds red clover, 2 pounds alsike, 6 pounds alfalfa and 6 pounds timothy per acre.

Third year.—Clover hay. Cut green for cattle.

OTTAWA.

5 GEORGE V., A. 1915

This is a rotation specially designed to supply soiling crops. Two years' records only have been kept.

If a careful examination of the above rotations be made there will be noted a few desirable characteristics common to all:—

1. Grain fields are always seeded down with clover, even though it be used only as a fertilizer, as in the case of the fifth year of rotation "A."

2. Grass and clover seedings are heavy. Increased crops of hay and rare failures of a catch have justified them.

3. Hoed crops form a large proportion of every rotation. An attempt to farm a small area without a hoed crop was not successful. Weeds could not readily be kept in check.

4. No field is left in hay for more than two successive years. Our records show that the second crop almost always costs more per ton than the first, and that succeeding crops are very liable to be grown at a loss.

5. Barnyard manure is applied frequently, in comparatively small quantities, rather than at long intervals, in large quantities.

In order that the net profits (profits after deducting cost of rent, all manual and horse labour, manure, seed, twine and use of machinery) as well as the yields of these rotations might be determined, careful records have been kept of all items chargeable against the rotations.

The following values have been fixed and are being used in this, and similar work, on all the Eastern Farms and Stations:—

Cost Values.

Manual labour	\$0 17 per hour.
Horse labour, including teamster—	
Single horse	27 "
2-horse team	34 "
3-horse team	41 "
4-horse team	48 "
Additional horses, each	7 "
Rent	3 00 per acre.
Machinery (inclusive of threshing machinery)	60 "
Barnyard manure (spread)	1 00 per ton.
Commercial fertilizers charged at cost.	
Seed wheat, oats, barley, buckwheat and rye.....	1 00 per acre.
Seed peas	2 00 "
Turnip, mangel, potato and corn seed charged at cost.	
Grass and clover seed charged at cost, total cost to be distributed over the number of years in hay and pasture.	
Twine charged at cost.	
Threshing charged according to actual labour expended, the items charged under this head to include only such operations as begin after the load of grain arrives at the feed table, or after the grain is stacked or placed in the mow ready to be thrown on the feed table. Loading, hauling, etc., to be charged to manual and horse labour.	

Return Values.

Wheat, oats, barley, rye and buckwheat.....	\$0 01 per pound.
Peas	1½ "
Hay (timothy, clover, alfalfa or mixed).....	7 00 per ton.
Straw (wheat, oat, barley, rye, buckwheat or peas)..	4 00 "
Corn ensilage	2 00 "
Sugar beets	3 00 "
Forage crops (green)	2 00 "
Turnips, carrots, mangels	2 00 "
Potatoes	50 per bushel.
Pasture—	
Horses per head	1 00 per month.
Cattle per head	1 00 "
Sheep per head	25 "

OTTAWA.

SESSIONAL PAPER No. 16

The items for which there are no fixed charges have been valued as follows:—

Twine	\$ 12 per pound.
Red clover	25 00 per 100 pounds.
Alsike clover	20 00 "
Alfalfa	22 60 "
Timothy	1 50 per bushel.
Seed corn	7 50 "
Mangel seed	25 per pound.

The season of 1913 was so extremely dry that many of our crops were grown at a loss. The returns are, therefore, very low as compared with the average returns for preceding years. A rearrangement of the rotations was made in 1912, hence averages have been drawn for the preceding eight years only.

COSTS, RETURNS and NET PROFITS of Rotations "A," "B," "C," "D" and "R," 1904-11.

Rotation.	Cost to operate per acre.	Value of returns per acre.	Profit or loss per acre, 1913.	Profit, average of 8 years, 1904-11.
	\$ cts.	\$ cts.	\$ cts.	\$ cts.
A (Five years' duration).....	17 55	19 40	1 85	8 78
B (Five ").....	21 83	21 47	- 36	9 03
C (Four ").....	17 08	16 97	- 11	8 15
D (Three ").....	19 35	17 80	-1 55	10 08
R (Three ").....	19 14	19 50	36*	

*Records kept for 1912-13 only.

COSTS, RETURNS and NET PROFITS of Rotations "A," "B," "C" and "D," 1904-11.

Year.	COST PER ACRE TO OPERATE.				VALUE PER ACRE OF RETURNS.				NET PROFIT PER ACRE.			
	A.	B.	C.	D.	A.	B.	C.	D.	A.	B.	C.	D.
	\$ c.	\$ c.	\$ c.	\$ c.	\$ c.	\$ c.	\$ c.	\$ c.	\$ c.	\$ c.	\$ c.	\$ c.
1904.....	14 37	14 59	19 89	15 73	24 33	23 58	22 98	27 25	9 96	8 99	3 09	11 52
1905.....	16 30	17 96	22 88	18 31	26 86	29 81	36 74	29 96	10 56	11 85	13 86	11 65
1906.....	15 54	15 16	19 31	14 56	23 67	21 19	25 06	21 65	8 13	6 09	5 71	7 09
1907.....	14 63	14 83	20 13	17 30	21 97	26 34	27 6	26 91	10 34	11 51	7 50	9 61
1908.....	14 16	13 70	15 84	15 07	19 07	17 43	20 21	19 26	4 91	3 73	4 37	4 19
1909.....	13 50	14 38	16 65	13 48	19 18	22 64	25 64	24 74	5 68	8 26	8 99	11 26
1910.....	13 56	13 48	13 67	14 77	23 54	22 92	23 36	28 86	9 98	9 44	9 69	14 09
1911.....	14 20	14 29	14 24	14 18	24 85	26 65	26 25	25 43	10 65	12 36	12 01	11 25
Total.....	116 26	118 33	142 65	123 40	186 47	190 56	207 87	204 06	70 21	72 23	65 22	80 66
Average for 8 years	14 53	14 79	17 83	15 43	23 31	23 82	25 98	25 51	8 78	9 03	8 15	10 08

The following tables contain details in
ROTATION

Rotation Year.	Crops.		Area.	ITEMS OF EXPENSE								
				Rent and manure.	Seed, twine and use of machinery.	Manual labour.		Horse labour (including teamster.)				Cost of horse labour.
						Hours.	Cost.	Hours.				
								Single horse.	2-horse team.	3-horse team.	4-horse team.	
	1912.	1913.	Ac.	\$ c.	\$ c.	No.	\$ c.	No.	No.	No.	No.	\$ c.
1st...	Oats.....	Corn.....	1-00	9 56	1 77	42	7 14	1½	12½	5½	2½	8 11
2nd...	Corn.....	Oats.....	1-00	9 56	1 91	3	0 51	1½	1½	5¼	1½	3 52
3rd...	Oats.....	Hay.....	1-00	9 56	2 40	6	1 02	2½	0 99
4th...	Hay.....	Hay.....	1-00	9 56	2 40	6	1 02	1½	2½	0 98
5th...	Hay.....	Grain.....	1-00	9 56	1 91	3	0 51	1½	1½	5¼	1½	3 52
	Aggregate.....		5-00	47 80	10 39	60	10 20	3½	20½	16	5½	17 12
	Average per acre in 1913.....											

ROTATION

1st...	Hay.....	Corn.....	1-00	9 00	1 77	38	6 46	1½	10½	5½	2½	7 43
2nd...	Corn.....	Oats.....	1-00	9 00	1 91	3	0 51	1½	1½	5¼	1½	3 52
3rd...	Oats.....	Hay.....	1-00	9 00	4 37	6	1 02	2½	0 99
4th...	Hay.....	Oats.....	1-00	9 00	2 02	2½	0 42	2	5¼	1½	3 69
5th...	Oats.....	Hay.....	1-00	9 00	4 37	5	0 85	1½	2½	0 98
	Aggregate.....		5-00	45 00	14 44	54½	9 26	3½	19	16	5½	16 61
	Average per acre in 1913.....											

ROTATION

1st...	Hay.....	Corn.....	1-00	9 00	1 77	41	6 97	1½	11½	5½	2½	7 77
2nd...	Corn.....	Oats.....	1-00	9 00	1 97	3	0 51	1½	1½	5¼	1½	3 52
3rd...	Grain.....	Hay.....	1-00	9 00	2 45	5	0 85	2½	0 99
4th...	Hay.....	Hay.....	1-00	9 00	2 45	4½	0 77	1½	2½	0 98
	Aggregate.....		4-00	36 00	8 64	53½	9 10	3	18	10¼	4	13 26
	Average per acre in 1913.....											

ROTATION

1st...	Hay.....	Corn.....	1-00	9 00	1 77	40	6 80	1½	11½	5½	2½	7 77
2nd...	Corn.....	Oats.....	1-00	9 00	1 91	2½	0 38	1½	1½	5¼	1½	3 52
3rd...	Oats.....	Hay.....	1-00	9 00	5 77	5	0 85	1½	2½	0 98
	Aggregate.....		3-00	27 00	9 45	47¼	8 03	2½	15½	10¼	4	12 27
	Average per acre in 1913.....											

SESSIONAL PAPER No. 16

connection with these rotations in 1913:—

"A."

IN RAISING CROP.					PARTICULARS OF CROP.						
Cost of threshing.	Total cost.	Cost for 1 acre.	Cost for 1 bushel.	Cost for 1 ton.	Weight.				Total value.	Value of crop per acre.	Profit or loss per acre.
					Grain.	Straw.	Hay.	Roots, ensilage or green feed.			
\$ c.	\$ c.	\$ c.	\$ c.	\$ c.	Lb.	Lb.	Lb.	Lb.	\$ c.	\$ c.	\$ c.
	26 58	26 58		1 50				29,530	29 53	29 53	2 95
1 16	16 66	16 66	0 39		1,450	1,622			17 82	17 82	1 16
	13 97	13 97		6 02			4,640		16 24	16 24	2 27
	13 96	13 96		6 00			4,650		16 27	16 27	2 31
1 11	16 61	16 61	0 41		1,389	1,631			17 15	17 15	0 54
2 27	87 78	87 78			28 47	3,253	9,290	29,530	97 01	97 01	9 23
		17 55								19 40	1 85

"B."

	24 66	24 66		2 37				20,760	20 76	20 76	-3 90
0 93	15 87	15 87	0 46		1,170	1,120			13 94	13 94	-1 93
	15 38	15 38		5 49			5,600		19 60	19 60	4 22
1 06	16 19	16 19	0 41		1,326	3,694			20 65	20 65	4 46
	15 20	15 20		9 74			3,120		10 92	10 92	-4 28
1 99	87 30	87 30			2,496	4,814	8,720	20,760	85 87	85 87	-1 43
		21 83								21 47	-0 36

"C."

	25 51	25 51		1 85				27,530	27 53	27 53	2 02
1 31	16 31	16 31	0 34		16 41	2,084			20 58	20 58	4 27
	13 29	13 29		9 23			2,880		10 08	10 08	-3 21
	13 20	13 20		9 60			2,770		9 69	9 69	-3 51
1 31	68 31	68 31			16 41	2,084	5,650	27,530	67 88	67 88	-0 43
		17 08								16 97	-0 11

"D."

	25 34	25 34		2 11				24,030	24 03	24 03	-1 31
1 30	16 11	16 11	0 34		1,628	1,197			18 67	18 67	2 56
	16 60	16 60		10 85			3,060		10 71	10 71	-5 89
1 30	58 05	58 05			1,628	1,197	3,060	24,030	53 41	53 41	-4 64
		19 35								17 80	-1 55

Rotation year.	Crops.		ITEMS OF EXPENSE									
			Area.	Rent and manure.	Seed, twine and use of machinery.	Manual labour.		Horse labour (including teamster.)				Cost of horse labour.
						Hours.	Cost.	Hours.				
								Single horse.	2-horse team.	3-horse team.	4-horse team.	
1912.	1913.	Ac.	\$ c.	\$ c.	No.	\$ c.	No.	No.	No.	No.	\$ c.	
1st...	Hay.....	Corn.....	1.60	14 40	2 83	50	8 50	2½	15¼	8½	3¾	11 15
2nd...	Corn.....	Mixed peas and oats.....	1.60	14 40	3 36	20	3 40	2	10	6¼	2	7 46
3rd...	Mixed peas and oats.....	Hay.....	1.60	14 40	9 23	6½	1 10	1	4			1 63
	Aggregate.....		4.80	43 20	15 42	76½	13 00	5½	29¼	14¾	5¾	20 24
	Average per acre in 1913.....											

SESSIONAL PAPER No. 16

"R."

IN RAISING CROP.					PARTICULARS OF CROP.							
Cost of threshing.	Total cost.	Cost for 1 acre.	Cost for 1 bushel.	Cost for 1 ton.	Weight.				Total value.	Value of crop per acre.	Profit or loss per acre.	
					Grain.	Straw.	Hay.	Roots, ensilage or green feed.				
\$ c.	\$ c.	\$ c.	\$ c.	\$ c.	Lb.	Lb.	Lb.	Lb.	\$ c.	\$ c.	\$ c.	
.....	36 88	23 05	1 93	38,300	38 30	23 94	0 89	
.....	28 62	17 89	1 90	30,140	30 14	18 84	0 95	
.....	26 36	16 47	7 33	7,190	25 16	15 72	-0 75	
.....	91 86	57 41	7,190	68,440	93 60	58 50	1 09	
.....	19 14	19 50	0 36	

SHALLOW PLOUGHING AND SUBSOILING *versus* DEEP PLOUGHING.

This experiment has now been under way for ten years. Two four-year rotations, differing only in the above-mentioned methods of preparation for hoed crop, were laid down in 1904.

ROTATION "S" (SHALLOW PLOUGHING AND SUB-SOILING).

First year.—Corn or roots. Field manured at rate of 24 tons per acre. Ploughed out of sod previous August, 4 inches deep, subsoiled to a depth of 8 or 9 inches and ridged up in late autumn. The land is ploughed shallow or cultivated in preparation for the grain which follows.

Second year.—Grain. Seeded down with 10 pounds red clover and 12 pounds timothy per acre.

Third year.—Clover hay. Cut twice in the season, and the aftermath left on the field.

Fourth year.—Timothy hay. Broken in August and prepared for corn or roots, as indicated above.

ROTATION "P" (DEEP PLOUGHING).

This rotation differs from rotation "S" only in the treatment of the timothy hay field in preparation for corn or roots. It is manured and ploughed in August, 7 inches deep, top-worked, and ploughed again in late fall, 7 inches deep.

The average returns for the ten years show a very slight advantage in favour of the deep ploughing. If there is taken into consideration the fact that where subsoiling is practised a single plough must be used, whereas a two-furrow riding plough may be operated under the deep-ploughing method, the higher cost of operation in the former method would reduce the actual net profits still more. This experiment will be continued, as the results have not as yet shown any decided advantage in favour of either method.

SESSIONAL PAPER No. 16

COSTS, RETURNS and NET PROFITS of Rotations "S" and "P," Average of 10 Years.

Year.	Cost to operate per acre.		Value of returns per acre.		Net profit per acre.	
	S.	P.	S.	P.	S.	P.
	\$ cts.	\$ cts.	\$ cts.	\$ cts.	\$ cts.	\$ cts.
1904	19 89	19 89	22 98	22 98	3 09	3 09
1905	22 88	22 89	36 74	36 89	13 86	14 00
1906	19 35	19 39	25 06	24 93	5 71	5 54
1907	20 13	20 29	27 63	27 41	7 50	7 12
1908	15 84	16 03	20 21	20 31	4 37	4 31
1909	16 65	17 05	25 64	25 80	8 99	8 75
1910	13 67	14 42	23 33	23 60	9 69	9 18
1911	14 24	14 53	26 25	26 72	12 01	12 19
1912	19 47	19 02	27 14	28 99	7 67	9 97
1913	18 13	17 52	17 71	18 34	42	82
Total	180 25	181 03	252 72	256 00	72 47	74 97
Average for 10 years	18 02	18 10	25 27	25 60	7 25	7 50

The following tables contain details of these rotations

ROTATION "S" (SHALLOW

Rotation year.	DESCRIPTION OF SOIL.		CROPS.		Area.	ITEMS OF				
	Surface Soil.	Subsoil.				Rent and manure.	Seed, twine and use of machinery.	Manual labour.		Horse
								Hours	Cost.	
			1912.	1913.	Acres.	\$ c.	\$ c.	No.	\$ c.	No.
1st.....	Sandy loam...	Clay hard-pan	Hay.....	Corn.....	1.00	9.00	1.77	37	6.29	1
2nd.....	" ..	" ..	Corn.....	Oats.....	1.00	9.00	1.91	3	.51	$\frac{1}{2}$
3rd.....	" ..	" ..	Oats.....	Hay.....	1.00	9.00	2.45	5	.85	$\frac{1}{2}$
4th.....	" ..	" ..	Hay.....	Hay.....	1.00	9.00	2.45	5	.85	$\frac{1}{2}$
Aggregate.....					4.00	36.00	8.58	50	8.50	3
Average per acre in 1913.....										

ROTATION "P"

1st.....	Sandy loam...	Clay hard-pan	Hay.....	Corn.....	1.00	9.00	1.77	39	6.63	$1\frac{1}{2}$
2nd.....	" ..	" ..	Corn.....	Oats.....	1.00	9.00	1.91	3	.51	$\frac{1}{2}$
3rd.....	" ..	" ..	Oats.....	Hay.....	1.00	9.00	2.45	5	.85	$\frac{1}{2}$
4th.....	" ..	" ..	Hay.....	Hay.....	1.00	9.00	2.45	5	.85	$\frac{1}{2}$
Aggregate.....					4.00	36.00	8.58	52	8.84	3
Average per acre in 1913.....										

SESSIONAL PAPER No. 16

in 1913. Values as given on page 96 have been used:—

PLOUGHING AND SUBSOILING).

EXPENSE IN RAISING CROP.

PARTICULARS OF CROP.

Labour (including teamster).			Weight.											Value of crop per acre.	Profit or loss per acre.
Hours			Cost of horse labour	Cost of threshing.	Total cost.	Cost for one aere.	Cost for one bush-el.	Cost for one ton.	Grain	Straw	Hay.	Fod-der corn.	Total value.		
2-horse team	3-horse team	4-horse team													
No.	No.	No.	\$ c.	\$ c.	\$ c.	\$ c.	cts.	\$ c.	Lb.	Lb.	Lb.	Lb.	\$ c.	\$ c.	\$ c.
29	1½	3½	12.56		29.62	29.62		2.46				24,100	24.10	24.10	-5.52
1½	5¼	1½	3.52	1.40	16.34	16.34	32		1,750	1,290			20.08	20.08	3.74
2½			.98		13.28	13.28		6.99			3,800		13.30	13.30	.02
2½			.99		13.29	13.29		6.96			3,820		13.37	13.37	.08
35½	6¾	5	18.05	1.40	72.53	72.53			1,750	1,290	7,620	24,100	70.85	70.85	-1.68
					18.13	18.13							17.71	17.71	--.42

(DEEP PLOUGHING).

12	9½	3	9.82		27.22	27.22		1.98				27,450	27.45	27.45	.23
1½	5¼	1½	3.52	1.34	16.28	16.28	33		1,678	1,262			19.30	19.30	3.02
2½			.98		13.28	13.28		6.87			3,870		13.54	13.54	.26
2½			.99		13.29	13.29		7.11			3,740		13.09	13.09	-.20
18½	14¾	4½	15.31	1.34	70.07	70.07			1,678	1,262	7,610	27,450	73.38	73.38	3.31
					17.52	17.52							18.34	18.34	.82

COMMERCIAL FERTILIZERS.

In 1913 there were completed five years of experiments designed to supply information concerning the relative fertilizing merits, in regular farm rotation, of:—

1. No manure or fertilizer of any kind, but pastured one year in four (records kept in 1913 only).
2. Barnyard manure.
3. Complete commercial fertilizer.
4. Barnyard manure, together with commercial fertilizer.

To carry out this work, four areas of land were selected, "N," in 1912, and "X," "Y" and "Z" in 1909. Each area was divided into four equal-sized plots, and placed under the following rotation:—

First year.—Hoed crop.

Second year.—Oats. Seeded down with 8 pounds red clover, 2 pounds alsike and 12 pounds timothy per acre.

Third year.—Clover hay.

Fourth year.—Timothy hay on rotations "X," "Y" and "Z," and pasture on rotation "N." Land ploughed shallow in early autumn, top worked and ribbed up in late autumn.

FERTILIZER Treatment Given Rotations "N," "X," "Y" and "Z."

Crop.	Rotation N.	Rotation X.	Rotation Y.	Rotation Z.
Mangels.....	No fertilizer....	Manure 15 tons.	No manure..... Superphosphate, 300 lb.... Muriate of potash, 75 lb.... Nitrate of soda, 100 lb....	Manure, 7½ tons. Superphosphate, 150 lb. Muriate of potash, 37½ lb. Nitrate of soda, 50 lb.
Oats.....	No fertilizer....	No fertilizer....	Nitrate of soda, 100 lb....	Nitrate of soda, 100 lb.
Clover hay.....	No fertilizer....	No fertilizer....	Nitrate of soda, 100 lb....	Nitrate of soda, 100 lb.
Timothy hay...	Pastured.....	No fertilizer....	Nitrate of soda, 100 lb....	Nitrate of soda, 100 lb.

The five years' results for this experiment supply rather interesting data.

Rotation "X," which was fertilized with barnyard manure alone, cost the least to operate and produced the largest returns. The average profit per acre for the period was \$7.88.

Rotation "Z," which received a mixture of barnyard manure and commercial fertilizers produced equally as well as rotation "X," but cost slightly more to operate with the result that the net profit was just \$6.77 per acre.

Rotation "Y," receiving commercial fertilizer alone was the lowest in producing power and cost as much to operate as "X." The profits therefrom have averaged only \$5.55 per acre.

These results show a distinct advantage of barnyard manure alone over commercial fertilizer alone for this soil, but point to the possibility of combining the two to good advantage when barnyard manure is scarce or high in price.

In calculating the returns from these rotations fixed values as given on page 96 of this report were used. Fertilizers were valued as follows:—

Muriate of potash.....	\$2 50 per 100 pounds.
Nitrate of soda.....	3 00 "
Superphosphate.....	0 90 "

SESSIONAL PAPER No. 16

COSTS, RETURNS AND PROFITS per Acre of Rotations "N," "X," "Y" and "Z."

Rotation.	Cost to operate.	Value of returns.	Net profit, 1913.	Net profit average of 5 years.
	\$ cts.	\$ cts.	\$ cts.	\$ cts.
N—No manure or fertilizer of any kind.....	11 92	13 05	1 13	*
X—Barnyard manure.....	16 47	22 09	5 62	7 88
Y—Complete commercial fertilizer.....	16 65	20 07	3 42	5 55
Z—Barnyard manure together with commercial fertilizer.....	17 81	21 16	3 35	6 77

*Average of one year only.

COSTS, RETURNS AND PROFITS per Acre of Rotations "X," "Y" and "Z," 1909-1913.

Year.	COST TO OPERATE PER ACRE.			VALUE OF RETURNS PER ACRE.			PROFIT PER ACRE.		
	X.	Y.	Z.	X.	Y.	Z.	X.	Y.	Z.
	\$ cts.	\$ cts.	\$ cts.	\$ cts.	\$ cts.	\$ cts.	\$ cts.	\$ cts.	\$ cts.
1909.....	13 15	15 42	14 51	19 72	20 70	20 82	6 57	5 28	6 31
1910.....	26 58	29 16	27 91	32 55	34 52	36 26	5 97	5 36	8 35
1911.....	14 86	16 70	16 16	24 90	22 84	26 88	10 04	6 14	10 72
1912.....	19 23	19 39	20 24	30 44	26 95	25 38	11 21	7 56	5 14
1913.....	16 47	16 65	17 81	22 09	20 07	21 16	5 62	3 42	3 35
Total for 5 years.....	90 29	97 32	96 63	129 70	125 08	130 50	39 41	27 76	33 87
Average per acre for 5 years	18 06	19 46	19 33	25 94	25 01	26 10	7 88	5 55	6 77

YIELDS of Hoed Crops on Rotations "X," "Y" and "Z," 1909-1913.

Year.	Area.		Rotation X.		Rotation Y.		Rotation Z.	
	Acres.		Lb.		Lb.		Lb.	
1909.....	1		26,540		28,290		26,445	
1910.....	2		75,520		78,276		81,200	
1911.....	1		28,160		22,730		29,970	
1912.....	1		48,360		49,130		48,360	
1913.....	1		36,000		32,480		34,418	
Total yield 5 years.....			212,580		210,906		220,483	
Average per acre for 5 years....			17 tons 1,430 pounds.		17 tons 1,151 pounds.		18 tons 747 pounds.	

YIELDS of Oats on Rotations "X," "Y" and "Z," 1909-1913.

Year.	Area.	ROTATION X.		ROTATION Y.		ROTATION Z.	
		Grain.	Straw.	Grain.	Straw.	Grain.	Straw.
		Lb.	Lb.	Lb.	Lb.	Lb.	Lb.
1909.....	1	1,455	2,725	1,615	2,735	1,576	2,789
1910*.....							
1911.....	1	1,474	2,436	1,709	2,530	1,893	2,777
1912.....	1	2,492	3,238	1,421	1,909	1,035	1,945
1913.....	1	1,650	1,680	1,457	1,363	1,565	1,735
Total yield 4 years..		7,071	10,079	6,202	8,537	6,069	9,246
Average per acre for 4 years.....		52 bushels.	2,519 pounds.	45 bush. 20 lb.	2,134 pounds.	44 bush. 21 lb.	2,311 lb.

*Hoed crops grown in place of grain in 1910.

SESSIONAL PAPER No. 16

YIELDS of Hay on Rotations "X," "Y" and "Z," 1909-1913.

Year.	Area.	Rotation X.	Rotation Y.	Rotation Z.
	Acres.	Lb.	Lb.	Lb.
1909.....	2	9,240	9,105	19,157
1910.....	2	6,900	7,230	7,860
1911.....	2	14,810	13,280	15,160
1912.....	2	12,000	11,610	11,120
1913.....	2	9,290	8,710	8,890
Total yield 5 years.....		52,240	50,235	53,187
Average per acre for 5 years....		2 tons 1,224 pounds.	2 tons 1,023 pounds.	2 tons 1,318 pounds.

FERTILIZER

Year of rotation.	DESCRIPTION OF SOIL.		CROPS.		Area.	ITEMS OF				
	Surface soil.	Subsoil.	Last Year.	This Year.		Rent and manure.	Seed, twine and use of machinery.	Manual labour.		Horse
								Hours	Cost.	
			1912.	1913.	Acres.	\$ c.	\$ c.	No.	\$ c.	No.
1st.....	Clay loam....	Clay hardpan	Pasture....	Mangels....	.33	1 00	70	22	3 74	1½
2nd.....	" ..	" ..	Mangels....	Oats.....	.33	1 00	64	1	17	1½
3rd.....	" ..	" ..	Oats.....	Hay.....	.33	1 00	82	1½	30	1½
4th.....	" ..	" ..	Hay.....	Pasture....	.33	1 00	62			1½
	Aggregate.....				1.32	4 00	2 78	24¾	4 21	1¾
	Average per acre in 1913.....									

FERTILIZER

1st.....	Black muck..	Clay hardpan	Hay.....	Mangels....	1 00	6 75	2 10	68	11 56	4
2nd.....	Clay loam...	" ..	Mangels....	Oats.....	1.00	6 75	1 97	2¾	46	½
3rd.....	" ..	" ..	Oats.....	Hay.....	1.00	6 75	2 47	5	85	½
4th.....	" ..	" ..	Hay.....	Hay.....	1.00	6 75	2 47	4	68	½
	Aggregate				4.00	27 00	9 01	79¾	13 55	5½
	Average per acre in 1913.....									
	Average per acre for 5 years									

FERTILIZER

1st.....	Black muck..	Clay hardpan	Hay.....	Mangels....	1.00	7 14	2 10	69½	11 82	4
2nd.....	Clay loam...	" ..	Mangels....	Oats.....	1.00	7 14	1 97	4½	72	½
3rd.....	" ..	" ..	Oats.....	Hay.....	1.00	7 14	2 47	6½	1 10	½
4th.....	" ..	" ..	Hay.....	Hay.....	1.00	7 14	2 47	5½	94	½
	Aggregate				4.00	28 56	9 01	85¾	14 58	5½
	Average per acre in 1913									
	Average per acre for 5 years									

FERTILIZER

1st.....	Black muck..	Clay hardpan	Hay.....	Mangels....	1.00	8 07	2 10	70	11 90	4
2nd.....	Clay loam....	" ..	Mangels....	Oats.....	1.00	8 07	1 97	2¾	46	½
3rd.....	" ..	" ..	Oats.....	Hay.....	1.00	8 07	2 47	6½	1 10	½
4th.....	Gravelly clay	" ..	Hay.....	Hay.....	1.00	8 07	2 47	5½	94	½
	Aggregate.....				4.00	32 28	9 01	84¾	14 40	5½
	Average per acre in 1913.....									
	Average per acre for 5 years.....									

SESSIONAL PAPER No. 16

ROTATION "N."

EXPENSE IN RAISING CROPS.									PARTICULARS OF CROP.						
Labour (including teamster).			Cost of horse labour	Cost of threshing.	Total cost.	Cost for one acre.	Cost for one bushel.	Cost for one ton.	Weight.				Total value.	Value of crop per acre.	Profit or loss per acre.
Hours.									Grain	Straw	Hay.	Mangels.			
2-horse team.	3-horse team.	4-horse team.	\$ c.	\$ c.	\$ c.	\$ c.	cts.	\$ c.	Lb.	Lb.	Lb.	Lb.	\$ c.	\$ c.	\$ c.
5 1/2	1 1/4	1 1/4	3 15	28	8 59	25 77	30	1 97	360	320	800	8,700	8 70	26 10	33
1	1 1/4	1 1/4	1 07	28	3 16	9 48	30	6 32	One	cow	fifty	days.	4 24	12 72	3 24
			41		2 53	7 59							2 80	8 40	81
					1 62	4 86							1 67	5 09	14
6 1/2	3	1 1/2	4 63	28	15 90	47 70			360	320	800	8,700	17 41	52 22	4 52
						11 92								13 05	1 13

ROTATION "X."

14 1/2	4	4	9 57		29 98	29 98		1 67				36,000	36 00	36 00	6 02
1 1/2	5 1/4	1	3 28	1 32	13 78	13 78	28		1,650	1,680			19 86	19 86	6 08
3			1 15		11 22	11 22		3 96			5,660		19 81	19 81	8 59
2 1/2			99		10 89	10 89		6 19			3,630		12 70	12 70	1 81
21 1/2	9 1/2	5	14 99	1 32	65 87	65 87			1,650	1,680	9,290	36,000	88 37	88 37	22 50
						16 47								22 09	5 62
						18 06								25 94	7 88

ROTATION "Y."

9 1/2	4	4	7 87		28 93	28 93		1 78				32,480	32 48	32 48	3 55
1 1/2	5 1/4	1	3 28	1 16	14 27	14 27	33		1,457	1,363			17 30	17 30	3 03
3			1 15		11 86	11 86		4 68			5,070		17 75	17 75	5 89
2 1/2			99		11 54	11 54		6 34			3,640		12 74	12 74	1 20
16 1/2	9 1/4	5	13 29	1 16	66 60	66 60			1,457	1,363	8,710	32,480	80 27	80 27	13 67
						16 65								20 07	3 42
						19 46								25 01	5 55

ROTATION "Z."

12 1/2	4	4	8 89		30 96	30 96		1 80				34,418	34 42	34 42	3 46
1 1/2	5 1/4	1	3 28	1 25	15 03	15 03	33		1,565	1,735			19 12	19 12	4 09
3			1 15		12 79	12 79		4 84			5,280		18 48	18 48	5 69
2 1/2			99		12 47	12 47		6 91			3,610		12 63	12 63	16
19 1/2	9 1/4	5	14 31	1 25	71 25	71 25			1,565	1,735	8,830	34,418	84 65	84 65	13 40
						17 81								21 16	3 35
						19 33								26 10	6 77

EXPERIMENTAL STATION FOR PRINCE EDWARD ISLAND, CHARLOTTETOWN, P.E.I.

REPORT OF THE SUPERINTENDENT, J. A. CLARK, B. S. A.

CHARACTER OF SEASON.

The previous winter was severe, with snow on the ground for a very short period. The spring opened early in April with very warm weather. This was followed by a cool, dull May and June. July and August were seasonable. September was fine and the early harvest was well saved. October was extremely wet, with moist, warm weather throughout. Very little harvesting was done during the month, and it was not until the cold, dry winds of November that the late harvest was saved. Seeding was begun on May 13. Hoar frost occurred four times in June, though 35.5° F. was the lowest temperature recorded. The last frost occurred on the 13th, when the lowest temperature at the Station was 37° F. On July 17 haymaking commenced, and on August 21 the first grain was cut.

SOME WEATHER OBSERVATIONS taken at Charlottetown Experimental Station, 1913.

Month.	TEMPERATURE F.			PRECIPITATION.				Total Sunshine. Hours.
	Highest.	Lowest.	Mean.	Rainfall.	Snowfall.	Total.	Heaviest in 24 hours.	
			°	Inches.	Inches.	Inches.	Inches.	
January.....	24.17	50	-3	2.01	15.7	3.58	.33	82.6
February.....	13.46	48	-17.5	.34	21.8	2.52	.55	117.6
March.....	30.80	60	-4	3.21	14.	4.61	.64	131.
April.....	40.06	78 $\frac{3}{4}$	17.5	3.09	7.7	3.86	.78	148.8
May.....	45.07	68 $\frac{3}{4}$	28.5	2.9	1.	3.	1.1	195.6
June.....	56.06	73	33.5	1.27	1.27	.39	255.5
July.....	64.19	83.5	44	4.01	4.01	1.14	222.2
August.....	64.42	79.5	43	2.89	2.89	.79	251.2
September.....	56.13	75	39	3.98	3.98	.91	182.3
October.....	55.05	70	33	7.71	7.71	1.85	66.3
November.....	38.82	61	18	1.65	4.4	2.09	.7	101.6
December.....	27.64	56	7	2.11	16.5	3.76	.76	62.5
Total for year.....				35.17	81.1	43.28		1,817.2
Average for five years.....				33.15	101.	43.01		1,883.1
Total for six growing months, April to September..				18.14	8.7	19.01		1,255.6
Average of five years for six growing months, April to September.....				17.79	7.9	18.58		1,292.3

SESSIONAL PAPER No. 16

CROP YIELDS AND COST OF PRODUCTION OF FIELD CROPS.

The following data are compiled from the rotation experiments which were conducted on fields of 1 acre each. The area of this Station being small, we do not have an opportunity to grow crops on a large scale. The grain was grown for seed purposes. The land was not uniform in quality as explained elsewhere in this report and as the data are for one year only they should be considered as approximate only.

YIELDS AND COSTS OF PRODUCTION of Field Crops, Charlottetown, 1913.

Crop.	Area.	Yield per acre.		Cost to produce.		
				Per acre.	Per ton.	Per bushel.
	Acres.	Tons Lb.	Bush. Lb.	\$ c.	\$ c.	Cents.
Oats	1		61 33	13 97		15
Barley.....	1		38 33	14 63		18
Wheat.....	1		19 38	11 95		39.4
Turnips.....	1	26 545	875 45	41 78	1 59	4.9
Mangels.....	1	26 1,635	893 55	42 35	1 58	4.75

ROTATION OF CROPS.

Six rotations were started in 1912 on the land lying along the east side of the F.E.I. railway, from the DeBlois road south. The land at the outset was very uneven. Buildings, brickyards and a large quantity of brick clay were removed. Cellars and ponds were drained and filled. The feature of these rotations during 1913 was the splendid crops of clover on all the fields of hay, from the aftermath of which seed was taken in the case of "D2," the others being equally good when they were ploughed under. The crops on these rotations were harvested in good condition, and, with the exception of wheat which was injured by the joint-worm and rust, the yields were good.

The following is a description of these rotations, and tables with details regarding the crops grown thereon this year:—

ROTATION "A" (FIVE YEARS' DURATION).

First year.—Hoed crop. Manured 25 tons per acre

Second year.—Oats. Seeded down.

Third year.—Clover hay.

Fourth year.—Timothy hay or pasture.

Fifth year.—Oats.

ROTATION "B" (FIVE YEARS' DURATION).

First year.—Hoed crop. Manured 25 tons per acre.

Second year.—Grain. Seeded down.

Third year.—Clover hay.

Fourth year.—Grain. Seeded down.

Fifth year.—Clover hay.

ROTATION "C" (FOUR YEARS' DURATION).

First year.—Hoed crop. Manured 20 tons per acre.

Second year.—Grain. Seeded down.

Third year.—Clover hay.

Fourth year.—Timothy hay or pasture.

ROTATION "D" (THREE YEARS' DURATION).

First year.—Hoed crop. Manured 15 tons per acre.

Second year.—Grain. Seeded down.

Third year.—Clover hay.

SESSIONAL PAPER No. 16

ROTATION " F " (FOUR YEARS' DURATION).

First year.—Hoed crop. Manured 20 tons per acre.*Second year.*—Grain. Seeded down.*Third year.*—Clover hay.*Fourth year.*—Grain. Seeded down.

ROTATION " G " (SEVEN YEARS' DURATION).

First year.—Grain.*Second year.*—Hoed crop. Manured 30 tons per acre.*Third year.*—Wheat or barley. Seeded down.*Fourth year.*—Clover hay.*Fifth year.*—Timothy hay.*Sixth year.*—Pasture.*Seventh year.*—Pasture.

Fixed values as given on page 96 of this report are being used.

5 GEORGE V., A. 1915

ROTATION "A"

Rotation Year.	Crops.		Area.	ITEMS OF EXPENSE								
				Rent and manure.	Seed, twine and use of machinery.	Manual labour.		Horse labour (including teamster).				
						Hours Manual labour.	Cost of Manual labour.	Hours.				
								Single horse	2-horse team	3-horse team	4-horse team	5-horse team
1912.	1913.	Acres	£ c.	£ c.	No.	£ c.	No.	No.	No.	No.	No.	
2nd...	Turnips and corn.....	Oats.....	1	8 15	1 90	3	51	9.03
3rd...	Oats.....	Hay.....	1	8 15	3 36	10.5	1 78	5.25
4th...	Hay.....	Hay.....	1	8 15	3 36	8.5	1 44	3.75
5th...	Hay.....	Barley.....	1	8 15	1 90	2.75	47	6.6	3.75
1st...	Barley.....	Mangels.....	1	8 15	3 30	101.	17 17	27.25	7	9.75
	Aggregate.....		5	40 75	13 82	125.75	21 37	27.25	31.63	13.50
	Average per acre.....		8 15	2 76	25.15	4 27	5.45	6.32	2.70

ROTATION "B"

2nd...	Corn.....	Wheat.....	1	5 86	1 84	2.75	47	6	2.25
3rd...	Oats.....	Hay.....	1	5 86	5 01	4.50	76	4
4th...	Mixed grain.....	Oats.....	1	5 86	1 81	2.75	47	5.1	.75
5th...	Barley.....	Hay.....	1	5 86	5 01	5.50	94	3.25
1st...	Mixed grain.....	Turnips.....	1	5 86	1 65	123.5	20 99	17.50	18.25	5.75
	Aggregate.....		5	29 30	15 32	139	23 63	17.50	37.6	8.75
	Average per acre.....		5 86	3 06	27.8	4.73	3.5	7.5	1.75

ROTATION "C"

2nd...	Turnips.....	Oats.....	.57	4 96	1 06	1.33	23	.25	1.08	1.25
3rd...	Oats.....	Hay.....	.57	4 96	1 91	2.75	47	.33	1.5
4th...	Mixed grain.....	Hay.....	.57	4 96	1 28	2.05	42	.33	1.25
1st...	Mixed grain.....	Corn and beans	.57	4 96	98	24.	4 08	5.	3.33
	Aggregate.....		2.28	19 84	5 23	30.13	5 20	5.91	7.16	1.25
	Average per acre.....		8 70	2 29	13.2	2 29	2.59	3.14	.55

*Beans.

ROTATION "D"

2nd...	Mangels.....	Wheat.....	1	7 05	1 84	3	51	2.58	3
3rd...	Wheat.....	Hay.....	1	7 05	5 01	7	1 19	4.33
1st...	Mixed grain.....	Potatoes.....	1	7 05	13 10	105½	17 89	15	12.83	1.75
	Aggregate.....		3	21 15	19 95	115½	19 59	15	19.74	4.75
	Average per acre.....		7 05	6 65	38.42	6 53	5	6.58	1.58

SESSIONAL PAPER No. 16

(five years' duration).

IN RAISING CROP.							PARTICULARS OF CROP.						
Value of Horse labour	Cost of threshing.	Total cost.	Cost for 1 acre.	Cost for 1 bushel.	Cost for 1 ton.	Height of Stubble.	Weight.				Total value.	Value of crop per acre.	Profit or loss per acre.
							Grain.	Straw.	Hay.	Hoed Crop.			
\$ c.	\$ c.	\$ c.	\$ c.	c.	\$ c.	Ins.	Lb.	Lb.	Lb.	Lb.	\$ c.	\$ c.	\$ c.
3 07	34	13 97	13 97	15		8	2,107	2,333			25 73	25 73	11 76
1 78		15 07	15 07						5,335		18 67	18 67	3 60
1 27		14 22	14 22						3,405		11 92	11 92	-2 30
3 77	34	14 63	14 63	18		6	1,857	3,873			26 32	26 32	11 69
13 74		42 35	42 35	4 75						53,635	53 63	53 63	11 28
23 63	68	100 24									136 27		
4 72	14		20 05									27 25	7 20

(five years' duration).

2 96	45	11 58	11 58	60			913	1,217			11 56	11 56	- 02
1 36		12 99	12 99						2,390		8 36	8 36	-4 63
2 06	45	10 65	10 65	10 6			1,898	2,357			23 69	23 69	13 04
1 10		12 91	12 91						3,490		12 21	12 21	- 70
13 28		41 78	41 78	4 9						52,545	52 54	52 54	10 76
20 76	90	89 91									108 36		
4 15	18		17 98									21 67	3 69

(four years' duration).

94	45	7 61	13 40	14 1			1,095	1,555			14 06	24 66	11 26
60		7 94	13 93						3,080		10 78	18 91	4 98
52		7 18	12 59						1,680		5 88	10 32	-2 27
2 48		12 50	21 93				*100			2,835	4 08	7 16	-14 77
4 54	45	35 26									34 80		
1 99	20		15 46									15 26	- 20

(three years' duration).

2 10	45	11 95	11 95	39 4			1,178	2,072			15 92	15 92	3 97
1 47		14 72	14 72						4,515		15 80	15 80	1 08
9 12	*1 15	48 31	48 31	21						13,585	113 21	113 21	64 90
12 69	1 60	74 98									144 93		
4 23	53		24 99									48 31	23 32

5 GEORGE V., A. 1915

ROTATION "F"

Rotation Year.	Crops.		ITEMS OF EXPENSE									
			Area.	Rent and manure.	Seed, twine and use of machinery.	Manual labour.		Horse labour (including teamster.)				
						Hours Manual labour.	Cost of Manual labour.	Hours.				5-hour team.
								Single horse	2-horse team	3-horse team	4-horse team	
1912.	1913.	Ac.	\$ c.	\$ c.	No.	\$ c.	No.	No.	No.	No.	No.	
2nd...	Peas.....	Wheat.....	.86	7 84	1 62	2 75	47	2 83	4 75
3rd...	Oats.....	Hay.....	.86	7 84	4 41	4 5	77	3 58
4th...	Mixed grain....	Barley.....	.86	7 84	1 59	2 5	42	11 83	3 25
1st...	Wheat.....	Turnips.....	.86	7 84	1 45	101	17 17	19	14 5	4 75
Aggregate.....			3 44	31 36	9 07	110 75	18 83	19	32 74	12 75
Average per acre.....			9 11	2 64	5 47

ROTATION "G"

2nd...	Oats.....	Corn.....	.4	2 43	64	26 1/4	4 46	4	5
3rd...	Turnips.....	Oats.....	.4	2 43	76	1	17	2 58	1
4th...	Wheat.....	Hay.....	.4	2 43	79	3	51	1 75
5th...	Mixed grain....	Hay.....	.4	2 43	79	3	51	1 75
6th...	Mixed grain....	Hay.....	.4	2 43	79	3	51	1 75
7th...	Mixed grain....	Hay.....	.4	2 43	79	3	51	1 75
1st...	Mixed grain....	Oats.....	.4	2 43	73	1 75	29	5 83	2 08
Aggregate.....			2 8	17 01	5 29	41	6 96	4	20 41	3 08
Average per acre.....			6 07	1 89	14	2 48	1 4	7 29	1 10

SESSIONAL PAPER No. 16

(four years' duration).

IN RAISING CROP.							PARTICULARS OF CROP.						
Value of Horse labour.	Cost of threshing.	Total cost.	Cost for 1 acre.	Cost for 1 bushel.	Cost for 1 ton.	Height of Stubble.	Weight.				Total value.	Value of crop per acre.	Profit or loss per acre.
							Grain.	Straw.	Hay.	Hoed Crop.			
\$ c.	\$ c.	\$ c.	\$ c.	\$ c.	\$ c.	Ins.	Lb.	Lb.	Lb.	Lb.	\$ c.	\$ c.	\$ c.
2 91	45	13 29	15 45	59	980	1,840	13 48	15 67	22
1 22	14 24	16 56	40	1,270	4 45	6 17	-10 39
5 35	45	15 65	18 19	1,339	2,301	17 99	29 92	2 73
12 01	38 47	44 73	4 7	48,505	48 50	56 39	11 66
21 49	90	81 65	84 42
6 25	26	23 73	24 78	1 06

(seven years' duration).

2 78	10 31	25 77	4,830	4 83	12 07	13 70
1 28	17	4 81	12 02	9 4	867	1,203	11 08	27 70	15 63
59	4 32	10 80	2,131	7 45	18 62	7 82
59	4 32	10 80	1,613	5 65	14 12	3 32
59	4 32	10 80	1,633	5 72	14 30	3 50
59	4 32	10 80	1,693	5 93	14 82	4 20
2 83	17	6 45	16 12	34	487	840	6 55	16 37	52
9 25	34	38 85	47 21
3 30	12	13 87	16 86	2 99

5 GEORGE V., A. 1915

BARNYARD MANURE—PLOUGHING DOWN *versus* TOP DRESSING FOR BARLEY.

One plot in rotation "F," with an area of .86 of an acre, had not received manure, so far as we could learn, for fifteen years. In the spring of 1913, 3 tons 1,800 pounds of barnyard manure were applied to the north half of the plot. The whole plot was then ploughed and worked similarly and seeded to Hannchen barley. After the grain came up, the south half received a top dressing of 3 tons 1,800 pounds of barnyard manure. During the summer the top-dressed portion of the field was at least one week behind the other, and at harvest it yielded 3 bushels 13 pounds less barley and 43 pounds less straw than the ploughed-under half. The difference in yield of barley per acre in favour of the manure being ploughed down was 7 bushels 29 pounds.

COUCH (TWITCH OR QUACK) GRASS.

A hay field that was badly infested with couch grass was ploughed August, 1912, and was rolled and cutaway-disc harrowed the following day. It was given a double cut with the disc harrow on August 14, 22, and 29, and on September 10, 12, and 27. It was worked deep and the couch cut in short pieces and buried. In the spring of 1913 the field was as green as ever with couch. It was then decided to resort to our old method of destroying this troublesome weed. The teeth of the spring-tooth harrow were set deep and the field was gone over twice on May 12, the smoothing harrow being used afterwards to shake out the roots. On May 14 the field was raked and several tons of couch roots per acre were removed. It was then ploughed 6 inches deep, spring-tooth harrowed twice, rolled and seeded. The smoothing harrow was used again to shake out the couch roots that the other harrow had brought to the surface, and though the harrow was lifted continually the couch gathered into bunches so that it had to be spread by hand. When the couch on the surface was thoroughly dried out, the field was given a light top-dressing of manure. The couch which had been hauled off and completely killed was placed on top of the spreader loads and put back on the field. The field gave an average yield of 80 bushels of oats per acre, and appeared to be completely free of couch.

SOIL CULTURAL EXPERIMENTS.

Ten acres of the land next to the Abegweit Athletic Association grounds, and lying between the Prince Edward Island railway on the east and the Malpeque road on the west have been set aside for a comprehensive set of experiments in soil cultivation and renovation.

In Prince Edward Island some of the problems in respect to which the farmers are looking to the Experimental Stations for solution or for further information are:—

1. The improvement of neglected lands. These lands fall into two classes. (a) Whole farms that have been robbed of their fertility by excessive cropping with oats and timothy until natural grasses and weeds have possession. (b) The back fields on the majority of homesteads, which need improved rotations, better cultivation and more fertilizing.

2. The conservation and increase of soil fertility.

3. The control and eradication of weeds.

4. The conservation of soil moisture.

Some of the lines of experiment that are to be put under way are:—

Neglected land treatment.

Depth of ploughing.

After-harvest treatment of sod land in preparation for grain.

CHARLOTTETOWN.

SESSIONAL PAPER No. 16

After-harvest treatment of sod land in preparation for hoed crop.
Depth of seeding.
Seed bed preparation.
Applying barnyard manure.
Rates of seeding nurse crop of barley
Rates of seeding nurse crop of oats.
Rates of seeding clover and timothy.
Underdraining.

DRAINAGE.

Thirty thousand feet of drain tile were purchased for the new areas and most of the area acquired from the Connolly Estate was tile drained. Forty acres of land in all were acquired by the Station in 1913 and two-thirds of it will be drained as soon as the tile can be laid. The land drained previously gave excellent results in 1913.

IMPROVEMENTS.

All the land newly acquired was fenced with a strong woven fence, and the posts painted. Dikes and rows of trees were levelled and removed. The fields were surveyed and roads opened.

EXPERIMENTAL FARM FOR NOVA SCOTIA, NAPPAN, N.S.

REPORT OF THE SUPERINTENDENT, W. W. BAIRD, B.S.A.

CHARACTER OF THE SEASON, 1913.

During the winter 1912-13 the snowfall was scanty, and no severe frost was registered during the latter part of the season. No snow fell after March 15, but 2 inches of rainfall, on March 27, caused considerable damage by washing the fields. Seeding commenced on May 6, but was retarded and germination was checked by the cold weather which prevailed throughout the month. In fact, growth was slow until July, when vegetation made remarkable progress. Due to the frequent rain throughout the growing season, the ripening of the harvest was slow. The early-sown grain was harvested in late August or early September but late-sown grain was not ripe until October, when the heavy rain damaged it to such an extent as to make it useless for seed and barely fit for feed.

SOME WEATHER OBSERVATIONS taken at Nappan Experimental Farm, 1913.

Month.	TEMPERATURE F.			PRECIPITATION.			Total Sunshine.
	Mean.	Highest.	Lowest.	Rainfall.	Snowfall.	Total.	
	°	°	°	Inches.	Inches.	Inches.	Hours.
January.....	23.96	52	- 4	2.42	5.0	2.92	86.75
February.....	13.31	51	-15	.45	17.0	2.15	112.15
March.....	32.52	62	- 1	2.04	41.2	6.16	140.00
April.....	40.03	71	14	3.01	4.5	3.46	132.70
May.....	47.75	67	26	2.38	2.38	169.15
June.....	54.56	74	31	1.97	1.97	265.90
July.....	62.33	82	41	4.98	4.98	226.05
August.....	61.00	80	33	3.76	3.76	238.10
September.....	54.59	78	31	2.70	2.70	165.95
October.....	55.28	72	28	7.83	7.85	71.30
November.....	38.09	65	10	1.63	4.0	2.03	115.45
December.....	27.50	55	0	2.65	16.0	4.25	80.20
Total for year.....				35.82	87.7	44.59	1803.70
Average for five years.....				32.17	62.94	38.47	1925.50
Total for six growing months, April to September.....				18.80	4.5	19.25	1197.85
Average of five years, for six growing months, April to Sept.				17.63	3.3	18.16	1228.21

SESSIONAL PAPER No. 16

FIELD CROP YIELDS.

The yields of crops grown in field lots and under regular field conditions averaged as follows in 1913:

FIELD CROP YIELDS, Nappan, 1913.

Area.		Crop.	Yield per acre.			
Acres.	Tons.		Lb.	Bush.	Lb.	
1	Mangels.....	19	685	644	45
10	Turnips.....	23	23	767	3
5	Corn.....	12	1,380
40	Marshland hay.....	1	1,856
24	Upland hay.....	2	856
2	Wheat.....	29	30
3	Upland oats.....	59	24
9	Marshland oats.....	20	—
2	Barley.....	33	44
4	Potatoes.....	376	—

YIELDS OF MANGELS.

Three varieties of mangels, considered the most suitable for this district, were grown in one-third acre plots on a clay loam soil.

YIELDS OF FIELD LOTS of Mangels, Nappan, 1913.

Area.		Name of variety.	Yield per acre.			
Acres.	Tons.		Lb.	Bush.	Lb.	
1/3	Mammoth Long Red	18	120	602
1/3	Yellow Intermediate	20	140	669
1/3	Yellow Globe.....	19	1,795	663	15

COST OF PRODUCTION OF FIELD CROPS.

In calculating net profits from the rotations, some interesting figures have been obtained regarding the cost of producing the various crops grown. In explanation of the rather high cost in some cases it may be explained that in 1913 some of the fields did not yield quite up to the average production for previous years. Corn and turnips were the chief sufferers. The values used in computing these costs are given on page 96 of this report.

COST OF PRODUCTION of Field Crops, Nappan, 1913.

Crop.	Yield per acre.		Cost to produce.		
			Per acre.	Per ton.	Per bushel.
	Tons. Lb.	Bush. Lb.	\$ cts.	\$ cts.	cts.
Turnips.....	23 23	767 03	45 57	1 98	5.94
Mangels.....	19 685	644 45	49 51	2 56	7.68
Ensilage corn.....	12 1,380	39 33	3 10
Potatoes.....	376 00	49 36	13.13
Oats.....	59 24	17 25	28.9
Wheat.....	29 30	14 42	48.9
Barley.....	33 44	13 83	40.8

ROTATION OF CROPS.

There is perhaps no single practice in farm management of more importance than a systematic rotation of crops. It will help to maintain fertility, conserve soil moisture and control weeds and yet withal it is a feature of farm work to which, as a rule very little consideration is given.

So many different combinations of crops are possible, that a test of all that suggested themselves to us was quite impracticable. The following three, chosen because of the good results they have given in other sections of the country are now in operation.

ROTATION "B" (FIVE YEARS' DURATION).

First year.—Roots. Manured at rate of 25 tons per acre.

Second year.—Grain. Seeded down with 10 pounds red cover, 2 pounds alsike and 6 pounds timothy per acre.

Third year.—Clover hay. Ploughed in autumn.

Fourth year.—Grain. Seeded down with 10 pounds red clover, 2 pounds alsike and 6 pounds timothy per acre.

Fifth year.—Clover hay.

ROTATION "C" (FOUR YEARS' DURATION).

First year.—Roots. Manured at rate of 20 tons per acre.

Second year.—Grain. Seeded down with 10 pounds red clover, 2 pounds alsike and 12 pounds timothy per acre.

Third year.—Clover hay.

Fourth year.—Pasture.

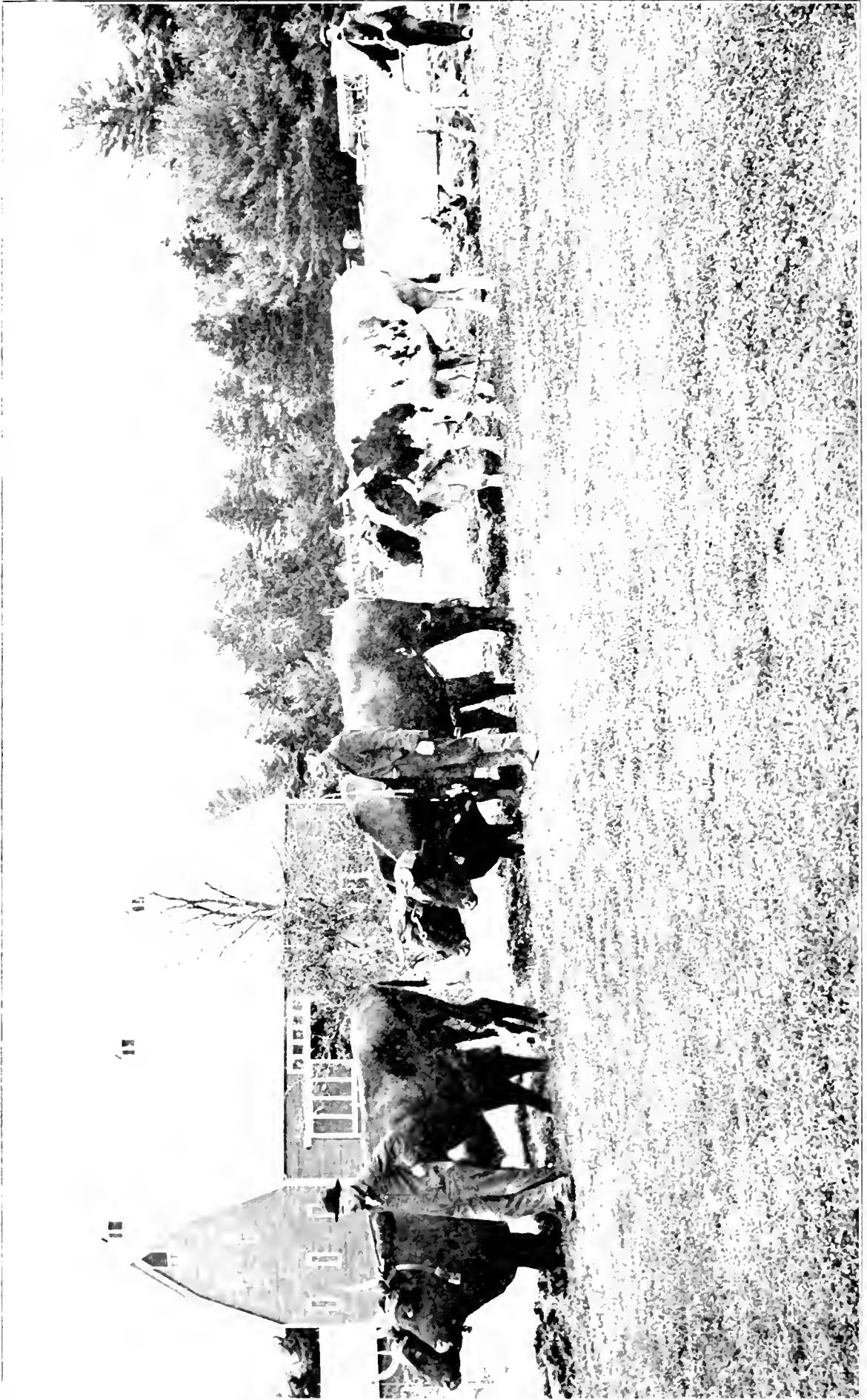

Kentville, N. S. — Breaking-up teams and Manitoba Brush Breaking Plough.

SESSIONAL PAPER No. 16

ROTATION "D" (THREE YEARS' DURATION).

First year.—Roots. Manured at the rate of 15 tons per acre.

Second year.—Grain. Seeded down with 10 pounds red clover, 2 pounds alsike and 6 pounds timothy per acre.

Third year.—Clover hay.

CROP HISTORY OF ROTATION LOTS.

Rotation "B" lot 1.—1905, no crop; 1906 and 1907 crop turned under; 1908 mixed grain, seeded down; 1909, hay; 1910, mixed grain, seeded down; 1911, roots, fertilized with 25 tons barnyard manure per acre, and 300 pounds mixed fertilizer per acre additional to every other half-acre plot; 1912, grain, seeded down. The soil is a whitish clay loam in fair heart. Is located on a steep slope. Surface drainage is good and lot is underdrained as well.

Rotation "B" lot 2.—1904, roots; 1905, grain, seeded down; 1906, clover hay; 1907, grain, seeded down; 1908, clover hay; 1909, roots; 1910, grain, seeded down; 1911, clover hay; 1912 roots. Lot has fair surface drainage and is partly underdrained. Soil is clay loam in fair heart.

Rotation "B" Lot 3.—Since 1905 lot 3 has received treatment similar to lot 2. No underdrainage has been done. Soil is clay loam, naturally wet and is not now in as good tilth as lot 2.

Rotation "B" Lot 4.—1908, pasture; 1909, no crop; 1910, one-half in pasture one-half in grain crop ploughed under, 400 pounds per acre of mixed fertilizer applied to every other half-acre plot; 1911 and 1912, green crop ploughed under; 1913, green crop of oats, peas and vetch turned under, 400 pounds per acre of mixed fertilizer applied to every other half-acre plot. The lot is in poor condition. Surface drainage is good, but it is naturally wet land. Soil is whitish clay loam.

Rotation "B" Lot 5.—1905 and 1906 pastured by sheep; 1907 and 1908, no crop; 1909, one-half in rape, one-half in buckwheat pastured very light; 1910, no crop; 1911, one-half of lot received 400 pounds mixed fertilizer per acre for green crop turned under, the remaining half was idle; 1912 the remaining half received 400 pounds mixed fertilizer per acre and green crop was ploughed under on entire lot; 1913, peas, oats, and vetch turned under. Soil varies from clay loam to sandy loam and is in poor heart. No underdrainage has been done and surface drainage is only fair.

Rotation "C" Lot 1.—1905, roots; 1906, grain, seeded down; 1907, clover hay; 1908, roots and corn; 1909, grain, seeded down; 1910, clover hay; 1911, pastured; 1912, roots; 1913, grain, seeded down. The soil is a clay loam underdrained and in good tilth, but infested with couch grass.

Rotation "C" Lot 2.—1907, grain, seeded down; 1908, clover hay; 1909, roots; 1910, grain, seeded down; 1911, clover hay; 1912, pastured; 1913, roots. Soil is clay loam underdrained and in good tilth.

Rotation "C" Lot 3.—1908, clover hay; 1909, grain; 1910, roots; 1911, grain, seeded down; 1912, clover hay; 1913, pasture. Soil is clay loam, underdrained and in good tilth.

Rotation "C" Lot 4.—1906, grain, seeded down; 1907, clover hay; 1908, roots; 1909, grain, seeded down; 1910, clover hay; 1911, roots; 1912, grain, seeded down; 1913, clover hay. Soil is whitish clay loam, underdrained and in good tilth.

NAPPAN.

5 GEORGE V., A. 1915

Rotation "D" Lot 1, located immediately west of wood orchard.—1907, clover hay; 1908, grain, seeded down; 1909, clover hay; 1910, grain; 1911, roots; 1912, grain, seeded down; 1913, clover hay. Soil is a sandy clay loam, underdrained and in fair tilth.

Rotation "D" Lot 2, located across railroad and next to marsh land.—1906, roots and grain; 1907, grain; 1908 and 1909, hay; 1910, buckwheat; 1911, green crop turned under; 1912, roots; 1913, grain, seeded down. Soil is clay loam, well surface drained. Is very badly infested with couch grass.

Rotation "D" Lot 3.—1907, hay; 1908, roots; 1909, grain, seeded down; 1910, clover hay; 1911, grain, seeded down; 1912, clover hay; 1913, roots and corn. Soil is variable, part being a clay loam and part black muck. Is in fairly good tilth, but is infested with couch grass.

COMMERCIAL FERTILIZERS FOR TURNIPS.

Seven different varieties of turnips were sown in lots of 1 acre each. One-half acre of each variety was fertilized with barnyard manure alone applied at the rate of 20 tons per acre. The other half acre of each variety received barnyard manure at the rate of 20 tons per acre, and in addition 400 pounds per acre of a commercial fertilizer mixed in the following proportion: Superphosphate, $1\frac{1}{2}$ pounds; bone meal, $1\frac{1}{2}$ pounds; nitrate of soda, 1 pound; muriate of potash, 1 pound.

YIELDS OF TURNIPS with Manure alone and with Commercial Fertilizer in Addition to Manure.

Area.	Variety.	Yield per acre with manure and comm'l fertilizers.	Yield per acre with manure alone.	Difference in yield in favour of addition of comm'l fertilizer.	Value of difference at 6c. per bushel.	Cost of fertilizer at \$38.80 per ton.	Gain or loss from application of fertilizer in addition to regular quantity of manure.
Aeres.		Bush. Lb.	Bush. Lb.	Bush. Lb.	¢ cts.	\$ cts.	\$ cts.
1 2 3 4 5 6 7	Elephant.....	873 15	733 10	140 05	8 41	7 76	65
	Jumbo.....	861 30	797 45	63 45	3 83	7 76	-3 93
	Rennie's Prize.....	887 30	863 00	24 30	1 47	7 76	-6 29
	Canadian Gem.....	760 30	725 30	35 00	2 10	7 76	-5 66
	Magnum Bonum.....	1021 45	854 30	167 15	10 04	7 76	2 28
	Sutton's Champion.....	342 30	307 15	35 15	2 12	7 76	-5 64
	Jumbo.....	820 30	739 45	80 45	4 85	7 76	-2 91
Best of All.....	889 30	831 00	58 30	3 51	7 76	-4 25	

Of the seven tests made, two only gave profits to compensate for the cost of the fertilizer. As these results accord closely with those obtained in previous years, it seems evident that turnips on our soil are not benefited to any extent by the use of the above commercial fertilizer in addition to the regular application of barnyard manure.

EXPERIMENTAL STATION FOR ANNAPOLIS AND CORN- WALLIS VALLEYS, KENTVILLE, N.S.

REPORT OF THE SUPERINTENDENT W. SAXBY BLAIR.

WEATHER CONDITIONS, 1913.

The early part of April was warm, the latter part cool. Land was fit for work on April 23. May was dull, with frequent light showers. Seeding and planting were done in good season. June was cool and unusually dry, and crops suffered from the drought. July continued cool with frequent showers. August was dry and crops were again checked for want of rain. September weather was favourable. October was wet, with a total rainfall of 9.60 inches, this being about 20 per cent more than the average. The temperature was unusually high, the average being 56.5°, which is 9° above the average for the twelve years previous. This condition was particularly favourable to roots, and as no frosts occurred on the corn area until October, this crop made good growth until cut, September 24 to 27.

Weather records have been taken since the month of April only, some of which are herewith reported.

SOME WEATHER OBSERVATIONS taken at Kentville Experimental Station, 1913.

Month.	TEMPERATURE F.			PRECIPITATION.				Total Sunshine.
	Mean.	Highest.	Lowest.	Rainfall.	Snow fall.	Total.	Heaviest in 24 hours.	
	°	°	°	Inches.	Inches.	Inches.	Inches.	Hours.
April.....	41.9	77	19	4.29	4.29	.70	137.1
May.....	46.2	70	27	3.17	3.17	.84	178.2
June.....	56.7	78	33	1.23	1.23	.51	270.1
July.....	65.4	87	44	3.72	3.72	.88	252.1
August.....	63.3	86	36	1.70	1.70	.55	258.4
September.....	51.3	81	35	2.55	2.55	.85	156.6
October.....	56.5	74	31	9.60	9.60	1.98	57.8
November.....	38.4	65	21	1.97	1.97	.63	141.5
December.....	23.44	55	6	3.02	13.75	4.39	1.44	74.65
Total for six growing months April to September..				16.66	1232.5

FIELD CROPS.

The field areas cultivated this season were principally those in orchards, the strips between the trees being devoted to various field crops. Some of the areas had been stumped the previous season and consequently were very uneven and difficult to work. Much time was necessarily spent during the spring months clearing these fields of stones and roots, and as a result the seeding of the crops was slightly delayed.

HAY.

Ten acres of dyked land were in hay. This produced about 18 tons of hay of fair quality.

CORN.

Ten acres of corn were planted. Part of it was seeded on May 26 on land fertilized with barnyard manure at the rate of 30 tons per acre. The manure was put into piles on the field during the winter and spread and ploughed under on May 13 to 15. A crop of buckwheat to be ploughed under had been grown the summer before, immediately following the removal of the stumps.

Three varieties of corn were sown in rows 3½ feet apart. The following yields were obtained:—

Longfellow,	11 tons	150 pounds per acre.
Compton's Early,	10 "	1,440 "
Canada Yellow,	8 "	1,440 "

Two acres of Longfellow, sown June 4, without stable manure, but fertilized with 400 pounds per acre of a complete fertilizer containing 4 per cent nitrogen, 8 per cent phosphoric acid, and 10 per cent potash, yielded only 4 tons 100 pounds per acre.

TURNIPS.

One and three-quarter acres of swede turnips were sown on May 19, the variety Lapland being used. The ground had been manured in the fall of 1912 with 20 tons of stable manure per acre. A crop of buckwheat had been ploughed in during the summer of 1912. This land was worked up and fertilized with 400 pounds per acre of a complete fertilizer. The turnips were sown in drills with a horse turnip seeder. The crop was harvested November 6 to 8, and yielded 628 bushels per acre.

Two acres of turnips were sown on land which had been stumped the previous summer and which had never before grown a crop. No stable manure was used, but a commercial fertilizer, containing 4 per cent nitrogen, 8 per cent phosphoric acid, and 10 per cent potash was applied at the rate of 800 pounds per acre. This was sown broadcast just before the ground was drilled for seeding. The variety Lapland was used. The yield was 565 bushels per acre.

OATS.

Ten acres of field oats, sown on newly-broken land, and fertilized with 200 pounds per acre of fertilizer containing 4 per cent nitrogen, 8 per cent phosphoric acid, and 10 per cent potash, yielded an average of 38.6 bushels per acre.

CLEARING LAND.

Seventeen acres of new land were cleared of stumps and ploughed during the season. Ten acres of the more easily cleared area cost as follows:—

Dynamite, 780 pounds (78 pounds per acre)	\$140 40
Fuse and caps	18 60
Pulling out stumps	932 00
Dynamiting	143 00
Cleaning roots, piling and burning	213 50
Clearing up roots (second time over) and burning	183 00
Moving stones	172 00
Harrowing	35 00
Ploughing	350 00
Total cost for ten acres	\$2,187 50
Cost per acre	218 75

KENTVILLE.

SESSIONAL PAPER No. 16

The remaining seven acres were much more difficult and cost \$282.40 per acre.

Thirteen acres were brushed ready for stumping during the summer, at a cost of \$21.15 per acre.

FENCING.

Eleven thousand three hundred and twenty feet of wire fences were erected on the east, north and west boundaries of the Station. Part of this was built through woods, which made the work very difficult. Owing to the great number of roots, and to the presence of sandstone and slate rock near the surface, holes for the posts had to be blasted in many cases. Cedar posts were used, and were set at a distance of 1 rod apart.

DYKING.

The dykes on the marsh area were badly out of repair, and in order to reclaim certain areas lying outside the old dykes, it was decided to construct new ones around the entire marsh. Eighty-five rods of dyke, 3½ feet high and with a 7-foot base, cost \$2.50 per rod. Sixty-eight rods of dyke 4 feet high and with an 8-foot base cost \$3 per rod. Five sluices were necessary to afford proper drainage. These were constructed of plank with a 5-inch by 7-inch opening, a metal sluice-gate being placed in each. The sluice-gates were of brass composition to prevent rusting from contact with salt water, and as a safe-guard against gnawing out by muskrats.

ROADS.

Work was commenced in the laying of a road through the ravine. The road leading to the ravine from the south end was graded and made passable. The sides of the ravine are very abrupt with sandstone near the surface which made it necessary to do considerable blasting. The field stones were used to form a foundation for the road where necessary.

EXPERIMENTAL STATION FOR NEW BRUNSWICK, FREDERICTON, N. B.

REPORT OF THE SUPERINTENDENT, W. W. HUBBARD.

WEATHER CONDITIONS, 1913.

The winter of 1913 was much milder, with a lighter snowfall than is usual. The spring was comparatively cold and wet. Frosts were frequent in May and as late as June 23 a heavy frost was observed on the low-lying portion of the Station. The land here is naturally damp, which defers seeding, even in a dry season. This condition, coupled with the unseasonable weather this year, further retarded field operations. Even sod ploughing for grain could not be accomplished until June 1. The rains continued until July 15, after which the summer was dry with sufficient precipitation to stimulate rapid crop growth. The first frost was recorded on September 16; a second heavier one, on September 28, affected both corn and potatoes. During October there were 5.9 inches rainfall, which fell so continuously as to interfere seriously with harvesting operations. The grain and potato crops, as a result, were greatly damaged in the southern part of the province. On October 21 the next frost was noticed, and on October 31 there were 4 degrees of frost. During the month there were only three days of sunshine. November 1 and 2 registered 10 degrees and 17 degrees of frost respectively; the remainder of the month, however, was mild and bright, the rainfall amounting to only 1.2 inches.

SOME WEATHER OBSERVATIONS taken at Experimental Station, Fredericton, 1913.

Month.	TEMPERATURE F.			Total Precipita- tion.	Total Sunshine.
	Mean.	Highest.	Lowest.		
	°	°	°	Inches.	Hours.
January.....	22	51	-11	4.1	81
February.....	12	38	-20	2.9	123
March.....	30	60	-9	6.	124
April.....	42	83	15	2.2	160
May.....	47	83	27	4.	181
June.....	58	83	34	1.9	257
July.....	64	91	47	5.1	213
August.....	63	87	36	2.4	244
September.....	55	85	29	1.3	192
October.....	53	76	26	5.9	57
November.....	36	62	4	1.2	107
December.....	24	47	-13	1.2	112
Total for year.....				33.2	1,851
Total for six growing months, April to September.....				16.9	1,247

SESSIONAL PAPER No. 16

FIELD CROPS.

As little autumn preparation could be made the area under spring crops was limited. Thirteen acres of sod were ploughed for corn and one and one-seventh acres were ploughed for potatoes. One and one-sixth acres of buckwheat stubble were cultivated in preparation for garden vegetables.

OATS.

As the season was wet, all the oats sown were late. The first seeding was done on June 1. One and one-quarter acres of oats, grown on tile drained soil, gave a yield of 48 bushels of grain per acre. Seven acres of oats grown on rather wet land gave a yield of less than 22 bushels per acre. The advantages of underdrainage are clearly illustrated by both the increased yield and superior quality of the oats grown on the drained soil.

ENSILAGE CORN.

Twelve and one-half acres of tough couch sod were autumn ploughed and spring worked with disc harrow. Eighteen 35-bushel loads of horse manure were applied per acre and harrowed in. On June 5 and 6 four varieties of corn—Longfellow, Compton's Early, Leaming, White Cap Yellow Dent—were planted with a 2-row corn planter, provided with a fertilizer attachment, from which was distributed 468 pounds mixed fertilizer per acre. The fertilizer was made up as follows: 78 pounds nitrate of soda, 26 pounds sulphate of ammonia, 312 pounds acid phosphate, 52 pounds muriate of potash, and containing 3.6 per cent nitrogen, 10 per cent phosphoric acid, and 5.5 per cent potash.

The plants appeared above the ground on June 21 and were given thorough cultivation throughout the growing season. The crop was harvested on September 25, giving a yield of 115 tons for the 12½ acres. The resulting silage was of excellent quality.

TURNIPS.

Five acres that had produced a crop of oats the previous year, were prepared for turnips. The soil was sandy loam with clay subsoil. There were many stumps, large boulders and surface stones in all 500 loads of stone being removed. The stumps and larger boulders were blown up with dynamite.

Twenty loads of horse manure were applied and worked in with the disc, and in addition 400 pounds of basic slag and a mixed fertilizer made up of the following were applied: 70 pounds nitrate of soda, 70 pounds sulphate of ammonia, 100 pounds acid phosphate, 100 pounds bone meal, 120 pounds muriate of potash per acre.

The time required for clearing and preparing the land delayed the seeding until July 4 and 5. The seed was sown at the rate of 2 pounds per acre with a hand wheel seeder. The stand was rather thin, and, due to the dry weather, made slow growth. The crop was harvested on November 3, 4 and 5.

The following table records the varieties grown, their characteristics and yields:—

YIELDS OF TURNIPS, Fredericton, 1913.

Variety.	Description.	Yield per acre.	
		Tons.	Lb.
Invieta.....	Purple top swede, smooth and even.....	15	1,500
Lapland.....	Green " " pronged and uneven.....	14	35
Good Luck.....	Purple " " smooth, fairly even.....	19	400
Halewoods Bronze top.....	Bronze " " smooth and even.....	16	175
Hall's Westbury.....	Purple " " small, smooth, even, and very shapely.....	14	800
Hartley's Bronze top.....	Bronze " " fairly smooth and even.....	18	1,350
Jumbo.....	Purple " " rather rough.....	17	80
Perfection.....	" " " large, even, fairly smooth.....	26	800
Bangholm.....	" " " fairly smooth and even.....	21	
Hazards Improved.....	Purple " " smooth and even.....	20	800
New Century.....	" " " large, fairly smooth, uneven....	27	360

Average yield per acre: 670 bushels or 20 tons 200 pounds.

FENCING.

The fencing used is of number nine galvanized woven wire throughout, 48 inches high, nine strands, with uprights every 16½ inches. The wire is stapled to cedar posts placed one rod apart and from 3 to 4 feet in the ground. Both side lines and part of the road fences have been built, while posts have been set along some of the field fence lines, in readiness for the wire.

CLEARING LAND.

The first clearing operation was the burning of the brush and bushes left after the cut of the winter. In all, 150 acres were cleared and burned over. The larger stones were used in building a driveway over a ravine which crosses the land being cleared. Dynamite was used to break up the boulders into pieces that could be moved by a two-horse team. A powerful stumping machine was tried on green stumps, but this method of operation was found more expensive than the use of stumping powder and the removal of the shattered portions with a direct horse hitch. The stumps of the softer trees were readily removed by means of direct team hitch. About fifty acres were cleared in this way, and will be ready for crop in 1914.

EXPERIMENTAL STATION FOR EASTERN QUEBEC,
STE. ANNE DE LA POCATIERE, QUEBEC.

REPORT OF THE SUPERINTENDENT, JOSEPH BEGIN.

WEATHER CONDITIONS, 1913.

The spring of 1913 opened favourably, and seeding was commenced in good time. Weather did not continue warm, however, through May and June, and all crops made slow growth. Corn, especially, suffered from the changeable temperature. July was cool and windy, with more rainfall than in June. Clovers had been badly winter killed, owing to the presence of ice on many of the fields, and hay yielded poorly. The early sown grain was harvested in September in good condition, but the late sown was not ripe till October, and had to be gathered under very unfavourable weather conditions.

SOME WEATHER OBSERVATIONS taken at Ste. Anne de la Pocatière Experimental Station, 1913.

Month.	TEMPERATURE F.			PRECIPITATION.			Total Sunshine.
	Mean.	Highest.	Lowest.	Rainfall.	Snowfall.	Total.	
	°	°	°	Inches.	Inches.	Inches.	Hours.
January.....	15.65	35	-25	2.05	20.	4.05	73.3
February.....		12			24.	2.4	95.4
March.....	23.33	61	-4	1.47	30.	4.47	107.5
April.....	39.4	82.2	8.6	.12	6	.72	209.6
May.....	49.2	87.8	22.	2.69		2.69	187.7
June.....	57.9	82.2	33.8	1.53		1.53	241.5
July.....	63.4	83.2	44.	3.64		3.64	226.8
August.....	62.4	81.2	39.2	1.34		1.34	216.8
September.....	54.3	81.8	33.2	2.81		2.81	199.8
October.....	47.5	75.4	24.2	3.42		3.42	80.2
November.....	36.5	63.2	3.8	.77		.77	89.9
December.....	17.2	32.2	-20.	.13	10	1.13	66.8
Total for year.....						28.97	1,816.3
Total for six growing months, April to September.....						12.73	1,303.2

CROP YIELDS.

There were no facilities this year for weighing the total crops as they came from the fields, but careful estimates were made in all cases, which we publish in order better to convey to our readers the degree of success attending our efforts to increase crop production by improved rotations and cultural methods.

CROP YIELDS (Approximate), Ste. Anne de la Pocatière, 1913.

Crop.	Area.	Yield per acre.			
	Acres.	Tons.	Lb.	Bush.	Lb.
Turnips, Magam Bonum variety.....	1.33	23	1175	786	15
Corn, Longfellow variety.....	8.00	4
Oats and peas, cut for hay.....	1.33	2	1000
Oats, for grain.....	20.3	31	17

ROTATION OF CROPS.

Believing that much benefit would result if our farmers would adopt rotations that would eliminate the long continued growth of any one crop on the same land, it was decided to inaugurate a series of rotations, so that, by comparison the benefits of a well-arranged succession of crops could be shown. As yet three rotations only have been laid down, but more will be added as soon as land for the purpose is available. The three already under way are:—

ROTATION "A" (FIVE YEARS' DURATION).

First year.—Hoed crop of corn or roots. For corn, manure applied at rate of 25 tons per acre in spring and ploughed under. After crop is harvested land is shallow ploughed or cultivated.

Second year.—Grain. Seeded down with 10 pounds red clover, 2 pounds alsike and 12 pounds timothy per acre.

Third year.—Clover hay. Cut twice if possible.

Fourth year.—Timothy hay or pasture. Ploughed shallow in August, top worked and re-ploughed or ridged up in late autumn.

Fifth year.—Grain. Seeded down with 10 pounds red clover which is allowed to grow to be turned under following spring, when the hoed crop is corn.

ROTATION "C" (FOUR YEARS' DURATION).

First year.—Hoed crop of corn or roots.

Second year.—Grain. Seeded down with 10 pounds red clover, 2 pounds alsike and 12 pounds timothy per acre.

Third year.—Clover hay. Cut twice if possible.

Fourth year.—Timothy hay. Field ploughed shallow in August, top-worked and re-ploughed or ridged up in late autumn.

ROTATION "D" (THREE YEARS' DURATION).

First year.—Hoed crop of corn or roots. For corn, land is manured, 15 tons per acre, and ploughed in spring; for roots it is manured and ploughed in fall.

Second year.—Grain. Seeded down with 10 pounds red clover, 2 pounds alsike 6 pounds alfalfa and 6 pounds timothy per acre.

Third year.—Clover hay. Cut twice if possible.

SESSIONAL PAPER No. 16

DRAINAGE.

After the removal of the old fences, and the ploughing up of the old, unproductive sod land, underdrainage was the first improvement work that claimed our attention; 9,410 feet of tile were laid during the season on land intended to be planted to orchard and a beginning was made in the draining of the land to be used for general crop production.

In order to demonstrate to just what extent underdrainage is profitable, two four-year rotations were laid down, one of which will be thoroughly underdrained, while the other will be left undrained. Records of the cost per acre to operate, and the value of the products from each rotation will be kept, so that at some future time we shall be able to publish reliable data as to the length of time required for the drains to pay for the cost of their installation.

EXPERIMENTAL STATION FOR CENTRAL QUEBEC, CAP ROUGE, QUEBEC.

REPORT OF THE SUPERINTENDENT GUS. A. LANGELIER.

CHARACTER OF SEASON AND CROP NOTES, 1913.

For the farmer in the districts about Quebec, 1913 was a very good year. The spring was very early, grain seeding commencing at this Station on April 29. Haying began on July 9, but not until a couple of weeks later was the bulk of clover and timothy cut. Manchurian barley was the first field grain harvested, it being cut on August 6, and by the 30th of the same month practically all grain was in the stook. The first snowfall recorded was on November 26, when about 2 inches fell. Freezing up took place the following day.

As affecting the hay crop.—The mild winter of 1912-13 left bare many meadows and pastures, which were injured by frost. On the undrained, low areas, practically all the clover was killed and some of the grasses suffered. The crop of hay, however, with the splendid growing weather of June and early July, was a fair one in the district and averaged over two tons per acre at this Station.

As affecting the grain crop.—The spring of 1913 was one of the earliest in many years, some grain being sown the latter part of April. The thermometer went down to 25.2° F on May 15, and to 27.2° F on May 17, and no doubt this early-sown grain, which was only a few inches high at the time, was affected by these frosts. All grain sown from the 7th to the 15th of May made a splendid growth, there being just enough precipitation and heat at this period to give what was nearly a record crop in the district. Farmers who delayed sowing until the end of May saw their grain at a standstill during the drought which lasted throughout August, and harvested crops yielding much lower than they would have obtained had they been more diligent. The crop of oats was a very heavy one at this Station, averaging over 78 bushels per acre.

As affecting the corn crop.—Though early sown cereal grains were not greatly affected by the drought, Indian corn suffered severely. It is a heat-loving plant, but requires plenty of moisture to grow well, and the farmers who did not conserve moisture by cultivating often had a poor crop. During the night of September 14, frost nipped the corn and terminated its growth. Our yield here was about 25 per cent below the average.

As affecting roots.—The growth of roots was no doubt delayed by the drought of the latter part of summer, but the cool nights of September and October, coupled with a fair precipitation, gave them a renewal of vigour with the result that an average crop was harvested both here and throughout the district.

SESSIONAL PAPER No. 16

SOME WEATHER OBSERVATIONS taken at Cap Rouge Experimental Station, 1913.

	TEMPERATURE F.			PRECIPITATION.				Total Sunshine. Hours.
	Mean.	Highest.	Lowest.	Rainfall.	Snowfall.	Total.	Heaviest in 24 hours.	
	°		°	Inches.	Inches.	Inches.	Inches.	Hours.
January.....	31.32	43.0	-22.2	0.24	4.5	6.96	0.83	47.8
February.....	4.80	41.0	-19.9	0.17	25.3	2.70	0.90	78.2
March.....	21.91	52.0	-14.9	2.80	23.0	5.10	0.71	67.5
April.....	39.35	83.0	15.2	2.14	1.2	2.26	0.83	199.8
May.....	48.95	85.0	25.2	3.27	3.27	1.05	207.4
June.....	57.30	84.0	36.2	2.53	2.53	0.68	233.7
July.....	65.19	88.0	45.2	5.36	5.36	1.22	215.4
August.....	61.58	83.0	40.2	1.97	1.97	0.58	239.7
September.....	56.60	82.0	28.2	4.01	4.01	1.95	209.3
October.....	48.96	73.0	24.2	4.11	4.11	0.81	76.3
November.....	33.42	61.0	13.2	1.75	2.6	2.01	0.88	61.1
December.....	21.23	37.0	-1.1	0.40	29.5	3.35	0.80	43.4
Total for year.....				28.75	86.1	40.28		1670.6
Average for two years, 1912-13.....				35.47	132.7	45.67		1603.0
Total for six growing months, May to October.....						21.25		1172.8
Average of two years for six growing months, May to October.....						24.77		1059.8

YIELDS OF FIELD CROPS.

The following statement of field crop areas and yields compares very favourably with that of 1912. The outstanding feature is the heavy crop of oats harvested, 10.89 acres averaging over 78 bushels per acre.

FIELD CROP AREAS AND YIELDS, Cap Rouge, 1913.

Crop.	Variety.	Acreage.	Total yield.	Yield per acre.
Corn.....	Longfellow.....	9.92	144,082 lb.	7 tons 524 lb.
Swedes.....	Good Luck.....	7.67	301,351 lb.	654 bush. 50 lb.
Carrots.....	White Belgian.....	1.52	40,583 lb.	444 bush. 59 lb.
Oats.....	Banner.....	10.89	28,955 lb.	78 bush. 7 lb.
Hay.....	Timothy and Clover.....	37.13	153,904 lb.	2 tons 145 lb.

COST OF PRODUCTION OF FIELD CROPS.

The exact cost of production was recorded for swede turnips, oats and hay. Details of this work are as follows:—

COST OF PRODUCTION OF SWEDE TURNIPS.

The figures herewith given are for 1 acre of turnips grown in a three-year rotation of turnips, grain, clover hay. The soil was a dry sandy loam, not unlike the soil of many farms in this district. The subsoil was shale.

Rent of land at \$3 per acre	\$3 00
Share of manure, at rate of 12 tons per acre, at \$1 per ton	4 00
Use of machinery at 60 cents per acre	0 60
Seed, 5 pounds at 23 cents per pound	1 15
Ploughing in autumn, 9 hours 2-horse team at 34 cents	3 06
Discing in spring, 6 hours 3-horse team at 41 cents	2 46
Harrowing, 1 hour 2-horse team at 34 cents	0 34
Rolling twice, 1½ hours 1-horse team at 27 cents	0 41
Ridging, 5 hours 2-horse team at 34 cents	1 70
Sowing, 2 hours 1-horse team at 27 cents	0 54
Singling and hoeing, 37 hours manual labour at 17 cents	6 29
Cultivating, 5 hours 1-horse team, at 27 cents	1 35
Cultivating, 5 hours 2-horse team at 34 cents	1 70
Puling, topping, loading, 20 hours manual labour at 17 cents	5 10
Hauling, 15 hours 1-horse team at 27 cents	4 05
Storing, 15 hours manual labour at 17 cents	2 55
Cost per acre	<u>\$38 30</u>

Yield of roots per acre, 19 tons 1,454 pounds or 657 bushels 34 pounds.

Cost to produce 1 ton, \$1.94.

Cost to produce 1 bushel, 5.82 cents.

COST OF PRODUCTION OF OATS.

One acre of Banner oats was grown on a light, sandy loam with shale subsoil. The land was in pasture from 1902 to 1907, in oats 1908, in hay 1909, in pasture 1910, in corn 1911, and in swedes 1912.

Rent of land at \$3 per acre	\$3 00
Share of manure, at rate of 20 tons per acre, at \$1 per ton	4 00
Use of machinery at 60 cents per acre	0 60
Seed, 2½ bushels	1 00
Twine, 2½ pounds at 8.3 cents per pound	0 21
Ploughing in autumn, 9 hours 2-horse team at 34 cents	3 06
Discing in spring, 6 hours 3-horse team at 41 cents	2 46
Harrowing, 1 hour 2-horse team at 34 cents	0 34
Rolling, 1 hour 1-horse team at 27 cents	0 27
Sowing, 1 hour 2-horse team at 34 cents	0 34
Cutting with binder, 1 hour 2-horse team at 34 cents	0 34
Stooking, 6 hours manual labour at 17 cents	1 02
Loading and unloading, 11 hours manual labour at 17 cents	1 87
Hauling, 2 hours 2-horse team at 34 cents	0 68
Storing, 2 hours manual labour at 17 cents	0 34
Threshing, 6.3 cents per bushel of 34 pounds	3 82
Cost per acre	<u>\$23 35</u>

Yield of grain per acre, 2,060 pounds or 60 bushels 20 pounds.

Yield of straw per acre 2,360 pounds or 1 ton 360 pounds.

Valuing the grain at 1 cent per pound, the cost to produce 1 ton of straw was \$3.68.

Valuing the straw at \$4 per ton, the cost to produce 1 bushel of grain was 31.4 cents.

SESSIONAL PAPER No. 16

COST OF PRODUCTION OF HAY.

The following figures are for 1 acre of clover grown in a four-year rotation of roots, grain, clover hay, timothy hay. The soil was a rather light, clay loam underlaid with shale at a depth varying from 12 to 18 inches.

Rent of land, at \$3 per acre	\$3 00
Share of manure, at rate of 16 tons per acre at \$1 per ton	4 00
Use of machinery, at 60 cents per acre	0 60
Half of the charges on 12 pounds timothy at 8½ cents, 8 pounds red clover at 27 cents, and 2 pounds alsike at 31 cents	1 90
Cutting, ½ hour with 2-horse team at 34 cents	0 17
Tedding, 1 hour with 2-horse team at 34 cents	0 34
Side delivery raking, ½ hour with 2-horse team at 34 cents	0 17
Raking, after loader, ½ hour with 1-horse team at 27 cents	0 14
Loading, 1½ hours with 2-horse team, at 34 cents, and 3 hours manual labour at 17 cents	1 02
Unloading, 1½ hour with 2-horse team, at 34 cents, and 3 hours manual labour at 17 cents	1 02
	12 36
Cost per acre	\$12 36

Yield of hay per acre, 3 tons 410 pounds.
 Cost to produce 1 ton \$3.86.

As the cost of production per unit depends very much on the yield, it should be noted that in this case the crop of clover was an exceptionally large one, the crop of oats more than the average, and the crop of swedes rather low. No doubt the tillage necessary to grow a crop of roots has a lasting effect, and a portion of the horse and manual labour charged to the root crop should perhaps go to the debit of the grain and the hay which follow it. Another point to be taken into consideration, is the favourable effect of succulent feeds, such as swedes, on the digestive tract of farm animals, allowing them to make a better use of dry roughages such as hay. With all this in mind, the wise farmer will do well to continue growing roots or other succulent feeds even though the cost of production is high as compared with hay. In fact, it is certain that the latter could not be produced so cheaply were it not for the beneficial effects derived from the hoed crop which preceded it.

ROTATION OF CROPS.

The rotations suitable for this district should, as a rule, include one hoed crop, one or two cereal crops (not grown in succession) and from one to four crops of hay or pasture. The following four rotations are under test at this Station:—

ROTATION "D" (THREE YEARS' DURATION).

First year.—Corn or roots.

Second year.—Grain. Seed down with 8 pounds red clover, 2 pounds alsike, and 8 pounds timothy per acre.

Third year.—Clover hay. Two crops when weather conditions permit.

This rotation is suited to high-priced and easily-tilled land where large crops must be secured to meet heavy rents and overhead charges. It presupposes either a sufficient area of untillable land to be used for pasture, or yard feeding.

Shortly after the second crop of hay is harvested the land is ploughed 4 inches deep, and as flat as possible to ensure a quick rotting of the turf. It is then rolled and the area is cultivated often during the autumn to kill weeds and conserve moisture. Late in the autumn a second ploughing is given, about 5 or 6 inches deep, a more upright furrow being turned this time, in order to leave a larger

surface on which the frost may work during the winter. Manure is applied the following spring, and the turnips sown in drills 30 inches apart, and the corn in rows 42 inches apart. After the turnips or corn is harvested the land is ploughed and left as rough as possible, it having been found here that if only disced, it is liable to pack with the snow to such a degree that ploughing might again be required in the spring. The grain is sown as soon as possible after the ground can be worked.

ROTATION "C" (FOUR YEARS' DURATION).

First year.—Corn or roots.

Second year.—Grain. Seed down with 8 pounds red clover, 2 pounds alsike and 12 pounds timothy per acre.

Third year.—Clover hay. Two crops when weather conditions permit.

Fourth year.—Timothy hay or pasture.

This is a very intensive rotation, especially where stock has to be pastured on the area under cultivation. As a part of the fourth year crop may be left to grow timothy for horses, and the remainder pastured off, it is a very good rotation for the general farmer. The aftermath of the third year crop may be pastured, or cut as a soiling crop if it is desired to add to the stock carrying capacity of the land. In either case, it is good policy to allow the grass to make a certain growth before freezing sets in, as the protection afforded is likely to affect favourably the meadow or pasture the following year.

The preparatory treatment for roots or corn is similar to that given in rotation "D." In case it is deemed advisable to leave the stock on the land until late, one ploughing only, with a fairly upright furrow, is made in the autumn, the ground being rolled as early as possible in the spring, then cross-ploughed in preparation for swedes or corn.

ROTATION "B" (FIVE YEARS' DURATION).

This rotation has been under test for one year only. The crops rotate in the following order:—

First year.—Corn or roots.

Second year.—Grain. Seed down with 8 pounds red clover, 2 pounds alsike and 8 pounds timothy per acre.

Third year.—Clover hay. Two crops when weather conditions permit.

Fourth year.—Grain. Seed down with 8 pounds red clover, 2 pounds alsike and 8 pounds timothy per acre.

Fifth year.—Clover hay. Two crops when weather conditions permit.

This is a very good rotation for the dairyman who has to pay high prices for mill feeds and bedding, as it gives a large proportion of grain and straw. By using one entire lot of clover and the aftermath of the other for soiling, quite a large number of stock can be carried.

In preparing for hoed crops, the clover sod is treated as in rotation "D."

ROTATION "K" (SIX YEARS' DURATION).

First year.—Corn or roots.

Second year.—Grain. Seed down with 8 pounds red clover, 2 pounds alsike and 12 pounds timothy per acre.

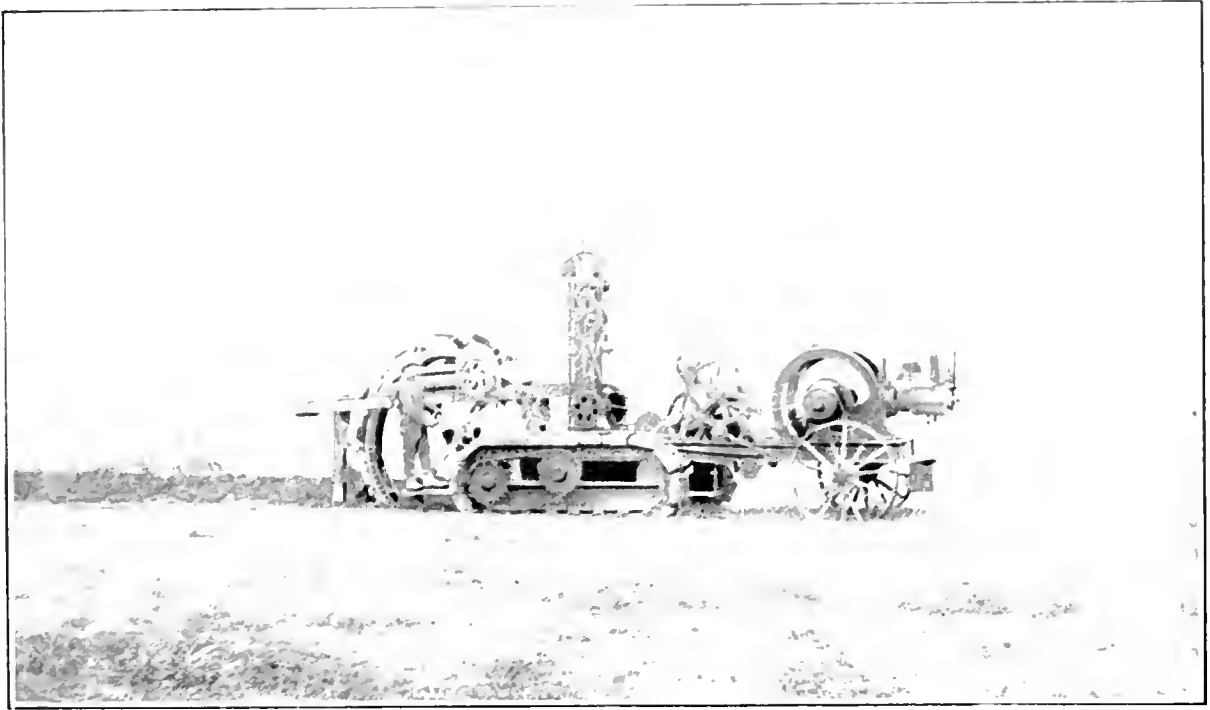

Ditching Machine, Cap Rouge, Que.



Ditching Machine, Cap Rouge, Que.

SESSIONAL PAPER No. 16

Third year.—Clover hay.

Fourth year.—Timothy hay.

Fifth year.—Pasture.

Sixth year.—Pasture.

This rotation would be found useful where manual labour is so scarce as to preclude the adoption of a shorter one, better calculated to produce maximum crops, control weeds and maintain soil fertility. It may well be recommended to farmers who follow no particular rotation and who are desirous of changing gradually to a more productive system of farming.

The land for hoed crops would be prepared as in rotation "D."

The following tables contain details in connection with the above four rotations. Values as given on page 96 have been used in calculating results:—

5 GEORGE V., A. 1915

ROTATION "D" (Three Years' Duration)

Rotation Year.	Lot.	Crops.		Area.	ITEMS OF EXPENSE IN RAISING						
					Rent and Manure.	Seed, Twine and Use of Machinery.	Manual labour.		Horse labour (including teamster)		
							Hours Manual Labour.	Cost of Manual Labour.	Hours.		
									Single Horse.	2-Horse Team.	3-Horse Team.
		1912.	1913.	Acres.	\$ c.	\$ c.	No.	\$ c.	No.	No.	No.
1st...	North Gaudreau 1	Potatoes...	Oats.....	1	7 00	1 85	20	3 40	2	14	6
2nd....	" 2	Oats.....	Hay.....	1	7 00	4 74	3	51	5	4
3rd....	" 3	Hay.....	Swedes....	1	7 09	1 75	82	13 94	23.5	20	6
	Aggregate.....				21 00	8 34	105	17 85	26	38	12
	Average per acre.....			3	7 00	2 78	35	5 95	8.66	12.66	4

ROTATION "C" (Four Years' Duration)

1st....	North Gaudreau 1	Hay.....	Swedes....	1	7 00	1 75	78	13 26	20.5	32	5
2nd....	" 2	Swedes....	Oats.....	1	7 00	1 85	18	3 06	1	14	6
3rd....	" 3	Oats.....	Hay.....	1	7 09	2 50	6	1 02	5	5
4th....	" 4	Hay.....	Hay.....	1	7 00	2 50	2	34	5	2
	Aggregate.....			4	28 00	8 60	104	17 68	22.5	53	11
	Average per acre.....				7 00	2 15	26	4 42	5.62	13.25	2.75

ROTATION "B" (Five Years' Duration)

1th....	South Gaudreau 1	Oats.....	Oats.....	1	7 00	1 77	14.5	2 47	1	14	6
2th....	" 2	Oats.....	Hay.....	1	7 00	4 74	2	31	5	2
3st....	" 3	Oats.....	Swedes....	1	7 00	1 75	65	11 05	18.5	32	5
5nd....	" 4	Swedes....	Oats.....	1	7 00	1 81	19	3 23	1	14	6
4rd....	" 5	Oats.....	Hay.....	1	7 00	4 74	2	34	5	2
	Aggregate.....			5	35 00	14 81	102.5	17 43	21.5	61	17
	Average per acre.....				7 00	2 96	20.5	3 49	4.3	12.8	3.4

ROTATION "K" (Six Years' Duration)

5th....	Big Trudel 1	Hay.....	Hay.....	1	7 00	1 55	4	68	5	6.5
6th....	" 2	Hay.....	Hay.....	1	7 00	1 55	4	68	5	6.5
1st....	" 3	Hay.....	Swedes....	1	7 00	1 75	65	11 05	18	34.5	5
2nd....	" 4	Swedes....	Oats.....	1	7 00	1 87	23	3 91	2	14.5	6
3rd....	" 5	Oats.....	Hay.....	1	7 00	1 55	6	1 02	5	9.5
4th....	" 6	Hay.....	Hay.....	1	7 00	1 55	4	68	5	6.5
	Aggregate.....			6	42 00	9 82	106	18 02	22	78	11
	Average per acre.....				7 00	1 64	17 66	3 00	3.66	13	1.83

CAP ROUGE.

SESSIONAL PAPER No. 16

Hoed Crop—Grain—Hay.

Crop.					PARTICULARS OF CROP.						
Value of Horse labour.	Cost of Threshing.	Total Cost.	Cost for 1 acre.	Cost for 1 Bushel.	Weight.				Total Value.	Value of Crop per Acre.	Profit or Loss per Acre.
					Grain.	Straw.	Hay.	Roots.			
\$ c.	\$ c.	\$ c.	\$ c.	Cents.	Lb.	Lb.	Lb.	Lb.	\$ c.	\$ c.	\$ c.
7 76	4 73	24 71	24 74	32.90	2,557	2,888			31 35	31 35	6 61
1 50		13 75	13 75				3,820		13 37	13 37	- 38
15 61		38 30	38 30	5.82				39,451	39 45	39 45	1 15
24 87	4 73	62 79	62 79		2,557	2,888	3,820	39,454	84 17	84 17	7 38
8 29	1 58	20 93	20 93		852	963	1,273	13,151	28 06	28 06	2 46

Hoed Crop—Grain—Hay—Hay or Pasture.

18 47		40 48	40 48	6.29				38,586	38 59	38 59	-1 89
7 49	3 59	22 99	22 99	40.40	1,935	3,105			25 56	25 56	2 57
1 81		12 36	12 36				6,410		22 44	22 44	10 03
78		10 62	10 62				1,700		5 95	5 95	-4 67
28 58	3 59	86 45	86 45		1,935	3,105	8,110	38 586	92 54	92 54	6 09
7 15	90	21 61	21 61		484	776	2,028	9,617	23 14	23 14	1 52

Hoed Crop—Grain—Hay—Grain—Hay.

7 49	3 07	21 89	21 80	44.76	1,656	1,874			20 31	20 31	-1 94
82		12 99	12 90				2,959		10 33	10 33	-2 57
17 93		37 73	37 73	6.86				32,997	33 00	33 00	-4 73
7 49	3 82	23 35	23 35	38.54	2,060	2,360			25 32	25 32	1 97
82		12 90	12 90				3,110		10 99	10 99	-1 91
34 55	6 89	108 68	108 68		3,716	4,234	6,060	32,997	99 95	99 95	-8 73
6 91	1 38	21 74	21 74		743	847	1,213	6,599	19 99	19 99	-1 75

Hoed Crop—Grain—Hay—Hay—Hay or Pasture—Hay or Pasture.

2 35		11 58	11 58				4,195		14 68	14 68	3 10
2 35		11 58	11 58				3,775		13 21	13 21	1 63
18 61		38 41	38 44	6.38				36,159	36 16	36 16	-2 28
7 87	4 95	25 69	25 60	32.60	2,670	3,400			33 59	33 59	7 90
3 37		12 94	12 94				6,435		22 52	22 52	9 58
2 35		11 58	11 58				4,275		11 96	14 96	3 38
36 93		111 72	111 72		2,670	3 400	18,680	36,159	135 03	135 03	23 31
6 16		18 62	18 62		445		3,113	6,027	22 51	22 51	3 89

The work done with these rotations, to date, has not given the results which might have been expected, as the long rotation has given the greatest profit. The figures are, nevertheless, interesting. It must be understood that for the three and four year rotations, the season of 1911 was of a preparatory nature, and that 1912 was one of the worst years for spring work in the past quarter-century. It was therefore to be expected that the six-year rotation, with its four years in hay, would forge ahead. Then again, the piece of land where is located rotation "K" had been under a good four-year rotation for eight years, whereas the area where are the two others, was an old pasture in rather poor condition.

COSTS, RETURNS AND LOSSES of Rotations "D," "C," and "K," average of 3 years.

Rotation.	Cost to operate per acre.	Value of returns per acre.	Loss per acre.
	\$ cts.	\$ cts.	\$ cts.
"D" (three years' duration).....	23 96	18 19	5 77
"C" four years' duration).....	20 10	14 60	5 50
"K" (six years' duration).....	17 88	16 42	1 46

The above figures, showing a loss throughout, do not at first sight appear encouraging. That all these rotations are rapidly improving and will soon show a handsome profit seems apparent, however, when the following table is examined:—

INCREASE IN VALUE of Products of Rotations "D," "C," and "K," in 3 years.

Items.	Rotation.	Rotation.	Rotation.
	D.	C.	K.
	\$ cts.	\$ cts.	\$ cts.
Value of products per acre, 1913.....	28 06	23 14	22 51
“ “ “ 1911.....	16 80	12 67	15 58
Increase in value of products from 1911 to 1913.....	11 26	10 47	6 93
Per cent increase in value of products from 1911 to 1913.....	0 67	0 83	0 44

RATES OF SEEDING.

Experiments have been undertaken to find the best rates of seeding corn for silage, oats, timothy and clover, and the effect on the yield of hay of different rates of seeding oats. As these experiments have not been long under way, however, the results may not yet be taken as conclusive.

RATES OF SEEDING CORN FOR SILAGE.

As in 1911 and 1912, Longfellow corn was sown at different spaces both in rows and in hills. The following table gives the yields in 1913, and the average yields for three years:—

CAP ROUGE.

SESSIONAL PAPER No. 16

PLANTING CORN in Hills *versus* Drills.

Method of planting.	Yield per acre 1913.	Yield per acre average of 3 years.
In rows 42 inches apart, plants 8 inches apart in row.....	10 tons 122 lb.	9 tons 1,094 lb.
In rows 48 inches apart, plants 8 inches apart in row.....	9 " 265 "	8 " 1,754 "
In hills 36 inches apart, every direction.....	5 " 167 "	5 " 1,398 "
In hills 42 inches apart, every direction.....	4 " 574 "	5 " 1,364 "

According to the above figures, which, it must be understood, are the result of only three years' work, it would appear that more weight can be had by sowing corn in rows than by having it in hills. Where land is dirty it would perhaps be advisable to sow in hills because of the greater ease of cultivation.

RATES OF SEEDING OATS.

To determine the best quantity of seed to use, oats are being sown at thirteen different rates varying from 1 to 4 bushels per acre. The test has been conducted one year only, and as no regular gradation in yield was shown, the results, as yet, suggest little of value. In our field operations, 2½ bushels per acre is the amount used. The following table shows in detail the results of this experiment 1913:—

RATES OF SEEDING OATS.

Rate of seeding per acre, Bushels.....	1	1¼	1½	1¾	2	2¼	2½	2¾	3	3¼	3½	3¾	4
Yield per acre, Bushels.....	60.9	59.6	63.9	73	58	56.7	65.3	58	64.2	71.7	53.8	67.3	68.8

RATES OF SEEDING CLOVER AND TIMOTHY.

To determine whether the liberal use of clover and timothy seed has any effect on the yield of hay, twenty-two plots were sown to oats in the spring of 1912, on eleven of which 6 pounds timothy, 4 pounds red clover and 1 pound alsike were used per acre, whilst on the other eleven, twice this quantity was seeded. The full seeding yielded at the rate of 3,447 pounds per acre, whilst the half seeding gave only 2,989 pounds. The difference in favour of the heavy seeding was 458 pounds per acre, an increase of 15 per cent.

EFFECT ON YIELD OF HAY OF QUANTITY OF GRAIN SOWN AS A NURSE CROP.

This experiment was carried out in duplicate, with one-sixtieth acre plots, using a nurse crop of oats varying in quantity from 1 to 3½ bushels per acre. One year's results do not supply sufficient data upon which to base a conclusion, but it may be pointed out that the group of consecutive seedings which gave the most oats produced the least hay afterwards, and vice versa. This is a very important question in a district where, after a crop of grain, the land is often in hay for five or six years, and then pastured for two or three more. The following figures give details:—

CAP ROUGE.

EFFECT ON YIELD of Hay of Quantity of Grain sown as a Nurse Crop.

Rate of seeding oats per acre, 1912, Bushels	1	1 $\frac{1}{4}$	1 $\frac{1}{2}$	1 $\frac{3}{4}$	2	2 $\frac{1}{4}$	2 $\frac{1}{2}$	2 $\frac{3}{4}$	3	3 $\frac{1}{4}$	3 $\frac{1}{2}$
Yield of oats per acre, 1912, Bushels	60.9	59.6	63.9	73	58	56.7	65.3	58	64.2	71.7	53.8
Yield of hay per acre, 1913, Pounds	2,550	2,550	3,360	3,900	3,960	3,720	3,620	3,150	3,120	3,000	2,460

When the above are divided into groups of light, medium and heavy seedings the yields average as follows:—

EFFECT ON YIELD of Hay of Quantity of Grain sown as a Nurse Crop.

Rate of seeding oats per acre, 1912, Bushels	1 to 1 $\frac{3}{4}$	2 to 2 $\frac{3}{4}$	3 to 3 $\frac{1}{2}$
Average yield of oats per acre, 1912, Bushels	64.3	59.5	63.2
Average yield of hay per acre, 1913, Pounds	3,690	3,615	2,860

YIELDS OF HAY WITH DIFFERENT KINDS OF NURSE CROP.

In 1912, all trial plots of cereals were seeded down with clovers and grass at the rate of 12 pounds timothy, 8 pounds red clover and 2 pounds alsike per acre, to determine with what kind of grain a good hay crop could best be secured. The following table shows the details of this experiment:—

YIELDS OF HAY with Different Kinds of Nurse Crop.

Nurse crop.	Number of tests.	Yield of hay per acre 1913
Barley	13	4,740 lb.
Wheat	14	4,320 "
Oats	12	3,660 "

It will be seen that the crop of hay was 30 per cent larger with barley than with oats, and 18 per cent larger with wheat than with oats.

DRAINAGE.

During 1913, 1,020 six-inch, 1,420 five-inch, 1,610 four-inch and 22,651 three-inch tiles were laid. A 15-horsepower gasoline traction ditcher was used for most of the excavating. Though the grade in many cases was very slight, and the ground uneven, the work of the ditcher was very satisfactory.

A number of two-inch tile laid by a previous owner were examined and found to be clogged. Though they were, theoretically, large enough to carry away all the water, a very slight bulge or misplacement was sufficient to put them out of working order. Nothing smaller than three-inch tile is now being laid here, or recommended for the general use of farmers.

CLEARING LAND.

About 20 acres of land were cleared and ploughed during the season of 1913. The large stumps were dynamited. For the small ones, a double block and tackle was used, which is much superior to the chain attached from stump to whiffletree direct. Another time saver is what is called a double grub hook. With one good horse many roots which could not be taken hold of by a chain were easily handled by this method.

SESSIONAL PAPER No. 16

EXPERIMENTAL FARM FOR MANITOBA, BRANDON, MAN.

REPORT OF THE SUPERINTENDENT, W. C. McKILICAN, B.S.A.

WEATHER CONDITIONS AND CROP NOTES, 1913.

The season of 1913 opened up with a very rapid disappearance of snow. Winter weather had continued to the end of March, but once warm weather began, spring came on apace. Work on the land commenced on the Experimental Farm on April 14, and the first seeding was made on April 16. On the higher part of the Farm, conditions for work were ideal, and seeding was finished early, but the lower lands were flooded by an overflow of the Assiniboine river. The river rose about May 1 and covered about 200 acres of the Farm, some of which had been seeded. The water remained on this land for about ten days at the highest level, and then gradually withdrew. It was nearly a month before any of the flooded fields were in condition to work, and some ponds remained for the greater part of the summer. With the exception of hay, crops already sown on this flooded land were badly injured, or destroyed entirely. Crops sown after the flood were very late and gave poor results. Seeding of grain was finished on May 8, on the unflooded land, and on June 11 on the flooded land. Planting corn was commenced on May 18 and finished on June 7. The weather during the early part of the summer was very dry, the total rainfall up to the end of July being only 5.33 inches. As a result, crops of all kinds suffered considerably and yields were not as large as would be expected in a normal season. Alfalfa haying began on June 20, and a good crop was harvested despite injuries from the flood in the lower places. The second cutting was commenced on July 31, and was only a fair crop, being reduced somewhat by the drought. The first grain to be cut was barley, on July 28. Cutting wheat commenced on August 13. The last cutting was oats for green feed on the flooded land, on September 13. Threshing began on the experimental plots on August 25, and was completed on September 29. Cutting corn commenced on September 12, and silo filling was completed on September 23. Fall ploughing was commenced on September 15 and was completed just before the ground froze up on October 27.

5 GEORGE V., A. 1915

SOME WEATHER OBSERVATIONS taken at Brandon Experimental Farm, 1913.

Month.	TEMPERATURE F.			PRECIPITATION.				Total sunshine. Hours.
	Mean.	Highest.	Lowest.	Rainfall.	Snowfall.	Total.	Heaviest in 24 hours.	
	°	°	°	Inches.	Inches.	Inches.	Inches.	
January.....	-8.5	36.9	-37.6	11	1.10	0.20	73.6
February.....	-3.8	32.0	-38.6	6	0.60	0.30	112.4
March.....	7.7	46.4	-29.7	5	0.50	0.30	148.2
April.....	43.7	82.7	18.1	0.25	1	0.35	0.19	226.4
May.....	48.5	88	18	1.04	1.04	0.44	199.8
June.....	60.4	90	32	2.34	2.34	0.97	218.8
July.....	61.9	95.3	41	1.70	1.70	0.54	228.8
August.....	64.4	94	41	3.56	3.56	1.48	235.6
September.....	54	87.3	23	0.68	0.68	0.17	199.1
October.....	34.4	81.3	-3	0.73	0.73	0.60	137.5
November.....	27.9	59.7	-3	0.04	3	0.34	0.20	93.1
December.....	15.7	41.1	-19.8	1	0.10	0.10	112.2
Total for year.....				10.34	27	13.04	1988.5
Average for 10 years.....				13.18	49.78	18.15	2021.1
Total for 6 growing months Apr. to Sept., 1913.....				9.67	1308.5
Average of 10 years for 6 growing months April to September.....				12.79	1378.3

SESSIONAL PAPER No. 16

FIELD CROP YIELDS.

Because of the flood and the drought the yields of grain on both the high and low land were scarcely up to the average. The statement of yields which follows does not include test plots nor special fields of grain grown for seed production.

FIELD CROP AREAS AND YIELDS, Brandon, 1913.

Crop.	Preceding crop.	Average.	Total yield.	Yield per acre.
Wheat, Red Fife.....	Summer-fallow (Rotation D.)	3 $\frac{1}{2}$	80 bush.	22 bush., 51 lb.
" Red Fife.....	Summer-fallow (Rotation E.)	3 $\frac{1}{2}$	81 "	23 " 9 "
" Red Fife.....	Wheat (Rotation D.)	5 $\frac{1}{2}$	84 "	24 " "
" Red Fife.....	Wheat (Rotation E.)	3 $\frac{1}{2}$	79 "	22 " 34 "
" Red Fife*.....	Clover (Rotation F.)	8 $\frac{1}{2}$	225 "30 lb.	26 " 32 "
" Red Fife.....	Wheat (Rotation F.)	8 $\frac{1}{2}$	180 "	21 " 14 "
" Red Fife.....	Pasture (Rotation H.)	4 $\frac{1}{2}$	57 "	12 " 40 "
" Marquis.....	Summer-fallow.....	2 $\frac{1}{2}$	91 "	40 " 26 "
" Marquis.....	Summer-fallow.....	5	115 "	29 " 09 "
Oats, Lamm.....	Wheat (Rotation D.)	3 $\frac{1}{2}$	118 "	42 " 16 "
" Banner.....	Wheat (Rotation E.)	3 $\frac{1}{2}$	139 "	31 " 24 "
" Banner*.....	Wheat (Rotation G.)	6	335 "	55 " 50 "
" Banner.....	Pasture (Rotation Q.)	4	151 "	37 " 26 "
" Banner.....	Peas (Rotation Q.)	5	160 "	32 " "
" Banner.....	Oats.....	10	584 "	58 " 14 "
" Banner*.....	Summer-fallow.....	2 $\frac{1}{2}$	116 "	46 " 14 "
" Banner.....	Summer-fallow.....	6	603 "	100 " 17 "
" Abundance.....	Summer-fallow.....	2	116 "	73 " "
" Dauboney.....	Summer-fallow.....	2	159 "	75 " "
Green oats for feed*.....	Wheat.....	10	35 tons.	3 tons, 1,000 lb.
" ".....	Flax (Rotation H.)	4 $\frac{1}{2}$	15 "	3 " 667 "
Barley, O.A.C. No. 21.....	Corn (Rotation F.)	8 $\frac{1}{2}$	470 bu-h.	55 bush., 14 lb.
" O.A.C. No. 21*.....	Wheat (Rotation G.)	6	247 "	41 " 8 "
" O.A.C. No. 21.....	Wheat (Rotation H.)	4 $\frac{1}{2}$	54 "	12 " "
" O.A.C. No. 21.....	Oats.....	2 $\frac{1}{2}$	99 "	36 " "
" Manchurian.....	Flax.....	3 $\frac{1}{2}$	230 "	65 " 48 "
Peas, Arthur.....	Oats (Rotation Q.)	3	52 "	17 " 20 "
Flax, Common.....	Pasture (Rotation I.)	4 $\frac{1}{2}$	65 "	14 " 27 "
Corn, Northwestern Dent.....	Wheat (Rotation F.)	8 $\frac{1}{2}$	64 tons.	7 tons, 1,059 lb.
" ".....	Pasture (Rotation G.)	6	70 "	11 " 1,333 "
" ".....	Barley.....	5	28 "	7 " 1,200 "
" ".....	Summer-fallow.....	2 $\frac{1}{2}$	31 "	13 " 1,200 "
Turnips, Hall's Westbury.....	Oats (Rotation Q.)	2	19 "	280 lb., 9 " 640 "
Mangels, YellowGlobe.....	Barley.....	2	20 tons.	1,165 lb., 10 " 581 "
Hay, Alfalfa.....	Alfalfa.....	15	50 tons.	3 " 667 "
Hay, Clover.....	Barley (Rotation F.)	8 $\frac{1}{2}$	13 "	1 " 1,058 "
Hay, Clover.....	Barley (Rotation G.)	6	15 "	2 " 1,000 "
Hay, Clover.....	Oats.....	8	12 "	1 " 1,650 "
Hay, Mixed.....	Hay (Rotation G.)	6	12 "	2 " "
Hay, Mixed.....	Oats (Rotation H.)	4 $\frac{1}{2}$	7 "	1 " 1,111 "
Hay, Mixed.....	Wheat (Rotation I.)	4 $\frac{1}{2}$	7 "	1 " 1,111 "
Hay, Mixed.....	Hay.....	5 $\frac{1}{2}$	8 "	1 " 900 "
Hay, Mixed.....	Oats.....	5 $\frac{1}{2}$	10 "	1 " 1,634 "
Hay, Mixed.....	Oats (Rotation Q.)	5	5 "	1 " "
Hay, (Brome).....	Hay (Rotation Q.)	5	1,000 lb.	" 200 "

* Fields marked thus were seriously injured by flood.

COST OF PRODUCTION OF FIELD CROPS.

The records kept in connection with the crop rotation experiments supply data on the cost of production of various crops. On account of the majority of the rotation fields having been inundated by the flood, there are not many fields from which reliable data can be given this year.

The values used are those that have been fixed for the rotation work on all the western Experimental Farms and Stations. In some instances they are not exactly in accord with this year's prices, but on the whole the data given are probably as nearly applicable to conditions here as can be obtained.

Cost of production of wheat on summer-fallow.

Number of acres: 3½.

Preceding crops: (Rotation D) wheat, oats, fallow.

Rent of land at \$2 per acre for 2 years	\$14 00
Ploughing previous June, 13 hours, 4-horse team at 48 cents	6 24
Packing after ploughing, 1¾ hours, 4-horse team at 48 cents	0 84
Harrowing after ploughing 2½ hours, 2-horse team at 34 cents	0 85
Cultivating in July, 5½ hours, 4-horse team at 48 cents	2 61
Cultivating in September, 4¼ hours, 4-horse team at 48 cents	2 04
Seeding, 3½ hours, 2-horse team at 34 cents	1 19
Harrowing, 2¼ hours, 2-horse team at 34 cents	0 76
Binding, 3½ hours, 3-horse team at 41 cents	1 43
Stooking, 4½ hours manual labour at 19 cents	0 86
Threshing, 80 bushels of wheat at 7 cents	5 60
Seed, 5½ bushels of wheat at \$1 per bushel	5 25
Twine, 10½ pounds at 13½ cents	1 40
Use of machinery, 2 years at 60 cents per acre each year	4 20
Total cost of 3½ acres wheat (including cost of summer-fallow)	\$47 30
Cost per acre	\$13 51
Yield of wheat per acrebushels.	22.85
Cost to produce 1 bushel wheat (value of straw neglected)cents.	59.1

Cost of production of wheat following wheat.

Number of acres: 3½.

Preceding crops: (Rotation D.) oats, fallow, wheat.

Rent of land at \$2 per acre	\$7 00
Quarter share of manure, 6 tons per acre at \$1 per ton	5 25
Ploughing in October, 11 hours, 5-horse team at 55 cents	6 05
Discing in April, 3½ hours, 2-horse team at 34 cents	1 19
Seeding, 3 hours 2-horse team at 34 cents	1 02
Harrowing, 4½ hours 2-horse team at 34 cents	1 53
Binding, 3½ hours 3-horse team at 41 cents	1 43
Stooking, 4 hours manual labour at 19 cents	0 76
Threshing, 84 bushels wheat at 7 cents	5 88
Seed, 5½ bushels wheat at \$1 per bushel	5 25
Twine, 11½ pounds of twine at 13½ cents	1 58
Use of machinery, 3½ acres at 60 cents	2 10
Total cost of 3½ acres wheat	\$39 04
Cost per acre	\$11 15
Yield of wheat per acrebushels.	24
Cost to produce 1 bushel wheat (value of straw neglected)cents	43.9

SESSIONAL PAPER No. 16

Cost of production of wheat sown on clover sod.

Number of acres: 8½.

Preceding crops: (Rotation E.) Wheat, corn, barley, clover.

Rent of land at \$2 per acre	\$17 00
Ploughing in August, 35 hours, 4-horse team at 48 cents	16 80
Discing, 31 hours, 2-horse team at 34 cents	10 54
Seeding, 7½ hours, 2-horse team at 34 cents	2 55
Harrowing, 12½ hours, 2-horse team at 34 cents	4 25
Binding, 9½ hours, 3-horse team at 41 cents	3 90
Stacking, 10 hours, manual labour at 19 cents	1 90
Threshing, 225½ bushels wheat at 7 cents	15 75
Seed, 12¾ bushels wheat at \$1 per bushel	12 75
Twine, 40½ pounds at 13½ cents	5 42
Use of machinery, 8½ acres at 60 cents per acre	5 10
<hr/>	
Total cost of 8½ acres of wheat	\$95 96
Cost per acre	\$11 53
Yield of wheat per acrebush.	29.5
Cost to produce 1 bushel wheat (value of straw neglected)cents	42.5

Cost of production of oats, following two crops of wheat.

Number of acres: 3½.

Preceding crops: (Rotation D.) Fallow, wheat, wheat.

Rent of land at \$2 per acre	\$7 00
Quarter share of manure, 6 tons per acre at \$1 per ton	5 25
Ploughing, 10 hours, 4-horse team at 48 cents	4 80
Seeding, 3 hours, 2-horse team at 34 cents	1 02
Harrowing, 4 hours, 2-horse team at 34 cents	1 36
Binding, 3½ hours, 3-horse team at 41 cents	1 43
Stacking, 5 hours manual labour at 19 cents	95
Threshing, 148 bushels oats at 4 cents per bushel	5 92
Seed, 7 bushels oats at 50 cents per bushel	3 50
Twine, 10½ pounds at 13½ cents	1 40
Use of machinery, 3½ acres at 60 cents per acre	2 10
<hr/>	
Total cost of 3½ acres oats	\$34 73
Cost per acre	\$ 9 92
Yield of oats per acrebush.	42.3
Cost to produce 1 bushel of oats (value of straw neglected)cents.	23.4

Cost of production of ensilage corn.

Number of acres: 8½.

Preceding crops: Wheat, wheat, wheat.

Rent of land at \$2 per acre	\$17 00
One-fifth share of manure, 8 tons per acre at \$1 per ton	13 40
Ploughing, 27½ hours, 5-horse team at 55 cents	15 12
Discing and harrowing, 34 hours, 2-horse team at 34 cents	11 56
Rolling, 3½ hours, 2-horse team at 34 cents	1 19
Seeding, 12 hours, 2-horse team at 34 cents	4 08
Cultivating, 74½ hours, 2-horse team at 34 cents	25 33
Cultivating, 25 hours, 1-horse at 27 cents	6 75
Hoeing, 86 hours, manual labour at 19 cents	16 31
Binding, 22 hours, 3-horse team at 41 cents	9 02
Ensiling, 64 tons of corn at 75 cents per ton	48 00
Seed	7 04
Twine	4 40
Use of machinery, 8½ acres at 60 cents per acre	5 10
<hr/>	
Total cost of 8½ acres corn	\$181 33
Cost per acre	\$21 69
Yield of ensilage per acretons.	7.53
Cost per ton placed in silo	\$2 88

BRANDON.

ROTATION OF CROPS.

The year has been almost lost so far as experimental work in the rotation of crops is concerned. The flood was the cause which so invalidated our results. The land on which several of the rotations are located, was inundated, other areas again, were partially flooded, and some escaped entirely. This means that the conditions under which the crops in the various rotations were grown, were not comparable. It is thus impossible to be sure whether any differences observed are due to the character of the rotation or to the effect of the flood.

ROTATION "D" (FOUR YEARS' DURATION).

First year.—Wheat.

Second year.—Wheat. Manured preceding fall at rate of 3 tons per acre.

Third year.—Oats.

Fourth year.—Summer-fallow.

Four fields of $3\frac{1}{2}$ acres each are used for this rotation. The soil varies from a sandy to a clayey loam. It was started in 1910, and has been in full operation since 1911.

Rotation "D" may be considered a typical grain farming rotation, except that manure is applied to the land once every four years. An adjoining rotation, "E," has exactly the same order of crops as "D," but differs in that it receives no manure. The manure applied to "D" is charged at the rate of \$1 per ton (spread over the rotation). In 1911 and 1912, the increase in crop more than paid for the cost of the manure. This year the unmanured rotation showed the greater profit.

Rotation "D" was not affected by the flood, but did, however, suffer from the dry weather. Field "D 1" in particular, being rather light sandy soil, did not give the yield that can usually be expected from summer-fallowed land.

ROTATION "E" (FOUR YEARS' DURATION).

First year.—Wheat.

Second year.—Wheat.

Third year.—Oats.

Fourth year.—Summer-fallow.

Rotation "E" receives no manure at any time, this being the only difference between it and "D". It is probably used by more of the successful grain farmers of Manitoba than any other rotation.

It consists of four fields of $3\frac{1}{2}$ acres each, lying contiguous to the corresponding fields of "D". The soil varies from a sandy loam to a clay loam. The rotation was started in 1910 and has been in full operation each year since that time.

One striking result already observed in rotations "D" and "E" is the great difficulty in keeping wild oats in check. The three successive grain crops give this weed a splendid opportunity to multiply, and the summer-fallow is not an entirely effective means of eradicating it. This result bears out the observation of many farmers in Manitoba, who find that in growing grain exclusively, it is impossible to keep the wild oats in check, no matter how thoroughly the work of summer-fallowing is done.

BRANDON.

SESSIONAL PAPER No. 16

Many seeds of wild oats remain dormant during the summer-fallow, but grow with the following crop of wheat. In the mixed farming rotations, in operation nearby, no such difficulty is experienced.

ROTATION "F" (FIVE YEARS' DURATION).

First year.—Wheat.

Second year.—Wheat.

Third year.—Corn or roots. Manured preceding fall.

Fourth year.—Oats or barley. Seeded with grass and clover.

Fifth year.—Clover hay.

Five fields of $8\frac{1}{2}$ acres each, are used for this rotation.

The soil is a black loam, mostly heavy, but with a lighter ridge running across each field. It was laid down in 1910 and 1911 and has been in full operation since that time. "F 2" and "F 3" were partially flooded, and as they were seeded with wheat before the flood, the wheat was thinner and later than it otherwise would have been.

Rotation "F" is a mixed farming rotation, suited to conditions where it is desired to grow both a considerable quantity of wheat, and a large amount of fodder for stock. It pre-supposes a sufficient area of permanent pasture outside the rotation. It eliminates the summer-fallow.

This rotation is proving a decided success on the Experimental Farm. In a country where summer-fallowing is generally considered essential, it demonstrates the possibility of producing a profitable crop every year. The substitutes for the summer-fallow are: First, corn or roots; and secondly, clover hay. While these crops do not show in themselves any very great profits, they more than pay for the operations they involve and for the overhead charges counted against them, and they leave the land in such a condition that the following crops of grain are more profitable than any grown in the straight grain-growing rotations. The wheat, grown on clover sod which is ploughed in July and well cultivated thereafter, is usually equal in every way to the best summer-fallow crop on the farm. Moreover, the crop of clover hay, which replaces the summer-fallow, has paid its own way and added to the humus of the land in addition. Similarly corn may be substituted for the summer-fallow to advantage, for, while the corn shows a very small profit in itself, the grain (usually barley) that follows is the most cheaply grown on the farm.

ROTATION "G" (SIX YEARS' DURATION).

First year.—Wheat.

Second year.—Wheat.

Third year.—Oats and barley. Seeded with grass and clover.

Fourth year.—Clover hay.

Fifth year.—Pasture.

Sixth year.—Corn or roots. Manured preceding fall.

Six fields of 6 acres each are allotted to rotation "G." The land is a heavy clay loam. This rotation was the first started on the Experimental Farm and has been in operation four years.

It is a mixed farming rotation, providing for wheat, coarse grains, hay, pasture and fodder corn.

Unfortunately the land for rotation "G" was entirely covered by the flood. Wheat had been sown in "G 1" and "G 2" and a beautiful stand was growing when the flood came. This crop was destroyed, and oats were sown. In "G 2" a fair crop was obtained, but in "G 1" the oats proved such a failure that they were ploughed up. The hay crop was increased by the flood, and that helped to counter-balance the loss on grain crops. The results, however, cannot be considered normal, and this year's figures will not be used in computing averages.

ROTATION "H" (SIX YEARS' DURATION).

First year.—Wheat.

Second year.—Wheat.

Third year.—Summer-fallow.

Fourth year.—Oats. Seeded with grass and clover.

Fifth year.—Hay.

Sixth year.—Pasture. Manured.

Six fields of $4\frac{1}{2}$ acres each comprise the land on which rotation "H" is located. It is a heavy clay loam. The rotation in its present form was started last year, but in a somewhat similar form was in operation for a year previous.

This rotation is suitable for a farm where grain growing is still the principal crop, but where hay and pasture are desired for stock. It includes one summer-fallow, and has no hoed crop. It is therefore suited to the farmer who considers a hoed crop impracticable under present labour conditions.

The land, on which rotation "H" is located, is badly infested with couch grass, and has been in that condition for many years. On that account the results obtained are not comparable with those obtained on the other rotations, and, as they are not fair to the rotation, they are not published. Rotation "H" was also entirely inundated during the flood, and the crops on it were altered from that cause.

SESSIONAL PAPER No. 16

ROTATION "I" (SIX YEARS' DURATION).

First year.—Flax.

Second year.—Oats.

Third year.—Summer-fallow.

Fourth year.—Wheat. Seeded with grass and clover.

Fifth year.—Hay.

Sixth year.—Pasture. Manured.

Six fields of $4\frac{1}{2}$ acres provide the land required for this rotation. These fields lie contiguous to the corresponding fields of rotation "II" and are of the same character. Rotation "I" is suited to conditions such as described for "II." The chief difference between the two rotations is that flax in "I" is substituted for wheat in "II."

The land under "I" is in the same condition in regard to couch grass as that under "II" and for that reason is not reported in detail. This land was also completely flooded this year. An effort is being made to get the couch grass under control on this land, in order that a fair comparison may be made between these two rotations and the others.

ROTATION "Q" (EIGHT YEARS' DURATION).

First year.—Roots and peas.

Second year.—Wheat or oats. Seeded with grass and clover.

Third year.—Hay.

Fourth year.—Hay.

Fifth year.—Pasture.

Sixth year.—Pasture.

Seventh year.—Pasture.

Eighth year.—Green feed and rape. Manured in fall.

This rotation is located in eight fields of 5 acres each on a poor gravelly hill top at the rear of the Experimental Farm. The land is used as a sheep ranch, and the rotation is arranged specially for that purpose. It was in partial operation in 1911 and 1912, and this year was in full operation except that the seeding of the hay and pasture land is much older than the order of the crops would indicate, and, in consequence is less productive. The quality of the land makes the results on this rotation quite incomparable to those obtained on the other rotations situated on good land. They must therefore be considered as a unit by themselves, as indicating what can be done on this poor land by this system. In the fields where a loss is shown, it will be noticed that the chief item of cost is the charge for rent. The uniform charge of \$2 per acre made against all the rotations, is made here; it is, of course more than this land is worth, and makes the profits unduly small.

ROTATION "W" (TEN YEARS' DURATION).

First year.—Wheat.

Second year.—Wheat.

Third year.—Corn or roots.

Fourth year.—Oats.

Fifth year.—Barley.

Sixth year.—Alfalfa. Seeded without nurse crop.

Seventh year.—Alfalfa.

Eighth year.—Alfalfa.

Ninth year.—Alfalfa.

Tenth year.—Alfalfa.

The fields varying in size from $1\frac{1}{2}$ acres to $2\frac{3}{4}$ acres are to be used for this rotation. The soil is a heavy clay loam. The rotation is not yet in full operation. All but two of the ten crops were in their place this year, and next year (1914) it is hoped to have it in full running order.

This is essentially an alfalfa rotation, and consequently has to be long. Alfalfa is expensive to start and profitable to retain, and therefore must be allowed quite a number of consecutive years. This rotation is specially suited to a dairyman or pure bred stock farmer, who wishes to grow a large amount of good feed for his stock.

The following fixed values are being used in this, and similar work here, and at the other prairie branch Farms and Stations.

Cost Values.

Rent	per acre.	\$2 00
Barnyard manure spread (charged equally over all years of the rotation)	per ton.	1 00
Seed wheat	per acre	1 50
Seed oats	"	1 00
Seed barley	"	1 00
All other seeds to be charged at actual cost. Cost of grass seed to be charged equally on the years producing grass		
Twine charged at actual cost.		
Machinery	per acre.	60
Manual labour	per hour.	19
Horse labour (including teamster)—		
Single horse	"	27
Two-horse team	"	34
Three-horse team	"	41
Four-horse team	"	48
Additional horses	"	7
Work done by traction engine is to be converted into the amount of horse labour required to do the work and charged accordingly.		
Threshing (covering work from stock to granary)—		
Wheat	per bush.	7
Oats	"	4
Barley	"	5
Flax	"	12
Peas	"	7



Cutting Fodder Corn, Brandon Experimental Farm.

SESSIONAL PAPER No. 16

Return Values.

Wheat (from the machine)	per lb.	11 ¹ / ₂ c.
Barley " "	"	1c.
Oats " "	"	1c.
Peas " "	"	1 ¹ / ₂ c.
Flax " "	"	3c.
Timothy hay	per ton.	\$10 00
Red clover hay	"	10 00
Alfalfa hay	"	12 00
Brome grass hay	"	10 00
Western rye grass hay	"	10 00
Mixed hay	"	10 00
Green hay	"	10 00
Oat straw	"	2 00
Barley straw	"	2 00
Wheat straw	"	1 00
Pea straw	"	2 00
Flax straw	"	2 00
Dry corn stalks	"	5 00
Corn ensilage	"	3 00
Mangels and turnips	"	3 00
Sugar beets	"	4 00
Pasture, each horse	per month.	1 00
" " cow	"	1 00
" " sheep	"	25

5 GEORGE V., A. 1915

ROTATION

Rotation Year.	Crops.		ITEMS OF EXPENSE												
			Area.	Rent and manure.		Seed, twine and use of machinery.		Manual labour.		Horse labour (including teamster.)					
										Hours.					
										Hours Manual Labour.	Cost of Manual Labour.	Single horse	2-horse team	3-horse team	4-horse team
1912.	1913.	Ac.	\$	c.	\$	c.	No.	\$	c.	No.	No.	No.	No.	No.	
1st.	Fallow.....	Wheat.....	3.5	7 00	8 75	4 $\frac{1}{2}$	0 86	5 $\frac{3}{4}$	3 $\frac{1}{2}$	4 $\frac{1}{4}$
2nd.	Wheat.....	Wheat.....	3.5	12 25	8 93	4	0 76	11	3 $\frac{1}{2}$	11
3rd.	Wheat.....	Oats.....	3.5	12 25	7 00	5	0 95	7	3 $\frac{1}{2}$	10
4th.	Oats.....	Fallow.....	3.5	12 25	2 10	20 $\frac{3}{4}$	27 $\frac{1}{2}$
	Aggregate.....		14	43 75	26 78	13 $\frac{1}{2}$	2 57	44 $\frac{1}{2}$	10 $\frac{1}{2}$	41 $\frac{3}{4}$	11
	Average per acre.....		3 13	1 91	0 18

ROTATION

1st.	Fallow.....	Wheat.....	3.5	7 00	8 58	4 $\frac{1}{2}$	0 86	5 $\frac{3}{4}$	3 $\frac{1}{2}$	4 $\frac{1}{4}$
2nd.	Wheat.....	Wheat.....	3.5	7 60	8 75	4	0 76	11	3 $\frac{1}{2}$	11
3rd.	Wheat.....	Oats.....	3.5	7 00	7 18	5	0 95	7	3 $\frac{1}{2}$	10
4th.	Oats.....	Fallow.....	3.5	7 00	2 10	20	27 $\frac{1}{2}$
	Aggregate.....		14	28 00	26 61	13 $\frac{1}{2}$	2 57	44 $\frac{1}{2}$	10 $\frac{1}{2}$	41 $\frac{3}{4}$	11
	Average per acre.....		2 00	1 90	0 19

ROTATION

1st.	Hay.....	Wheat.....	8.5	17 00	23 27	10	1 90	51	9 $\frac{1}{2}$	35
2nd.	Wheat.....	Wheat.....	8.5	17 00	23 27	10	1 90	23 $\frac{1}{2}$	9	27
3rd.	Wheat.....	Corn.....	8.5	30 40	16 54	86	16 34	25	124	22	27 $\frac{1}{2}$
4th.	Corn.....	Barley.....	8.5	30 40	26 85	15	2 85	20 $\frac{1}{2}$	13	5
5th.	Barley.....	Hay.....	8.5	30 40	46 19	30	5 70	6	17 $\frac{1}{2}$
	Aggregate.....		42.5	125 20	136 12	151	28 69	31	240 $\frac{1}{2}$	52 $\frac{1}{2}$	40	54 $\frac{1}{2}$
	Average per acre.....		2 94	3 20	0 68

ROTATION

1st.	Corn.....	Wheat.....	6	20 00	18 60	67 $\frac{1}{2}$	35 $\frac{1}{2}$
2nd.	Wheat.....	Oats.....	6	20 00	23 85	17	3 23	32 $\frac{1}{2}$	7 $\frac{1}{2}$	20
3rd.	Wheat.....	Barley.....	6	20 00	12 75	16	3 04	22 $\frac{1}{2}$	7 $\frac{1}{2}$	13
4th.	Barley.....	Hay.....	6	12 00	14 55	30	5 70	42
5th.	Hay.....	Pasture (hay)..	6	12 00	10 50	28	5 32	47
6th.	Pasture.....	Corn.....	6	20 00	13 20	226	42 94	10	63	13	42 $\frac{1}{2}$
	Aggregate.....		36	104 00	93 45	317	60 23	10	194 $\frac{1}{2}$	28	116
	Average per acre.....		2 88	2 60	1 67

BRANDON.

SESSIONAL PAPER No. 16

"D." (Four years' duration.)

IN RAISING CROP.							PARTICULARS OF CROP.						
Value of horse labour.	Cost of threshing.	Total cost.	Cost for 1 acre.	Cost for 1 bushel.	Cost for 1 ton.	Height of Stubble.	Weight.				Total value.	Value of crop per acre.	Profit or loss per acre.
							Grain.	Straw.	Hay.	Wood crop.			
\$ c.	\$ c.	\$ c.	\$ c.	\$ c.	\$ c.		Lb.	Lb.	Lb.	Lb.	\$ c.	\$ c.	\$ c.
5 42	5 60	27 63	7 89	0 59			4,800	8,000			68 00	19 43	11 54
11 22	5 88	39 04	11 15	0 46			5,040	9,000			71 70	20 49	9 34
8 61	5 92	34 73	9 92	0 23			5,032	8,000			58 32	16 69	6 74
20 25		34 60	9 89										-9 89
45 50	17 40	136 00									198 02		
3 25	1 25		9 72									14 15	4 43

"E." (Four years' duration.)

5 42	5 67	27 53	7 87	0 58			4,860	7,000			68 30	19 55	11 68
11 22	5 53	33 26	9 50	0 42			4,740	8,000			67 20	19 20	9 70
8 61	5 56	29 30	8 37	0 21			4,626	9,000			55 26	15 77	7 40
20 25		29 35	8 39										-8 39
45 50	16 76	119 44									190 76		
3 25	1 19		8 53									13 62	5 09

"F." (Five years' duration.)

38 04	15 75	95 96	11 29	0 42			13,530	31,000			195 50	23 05	11 26
26 53	12 69	84 30	9 56	0 45			10,800	31,000			159 50	18 77	9 91
73 05	48 00	184 33	21 68							128,000	192 00	22 58	0 70
11 70	23 50	98 30	11 56	0 21			22,560	32,000			257 60	30 31	18 75
7 57		89 86	10 57							26,000	130 00	15 23	4 13
159 89	99 85	519 75									934 60		
3 76	2 35		12 93									22 00	9 07

"G." (Six years' duration.)

39 99		78 59	13 10										-13 10
23 72	13 40	84 20	14 03	0 25			12,070	30,000			150 70	25 11	11 09
19 36	12 35	67 50	11 25	0 27			11,856	18,000			136 56	22 76	11 51
11 28		46 53	7 76							3,000	162 00	27 00	19 24
15 98		43 80	7 30							2,400	132 00	22 00	14 70
49 85	52 50	178 49	29 41							10,000	210 00	35 00	5 59
163 18	78 25	499 11									791 26		
4 53	2 17		13 86									21 98	8 12

Rotation Year.	Crops.		ITEMS OF EXPENSE													
			Area.	Rent and manure.	Seed, twine and use of machinery.	Manual labour.		Horse labour (including teamster.)								
						Hours Manual Labour.	Cost of Manual Labour.	Hours.								
								Single horse	2-horse team	3-horse team	4-horse team	5-horse team				
1912.	1915.	Ac.	\$	c.	\$	c.	No.	\$	c.	No.	No.	No.	No.	No.		
1st...	Oats and rape..	Roots and peas	5	20	00	15	00	174	33	06	17	46	9
2nd...	Roots and peas	Oats.....	5	20	00	10	10	6	1	14	29 ¹ / ₂	6	3
3rd...	Oats and alfalfa	Hay.....	5	20	00	6	98	13	2	47	19 ¹ / ₂
4th...	Hay.....	Hay.....	5	10	00	3	00	1	0	19	11 ¹ / ₂
5th...	Hay.....	Pasture.....	5	10	00	5 ¹ / ₂
6th...	Pasture.....	Pasture.....	5	10	00	4 ¹ / ₂
7th...	Pasture.....	Pasture.....	5	10	00	4 ¹ / ₂
8th...	Pasture.....	Oats and rape..	5	10	00	10	62	5	0	95	6	46	5	17
Aggregate.....			40	110	00	45	70	199	37	81	23	167	11	29
Average per acre.....			2	75	1	14	0	94

SESSIONAL PAPER No. 16

"Q." (Eight years' duration.)

RAISING CROP.							PARTICULARS OF CROP.						
Value of horse labour.	Cost of threshing.	Total cost.	Cost for 1 acre.	Cost for 1 bushel.	Cost for 1 ton.	Height of Stubble.	Weight.				Total value.	Value of crop per acre.	Profit or loss per acre.
							Grain.	Straw.	Hay.	Wool Crop.			
\$ c.	\$ c.	\$ c.	\$ c.	\$ c.	\$ c.		Lb.	Lb.	Lb.	Lb.	\$ c.	\$ c.	\$ c.
24 55	3 64	96 25	19 25	3,129	5,000	38,280	109 22	21 84	2 59
13 93	6 40	51 57	10 31	5,440	16,000	76 40	14 08	3 77
6 63	36 08	7 21	10,000	54 00	16 80	3 59
3 99	17 18	3 40	1,000	10 25	2 05	-1 39
1 78	11 78	2 36	21 00	4 20	1 84
1 53	11 53	2 31	21 00	4 20	1 89
1 53	11 53	2 31	10 50	2 10	-0 21
27 47	6 04	55 08	11 02	5,134	7,000	65 84	13 17	2 15
81 41	16 08	291 00	362 21
2 04	0 40	7 27	9 06	1 79

SOIL CULTURAL EXPERIMENTS.

Soil cultural experiments inaugurated in 1911 for the purpose of investigating some of our more important problems in soil cultivation have been carefully carried out. The results do not yet supply much decisive information and little comment is therefore made in connection with the various experiments recorded.

DEPTH OF PLOUGHING WHEAT STUBBLE TO BE SOWN TO OATS.

The land was ploughed and packed in October, 1912. In the spring it was harrowed and the seed sown May 7, at the rate of 2½ bushels per acre. The oats came up on all plots May 23, headed out July 9, ripened August 14, were cut August 14, and threshed September 2.

DEPTH OF PLOUGHING Wheat Stubble to be sown to Oats.

Plot No.	Depth of ploughing wheat stubble, fall of 1912.	Yield of oats per acre, 1913.	
		Grain.	Straw.
		Lb.	Lb.
1	Ploughed 3 inches deep.....	3,260	3,340
2	Ploughed 4 inches deep.....	3,240	3,320
3	Ploughed 5 inches deep.....	3,390	3,320

There is a slight advantage in favour of ploughing 5 inches deep, but the difference is hardly great enough to be regarded as conclusive.

DEPTH OF PLOUGHING SUMMER-FALLOW TO BE SOWN TO WHEAT.

The summer-fallow was ploughed in June, 1912, packed immediately, cultivated twice afterwards during the season, and harrowed after each packing or cultivating. In the spring it was cultivated and harrowed again, and the wheat was sown April 25, at the rate of 1½ bushels per acre. All plots came up May 14, headed out July 6, ripened August 12, were cut August 13 and threshed August 28.

DEPTH OF PLOUGHING Summer-fallow to be sown to Wheat.

Plot No.	Depth of ploughing summer-fallow, 1912.	Yield of wheat per acre, 1913.	
		Grain.	Straw.
		Lb.	Lb.
1	Ploughing 3 inches deep.....	3,720	5,000
2	Ploughing 4 inches deep.....	3,610	4,880
3	Ploughing 5 inches deep.....	3,390	4,410
4	Ploughing 6 inches deep.....	3,530	4,590
5	Ploughing 7 inches deep.....	3,360	4,280
6	Ploughing 8 inches deep.....	3,750	6,850
7	Ploughing 5 inches deep and subsoiling 4 inches.....	2,850	3,270
8	Ploughing 6 inches deep and subsoiling 4 inches.....	3,120	4,600
9	Ploughing 7 inches deep and subsoiling 4 inches.....	3,220	4,020
10	Ploughing 8 inches deep and subsoiling 4 inches.....	2,920	4,240

SESSIONAL PAPER No. 16

The results obtained would indicate that subsoiling was injurious rather than helpful, since the four subsoiled plots were lower in yield than any of the others. It is impossible to gather much information from the results on the other plots, as ploughing eight inches deep gave the best returns while three inches deep was a close second, with the other plots showing no regular gradation in yield.

DEPTH OF PLOUGHING SOD TO BE SOWN TO WHEAT.

After the hay was cut, 1912, the land was ploughed August 3, double disced the same day and again October 7. It was harrowed twice in the spring, and the wheat was sown April 17, at the rate of 15 bushels per acre. All plots came up May 3, headed out June 24, ripened August 5, were cut August 5, and threshed August 28.

The experiment has not yet been in operation long enough to note the results of the stubble ploughing following the sod.

DEPTH OF PLOUGHING Sod to be sown to Wheat followed by Oats.

Plot No.	Depth of ploughing sod, 1912.	Yield of wheat	Yield of oats
		per acre on sod.	per acre on wheat stubble.
		Lb.	Lb.
11	Ploughing three inches deep sod and stubble.....	2,300	3,400
12	Ploughing four inches deep sod and stubble.....	2,660	3,130
13	Ploughing five inches deep sod and stubble.....	2,820	3,610
14	Ploughing three inches deep on sod and six inches deep fall or spring after wheat.....	2,690	3,600

The deep ploughing has the advantage in point of yield and, moreover, the grass was subdued better by the deep than by the shallow ploughing.

SUMMER-FALLOW TREATMENT.

With the exception of plots 11 and 13, which were ploughed May 17 and July 17 respectively, the land received the first ploughing of the fallow June 12 and 13, 1912. The plots that were ploughed twice received their second ploughing September 4, 1912. All except plot 17 were packed immediately after the first ploughing. Plots 1 to 9 were cultivated once in July and once in August, and harrowed after each cultivation. Plot 10 was well harrowed and sown to rape on June 17, which was pastured by pigs, beginning August 13. Plot 11 was cultivated three times during the summer, plot 12 twice, and plot 13 only once. Plots 14 to 17 were cultivated twice (July and August). All plots were harrowed after each cultivation. After harrowing in the spring, all plots were sown to wheat April 16. All came up April 29. Plots 1 to 9 headed out June 30 and plots 10 to 17 June 26. They were cut August 4 and threshed August 6.

5 GEORGE V. A. 1915

TREATMENT OF SUMMER-FALLOW to be sown to Wheat.

Plot No.	Treatment of Summer-fallow, 1912.	Date of Ripening.	Yield of wheat per acre.	
			Grain.	Straw.
			Lb.	Lb.
1	Plough 4 inches, June, pack if necessary and practicable, cultivate as necessary.	Aug. 4 ...	2,420	4,020
2	Plough 6 inches, June, pack if necessary and practicable, cultivate as necessary.	" 4 ...	2,740	3,460
3	Plough 8 inches, June, pack if necessary and practicable, cultivate as necessary.	" 4 ...	2,670	3,850
4	Plough 4 inches, June, cultivate.	" 6 ...	2,850	3,790
5	Plough 6 inches, June, cultivate.	" 6 ...	2,730	3,990
6	Plough 8 inches, June, cultivate.	" 6 ...	2,730	3,990
7	Plough 6 inches, June, cultivate.	" 6 ...	2,870	3,770
8	Plough 4 inches, June, cultivate.	" 6 ...	2,780	3,820
9	Plough 4 inches, June, early as possible, cultivate	" 6 ...	2,610	3,970
10	Plough 6 inches, September, harrow.	" 4 ...	2,770	3,270
11	Plough 5 inches, June, seed to rape or other green forage crop and pasture off.	" 4 ...	2,950	3,810
12	Plough 6 inches, May 15, harrow and pack if necessary, cultivate as necessary.	" 4 ...	2,750	3,850
13	Plough 6 inches, July 15, harrow and pack if necessary, cultivate as necessary.	" 4 ...	2,920	4,320
14	Fall cultivate, before summer-fallowing.	" 4 ...	2,840	4,240
15	Plough 6 inches, June, harrow and pack if necessary, cultivate as necessary.	" 4 ...	2,750	4,330
16	Fall plough 4 inches before summer-fallowing.	" 4 ...	3,120	4,000
17	Plough 6 inches, June, harrow and pack if necessary, cultivate as necessary.	" 4 ...	2,720	3,720

The plots that were ploughed twice were uniformly two days later than those that were ploughed only once. Plots 16 and 17 considered by themselves seem to show a decided advantage for soil packing. When, however, it is remembered that all plots except plot 17 were packed, and that plot 12 received identical treatment with plot 16, this result is not so clear. A note on the condition of the crop shows that plot 13, ploughed in July, was much weedier than the others.

STUBBLE TREATMENT.

The plots on which this experiment was conducted grew wheat in 1912. The experimental treatment of the stubble land, as described below, was performed in the fall of 1912 and spring of 1913. Plots 1 to 10 were sown to wheat April 17, at the rate of 1½ bushels per acre. Plots 2 and 3 came up May 2, plot 5 May 3, and the others May 4. Plots 1, 2, 3, 5 and 10 headed out June 27, plots 4, 6, 7, and 9 June 28 and plot 8 June 29. All ripened August 5, were cut August 5, and threshed August 29.

Plots 11 to 13 were sown to oats May 7. All came up May 23, headed out July 9, ripened August 14, were cut August 14 and threshed September 2.

BRANDON.

SESSIONAL PAPER No. 16

TREATMENT OF WHEAT STUBBLE to be sown to Wheat.

Plot No.	Treatment given wheat stubble preceding wheat.	Yield of Wheat per acre, 1913.	
		Grain.	Straw.
		Lb.	Lb.
1	Plough, autumn.....	1,670	2,170
2	Disc harrow, autumn.....	1,670	1,690
3	Burn stubble—then disc, autumn.....	1,600	1,840
4	Burn stubble—then plough, autumn.....	1,630	2,010
5	Burn stubble in spring—seed at once.....	1,310	1,709
6	Plough in spring—seed at once.....	1,670	1,930
7	Disc at cutting time—spring plough.....	1,650	1,510
8	Disc at cutting time—autumn plough.....	1,790	1,850
9	Plough, autumn—subsurface pack at once.....	1,690	1,950
10	Plough, spring—seed—subsurface pack.....	1,680	1,960

TREATMENT OF WHEAT STUBBLE to be sown to Oats.

Plot No.	Treatment given wheat stubble preceding oats.	Yield of oats per acre, 1913.	
		Grain.	Straw.
		Lb.	Lb.
11	Plough, autumn.—subsurface pack at once.....	2,340	1,860
12	Plough, spring—seed, subsurface pack.....	2,280	1,710
13	Cultivate, autumn—spring plough, seed.....	2,550	2,410

Plots 2, 3 and 5, which were not ploughed, were conspicuously weedy, as compared to the ploughed plots. The difference in yield between the discing and ploughing is hardly as great as would be expected. Plot 5, which received no cultivation is the lowest in yield of any, as might be expected. The three plots on which the stubble was burned are the three lowest in yield. No very distinct difference can be observed between spring and fall ploughing, but what advantage there is, is in favour of fall ploughing. In the case of oats, the plot that was cultivated, (disced) in the fall and ploughed in the spring, gave best results.

SEEDING TO GRASS AND CLOVER.

The group of plots which reached the result-producing stage in this experiment in 1913, were seeded as per the directions given below, in the year 1912. Plots 1 to 8 received the required preparatory treatment in previous years. Plots 9, 10 and 11, requiring two previous grain crops, did not have more than one, as the experiment was laid out only in 1911, and the land was in summer-fallow in 1910. The first crop was cut June 27 and the second August 22.

SEEDING to Grass and Clover.

Plot No.	Method of seeding.	Yield of hay per acre.		
		First cutting.	Second cutting.	Total.
		Lb.	Lb.	Lb.
1	Seeding rye grass 10 lb. and red clover 10 lb. with nurse crop on summer-fallow.....	6,760	1,960	8,720
2	Seeding rye grass 10 lb. and red clover 10 lb. alone after summer-fallow.....	8,720	2,600	11,320
3	Seeding rye grass 10 lb. and red clover 10 lb. with nurse crop on first year after hoed crop.....	6,360	3,320	9,680
4	Seeding rye grass 10 lb. and red clover 10 lb. alone after hoed crop.....	7,160	3,040	11,200
5	Seeding rye grass 10 lb. and red clover 10 lb. with nurse crop on first year wheat stubble.....	4,040	2,960	7,000
6	Seeding rye grass 10 lb. and red clover 10 lb. alone after first year wheat.....	5,280	2,360	7,640
7	Seeding rye grass and red clover, with oats to cut green, on first year wheat stubble.....	4,280	2,560	6,840
8	Seeding rye grass 10 lb. and red clover 10 lb. alone on first year wheat stubble, manured 8 tons per acre, ploughed preceding fall.....	4,720	2,440	7,160
9	Seeding rye grass 10 lb. and red clover 10 lb. with nurse crop on second year wheat stubble.....	4,680	2,080	6,760
10	Seeding rye grass 10 lb. and red clover 10 lb. alone after second year grain (oats).....	3,800	1,920	5,720
11	Seeding rye grass 10 lb. and red clover 10 lb. with nurse crop on second year after hoed crop.....	4,640	2,160	6,800

The yield on plot 10 was reduced by causes other than the experimental treatment. The seeding on land that was in summer-fallow or hoed crop the previous year was decidedly the best. Seeding alone gives a better yield than with a nurse crop, but not enough better on this land to pay for the lost crop of grain. Possibly on unimproved or light land the advantage of seeding alone would be greater.

BREAKING SOIL FROM CULTIVATED GRASSES AND CLOVERS.

The following methods are being tried in this experiment:—

1. Plough 5 inches July 20 to 30, pack and disc at once, disc in fall.
2. Plough 5 inches October, pack, disc harrow.
3. Plough 3 inches early July, backset September, cultivate as necessary.
4. Stiff-tooth rip July, plough 5 inches September, cultivate.
5. Spring plough 5 inches deep, seed same spring to wheat.
6. Duplicate No. 5, sow flax.
7. Repeat No. 5, sow peas.
8. Plough May 15, work as summer-fallow.

No results are available in this experiment as yet. The land was seeded in 1911 and produced hay in 1912. The first set of plots have received the experimental treatment this year 1913, and should give results in 1914.

APPLICATION OF BARNYARD MANURE.

Application of barnyard manure for corn and roots.

Turnips were used in this experiment. Plots 1 to 7 grew wheat the two previous years. Plots 8 and 9 were summer-fallowed the previous year. The manure was applied to each plot as per directions given below. The turnips were sown May 15 and pulled on October 1.

BRANDON.

SESSIONAL PAPER No. 16

APPLICATION of Barnyard Manure for Roots.

Plot No.	Application of Manure.	Yield of turnips per acre, 1913.
		Lb.
1.....	No manure, plough second-year stubble in autumn.....	21,200
2.....	Apply in autumn after ploughing second-year stubble, work in at once.....	30,600
3.....	Apply in spring on autumn ploughed second-year stubble, work in at once.....	28,800
4.....	Apply in autumn on second year stubble, plough under in autumn.....	30,400
5.....	Apply in spring on second-year stubble, plough under in spring.....	22,800
6.....	Apply in winter on second-year stubble, plough under in spring.....	24,800
7.....	Apply in winter green manure (cut straw) on second-year stubble, plough under in spring.....	28,600
8.....	Apply in winter green manure (cut straw) on summer-fallow, disc in.....	32,400
9.....	Summer-fallow, no manure.....	30,800

Plots 1 to 7 gave an average crop of 27 bushels of wheat per acre in 1912. Allowing for this, plots 8 and 9 have not given sufficient extra crop to pay for the wheat which was lost by the summer-fallowing.

The fall application of manure either before or after fall ploughing seems to have the advantage over winter or spring application.

Application of Barnyard Manure for Wheat.

In this experiment there is followed a rotation of summer-fallow, wheat, wheat. In the case of plots 2 and 4 the manure is applied to affect the wheat crop after summer-fallow, whereas in the remaining plots it is applied to affect the second wheat crop of the rotation. To make a fair comparison of the different methods of application it is therefore necessary to average the yields for the two crop-producing years of the rotation.

APPLICATION of Barnyard Manure for Wheat.

Plot No.	Application of Manure.	Yield of wheat per acre on summer-fallow.	Yield of wheat per acre on wheat stubble.	Average yield of wheat per acre for entire rotation.
		Lb.	Lb.	Lb.
1.....	Apply in winter green manure (cut straw) on first-year stubble, disc in.....	2,920	*1,810	2,365
2.....	Apply in winter green manure (cut straw) on summer-fallow, disc in.....	*3,140	2,310	2,725
3.....	Top dress, with spreader, grain sown on first-year stubble.....	3,220	*2,620	2,920
4.....	Top dress, with spreader, grain sown on summer-fallow.....	*3,350	2,360	2,855
5.....	No manure, plough first-year stubble in autumn.....	3,060	2,520	2,790
6.....	Apply on surface first-year stubble, plough under in autumn.....	3,130	*2,680	2,905
7.....	Apply on surface first-year stubble, plough under in spring.....	3,030	*3,400	3,215
8.....	No manure, disc first-year stubble in autumn.....	3,190	2,300	2,745
9.....	No manure, barn first-year stubble.....	3,120	2,340	2,730

* Indicates plots on which manure was applied this year.

5 GEORGE V., A. 1915

Application of Barnyard Manure for Barley.

In this experiment a three-year rotation has been adopted as follows:—

First year.—Summer-fallow.

Second year.—Wheat, or barley where indicated.

Third year.—Barley, or oats where indicated. Where barley follows summer-fallow oats follow barley.

Owing to the different cropping system, followed a comparison of all the methods of application is somewhat difficult. Plots 2 and 4, in which barley is sown on summer-fallow and followed by oats, must be considered apart from the remaining plots where the barley is sown on wheat stubble which follows summer-fallow. Barley and oats are valued at one cent and wheat at one and one-third cents per pound and the average value per acre of the two crops taken, so that the comparative results of the different methods of application may be clearly shown.

APPLICATION of Barnyard Manure for Barley.

Plot No.	Application of Manure.	Yield	Yield	Value
		per acre of wheat on summer- fallow.	per acre of barley on wheat stubble.	per acre of crops for entire rotation.
		Lb.	Lb.	\$ cts.
1.....	Apply in winter green manure (cut straw) on first year stubble, disc in.....	3,020	2,420	32 23
3.....	Top dress, with spreader, barley sown on first year stubble.....	2,980	2,799	33 81
5.....	No manure, plough first-year stubble in autumn.....	2,970	2,910	34 35
6.....	Apply on first-year stubble, plough under in autumn....	3,180	3,160	37 00
7.....	Apply on first-year stubble, plough under in spring.....	3,020	3,060	35 43
8.....	No manure, disc first-year stubble in autumn.....	3,040	2,550	33 01
9.....	No manure, burn first-year stubble.....	3,200	2,830	35 48

APPLICATION of Barnyard Manure for Barley.

Plot No.	Application of Manure.	Yield	Yield	Average
		per acre of barley on summer- fallow.	per acre of oats on barley stubble.	value per acre of crops for entire rotation.
		Lb.	Lb.	\$ cts.
2.....	Apply in winter green manure (cut straw) on summer-fallow, sow barley on summer-fallow.....	3,330	3,330	33 30
4.....	Top dress, with spreader, barley sown on summer-fallow.....	3,180	3,950	35 65

APPLICATION of Barnyard Manure for Oats.

In this experiment a three-year rotation has been adopted as follows:—

First year.—Summer-fallow.

Second year.—Wheat, or oats where indicated.

Third year.—Oats or barley where indicated.

BRANDON.

SESSIONAL PAPER No. 16

As in the previous experiment the different cropping systems followed make it necessary to consider plots 2 and 4 apart from the remaining plots, and to average the value of both crops of the rotation in order to make a fair comparison of the different methods of applying manure. Oats and barley are valued at one cent and wheat at one and one-third cents per pound.

APPLICATION of Barnyard Manure for Oats.

Plot No.	Application of Manure.	Yield	Yield	Average
		per acre of wheat on summer- fallow.	per acre of oats on wheat stubble.	value of crops per acre for entire rotation.
		Lb.	Lb.	\$ cts.
1.....	Apply in winter green manure (cut straw) on first-year stubble, disc in.....	2,870	3,770	37 98
3.....	Top dress, with spreader, oats sown on first-year stubble.....	3,200	4,110	41 88
5.....	No manure, plough first-year stubble in autumn.....	3,680	4,200	41 53
6.....	Apply on first-year stubble, plough under in autumn....	3,190	4,830	45 41
7.....	Apply on first-year stubble, plough under in spring.....	3,160	4,240	42 26
8.....	No manure, disc first-year stubble in autumn.....	3,390	4,150	44 10
9.....	No manure, burn first-year stubble.....	3,070	4,360	42 26

APPLICATION of Barnyard Manure for Oats.

Plot No.	Application of manure.	Yield per	Yield per	Average
		acre of oats on summer- fallow.	acre of barley on oat stubble.	value per acre of crops for entire rotation.
		Lb.	Lb.	\$ c.
2	Apply in winter green manure (cut straw) on summer-fallow, sow oats on summer-fallow.....	4,300	2,870	35 85
4	Top dress with spreader, oats sown on summer-fallow.....	4,360	3,310	38 35

GREEN MANURING.

A group of plots in this experiment was given the prescribed treatment in 1912 and grew wheat this year, 1913. The wheat was sown April 19, at the rate of 1½ bushels per acre. It came up on all plots May 5. Plot 5 headed out June 29, and the others one day later. All ripened August 9, were cut August 9 and threshed August 30.

GREEN MANURING for Wheat, followed by Oats.

Plot No.	Treatment of land year previous to wheat.	Yield of wheat per acre, 1913.	
		Grain.	Straw.
		Lb.	Lb.
1	Summer-fallow.....	3,100	3,100
2	Peas, two bushels Golden Vine (or other similar variety) ploughed under early in July.....	3,100	4,180
3	Peas, two bushels Golden Vine, ploughed under when in blossom.....	3,070	3,970
4	Tares, one bushel per acre, ploughed under late in July.....	3,060	3,900
5	Summer-fallow. Barnyard manure, 12 tons per acre, applied on summer-fallow in September.....	3,620	4,300
6	Summer-fallow.....	3,060	4,060

No difference is apparent between a green manuring crop and a bare summer-fallow. Barnyard manure shows a decided advantage over both.

SEED-BED PREPARATION.

The purpose of this experiment is to find out the degree to which work in preparing a seed-bed for grain—wheat and oats—may be carried with profit. The wheat was grown on summer-fallowed land, which was uniformly treated, so that the difference in preparation lay entirely in the work done in the spring before seeding. Plot 1 received no spring work; plot 2 received three strokes of the harrow; plot 3 was packed with the surface packer, cultivated with a stiff tooth cultivator, and harrowed four times. The wheat was sown April 19. All plots matured on the same date, though plot 3 was one day earlier in heading out.

PREPARATION of Seed Bed for Wheat.

Plot No.	Treatment given seed bed.	Yield of wheat per acre, 1913.		Yield of wheat per acre average of 2 years.	
		Grain.	Straw.	Grain.	Straw.
		Lb.	Lb.	Lb.	Lb.
1	Good preparation.....	3,090	3,950	2,265	3,855
2	Poor preparation.....	3,210	4,190	2,425	4,675
3	Extraordinary preparation.....	3,280	4,080	2,420	4,860

This experiment was also conducted with oats sown on wheat stubble. The three plots were equally well ploughed and packed in the fall of 1912. Plot 1 was harrowed once in the spring and sown; plot 2 was harrowed seven times and packed in the spring, the ground was hard and rather lumpy, rendering this amount of work necessary to give "good" cultivation; plot 3 was harrowed nine times and packed three times. The oats were sown May 7. No difference in growth could be noted at any time.

SESSIONAL PAPER No. 16

PREPARATION of Seed Bed for Oats.

Plot No.	Treatment given seed-bed.	Yield of oats per acre 1913.		Yield of oats per acre average of 2 years.	
		Grain.	Straw.	Grain.	Straw.
		Lb.	Lb.	Lb.	Lb.
1	Poor preparation	2,970	2,350	3,005	3,655
2	Good preparation.....	2,960	2,440	3,300	3,600
3	Extraordinary preparation.....	3,190	2,410	3,415	3,385

SOIL PACKING FOR WHEAT SOWN ON SUMMER-FALLOW.

The plots for this experiment were summer-fallowed in 1913. Plots 15 to 20 were packed after the ploughing. All plots received sufficient summer cultivation to keep them clean. In the spring, the experimental treatment described below, was applied. The wheat was sown April 17, at the rate of 1½ bushels per acre. Plots, 2, 3, 6, 8, 9, 10, 11, 23, 24 and 25 came up May 1; the remaining plots came up the next day. No difference in earliness could be observed at heading out or ripening time. All were cut August 5 and threshed August 28.

SOIL PACKING in Preparation for Wheat following Summer-fallow.

Plot No.	Cultural treatment given.	Yield of wheat per acre, 1913.	
		Grain.	Straw.
		Lb.	Lb.
1	Harrow, seed.....	2,920	4,040
2	" " surface pack.....	3,030	4,190
3	" " " harrow.....	2,660	4,540
4	" " subsurface pack.....	3,030	4,170
5	" " " harrow.....	2,910	3,930
6	" " combination pack.....	3,030	3,950
7	" " " harrow.....	3,110	4,370
8	Surface pack, seed, surface pack.....	3,060	4,140
9	Subsurface pack, seed, subsurface pack.....	3,080	4,200
10	Combination pack, seed, combination pack.....	2,940	4,220
11	Surface pack, harrow, seed.....	3,200	4,280
12	Subsurface pack, harrow, seed.....	3,060	4,500
13	Combination pack, harrow, seed.....	3,220	4,420
14	Harrow, seed.....	3,120	4,320
15	Plough for summer-fallow, surface pack, cultivate; next spring, smoothing harrow, seed.....	3,080	4,480
16	Plough for summer-fallow, subsurface pack, cultivate; next spring, smoothing harrow, seed.....	3,420	4,500
17	Plough for summer-fallow, combination pack, cultivate; next spring, smoothing harrow, seed.....	3,080	4,740
18	Plough for summer-fallow, surface pack, cultivate; next spring, smoothing harrow, seed, surface pack.....	3,320	5,240
19	Plough for summer-fallow, subsurface pack, cultivate; next spring, smoothing harrow, seed, subsurface pack.....	3,370	4,750
20	Plough for summer-fallow, combination pack, cultivate; next spring, smoothing harrow, seed, combination pack.....	3,560	4,720
21	Harrow, seed.....	3,180	4,940
22	" " harrow when 6 inches high.....	3,000	4,880
23	" " surface pack when 6 inches high.....	2,950	4,090
24	" " roll when 6 inches high.....	2,840	4,320
25	" "	2,890	3,990

5 GEORGE V., A. 1915

The land for this experiment was very firm this spring, and obviously was not in great need of packing. It was therefore to be expected that the packing would not have a decidedly beneficial effect. From the figures obtained we would not make any observations as to which kind of packer will give best results, nor as to what time of packing is best, but might point out that the three plots packed after ploughing in the summer, and again after seeding in the spring gave the highest yields.

SOIL PACKING for Wheat Sown on Spring Ploughed Stubble Land.

The plots for this experiment grew wheat in 1912. They were ploughed April 16 and treated as described below. The wheat was sown April 17 at the rate of 1½ bushels per acre. Considerable variations was observed in the time required for germination, heading out, and ripening, as will be noted in the following table:—

SOIL PACKING for Wheat sown on Spring Ploughed Stubble Land.

Plot No.	Cultural treatment given.	Date of coming up.	Date of ripening.	Yield of wheat per acre, 1913.	
				Grain.	Straw.
				Lb.	Lb.
1	Harrow, subsurface pack, harrow, seed.....	May 2	Aug. 7	2,380	2,860
2	“ surface pack, harrow, seed.....	“ 1	“ 7	2,360	2,940
3	“ combination pack, harrow, seed.....	“ 1	“ 7	2,120	2,680
4	“ subsurface pack, harrow, seed, subsurface pack.....	“ 2	“ 7	2,440	2,560
5	“ surface pack, harrow, seed, surface pack.....	“ 1	“ 7	2,330	2,590
6	“ combination pack, harrow, seed, combination pack.....	“ 1	“ 8	2,220	2,660
7	“ seed, harrow.....	“ 4	“ 8	2,120	2,560
8	“ “ surface pack.....	“ 2	“ 8	2,390	2,740
9	“ “ subsurface pack.....	“ 4	“ 8	2,260	2,340
10	“ “ combination pack.....	“ 3	“ 8	2,250	2,670
11	“ “	“ 4	“ 8	2,140	2,420

We are unable to draw any conclusion from these results except that the two unpacked plots were a little later and more uneven in germinating.

SOIL PACKING FOR WHEAT ON FALL PLOUGHED STUBBLE LAND.

The plots for this experiment grew wheat in 1912. They were ploughed October 10, 1912. Those on which fall packing is given were packed October 15. The spring packing was done April 16 and 18. Wheat was sown April 19, at the rate of 1½ bushels per acre. The date of coming up and ripening is given in tabular form below. All headed out June 28, except plot 22, which was two days later.

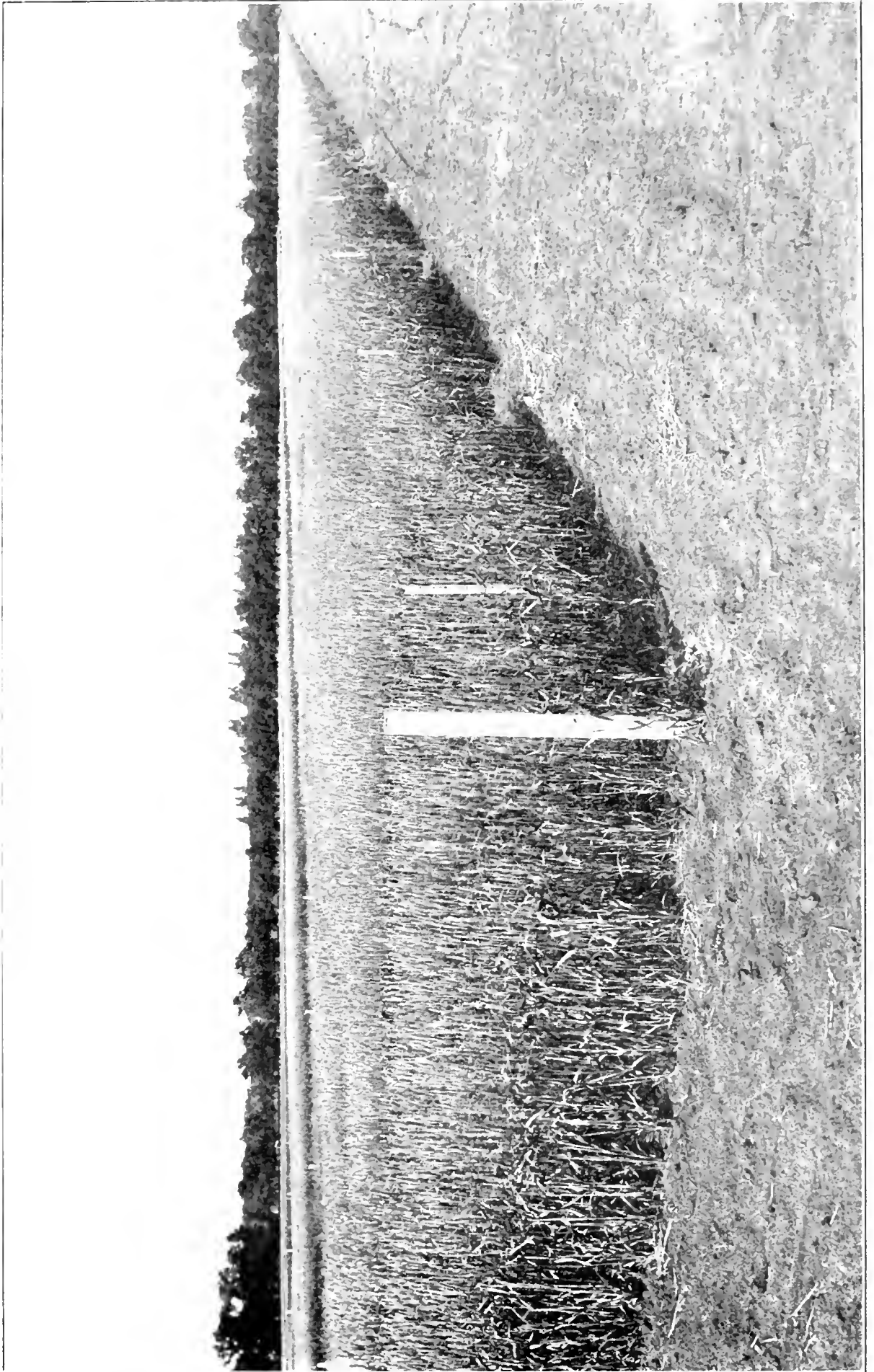

Some of the Cultural Experimental Plots. Brandon Experimental Farm.

SESSIONAL PAPER No. 16

SOIL PACKING for Wheat sown on Fall Ploughed Stubble Land.

Plot No.	Cultural treatment given.	Date of coming up.	Date of ripening.	YIELD OF WHEAT PER ACRE	
				Grain.	Straw.
				Lb.	Lb.
12.....	No packer, harrow, seed.....	May 3.....	Aug. 8.....	2,200	2,400
13.....	Subsurface pack in fall, seed in spring.....	" 4.....	" 8.....	2,310	2,299
14.....	Subsurface pack in spring, then seed.....	" 4.....	" 8.....	2,330	2,790
15.....	Subsurface pack in spring, after seeding.....	" 4.....	" 8.....	2,480	2,680
16.....	Surface pack in fall, seed in spring.....	" 3.....	" 8.....	2,330	2,750
17.....	Surface pack in spring, then seed.....	" 3.....	" 8.....	2,350	2,610
18.....	Surface pack in spring after seeding.....	" 3.....	" 8.....	2,280	2,680
19.....	Combination pack in fall, seed in spring.....	" 3.....	" 8.....	2,550	2,730
20.....	Combination pack in spring, then seed.....	" 3.....	" 8.....	2,680	2,760
21.....	Combination pack in spring after seeding..	" 3.....	" 8.....	2,700	2,780
22.....	No packer, harrow, seed.....	" 4.....	" 8.....	2,430	2,770
23.....	Surface pack in fall, seed, surface pack.....	" 2.....	" 7.....	2,570	2,670
24.....	Subsurface pack in fall, seed, subsurface pack	" 3.....	" 7.....	2,640	2,760
25.....	Combination pack in fall, seed, combina- tion pack.....	" 2.....	" 7.....	2,540	2,860

DEPTH OF SEEDING.

This experiment was tried with wheat on summer-fallow. The wheat was sown April 28, at the rate of 1½ bushels per acre. It came up on all plots May 5, headed out June 24 and ripened August 9.

DEPTHs of Seeding Wheat.

Plot No.	Depths sown.	YIELD OF WHEAT PER ACRE, 1913.	
		Grain.	Straw.
		Lb.	Lb.
1.....	Sowing 1 inch deep.....	2,530	3,710
2.....	Sowing 2 inches deep.....	3,030	4,130
3.....	Sowing 3 inches deep.....	3,120	4,000
4.....	Sowing 4 inches deep.....	2,960	4,000

This experiment was also tried with oats on wheat stubble. The land was ploughed in October, 1912. The oats were sown May 7, 1913 at the rate of 2¼ bushels per acre. They came up May 23, headed out July 9 and ripened August 14.

DEPTHs of Seeding Oats.

Plot No.	Cultural Method.	YIELD OF OATS PER ACRE, 1913.	
		Grain.	Straw.
		Lb.	Lb.
1.....	Sowing 1 inch deep.....	3,470	3,170
2.....	Sowing 2 inches deep.....	3,600	3,280
3.....	Sowing 3 inches deep.....	3,160	3,040
4.....	Sowing 4 inches deep.....	2,910	2,690

BRANDON.

EXPERIMENTAL FARM FOR SOUTHERN SASKATCHEWAN, INDIAN HEAD, SASK.

REPORT OF THE SUPERINTENDENT, T. J. HARRISON, B.S.A.,

WEATHER CONDITIONS AND CROP NOTES, 1913.

As climatic conditions affect materially the results of experimental work in Field Husbandry, it has been deemed advisable to give a brief outline of local weather conditions for the season of 1913. The spring opened up comparatively early and the soil was in a tillable condition by April 14. May was fairly dry, which facilitated the early sowing of the crop, all the grain being sown by May 15. In June and July, 8.5 inches of rain fell, giving the crops plenty of moisture at the growing period. This resulted in a rank growth of straw on the summer-fallowed land. August, with the exception of one bad storm which lodged the grain, was dry and bright, ripening the grain early so that it was nearly all harvested before the first of September. September was dry and warm, and the threshing was well advanced before the cold weather came in October.

In the following table there are recorded the temperatures, precipitation and sunshine for the year 1913:—

SOME WEATHER OBSERVATIONS taken at Experimental Farm, Indian Head, 1913.

Month.	TEMPERATURE F.			PRECIPITATION.			Total Sunshine.
	Mean.	Highest.	Lowest.	Rainfall.	Snowfall.	Total.	
				Inches.	Inches.	Inches.	Hours.
January.....	- 6.51	40	-45	8	.8	57.9
February.....	1.50	40	-35	13	1.3	63.1
March.....	10.58	45	-31	11.75	1.175	121.
April.....	42.63	80	12	.1313	166.5
May.....	48.39	90	23	1.20	7	1.90	174.6
June.....	61.30	88	33	4.73	4.73	224.9
July.....	61.16	84	38	4.13	4.13	285.3
August.....	61.61	84	41	2.35	2.35	245.5
September.....	53.33	88	26	.5555	200.9
October.....	33.22	73	5	4.87	16	6.47	107.2
November.....	27.06	53	- 3	7.50	.75	99.2
December.....	17.10	43	-1250	123.2
Total for year.....				17.96	63.75	24.335	1,869.3

SESSIONAL PAPER No. 16

SCOPE OF FIELD HUSBANDRY WORK.

The growing of field crops is no doubt the most important work on the majority of farms in southern Saskatchewan, and in view of this a large portion of our experimental work is devoted to soil and crop management problems. One hundred and fifty acres are used in the testing of crop rotations under field conditions. Twenty acres are occupied by an extensive set of soil cultural experiments. While some of these experiments have not been in operation long enough to give decisive results, others again have already given valuable information. A considerable portion of the Farm is devoted to producing feeds for live stock. In the areas used for this purpose the cost of production of crops is calculated, and varieties that have been giving best results in small plots are tested out in field lots.

YIELDS OF FIELD CROPS.

TOTAL QUANTITIES of Field Crops, Indian Head, 1913.

Crop.	Quantity produced.
Wheat, Registered Marquis.....	1,348 bushels, 35 pounds.
“ Marquis.....	548 “ 40 “
“ Red Fife.....	904 “ 10 “
“ Prelude.....	273 “ 35 “
“ Pioneer.....	44 “
“ Numbered sorts.....	154 “
Oats, Banner.....	2,205 “
“ Ligowo Swedish.....	312 “
“ Abundance.....	396 “
Barley, Manchurian.....	1,671 “ 34 “
“ O. A. C. No. 21.....	132 “ 19 “
“ Canadian Thorpe.....	247 “ 34 “
Flax, Premost.....	79 “ 46 “
Peas, Arthur.....	350 “ 40 “
Hay.....	74 tons
Corn.....	90 “
Roots.....	117 “ 1,167 “
Potatoes.....	342 bushels.

YIELDS OF SPRING WHEAT.

Field tests, of the named varieties of wheat, were made on both summer-fallow and stubble-land. The Registered Marquis is the product of a plot sown with Special Registered Marquis supplied by the Dominion Cerealists in 1912. The Marquis is the progeny of seed supplied to the Farm in 1907.

SPRING WHEAT—Average and Total Yields. Indian Head, 1913.

Variety.	Cultivation.	Acres.	Yield per acre.		Total yield.	
			Bush.	Lb.	Bush.	Lb.
Prelude.....	Fallow.....	10.00	25	21	253	35
Prelude.....	".....	.75	26	40	20	
Reg. Marquis.....	".....	11.00	44	45	492	15
".....	".....	5.00	47	20	236	40
".....	".....	3.00	52	43	158	10
Marquis.....	Stubble.....	5.00	40	46	203	50
".....	".....	10.00	32	49	328	10
Reg. Marquis.....	Fallow.....	5.50	44	46	329	40
".....	".....	5.50	42	8	231	50
Red Fife.....	Stubble.....	6.00	38	57	237	5
".....	Fallow.....	6.00	43	40	260	
".....	".....	6.25	37	8	232	5
".....	Stubble.....	6.25	28		175	
Total.....		80.25		3,058	20

Average yield per acre, 38 bushels 8 pounds.

YIELD OF WINTER WHEAT.

A small field of winter wheat was sown September 10, 1912, but was almost entirely winter killed. A small portion that was sheltered came through in good condition, and was harvested on August 13, 1913, yielding 32 bushels per acre. From the results of tests for a number of years it would seem that winter wheat is not suitable to southern Saskatchewan.

YIELDS OF WINTER RYE.

A field of 1 $\frac{3}{4}$ acres was sown to winter rye on September 12, 1912. This came through in good condition and produced a heavy crop of straw. It was harvested July 31, 1913. The yield was 37 bushels 40 pounds. A 10-acre field in Prelude was disced in the fall and sown to winter rye. It was sown on September 5 and came through the winter in good condition. The reason for sowing this fall rye on the Prelude stubble was the presence of wild oats in the previous crop, and it was thought that by seeding with winter rye the grain would be harvested before the wild oats were ripe. The effectiveness of this treatment will be noted and reported on next season.

YIELDS OF OATS.

Three varieties of oats were grown in field lots. These were sown between May 4 and May 7 and were ripe between August 15 and 25.

INDIAN HEAD.

SESSIONAL PAPER No. 16

OATS—Average and Total Yields, Indian Head, 1913.

Variety.	Cultivation.	Acres.	Yield per acre.		Total Yield.
			Bush.	Lb.	Bushels.
Banner.....	Summer-fallow.....	5	81	13	497
Banner.....	Stubble.....	5½	50	12	277
Banner.....	Stubble.....	5½	39	9	216
Banner.....	Stubble.....	6	46		276
Ligowo Swedish.....	Summer-fallow.....	5	62	13	312
Abundance.....	Summer-fallow.....	8	49	19	396
Total.....	35	1,884

Average yield per acre, 53 bushels 29 pounds.

YIELDS OF BARLEY.

Two varieties of six-row barley and one of two-row barley were sown in field lots on April 30 and May 1. The crop was harvested on August 12 and 13. Manchurian, which is a very promising variety, would have given a considerably larger yield had it not shelled so badly with the winds. This could possibly be remedied to some extent by cutting the barley before it becomes quite ripe.

BARLEY—Average and Total Yields, Indian Head, 1913.

Variety.	Cultivation.	Acres.	Yield per acre.		Total yield.	
			Bush.	Lb.	Bush.	Lb.
Manchurian.....	Summer-fallow.....	12	61	35	699	03
Manchurian.....	Root land.....	6	55	32	334	
Manchurian.....	Summer-fallow.....	6½	55	4	358	01
Manchurian.....	Summer-fallow.....	6½	43	8	380	30
O. A. C. No. 21.....	Summer-fallow.....	2½	52	46	132	19
Canadian Therpe.....	Summer-fallow.....	5	49	26	247	34
Total.....	38½	2,051	39

Average yield per acre, 53 bushels 14 pounds.

YIELD OF FLAX.

The Premost variety only is grown in our field lots. It has proven superior to the other sorts under test.

YIELD of Flax, Indian Head, 1913.

Variety.	Cultivation.	Date sown.	Date up.	Days to mature.	Length of straw.	Yield of straw per acre.	Yield of grain per acre.	Weight per measured bushel.
					Inches.	Tons.	Bushels.	Lb.
Premost....	Summer-fallow.....	August 8....	September 3	118	29	1.344	24	54
Premost....	Summer-fallow.....	August 16...	September 6	113	29	1.344	24	54½

YIELD OF FIELD PEAS.

Early maturity is the most important point in connection with the growing of peas in this district. For this reason only the Arthur variety is grown. Peas sown on sod that is broken and backset the year previous mature earlier than when sown after summer-fallow.

YIELD of Field Peas, Indian Head, 1913.

Variety.	Size of pea.	Date sown.	Date ripe.	Days to mature.	Length of straw.	Length of pod.	Yield of straw per acre.	Yield of grain per acre.	Weight per measured bushel.
					Inches.	Inches.	Lb.	Bush Lb.	Lb.
Arthur (backsetting).....	Large.....	April 23...	Aug. 27....	126	59	2	2,260	37 40	64
Arthur (summer-fallow..)	Large.....	April 24...	Sept. 10...	139	78	2	1,912	31 31	64

COST OF PRODUCTION OF FIELD CROPS.

At the present time there is considerable controversy as to the cost of producing our farm crops. Three years ago when the rotation work was inaugurated on this Farm, the keeping of data on the cost of production of the different crops was begun. For this, as well as for our rotation work, fixed values are used, schedule of which is given on page 156.

SESSIONAL PAPER No. 16

The following table summarizes the cost of production of the more important field crops grown this year:—

Cost of Production of Field Crops, Indian Head, 1913.

Crop.	Acreage.	Soil Preparation.	Cost per acre.	Cost per bushel.	Cost per ton.	Value per acre.	Profit per ac. e.
			\$ c.	Cents.	\$ c.	\$ c.	\$ c.
Wheat.....	22½	Summer-fallow....	11 87	29.14	35 45	*23 38
Wheat.....	17½	Stubble land (burnt).....	11 59	32.5	30 19	18 60
Wheat.....	5½	Corn land.....	12 18	28.8	33 72	21 54
Oats.....	16	Stubble land (spring ploughed)	11 59	22.1	21 58	9 99
Barley.....	6	Root land.....	12 52	22.5	29 47	16 95
Hay.....	16½	Seeded with nurse crop.....	6 70	5 19	13 05	6 35
Corn.....	6	Summer-fallow....	14 07	1.26	33 30	*19 23
Roots.....	5½	Summer-fallow....	28 42	1 38	64 20	*35 78

*This does not include the cost of summer-fallowing.

ROTATION OF CROPS.

Southern Saskatchewan is devoted primarily to grain-growing, and wheat has been the only crop grown extensively since the country was first settled. It will no doubt remain the important crop for some years to come because of our location and climatic conditions. But that there must be a change in the system of cropping is admitted by all up-to-date farmers, for the growing of wheat alone and summer-fallowing every third year, is too favourable to the introduction of weeds, the exhaustion of the soil fibre and the depletion of fertility. If the quantity and quality of wheat are to be maintained, loss from these causes must be guarded against. Suitable rotations of crops will do much to minimize these losses. With this in mind, a number of different rotations have been put in operation to test their adaptability to this district. The costs, returns and profits of these rotations are being recorded, and analyses will be made from time to time to gather information as to their effect on soil fertility.

ROTATION "C" (THREE YEARS' DURATION).

First year.—Summer-fallow.

Second year.—Wheat.

Third year.—Wheat.

This rotation consists of three fields containing 6½ acres each. In 1913 the entire rotation gave a profit of \$9.61 per acre, and the average profit for two years is \$6.72 per acre.

This rotation is followed by the majority of farmers in the southern portion of the province. The rainfall being more or less sparse the summer-fallow is necessary to store moisture for the two succeeding crops. The objection to the long-continued use of this rotation is that it tends to exhaust the soil fibre, facilitates the introduction of weeds, and must ultimately deplete fertility.

ROTATION " J " (SIX YEARS' DURATION).

First year.—Summer-fallow.

Second year.—Wheat.

Third year.—Wheat.

Fourth year.—Oats. Seeded down with 8 pounds western ryè grass, 4 pounds alfalfa and 4 pounds red clover per acre.

Fifth year.—Hay.

Sixth year.—Pasture.

This was started in 1911 and consists of six fields containing 5 acres each. The profit per acre in 1913 was \$12.98. It would seem a rotation well suited to the needs of the farmer at present.

The grass will return fibre to the soil, and as the keeping of live stock is called for, there will be manure to help conserve fertility. The two years hay and pasture followed by summer-fallow will, to a great extent, keep the weeds under control. Seemingly, the greatest objection will be the difficulty, in a dry season, of procuring a good stand of grass with a nurse-crop on second year stubble.

ROTATION " P " (EIGHT YEARS' DURATION).

First year.—Summer-fallow.

Second year.—Wheat.

Third year.—Wheat.

Fourth year.—Summer-fallow.

Fifth year.—Roots or legumes. Manured 15 tons per acre.

Sixth year.—Barley. Seeded down with rye grass, red clover and alfalfa.

Seventh year.—Hay.

Eighth year.—Pasture.

This was started in 1911 and consists of eight fields containing 6 acres each. In 1913 the profit per acre was \$8.19. A rotation of this nature is adapted to a stock-raising district and will not be followed to any extent, locally, for some years. But as the weeds become more prevalent this, or a similar, rotation will have to be adopted, because there are six years out of the eight under crop and cultivation suitable for the eradication of weeds. The chief objection of applying it to the average farm at present is the small amount of grain and the large amount of hoed crop.

SESSIONAL PAPER No. 16

ROTATION "R" (NINE YEARS' DURATION).

First year.—Summer-fallow.

Second year.—Hoed crops or legumes. Manured 15 tons per acre.

Third year.—Wheat.

Fourth year.—Oats.

Fifth year.—Summer-fallow.

Sixth year.—Wheat.

Seventh year.—Oats. Seeded down with rye grass, red clover and alfalfa.

Eighth year.—Hay.

Ninth year.—Pasture.

This rotation was started in 1910 and consists of nine fields of $5\frac{1}{2}$ acres each. In 1913 a profit of \$9.45 per acre was received. As this is very similar to rotation "P" much the same criticism will apply.

In order to determine the profits from these rotations fixed values are used from year to year, as given on page 156 of this report.

Tabulated details are as follows:—

Rotation Year.	Crops.		Area.	ITEMS OF EXPENSE								
				Rent and manure.	Seed, twine and use of machinery.	Manual labour.		Horse labour (including teamster).				
								Hours.				
						Hours.	Cost.	Single horse	2-horse team	3-horse team	4-horse team	5-horse team
	1912.	1913.	Ac.	\$ c.	\$ c.	No.	\$ c.	No.	No.	No.	No.	No.
3rd...	Wheat.....	Wheat.....	6 $\frac{1}{4}$	12 50	20 54	9	1 71	4	35
1st...	Wheat.....	Summer-fallow	6 $\frac{1}{4}$	12 50	3 75	36
2nd...	Summer-fallow	Wheat.....	6 $\frac{1}{4}$	12 50	20 54	16 $\frac{1}{2}$	3 14	9	28 $\frac{3}{4}$
	Aggregate.....		18 $\frac{3}{4}$	37 50	44 83	25 $\frac{1}{2}$	4 85	13	99 $\frac{1}{4}$
	Average per acre, 1913.....		2 00	2 39	1.3	0 25	7	5.3

ROTATION

2nd...	Summer-fallow	Wheat.....	5	10 00	16 19	17	3 23	14	23
3rd...	Wheat.....	Wheat.....	5	10 00	16 19	12	2 28	4	29
4th...	Wheat.....	Oats.....	5	10 00	15 19	16	3 04	6	34 $\frac{1}{2}$
5th...	Wheat.....	Hay.....	5	10 00	10 55	16 $\frac{1}{2}$	3 14	13 $\frac{1}{2}$
6th...	Wheat.....	Pasture.....	5	10 00	7 55
1st...	Wheat.....	Summer-fallow	5	10 00	3 00	44 $\frac{1}{2}$
	Aggregate.....		30	60 00	68 67	61 $\frac{1}{2}$	11 69	37 $\frac{1}{2}$	130 $\frac{3}{4}$
	Average per acre, 1913.....		2 00	2 29	0 39

ROTATION

4th...	Wheat.....	Oats.....	5 $\frac{1}{2}$	20 16	16 70	13 $\frac{1}{2}$	2 57	6 $\frac{1}{2}$	16 $\frac{1}{2}$
5th...	Oats.....	Summer-fallow	5 $\frac{1}{2}$	20 16	3 30	15	2 85	29 $\frac{1}{2}$
6th...	Summer-fallow	Wheat.....	5 $\frac{1}{2}$	20 16	18 09	9	19 $\frac{1}{2}$
7th...	Wheat.....	Oats.....	5 $\frac{1}{2}$	20 16	16 70	16 $\frac{1}{2}$	3 09	4 $\frac{1}{2}$	21 $\frac{1}{4}$
8th...	Oats.....	Hay.....	5 $\frac{1}{2}$	20 16	11 60	10	1 90	2	15
9th...	Hay.....	Pasture.....	5 $\frac{1}{2}$	20 16	8 31
1st...	Pasture.....	Summer-fallow	5 $\frac{1}{2}$	20 16	3 30	24 $\frac{1}{2}$
2nd...	Summer-fallow	Roots.....	5 $\frac{1}{2}$	20 16	5 81	449	85 32	24	104	7 $\frac{3}{4}$
3rd...	Corn.....	Wheat.....	5 $\frac{1}{2}$	20 16	18 09	17	3 23	3 $\frac{3}{4}$	19
	Aggregate.....		49.5	181 44	101 90	520 $\frac{3}{4}$	98 96	26	143	137 $\frac{3}{4}$
	Average per acre, 1913.....		3 67	2 06	1 99

ROTATION

3rd...	Wheat.....	Wheat.....	6	23 25	19 73	14	2 66	12	36 $\frac{1}{2}$
4th...	Wheat.....	Summer-fallow	6	23 25	3 60	17 $\frac{1}{2}$
5th...	Summer-fallow	Corn.....	6	23 25	12 23	78 $\frac{1}{2}$	14 92	21 $\frac{1}{2}$	62 $\frac{1}{2}$	70
6th...	Roots.....	Barley.....	6	23 25	21 23	33 $\frac{1}{2}$	6 37	7 $\frac{1}{2}$	27 $\frac{3}{4}$
7th...	Barley.....	Hay.....	6	23 25	12 66	9	1 71	4 $\frac{1}{2}$	15
8th...	Hay.....	Pasture.....	6	23 25	9 06
1st...	Pasture.....	Summer-fallow	6	23 25	3 60	60 $\frac{3}{4}$
2nd...	Summer-fallow	Wheat.....	6	23 25	19 73	18	3 42	10	26
	Aggregate.....		48	186 00	101 84	153	29 08	25 $\frac{3}{4}$	107	238 $\frac{1}{2}$
	Average per acre, 1913.....		3 87	2 12	0 60 $\frac{1}{2}$

SESSIONAL PAPER No. 16

"C" (three years' duration).

IN RAISING CROP.						Height of Stubble.	PARTICULARS OF CROP.						
Value of horse labour.	Cost of threshing.	Total cost.	Cost for 1 acre.	Cost for 1 bushel.	Cost for 1 ton.		Weight.				Total value.	Value of crop per acre.	Profit or loss per acre.
							Grain.	Straw.	Hay.	Hoed crop.			
\$ c.	\$ c.	\$ c.	\$ c.	\$ c.	\$ c.	Ins.	Lb.	Lb.	Lb.	Lb.	\$ c.	\$ c.	\$ c.
15 71	12 25	62 71	10 03	35 8	6	10,500	11,176	145 59	23 29	13 26
14 76	31 01	4 96	6	-4 96
14 85	14 58	75 61	10 49	32 5	6	13,925	16,384	193 86	31 01	20 52
45 32	26 83	159 33	339 45
2 41	1 43	8 49	18 10	9 61

"J" (six years' duration).

14 19	16 54	60 15	12 03	25 4	6	14,200	17,328	197 99	39 59	27 56
13 25	14 27	55 99	11 20	27 4	6	12,230	15,328	170 73	34 15	22 95
16 08	16 28	60 59	12 12	14 8	6	13,838	16,178	154 55	30 91	18 79
4 59	28 28	5 66	13,110	65 55	13 11	7 45
.....	17 55	3 51	27 50	5 50	1 99
18 25	31 25	6 25	-6 25
66 36	47 09	253 81	616 32
2 21	1 57	8 46	20 54	12 08

"R" (nine years' duration).

9 07	10 91	59 41	10 80	21 4	6	9,418	10,540	104 72	19 04	8 24
12 10	38 41	6 98	6	-6 98
10 95	16 08	65 28	11 87	23 4	6	13,780	17,600	192 53	35 00	23 13
10 24	15 12	65 31	11 87	30	6	7,344	7,964	81 40	14 80	2 93
5 64	39 30	7 14	73 22	13 31	6 17
.....	28 47	5 17	30 27	5 50	0 33
10 05	33 51	6 09	-6 09
45 02	156 31	28 42	235,167	353 14	61 20	35 78
9 28	16 23	66 99	12 18	28 8	6	13,910	17,820	185 47	33 72	21 54
112 35	58 34	552 99	1,020 75
2 27	1 18	11 17	20 62	9 45

"P" (eight years' duration).

19 05	16 60	81 29	13 55	34 3	6	14,225	18,450	198 90	33 15	19 60
28 91	55 76	9 29	6	-9 29
31 03	84 43	14 07	6	1,332,660	195 80	33 30	19 23
13 93	16 70	81 48	13 58	24 4	6	16,032	16,500	176 82	29 47	15 89
6 25	43 87	7 31	75 50	12 72	5 41
.....	32 31	5 38	33 60	5 50	0 12
24 91	51 76	8 66	6	-8 66
14 06	18 20	78 66	13 11	30 2	6	15,600	19,628	217 81	36 30	23 19
141 14	51 50	509 56	902 63
2 94	1 07	10 61	18 80	8 19

5, GEORGE V., A. 1915

The following brief summary records the chief items in the rotations tabled in detail above.

COST OF OPERATIONS, Value of Products, and Profits of Rotation "C" "J," "P" and "R."

Rotation.	Area.	Total cost to operate.	Total value of products.	Profit per acre.
	Acres.	\$ cts.	\$ cts.	\$ cts.
"C" (3 years' duration).....	18 $\frac{3}{4}$	159 33	339 45	9 61
"J" (6 years' duration).....	30	253 81	616 32	12 08
"P" (8 years' duration).....	48	503 56	902 63	8 19
"R" (9 years' duration).....	49 $\frac{1}{2}$	552 99	1,020 75	9 45

SOIL CULTURAL EXPERIMENTS.

DEPTH OF PLOUGHING SUMMER-FALLOW TO BE SOWN TO WHEAT.

The land in this experiment was ploughed in June for summer-fallow at depths varying from 3 to 8 inches and from 5 to 8 inches with a 4-inch subsoiling.

No conclusions can be reached from the results of only two years' work along this line, but it might be pointed out that this year the plot ploughed 6 inches deep shows a slight advantage in yield over any of the others.

DEPTH OF PLOUGHING Summer-fallow to be Sown to Wheat.

Plot No.	Depth of ploughing summer-fallow, 1912.	Days to mature.	Yield of wheat per acre, 1913.	
			Bush.	Lb.
1	Ploughing 3 inches deep.....	131	32	00
2	Ploughing 4 inches deep.....	131	38	40
3	Ploughing 5 inches deep.....	131	36	00
4	Ploughing 6 inches deep.....	131	42	00
5	Ploughing 7 inches deep.....	131	36	40
6	Ploughing 8 inches deep.....	131	36	00
7	Ploughing 5 inches deep and subsoiling 4 inches.....	131	34	00
8	Ploughing 6 inches deep and subsoiling 4 inches.....	131	38	00
9	Ploughing 7 inches deep and subsoiling 4 inches.....	131	40	00
10	Ploughing 8 inches deep and subsoiling 4 inches.....	131	38	00

DEPTH OF PLOUGHING WHEAT STUBBLE TO BE SOWN TO OATS.

The wheat stubble of 1912, in the above experiment, was ploughed as in the table below for oats. The deep ploughing and subsoiling in preparation for the wheat crop preceding oats, seems to have had a favourable effect on the latter crop as will be noted in the table of results given herewith.

INDIAN HEAD.

SESSIONAL PAPER No. 16

DEPTH OF PLOUGHING Wheat Stubble to be sown to Oats.

Plot No.	Depth of ploughing summer-fallow for wheat, 1911.	Depth of ploughing wheat stubble fall of 1912.	Days to mature.	Yield of oats per acre, 1913.	
				Bush.	Lb.
1	Ploughed 3 inches.....	Ploughed 5 inches deep.....	113	64	24
2	" 4 "	" 4 "	113	58	26
3	" 5 "	" 5 "	115	58	26
4	" 6 "	" 5 "	115	64	24
5	" 7 "	" 5 "	115	68	08
6	" 8 "	" 5 "	115	75	10
7	Ploughed 5 inches, subsoiled 4 inches.....	" 5 "	115	76	24
8	Ploughed 6 inches, subsoiled 4 inches.....	" 5 "	115	78	28
9	Ploughed 7 inches, subsoiled 4 inches.....	" 5 "	115	67	2
10	Ploughed 8 inches, subsoiled 4 inches.....	" 5 "	115	95	10

While it is possible that the above tests have not been running long enough to give decisive data, this season's work would seem to indicate that while deep ploughing did not always give noticeable increases the first season, it did increase the yield the second season. The ploughing of summer-fallow should be at least 6 inches deep and fall ploughing for oats 5 inches.

DEPTH OF PLOUGHING SOD.

This experiment is being conducted in a four-year rotation of:—

First year.—Wheat.

Second year.—Oats. Seeded down.

Third year.—Hay.

Fourth year.—Hay.

The sod was ploughed 3, 4 and 5 inches deep in preparation for wheat, and the wheat stubble, 3, 4, 5 and 6 inches deep in preparation for oats.

DEPTH OF PLOUGHING Sod to be sown to Wheat followed by Oats.

Plot No.	Depth of ploughing sod, 1912.	Days to mature.	Yield of wheat per acre on sod.	Depth of ploughing wheat stubble for oats.	Days to mature.	Yield of oats per acre on wheat stubble.
			Lb.			Lb.
1	Ploughing 3 inches deep...	105	1,240	Ploughing 3 inches deep.	115	1,640
2	Ploughing 4 inches deep...	105	1,560	Ploughing 4 inches deep.	115	1,800
3	Ploughing 5 inches deep...	105	1,280	Ploughing 5 inches deep.	115	1,800
4	Ploughing 3 inches deep...	105	1,240	Ploughing 6 inches deep.	115	1,800

SUMMER-FALLOW TREATMENT.

The rotation used by the majority of farmers in southern Saskatchewan is:—

First year.—Summer-fallow.

Second year.—Wheat.

Third year.—Wheat or oats.

This means that one-third of the farm is in summer-fallow each season, consequently information as to the best methods of summer-fallowing is of vital importance. An experiment including fifteen different kinds of treatment was started in 1911. As climatic conditions will affect the yield materially, the average results for a number of years are necessary before deductions may be made. The table below outlines the different methods of cultivation and shows the yields of wheat as a result thereof. The yields of oats following the wheat are also given. It will be noted that the plot ploughed four inches deep in June, cultivated and ploughed 4 inches deep again in September gave best returns. The only other method that yielded nearly so high was the land that was fall disced before summer-fallowing, ploughed 6 inches deep in June, harrowed and packed as necessary. It must be remarked, however, that with the latter method weeds are under better control and the crop of oats following the wheat has surpassed all the others, so that, all things considered, it may be regarded as the most generally satisfactory treatment.

TREATMENT OF SUMMER-FALLOW to be sown to Wheat followed by Oats.

Plot No.	Treatment of summer-fallow, 1912.	Days to mature.	Yield of wheat per acre on summer-fallow.		Yield of oats per acre following wheat.	
			Bush.	Lb.	Bush.	Lb.
1	Plough 4 inches June, pack if necessary and practicable, cultivate as necessary.....	124	23	20	72	32
2	Plough 6 inches June, pack if necessary and practicable, cultivate as necessary.....	127	34	40	76	16
3	Plough 8 inches June, pack if necessary and practicable, cultivate as necessary.....	127	36	40	71	26
4	Plough 4 inches June, cultivate. Plough 4 inches September, harrow.....	127	40	00	76	16
5	Plough 6 inches June, cultivate. Plough 6 inches September, harrow.....	127	29	20	68	08
6	Plough 8 inches June, cultivate. Plough 8 inches September, harrow.....	127	36	00	67	02
7	Plough 6 inches June, cultivate..... Plough 4 inches September, harrow.....	127	38	40	76	16
8	Plough 4 inches June, cultivate. Plough 6 inches September, harrow.....	127	36	20	54	04
9	Plough 4 inches June, early as possible, cultivate. Plough 6 inches September, leave untouched.....	127	38	00	67	02
10	Plough 5 inches June, seed to rape or other green forage crop and pasture off.....	127	26	40	69	14
11	Plough 6 inches May 15, harrow and pack if necessary, cultivate as necessary.....	127	37	20	72	32
12	Plough 6 inches June 15, harrow and pack if necessary, cultivate as necessary.....	127	35	20	62	12
13	Plough 6 inches July 15, harrow and pack if necessary, cultivate as necessary.....	127	35	20	81	06
14	Fall cultivate before summer-fallowing. Plough 6 inches June, harrow and pack if necessary, cultivate as necessary.....	127	38	40	82	12
15	Fall plough 4 inches, before summer-fallowing. Plough 6 inches June, harrow and pack if necessary, cultivate as necessary.....	127	38	00	76	16
16	Plough 6 inches June, pack, cultivate as necessary.....	127	36	40	76	16
17	Plough 6 inches June, no packing, otherwise same as other plots.....	127	36	00	82	12

SESSIONAL PAPER No. 16

STUBBLE TREATMENT.

An experiment including ten different methods of stubble treatment has been running for two years. The indications are that the method calculated to conserve the moisture will give the highest yield. Fall ploughing and subsurface packing at once proved the most satisfactory method in the test just completed.

TREATMENT OF WHEAT STUBBLE to be sown to Wheat.

Plot No.	Treatment given wheat stubble preceding wheat.	Days to mature.	Yield of wheat per acre, 1913.	
			Bush.	Lb.
1	Plough autumn.....	128	13	20
2	Disc harrow autumn.....	128	14	40
3	Burn stubble, then disc autumn.....	128	18	00
4	Burn stubble, then plough autumn.....	127	24	00
5	Burn stubble in spring, seed at once.....	128	24	00
6	Plough in spring, seed at once.....	128	27	20
7	Disc at cutting time, spring plough.....	128	23	20
8	Disc at cutting time, autumn plough.....	128	20	00
9	Plough autumn, subsurface pack at once.....	128	30	09
10	Plough spring, seed, subsurface pack.....	128	26	40

TREATMENT OF WHEAT STUBBLE to be sown to Oats.

Plot No.	Treatment given wheat stubble preceding oats	Days to mature.	Yield of oats per acre, 1913.	
			Bush.	Lb.
11	Plough autumn, subsurface pack at once.....	115	60	00
12	Plough spring, seed, subsurface pack.....	115	77	32
13	Cultivate autumn, spring plough, seed.....	115	83	18

SEEDING TO GRASS AND CLOVER.

As interest grows in mixed farming the different methods of seeding down to grasses and clovers become a more important consideration.

In 1911 an experiment was begun to determine the best preceding crops and soil preparation for seeding to western rye grass and red clover. The results of only one test are as yet available. They are as follows:—

SEEDING to Grass and Clover.

Plot No.	Method of seeding.	Yield of first year hay.	
		Tons.	Lb.
1	Seeding rye grass 10 lb. and red clover 10 lb. with nurse crop on summer-fallow.....	4	1,440
2	Seeding rye grass 10 lb. and red clover 10 lb. alone after summer-fallow.....	4	1,660
3	Seeding rye grass 10 lb. and red clover 10 lb. with nurse crop on first year after hoed crop.....	5	600
4	Seeding rye grass 10 lb. and red clover 10 lb. alone after hoed crop.....	4	840
5	Seeding rye grass 10 lb. and red clover 10 lb. with nurse crop on first year wheat stubble.....	3	1,400
6	Seeding rye grass 10 lb. and red clover 10 lb. alone after first year wheat.....	3	1,760
7	Seeding rye grass and red clover with oats to cut green, on first year wheat stubble.....	3	100
8	Seeding rye grass 10 lb. and red clover 10 lb. alone on first year wheat stubble, manured 8 tons per acre, ploughed preceding fall.....	4	400
9	Seeding rye grass 10 lb. and red clover 10 lb. with nurse crop on second year wheat stubble.....	4	280
10	Seeding rye grass 10 lb. and red clover 10 lb. alone after second year grain oats.....	4	520
11	Seeding rye grass 10 lb. and red clover 10 lb. with nurse crop on second year after hoed crop.....	3	80

APPLICATION OF BARNYARD MANURE.

Southern Saskatchewan is a comparatively newly-settled country, and the problem of conserving soil fertility has not as yet forced itself upon us. In the older districts, however, where wheat growing has been followed year after year, yields are commencing to show a falling off and the need of methods for conserving fertility and restoring fibre is indicated. Probably the cheapest way of returning plant food and vegetable matter to the soil is by the use of barnyard manure. In order to learn something as regards how and when manure may be most advantageously applied the following experiments have been incepted.

Application of barnyard manure for corn and roots.

Corn was used in the test of 1913. In plots 1 to 7 wheat is grown two years in succession following corn; in plots 8 and 9 the rotation is corn, wheat, summer-fallow. The following table indicates the yield and value of the crops from the entire rotation. Corn is valued at \$3 per ton and wheat at 80 cents per bushel:—

SESSIONAL PAPER No. 16

APPLICATION of Barnyard Manure for Corn.

Plot No.	Application of manure.	Yield of corn per acre, 1913.		Yield of wheat per acre following corn, 1912.		Yield of wheat per acre following wheat, 1912.		Value of crops per acre for entire rotation.	
		Tons.	Lb.	Bush.	Lb.	Bush.	Lb.	\$	c.
1	No manure, plough second-year stubble in in autumn.....	11	1040	25	00	14	40	22	10
2	Apply in autumn after ploughing second-year stubble, work in at once.....	12	960	23	20	12	00	21	90
3	Apply in spring, on autumn ploughed second-year stubble, work in at once.....	11	800	20	00	18	00	21	53
4	Apply in autumn on second-year stubble, plough under in autumn.....	10	1820	18	40	16	00	20	19
5	Apply in spring on second-year stubble, plough under in spring.....	11	80	24	40	14	00	21	35
6	Apply in winter on second-year stubble, plough under in spring.....	12	960	26	40	16	40	24	03
7	Apply in winter green manure (cut straw) on second-year stubble, plough under in spring.....	13	1070	22	00	16	00	23	67
8	Apply in winter green manure (cut straw) on summer-fallow, disc in.....	11	1920	30	40	Summer-fallow		20	14
9	Summer-fallow, no manure.....	15	1200	42	40	"		26	98

Application of barnyard manure for wheat.

In this experiment there is followed a rotation of summer-fallow, wheat, wheat. In the case of plots 2 and 4 the manure is applied to affect the wheat crop after summer-fallow, whereas in the remaining plots it is applied to affect the second wheat crop of the rotation. To make a fair comparison of the different methods of application it is therefore necessary to average the yields for the two crop producing years of the rotation.

APPLICATION of Barnyard Manure for Wheat.

Plot No.	Application of manure.	Yield of wheat per acre on wheat stubble.		Yield of wheat per acre on summer-fallow.		Average yield of wheat per acre for entire rotation.	
		Bush.	Lb.	Bush.	Lb.	Bush.	Lb.
1	Apply in winter green manure (cut straw) on first-year stubble, disc in.....	16	40	34	00	25	20
2	Apply in winter green manure (cut straw) on summer-fallow, disc in.....	17	20	42	00	29	40
3	Top dress, with spreader, grain sown on first-year stubble	20	00	39	20	29	40
4	Top dress, with spreader, grain sown on summer-fallow	16	40	40	00	28	20
5	No manure, plough first-year stubble in autumn.....	16	40	38	00	27	20
6	Apply on first-year stubble, plough under in autumn..	26	00	38	40	32	20
7	Apply on first-year stubble, plough under in spring.....	19	20	38	00	28	40
8	No manure, disc first-year stubble in autumn.....	20	00	38	00	29	00
9	No manure, burn first-year stubble.....	34	00	38	40	36	20

Application of barnyard manure for barley.

In this experiment a three-year rotation has been adopted:—

First year.—Summer-fallow.

Second year.—Wheat, or barley where indicated.

Third year.—Barley, or oats where indicated. Where barley follows summer-fallow oats follow barley.

Owing to the different cropping systems followed a comparison of all the methods of application is somewhat difficult. Plots 2 and 4, in which barley is sown on summer-fallow and followed by oats, must be considered apart from the remaining plots where barley is sown on wheat stubble which follows summer-fallow. Barley and oats are valued at 1 cent and wheat at 1½ cents per pound and the average value per acre of the two crops taken so that the comparison of the different methods of application may be more clearly set forth.

APPLICATION of Barnyard Manure for Barley.

Plot No.	Application of manure.	Yield of wheat	Yield of barley	Value per acre of crops for entire rotation.	
		per acre on summer-fallow.	per acre on wheat stubble.	\$	c.
		Lb.	Lb.	\$	c.
1	Apply in winter green manure (cut straw) on first-year stubble, disc in.....	2040	1280	20	00
3	Top dress, with spreader, barley sown on first-year stubble.....	2240	1760	23	73
5	No manure, plough first-year stubble in autumn.....	2360	2000	25	73
6	Apply on first-year stubble, plough under in autumn....	3000	2000	30	00
7	Apply on first-year stubble, plough under in spring.....	2520	1840	26	00
8	No manure, disc first-year stubble in autumn.....	2320	1720	24	06
9	No manure, burn first-year stubble.....	2320	1800	24	46

APPLICATION of Barnyard Manure for Barley.

Plot No.	Application of manure.	Yield of barley	Yield of oats	Value of crops per acre for entire rotation	
		per acre on summer fallow	per acre on barley stubble	\$	c.
		Lb.	Lb.	\$	c.
2.....	Apply in winter green manure (cut straw) on summer-fallow, sow barley on summer-fallow	1,560	2,440	20	00
4.....	Top dress, with spreader, barley sown on summer fallow.....	2,000	1,920	19	60

Application of barnyard manure for oats.

In this experiment a three-year rotation is being followed:—

First year.—Summer-fallow.

Second year.—Wheat, or oats where indicated.

Third year.—Oats, or barley where indicated.

SESSIONAL PAPER No. 16

As in the previous experiment the different cropping systems followed make it necessary to consider plots 2 and 4 apart from the remaining plots and to average the value of both crops of the rotation in order to make a clear comparison of the different methods of applying manure. Oats and barley are valued at one cent and wheat at 1½ cents per pound.

APPLICATION of Barnyard Manure for Oats.

Plot No.	Application of manure.	Yield of wheat per acre on summer fallow.	Yield of oats per acre on wheat stubble	Average value of crops per acre for entire rotation
		Lb.	Lb.	\$ c.
1.....	Apply in winter green manure (cut straw) on first-year stubble, disc in.....	2,070	2,560	26 40
3.....	Top dress, with spreader, oats sown on first-year stubble.....	2,560	2,520	29 66
5.....	No manure, plough first-year stubble in autumn.....	2,320	2,560	29 46
6.....	Apply on first-year stubble, plough under in autumn.....	2,440	2,600	29 26
7.....	Apply on first-year stubble, plough under in spring.....	2,520	2,800	30 80
8.....	No manure, disc first-year stubble in autumn.....	2,640	3,360	34 40
9.....	No manure, burn first-year stubble.....	2,160	3,200	30 40

APPLICATION of Barnyard Manure for Oats.

Plot No.	Application of manure.	Yield of oats per acre on summer-fallow	Yield of barley per acre on oat stubble.	Average value of crops for entire rotation
		Lb.	Lb.	\$ c.
2.....	Apply in winter green manure (cut straw) on summer-fallow, sow oats on summer-fallow.....	2,040	1,160	16 00
4.....	Top dress, with spreader, oats sown on summer-fallow.....	2,440	1,760	21 00

GREEN MANURING.

Where barnyard manure is not available and the soil has become depleted of its fertility it is often desirable to plough under some green crop. If this crop is a legume so much the better, as nitrogen will then be added.

In the experiment tabulated below peas and tares are used as green crops and their value is being compared to a bare summer-fallow, and summer-fallow with manure. Oats are valued at one cent and wheat at 1½ cents per pound.

GREEN MANURING for Wheat followed by Oats.

Plot No.	Treatment of land year previous to wheat.	Yield of wheat	Yield of oats	Value of crops
		per acre.	per acre on wheat stubble	per acre for entire rotation
		Lb.	Lb.	\$ c.
1.....	Summer-fallow.....	2,240	2,120	25 53
2.....	Peas, ploughed under early in July.....	2,320	2,080	25 86
3.....	Peas, ploughed under when in bloom.....	2,120	2,200	25 13
4.....	Tares, ploughed under late July.....	2,120	2,240	25 33
5.....	Summer-fallow, batyard manure 12 tons per acre applied on summer-fallow.....	2,406	2,360	27 80
6.....	Summer-fallow.....	1,800	2,330	23 90

SEED-BED PREPARATION.

There is a great tendency, more especially in the newly-settled districts of Saskatchewan, to endeavour to seed a large acreage, often at the expense of the soil preparation. In order to learn to what extent careful preparation of the seed-bed for grain is actually profitable an experiment has been inaugurated in which the seed-bed for wheat and oats is prepared to three different degrees of perfection.

With the exception of one case, which is rather difficult to explain, the "good" and "extraordinary" treatments have greatly increased yields over the "poor" treatment.

PREPARATION of Seed Bed for Wheat.

Plot No.	Preparation given.	Yield of wheat per acre, 1913.	
		Bush.	Lb.
1.....	"Poor" (harrowed only once).....	12	00
2.....	"Good" (harrowed twice).....	20	40
3.....	"Extraordinary" (harrowed three times and packed).....	34	00

PREPARATION of Seed Bed for Oats.

Plot No.	Preparation given.	Yield of oats per acre, 1913.	
		Bush.	Lb.
1.....	"Poor" (harrowed twice).....	80	18
2.....	"Good" (harrowed three times).....	71	26
3.....	"Extraordinary" (harrowed four times and packed).....	75	10

SOIL PACKERS.

The soil packer being a comparatively new type of implement, the effect of its use is not widely known. In order to determine whether or not results justify its purchase, and if so, which type to buy and when to apply it, an experiment involving seventy-five plots was begun in 1911.

SESSIONAL PAPER No. 16

In the table of results presented below it will be noted that after ploughing for summer-fallow the application of the sub-surface packer greatly increased yields. Of the three different methods of packing after seeding in the spring the surface packer this year gave best results.

Harrowing the grain after it was up about six inches produced a higher yield than rolling or packing it at that period of growth.

SOIL PACKING for Wheat following Summer-fallow.

Plot No.	Cultural treatment given.	Days to mature.	Yield of wheat per acre, 1913.	
			Bush. Lb.	
1	Harrow, seed.....	129	41	20
2	" " surface pack.....	129	45	20
3	" " " harrow.....	129	40	40
4	" " subsurface pack.....	129	40	00
5	" " " harrow.....	129	41	20
6	" " combination pack.....	129	42	00
7	" " " harrow.....	129	47	20
8	Surface pack, seed, surface pack.....	129	45	20
9	Sub-surface pack, seed, subsurface pack.....	129	49	20
10	Combination pack, seed, combination pack.....	129	45	20
11	Surface pack, harrow, seed.....	129	51	00
12	Sub-surface pack, harrow, seed.....	129	52	40
13	Combination pack, harrow, seed.....	129	52	00
14	Harrow, seed.....	129	48	40
15	Plough for summer-fallow, surface pack, cultivate; next spring, smoothing harrow, seed.....	129	49	20
16	Plough for summer-fallow, subsurface pack, cultivate; next spring, smoothing harrow, seed.....	129	51	20
17	Plough for summer-fallow, combination pack, cultivate; next spring, smoothing harrow, seed.....	129	46	40
18	Plough for summer-fallow, surface pack, cultivate; next spring, smoothing harrow, seed, surface pack.....	129	42	40
19	Plough for summer-fallow, subsurface pack, cultivate; next spring, smoothing harrow, seed, subsurface pack.....	129	54	00
20	Plough for summer-fallow, combination pack, cultivate; next spring, smoothing harrow, seed, combination pack.....	129	45	20
21	Harrow, seed.....	129	47	20
22	" " harrow when 6 inches high.....	129	46	40
23	" " surface pack when 6 inches high.....	129	43	20
24	" " roll when 6 inches high.....	129	40	00
25	" "	129	42	40

SOIL PACKING for Wheat sown on Spring Ploughed Stubble Land.

Plot No.	Cultural treatment given.	Days to mature.	Yield of wheat per acre, 1913.	
			Bush. Lb.	
1	Harrow, subsurface pack, harrow, seed.....	133	29	20
2	Harrow, surface pack, harrow, seed.....	133	41	20
3	Harrow, combination pack, harrow, seed.....	133	43	20
4	Harrow, subsurface pack, harrow, seed, subsurface pack.....	133	34	00
5	Harrow, surface pack, harrow, seed, surface pack.....	133	42	40
6	Harrow, combination pack, harrow, seed, combination pack.....	133	34	40
7	Harrow, seed, harrow.....	133	29	20
8	Harrow, seed, surface pack.....	133	30	00
9	Harrow, seed, subsurface pack.....	133	34	00
10	Harrow, seed, combination pack.....	133	32	40
11	Harrow, seed.....	133	27	20

SOIL PACKING for Wheat sown on Fall Ploughed Stubble Land.

Plot No.	Cultural treatment given.	Days to mature.	Yield of wheat per acre, 1913.	
			Bush.	Lb.
12	No packer, harrow, seed	133	24	40
13	Subsurface pack in fall, seed in spring	133	17	20
14	Subsurface pack in spring, then seed	133	18	40
15	Subsurface pack in spring, after seeding	133	20	40
16	Surface pack in fall, seed in spring	133	24	10
17	Surface pack in spring, then seed	133	23	20
18	Surface pack in spring, after seeding	133	19	20
19	Combination pack in fall, seed in spring	133	28	00
20	Combination pack in spring, then seed	133	29	40
21	Combination pack in spring, after seeding	133	32	00
22	No packer, harrow, seed	133	26	00
23	Surface pack in fall, seed, surface pack	133	27	20
24	Subsurface pack in fall, seed, subsurface pack	133	26	00
25	Combination pack in fall, seed, combination pack	133	22	40

DEPTH OF SEEDING.

Oats and wheat were sown at depths varying from 1 to 4 inches. In each case there were remarkable differences in the yields. It would seem that the best results are obtained when wheat is sown from two to three inches deep and oats from three to four inches deep.

DEPTHS of Seeding Wheat.

Plot No.	Depths sown.	Days to mature.	Yield of wheat per acre, 1913.	
			Bush.	Lb.
1	Sowing 1 inch deep	132	43	20
2	Sowing 2 inches deep	132	44	40
3	Sowing 3 inches deep	132	44	20
4	Sowing 4 inches deep	132	37	40

SESSIONAL PAPER No. 16

DEPTHs of Sowing Oats.

Plot No.	Depths sown.	Days to mature.	Yield of oats per acre, 1913.	
			Bush.	Lb.
1	Sowing 1 inch deep.....	113	65	30
2	Sowing 2 inches deep.....	113	72	32
3	Sowing 3 inches deep.....	113	77	22
4	Sowing 4 inches deep.....	113	78	28

SPLIT LOG DRAG.

The value of the plank drag has been well demonstrated at this Farm. The roads are drag harrowed as soon as they start to dry after a rain. This levels them down and keeps them from rutting. As soon as they are dry enough to work nicely the road drag is put on which has the effect of rounding them up. In the dry weather the road drag is put on once a week. By following this system the grader is not used to any extent.

EXPERIMENTAL STATION FOR CENTRAL SASKATCHE- WAN, ROSTHERN, SASK.

REPORT OF THE SUPERINTENDENT, WM. A. MUNRO, B.A., B.S.A.

WEATHER CONDITIONS, 1913.

The precipitation was lower in 1913 than in 1911 or 1912, but was more evenly distributed throughout the season. This produced a much more uniform growth in the grain crops than occurred in 1912. Coupled with this was the fact that in 1913 there were no severe frosts until September 20, which allowed the grain to mature fully. The grain of 1913 was therefore of a superior grade.

There was the least snowfall in 1913-14 of any season since the establishment of the Station, in 1909.

A severe hailstorm damaging an area 2 miles wide and more than 30 miles long, passed within half a mile of the north boundary of the Station on July 25. The crops within the range of this storm were a total loss. On September 5 lightning struck and burned a shock of oats at a distance of 400 feet from the Superintendent's residence.

Seeding began on April 17, haying on July 21 and the harvesting of grain on August 13. The ground was frozen preventing further cultivation on October 27.

Following is the weather record for the year:—

SESSIONAL PAPER No. 16

MONTH.	TEMPERATURE F.			PRECIPITATION.			Heaviest in 24 hours.	Total Sunshine.
	Highest.	Lowest.	Mean.	Rainfall.	Snowfall.	Total.		
	°	°	°	Inches.	Inches.	Inches.	Inches.	Hours.
January.....	38.6	-49.5	-13.3	5.5	0.55	.20	73.9
February.....	35.0	-34.0	- 0.6	5.0	0.50	.25	103.8
March.....	41.1	-33.8	4.25	3.5	0.35	.20	160.3
April.....	72.2	14.8	40.45	.23	0.3	0.26	.13	203.0
May.....	78.7	22.1	46.3	1.26	1.26	.15	227.9
June.....	85.7	35.0	59.2	1.87	1.87	.48	234.7
July.....	84.1	39.7	59.4	3.80	3.80	1.26	289.2
August.....	82.1	39.7	60.0	3.59	3.59	1.47	248.7
September.....	84.1	29.7	50.6	2.89	2.89	1.48	231.5
October.....	69.0	0.7	32.1	2.9	.29	.18	126.4
November.....	52.9	- 3.9	22.45	.09	2.5	.34	.25	109.9
December.....	33.0	-21.8	12.59	109.5
Total for year.....	13.73	19.7	15.70	2,118.8
Average for three years.....	17.48	2,139.2
Total for six months, April to September...	13.67	1,435.0
Average for three years, April to September	14.06

CROP YIELDS.

The varieties of grains used in our general farm work are Marquis wheat, O.A.C. No. 21 barley and Banner oats.

YIELDS OF WHEAT.

The average yield per acre of Marquis wheat on 8 acres of fallow was 26 bushels 40 pounds in 1912, and 38 bushels 59 pounds in 1913. The average per acre on 6 acres of fall-ploughed stubble was 15 bushels 24 pounds in 1912, and 22 bushels 27 pounds in 1913. The yield per acre on 2 acres of corn ground was 33 bushels in 1912, and 52 bushels 11 pounds in 1913. It is rather significant that the average yield after corn (preceded by summer-fallow) is higher than the average yield for the same years directly after summer-fallow.

YIELDS OF BARLEY.

Manchurian barley yielded at the rate of 96 bushels 32 pounds per acre in 1911, and 55 bushels 40 pounds per acre in 1912. It is similar in appearance and yield to O.A.C. No. 21. Two acres of O.A.C. No. 21 on root ground yielded 45 bushels 27 pounds per acre in 1912, and 53 bushels 41 pounds per acre in 1913.

YIELDS OF OATS.

Six acres of Banner oats on fall-ploughed wheat stubble yielded an average of 69 bushels 26 pounds per acre in 1912, and 4 acres yielded an average of 74 bushels 19 pounds per acre in 1913.

ROTATION OF CROPS.

Four rotations have been in operation for three years, and a careful record kept of the total cost to operate and the resulting crop. The area of each lot in each rotation is exactly 2 acres, which makes the conditions as nearly like ordinary field conditions as is possible on a small Experimental Farm.

ROTATION "C."

First year.—Summer-fallow.

Second year.—Wheat.

Third year.—Wheat or coarse grain.

ROTATION "J."

First year.—Summer-fallow.

Second year.—Wheat.

Third year.—Wheat or coarse grain.

Fourth year.—Oats. Seeded down with rye grass, red clover and alfalfa.

Fifth year.—Hay.

Sixth year.—Pasture.

SESSIONAL PAPER No. 16

ROTATION " P. "

First year.—Summer-fallow.*Second year.*—Wheat.*Third year.*—Wheat.*Fourth year.*—Summer-fallow.*Fifth year.*—Hoed crops or legumes.*Sixth year.*—Barley. Seeded down with rye grass, red clover and alfalfa.*Seventh year.*—Hay.*Eighth year.*—Pasture.

ROTATION " R. "

First year.—Summer-fallow.*Second year.*—Hoed crop or legumes. Manured 15 tons per acre.*Third year.*—Wheat.*Fourth year.*—Oats.*Fifth year.*—Summer-fallow.*Sixth year.*—Wheat.*Seventh year.*—Oats. Seeded down with rye grass, red clover and alfalfa.*Eighth year.*—Hay.*Ninth year.*—Pasture.

The valuations that have been fixed for computing the results of these rotation experiments will be found on page 156.

Details of operations in 1913, are given in the following tables:—

Rotation Year.	Crops.		ITEMS OF EXPENSE									
			Area.	Rent and manure.	Seed, twine and use of machinery.	Manual labour.		Horse labour (including teamster).				Value of horse labour.
						Hours.	Cost.	Hours.				
								Single horse	2-horseteam	3-horseteam	4-horseteam	
	1912	1913.	Ac.	\$ c.	\$ c.	No.	\$ c.	No.	No.	No.	No.	\$ c.
1st...	Wheat.....	Summer-fallow	2	4 00	1 20					15		6 15
2nd...	Summer-fallow	Wheat.....	2	4 00	6 10	4	76		1½	8½		3 99
3rd...	Wheat.....	Wheat.....	2	4 00	6 95	4	76		1½	3½		1 95
	Aggregate.....		6	12 00	14 25	8	1 52		3	27		12 09
	Average per acre.....			2 00	2 37		25					2 01

ROTATION "J"

3rd...	Wheat.....	Wheat.....	2	4 00	6 95	4	76		1½	8½		3 99
4th...	Wheat.....	Oats.....	2	4 00	10 43	1	19		4½	3		2 76
5th...	Oats.....	Hay.....	2	4 00	1 20				3			1 02
6th...	Hay.....	Hay.....	2	4 00	1 20				3	6		3 48
1st...	Hay.....	Summer-fallow	2	4 00	1 20					18		7 38
2nd...	Summer-fallow	Wheat.....	2	4 00	7 05	4	76		1½	2¾		1 64
	Aggregate.....		12	24 00	28 03	9	1 67		13½	38¼		20 27
	Average per acre.....			2 00	2 33		14					1 69

ROTATION "P"

3rd...	Wheat.....	Wheat.....	2	7 75	6 95	4	76		1½	8¼		3 89
4th...	Wheat.....	Summer-fallow	2	7 75	1 20				2	17		7 65
5th...	Summer-fallow	Roots.....	2	7 75	6 80	224½	42 66	8	3			3 18
6th...	Roots.....	Barley.....	2	7 75	11 53	5	95		1½	11		5 02
7th...	Barley.....	Hay.....	2	7 75	7 04	2	38			6½		2 66
8th...	Hay.....	Hay.....	2	7 75	1 20				3	6		3 48
1st...	Hay.....	Summer-fallow	2	7 75	1 20					18		7 38
2nd...	Summer-fallow	Wheat.....	2	7 75	6 30	3½	66		1½	7¾		3 68
	Aggregate.....		16	62 00	41 72	239	45 41					36 94
	Average per acre.....			3 88	2 60		2 84					2 31

ROTATION "R"

3rd...	Corn.....	Wheat.....	2	7 33	7 15	4	76		1½	11½		5 22½
4th...	Wheat.....	Oats.....	2	7 33	6 80	4	76		2½	7½		3 92½
5th...	Oats.....	Summer-fallow	2	7 33	1 20				1	14		6 08
6th...	Summer-fallow	Wheat.....	2	7 33	7 05	4	76		2½	3		2 08
7th...	Wheat.....	Oats.....	2	7 33	10 93				2½	4		2 49
8th...	Oats.....	Hay.....	2	7 33	1 20				3			1 02
9th...	Hay.....	Hay.....	2	7 33	1 20				3	6		3 48
1st...	Hay.....	Summer-fallow	2	7 33	1 20					18		7 38
2nd...	Summer-fallow	Corn.....	2	7 33	4 40	81	15 39	5	5	4½		4 89
	Aggregate.....		18	65 97	41 13	93	17 67	5	21	68½		36 57
	Average per acre.....			3 66	2 28		98					2 03

SESSIONAL PAPER No. 16

(Three years' duration).

IN RAISING CROP.				Height of stubble.	PARTICULARS OF CROP.						
Cost of threshing.	Total cost.	Cost for 1 acre.	Cost for 1 bushel.		Weight.				Total value.	Value of crop per acre.	Profit or loss per acre.
					Grain.	Straw.	Hay.	Wood crop.			
£ c.	£ c.	£ c.	£ c.	Inch.	Lb.	Lb.	Lb.	Lb.	£ c.	£ c.	£ c.
.....	11 35	5 67	-5 67
5 93	20 78	10 39	24	5,080	9,531	72 49	36 24	25 85
2 84	16 50	8 25	40	2,430	5,126	34 96	17 48	9 23
8 77	48 63	7,510	14,657	107 45
1 46	8 10	17 91	9 81

(Six years' duration).

3 53	19 23	9 61	38	3,030	7,067	43 93	21 96	12 35
.....	17 38	8 69	10,343	51 71	25 85	17 16
.....	6 22	3 11	4,570	22 85	11 42	8 31
.....	8 68	4 34	4,670	23 35	11 67	7 33
.....	12 58	6 29	-6 29
5 20	18 65	9 33	25	4,468	8,844	63 99	31 99	22 66
8 73	82 74	205 83
72	6 89	17 15	10 26

(Eight years' duration).

3 06	22 41	11 20	51	6	2,622	6,586	38 25	19 12	7 92
.....	16 60	8 30	-8 30
.....	60 39	30 19	71,406	107 10	53 55	23 36
5 38	30 63	15 31	27	5,170	6,766	58 46	29 23	13 92
.....	17 83	8 91	-8 91
.....	12 43	6 21	5,584	27 92	13 96	7 75
.....	16 33	8 16	-8 16
4 99	23 38	11 69	32	6	4,280	7,656	60 89	30 44	18 75
13 43	200 00	292 62
84	12 50	18 29	5 79

(Nine years' duration).

7 30	27 76½	13 88	25	6,262	9,661	88 32	44 16	30 28
6 75	25 56	12 78	26	5,734	6,410	63 75	31 87	19 09
.....	14 61	7 30½	-7 30
5 70	22 92	11 46	28	4,882	7,916	69 04	34 52	23 07
6 36	27 11	13 55	30	5,408	5,822	59 90	29 95	16 40
.....	9 55	4 77	4,134	20 67	10 32	5 56
.....	12 01	6 00	5,900	29 50	14 75	8 75
.....	15 91	7 95	-7 95
.....	32 01	16 00	79,240	118 86	59 43	43 43
26 11	187 45	450 04
1 45	10 41	25 00	14 59

COST OF OPERATIONS, Value of Products and Profits of Rotations "C," "J," "P,"
and "R."

Rotation.	Area.	Total cost to operate.	Total value of products.	Total profit.	PROFIT PER ACRE.	
					1912.	1913
					\$ c.	\$ c.
"C" 3 years' duration.....	6	48 63	107 45	58 82	3 89	9 81
"J" 6 years' duration.....	12	82 74	205 83	123 09	5 66	10 23
"P" 8 years' duration.....	16	200 00	292 62	92 62	7 65	5 79
"R" 9 years' duration.....	18	187 45	450 04	262 59	11 26	14 59

The results from two years' work on these rotations tend to show:—

1. That land worked under a rotation including grains and hay gives a greater profit per acre than where wheat alone is grown, and this is emphasized in a season of early frosts.

2. That a hoed crop in the rotation increases the cost of operation per acre, but very much more increases the profit per acre as well as the yield of the succeeding grain crops.

3. That the diversity of crops affords more suitable food for live stock. When these crops are marketed through the medium of live stock, greater profit per acre would accrue than is here shown.

CULTURAL INVESTIGATION WORK.

A series of soil cultural experiments has been carried on for two years. Marked results as yet have not been obtained. Some treatments that were apparently superior in 1912 have proven inferior in 1913. When, however, these results are related to the precipitation for the corresponding seasons the discrepancies are at least partly explained. The total precipitation for the year ending March, 1913, was 18.60 inches, and for the year ending March, 1914, was 15.50 inches. There were 3 inches more rainfall in 1912 than in 1913, and yet the crops suffered more from drought in 1912 than in 1913 because of the difference in the distribution throughout the season. In 1912 there was no rain in June until the end of the month, and then there were over 7 inches before the end of July. In 1913 the showers were more frequent.

Following are the results of the various experiments under way:—

PRAIRIE BREAKING.

In this experiment five plots are broken each year according to the directions given below. Test No. 1 was commenced in 1911 and No. 2 in 1912. Test No. 1 will be concluded in 1915 and No. 2 in 1916.

The sequence of the crops is as follows:—

First year.—Broken and treated as indicated below.

Second year.—Wheat.

Third year.—Wheat.

Fourth year.—Summer-fallow.

Fifth year.—Wheat.

ROSTIERN.

SESSIONAL PAPER No. 16

TEST NO. 1, BROKEN 1911.

The stubble of the wheat crop which followed the breaking of 1911, was ploughed in the fall of 1912, harrowed April 23, 1913, disced and sown to Marquis wheat April 21, packed April 25. Wheat came up May 20, headed out July 11, ripened and was cut on August 30.

Test No. 1, Broken 1911.

Plot No.	Treatment when breaking 1911.	Yield of wheat per acre 1912.	Yield of wheat per acre 1913.
		Lb.	Lb.
1	Plough 3 inches to 4 inches early spring, pack, double disc, harrow, double disc, sow to peas and oats.	2,010	1,770
2	Plough 3 inches to 4 inches early spring, pack, double disc, harrow, double disc, sow to flax.	2,090	2,080
3	Plough 3 inches to 4 inches early spring, pack, double disc, harrow, sow to flax.	1,680	2,280
4	Break early June, 4 inches to 5 inches, keep cultivated from day broken.	2,440	1,880
5	Break early June, 2 inches to 3 inches, roll, backset early September, keep cultivated from day broken.	2,460	2,960

DEPTH OF PLOUGHING WHEAT STUBBLE TO BE SOWN TO OATS

The wheat stubble was ploughed in the spring of 1913 for the oat crop of 1913.

DEPTH OF PLOUGHING Wheat Stubble to be sown to Oats.

Plot No.	Depth of ploughing.	Yield of Oat per acre 1913.
		Lb.
1	Ploughed 3 inches deep.	3,490
2	" 4 " "	3,440
3	" 5 " "	4,130

DEPTH OF PLOUGHING SUMMER-FALLOW TO BE SOWN TO WHEAT.

The summer-fallow for the crop of 1913 was ploughed on June 8, 1912.

DEPTH OF PLOUGHING Summer-fallow to be sown to Wheat.

Plot No.	Depth of ploughing summer-fallow.	Yield of wheat per acre 1913.
		Lb.
1	Ploughed 3 inches deep	2,080
2	" 4 " "	2,460
3	" 5 " "	2,240
4	" 6 " "	2,360
5	" 7 " "	2,280
6	" 8 " "	2,400
7	" 5 " " subsoiled 4 inches	2,600
8	" 6 " " " 4 " "	2,560
9	" 7 " " " 4 " "	2,840
10	" 8 " " " 4 " "	2,600

DEPTH OF PLOUGHING SOD.

Western rye grass sod was ploughed July 19, 1912, for a crop of wheat in 1913.

DEPTH OF PLOUGHING Sod to be sown to Wheat.

Plot No.	Depth of ploughing sod.	Yield of wheat per acre 1913.
		Lb.
1	Ploughed 3 inches deep.....	2,440
2	" 4 " ".....	2,640
3	" 5 " ".....	2,480

SUMMER-FALLOW TREATMENT.

Seventeen plots were summer-fallowed as given below and sown to wheat followed by oats.

TREATMENT OF SUMMER-FALLOW to be sown to Wheat followed by Oats.

Plot No.	Treatment of summer-fallow 1912.	Yield of wheat per acre. 1913.
		Lb.
1	Plough 4 inches June, pack if necessary and practicable, cultivate as necessary ..	2,000
2	Plough 6 inches June, pack if necessary and practicable, cultivate as necessary ..	2,320
3	Plough 8 inches June, pack if necessary and practicable, cultivate as necessary ..	2,240
4	Plough 4 inches June, cultivate. Plough 4 inches September, harrow.....	2,000
5	Plough 6 inches June, cultivate. Plough 6 inches September, harrow.....	1,920
6	Plough 8 inches June, cultivate. Plough 8 inches September, harrow.....	1,920
7	Plough 6 inches June, cultivate. Plough 4 inches September, harrow.....	1,920
8	Plough 4 inches June, cultivate. Plough 6 inches September, harrow.....	1,680
9	Plough 4 inches June, early as possible, cultivate. Plough 6 inches September, leave untouched.....	1,560
10	Plough 5 inches June, seed to rape or other green forage crop and pasture off..	1,280
11	Plough 6 inches May 15, harrow and pack if necessary, cultivate as necessary...	2,240
12	Plough 6 inches June 15, harrow and pack if necessary, cultivate as necessary...	2,400
13	Plough 6 inches July 15, harrow and pack if necessary, cultivate as necessary ..	2,440
14	Fall cultivate before summer-fallowing. Plough 6 inches June, harrow and pack if necessary, cultivate as necessary.....	2,600
15	Fall plough 4 inches before summer-fallowing. Plough 6 inches June, harrow and pack if necessary, cultivate as necessary.....	2,680
16	Plough 6 inches June, pack, cultivate as necessary.....	2,440
17	Plough 6 inches June, no packing, otherwise same as other plots.....	2,680

SESSIONAL PAPER No. 16

GREEN MANURING.

This experiment shows more than any other at the Station the beneficial effect of barnyard manure. Throughout the season plot 5, on which barnyard manure was applied for wheat, stood from two to four inches higher than the other plots, and a similar advantage was noted on the succeeding oat crop.

GREEN MANURING for Wheat followed by Oats.

Plot No.	Treatment of land year previous to wheat.	Yield of wheat per acre. 1913.
		Lb.
1.....	Summer-fallow.....	2,720
2.....	Peas, ploughed under early in July.....	2,680
3.....	Peas, ploughed under when in bloom.....	2,440
4.....	Tares, ploughed under late July.....	2,520
5.....	Summer-fallow, barnyard manure 12 tons per acre applied on summer-fallow in September.....	3,680
6.....	Summer-fallow.....	2,280

DEPTHIS OF SEEDING.

Oats and wheat were sown at depths varying from one to four inches.

DEPTHIS of Seeding Wheat.

Plot No.	Depth sown.	Yield of wheat per acre 1913.
		Lb.
1	Sowing 1 inch deep.....	2,720
2	" 2 inches deep.....	2,760
3	" 3 ".....	2,560
4	" 4 ".....	2,120

DEPTHIS of Seeding Oats.

Plot No.	Depth sown.	Yield of oats per acre 1913.
		Lb.
1	Sowing 1 inch deep.....	3,800
2	" 2 inches deep.....	3,600
3	" 3 ".....	4,320
4	" 4 ".....	4,360

EXPERIMENTAL STATION FOR NORTHWESTERN SASKATCHEWAN, SCOTT, SASK.

REPORT OF THE SUPERINTENDENT, R. E. EVEREST, B.S.A.

WEATHER AND CROP CONDITIONS, 1913.

The season of 1913 was favourable to growth and a fair crop of good quality was harvested. Seeding commenced April 8, haying July 23, the harvesting of grain August 7. On October 27 the ploughing was stopped by frost.

SOME WEATHER OBSERVATIONS taken at Scott Experimental Station, 1913.

Month.	TEMPERATURE F.			PRECIPITATION.			Total sunshine.	
	Mean.	Highest.	Lowest.	Rainfall.	Snowfall.	Total.		Heaviest. in 24 hours.
	°	°	°	Inches.	Inches.	Inches.	Inches.	Hours.
January.....	-8.86	38.8	-43.8	0.59	83.9
February.....	3.33	38.8	-35.4	0.42	104.4
March.....	11.08	46.0	-35.6	0.23	157.4
April.....	43.23	79.0	14.1	0.15	0.15	0.09	238.1
May.....	45.61	84.9	18.2	0.95	0.95	0.50	247.3
June.....	56.72	90.1	28.7	1.28	1.28	0.40	220.1
July.....	59.85	87.4	35.2	2.98	2.98	0.85	282.3
August.....	59.89	86.1	34.3	2.62	2.62	0.68	238.8
September.....	51.24	86.0	20.1	1.21	1.21	1.21	234.5
October.....	32.99	72.0	-5.4	0.46	0.46	0.20	137.0
November.....	23.90	54.8	-8.8	2.5	0.25	0.25	108.8
December.....	15.57	40.5	-12.875	0.03	0.05	101.1
Total for year...	9.68	3.25	11.25	2153.7

YIELDS OF FIELD CROPS.

FIELD CROP Areas and Yields, Scott, 1913.

Crop.	Acreage.	Yield per acre.
Wheat, Marquis.....	15.80	25 bush.
Oats, Ligowo.....	6.80	54 "
Oats, Banner.....	0.80	98 "
Barley, Manchurian.....	1.50	20 "
Peas, Arthur.....	3.83	23 "
Western Rye Grass Hay.....	1 ton 937 lb.
Peas and oats (cured for hay).....	1 ton 181 lb.

SESSIONAL PAPER No. 16

COST OF PRODUCTION OF FIELD CROPS.

In recording the results of the rotation experiments figures on the cost of production of the various crops have been obtained. They are summarized in the following table.

COST OF PRODUCTION of Field Crops, Scott, 1913.

Crop.	Area.	Yield per acre.		COST TO PRODUCE.	
				Per acre.	Per bushel.
	Acre.	Bush.	Lb.	\$ cts.	Cents.
Wheat.....	15.94	23	45	7 78	33.45
Oats.....	4.53	52	19	8 36	15.99
Barley.....	4.59	20	16	7 44	36.59
Peas.....	3.83	22	18	8 94	40.19

ROTATION OF CROPS.

ROTATION "A" (GRAIN CONTINUOUSLY).

On this area, which comprises 1 acre, wheat is the grain crop used. The land is given good cultivation. No return of manure or fertilizer is made to this area. By carrying on this work over a series of years information as to the power of our soil to grow wheat continuously will be obtained.

ROTATION "C" (THREE YEARS' DURATION).

First year.—Summer-fallow.

Second year.—Wheat.

Third year.—Wheat.

Rotation "C" is a straight grain-growing rotation commonly used where it is desired to make wheat the main crop. When the cultural operations are timely, and thoroughly performed, this rotation is fairly satisfactory for a time at least. By its use the land may be kept clean and in a good state of tilth. Further, the growing of two crops with the use of three years' rainfall ensures to the growing crop a sufficient amount of moisture to produce a fair yield of wheat. There is the danger in this rotation that in time the soil will become deficient in fibre and humus, that crop yields will show a falling off, and that the single crop may meet with some disaster from inclement weather before maturity. The net profit per acre from rotation "C" in 1913 was \$4.78.

SCOTT.

ROTATION "J" (SIX YEARS' DURATION).

First year.—Summer-fallow.

Second year.—Wheat.

Third year.—Wheat.

Fourth year.—Oats. Seeded down with 10 pounds western rye grass, 3 pounds red clover and 3 pounds alfalfa per acre.

Fifth year.—Hay.

Sixth year.—Pasture.

Rotation "J" is a mixed-farming rotation. It provides pasture for summer feeding and hay and grain for winter feeding of stock. With one-third of the land in wheat considerable revenue is obtained from marketing this product. From a labour standpoint also, rotation "J" is well suited to our conditions. None of the crops grown requires any extra labour in its handling. The spread of the work over the caring for stock, seeding, summer-fallowing, haying and harvesting is a consideration worthy of note. The addition of fibre and humus to the soil from the meadow and pasture years of the rotation tends towards the upkeep of fertility and the conservation of moisture. Just whether or not this together with only one summer-fallow in six years will be sufficient means to maintain a moisture content equal to the needs of the plant, can be determined only by many years of experiment. The net profit from this rotation in 1913 was \$5.95.

ROTATION "P" (EIGHT YEARS' DURATION).

First year.—Summer-fallow.

Second year.—Wheat.

Third year.—Wheat.

Fourth year.—Summer-fallow.

Fifth year.—Roots or legume. Manured 15 tons per acre.

Sixth year.—Barley. Seeded down with 10 pounds western rye grass, 3 pounds red clover and 3 pounds alfalfa per acre.

Seventh year.—Hay.

Eighth year.—Pasture.

Rotation "P" is a mixed-farming rotation suited to conditions where it is desired to sell some grain and to grow fodder and coarse grain for live stock. Moisture is amply provided for by including two summer-fallows and a possible hoed crop in the course of eight years. To the hoed crop or legume are applied 15 tons of manure per acre. This, in addition to the hay and pasture years should do much towards the upkeep of fertility and the maintenance of crop yields. This rotation gives a place for the marketing of grain in that one-quarter of the area is in wheat. A strong point is the provision made for growing valuable concentrated foods which could be used in the rearing and fitting of live stock or in dairying.

The net profit per acre of rotation "P" in 1913 was \$4.40.

SESSIONAL PAPER No. 16

ROTATION "R" (NINE YEARS' DURATION).

First year.—Summer-fallow.

Second year.—Hoed crop or legume. Manned 15 tons per acre.

Third year.—Wheat.

Fourth year.—Oats.

Fifth year.—Summer-fallow.

Sixth year.—Wheat.

Seventh year.—Oats. Seeded down with 10 pounds western rye grass, 3 pounds red clover and 3 pounds alfalfa per acre.

Eighth year.—Hay.

Ninth year.—Pasture.

Rotation "R" permits of mixed farming. Four-ninths of the land is devoted to the production of oats, hay and pasture. One-ninth would be in roots or legumes. To wheat is allotted only a small area, two-ninths of the whole being given to its production. This rotation will be valuable in cases where the rearing and fitting of horses for market and the keeping of other live stock are the aim, but for the present it is not likely to prove very popular, as wheat receives so little prominence.

The net profit per acre of rotation "R" in 1913 was \$5.53.

In the following tables details regarding these rotations are given. The values used will be found on page 156.

ROTATION EXPERIMENT.—Comparative Costs, Returns and Net Profits per Acre.

Rotation.	Total cost to operate 1913.	Value of returns 1913.	Net profit 1913.
	\$ cts.	\$ cts.	\$ cts.
"A" one years' duration.....	8 99	17 78	8 79
"C" three years' duration.....	7 32	12 10	4 78
"J" six years' duration.....	7 54	13 49	5 95
"P" eight years' duration.....	7 59	11 99	4 40
"R" nine years' duration.....	6 85	13 48	6 63

ROTATION "A"

Rotation Year.	Crops.		Area.	ITEMS OF EXPENSE										
				Rent and manure.		Seed, twine and use of machinery.		Manual labour.		Horse labour (including teamster.)				
				\$ c.	¢ c.	Hours.	Cost.	Hours.						
1912.	1913.	Ae.	\$ c.	¢ c.	No.	¢ c.	Single horse	2-horse team.	3-horse team.	4-horse team.	5-horse team.			
1st...	Wheat.....	Wheat.....	1	2 09	2 40	14	24		17½			45½		

ROTATION "C"

3rd...	Wheat.....	Wheat.....	1½	3 00	3 60	1½	28		3½			5½	
1st...	Wheat.....	Summer-fallow	1½	3 00	90							10½	
2nd...	Summer-fallow	Wheat.....	1½	3 00	3 60	1½	25		2½			15½	
	Aggregate.....		4½	9 00	8 10	2½	53		6½			17¾	
	Average per acre.....			2 00	1 80		12						

ROTATION "D"

3rd...	Wheat.....	Wheat.....	2	4 00	4 80	2¾	51		3½			7½	
4th...	Wheat.....	Oats, seeded...	2½	4 40	4 18	3	57		4½			6½	
5th...	Oats.....	Peas and oats, seeded.....	2½	4 40	5 28	10½	1 99		11½			6½	
6th...	Hay.....	Pasture.....	2½	4 40	3 50	20	3 80		12½				
1st...	Hay.....	Summer-fallow	2½	4 40	1 32				1¾			12¾	
2nd...	Summer-fallow	Wheat.....	2½	4 40	5 25	2¾	52		2½			2½	
	Aggregate.....		13	26 00	24 36	38	7 59		34½			35	
	Average per acre.....			2 00	1 87		57						

ROTATION "R"

3rd...	Peas.....	Wheat.....	2½	4 67	5 60	3	57		2½			6½	
4 h...	Wheat.....	Oats.....	2½	4 67	4 43	3	57		4			7	
5th...	Oats.....	Summer-fallow	2½	4 67	1 40				3			12½	
6 h...	Summer-fallow	Wheat.....	2½	4 67	5 60	2½	44		3½			3	
7th...	Wheat.....	Oats, seeded...	2½	4 67	4 43	2½	47		4½			7½	
8 h...	Seeded alone...	Hay.....	2½	4 67	5 11	11¼	2 15		15½				
9 h...	Hay.....	Pasture.....	2½	4 67	3 18								
1st...	Hay.....	Summer-fallow	2½	4 67	1 40							13½	
2nd...	Summer-fallow	Peas.....	2½	4 67	4 90	12	2 28		5½			5½	
	Aggregate.....		21	42 03	36 05	34½	6 48		33½			51½	
	Average per acre.....			2 00	1 72		31						

ROTATION "P"

3rd...	Wheat.....	Wheat.....	1½	3 00	3 60	1½	28		2½			5½	
4th...	Wheat.....	Summer-fallow	1½	3 00	90				2½			8½	
5th...	Summer-fallow	Peas.....	1½	3 00	3 15	10	1 96		4			3½	
6th...	Peas.....	Barley seeded.	1½	3 00	2 85	2¼	43		2¼			5½	
7th...	Barley, seeded	Hay.....	1½	3 00	2 23	10	1 90		7½				
8th...	Oats.....	Peas and oats	1½	3 00	3 69	11	2 09		11½			5½	
1st...	Hay.....	Summer-fallow	1½	3 00	90				1			11½	
2nd...	Summer-fallow	Wheat.....	1½	2 75	3 30	2	38		2½			3½	
	Aggregate.....		11.875	23 75	21 58	36¼	6 98		33½			39½	
	Average per acre.....			2 09	1 82		59						

SESSIONAL PAPER No. 16

(Wheat continuously).

IN RAISING CROP.							PARTICULARS OF CROP.						
Value or horse labour.	Cost of threshing.	Total cost.	Cost for 1 acre.	Cost for 1 bushel.	Cost for 1 ton.	Height of stubble.	Weight.				Total value.	Value of crop per acre.	Profit or loss per acre.
							Grain.	Straw.	Hay.	Food crop.			
£ c.	£ c.	£ c.	£ c.	Cts.	£ c.	Inches.	Lb.	Lb.	Lb.	Lb.	£ c.	£ c.	£ c.
2 86	1 49	8 98	8 98	42		6½	1,280	1,420			17 78	17 78	8 79

(Three Years' Duration).

3 71	2 37	12 96	8 61	38		6½	2,030	2,165			28 15	18 76	10 12
5 49		9 30	6 29										-6 20
1 62	2 22	10 69	7 12	31		6½	1,900	2,070			26 28	17 52	10 40
10 73	4 59	32 95					3,930	4,235			51 43		
2 33	1 02		7 3									12 09	4 77

(Six Years' Duration).

4 62	3 14	17 07	8 53	38		6½	2,695	3,035			37 45	18 72	10 19
4 43	4 82	18 40	8 36	10½		7½	4,100	2,855			43 55	19 93	11 57
6 97		18 64	8 47			6				4,175	20 87	9 49	1 02
4 19		15 89	7 22						5,780		28 90	13 11	5 92
6 67		12 39	5 63										-5 63
1 78	3 71	15 69	7 13	30		6½	3,180	3,865			4,433	20 15	13 02
28 66	11 67	98 03									175 40		
2 21	90		7 55									13 50	5 5

(Nine Years' Duration).

4 17	4 07	19 03	8 18	33		6½	3,488	4,612			48 83	20 93	12 75
4 72	4 65	19 04	8 16	16		7½	3,950	3,060			42 53	18 24	10 03
6 91		13 91	5 58										-5 58
2 52	3 58	16 81	7 20	33		6½	3,966	4,384			43 07	18 44	11 24
5 10	5 14	19 81	8 49	15		7½	4,370	7,840			51 54	22 09	13 60
5 16		17 09	7 32						8,745	Pasture days.	43 72	18 74	11 42
		7 85	3 36							90	3 00	1 29	-2 07
6 98		13 05	5 59										-5 59
2 10	4 15	18 10	7 76	30			3,556	2,924			50 33	21 57	13 81
37 62	21 59	143 84									283 05		
1 79	1 03		6 85									13 48	6 63

(Eleven Years' Duration).

3 45	2 33	12 66	8 44	38		6½	2,000	2,305			27 82	18 51	10 10
4 91		8 81	5 87										-5 87
1 32	2 02	11 59	7 72	40			1,730	2,125			25 19	16 79	9 07
3 36	1 52	11 16	7 44	37		7½	1,464	4,115		green-	18 75	12 50	5 03
2 55		10 73	7 15						3,130	feed.	15 65	10 44	3 29
6 37		15 06	10 04			6				3,895	19 43	12 98	2 94
5 78		9 68	6 46										-6 46
2 22	1 79	10 41	7 60	26		6½	2,534	3,411			35 50	25 82	18 22
30 16	7 66	90 13									142 39		
2 54	65		7 59									11 99	4 40

DATES OF SEEDING.

Experiments were conducted with wheat, oats and barley in dates of seeding with the object of determining the time of seeding best suited to these crops. The following results were given this year:—

DATES of Seeding Spring Wheat.

Variety.	Date of sowing.	Date of ripening.	Number of days to mature.	Average length of straw including head.	Strength of straw on a scale of 10 points.	Average length of head.	Yield of grain per acre.	Yield of grain per acre.	
				Inches.		Inches.		Lb.	Bush. Lb.
Marquis.....	April 11	August 22	123	33½	10	2¼	1,220	20	20
"	" 18	" 27	131	34	10	2¾	1,700	28	20
"	" 25	" 28	125	33	10	2½	1,760	29	20
"	May 2	Sept. 1	122	34	10	2¾	2,100	35	00
"	" 9	" 2	116	33½	10	2¾	2,000	33	20

It will be noted that the fourth date of seeding May 2 gave the highest yield. This is partly accounted for by the fact that a slight drought followed the earlier seedings.

DATES of Seeding Oats.

Variety.	Date of sowing.	Date of ripening.	Number of days to mature.	Average length of straw including head.	Strength of straw on a scale of 10 points.	Average length of head.	Yield of grain per acre.	Yield of grain per acre.	
				Inches.		Inches.		Lb.	Bush. Lb.
Banner.....	April 11	August 19	120	44	10	6½	2,400	70	20
"	" 18	" 21	125	45	10	7½	2,840	83	18
"	" 25	" 25	122	43	10	7¼	2,640	77	22
"	May 2	" 27	117	44	10	7¼	3,440	101	6
"	" 9	" 28	111	44½	10	7¼	2,820	82	32

DATES of Seeding Barley.

Variety.	Date of sowing.	Date of ripening.	Number of days to mature.	Average length of straw including head.	Strength of straw on a scale of 10 points.	Average length of head.	Yield of grain per acre.	Yield of grain per acre.	
				Inches.		Inches.		Lb.	Bush. Lb.
Manchurian.....	April 11	August 12	123	42	10	3¼	1,880	39	8
"	" 18	" 15	119	41	10	3	1,320	27	24
"	" 25	" 16	113	40	10	3¼	1,560	32	24
"	May 2	" 18	109	43	10	4	1,680	35	00
"	" 9	" 21	104	42	10	4	1,720	35	40

SESSIONAL PAPER No. 16

It will be noticed that the first seeding, April 11, and the last seeding, May 9, gave the highest and next highest yields respectively. This is a condition difficult to account for. Throughout the season it appeared that the plot sown first had a decided advantage over the plots sown on the four later dates, but when threshed out the plot sown last yielded surprisingly high.

RATES OF SEEDING.

RATES of Seeding Marquis Wheat on Summer-fallow.

Variety.	Quantities of seed per acre.	Date of sowing.	Date of ripening.	Number of days to mature.	Average length of straw including head.	Strength of straw on a scale of 10 points.	Average length of head.	Yield of grain per acre.	Yield of grain per acre.	
					Inches.		Inches.		Lb.	Bush. Lb.
Marquis.....	$\frac{3}{4}$ bush.	April 11	Aug. 25	136	33 $\frac{1}{2}$	10	2 $\frac{3}{4}$	1,440	24	00
"	1 $\frac{1}{4}$ "	" 11	" 25	136	33	10	2 $\frac{1}{2}$	1,440	24	00
"	1 $\frac{3}{4}$ "	" 11	" 20	131	34	10	3	2,080	34	40
"	2 $\frac{1}{4}$ "	" 11	" 19	130	35	10	2 $\frac{3}{4}$	2,100	35	00
"	2 $\frac{3}{4}$ "	" 11	" 19	130	34 $\frac{1}{2}$	10	2 $\frac{1}{4}$	1,920	32	00

Two and one-quarter bushels per acre was the amount of seed giving the largest yield. After the quantity of seed sown is deducted it will be seen that 1 $\frac{3}{4}$ bushels per acre gave the largest net return.

RATES of Seeding Banner Oats on Summer-fallow.

Variety.	Quantities of seed per acre.	Date of sowing.	Date of ripening.	Number of days to mature.	Average length of straw including head.	Strength of straw on a scale of 10 points.	Average length of head.	Yield of grain per acre.	Yield of grain per acre.	
					Inches.		Inches.		Lb.	Bush. Lb.
Banner.....	1 bush.	April 29	Aug. 28	121	49	10	7 $\frac{1}{4}$	3,200	94	4
"	1 $\frac{1}{2}$ "	" 29	" 25	118	42 $\frac{1}{2}$	10	7	3,780	111	6
"	2 "	" 29	" 22	115	42	10	7	3,200	94	4
"	2 $\frac{1}{2}$ "	" 29	" 22	115	43	10	7 $\frac{3}{4}$	2,400	70	20
"	3 "	" 29	" 22	115	43	10	7	2,760	81	6
"	3 $\frac{1}{2}$ "	" 29	" 21	114	40	10	6 $\frac{1}{2}$	2,780	81	20

It will be noted that 1 $\frac{1}{2}$ bushels per acre is the rate giving the highest yield. In 1912 seeding at the rate of one bushel per acre had a decided advantage over the five heavier seedings used. The results of these two years' work would indicate the advisability of using smaller quantities of seed oats per acre on well prepared land than is at present done. Further work will be carried out in this connection.

RATES of Seeding Manchurian Barley on Summer-fallow.

Variety.	Quantities of seed per acre.	Date of sowing.	Date of ripening.	Number of days to mature.	Average length of straw including head.	Strength of straw on a scale of 10 points.	Average length of head.	Yield of grain per acre.	Yield of grain per acre.
					Inches.		Inches.	Lb.	Bush. Lb.
Manchurian..	1 Bush.	April 29	Aug. 18	111	43 $\frac{1}{4}$	10	4	1,640	34 8
"	1 $\frac{1}{2}$ "	" 29	" 19	112	42	10	4	1,500	31 12
"	2 "	" 29	" 19	112	42 $\frac{1}{2}$	10	4 $\frac{1}{2}$	1,240	25 40
"	2 $\frac{1}{2}$ "	" 29	" 19	112	43 $\frac{1}{2}$	10	4 $\frac{1}{2}$	1,440	30 00
"	3 "	" 29	" 19	112	42 $\frac{1}{2}$	10	4 $\frac{1}{4}$	1,520	31 32

One bushel of barley seed per acre gave the largest yield. This result was obtained in 1912. From these two years' work favouring the 1 bushel seeding we are inclined to think that somewhat lighter seedings than are usually given with this cereal would be good practice for this section of country.

SOIL CULTURAL EXPERIMENTS.

Four experiments in methods of cultivation of field crops are now under way, namely:—

- Prairie breaking.
- Seeding to grass and clover.
- Soil packers.
- Depth of seeding.

The prairie breaking and soil packing experiments are not being reported upon as no decisive data have yet been obtained.

SEEDING TO GRASS AND CLOVER.

In 1911 an experiment was begun to determine the best preceding crops and soil preparation for seeding to western rye grass and red clover. The yields of hay this year were as follows:—

SEEDING to Grass and Clover.

Plot No.	Treatment 1911.	Treatment 1912.	Crop 1913.	Yield per acre.	Yield per acre.
				Lb.	Tons. Lb.
1	Summer-fallow	Seeded with wheat.....	Hay.....	4,400	2 400
2	Summer-fallow.....	Seeded alone.....	Hay.....	5,200	2 1,200
3	Hoed crop	Seeded with wheat.....	Hay.....	4,800	2 800
4	Hoed crop	Seeded alone.....	Hay.....	4,680	2 680
5	Wheat.....	Seeded with wheat	Hay.....	3,240	1 1,240
6	Wheat.....	Seeded alone.....	Hay.....	3,160	1 1,160
7	Wheat.....	Seeded with oats.....	Hay.....	1,720	0 1,720
8	Wheat.....	Seeded alone.....	Hay.....	2,080	1 80
9	Wheat.....	Seeded with wheat.....	Hay.....	2,820	1 820
10	Oats.....	Seeded alone.....	Hay.....	2,400	1 400
11	Wheat.....	Seeded with wheat.....	Hay.....	3,860	1 1,860

SESSIONAL PAPER No. 16

It will be noted that the four highest yields were obtained from seeding with and without a nurse crop after summer-fallow or hoed crop. It would appear evident from the results of the one year's work that a good catch of seeds is much more likely to be obtained when the preparatory treatment is summer-fallow or hoed crop than when oats or wheat are grown.

DEPTH OF SEEDING.

DEPTH of Seeding Wheat.

Plot No.	Depth sown.	Date of Sowing.	Date of Coming up.	Date of Heading.	Date of Ripening.	Days to Mature.	Yield of wheat per acre.	
							Grain.	Straw.
1	Sowing 1 inch deep.....	April 18	May 9	July 5	Aug. 21	125	Lb. 1,869	Lb. 3,910
2	Sowing 2 inches deep.....	" 18	" 10	" 4	" 21	125	1,960	3,840
3	Sowing 3 inches deep.....	" 18	" 10	" 3	" 19	123	1,980	2,920
4	Sowing 4 inches deep.....	" 18	" 12	" 5	" 21	125	1,780	3,820

DEPTH of Seeding Oats.

Plot No.	Depth sown.	Date of Sowing.	Date of Coming up.	Date of Heading.	Date of Ripening.	Days to Mature.	Yield of wheat per acre.	
							Grain.	Straw.
1	Sowing 1 inch deep.....	April 28	May 17	July 4	Aug. 21	115	Lb. 1,040	Lb. 2,560
2	Sowing 2 inches deep.....	" 23	" 17	" 4	" 21	115	1,680	3,120
3	Sowing 3 inches deep.....	" 23	" 19	" 5	" 19	113	1,580	2,420
4	Sowing 4 inches deep.....	" 28	" 20	" 5	" 19	113	1,440	3,360

EXPERIMENTAL STATION FOR SOUTHERN ALBERTA, LETHBRIDGE, ALTA.

REPORT OF THE SUPERINTENDENT, W. H. FAIRFIELD, M.S.

SEASONAL CONDITIONS.

The season of 1913 opened at about the usual time for the district. Winter grain however, suffered, many areas in the winter wheat fields being badly injured owing to the high, dry winds that prevailed. Spring seeding commenced early in April; germination was rapid and a good stand was obtained in all cases. The rainfall during the spring was scant, especially during late May and early June. Crops of all kinds suffered acutely, particularly early sown grain. The rainfall for the growing season was as follows:—

April	0.52 inches.
May	1.70 “
June	4.70 “
July	1.29 “
August 1 to 15	1.22 “
Total	<u>9.43</u> “

Although the precipitation for June was reasonably satisfactory, generous rains were not received till the 16th: from then to the end of the month moisture was abundant; 4.3 inches out of 4.7 inches for the month fell during this period. The late rain, however, stimulated a second growth which caused uneven ripening and thus materially reduced the yield and quality of both wheat and barley. The effect on oats was not so serious, the second growth being so strong and vigorous that it reached maturity before any great loss was sustained from the shelling of the first growth.

The rainfall over the southern part of the province was quite uneven, some localities being more favoured than others. One of the districts where the grain crops were comparatively good was along the Aldersyde branch of the Canadian Pacific railway from Monarch and Carmangay.

SESSIONAL PAPER No. 16

SOME WEATHER OBSERVATIONS taken at Lethbridge Experimental Station, 1913.

Month.	TEMPERATURE F.			Total Precipitation.	Total Sunshine.
	Mean.	Highest.	Lowest.		
	°	°	°	Inches.	Hours.
January.....		47.0	-30.0	.80	91.9
February.....		57.8	-22.0	.30	102.1
March.....		59.9	-23.0	.42	157.3
April.....	43.8	81.2	17.0	.52	223.4
May.....	48.45	83.3	19.2	1.70	244.8
June.....	60.96	86.6	39.9	4.70	281.8
July.....	61.89	89.2	38.0	1.29	345.0
August.....	54.21	92.8	35.8	1.93	321.2
September.....	59.9	89.3	26.2	1.65	276.5
October.....	39.2	78.2	12.3	.50	152.7
November.....	35.1	58.0	9.0	.36	121.8
December.....	29.57	60.0	-7.0	.00	156.0
Total for year.....				14.17	2,474.5

As there are two distinct farms being operated at this Station, one irrigated and one non-irrigated, the report is divided to avoid any possible confusion.

PART I.—THE NON-IRRIGATED OR "DRY FARM."

CROP ROTATIONS (NON-IRRIGATED).

This is the third season for the following rotations:—

ROTATION "A"

Wheat continuously.

ROTATION "B" (TWO YEARS' DURATION).

First year.—Wheat.

Second year.—Summer-fallow.

ROTATION "C" (THREE YEARS' DURATION).

First year.—Summer-fallow.

Second year.—Wheat.

Third year.—Wheat, or coarse grain.

ROTATION "M" (SIX YEARS' DURATION).

First year.—Summer-fallow.

Second year.—Wheat.

Third year.—Coarse grain. Manured in fall.

Fourth year.—Summer-fallow.

Fifth year.—Peas and oats for hay.

Sixth year.—Barley or oats.

ROTATION "S" (NINE YEARS' DURATION)

First year.—Summer-fallow.

Second year.—Hoed crop.

Third year.—Wheat.

Fourth year.—Summer-fallow.

Fifth year.—Wheat.

Sixth year.—Coarse grain.

Seventh year.—Summer-fallow. Manured.

Eighth year.—Peas and oats for hay. Seeded in fall to rye.

Ninth year.—Rye pasture.

SESSIONAL PAPER No. 16

ROTATION "T" (TEN YEARS' DURATION).

First year.—Summer-fallow.

Second year.—Wheat.

Third year.—Oats or barley.

Fourth year.—Seeded to alfalfa in rows.

Fifth year.—Alfalfa hay or seed.

Sixth year.—Alfalfa hay or seed.

Seventh year.—Alfalfa hay, seed or pasture.

Eighth year.—Summer-fallow.

Ninth year.—Hoed crop.

Tenth year.—Wheat. Manured on stubble.

So that the results from year to year may be easily compared, cost and return values have been fixed, schedule of which will be found on page 155. The following tables contain details in connection with these rotations:—

Rotation Year.	Crops.		ITEMS OF EXPENSE										
			Area.	Rent and manure.		Seed, twine and use of machinery.	Manual labour.		Horse labour (including teamster).				
									Hours.				
							Hours.	Cost.	Single horse	2-horse team.	3-horse team.	4-horse team.	5-horse team.
1912.	1913.	Ac.	£ c.	£ c.	No.	£ c.	No.	No.	No.	No.	£ c.		
.....	Wheat.....	Wheat.....	1.57	3 14	3 71	11 ¹ / ₄	24	11 ⁶ / ₆	5 ³ / ₃	
Aggregate.....		
Average per acre.....		2 00	2 36	15	

ROTATION "B"

1st...	Wheat.....	Summer-fallow	1.57	3 14	3 94	3 ¹ / ₃	10	8 ¹ / ₃
2nd...	Summer-fallow	Wheat.....	1.57	3 14	3 70	3 ¹ / ₃	63	11 ⁶ / ₆	8 ¹ / ₃
Aggregate.....		3.14	6 28	4 64	73
Average per acre.....		2 00	1 48	23

ROTATION "C"

3rd...	Wheat.....	Oats.....	1.57	3 14	2 87	3 ¹ / ₄	62	1	5 ³ / ₄
1st...	Oats.....	Fallow.....	1.57	3 14	3 94	3 ¹ / ₃	05	8 ¹ / ₃
2nd...	Summer-fallow	Wheat.....	1.57	3 14	3 70	1 ¹ / ₄	33	1	8 ¹ / ₃
Aggregate.....		4.71	9 42	7 51	1 00
Average per acre.....		2 00	1 59	21

ROTATION "M"

3rd...	Wheat.....	Oats.....	1.25	5 00	2 96	1 ¹ / ₄	33	11 ⁶ / ₆	1 ¹ / ₂	5 ³ / ₄
4th...	Oats.....	Summer-fallow	1.25	5 00	16	6 ³ / ₄
5th...	Summer-fallow	Peas and Oats.	.59	2 36	1 26	16	1 ¹ / ₂	1 ¹ / ₂
6th...	Peas and Oats.	Oats.....	.66	2 64	1 57	3 ⁴ / ₆	71	2 ¹ / ₃	1 ¹ / ₂
1st...	Oats.....	Summer-fallow	1.25	5 00	2 48	1 ³ / ₆	30	1 ¹ / ₆	5 ³ / ₄
2nd...	Summer-fallow	Wheat.....	1.25	5 00	2 99	1 ¹ / ₄	19	1 ¹ / ₆	5 ³ / ₄
Aggregate.....		7.5	30 00	12 76	2 13
Average per acre.....		4 00	1 70	29

SESSIONAL PAPER No. 16

(Wheat continuously.)

IN RAISING CROP.

PARTICULARS OF CROP.

Value of horse labour.	Cost of threshing.	Total cost.	Cost for 1 acre.	Cost for 1 bushel.	Cost for 1 ton.	Weight of stubble.	Weight.				Total value.	Value of crop per acre.	Profit or loss per acre.
							Grain.	Straw.	Hay.	Wood crop.			
£ c.	£ c.	£ c.	£ c.	£ c.	£ c.	Inch.	Lb.	Lb.	Lb.	Lb.	£ c.	£ c.	£ c.
3 20	1 87	12 16	7 74	46	5	1,600	2,690	22 67	14 44	6 70
2 03	1 19	7 74	14 44	6 70

(Two Years' Duration).

3 92	8 10	5 16	-5 16
80	2 47	10 74	6 84	30	5	2,120	2,415	29 48	18 77	11 93
4 72	2 47	18 84	12 00	29 48
1 50	78	6 00	6 00	9 38	3 38

(Three Years' Duration).

3 25	3 22	13 10	8 34	16	4-5	2,737	2,915	30 26	19 27	10 93
3 92	8 05	5 12	-5 12
77	2 33	10 27	6 48	31	4-5	2,000	2,375	28 35	18 06	11 58
7 94	5 55	31 42	58 61
1 68	1 18	6 65	12 44	5 79

(Six Years' Duration).

3 37	94	12 60	10 08	54	4-5	800	730	2,180	19 63	15 70	5 62
3 24	9 15	7 32	-7 32
32	1 80	5 90	10 00	18	3½	1,515	1,650	16 80	28 47	18 47
1 44	6 36	9 64	3	4,460	22 30	33 79	24 15
3 26	3 41	14 45	11 56	18	4-5	2,900	2,990	31 99	25 52	13 96
2 78	8 72	6 98	-6 98
92	2 28	11 47	9 18	35	4-5	1,950	3,040	27 52	22 02	12 84
15 33	8 43	68 65	118 24
2 01	1 12	9 15	15 76	6 61

Rotation Year.	Crops.		ITEMS OF EXPENSE									
			Area.	Rent and manure.	Seed, twine and use of machinery.	Manual labour.		Horse labour (including teamster.)				
						Hours.	Cost.	Hours.				
								Single horse	2-horse team.	3-horse team.	4-horse team.	5 horse team.
	1912.	1913.	Ac.	\$ c.	\$ c.	No.	\$ c.	No.	No.	No.	No.	No.
1st...	Rye pasture...	Summer-fallow	1.25	5 83	75	6 ⁵ / ₅₀
2nd...	Summer-fallow	Corn.....	1.25	5 83	2 92	43 ¹ / ₂	8 22	7 ¹ / ₆₀	5
3rd...	Corn.....	Wheat.....	1.25	5 83	3 10	15 ⁵ / ₆₀	35	1 ¹ / ₂
4th...	Wheat.....	Summer-fallow	1.25	5 83	75	4 ⁴ / ₆₀	13	11 ¹ / ₆₀
5th...	Summer-fallow	Wheat.....	1.25	5 83	3 00	1 ¹ / ₂	28	1 ⁵ / ₃	5 ⁵ / ₅₀
6th...	Wheat.....	Oats.....	1.25	5 83	2 45	12 ⁵ / ₆₀	28	1 ¹ / ₃	5 ⁵ / ₅₀
7th...	Oats.....	Summer-fallow	1.25	5 83	75	1	19	10 ⁵ / ₆₀
8th...	Summer-fallow	Peas and oats	1.25	5 83	2 87	9 ⁵ / ₆₀	1 88	1 ¹ / ₂	5 ⁵ / ₆₀	3 ⁴ / ₄	3 ⁴ / ₄
9th...	Peas and oats	Rye pasture...	1.25	5 83	1 50	1 ¹ / ₂	25	6 ⁵ / ₆₀	5 ⁵ / ₅₀
	Aggregate.....		11.25	52 47	18 09	11 58
	Average per acre	4 66	1 61	1 03

ROTATION "T"

6th...	Alfalfa.....	Alfalfa.....	1.57	5 02	1 24	16 ¹ / ₂	3 10	8 ⁵ / ₆₀	5 ¹ / ₁₂
7th...	Alfalfa.....	Alfalfa.....	1.57	5 02	1 24	28 ⁵ / ₆₀	49	4 ¹ / ₃	1 ¹ / ₃
8th...	Alfalfa.....	Summer-fallow	1.57	5 02	94	9 ¹ / ₆	9	11 ⁵ / ₆₀
9th...	Summer-fallow	Roots.....	1.57	5 02	3 07	119	22 61	2 ¹ / ₃
10th...	Roots.....	Wheat.....	1.57	5 02	3 65	3 ¹ / ₂	67	1 ¹ / ₄	1 ⁴ / ₄
1st...	Wheat.....	Summer-fallow	1.57	5 02	94	5 ⁵ / ₆₀	17	7 ¹ / ₆₀
2nd...	Summer-fallow	Wheat.....	1.57	5 02	3 89	2 ¹ / ₃	44	1 ¹ / ₆₀	3 ⁵ / ₆₀
3rd...	Wheat.....	Oats.....	1.57	5 02	2 93	1 ¹ / ₂	29	1 ⁵ / ₆₀	1 ⁴ / ₄
4th...	Oats.....	Summer-fallow	1.57	5 02	1 24	14 ⁵ / ₆₀	33	4 ¹ / ₃	4 ⁵ / ₆₀	5 ¹ / ₁₂
5th...	Summer-fallow	Alfalfa.....	1.57	5 02	1 24	45	8 55	1 ¹ / ₃	1 ¹ / ₃
	Aggregate.....		15.7	50 20	20 38	36 65
	Average per acre.....		5 02	2 04	3 67

SESSIONAL PAPER No. 16

(Nine Years' Duration).

IN RAISING CROP.							PARTICULARS OF CROP.						
Value of horse labour.	Cost of threshing.	Total cost.	Cost for 1 acre.	Cost for 1 bushel.	Cost for 1 ton.	Height of stubble.	Weight.				Total value.	Value of crop per acre.	Profit or loss per acre.
							Grain.	Straw.	Hay.	Hoed crop.			
\$ c.	\$ c.	\$ c.	\$ c.	\$ c.	\$ c.	Inch.	Lb.	Lb.	Lb.	Lb.	\$ c.	\$ c.	\$ c.
3 08	9 66	7 73	-7 73
4 31	21 31	17 05	3	28,397	42 60	34 03	17 03
4 45	2 94	12 67	10 13	30	4-5	2,500	4,630	35 65	28 50	18 39
5 36	12 07	9 66	-9 66
92	2 50	12 53	10 02	35	4-5	2,140	3,255	30 16	24 13	14 11
3 15	2 54	14 25	11 49	22	4-5	2,160	2,685	22 94	18 35	6 95
5 08	11 85	9 48	-9 48
2 80	13 38	10 70	3	9,215	46 03	36 80	26 10
4 85	12 43	9 94	3	470	125½ Pasture days	4 38	3 50	-6 41
30 03	7 98	120 15	181 81
2 67	89	10 68	16 16	5 48

(Ten Years' Duration).

4 12	1 83	15 31	9 75	8 35	3	110	2,090	67 54	43 03	33 28
1 62	1 58	9 95	6 33	6 28	3	95	47 50	30 25	23 92
5 56	11 52	7 33	-7 33
6 66	37 36	23 80	05	43,150	64 73	41 23	17 43
1 35	1 75	12 44	7 92	50	4-5	1,500	2,580	21 29	13 50	5 58
3 44	9 57	6 10	-6 10
76	3 89	11 00	8 91	25½	4-5	3,330	4,990	46 90	29 87	20 96
3 69	3 65	15 58	9 92	17	4-5	3,100	3,425	34 43	21 29	11 37
5 27	11 86	7 55	-7 55
81	1 82	17 44	11 11	960	3	109	54 50	34 71	23 60
33 28	14 52	155 03	336 87
.....	1 45	9 87	21 39	11 52

In the following table the chief items in connection with the above rotations are recorded:—

ROTATION EXPERIMENT—Cost of Operations, Value of Products and Profits.

Rotation.	Total cost per acre.	Total value per acre.	Net profit per acre, 1913.
	\$ c.	\$ c.	\$ c.
"A" wheat continuously.....	7 74	14 44	6 70
"B" two years' duration.....	6 00	9 38	3 38
"C" three years' duration.....	6 65	12 44	5 79
"M" six years' duration.....	9 15	15 76	6 61
"S" nine years' duration.....	10 68	16 16	5 48
"T" ten years' duration.....	9 87	21 39	11 52

DATES OF SEEDING.

DATES OF SEEDING Marquis Wheat (non-irrigated) on Summer-fallow.

Size of plot.	Date sown.	Date ripe.	Yield per acre.	Average yield per acre for 2 years.
Acres.			Bush. Lb.	Bush. Lb.
1/60	April 3.....	August 2.....	30 30	27 45
"	April 11.....	August 4.....	29 30	26 45
"	April 21.....	August 6.....	33 00	28 00
"	May 2.....	August 8.....	39 30	31 30
"	May 12.....	August 16.....	39 00	30 00
"	May 22.....	August 23.....	42 30	*31 30
"	June 2.....	September 2.....	31 30	*28 30

*1912 crop frosted.

DATES OF SEEDING Banner Oats (non-irrigated) on Summer-fallow.

Size of plot.	Date sown.	Date ripe.	Yield per acre.	Average yield per acre for 2 years.
Acres.			Bush. Lb.	Bush. Lb.
1/60	April 3.....	August 4.....	83 28	76 11
"	April 15.....	August 3.....	87 12	77 7
"	May 2.....	August 3.....	79 14	78 18
"	May 16.....	August 13.....	82 32	88 8
"	June 2.....	September 2.....	69 24	78 3
"	*June 16.....

*Crop frosted somewhat.

SESSIONAL PAPER No. 16

DATES OF SEEDING Mensury Barley (non-irrigated) on Summer-fallow.

Size of plot.	Date sown.	Date ripe.	Yield per acre.		Average yield per acre for 2 years.	
Acres.			Bush.	Lb.	Bush.	Lb.
1 60	April 3.....	July 30.....	35	00	30	23
"	April 15.....	July 30.....	31	12	29	18
"	May 2.....	July 31.....	38	6	35	15
"	May 16.....	August 4.....	38	36	32	23
"	June 2.....	43	6	36	12
"	June 16.....	September 2.....	40	00	40	00
"	*July 2.....

*Crop frosted.

DATES OF SEEDING Flax (non-irrigated) on Summer-fallow.

Size of plot.	Date sown.	Date ripe.	Yield per acre.		Average yield per acre for 2 years.		
Acres.			Bush.	Lb.	Bush.	Lb.	
1 60	April 3.....	August 7.....	15	30	19	31	
"	April 15.....	August 7.....	19	46	23	44	
"	May 2.....	August 12.....	21	54	23	47	
"	May 16.....	August 16.....	20	50	*23	17	
"	June 2.....	August 29.....	17	48	*21	51	
"	June 16.....	Crop destroyed by frost both years.					
"	July 2.....	Crop destroyed by frost both years.					

*10 2 c p frosted.

RATES OF SEEDING PER ACRE.

As experiments with different amounts of seed per acre have been carried on for five years with wheat, oats and barley they were discontinued this year. The average results would indicate about the following amounts as the most profitable quantities to use:—

Spring wheat..... 60 to 75 pounds of seed per acre.
 Oats..... 60 to 75 " "

5 GEORGE V., A. 1915

RATES OF SEEDING Red Fife Wheat (non-irrigated) on Summer-fallow.

Size of plot.	Rate of seeding per acre.	Date sown.	Date ripe.	Days to mature.	Yield per acre.		Average yield per acre for 5 years.	
Acres.	Lb.				Bush.	Lb.	Bush.	Lb.
1/20	15	April 7.....	August 15.....	130	14	00	12	24
"	30	" 7.....	" 7.....	122	20	40	17	8
"	45	" 7.....	" 11.....	126	21	20	21	16
"	60	" 7.....	" 5.....	120	22	20	21	48
"	75	" 7.....	" 6.....	121	25	10	22	58
"	90	" 7.....	" 6.....	121	24	40	22	44
"	105	" 7.....	" 6.....	121	24	00	23	46
"	120	" 7.....	" 5.....	120	20	50	22	34

RATES OF SEEDING Banner Oats (non-irrigated) on Summer-fallow.

Size of plot.	Rate of seeding per acre.	Date sown.	Date ripe.	Days to mature.	Yield per acre, 1913.		Average yield per acre for 5 years.	
Acres.	Lb.				Bush.	Lb.	Bush.	Lb.
1/20	15	April 9.....	August 6.....	119	67	22	47	22
"	30	" 9.....	" 6.....	119	73	18	54	16
"	45	" 9.....	" 5.....	118	74	24	57	2
"	60	" 9.....	" 5.....	118	78	8	59	1
"	75	" 9.....	" 5.....	118	80	20	59	25
"	90	" 9.....	" 4.....	117	64	24	52	27
"	105	" 9.....	" 4.....	117	72	32	54	32
"	120	" 9.....	" 4.....	117	72	12	50	18

RATES OF SEEDING Mensury Barley (non-irrigated) on Summer-fallow.

Size of plot.	Rate of seeding per acre.	Date sown.	Date ripe.	Days to mature.	Yield per acre.		Average yield per acre for 4 years.	
Acres.	Lb.				Bush.	Lb.	Bush.	Lb.
1/20	15	April 17.....	July 31.....	105	28	36	14	31
"	30	" 17.....	" 31.....	105	37	24	19	18
"	45	" 17.....	" 31.....	105	38	36	20	45
"	60	" 17.....	" 31.....	105	36	12	22	27
"	75	" 17.....	" 31.....	105	37	4	24	8
"	90	" 17.....	" 30.....	104	37	24	27	19
"	105	" 17.....	" 30.....	104	34	28	27	42
"	120	" 17.....	" 29.....	103	34	28	25	40

SESSIONAL PAPER No. 16

SOIL CULTURAL EXPERIMENTS.

The dry-land soil cultivation investigations incepted in 1911 were continued but as yet few of the experiments have shown any marked results. Some interesting points, however, have been brought out, which may be briefly mentioned.

PRAIRIE BREAKING.

In this experiment, the results have brought out nothing that has not before been fairly well demonstrated. They strongly support our contention that sowing crops immediately after breaking is unprofitable, and point out that the most advisable and practical method of procedure on new land is to break the sod in the spring and allow it to remain till the following season before cropping.

DEPTH OF PLOUGHING.

The plots ploughed 3 and 4 inches deep appeared to suffer from drouth before those ploughed 6 and 7 inches deep. Ploughing beyond the latter depth, however, seemed of no advantage.

TIME OF PLOUGHING.

One of the most striking results observed, because it happened almost without exception, was the fact that land ploughed in the fall gave poorer returns than that which was ploughed in the spring. Similar results have been obtained in previous years, but the difference has never been so marked as was the case this year. No doubt the dry winter with its scanty rainfall was, in a great measure, responsible for these results.

PART II.—THE IRRIGATED FARM.

The yields on the irrigated part of the Station were satisfactory on the whole, average crops being harvested.

ROTATIONS ON THE IRRIGATED LAND.

There are at the present time two rotations under test on the irrigated part of the Farm, "U" and "V," the latter being simply a field left in alfalfa continuously.

ROTATION "U."

First year.—Seedling alfalfa.

Second year.—Alfalfa hay.

Third year.—Alfalfa hay.

Fourth year.—Alfalfa hay.

Fifth year.—Alfalfa hay.

Sixth year.—Alfalfa hay.

Seventh year.—Hoed crop.

Eighth year.—Wheat.

Ninth year.—Oats.

Tenth year.—Barley.

ROTATION "V."

Alfalfa continuously.

In computing the tables set forth herewith values as given on page 156 have been used.

Rotation Year.	Crops.		ITEMS OF EXPENSE									
			Area.	Rent and manure.	Seed, twine and use of machinery.	Manual labour.		Horse labour (including teamster).				
						Hours.	Cost.	Hours.				
								Single horse	2-horse team	3-horse team	4-horse team	5-horse team
	1912.	1913.	Ac.	\$ c.	\$ c.	No.	\$ c.	No.	No.	No.	No.	No.
3rd...	Alfalfa.....	Alfalfa.....	1	4 20	1 19	18 ¹ / ₂	3 57	21 ¹ / ₂	7 ¹ / ₂
2nd...	Alfalfa seeding.	Alfalfa.....	1	4 20	1 19	16 ¹ / ₄	3 09	1 ¹ / ₂	5 ¹ / ₄
1st...	Oats.....	Alfalfa.....	1	4 20	1 19	10 ³ / ₈	2 06	1 ¹ / ₂	61 ¹ / ₂
10th..	Oats.....	Barley.....	1	4 20	1 90	5 ¹ / ₂	98	5 ¹ / ₂	51 ¹ / ₂
9th...	Wheat.....	Oats.....	1	4 20	2 05	5 ¹ / ₂	1 06	1	6
8th...	Potatoes.....	Wheat.....	1	4 20	2 67	10 ⁵ / ₈	2 06	1 ⁵ / ₈	31 ¹ / ₂
7th...	Alfalfa.....	Potatoes.....	1	4 20	15 40	162 ⁵ / ₈	30 94	61 ³ / ₄	17	164 ¹ / ₈
6th...	Alfalfa.....	Alfalfa.....	1	4 20	1 19	20 ¹ / ₈	3 93	31 ¹ / ₄	7 ¹ / ₂
5th...	Alfalfa.....	Alfalfa.....	1	4 20	1 19	21 ¹ / ₂	4 06	3	8 ¹ / ₂
4th...	Alfalfa.....	Alfalfa.....	1	4 20	1 19	21 ¹ / ₂	4 06	3	8 ¹ / ₂
	Aggregate.....		10	42 00	29 16	55 81
	Average per acre.....			4 20	2 92	5 58

ROTATION

Alfalfa.....	Alfalfa.....	1 06	3 18	64	261 ¹ / ₈	4 97	31 ¹ / ₈	7 ¹ / ₂
Aggregate.....	
Average per acre.....		3 00	60	4 69

SESSIONAL PAPER No. 16

"U" (ten years' duration).

IN RAISING CROP.						PARTICULARS OF CROP.								
Cost of horse labour.	Cost of threshing.	Total cost.	Cost for 1 acre.	Cost for 1 bushel.	Cost for 1 ton.	Height of Stubble.	Weight.				Total value.	Value of crop per acre.	Profit or loss per acre.	
							Grain.	Straw.	Hay.	Hoed crop.				
£ c.	£ c.	£ c.	£ c.	Cts.	£ c.	Ins.	Lb.	Lb.	Lb.	Lb.	£ c.	£ c.	£ c.	
3 36		12 32	12 32			3			9,165		54 99	54 99	42 67	
2 40		10 88	10 88			3			5,845		34 89	34 89	24 01	
3 73		11 18	11 18						1,006		6 00	6 00	-5 18	
2 88	1 55	11 51	11 51	37		3	1,475	1,385			16 13	16 13	4 62	
3 35	2 98	13 64	13 64	19			2,530	2,560			27 86	27 86	14 22	
2 05	3 71	14 69	14 69	28			3,160	5,270			32 88	32 88	18 19	
16 68		67 22	67 22	11					2,593	35,537	3 89	390 06	233 74	
											296 17			
3 50		12 82	12 82			3			9,385		56 31	56 31	43 49	
3 76		13 20	13 20			3			11,075		66 45	66 45	53 25	
3 76		13 20	13 20			3			11,075		66 45	66 45	53 25	
45 47	8 24	180 66									662 02			
4 55	82		18 06									66 20	48 14	

"V" (alfalfa continuously).

3 25		12 04	11 36			3			8,375		50 25	47 41	34 90
3 06			11 36									47 41	36 05

MEASUREMENT OF IRRIGATION WATER.

All the water used for irrigation was measured over a weir, and a record made by a Friez self-registering instrument. An effort has always been made to ascertain the amounts of water used on each individual crop but, because of the large number of small fields, this has not always been feasible. The quantity of water used for the season was sufficient to cover the land to a depth of 1.525 feet. The depth of water on the land on the Station devoted to mixed crops for the season of 1913 may therefore be said to be 1.525 acre-feet. It should be stated in this connection that a continuous flow of a fixed amount was not used. Water was obtained from the main canal at such times, and in such quantities, as we desired.

The following table, giving details regarding dates and quantities of water used on an alfalfa field of 15 $\frac{3}{4}$ acres, may be of interest:—

Area of field.	Dates of Irrigation.	Amount of water used, <i>i.e.</i> , depth of water applied.
15.75 acres.....	May 22-29	.664 feet.
	July 15-17	.754 "
	Sept. 25-27	.495 "

Total depth of water applied.....1.913 feet.
Average yield per acre of alfalfa.....4 tons 230 pounds.

The rainfall during the growing season was:—

April..	0.52 inches.
May..	1.70 "
June..	4.70 "
July..	1.29 "
August..	1.93 "
Total..	10.14 "

The alfalfa was cut twice, and the yield of hay was 4 tons 230 pounds per acre. The irrigation in September was applied for the benefit of the 1914 crop. If the rainfall in the spring of 1914 proves to be normal, probably no irrigation will be required before the first cutting is made.

SESSIONAL PAPER No. 16

EXPERIMENTAL STATION FOR CENTRAL ALBERTA, LACOMBE, ALTA.

REPORT OF THE SUPERINTENDENT, G. H. HUTTON, B.S.A.

WEATHER CONDITIONS, 1913.

The seeding season opened on April 10. The weather during April and for the first ten days of May was both cool and dry, keeping growth in check. Afterwards, however, conditions were so favourable that by June 15 all crops on well prepared land were as far advanced as has been the case in any season since the establishment of the Station. Favourable weather continued until harvesting and threshing were concluded. Fair yields of grain of better than average quality were the rule.

SOME WEATHER OBSERVATIONS taken at Lacombe Experimental Station, 1913.

Month.	TEMPERATURE F.			Total Precipitation.	Total Sunshine
	Mean.	Highest.	Lowest.		
		°	°	Inches.	Hours.
January		45.3	-35.5	0.93	63.3
February.....		55.6	-28.6	1.15	103.2
March.....		52.1	-23.6	0.81	164.1
April.....		77.8	17.4	0.15	260.8
May.....		77.4	18.1	0.48	277.1
June.....		81.8	36.2	2.98	271.9
July.....		83.8	31.9	3.43	336.3
August.....		84.0	35.5	2.135	311.1
September.....		80.0	21.4	0.59	210.4
October.....		81.5	9.7	0.68	141.7
November.....		59.8	-0.5	0.05	146.2
December.....		57.8	-13.	0.07	136.7
Total for year.....				13.755	2452.8
Total for 6 growing months, April to September				10.065	1697.6

YIELDS OF FIELD CROPS.

Though the yield of grain in field lots this year has not been high, the quality has been good.

AREAS AND YIELDS of Field Crops, Lacombe, 1913.

Variety.	Area.	Total yield.		Yield per acre.	
	Acres.	Bush.	Lb.	Bush.	Lb.
Banner oats.....	5.859	410	16	70	2
Abundance oats.....	33.0	1,776	31	53	29
Marquis wheat.....	11.101	517	30	44	57
O. A. C. No. 21 barley.....	6.0	150	00	25	00
Mensury barley.....	26.0	902	00	37	00

ROTATION OF CROPS.

While it is rather too early to draw definite conclusions as to the particular rotation best adapted to local conditions, it has been shown that a rotation which includes an application of barnyard manure and at least two years in hay or pasture, will insure heavier yields of grain during the years in which it is sown to these crops, than is possible where no rotation is followed other than continuous grain growing. A rotation such as "K" or "L" described below, is well adapted to conditions as obtain in this district. The sod, by returning fibre to the soil, helps to prevent blowing, increases its water holding capacity and improves its physical condition. The moderate application of barnyard manure has a similar effect, and it is noticeable that crops on land so treated make greater headway, especially in the early stages, than those on equally rich soil where no manure has been used. Extremely heavy applications of manure, more particularly if it is coarse, may prove injurious the first year after its application, especially if the season happens to be dry. If comparatively fine manure is applied on sod in the fall after the first crop of hay is cut, beneficial results will certainly follow.

The following rotations are now under test, "N" reported upon last year having been dropped to make room for some new poultry buildings.

ROTATION "C."

First year.—Summer-fallow.

Second year.—Wheat.

Third year.—Wheat, or coarse grain.

ROTATION "K."

First year.—Hoed crop—peas—mixed grain.

Second year.—Wheat.

Third year.—Oats or barley. Seeded down per acre as follows: one-third, alsike clover 6 pounds and rye grass 10 pounds; one-third, alsike clover 6 pounds, alfalfa 6 pounds and timothy 3 pounds; one-third, alsike clover 2 pounds, red clover 6 pounds, timothy 2 pounds and rye grass 2 pounds.

Fourth year.—Hay. Manured in autumn, 12 tons per acre.

Fifth year.—Pasture.

Sixth year.—Pasture. Ploughed July after haying, in preparation for roots.

LACOMBE.

SESSIONAL PAPER No. 16

ROTATION "L."

First year.—Hay.

Second year.—Pasture. Manured in autumn. 12 tons per acre.

Third year.—Pasture. Break July, for fall wheat.

Fourth year.—Grain. Winter wheat, or, in case of failure, spring wheat.

Fifth year.—Oats.

Sixth year.—Barley. Seeded down with 4 pounds timothy, 4 pounds alsike and 4 pounds red clover per acre.

ROTATION "G."

First year.—Hood crops, or peas and oats mixed, cut early, and land disced and cultivated in fall.

Second year.—Wheat.

Third year.—Oats.

Fourth year.—Summer-fallow.

Fifth year.—Barley. Seeded down with 3 pounds timothy, 2 pounds alsike and 6 pounds alfalfa per acre.

Sixth year.—Hay. Manured in fall 6 tons per acre.

Seventh year.—Pasture. Portion intended for roots the following year to be ploughed early July.

The following tables contain details in connection with the above rotations for 1913. In computing the results fixed values as given on page 156 of this report have been used.

ROTATION

Rotation Year.	Crops.		ITEMS OF EXPENSE										
			Area.	Rent and manure.	Seed, twine and use of machinery.	Manual labour.		Horse labour (including teamster).					
						Hours.	Cost.	Hours.					
								Single horse	2-horse team.	3-horse team.	4-horse team.	5-horse team.	
1912.	1913.	Ac.	\$ c.	\$ c.	No.	\$ c.	No.	No.	No.	No.	No.		
1st...	Barley.....	Wheat.....	1	2 00	2 60	2 ³ / ₄	0 52			11 ¹ / ₂			
2nd...	Barley.....	Summer-fallow	1	2 00	0 60					12 ¹ / ₂			
3rd...	Summer-fallow	Wheat.....	1	2 00	2 72	4	0 76		4			1 ¹ / ₂	
	Aggregate.....		3	6 00	5 92		1 28						
	Average per acre.....			2 00	1 97		0 43						

ROTATION

4th...	Barley seeded down.....	Hay.....	3-909	15 64	7 23	19 ³ / ₄	3 75					
5th...	Hay.....	Pasture.....	3-909	15 64	5 87				16 ³ / ₄			
6th...	Pasture.....	Pasture.....	3-909	15 64	5 87							
1st...	Pasture.....	Hoed crop.....	3-909	15 64	30 72	230 ¹ / ₂	43 79	7 ¹ / ₄	72			22
2nd...	Hoed crop.....	Wheat.....	5-909	15 64	10 45	8 ¹ / ₄	1 57		8			4 ¹ / ₂
3rd...	Wheat.....	Barley seeded down.....	3-909	15 64	7 32	6 ¹ / ₄	1 19		8 ¹ / ₄	3 ¹ / ₂		14 ¹ / ₂
	Aggregate.....		23-45	93 84	67 46		50 30					
	Average per acre.....			4 00	2 88		2 14					

ROTATION

3rd...	Pasture.....	Pasture.....	1-74	6 96	2 39	2 ³ / ₄	0 52		4 ¹ / ₂			
4th...	Pasture.....	Wheat.....	1-74	6 96	4 65	3 ¹ / ₄	0 62		22 ¹ / ₂			2 ¹ / ₂
5th...	Wheat.....	Oats.....	1-74	6 96	3 40	1 ¹ / ₄	0 24		3 ³ / ₄	1 ¹ / ₄		8 ³ / ₄
6th...	Oats.....	Barley seeded down.....	1-74	6 96	3 53	1 ¹ / ₂	0 28		4 ³ / ₄			7 ¹ / ₂
1st...	Barley seeded down.....	Hay.....	1-74	6 96	3 03	3 ¹ / ₄	0 62		5 ³ / ₄			
2nd...	Hay.....	Pasture.....	1-74	6 96	2 39	1 ¹ / ₄	0 24		3			
	Aggregate.....		10-44	41 76	19 44		2 52					
	Average per acre.....			4 00	1 86		0 24					

ROTATION

4th...	Oats.....	Green feed.....	3-210	9 18	17 89	9 ⁵ / ₈	1 84		4	3		8 ¹ / ₅
5th...	Summer-fallow	Barley seeded down.....	2-727	7 79	6 24	15	2 85		7 ¹ / ₄	3 ¹ / ₄		
6th...	Barley seeded down.....	Hay.....	3-202	9 33	6 91	16	3 04		9 ¹ / ₂			
7th...	Hay.....	Pasture.....	4-119	11 78	8 51							
1st...	Pasture.....	Hoed crop.....	4-119	11 78	20 01	275 ¹ / ₄	51 92	43 ¹ / ₂	87 ³ / ₄			4 ³ / ₄
2nd...	Hoed crop.....	Wheat.....	4-119	11 78	11 46	11 ¹ / ₄	2 14		8			6
3rd...	Wheat.....	Oats.....	4-119	11 78	7 96	10	1 90		5			17 ¹ / ₂
	Aggregate.....		25-675	73 42	78 98		63 69					
	Average per acre.....			2 86	3 08		2 48					

SESSIONAL PAPER No. 16

"C" (three years' duration).

IN RAISING CROP.							PARTICULARS OF CROP.						
Value of horse labour.	Cost of threshing.	Total cost.	Cost for 1 acre.	Cost for 1 bushel.	Cost for 1 ton.	Height of stubble.	Weight.				Total value.	Value of crop per acre.	Profit or loss per acre.
							Grain.	Straw.	Hay.	Hoed crop.			
\$ c.	\$ c.	\$ c.	\$ c.	Cts.	\$ c.	Ins.	Lb.	Lb.	Lb.	Lb.	\$ c.	\$ c.	\$ c.
0 71	1 45	7 28	7 28	35			1,240	3,965			18 51	18 51	11 23
4 25		6 85	6 85										-6 85
1 91	3 03	10 42	10 42	24			2,600	5,675			37 50	37 50	27 08
6 87	4 48	24 55									56 01		
2 29	1 49		8 18									18 67	10 49

"K" (six years' duration).

		32 31	8 27						13,244		66 22	16 94	8 67
5 69		24 51	5 50								2 63	0 67	-4 83
		21 51	5 50								2 86	0 73	-4 77
37 68		127 83	32 70						14,762	32,130	341 56	87 38	54 68
4 88	10 41	42 95	10 99	28.8			8,920	18,975			128 42	32 85	21 86
11 19	5 50	40 84	10 45	37.1			5,280	8,380			61 18	15 65	5 20
59 44	15 91	286 95									602 87		
2 53	0 68		12 23									25 70	13 47

"L" (six years' duration).

1 53		11 40	6 55						4,210		21 68	12 46	5 91
8 73	2 49	23 45	13 48	65.9			2,135	5,805			31 37	18 03	4 55
5 98	3 87	20 45	11 75	20.6			3,287	6,373			39 24	22 55	10 80
5 20	2 35	18 33	10 53	39.0			2,256	3,181			25 74	14 79	4 26
1 95		12 61	7 25						6,450		32 25	18 53	11 28
1 02		10 61	6 10						1,060		6 17	3 55	-2 55
24 42	8 71	96 85									156 45		
2 34	0 83		9 27									14 98	5 71

"O" (seven years' duration).

6 59		55 50	11 06						9,028		45 14	14 06	3 00
3 79	3 90	24 57	9 01	31.5			3,744	17,196			54 61	20 01	11 03
3 23		22 51	6 90						10,785		53 93	16 54	9 64
		20 29	4 93								4 28	1 04	-3 87
43 85		127 56	30 97							57,432	140 91	34 21	3 21
5 60	14 35	45 33	11 00	22.1			12,300	21,451			174 73	42 42	31 42
10 10	12 55	44 29	10 78	14.0			10,670	16,790			123 19	29 98	19 20
73 16	30 80	320 05									597 12		
2 85	1 20		12 47									23 26	10 79

FANNED VERSUS NOT FANNED WHEAT FOR SEED.

An interesting experiment has been conducted with fanned and not fanned Marquis wheat for seeding purposes. The results indicate the importance of a careful grading of all seed grain.

Wheat fanned twice yielded..38 bush.	90 lb.	per acre.
Wheat fanned once yielded..26	" 50	" "
Wheat not fanned yielded..24	" 90	" "

SOIL CULTURAL EXPERIMENTS.

A series of soil cultivation experiments is being conducted and, as far as it has been possible to judge, the yields have not been influenced other than by the treatment given. Among the experiments conducted, the following are those considered conclusive enough to be reported upon:—

DEPTH OF PLOUGHING.

- A. Ploughing on wheat stubble to be sown to oats.
- B. Ploughing for summer-fallow.
- C. Ploughing on sod.

The deep working of the land in the summer-fallow year did not appear to give any special results on the first succeeding crop (wheat) but influenced favourably the second crop (oats).

In the breaking out of sod, ploughing at a depth of five inches gave better results than at 3 or 4 inches. This practice also proved superior, this year, to breaking sod 3 inches and ploughing the wheat stubble 6 inches for the following oat crop.

SUMMER-FALLOW TREATMENT.

In the experiment with methods of summer-fallowing, the following points have been indicated:—

1. That it is of advantage to plough summer-fallow but once.
2. That deep ploughing gives better results than shallow ploughing.
3. That working or ploughing the stubble land in the fall previous to the summer-fallow does not always result in increased yields.

STUBBLE TREATMENT.

The fall or spring ploughing of stubble land proved better practice than the burning of the stubble in spring, and then seeding.

SEEDING TO GRASS AND CLOVER.

When the seeding of grass is made with a nurse crop, the yield of hay is increased, but the increase is not sufficient to compensate for the loss of crop sustained when seeding alone.

SESSIONAL PAPER No. 16

CLEARING AND BREAKING.

About 15 acres of the more heavily timbered portion of the newly purchased farm have been cleared, and broken by means of a steam plough. The engine drew two 24-inch brush breakers and cut a clean and well-turned furrow, considering that many of the roots encountered measured twelve inches or more across. Another 6-acre area has been brushed, cleared and broken by horse-power.

FENCING.

About 6½ miles of woven wire fence were erected during the season, the style for the most part being a nine-wire 52-inch fence, ten stays to the rod, number nine gauge wire throughout. A few other styles were also erected so that comparisons may be made.

EXPERIMENTAL FARM FOR BRITISH COLUMBIA, AGASSIZ, B. C.

REPORT OF THE SUPERINTENDENT, P. H. MOORE, B.S.A.

FIELD CROPS.

In the spring of 1911 practically the entire Farm was put down to a four-year rotation, namely:—

First year.—Hoed crop of corn, roots or potatoes.

Second year.—Grain. Seeded down.

Third year.—Clover hay.

Fourth year.—Pasture.

With the increase of barnyard manure, the results from each new section planted to hoed crops have shown an improvement.

The hoed crops this season were grown on a piece of land from which, since 1910, orchards have been removed from time to time. A part of the area is badly infested with couch grass, and another portion suffers somewhat from shading, due to its location between the mountains on the north and a section of Douglas fir trees on the south. Notwithstanding this, the yields have been fair. In all, there were harvested 284 tons 1,770 pounds of silage corn, 136 tons 110 pounds of mangels, 9 tons 1,980 pounds of carrots, 6 tons 100 pounds of sugar beets, 16 tons 1,500 pounds of potatoes, and 10 tons 800 pounds of turnips, making a total hoed crop yield of 464 tons 260 pounds.

Two varieties each of corn and mangels were grown as field crops, namely: Longfellow and Compton's Early corn and Giant Half Sugar White and Perfection Mammoth Long Red mangels. Regarding the corn, the sorts grown give the best results of any of the varieties grown to date. With regard to the mangels, we are not in a position to make this statement with such assurance as yet, because several of the varieties now being tested give promise of greater yields per acre.

The mangels were planted at the rate of 9 pounds per acre in drills, 30 inches apart. These drills were set up with a double mould board plough, rolled and the seed sown with a hand drill. This rate of planting gave, at the time of the two-leaf stage, a perfect stand. Where fertilizer tests were not carried on, there were sown in the drills, at drilling time, 600 pounds per acre of a mixture of chemical fertilizers, consisting of 350 pounds superphosphate, 150 pounds muriate of potash and 100 pounds nitrate of soda. For the last two years the mangels, when treated this way, have grown faster than the average weeds. When once up and growing nicely they were hoed by hand with a small wheel hoe. They were thus easily and cheaply kept above the weeds, and the horse cultivator did the rest until thinning time. They were thinned about 14 inches apart and hoed but once thereafter.

Because the field was badly overrun with couch grass, a great deal of preparation was required for the corn land. Many harrowings were given with the drag type of harrow, for too much cutting only defeated our aims. Barnyard manure was ploughed in at the rate of 16 tons per acre. The corn was planted by

SESSIONAL PAPER No. 16

machine in checks 3 feet apart each way, for this distance has proven the most advantageous for this district in getting good silage results. The land was harrowed with a drag harrow twice before the corn came up, to keep down the corn spurrey. After the last cultivation with a two-horse two-rowed cultivator (except the finishing off, for which we used the single walking scuffler), it was hand hoed once. In harvesting, the corn was bound and hauled on low-wheeled wagons. The total cost in the silo was \$2.73 per ton.

BARNYARD MANURE.

COMMERCIAL FERTILIZER ALONE *versus* COMMERCIAL FERTILIZER TOGETHER WITH BARNYARD MANURE FOR MANGELS.

In order to ascertain the value of barnyard manure for mangels, an experiment was begun using a mixture of commercial fertilizer only on one plot, and the same mixture, together with 16 tons per acre of barnyard manure on a second plot. While the second plot yielded over 3 tons per acre more mangels than the first, the manure could not be considered as having entirely paid for itself from the first crop after application. The yields of succeeding crops must, of course, be considered before the full value of the manure will be known.

COMMERCIAL FERTILIZER ALONE *versus* Commercial Fertilizer together with Barnyard Manure.

Plot.	Fertilizers.		Yield of mangels per acre.	Cost of fertilizers.	Value of crop per acre less cost of fertilizers.
	Barnyard manure.	Commercial fertilizers.			
			Tons. Lb.	\$ cts.	\$ cts.
1	16 tons, fresh, applied in spring.....	Superphosphate, 350 lb.; muriate of potash, 150 lb.; nitrate of soda, 100 lb.....	26 1820	24 42	56 30
2		Superphosphate, 350 lb.; muriate of potash, 150 lb.; nitrate of soda, 100 lb.....	23 1550	8 42	62 90

SPRING APPLICATION *versus* WINTER APPLICATION OF FRESH MANURE.

In this very wet winter climate it is thought there may be undue loss through the leaching of barnyard manure applied in the fall or winter. An experiment to learn the probable extent of this loss has been conducted during the past season. The results, as tabulated below, favour spring application.

Further tests, verifying these results, must be made, before accepting them as conclusive.

SPRING APPLICATION *versus* Winter Application of Fresh Manure.

Plot.	Fertilizers.		Yield of mangels per acre.	Cost of fertilizers.	Value of crop per acre less cost of fertilizers.
	Barnyard manure.	Commercial fertilizers.			
			Tons. Lb.	\$ cts.	\$ cts.
1	16 tons, fresh, applied in winter....	Superphosphate, 350 lb.; muriate of potash, 150 lb.; nitrate of soda, 100 lb.....	25 1000	24 42	52 07
2	16 tons, fresh, applied in spring....	Superphosphate, 350 lb.; muriate of potash, 150 lb.; nitrate of soda, 100 lb.....	26 1820	24 42	56 30

WINTER APPLICATION OF MANURE (FRESH) *versus* SPRING APPLICATION (STACK).

In this experiment, 16 tons per acre of manure were weighed and hauled on the plot in the winter and left in the stack, to be spread in the spring. The other plot received fresh manure direct from the yard in the spring. Spring application again produced a somewhat heavier yield of mangels, but results will be accepted as final only after further verification.

APPLICATION of Fresh Manure in Winter *versus* Application from Stack in Spring.

Plot.	Fertilizers.		Yield of mangels per acre.	Cost of fertilizers.	Yield of crop per acre less cost of fertilizers.
	Barnyard manure.	Commercial fertilizers.			
			Tons. Lb.	\$ cts.	\$ cts.
1	16 tons, fresh, applied in winter....	Superphosphate, 350 lb.; muriate of potash, 150 lb.; nitrate of soda, 100 lb.....	25 1000	24 42	52 07
2	16 tons, from stack, applied in spring..	Superphosphate, 350 lb.; muriate of potash, 150 lb.; nitrate of soda, 100 lb.....	25 1780	24 42	53 24

DOMINION OF CANADA
DEPARTMENT OF AGRICULTURE
DOMINION EXPERIMENTAL FARMS

REPORT

FROM THE

DIVISION OF ANIMAL HUSBANDRY

ON

BEEF CATTLE, DAIRY CATTLE AND DAIRYING, HORSES, SHEEP AND SWINE

FOR THE FISCAL YEAR ENDING MARCH 31, 1914

PREPARED BY

The Dominion Animal Husbandman, Ottawa, Ont. - - - - E. S. Archibald, B.A., B.S.A.
Superintendent—

Experimental Station, Charlottetown, P.E.I. - - - -	J. A. Clark, B.S.A.
Experimental Farm, Nappan, N.S. - - - - - - - -	W. W. Baird, B.S.A.
Experimental Station, Kentville, N.S. - - - - - - - -	W. S. Blair.
Experimental Station, Fredericton, N.B. - - - - - - - -	W. W. Hubbard.
Experimental Station, Cap Rouge, P. Q. - - - - - - - -	Gus. A. Langelier
Experimental Station, Ste. Anne de la Pocatière, P.Q. -	J. Bégin.
Experimental Farm, Brandon, Man. - - - - - - - -	W. C. McKillican, B.S.A.
Experimental Farm, Indian Head, Sask - - - - - - - -	T. J. Harrison, B.S.A.
Experimental Station, Scott, Sask. - - - - - - - -	R. E. Everest, B.S.A.
Experimental Station, Rosthern, Sask. - - - - - - - -	Wm. A. Munro, B.A., B.S.A.
Experimental Station, Lacombe, Alta. - - - - - - - -	G. H. Hutton, B.S.A.
Experimental Station, Lethbridge, Alta. - - - - - - - -	W. H. Fairfield, M.S.
Experimental Farm, Agassiz, B.C. - - - - - - - -	P. H. Moore, B.S.A.

REPORT

FROM THE

DIVISION OF ANIMAL HUSBANDRY.

Ottawa, March 31, 1914.

J. H. GRISDAL, Esq., B.Agr.,
Director Dominion Experimental Farms,
Ottawa.

SIR,—I have the honour to submit herewith reports upon the beef cattle, dairy cattle and dairying operations, horses, sheep, and swine on the Central Experimental Farm and branch Farms and Stations for the past year.

On October 11, 1914, this Division suffered severely at the Central Experimental Farm in the loss of the main dairy barn, calf, bull and steer barns by fire. This necessitated the discontinuing of many lines of work at this Farm, not only with Dairy and Beef cattle, but also with other classes of stock, as all remaining buildings were crowded to their limit. With the completion of the new buildings, now under construction, all such postponed work will be continued.

For help in preparing and compiling a large proportion of the data contained in the text of the Central Farm report, I am indebted to Mr. G. B. Rothwell. The conducting of work and reporting results of such work on the branch Farms and Stations have been in the hands of the Superintendents of those Farms and Stations.

In work with swine, both breeding and feeding, on the Central Experimental Farm, Mr. D. D. Gray, farm foreman, deserves special credit for the very efficient manner in which he conducted the various operations and retained careful and accurate records of same.

The work of keeping breeding and sales records for the Central Experimental Farm, and also the registration work for all Dominion Experimental Farms, has been most efficiently performed by Mr. G. B. Rothwell.

To Mr. Jos. Meilleur, dairyman at the Central Farm, I am indebted for excellent work and careful records in his department.

To Mr. Robt. Cunningham, herd-man, I am indebted for constant and efficient care of stock and for interest and assistance in new work, as well as the satisfactory performance of the routine work in connection with all classes of cattle.

To my secretary, Mr. O. Johnson, I am indebted for efficiency and diligence in office work, which includes heavy correspondence and the keeping records tabulated and filed.

Attention is drawn to the fact that all feeding experimental work is conducted in co-operation with the Division of Chemistry. Readers are referred to the report of the Dominion Chemist, Mr. F. T. Shutt, in which are contained the analyses of all foodstuffs being fed experimentally.

5 GEORGE V., A. 1915

During the year I have attended many meetings, and judged at various exhibitions, in addition to my regular duties on the Central Experimental Farm. I have also visited each of the branch Farms and Stations in the Eastern Provinces where live stock work is being conducted or is anticipated, but owing to the losses by fire at Ottawa, was compelled to postpone visiting the western Farms.

I have the honour to be, sir,
Your obedient servant,

E. S. ARCHIBALD,
Dominion Animal Husbandman.

BEEF CATTLE.

CENTRAL EXPERIMENTAL FARM, OTTAWA, ONT.

REPORT OF THE DOMINION ANIMAL HUSBANDMAN E. S. ARCHIBALD, B.A., B.S.A.

As reported previously, no breeding herds of beef cattle have been maintained on the Central Experimental Farm since the removal, in 1911, of the Shorthorn herd from Ottawa to the branch Farm at Brandon, Man., this owing to lack of pasture, forage crops, and buildings necessary for such work.

BEEF EXPERIMENTAL FEEDING.

Previous experiments have clearly demonstrated the fact that stall feeding of stockers and thin butcher cattle during summer months as a rule leaves little if any profit. Hence during the past year no work was undertaken in the summer months. In the early part of September a good bunch (thirty head) of 2-year-old stockers was purchased preparatory to winter feeding experiments. These were dehorned and tuberculin tested at once, and maintained on a preparatory feeding period during the last two weeks of that month. On October 1 three experiments were started, comparing three grain rations with and without molasses and molasses meals. These experiments promised interesting and valuable data, but unfortunately had to be discontinued owing to the destruction of the steer barn by fire.

However, at that time the Superintendent of the Experimental Farm at Nappan, N.S., was commencing steer purchases for experimental feeding, and it was considered advisable to ship this lot of steers from Ottawa and incorporate some of the features of the started experiment in the work at that Farm. See report of the Superintendent, Experimental Farm, Nappan, N.S.

It is hoped that such work may be re-established on this Farm during the coming year, in temporary quarters, and that in the near future ample accommodation may be provided for this most important line of work.

FINANCIAL STATEMENT FOR BEEF CATTLE.

Below are submitted inventories and returns for beef cattle on the Central Experimental Farm during the year April 1, 1913, to March 31, 1914.

RETURNS.

By sale of ten finished steers	\$ 909 38	
By sale of fattened cows	178 45	
By sale of twenty-four steers to Experimental Farm, Nappan	1,909 25	
By manure, 240 tons at \$1	240 00	
Gross returns	<u> </u>	\$3,237 08

EXPENDITURES.

To feed consumed by steers and fattening cows	\$ 265 10	
To twenty-eight steers purchased September 12, 1913, at \$7 a cwt.	2,199 75	
To value of steers and fattening cows April 1, 1913	454 30	
To labour with beef animals	205 00	
Gross expenditure	<u> </u>	2,124 15
Net balance from beef cattle		<u> </u> 112 93

EXPERIMENTAL STATION, CHARLOTTETOWN, P.E.I.

REPORT OF THE SUPERINTENDENT, J. A. CLARK, B.S.A.

BEEF CATTLE.

The work with beef cattle at this Station was limited to steer feeding.

Feeders of a good beef type were very scarce and rather thin in flesh in the autumn of 1913. The cattle were mostly grades of various breeds and were purchased and marketed at the ruling market prices. They were dehorned and allowed to run on rape with shelter and hay at night, during part of November, at a cost per steer per month of \$1.73. The meal mixture cost \$25 per ton and was made up as follows:—

Oats (ground)	Lb.	43
Barley (ground)	"	43
Peas	"	14

The bran cost \$25 per ton and was mixed as fed, some pens requiring more than others.

Roots were valued at \$2 per ton.

Hay (mixed clover and timothy) was valued at \$7 per ton.

The test started on December 1, 1913, with sixteen head.

The following is a detailed statement of the different lots fed:—

LOT I.

The steers in the first pen were in good condition. They were Holstein and Shorthorn grades which, at the date of sale, would be about 2 years and 9 months old.

Number of steers in lot		4
First weight, gross	Lb.	3,810
First weight, average	"	952½
Finished weight, gross	"	4,400
Finished weight, average	"	1,100
Total gain in eighty days	"	590
Average gain per steer	"	147½
Daily gain per steer	"	1.84
Daily gain per lot	"	7.37
Gross cost of feed	\$	73 19
Cost of one pound gain	Cts.	12.4
Value of beef at the beginning, 3,810 pounds at 4.73 cents		
Total cost to produce beef	"	253 31
Selling price at 6½ cents per pound	"	286 00
Profit	"	33 29
Profit per steer	"	8 32
Average valuation of steer at start	"	45 03
Average value price at finish	"	71 50
Average increase in value	"	26 47
Average cost of feed per steer	"	18 29
Amount of meal eaten by lot (crushed grain, 1,450, bran, 1,845)	Lb.	3,295
Amount of roots eaten by lot	"	19,805
Amount of hay eaten	"	3,486

SESSIONAL PAPER No. 16

LOT II.

These were two steers of good beef type and one pure-bred Shorthorn heifer. They were in good thrifty condition and were about 3 months younger on the average than lot 3.

Number of cattle in lot	3
First weight, gross	Lb. 2,625
First weight, average	" 875
Finished weight, gross	" 3,285
Finished weight average	" 1,095
Total gain in 106 days	" 660
Average gain per animal	" 220
Daily gain per animal	" 2.075
Daily gain per lot	" 6.225
Gross cost of feed	\$ 67 52
Cost of 1 pound gain	Cts. 10.23
Value of beef at beginning, 2,625 pounds at 4.83 cents	\$ 126 99
Total cost to produce beef	" 194 51
Selling price at 7½ cents per pound	" 246 37
Profit	" 51 86
Profit per animal	" 17 29
Average valuation of animal at start	" 42 33
Average value price at finish	" 82 12
Average increase in value	" 39 79
Average cost of feed per animal	" 22 51
Amount of meal eaten by lot (crushed grain, 1,371; bran, 1,704).Lb.	3,081
Amount of roots eaten by lot	18,320
Amount of hay eaten by lot	3,953

LOT III.

These were two Hereford grades about 3 years old at date of sale, and one Shorthorn grade just 2 years old when sold. The Hereford grades were very thin at the beginning and at the close were shown in the Easter market by the butcher.

Number of steers in lot	3
First weight, gross	Lb. 2,425
First weight, average	" 808
Finished weight, gross	" 3,115
Finished weight, average	" 1,013
Total gain in 128 days	" 720
Average gain per steer	" 240
Daily gain per steer	" 1.875
Daily gain per lot	" 5.625
Gross cost of feed	\$ 88 95
Cost of one pound gain	Cts. 12.35
Value of beef at beginning, 2,425 pounds at 5.26 cents	\$ 127 65
Total cost to produce beef	" 216 60
Selling price at 7½ cents per pound	" 235 87
Profit	" 19 27
Profit per steer	" 6 42
Average valuation of steer at start	" 42 55
Average value price at finish	" 78 62
Average increase in value	" 36 07
Average cost of feed per steer	" 29 65
Amount of meal eaten by lot (crushed grain, 2,272; bran, 2,183). Lb.	4,455
Amount of roots eaten by lot	21,758
Amount of hay eaten by lot	3,286

LOT IV.

These were two Hereford grades and one Ayrshire grade all about 3 years old at date of sale. The lot were all thin when started. They were fed all the meal mixture they would stand from start to finish.

Beef Production.—Lot IV.

Number of steers in lot.....	3
First weight, gross..... Lb.	2,335
First weight, average..... "	778
Finished weight, gross..... "	3,230
Finished weight, average..... "	1,077
Total gain in 134 days..... "	895
Average gain per steer..... "	298
Daily gain per steer..... "	2.226
Daily gain per lot..... "	6.678
Gross cost of feed..... \$	98 64
Cost of one pound gain..... Cts.	11.021
Value of beef at beginning, 2,335 pounds at 5.6 cents..... \$	130 78
Total cost to produce beef..... "	229 42
Selling price at 7½ cents per pound..... "	242 25
Profit..... "	12 83
Profit per steer..... "	4 28
Average valuation of steer at start..... "	43 59
Average value price at finish..... "	80 75
Average increase in value..... "	37 16
Average cost of feed per steer..... "	32 88
Amount of meal eaten by lot (crushed grain, 2,519; bran, 2,492)..... lb.	5,011
Amount of roots eaten by lot..... "	23,680
Amount of hay eaten by lot..... "	3,520

LOT V.

These were two dairy type steers and one pure-bred Shorthorn steer. They were young and thrifty, averaging about 2 years old when sold.

Number of steers in lot.....	3
First weight, gross..... Lb.	2,175
First weight, average..... "	725
Finished weight, gross..... "	2,900
Finished weight, average..... "	967
Total gain in 151 days..... "	725
Average gain per steer..... "	242
Daily gain per steer..... "	1.6
Daily gain per lot..... "	4.8
Gross cost of feed..... \$	89 80
Cost of one pound gain..... Cts.	12.35
Value of beef at beginning, 2,175 pounds at 4.775 cents..... \$	103 84
Total cost to produce beef..... "	193 67
Selling price, 2,900 pounds at 7½ cents..... "	210 25
Profit..... "	16 58
Profit per steer..... "	5 52
Average valuation of steer at start..... "	34 62
Average value price at finish..... "	70 08
Average increase in value..... "	35 46
Average cost of feed per steer..... "	29 93
Amount of meal eaten by lot (oats, etc., 2,169; bran, 1,971)..... lb.	4,130
Amount of roots eaten by lot..... "	24,591
Amount of hay eaten by lot..... "	3,883

Deductions.—Only deductions of a general nature may be drawn from these feeding tests where the types of animals and the number of days of test vary so greatly. However, the following points are of interest:—

(1) Steers fed quickly give a good margin of profit.

(2) The type of steer that is sold as feeders throughout the province, although conforming more to the dairy than the beef type, may be profitably finished in from three to five months, according to age.

(3) Many steers slaughtered in November and December would pay good profitable returns if fed a few months longer.

SESSIONAL PAPER No. 16

EXPERIMENTAL FARM, NAPPAN, N.S.

REPORT OF THE SUPERINTENDENT, W. W. BAIRD, B.S.A.

EXPERIMENT WINTER OF 1913-14.

Twenty-four steers were purchased from the Central Farm, Ottawa, in October, 1913, costing 7 cents f.o.b. Freight charges on the twenty-four steers were \$62.88, making the total cost of steers when landed here \$7.23 per hundred, live weight.

All were well-bred grade Shorthorns, and twelve were in such a condition as would class them as good butchers. The remaining twelve were slightly thinner and could be ranked as good stockers. Four more good grade steers were purchased locally at 43 cents per pound and were in sufficiently good flesh to be classed as good butcher cattle.

The twenty-eight steers then were divided into two main lots, namely, sixteen good butchers and twelve good stockers; these in turn were divided into sublots for feeding as follows:—

- Lot 1, six steers, good butchers.
- Lot 2, six steers, good stockers.
- Lot 3, six steers, good butchers.
- Lot 4, six steers, good stockers.
- Lot 5, four steers, good butchers.

These were fed as follows:—

- Lot 2 were fed 50 per cent more roots and meal than lot 4.
- Lot 3 were fed 50 per cent more roots and meal than lot 1.
- Half of lot 1 were fed 2 pounds molasses per day per steer during period.
- Other half of lot 1 were fed none.
- Half of lot 2 were fed 2 pounds molasses per day per steer during period.
- Other half of lot 2 were fed none.
- Half of lot 3 were fed 2 pounds of molasses per steer per day during period.
- Other half of lot 3 were fed none.
- Half of lot 4 were fed 2 pounds molasses per steer per day during period.
- Other half of lot 4 were fed none.
- Lot 5 were fed same roughage as lot 1 but replaced 2 pounds of meal with molasses.

All steers had a preparatory feeding period from November 3 to 17 to allow them to become accustomed to their feed and surroundings.

5 GEORGE V., A. 1915

STEER FEEDING EXPERIMENT AT NAPPAN, FROM NOVEMBER 17, 1913, TO MARCH 30, 1914.

Comparison of Lots 1 and 3, Good Butchers, Heavy fed vs. Light fed.

	Lot 1. 6 steers. "Light Fed"	Lot 3. 6 steers. "Heavy Fed"
Total live weight of steers, Nov. 17, 1913.....lb.	7,155	6,885
Total live weight of steers, March 31, 1914.....lb.	8,945	8,765
Increase to March 31, 1914.....lb.	1,790	1,880
(Lot 1) —		
Original weight of 6 steers, 7155 pounds, at 7.23 cents.....\$	517.30	
Weight at finish of 6 steers, 8,945 pounds at 9 cents.....\$	805.05	
(Lot 3) —		
Original weight of 6 steers, 6,885 pounds at 7.23 cents.....\$		497.78
Weight at finish of 6 steers, 8,765 pounds at 9 cents.....\$		788.85
Gross profit.....\$	287.75	291.07
Amount of hay consumed.....lb.	11,970	11,970
Amount of meal consumed.....lb.	3,528	5,292
Amount of roots consumed.....lb.	30,660	45,990
Amount of molasses consumed.....gal.	55	55
Cost of feed for lot for 133 days.....\$	135.40	173.66
Net profit.....\$	152.35	117.41
Daily rate of gain per steer.....lb.	2.243	2.355
Cost of 1 pound gain.....cts.	7.56	9.24
Cost of feed per day per steer.....cts.	16.96	21.76
Profit per steer.....\$	25.39	19.57

STEER FEEDING EXPERIMENT at Nappan from November 17, 1913, to March 30, 1914.

Comparison of Lots 2 and 4, Good Stockers, Heavy fed vs. Light fed.

	Lot 2. 6 steers "Heavy Fed"	Lot 4. 5 steers "Light Fed"
Total live weight of steers, Nov. 17, 1913.....lb.	6,655	5,790
Total live weight of steers, March 31, 1914.....lb.	8,490	7,205
Increase to March 31, 1914.....lb.	1,835	1,415
Lot 2—		
Original weight of 6 steers, 6,655 pounds at 7.23 cents.....\$	481.15	
Weight at finish of 6 steers, 8,490 pounds at 9 cents.....\$	764.10	
Lot 4—		
Original weight of 5 steers, 5,790 pounds at 7.23 cents.....\$		418.61
Weight at finish of 5 steers, 7,205 pounds at 9 cents.....\$		648.45
Gross Profit.....\$	282.95	229.84
Amount of hay consumed.....lb.	11,970	9,975
Amount of meal consumed.....lb.	5,292	2,940
Amount of roots consumed.....lb.	45,990	25,550
Amount of molasses consumed.....gal.	55	55
Cost of feed for lot for 133 days.....\$	173.66	114.67
Net profit.....\$	109.29	115.17
Daily rate of gain per steer.....lb.	2.299	2.127
Cost of 1 pound gain.....cts.	9.46	8.10
Cost of feed per day per steer.....cts.	21.76	17.21
Profit per steer.....\$	18.21	23.03

SESSIONAL PAPER No. 16

STEER FEEDING EXPERIMENT at Nappan from November 17, 1913, to March 30, 1914.

Lot 5, Good Butchers, fed the same as Lot 1, except 2 pounds of meal which was replaced by molasses.

	Lot 5. 4 steers " Good Butchers"	Lot 5, calcu- lated on same basis as Lot 1.
Total weight of 4 steers, Nov. 21, 1913.....lb.	4,535	4,535
Total weight of 4 steers, March 31, 1914.....lb.	5,760	5,760
Increase to March 31, 1914.....lb.	1,225	1,225
Original weight of steers, 4,535 pounds at 4.75 cents.....\$	215.41	327.88
Weight at finish of 4 steers, 5,760 pounds at 9 cents.....\$	518.40	518.40
Gross profit.....\$	302.99	190.52
Amount of hay consumed.....lb.	7,560	7,560
Amount of meal consumed.....lb.	19,320	19,320
Amount of roots consumed.....lb.	1,596	1,596
Amount of molasses consumed.....gal.	71	71
Cost of feed for lot for 126 days.....\$	84.50	84.50
Net profit.....\$	218.49	106.02
Daily rate of gain per steer.....lb.	2.430	2.430
Cost of 1 pound gain.....cts.	6.89	6.89
Profit per steer.....\$	54.62	26.50

STEER FEEDING EXPERIMENT at Nappan from November 17, 1913, to March 30, 1914.

Comparison of sub-lots of Lot 1, Good Butchers, Light fed, Molasses vs. No Molasses.

	$\frac{1}{2}$ Lot 1. 3 steers. Molasses.	$\frac{1}{2}$ Lot 1. 3 steers. No Molasses.
Total live weight of 3 steers Nov. 17, 1913.....lb.	3,510	3,645
Total live weight of 3 steers March 30, 1914.....lb.	4,440	4,505
Increase to March 30, 1914.....lb.	930	860
Molasses—		
Original weight of three steers 3,510 pounds at 7.23 cents.....\$	253.77	
Weight at finish of 3 steers, 4,440 pounds at 9 cents.....\$	399.60	
No Molasses—		
Original weight of 3 steers, 3,615 pounds at 7.23 cents.....\$		263.53
Weight at finish of 3 steers, 4,505 pounds at 9 cents.....\$		405.45
Gross profit.....\$	145.83	141.92
Amount of hay consumed.....lb.	5,985	5,985
Amount of meal consumed.....lb.	1,764	1,764
Amount of roots consumed.....lb.	15,330	15,330
Amount of molasses consumed.....gal.	55	
Cost of feed for lot for 133 days.....\$	73.20	62.20
Net profit.....\$	72.63	79.72
Daily rate of gain per steer.....lb.	2.330	2.155
Cost of 1 pound gain.....cts.	7.87	7.23
Cost of feed per day per steer.....cts.	18.34	15.59
Profit per steer.....\$	24.21	26.57

5 GEORGE V., A. 1915

STEER FEEDING EXPERIMENT at Nappan from November 17, 1913, to March 30, 1914.
Comparison of sub-lots of Lot 2, Good Stockers, Heavy Fed. Molasses vs. No Molasses.

	$\frac{1}{2}$ Lot 1. 3 steers. Molasses.	$\frac{1}{2}$ Lot 1. 3 steers. No Molasses.
Total live weight of 3 steers Nov. 17, 1913.....lb.	3,525	3,130
Total live weight of 3 steers March 30, 1914.....lb.	4,500	3,990
Increase to March 30, 1914.....lb.	975	860
Molasses—		
Original weight of three steers 3,525 pounds at 7.23 cents.....\$	254.85	
Weight at finish of 3 steers, 4,500 pounds at 9 cents.....\$	405.60	
No Molasses—		
Original weight of 3 steers 3,130 pounds at 7.23 cents.....\$		226.29
Weight at finish of 3 steers, 3,990 pounds at 9 cents.....\$		359.10
Gross profit.....\$	150.15	132.81
Amount of hay consumed.....lb.	5,985	5,985
Amount of meal consumed.....lb.	2,646	2,646
Amount of roots consumed.....lb.	22,995	22,995
Amount of molasses consumed.....gal.	55	
Cost of feed for lot for 133 days.....\$	92.32	81.32
Net profit.....\$	57.83	51.49
Daily rate of gain per steer.....lb.	2.443	2.155
Cost of 1 pound gain.....cts.	9.46	9.45
Cost of feed per day per steer.....cts.	23.13	20.38
Profit per steer.....\$	19.27	17.16

STEER FEEDING EXPERIMENT at Nappan from November 17, 1913, to March 30, 1914.
Comparison of sub-lots of Lot 3, Good Butchers, Heavy Fed. Molasses vs. No Molasses.

	Half Lot 3. 3 steers. "Molasses."	Half Lot 3. 3 steers. "No Molasses."
Total live weight of 3 steers November 17, 1913.....lb.....	3,275	3,610
Total live weight of 3 steers March 30, 1914.....lb.....	4,155	4,610
Increase to March 30, 1914.....lb.....	880	1,000
Molasses—		
Original weight of 3 steers, 3,275 pounds, at 7.23 cents.....\$	236.78
Weight at finish of 3 steers, 4,155 pounds, at 9 cents.....\$	373.95
No Molasses—		
Original weight of 3 steers, 3,610 pounds, at 7.23 cents.....\$	261.00
Weight at finish of 3 steers, 4,610 pounds, at 9 cents.....\$	414.90
Gross profit.....\$	137.17	153.90
Amount of hay consumed.....lb.....	5,985	5,985
Amount of meal consumed.....lb.....	2,646	2,646
Amount of roots consumed.....lb.....	22,995	22,995
Amount of molasses consumed.....gal.....	55
Cost of feed for lot for 133 days.....\$	92.32	81.32
Net profit.....\$	44.85	72.58
Daily rate of gain per steer.....lb.....	2.205	2.506
Cost of 1 pound gain.....cts.....	10.49	8.13
Cost of feed per day per steer.....cts.....	23.13	20.38
Profit per steer.....\$	14.95	24.19



Steers fed at Nappan, N.S., 1913-14.

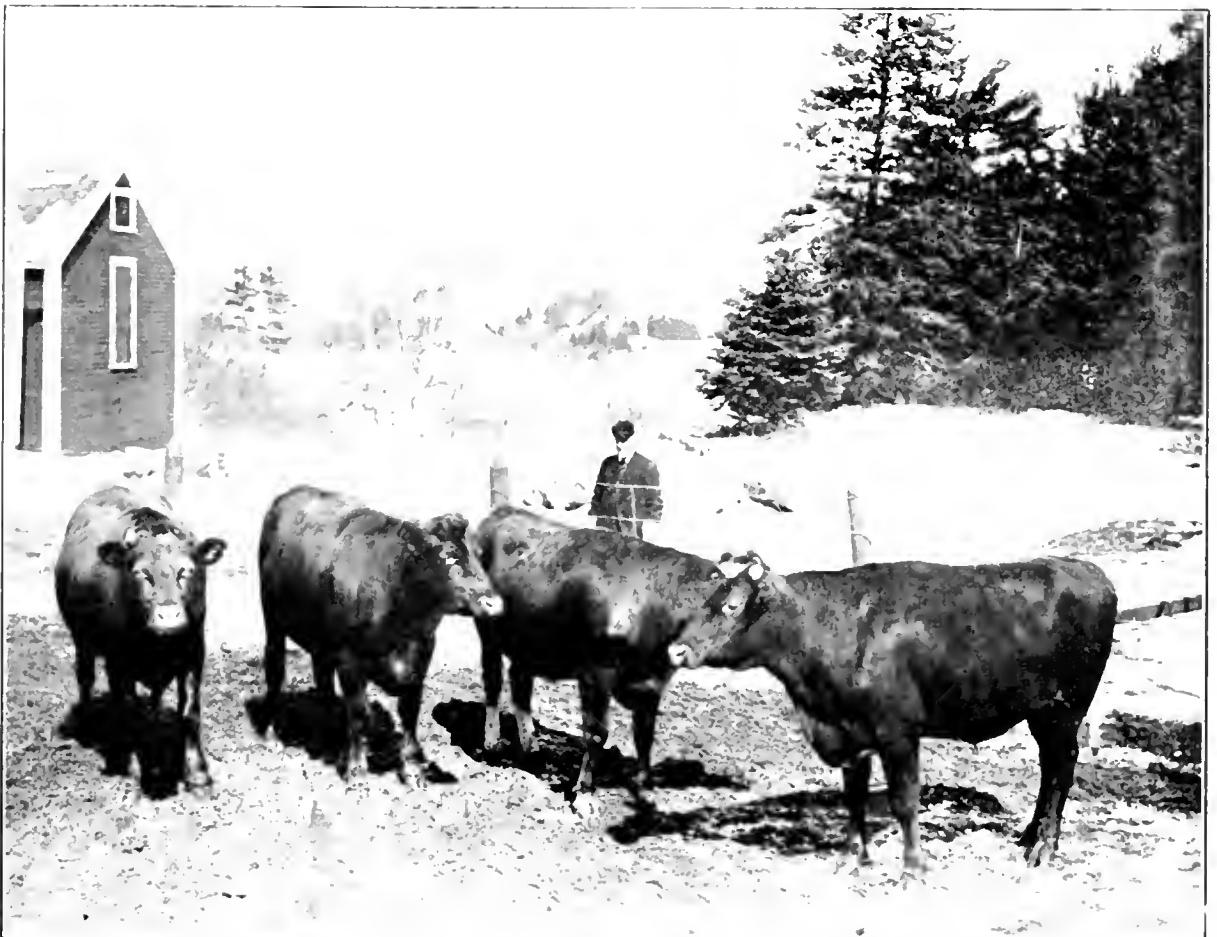

Steers fed at Kentville, N.S., 1913-14.

SESSIONAL PAPER No. 16

STEER FEEDING EXPERIMENT at Nappan from November 17, 1913, to March 30, 1914.
Comparison of sub-lots of Lot 4, Good Stockers, Light Fed. Molasses vs. No Molasses.

	Half Lot 4. 3 steers. "Molasses."	Half Lot 4. 2 steers. "No Molasses."
Total live weight of steers November 17, 1913..... lb.....	3,815	1,975
Total live weight of steers March 30, 1914..... lb.....	4,650	2,555
Increase to March 30, 1914..... lb.....	835	580
Molasses—		
Original weight of 3 steers, 3,815 pounds, at 7.23 cents..... \$.....	275 82
Weight at finish of 3 steers, 4,650 pounds, at 9 cents..... \$.....	418 50
No Molasses—		
Original weight of 2 steers, 1,975 pounds, at 7.23 cents..... \$.....	142 79
Weight at finish of 2 steers, 2,555 pounds, at 9 cents..... \$.....	229 95
Gross profit..... \$.....	142 68	87 16
Amount of hay consumed..... lb.....	5,985	3,950
Amount of meal consumed..... lb.....	2,646	1,176
Amount of roots consumed..... lb.....	22,995	10,220
Amount of molasses consumed..... gal.....	55
Cost of feed for lot for 133 days..... \$.....	92 32	41 46
Net profit..... \$.....	50 36	45 70
Daily rate of gain per steer..... lb.....	2 092	2 180
Cost of 1 pound gain..... cts.....	11 05	7 14
Cost of feed per day per steer..... cts.....	23 43	15 58
Profit per steer..... \$.....	16 78	22 85

METHOD OF WORK.

WEIGHING.

The steers were weighed three consecutive mornings, starting November 15, 1913, then weighed into experiment on November 17, and weighed at one-week intervals (Monday mornings) until the end of the feeding period. The steers were weighed at a reasonable time after morning's meal and before they were watered. Individual weights were kept.

FEEDING.

1. Feeding period was from November 17, 1913, to March 30, 1914.
2. From November 3 to 17 was the preparatory period, in which they were given roots, hay, and meal, gradually working them up to a normal feed at the beginning of the experiment.
3. See table for period of feeding.
4. All hay fed was best quality, and the amount fed to each lot was weighed weekly.
5. Roots consisted mostly of turnips, and were weighed daily on barn scales.
6. Meal ration consisted of the following mixture:—

Mixed crushed grain: bran, 200 pounds; oats, 200 pounds; barley, 200 pounds; cotton seed, 100 pounds.
Molasses as per diagram.

The prices of feed were: Meal ration, \$1.30 per cwt.; roots, \$2 per ton; hay, \$8 per ton; and molasses, 20 cents per gallon.

See table as to amounts for respective periods of four weeks each, except the last period which was to have extended to April 6, but owing to the fact that a most satisfactory sale was made for the Easter market, and part of the steers were shipped on the 2nd of April, it was found necessary to close the experiment on March 30. Consequently, there are only three weeks in the last period.

RATIONS FOR STEERS.

Lot.	Row.	No. of Steers	RATION PER STEER PER DAY.																			
			Nov. 17 to Dec. 14, 1913				Dec. 14 to Jan. 11, 1914				Jan. 11 to Feb. 8, 1914				Feb. 8 to Mar. 8, 1914				Mar. 8 to Mar. 30, 1914			
			Roots.	Meal.	Mo- lasses.	Roots.	Meal.	Mo- lasses.	Roots.	Meal.	Mo- lasses.	Roots.	Meal.	Mo- lasses.	Roots.	Meal.	Mo- lasses.					
1.....	2	6	Lb. 40	Lb. 2-3	1	Lb. 40	Lb. 3-4	2	Lb. 40	Lb. 4-6	2	Lb. 40	Lb. 6-8	2	Lb. 30	Lb. 8	2	Lb. 3 steers.	Lb. 3 steers.	Lb. 3 steers.	Lb. 3 steers.	
2.....	3	6	60	3-4½	1	60	4½-6	2	60	6-9	2	60	9-12	2	45	12	2	45	12	2	45	12
3.....	1	6	60	3-4½	1	60	4½-6	2	60	6-9	2	60	9-12	2	45	12	2	45	12	2	45	12
4.....	1	6	40	2-3	1	40	3-4	2	40	4-6	2	40	6-8	2	30	8	2	30	8	2	30	8
5.....	4	4	40	1-2	1	40	2-3	2	40	3-4	2	40	4-6	2	30	6	2	30	6	2	30	6

P.S.—15 pounds of hay per steer per day.

SESSIONAL PAPER No. 16

OBJECT OF THE EXPERIMENT.

1. To show the results in feeding 50 per cent more roots and meal to heavy weight steers.
2. To show the results in feeding 50 per cent more roots and meal to medium weight steers.
3. To show the difference in profit in feeding the medium and heavy weight steers.
4. To show the value of molasses in finishing beef.
5. To show that molasses can or cannot profitably replace part of meal ration.

DEDUCTIONS.

While these results do not coincide with those of the 1912-13 test, which was carried on along similar lines, it goes to show that it is quite impossible to draw a definite conclusion from one or even two years' results, due to such influences as the difference in the livability of the animals, and the selling price. These steers, though not all in the same table, sold for the same price, whereas had they been divided according to class, the selling price of the different grades might have been somewhat different, which, naturally, would have made some difference in profit from the different grades. However, there are some interesting points to be noted:—

1. While the daily rate of gain is greater in heavy-fed than in light-fed lots, yet the average gain per pound gain of the former is considerably higher, and the greatest profit was realized from the light-fed lots. One might expect this in the good butcher, but not in the good stocker.

2. Meal can be profitably replaced by molasses when used in only a limited amount.

3. When feeding the same amount of meal the addition of molasses at the price paid for it decreases the profit.

4. The molasses appears to have a more beneficial effect when fed to good stockers than to good butchers, when getting the same amount of meal.

5. In table three, lot 5 is figured at the actual buying and selling prices (See column 1). In column 2 the calculations are made on the same basis as lot 1. Even then, molasses shows a profit over the full-meal ration.

6. If, then, good feed molasses could be purchased for about \$22 to \$25 per ton instead of \$33 it would add greatly to the value of a feeding ration.

7. Note in lot 4, steer No. 1 in row 1 had a set-back with a sore jaw and did not make very good gain. In lot 2, steer No. 5 was a very nervous animal, hence did not make as good daily gains as he otherwise would. In lot 4, steer No. 4 took ill with respiratory trouble, and died. These unavoidable facts will account for some slight difference in the tables.

EXPERIMENTAL STATION, KENTVILLE, N.S.

REPORT OF THE SUPERINTENDENT, W. S. BLAIR.

BEEF CATTLE.

Eighteen steers were purchased about the middle of November for feeding tests. They weighed 18,905 pounds and cost $5\frac{3}{4}$ cents per pound, live weight. Sixteen were separated into uniform lots of four each. Of these, eight were dehorned and placed loose, four each in two box stalls 12 by 12 feet in size. Eight were tied in stanchions. The different lots were fed exactly alike. The steers were all grade Shorthorns except the No. 5 lot which were grade Holsteins. The test covered a period of twenty weeks, commencing November 15 and ending March 29. The gain from these and the extra pair which were tied in stanchions is as follows:—

	Weight at start.	Weight at finish.	Total gain.
	lb.	lb.	lb.
No. 1 Loose.....	4,240	5,275	1,035
" 2 ".....	3,895	5,080	1,185
" 3 Tied.....	4,560	5,280	720
" 4 ".....	4,105	4,765	660
" 5 ".....	2,105	2,510	405
	<hr/> 18,905	<hr/> 22,910	<hr/> 4,005

The steers were fed 60 pounds roots, 12 pounds hay, and $5\frac{1}{2}$ pounds meal mixture per day on the average. The meal during the first two weeks was 1 pound per day and was increased 1 pound every two weeks until the end of the twenty weeks, when they were getting 10 pounds each per day. The roots fed during the first period were 80 pounds per day which was lessened to 40 pounds at the close of the period, as the meal mixture was increased.

The meal mixture was made up of and cost as follows:—

400 pounds bran at \$1.05 per cwt.....	\$4 20
100 " cottonseed meal at \$1.95 per cwt.....	1 95
100 " linseed meal at \$2 per cwt.....	2 00
200 " cornmeal at \$1.85 per cwt.....	3 70
100 " crushed oats at \$1.65.....	1 65
<hr/> 900 " cost.....	<hr/> \$13 50

Or $1\frac{1}{2}$ cents per pound, \$30 per ton.

The roots were valued at \$2 per ton.

Hay used cost \$10 per ton.

The cost of feed per steer for period of 20 weeks was as follows:—

Roots, 8,400 pounds at \$2 per ton.....	\$ 8 40
Hay, 1,680 pounds at \$10 per ton.....	8 40
Meal, 770 pounds at $1\frac{1}{2}$ cents per pound.....	11 55
<hr/> Total.....	<hr/> \$28 35

Cost per day for steer, $20\frac{1}{4}$ cents.

SESSIONAL PAPER No. 16

Lot 1—Loose.

Number of steers in lot.....	4
First weight, gross, November 15, 1913.....lb.	4,240
First weight, average.....	1,060
Finished weight, gross, March 30, 1914.....	5,275
Finished weight, average.....	1,318
Number of days in test.....days	140
Total gain in 140 days.....lb.	1,935
Average gain per steer.....	258
Daily gain per steer.....	1.84
Daily gain per lot.....	7.37
Gross cost of feed for period.....\$	113 40
Cost of 1 pound gain per lot.....cts.	10.95
Cost, original, November 15, 1913, at \$5.75 per cwt.....\$	243 80
Total cost March 30, 1914.....	357 20
Selling price, March 30, 1914, at \$7.25 per cwt.....	382 43
Profit per lot.....	25 23
Profit per steer.....	6 30
Average valuation per steer to start, November 15, 1913.....	60 95
Average sale price per steer at finish, March 30, 1914.....	95 60
Average increase in value.....	34 65
Average cost of feed per steer.....	28 35
Amount of meal eaten.....lb.	770
Amount of roots eaten.....	8,400
Amount of hay eaten.....	1,680

Lot 2—Loose.

Number of steers in lot.....	4
First weight, gross, November 15, 1913.....lb.	3,895
First weight, average.....	974
Finished weight, gross, March 30, 1914.....	5,080
Finished weight, average.....	1,270
Number of days in test.....days	140
Total gain in 140 days.....lb.	1,185
Average gain per steer.....	296
Daily gain per steer.....	2.11
Daily gain per lot.....	8.44
Gross cost of feed for period.....\$	113 40
Cost of 1 pound gain per lot.....cts.	9.57
Cost, original, November 15, 1913, at \$5.75 per cwt.....\$	223 96
Total cost March 30, 1914.....	327 36
Selling price, March 30, 1914 at \$7.25 per cwt.....	368 30
Profit per lot.....	30 94
Profit per steer.....	7 72
Average valuation per steer to start November 15, 1913.....	55 9
Average sale price per steer at finish, March 30, 1914.....	92 07
Average increase in value.....	36 08
Average cost of feed per steer.....	28 35
Amount of meal eaten.....lb.	770
Amount of roots eaten.....	8,400
Amount of hay eaten.....	1,680

Lot 3.—Tied.

Number of steers in lot.....	4
First weight, gross, November 15, 1913.....lb.	4,560
First weight, average.....	1,140
Finished weight, gross, March 30, 1914.....	5,280
Finished weight, average.....	1,320
Number of days in test.....days	140
Total gain in 140 days.....lb.	720
Average gain per steer.....	180
Daily gain per steer.....	1.28
Daily gain per lot.....	5.12
Gross cost of feed for period.....\$	113 40
Cost of 1 pound gain per lot.....cts.	15.75
Cost, original, November 15, 1913, at \$5.75 per cwt.....\$	262 20
Total cost, March 30, 1914.....	375 60
Selling price, March 30, 1914, at \$7.25 per cwt.....	382 80
Profit per lot.....	7 20
Profit per steer.....	1 80
Average valuation per steer to start, November 15, 1913.....	65 55
Average sale price per steer at finish, March 30, 1914.....	95 70
Average increase in value.....	30 15
Average cost of feed per steer.....	28 35
Amount of meal eaten.....lb.	770
Amount of roots eaten.....	8,400
Amount of hay eaten.....	1,680

Lot 4.—Tied.

Number of steers in lot.....	4
First weight, gross, November 15, 1913.....lb.	4,105
First weight, average....."	1,026
Finished weight, gross, March 30, 1914....."	4,765
Finished weight, average....."	1,191
Number of days in test.....days	140
Total gain in 140 days.....lb.	660
Average gain per steer....."	165
Daily gain per steer....."	1.18
Daily gain per lot....."	4.72
Gross cost of feed for period.....\$	113 40
Cost of 1 pound gain per lot.....cts.	17.18
Cost, original, November 15, 1913, at \$5.75 per cwt.....\$	236 03
Total cost March 30, 1914....."	349 43
Selling price, March 30, 1914, at \$7.25 per cwt....."	345 46
Loss per lot....."	3 97
Loss per steer....."	99
Average valuation per steer to start, November 15, 1913....."	59 00
Average sale price per steer at finish, March 30, 1914....."	86 36
Average increase in value....."	27 36
Average cost of feed per steer....."	28 35
Amount of roots eaten....."	8,400
Amount of meal eaten.....lb.	770
Amount of hay eaten....."	1,680

Lot 5.—Tied.

Number of steers in lot.....	2
First weight, gross, November 15, 1913.....lb.	2,105
First weight, average....."	1,052
Finished weight, gross, March 30, 1914....."	2,510
Finished weight, average....."	1,255
Number of days in test.....days	140
Total gain in 140 days.....lb.	405
Average gain per steer....."	202
Daily gain per steer....."	1.44
Daily gain per lot....."	2.88
Gross cost of feed for period.....\$	56 70
Cost of 1 pound gain per lot.....cts.	.14
Cost, original, November 15, 1913, at \$5.75 per cwt.....\$	121 03
Total cost, March 30, 1914....."	177 73
Selling price March 30, 1914, at \$7.25 per cwt....."	181 97
Profit per lot....."	4 24
Profit per steer....."	2 12
Average valuation per steer to start, November 15, 1913....."	60 51
Average sale price per steer at finish, March 30, 1914....."	90 98
Average increase in value....."	30 47
Average cost of feed per steer....."	28 35
Amount of meal eaten.....lb.	770
Amount of roots eaten....."	8,400
Amount of hay eaten....."	1,680

It will be seen that the eight steers in lots 1 and 2, given freedom in the box stalls, made a gain of \$56.17 as compared with the eight in stanchions, lots 3 and 4 tied, which made a gain of \$3.23. It may be pointed out that lots 3, 4 and 5 were not given exercise except that afforded by the swinging stanchion, and received their water in drinking bowls alongside the stall. When the steers were selected into lots an effort was made to place in lots 3 and 4 steers equally as good as those in lots 1 and 2.

The steers were sold to Linton and McLeod, Halifax, N.S., at \$7.25 per hundred, fasted 12 hours.

EXPERIMENTAL STATION, FREDERICTON, N.B.

REPORT OF THE SUPERINTENDENT, W. W. HUEBARD.

BEEF CATTLE.

On account of the unfinished condition of the barns, the feeding of cattle could not begin until the 8th of January. At that time it was very difficult to get cattle, and the price was considerably higher than later in the season. Thirty-four head, mostly three and four-year-old steers, and many of them very poor type, were bought and stabled on the date mentioned. On the 14th of March, five more cattle were put in. They all cost 5½ cents a pound. The thirty-nine head weighed, unshrunk, 36,361 pounds.

On March 31 these cattle weighed 37,123 pounds, which, at 6½ cents per pound, would be worth \$2,413.

As these cattle were very rough and had to be cleaned up and conditioned, no grain was fed except bran, heavier feeding being reserved for the latter part of the fattening period.

Until the 1st of April these cattle consumed:—

Hay, 28 tons at \$8.	\$ 224 00
Turnips, 2,000 bushels at 8 cents.	166 00
Bran, 4,500 pounds at \$18 per ton	40 50
	<hr/>
	\$ 424 50

The account would stand as follows:—

Cost of feed.	\$ 424 50
Cost of cattle.	2,000 00
Value at 6½ cents per pound, stable weight.	\$2,413 00
Loss on first feeding period.	11 50
	<hr/>
	\$2,424 50
	<hr/>
	\$2,424 50

EXPERIMENTAL FARM, BRANDON, MAN.

REPORT OF THE SUPERINTENDENT, W. C. McKILLICAN, B.S.A.

STEER FEEDING EXPERIMENTS.

During the winter of 1912-13, twenty steers were fed for experimental purposes. They were all fed out-of-doors and the season was quite unfavourable for the out-door feeding. There was a large amount of stormy weather, with strong winds and snow. This is much harder to bear than severe cold. The gains made were small, and the profits not as large as should have been obtained considering the margin between buying and selling prices.

The experiment conducted was a comparison of alfalfa against part of the meal ration. The alfalfa steers were hardly as good a lot as the others, and were in a more exposed location, so that the results are not a fair indication of the comparative feeding value of alfalfa.

Both lots were given all the straw they would eat. Both lots were started on 2 pounds of grain per day; this was gradually increased from week to week. From January 1, lot 1 received 3 pounds less grain each per day than lot 2, and in its place received 3 pounds of alfalfa. The grain ration at the end of the test was 15 pounds per steer daily for lot 2. After April 15, lot 2 received some alfalfa in addition to straw, and both lots received a small allowance of roots daily.

The details of the experiment and the results obtained are stated in tabular form herewith:—

STEER FEEDING Experiment, 1912-13.

	Lot 1.	Lot 2.
No. of steers in lot.....	8	12
First weight gross, November 18, 1912.....lb.....	8,750	13,735
First weight average....."	1,094	1,145
Finished weight gross, June 6, 1913....."	9,855	15,655
Finished weight average....."	1,232	1,305
Total gain in 200 days....."	1,105	1,880
Average gain per steer....."	138	157
Average daily gain per steer....."	.69	.78
First cost of steers at \$5.80 per cwt....."	507 50	796 63
Total cost of feed....."	199 27	300 32
Total cost....."	706 77	1,096 95
Receipts from sale at \$7.75 per cwt., 5 per cent shrinkage....."	725 63	1,152 58
Profit....."	18 86	55 63
Average cost per steer....."	63 44	66 39
Average cost of feed per steer....."	24 91	25 03
Average selling price per steer....."	90 70	96 05
Average profit per steer....."	2 35	4 63
Average cost of 1 pound gain.....cts.....	18	16
Returns realized per 100 pounds of oats and barley....."	95	99
Amount of feed used		
Oat and barley chop, \$15 per ton.....lb.....	13,656	23,202
Ground corn, \$20 per ton....."	718	1,092
Alfalfa, \$10 per ton....."	7,488	7,452
Roots, \$3 per ton....."	2,821	4,074
Straw, \$2 per ton....."	48,000	72,000

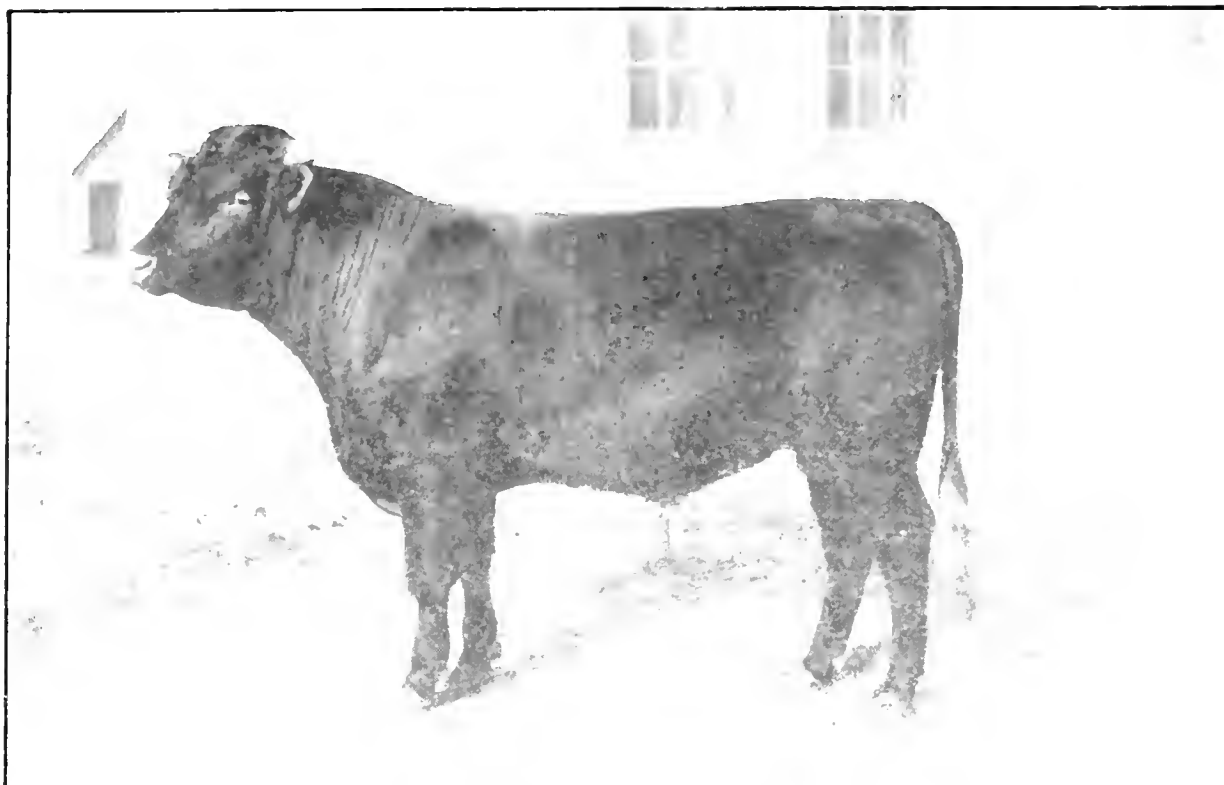

King Edward by Butterfly King. Dual purpose Shorthorn at the head of the Experimental Farm Herd at Indian Head, Sask.



Steers fed outside in a corral at Indian Head, Sask.

SESSIONAL PAPER No. 16

CORN SILAGE VS. DRY CORN FODDER.

For the season of 1913-14 a very interesting experiment is under way in which corn silage is being tested against dry corn fodder cured in stocks, as a feed for fattening steers. A carload of rather good steers was purchased at 6 cents per pound in Winnipeg in November, 1913. Freight, commission, and shrinkage in weight brought their cost up to \$6.40 per cwt., when landed in Brandon. They were divided into two lots, and great care was taken to have them divided as equally as possible. Both lots are being fed in large box stalls of the stable. They were dehorned when put in; one steer in lot 2 bled badly, but recovered afterwards. Both lots received the same quantity of meal and the same quantity of straw and, later in the test, the same quantity of alfalfa. The corn silage and fodder were analysed to find the percentage of moisture in each, and were fed in such quantities as to give each lot the same amount of dry matter. The corn fodder was cut up and mixed with straw the same as is done with ensilage, so that both should be fed under identical conditions.

The experiment is not finished at the end of the fiscal year, and consequently it is impossible to report the results, but the weights of each steer during each month of the test up to the present are available and as they are rather interesting and instructive, are given herewith:—

Lot I.—Fed Dry Corn Fodder.

No. of Steer.	Weight at start.	Weight after 1 month.	Weight after 2 months.	Weight after 3 months.	Weight after 4 months.	Weight after 5 months.
	Lb.	Lb.	Lb.	Lb.	Lb.	Lb.
1	1,015	1,060	1,095	1,125	1,155	1,190
2	935	1,000	1,030	1,085	1,180	1,195
3	1,025	1,055	1,080	1,160	1,180	1,260
4	1,010	1,120	1,130	1,165	1,215	1,260
5	1,105	1,180	1,270	1,290	1,355	1,425
6	1,030	1,065	1,085	1,145	1,220	1,250
7	1,015	1,015	1,090	1,130	1,165	1,220
8	940	1,005	1,050	1,090	1,120	1,185
9	1,110	1,150	1,200	1,250	1,290	1,330
10	1,050	1,105	1,110	1,145	1,215	1,245
Total.....	10,265	10,755	11,140	11,585	12,095	12,560
Average per steer.....	1,026½	1,075½	1,114	1,158½	1,209½	1,256
Average gain in month.....	49	38½	44½	51	46½

Total gain for 5 months, 2,295 pounds.
 Average gain per steer for 5 months, 229½ pounds.
 Average gain per steer per day, 1.5 pounds.

Lot 2.—Fed Corn Silage.

No. of Steer.	Weight at start.	Weight after 1 month.	Weight after 2 months.	Weight after 3 months.	Weight after 4 months.	Weight after 5 months.
	Lb.	Lb.	Lb.	Lb.	Lb.	Lb.
1	1,010	1,080	1,100	1,195	1,230	1,270
2	1,000	1,080	1,110	1,225	1,282	1,340
3	1,225	1,280	1,310	1,410	1,465	1,480
4	965	1,015	1,080	1,185	1,200	1,270
5	1,055	1,175	1,230	1,320	1,380	1,460
6	975	1,030	1,090	1,155	1,200	1,215
7	1,000	1,050	1,100	1,185	1,210	1,260
8	1,025	1,080	1,125	1,199	1,230	1,280
*9	920	905	1,000	1,055	1,125	1,140
10	1,065	1,120	1,155	1,200	1,255	1,320
Total	10,240	10,845	11,280	12,160	12,555	13,085
Average per steer	1,024	1,081½	1,128	1,220	1,25½	1,308½
Average gain in month	57½	46½	92	55

*Bled badly when dehorned.

Total gain for 5 months, 2,845 pounds.

Average gain per steer for 5 months, 284½ pounds.

Average gain per steer per day, 1.86 pound.

EXPERIMENTAL FARM, INDIAN HEAD, SASK.

REPORT OF THE SUPERINTENDENT, T. J. HARRISON, B.S.A.

BEEF CATTLE.

The herd of Shorthorns was formerly handled entirely as a beef herd, but in future the main work with cattle is the development of the dual-purpose Shorthorn, while any individuals that are of decided beef type and conformation will be dealt with as such.

The cost of raising calves by hand will be compared with the cost of raising beef calves by rearing with the cow. At present one cow is raising two calves and doing justice to them. She really should be treated as a dual-purpose cow, but is of such an angry disposition as to forbid milking by hand. Sometimes she objects even to her own calf sucking her, let alone her foster calf, but as far as type is concerned she is a very promising cow and so there are hopes of raising one or two dual-purpose heifers from her.

During last season there were sold from the Farm for breeding purposes, five young bulls and one aged bull.

STEER FEEDING EXPERIMENTS.

Supplementary to the work with the beef herd, steer-feeding experiments were conducted during the past winter. Fourteen two-year-old steers and fourteen three-year-olds were bought November, 1913. The former were apparently raised on farms, while the latter were "range" steers and gave, as one would naturally expect, trouble accordingly. Our experience with them would not warrant our attempting again to fatten "range" steers, especially of that age. Stabbling them even "loose" is too much of a contrast to their former existence to give good results, while tying them up in stanchions is nothing but imprisonment. The care and handling was such as to leave the suggestion that if steers of a like kind be bought again, they should be fed loose outside. According to results in the following tables, where, among other comparisons, that of feeding outside and inside was reckoned, it was found that those fed outside gave more satisfactory returns than those fed similarly inside. Those fed outside brought \$7.35 per cwt., while those fed the same ration inside brought only \$7.25 per cwt. As far as weights were concerned there was nothing to choose between these two groups, but the appearance of those fed outside was much in their favour compared with the inside lot similarly fed.

The steers were divided into four groups, and each group again subdivided into two lots. This experiment comprised a comparison of two-year-olds and three-year-olds, steers of similar ages fed inside compared with those fed outside and getting the same feed, and also a comparison between different feeds.

STEER-FEEDING Experiments.

Group	Ration.	Method of feeding.	Lot 1.	Lot 2.
			Three-year olds.	Two-year olds.
			No.	No.
1	Oat straw, mixed hay, meal (oats and barley).....	Fed outside.....	4	4
2	Same as above.....	Fed inside (tied)	4	4
3	Same as above with an addition of ensilage (to test value of ensilage).....	“ “	4	4
4	Mixed hay, ensilage, roots, meal (bran, peas, oats and barley).....	“ “	2	2

MIXTURE.

The meal mixture in the first three groups was made up of equal parts of barley and oats, while in group 4 the proportion was two of oats, two of barley, one of peas, and one of bran. The main purpose of using ration number four was to make a comparison between a good standard ration of this kind and other rations which, while open to criticism, could well be used by the average farmer in the district. The prices charged for feed are as follows:—

Ground oats.....	\$24 00 a ton.	Alfalfa.....	\$10 00 a ton.
“ barley.....	24 00 “	Oat straw.....	2 00 “
“ peas.....	28 00 “	Ensilage.....	2 50 “
Bran.....	20 00 “	Roots.....	2 50 “
Mixed hay.....	10 00 “		

SESSIONAL PAPER No. 16

RESULTS of Steer-feeding Experiments.

	Group 1.		Group 2.		Group 3.		Group 4.	
	Lot 1.	Lot 2.	Lot 1.	Lot 2.	Lot 1.	Lot 2.	Lot 1.	Lot 2.
Number of steers in experiment.....	4	4	4	4	4	4	2	2
Number of days in experiment.....	140	140	140	140	140	140	140	140
Total weight at beginning of experiment.....	4,680	3,885	4,337	3,050	4,770	3,505	2,200	1,825
“ “ “ end “ “	5,655	5,104	5,268	4,235	6,138	4,925	2,950	2,688
Gain during period.....	975	1,219	931	1,245	1,368	1,420	750	863
Gain per head.....	243.75	304.75	232.75	311.25	342	355	375	431.5
Daily gain per head.....	1.75	2.15	1.65	2.22	2.44	2.5	2.65	3
Amount of meal eaten by lot.....	5,690	5,600	5,880	4,760	5,040	3,644	2,520	1,960
“ mixed hay “	4,760	4,760	5,040	4,760	3,920	3,360	2,940	2,100
“ oat straw “	2,800	2,800	2,800	2,800	2,240	1,960	1,960	1,960
“ ensilage “					32,480	29,680	4,200	3,780
“ roots.....							4,200	3,780
Total cost of feed.....	\$ 93.80	\$ 93.80	\$ 98.50	\$ 83.72	\$ 97.63	\$ 80.99	\$ 57.95	\$ 45.48
Cost of feed per head.....	23.45	23.45	24.62	20.93	24.40	20.25	28.95	22.74
“ “ “ per day.....	.16	.16	.17	.14	.17	.14	.20	.16
Cost to produce one pound gain.....	.09	.07	.10	.07	.07	.06	.07	.52
Original cost of steers.....	292.50	233.10	271.06	183.00	298.10	210.30	137.50	109.50
“ “ “ and feed.....	386.30	326.90	369.56	266.72	395.73	291.29	195.45	154.98
Total receipts from sale.....	415.65	375.15	381.93	311.38	461.35	369.37	221.25	187.60
Net profit on lot.....	29.35	48.25	12.37	44.66	65.62	78.08	25.80	32.62
Net profit on steer.....	7.35	12.06	3.09	11.16	16.40	19.52	12.95	16.31

5 GEORGE V., A. 1915

The foregoing steers were bought at an average price of 6½ cents per pound, 6½ cents for the three-year-olds and 6 cents for the two-year-olds. The highest selling price was 7½ cents per pound given for groups 3 and 4, with \$7.35 per cwt. for the outside lot, and \$7.25 for those inside fed similarly to those outside.

A study of the results of this experiment will show that, though only a fair profit was made, yet considerable information was gained. At the outset it was the intention to carry on a "short" feeding-period, but when this period was expired (three months) markets were low. At that time the steers showed a very satisfactory profit, while the ultimate results were not so good. The reason is obvious. The steers were kept two months awaiting a reasonably high market, but during the last month they held their own only. This experience proves the point that unless markets are favourable, the feeder has difficulty to make money in this business. Our results show that the steers, generally speaking, fed fairly well but the margin between the buying and selling price was too narrow.

Another fact well worthy of notice is that the steers fed the choicest rations brought the highest price.

EXPERIMENTAL STATION, SCOTT, SASK.

REPORT OF THE SUPERINTENDENT, R. E. EVEREST, B.S.A.

BEEF CATTLE.

Work was undertaken this year in the line of outside winter feeding of steers for beef production. For this purpose seventeen steers were purchased in October and placed on prairie pasture, where they remained until the 1st of December, at which time they were weighed into corral and fed on a ration of meal and put on hay. Water, salt and a lot of straw were provided at all times. The corral was enclosed by woven wire fence and on its east side was attached a shed, and by an implement shed. On the north side a covered shelter was provided and a pen front was constructed. The corral on the following table was allowed to make a fair showing. The figures which are there set out are, however, the actual purchasing and selling weights. Both of these were brought to points when the halfway journey had in general. A further circumstance which affected unfavourably the results was the conditional offer which was accepted in the disposal of the stock. The fulfilment of this offer resulted in a severe falling of cattle with resultant low prices, and the shrinkage in weight was large. In fairness to the cattle and this line of work it may be said that even on the little change in price which existed in the general market from buying as feeders in October, 1913, to selling as beef in April, 1914, the steers, on a previous sale, would have shown a small profit.

Outside Winter Feeding of Steers for Beef Production.

Number of animals fed	17
Purchasing weight, October 11, 1913	17,905.00
Purchasing weight, average	1,053.24
Selling weight, gross, April 4, 1914.....	18,790.00
Selling weight, average	1,101.76
Number of days in pasture, 16; in corral, 122.....	168
Total gain for period	825.06
Average gain per animal	48.53
Average daily gain for group.....	4.91
Average daily gain per animal.....	0.29
Quantity of meal eaten by group	23,358.00
Quantity of hay eaten by group.....	48,670.00
Quantity of oat sheaves eaten by group.....	1,226.00
Total cost of feed.....	\$ 325.12
Cost of feed per head	19.12
Cost of feed per head per day.....	cts. 11 ⁸ / ₁₁
Cost to produce 1 pound gain.....	39 ¹ / ₂
Original cost of animals	\$ 1,119.06
Original cost plus cost of feed.....	\$ 1,444.18
Selling price	\$ 1,285.67
Net loss per group	\$ 158.51
Net loss per animal	\$ 9.32
<i>Findings from experiment—</i>	
Nutritive ratio of total ration	1 to 7.61
Nutritive ratio of meal ration	1 to 7.95
Dry matter required to produce 1 pound gain.....	77.31
Digestible matter required to produce 1 pound gain.....	32.34
Meal required to produce 1 pound gain.....	28.35
Meal digestible dry matter required to produce 1 pound gain	22.06
Roughage required to produce 1 pound gain.....	59.89
Roughage digestible matter required to produce 1 pound gain..	10.29

EXPERIMENTAL STATION, ROSTHERN, SASK.

REPORT OF THE SUPERINTENDENT, W. A. MUNRO, B.A., B.S.A.

STEER-FEEDING EXPERIMENT.

The first experiment in steer feeding was begun by the purchase of eleven steers on November 17, 1913. They were fed in the open and the only shelter afforded was an open shed. Until December 8, they had the run of a straw stack, which perhaps afforded a little better fare than pure straw because of some grain left where the machine stood. On December 8 they were started on a ration of meal which gradually increased until the finish.

The water was supplied *ad libitum*, and was kept from freezing by means of a tank heater.

Following is the rate of feeding and the rations used at different dates, followed by a table of the weights for the total herd at stated periods, and of two individual steers in the herd, together with a statement of the cost price, cost of feed, and gain or loss. The cost of feed is based upon the following values: Corn stover, \$3 per ton (green weight); hay, \$10 per ton; roots, \$3 per ton; oat and barley meal, 1 cent per pound.



Steers. Experimental Station, Rosthern.



Lacombe. Group fed in Barn, 1913-14.

SESSIONAL PAPER No. 16

DAILY RATIONS for Steers during the following periods.

Feed.	Nov. 17	Dec. 8	Dec. 8 to 22	Dec. 22 to Jan. 5	Jan. 5 to Jan. 12	Jan. 12 to Jan. 26	Jan. 26 to Feb. 9	Feb. 9 to Feb. 23	Feb. 23 to Mar. 9	Mar. 9 to Mar. 23	Mar. 23 to Apr. 6	Apr. 6 to Apr. 20	Apr. 20 to Apr. 28	TOTAL FEED.	
	lb.	lb.	lb.	lb.	lb.	lb.	lb.	lb.	lb.	lb.	lb.	lb.	lb.	Per Steer	Per Herd.
Corn stover.....			37	37	37	37	37	37	15	15	15	10	10	2,331	25,641
Hay.....														850	9,350
Straw.....															
Roots.....															
Oat chop.....			2½	20	25	35	35	35	40	40	40	30	30	3,906	42,966
3 oat.....			5	9	12	14								532	5,852
1 barley.....								13½	15	18	18	18	18	320	3,523

WEIGHTS of Steers at Intervals.

	Nov. 17	Dec. 8	Jan. 5	Feb. 23	Mar. 9	Mar. 23	Apr. 6	Apr. 20	Apr. 28	Gain	Cost at 5½c.	Cost of Feed.	Selling Price at 7c.	Gain.	Loss.
	lb.	lb.	lb.	lb.	lb.	lb.	lb.	lb.	lb.	lb.	\$ cts.	\$ cts.	\$ cts.	\$ cts.	\$ cts.
Eleven steers.....	11,048	11,644	11,704	12,979	13,482	13,890	14,048	14,316	14,665	3,617	607.64	349.08	1026.55	69.83	
No. 1 (beef type).....	1,175	1,246	1,218	1,354	1,410	1,442	1,470	1,522	1,558	383	64.62	31.73	109.06	12.71	
No. 2 (dairy type).....	979	1,028	1,030	1,104	1,150	1,184	1,160	1,220	1,190	211	53.84	31.73		2.27	
Average.....	1,004	1,058	1,064	1,170	1,222	1,202	1,277	1,301	1,333	329	55.24	31.73	93.32	6.35	

RESULTS OF EXPERIMENT.

Number of steers in lot	11
First weight, gross, November 17, 1913.....	11,048
First weight, average	1,004
Finished weight, gross	14,665
Finished weight, average	1,333
Number of days under test	162
Total gain in 162 days	3,617
Average gain per steer	329
Daily gain per steer	2.03
Daily gain per lot	22.33
Gross cost of feed for period	\$ 349.08
Cost of 1 pound gain per lot	9.65
Cost, original, November 17, 1913, \$5.50 per cwt.....	\$ 607.64
Selling price, April 28, 1914, at \$7 per cwt.....	1,026.55
Profit per lot	69.83
Profit per steer	6.35
Average valuation per steer at start, November 17, 1913.....	\$ 55.24
Average sale price per steer at finish, April 28, 1914.....	93.33
Average increase in value	38.09
Average cost of feed per steer.....	31.73
Amount of meal eaten	19,943
Amount of roots eaten	42,966
Amount of hay eaten	9,350
Amount of straw eaten, <i>ad libitum</i> , no record taken.	
Amount of corn stover eaten (green weight)	25,641

SESSIONAL PAPER No. 16

DEDUCTIONS.

1. Corral steer feeding, even in spite of severe weather, may be profitable.
2. Good steers of beef type make rapid gains and fair profit under these conditions, with these food stuffs, and with \$1.50 spread between buying and selling prices.
3. Grains and roughages may be marketed most profitably through the feeding of steers.
4. In this experiment, steers of good beef type made rapid and economical gains and good profits, and steers of dairy type made slower gains costing more to produce, and were fed at a loss.

EXPERIMENTAL STATION, LACOMBE, ALTA.

REPORT OF THE SUPERINTENDENT, G. H. HUTTON, B.S.A.

BEEF CATTLE.

The herd of pure-bred Aberdeen Angus cattle now number twenty-four, of which fifteen are females over 1 year old, and all but two of which are of breeding age. Two pure-bred Aberdeen Angus cattle aborted during the year, but the loss is believed not to have been due to contagious abortion, as after some months there has been no indication of the recurrence of the trouble.

A number of very fine calves have been reared during the year.

Four steer calves from Shorthorn sires have been hand-raised this season. The following table shows weights attained and cost of food to March 31, 1914:—

No.	Date of Birth	Weight at Birth	Weight March 31 1914.	Whole and Skim Milk.	Chop.	Hay and Green Feed.	Cost.	Cost per 100 lbs. Gain.
				lb.	lb.	lb.		
8	Dec. 25, 1912.....	90	860	2,940	1,340	1,700	\$41.04	\$4.77
9	Jan. 1, 1913.....	90	810	2,990	1,131	2,960	40.65	5.01
21	Feb. 7, 1913.....	86	715	2,800	1,057	2,760	33.97	4.75
22	Feb. 13, 1913.....	82	695	2,840	1,057	2,760	34.29	4.93

The dams of these four calves produced 24,881.6 pounds of milk during the lactation period following freshening at the birth of these calves, which, if sold at market price for butter production, would leave a fair profit. The cows were not kept simply for the production of the calves, but were of considerable value as dairy cows, and leave a profit after covering the cost of feed and depreciation.

Eight calves were raised on the cows and weighed less at the same age, though these were not so favourably housed. They ran out through the winter, being fed hay, green feed and chop. The feed cost per head figuring the charges up to 6 months old is as follows:—

Interest on an investment of \$90.....	\$7 20
Maintenance of dam during winter, 6 months.....	9 00
Maintenance of dam during summer, 6 months.....	6 00
Depreciation in value of dam	10 00
Roughage per head for calf for first four months of winter at \$10..	4 95
Chop per head for calf for first four months of winter at 1 cent per pound	4 95
Total cost per head to rear calves to approximately 1 year old....	\$42 10
Average weight per head	622 lb.
Cost per 100 pounds gain	\$ 6 76

It should be remembered that the first summer's gains on pasture will doubtless reduce cost of production more rapidly on the group raised on the cows and wintered outside than on those raised by hand and wintered inside.

Fourteen grade cattle are being used in the experimental work in the beef cattle division of the live stock work at this Station.

SESSIONAL PAPER No. 16

FEEDING FOR BELF.

Three groups of steers of similar quality were fed under different conditions during the winter of 1913-14. The cattle were divided at the beginning into three lots as nearly equal in point of breeding, age, and conformation as was possible. One group was fed in the barn in loose boxes, another in a corral without shelter except a straw stack and with a very limited run, and a third was fed in the brush with free run, having the brush and straw stack for shelter. The group fed in the barn had access to water at all times, the group fed in the corral was watered at a large tank which was kept open practically all the time by the use of a tank heater. The group in the brush was watered through the ice at a water hole in a small lake. A similar experiment last year gave results showing the cost of gain less for the group fed in the corral than those under other conditions. This year's results are somewhat contradictory, the group fed inside showing cheapest gains. It is certain that the group fed inside would show a heavier shipping shrinkage than either of those fed under outside conditions. The inside group this year had the advantage over those fed inside a year ago, in that water had been put into the barns this season and the inside steers were able to drink at will, while those inside, a year ago, were watered only twice daily.

The average cost of 1 pound of gain is less for the three groups than the cost of gain in any year since 1909-10. Since the price charged for feed is higher for this test than that of 1909-10, it is safe to say that the cost of gain this year as compared with the cost of feed is less than for any season since feeding trials began here. Green feed (peas and oats cut green and cured as hay) is charged against the cattle at \$10 per ton and, since 119 tons were cut from 35 acres, it is evident that this crop is a paying one when sold at this rate. A mixture of oats, barley, and wheat made up of about two-fifths oats, two-fifths barley, and one-fifth wheat constituted the grain ration, which is charged at 1 cent per pound ground. A small charge is made to cover cost of bedding. The selling price was only slightly in advance of the purchase price and, considering this fact in conjunction with the fact that feed consumed by the cattle has been well sold, it is somewhat remarkable that even a small profit can be shown. These results are further evidence of the value of live stock as a medium for the most profitable marketing of grain and fodder. It is commonly believed to be a difficult matter to transform products, such as low grade grain and fodder crops, into profits at the present time, yet when fed to steers these crops bring high prices.

While the results this season indicate an advantage in favour of inside feeding, it is well to remember that those fed outside without shelter made good gains. The fact that a prospective feeder does not feel able to erect shelter should not deter him from undertaking cattle feeding. It should also be pointed out that a charge of \$4 per head might be made against the cattle fed in the barn to cover interest on the investment, and that three groups of steers would be required to be fed in the barn in the course of a year to fully cover such interest charge. It is, therefore, doubtful as to whether it would be possible to pay interest on such shelter by feeding cattle, even with the same advantage secured in each test as in the trial, since it would scarcely be practical at the present time to buy and turn off three groups per annum. Another advantage enjoyed by the inside group this year consisted in the fact that they were protected from the cold weather, permitting good gains, even in the extreme cold. The cattle were sold before warm weather made more rapid gains possible in the outside groups.

All steers were dehorned in October, 1913, some time before the grain ration was commenced, but after danger from flies was past. The dehorning did not appear to interfere to any great extent with the gains made.

The following figures give the results in detail:—

	Brush	Corral.	Barn.	Total.
Number steers in lot.....	8	11	8	27
First weight November 16, 1913.....lb.	9,480	13,484	9,056	32,020
First weight average....."	1,185	1,226	1,132	1,181
Finished weight, February 9, 1914....."	10,655	14,941	10,865	36,461
Finished weight average....."	1,332	1,353	1,359	1,350
Total gain in 85 days....."	1,175	1,457	1,809	4,441
Average gain per steer....."	147	132	227	169
Average daily gain per steer....."	1.73	1.55	2.67	1.99
Average daily gain per lot....."	13.84	17.05	21.36	52.25
Total cost of feed.....\$	111.22	152.71	111.16	370.09
Cost of 100 pounds gain....."	9.47	10.48	6.15	8.70
Selling price, \$7.15 per cwt., less 5 per cent shrink....."	723.72	1,014.87	738.02	2,476.61
Profit on lot....."	10.78	24.55	31.42	9.97
Profit per steer....."	1.34	2.23	3.93	.37
Average value of steer at start....."	77.91	80.61	74.43	77.65
Average selling price per steer....."	90.46	92.25	92.00	91.57
Amount of meal eaten.....lb	5,902	8,129	5,902	19,933
Amount of green feed eaten....."	9,100	12,530	9,100	30,730
Amount of straw eaten....."	11,856	16,302	11,842	40,000
Amount of salt eaten....."	54	54	50	158
Average increase in value.....\$	12.55	11.64	17.57	13.92
Average cost of feed per steer....."	13.90	13.88	13.89	13.89

EXPERIMENTAL STATION, LETHBRIDGE, ALTA.

REPORT OF THE SUPERINTENDENT, W. H. FAIRFIELD, M.S.

STEER-FEEDING EXPERIMENT.

With the yearly increase in acreage of alfalfa on the irrigated lands in the district, more and more interest is being taken by farmers in the question of feeding it at home rather than baling and shipping. To gather data along this line a feeding test was carried out with a carload of steers.

Steers were purchased from Mr. A. C. Christensen, Beazer, Alta. The price paid was \$75 per head for 3-year-olds and \$65 per head for 2-year-olds; the average price per hundred pounds was \$6.17. They were shipped from Cardston by rail and were received at the Station on September 21. From then on to November 2 they were allowed to run on stubble, with access to a small field of rape.

One of the objects aimed at was to test the feeding of alfalfa combined with oat hay as a roughage, compared with feeding alfalfa alone.

The cattle were divided into three groups and fed as follows:—

Group I.—Alfalfa, roots and meal.

Group II.—Alfalfa, oat sheaves, roots and meal.

Group III.—Alfalfa, oat sheaves, roots and meal.

The first two groups were as nearly equal in point of size and conformation as possible, whereas group III contained some of the culls and the four two-year-old steers. All three groups were fed in the open in corrals adjacent to the barn and had open straw sheds for shelter. They were watered once a day by being driven to the farm reservoir which was about a quarter of a mile from the feeding yards.

FEEDS.

In every case the steers were given all the alfalfa they would eat up clean. Four pounds per day of green oat sheaves were given to groups II and III for the greater part of the feeding period; during the balance of the time they received 5 pounds. The roots consisted of pulped turnips; the meal of equal parts of wheat, oats, and barley. The prices charged for the feed were as follows:—

	Per Ton.
Alfalfa hay	\$12 00
Green oat sheaves	10 00
Meal	20 00
Roots	3 00

5 GEORGE V., A. 1915

	Group 1	Group 2	Group 3
Number of steers in group.....	6	6	7
First weight, gross, November 2, 1913.....lb.	7,770	7,980	7,300
First weight, average....."	1,295	1,330	1,043
Finishing weight, March 16, 1914, gross....."	9,050	9,175	8,795
Finishing weight, average....."	1,508	1,529	1,256
Total gain for period, 135 days....."	1,280	1,195	1,495
Average gain per steer....."	213	199	214
Average daily gain per steer....."	1.6	1.5	1.6
Amount of meal eaten by group....."	6,335	5,553	7,062
Amount of alfalfa hay eaten by group....."	16,441	11,344	11,373
Amount of oat hay eaten by group....."	—	3,499	4,124
Amount of roots eaten by group....."	16,836	16,672	19,769
Amount of salt eaten by group....."	39	35	33
Total cost of feed.....\$	187.69	166.45	189.46
Cost of feed per steer....."	31.28	27.74	27.06
Cost of feed per steer per day....."	.23	.21	.20
Cost to produce 1 pound gain....."	.15	.14	.13
Original cost of group including freight, etc....."	462.00	462.00	499.60
Interest on investment at 8 per cent....."	18.48	18.48	19.96
Original cost plus cost of feed....."	668.17	646.93	708.42
Selling price, at \$8.10 per hundred....."	733.05	743.17	712.39
Net profit per group....."	64.88	96.24	3.97
Net profit per steer....."	10.81	16.04	.57

THE SALE.

The steers were sold locally to Delaney's, Limited, on March 16.

FINANCIAL STATEMENT.

The day after the experiment started, a rather unusual accident happened. One steer died, presumably from the result of bloat. This is unusual, because cattle very rarely bloat on cured alfalfa hay. This one died in group 1, which had seven steers to start with, but the results are computed on six steers. In the financial statement, however, the price of the steer that died is included.

Cost of sixteen 2-year-old steers.....	\$1,200 00
Cost of four 2-year-old steers.....	260 00
Freight charges.....	23 00
Interest on investment at 8 per cent.....	56 92
Pasture, 1½ months at \$1 per head.....	30 00
Cost of feed.....	543 60
Selling price.....	\$2,188.61
Net profit.....	75 09
	<hr/>
	\$2,188 61
	<hr/>
	\$2,188 61

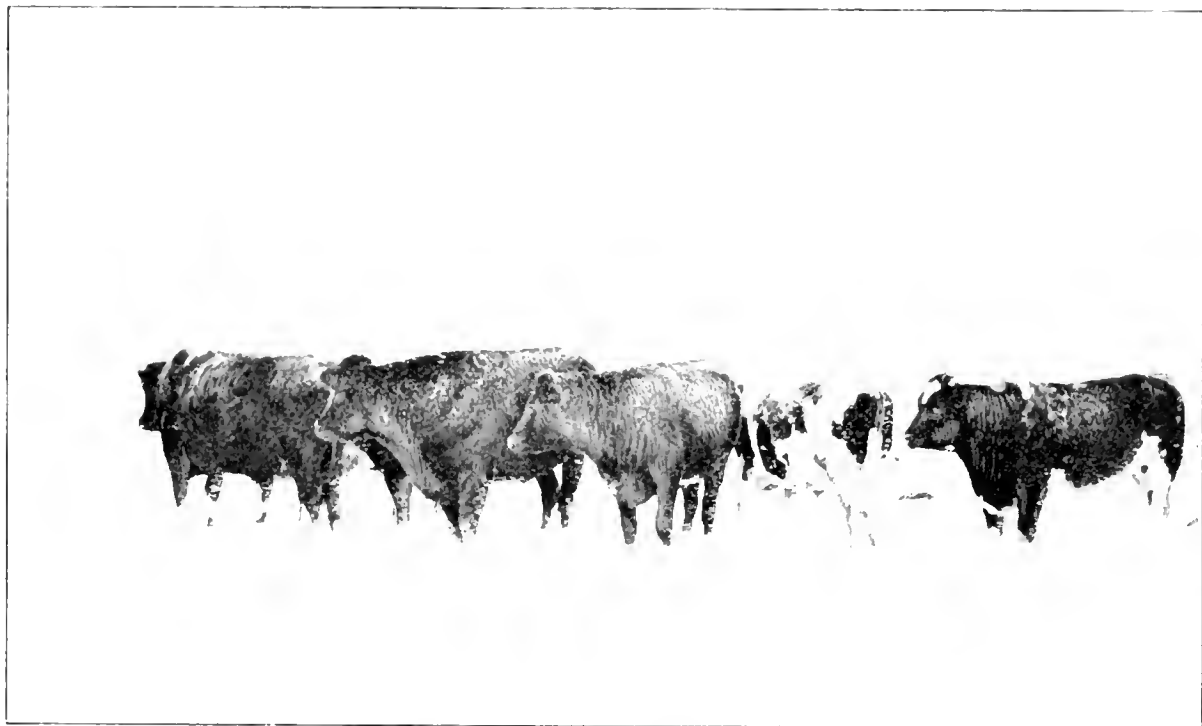

Lacombe. Group fed in Brush, 1913-14.



Lacombe. Group fed in Corral, 1913-14.

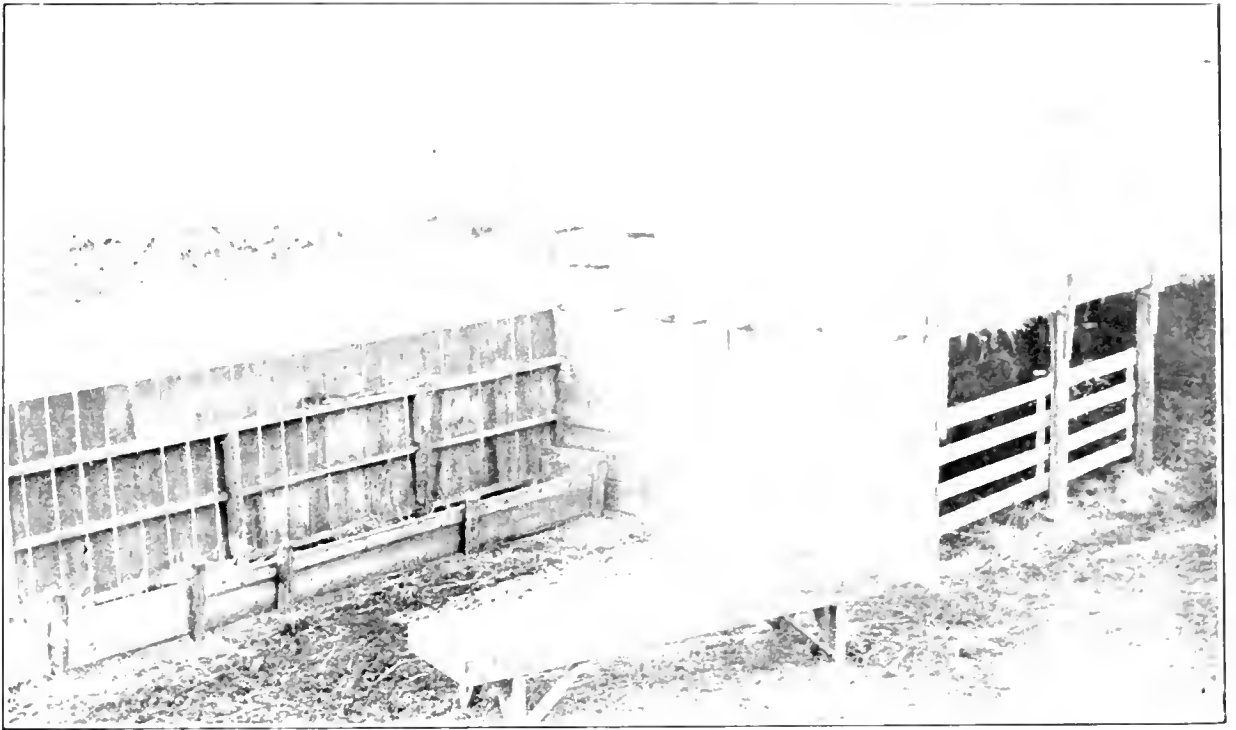

Steer Corral, Lethbridge, Alta. Note, 1, straw covered shed; 2, grain table; 3, roughage rack.



Lethbridge, Alta. Steers representing the type in Group II, 1913.

DAIRY CATTLE

CENTRAL EXPERIMENTAL FARM, OTTAWA, ONT.

REPORT OF THE DOMINION ANIMAL HUSBANDMAN,
E. S. ARCHIBALD, B.A., B.S.A.

DAIRY CATTLE.

There are in all 140 head of cattle in temporary quarters, comprised of 102 pure-bred breeding cattle and 38 grade milch cows and heifers. All dairy cattle are kept for experimental breeding and feeding work.

PURE-BRED BREEDING CATTLE.

Ayrshires..	24, including	11 milch cows,	11 heifers,	2 males.
Canadians..	25 " "	14 " "	6 " "	5 " "
Guernseys..	22 " "	8 " "	10 " "	4 " "
Holsteins..	21 " "	10 " "	8 " "	3 " "
Jerseys..	10 " "	6 " "	3 " "	1 " "

The pure-bred herds of dairy cattle during the year 1913-1914 included only 49 milch cows.

These herds are maintained for the following reasons:—

- I. To compare breeds and breed types, and illustrate the same to visitors.
- II. To supply breeding stock to farmers at reasonable figures.
- III. To supply milk for dairy experimental manufacture.
- IV. To conduct experiments and demonstrate methods as regards the breeding, feeding, care and management of cattle.

The Holstein herd, established in 1911, has not increased as rapidly as desired, owing to the large proportion of bull calves. However, these excellent bulls have been widely distributed at reasonable figures, and will be heard from in the future. This herd is headed by the splendid young bull "King of the Ormsbys," No. 14959.

The Ayrshire herd, established in 1901, is reported smaller than previously, owing to a large number of sales. Eleven choice females were sent to the new Station at Ste. Anne de la Pocatière, Que., a few more females and a number of splendid bulls were sold to Agricultural Societies and farmers, and a few of the older cows were weeded out and sold to the butcher. This herd is headed by the well-bred bull "Monarch of Tanglewyld," No. 36442, whose progeny is of out-standing promise. The three best families of this herd trace back, in one or two generations, to "Daniel of Auchenbrain" (3586), the grandsire of "Auchenbrain Brown Kate 4th," world's champion Ayrshire cow.

The Guernsey herd, established in 1901, has not made an increase during the past year, also owing to the high proportion of bull calves and the necessary weeding out of a few of the oldest cows.

The French Canadian herd remains practically unchanged. A few choice heifers were forwarded to the Experimental Station, Cap Rouge, Que., to strengthen that herd.

5 GEORGE V., A. 1915

The Jersey herd, established in 1911, has shown very marked improvement, especially during the latter part of the past fiscal year.

GRADE HERDS.

Grade Ayrshires... ..	17, including 14 milch cows, 3 heifers.
Grade Holsteins... ..	21 " 15 " 5 "

These cows are kept for the following reasons:—

- I. To supply milk for dairy experimental manufacturing.
- II. To compare the high quality grade with pure-breds for economic production and in their breeding qualities.
- III. To continue the upgrading of these herds as in the dairy cattle grading experiment on branch Farms.

A few excellent heifers have been produced by these grade cows, and sired by the excellent pure-bred bulls in the pure-bred herds. These calves promise even better than their dams, whose first year's record on this Farm may be found under "Milk Records" in this report.

FEEDING THE DAIRY COWS.

The year 1913-14 has been most unsatisfactory for pasture. Grass started too early in the spring, was severely injured by spring frosts, and suffered considerably from drought during July and early August. The rains of September, however, made fairly good pasture, but the loss of clover caused severe shortage, both as to quality and quantity of pasture and hay.

SUMMER FEEDING.

As in previous years, the dairy cattle were allowed only a small area for pasture, and were compelled to depend largely upon soiling crops and corn silage. As pasture, there was available only a little over 19 acres. This afforded forage for nearly a month, and was so charged.

In July and parts of August and September, soiling crops, consisting of clover, mixed peas and oats, and green corn, were fed either in the stables or in pasture.

Corn ensilage for feeding in August had been provided in 1912.

Meal was fed during the entire summer, as needed by cows in milk, and dry cows and pregnant heifers in low condition.

As formerly, during the early part of the summer, the cows were in the field during the daytime and stabled at night, but during the heat of midsummer, and as flies became more troublesome, they were housed during the day and kept in pasture at night.

WINTER FEEDING.

The winter feeding was conducted under most unfavourable conditions owing to the loss of buildings and foodstuffs by fire. Although a large quantity of splendid forage had been well preserved for winter use, yet most of this was completely ruined by fire. Of the 500 tons of corn ensilage stored in the silos of the main barn, only about 250 tons escaped injury by fire or subsequent spoiling owing to the loss of the silos, which were of wood. All the hay and straw preserved for winter feed, amounting to over 300 tons, was also lost.

The milch cows were kept in the sheep sheds until the first of December, when two temporary structures were completed for the housing of the same during the winter. All heifers and dry cows until this time were of necessity kept in the fields. However, the cattle entered these barns in the fall in good flesh and, considering the housing and food conditions, did exceptionally well.

SESSIONAL PAPER No. 16

The winter ration per day for milch cows on the average was about as follows:—

	Pounds.
Hay	7
Corn ensilage	23
Roots	15
Straw	1
Meal	7

The meal consisted of a mixture of 600 pounds bran; 300 pounds oat meal; 200 pounds oil cake meal; and 200 pounds cottonseed meal.

All the hay was purchased for the cattle which had formerly been housed in the main barn, and owing to the spring killing of clover in 1913, was mostly timothy. The corn ensilage was of good quality, rich in grain, and the part that was used for feed was uninjured.

The roots were mangels, sugar mangels, and turnips. These of necessity were fed whole owing to our lack of facilities for pulping. In the future, however, the former method of pulping and mixing with ensilage and cut straw will be continued.

The straw purchased was, of course, oat straw, and was of poor feeding value. Again, owing to lack of cutting facilities, the straw was fed long, once per day.

The meal was scattered on the ensilage after it was before the cattle. The hay given was fed uncut, after the other materials had been cleaned up.

Generally speaking, the milch cow is allowed all the roughage she will consume. Meal was given in proportion to milk produced, and if a cow responded freely and profitably to an increase of meal she was fed more liberally up to the point where profits ceased. Some of the cows, recently freshened, consumed profitably 1 pound of meal for every 3 pounds of milk produced. However, a fair average of the herd and a reasonable standard for farmers, and one which will give on the average best results, is: 1 pound of meal fed for every 4 pounds of milk produced. However, this ratio between the pounds of meal and the pounds of milk must be largely governed by the quantity and the richness of the coarse forage, together with the richness, palatability, and variety of the meal mixture.

Water was before the cows all the time; and salt was added to the roughage at the time of mixing.

DAIRY CATTLE FEEDING EXPERIMENTS.

EXPERIMENTS WITH THE FEEDING OF MOLASSES AND MOLASSES MEALS TO DAIRY CATTLE.

Following the experiments conducted in 1912-13, and already reported, on the feeding of molasses to dairy cattle, further work in relation to the value of this substance as a cattle food was carried on in the summer of 1913.

Molasses vs. Caldwell's Molasses Meal.

Beginning April 27, an experiment was conducted with the grade herd to ascertain, if possible, a comparison of the value of molasses and molasses meal added to the regular meal ration. During the test, each cow received the same number of pounds of meal and molasses, or Caldwell's molasses meal. Each feeding period consisted of two weeks; the first week as a transitory stage, the second as a basis of calculation. This allowed one week for the animals to become accustomed to any change in the ration, and by averaging the first and third periods of the experiment, a comparison

with results of the second period is possible. The following table is calculated on the feed and production of thirteen cows in the herd:—

Dairy Cow Feeding Experiment No. 3A.—Central Experimental Farm, Ottawa.

Object of Experiment.—To compare molasses with Caldwell's molasses meal.

Rations.—Period 2: Meal mixture plus 25 per cent Caldwell's molasses meal. Periods 1 and 3: Meal mixture plus 20 per cent molasses.

Value of feeds per ton.—Hay, \$7; straw, \$4; turnips and ensilage, \$2; molasses, \$23; Caldwell's molasses meal, \$32; meal, 1½ cents per pound.

Grain, mixture of.—Bran, 600 pounds; gluten meal, 300 pounds; oil cake, 200 pounds; cottonseed, 200 pounds; dried brewers' grains, 200 pounds.

	Period 1	Period 3	Periods 1 and 3 average.	Period 2
Number of cows in test.....	13	13	13	13
Pounds of milk produced by 13 cows..... lb.	2,075	2,130	2,102	2,192
Average milk per cow per day..... "	22.8	23.4	23.1	24
Average per cent fat in milk..... p.c.	3.6	3.9	3.75	3.8
Total pounds fat produced by 13 cows..... lb.	74.7	83	78.8	83.29
Average pounds fat per cow per day..... "	0.82	0.91	0.86	0.916
Total meal consumed..... "	711	711	711	666
Total molasses or molasses meal consumed..... "	178	178	178	223
Mixture consumed per 100 pounds fat produced.... "	1,190	1,071	1,129	1,067
Mixture consumed per 100 pounds of milk produced "	42.8	41.7	42.3	40.6
<i>Findings from Experiment—</i>				
Cost of meal mixture fed..... \$	11.03	11.03	11.03	11.90
Value of roughage fed..... "	5.54	5.54	5.54	5.54
Total cost of feed..... "	16.57	16.57	16.57	17.44
Cost to produce 100 pounds fat..... "	22.17	19.96	21.03	20.95
Cost to produce 1 pound fat..... "	0.221	0.199	0.21	0.209
Cost to produce 1 pound butter..... "	0.176	0.159	0.168	0.167
Profit on 1 pound butter at 30 cents per pound... "	0.124	0.141	0.132	0.133
Cost to produce 100 pounds milk..... "	0.799	0.773	0.788	0.795
Profit on 100 pounds milk at \$1.70 per cwt..... "	0.901	0.927	0.914	0.915

Reviewing the results it will be seen that the production was higher during that week when the molasses constituent consisted of Caldwell's meal. The cost of production, however, is not reduced, being practically the same in all periods.

In conjunction with the foregoing work, a duplicate experiment was carried on with the pure-bred herd.

SESSIONAL PAPER No. 16

Dairy Cow Feeding Experiment No. 3 B.—Central Experimental Farm, Ottawa.

Object of Experiment.—To compare Caldwell's molasses meal with molasses.

Rations.—Period 2: Meal mixture plus 25 per cent Caldwell's molasses meal. Periods 1 and 3: Meal mixture plus 20 per cent molasses.

Value of feeds per ton.—Hay, \$7; straw, \$4; turnips and ensilage, \$2; molasses, \$23; Caldwell's molasses meal, \$32; meal, 1½ cents per pound.

Grain, Mixture of.—Bran 600 pounds; gluten meal, 300 pounds; cottonseed, 200 pounds; dried brewers' grains, 200 pounds.

	Period 1.	Period 3.	Periods 1 and 3 average.	Period 2.
Number of cows in test.....	11	11	11	11
Pounds of milk produced by 11 cows..... lb.	2,318	2,255	2,286.5	2,283
Average milk per cow per day..... "	30	29.3	29.7	29.7
Average per cent fat in milk..... p.c.	3.63	3.7	3.69	3.7
Total pounds fat produced by 11 cows..... lb.	85.30	83.43	84.37	84.47
Average pounds fat per cow per day..... "	1.10	1.08	1.09	1.09
Total meal consumed..... "	576	576	576	540
Total molasses consumed..... "	144	144	144	180
Mixture consumed per 100 pounds fat produced.... "	843	864	855	851
Mixture consumed per 100 pounds milk produced... "	31.1	31.9	31.5	31.54
<i>Findings from Experiment:—</i>				
Cost of meal mixture fed..... \$	8.93	8.93	8.93	9.63
Value of roughage fed..... "	4.36	4.36	4.36	4.36
Total cost of feed..... "	13.29	13.29	13.29	13.99
Cost to produce 100 pounds fat..... "	15.58	15.93	15.75	16.55
Cost to produce 1 pound fat..... "	0.155	0.159	0.157	0.165
Cost to produce 1 pound butter..... "	0.124	0.127	0.125	0.132
Profit on one pound butter at 30 cents per pound.. "	0.176	0.173	0.175	0.168
Cost to produce 100 pounds milk..... "	0.569	0.589	0.581	0.61
Profit on 100 pounds milk at \$1.70 per cwt..... "	1.13	1.11	1.12	1.09

Here a comparison of the average of the two molasses feeding periods with the Caldwell's molasses meal period shows practically the same production in all three. Consequently, the cost of production was less where the molasses constituent was used.

In discussing the cost of production it must be remembered that the term, as here used, refers only to the actual cost of the feeds themselves. It should be stated in fairness to the molasses meals that, while they form rather an expensive food, they present molasses in a form where it may be fed as easily as any other meal. The farmer who has used feeding molasses, especially during the winter months, will realize thoroughly its inconvenience and proverbial slowness. Roughly speaking there are three ways in which molasses may be fed. The first, by simply pouring it, slightly warmed, over the feed; second, by diluting with warm water and mixing it with the roughage or meal, using a watering can or other receptacle; third, by using a mechanical power-mixer—consisting of a large hopper in which revolves a specially constructed system of mixers, operated from a horizontal spindle and driven by hand or preferably by power through chain and sprocket. In this hopper may be placed the component parts of the grain or meal mixture together with the proportion of molasses required. One or two minutes' operation will so thoroughly incorporate a 20 to 30 per cent addition of molasses that the presence of a liquid may scarcely be detected from the texture of the mixture. Such an apparatus was used in the mixture of molasses food, and while proving satisfactory as regards work done, it was mechanically weak, and with all its simplicity, much too expensive for general adoption. However, the use of some such contrivance was practically necessary where definite and differing percentages of molasses were to be used. Such items as the extra and not inconsiderable trouble of mixing, the cost of power, interest on investment, etc., were not figured against molasses.

5 GEORGE V., A. 1915

Molasses vs. Caldwell's Molasses and Molassine Meals.

A number of the grade cows used in Experiment 3A were well advanced in their lactation periods, were decreasing rapidly in milk flow and were therefore much less likely to respond to slight changes in feeding. At the close of the experiment just mentioned, a number of high-grade, fresh-calved cows were purchased, and with them the comparison of molasses with molasses meals was continued as experiment No. 4, parts 1 and 2. In experiment 3, molasses formed the basis of experimentation, while in experiment No. 4 comparison was made from a molasses meal basis. Apart from this, no further explanation is necessary.

Dairy Cow Feeding Experiment No. 4—Part I—Central Experimental Farm, Ottawa.

Object of Experiment.—Caldwell's molasses meal vs. molasses (Caldwell's meal Standard).

Rations.—Period 2: Grain mixture plus 20 per cent molasses

Periods 1 and 3: Grain mixture plus 25 per cent Caldwell's molasses meal.

Value of feeds per ton.—Hay, \$7; straw, \$4; turnips and ensilage, \$2; molasses, \$23; Caldwell's molasses meal, \$32; meal, 1½ cents per pound.

Grain mixture of.—Bran, 600 pounds; gluten meal, 300 pounds; oil cake, 200 pounds; cottonseed, 200 pounds; dried brewers' grains, 200 pounds.

	Period 1.	Period 3.	Periods 1 and 3 Average.	Period 2.
Number of cows in test.....	8	8	8	8
Pounds of milk produced by 8 cows..... lb.	2,175	2,257	2,216	2,345
Average milk per cow per day..... "	38.8	40	39.5	41.9
Average per cent fat in milk..... p.c.	3.7	3.8	3.75	3.8
Total pounds fat produced by 8 cows..... lb.	79.47	85.76	83.10	89.11
Average pounds fat per cow per day..... "	1.42	1.53	1.48	1.59
Total meal consumed..... "	483	483	483	515
Total molasses consumed..... "	161	161	161	129
Mixture consumed per 100 pounds fat produced.... "	810.3	750.9	774.8	722.7
Mixture consumed per 100 pounds milk produced. "	29.6	28.5	29	27.4
<i>Findings from Experiment.</i> —				
Cost of meal mixture fed..... \$	8.62	8.62	8.62	7.99
Value of roughage fed..... "	3.55	3.55	3.55	3.55
Total cost of feed..... "	12.17	12.17	12.17	11.54
Cost to produce 100 pounds fat..... "	15.31	14.19	14.64	12.95
" " 1 " "..... "	0.153	0.141	0.146	0.129
" " 1 " butter 80 per cent..... "	0.122	0.112	0.116	0.103
Profit on 1 pound butter at 30 cents per pound..... "	0.178	0.188	0.184	0.197
Cost to produce 100 pounds milk..... "	0.559	0.539	0.549	0.493
Profit on 100 pounds milk at \$1.70 per cwt.... "	1.14	1.16	1.15	1.20

In the above experiment, comparing molasses feeds on a Caldwell's molasses meal standard, the eight cows gave an appreciably greater response during the period when they received the 20 per cent molasses addition to the meal mixture. This, combined with the lower cost of the ration, reduced the cost of production during the molasses feeding period. No effect was noticed in the average percentage fat during the different periods.

SESSIONAL PAPER No. 16

*Dairy Cow Feeding Experiment No. 4—Part II—Central Experimental Farm, Ottawa.**Object of Experiment.*—Molassine vs. Molasses (Molassine standard).*Rations.*—Period 2: Meal mixture plus 20 per cent molasses.

Periods 1 and 3: Meal mixture plus 25 per cent Molassine meal.

Value of feeds per ton: Hay, \$7; straw, \$4; turnips and silage, \$2; molasses, \$23; Molassine meal, \$37; meal, 1½ cents per pound.*Grain, mixture of.*—Bran, 600 pounds; gluten meal, 300 pounds; oil cake, 200 pounds; cottonseed, 200 pounds; dried brewers' grains, 200 pounds.

	Period 1.	Period 3.	Periods 1 and 3 Average.	Period 2.
Number of cows in test	8	8	8	8
Pounds of milk produced by 8 cows..... lb.	2,138	2,084	2,111	2,138
Average milk per cow per day..... "	38	37	37.5	38
Average per cent fat in milk..... p.c.	3.6	3.5	3.55	3.6
Total pounds fat produced by 8 cows..... lb.	76.96	72.94	74.94	76.96
Average pounds fat per cow per day..... "	1.36	1.29	1.30	1.30
Total meal consumed..... "	483	483	483	515
Total molasses consumed..... "	161	161	161	129
Mixture consumed per 100 pounds fat produced.... "	836.7	882.9	859.3	836.7
Mixture consumed per 100 pounds milk produced. "	30.1	30.9	30.5	30.1
<i>Findings from Experiment.</i> —				
Cost of meal mixture fed..... \$	8.94	8.94	8.94	7.99
Value of roughage fed..... "	3.55	3.55	3.55	3.55
Total cost of feed..... "	12.59	12.59	12.59	11.54
Cost to produce 100 pounds fat..... "	16.35	17.26	16.80	15.00
" " 1 " " "..... "	0.163	0.172	0.168	0.15
" " 1 " " butter 80 p.c..... "	0.13	0.137	0.134	0.12
Profit on 1 pound butter at 30 cents per pound..... "	0.17	0.163	0.166	0.18
Cost to produce 100 pounds milk..... "	0.58	0.60	0.59	0.54
Profit on 100 pounds milk at \$1.70 per cwt.... "	1.11	1.09	1.10	1.16

In part 2 of this experiment, Molassine meal was used during the first and third periods. The production of the periods decreases slightly, due to a great extent to the fact that the cows were housed continually during comparatively warm weather. Here again the average for the two Molassine meal feeding periods is slightly lower than where molasses is used, resulting in practically the same lessening in cost with the latter food that was shown in part 1.

The tests as outlined were conducted with comparatively few cows, and under conditions not altogether conducive to thorough contentment on the part of the animals, and are, perhaps, rather inconclusive. One point is fairly well shown, namely, that molasses added to the meal ration is more palatable, cheaper, and capable of producing more milk than any of the above molasses meals used. The palatability of molasses is unquestionable. During the first week of each two-week period, the cows were unmistakably glad to welcome the molasses mixed meal. When, on the contrary, they were changed to the meal mixture plus the molasses meals, they showed a lack of enthusiasm. Attention might here be drawn to the fact that in purchasing molasses meals, great care should be taken to examine them and ascertain that they are reasonably fresh. The matrix or solid portion of these meals consists in most cases of peat, sphagnum moss, ground sugar cane or other more or less edible organic material of an absorbent nature. With these substances, in a finely-ground state, is incorporated the molasses, the whole being, when freshly mixed, of a soft mealy consistency and a palatable nature. Where, however, large quantities of such meals are stored, piled high in warehouses, the result is a compacting of the material and, in warm weather,

more or less fermentation, leaving the contents of each bag a solid "fire-fanged" mass, with adhesive qualities sufficient to make disintegration almost impossible. The feeding value, palatability, and convenience of molasses meal in such a condition is destroyed. With Molassine meal, some difficulty was met with in obtaining the fresh-mixed product on the open market. This meal in the foregoing experiments and in experiment 5 was not of the best quality. With Caldwell's molasses meal, however, no such trouble was experienced, it being uniformly fresh and sweet wherever purchased, and apparently able to retain these qualities indefinitely. To this was likely due the fact that throughout the experiments cattle showed a preference for this meal over other meals of like nature. Where purchased in any considerable quantity, the bags containing molasses meals should either be placed on end or piled flat in tiers not more than 3 or 4 deep.

COMPARISON OF MOLASSES MEALS.

For the winter of 1913-14, due to the destruction of all machinery and special appliances used in molasses feeding, investigations in this line were necessarily confined to a straight comparison of molasses meals. Of these, three were chosen, Caldwell's molasses meal, Molassine meal, and Molaseuit. The two first-mentioned have already been used as reported. The latter, however, is a newer meal, and is composed of refuse sugar cane and pulp, ground and dried, mixed with cane feeding molasses. Although it does not impress one at first sight as an attractive or palatable meal, this feature is not apparent in the results, which show little difference in the production for the various feeding periods.

The operation of these tests was very seriously interfered with by frequent changes in the herd, individuals being removed temporarily and returned, or permanently disposed of and replaced by new cows. This was necessitated by crowding and the frequent changing of stock in all quarters due to lack of housing facilities and to other untoward circumstances not under control. In experiment No. 5, therefore, only six cows were available, these cows being in good milk flow and in the grade herd under uniform conditions throughout the test.

In order to give a fair comparison, the results of the tests are compiled in three tables, in each of which the basic Molassine meal is compared with one of the three-meal rations plus Molaseuit, plus Caldwell's molasses meal, and less molasses meal constituent. Molasses meal was therefore fed during periods 1 and 3, 3 and 5, and 5 and 7. In the intermediate period in each case comparison was possible with the other molasses meals or with the mixture less molasses by averaging the two Molassine meal feeding periods. This is the fairest comparison possible, as it allows for the natural decrease in milk flow. In the case of a direct comparison of two feeding periods, the later is always at a disadvantage, due to the natural falling off in production.

The preface appearing at the top of the first table contains information applying of course to the two tables following.

Dairy Cow Feeding Experiment No. 5—Central Experimental Farm, Ottawa.

Object of Experiment.—To compare molasses meals (Molassine meal standard).

Rations.—Period 1, 3, 5, 7: Meal mixture plus Molassine meal.

Period 2: Meal mixture less molasses meal.

Period 4: Meal mixture plus Molaseuit.

Period 6: Meal mixture plus Caldwell's molasses meal.

Value of Feeds per ton.—Hay, \$7; straw, \$4; roots and ensilage, \$2; molasses, \$23; Caldwell's molasses meal, \$32; Molassine meal, \$37; Molaseuit, \$32; regular meal mixture, 1½ cents per pound.

Grain and Molasses Meal Mixture.—Bran, 400 pounds; gluten feed, 200 pounds; nutted oil cake, 200 pounds; molasses meal (make depending on experiment) 200 pounds.

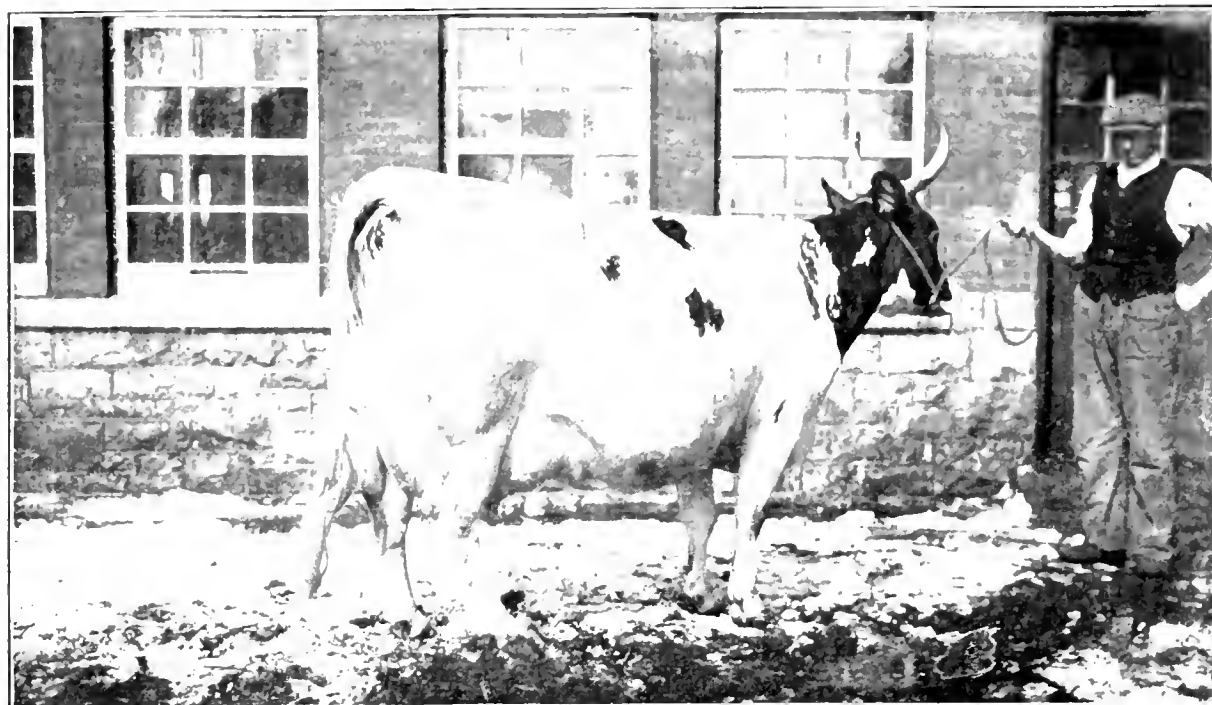

Ayrshire cow, Flavia 2nd of Ottawa, 22,197. Official record for year 1912:—10,318.5 lb. milk, 414.8 lb. fat in 330 days. Official record for year 1913:—9,520.5 lb. milk, 374.8 lb. fat in 317 days. Bred and owned by Central Experimental Farm, Ottawa.

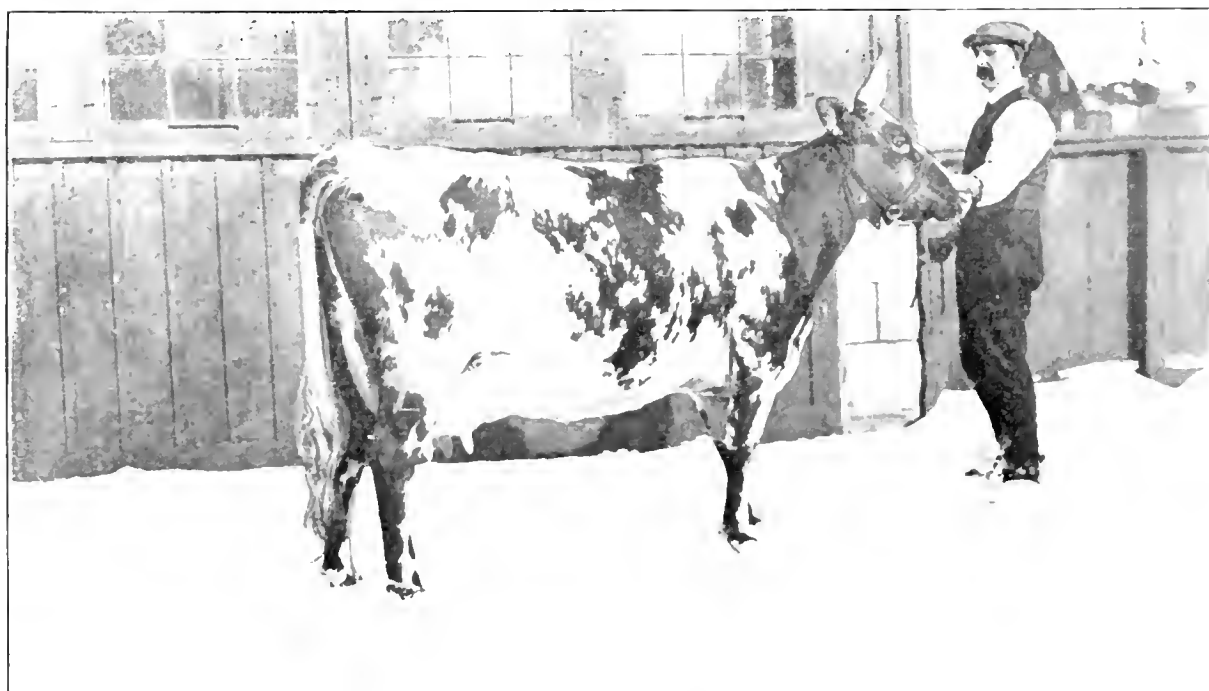

Ayrshire cow, Ottawa Kate, 29,601. Official record for year 1913: 11,873 lb. milk, 478.7 lb. fat in 365 days. Bred and owned by Central Experimental Farm, Ottawa. Her dam is a full sister of the dam of world's champion Ayrshire cow Auchenbraine Brown Kate 4th.

SESSIONAL PAPER No. 16

COMPARING Molassine Meal with Meal Ration less molasses.

	Period 1. — Molassine.	Period 3. — Molassine.	Periods 1 and 3 Average. — Molassine.	Period 2. — Less Molasses.
Number of cows in test.....	6	6	6	6
Pounds of milk produced by six cows..... lb.	1,062.5	1,087	1,074.7	1,141.5
Average milk per cow per day..... "	25.3	25.9	25.6	27.1
Average per cent fat in milk..... "	3.4	3.5	3.45	3.4
Total pounds fat produced by six cows..... "	36.2	38	37.1	38.8
Average pounds fat per cow per day..... "	.86	.90	.88	.92
Total meal consumed..... "	336	336	336	420
Total molasses meal consumed..... "	84	84	84	
Mixture consumed per 100 pounds fat produced... "	1,160	1,105	1,132.5	1,082
Mixture consumed per 100 pounds milk produced. "	39.5	38.7	39.1	37.
<i>Findings from Experiment.—</i>				
Cost of meal mixture fed..... \$	5.71	5.71	5.71	5.25
Value of roughage fed..... "	3.94	3.94	3.94	3.94
Total cost of feed..... "	9.65	9.65	9.65	9.19
Cost to produce 100 pounds fat..... "	26.65	25.13	25.89	23.71
Cost to produce 1 pound fat..... "	0.266	0.25	0.258	0.23
Cost to produce 1 pound butter..... "	0.212	0.20	0.206	0.184
Profit on 1 pound butter at 30 cents per pound "	0.08	0.10	0.09	0.11
Cost to produce 100 pounds milk..... "	0.908	0.888	0.898	0.805
Profit on 100 pounds milk at \$1.70 per cwt.... "	0.792	0.812	0.802	0.895

The outstanding feature of the results, as indicated, is the appreciable increase in production when the Molassine meal was omitted from the ration. This increase, combined with the lower cost of the ration less molasses, resulted in a considerably lower cost of production during period 2.

Dairy Cow Feeding Experiment No. 5—Central Experimental Farm, Ottawa.

COMPARING Molassine Meal with Molascuit.

	Period 3. — Molassine.	Period 5. — Molassine.	Periods 3 and 5 Average — Molassine.	Period 4. — Molascuit.
Number of cows in test.....	6	6	6	6
Pounds of milk produced by six cows..... lb.	1,087	1,004	1,046	1,065
Average milk per cow per day..... "	25.9	23.9	24.9	25.3
Average per cent fat in milk..... p.c.	3.5	3.6	3.55	3.5
Total pounds fat produced by six cows..... lb.	38	36.1	37.1	37.2
Average pounds fat per cow per day..... "	.90	.86	.88	.88
Total meal consumed..... "	336	336	336	336.8
Total molasses meal consumed..... "	84	84	84	84
Mixture consumed per 100 pounds fat produced... "	1,105	1,163	1,134	1,129
Mixture consumed per 100 pounds milk produced. "	38.7	41.8	40.3	39
<i>Findings from Experiment.—</i>				
Cost of meal mixture fed..... \$	5.71	5.71	5.71	5.55
Value of roughage fed..... "	3.94	3.94	3.94	3.94
Total cost of feed..... "	9.65	9.65	9.65	9.49
Cost to produce 100 pounds fat..... "	25.13	26.73	25.93	25.51
Cost to produce 1 pound fat..... "	0.25	0.267	0.259	0.255
Cost to produce 1 pound butter..... "	0.20	0.213	0.207	0.204
Profit on 1 lb. butter at 30 cents per pound... "	0.10	0.087	0.093	0.096
Cost to produce 100 pounds milk..... "	0.888	0.96	0.924	0.89
Profit on 100 pounds milk at \$1.70 per cwt.... "	0.812	0.74	0.776	0.81

The results show a slightly increased production during the period in which was fed Molascuit as compared with the average of the two Molassine meal periods. Molascuit being lower in cost than Molassine, the cost of production for period 4 is still further lowered.

Dairy Cow Feeding Experiment No. 5.—Central Experimental Farm, Ottawa.—Con.

COMPARING Molassine Meal with Caldwell's Molasses Meal.

	Period 5. — Molassine.	Period 7. — Molassine.	Periods 5 and 7 Average. — Molassine.	Period 6. — Caldwell's Molasses Meal.
Number of cows in test..... lb.	6	6	6	6
Pounds of milk produced by six cows.....	1,004	1,014.5	1,009.2	1,049
Average milk per cow per day.....	23.9	24.1	24.	25
Average per cent fat in milk.....	3.6	3.7	3.65	3.6
Total pounds fat produced by six cows.....	36.1	37.5	36.8	37.7
Average pounds fat per cow per day.....	86	89	87.5	90
Total meal consumed.....	336	336	336	336
Total molasses meal consumed.....	84	84	84	84
Mixture consumed per 100 pounds fat produced.....	1,163	1,120	1,142	1,114
Mixture consumed per 100 pounds milk produced.....	41.8	41.4	41.6	40
<i>Findings from Experiment.—</i>				
Cost of meal mixture fed..... \$	5.71	5.71	5.71	5.55
Value of roughage fed.....	3.94	3.94	3.94	3.94
Total cost of feed.....	9.65	9.65	9.65	9.49
Cost to produce 100 pounds fat.....	26.73	25.73	26.23	25.17
Cost to produce 1 pound fat.....	0.267	0.257	0.262	0.25
Cost to produce 1 pound butter.....	0.213	0.205	0.209	0.20
Profit on 1 pound butter at 30 cents per pound.....	0.087	0.095	0.091	0.10
Cost to produce 100 pounds milk.....	0.96	0.95	0.955	0.904
Profit on 100 pounds milk at \$1.70 per cwt....	0.74	0.75	0.745	0.796

Here the results are in favour of the Caldwell's molasses meal, milk production being slightly higher, and cost to produce lessened accordingly, the lower price of the latter meal still further reducing the cost.

SUMMARY.

The feeding periods with the meal mixture plus Molascuit, meal mixture plus Caldwell's molasses meal, and meal mixture less molasses, all show increased production over the average of a preceding and following Molassine meal feeding period. The lower price of the three former meal mixtures, combined with the above fact, quite appreciably lessens the cost to produce.

COMPARING MOLASSES MEALS FROM A CALDWELL'S MEAL STANDARD.

At the expiration of the foregoing experiment, the test was continued on the above indicated basis. A number of high-class Holstein and Ayrshire grades having been purchased, and several individuals of the herd having freshened, eleven cows were available, all at a stage of lactation where production would likely be affected by change in diet.

Except for the change in the basis of comparison, experiment 6 was practically a replica of experiment 5. The results being tabulated as in experiment 5, no further explanation should be required.

SESSIONAL PAPER No. 16

Dairy Cow Feeding Experiment No. 6.—Central Experimental Farm, Ottawa.

Object of Experiment.—To compare molasses meals. (Caldwell's molasses meal standard).

Rations: Periods 1, 3, 5 and 7: Meal mixture plus Caldwell's molasses meal.

Period 3: Meal mixture plus Molascuit.

Period 5: Meal mixture plus Molassine meal.

Period 7: Meal mixture less molasses meal.

Value of feeds per ton.—Hay, \$7; straw, \$4; ensilage, \$2; Caldwell's molasses meal, \$32; Molascuit, \$32; Molassine meal, \$37; meal, 1½ cent per pound.

Grain and Molasses Meal Mixture.—Bran, 400 pounds; gluten feed, 200 pounds; nitted oil cake, 200 pounds; molasses meal (make depending on experiment) 200 pounds.

COMPARING Caldwell's Molasses Meal with Molascuit.

	Period 1 — Caldwell's Molasses Meal	Period 3 — Caldwell's Molasses Meal	Periods 1 and 3 Average. — Caldwell's Molasses Meal	Period 2 — Molascuit.
Number of cows in test.....	11	11	11	11
Pounds of milk produced by 11 cows.....lb.	2,699·	2,520·	2,609·5	2,638·
Average milk per cow per day....."	35·	32·7	33·8	34·2
Average per cent fat in milk.....p.c.	3·9	3·9	3·9	3·9
Total pounds of fat produced by 11 cows.....lb.	105·2	98·2	101·7	102·9
Average pounds fat per cow per day....."	1·35	1·27	1·32	1·34
Total meal consumed....."	941·	941·	941·	941·
Total molasses meal consumed....."	235·	235·	235·	235·
Mixture consumed per 100 pounds fat produced...."	1,118·	1,197·	1,157·5	1,197·
Mixture consumed per 100 pounds milk produced..."	43·5	46·6	45·5	46·6
<i>Findings from Experiment.</i> —				
Cost of meal mixture fed.....\$	15·52	15·52	15·52	15·52
Value of roughage fed....."	4·38	4·38	4·38	4·38
Total cost of feed....."	19·90	19·90	19·90	19·90
Cost to produce 100 pounds fat....."	18·91	20·26	19·53	19·31
Cost to produce 1 pound fat....."	0·189	0·202	0·195	0·193
Cost to produce 1 pound butter....."	0·151	0·161	0·156	0·154
Profit on 1 pound butter at 30 cents per pound...."	0·149	0·139	0·144	0·146
Cost to produce 100 pounds milk....."	0·741	0·789	0·765	0·751
Profit on 100 pounds milk at \$1·70 per cwt....."	0·959	0·911	0·935	0·946

The results for the average of the Caldwell's molasses meal feeding periods, as against the Molascuit period, were practically the same both as to production and cost to produce.

Dairy Cow Feeding Experiment No. 6.—Central Experimental Farm, Ottawa.—Con.

COMPARING Caldwell's Molasses Meal with Molassine Meal.

	Period 3. — Caldwell's Molasses Meal.	Period 5. — Caldwell's Molasses Meal.	Periods 3 and 5 Average. — Caldwell's Molasses Meal.	Period 4. — Molassine Meal.
Number of cows in test.....	11	11	11	11
Pounds of milk produced by 11 cows..... lb.	2,520·	2,438·	2,479·	2,402·
Average milk per cow per day..... "	32·7	31·6	32·2	31·1
Average per cent of fat in milk..... p.c.	3·9	3·8	3·85	3·8
Total pounds of fat produced by eleven cows..... lb.	98·2	92·6	95·4	91·2
Average pounds fat per cow per day..... "	1·27	1·20	1·24	1·18
Total meal consumed..... "	941·	941·	941·	941·
Total molasses consumed..... "	235·	235·	235·	235·
Mixture consumed per 100 pounds fat produced.... "	1,197·	1,270·	1,234·	1,289·
Mixture consumed per 100 pounds milk produced.. "	46·6	48·5	47·6	48·9
<i>Findings from Experiment.—</i>				
Cost of meal mixture fed..... \$	15·52	15·52	15·52	16·00
Value of roughage fed..... "	4·38	4·38	4·38	4·38
Total cost of feed..... "	19·90	19·90	19·90	20·38
Cost to produce 100 pounds fat..... "	20·26	21·49	20·88	22·34
Cost to produce 1 pound fat..... "	0·202	0·214	0·208	0·223
Cost to produce 1 pound butter..... "	0·161	0·171	0·166	0·178
Profit on 1 pound butter at 30 cents per pound.... "	0·137	0·129	0·134	0·122
Cost to produce 100 pounds milk..... "	0·789	0·812	0·801	0·848
Profit on 100 pounds milk at \$1.70 per cwt..... "	0·911	0·888	0·899	0·852

The average of the Caldwell's meal periods was here higher than the Molassine period, and in conjunction with the lower cost of the former meal the total cost to produce was consequently lowered.

COMPARING Caldwell's Molasses Meal with a Meal Ration less Molasses.

	Period 5 — Caldwell's Molasses Meal.	Period 7. — Caldwell's Molasses Meal.	Periods 5 and 7 Average. — Caldwell's Molasses Meal.	Period 6. — Meal Ration less Molasses.
Number of cows in test.....	11	11	11	11
Pounds of milk produced by 11 cows..... lb.	2,438·	2,202·	2,320·	2,199·
Average milk per cow per day..... "	31·6	28·5	30·1	28·5
Average per cent fat in milk..... p.c.	3·8	3·6	3·7	3·7
Total pounds fat produced by 11 cows..... lb.	92·6	79·3	86·	81·4
Average pounds fat per cow per day..... "	1·20	1·02	1·21	1·05
Total meal consumed..... "	941·	941·	941·	1,176·
Total molasses meal consumed..... "	235·	235·	235·	
Mixture consumed per 100 pounds fat produced.... "	1,270·	1,482·	1,376·	1,444·
Mixture consumed per 100 pounds milk produced.... "	48·5	53·4	51·	53·4
<i>Findings from Experiment.—</i>				
Cost of meal mixture fed..... \$	15·52	15·52	15·52	14·60
Value of roughage fed..... "	4·38	4·38	4·38	4·38
Total cost of feed..... "	19·90	19·90	19·90	18·98
Cost to produce 100 pounds fat..... "	21·49	25·09	23·29	23·32
Cost to produce 1 pound fat..... "	0·214	0·25	0·232	0·233
Cost to produce 1 pound butter..... "	0·171	0·20	0·185	0·186
Profit on 1 pound butter at 30 cents per pound.... "	0·129	0·10	0·115	0·114
Cost to produce 100 pounds milk..... "	0·812	0·90	0·856	0·863
Profit on 100 pounds milk at \$1.70 per cwt..... "	0·888	0·80	0·844	0·837

SESSIONAL PAPER No. 16

Caldwell's molasses meal here showed a considerable superiority over the ration less molasses. In the previous experiment exactly the reverse was the case, quite as decided a rise being shown when the molasses meal was omitted. Notwithstanding the drop in production in this case, however, the cost to produce was very little higher, due to the absence, in period 6, of the relatively expensive Caldwell's meal.

GENERAL CONCLUSIONS.

Reviewing the results as obtained throughout the year it would appear that in view of their relatively high cost, molasses meals tend to increase the cost of milk production. Comparing them with the pure molasses addition, the results are not as conclusive as might be desired in order to make deductions. The cost to produce, as figured, is lower with molasses, which is more palatable, and looks to be a better milk producer than the meals. It is a foodstuff of inconvenient nature, however, and the necessary expense involved in its incorporation with the food, must not be forgotten. Among the meals themselves, Caldwell's molasses meal has shown a slight but consistent superiority. This may have been due to the fact that, when purchased, it was uniformly fresh. Although results as to milk production were contradictory when compared with a meal mixture less molasses, the addition of molasses meals to a well-balanced ration, as largely home-grown as possible, would be of doubtful benefit, when the question is viewed in the last analysis—the cost to produce. However, this is the first test of its kind to be conducted at the Central Experimental Farm, and no further attempt should be made at hard and fast deductions.

Below is given a table of the weights of the cows taken at the beginning of experiments 5 and 6 and at the end of each feeding period throughout the tests.

WEIGHTS OF CATTLE AT END OF FEEDING PERIODS.

EXPERIMENT No. 5.

	At Beginning of Experiment.	Period 1.	Period 2.	Period 3.	Period 4.	Period 5.	Period 6.	Period 7.	Period 8.
6 cows.....	6,645	6,795	6,769	6,712	7,013	6,707	6,847	6,654

EXPERIMENT No. 6.

11 cows.....	11,432	11,617	11,618	11,660	11,944	11,920	11,886	11,875	11,905
--------------	--------	--------	--------	--------	--------	--------	--------	--------	--------

The results, although interesting, do not permit of any deductions bearing on the excellence of the meals tested.

GUARANTEED ANALYSES.

In connection with the foodstuffs used in the foregoing experiments, the following analyses, as quoted by manufacturers, may be of interest. Further analyses will be made by the Chemical Division, of composite samples of these foods, taken during the period of experiment.

GUARANTEED ANALYSES.

Foodstuff.	Protein.	Carbo- hydrate.	Fat.	Fibre.
	%	%	%	%
<i>Bran</i> — (Ontario and Manitoba Flour Mills)	11.9	42.	2.5
<i>Gluten Feed</i> — (Canada Starch Co.)	23.	3.	6.
<i>Nutted Oil Cake</i> — (Sherwin-Williams Co.)	31.5	35.7	3.
<i>Cotton Seed Meal</i> — (Michigan Farmer Brand)	41-48	7-12	4-10

GUARANTEED ANALYSES (Molasses Meals).

Meal.	Moisture.	Protein.	Carbo- hydrate and Digest- ible Fibre.	Sugar.	Fat.	Fibre.	Ash.
	%	%	%	%	%	%	%
Molascuit	15.33	2.50	69.02	53.19	.13	6.23	6.75
Caldwell's	4.61	64.56	39.16	.81	2.71
Molassine	19.23	7.94	55.48	1.06	6.87	9.42

Molascuit.—Composed of the interior of the sugar cane after the juice has been expressed this material, after screening and drying, is known as Megass meal, is said to be 75 per cent digestible, and, furthermore, is capable of absorbing four times its weight of molasses, the original juice being largely replaced by molasses.

Caldwell's Molasses Meal.—Composed of 80 to 84 per cent pure cane molasses, and the balance sphagnum moss.

Molassine Meal.—Much similar in composition to Caldwell's, sphagnum moss or peat forming the absorbent matrix which holds a high percentage of molasses.

ANALYSES BY THE DIVISION OF CHEMISTRY.

Readers interested in the above as well as all other live stock feeding experiments are referred to the report of the Dominion Chemist, as contained in previous chapters of this volume, for the analyses of all the various foodstuffs under experiment. Such analyses are absolutely essential in the final deductions relating to any feeds. The

SESSIONAL PAPER No. 16

foregoing "guaranteed analyses" are available to all purchasers who request such from sales agents. Whether or not such feeds are uniform in composition or live up to the guaranteed analyses, can be proven only by careful sampling and analysing by a chemist.

The following analyses were made by Mr. E. T. Shutt, Dominion Chemist, who has done a large amount of work relating to molasses as a foodstuff. These figures are here copied to illustrate the above-mentioned comparisons. Readers are particularly referred to complete analyses and explanatory notes as contained in the report of the Dominion Chemist.

Samples Nos. 1 and 2 were analysed a year ago and reported in the annual report for the year ending March 31, 1913. Samples Nos. 3, 4, and 5 were analysed during the past year, complete details of which are found in previous chapters of this report.

No.	Feed.	Moisture.	Protein.	Carbo- hydrate.	Sugar.	Fat or Oil.	Fibre.	Ash.
		%	%	%	%	%	%	%
1	Molassuit Meal.....	16.10	2.81	66.23	43.70	.20	6.97	7.69
2	Molassine Meal.....	21.45	8.44	56.29	39.12	.35	5.44	8.07
3	Molassine Meal.....	17.06	6.34	58.23	35.32	.68	10.55	6.99
4	Caldwell's meal.....	22.04	4.89	58.22	44.86	.46	7.03	7.36
5	Molasses.....	28.70	4.94	60.95	60.57	5.41

Whether or not these meals were representative of their respective brands cannot be said. These, however, were all purchased on the market, and should be representative.

Comparisons of the above analyses with the results of the feeding experiments are most interesting. Final deductions would be impossible owing to the shortness of the test, yet one most noticeable fact may be noted, namely, in the above experiments the food values of molasses and molasses meals are in the same order and proportion to their sugar content, while the protein might be largely discarded in calculations as being mostly indigestible.

MILKING MACHINES.

As reported in the annual report for the fiscal year ending March 31, 1913, considerable work has been done at the Central Experimental Farm in connection with milking machines. Although nothing of a definite nature is as yet ready for publication, a brief summary of operations to date is worthy of note.

In July, 1912, a Sharples mechanical milker was installed in the main barn of the Central Experimental Farm with an idea of testing thoroughly this method of milking, and this machine in particular, as to its commercial value, its economy, durability, the effect on the cows as compared with hand milking, and particularly on the bacterial quality of the milk produced. Six milking units of this mechanical milker, together with all necessary equipment, including an electric motor, were installed with a total cost of \$1,043. Each milking unit cost \$110, with the pump, vacuum tanks, etc., extra. To readers who are not acquainted with milking machines, attention is drawn to the fact that with the Sharples mechanical milker a milking unit milks only one cow at a time.

In September, 1913, another make of milking machine, namely, the Burrell-Lawrence-Kennedy, was also installed in the main barn of the Central Experimental Farm. The reason for this installation was to obtain comparative data between the Burrell-

5 GEORGE V., A. 1915

Lawrence-Kennedy, the Sharples, and eventually other makes of mechanical milkers, in contrast to good hand milking. This installation did not in any way mean the discarding of the first installed machine. A complete outfit of the Burrell-Lawrence-Kennedy milker, consisting of three double milking units, together with all necessary appliances and incidentals, was installed, the one motor, however, being capable of handling the two makes of mechanical milkers. The cost of the Burrell-Lawrence-Kennedy milker amounted to \$102 per milking unit, with extra for the pump, tank, and valves. A unit of this machine consists of a milk pail, cover with pulsator attached, eight teat cups and all rubber tubing. One unit of the Burrell-Lawrence-Kennedy machine milks two cows at a time, in contrast to one cow at a time in the Sharples machine.

The fire which destroyed the main barn in October, 1913, also destroyed all piping, motors, pumps, vacuum tanks, etc., of both of these makes of mechanical milkers and, in consequence of the loss of buildings and this part of the equipment, it was deemed advisable to discontinue experimental work with milking machines until the completion of the new structure, when all such work will be much enlarged and continued.

The Sharples mechanical milker had been in use for fifteen months, excepting check periods of hand milking, amounting to approximately three months. The Burrell-Lawrence-Kennedy machine was in use just one month previous to the fire. Comparisons between these two machines in any way would be utterly impossible owing to the fact that the latter installed machine was used for such a short time and also that the former machine had in a way prepared the cows for mechanical milking. However, with the ten months of hand milking subsequent to the loss of buildings, all herds will be in a position on a uniform basis to take up the experimental work comparing these two machines with hand milking.

The bacteriological study for purity of milk in this work has, in the past, been conducted by Miss L. Dean, and with the assistance and under the supervision of the Dominion Botanist, Mr. H. T. Güssow. Many new bacterial phases of this work will be taken up as soon as this experimental work with mechanical milkers is re-established.

A brief summary of results with the Sharples mechanical milker to date is as follows:—

Although uniform conditions as to cleanliness of barn, cattle, etc., were maintained, yet with the best methods possible adopted, certified milk was an impossibility with the Sharples machine, while, with difficulty, it was possible by the best of hand milking. For good pure milk the Sharples mechanical milker gave good results if special precautions were taken in the washing and sterilizing of the milker after each milking period. The utility of this mechanical milker in the production of pure milk depends absolutely on the man who is operating the same, both as to cleanliness of the cows, care in handling the machine during operation, and thorough sterilization of the machine before using.

This machine apparently had no ill effect upon the cattle, only a few objecting to its use at the commencement of the experiment, and all taking kindly to it in a short time.

As to economy of labour, it undoubtedly has decreased the labour of milking fully 50 per cent but, on the other hand, has largely increased the labour in washing and sterilizing of all utensils. Generally speaking, it has decreased the most important labour of milking to an extent which would warrant the installation of the machine in a herd of some dimensions—fifteen cows or more.

Apparently the machine has exerted some influence in hastening the end of the lactation period; however, as it was the first year of installation, no definite figures or no definite conclusions could be drawn.

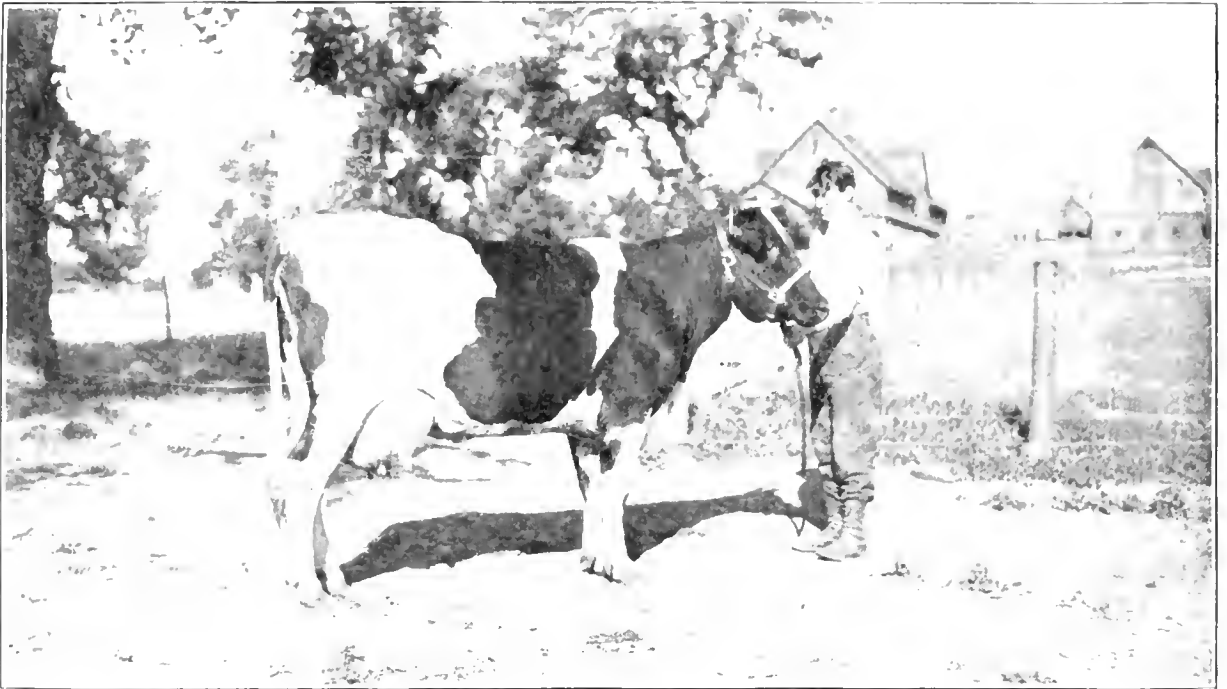

Holstein cow "Evergreen March," official records as 3 years in 1913:—Record of performance—13,804 lb. milk testing 3·8 % fat, or 525·4 lb. fat in 335 days. Record of milk, 3 years, 5 months, 1 day:—7 days: 549·5 lb. milk, 19·38 lb. fat, 24·22 lb. butter; 30 days: 2,202·5 lb. milk, 74·86 lb. fat, 93·58 lb. butter. Owned by Central Experimental Farm, Ottawa.

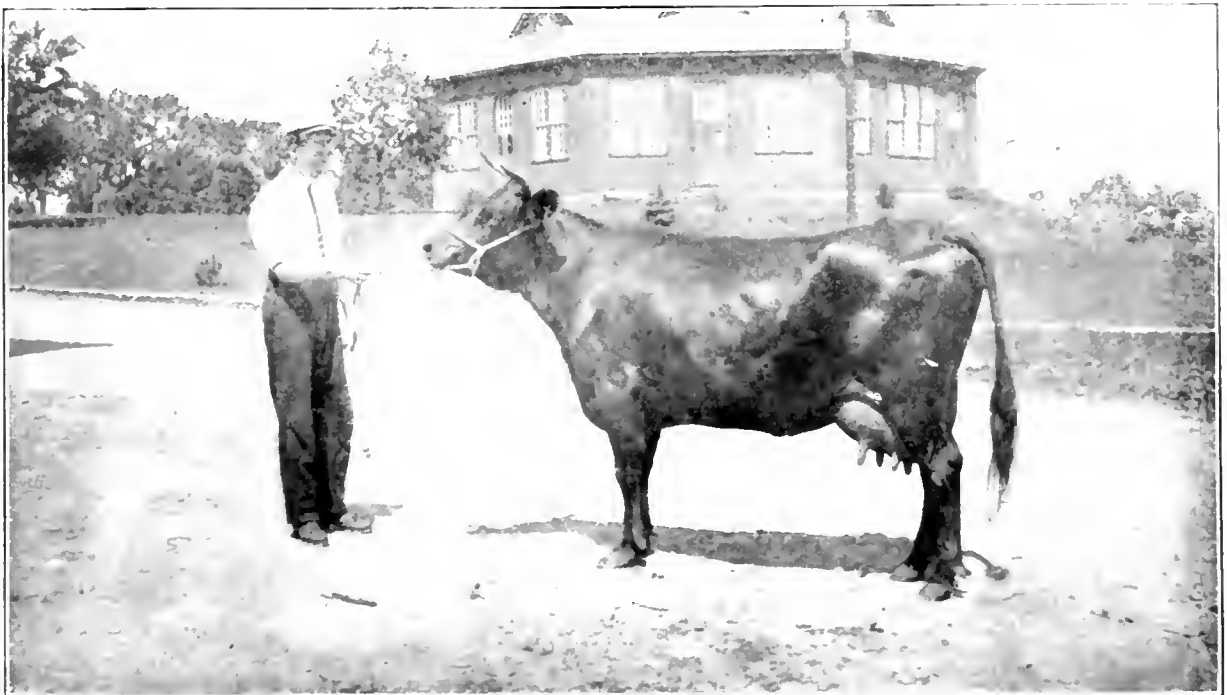

French Canadian cow, Fortune 4th, of Ottawa, age 5 years. Record of performance, 1913:—9,127 lb. milk testing 4·42 % fat; 410·02 lb. fat 365 days. Bred and owned by Experimental Farm, Ottawa.

SESSIONAL PAPER No. 16

The cost of renewal of rubber linings for teat cups and rubber tubing amounted to more than was expected. However, the manufacturers of the Sharples machine have, during the year 1913, greatly improved the finish and quality of the machine, both as to rubber parts and also as to the smoothness of the metal surfaces, which will greatly overcome part of the difficulty in washing and thorough sterilizing.

Further conclusions would be unwarranted owing to the short duration of the experiment. However, it is hoped that after three or more years of careful study of this and other mechanical milkers, a large amount of definite information of valuable character will be available for distribution.

DAIRY HERD RECORDS.

Following are the dairy cow milk records for all cows which have finished a lactation period during the fiscal year ending March 31, 1914.

In the case of heifers with their first calves, charges for feed include the consumption from a date two months previous to parturition, to the time of being dried off preparatory to second calving. In the case of heifers and cows 3 years old and over, charges for feed include the period in which they were dry previous to the lactation period reported.

In estimating the cost of feeding the following values are used:—

Pasture, per month	\$ 1 per cow.
Meal mixture	25 per ton.
Hay	7 "
Straw	4 "
Roots and ensilage	2 "
Green feed	3 "

In calculating the value of the product, 30 cents per pound is allowed for the butter, and 20 cents per hundred pounds for skim-milk. In reality a considerable quantity of milk conforming to the "certified" standard has again been sold at \$3 per hundred pounds, while the price of butter ranged from 29 to 35 cents per pound. The cream cheeses sold realized from \$3.25 to \$3.50 per hundred pounds of milk, and the Coulommier cheeses sold realized from \$2.20 to \$3 per hundred pounds of milk. The skim-milk, too, has acquired a value much exceeding the 20 cents per hundred pounds. In many cases, in the feeding of either calves or young pigs, it has reached a value of 75 cents and, in exceptional cases, nearly a dollar per hundred pounds.

However, the figures chosen for calculation were regular market values, and form a fair basis for comparison of the various individuals in the herd with each other, for this and previous fiscal years, as well as with the individuals of other herds either on branch Farms and Stations or on the farms of private individual farmers.

In computing these returns it will be noted that the bedding and labour in connection with caring for the cattle, and also the manufacture of the butter, cost of handling milk, manufacturing of cheese, and the like, have not been taken into account. From careful calculation covering several years it has been found that the value of the manure made and the value of the calves at birth, if properly cared for, more than counterbalance the above-mentioned items.

All cows are reported upon that have finished a lactation period during the past fiscal year. This list, however, does not include all cows that are at present in milk on the Central Experimental Farm, for in a few cases the cows have overrun the full year milking, and many heifers have not completed their first lactation period.

Owing to the loss of the splendid roughage together with the complete winter's supply of meals, all dairy cows on the Farm suffered severely from lack of a well-balanced ration, until such time as sufficient materials could be purchased for the same.

5 GEORGE V., A. 1913

In comparing the results from the various herds, special note must be made of the fact that the barn in which the grade cows were housed was not lost by fire, only the main barn and its various wings, in which all the pure-bred dairy cattle were housed, being destroyed. In consequence, the grade cows had, during the latter half of the fiscal year, a very much better opportunity than did the pure-breds, as they were not seriously affected by the fire.

OFFICIAL RECORDS OF PRODUCTION.

Although the herd records on the Central Experimental Farm are considered official, yet the policy of the Farms has been to place individual cows under test similar to cows of private individuals, and conduct the same under similar supervision. In consequence of this policy, pure-bred individual cows from the various herds on the Central Experimental Farm have, during the past years, been entered in the Record of Performance and, added to this during the past fiscal year, a few individual Holsteins were entered in the Canadian Holstein Friesian Association Record of Merit.

Following is a list of the cows which have completed these official records during the past fiscal year:—

CANADIAN Record of Performance.

Name of cow.	Breed.	Age at commencement of test.	Number days milking.	Pounds milk produced.	Pounds fat produced.	Average per cent. fat.
Evergreen March 3rd.....	Holstein.....	3	335	13,804	525.48	3.8
Ottawa Kate.....	Ayrshire.....	7	365	11,873	478.70	3.9
Flavia 2nd.....	Ayrshire.....	8	317	9,520	374.84	3.94
Fortune 4th of Ottawa.....	Fr. Canadian	5	365	9,127	410.02	4.42
Aromaz.....	" "	5	360	7,712	415.86	5.33
Inoquette 3rd.....	" "	5	365	6,763	315.28	5.01
Fortune Cadette.....	" "	3	319	5,801	287.00	4.71

SESSIONAL PAPER No. 16

CANADIAN Holstein Friesian Record of Merit.

Name of Cow.	Age at commencement of test.	No. of days in test.	Pounds milk produced.	Pounds fat produced.	Pounds 80 per cent. butter produced.
Evergreen March 3rd (12659).....	3y., 5m., 10d.	7	549.5	19.38	24.22
		30	2,202.5	74.86	93.58
Beulah Clay (7,705).....	6y., 0m., 27d.	7	472	16.79	20.99
		30	1,897	59.96	74.95
Centre View Bessie Ann (12,234).....	4y., 5m., 27d.	7	475	14.80	18.51
		30	1,758.5	53.30	66.62
Rhoda 2nd's Maud (7,314).....	7y., 3m., 18d.	7	411	13.79	17.24
		30	1,600	51.46	64.33
Beulah Clay 3rd (17,034).....	2y., 3m., 12d.	7	262.5	10.40	13.00
		30	1,194	41.81	52.27

RECORD of Dairy Herd—

Name and Breeds of Cows.	Age at beginning of Lactation Period.	Date of Dropping Calf.	Number of days in Lactation Period.	Total pounds of Milk for Period.	Daily average Yield of Milk.	Average per cent Fat in Milk.	Pounds of Butter produced in Period.	Value of Butter at 30c. per pound.
				Lb.	Lb.	p. c.	Lb.	\$ c.
Evergreen March 3rd.....—.....H.	3	Apr. 7, 1913....	340	13,817	40.6	3.80	618.21	185 46
Brampton Fereor Tister.....J.	4	Nov. 8, 1912....	598	9,567	18.8	5.37	604.65	181 40
Ottawa Kate.....A.	6	Jan. 12, 1913....	335	12,262	31.0	3.90	563.17	168 95
Annie Laurie.....G.A.	6	July 7, 1912....	427	10,206	23.9	4.08	489.87	146 96
Tannahill's Diamond.....G.H.	5	Oct. 10, 1912....	320	12,618	39.4	3.28	487.64	146 29
Maggie Murphy.....G.H.	8	July 9, 1912....	427	13,292	31.1	3.20	500.40	150 12
Jennie Dean.....G.A.	6	July 1, 1912....	417	9,252	22.2	4.00	435.64	130 69
Beulah Clay.....H.	7	June 17, 1913....	286	11,472	40.1	3.53	477.06	143 12
Archer's Pearl.....G.	3	Jan. 10, 1912....	615	8,120	13.2	5.46	521.93	156 58
Flavia 2nd of Ottawa.....A.	7	Mar. 11, 1913....	327	9,493	29.0	3.94	441.00	132 30
Milkmaid.....G.A.	8	June 16, 1912....	437	8,805	20.1	4.11	426.30	127 89
Rhoda 2nd's Maud.....H.	7	June 4, 1913....	276	10,087	36.6	3.45	410.25	123 08
Dolly.....G.A.	6	July 6, 1912....	417	7,442	17.8	4.41	386.35	115 91
Canaan Beauty.....H.	5	July 13, 1912....	444	12,154	27.4	3.44	492.28	147 68
Itchen's Pride.....G.	3	Dec. 8, 1911....	517	7,592	14.7	4.91	442.84	132 85
Fanny.....G.H.	3	Apr. 15, 1913....	334	9,780	29.3	3.60	422.58	126 77
Archer's Spot.....G.	2	Oct. 2, 1911....	879	9,806	11.2	4.94	569.95	170 99
Belle K.....G.H.	5	Apr. 12, 1913....	236	9,072	38.4	3.46	369.41	110 82
Belle's Pauline.....G.H.	6	Aug. 10, 1912....	325	9,279	28.6	3.70	404.45	121 34
Ottawa Itchen's Favour.....G.	4	Dec. 6, 1912....	363	6,389	17.6	5.16	387.89	116 37
Queen Bess.....G.H.	6	Oct. 6, 1912....	319	8,776	27.5	3.55	366.80	110 04
Katrina.....G.H.	5	Apr. 19, 1913....	236	8,884	37.6	3.34	349.05	104 72
Brampton Raleigh Cra.....J.	3	Sept. 13, 1912....	361	5,951	16.5	5.30	371.72	111 52
Arthur's Rose.....G.H.	6	Sept. 15, 1912....	407	9,068	22.3	3.48	371.53	111 46
Centre View Bessie Ann.....H.	4	May 11, 1913....	231	8,576	37.1	3.25	339.91	101 97
Flavia 4th of Ottawa.....A.	3	Sept. 29, 1912....	247	6,485	26.3	4.39	335.41	100 62
Daisy Belle.....G.A.	8	July 6, 1912....	411	7,653	18.6	3.82	344.14	103 24
Ruby's Pride.....G.	3	Jan. 31, 1913....	331	5,693	17.0	5.36	359.40	107 82
Itchen's Girl.....G.	3	Aug. 31, 1912....	382	6,211	16.3	5.02	367.33	110 20
Maggie Pulehvae.....A.	4	May 6, 1913....	285	6,929	24.3	4.26	347.95	104 39
Rose Korndyke.....H.	5	Aug. 16, 1912....	532	11,364	21.4	3.44	459.44	137 83
Mainstay Pearl.....G.	2	June 20, 1913....	272	4,400	16.2	5.79	300.05	90 02
Ottawa Deanie.....G.	3	Oct. 10, 1912....	354	5,083	14.4	5.61	335.93	100 78
Betty.....G.A.	7	June 16, 1912....	417	7,761	18.6	3.64	332.41	99 72
Brampton Blue Duchess.....J.	2	Sept. 20, 1912....	375	5,701	15.2	4.93	330.91	99 27
Soney 3rd of Ottawa.....A.	4	Oct. 18, 1912....	375	7,421	19.8	3.94	344.70	103 41
Aldyne.....G.H.	8	Feb. 28, 1913....	365	8,605	23.6	3.81	385.76	115 73
Kirsty 2nd.....G.A.	8	Apr. 30, 1913....	290	7,715	26.6	3.64	330.83	99 25
Mainstay's Pride.....G.	2	May 10, 1913....	290	4,975	17.2	5.14	300.82	90 25
Orange Blossom.....F.C.	4	Sept. -, 1912....	273	4,584	16.8	5.32	287.04	86 11
Fortune Cadette.....F.C.	3	Nov. 15, 1912....	319	5,797	18.2	4.66	318.14	95 44
La Belle.....F.C.	7	May 20, 1912....	315	5,764	18.3	4.55	310.30	93 09
Ottawa Kate 2nd.....A.	3	Nov. 17, 1912....	299	5,056	16.9	4.78	284.64	85 39
Brampton Oakland Trial.....J.	2	Oct. 10, 1912....	354	3,870	10.9	6.66	303.37	91 01
Johanna.....G.H.	9	Feb. 10, 1913....	234	6,415	27.4	3.34	252.41	75 72
Ottawa Itchen.....G.	7	Sept. 5, 1912....	296	4,269	14.4	5.47	274.79	82 44
Denty 4th of Ottawa.....A.	6	Feb. 22, 1913....	341	7,280	21.4	3.91	337.70	101 31
Nancy 2nd.....G.A.	5	Apr. 5, 1913....	304	6,864	22.6	3.76	304.04	91 21
Flavia 3rd of Ottawa.....A.	5	Apr. 8, 1913....	269	6,258	23.3	4.15	305.91	91 77
Marjorie (imp.).....A.	10	July 22, 1912....	267	7,285	27.3	3.47	297.64	89 29
Lady Ann 2nd.....G.A.	6	Apr. 12, 1913....	296	6,580	22.2	3.69	285.89	85 77
Marjorie 4th of Ottawa.....A.	4	Oct. 25, 1912....	242	5,657	23.4	4.22	281.09	84 33
Bonnie Jean.....G.A.	7	July 10, 1912....	442	7,166	16.2	3.28	276.94	83 08
Sangster's Mayflower.....G.H.	6	Sept. 1, 1912....	271	5,400	19.9	3.71	236.23	70 87
Dixie 2nd.....G.A.	5	Apr. 12, 1913....	254	5,550	21.9	3.87	251.42	75 43
Clothilde Hengerveld Korndyke H.	2	Sept. 17, 1912....	338	6,437	19.0	3.46	261.86	78 56
Zaza Fille 2nd.....F.C.	3	Dec. 6, 1912....	297	4,588	15.5	4.77	257.76	77 33
Pearly's Maid.....G.	2	Dec. 19, 1912....	388	4,450	11.5	5.48	287.01	86 10
Duchesse Sauvée.....F.C.	3	Dec. 28, 1912....	273	3,694	13.5	5.43	236.14	70 84
Inoquette 5th.....F.C.	2	Sept. 12, 1912....	442	5,284	12.0	4.88	303.88	91 16
Marjorie 6th of Ottawa.....A.	3	Dec. 17, 1912....	318	5,334	16.8	4.03	253.09	75 93
Marjorie 2nd of Ottawa.....A.	6	Oct. 4, 1912....	244	5,547	22.7	3.93	256.47	76 94
Elegante Poupee.....F.C.	2	May 25, 1912....	309	4,062	13.2	4.80	229.70	68 91
Denty 3rd of Ottawa.....A.	7	July 20, 1912....	288	5,448	18.9	3.92	250.00	75 00
Inoquette 4th.....F.C.	3	Oct. 24, 1912....	325	4,977	15.3	4.69	275.05	82 52
Jessie D. of Ottawa.....A.	7	Apr. 7, 1913....	244	4,746	19.5	4.14	231.61	69 48
Jessie E. of Ottawa.....A.	5	Aug. 31, 1912....	303	5,528	18.2	3.35	218.33	65 50

SESSIONAL PAPER No. 16

Central Experimental Farm.

Value of Skim-milk at 20c. per cwt.	Total Value of Product.	Amount of Meal Eaten, at 1½c. per pound.	Amount of Roots and Ensilage Eaten, at \$2 per ton.	Amount of Hay Eaten, at \$7 per ton.	Amount of Green Feed Eaten, at \$3 per ton.	Amount of Straw Eaten, at 20c. per cwt.	Months on Pasture, at \$1 per month.	Total Cost of Feed between Calvings.	Cost to Produce 100 pounds Milk.	Cost to Produce 1 pound Butter (skim milk neglected).	Profit on 1 pound Butter (skim milk neglected).	Profit on Cow between Calvings (dairy and calf neglected).
\$ c.	\$ c.	Lb.	Lb.	Lb.	Lb.	Lb.	Mo.	\$ c.	Cts.	Cts.	Cts.	\$ c.
26 40	211 86	5,066	14,075	2,416	2,450	557	1	91 65	66.3	14.8	15.2	120 21
17 92	199 32	3,741	19,324	3,162	3,620	786	1	85 15	89.0	14.1	15.9	114 17
23 40	192 35	4,275	17,205	2,327	2,450	711	1	84 88	69.2	15.1	14.9	107 47
19 43	166 39	2,443	13,860	2,310	3,040	765	1	59 57	58.4	12.2	17.8	106 82
24 26	170 55	3,063	15,150	1,770	3,040	465	1	66 13	52.4	13.6	16.4	104 42
25 58	175 70	3,313	16,950	2,310	3,040	935	1	73 88	55.6	14.8	15.2	101 82
17 63	148 32	2,607	13,860	2,310	3,040	765	1	61 62	66.6	14.1	15.9	86 70
21 99	165 11	4,241	13,155	2,097	2,450	473	1	79 13	69.0	16.6	13.4	85 98
15 20	171 78	3,344	22,184	2,888	5,710	1,263	1	86 18	106.1	16.5	13.5	85 60
18 10	150 40	3,386	15,265	1,867	2,450	650	1	70 10	73.8	15.9	14.1	80 30
16 76	144 65	2,836	13,860	2,310	3,040	765	1	64 49	73.2	15.1	14.9	80 16
19 35	142 43	3,546	7,415	1,675	2,450	141	1	62 56	62.0	15.3	14.7	79 87
14 11	130 02	1,869	13,860	2,310	3,040	765	1	52 40	70.4	13.6	16.4	77 62
23 32	171 00	4,043	23,701	2,163	6,005	1,011	1	93 84	77.2	19.1	10.9	77 16
14 30	147 15	2,735	19,585	2,513	3,260	1,041	1	70 54	92.9	15.9	14.1	76 61
18 72	145 49	3,338	14,395	1,782	3,040	577	1	69 07	70.6	16.3	13.7	76 42
18 47	189 46	4,632	28,581	4,273	5,710	1,288	1	113 58	115.8	19.9	10.1	75 88
17 41	128 23	2,592	9,315	1,182	3,040	471	1	52 35	57.7	14.2	15.8	75 88
17 75	139 09	3,007	14,395	1,782	3,040	577	1	64 93	70.0	16.1	13.9	74 16
12 00	128 37	2,413	14,955	1,911	2,450	786	1	58 05	90.9	15.0	15.0	70 32
16 82	126 86	2,345	14,950	1,770	3,040	665	1	57 35	65.3	15.6	14.4	69 51
17 07	121 79	2,592	9,315	1,182	3,040	471	1	52 35	58.9	15.0	15.0	69 44
11 16	122 68	2,227	13,392	1,791	2,450	666	1	53 49	89.9	14.4	15.6	69 19
17 40	128 86	2,492	18,140	2,136	3,040	848	1	64 02	70.6	17.2	12.8	64 84
16 47	118 44	2,906	8,685	1,023	2,450	383	1	54 03	63.0	15.9	14.1	64 41
12 30	112 92	2,059	13,675	1,662	1,240	616	1	49 32	76.1	14.7	15.3	63 60
14 62	117 86	2,067	13,860	2,310	3,040	765	1	54 87	71.7	15.9	14.1	62 99
10 67	118 49	2,481	13,455	1,743	2,450	711	1	56 67	99.5	15.8	14.2	61 82
11 69	121 89	2,516	14,439	1,821	3,650	730	1	60 20	96.9	16.4	13.6	61 69
13 16	117 55	2,635	11,575	1,793	2,450	473	1	56 41	81.4	16.2	13.8	61 14
21 81	159 64	4,336	23,925	2,599	6,005	839	1	98 91	87.0	21.5	8.5	60 73
8 20	98 22	1,992	5,010	1,383	2,450	176	1	39 78	90.4	13.3	16.7	58 44
9 49	110 27	2,190	12,647	1,641	2,450	730	1	51 90	102.1	15.5	14.5	58 37
14 86	114 58	2,176	13,860	2,310	3,040	765	1	56 24	72.5	16.9	13.1	58 34
10 74	110 01	2,235	13,792	1,791	2,450	810	1	54 29	95.2	16.4	13.6	55 72
14 15	117 56	2,366	17,295	2,130	3,580	799	1	62 29	83.9	18.1	11.9	55 27
16 44	132 17	3,712	17,085	1,956	3,040	757	1	77 40	89.9	20.1	9.9	54 77
14 77	114 02	3,002	10,205	1,576	3,040	577	1	59 96	77.7	18.1	11.9	54 06
9 35	99 60	2,296	5,800	1,797	2,450	60	1	45 58	91.6	15.2	14.8	54 02
8 59	94 70	1,714	12,746	1,749	610	1	42 51	92.7	14.8	15.2	52 19
10 96	106 40	2,294	13,932	1,821	2,450	730	1	55 11	95.1	17.3	12.7	51 29
10 91	104 00	2,095	15,480	1,813	3,260	697	1	55 30	95.9	17.8	12.2	48 70
9 54	94 93	1,912	12,765	1,359	2,450	726	1	47 55	94.1	16.7	13.3	47 38
7 13	98 14	2,121	12,680	1,641	2,450	730	1	51 07	132.0	16.8	13.2	47 07
12 33	88 05	2,078	9,315	1,186	471	1	41 38	64.5	16.4	13.6	46 67
7 99	90 43	1,767	12,570	1,611	980	657	1	44 08	103.3	16.0	14.0	46 35
13 88	115 19	2,942	18,125	2,233	2,450	801	1	68 99	94.8	20.4	9.6	46 20
13 12	104 33	2,918	10,775	1,596	3,040	577	1	59 55	86.8	19.6	10.4	44 78
11 90	103 67	2,576	15,055	1,867	2,450	634	1	59 73	95.5	19.5	10.5	43 94
13 97	103 26	2,202	18,280	1,818	3,380	780	1	59 80	82.1	20.1	9.9	43 46
12 59	98 36	2,670	10,205	1,596	3,040	577	1	55 88	84.9	19.5	10.5	42 48
10 75	95 08	2,099	16,210	1,782	1,240	678	1	52 90	93.5	18.8	11.2	42 18
13 78	96 86	2,099	14,790	2,496	3,040	858	1	57 04	79.6	20.6	9.4	39 82
10 33	81 20	1,472	13,350	1,530	1,360	665	1	41 48	76.8	17.6	12.4	39 72
10 60	86 03	2,038	9,760	1,428	3,040	563	1	46 92	84.5	18.7	11.3	39 11
12 35	90 91	2,167	12,857	1,771	2,450	610	1	52 04	80.9	19.9	10.1	38 87
8 66	85 99	1,952	12,847	1,641	2,450	730	1	49 13	107.1	19.1	10.9	36 86
8 33	94 43	2,460	14,540	2,022	2,450	711	1	58 46	131.4	20.4	9.6	35 97
6 92	77 76	1,766	10,355	1,275	2,450	655	1	42 88	116.1	18.2	11.8	34 88
9 96	101 12	2,820	16,687	2,539	2,450	666	1	66 83	126.5	22.0	8.0	34 29
10 16	86 09	2,229	14,441	1,377	2,450	801	1	53 40	100.1	21.1	8.9	32 69
10 58	87 52	2,323	16,290	1,782	2,140	657	1	57 09	102.9	22.3	7.7	30 43
7 66	76 57	1,670	13,566	1,582	3,200	597	1	46 96	115.6	20.4	9.6	29 61
10 40	85 40	2,040	17,240	1,644	3,380	636	1	55 84	102.5	22.3	7.7	29 56
9 40	91 92	2,298	15,997	2,007	5,710	730	1	62 77	126.1	22.8	7.2	29 15
9 03	78 51	2,324	10,615	1,208	2,450	557	1	49 68	104.7	21.5	8.5	28 83
10 62	76 12	2,209	15,080	1,818	1,240	701	1	53 32	96.5	24.4	5.6	22 80

Central Experimental Farm.

GRADE AYRSHIRES.

Name of Cow.	Age at beginning of Lactation Period.	Date of Dropping Calf.	Number of days in Lactation Period.	Total pounds of Milk for Period.	Daily average Yield of Milk.	Average per cent Fat in Milk.	Pounds of Butter produced in Period.	Value of Butter at 30c. per pound.
				Lb.	Lb.	p. c.	Lb.	\$ c.
Annie Laurie.....	6	July 7, 1912....	427	10,206	23.9	4.08	489.87	146 96
Jennie Dean.....	6	July 1, 1912....	417	9,252	22.2	4.00	435.64	130 69
Milkmaid.....	8	June 16, 1912....	437	8,805	20.1	4.11	426.30	127 89
Dolly.....	6	July 6, 1912....	417	7,442	17.8	4.41	386.35	115.91
Daisy Belle.....	8	July 6, 1912....	411	7,653	18.6	3.82	344.14	103 24
Average.....	7	422	8,672	20.5	4.08	416.46	124 94

GRADE HOLSTEINS.

Tannahill's Diamond.....	5	Oct. 10, 1912....	320	12,613	39.4	3.28	487.64	146 29
Maggie Murphy.....	8	July 9, 1912....	427	13,292	31.1	3.20	500.40	150 15
Fanny.....	3	Apr. 15, 1913....	334	9,780	29.3	3.60	422.58	126 71
Belle K.....	5	Apr. 12, 1913....	236	9,072	38.4	3.46	369.41	110 85
Bell's Pauline.....	6	Aug. 10, 1912....	325	9,279	28.6	3.70	404.45	121 34
Average.....	5	328	10,808	33.0	3.44	436.90	131.07

AYRSHIRES.

Ottawa Kate.....	6	Jan. 12, 1913....	395	12,262	31.0	3.90	563.17	168 95
Flavia 2nd of Ottawa.....	7	Mar. 11, 1913....	327	9,493	29.0	3.94	441.00	132 30
Flavia 4th of Ottawa.....	3	Sept. 29, 1912....	247	6,435	26.3	4.39	335.41	100 62
Maggie Pulchrae.....	4	May 6, 1913....	285	6,929	24.3	4.26	347.95	104 39
Soney 3rd of Ottawa.....	4	Oct. 18, 1912....	375	7,421	19.8	3.94	344.70	103 41
Average.....	5	326	8,518	26.1	4.06	406.45	121 93

CANADIANS.

Orange Blossom.....	4	Sept.—, 1912....	273	4,584	16.8	5.32	287.04	86 11
Fortune Cadette.....	3	Nov. 15, 1912....	319	5,797	18.2	4.66	318.14	95 44
La Belle.....	7	May 29, 1912....	315	5,764	18.3	4.55	310.30	93 09
Zaza Fille 2nd.....	3	Dec. 6, 1912....	297	4,588	15.5	4.77	257.76	77 33
Duchesse Sauvée.....	3	Dec. 28, 1912....	273	3,694	13.5	5.43	236.14	70 84
Average.....	4	295	4,885	16.6	4.90	281.88	84 56

GUERNSEYS.

Archer's Pearl.....	3	Jan. 10, 1912....	615	8,120	13.2	5.46	521.93	156 58
Itchen's Pride.....	3	Dec. 8, 1911....	517	7,592	14.7	4.91	442.84	132.85
Archer's Spot.....	2	Oct. 2, 1911....	879	9,806	11.2	4.94	569.95	170 99
Ottawa Itchen's Favour.....	4	Dec. 6, 1912....	363	6,389	17.6	5.16	387.89	116.37
Ruby's Pride.....	2	Jan. 31, 1913....	331	5,693	17.0	5.36	359.40	107 82
Average.....	3	541	7,520	13.9	5.16	456.40	136 92

GRADE AYRSHIRES.

Value of Skim Milk at 20c. per cwt.	Total Value of Product.	Amount of Meal Eaten, at 14c. per pound.	Amount of Roots and Ensilage Eaten, at \$2 per ton.	Amount of Hay Eaten, at \$7 per ton.	Amount of Green Feed Eaten, at \$3 per ton.	Amount of Straw Eaten, at 20c. per cwt.	Months on Pasture, at \$1 per month.	Total Cost of Feed between Calvings.	Cost to Produce 100 pounds Milk.	Cost to Produce 1 pound Butter (skim milk neglected).	Profit on 1 pound Butter (skim milk neglected).	Profit on Cow between Calvings (labour and calf neglected).
\$ c.	\$ c.	Lb.	Lb.	Lb.	Lb.	Lb.	Mo.	\$ c.	Cts.	Cts.	Cts.	\$ c.
19 43	166 39	2,443	13,860	2,310	3,040	765	1	59 57	58.4	12.2	17.8	106 82
17 63	148 32	2,607	13,860	2,310	3,040	765	1	61 62	66.6	14.1	15.9	86 70
16 76	144 65	2,836	13,860	2,310	3,040	765	1	64 49	73.2	15.1	14.9	80 16
14 11	130 62	1,869	13,860	2,310	3,040	765	1	52 40	70.4	13.6	16.4	77 62
14 62	117 86	2,067	13,860	2,310	3,010	765	1	54 87	71.7	15.9	14.1	62 99
16 51	141 45	2,364	13,860	2,310	3,040	765	1	58 59	67.6	14.1	15.9	82 86

GRADE HOLSTEINS.

24 26	170 55	3,063	15,150	1,770	3,040	465	1	66 13	52.4	13.6	16.4	104 42
25 58	175 70	3,313	16,950	2,310	3,040	935	1	73 88	55.6	14.8	15.2	101 82
18 72	145 49	3,338	14,395	1,782	3,040	577	1	69 07	70.6	16.3	13.7	76 42
17 41	128 23	2,592	9,315	1,182	3,040	471	1	52 35	57.7	14.2	15.8	75 83
17 75	139 09	3,007	14,395	1,782	3,040	577	1	64 93	70.0	16.1	13.9	74 16
20 74	151 81	3,063	14,041	1,765	3,040	605	1	65 27	60.4	14.9	15.1	86 54

AYRSHIRES.

23 40	192 35	4,275	17,205	2,327	2,450	711	1	84 88	69.2	15.1	14.9	107 47
18 10	150 40	3,336	15,265	1,867	2,450	650	1	70 10	73.8	15.9	14.1	80 30
12 30	112 92	2,059	13,675	1,662	1,240	616	1	49 32	76.1	14.7	15.3	63 60
13 16	117 55	2,635	11,575	1,793	2,450	473	1	56 41	81.4	16.2	13.8	61 14
14 15	117 56	2,366	17,295	2,130	3,580	799	1	62 29	83.9	18.1	11.9	55 27
16 22	138 15	2,944	15,003	1,956	2,434	650	1	64 60	75.8	15.9	14.1	73 55

CANADIANS.

8 59	94 70	1,714	12,746	1,719	610	1	42 51	92.7	14.8	15.2	52 19
19 96	106 40	2,294	13,932	1,821	2,450	730	1	55 11	95.1	17.3	12.7	51 29
10 91	104 00	2,095	15,480	1,813	3,260	697	1	55 30	95.9	17.8	12.2	48 70
8 66	85 99	1,952	12,847	1,641	2,450	730	1	49 13	107.1	19.1	10.9	36 85
6 92	77 76	1,766	10,355	1,275	2,450	655	1	42 88	116.1	18.2	11.8	34 88
9 21	93 77	1,964	13,072	1,660	2,122	684	1	43 98	100.3	17.4	12.6	44 79

GUERNSEYS.

15 20	171 78	3,344	22,184	2,888	5,710	1,263	1	86 18	106.1	16.5	13.5	85 60
14 30	147 15	2,735	19,585	2,513	3,260	1,011	1	70 54	92.9	15.9	14.1	76 61
18 47	189 46	4,632	28,581	4,273	5,710	1,288	1	113 58	115.8	19.9	10.1	75 88
12 00	128 37	2,413	14,955	1,974	2,450	736	1	58 05	90.9	15.0	15.0	70 32
10 67	118 49	2,481	13,455	1,743	2,450	711	1	56 67	99.5	15.8	14.2	61 82
14 13	151 05	3,121	19,752	2,666	3,916	1,018	1	77 00	102.4	16.9	13.1	74 05

5 GEORGE V., A. 1915
RECORD of Dairy Herd—

HOLSTEINS.

Name of Cow.	Age at beginning of Lactation Period.	Date of Dropping Calf.	Number of Days in Lactation Period.	Total pounds of Milk for Period.		Daily Average Yield of Milk.	Average per cent Fat in Milk.	Pounds of Butter produced in Period.	Value of Butter at 30c. per Pound.
				Lb.	Ld.				
Evergreen March 3rd.....	3	Apr. 7, 1913....	340	13,817	40.6	3.80	618.21	185.46	
Beulah Clay.....	7	June 17, 1913....	286	11,472	40.1	3.53	477.06	143.12	
Rhoda 2nd's Maud.....	7	June 4, 1913....	276	10,087	36.6	3.45	410.25	123.08	
Canaan Beauty.....	5	July 13, 1912....	444	12,154	27.4	3.44	492.28	147.68	
Centre View Bessie Ann.....	4	May 11, 1913....	231	8,576	37.1	3.25	339.91	101.97	
Average.....	5	315	11,221	35.6	3.54	467.54	140.26	

JERSEYS.

Brampton Fereor Tister—.....	4	Nov. 8, 1912....	508	9,567	18.8	5.37	604.65	181.40
Brampton Raleigh Cora.....	3	Sept. 13, 1912....	361	5,951	16.5	5.30	371.72	111.52
Brampton Blue Duchess.....	2	Sept. 20, 1912....	375	5,701	15.2	4.93	330.91	99.27
Brampton Oakland Trial.....	2	Oct. 10, 1912....	354	3,870	10.9	6.66	303.37	91.01
Average.....	3	400	6,272	15.7	5.45	402.66	120.80

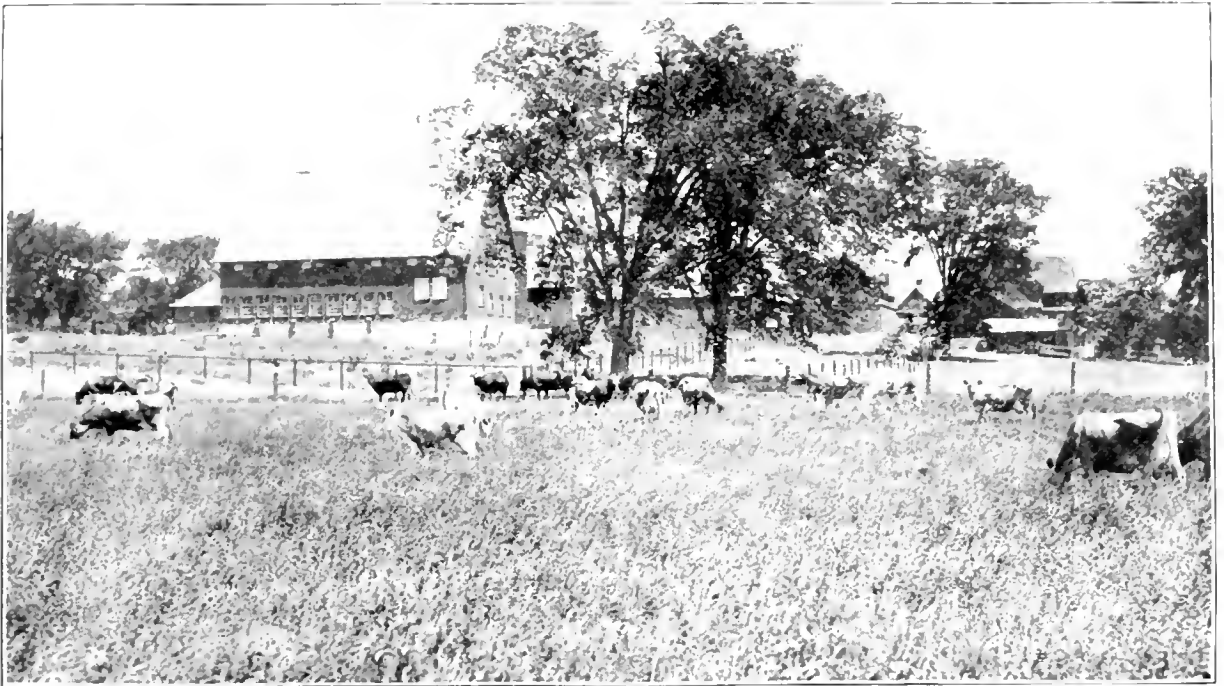

Central Experimental Farm, Ottawa : A group of dairy cows on pasture ; experimental feeding barn to the left ; horse and sheep barns to the right in background.

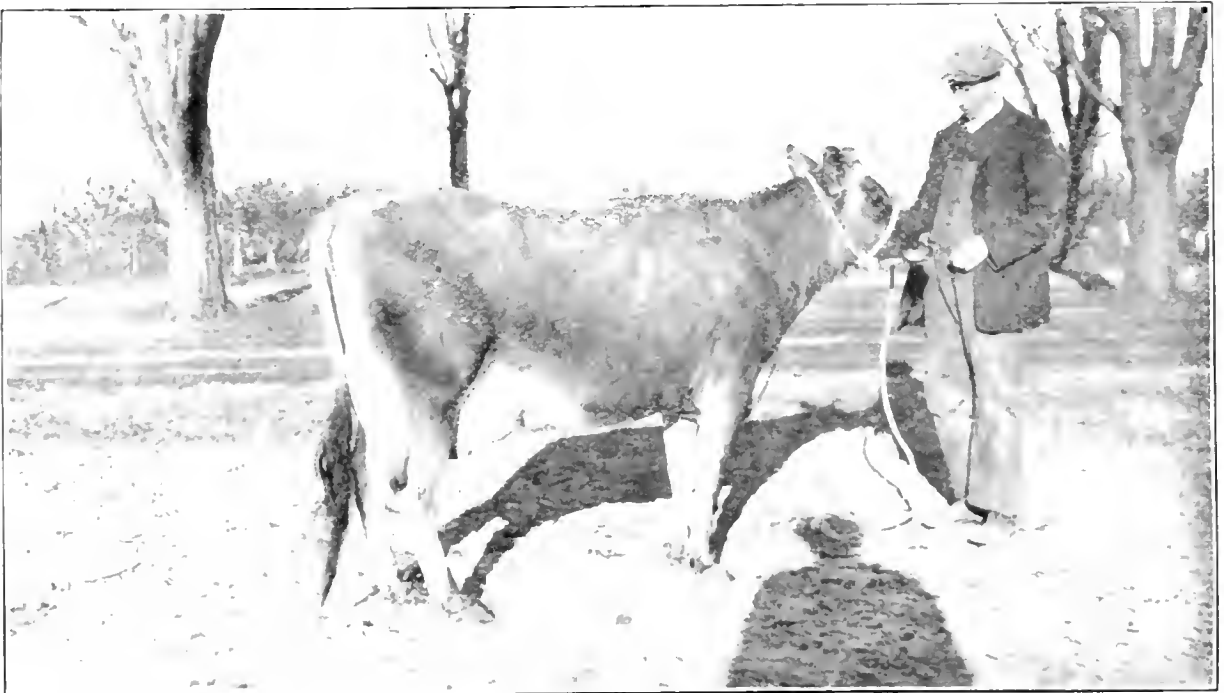

Jersey cow, Blue Duchess. Record at 3 years :—5,701 lb. milk, testing 4·93 % fat, or 281·28 lb. fat in 375 days. Owned by Central Experimental Farm, Ottawa.

SESSIONAL PAPER No. 16

Central Experimental Farm.—Continued.

HOLSTEINS.

Value of Skim Milk at 20c. per cwt.	Total Value of Product.	Amount of Meal eaten, at 14c. per Pound.	Amount of Roots and Ensilage eaten, at \$2 per ton.	Amount of Hay Eaten, at \$7 per ton.	Amount of Green Feed Eaten, at \$3 per ton.	Amount of Straw Eaten, at 20c. per cwt.	Months on Pasture at \$1 per month.	Total cost of Feed between Calvings.	Cost to produce 100 pounds Milk.	Cost to produce 1 pound Butter (Skim Milk neglected).	Profit on 1 pound Butter (Skim Milk neglected).	Profit on Cow between Calvings (Labour and calf neglected).
\$	\$	Lb.	Lb.	Lb.	Lb.	Lb.	Mo.	\$	Cts.	Cts.	Cts.	\$
26 40	211 86	5,066	14,075	2,416	2,450	557	1	91 65	66.3	14.8	15.2	120 21
21 99	165 11	4,241	13,155	2,097	2,450	473	1	79 13	69.0	16.6	13.4	85 98
19 35	142 43	3,546	7,415	1,675	2,450	141	1	62 56	62.0	15.3	14.7	79 87
23 32	171 00	4,043	23,701	2,163	6,005	1,011	1	93 84	77.2	19.1	10.9	77 16
16 47	118 44	2,906	8,685	1,623	2,450	383	1	54 03	63.0	15.9	14.1	64 41
21 51	161 77	3,960	13,406	1,875	3,161	513	1	76 24	67.9	16.3	13.7	85 53

JERSEYS.

17 92	199 32	3,741	19,324	3,162	3,620	786	1	85 15	89.0	14.1	15.9	114 17
11 16	122 68	2,227	13,392	1,791	2,450	666	1	53 49	89.9	14.4	15.6	69 19
10 74	110 01	2,235	13,792	1,791	2,450	810	1	54 29	95.2	16.4	13.6	55 72
7 13	98 14	2,121	12,689	1,641	2,450	730	1	51 07	132.0	16.8	13.2	47 07
11 74	132 54	2,581	14,797	2,096	2,743	748	1	61 00	97.3	15.1	14.9	71 54

CO-OPERATIVE MILK RECORDS.

Although repetition is not as a rule considered advisable yet owing to the increased demand for literature regarding milk and feed record forms, the following is a list of some of these forms, which may be obtained free upon application to this Division. An increasingly large number of dairy farmers have during the past year availed themselves of this offer, which is a gratifying indication of the rapidly advancing methods being adopted by our dairy farmers in the keeping of records for the individual cows of their herds. However, from inquiries, there are apparently a very large number of farmers who, as yet, have not adopted any such records in their herds, nor availed themselves of this offer, being in ignorance of this distribution. The object of this free distribution is not to in any way overlap the work of the Cow Testing Association of the Dairy Branch, Department of Agriculture, Ottawa, but rather to encourage individual farmers in the keeping of dairy records, which individuals in turn will eventually form the nuclei of record centres. The week-long milk record form here illustrated, shows the simplicity and utility of milk record forms for distribution.

The forms for distribution are as follows:—

Month long.—Daily milk records suitable for herds numbering up to twenty-two cows.

Week long—Daily records for herds of sixteen cows.

Week long.—Daily records for herds of twenty-four cows.

Monthly summary records.

Yearly summary records.

Feed record forms.

SESSIONAL PAPER No. 16

DAILY MILK RECORD.

Herd belonging to
Post Office
Record for week ending

*This form supplied free by Live Stock
 Division, Central Experimental
 Farm, Ottawa, Ont.*

Day.	Time.							Total for day.
Sunday.	Morning							
	Evening							
Monday.	Morning							
	Evening							
Tuesday.	Morning							
	Evening							
Wednesday.	Morning							
	Evening							
Thursday.	Morning							
	Evening							
Friday.	Morning							
	Evening							
Saturday.	Morning							
	Evening							
Total	Week.							

Remarks:

[REVERSE SIDE OF RECORD FORM.]

CENTRAL EXPERIMENTAL FARM.

J. H. GRISDALE,
Director.

E. S. ARCHIBALD,
Dominion Animal Husbandman.

MILK RECORDS.

1. The profitable dairy cow must give over 5,000 pounds of milk each year. To know the value of a cow, her total annual yield of milk must be known. The only way to know this is to keep a record of her daily milk yield.

2. The form on the other side of this sheet is intended to help progressive dairy farmers by supplying them with a simple and convenient sheet for the keeping of the milk records of their individual cows. A study of such records will soon indicate which cows should go to the butcher. We should be pleased to receive a summary of your record. If you have no summary forms write us.

3. Such records are being kept by hundreds of successful dairymen to-day. Many of these men attribute their success to the keeping of such records. Why not give the thing a trial if you are a dairyman? It will increase your milk production. It will lighten your labour, since your interest will be increased in your work and "interest lightens labour." It will show you the unprofitable cow, the "boarder." You cannot get rid of her too quickly.

4. For weighing the milk, a simple legal spring balance may be secured for from one and a half to four and a half dollars. If your local dealer cannot supply you, write the undersigned for particulars. A small platform scale is fairly convenient, but we find the spring balance preferable.

5. Many farmers keep records of the amount of food fed to individual cows. If you would like to do so, sample forms would be sent free on writing E. S. Archibald, Dominion Animal Husbandman, Central Experimental Farm, Ottawa, Ont.

DISPOSAL OF MILK.

As previously reported, milk produced on the Central Experimental Farm prior to the year 1911 was largely manufactured into butter, and the skim-milk fed to calves and pigs. Aside from this, a small amount of milk and cream was sold daily to the Farm employees. The manufacture of butter and utilization of the dairy by-products for feeding purposes is continued on about the same scale as in previous years. However, in the year 1911, it was found necessary to look for different methods of disposal of the surplus milk, owing to the necessary increase in the size of the herd, and in consequence experimental work along the lines of cheesemaking was commenced. The following is a list of the methods which were utilized during the past year for the disposal of the milk, and the prices realized on this product, either in its raw or manufactured form.

CREAM CHEESE.

During the past year work was continued in the manufacture of soft cheeses, but owing to a lack of facilities, the manufacture of Canadian Cheddar cheese in an experimental way was discontinued, awaiting the erection of the new dairy building. For full particulars as to the manufacture of cream cheese, a pamphlet has been prepared by this Division, being a slight remodelling of the methods described in the annual report for the year 1911.

These cream cheese are made daily, and are marketed 24 hours after manufacture. Twenty pounds of milk, testing $4\frac{1}{2}$ per cent fat, to which is added four pounds of cream, testing 20 per cent fat, makes fourteen cream cheese, weighing about 6 ounces; hence, by this method of manufacturing, 100 pounds of $4\frac{1}{2}$ per cent milk will make 35 or 36 cheeses. These sell at 15 cents each retail and 11 cents wholesale, or realizing on the milk from \$3.80 to \$5.40 per hundred pounds. Various methods of manufacturing have been experimented with during the past three years, and even when using a much richer cream, milk testing $4\frac{1}{2}$ per cent butter-fat will still realize over \$3 per hundred pounds. The demand for this type of cheese is growing rapidly, and far exceeds the possible output. Many inquiries have come from private individuals regarding the manufacture of this cheese, and it is to be hoped that any such who have ready railway transportation will work up permanent markets in the Canadian towns and cities.

COULOMMIER CHEESE.

This, too, is a very popular type of soft cheese, which requires but little expenditure for equipment and is easily made and ripened. For full particulars as to the manufacture of the same, a special pamphlet describing methods used on the Central Experimental Farm has been written, to which readers are referred, as well as to special bulletins published by the Dairy and Cold Storage Branch of the Department of Agriculture, Ottawa.

One hundred pounds of milk, testing $4\frac{1}{2}$ per cent butter-fat, according to the methods which are being used on the Central Experimental Farm at the present time, will make twenty Coulommier cheese, weighing about 16 ounces each. These are sold on the local market for 15 cents each retail, and 11 cents wholesale; hence 100 pounds of milk, testing $4\frac{1}{2}$ per cent fat, is marketed at from \$2.20 to \$3 per hundred pounds.

Work similar to the above in the manufacture of the soft cheeses is being started on many of the branch Farms, and it is to be hoped that in a few years a large amount of data regarding these products and the marketing of the same may be available for publication.

SESSIONAL PAPER No. 16

CERTIFIED MILK.

Investigations along the lines of pure milk production and certified milk production were started during the year 1912. Although considerable valuable data have been collected, this, as yet, is insufficient to give conclusive and detailed results. Owing to the resignation of the bacteriologist, who, with the assistance of the Dominion Botanist, Mr. H. T. Güssow, was conducting the bacterial studies of this milk, such lines of work were discontinued for the latter half of the fiscal year. It is to be hoped, however, that with another appointment this work will be continued immediately.

Certified milk, namely, milk which conforms to a certain standard as to health of the herd, health of the stablemen, and the light, ventilation, sanitation, and cleanliness of the stable, methods of handling milk, and above all the freedom of the milk from bacteria of an injurious nature, shall, according to the Ontario standards, contain not more than 5,000 bacteria per c.c. during the winter months, and 10,000 bacteria per c.c. during the summer months.

A number of private individuals in Canada have from time to time tried the production of this milk, but at present only a few dairy concerns are working on the same.

Many difficulties are met in the keeping down of the bacterial count of the milk in the herd, the stable and in the dairy, as well as the eliminating of the growth of bacteria during delivery. In the overcoming of these difficulties, much valuable information is being gained as to the extra cost of production of the milk and the most advantageous procedures, as well as their feasibility for the Canadian dairyman.

Owing to the lack of a modern and convenient dairy building, with good refrigeration and sanitary conditions for the handling of certified milk, a great deal of difficulty has been met in this work. In consequence of these conditions it has been found advisable to not undertake the bottling of the milk until such time as better facilities warrant. This milk sells to a large local dairy concern for \$3 per hundred pounds, in bulk, cooled to 45° F.

BUTTER.

Butter from the Central Experimental Farm usually commands a slightly higher price than the current market figures. During the past fiscal year, for example, it sold at an average of 33½ cents per pound, with a range of 29 to 35 cents. The average milk from the herd tests 4½ per cent butter-fat. In other words, milk sold as butter would realize \$1.74 per hundred pounds, not considering the value of the skim-milk. Skim-milk is valued at 20 cents per hundred pounds when fed to calves and pigs. When fed with discretion, this is the minimum valuation; it often reaching a value of 75 cents or more per hundred pounds when fed to young calves and newly-weaned pigs.

DAIRY BARN PLANS.

During the fiscal year ending March 31, 1914, a large number of completed plans, with specifications, for dairy barns to suit local conditions and individual needs of farmers have been distributed free. Although this entails a large amount of work, yet the many inquiries as to the details of modern dairy barn plans are increasing in numbers from all parts of Canada and, considering the most undesirable state of the average Canadian barn, it is felt that such work demands immediate attention; hence the farmers who anticipate the construction of new barns or the remodelling of their old barns, have been encouraged to write for free information to the Division of Animal Husbandry, Central Experimental Farm, Ottawa.

This Division has also supplied complete sets of plans and specifications for two of the new Farms of the Experimental Farm system. These plans and specifications,

prepared by the Dominion Animal Husbandman under the supervision of the Director of Experimental Farms, are as follows:—

For the Experimental Station, Fredericton, N.B., one large dairy barn, one main storage barn with housing accommodations for dairy heifers and beef breeding and feeding animals, one horse barn, and one model farm dairy with the refrigeration building attached.

For the Experimental Station, Ste. Anne de la Pocatière, Que., one large dairy barn and one horse barn.

For further details regarding these buildings see reports of these Stations.

The plans of the barns recently destroyed by fire on the Central Experimental Farm have also been prepared by this Division under the supervision of the Director of Experimental Farms, and the work also conducted under the supervision of this Division. It is to be hoped that these buildings will be completed on or before August 15, 1914. Full details as to the same will appear in the annual report for the fiscal year ending March 31, 1915. However, details as to the structure of the same are at any time available to any one inquiring.

SESSIONAL PAPER No. 16

FINANCIAL STATEMENT FOR DAIRY CATTLE.

Below are submitted inventories and returns from dairy cattle on the Central Experimental Farm during the year April 1, 1913, to March 31, 1914.

—	April 1, 1913.		March, 31 1914.		Returns including sales of dairy produce, breeding cattle, and bull service.	Gross returns made up of increase in value of products and value of animals sold.
	No.	Value.	No.	Value.		
Dairy cattle.....	138	\$ 22,289 00	140	\$ 24,275 00	\$ 16,596 02	\$ 18,582 02

Returns.

By increased value of herds	\$ 1,986 00
Returns from dairy products	11,157 02
Returns from sales of dairy breeding cattle....	4,300 00
Returns from bull service	59 00
Returns from manure, 980 tons at \$1 per ton...	980 00
Gross returns	\$18,482 02

Expenditures.

To value of food stuffs consumed.....	\$7,014 00
Cost of labour	3,090 00
Cost of new stock purchased	1,680 00
Gross expenditures	11,784 00
Net balance from dairy cattle	\$6,698 02

EXPERIMENTAL STATION, CHARLOTTETOWN, P.E.I.

REPORT OF THE SUPERINTENDENT, J. A. CLARK, B.S.A.

A dairy barn is in prospect and land suitable for pasture and forage crops is likely to be acquired in the near future.

The dairy live stock work is limited at this Station to one grade dairy cow, which is kept as a milk supply to the Farm houses.

DAIRY COW.

The cow calved June 2. She was out on pasture for five and one-half months. The following data were recorded:—

Number of days milking	days	278
Number of pounds of milk	lb	7,881
Amount of hay fed, counted for one year.....	"	1,858
Amount of oats fed, counted for one year.....	"	1,871
Amount of bran fed, counted for one year.....	"	2,717
Amount of roots fed, counted for one year.....	"	10,315
Pasture, 5½ months at \$1 per month.....	\$	5 50
Cost of feed	"	80 71
Value of milk, 2,152.4 quarts at 5 cents per quart.....	"	157 62
Balance	"	76 91

SESSIONAL PAPER No. 16

EXPERIMENTAL FARM, NAPPAN, N.S.

REPORT OF THE SUPERINTENDENT, W. W. BAIRD, B.S.A.

DAIRY CATTLE GRADING EXPERIMENT.

OBJECT OF EXPERIMENT.

The object of this experiment is to discover the actual cash value of the pure-bred dairy sire, in a herd of common and mixed breeding, in the increased production of the progeny, as well as their proportionately greater market value. The outline of this experiment was reported in the annual report for the year ending March 31, 1913.

RESULTS OF EXPERIMENT TO DATE, APRIL 1, 1914.

The twelve heifers termed the "foundation heifers" have dropped their first lot of calves from the Ayrshire cross, Holstein cross, and Guernsey cross, and have completed their first two lactation periods.

The first crop of calves (first cross Ayrshire), calved in the fall of 1911, yielded eight heifers, which in turn have dropped their first crop (second cross Ayrshire), calved in the fall of 1913, yielding five heifers. These in turn are to be bred to a pure-bred Ayrshire bull to calve in the fall of 1915.

The second crop of calves from the foundation cows (first cross Holstein), calved in the fall of 1912, yielded six heifers. These are being bred to a pure-bred Holstein bull to calve in the fall of 1914.

The third crop of calves (first cross Guernsey), calved in the fall of 1913, yielded three heifers, which are being fitted to be bred to calve in the fall of 1915.

The greater percentage of progeny are promising to be superior to their dams and, as would naturally be expected, a few only are not.

Unfortunately two of the foundation heifers have not been successful in passing the yearly test and have been disposed of. These are Jessie and Spot, both of which have heifers to succeed them.

The following table will give the results of the second year's work in milk production:—

5 GEORGE V., A. 1915

RECORD of Dairy Herd—

Name of cow.	Date of dropping calf.	Number of days in lactation period.	Total pounds of milk for period.	Daily average yield of milk.	Average per cent fat in milk.	Pounds of butter produced in period.
			lb.	lb.	p. c.	lb.
Maggie.....	Dec. 15, 1912.....	365	8,202.4	22.47	4.5	434.23
Vera.....	" 27, 1912.....	317	7,978.8	25.17	3.7	317.31
Mossy.....	" 6, 1912.....	352	4,798.2	14.45	5.3	239.48
Jean.....	Mar. 8, 1913.....	270	6,480.1	24.00	3.9	297.32
Spot.....	Jan. 14, 1913.....	335	5,630.8	16.8	4.3	284.85
Jessie.....	Dec. 19, 1912.....	353	6,221.3	17.62	3.9	285.45
Bell.....	Jan. 24, 1913.....	299	6,057.0	20.25	3.9	277.90
Queen.....	Dec. 21, 1912.....	307	5,095.1	16.30	4.0	235.53
Ella.....	Jan. 12, 1913.....	261	4,914.1	18.82	4.0	231.25
Myrtle.....	Feb. 1, 1913.....	261	3,628.5	13.90	3.9	163.48
Georgie.....	" 2, 1913.....	261	3,411.7	13.07	4.1	164.55
Average 11 head.....		305	5,666.2	18.58	4.1	271.91

SESSIONAL PAPER No. 16

Nappan Experimental Farm.

Value of butter at 30 cts. per pound.	Value of skim-milk at 20 cts. per cwt.	Total value of product.	Amount of meal eaten, at 1 1/4 cts. per pound.	Amount of roots and ensilage eaten at \$2 per ton.	Amount of hay eaten at \$7 per ton.	Amount of green feed eaten, at \$3 per ton.	Months on pasture, at \$1 per month.	Total cost of feed for period.	Cost to produce 100 pounds of milk.	Cost to produce 1 pound of butter, skim-milk neglected.	Profit on 1 pound of butter, skim-milk neglected.	Profit on cow during period, labor and calf neglected.
\$ c.	\$ c.	\$ c.	lb.	lb.	lb.	lb.	Mo.	\$ c.	cts.	cts.	cts.	\$ c.
130 27	15 54	145 81	2,545	13,050	3,855	1,830	4	65 10	79.4	14.99	15.01	80 71
104 19	15.26	119 45	2,407	13,050	3,855	1,830	4	63 37	79.4	18.24	11.76	56 08
89 75	9 00	98 75	1,810	13,050	3,855	1,830	4	55 91	116.5	18.69	11.31	42 84
89 20	12.37	101 57	2,375	13,050	3,855	1,830	4	62 97	97.2	21.47	8.83	38 60
85 46	10 69	96 15	1,991	13,050	3,855	1,830	4	58 17	103.3	20 12	9.53	37 93
85 64	11 87	97 51	2,128	13,050	3,855	1,830	4	59 89	96.3	20.98	9.02	37 62
83 37	11 56	94 93	2,031	13,050	3,855	1,830	4	58 67	96.9	21.11	8.80	36 26
70 66	9 54	80 20	1,729	13,050	3,855	1,830	4	54 89	109.7	23.30	6.70	25 31
69 38	9.36	78 74	1,731	13,050	3,855	1,830	4	54 96	111 8	23.77	6.23	23 78
49 94	6 93	56 87	1,257	13,050	3,855	1,830	4	49 00	135.0	29.43	.57	7 87
49 37	6 49	55 86	1,224	13,050	3,855	1,830	4	48.58	142.4	29.52	.48	7 23
82 47	10 78	93 25	1,930	13,050	3,855	1,830	4	57 41	101.3	20 52	9.48	35 84

5 GEORGE V., A. 1915

DATA re Cost of Holstein Heifers from Birth until 1 year old.

Name.	Period.	Whole Milk.	Skim-milk.	Meal	Roots or Ensilage.	Hay	Green Feed.	Mol-asses.	Total Cost.
		Lb.	Lb.	Lb.	Lb.	Lb.	Lb.	Lb.	\$ cts
Myrtle 1 H.....	Feb. 1, 1913, to Feb. 1, 1914...	420	2,260	692 $\frac{1}{2}$	5,660	1,827	1,220	112	32 56
Bell 1 H.....	Jan. 24, 1913, to Jan. 24, 1914..	424	2,400	671 $\frac{1}{2}$	5,380	1,757	1,220	112	32 09
Spot 1 H.....	Jan. 14, 1913, to Jan. 14, 1914...	420	2,320	644	5,036	1,678	1,220	112	30 93
Vera 1 H.....	Dec. 27, 1912, to Dec. 27, 1913..	420	2,080	625 $\frac{1}{2}$	4,388	1,509	1,220	112	28 98
Jessie 1 H.....	Dec. 19, 1912, to Dec. 19, 1913.	569	2,080	571 $\frac{1}{4}$	4,068	1,429	1,200	112	28 93
Mossy 1 H.....	Dec. 6, 1912, to Dec. 6, 1913...	560	2,340	539	4,248	1,299	1,200	106	28 69

DATA re Cost of Ayrshire Heifers from the time they are Yearlings until they drop their first calves.

Name.	Period.	Hay.	Roots and Ensilage.	Meal.	Pasture—Months.	Total Cost.
		Lb.	Lb.	Lb.		\$ cts.
Lessie 1 A.....	Nov. 25, 1912, to Jan. 7, 1914.	3,475	10,900	1,069	4 $\frac{1}{2}$	41 76
Jessie 1 A.....	" 18, 1912, to Nov. 19, 1913.	2,800	9,120	872	4 $\frac{1}{2}$	34 76
Spot 1 A.....	Dec. 4, 1912, to Jan. 10, 1914.	3,255	9,970	1,029	4 $\frac{1}{2}$	39 24
Mossy 1 A.....	" 28, 1912, to Dec. 26, 1913.	2,790	8,650	882	4 $\frac{1}{2}$	34 38
Myrtle 1 A.....	" 24, 1912, to Nov. 17, 1913	2,410	7,650	754	4 $\frac{1}{2}$	30 38
Queen 1 A.....	" 21, 1912, to Dec. 12, 1913.	2,650	8,300	833	4 $\frac{1}{2}$	32 90
Ella 1 A.....	Feb. 1, 1913, to Feb. 24, 1914.	3,055	8,920	982	4 $\frac{1}{2}$	27 88
Jean 1 A.....	Mar. 7, 1913, to Feb. 24, 1914.	2,715	7,560	873	4 $\frac{1}{2}$	32 91

SESSIONAL PAPER No. 16

EXPERIMENTAL STATION, KENTVILLE, N.S.

REPORT OF THE SUPERINTENDENT, W. S. BLAIR.

DAIRY CATTLE.

During the summer of 1913, the only head of dairy cattle at this Station was one grade cow. During the month of October, 1913, an importation was made from Ontario of eleven Shorthorn cows and one Shorthorn bull. These cows are all of Scotch foundation blood and were picked out as representing a good type of farmers' Shorthorn, showing indications of fair milk production over and above the requirements of their calves. These are not dairy Shorthorns as to breeding, but will be treated in the herd as pure-bred farmers' cows, from the dairy standpoint. A Shorthorn bull from good milking strain was purchased to head this herd, and the purpose of the herd is the development of a thick, strong beef type of Shorthorn which will give at least a reasonable flow of milk—sufficient to warrant profitable milking of such.

From the time when the Shorthorn cows arrived at this Farm until the end of the fiscal year, five head freshened, giving four heifer calves and one bull calf. All these cows are milking fairly well, and their calves are most promising. The practice of taking the calf from the cow on the third day has been followed. Two of the cows, apparently used to suckling their calves, objected most strenuously, but these have gradually become more accustomed to hand-milking, and in another year give promise of a good milk record. As no cow has finished a lactation period, reports of production from this herd will not be given until the annual report for the fiscal year 1914-15.

FEEDING THE DAIRY COW.

The cows were fed on a meal ration of 1 pound to each 3 pounds of milk produced. The meal ration consisted of 400 pounds bran, 100 pounds cottonseed meal, 200 pounds crushed oats, 100 pounds linseed meal, and 100 pounds cornmeal, mixed together. The succulent feed consisted of 40 pounds ensilage or turnips, and 12 pounds hay each per day.

They were given a light feed of hay early in the morning, followed by the ensilage or roots, on which half the daily meal ration was scattered; this was followed by another light feed of hay. This was all eaten by ten o'clock and the next feed was given about three o'clock. The afternoon feed consisted of, first, ensilage or roots, and the other half of the daily meal ration and half the daily hay ration to finish up. Drinking bowls were alongside the cows so that they could get water when needed.

EXPERIMENTAL STATION, FREDERICTON, N.B.

REPORT OF THE SUPERINTENDENT, W. W. HUBBARD.

DAIRY CATTLE.

No dairy work was done during the year. Two cows were purchased in May and their milk sold to the various families belonging to the officers and men connected with the Station. These two cows produced approximately 15,000 pounds of milk.

In the absence of equipment no record was kept of the cost of feeding.

Next year it is intended to have about thirty-five milch cows on the Farm; part of them will be pure-bred Shorthorns, Ayrshires, and Holsteins, and eighteen cows of no particular breeding will be kept under record. These latter will be served by a Holstein bull with the object of testing out heifers for comparison with the records of their dams.

COW BARNS.

The accompanying plans and photographs of the new cow barns erected in the summer of 1915 at the Experimental Station, Fredericton, N. B., are for the most part self-explanatory. A few additional remarks, however, may help to make some points more intelligible. For more complete specifications, special reference is made to the report of the Dominion Animal Husbandman for the year ending March 31, 1913, in which complete plans and specifications of a new dairy barn at Ottawa are detailed. The details of the Fredericton barn, particularly of the dairy cattle wing, are largely similar to the Ottawa structure.

FOUNDATION.

All foundations are of concrete, well reinforced and extending 3 feet above the floor level of barns, on which are bolted the sills.

SUPERSTRUCTURE.

The superstructure of both of these barns is of wood, hip roofed, plank frame, and the roof covered with best quality galvanized metal shingles. The framing throughout this barn is of timbers made from plank of the dimensions 2 by 6 inches, 2 by 8 inches, and 2 by 10 inches.

The covering of the frame, the method of flooring, ceiling, insulating the walls, and the like, are similar to those described under the horse barn, and also other specifications as found in the annual report of Superintendents in other chapters of this volume.

SESSIONAL PAPER No. 16

DIMENSIONS.

The main barn is 100 feet long by 50 feet wide, outside dimensions. The ceiling of the stable is 10 feet in height, and the post in the storage barn above is 15 feet in height. Underneath the driveway is the root cellar, capable of holding approximately 5 000 bushels. A silo, conveniently situated, opens into feed room.

The dairy cattle barn is a wing to the main barn, the same being 101 feet 3 inches long by 41 feet 2 inches wide, with milk room and wash room underneath driveway to storage barn above.

The main barn accommodates beef breeding cows, steers, bulls, and all calves, together with the feed room and hospital, while the dairy barn wing accommodates forty-eight head of milch cows or dairy heifers.

Details as to dimensions of stalls, together with the cement finish, levels, slopes, etc., may be found in the brief specifications as contained in the reports for the superintendents of other Farms, and also in the report of the Dominion Animal Husbandman for the year ending March 31, 1913.

Particular attention is drawn to the different types of mangers experimented with. In the dairy barn the raised front manger is illustrated, while in the beef or main barn, the continuous mangers with the raised feed passage, and also with the submerged feed passage, but with only 10-inch curbing front manger, are illustrated.

LIGHT.

As much light as the strength of the walls would permit was installed in this barn. The barn is lighted by 768 square feet of glass, or at the rate of 15.8 square feet per head. The direct sunlight thus reaches every part of the barn, which renders it most sanitary, bright and cheerful.

VENTILATION.

The modified Rutherford system of ventilation is used in this barn, the details of which have been so thoroughly described elsewhere. The area of intake ducts per head is about 13 square inches, and the area of the foul air outlets per head is about 26 square inches. Aside from this, the windows of the barn can be so operated that they may be tilted inwards from the top, thus facilitating ventilation in weather so warm that the ventilation system is insufficient.

The ventilation of the root cellar is on the same principle as that of the barn, and seems to work quite satisfactorily. Especial care must be taken, however, in the ventilation of any root cellar, that the ventilators be closed immediately after the roots are thoroughly cooled and dried, in order that frost be not allowed into the roots.

ACCOMMODATION.

As will be seen from the plans, the dairy barn accommodates forty-eight head of cattle, while the main or beef barn will accommodate twenty-one head tied in stanchions, thirty calves, three bulls, and three box stalls which will accommodate either five steers or six heifers each, as well as the maternity hospital.

Complete accommodations in milk rooms, wash room, feed room with meal room above, root cellars, silo, litter carriers throughout the barn, etc., may be seen by a close examination of the plans and illustrations.

WATER.

Individual water basins are provided for all tie stalls, and convenient taps arranged for the watering of calves and all individuals maintained in box stalls.

PLANS AND SPECIFICATIONS.

More complete plans and specifications of this barn, or any part of same, will be forwarded to parties interested, upon application to the Superintendent, Experimental Station, Fredericton, N.B.

TO DAIRY →

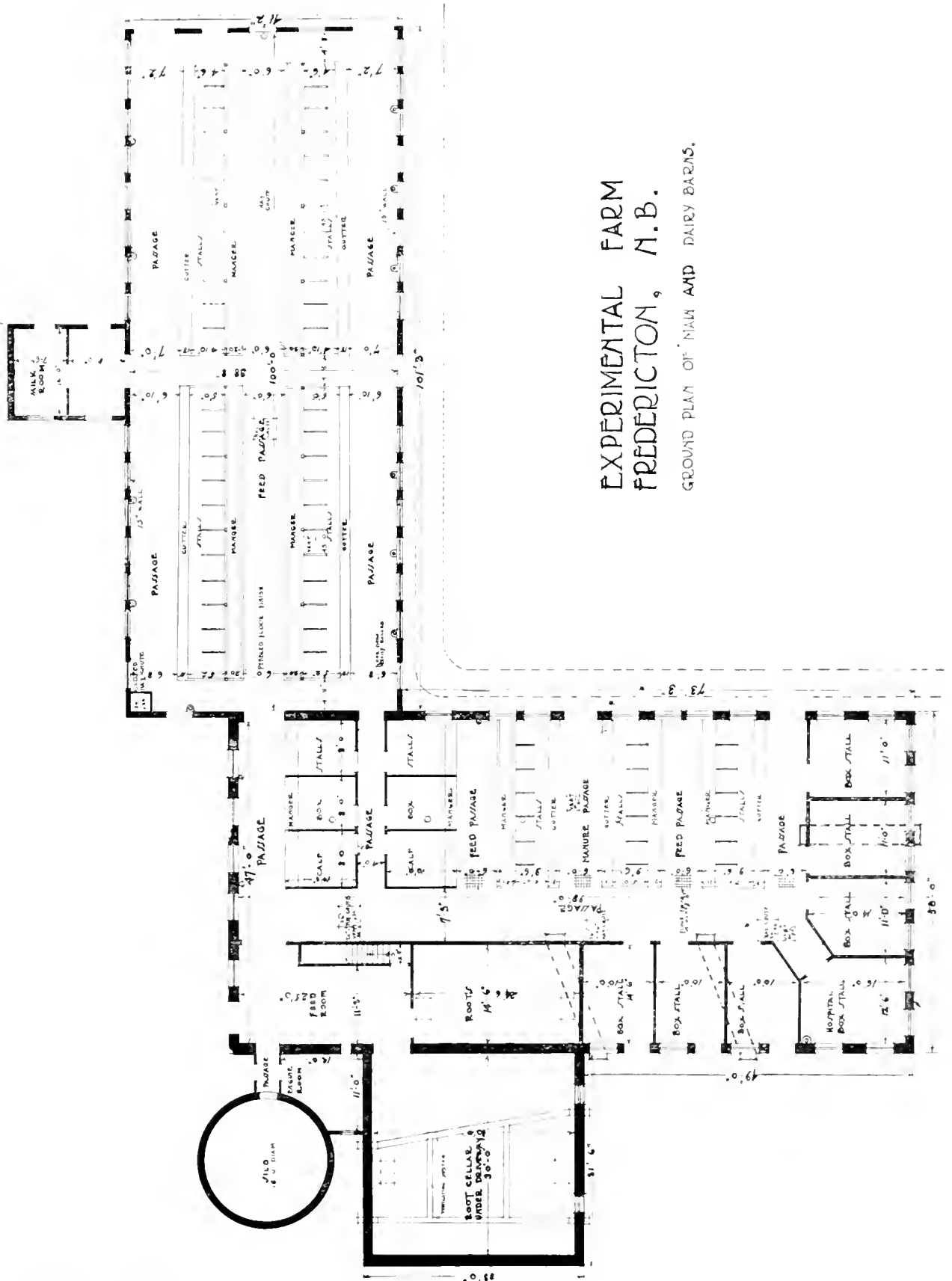

EXPERIMENTAL FARM FREDERICTON, N.B.

GROUND PLAN OF MAIN AND DAIRY BARN.

EXPERIMENTAL FARM
FREDERICTON, N.B.

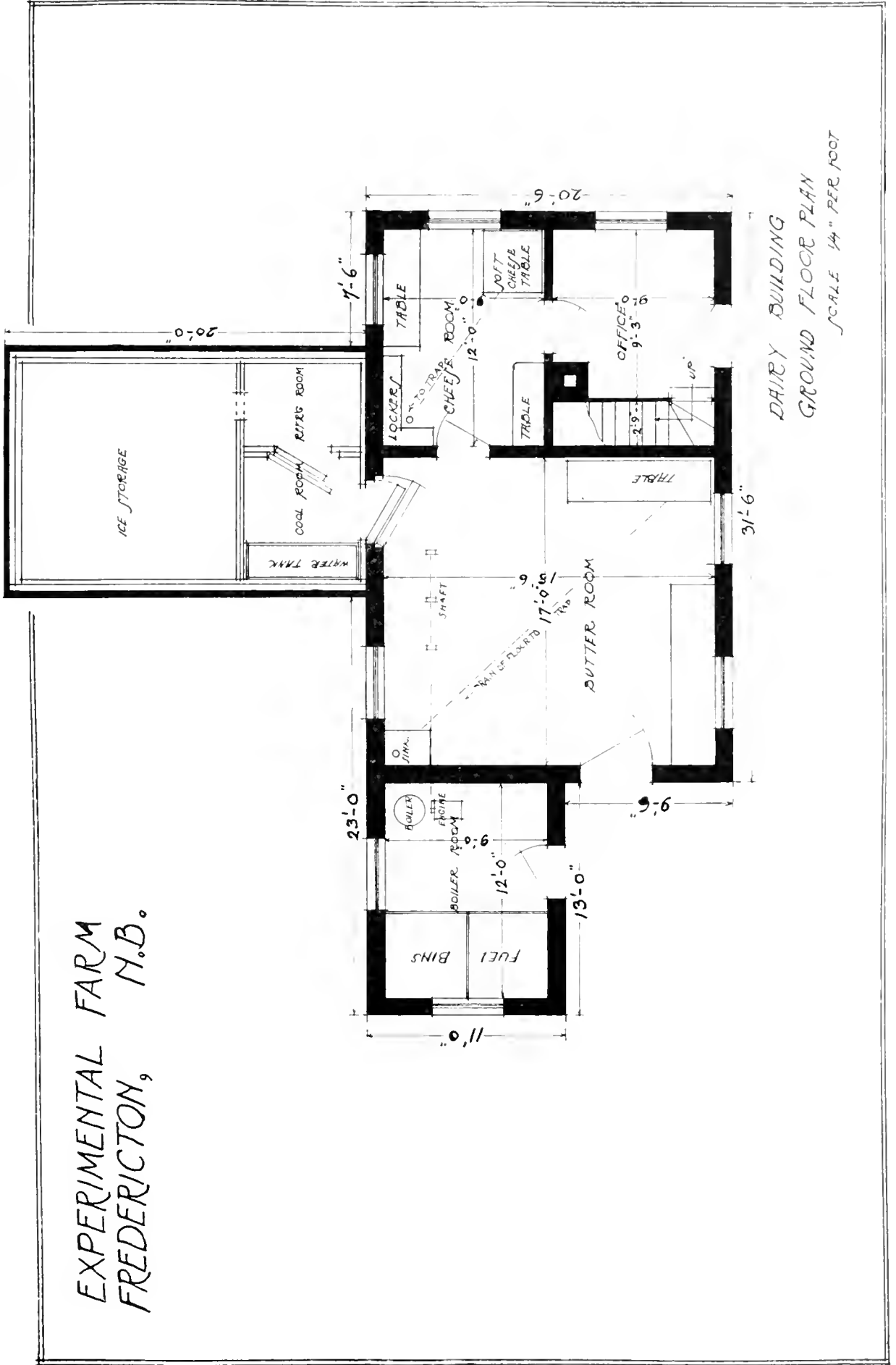

DAIRY BUILDING
GROUND FLOOR PLAN
SCALE 1/4" PER FOOT

EXPERIMENTAL STATION, CAP ROUGE, QUE.

REPORT OF THE SUPERINTENDENT, GUS. A. LANGELIER.

DAIRY CATTLE.

The herd now comprises fifty-three head of pure-bred and grade French Canadians. There are one aged and three yearling bulls, twenty-seven cows, nine yearling heifers, and thirteen calves, ranging from a few days to ten months of age. Out of this number there are sixteen grade cows and heifers. These grades are kept to show that, with a good pure-bred bull, a fairly uniform and a paying herd can be bred. It is remarkable to note how the first point has already been reached, as there are six grade heifers which appear to be pure-breds. Time alone, of course, will tell whether they will be as profitable at the pail as their more aristocratic registered sisters, but it is difficult to see why this would not be the case.

The following table gives detailed results for cows which finished a lactation period during the year:—

Names of cows.	Registration No.	Age at beginning of lactation period.	Date of dropping Calf.	Number of days in lactation period.	Total pounds of milk for period.	Daily average yield of milk.	Average per cent fat in milk.	Pounds of butter produced in period.
					lb.	lb.	p.c.	lb.
Gipsy.....	G.F.C.	5½	Sept. 11, 1912..	465	11,923.00	25.65	4.0	561.86
Finette 2.....	218.....	8	Mar. 4, 1913..	311	8,039.25	23.57	4.0	398.21
Jeannette de St. Denis.....	2,409..	7	April 27, 1912..	337	6,453.00	19.15	4.71	357.34
Flora.....	G.F.C.	13	Mar. 25, 1912..	339	6,852.75	20.21	4.66	375.42
Empire.....	2,398..	1½	May 29, 1912..	426	5,706.25	13.39	4.59	307.57
Delphine.....	G.F.C.	6	May 26, 1912..	461	6,988.50	15.16	4.4	333.94
Amanda.....	G.F.C.	7	" 4, 1912..	311	5,677.75	18.26	4.35	288.23
Bella.....	G.F.C.	10	May 6, 1912..	329	5,673.00	17.24	4.49	299.62
La Brune du Sable.....	2,440	8	April 20, 1912..	403	4,902.00	12.40	4.78	275.97
Exilée de Kamouraska.....	2,414	2	" 5, 1912..	402	4,453.25	11.08	5.07	265.36
Princesse du Sable.....	2,261	2½	Dec. 5, 1912..	271	4,345.25	16.03	4.63	236.70
Christine.....	G.F.C.	6	May 25, 1912..	285	4,350.50	15.34	4.63	233.45
Eva.....	G.F.C.	8	Mar. 25, 1912..	257	4,360.50	16.97	4.28	219.69
Hilda.....	G.F.C.	9	April 26, 1913..	243	4,004.00	12.33	4.57	215.57
Simonne.....	2,259	8	June 13, 1912..	271	4,153.75	15.33	4.64	226.57
Kate.....	G.F.C.	6	April 6, 1912..	316	4,201.00	13.29	4.59	226.67
Frisée.....	1,612..	6	April 27, 1912..	352	3,643.75	10.35	4.95	210.88
Denise Besse.....	1,269	7½	Dec. 18, 1912..	292	3,372.00	11.50	4.5	184.65

SESSIONAL PAPER No. 16

Value of butter at 25 cts. per lb.	Value of skim milk at 40 cts. per cwt.	Total value of product.	Amount of meal eaten, at 14 cts. per lb.	Amount of roots and ensilage eaten, at \$2 per ton.	Amount of hay eaten, at \$7 per ton.	Amount of green feed eaten, at \$3 per ton.	Months on pasture, at \$1 per month.	Total cost of feed per period.	Cost to produce 100 lbs. of milk.	Cost to produce 1 lb. of butter, skim milk neglected.	Profit on 1 lb. of butter, skim milk neglected.	Profit on cow during period, labour neglected.
\$ cts.	\$ cts.	\$ cts.	lb.	lb.	lb.	lb.	Mo.	\$ cts.	cts.	cts.	cts.	\$ cts.
157 31	22 90	180 21	3,073 8	5,624 5	2,439 5	12,689 5	1½	73 11	61 3	13 0	15 0	107 10
111 50	15 40	126 91	2,267 8	5,726 0	2,247 0	7,290 0	1½	54 39	67 0	11 1	16 9	72 52
100 05	12 30	112 35	1,761 8	4,270 4	1,802 5	6,878 0	1½	11 43	68 8	12 7	15 3	67 92
105 12	13 07	118 19	1,907 8	6,159 5	2,695 0	8,830 0	1½	51 18	70 3	14 4	13 6	64 01
86 12	10 89	97 01	1,741 3	4,077 5	1,911 0	6,352 0	3	45 06	78 7	11 0	14 0	51 95
94 90	13 40	108 30	2,981 5	5,280 0	2,432 0	9,300 0	3	56 76	81 2	16 7	11 3	51 54
80 70	10 86	91 56	1,550 1	3,527 5	1,641 0	6,878 0	1½	40 96	72 0	14 2	13 8	50 80
83 89	10 83	94 92	1,733 2	5,310 0	2,430 0	8,100 0	1½	49 13	86 6	16 4	11 6	45 59
77 27	9 33	86 60	1,479 6	4,228 0	2,032 0	6,480 0	1½	41 04	83 7	14 8	13 2	45 56
74 30	8 46	82 76	1,479 5	4,260 0	1,860 0	4,760 0	1½	37 99	85 1	14 2	13 8	44 86
66 28	8 29	74 57	1,363 7	3,749 8	1,657 5	4,212 0	1½	64 46	79 2	14 5	13 5	40 11
65 37	8 30	73 67	1,324 1	3,251 1	1,470 5	6,878 0	1½	36 77	84 5	15 7	12 5	36 90
61 51	8 35	69 86	1,242 9	2,992 5	1,215 0	7,290 0	1½	35 22	80 7	16 3	11 7	34 64
60 35	7 64	68 00	1,170 5	2,495 5	1,021 0	7,689 0	1½	53 73	84 2	15 5	12 5	34 27
63 44	7 92	71 36	1,392 8	3,676 1	1,640 5	6,878 0	1½	37 52	90 3	16 5	11 5	33 84
63 47	8 01	71 48	1,285 8	3,570 0	1,629 0	7,290 0	1½	57 78	89 9	16 6	11 4	33 70
59 05	6 93	65 97	1,116 0	3,909 7	1,734 0	6,878 0	1½	35 74	98 0	16 9	11 1	30 23
51 70	6 43	58 13	989 0	3,982 5	1,813 0	6,483 0	1½	33 91	100 5	18 5	9 5	24 22

One thing stands out very plainly from the above table; that the biggest profit-making cows are in general the largest producers, which consume the most feed at the highest cost. There are, of course, exceptions, but here again is shown the fact that good cows, well fed, are the only ones which pay. This is so often repeated that it seems useless to mention the matter here, but it is wonderful that so few farmers will, in this case, put into practice what is acknowledged by all to be the best procedure to follow. Culling and feeding, more than breeding, is the shortest road to success. Why it seems to a large number the hardest to follow is beyond comprehension.

FEEDING EXPERIMENT WITH DAIRY CATTLE.

The question of concentrates is becoming an important one now that mill by-products cost so much, and with the price of milk not advancing very much. A feeding experiment was thus planned in which nine cows, whose weights did not differ enough to materially change the result, were fed exactly the same quantities

DAIRY RECORDS.—

Name of Cow.	Registration No.	Age at beginning of test.	PRODUCED DURING PREVIOUS LACTATION PERIOD.			Date of calving.	Days in feeding test.
			Milk.	Fat.	Milk per day.		
			lb.	lb.	lb.		
Lot I.—Amanda.....	G.F.C.	7	5,677.75	288.23	18.26	June 8, 1913...	128
Christine ¹	G.F.C.	6	4,359.5	233.45	15.34	" 27, "	"
Hilda.....	G.F.C.	9	4,004.69	215.57	12.33	" 18, "	"
Lot II.—Bella.....	G.F.C.	10	5,673.00	299.62	17.24	July 22, "	"
Eva.....	G.F.C.	8	4,360.5	219.69	16.97	June 12, "	"
Flora.....	G.F.C.	13	6,852.75	375.42	20.21	" 25, "	"
Lot III.—La Brune du Sable.....	2,440	8	4,902.00	275.97	12.40	July 18, "	"
Jeannette de St. Denis.....	2,409	7	6,453.00	357.34	19.15	June 24, "	"
Suzonne.....	2,259	8	4,153.75	226.57	15.33	" 29, "	"

¹Ceased giving milk before end of experiment. Roughages charged to her only when milking.

SESSIONAL PAPER No. 16

of roughages, whilst three received 1 pound of concentrates for 8 pounds of milk, three others 1 pound of concentrates for 4 pounds of milk, and the last three all the concentrates they would eat, which was 1 pound per 2.25 pounds of milk.

The following table gives details about previous records of cows, their feed, production and profit:—

Cap Rouge, Que.

Amount of meal eaten, at 14 cts. per lb.	Amount of roots and ensilage eaten, at \$2 per ton.	Amount of hay eaten, at \$7 per ton.	Total cost of feed for period.	Total pounds of milk for period.	Pounds of butter produced in period.	Value of butter, at 28 cts. per lb.	Value of skim milk, at 20 cts. per cwt.	Total value of product.	Profit on cow during period, labour neglected.	Profit on each group during period, labour neglected.	Gain in weight for each group during period.	Pounds of milk for one lb. of meal.
lb.	lb.	lb.	\$ cts.	lb.	lb.	\$ cts.	\$ cts.	\$ cts.	\$ cts.	\$ cts.	lb.	lb.
104.11	5,534.00	1,024.00	11.51	1,553.85	74.49	20.85	2.98	23.83	12.29			
118.88	4,874.00	920.00	9.58	951.04	46.42	11.45	1.82	13.27	3.69	9.26	38	8
223.23	5,531.00	1,024.00	11.10	1,786.49	72.26	20.23	3.45	23.68	11.78			
480.61	5,534.00	1,024.00	15.12	1,903.19	82.26	23.03	3.67	27.36	12.18			
425.67	5,534.00	1,024.00	14.43	1,702.68	72.83	20.38	3.28	23.66	9.23	10.67	11	4
397.51	5,534.00	1,024.00	14.08	1,590.04	77.26	21.63	3.05	24.68	10.60			
1,024.00	5,534.00	1,024.00	21.91	2,446.20	119.97	33.59	4.69	38.28	16.37			
1,193.00	5,534.00	1,024.00	21.02	2,617.50	129.67	36.31	5.01	41.32	17.39	15.50	17	2.25
1,024.00	5,534.00	1,024.00	21.91	2,220.25	112.47	39.49	4.25	34.74	12.83			

Here again is demonstrated the importance of "feed and weed." Taking the average for each group, we find that the three cows which received 1 pound of meal for 2.25 pounds of milk gave, during the period of the experiment, an average profit of \$15.50 each, the three which received 1 pound of meal per 4 pounds of milk gave an average profit of \$10.67, whilst the three which received 1 pound of meal per 8 pounds of milk only gave an average profit of \$9.26. These profits look small for the length of the feeding experiment, 128 days, but it must not be forgotten that this test commenced when, on an average, each of the nine cows had already been milking 137 days. Most of these cows are served to calve during August, 1914, to gather more data on the subject, and it is proposed to commence the feeding test soon after they calve. A small paddock, practically bare, will be used to give them exercise, and green feed will be fed in the stable after being weighed.

As to the question of weeding out the "boarders," a few figures given here will show that it is an important one. It shows one other point: besides knowing what the cow produces, a farmer must also have an idea of what she eats, as a good producer may not make an economical use of her feed. No doubt many will say that it is too much trouble to do all this weighing, but the farmer is in business as the manufacturer, the merchant and the contractor, and if he is to make a success of this business, he must know what it costs him to produce the goods which he sells. It is reasonably safe to say that when a majority of farmers get to know how much it costs them to produce milk, they will then commence to make larger profits, as they will discard the non-paying cows and perhaps also insist on getting more for their milk. Both these things must be done before the dairying industry pays the dividends which it should for the money invested therein.

ECONOMICAL and Non-economical Producers compared.

Name of cows.	Ratio of meal fed per lb. of milk.	Cost of feed.	Value of product.	Gain in weight.	Value of this gain at 7c per pound.	Profit over feed.	Profit including gain in weight.
		\$ cts	\$ cts.	Lb.	\$ cts.	\$ cts.	\$ cts.
Amanda.....	1-8	11 54	23 83	30	2 10	12 29	14 39
Bella.....	1-4	15 12	27 30	15	1 05	12 18	11 13
Simonne.....	1-2.25	21 91	34 74	25	1 75	12 83	14 58

It is easily seen here that Amanda, which received only 1 pound of meal per 8 pounds of milk, and which gave a profit of \$14.39, made better use of her feed than Simonne, which received 1 pound of meal per 2.25 pounds of milk and only gave a profit of \$14.58. There is no positive proof that Amanda would have given a larger profit had she received more meal, but the averages, on the large table above, would tend to show to any fair-minded person that she would. What the dairyman wants is more Amandas and less Simonnes. To keep the first and get rid of the second, there is nothing else to do but weigh the milk and keep a record of the concentrates given, increasing the amount until it is found that the cow does not respond with a profitable increase.

EXPERIMENTAL STATION, STE. ANNE DE LA POCATIÈRE,
QUE.

REPORT OF THE SUPERINTENDENT, JOS. BEGIN.

DAIRY CATTLE.

A small but excellent start was made in a dairy herd at this Station in June, 1913, when eleven head of pure-bred Ayrshire females were transferred from the Central Experimental Farm, Ottawa, to this Station. Added to this number was a 2-year-old Ayrshire bull, transferred from the Experimental Farm, Nappan, N.S. These cows were all of the choicest breeding and are excellent individuals. All the cows 2 years and over were in calf to the pure-bred Ayrshire bull at the Central Experimental Farm, "Monarch of Tanglewyld" 36442, son of the famous Ayrshire cow "Primrose of Tanglewyld" 15943. Hence, all the first crop of calves on this Farm are by this noted sire. When transferred to this Station, all cows and heifers, excepting one, were dry. Seven of these have calved during the fall and early winter, giving four heifer calves and three bull calves. Herewith is submitted a list of the foundation herd:—

	Years.
Marjorie 2nd—22196	9
Marjorie 4th—28101	6
Sonny 3rd—29604	7
Flavia's Girl—32565	6
Duchess Flavia—36408	3
Denty 3rd's Own—36442	3
Flavia Spot—36412	3
Jessie G.—36467	2
Princess Denty—36411	2
Margaret Ottawa—36413	2
Margaret 2nd—38051	1

As no cows have completed a full lactation period, no complete records for this year will be given until the annual report for the coming fiscal year. However, returns as given below will show the fact that the cows have produced profitably to date:—

Number of cows	7
Total number of milking days	1,203
Amount of milk produced	28,873 lb.
Average production of milk per cow.....	4,122 lb. per day.
Milk sold at 4 cents per quart.....	\$ 461 96
Amount of expenses during that time.....	" 196 15
Profit	" 265 81
Average profit per cow	" 37 97

Taking into consideration the fact that three of these seven head milking were heifers with their first calf, and that the stabling conditions until nearly the end of the fiscal year were most unfavourable, these returns are quite satisfactory. These cows were installed in the new barn on the 1st of March, 1914.

In connection with the pure-bred herd, there will also be conducted, at this Station, a dairy cattle grading experiment. This experiment will entail the purchase of a number of average heifers of common breeding with which only pure-bred Ayrshire bulls will be used. Preparations are being made to commence this experiment during the first of the coming fiscal year, and a more complete report of the outline and progress of the same will be given in the report for the coming fiscal year.

A GOOD COMMERCIAL DAIRY BARN.

During the past year a dairy barn was erected at this Station. The following is briefly a description of this complete modern commercial dairy barn, illustrating capacity, strength, lightness of structure, convenience, light, and ventilation.

This is called a good commercial dairy barn for the reason that many dairymen much prefer having the calves and bulls in the same barn with the cows, and in fact this is the common practice throughout Canada. Although this may not be conducive toward the most economical manufacture of the very purest milk, yet such a system has many advantages. This barn contains box stalls, feed rooms, calf pens, milk room, and, in fact, is a complete barn which will house all classes and ages of dairy cattle.

The plans and specifications herewith submitted may be changed to suit the location, the convenience, or the taste of any farmer; but in essentials, at least, represent the ideal of this type of dairy barn, both as to appearance, convenience, economy, and efficiency.

A brief outline of the specifications is as follows:—

1. FOUNDATION.

The foundation is of concrete. A concrete footing, 18 inches wide and 18 inches deep, supports the foundation walls. The concrete foundation walls extend 2 feet above the floor level inside the barn, excepting where adjoining the root cellar under driveway, where the foundation wall extends full height of the cattle stable. This foundation wall is 18 inches in thickness, to which the sill is firmly bolted with cement bolts. A 3-inch tile just below and outside the footing of wall was installed to prevent the heaving and cracking of foundation.

2. SUPERSTRUCTURE.

The superstructure is of wood, hip roofed, plank frame, and the roof covered with best quality of galvanized metal shingles. The sills are made of two ply 2- by 8-inch plank with broken joints, well spiked together. Wall posts and studding are made of 2- by 8-inch plank. The purlins and plates are also made of two ply 2- by 8-inch planks, well spiked with broken joints. The truss is made from 2- by 10-inch and 2- by 6-inch planking. The purlin brace is made of two ply 2- by 10-inch bolted 2 inches apart to receive braces and props and also to receive the ridge brace, which is also 2- by 10-inch. All short braces and cross braces of truss are made from 2- by 6-inch planks. Floor joists are made of 2- by 12-inch planks on 22-inch centres. Girths holding joist are made of five ply of 2- by 12-inch, these resting on 6-inch wood posts along the line of calf pens and bull stalls and on 3½-inch steel columns along the lines of cattle ties. Rafters are of 2- by 6-inch plank.

The covering of the frame is as follows: The walls are built from the outside with battens, 1-inch planed boards, one ply building paper, 2- by 8-inch studs and posts, one thickness of heavy fibre wall paper called "Linofelt," and seven-eighths inch matched lumber on the inside. This sheathing is only for the stable below. In the storage barn above stable, the studs and posts are exposed. The rafters are covered with inch boarding, one ply of good building paper to preserve the underside of shingles, and best quality metal shingles. The floor of the storage barn above cattle is composed of one-ply inch lumber laid angle-wise to thoroughly tie the barn. In the drive floor this is covered in turn with 2-inch hemlock planking, while over the balance of floor the covering is inch lumber nailed lengthwise of the barn. Building paper is used between the two ply of lumber in the floor of barn to keep dust from settling through

EXPERIMENTAL STATION
 ST ANNE DE LA ROCATIERE, QUE
 GROUND PLAN OF CATTLE BARN.
 - $\frac{1}{8}$ IN SCALE-

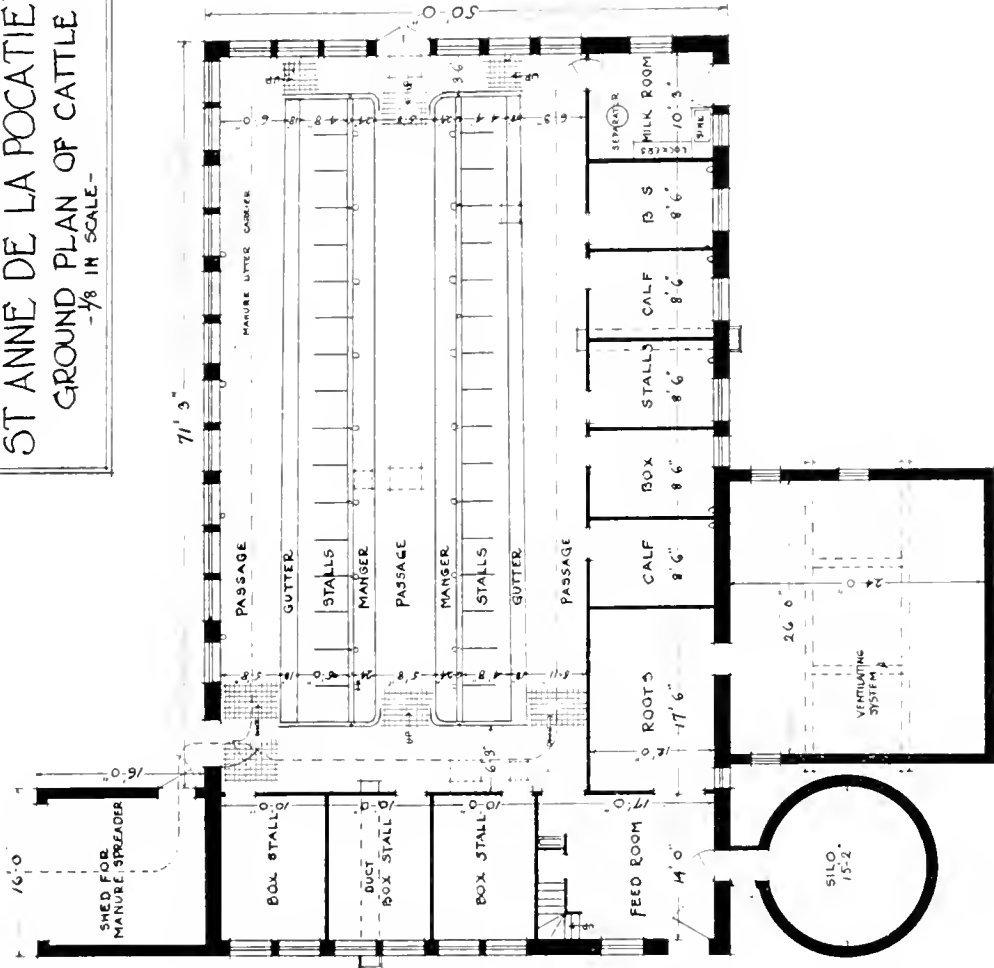

EXPERIMENTAL STATION ST ANNE DE LA POCATIERE, QUE

CROSS SECTION THROUGH BARN
1/4 IN SCALE.

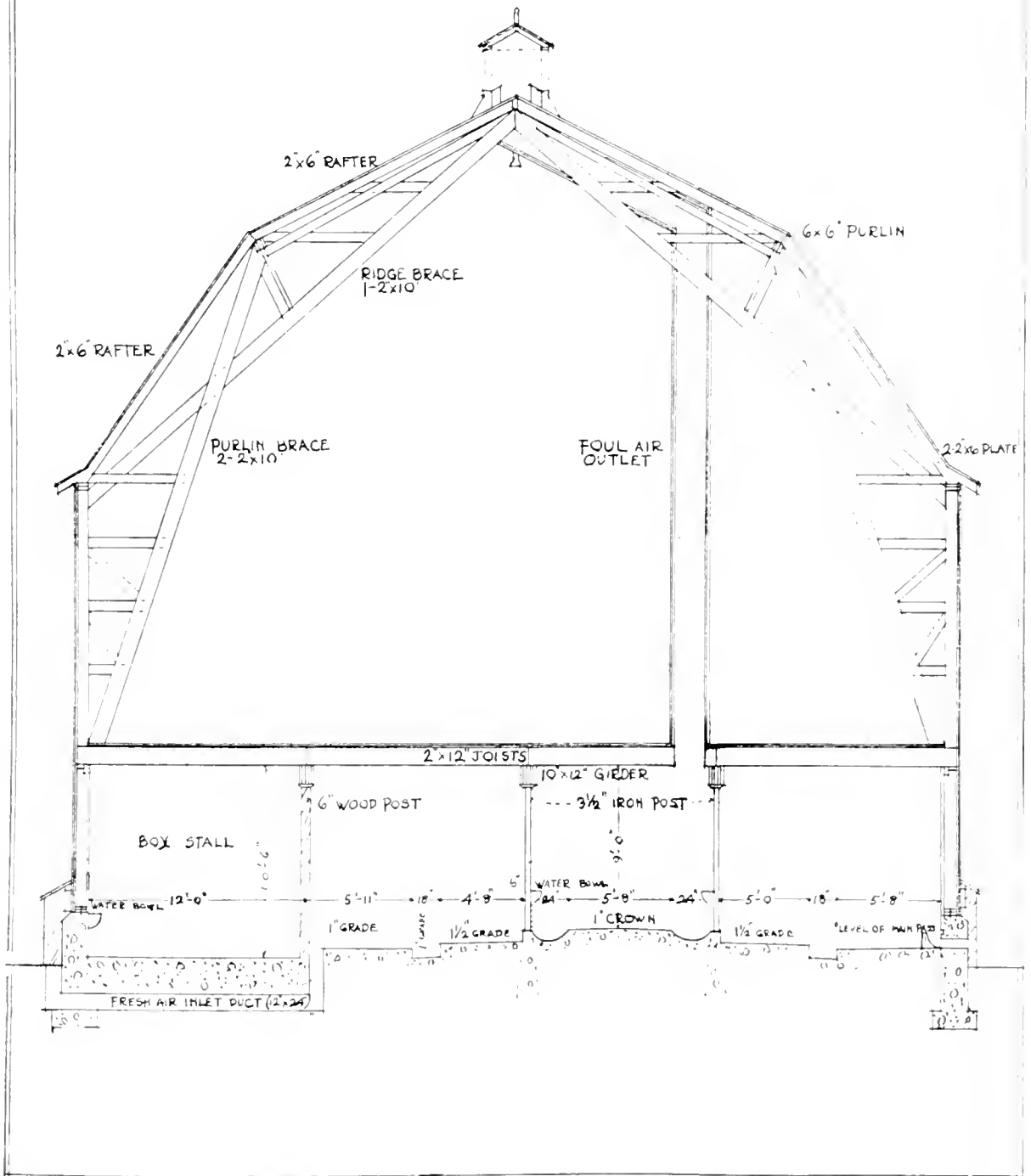

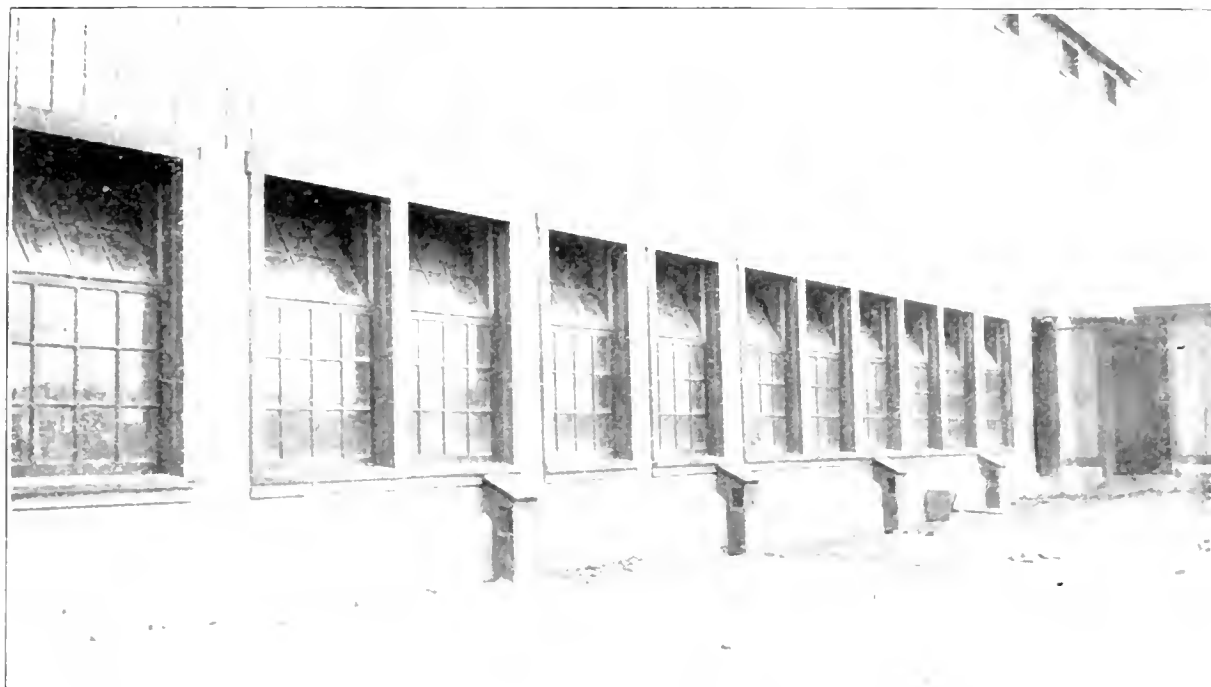

Cattle Barn, Ste. Anne de la Pocatière. Note the lighting and hoods of fresh air intakes.



Experimental Station, Ste. Anne de la Pocatière, Que. Horse barn to right.

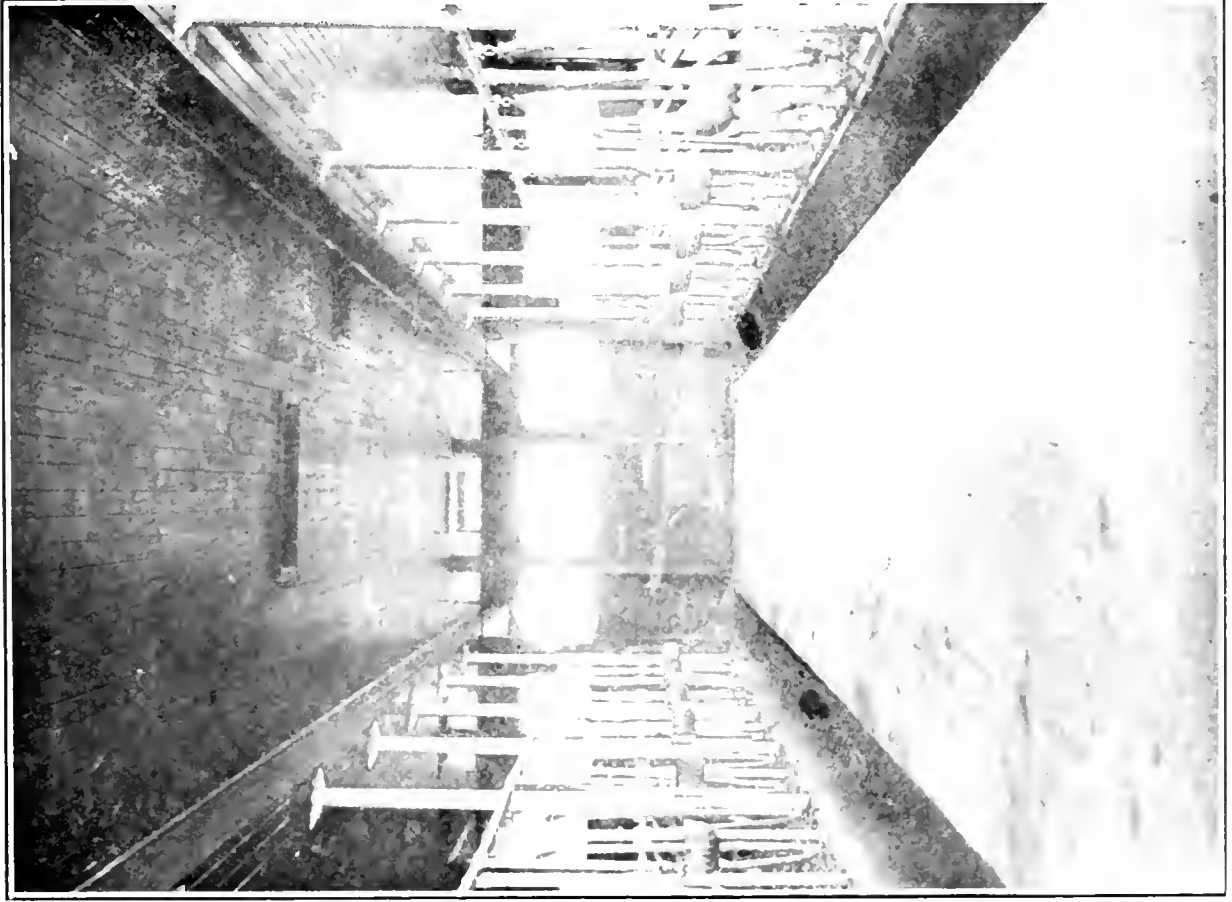

Dairy Barn, Ste. Anne de la Pocatiere. Central feed Passage.
Note the feed air outlets.

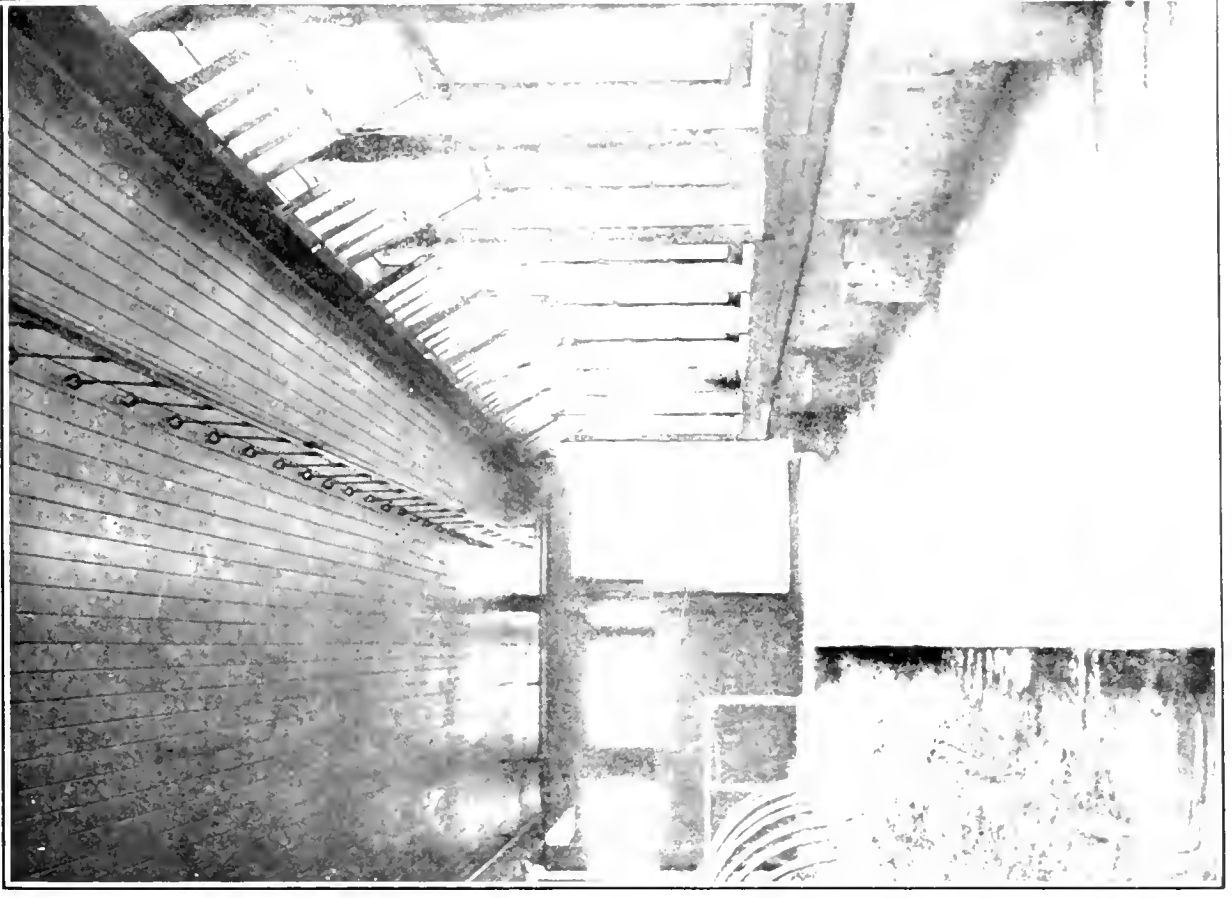

Cattle Barn, Ste. Anne de la Pocatiere. Manure Passage.
Note the fresh air intakes.

SESSIONAL PAPER No. 16

the floor into the cattle barn beneath. Dressed matched lumber is used in flooring in order to give a dead air space in ceiling for better ventilation, and also to dispense with the dust-collecting space between joists.

3. DIMENSIONS.

The main barn is 86 by 50 feet outside measurement. The ceiling of stable is 10 feet in height from the manure passages, 9 feet in height from the feed passage, and 10 feet 6 inches in height from the floor of box stalls. The wall post in storage barn is 14 feet clear above floor, thus making a total height of post above the sill of 22½ feet, to which is added 8 inches for plate and sill.

The cattle stands from end to end are of different lengths, one varying from 5 feet to 4 feet 8 inches, and the other from 4 feet 8 inches to 4 feet 4 inches. All the tie stalls are 3 feet 6 inches in width to centre of divisions. The feed passage is 5 feet 8 inches wide. Mangers are 24 inches wide; division between manger and stand, 6 inches wide; and gutters 18 inches wide, with sloping bottoms. The box stalls vary in width from 8 feet 6 inches to 10 feet, and are 12 feet deep, excepting three boxes at end of barn, which are 14 feet deep.

4. CEMENT FINISH.

The 2 feet of cement wall above the floor, the floors of milk room, the mangers, and gutters were finished perfectly smooth. Feed passages were given a smooth finish and then rolled. Cattle stands and floor of box stalls were given a true but rough finish with a wood float. The manure passages and the main passage were given a smooth finish and then heavily rolled with a cement roller to give the pebbled finish, this to prevent cattle from slipping. The grades at the ends of manure passages and feed passages were cross-lined at every 5 inches and also rolled.

5. LEVELS.

All the floors in the stable are of concrete. The two manure passages running lengthwise of barn are 4½ inches lower than the passages at end of rows, while the feed passage is again 4½ inches higher than end passages. The rear of stand is 2 inches higher than the manure passage at gutter. The manger bottoms are 1½ inches higher than the front of stands. The divisions between manger and stand are of concrete, the same being 7 inches higher than front of stand and 5½ inches above the manger bottom. The manger is of the continuous type, the top of feed passage forming the outer side of manger. The manure gutters are 7½ inches deep next the stand and 6 inches deep next manure passage.

6. SLOPES.

The cattle stands have a slope of 1½ inches from front to rear. The main feed passage has a crown of 1 inch to centre. The manure passages have a fall toward gutter of 1 inch. The bottom of gutter is one-half inch higher next the cattle stand than next the manure passage, and the gutter slopes to drain at one end in the proportion of 1 inch per 25 feet, with an extra inch in the last 2 feet toward drain. These slopes facilitate the cleaning out of liquid manure, as well as the keeping clean of the tails of the cows. The mangers have the same slope toward drain at end as manure gutters. The sides of the gutters are vertical, while manger bottoms are curved.

The slopes from manure passages and feed passage to end passage are at the rate of 1 inch per foot, the finish being deeply grooved in squares. The floor of the milk room slopes to a floor drain at one side at the rate of 1 inch per 6 feet.

7. LIGHT.

As much light as the strength of walls would permit was installed in this barn. The windows in walls and doors were made as large as possible. The cattle barn will accommodate thirty-four cows tied, two bulls in box stalls, and twenty calves and heifers in the remaining boxes. The barn is lighted by 650 square feet of glass, or at the rate of 12.87 square feet per head. Direct sunlight reaches every part of the barn, which renders it most sanitary, bright, and cheerful.

8. VENTILATION.

A modified Rutherford system of ventilation is used in this barn. On the south side the fresh air intakes are brought in at the floor level and carried up to the height of 10 inches against wall. These intakes are constructed from sewer pipe elbows, being 6 inches in diameter. On the north side and east end, ventilator ducts had to be made under box stalls.

Fresh air is admitted through the walls at or near floor level. Cement casing guards are placed around all fresh-air intakes in order to cut down possibility of damage and to exclude dirt.

Ventilator boxes on the outside of walls extend 3 feet above the pipe opening in wall. These ventilator boxes are resting on small cement bases to prevent decay, and contain openings in the sides near top. The fresh air entering thus describes a deep parabola, thus preventing strong direct air currents, yet supplying a uniform, adequate flow of fresh air for the barn. The area of each opening in the intake box is equal to the area of the intake pipe. Dampers are installed in these boxes to control the flow of fresh air.

The area of intake ducts per head is about 14 square inches.

The foul-air outlets are three in number, each being 18 square inches in diameter, inside measurement, and thoroughly insulated to prevent condensation of moisture. These outlets are not placed in the centre of building but alternately in each side, extending from ceiling of stable to roof, and following the line of upper rafters to barn peak, thus straddling the hay track in loft, yet using the cupolas on ridge as outlets. These foul-air outlets are constructed as follows: From the outside, one ply of matched lumber, inch battens and air space; one ply of building paper and one ply of matched lumber on the inside. This makes a perfect foul-air outlet. The area of outlet for this stable is 39 square inches per cow. The damper at the lower end of foul-air outlet, swivelling in the centre with control cords extending to the stable below, is used to control the outgoing air.

The windows of this barn throughout, excepting in box stalls, are of two sashes, the upper one of which is hinged to the lower sash, opening inward from the top. These may be tilted at any angle by means of a cord operating a small pulley on a worm spindle. Such a device costs in the vicinity of 50 cents each, is easy to operate, and prevents the slamming of windows and the consequent destruction of glass. When warm weather necessitates more fresh air than is admitted through the fresh air intakes, the windows are opened as needed. From an ideal dairy barn viewpoint, if screens were supplied for the windows and sashes in the dairy of this barn for the summer months, it would allow the taking off of windows during the heat of summer and yet prohibit the entrance of flies.

The ventilation of the root cellar is on the same principle as that of the barn. However, the fresh air is conducted through the walls at a height of about 6 feet above floor, but is carried down to floor level before being dispersed. On the floor is a slatted system of ventilator boxes, which allows the air not only to go from opening to opening, but at the same time to work its way gradually upward through the roots. If

SESSIONAL PAPER No. 16

necessary, upright slatted shafts may be provided to the trap doors for filling. The fresh air intakes are controlled by double dampers, which can be closed after the roots are cooled, thus prohibiting the entrance of frost.

9. ACCOMMODATION.

The cattle barn will accommodate thirty-four milch cows standing in all-steel stalls and tied by means of swinging steel stanchions, and also the eight box stalls will accommodate twenty-two bulls, heifers, and calves.

A separate milk room, well equipped with lockers and sink, etc., is contained in the northwest corner of barn. This milk room being farthest away from the manure pit and feed room, facilitates cleanliness of the milk. A self-closing door from the milk room to the barn ensures the exclusion of dust.

In the southeast corner of barn there is a small open shed sufficiently large to accommodate a large manure wagon. This provided with a concave cement floor facilitates the keeping of the manure away from the barn with the least possible labour. The exclusion of the manure from the vicinity of a dairy barn is absolutely essential in order to make the best flavoured and purest milk, and also to prohibit the breeding of flies in the vicinity of the barn.

A commodious feed room is provided in the northeast corner of stable, into which enter the silo and the root cellars. Into this feed room dump four meal chutes from the meal room above. A stairway to meal room, properly fitted with closets and sink, underneath, makes this an ideal place for the mixing of feeds.

The meal room above the feed room is of the same size as feed room, and is well fitted with hopper-shaped bins and with chutes extending to feed room below.

The rest of this end of the storage barn is taken up with a granary.

The root cellar under driveway is sufficiently large to accommodate approximately 4,000 bushels of roots. This root cellar has a ceiling of reinforced concrete, the same being floor of the driveway to barn. Contained in this ceiling are two watertight traps for the filling of the root cellar. Adjoining this root cellar in the barn is a smaller emergency root cellar sufficiently large to accommodate approximately 1,600 bushels of roots.

The silo opening into feed room has a capacity of approximately 140 tons.

A litter carrier is installed throughout the barn, which takes the manure to the small manure shed and runs it directly over the cart there placed for the reception of all litter. All manure is hauled directly to the fields.

The distribution of feed is done by means of two low, three-wheeled trucks. The meal truck is fitted with bins to accommodate three different meal mixtures or straight meals. The ensilage truck is of the large hopper-shaped type, accommodating 20 bushels. It might be well to again mention that experience with these trucks has shown distinct superiority over the suspended feed carriers.

10. WATER.

Individual basins are provided for the tie stalls and all calf boxes. For comparative purposes, two systems representing two types were installed. For one row of cow stalls and the calf boxes a good underfeed system of bowls was installed with two control tanks to regulate the same. On one of the rows of ties an overhead feed system was installed. This latter, however, has not given very good satisfaction as yet, but it is hoped that remodellings will materially improve the same, for it has many distinct advantages over the underfeed system in principle, although as yet not in practice. These water systems to date have been fairly satisfactory and are much more convenient and cleanly than watering in the mangers or with buckets. The bull boxes were not supplied with water basins owing to the possibility of breakage, thus causing the flooding of the stalls. Hence the bulls are watered with pails.

SEE ANNE.

EXPERIMENTAL FARM, BRANDON, MAN.

REPORT OF THE SUPERINTENDENT, W. C. McKILLICAN, B.S.A.

DUAL-PURPOSE AND DAIRY CATTLE.

The breeding herd consists of thirty-one head of cattle as follows:—Shorthorn: 2 bulls, 16 milch cows, and 8 heifers and calves. Ayrshire: 1 milch cow. Grade: 2 milch cows, and 2 calves.

The Shorthorns are mostly of the dual-purpose type and are being bred for capacity of milk production as well as for suitability for beef. There is a great demand in Western Canada for cattle of this type, and large numbers of both sexes could be sold to farmers in all parts of the country if there were more obtainable. It has been found impossible to sell females this year as the herd is small and all heifer calves were retained to increase the herd. Nine bull calves were sold during the year.

MILK RECORDS.

The following milk records are for the last complete lactation period of the cows now on hand. In addition to the cows recorded there are six young cows which have not yet completed their first lactation period.

Name of Cow.	Breed.	Age at beginning of lactation period.	Date of dropping calf.	Number of days in lactation period.	Total pounds of Milk for period.
Ottawa Marchioness 5th.....	Shorthorn..	4	Dec. 21, 1912.	387	11,334
Illuminata 3rd.....	" ..	7	Nov. 25, 1911.	443	10,287
Duchess 3rd.....	" ..	5	Dec. 4, 1912.	285	9,621
Ottawa Janet 4th.....	" ..	3	Mar. 18, 1913.	401	8,462½
Buttercup.....	Grade.....	6	July 3, 1912.	443	7,578
Ottawa Janet 3rd.....	Shorthorn..	4	Oct. 2, 1912.	334	6,598½
Jane of Brandon.....	" ..	7	Mar. 23, 1913.	365	6,042
Rose of Brandon	" ..	9	April 16, 1912.	305	5,832½
Daisy of Brandon	" ..	8	April 1, 1912.	271	5,530½
Illuminata 4th.....	" ..	6	Feb. 22, 1912.	306	5,410
Poppy of Brandon.....	" ..	6	May 29, 1913.	200	3,284½
Brandon Beauty.....	" ..	5	May 23, 1913.	126	2,287
Ottawa Marchioness 2nd.....	" ..	8	April 9, 1913.	164	580½

¹Due to attack of inflammation of udder.

A Babcock test outfit was purchased during the season and a commencement made at testing the percentage of butter fat in the milk produced by each cow. A test is made on the 5th and 20th of each month. As the test was started in the latter part of the year, there are, as yet, no complete reports ready for publication.

WINTER RATIONS FOR DAIRY COWS.

The daily winter ration fed the dairy cows is on the average about as follows:—

Hay (clover and grasses mixed or alfalfa).....	lb.	6
Straw	"	8
Corn silage	"	32
Roots	"	6
Grain (chiefly oats and bran)	"	5 to 14

The meal ration varies with the flow of the milk and is usually 1 pound to about 3 or 3½ pounds of milk.

SESSIONAL PAPER No. 16

COST OF MILK PRODUCTION.

On April 1, 1913, a start was made at keeping the exact weight of each kind of feed given to each individual cow. This will make it possible to know the cost of producing milk from each cow, and also the profit or loss returned by each cow. As most of the lactation periods reported on began before this system of weighing feed was started, it is not practicable to show the profit and loss from every cow. Three typical cows that freshened about the time the individual feed records were started are chosen, one above average, one about average, and one of the poorest; the results from these three cows are as follows. The labour is not considered, neither is the value of the calf and of the manure.

Ottawa Janet 4th (3 years old).

Calved March 18, 1913; milked to March 31, 1914.
Feed consumed, April 1, 1913, till March 31, 1914:—

2,094 pounds grain (oats, barley and bran) at \$20 per ton.....	\$	20 94
775 pounds mixed hay at \$10 per ton.....		3 88
569 pounds alfalfa at \$12 per ton.....		3 41
775 pounds mixed hay at \$10 per ton.....		3 88
1,421 pounds straw at \$2 per ton.....		1 42
6,991 pounds corn ensilage at \$3 per ton.....		10 49
1,653 pounds roots at \$3 per ton.....		2 48
5 months pasture at \$1 per month.....		5 00
		<hr/>
	\$	47 62
Milk produced from April 1 to March 31, 8,045 pounds at 1½ cent per pound	\$	120 67
Profit on milk over cost of feed.....		73 05
Cost of feed to produce 100 pounds milk.....		59

Jane of Brandon (7 years old).

Calved March 28, 1913; milked till March 28, 1914.
Feed consumed April 1, 1913, to March 31, 1914:—

1,879 pounds grain (oats, barley and bran) at \$20 per ton.....	\$	18 79
569 pounds alfalfa at \$12 per ton.....		3 41
775 pounds mixed hay at \$10 per ton.....		3 88
1,421 pounds straw at \$2 per ton.....		1 42
6,991 pounds corn ensilage at \$3 per ton.....		10 49
1,653 pounds roots at \$3 per ton.....		2 48
5 months pasture at \$1.....		5 00
		<hr/>
	\$	45 47
Milk produced from April 1, 1913, to March 28, 1914, 5,956 pounds at 1½ cent per pound.....	\$	89 34
Profit on milk over cost of feed.....		43 87
Cost of feed to produce 100 pounds milk.....		76

Poppy of Brandon (6 years old).

Calved May 29, 1913; milked till December 28, 1913.
Feed consumed April 1, 1913, to March 31, 1914:—

1,535 pounds grain (oats, barley and bran) at \$20 per ton.....	\$	15 35
569 pounds alfalfa at \$12 per ton.....		3 41
775 pounds mixed hay at \$10 per ton.....		3 88
1,421 pounds straw at \$2 per ton.....		1 42
6,991 pounds corn ensilage at \$3 per ton.....		10 49
960 pounds roots at \$3 per ton.....		1 44
5 months pasture at \$1.....		5 00
		<hr/>
	\$	40 99
Milk produced from May 29, 1913, to December 15, 1913, 3,284½ pounds at 1½ cent.....	\$	49 27
Profit on milk over cost of feed.....		8 28
Cost of feed to produce 100 pounds of milk.....		1 25

BRANDON.

5 GEORGE V., A. 1915

COST OF FEED FOR MATURE BULL FOR ONE YEAR.

Butterfly King 21st (age 4 years). Weight at beginning of year, 2,070 pounds.
Weight at end of year 2,335 pounds.

Feed consumed April 1, 1913, to March 31, 1914:—

2,609 pounds grain (oats, barley and bran) at \$20 per ton.....	\$	26 09
639 pounds alfalfa at \$12 per ton.....		3 83
2,400 pounds mixed hay at \$10 per ton.....		12 00
2,056 pounds straw at \$2 per ton.....		2 06
8,179 pounds corn ensilage at \$3 per ton.....		12 22
540 pounds roots at \$3 per ton.....		81
Total cost for year.....	\$	57 01

COST OF RAISING HEIFERS.

Brandon Maid 2nd (from birth to six months).

Born September 29, 1913. Weight at birth, 65 pounds. Weight March 31, 1914, 390 pounds.

Feed consumed September 29, 1913, to March 31, 1914:—

2,199 pounds whole milk at 1½ cent per pound..	\$	32 98
134 pounds corn silage at \$3 per ton..		20
24 pounds straw at \$2 per ton..		2
21 pounds alfalfa at \$12 per ton..		6
153 pounds mixed hay at \$10 per ton..		77
144 pounds grain (oats and bran) at \$20 per ton..		1 44
Total..	\$	35 47

Marchioness 9th (from 3 months to 15½ months).

Born December 21, 1912. Weight April 1, 1913, 165 pounds. Weight March 31, 1914, 735 pounds.

Feed consumed during year:—

2,604 pounds of whole milk at 1½ cent per pound..	\$	39 06
1,680 pounds corn silage at \$3 per ton..		2 64
364 pounds straw at \$2 per ton..		36
460 pounds alfalfa at \$12 per ton..		2 86
427 pounds mixed hay at \$10 per ton..		2 13
594 pounds grain (oats, barley, and bran) at \$20 per ton.. . .		5 94
Total..	\$	52 99

Brandon Marchioness Bess (from 16½ months to 28½ months).

Born November 20, 1911. Weight April 1, 1913, 785 pounds. Weight March 31, 1914, 1,185 pounds.

Feed consumed during the year:—

5,943 pounds corn silage at \$3 per ton..	\$	8 36
784 pounds straw at \$2 per ton..		78
371 pounds alfalfa at \$12 per ton..		2 23
751 pounds mixed hay at \$10 per ton..		3 75
630 pounds grain (oats, barley and bran) at \$20 per ton.. . . .		6 30
Total..	\$	22 02

EXPERIMENTAL FARM, INDIAN HEAD, SASK.

REPORT OF THE SUPERINTENDENT, T. J. HARRISON, B.S.A.

DUAL-PURPOSE CATTLE.

On the Indian Head Experimental Farm at present there are in all about forty-eight head of breeding cattle, made up as follows:—

Shorthorns: 1 bull, 7 aged cows, 16 milch cows, 9 two-year old heifers, 3 yearling heifers, 2 heifer calves, 6 bull calves.

Grades: 4 cows.

These are not all dairy cattle, as a number of the cows are of strictly beef type. The object, however, of maintaining the herd is to develop, if possible, the dual-purpose Shorthorn; in other words, a non-specialized farmer's cow. With this end in view, during the fall of 1913 there was purchased a yearling bull, "King Edward," of a good milking strain, and sired by "Butterfly King," one of the best dairy sires of the breed in Canada. With this bull at the head of the Shorthorn herd, in which are already a few promising individuals, there is hope of developing a profitable milking type that would be suitable to the average farmer in southern Saskatchewan. Among the young cattle especially there are some fair individuals, and with the culling out of a number of old cows whose days of usefulness are over, we will be in possession of some good foundation stock which, with judicious handling, should develop into a creditable herd of dual-purpose Shorthorns.

In former years this herd was treated strictly as a beef herd, the calves being allowed to suck their dams. Now, all the cows are being milked by hand and a record taken of the amount of milk and butter-fat produced in each lactation period. None of the cows have yet completed a lactation period since the commencement of keeping records, and therefore cannot be reported further than that three or four are milking very satisfactorily. One drawback is found to this work. It is that the cows that have suckled their calves in former years have commenced to drop off in their milk production very early in their lactation period. The reason for this is that the cow was allowed to go dry early when suckling her young and the habit has now become second nature with her. Not much is expected from these cows except that they may raise a few promising heifers. Therefore, our most reliable foundation will be the heifers that are yet to freshen.

This experiment will require a number of years before results are forthcoming. However, as there is such interest being taken in the dual-purpose cow in the West it seems that the development of this cow would be a profitable line to follow. The grain farmers require a cow that will give a large flow of milk and produce a calf that will develop into a good beef steer.

It is also the endeavour to begin an experiment to determine the profits from a dual-purpose herd by keeping data in regard to the cost of production of milk and butter-fat from the cows, and the cost of rearing calves, yearlings, and 2-year-old Shorthorn heifers.

EXPERIMENTAL STATION, LACOMBE, ALTA.

REPORT OF THE SUPERINTENDENT, G. H. HUTTON, B.S.A.

DAIRY CATTLE.

Experiments were conducted in January, February, and March to determine the comparative feeding value of timothy and green feed, and also to fix a value for roots when fed in conjunction with either of these bulky fodders.

The results indicate the advantage of feeding roots in reducing the cost of production of milk. These tests will be repeated next season to verify the results before publishing.

Nineteen head comprise the herd of pure-bred Holstein cattle, eleven of which are females of breeding age. Besides those whose records are published herewith, a number are making a very satisfactory showing. Not having completed their lactation period at the end of the fiscal year, their production to date is not shown. The heifer "Lawnerest Rosa Echo" gave 11,143 pounds milk in twelve months after freshening for the first time at about three years of age. The 2-year-old heifer, "Rhode De Kol Beets" produced 7,322.6 pounds of milk from August 3 to March 31. A number of these animals are entered in the R.O.P. test.

The pure-bred Jerseys at this Station now number six, three of which are of breeding age. The 3-year-old heifer "Brampton Wolseley Girl" is making a good showing in her 3-year-old form.

Records are being kept of the production of a number of grade cows which were selected in the hope of being able to secure a grade herd representing the average dairy herd of the province. These cows are being bred to the Holstein bull "Royalton Korn-dyke Count", 13237, whose pedigree is one of the best in Canada. The object of this experiment is to determine the influence of the sire of high-producing pedigree in raising the production of common herds by grading up.

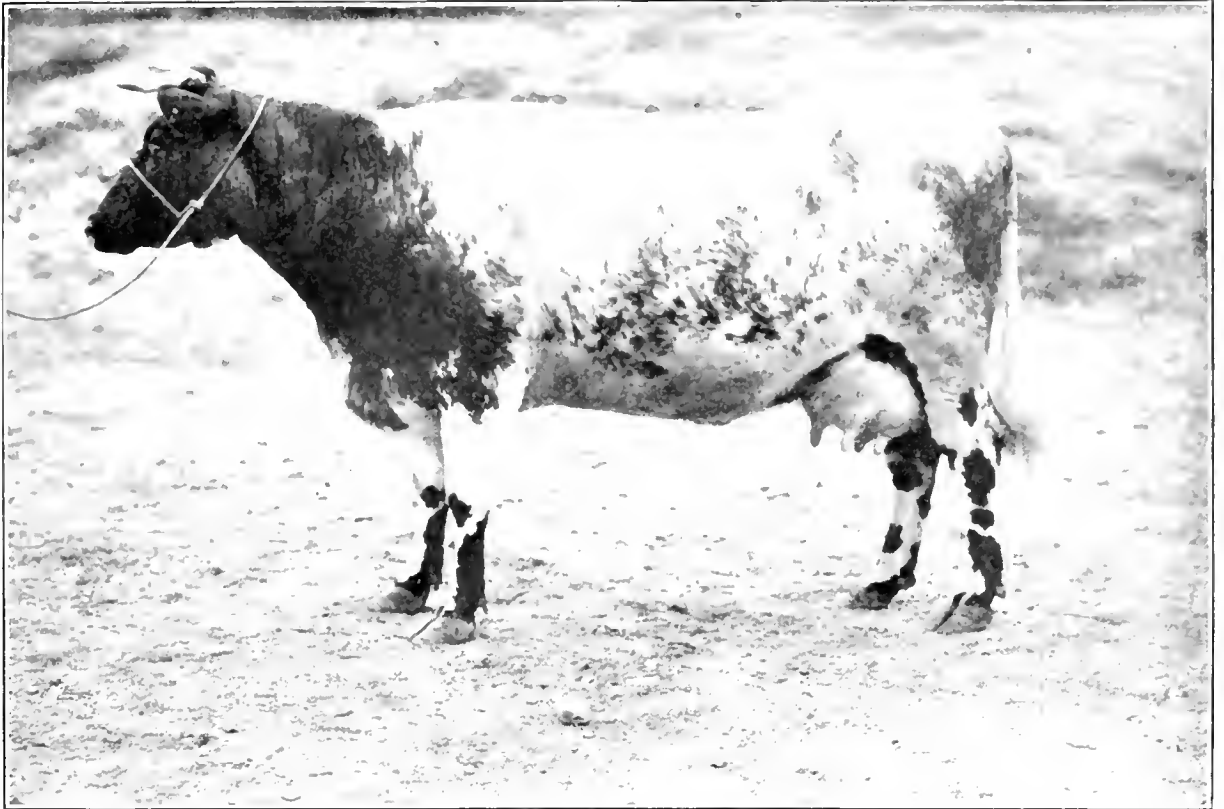

Brandon : Ottawa Marchioness 5th (dual-purpose Shorthorn). Gave 11,335 lb. of milk in one milking period.

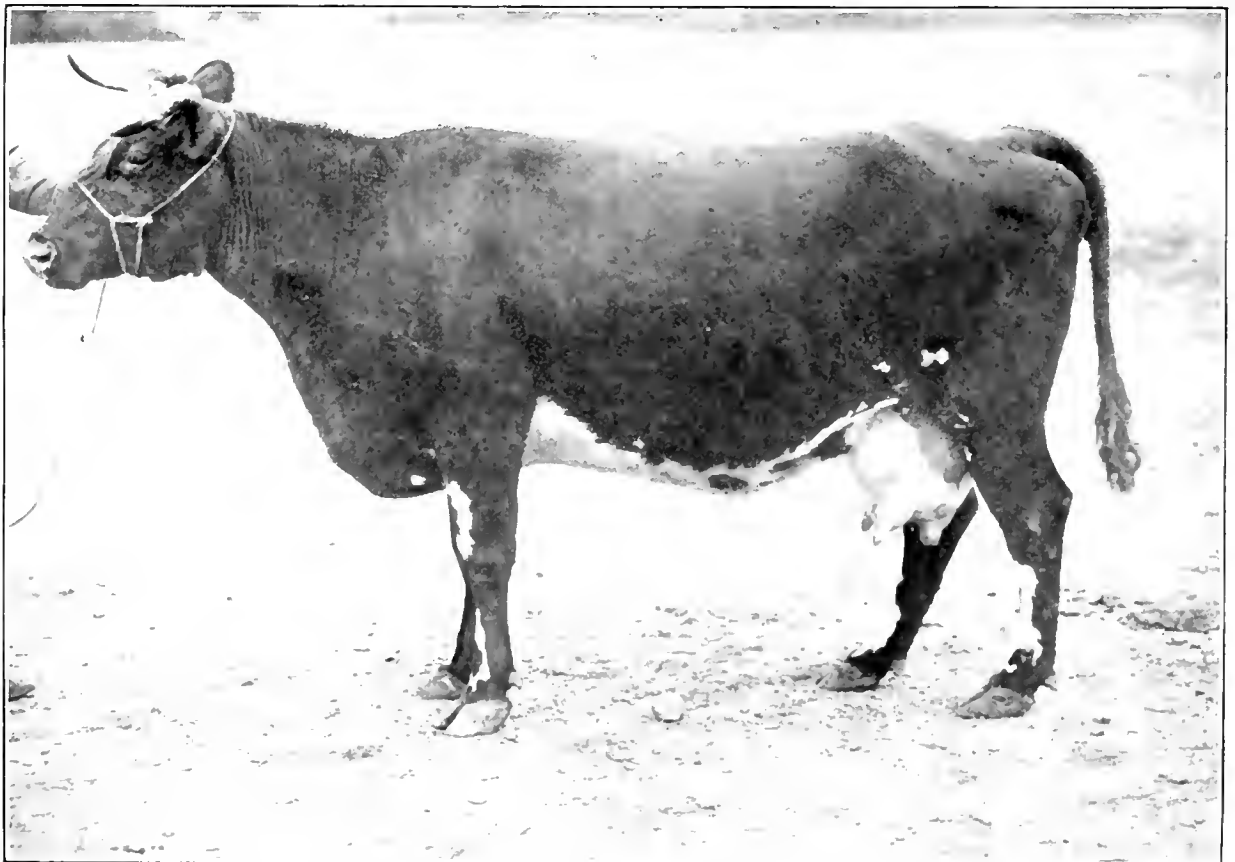

Brandon : Illuminata 3rd (dual-purpose Shorthorn). Gave 10,387 lb. of milk in one milking period.

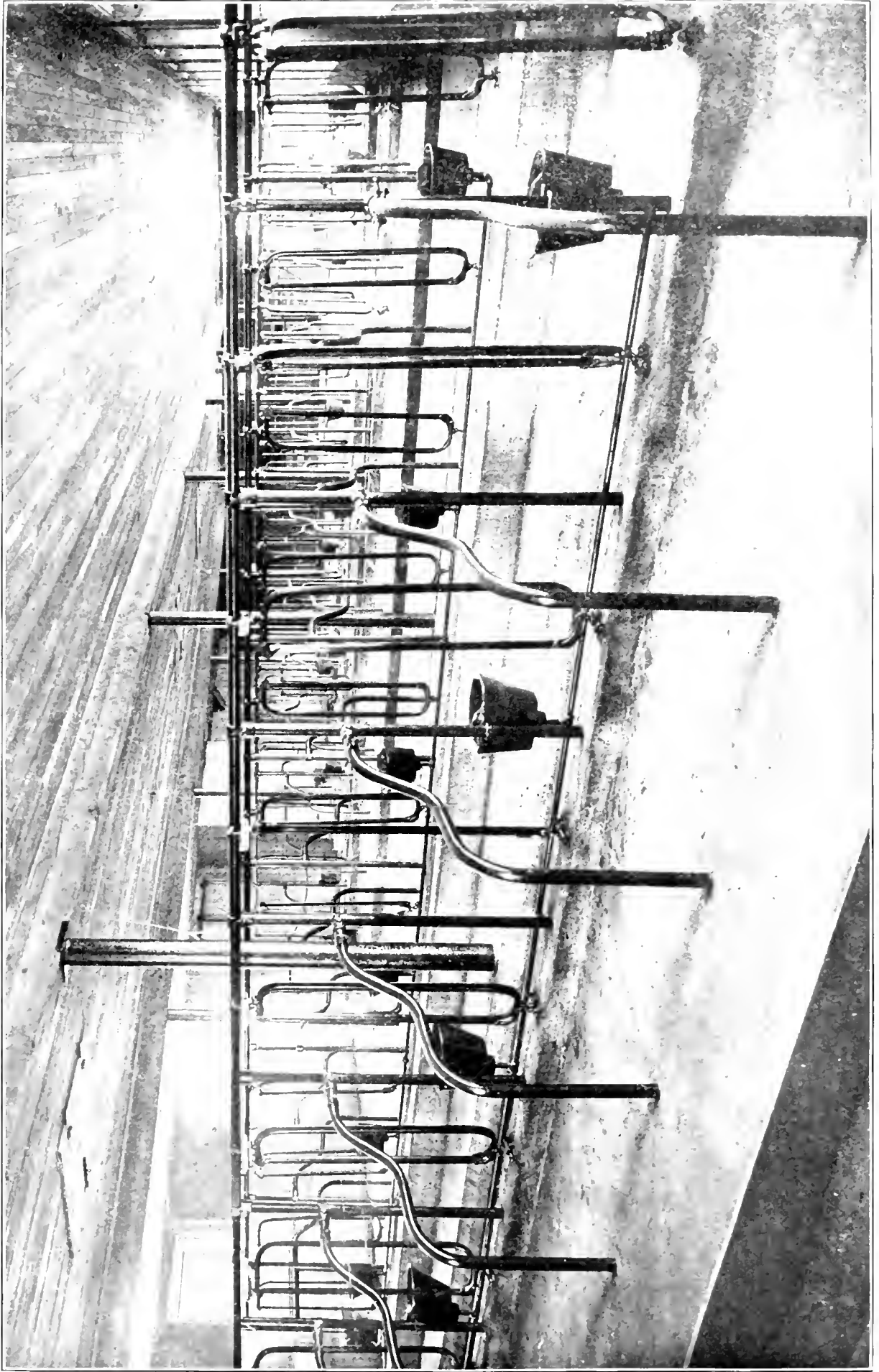

Interior of Dairy Stable, Indian Head, Sask.



Part of Dairy Herd, Latcombe, Alta.

SESSIONAL PAPER No. 16

DAIRY COW RECORDS.—Record of Dairy Herd, Lacombe Station.

Name of Cow.	Age at beginning of Lactation	Date of Dropping Calf.	Number of days in Lactation	Total pounds of Milk for Period.	Daily average yield of milk.	Value of Milk at \$2 per cwt.	Total value of product.	Amount of meal eaten at 1 cent per pound.	Amount of Roots eaten at \$3 per ton.	Amount of Hay eaten at \$10 per ton.	Amount of Green feed eaten at \$10 per ton.	Months on pasture at \$1 per month.	Total cost of food between calvings.	Cost to Producer 100 lbs. Milk.	Profit on 100 lbs. Milk.	Profit on (low base) between calvings (four and eight neglected).
			lb.	lb.	lb.	\$ cts.	\$ cts.	lb.	lb.	lb.	lb.		\$ cts.	cents.	\$ cts.	\$ cts.
Lawnerest Lee Beets.....Hol	2	Feb. 26, 1913	365	8166.7	22.4	163 33	163 33	1,702	2,837	2,470	2,907	5 1/2	53 65	65.7	1 31	109 68
Maud Sarcastic.....Hol	2	Feb. 11, 1913	332	6326.1	19.1	126 52	126 52	1,581	865	1,715	2,497	5 1/2	43 66	69.0	1 31	82 86
Princess Margaret HolbonHol	2	Feb. 9, 1913	444	9923.8	22.3	198 48	198 48	1,974	2,575	2,315	3,291	5 1/2	57 27	57.7	1 42	141 21
Concordia Princess.....Hol	5	Feb. 25, 1913	272	6162.4	22.7	123 25	123 25	1,232	1,370	2,131	5 1/2	55 32	57.3	1 43	87 93
Brampton Wolsley Thelma Jer.	3	Nov. 24, 1912	341	5054.1	14.8	101 08	101 08	1,262	1,961	2,278	5 1/2	39 33	78.8	1 21	61 75
Grade Holstein No.13.....	2	Apr. 25, 1913	309	7732.1	25.0	154 64	154 64	1,925	1,782	2,780	5 1/2	47 56	61.0	1 39	107 08
Grade No. 5.....	9	Feb. 13, 1913	284	5811.1	20.5	116 22	116 22	1,458	1,831	2,053	5 1/2	39 49	67.9	1 22	76 73
Grade No. 1.....	4	Jan. 1, 1913	365	7230.3	19.8	114 61	144 61	1,813	508	2,275	3,124	5 1/2	51 38	71.1	1 29	93 23
Grade No. 7.....	7	Dec. 25, 1912	329	7923.4	24.1	158 47	158 47	1,995	1,863	2,736	5 1/2	48 41	61.1	1 39	110 63
Grade No. 4.....	8	June 1, 1913	176	3087.7	17.5	61 75	61 75	871	288	331	5	16 95	54.9	1 45	44 80
Grade No. 31.....	3	June 4, 1913	241	3723.2	15.5	74 46	74 46	1,020	715	1,147	1,317	5 1/2	31 39	84.1	1 16	43 16
Average of 11 head.....	5		314	6467.3	20.3	129 35	129 35	1,530	682	1,735	2,313	5.4	42 21	66.2	1 34	87 13

DAIRY PRODUCTS.

The complete equipment for the dairy was slow in arriving, rendering it impossible to finish the installation till November. The boiler was the last to arrive, but since hot water was available from the furnace in the basement of the dairy building for some time, work of the dairy was not seriously handicapped for lack of live steam. Sweet cream has been shipped to Edmonton during the entire season, and for this cream the current price has been received, which is at present on the basis of 34 cents per pound butter fat f.o.b. Lacombe. Commencing in July, cream cheese have been made in limited numbers, and have been offered the local market. As yet the quality of these cheese appears somewhat variable in character and it cannot be said at present that a market for this product has been established. Those who are within shipping distance of Edmonton and Calgary find a profitable outlet in these cities for milk, cream, and butter.

EXPERIMENTAL FARM, AGASSIZ, B.C.

REPORT OF THE SUPERINTENDENT, P. H. MOORE, B.S.A.

DAIRY CATTLE.

The most important work in the dairy herd of Holstein-Friesian cattle this past year has been: first, the breeding work; and second, the testing of the various individuals with the object of having uniform groups for experimental purposes. Five grade cows of the original herd have been sold to the butcher. For various reasons they were both unprofitable and unsuitable for experimental work.

Only one loss is reported during the year. Cow No. 27 died from septicæmia at calving time, in spite of the fact that the best of veterinary attention and nursing had been given her. The only other serious trouble encountered this year was the poisoning of a yearling heifer in March; this did not prove fatal. The heifer is suspected of having eaten something poisonous in the field when first turned out. She became totally paralyzed but was treated for dietetic poisoning and very slowly recovered. Some inconvenience was experienced with sore teats, but as soon as there was a change from hard to liquid soap for washing the milkers' hands, the trouble disappeared. This may have been only a coincidence, but it seemed at the time that the infection was being carried on the cake of soap. However, no bacteriological tests were made, but when the liquid soap was used the trouble disappeared.

Of the twenty cows which finished a lactation period this year, 50 per cent gave heifer calves; all of these calves were raised. The 2-year-old heifers of unknown breeding have grown well, and some are about ready to freshen. They were divided into two groups for breeding. One lot was bred to come in at 24 to 25 months of age, and the others bred to come in at 28 to 30 months. Nearly all the yearlings will be carried over and bred to come in during the autumn, when they will be, as near as possible, 30 months old. The average results for the whole herd are better this year than they were last year. The cows have become thoroughly acclimatized and are responding more to food and care. The average lactation period is not as long as last year, because it did not pay to keep some of the old grade cows unless they had a calf at least once in twelve months.

The increase is also partly due to feeding silage during the summer when the pasture became short. There are several cows to be culled out of this herd during the next year. They will be discarded as soon as the heifers are ready to replace them.

It seems well to say a word here concerning the method of handling the cows during the past year. The treatment is substantially the same as that given last year, with a few exceptions. The cows are milked at 5 a.m. then fed silage, roots, and grain. After breakfast the cows are turned out and the stables are cleaned, and fresh bedding is put down. If the weather is fine the cows remain out until 1.30 p.m., and if it is cold or wet they are let in as soon as the stables are prepared. At three o'clock they are again fed silage, roots, and grain, after which they are prepared for milking, which begins at 4.30 p.m. After milking, the floors are swept, and, lastly, the cows are given a feed of long hay, which they eat up clean before morning. Where silage is fed heavily, this method has proved more economical than when the hay is chaffed and fed with the silage. It has, besides, two distinct advantages: it gives the cows some-

5 GEORGE V., A. 1915

thing to work at during the longer period between feeds, and also keeps down the dust during milking.

When the cows are groomed it is generally done as soon as they have come in from the yard. In summer they are in the stable only as long as it takes to milk them or to feed anything which may be given to supplement pasture.

Below is given a table showing the records of each cow which has finished a lactation period since the last report. At each milking the milk was weighed and a small quantity taken for a composite sample; these samples were tested every five days, thus giving a very detailed record of production during the whole period. Accurate figures were taken of all the food consumed and the cost of this was estimated from the following prices:—

	Per ton.
Clover hay..	\$ 10 00
Corn silage..	3 00
Roots..	3 00
Bran (car lots)..	20 00
Brewers' grains (dried)..	22 50
Soy bean cake..	45 00
Oil cake (flax)..	45 00
Wheat Germ meal..	33 00
Salt..	9 50

SESSIONAL PAPER No. 16

RECORD OF DAIRY HERD.—Agassiz, B.C.

Cow No.	No. days milked	Total milk produced.	Average per cent. fat in milk.	Amount fat produced in period.	Amount meal consumed.	Amount roots and silage consumed.	Amount of hay consumed.	Amount of green food consumed.	Months on pasture at \$2.	Total cost of food for period.	Profit on product.	Cost to produce 100 lb. milk.	Cost to produce 1 lb. of butter.
		lb.	%	lb.	lb.	lb.	lb.	lb.		\$ cts.	\$ cts.	cents.	cents.
2	247	7005.6	3.3	232.69	1469	8058	1422	1680	3	49.61	82.49	70.81	17.76
4	339	9011.4	3.7	334.57	1691	16152	1735	1680	3	60.63	126.92	67.28	15.09
6	298	8033.6	3.44	274.82	1497	11617	1369	1680	3	56.66	98.82	70.	17.18
8	347	7747.9	3.73	285.33	1550	11731	1579	1680	3	55.005	105.052	70.99	16.06
11	272	8042.6	3.66	287.52	1510	7554	1181	1680	3	49.37	117.18	58.65	13.1
13	341	7874.3	3.3	265.06	1668	11214	1753	1680	3	61.65	88.59	78.32	19.38
14	344	7533.6	3.49	308.98	1500	13718	1569	1680	3	51.78	116.66	72.71	15.65
15	280	7003.5	3.9	273.3	1118	11939	1325	1680	3	46.92	105.48	66.99	11.30
16	250	6695.	3.82	254.81	1076	6829	926	1680	3	41.10	101.36	61.40	26.56
17	314	9416.8	3.6	310.08	1761	15309	1691	1680	3	61.39	129.83	65.30	15.04
18	306	6069.9	3.06	186.06	1144	14221	1553	1680	3	49.96	56.72	82.30	22.35
19	288	7656.7	3.47	266.99	1606	9831	1454	1680	3	52.00	98.71	67.85	16.23
20	294	7115.2	3.	244.25	1140	13770	1177	1680	3	46.86	76.27	65.85	18.28
21	312	8120.	3.2	259.45	1731	13888	1650	1680	3	58.61	89.35	70.21	18.83
22	287	6908.8	3.6	252.67	1267	11781	1317	1680	3	48.92	93.01	70.19	16.13
24	236	6782.9	3.76	252.05	1304	7601.5	1318.5	1680	3	41.90	96.35	66.19	14.84
25	316	9577.9	3.2	306.85	1613	12242	1596	1680	3	51.96	120.01	57.38	14.92
26	262	6655.8	3.6	230.82	1045	8334.5	1025.5	1680	3	40.06	90.32	60.20	14.46
*61	301	14510.6	3.6	415.67	2061	10276	3390	1680	3	60.58	173.45	52.63	12.48
*75	323	10938.7	3.5	390.02	2436	12485	1395	1680	3	63.12	156.20	57.97	13.59
Average	296	7987.62	3.52	283.09	1496	11330.7	1532.8	1680	3	52.87	106.14	66.65	16.57

* Pure-bred Holstein cows.

Last year was reported the production of the five most profitable and the five least profitable cows. The difference in profit last year was \$50.15. Since that time some of the poorest cows have been culled out, but this year the difference is \$62.54. Last year the poorest five averaged \$67.68 profit, with a food cost of \$36.62; this year the average of this class was \$78.68 profit and a food cost of \$52.54. The greatest difference is in the best five. A year ago the food of the five best cows cost \$54.27 per cow, and they made \$117.83 profit. This year the food cost per cow for the best five was \$60.19 and they gave a profit of \$141.22. This difference can be accounted for by a variety of reasons. First, two pure-bred Holstein-Friesian cows have been added to the herd, and their records are the two best. All the cows are acclimatized and are beginning to respond to good care and food. All the stock was fed more silage, roots, and grain, and the average length of lactation period was not so long. The performances of the most profitable and least profitable five for this year are charted below.

—	Number of days milked.	Yield of Milk.	Yield of fat.	Cost of food	Profit over food.
		Lb.	Lb.	\$ cts.	\$ cts.
Five most profitable cows.....	301	11510 6	415 67	60 58	173 15
	323	10938 7	390 02	63 42	156 20
	316	9577 9	306 85	54 96	129 83
	314	9416 8	340 03	61 39	129 01
	339	9011	334 57	60 63	126 92
Average.....	318 6	10091	357 438	60 19	141 22
Five least profitable cows.....	247	7005 6	232 69	49 61	82 49
	341	7871 3	265 06	61 65	88 59
	306	6069 9	183 06	49 96	56 72
	294	7115 2	214 25	46 86	76 27
	312	8120	259 45	54 64	89 35
Average.....	300	7236 4	230 902	52 54	78 68

Most Profitable Cow versus Least Profitable Cow.

Cow No.	No. of days milked.	Yield of milk.	Yield of fat.	Cost of food.	Profit over food.
		Lb.	Lb.	\$ cts.	\$ cts.
61	301	11510 6	415 67	60 58	173 15
18	306	6069 9	183 06	49 96	56 72

Statement for Two Years.

Average of Five Cows.	Five most profitable cows.		Five least profitable cows.	
	1912-13.	1913-14.	1912-13.	1913-14.
Number of days in lactation period..	345	318	270	300
Total yield of milk.....Lb.	9637 2	10091 0	6136 2	7236 4
Total yield of butter fat.....Lb.	344 2	357 43	208 6	230 90
Total cost of food.....\$	54 27	60 19	36 62	52 54
Total profit over cost of food.\$	117 83	141 22	67 68	78 68

SESSIONAL PAPER No. 16

DAIRY STABLE NOTES.

The stable has now been in use for three winters and definite results regarding the construction and fittings from a practical point of view may be mentioned.

The window ventilation has proven quite adequate for this climate. This stable accommodates forty-two head of cows. There are 767 cubic feet of air-space per cow and 10 square feet of glass per cow. Although this space was not filled with full-grown cattle, yet every stall was occupied this past winter.

Careful record has been kept of the temperatures, both morning and evening at 5 o'clock, throughout the housing season. The average morning temperature was 55.06°, and the average evening temperature was 52.8°. The highest morning temperature was 60°, and the highest evening temperature was 66°; the lowest at both times has been 50°. Both extremes occurred in reasonably warm weather in March. The barn has always been free from moisture or foul air.

This past season water bowls were installed, one between every two cows. This improvement cost, including our own labour, \$4.10 per cow. Watering from the concrete manger gave good results, considering that there was no money outlay, but the bowl system is an improvement and has none of the objections of the former system. Any protection the bowl system gives to the health of the cows, or any increase in milk flow or general condition, should pay for the cost of installation. In installing this system, the main feed pipe was placed on top of the concrete dyke which holds the stanchions, instead of putting it on the bottom of the manger, as is often done. This is found a decided advantage in that it keeps the mangers clean. (See plate xxviii.)

Last year was reported the stripping of the iron stall fixtures of all their "extras." The barn has been kept thus during this year and is found satisfactory. The iron manger is the most unsightly and unsatisfactory portion of the present equipment.

The gutter, which is 7 inches deep next the cows, 20 inches wide, and 4 inches next the alley, has given the best of results for even our largest cows. The 5-foot stand has proven ample for the largest cows, and has never allowed dirt to collect. The 3-foot 6-inch width has been wide enough for the average, but hardly wide enough for the largest cows, *i.e.*, those over 1,400 pounds. The concrete stand is dry and comfortable, but needs a lot of bedding to prevent teat trouble. Straw was very scarce last year and there was difficulty with bruised teats.

On the whole, the stable is light, airy, comfortable, and convenient to work in, without having any tendency to faddishness or luxury.

CALF REARING.

To date no experiments have been made on the rearing of heifer calves. A few well known general principles have been followed very closely and as yet no failures are to be reported.

It may be useful to some to outline here the method which has been followed and found very satisfactory. The cows, when dry, are fed a small amount of grain and enough succulent food to put them in good condition. As parturition approaches, they are fed some laxative food such as linseed meal (flax oil cake), in addition to the regular ration. In almost every case all the calves born were perfectly healthy. In some cases calves were born with goitre, but, without treatment, this malady has always disappeared. The calf is left with the cow until it has had at least one good meal of the colostrum. It is then taken away and fed three times a day on warm, whole milk. The amount is varied according to the individuality of the calf. They are fed regularly, and each has meal as nearly as possible equal. They are always fed under the limit of their appetites. After three weeks a small amount of skim-milk is added to the ration. The skim-milk is increased gradually until at four months of

age, all the whole milk is supplanted by skim-milk. At about three weeks of age the calves are taught to eat bran and oats, and in a week or two later, some pulped mangels and silage are added. After the first month clean water is kept before them all the time. The chop and roots are seasoned with a little salt. Clover hay is kept before them all night.

The pens are light and well ventilated, clean, and not over-crowded. The calves are allowed into the yard to exercise when the weather is favourable. They are never left out in extreme wet, cold, or heat.

One thing in which great care has been taken is the cleanliness of the pail from which the calf drinks. These pails are washed after each feed, and although it takes time, it is time well spent.

The points which we try to keep in mind and practise are: Good food, regularly given; light pens, kept clean and dry; and reasonable exercise, with protection from extremes.

Below is given in detail the average cost of a bunch of calves, grown to 1 year of age. These calves were never fat, but were always in thrifty, growing condition throughout the entire year.

COST TO RAISE GRADE HOLSTEIN-FRIESIAN HEIFERS.

First period, 225 days—		
Average weight at birth..	pounds	72
Average weight at 225 days..	"	461·6
Average gain in weight in 225 days..	"	389·6
Average gain in weight per day..	"	1·7
Average cost per pound gain..	cents	6·8
Food consumed per calf—		
Whole milk, 888 pounds at 1·8 cents..	\$	15 98
Skim-milk, 2,326 pounds at 25 cents..		5 81
Bran and oats, 440 pounds at 1 cent..		4 40
Mangels, 160 pounds at ·25 cent..		40
		<hr/>
Total cost for period of 225 days..	\$	26 59
Second period, 140 days—		
Average weight at beginning..	pounds	461·6
Average weight at close..	"	618·3
Average gain in weight per period..	"	176·7
Average daily gain per calf..	"	1·2
Average cost per pound gain..	cents	4·4
Food consumed per calf—		
Silage, 1,365 pounds at ·15 cent..	\$	2 04
Clover hay, 95 pounds at ·5 cent..475
Green feed, 450 pounds at ·15 cents..675
Bran and oats, 364 pounds at 1 cent..		3 60
Oil cake, 46 pounds at 2·25 cents		1 03
		<hr/>
Total cost for period of 140 days..	\$	7 86
Total cost for 365 days..	\$	34 45
Total gain for 365 days..	pounds	546·3
Average daily gain for 1 year..	"	1·5
Cost per pound gain for 1 year..	cents	6·3

VEAL CALVES.

Three lots of calves were fed for veal. The ration used was fresh, whole milk. The periods varied from thirty-four to forty-eight days, and the calves used were grade Holstein bulls. Lot 3 contained one calf from a dam that was at least three parts Shorthorn.

Considering the price paid for milk on this market, it does not pay to veal calves on an exclusive whole-milk ration. It will be noticed in the chart below that the most expensive lots were those getting over a gallon and a half for the longer period. The

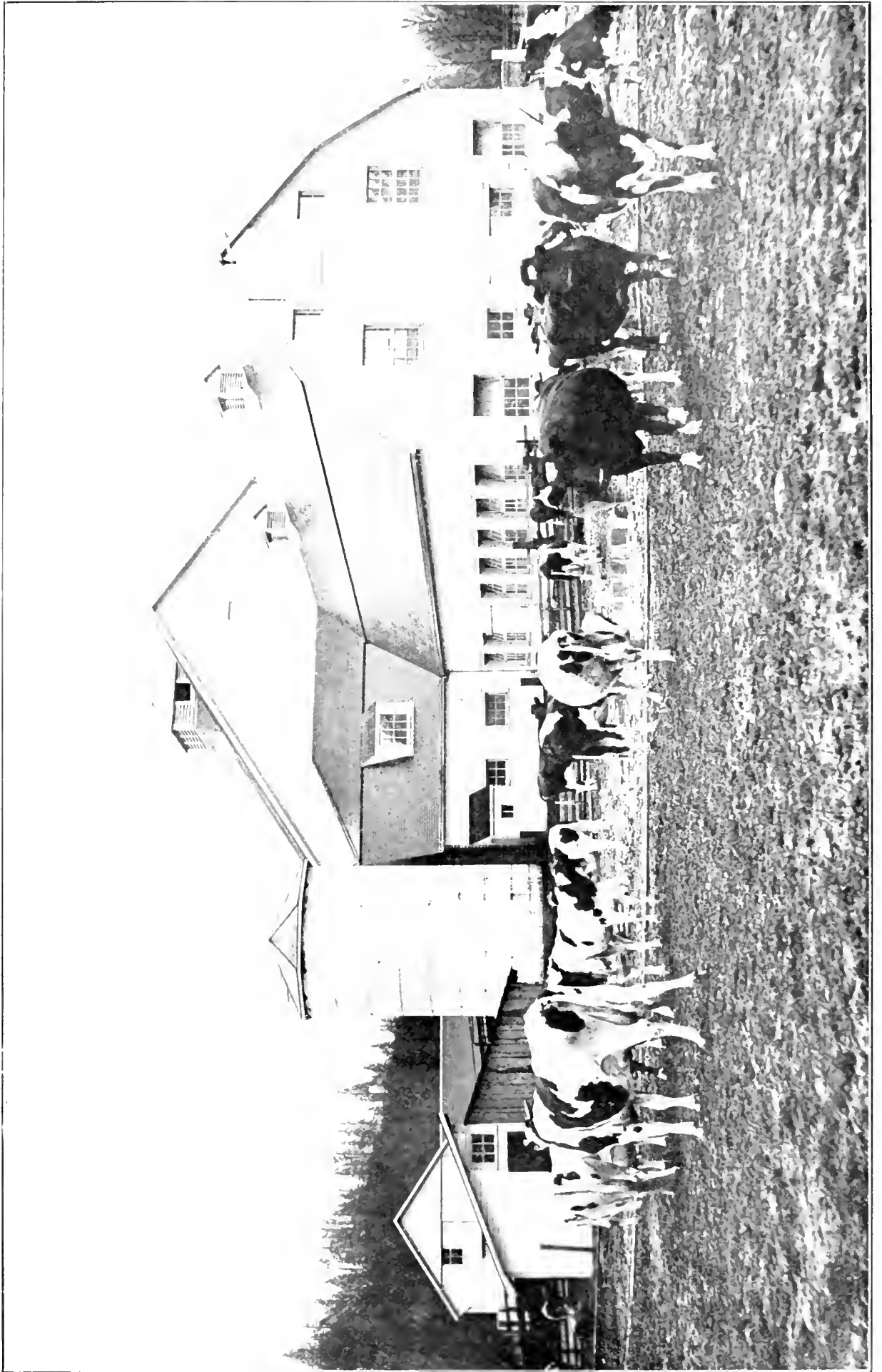

Agassiz Dairy Herd in winter exercising Yard. Buildings from left to right :—Sheep-shed, silos, feed-room and granary, main barn and dairy stable.

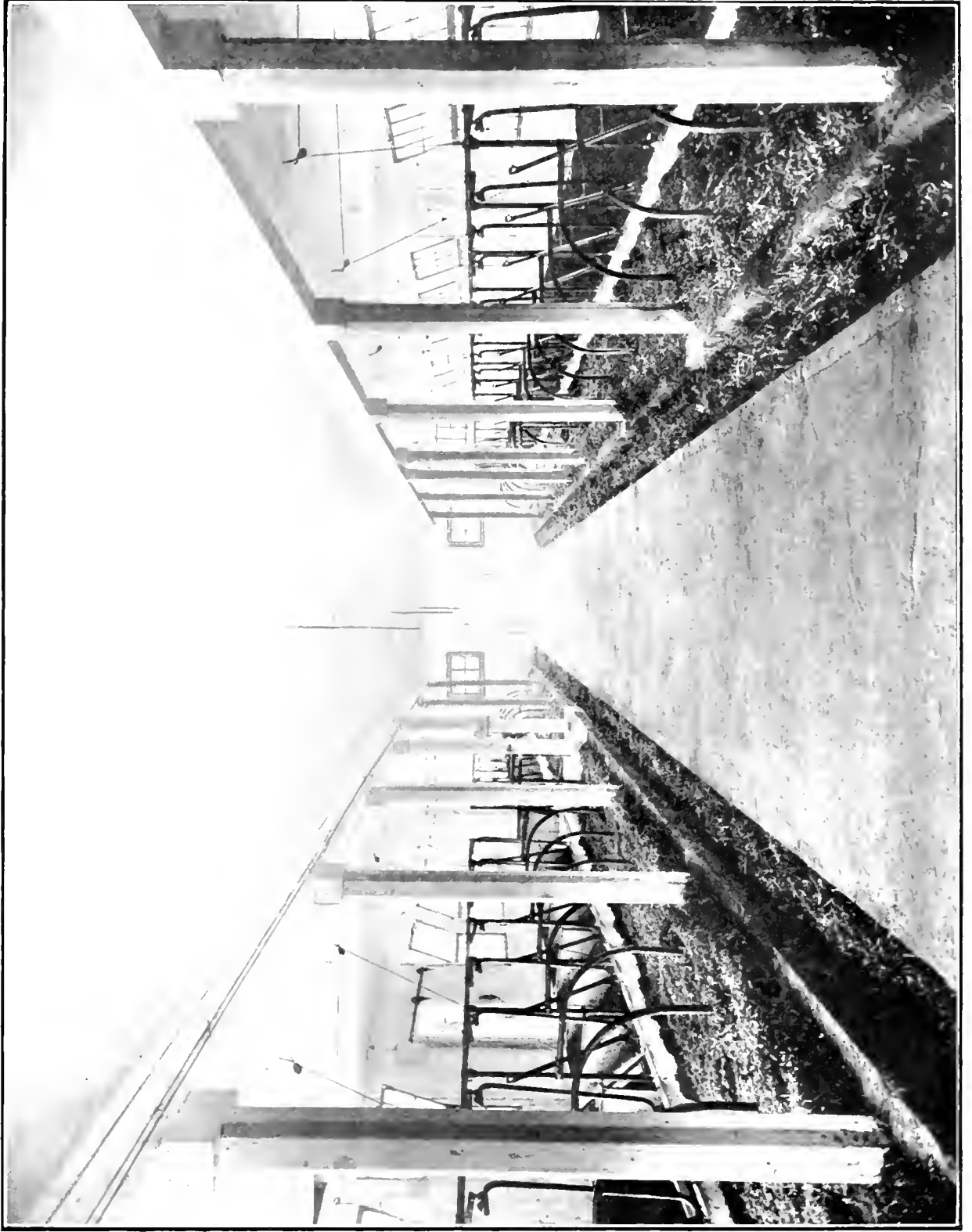

Interior of Dairy Stable, Agassiz, B.C.

SESSIONAL PAPER No. 16

cheapest lot was fed less than a gallon of milk per day, and they were turned off early, although the daily gain was much greater in the two most expensive lots.

The following chart gives the results of the three lots in detail:—

	Lot 1.	Lot 2.	Lot 3.
Average weight at birth. Lbs.	78	82	89
Number of days fed "	48	25	34
Average gain per period. "	96	74	51
Average daily gain per period. "	2	2.1	1.5
Pounds whole milk fed per period "	755	540	314
" of milk fed per day per calf "	15.7	15.4	9.2
" " for 100 pounds gain. "	786.4	729.7	615.6
Cost of 100 pounds gain, milk at \$1.80 per 100 pounds. \$	14.15	13.34	11.08

PURE MILK PRODUCTION.

Below are given the results of some bacteriological tests of milk in barn and dairy. We desire here to express our appreciation of the courtesy of Mr. G. H. Unwin, of the Health of Animals Branch here, by whom the bacteriological work was done.

During the months of February, March, and April, 1914, a number of bacterial counts were made with the milk of the dairy herd. The object of these tests was two-fold:—

- (1) To ascertain approximately the quantity of bacteria taken up by milk in the process of handling, from the cow to the consumer's bottle.
- (2) To find the relation between the number of bacteria in the air of the barn at milking and the number in the milk.

METHOD OF HANDLING MILK IN BARN AND DAIRY.

The cows are driven in from pasture or yard an hour or more before milking. The ensilage, grain, and roots are fed, and then some time is allowed to pass before milking is begun. All sweeping and hay-feeding is done afterwards. The men milk in white coats and overalls; and after milking each cow the bands are washed at a tap and dried with a paper towel, which is then thrown away. The udder is wiped with a damp cloth. It might be mentioned here that the cows are usually groomed after the morning milking during the winter months. Closed pails are used and the milk, after being weighed, is poured into closed cans. It is then taken to the dairy, a distance of about 60 feet, cooled, strained, and put into bottles. In the dairy all utensils are washed and scalded after using, and then left exposed to air and sunlight. It will be seen that the methods employed are simple, the object being to produce pure milk by means of care and cleanliness, without the use of an elaborate and expensive outfit.

(1) COMPARATIVE TESTS OF MILK FROM UDDER, FROM PAIL, AND FROM COOLER.

Method of Quantitative Testing for Bacteria.—Three samples were taken from each cow. The first was drawn from the teat, the second poured from the milk-pail, the third was run through the cooler, strained, and then dipped into the milk bottle. Sterile bottles were used in each case. The milk thus obtained was plated in the following manner:—

From the sample bottle 1 c.c. of milk was taken with a sterile pipette, and allowed to drop into a bottle containing 200 c.c. of sterile water, where it was well mixed by shaking. Of this dilute mixture, 1 c.c. was drawn out and poured into the

Petri dish. The Agar medium was cooled to about 40°C. and poured into the dish, the whole being then mixed and spread over the plate. The plates were then placed in the incubator at 37°C. and left for forty hours. This is a long incubation period, a fact which should be remembered in considering results. Two plates were used with each sample, to check results. It was found that the dilution used (200: 1) was convenient, the colonies spreading out well and being easily counted. This is the method followed by W. H. Park, N.Y. (*Journal of Hygiene*, July, 1901). The following table shows the results of the first series of tests:—

TABLE "A."

Date.	Number of Cow.	Milk from Teat per c. c.	Milk from Pail, per c. c.	Milk from Cooler, per c. c.
Feb. 17.....	19	600	2,400	6,600
" 19.....	24	800	Spreading growth.	3,500
" 20.....	87	600	3,200	6,000
" 23.....	2	3,600	5,400	8,200
" 25.....	3	Sterile.	17,600	39,000
" 26.....	4	10,000	13,600	16,000
" 27.....	30	1,000	4,000	9,000
Mar. 4.....	33	200	3,300	12,000
" 5.....	31	Sterile.	2,700	6,600
" 7.....	25	"	1,800	5,200
" 9.....	13	400	2,600	6,500
" 10.....	6	800	1,000	4,600
" 15.....	36	600	Spreading growth.	9,000
" 17.....	11	2,000	5,800	20,000
" 18.....	6	3,200	4,200	21,600
Average of counts		1,587	5,154	10,987

With regard to the first column of figures, it may be observed that the milk drawn directly from the udder is not often sterile.

Five counts were discarded, it being clear in these cases that accidental contamination had occurred. Thus on February 24 the milk of No. 29 showed 6,600 per c.c. from the teat, and only 4,000 in each of the samples from pail and cooler. Again, on February 28, No. 13 showed 30,000 in the milk from the teat, and 20,000 in the milk from the pail. The first sample was obviously contaminated from some other source. Such counts as these, where an error was clearly indicated, were therefore discarded. The average of the fifteen counts tabulated gives:—

Milk taken directly from teat contained..	per c. c.	1,587
" " " pail contained..	per c. c.	5,154
" " " cooler contained..	per c. c.	10,987

Reducing this to a percentage we have the following facts indicated:—

Process 1.—Milking..	224 per cent increase.
Process 2.—Cooling and straining..	113 per cent increase.

The value of these figures is relative. Quantitative tests of bacteria cannot be taken too literally. Yet it will be seen from the table given above that the results are quite uniform, and are to be relied upon as far as they go. They will in any case serve to emphasize the fact that each additional handling of milk greatly increases the risk of contamination, even where clean methods are followed; and consequently, that simplicity and quickness of handling are of prime importance in producing clean milk.

SESSIONAL PAPER No. 16

(2) THE AIR AS A SOURCE OF CONTAMINATION OF MILK.

This series of tests was carried on during the month of April. The object, as stated above, was to find approximately the relation between the number of bacteria in the air of the barn and the number in the milk. The weather, for the most part, was sunny and dry, and, as would be expected, the counts were slightly higher than in February and March.

For the air test the method originally devised by Koch was followed. Agar plates were exposed to the air during milking. The period of exposure was three minutes; and the plates were placed upon a milking-stool, which gave about the height of the milk pail. They were exposed as near to the cow and the milker as possible, in order to reproduce the conditions of milking.

With each air test a corresponding test was made of the milk of the whole herd; the sample was taken from the milk which had been cooled, strained, and bottled for the consumer. Check tests were made in every case. Following are the results in tabulated form:—

DATE.	TIME OF TEST.	AIR CONTENT.	MILK CONTENT.
		Exposure 3 minutes, average of 2 plates.	(40 hrs. incubation.) No. per c.c.
	P.M.		
April 4.....	5:10	97 (108.86)	29,000
" 6.....	5:10	69 (78.60)	16,400
" 7.....	5:15	48 (45.51)	29,000
" 9.....	5:16	50 (49.51)	13,000
" 11.....	5:5	99 (91.104)	35,000
" 14.....	5:0	(¹) 276 (311.241)	80,000
" 15.....	5:19	70 (76.64)	12,000
" 16.....	5:5	37 (36.38)	8,000
" 17.....	5:0	80 (78.81)	22,000
" 21.....	5:20	(²) 100 (97.104)	5,000
" 22.....	5:5	58 (51.65)	9,200
" 23.....	5:0	104 (107.101)	27,000

(1) On this date hay was being chopped in the barn above and the air was full of dust.

(2) The air plates were exposed after some of the heifers had been turned out. This may account for the high air count, as compared with the milk count.

From the figures it may be seen that the number of bacteria in the air of the barn appears to correspond to a great extent with the number in the milk. Particularly interesting is the test made on April 14, when an abnormal condition of the air existed. Dust-laden air is followed by a correspondingly dirty sample of milk. Excluding this abnormal case, the average of the counts shows:—

Air plate—75 colonies.
Milk plate—19,559 colonies.

Seven of the milk samples contained 20,000 or less per c.c.; of these, six showed a corresponding air count of less than 75. The remaining six show over 20,000 in the milk; and all these have an air count of more than 75. Of the thirteen tests one shows a marked variation (April 24). Considering the numerous other sources of contamination which might cause variations, the results are sufficiently uniform to be convincing. The fact that air is a fertile source of milk contamination is, of course, well established. The figures taken from these tests are useful only in so far as they magnify the danger of such contamination.

5 GEORGE V., A. 1915

The different organisms observed upon the air plates correspond to many of those found in the milk. Chromogenic forms, green and yellow, were present both in milk and air. A yellow *Staphylococcus*, similar to *St. pyogenes aureus*, was found in both plates. The yellow and white cocci mentioned by Hastings in Research Bulletin 6, Wisconsin Experiment Station, as being very frequently found in the milk of normal healthy cows, were abundant; and a spore-bearing bacillus, forming a spreading, arborescent growth, was common to both. This last corresponds in many respects to *Bacillus mycoides lactis*. Putrefactive, evil-smelling bacteria were found in air and milk.

CONCLUSIONS.

(1) That quickness and simplicity in methods of handling milk, reduce the risk of contamination.

(2) That air-borne organisms play a great part in milk contamination, and that especial care should be taken to have the air in barns as free from dust as possible.

DAIRY WORK FOR THE YEAR 1913-14.

Since June, 1913, the dairy work has been done by Miss R. Keene. Miss Keene has had considerable experience in dairy work, and particularly in the making of soft cheese, both in England and France. The work in the dairy here has been quite varied in nature, including the handling of the product of the herd, which was marketed in the form of sweet cream, butter, and soft cheese, as well as a small local supply of high-class bottled milk.

In addition, the milk of the individual cows of the herd has been tested regularly throughout the year; also special tests have been made with the pure-bred cows, and a considerable number of samples, sent in by dairymen from the surrounding country, have been tested. All this entails a considerable amount of detailed work. In addition, Miss Keene has acted as judge of dairy products at a number of fall fairs in different parts of the province.

Quite extensive tests have been made with formalin and corrosive sublimate, both alone and combined, as preservatives of milk for Babcock testing. This work was conducted in both summer and winter conditions. Quoting from the protocols of the experiments made, it has been found that a saturated solution of corrosive sublimate and water, used at the rate of ten drops per 8 ounces, will keep milk for one month in good condition for testing. The same amount of commercial formalin, although a perfect preservative for about three weeks, was not as successful for a longer period. A saturated solution of corrosive sublimate in formalin, used at the same rate, gave the best results for both a short and a long period.

Tests were made, extending over a period of 200 days, on the relative acidity of milk produced by cows when fed on different foods. These tests were made with milk kept on the one hand in refrigerators, and on the other in ordinary temperatures. The following rations were fed: Clover pasture, clover as a soiling crop; oats, peas, and vetches as a soiling crop; corn silage in conjunction with pasture; corn silage in conjunction with green feed; corn silage, mangels, mixed grain, and hay; and mangels, mixed grain, and hay. It is a popular argument of the enemies of corn silage that this food produces a milk which sours rapidly; the trials made with the rations given above show, however, that there is as much variation with one single ration as there is between any two rations.

With the amount of labour expended and with the transportation facilities available, the various marketable products may be considered profitable in the following order: sweet cream, bottled milk, soft cheese, and butter.

AGASSIZ.

SESSIONAL PAPER No. 16

In view of the fact that the making of soft cheese is an important branch of the dairy work here, it is advisable to give in detail some of the experiences during the past year.

CHEESE.

The object aimed at was to produce a ripened soft cheese, approximating as closely as possible, the European original, Coulommier being the particular type chosen to begin with. For this three rooms are desirable (making-, drying-, and curing-rooms). This is not possible here, owing to lack of space, but by utilizing the latter dairy as a making-room, the cheese room was set free for a curing-room.

Though by no means ideal, this arrangement rendered possible the manufacture (in small quantities) of a well-flavoured Coulommier which ripened in from ten to twelve days. The principal difficulty all through has lain in controlling the temperature of the making-room, and the humidity of the curing-room. The temperature of the former varied from 84° in summer to 29° in winter, the proper temperature being from 65° to 68°. As nothing could be done to reduce the heat in this room, during the hottest weather the cheeses were set and laddled at night.

A canvas screen arranged so as to keep the sun off the curing-room during the afternoon improved the conditions there considerably, though even with this addition the temperature was frequently higher than desirable. About the middle of September, it became necessary to heat the making room artificially at night. It was necessary to transfer the cheeses to another room where there is a heater. Here it was possible to control the temperature at will, but the question of humidity arose. The room being very small, some cheeses were too near the heater, causing excessive evaporation. The simplest remedy was to keep these cheeses covered during the earlier stages.

The curing-room at times became too dry; to remedy this the floor was flooded and wet cloths hung up near the cheeses. These were the only means at hand for correcting the conditions, and proved fairly successful.

At the beginning of September, a hardwood draining table was purchased to hold one dozen cheeses. Previous to this, it had been impossible to make more than two cheeses at one time. The straw mats for draining were purchased in England at a cost of 54 cents per dozen.

Experiments to determine the proportions, and renneting temperature most suitable to the conditions here, show the following to be the best, subject to occasional variations: Fresh morning's milk; rennet at the rate of 3.6 c.c. to 30 pounds milk, starter (acidity .7 to .8) at the rate of 9 to 10 c.c. to 30 pounds milk, Rennetting temperature of milk 86°; room temperature 65° to 68°. Some cheeses were tried without starter but were unreliable. They were doubtful under approximately correct conditions (July 27) and became unmarketable where the conditions were bad (July 21).

It may be noted that the cheeses will stand heat better when the percentage of moisture in the atmosphere is low, as here the percentage of moisture is usually high in hot weather. It will be seen that in those which are set with starter (August 18 to November 3), the room temperature may be somewhat raised or lowered without injuring the products, though this variation is not desirable. Cheeses invaded by the liquifying organisms may frequently be saved by exaggerated salting (July 27 and August 4), but this depreciates the product considerably.

Some experiments were made with Pont l'Eveque, but as they need different ripening conditions, it was not possible to do them full justice side by side with Coulommier.

Coulommier sells at 15 cents retail. Pont l'Eveque have not been marketed, but should realize 18 cents to 20 cents each. Cream cheeses have been made of both sweet and acid varieties, but there is little demand for a cheese of this type.

5 GEORGE V., A. 1915

The total additions to cheesemaking equipment have been: One draining table; four dozen straw mats; three Camembert moulds; six Pont l'Evêque moulds; twelve Coulommier moulds; sundries, such as curd ladles, etc.

Below are the protocols of the trials under different conditions of temperature, etc.

COULOMMIER.

July 21.—5 pounds milk, 9 drops rennet. Milk 86°. Room 73°. Set 11.40 a.m. Ladled 1.50 p.m. Drainage, too rapid on account of heat of room, which varied from 78° to 84°.

July 27.—Temperature dropped to 68°. Cheese began to smell putrid. Destroyed.

COULOMMIER.

July 27.—6 pounds milk, .75 c.c. rennet. Temperature of milk, 86°. Temperature of room, 72°. Set, 7.20 p.m. Ladled, 10.15 p.m. Turned, 10.35 p.m.

July 28.—Room, 64°. Turned twice before 10.30. Upper mould removed at second turning. Room temperature fell to 62°. Drainage slow, removed to butter dairy where temperature was 64°.

July 29.—Drainage still slow. Turned four times between 6.30 and 7.30. Salted once on each surface and sides. Slight appearance of gasiness on sides.

July 30.—Turned and salted again. Room temperature 74°.

July 31.—Temperature dropped to 61°.

August 1.—Turned. White mould showing. Temperature, 61°. Turned once daily until August 6. Trace of *P. glaucum*. Rest of the cheese covered with white mould.

August 6.—Cheese liquifying under coat. Coat wrinkled.

August 7.—Slightly gassy appearance, but flavour and texture good. Would be no good for shipping, but good for immediate consumption.

COULOMMIER.

August 1.—5½ pounds milk. Rennet, .7 c.c. Room temperature, 86°. Milk temperature, 72°. Set, 8.20 p.m. Ladled, 10.30 p.m. Turned, 10.45 p.m. Curd not all used; resulting cheese rather thin. No straw mats, muslin placed between cheese and board to prevent curd sticking at first turning.

August 5.—Turned. Temperature, 64°. Temperature rose to 73° and dropped again to 74°.

August 6 and 7.—Turned and salted. (N.B.—This cheese was salted several times where liquifying organisms appeared.) Temperature dropped to 58°, rising to 68° on August 17. *Penicillium* growing but not freely. Salted again, in one place, salt rubbed in lightly.

August 13.—Ready for use. Flavour and texture good, but too salty.

COULOMMIER (ONE CHEESE).

August 18.—5½ pounds milk. Rennet .6 c.c. Starter, 1.5 c.c. Starter added at 10.55 a.m. Room temperature, 68°. Milk temperature, 86°. Ladled, 2.45 p.m. Rennetted, 11.55 a.m. Turned 3.20 p.m., and again the same evening.

August 19.—Turned. Whey fairly clear.

August 20.—Turned, salted top and sides. Removed to cheese room.

August 21.—Turned, salting completed. Room temperature, 72°.

August 22.—Turned.

SESSIONAL PAPER No. 16

August 25.—Room temperature, 72°. Progress good.

August 29.—Cheese eaten this and following day. Good texture and flavour. Rapid ripening is accounted for by high room temperature and delay in salting.

COULOMMIER (SIX CHEESES).

November 3.—50 pounds milk. Rennet, 3.6 c.c. Starter, 9 c.c., (acidity .66). Temperature of room, 68°. Temperature of milk 87°. Starter put in 11.50 a.m. Rennet put in 12.50 p.m. Laddled, 3 p.m. Whey had risen before laddling. Turned 8.30 p.m.

November 4.—Temperature of room had dropped to 56°. Cheese turned twice before 10 a.m. Salted upper surface. Turned in the evening. Room temperature dropped during night to 56°.

November 5.—Drainage continuing. Cheese turned. Demoulded. Salted other surface and sides.

November 6.—Removed to curing room. Ripening normal.

November 14.—Specimens taken to Victoria. Good average cheese.

HORSES.

CENTRAL EXPERIMENTAL FARM, OTTAWA, ONT.

REPORT OF THE DOMINION ANIMAL HUSBANDMAN, E. S. ARCHIBALD, B.A., B.S.A.

The horses on the Central Experimental Farm have in years previous to 1912 been maintained for labour purposes exclusively. However, in the fiscal year ending March 31, 1913, a small start was made in breeding work. There are now on the Central Experimental Farm twenty-seven horses, made up as follows: 11 heavy draught grade Clydesdale geldings, 6 pure-bred Clydesdale mares, 4 grade Clydesdale mares, 3 expressers, 2 light driving horses, and 1 Clydesdale stallion colt 1 year of age.

HORSE LABOUR.

The twenty-one heavy draught mares and geldings on the Farm are expected to do all the labour not only on the 200-acre farm, but, in addition, must supply the necessary labour to the Horticultural Division, Cereal Division, Poultry Division, Agrostology Division, and Botanical Division. In addition, a large amount of hauling and cartage in connection with all the Divisions, as well as roadmaking, messenger service, and the like, takes up much of their time. Following is a detailed statement of the horse labour for the past fiscal year.

During the year April 1, 1913, to March 31, 1914, the work done by horses kept in the stables was equivalent to 6,889 days' work, distributed as follows:—

	Days.
Live stock, hauling feed, milk delivery, etc.	295½
Farm work (200-acre farm)	1,092½
Manure on 200-acre farm	451
Horticultural Division	926
Cereal Division	875
Poultry Division	55
Agrostology Division	39
Bulletins to and from offices	27
Lawns	157
Arboretum	152½
Omnibus service and supervision of work	1,460
Care of roads on farm	403½
Various, including hauling freight, sidewalks, exhibitions, etc., build- ings, clearing refuse, hauling materials, etc.	955
Total	6,889

HORSE BREEDING.

There is now at the Central Experimental Farm a good string of breeding mares with which to conduct breeding operations, and the many phases of experimental work both as to breeding, feeding, care, and management of brood mares and foals. Ten uniform, good quality Clydesdale mares are as follows: Four imported Clydesdale mares, two registered Canadian-bred mares; four high quality grade Clydesdale mares,

SESSIONAL PAPER No. 16

The imported mares are of particularly high order both as to size, substance, quality, and breeding. These mares are the pick of two of the largest importations of 1913 and contain the choicest blood of the breed. It is hoped that in the course of another year, when breeding operations start on a larger scale, that these mares will be heard from as to the quality of their progeny.

During the past year, two Canadian-bred registered mares gave birth to foals. The first mare to foal had been in the stables of the Central Experimental Farm for a year, and gave birth to a splendid stallion foal. The second mare, also a Canadian-bred registered Clydesdale mare, was purchased three months previous to foaling. This mare had been heavily fed and under-exercised during the winter of 1912-13 and in consequence was overloaded with fat and produced a weak foal which died within twenty-four hours. This is a condition which is altogether too common throughout the farms of Eastern Canada, and a phase of experimental work which will be dealt with both on the Central Experimental Farm and branch Farms and Stations during the coming years.

HORSE STABLES.

The horse stable, constructed in the year 1907, is unaltered since its erection. In view of the fact that there is an increasingly large number of inquiries regarding stable construction, concrete floors and stands, and particularly of ventilation, reference is again made to detailed plans and brief specifications as to this horse barn in the reports for the years 1908 and 1910. In addition to this, readers are referred to a bulletin on farm building ventilation now in the hands of the printers, in which is given details as to the proper method of ventilating the horse barn for all parts of Canada where atmospheric conditions are somewhat similar to those at Ottawa. Based on the results at the Central Experimental Farm, considerable experimental work is being conducted, in the construction of horse barns, on the branch Farms. As to best methods of flooring, lighting, construction of box stalls, and the like, readers of this report are referred to the reports of the Superintendents of the Experimental Stations at Cap Rouge and Ste. Anne de la Pocatière, Que.

FEEDING THE WORK HORSES.

The feeding of the work horses is conducted along the same lines as in former years. However, owing to a large number of inquiries, these methods will bear repetition.

The stableman feeds all horses, and, under his supervision, each teamster is responsible for the washing and cleaning of his horses and harness.

The feeds used are mixed hay, fed long, oats and bran, generally in the proportion of five parts oats to two parts bran, mixed and fed dry. Warm bran mashes, 5 or 6 pounds per horse, are used on Saturday nights to replace the regular grain ration. When horses are on very heavy work, the proportion of bran is decreased to one part for five parts oats. These ratios between bran and oats were decided best after much experimental work. Readers interested are referred to the annual reports of the Dominion Agriculturist, years 1904 and 1905.

A safe standard for feeding draught horses, and one commonly used here, is that of giving from 1 to 1½ pounds of the above grain mixture and 1 pound of hay for each 100 pounds live weight; this, of course, subject to variation depending on the severity of work, condition of animal when fed, the health of animal, and other minor considerations.

The morning feed, about 5 a.m., consists of about three-eighths of the total grain mixture and one-quarter of the hay for that day. The noon ration is the same. The

5 GEORGE V., A. 1915

evening feed consists of one-quarter of the grain and about one-half of the hay for the day.

Water is supplied after the morning feed and before the noon and evening feeds. During the winter, water is also supplied in the evenings, some three hours after the feed.

With the above treatment, the horses are maintained in good working condition, and with an almost entire absence of common stomach and intestinal ailments, such as indigestion and colic. No condiments are used, but to horses somewhat low in flesh and requiring more feed, molasses mixed with the grain is used in small quantities, as it stimulates the appetite by increasing the palatability of the food.

Experimental work as to the feed value of molasses, and similar lines of work are anticipated.

FEEDING BROOD MARES.

All brood mares are worked up until the day of foaling, care, however, being taken, during the month previous to parturition, that the mares are not overworked, overheated, or worked in shafts or quarters so narrow that it might in any way induce abortion. During the period in which they are carrying their colts they are fed exactly the same as the working geldings and the non-breeding mares. After foaling, the ration of the mare is immediately changed. During the first twenty-four hours after foaling, nothing is given to the brood mare excepting heated drinks and a bran mash, after which she is gradually put on to a good milking ration. A large number of horse breeders lose sight of the fact that the mare suckling the foal must be fed on a milk-producing ration in just the same way as a cow or other classes of stock. A ration which has given us very good success during the past year, for the brood mare suckling the foal, is composed of: oats, four parts; bran, two parts; and cracked corn, two parts. If the mare is slightly down in condition, the ration would be improved by adding one part of oil cake meal, which would not only improve her general condition, but would also increase the milk flow. The quantity of the above ration fed to the mare suckling the colt depends largely upon the condition of the mare, amount of milk which she is giving, and the availability of good pasture. However, even on the best of pasture, a limited amount of meal is very profitable.

FEEDING THE YOUNG COLT.

Since the records in colt feeding on the Central Experimental Farm included only that of one colt for one year, publication of the same would be useless. The principle used, however, was that of teaching the colt to eat grain, composed of crushed oats and bran, as soon as possible. Although a limited amount of pasture was available, yet the colt was taught to eat as soon as he would take it, with the result that within two months he was feeding to advantage from the same ration as the mare, both as to grain and roughage.

As a number of mares on the Central Experimental Farm are in foal, experimental work and data along the lines of cost of feeding will be taken up on a much larger scale during the coming fiscal year, and it is hoped that within a few years a great deal of valuable data will be acquired.

SESSIONAL PAPER No. 16

FINANCIAL STATEMENT FOR HORSES.

Below are submitted inventories and returns from horses on the Central Experimental Farm during the year April 1, 1913, to March 31, 1914.

	April 1, 1913.		March 31, 1914.		Returns from Labour.	Gross returns including increased value and labour.
	No.	Value.	No.	Value.		
		\$		\$ cts.	\$ cts.	\$ cts.
Horses.....	21	6,925.00	26	9,925.60	4,822.30	7,982.30

RETURNS.

By 6,889 days' labour at 70 cents.....	\$1 822 30
increased value of horses	3,000 00
160 tons manure at \$1.....	160 00
	<hr/>
Gross returns	\$7,982 30

EXPENDITURES.

To cost of feed and bedding.....	\$2,425 00
purchases	3,875 00
shoeing of horses	375 30
labour, stableman	700 00
harness and repairs	432 25
	<hr/>
Gross expenditure	7,810 55
Net balance from horses.....	<hr/> \$171 75

EXPERIMENTAL STATION, CHARLOTTETOWN, P.E.I.

REPORT OF THE SUPERINTENDENT, J. A. CLARK, B.S.A.

HORSES.

The horses were kept for labour purposes. A team of grade draught mares was purchased during the year. At present there are six horses at this Station, as follows: three draught mares, one draught horse, one express horse and one carriage horse.

During heavy work they were fed as follows: 13.3 pounds oats and bran, mixed 1 part bran to 5½ parts oats, and 14 pounds hay per 1,000 pounds live weight; and during light work about 10½ pounds oats and bran, mixed 1 part bran to 4½ parts oats, and 18½ pounds hay per day. Roots were fed as required. The horses have been healthy and are in better condition than ever before.

The team of draught mares purchased during the year was fed for 6 weeks on cheap roughage and bran from February to March 31; it consisted of 30 pounds natural grass hay and bran each per day.

They were given light work and continued in good health; gaining respectively 5 pounds and 10 pounds during the period.

SESSIONAL PAPER No. 16

EXPERIMENTAL FARM, NAPPAN, N.S.

REPORT OF THE SUPERINTENDENT, W. W. BAIRD, B.S.A.

HORSES.

In the spring of 1913 there were nine horses at this Station, six of which are heavy grades, all being geldings except one. They are used for the general farm work, doing all the heavy work in the different departments, and the miscellaneous trucking.

Three light horses were used for light work, such as express work, cultivating, spraying in gardens and orchards, and driving.

One of these, being badly blemished, was exchanged for a more sound animal later in the season. Another has been used principally for express work for a long time, but is now very old.

The third one, being a very spirited animal, wrenched her fetlock joint, kicking in the stall, and has been laid up for the greater part of the season. Though she is now sufficiently well for use, yet the fetlock joint is much enlarged.

With a view to raising colts, two pure-bred Clydesdale mares have been purchased, one a 3-year-old and the other a 4-year-old. Both are very fine mares, typical of the breed, and should give satisfaction as breeding stock.

EXPERIMENTAL STATION, KENTVILLE, N.S.

REPORT OF THE SUPERINTENDENT, W. S. BLAIR.

HORSES.

Seven horses are kept. There are three working teams and one driving horse. The work horses were fed as follows: Spring and summer feed, 16 pounds oats, 5 pounds bran; winter feed, 8 pounds oats, 5 pounds bran.

The oats are crushed and mixed with the bran for feeding. They also get 13 to 20 pounds hay per day. Carrots were fed from time to time during the winter.

WORKING OXEN.

From April 1 to November 1, three pair of oxen were kept for breaking new land. These were purchased in the spring and sold in the fall. They were fed 5 pounds crushed oats and 5 pounds cornmeal, with a hay ration of 25 pounds per day.

EXPERIMENTAL STATION, FREDERICTON, N.B.

REPORT OF THE SUPERINTENDENT, W. W. HUBBARD.

HORSES.

The teams bought for use on the Farm consist of the following animals: Three pure-bred Clydesdale mares (imported), six grade Clyde-dale mares, two grade Percheron mares, two geldings of draught breeding, one driving mare by a standard bred sire out of a Morgan grade mare.

One of the grade Clydesdale mares purchased in 1912 proved in foal and dropped a colt of unknown breeding August 1, 1913. This colt developed well, and was sold in March, 1914.

The above draught horses range in weight from 1,550 pounds to 1,900 pounds, and the driving mare, showing good style and action, stands 16.3 hands high, and weighs 1,150 pounds.

It is intended to breed most of the mares yearly. Last season, six grade Clydesdale and three pure-bred Clydesdale mares and the two grade Percherons were bred, but only one pure-bred Clydesdale, one grade Clydesdale and the two grade Percherons proved pregnant.

All these horses, except one grade Clydesdale mare which had no mate and was used on odd jobs, worked steadily from April 1 to November 30. After that they worked about half time, three teamsters being retained to work the six teams.

They were fed oats, cracked oats, bran, cracked corn, and a little ground oil cake. Some turnips were fed from November till May.

The average daily ration was approximately as follows:—

	Pounds.
Whole oats..	12 to 13
Cracked oats..	3 to 3.5
Bran..	1 to 2
Corn..	1 to 1½
Turnips..	5 to 10
Hay..	15 to 20

These horses all kept in good flesh. One grade Clydesdale mare was sold during the latter part of March, as there were six teams without her, and a general utility horse was preferred to replace her.

Team labour with driver costs from \$4.50 to \$5 per day. Based on the smaller cost, with the wages of the teamsters deducted, these six teams earned for the 200 days which they worked, from April 1 to November 30, \$3,399.96; and from December 1 to April 1, half time, or 47 days each, \$798.96; a total for the year of \$4,198.92. One colt selling for \$70, the total revenue is \$4,268.92.

Their feed bills were as follows:—

Hay, 45 tons at \$8..	\$ 360 00
Oil cake, 1 ton at \$20..	20 00
Oats, 2,450 bushels at 48 to 55 cents..	1,255 25
Corn, 6,200 pounds..	106 50
Turnips, 350 bushels at 8 cents..	28 00
Bran, 2,000 pounds at \$18 per ton..	72 00
Straw, 28 tons at \$4.50 to \$10..	168 00
	<hr/>
	\$2,009 75
Services of mares..	80 00
Shoeing..	137 40
Stable supplies, veterinary attendance, medicines, etc..	75 00
Six per cent interest on cost price, \$5,100..	306 00
Ten per cent depreciation..	510 00
	<hr/>
Gross expenditure..	\$3,118 15
Profit..	1,150 77
	<hr/>
	\$4,268 92

In the above statement nothing is allowed for the earning of the driving mare nor the odd grade Clydesdale, nor is the manure valued; which all might be placed against the attendance of one stableman, and depreciation of harness, clothing, etc.

HORSE BARN.

In 1913, on the Experimental Station, Fredericton, N.B., a new horse barn was erected, capable of accommodating fifteen horses. The accompanying plans and photographs of this barn are for the most part self-explanatory. A few additional remarks, however, may help make some points more intelligible.

FOUNDATION.

The foundation of this barn is a concrete wall 12 inches in thickness and 2 feet in height, the same resting on a concrete footing 18 inches wide and 18 inches deep.

SUPERSTRUCTURE.

The superstructure is of wood, built on the plank frame type. All timbers throughout this barn in the frame are 2- by 6-inch plank, excepting the joists of the loft floor which are made of 2- by 10-inch planks, and the girths supporting this floor, made of five ply 2- by 10-inch planks. This type of structure is exceedingly strong and is very economical in that it requires less lumber for construction and is more economical in erection than the square-timbered type of barn.

Special attention is drawn to the economic structure of the walls of this barn, which, starting at the outside, are composed of: vertical inch dressed lumber with battens over joints, two ply building paper, 6-inch studs and posts with air space between and, on the inside of stable, one ply of specially prepared building paper (Linofelt), with sheathing on the inside. The ceiling or upper floor is constructed of one ply of rough boards placed diagonally over joists, covered by one ply of building paper and matched lumber, making the same dust-proof, while on the underside the ceiling is sheathed with matched lumber.

DIMENSIONS.

The barn is 89 feet 6 inches in length and 32 feet in width, with a wing 20 feet in width and 26 feet in length. The main barn accommodates fifteen tie stalls, and six box stalls. The wing accommodates feed room, harness room, a stairway, and

FREDERICTON.

EXPERIMENTAL FARM FREDERICTON N.B. PLAN OF HORSE BARN.

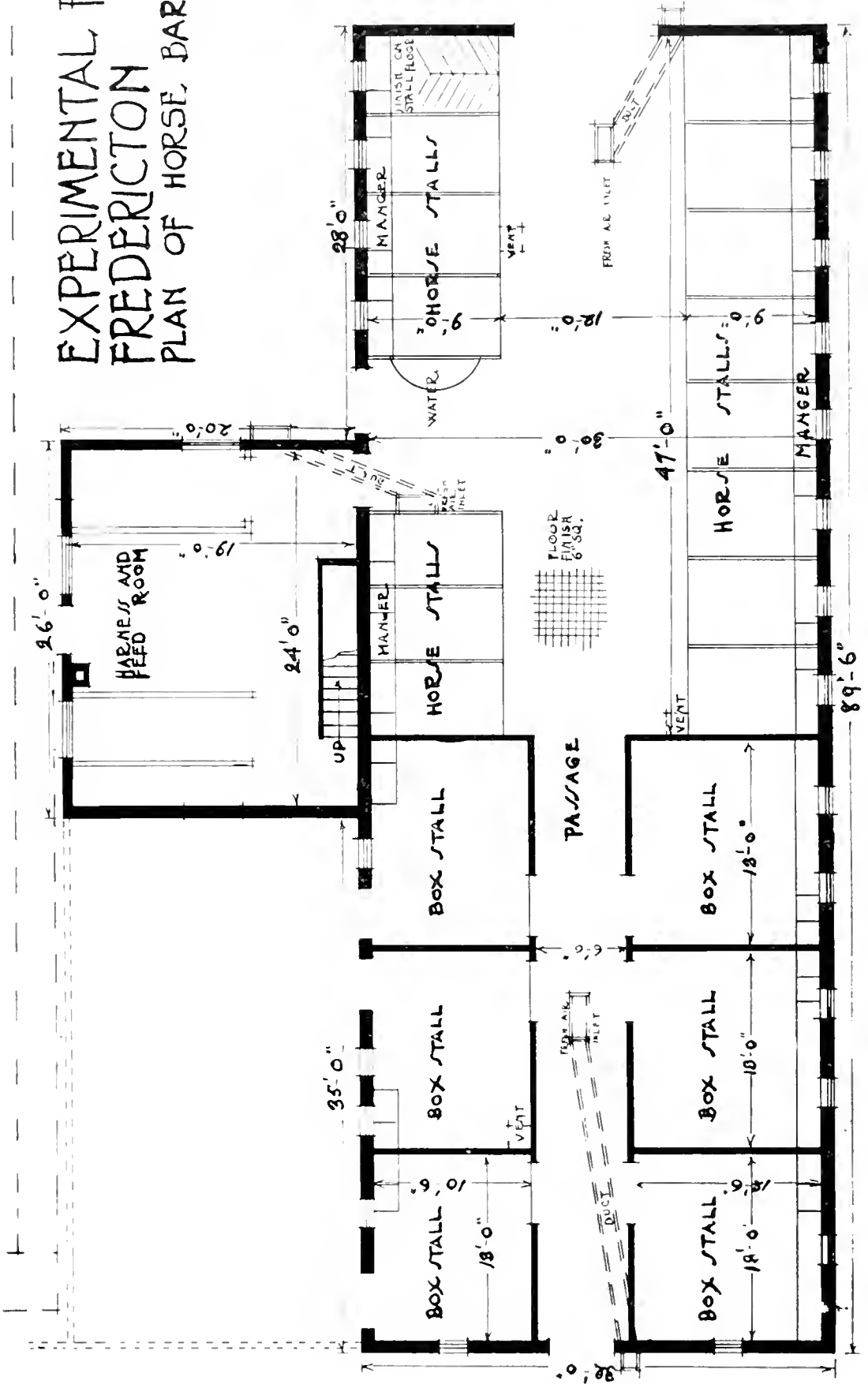

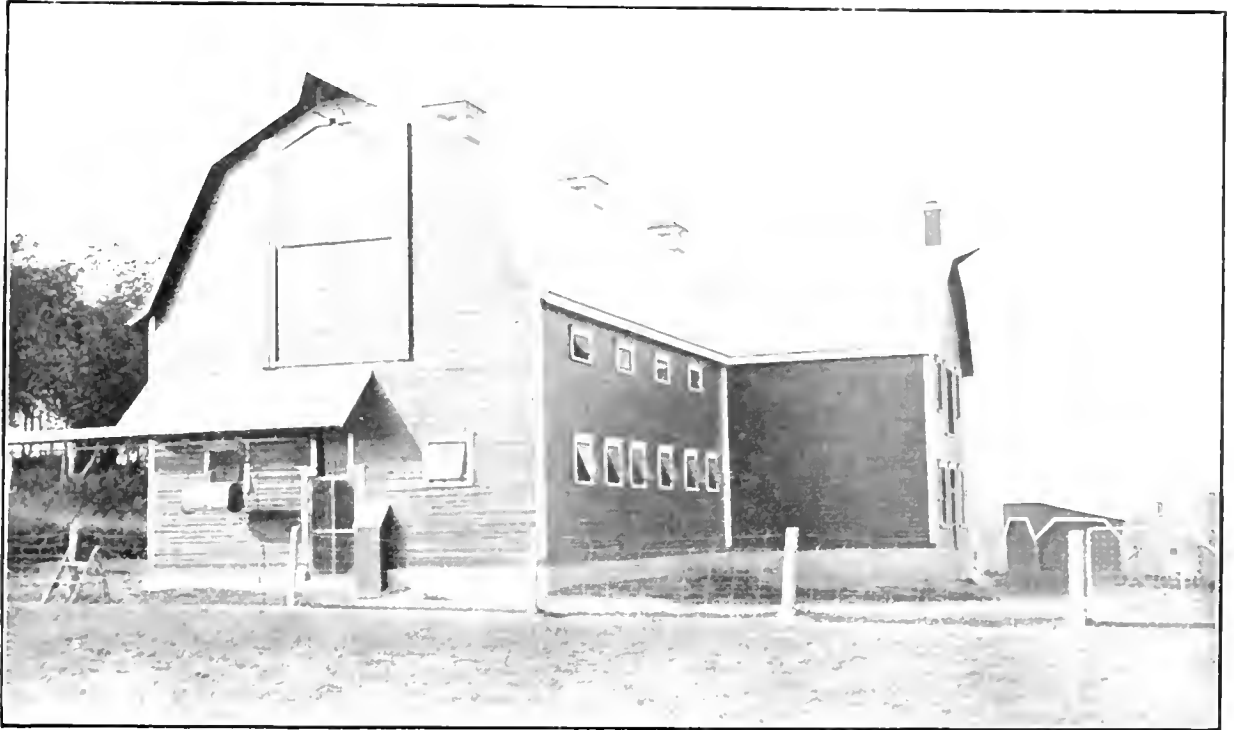

Western end of Horse Barn at Experimental Station, Cap Rouge, Que.
Note the lighting, ventilation and conveniences for handling hay and manure.



Interior View of Horse Stable, Cap Rouge, P.Q. Note the fresh air intake covered by grating in floor, and the foul air outlet in ceiling.

SESSIONAL PAPER No. 16

meal storage room above. The stalls are 9 feet in length and vary in width from 5 to 6 feet. The box stalls are 10 feet 6 inches by 13 feet. The passage between the two rows of tie-stalls is 12 feet in width.

LEVELS.

The floors throughout are of concrete. All floors are resting on 6 inches or more of field stone, covered by 5 inches of rough cement and 2 inches of finish-coat. The main passage is 5 inches lower than the rear end of the tie-stalls, and is on the same level as feed room and harness room.

SLOPES.

The main passage has a crown of 2 inches to centre. Next the tie-stall is a 1-inch depression to act as a gutter for collecting the urine. The tie stalls have a slope of two inches from front to rear. These tie stalls are finished with a very rough surface and are sloped to centre of stall as well as from front to rear, and also grooved in order to facilitate ease of moving about of occupant and also the carrying away of all liquid manure.

LIGHT.

All light possible was installed in this barn. A window as large as possible was placed in the front of each tie-stall, and all windows possible in doorways, box stalls and feed rooms were installed, in order to give as much light as possible to this building.

VENTILATION.

Fresh air is admitted at the floor level by means of air ducts bringing the fresh air from the intakes just outside the walls. The outlets are three in number, situated to one side of the middle of the barn, when considered from side to side. These run vertically to rafters and follow the line of rafters to cupolas on roof. By the installation of foul-air outlets in this way, there is no interference with the track for hay carriers in loft. The foul-air outlets are constructed of two ply of $\frac{3}{4}$ -inch matched lumber with a dead air space between, thus giving splendid insulation and preventing condensation of moisture in ventilators. Both incoming fresh air and outgoing foul air are controlled by dampers or keys. It is thus possible to regulate the temperature as desired. This system is known as the Rutherford system of ventilation, and has given the best results on the Central Experimental Farm and branch Farms where tried.

FACILITIES AND FEEDING CONVENIENCES.

Feed chutes, as shown in diagram, extend from the bottom of manger to the plate of barn. Doors to admit the hay into chutes occur at the top and half-way down to the floor of loft. The chute is slightly bell-shaped, so that hay once started drops easily to manger. This plan of feeding long hay has been found very satisfactory elsewhere. The manger extends clear across the stall, the hay in chute falling into one end. The grain or meal is fed in the manger, no special box being provided. Horses are watered by men in charge, a water tank at side entrance of barn being conveniently situated for incoming or outgoing horses.

The feed room, although not very large, is sufficient to accommodate the meal trucks necessary. Into this feed room, grain chutes from bins in the meal storage room above empty into movable trucks.

The harness room is conveniently situated, and has facilities for warming should such be necessary. In the harness room are also installed a sink for washing, a tank for heating water on stove, harness racks, and a locker underneath stairway for the keeping of small harness, medicines and the like. The manure is removed from this barn by barrows, there being no overhead track for this purpose.

FREDERICTON.

EXPERIMENTAL STATION, CAP ROUGE, QUE.

REPORT OF THE SUPERINTENDENT, GUS. A. LANGELIER.

HORSES.

We now have seventeen horses at the Station: 12 registered French Canadians—nine mares, two yearling fillies, one colt—two teams of from 2,600 to 2,900 pounds weight, and a driver of about 1,000 pounds. They have all been, and are now, in very good condition.

During the year, fourteen of these horses, leaving the colts out, worked during 23,190.5 hours as follows:—

	Hours.
Farm work	8,019.5
Care of stock (hauling feed, etc.)	1,392.5
Care of grounds (including roads)	877.
Horticulture	1,222.
Drawing manure	6,050.5
Messenger service	3,306.5
Exhibitions	505.
Draining (hauling tiles, ploughing)	523.
Implements and tools	37.5
Blacksmithing, harness, carriages	39.5
Apiary	25.
Clearing land	2.
Buildings (hauling material)	914.
Fuel (hauling wood and coal)	193.5
Fencing	51.
Waterworks (hauling pipes, etc.)	2.
	23,190.5

EXPERIMENT—WINTERING A HORSE AT LOW COST.

As a great many farmers keep more horses than they can utilize during the winter, it has seemed advisable to try to find a ration which, while of low cost, maintains the animal in good health and leaves him enough energy to perform the spring's work with celerity. In theory, 1 pound of mixed grass, 1 pound of oat straw, and 1 pound of swedes or carrots per 100 pounds of horse, should about maintain the weight of the animal when he is idle. In other words, this is, according to feeding tables, a good maintenance ration. The hay and straw furnish plenty of bulk to distend the digestive tract, whilst the roots cool all the system and add succulence and palatability to the ration.

It is agreeable to note that practice goes hand in hand with theory in this case, as we have tried this ration for three winters with great success. Not only have the animals increased their weight in 1911-12 and 1912-13, but they performed their work all through spring and summer in a way which plainly showed that they were in perfect physical condition. Moreover, one of these animals, a gelding which was subject to frequent attacks of mild colic or bad indigestion, never evidenced the least trouble from this source since he was put through the experiment. A reasonable explanation of this would be that the digestive tract, overworked by the constant high feeding of grain necessary to produce the required energy to do heavy work, gets a much needed rest and is in good shape in the spring.

During the winter of 1913-14, we used a pure-bred French Canadian mare for this experiment. On November 1, 1913, she weighed 1,150 pounds, and on April 1, 1914,

SESSIONAL PAPER No. 16

she tipped the scales at 1,135. It is interesting to note, in this connection, that the gelding used in 1911-12 weighed 1,375 in the fall and 1,395 in the spring, and the mare used in 1912-13, tipped the scales at 1,350 in the fall and 1,415 in the spring. This is according to Arnsby, who says "experiment has shown that the increase (in the maintenance ration of horses) is not proportional to the weight of the animal, but approximately to the amount of surface which it exposes, so that the large animal requires less food in proportion to its weight to maintain it than does the small one." Jordan also claims that "somewhat larger amounts of protein and carbohydrates are considered necessary with small horses." It must be understood that it is not the intention of the writer to "make a case" in favour of the draught breeds, but it seems opportune at this moment to correct the wrong ideas which most people have about this matter.

In conclusion, it may be said that a farmer who wishes to use this method of feeding must remember that the animal must be gradually taken away from work, in the fall, at the same time as the ration is cut down, whilst in the spring, the ration and work should be gradually increased. At the Station we replaced one-half pound of oats per day, by the same weight both of straw and carrot, whilst the hay from grasses replaced the timothy. In the spring, the reverse is done until the animal is on full feed when work, given gradually at first, is performed during ten hours every day, weather permitting.

That the ration is an economical one can readily be understood when it is said that it cost \$10.99 to feed this mare during 150 days, during which time she received 1,725 pounds of hay, valued at \$7 per ton, 1,612 pounds of straw at \$4, and 1,725 pounds of carrots at \$2. The box stall in which she stood was bedded with shavings, and she left during the winter 113 pounds of straw which was weighed and credited to her.

COST OF FEED OF WEANLINGS.

There is not much data on the cost of feed for colts until they are ready to work and earn their living. This has led us to weigh all the feed received by a weanling, with the exception of grass which he ate in a small paddock which was practically bare all the time. It must be remarked that this colt spent all the winter outside, having only a single-boarded shed for a shelter. As the temperature went down to 31° below zero and the animal never even shivered, it can easily be seen that farmers need not be afraid of this way of wintering colts. It is certainly a very good plan if a person wishes to feed heavily, which should be done if any size is to be attained by the animal.

Feed eaten by a colt from birth, May 31, 1913, until April 1, 1914:—

Hay, 816 pounds at \$7 per ton.....	\$ 5 71
Oats, 1,018 pounds at 1.5 cent per pound.....	15 27
Bran, 339.25 pounds at 1 cent per pound.....	3 39
Wheat, 25 pounds at 1.5 cent per pound.....	38
Oil cake, 16 pounds at 1.5 cent per pound.....	24
Skim-milk, 1,260 pounds at .2 cent per pound.....	2 52
	<hr/>
	\$27 51

The sire of this colt does not weigh 1,100 pounds and the dam's average weight for six months (she was weighed once a month), is 1,051 pounds. The colt, on the day when he was 10 months old, weighed 735 pounds, which shows that he will weigh over 1,200 and possibly 1,300 at maturity. He took more feed, to warm his body, because he was wintered outside, but his limbs are in fine shape, which might certainly not have been the case, had he been kept in the stable with such heavy feeding.

It is intended to weigh all feed eaten by this young stallion—a registered French Canadian—until he is 3 years of age; also to do the same with at least one of the foals to be dropped this spring (1914).

HORSE BARN.

In 1913, on the Experimental Station, Cap Rouge, Que., a new horse barn was erected. This barn is capable of accommodating fifteen horses in ties and also contains eight box stalls. The accompanying photographs, showing the exterior and interior views, will give a good idea regarding the structure of this barn. As the plans and specifications of this building are exactly similar to those of the barn erected on the Experimental Station, Fredericton, N.B., with the exception that there are two more box stalls in this barn, readers are referred to the annual report of that Station for complete plans and specifications. Although this building has, to date, only been used for a few weeks, it has proven most satisfactory and might easily be considered a standard of excellence for horse barns in this province. Already, visitors have inquired as to the details of the building and it is likely that this building, in part at least, will be copied extensively throughout this part of the province of Quebec. Particular attention has been given, in the erection of this building, to the light, ventilation, durability, and conveniences, which can be readily noted from the illustrations.

SESSIONAL PAPER No. 16

EXPERIMENTAL STATION, STE. ANNE DE LA POCATIÈRE, QUE.

REPORT OF THE SUPERINTENDENT, JOS. BEGIN.

HORSES.

At present, seven horses are in the stables on this Farm, these being used entirely for labour purposes. Although this number is insufficient for carrying on the work of this Farm, yet owing to the limited stabling facilities previous to the erection of the new horse barn, it was impossible to keep the proper number. This number will be increased from time to time, to which will also be added a number of mares for breeding purposes.

HORSE BARN.

In 1913, on the Experimental Station, Ste. Anne de la Pocatière, Que., a new horse barn was erected, capable of accommodating fifteen horses. The accompanying plans and photographs of this barn are for the most part self-explanatory. A few additional remarks, however, may help make some points more intelligible.

FOUNDATION.

The foundation of this barn is a concrete wall 12 inches in thickness and 2 feet in height, the same resting on a concrete footing 18 inches wide and 18 inches deep.

SUPERSTRUCTURE.

The superstructure is of wood, built of the plank frame type. All timbers throughout this barn in the frame are 2- by 6-inch plank, excepting the joists of the loft floor, which are made of 2- by 10-inch planks, and the girths supporting this floor, made of five ply 2- by 10-inch planks. This type of structure is exceedingly strong and is very economical in that it requires less lumber for construction and is more economical in erection than the square-timbered type of barn.

Special attention is drawn to the economic structure of the walls of this barn, which, starting at the outside, are composed of: vertical inch dressed lumber with battens over joints, two ply building paper, 6-inch studs and posts with air space between and, on the inside of stable, one ply of specially prepared building paper (Lino-felt) with sheathing on the inside. The ceiling or upper floor is constructed of one ply of rough boards placed diagonally over joists, covered by one ply of building paper and matched lumber, making the same dust-proof, while on the underside the ceiling is sheathed with matched lumber.

DIMENSIONS.

The barn is 76 feet 6 inches in length and 32 feet in width, with a wing 20 feet in width and 26 feet in length. The main barn accommodates thirteen tie stalls, two box stalls and a carriage shed. The wing accommodates feed room, harness room, stairway, and meal storage room above. The stalls are 9 feet in length and vary in width from 5 to 6 feet. The box stalls are 11 feet 6 inches by 13 feet 6 inches. The drive shed is 18 by 30 feet. The passage between the two rows of tie-stalls is 12 feet in width.

LEVELS.

The floors throughout are of concrete. All floors are resting on 6 inches or more of field stone, covered by 5 inches of rough cement and 2 inches of finish-coat. The main passage is 5 inches lower than the rear end of tie-stalls, and is on the same level as feed room and harness room.

SLOPES.

The main passage has a crown of 2 inches to centre. Next the tie stall is a 1-inch depression to act as a gutter for collecting the urine. The tie stalls have a slope of 2 inches from front to rear. These tie stalls are finished with a very rough surface and are sloped to centre of stall as well as from front to rear, and also grooved in order to facilitate ease of moving about of occupant, and also the carrying away of all liquid manure.

LIGHT.

All light possible was installed in this barn. A window as large as possible was placed in the front of each tie stall, and all windows possible in doorways, box stalls and feed rooms were installed, in order to give as much light as possible to this building.

VENTILATION.

Fresh air is admitted at the floor level by means of air ducts bringing fresh air from the intakes just outside the walls. The outlets are two in number, situated to one side of the middle of the barn when considered from side to side. These run vertically to rafters and follow the line of rafters to cupolas on roof. By the installation of foul air outlets in this way, there is no interference with the track for hay carriers in loft. The foul air outlets are constructed of two ply of $\frac{3}{4}$ -inch matched lumber with a dead air space between, thus giving splendid insulation and preventing condensation of moisture in ventilators. Both incoming fresh air and outgoing foul air are controlled by dampers or keys. It is thus possible to regulate the temperature as desired. This system is known as the Rutherford system of ventilation, and has given the best results on the Central Experimental Farm and branch Farms where tried.

FEEDING CONVENIENCES.

Feed chutes, as shown in diagram, extend from the bottom of manger to the plate of barn. Doors to admit the hay into chutes occur at the top and half-way down to the floor of loft. The chute is slightly bell-shaped so that hay once started drops easily to manger. This plan of feeding long hay has been found very satisfactory elsewhere. The manger extends clear across the stall, the hay in chute falling into one end. The grain or meal is fed in the manger, no special box being provided. Horses are watered by men in charge, a water tank at side entrance of barn being conveniently situated for incoming or outgoing horses.

FACILITIES AND CONVENIENCES.

The feed room, although not very large, is sufficient to accommodate the meal trucks necessary. Into this feed room grain chutes from bins in the meal storage room above empty into movable trucks.

The harness room is conveniently situated and has facilities for warming, should such be necessary. In the harness room are also installed a sink for washing, a tank for heating water on stove, harness racks, and a locker underneath stairway for the keeping of small harness, medicines, and the like. The manure is removed from this barn by barrows, there being no overhead track for this purpose.

SESSIONAL PAPER No. 16

EXPERIMENTAL FARM, BRANDON, MAN.

REPORT OF THE SUPERINTENDENT, W. C. McKILLICAN, B.S.A.

HORSES.

The horses on this Farm at present consist of the following: twelve heavy farm horses, two light horses for driving, and one 2-year old colt.

The horses are kept for labour purposes; no breeding or experimental work has been done during the year.

CLASSIFICATION OF LABOUR.

The labour performed by the horses during the year was divided as follows: Farm work (regular), 12,150 hours; farm work (experimental) 10,710 hours; horticulture, 610 hours; roads, 750 hours; drawing feed, 630 hours; drawing manure, 1,250 hours; messenger service, 3,120 hours.

HORSE BARN.

A new horse barn has been built this year. It is 72 feet 4 inches long and 32 feet wide, and provides accommodation for fourteen horses tied up in single stalls, and three roomy box stalls.

The single stalls are on each side of a 12-foot main passage which runs lengthwise of the building. The space of two stalls in the middle of the west side is used for the main entrance to the stable. The ends of the building are used for the box stalls and feed room, two box stalls being at the south end and one box stall and the feed room at the north end. This is found to be a very convenient and compact arrangement, and is more economical of space than a driveway through the stable from end to end.

There are no feed passages; the mangers are tight up to the wall, and the hay is fed through chutes which extend from the manger to a height of 7 feet above the loft floor. These chutes are double boarded, with air spaces between the boards, and the doors which open into them are constructed in the same way. They work very satisfactorily, the only difficulty being the swelling of the doors at the top of the chute from the steam which rises from the stable.

The stable is well lighted, a window opens directly into every stall. This gives a bright and cheery appearance and should make it more healthful.

The ventilation is the Rutherford system. There are three fresh-air inlets; each receives the fresh air in a little box placed against the outside wall, with an opening at each side 1 foot square covered by wire netting. From this entrance the air goes through a 1-foot sewer pipe underneath the wall and the cement floor and comes up through a grating placed so as to avoid sending a direct draft against a horse's body. The locations of the ventilator inlets are shown in the accompanying plan. The ventilator outlets consist of two wooden flues which rise from the ceiling of the stable and deliver the foul air through the vents shown on the roof. The flues are of two-ply of matched lumber with an air space between. They are each 2 feet square. The outlet on the roof is wide open to all four directions, and roofed on the top; it has no louvres or other obstacles to impede the ventilation or form a settling place for moisture. The flow of air is regulated by a damper placed in the outlet just above the stable ceiling, and controlled by a rope hanging down in the stable.

This ventilation system has proven very effective. The stable has always been fresh and dry, and almost entirely free from stable smells.

EXPERIMENTAL FARM, INDIAN HEAD, SASK.

REPORT OF THE SUPERINTENDENT, T. J. HARRISON, B.S.A.

HORSES.

On the Indian Head Experimental Farm there are at present fourteen horses, viz., three Clydesdale mares, five grade mares, four geldings and two drivers. Among these there are some fine draught horses, but there are also three or four that are past the age of usefulness. This also applies to the two drivers, which are hardly ever used for driving purposes, but are very useful for doing the light farm work. Of the above horses, two grade mares were bought last April to supplement the stock of horses, as there was too much work for the number on hand.

During past years horses were kept on this Farm for labour purposes only, but in the future the breeding of draught horses is also to be carried on. Two mares are now in foal and in due course it is hoped to be able to secure data on the costs of rearing colts, yearlings, 2-year-olds and 3-year-olds. With the purchase of two or three pure-bred Clydesdale mares it should be possible to procure some valuable information in regard to breeding Clydesdales. The breeding of grade draught horses is also to be carried on, the purpose of which is to primarily supply work horses for the Farm. By the use of the pure-bred Clydesdale, the improvement that can be brought about by pure-bred top crosses from a good quality Clydesdale stallion will be noted.

HORSE FEEDING EXPERIMENTS.

With a view to investigating the most economic means of handling and feeding the draught horse in winter an experiment was started last season and will be continued again this winter. The following table will indicate the outline that was followed. It will be noted that horses handled similarly were fed differently, while those fed similarly were handled differently.

Group.	Ration.	Method of Handling.								
		Light Work.	Let Out Each Day.	Stabled and Exercised N.B.						
1	Oat straw, oat sheaves, oats, and bran	{ Duke.....	Lucy.....	{ Flora.						
2	Oat straw, mixed hay, oats, and ground flaxseed				{ Jimmie.....	Queen.....	{ Mary.			
3	Oat straw, mixed hay, oats, and bran.....							{ Maggie Ann . . .	Dick.....	{ Prince.
4	Oat straw, alfalfa hay, oats, and bran.....									

The horses bracketed under "light work" were worked together, while those bracketed under "stabled and exercised" were handled together in respective two-horse teams. Those under "light work" were worked every second day by the teamster, while the "stabled and exercised" lot were exercised every second day by the stableman. In this way it was possible to work one team of the four each day and exercise one team of the other four. The four horses "let out each day" were, with the exception of two or three very stormy days, turned out in a field every morning where they were allowed to remain most of the day.

EXPERIMENTAL STATION
ST ANNE DE LA POCATIERE, QUE.
PLAN OF HORSE BARN
1/8 IN SCALE.

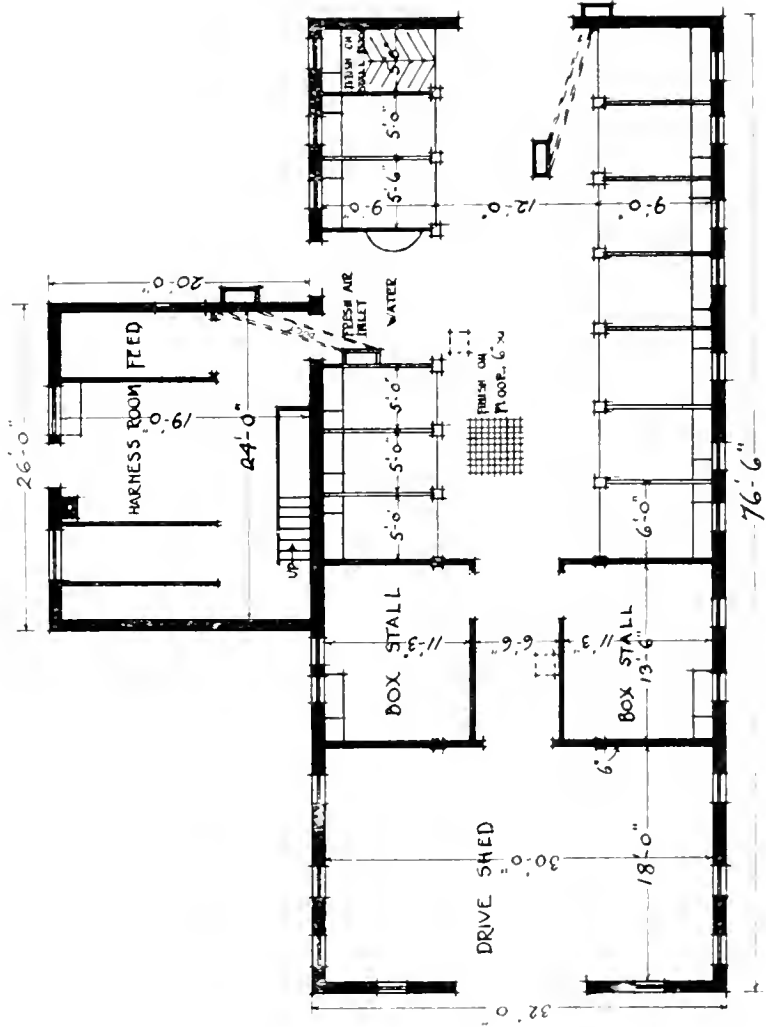

EXPERIMENTAL STATION
ST^E ANNE DE LA POCATIERE, QUEBEC
SECTION OF HORSE BARN
1/4 IN SCALE.

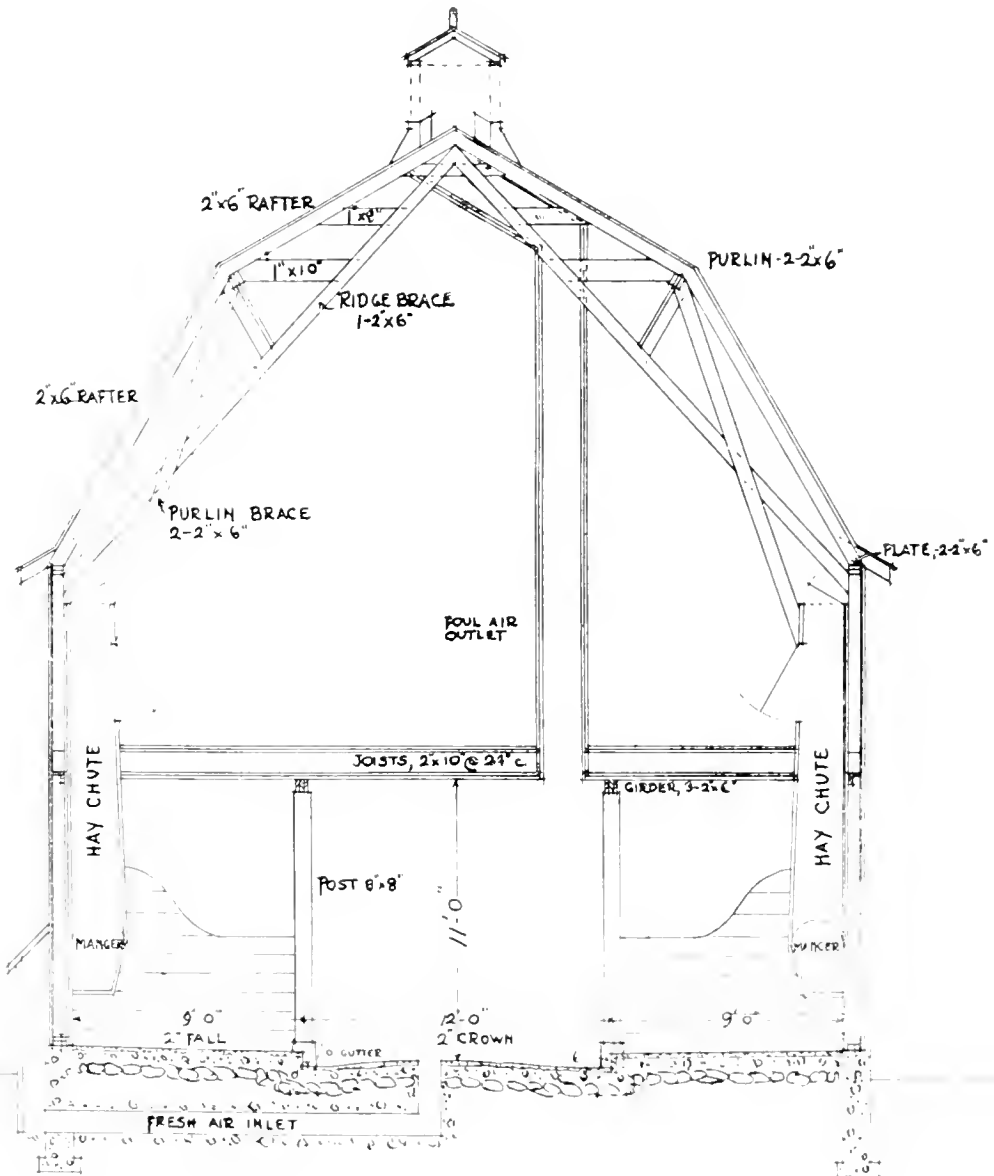

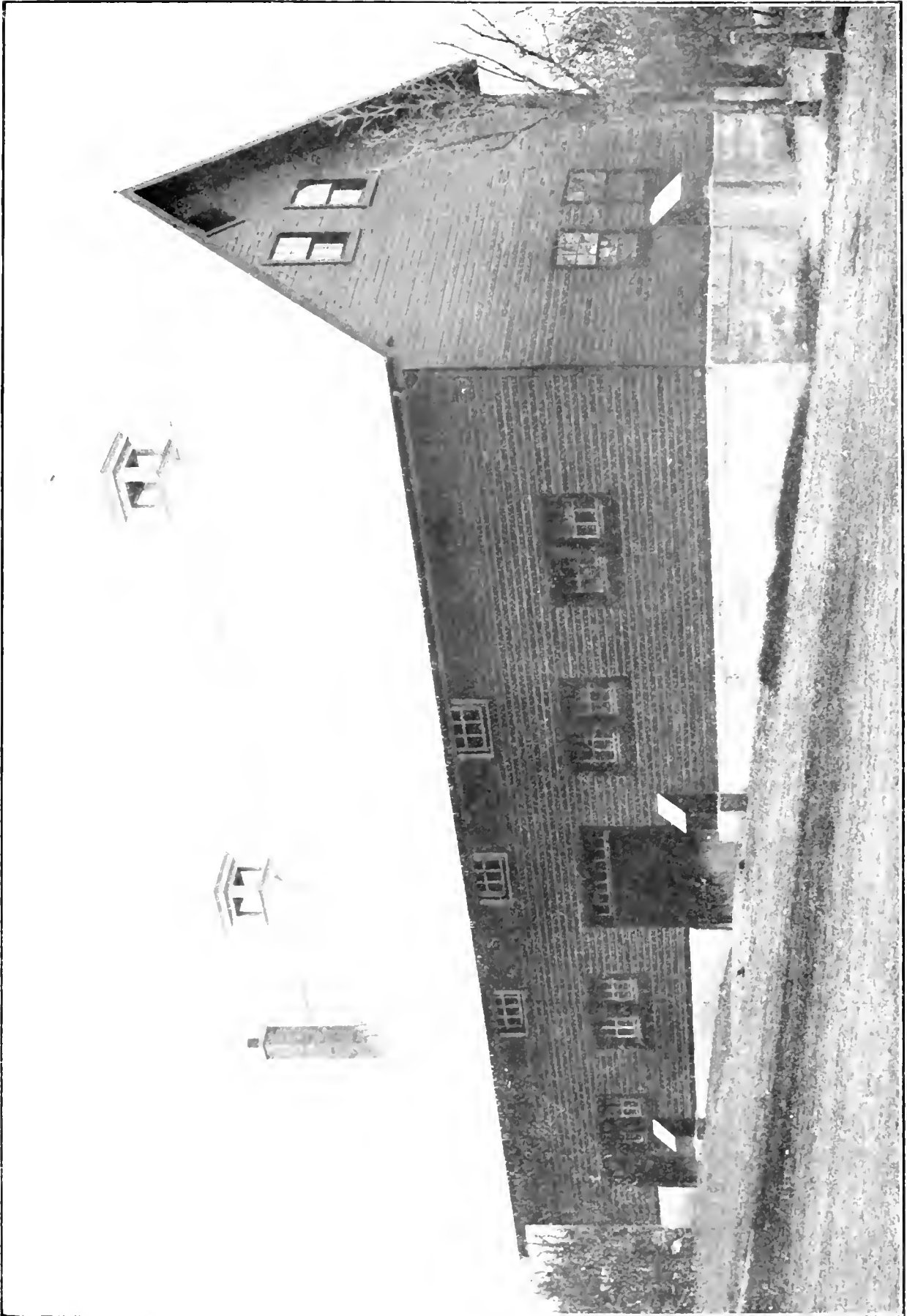

Exterior View of New Horse Stable, Brandon, Main.

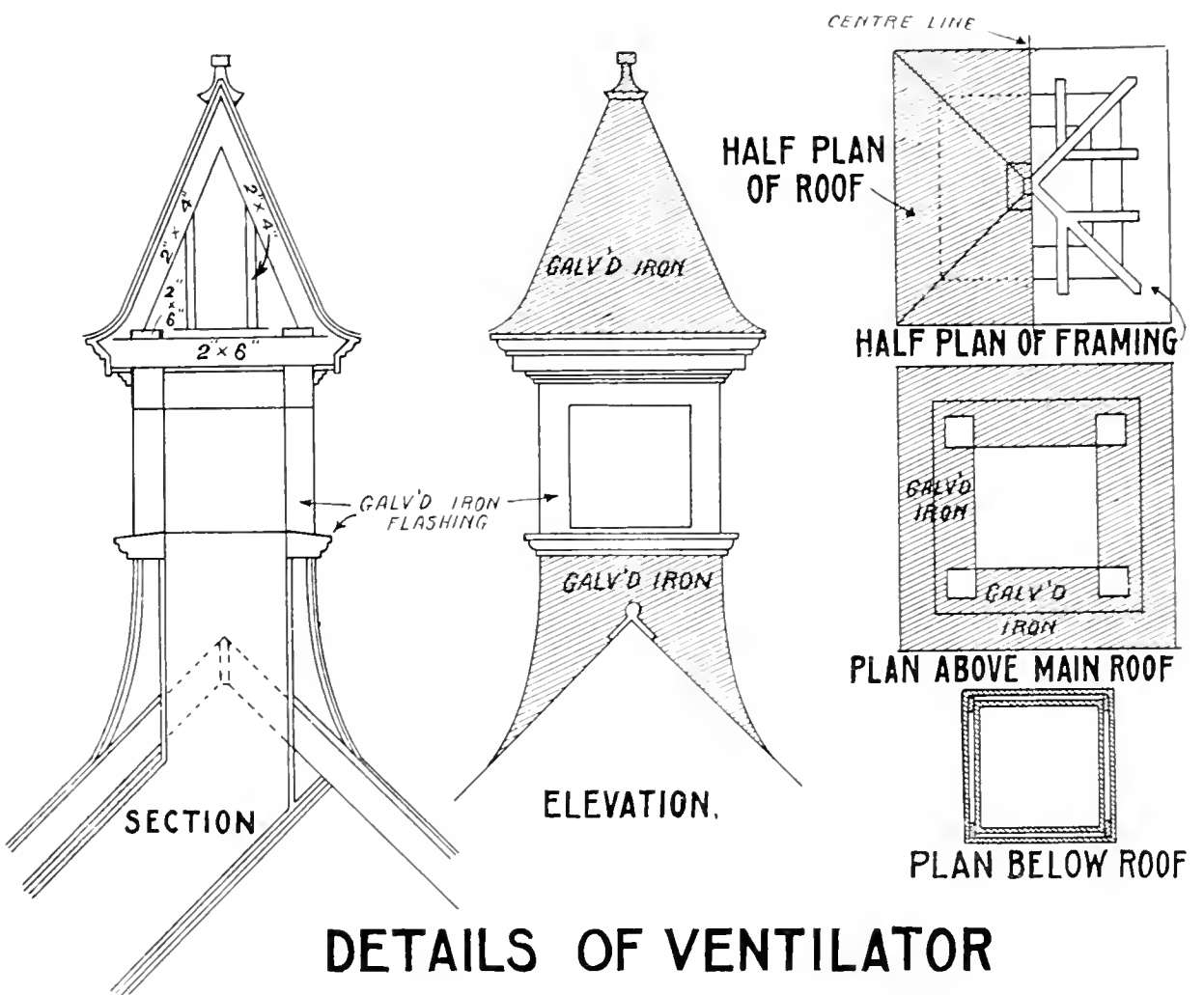

Ventilation of Horse Stable, Brandon (Showing Detail of Ventilator Outlet)

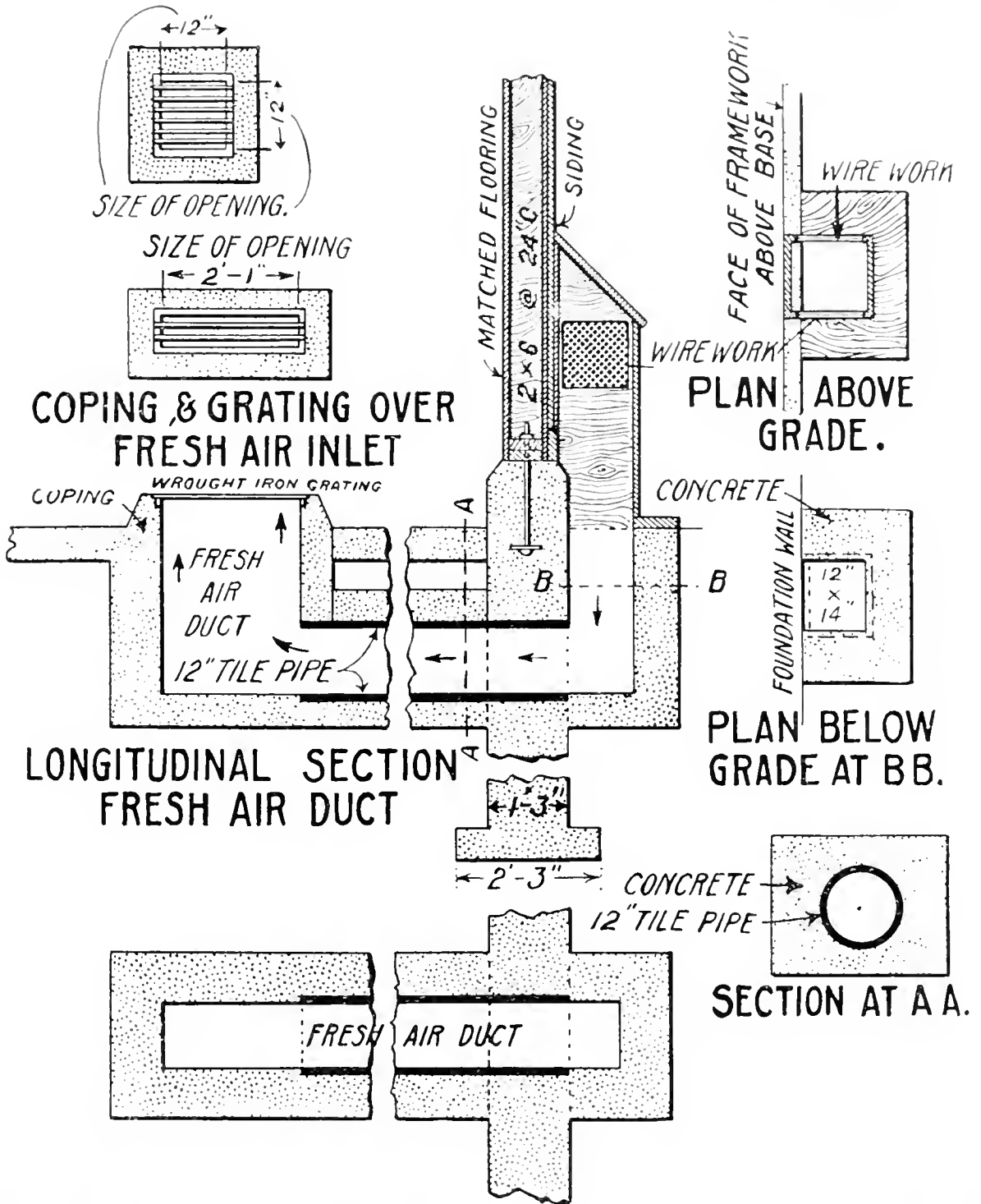

DETAIL OF FRESH AIR INTAKE DUCT.

Ventilation of Horse Stable, Brandon (Showing detail of fresh air intake duct).

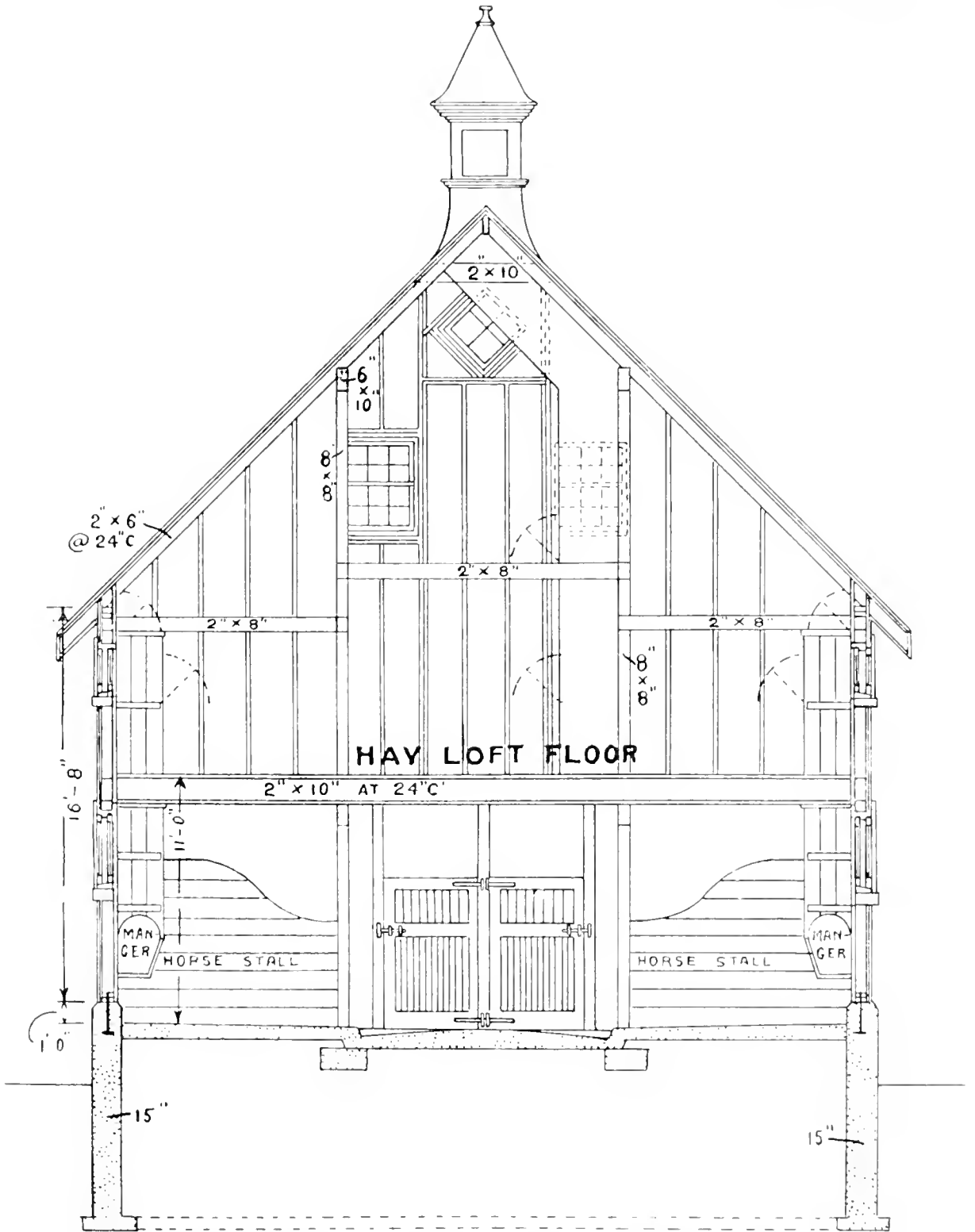

CROSS SECTION ON LINE A--A.

Cross Section of Horse Stable, Brandon.

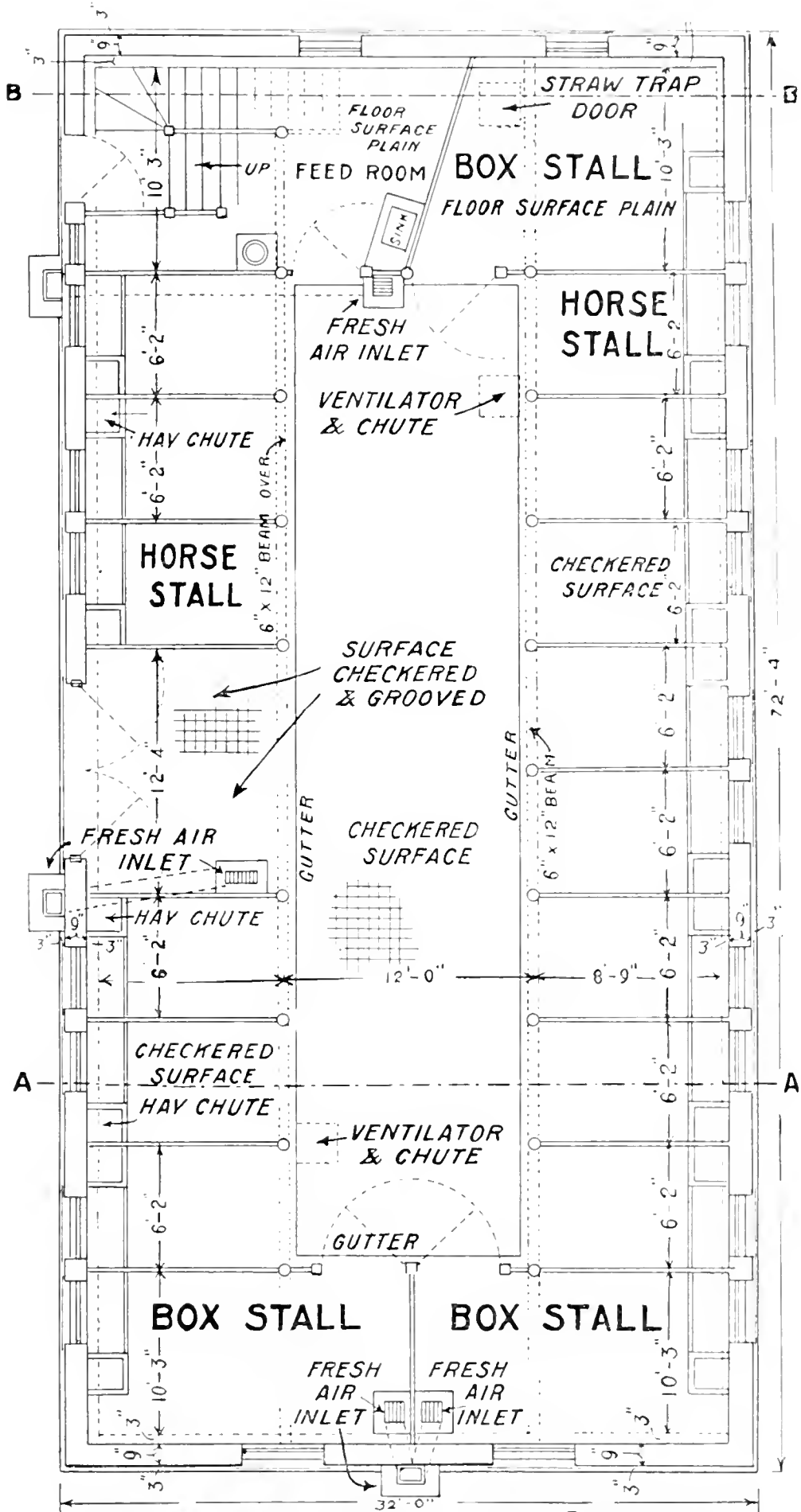

PLAN AT LEVEL OF STABLE

Ground Plan of Horse Stable, Brandon.

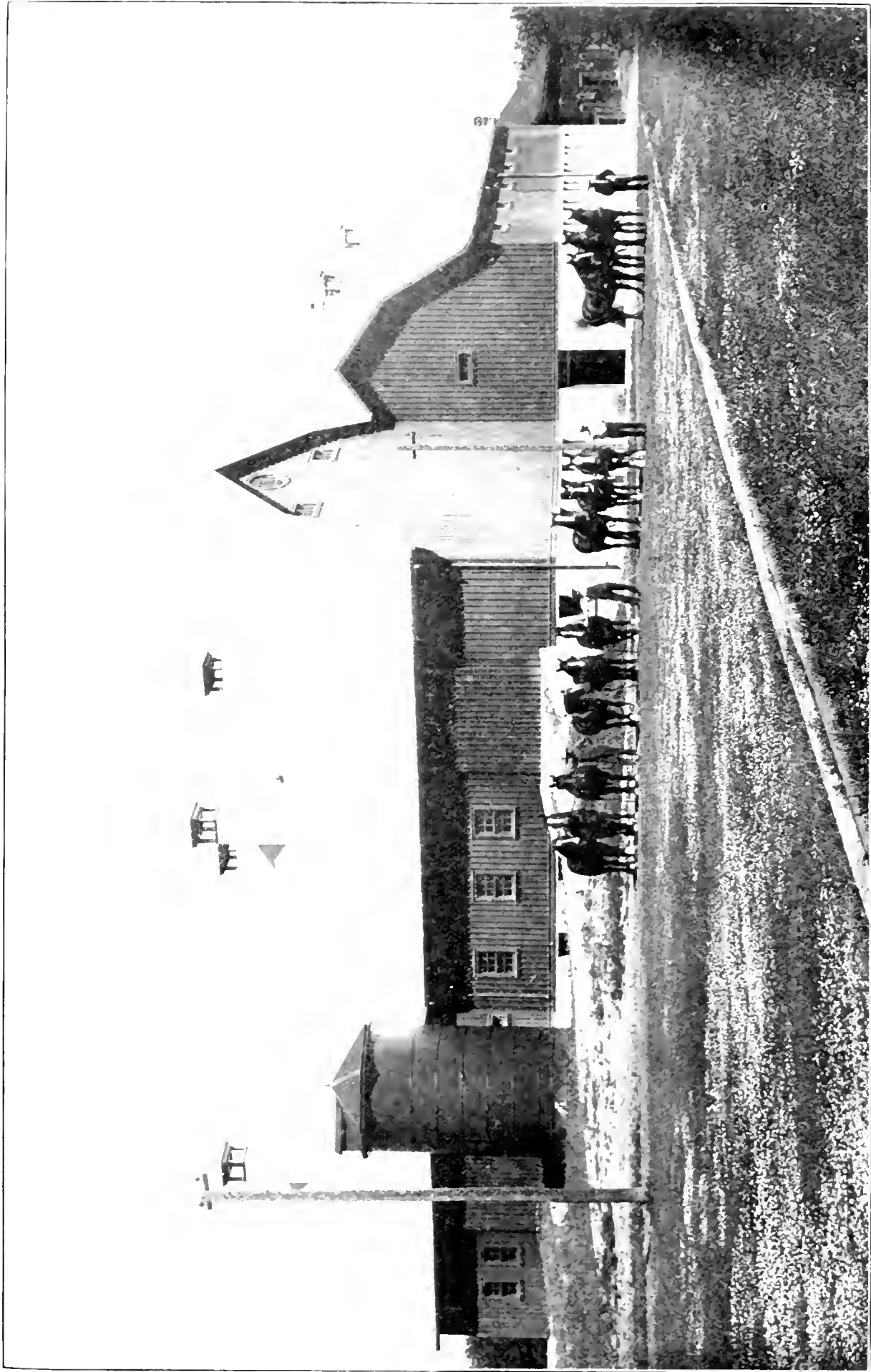

Barn and Work Horses, Indian Head, Sask.

SESSIONAL PAPER No. 16

The stableman feeds all the horses, while the teamsters, under his supervision, are responsible for the care of their respective teams. The horses are always watered before meals and not after unless to merely wash out their mouths. During the experiment, which lasted for four months, the rations were weighed every week and the horses weighed monthly.

In the feeding of the horse not only the animal's weight but also its individuality was recognized. In the latter connection especially, very noticeable peculiarities were observed, some horses of similar weights being much easier to feed than others. The horse "Duke" is a very hard feeder at any time and particularly did he give evidence of this when fed straw, oat sheaves, oats, and bran. The outline below will give the amount fed the average horse per day. It will be noticed they were all fed lightly in the belief that the idle horse should be limited to about half the feed given when on regular work. Those working, however, were fed according to the nature of the work.

GROUP 1.—STRAW, OAT SHEAVES, OATS, AND BRAN.

Morning.—Oat sheaf.

Noon.—Oats, $\frac{1}{2}$ gallon; bran, $\frac{1}{4}$ gallon; oat straw, 3 to 5 pounds.

Evening.—Oat sheaf.

NOTE.—In this ration as in the others the horses took a long time to acquire a taste for the straw. Neither did they appreciate the oat sheaves. After a time they thrived on this ration but were never in as good a state of thrift as those fed on the other rations. In the spring, however, after two weeks of good feeding on hay and oats, before the heavy work started, they stood the work as well as the horses in the other groups.

GROUP 2.—STRAW, MIXED HAY, OATS, AND GROUND FLAXSEED.

Morning.— $\frac{1}{2}$ gallon oats; ground flaxseed, handful; hay, 3 to 6 pounds.

Noon.—Oats, $\frac{1}{2}$ gallon; ground flaxseed, handful; oat straw, 3 to 5 pounds.

Evening.—Oats, $\frac{1}{2}$ gallon; ground flaxseed, handful; hay, 3 to 6 pounds.

NOTE.—The amount of flaxseed fed in this ration was about one-quarter gallon per day. This ration being more expensive than the former naturally kept the horses up in better condition, but care had to be exercised in giving only a small quantity of flaxseed as it is very laxative in its properties.

GROUP 3.—STRAW, MIXED HAY, OATS, AND BRAN.

Morning.—Oats, $\frac{1}{2}$ gallon; bran, $\frac{1}{4}$ gallon; hay, 3 to 6 pounds.

Noon.—Oats, $\frac{1}{2}$ gallon; bran, $\frac{1}{4}$ gallon; oat straw, 3 to 5 pounds.

Evening.—Oats, $\frac{1}{2}$ gallon; bran, $\frac{1}{4}$ gallon; hay, 3 to 6 pounds.

NOTE.—Of all the rations, this last gave the best satisfaction. The hay seemed to give better results than oat sheaves in No. 1, while the bran is an ideal feed to mix with oats, as contrasted with flax seed in No. 2.

GROUP 4.—STRAW, ALFALFA HAY, OATS, AND BRAN.

Morning.—Oats, $\frac{1}{2}$ gallon; bran, $\frac{1}{4}$ gallon; alfalfa hay, 2 to 5 pounds.

Noon.—Oats, $\frac{1}{2}$ gallon; bran, $\frac{1}{4}$ gallon; straw, 3 to 5 pounds.

Evening.—Oats, $\frac{1}{2}$ gallon; bran, $\frac{1}{4}$ gallon; alfalfa hay, 2 to 5 pounds.

NOTE.—It was found that alfalfa hay is slightly laxative and consequently would not be advisable for drivers or horses at very hard work. It might be used to good advantage with horses at slow, steady work or under such conditions as outlined in the experiment above.

5 GEORGE V., A. 1915

The ration which was found most expensive was that in which the flaxseed was included. That containing the alfalfa hay followed next, while the "oat sheaves" ration came third, and the "mixed hay, oats, and bran" ration cheapest. This may be largely due to the fact that there was less waste with the latter than with the oat sheaves. The prices for feed were allowed as follows: Oat sheaves, 5 cents; oats, 1 cent per pound; flaxseed meal, 4 cents per pound; mixed hay, \$10 a ton; alfalfa hay, \$12 a ton; oat straw, \$2 a ton; bran, \$20 a ton.

The average cost per horse was, of course, low in each group, for the reason that they were fed as lightly as possible in consideration of the fact that our aim was the economical feeding. The cost per day per horse was as follows:—

Group 1.—	16	cents	per	horse	per	day.
" 2.—	18	"	"	"	"	"
" 3.—	15	"	"	"	"	"
" 4.—	17	"	"	"	"	"

The average weight of the horses under this test was 1,600 pounds. With the foregoing method of handling and feeding all horses were carried through the winter in a very satisfactory condition. This work, however, has only just been started, and no definite conclusions can be drawn. It has, however, opened up a very interesting line of investigation that will be followed up in years to come, when more definite data can be published.

EXPERIMENTAL STATION, SCOTT, SASK.

REPORT OF THE SUPERINTENDENT, R. E. EVEREST, B.S.A.

HORSES.

COST OF REARING FOALS.

The cost of raising foals and the cost of wintering idle horses are the two phases of horse investigational work entered upon.

For the purpose of ascertaining figures on the cost of raising horses, the foals of two work mares were taken at weaning time (in this case 5 months of age) and from then a record of feed consumed was kept when stall fed, and of time when animals were on pasture. The following table gives cost of food up to 2 years of age:—

VALUE OF FOOD CONSUMED.

Oat chop, 2,974 pounds at 31 cents per bushel.....	\$29 74
Hay, 2,832 pounds western rye grass, \$19 per ton.....	14 16
Alfalfa hay, 334 pounds at \$12 per ton.....	2 18
Oat sheaves, 209 at 3 cents each.....	6 27
Pasture, seven months, two animals at \$1 per month.....	14 00
	\$66 35
Total cost	
Cost of growing one horse from weaning at five months till 2 years of age	33 17½

THE ECONOMIC WINTERING OF IDLE HORSES.

In the work of economy or maintenance of idle horses over winter, five mature work horses were used. These, after a steady summer's work were, on the 2nd of December, started in the following manner: At 7 a.m. they received a drink and a small feed of oat chop in the stable; as soon as this feed was eaten the horses were taken to a prairie pasture field where they remained until 5 p.m., when they were brought to stable, watered, and again given a small feed of oat chop; when occasion required an oat sheaf was also fed. This treatment was given for three months.

The following data give weights of the horses at the beginning of period and conclusion of period, and the value of food consumed:—

Total weight of five horses, December, 1913.....lb	7,432
Average weight, December, 1913....."	1,486
Total weight of horses, March, 1914....."	7,716
Average weight of horses, March, 1914....."	1,543
Total gain in weight	284
Average gain in weight	57
Value of feed consumed, total	\$ 45 86
Value of feed consumed, one horse	9 17
Cost of maintaining a horse for 129 days, winter of 1913-14....."	9 17

EXPERIMENTAL STATION, LACOMBE, ALTA.

REPORT OF THE SUPERINTENDENT, G. H. HUTTON, B.S.A.

HORSES.

The Station now owns twenty head of horses. There are thirteen pure-bred Percheron, Clydesdale, and grade mares. We were successful in raising three foals. Nine of the mares were bred for foaling during the spring and early summer of 1913. Of this number five foaled prematurely, three being, without doubt, cases of abortion and in the other two cases this disease was the probable cause. The mares were wintered outside day and night, had access to a straw stack, were watered at a small lake and were not fed hay or grain. A number were brought up for spring work, were then fed hay and grain, while the others were left out and were fed a light grain ration. Of the six in-foal mares which were worked, only one raised a foal, which was malformed, while all three mares left out raised good colts. It is planned to repeat this test next spring, though all mares are bred to foal comparatively late.

All horses, wintered outside in the manner above described, came through the winter in prime condition and, without exception, showed increase in weight. This method of wintering horses is very inexpensive, costing probably about \$1 per month per head. When straw, which would otherwise be burned, can be put to this use, the cost of wintering horses is practically negligible.

Three foals were carried from November 1, to March 31, at a feed cost as follows:—

	Pounds.	Value per Ton.	Cost.	Combined Weight at 6 Months.
		\$	\$ cts.	Lb.
Hay	2,718	10	13 59	
Green feed.....	2,340	10	11 70	
Oats	1,530	20	15 30	
Bran.....	1,000	20	10 00	
Total.....			50 59	2,160

EXPERIMENTAL FARM, AGASSIZ, B.C.

REPORT OF THE SUPERINTENDENT, P. H. MOORE, B.S.A.

HORSES.

During the year no experiments have been made with the horses. Ten have been kept for working purposes only. Just at the close of the year, two 3-year-old pure-bred Clydesdale mares were added to the force. These mares are good specimens of the breed, and they are working well at the time of writing. They were both foaled the property of the Colony Farm, Coquitlam, B.C. They are bred as follows:—

Colony Lilly—27871—
 {Sire, Brown Spots (imp.)—8383—12877.
 {Dam, Lilly of Grandview—15750.

Nellie Dean—28843—
 {Sire, Dean Swift (imp.)—5397—12936.
 {Dam, Nellie Carriek (imp.)—7375.

The three old light draught horses mentioned in last year's report as being on the downgrade are still retained, and also one general-purpose mare, which is pretty well worn out. In addition to these, there are four grade Clydesdale heavy draught horses, bought in 1912.

Throughout the season all the horses were kept at hard work, and in the winter they were all put on lighter work, but all kept working. They were all fed a mixture of ground oats, peas, and barley, bran, and clover or mixed hay. During the winter they ate about 5 pounds of roots per day. The hay fed averaged at the end of the year slightly less than 1 pound for every 100 pounds live weight.

The average food cost to keep the big horses for the year was:—

Grain, 5,110 pounds at 1.2 cent.....	\$61 32
Hay, 6,570 pounds at .5 cents.....	32 85
Roots, 510 pounds at .2 cents.....	1 02
	<hr/>
	\$95 19

The average food cost of the small horses was less as indicated:—

Grain, 4,380 pounds at 1.2 cent.....	\$52 56
Hay, 5,657 pounds at .5 cents.....	28 28
Roots, 510 pounds at .2 cents.....	1 02
	<hr/>
	\$81 86
	<hr/>

Such feeding kept the horses in good condition for the entire year and no trouble from disease of any nature was encountered. One of the old horses was slightly crippled for a time, but this was caused by a combination of hard work and old age. Owing to lack of room no breeding work can be done.

SHEEP.

CENTRAL EXPERIMENTAL FARM, OTTAWA, ONT.

REPORT OF THE DOMINION ANIMAL HUSBANDMAN, E. S. ARCHIBALD, B.A., B.S.A.

BREEDING SHEEP.

There are now eighty-one pure-bred sheep in the pens. Two breeds only are kept, namely, Shropshires and Leicesters.

The Shropshires include 48 head, made up of 1 ram, 21 aged ewes, 7 shearling ewes, 8 spring ewe lambs, and 11 spring ram lambs.

The Leicesters include 33 head, made up of 1 ram, 11 aged ewes, 8 shearling ewes, 6 spring ewe lambs, and 7 spring ram lambs.

Only a fairly successful year can again be reported in the breeding operations with sheep. The lamb crop in the spring of 1913 was exceptionally good, namely, 151 per cent; and to date, March 31, 1914, has also been very good although many ewes have yet to lamb. During the past fiscal year both ewes and lambs did particularly well until mid-summer. Limited as they were to the 2 acres of pasture contained in the 6-acre sheep rotation, the pasture became very poor after the first month. In past years it has been the practice to allow the sheep to remain on this closely-cropped pasture and supplement the shortage with green crops. This, however, has proved dangerous in that it induced the rapid spreading and multiplying of intestinal parasites. In consequence of our experience in this matter it was deemed advisable to keep the sheep away from this pasture after the grass became closely cropped. An experiment was tried in the keeping of sheep on the Farm roadsides, to ascertain their influence on the keeping clean of roadside as well as the cost of attention for this method of pasturing. Although it proved somewhat more expensive than the other method of pasturing, yet the added weight of the lambs and increased condition of the ewes appeared to warrant the same for these conditions, as long as the Central Experimental Farm is so limited in its land area.

The ewes and lambs, as in former years, were attacked with both tape worms and stomach worms, although only to a small degree. Had they been removed from the 2-acre pasture a few weeks sooner, the probabilities are that the flock would not have become reinfested with these parasites. Treatment was made for these parasites as reported in annual report for 1912, and although it was discovered that but a few individuals were infested, yet these treatments again were quite successful, and are worthy of repetition.

The treatment given for tapeworms, with such good results, was as follows:—

Fast the animals for at least twenty-four hours. Drench mature sheep and shearlings with a mixture of 4 ounces of castor oil and 1 dram ($\frac{1}{8}$ ounce) of ethereal extract of male fern. Lambs may have one-quarter to three-quarters of the above dose, depending on size and age. Confine sheep for twenty-four hours after drenching. Destroy worms given off in manure.

Follow the above drench with a laxative tonic, such as: Common salt, 2 pounds; potassium nitrate, 4 ounces; Epsom Salts, 1 pound; iron sulphate, 8 ounces; powdered gentian, 8 ounces. This mixture is sufficient for 100 mature sheep or 150 to 200 lambs, and also is best given in water solution as a drench.

SESSIONAL PAPER No. 16

Apparently very favourable results were obtained in the eradication of stomach worms by the use of a 1 per cent solution of coal tar creosote. Lambs were given 2 to 4 ounces, and mature sheep 3 to 5 ounces, varying with the size. This was administered as a drench, was preceded by a twenty-four hour fast, and succeeded by a twenty-four hour confinement and the laxative tonic as above.

Owing to the winter-killing of all the clovers in the spring of 1913, the after-grass, some of which is usually used for cattle and sheep for pasture, was extremely limited and not of particularly high quality. However, the pasturage on roadsides was so good that at weaning time the lambs were well advanced and after weaning the ewes gained in flesh rapidly previous to mating season in the fall.

All breeding sheep were housed in sheds of a very rough nature during the past winter, as the regular sheep barn and lamb-feeding sheds were completely filled with cattle. Nevertheless, all the breeding stock came through the winter in exceptionally good shape at a minimum of cost.

FEEDING LAMBS.

A special lamb-feeding shed was erected during the summer of 1913 and experimental work on a considerable scale was anticipated. Lambs were purchased subject to delivery on the 20th of October, 1913, and a particularly good bunch of lambs were purchased, at regular market prices, for this feeding experimental work. However, in consequence of the fire, this lamb-feeding shed was the only building available for milch cows until temporary structures could be completed, and was used continuously throughout the past winter for the housing of heifers and bulls. In consequence, the lamb-feeding experimental work was postponed for a year.

LAMB-FEEDING SHED.

Although the inclosed diagrams and photographs are self-explanatory, yet a few details as to a cheap but very efficient shed either for the feeding of lambs or the maintaining of a breeding flock excepting for lambing season, are worthy of mention. This shed was erected on the Central Experimental Farm during the month of July, 1913, and is very satisfactory in all its details.

1. Foundation.

Although originally it was the intention to place the sills of this building on cedar posts, yet it was found nearly as economical to build a low concrete wall for this purpose. This would not be advisable where a farmer anticipates moving the shed from time to time, but where good river gravel and sand are available, it will eventually prove even more economical than post foundations, or the placing of the sills on the earth. This wall also prevents very strong draughts from the northern and western exposures. The foundation wall was made 10 inches in thickness, an average of 2 feet in depth, and was composed of a mixture of concrete, 1 to 6, with as many field stones in the concrete as possible.

2. Superstructure.

The sills and plates and posts were made of 2-inch by 6-inch scantling. Rafters were made of 2-inch by 5-inch scantling, and collar beams of 8-inch boards. The walls were single boarded and battened on the outside of posts and studding, no finish whatever being necessary on the inside. The roof was single boarded and covered with prepared roofing, which to date is proving fairly satisfactory.

3. *Light.*

Special attention was paid to the lighting of this shed, as undoubtedly the great proportion of sheep troubles come from insufficient light, lack of fresh air, and poor ventilation. All windows were hinged at the bottom and fastened at the top with a short chain, thus allowing the window to drop open from the top and allow a free passage of air through the building. The doors also were made 4 feet in width and were so arranged that they can be open at all times except during very severe weather. No ventilation system, aside from the windows and doors, was provided, since both windows and doors are kept open at practically all times.

4. *Feed Passage.*

The feed passage across the ends of the pens was provided for the ease in feeding of the forages and also, at one end, to provide room for keeping a limited amount of grains in this building. A wood floor was provided for this passage, both from a point of cleanliness and economy of foodstuffs.

5. *Pens.*

The site of the building was chosen on account of its dryness and good facilities for drainage. Earth floors, for the pens where straw bedding can be used, are considered the best. The doors of pens into paddocks were arranged to eliminate draughts. These doors open to the south, and were made 4 feet in width in order to eliminate the hiping of ewes or the crowding of lambs in the doorway. The sizes of pens were based on the area required for various classes of stock according to the experience with sheep on the Central Experimental Farm. These areas are as follows: For large breeding ewes, 10 to 12 square feet of floor space; smaller breeding ewes, 8 to 10 square feet; feeding and breeding lambs, 5 to 8 square feet. The four pens of this shed will conveniently accommodate twenty-five to thirty feeding lambs each.

6. *Feed racks.*

The accompanying diagrams of feed racks installed are self-explanatory. Three different types of hay racks were installed for comparative purposes, type "A" rack including the grain trough in bottom of rack, while the other two types of racks have the grain trough in front of rack. All three types have given good satisfaction in the limited time which they have been used. These and other types of racks and troughs will be installed for comparative purposes, during the coming year.

W. P. SHEPHERD
CENTRAL EXPERIMENTAL FARM,
OTTAWA, ONT.
1/4 IN. SCALE.

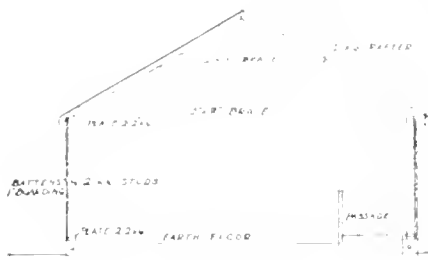

CROSS SECTION



EAST ELEVATION

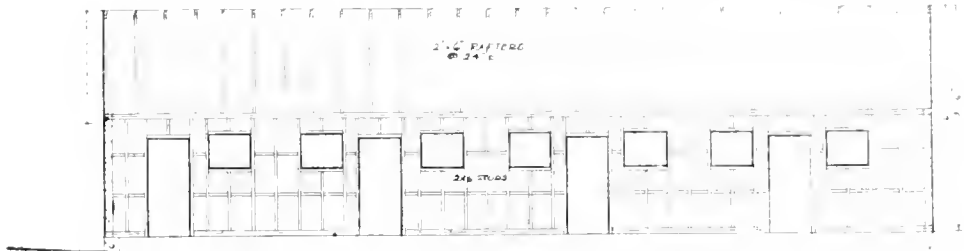

LONG SECTION, SHOWING FRAMING

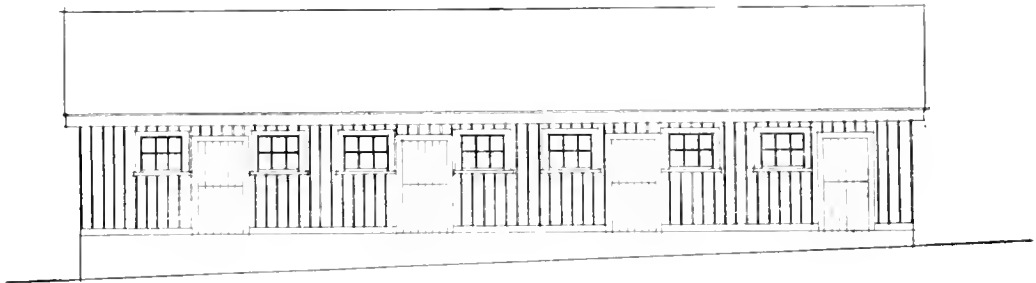

SOUTH ELEVATION



57-0
PLAN

DETAIL OF SHEEP RACKS.

- 1½ IN SCALE -

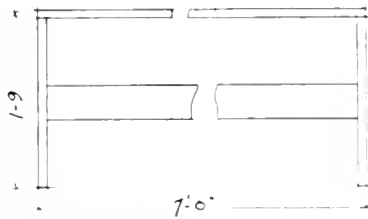
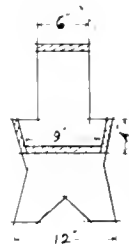
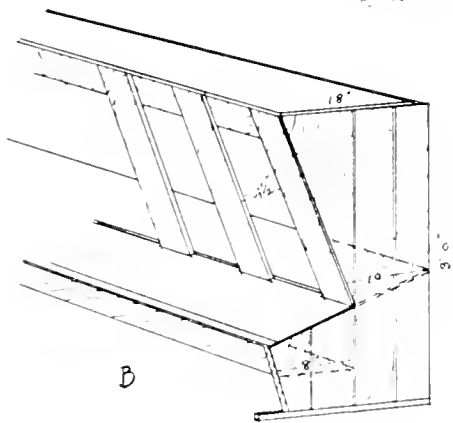
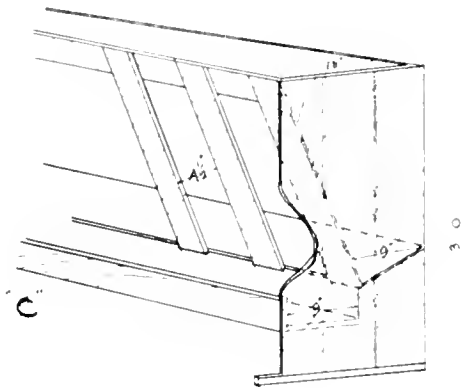
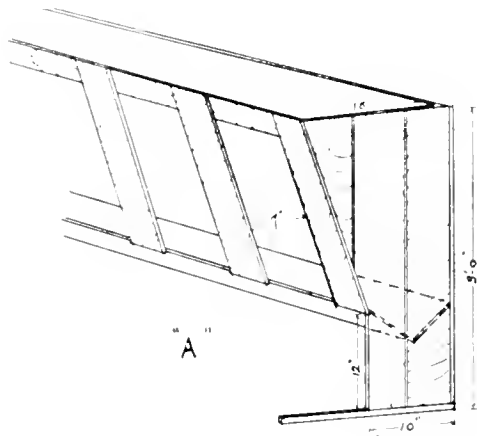

FEED RACK FOR LAMBS

SESSIONAL PAPER No. 16

FINANCIAL STATEMENT FOR SHEEP.

Below are submitted inventories and returns for sheep on the Central Experimental Farm during the year April 1, 1913, to March 31, 1914:--

	April 1, 1913.		March 31, 1914.		Returns including sales.	Gross returns made up of increased value and sales.
	No.	Value	No.	Value.		
		\$ cts.		\$ cts.	\$ cts.	\$ cts.
Sheep, all breeds and ages	57	1,028 00	81	1,866 00	267 99	1,077 99

RETURNS

By increase in value of flocks	\$ 810 00
Sales of breeding stock	120 00
Sales of lamb	6 44
Sales of wool	71 55
Manure, 70 tons at \$1 per ton	70 00
Gross returns	\$ 1,077 99

EXPENDITURES.

To food consumed	402 15
Labour expended	345 00
Purchase of breeders	290 00
Gross expenditure	1,037 15
Net balance from sheep	40 84

EXPERIMENTAL STATION, CHARLOTTETOWN, P. E. I.

REPORT OF THE SUPERINTENDENT, J. A. CLARK, B.S.A.

BREEDING SHEEP.

A flock of eight Leicester sheep was transferred from the Nappan Experimental Farm on December 12, 1913. Six other pure-bred Leicester sheep were purchased locally, making a flock of fourteen; consisting of one ram, nine breeding ewes and four ewe lambs. Three of the ewe lambs purchased for breeding purposes proved to be with lamb and were kept over.

The sheep received in December had severe colds in the head which proved very stubborn to treatment. With the ram it developed into catarrhal pneumonia and killed him.

EXPERIMENT IN FATTENING LAMBS.

The experiment to determine the relative value of roughage in lamb fattening was continued with four pens of nine lambs each.

The total number of lambs in the experiment was thirty-six. The original cost was very high being \$5.90 per cwt. live weight. Wether and ewe lambs were selected, weighing on the average 87 pounds for three pens and 70 pounds for the fourth.

The lambs were allowed to run on pasture for a short time before the beginning of the test.

After this preparatory period they were fed as follows: Each lot received 2½ pounds of meal mixture per diem and 1 pound of bran at starting. The meal mixture was increased by one-tenth of a pound per diem, throughout the experiment. The bran was increased as necessary up to 2½ pounds per diem, the average amount of bran fed being about 2 pounds per diem.

Pen IV, though lighter in weight, received the same amount of meal and bran per diem until January 23. From that time on they received a 10 per cent increase of the meal mixture.

The roughage fed the different lots was as follows:—

Lot I received alfalfa and clover hay of fair quality.

Lot II was fed mixed clover and timothy hay, and corn stover in the proportion of 2 of hay and 1 of corn stover.

Lot III was fed timothy hay and mangels.

Lot IV was fed mixed clover and timothy hay and mangels.

The lambs were dipped with Cooper's dip for lice and ticks on December 22. This set them back for a time.

In calculating the cost of feeding the following prices were charged:—

Roots and corn stover at \$2 per ton.

Hay at \$8 per ton.

Meal mixture and bran at \$25 per ton.

SESSIONAL PAPER No. 16

LAMB FEEDING EXPERIMENT.—(Clover hay, largely alfalfa, *vs.* mixed hay, and corn stover *vs.* timothy hay and roots *vs.* mixed hay and root, and extra grain).

Lot :	I.	II.	III.	IV.
Class of feed for lot.	Clover hay, considerable alfalfa.	Mixed hay and corn stover.	Timothy hay and roots.	Mixed hay and roots and extra grain
Number of lambs in lot	9	9	9	9
Number of days in experiment	97	97	97	97
Total weight at beginning	787½	784½	788	648½
Total weight at end.	862	833	822	711½
Gain during period	74½	58½	34	93
Gain per head.	8.3	5.91	3.66	10.3
Gain per head per day.	.085	.065	.037	.105
Quantity of meal eaten by lot	815	815	809	861
Quantity of clover hay eaten	1,898			
Quantity of mixed hay eaten.		1,877		1,691
Quantity of timothy hay eaten.			1,577	
Quantity of roots and ensilage eaten.		703	841	861
Total cost of feed.	16.82	15.70	15.77	15.42
Cost of feed per head	1.89	1.74	1.75	1.71
Cost of feed per head per day.	1.91	1.8	1.80	1.76
Original cost of lambs at \$5.93 per 100 pounds, live weight.	\$ 46.70	\$ 46.52	\$ 46.79	\$ 38.45
Original cost of lambs plus cost of feed.	\$ 67.52	\$ 62.22	\$ 62.56	\$ 53.57
Selling price at 7½ cents per pound	\$ 64.65	\$ 62.85	\$ 61.65	\$ 55.71
Net profit on lot.	\$ 1.13	\$.63	\$.91	\$ 1.84
Net profit on lamb.	cts. 12	7	10	20
Cost to produce 1 pound gain.	22.7	29.6	47.7	16.6

* Loss.

LAMB FATTENING EXPERIMENT.—(Average results of three years' test of alfalfa hay *vs.* mixed hay, and corn stover *vs.* timothy hay and roots as roughage in fattening lambs).

Lot.	I.	II.	III.
Class of Feed.	Alfalfa Hay.	Mixed Hay and Corn Stover.	Timothy Hay and Roots.
Number of lambs in group.	31	31	31
Average number of days in experiment.	92	92	92
Total weight at beginning of experiment.	2,529½	2,519½	2,462
Total weight at end of experiment.	2,872½	2,674½	2,655½
Gain during period.	342½	155	193½
Gain per head.	11	5	6.2
Gain per head per day.	.2	.054	.068
Quantity of grain eaten by lot in period	2,126	2,003½	1,891½
Quantity of alfalfa	6,717		
Quantity of timothy.			4,194
Quantity of mixed hay		4,141	
Quantity of roots and ensilage.		3,826	4,147½
Total cost of feed	\$ 50.07	\$ 43.34	\$ 42.47
Cost of feed per head	1.61	1.39	1.37
Cost of feed per head per day	cts. 1.75	1.51	1.49
Original cost of lambs.	\$ 125.08	\$ 124.67	\$ 12,207
Original cost of lambs, plus cost of feed	\$ 175.15	\$ 168.01	\$ 151.51
Selling price	\$ 187.75	\$ 175.29	\$ 165.39
Net profit on lot	\$ 12.60	\$ 7.28	\$ 84
Net profit on lamb	cts. 46	23	02
Cost to produce a pound of gain.	cts. 14½	28	22

5 GEORGE V., A. 1915

LAMB FEEDING EXPERIMENTS.—Table of Weights and Gains.

Tag Number.	First Weight.	Last Weight.	Total Gain.	Dressed Weight.	Percentage of Dressed Meat.
	Lb.	Lb.	Lb.	Lb.	%
Pen No. 1—No. 1.....	89.5	98	8.5	49	50
" " 2.....	79	86	13	41	47.7
" " 11.....	88	97	9	46	47.4
" " 22.....	95	107	12	59	55.1
" " 26.....	86	93	7	47	50.5
" " 34.....	80.5	86	5.5	39	45.35
" " 36.....	77	88	*11	44	50
" " 37.....	112.5	112	.5	53	48.2
" " 39.....	80	85	15	47	49.5
Total.....	787½	862	74.5	425	
Pen No. 2—No. 3.....	75.5	82	6.5	40	48.78
" " 4.....	77	82	5	38	46.3
" " 5.....	93	98	5	50	51
" " 6.....	76.5	84	7.5	40	47.8
" " 8.....	78	88	10	42	47.7
" " 10.....	112	114	2	53	46.5
" " 14.....	90	89	*1	43	48.3
" " 18.....	87	97	10	49	50.5
" " 23.....	95.5	104	8.5	55	52.88
Total.....	784.5	838	53.5	410	
Pen No. 3—No. 9.....	98	102	4	53	51.96
" " 12.....	81	78	*3	40	51.3
" " 15.....	86	84	*2	41	48.8
" " 25.....	76	79	3	40	50.63
" " 29.....	100	92	*8	47	51.1
" " 31.....	79.5	82	2.5	44	53.66
" " 32.....	92	105	13	56	53.1
" " 35.....	85	93	8	47	50.5
" " 38.....	91.5	107	15.5	53	49.53
Total.....	789	822	33	421	
Pen No. 4—No. 7.....	72.5	83.5	16	40	45.2
" " 16.....	71	79	8	37	46.8
" " 17.....	70	83.5	13.5	43	50.3
" " 19.....	67	74.5	6.5	31	41.6
" " 20.....	70	83	13	37	44.6
" " 21.....	71	83	12	38	45.8
" " 27.....	69	82.5	13.5	41	49.7
" " 28.....	70	86.5	16.5	36	41.6
" " 33.....	88	81	*7	34	42
Total.....	648.5	741.5	93	337	

The last weight was taken after the lambs had been starved sixteen hours.

The demand for lambs carried over winter is much greater than the supply. Lambs of medium weight make the best gains and are most profitable for winter feeding.

Good clover hay with roots and grain has been found most satisfactory. The quantity of grain at the commencement of the feeding period should be small. The increase should be gradual.

EXPERIMENTAL FARM, NAPPAN, N.S.

REPORT OF THE SUPERINTENDENT, W. W. BAIRD, B.S.A.

SHEEP.

BREEDING FLOCK.

Owing to the fact that we were handicapped for pasture and stable room, it was thought best to discontinue for the present the practice of keeping more than one breed of sheep at this Farm. Hence, in the fall of 1913, the flock of Leicesters was shipped to the Experimental Station, Charlottetown, P.E.I., and the Shropshires retained, as they were considered the more suitable breed for this district. As part of this flock was getting somewhat aged, and others not of desirable type, it was decided to dispose of them and purchase a younger and more typical foundation flock.

This was done in December, 1913, when there were purchased nine ewes, consisting of one two-shear, two shearlings and six lambs, all of which were from well-bred stock, in fact, prize winners. These are very uniform and typical of the breed, and especially is this true of the six lambs, which have made excellent development during the winter.

Three only were bred, namely, the two-shear and the two shearlings. We were very unfortunate in losing one shearling ewe on February 23, 1914. Death was caused by wool-ball in paunch. The other two gave three very nice lambs, two ewes and a ram.

The ram that heads the flock is a very typical sire, "Kelsey's Promise."

All record of feed, etc., is being kept of this flock in order to demonstrate the profit to be derived from such. Naturally it may be expected that the first year is the most expensive one, more especially where the greater percentage of the flock is lambs which do not give any return except the wool and manure. Following is the method of feeding and foodstuffs consumed during the remaining part of the year:—

From December 20 to March 5 they received 1½ pounds hay, 6 pounds pulped roots, and ¾ pound whole oats, per head per day.

From March 5 to April 1 they received 1½ pounds hay, 3 pounds whole roots, ¾ pound crushed oats.

The following table gives the total amounts of each and cost of feed:—

BREEDING SHEEP.—Value of food stuffs was: Hay, \$8 per ton; meal, \$1.38 per cwt.; and roots and ensilage, \$2 per ton.

No. of Sheep.	Period.	Hay.	Roots and Ensilage.	Meal.	Cost of Feed.
		Lb.	Lb.	Lb.	\$ cts.
10	Dec. 20, 1913, to Feb. 23, 1914.....	975	3,900	487.5	14 53
9	Feb. 23, 1914, to Mar. 5, 1914.....	135	549	67.5	2 01
9	Mar. 5, 1914, to Apr. 1, 1914.....	351	702	58.5	2 91
9	101 days.....	1,461	5,142	613.5	19 45

FINANCIAL STATEMENT.

Breed.	Dec., 1913.		Apr., 1914.		Return.	Gross returns made up of increase in value and returns from wool.
	No.	Value.	No.	Value.		
		\$ cts.		\$ cts.	\$ cts.	\$ cts.
Shropshires of all ages.....	10	230 00	12	278 00	18 46	66 46

RETURNS.

Made up in increase in value and returns from wool.....	\$66 46
6 $\frac{1}{2}$ tons manure at \$1 per ton.....	6 75
	<u>\$73 21</u>

EXPENDITURES AND LOSSES.

Food consumed	\$19 45
Labour	30 30
Loss of one ewe	25 00
	<u>\$74 75</u>
Net balance	\$1 84

LAMB FEEDING EXPERIMENT.

In order to get more conclusive data on the relative value of clover and timothy hay in fattening lambs, a similar experiment to that of 1912-13 was carried on during the winter of 1913-14.

Of the fifty-six grade lambs purchased for this test, all were wethers except ten.

These were divided into four lots of fourteen each. Lots 1 and 2 were the heaviest, lots 3 and 4 the lightest, but all fairly uniform. Lot 1 was fed clover hay, roots, and meal; lot 2, clover hay and meal; lot 3, timothy hay, roots, and meal; and lot 4, timothy hay and meal.

The meal ration was fed alike to all lots throughout the test and at the start they received three-quarters pound per head per day. This was gradually increased until at the end of the period they were receiving 1 $\frac{3}{4}$ pounds. Each lamb in lots 2 and 3 received 2 $\frac{1}{2}$ pounds at the beginning and increased to 4 pounds of pulped roots per lamb per day. Lots 2 and 4 did not receive any roots. Lots 1 and 2 were fed clover hay at the rate of 1 $\frac{1}{2}$ pounds per lamb per day. Lots 3 and 4 were fed timothy hay at the rate of 1 $\frac{1}{2}$ pounds per lamb per day.

The meal ration was made up as follows: Bran, 200 pounds; mixed crushed grain, (oats and barley) 200 pounds, cotton seed (100 pounds) at the first of period, then replaced by oil cake (100 pounds).

The cost of different feeds was figured at: Hay, \$8 per ton; meal mixture, \$1.30 per cwt.; roots, \$2 per ton.

The following table gives the results of the test:—

SESSIONAL PAPER No. 16

LAMB FEEDING EXPERIMENT at Nappan Experimental Farm, 1913.

	Lot 1.	Lot 2.	Lot 3.	Lot 4.
	Clover Hay Roots and Meal.	Clover Hay and Meal.	Timothy Hay Roots and Meal.	Timothy Hay and Meal.
No. of lambs in lot	14	13	11	12
No. of days in experiment	118	118	118	118
Total weight at beginning of experiment lb.	1,299	1,221	1,199	917.5
Total weight at finish of experiment	1,634	1,488	1,518	1,151
Gain during period	335	267.5	319	233.5
Gain per head	23.9	20.5	22.7	19.4
Gain per head per day20	.17	.19	.16
Quantity of hay consumed	2,478	2,301	2,478	2,124
Quantity of meal consumed	2,089.50	1,910.25	2,089.50	1,791
Quantity of roots consumed	6,608	6,608
Total cost of feed \$	43.68	34.43	43.68	31.78
Cost of feed per head	3.12	2.65	3.12	2.65
Cost of feed per head per day cts.	2.64	2.24	2.61	2.24
Cost of 1 pound gain	13.04	12.89	13.69	13.60
Original cost of sheep \$	76.49	71.89	70.60	54.02
Original cost of sheep plus cost of feed	120.17	106.32	114.28	85.80
Selling price at \$8 per hundred pounds	150.72	119.04	121.44	92.08
Net profit on lot	10.55	12.72	7.16	6.28
Net profit per lamb75	.98	.51	.52

AVERAGE Two Years' Lamb Feeding Experiment at Nappan Experimental Farm.

	Lot 1.	Lot 2.	Lot 3.	Lot 4.
	Clover Hay, Roots and Meal.	Clover Hay, and Meal.	Timothy Hay, Roots and Meal.	Timothy Hay, and Meal.
Number of lambs in lot	12	11.5	12	11
Number of days in experiment	97	97	97	97
Total weight at beginning of experiment lb.	1,009.5	970.5	960.5	816.25
Total weight at finish of experiment	1,294.5	1,208	1,237.5	1,029
Gain during period	285.0	237	277.0	212.75
Gain per head	23.75	20.65	23.08	19.54
Gain per head per day21	.21	.24	.20
Quantity of hay consumed	1,809	1,720.5	1,809	1,632
Quantity of meal consumed	1,599.75	1,435.125	1,599.75	1,360.5
Quantity of roots consumed	4,704	4,704
Total cost of feed \$	32.50	26.48	32.50	25.15
Cost of feed per head	2.71	2.30	2.71	2.29
Cost of feed per head per day cts.	2.79	2.37	2.79	2.35
Cost of 1 pound gain	11.4	11.15	11.7	11.82
Original cost of sheep \$	56.25	53.95	53.35	44.89
Original cost of sheep plus cost of feed	88.75	80.43	85.85	70.04
Selling price at \$7.50 and \$8 per hundred pounds	101.18	94.32	96.61	80.06
Net profit on lot	12.43	13.89	10.76	10.02
Net profit per lamb	1.04	1.21	.90	.91

DEDUCTIONS.

While no positive deductions can be drawn even from two years' results, yet, when we have compared the results of 1912-13 with those of 1913-14 and find they coincide as well as they do, we are most apt to lay considerable stress on such results. Hence the following points may be of great interest to note:—

First: That 1912-13 test showed that clover hay surpassed timothy hay in economy of production likewise this test.

Second: That when timothy is fed, roots play a great part in the feed ration.

Third: That in both cases, clover hay and meal have given greatest profit.

Fourth: Both 1912-13 and 1913-14 tests have shown quite conclusively that a good profit can be realized over and above the market value of food stuffs in fattening lambs.

Fifth: Note that when roots are used a better daily gain is obtained but not quite sufficient to produce any appreciable profit by using them.

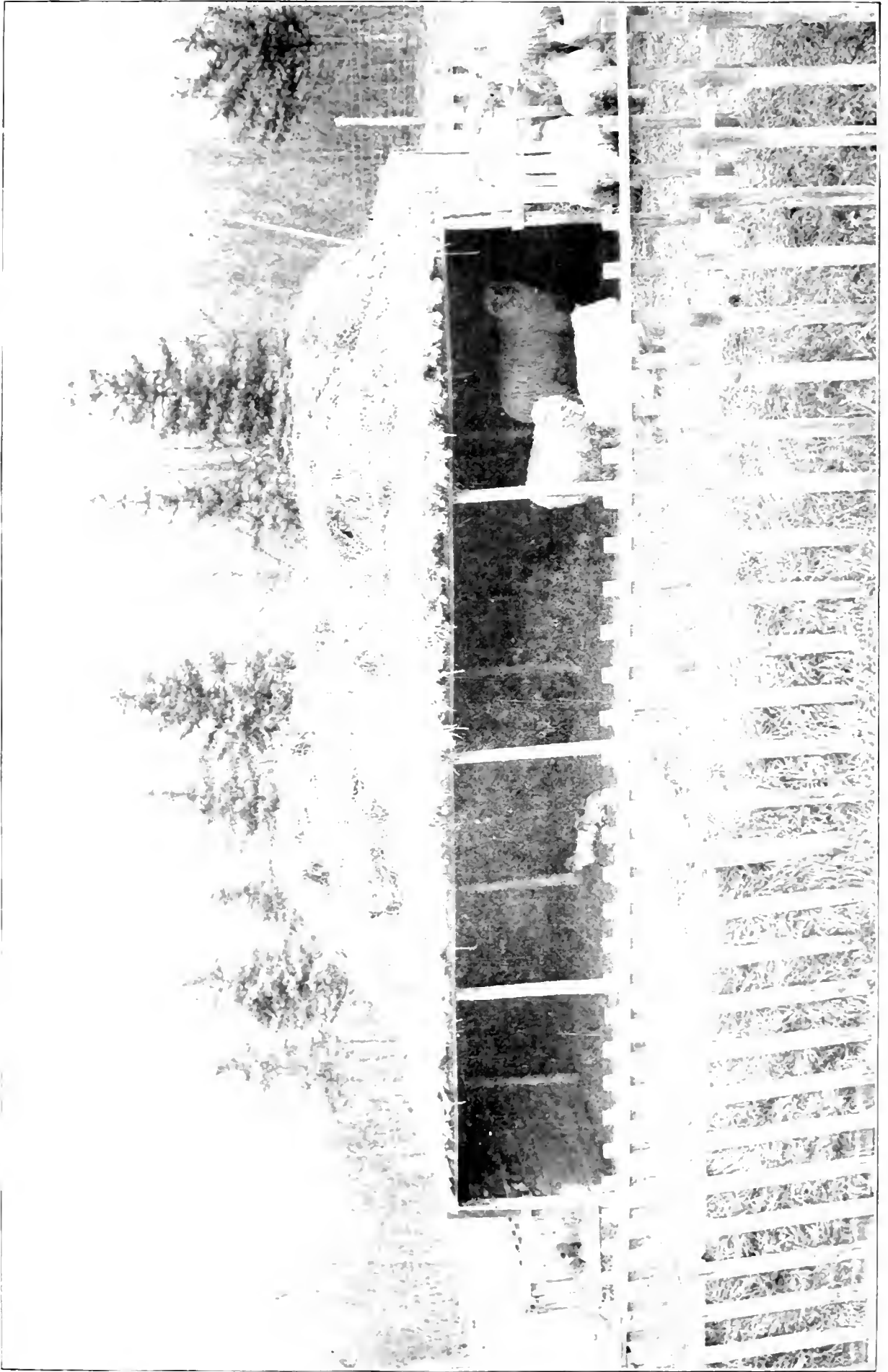

Brandon : Sheep-wintering Experiment. This illustrates the cheap shed used in this experiment.

EXPERIMENTAL STATION, CAP ROUGE, QUE.**REPORT OF THE SUPERINTENDENT, GUS. A. LANGELIER.****SHEEP.**

A small but select flock of Leicesters is kept, consisting of one ram, six breeding ewes, and eight ewe lambs. Four ram lambs, sold during the autumn of 1913 to the Provincial Government, made an average of over \$40 each at the public sale held in Quebec during October of that year.

A good dog-proof fence was made around the sheep pasture and as this pasture is on a high knoll and very dry it had to be supplemented with green peas and oats. A creep was made to allow grain feeding to the lambs, and the stock kept in fine shape until the end of March, when this report is written.

The ram, instead of being turned in with the ewes to serve them, was kept in a separate paddock in which grain was fed to the ewes once a day, when the man who fed could watch them and take note of the ear number of the ewe served. This method not only has the advantage of saving the ram's energy, but also of giving positive and correct information as to the date of lambing, when the ewes can be watched carefully.

During the winter of 1913, the horses had to be kept in the future sheep barn, pending the completion of a new stable. This prevented doing any feeding experiment through lack of room.

EXPERIMENTAL FARM, BRANDON, MAN.

REPORT OF THE SUPERINTENDENT, W. C. McKILLICAN, B.S.A.

SHEEP.

The flock is comprised as follows on March 31, 1914: One Oxford Down ram; three Oxford Down ewes (two aged and one yearling); forty-six grade ewes (twenty-three aged, eighteen yearlings and five lambs).

In 1910 and 1911 a start was made at sheep raising here, by obtaining a small flock of grade ewes. These ewes were part of a shipment brought by the Manitoba Sheep Breeders' Association from the range districts of western Saskatchewan. They were of the usual range type, though rather better than the average, and were of decidedly mixed breeding and appearance. These ewes have improved greatly in appearance under farm treatment and good feeding. They have been bred each season to a pure-bred Oxford Down ram, and a noticeable improvement is being observed in the progeny, as illustrated in the accompanying plate.

The season of 1913 was not a particularly successful one for the raising of lambs. The lambs raised averaged about .75 to the ewe, and more than two-thirds of these were rams, so that the increase of females to the flock was only five.

EXPERIMENT IN WINTERING BREEDING FLOCK.

An experiment was tried this winter in which alfalfa was compared with mixed hay, consisting chiefly of timothy and Western Rye grass, as a feed for breeding ewes, and also in which an expensive sheep barn was compared with a cheap open shed as a place for wintering these ewes.

The flock was divided as equally as possible into three lots. Two lots were housed in the sheep barn, were each given a small yard in which to run, were only confined in the barn on stormy days, and were always fed inside. The other lot were given an open shed for shelter and were fed entirely out-of-doors. Of the two lots in the sheep barn, one was fed mixed hay and the other alfalfa; the outside lot received alfalfa. All three lots received straw in equal quantities per sheep once a day and were fed a small ration (one-quarter pound per sheep per day) of peas and oats. The hay and the alfalfa were fed in equal quantities per sheep to all lots.

The results are reported in tabular form as follows:—

	Lot 1.	Lot 2.	Lot 3.
	Open Shed. Fed alfalfa.	Sheep Barn. Fed alfalfa.	Sheep Barn. Fed hay.
No. in lot	16	16	17
Total weight on January 9..... Lb.	2,340	2,035	2,300
Total weight on March 31..... "	2,770	2,574	2,675
Total gain in 81 days..... "	430	439	375
Average gain per sheep..... "	26.88	27.42	22.06
Pounds of mixed hay used			6,024
Pounds of alfalfa used	5,670	5,670
Pounds of straw used..... "	1,620	1,620	1,731
Pounds of grain used..... "	324	324	364

SESSIONAL PAPER No. 16

It will be observed that the sheep that received alfalfa wintered better than hay-fed sheep. This was shown in their general appearance, as well as in their weight.

The sheep that were fed in the open shed did practically as well by weight as the lot receiving the same feed inside. In general appearance they looked healthier and more vigorous than either of the other lots. (Note in plates the two buildings referred to in this experiment.)

The ewes had not commenced to lamb at the end of the fiscal year; it is therefore impossible to report on the lamb crop resulting from the different treatments. Notes will be taken on this aspect of the question and the results reported next year.

No experiments in the winter fattening of lambs or wethers have been conducted this year. The spread between the price of feeders in the fall and the probable price of fat sheep in the spring was not sufficiently great to give inducement. Butchers will give almost as much for a lamb off pasture in the fall as they will for the same lamb the next spring. Under these conditions the raising of lambs is a much more attractive proposition than winter fattening.

EXPERIMENTAL FARM, INDIAN HEAD, SASK.

REPORT OF THE SUPERINTENDENT, T. J. HARRISON, B.S.A.

SHEEP.

The flock of sheep on the Farm on March 31, 1914, was composed of the following: Shropshires, one ram, one ram lamb, seven ewes; Grades, eight ewes, four shearing ewes.

During the last year, six ram lambs and one aged ram were sold from the Farm for breeding purposes. In October there were purchased four Shropshire shearing ewes and one Shropshire shearing ram to strengthen the flock. These are all of a fine type of Shropshire and should aid materially in building up the flock on this Farm.

Supplementary to the handling of the flock of pure-bred sheep, which is established to procure data regarding the cost of rearing and maintaining sheep in the West, a sheep grading experiment is under way. The object of this test is to discover the possible improvement in regard to mutton and wool qualities by the continuous use of pure-bred rams of the same breed on the common ewes of mixed breeding and on their grade female progeny. The foundation flock in this work is the common range ewe, which can be procured quite reasonably in the western portion of this province.

FEEDING EXPERIMENTS.

One hundred range lambs were bought last November for the purpose of conducting a feeding experiment during the winter. These were divided into four groups of twenty-five each. The experiment was started on December 1, and completed at the end of sixteen weeks. From the outline below it will be noted that very satisfactory gains were made. However, a loss is reported as there was no margin between the buying and selling prices. The difficulty with feeding lambs during the winter is that it is necessary to buy them in the fall and pay a "lamb" price, and when they are sold in the spring we can only obtain a "sheep" price. In view of this fact it would appear that there is little money made in this line of work. Next season, however, shearlings will be purchased, which are cheaper than the lambs and will sell for the same price in the spring. Below is an outline of the rations fed to the different groups:—

Group 1.—Oat straw and grain.

Group 2.—Oat straw, mixed hay, and grain.

Group 3.—Oat straw, mixed hay, grain, and turnips.

Group 4.—Oat straw, alfalfa hay, grain, and turnips.

The grain in the above ration was composed of equal parts of oats and barley.

With the ration used in group 1 considerable trouble was experienced in keeping the lambs on their feed. This ration was very binding in its properties. In this group one lamb was lost, through indigestion, and it was found that the lambs required careful watching and needed a laxative from time to time. In group 2 a lamb was also lost, due to stone in the bladder. The lambs in groups 3 and 4 seemed to be quite contented and thrifty.

SESSIONAL PAPER No. 16

A week previous to the commencement of the experiment the lambs were arranged in their respective groups and fed their proper rations so as to get them accustomed to their feed before the experiment was set in running order. The prices charged for feed in computing the cost are as follows:—

- Grain, \$20 a ton.
- Mixed hay, \$10 a ton.
- Alfalfa hay, \$10 a ton (not well cured).
- Turnips, \$2 a ton.
- Oat straw, \$2 a ton.

RESULTS of Lamb feeding Experiment, 1913-14.

	Group 1. Oat straw and grain (oats and barley in equal pro- portions.)	Group 2. Oat straw, mixed hay, and same grain.	Group 3. Oat straw, mixed hay, same grain, and turnips.	Group 4. Oat straw, alfalfa hay, same grain, and turnips.
Number of lambs in experiment.....	25	25	25	25
" " days in "	112	112	112	112
Total weight at beginning of experiment . . . lb.	1,590	1,770	1,922	1,970
" " " end of experiment.....	2,030	2,490	2,695	2,718
Gain during period (112 days).....	440	720	683	748
Gain per head	17 6	28 8	27 3	29 9
Gain per day per head.....	19	26	25	27
Amount of grain eaten by lot.....	3,462 50	3,662 5	3,412 50	3,500 5
" " hay " "		2,362 5	2,187 5	
" " alfalfa hay.....				2,187 5
" " oat straw	1,980	1,855	1,737 5	1,627 5
" " turnips.....			4,462 5	4,462 5
Total cost of feed	\$ 36 58	50 20	51 18	51 96
Cost of feed per head.....	\$ 1 46	2 00	2 04	2 07
" " " " per day.....	cts. 013 ³ / ₁₀	017 ⁷ / ₁₀	017 ⁷ / ₁₀	017 ⁷ / ₁₀
" " " " pound gain.....	cts. 08 ³ / ₁₀	06 ⁷ / ₁₀	07 ³ / ₁₀	06 ³ / ₁₀
Original cost of lambs	\$ 95 40	106 20	115 32	119 20
" " " " plus cost of feed.....	131 98	156 40	166 50	171 15
Total receipts from sale	\$ 121 89	149 40	156 30	163 08
Loss on lot	\$ 10 18	7 00	10 20	8 08
" " lamb.....	cts. 40	.28	.40	.32

From the foregoing it will be seen that, though the cost of feed per head in group 1 was the lowest, yet the cost of 1 pound gain was far in excess of any of the others and, as noted before, did not prove very satisfactory. This ration will be continued another season, but an endeavour will be made to have included some laxative food, such as flaxseed meal.

Strange to say, group 2 made better returns than group 3, even though the latter had the advantage of roots to keep their digestive organs in order. This can partly be accounted for by the fact that group 3 went off their feed during the first two weeks of the experiment, when it was attempted to make the roots and snow suffice without giving water also, since many people believe that sheep require no water. After this happened, all the groups received water and drank a little each day. Group 4, getting alfalfa and roots, gave the most satisfactory returns, and compared well in cost of feed per pound gain with group 2.

The conclusions that can be drawn are: (1) There is little profit in lamb feeding because of the difference in price of lamb and shearling; (2) the ration fed group 1, while the cheapest, was not satisfactory and was one of the most expensive when considering the cost per pound gain; (3) for the average farmer who has mixed hay, a ration fed as in group 2 would prove quite satisfactory; (4) where alfalfa is being grown, fattening sheep will respond to this feed most readily.

EXPERIMENTAL STATION, LACOMBE, ALTA.**REPORT OF THE SUPERINTENDENT, G. H. HUTTON, B.S.A.****SHEEP.**

Twenty common range ewes were purchased in October, and were mated to a pure-bred Shropshire ram with the object of carrying on a grading up experiment with such sheep as are being generally brought into this country. Lambs from the first and each successive cross will be weighed at birth and periodically thereafter; samples of wool from the foundation flock and from each cross will be taken and data secured as to the effect of such grading on both mutton and wool production.

The cost of carrying these sheep through the winter was 1 $\frac{3}{4}$ cents per head per day. They consumed 2 pounds of hay at \$10 per ton and three-quarters of a pound of oats at 1 cent per pound per head daily.

EXPERIMENTAL STATION, LETHBRIDGE, ALTA.

REPORT OF THE SUPERINTENDENT, W. H. FAIRFIELD, M.S

SHEEP FEEDING EXPERIMENT.

The work in lamb feeding was again carried out along similar lines as those followed during the past two winters with quite satisfactory results.

Two hundred and fifty range lambs and fifty yearling wethers were purchased from A. Green, of Taber, Alta., through Mr. Geo. Kerr. Delivery was taken on October 10. They were run on stubble fields till November 1, when the feeding experiment began.

GENERAL OUTLINE.

The primal object of the experiment was to obtain data regarding the possibility of marketing alfalfa hay profitably through the feeding of range sheep. They were divided into groups of fifty each. The yearlings were put in group I and were fed similarly to group II which was made up of lambs. In every case each group was fed what alfalfa they would clean up at all times. The different lots were fed as follows:—

- Group I.—Alfalfa, meal and roots (yearlings).
- Group II.—Alfalfa, meal and roots (lambs).
- Group III.—Alfalfa and roots (lambs).
- Group IV.—Alfalfa and meal (lambs).
- Group V.—Alfalfa and screenings (lambs).
- Group VI.—Alfalfa alone (lambs).

Groups I, II, IV, and V were sold March 15, but Groups III and VI, which were fed respectively alfalfa and roots and alfalfa alone, were carried for a longer period. From March 15 they were fed meal, and were sold May 9, being sheared just previous to this date. The yield of wool averaged 8 pounds per head and sold for 16½ cents per pound. The selling price of the four lots sold March 15 was \$7 per cwt. with no shrink, and the price obtained for the two lots sheared was \$6.60 per cwt., with no shrink. They were sold in each case to Delaney's Limited, of Lethbridge.

In calculating the cost of feeding, the following prices were charged:—

Alfalfa hay	\$12 00 per ton.
Meal—equal parts of wheat, oats, and barley.....	20 00 “
Screenings	9 00 “
Roots (turnips)	3 00 “

The quality of the screenings fed this year was particularly good, as they contained in addition to weed seeds a good proportion of cracked wheat.

GENERAL STATEMENT.

	Group I Year- lings.	Group II Lambs.	Group III Lambs.	Group IV Lambs.	Group V Lambs.	Group VI Lambs.
Number of lambs or yearlings in lot at beginning of period.....	49	50	50	50	50	50
Number of lambs or yearlings in lot at end of period.....	49	49	47	50	48	46
Number of days in experiment.....	135	135	191	135	135	191
Total weight at beginning of experiment..... Lb.	5,490	3,480	3,451	3,465	3,483	3,488
Average weight at beginning of experiment..... "	112	69.6	69.2	69.3	69.7	69.8
Total weight at beginning of experiment after deducting weight of loss..... "		3,410	3,243		3,344	3,209
Total weight at end of experiment.....	6,900	5,008	4,735	4,943	4,919	4,610
Gain for period.....	1,410	1,598	1,492	1,487	1,605	1,401
Gain per head for period.....	28.8	32.6	31.7	29.7	32.4	30.5
Gain per head per day.....	.25	.24	.17	.22	.24	.16
Quantity of meal eaten by lot for period.....	5,850	5,648	1,692	5,578	275	1,692
Quantity of screenings eaten by lot for period.....					7,523	
Quantity of alfalfa hay eaten by lot for period.....	16,325	10,505	18,433	11,520	10,243	22,044
Quantity of roots eaten by lot for period.....	10,987	10,160	17,095			
Quantity of salt eaten by lot for period.....	103	103	138	104	101	103
Total cost of feed..... \$	173.96	135.78	154.54	125.94	99.07	150.21
Cost of feed eaten by the 49, 49, 47, 50, 48 and 45 respectively.....	173.96	134.60	153.22	125.94	98.94	145.46
Cost of feed per head for period.....	3.55	2.74	3.26	2.52	2.06	3.16
Cost of feed per head per day..... cts.	2.63	2.03	1.70	1.86	1.52	1.65
Cost to produce 1 pound gain.....	12.33	8.20	10.27	8.47	6.16	10.38
Original cost of yearlings at \$5, and lambs at \$3.25 per head..... \$	245.00	159.25	152.75	162.50	156.00	149.50
Original cost plus cost of feed.....	418.96	293.85	305.97	288.44	254.94	294.96
Original cost plus cost of shearing at 9 cents per head, and cost of feed.....			310.20			299.10
Selling price at \$7 per cwt., live weight.....	483.00	350.56		346.01	346.43	
Selling price at \$6.60 per cwt., live weight.....			312.51			304.26
Selling price at \$6.60 per cwt., live weight, plus wool at 16½ cents per lb.....			374.55			364.98
Net profit on group.....	64.04	56.71	64.35	57.57	91.49	65.88
Net profit per head.....	1.31	1.16	1.37	1.15	1.90	1.42

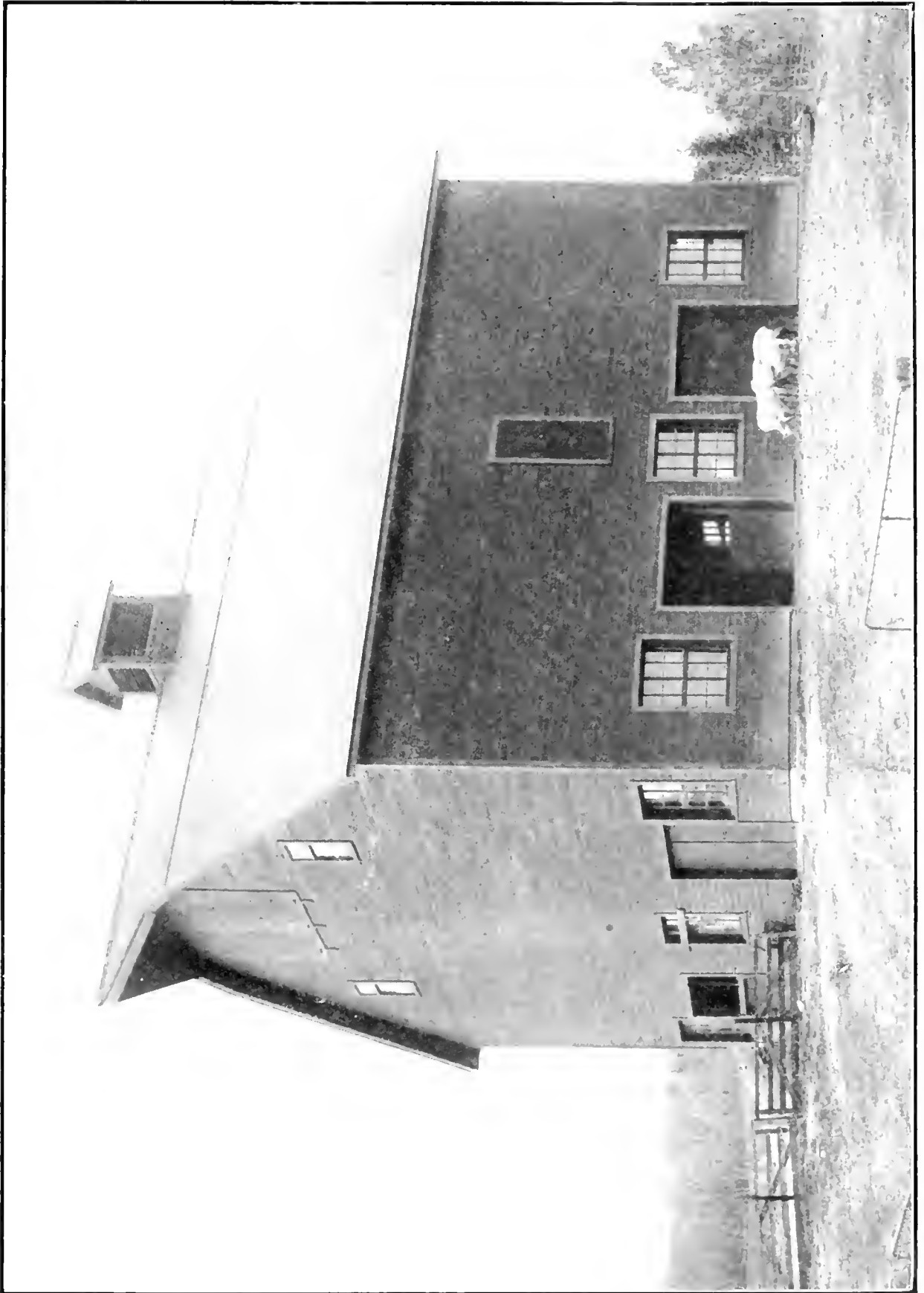

Sheep-wintering Experiment, Brandon, Man. This illustrates the barn used in this experiment.

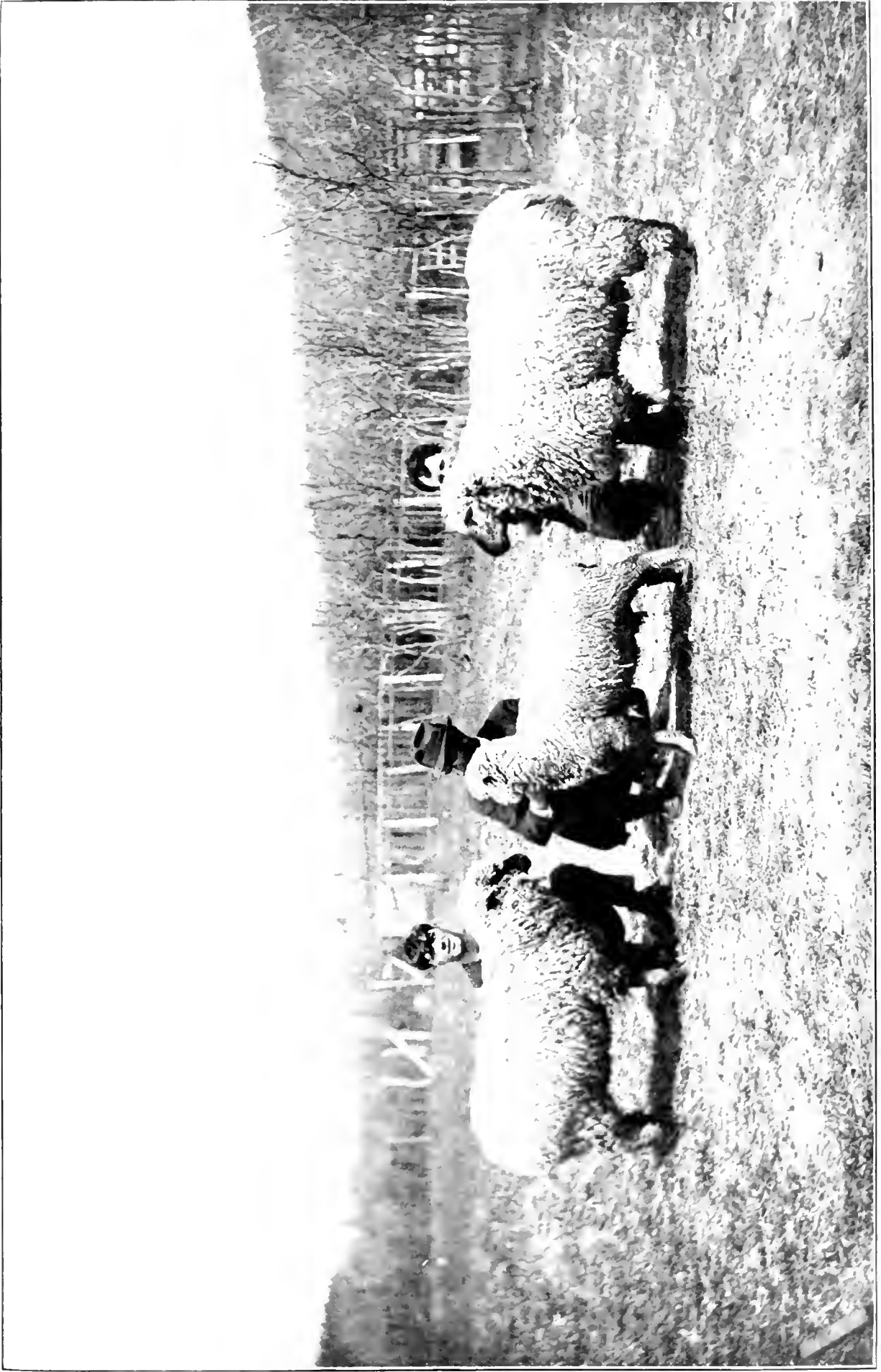

Brandon - Sheep grading Experiment : Centre, typical range ewe used as foundation stock ; right, Oxford Down ram used for grading up ; left, shearing ewe resulting from first cross.

SESSIONAL PAPER No. 16

AVERAGE, Three Years' Lamb feeding Experiments.

	Lot I.	Lot II.	Lot III.	Lot IV.	Lot V.	Lot VI.
Number of lambs or yearlings in lot at beginning of period	*49.5	47	49.33	50	49.33	49.33
Number of lambs or yearlings in lot at end of period	49	46.33	48	49.67	48.67	47
Number of days in experiment	126	121	140	121	121	140
Total weight at beginning of experiment Lb.	4,637	3,418	3,669	3,739	3,636	3,701
Average weight at beginning of experiment "	93.7	72.7	74.2	74.8	74.7	75.0
Total weight at beginning of experiment after deducting weight of loss "	4,599	3,368	3,564	3,713	3,640	3,531
Total weight at end of experiment "	5,993	4,966	4,822	5,180	5,018	4,642
Gain for period "	1,394	1,598	1,258	1,467	1,378	1,111
Gain per head for period "	28.4	34.5	26.2	29.5	28.3	23.6
Gain per head per day "	.23	.29	.19	.24	.23	.17
Quantity of meal eaten by lot for period "	5,514	5,400	1,476	5,747	92	3,679
Quantity of screenings eaten by lot for period "					6,303	
Quantity of alfalfa hay eaten by lot for period "	13,375	9,921	14,849	11,447	11,038	15,842
Quantity of roots eaten by lot for period "	9,114	8,733	12,739			
Quantity of salt eaten by lot for period "	52	34	46	35	34	34
Total cost of feed \$	149.87	122.27	118.17	122.51	84.18	111.52
Cost of feed eaten by the 49, 46.33, 48, 49.67, 48.67, and 47, respectively \$	149.23	121.11	117.53	122.04	84.14	108.91
Cost of feed per head for period \$	3.65	2.61	2.45	2.46	1.73	2.32
Cost of feed per head per day Cts.	2.42	2.16	1.75	2.03	1.43	1.66
Cost to produce one pound gain "	19.71	7.58	9.34	8.32	6.11	9.89
Original cost of sheep \$	214.38	151.74	159.68	165.94	161.69	156.58
Original cost plus cost of feed \$	363.61	272.85	277.21	287.38	245.83	265.49
Original cost plus cost of shearing and cost of feed \$			278.62			266.87
Selling price \$	406.80	320.55	325.73	334.64	324.88	314.01
Net profit on group \$	43.19	47.70	47.11	46.66	79.05	47.14
Net profit per head \$.88	1.03	.98	.94	1.62	1.00

*This lot has only been fed two years.

SOME DEDUCTIONS.

As the prime object of the tests was to get some idea as to the price that could be obtained for alfalfa hay when fed to lambs, the figures given below will be of interest. The meal, roots, and screenings are charged at the prices mentioned, and all the profit is credited to alfalfa hay. The cost of labour is omitted, for the amount involved in experimental feeding when such small lots are fed in each case is so much greater than would be the case when a farmer would be feeding on a more extensive scale, that it is hardly comparable. However, it might be safe to assume that it would not be much greater than the cost of baling and delivering to cars in case a farmer was selling his hay outright.

Price obtained for alfalfa hay when all the profit is credited to it:—

Group.	Alfalfa hay per ton.
I	\$19.85
H	22.80
III	18.90
IV	21.99
V	29.86
VI	18.25
	<hr/>
	\$131.65
Average price	\$21.95

The average price obtained for alfalfa hay when computed in the same manner for the past three years for all lots fed is \$19.49 per ton.

VALUE OF ROOTS.

The relatively small increase in gains of the lots fed roots would indicate that under our conditions it is not particularly profitable to raise them for this purpose.

EXPERIMENTAL FARM, AGASSIZ, B.C.

REPORT OF THE SUPERINTENDENT, P. H. MOORE, B.S.A.

SHEEP.

This year there were kept through the season eighteen ewes eligible to raise lambs. Two ewes would not breed and two died of pneumonia. The old ram was sold at the close of the breeding season.

The results this year from the flock are not as good as the previous year, although from a money-making point of view, the flock may have been more profitable than before. The whole flock ran to pasture the entire year and ate pasture that would otherwise have gone to waste. They were fed hay for eight days in February, and some at lambing time. The entire flock consumed 840 pounds, making a total cost of 30 cents per sheep for hay. Even with feeding such as this, the sheep became very fat, and trouble at lambing time resulted. Two ewes would not breed, two died of pneumonia early in the season; one was a sheep that had an attack last year, and the other was a fresh case. Both cases came on in good weather and the cause could not be ascertained.

At lambing time, some of the lambs were born deformed, some had not strength to get up, and others were blind. From all these causes, the mortality in the lambs was high. The lambing results of the season are as follows:—

Total number of ewes	14
Total number of lambs dropped	26
Total number of lambs dropped per ewe.....	1.84
Total number of lambs raised	16
Average number of lambs raised per ewe.....	1.14
Per cent of lambs raised	61.5%

One of the ewes raised a pair of lambs in the autumn of 1913, but they are not counted in the above. She also had a strong lamb in March, 1914. Two other ewes had lambs in the autumn but did not raise them.

The wool from the flock was of good quality and quantity. The heaviest fleece was 11.1 pounds, from a yearling, and the lightest was 4.5 pounds, from the ewe which raised the two sets of lambs. The average for the flock was 7.28 pounds per ewe.

No experimental work was done on account of not having sufficient housing accommodation.

SWINE.

CENTRAL EXPERIMENTAL FARM, OTTAWA, ONT.

REPORT OF THE DOMINION ANIMAL HUSBANDMAN,

E. S. ARCHIBALD, B.A., B.S.A.

There are 217 head of swine of all breeds and ages now on the Central Experimental Farm. These are used for experimental breeding, feeding, and housing, as well as for sales of high-class breeders at a reasonable figure. The breeds kept are Berkshire, Tamworth, and Yorkshire.

The Berkshires are 37 in number, including 18 breeding sows, 17 young pigs and 2 boars.

The Tamworths are 31 in number, including 10 breeding sows, 19 young pigs and 2 boars.

The Yorkshires are 149 in number, including 34 breeding sows, 110 young pigs and 5 boars.

The main piggery, erected in 1910, continues to give excellent satisfaction in all respects, both for experimental feeding work and also in its uses for farrowing season, feed rooms, and the like. The housing of brood sows, during both winter and summer, in the single-board cabins has also continued to give good results.

The increasing sales and demand from individual farmers and agricultural societies for young breeding pigs may again be reported, and is a healthy indication of the added interest of the farmers, both in the Experimental Farms and in the swine industry.

The experimental feeding work, together with general supervision of the breeding operations, was conducted by Mr. D. D. Gray, to whom special credit is due for the returns, which are quite satisfactory considering the crowded condition of the buildings.

PIG FEEDING EXPERIMENT.

In October, 1913, a pig feeding experiment was started to determine the value of various grains fed in different ways, with and without supplements; this being, in part, a continuation of the work carried on in the fiscal year ending March 31, 1913. The object of this experiment was: (1) to determine the value of the hog motor grinder; (2) the value of dry feeding versus slop feeding; (3) the value of home-grown grains alone versus supplements; (4) the value of milk as a supplement to grain; and (5) the value of roots as a supplement to grain. The home-grown grains chosen were barley, oats, and wheat, mixed in varying proportions. Six lots of pigs were started on this experiment. However, owing to the fact that the pigs on the hog motor grinder did not seem to have as fair a chance as the others, and owing to the fire which destroyed the cattle barns, this experiment was discontinued, but will be taken up again on a more complete scale during the coming fiscal year.

SOW FEEDING EXPERIMENT.

Although the main piggery was, during the winter, utilized for calf feeding, yet experimental work with the brood sows housed in single-board cabins was quite possible.

A great deal of work, with more or less indefinite results, along the lines of feeding of tankage to pigs, has been carried on by individual farmers and experiment stations throughout America. A series of experiments has been outlined on the Central Experimental Farm and branch Farms and Stations toward the determination of the value of tankage fed to both sows and litters, and both as an addition to the regular feed and as a supplement to some of the foodstuffs which in many cases are not available to the average farmer. A start was made in this work in the fall of 1913, and although only a small proportion of this first experiment has, as yet, reached completion, yet a brief summary of results will show the line of work started and results to date. However, it must be held in mind that this is only a part of one year's experiment, which, even though complete for one period, will be altogether too incomplete for definite conclusions.

OBJECTS OF EXPERIMENT.

The objects of this first experiment with tankage were to determine the value of tankage fed to in-pig sows as an influence on the condition of the sow during pregnancy, the condition of the litters at birth, and the influence on the milking qualities of the sow during the first eight weeks after parturition.

PLAN OF EXPERIMENT.

Two pens of eight brood sows each were set aside for this work. These sows were of uniform nature, both as to age, weight, general type, and breeding qualities.

Pen I. was to be fed the regular winter meal mixture, namely, a combination of wheat bran and shorts, varying with the advancing season.

Pen II. was to be fed the regular meal mixture, as pen I., with the exception that one-third (33 per cent in weight) of this mixture was replaced by tankage.

In both pens meal was fed in the same way, and each pen was to receive approximately the same amount of water, roots, clover hay, and skim-milk when available.

The regular winter meal for brood sows consisted of a mixture of bran, two parts, and shorts, one part, from December 1 until February 1, and a mixture of bran, two parts, and shorts, two parts, for the second period, namely, from February 1 until farrowing.

Although it is the practice on the Central Experimental Farm to add other ingredients after farrowing in order to make a somewhat more concentrated ration for nursing sows, yet the above mixtures were continued until eight weeks after farrowing, in order to give comparative results as to the tankage. Samples of meals were taken for chemical analyses, which will be reported on when this line of experimental work has reached greater dimensions.

VALUATION OF FOODSTUFFS.

The following valuations were placed on the meals and forages consumed:—

Bran	\$20 00 per ton.
Shorts	23 00 "
Tankage (protein, 60 per cent; fat, 8 per cent; fibre, 6 per cent)	50 00 "
Roots	2 00 "

OTTAWA.

SESSIONAL PAPER No. 16

PEN I.—BROOD SOW EXPERIMENT, 1913-14.—MEAL.

Breed.	Farrow.	Date of service.	Date of farrowing.	Weight December 10.	Weight before farrowing.	Weight of sows 4 weeks after farrowing.	Weight of sows 8 weeks after farrowing.	Number in litter.	Weight of litters.	Number in litter 4 weeks after farrowing.	Weight of litter 4 weeks after farrowing.	Number in litter 3 weeks after farrowing.	Weight of litter 3 weeks after farrowing.	Amount of meal consumed up to farrowing time.	Amount of roots consumed up to farrowing time.	Meal consumed 8 weeks after farrowing.	Total cost of ration.	Days on experiment.	Ration.
				Lb.	Lb.	Lb.	Lb.		Lb.	Lb.	Lb.	Lb.	Lb.	Lb.	Lb.	Lb.	\$ cts.		
Yorkshire	272	Dec. 11 '13	Apr. 5 '14	385	450	363	351	10—4 good, 6 dead.	244	8	41½	3	68	557	456	392	172	Bran and shorts.
Yorkshire	216A	Dec. 27 '13	Apr. 19 '14	345	375	275	273	14—12 good, 2 small.	27½	10	79½	6	113	655	456	392	186	Period I (Bran 2 shorts 1)
Yorkshire	257	Dec. 26 '13	Apr. 18 '14	380	435	333	300	11—all good.	28	7	83	5	51	648	456	392	185	Feed up to Feb. 1, 1914
Berkshire	202	Dec. 9 '13	Apr. 3 '14	490	560	477	443	10—all good.	29	4	48	4	87	543	456	392	170	Period II (Bran 2 shorts 2)
Yorkshire	221A	Dec. 8 '13	Apr. 2 '14	390	550	440	365	9—all good	23	9	124½	9	209½	536	456	392	169	From Feb. 1 to end of experiment.
Total				1990	2350	1888	1732	132	33	376.5	27	531.5	2916	2280	1960	54.48	
Average 5 head				398	470	377.6	346.4	10.8	26.4	6.6	75.3	5.4	106.3	588	456	392	10.89	176	

PEN II.—MEAL AND TANKAGE.

Breed.	Farrow.	Date of service.	Date of farrowing.	Weight December 10.	Weight before farrowing.	Weight of sows 4 weeks after farrowing.	Weight of sows 8 weeks after farrowing.	Number in litter.	Weight of litters.	Number in litter 4 weeks after farrowing.	Weight of litter 4 weeks after farrowing.	Number in litter 3 weeks after farrowing.	Weight of litter 3 weeks after farrowing.	Amount of meal consumed up to farrowing time.	Amount of roots consumed up to farrowing time.	Meal consumed 8 weeks after farrowing.	Total cost of ration.	Days on experiment.	Ration.
				Lb.	Lb.	Lb.	Lb.		Lb.	Lb.	Lb.	Lb.	Lb.	Lb.	Lb.	Lb.	\$ cts.		
Yorkshire	219	Nov. 29 '13	Mar. 25 '14	455	490	413	349	9—8 good, 1 small.	24	8	102	7	175.5	480	456	392	161	Bran and shorts with one-third tankage in each case.
Yorkshire	212A	Dec. 2 '13	Mar. 26 '14	455	505	434	414	7—6 good, 1 small.	20	4	55	4	116.5	487	456	392	162	Period I—same as Pen with tankage.
Yorkshire	277	Nov. 29 '13	Mar. 23 '14	405	465	321	288	12—11 good, 1 small.	28.5	9	131	8	191.5	466	456	392	159	Period II—same as Pen 1 with tank- age.
Yorkshire	210A	Dec. 5 '13	Mar. 31 '14	395	435	379	341	8—7 good, 1 small.	19.5	7	113	7	200.5	522	456	392	167	
Yorkshire	217A	Dec. 4 '13	Mar. 28 '14	360	455	382	326	13—all good.	26.5	9	98.5	8	175.5	501	456	392	164	
Total				2050	2350	1929	1721	49	118.5	37	499.5	34	859.5	2455	2280	1960	70.33	
Average 5 head				410	470	385.8	344.2	9.8	23.7	7.4	99.9	6.8	171.9	491	456	392	14.07	163	

DEDUCTIONS FROM EXPERIMENT.

No definite deductions could be drawn from a one-year experiment, and especially where so few individuals were included. However, many interesting facts may be noted in the above tables, which might be summarized as follows:—

1. The tankage-fed sows (pen II) did not consume as much meal as pen I, where no tankage was fed. By comparing the weights of the two pens of sows throughout the experiment it will be noticed that all sows were practically of the same weight at each stage of the experiment, and that the proportionate loss of weight per sow in the advanced stage of lactation was practically uniform in each case.

2. The natural deduction from such comparative figures would be that any variation in the increasing weight of the litters would be due to the milk-producing properties of the meals consumed by the sows during nursing period.

3. Undoubtedly the mortality in all litters was much higher than should be. This, however, was due, in all cases except sow No. 1 of pen No. 1, to the carelessness on the part of the sow several days after the pigs were farrowed. Undoubtedly the average pig from the tankage-fed sows was more rugged than the average pig from the sows which received no tankage. By a comparison of the weights of litters at farrowing, at four weeks of age, and at eight weeks of age it will be noticed that the average pig in pen I weighed 2.44 pounds at birth, 11.4 pounds at four weeks of age, and 19.7 pounds at eight weeks of age, while the average pig in pen II weighed 2.42 pounds at birth, 13.5 pounds four weeks after farrowing, and 25.3 pounds eight weeks after farrowing.

4. From the above figures it will be noted that there was practically no difference in the average pigs at birth, which is somewhat contrary to the results of experiments reported from various experiment stations throughout America. However, the more rapid increase in weight of the small pigs during the nursing period would warrant a continuation of this experiment, and a more complete study from this and other viewpoints.

5. It will be noticed that the cost of feeding pen I amounted to \$10.89 per sow for the 176 days on experiment, while the cost of feeding pen II amounted to \$14.07 per sow for the 163 days on experiment. Although the tankage is, when fed in these proportions, expensive for the feeding of brood sows, yet in the above instance the difference in cost was more than counterbalanced by the greater ruggedness of litters, lower percentage of mortality, and the increased weight of litters at eight weeks of age. This, however, is but the result of one experiment.

A repetition of this experiment, together with the several lines of experimental work in the use of tankage and other meals in the feeding of young pigs, is already under way and more complete data along the lines of this foodstuff will be available for publication in the near future.

Readers are particularly referred to the report of the Dominion Chemist, Mr. E. T. Shutt, in which may be found the chemical analyses of the foodstuffs under experiment.

EXPERIMENTAL FARM, NAPPAN, N. S.

REPORT OF THE SUPERINTENDENT, W. W. BAIRD, B.S.A.

BREEDING SWINE.

In the spring of 1912-13 there were only five breeding swine at this Station, hence it was decided to increase them to ten, adding two Berkshire and three Yorkshire sows, so at present there are: Three Berkshire sows, one Berkshire boar, five Yorkshire sows, one Yorkshire boar.

The Berkshires are all in good shape and are excellent pigs.

Two of the York-shire sows are getting somewhat aged, and will be disposed of. The other three are young, in fact, just a year old, and are developing into three very fine sows.

During the season of 1913 only fair success was met with in the litters. The Berkshire sow only gave a litter of six, and lost one. One of the Yorkshires gave a nice litter of eleven, but was a very clumsy mother, and tramped and laid on five. The other Yorkshire sow gave only five and killed two of those, so that there were but few to dispose of.

As the present piggery is not at all suitable for pigs, it was decided to build four colony houses for housing boars and sows. The accompanying plate will show the structure of these cabins.

During last winter all sows and boars were wintered in these houses except for just a short period. While there was a little more feed and labour connected with it, we found that the sows wintered in excellent shape and were in good condition at farrowing time. They were moved into warmer quarters a week or more before farrowing date. This allowed them to get accustomed to the quarters and feed inside.

For the greater part of the time, they received shorts and bran, with cracked corn when it could be had, in the following amounts: shorts 2½; bran 1; cracked corn 1½; by weight, or, when shorts and bran only were used, it was shorts 3 and bran 1.

The following is a financial statement of the piggery:—

FINANCIAL STATEMENT of Piggery for 1913-14.

Sales during the year	\$172 18
Value of manure	6 00
Value of pigs on hand April 1, 1914.....	300 00
	\$478 18
Cost of feed and bedding	\$198 94
Cost of labour	164 25
Cost of new stock	55 00
Value of stock on hand April 1, 1913.....	125 00
	\$543 19
Net balance against pigs	\$65 01

NOTE.—The reasons for there being a balance against the pigs are: First, the number was too small to warrant full time for one man, yet the time spent on these is sufficient to attend to twice or even three times as many more; Second, the bad luck with the litters last season; Third, the addition of new stock.

FEEDING SWINE.

Not having any facilities for carrying on any experiments in feeding, no work was done along this line. Four of the small pigs which were not sold were fed on a mixture of shorts and cracked corn for the respective periods, as per table of food consumed. Below is a statement of returns and profits:—

Number of Pigs.	Time Fed.	Meal.	Cost of feed.
2	July 27, 1913, to March 2, 1914, 218 days	1,424	\$ 21.79
2	May 21, 1913, to December 19, 1913, 212 days	1,364	20.87
		2,788	\$ 42.66

EXPENDITURE.

First pair, cost of feed consumed	\$21 79
Second pair, cost of feed consumed	20 87
Labour	30 00
Cost of four pigs at \$3	12 00
	\$84 66

RETURNS.

First pair, 390 pounds pork at 12 cents per pound	\$46 80
Second pair, 388 pounds pork at 13½ cents per pound	52 38
	\$99 18
Net balance	\$14 52



Central Experimental Farm, Ottawa. Sows on Pasture. The shelters are the same in which brood sows are wintered.

EXPERIMENTAL STATION, CAP ROUGE, QUE.**REPORT OF THE SUPERINTENDENT, GUS. A. LANGELIER.****SWINE.**

There are only three sows on the Farm, pure-bred Yorkshires. The piggery is to be transformed into a sheep barn and, pending the construction of a new building, it will be impossible to keep many hogs. A boar from this Station made the highest price, in October, 1913, of any hog at the sale of the Provincial Department of Agriculture at Quebec. As soon as proper accommodation is available, a larger herd of Yorkshires will be established and feeding tests will be started.

EXPERIMENTAL STATION, STE. ANNE DE LA POCATIERE, QUE.

REPORT OF THE SUPERINTENDENT, JOS. BEGIN.

SWINE.

During the past fiscal year, a small start was made in swine operations in the transfer of an excellent Yorkshire boar and two first-class yearling Yorkshire sows from the Experimental Station, Cap Rouge, Que., to this Station. During the past winter, accommodations for these individuals were most inconvenient; nevertheless the spring litters from these sows were fairly good.

A modern, inexpensive, but complete piggery is anticipated during the coming year, in which feeding experimental work with swine will be conducted. At such time as more ample accommodations are available, the swine breeding work will also be considerably enlarged, as this department of the live stock industry, for this district of Quebec, deserves immediate attention.

EXPERIMENTAL FARM, BRANDON, MAN.**REPORT OF THE SUPERINTENDENT, W. C. MCKILICAN, B.S.A.****SWINE.**

There are 37 swine on this Farm on March 31, 1914. They are divided as follows: Yorkshire, 1 boar, 5 brood sows and 4 young pigs; Berkshire, 1 boar, 2 brood sows and 3 young pigs; experimental feeders, 21.

Four Yorkshire boars and four Yorkshire sows have been sold to farmers for breeding purposes. As no stock boar of the Berkshire breed was on hand until late in the season, the Berkshire sows were bred to the Yorkshire boar and the crossbred offspring used for pork production. The surplus Yorkshire young pigs were used in the same way.

SWINE FEEDING EXPERIMENT.**BARLEY VS. OATS VS. SHORTS.**

A feeding test was conducted in which oats, barley, and shorts were compared as winter feeds for the production of pork. The pigs used averaged between 65 and 70 pounds at the start of the test.

Lot 1 received ground oats as the main portion of their feed; lot 2 received ground barley; and lot 3 received shorts. All three lots received one part of feed flour to three parts of the principal meal fed. All received a small ration of mangels—from 2 to 3 pounds per pig per day. These feeds were charged against them at the following rates: Oats, 30 cents per bushel; barley, 40 cents per bushel; feed flour, \$28 per ton; mangels, \$3 per ton.

The lot that were fed shorts became crippled and went very badly off feed early in the test, consequently that part of the experiment had to be dropped. Some of the pigs in the other lots showed a tendency in the same direction, but the majority did well and even the poorer ones did not get seriously wrong.

The individual and average gains per month and for the whole period are as follows:—

5 GEORGE V., A. 1915

LOT 1.—Fed Ground Oats (with Feed Flour and Mangel's).

Pig.	Weight Nov. 27.	Weight Dec. 27.	Weight Jan. 27.	Weight Feb. 27.	Weight March 27;	Gain in 4 months.
	Lb.	Lb.	Lb.	Lb.	Lb.	Lb.
No. 942	45	62	75	89	113	68
No. 943	66	86	102	113	128	62
No. 944	67	96	117	130	143	76
No. 945	64	91	105	124	149	85
No. 946	73	101	115	122	143	70
No. 940	70	98	116	120	133	63
No. 941	72	103	118	133	154	82
Total.....	457	637	748	831	963	506
Average per pig.....	65 $\frac{2}{3}$	91	106 $\frac{2}{3}$	118 $\frac{2}{3}$	137 $\frac{2}{3}$	72 $\frac{2}{3}$

LOT 2.—Fed Ground Barley (with Feed Flour and Mangel's).

Pig.	Weight Nov. 27.	Weight Dec. 27.	Weight Jan. 27.	Weight Feb. 27.	Weight March 27.	Gain in 4 months.
	Lb.	Lb.	Lb.	Lb.	Lb.	Lb.
No. 947	73	107	125	128	150	77
No. 948	79	116	132	143	146	67
No. 949	80	95	111	145	158	78
No. 950	50	70	86	103	131	81
No. 951	62	94	114	139	174	112
No. 952	68	97	111	124	139	71
No. 953	45	65	81	100	122	77
Total.....	457	644	760	882	1,020	563
Average per pig.....	65 $\frac{2}{3}$	92	108 $\frac{2}{3}$	126	145 $\frac{2}{3}$	80 $\frac{2}{3}$

LOT 3.—Fed Shorts (with Feed Flour and Mangel's).

Pig.	Weight Nov. 27.	Weight Dec. 27.	Weight Jan. 27.	Weight Feb. 27.	Weight Mar. 27.
	Lb.	Lb.	Lb.	Lb.	Lb.
No. 953	88	112	114		
No. 954	68	96	115		
No. 955	65	97	105		
No. 956	61	87	97		
No. 957	65	91	90		
No. 958	70	97	112		
No. 959	69	95	102		
	486	675	735		
Average per pig.....	69 $\frac{2}{3}$	96 $\frac{2}{3}$	105		

Pigs became crippled and went off their feed during January; the method of feeding was changed on January 31 in order to try to restore their health.

BRANDON

SUMMARY of Results.

	Lot 1.	Lot 2.
No. of pigs in lot	7	7
Weight at start of test November 27, 1913. Lb.	457	457
Weight at end of test March 27, 1914 "	963	1,020
Gain in four months "	506	563
Gain per pig per day "	.6	.67
Total amount of oats fed "	1,638	1,638
Total amount of barley fed "		1,638
Total amount of feed flour fed "	548	548
Total amount of mangels fed "	1,018	1,016
Total cost of feed \$	23 61	22 84
Cost of feed per 100 pounds gain in weight \$	4 66	4 03

This experiment would indicate that, whatever may be the value of the shorts for milking sows and freshly weaned pigs, it is not a satisfactory winter feed for half-grown pigs unless it is fed in combination with some coarse lighter feed, such as ground barley or oats. When fed alone or with feed flour it induced digestive troubles and crippling. Last year's results were corroborative of this conclusion.

In comparing oats and barley, results are not very conclusive, but in as far as they give any evidence are in favour of barley, for the production of larger and cheaper gains.

FEEDING TWICE A DAY VS. THREE TIMES.

A feeding test was conducted in which feeding pigs three times a day was compared with feeding twice a day. The pigs were Yorkshires and grade Yorkshires. The test was started on November 27 and was completed on February 27, when the pigs were ready for market. Lot 4 weighed 117 $\frac{3}{4}$ pounds average per pig at the start, and lot 5 weighed 120 $\frac{1}{2}$ pounds average. Both lots received 3 pounds of barley chop and 1 pound of feed flour per pig per day part of the period, and 4 $\frac{1}{2}$ pounds of barley chop and 1 $\frac{1}{2}$ pounds of feed per pig per day the rest of the time. Both lots received about 2 to 3 pounds of mangels per pig per day. These feeds were charged at the following rates: Barley, 40 cents per bushel; feed flour, \$28 per ton; mangels, \$3 per ton. The following are the gains made per month and for the whole period:—

LOT 4.—Fed Twice a Day.

Pig.	Weight Nov. 27,	Weight Dec. 27.	Weight Jan. 27.	Weight Feb. 27.	Gains in 3 month.
	Lb.	Lb.	Lb.	Lb.	Lb.
No. 891	139	188	205	241	102
No. 892	113	175	185	228	115
No. 894	132	195	213	260	128
No. 895	87	119	131	160	73
Total	471	677	734	889	418
Average per pig	117 $\frac{3}{4}$	169 $\frac{1}{4}$	183 $\frac{1}{2}$	222 $\frac{1}{4}$	104 $\frac{1}{2}$

LOT 5.—Fed Three Times a Day.

Pig.	Weight Nov. 27.	Weight Dec. 27.	Weight Jan. 27.	Weight Feb. 27.	Gain in 3 months.
	Lb.	Lb.	Lb.	Lb.	Lb.
No. 896.....	118	165	202	217	99
No. 897.....	13	177	210	231	100
No. 898.....	135	175	205	240	105
No. 899.....	98	146	180	197	99
Total.....	482	663	797	885	403
Average per pig.....	120½	165¾	199¼	221½	100¾

SUMMARY of Results.

	Lot 4.	Lot 5.
Number of pigs in lot..... Lb	4	4
Weight at start of test November 27, 1913..... "	471	482
Weight at end of test February 27, 1914..... "	889	885
Gain in three months..... "	418	403
Gain per pig per day..... "	1.13	1.1
Total amount of barley fed..... "	1,155	1,155
Total amount of feed flour fed..... "	385	385
Total amount of mangels fed..... "	578	578
Total cost of feed..... \$	14.01	14.01
Cost of feed per 100 pounds gain in weight..... \$	3.35	3.45

The results would indicate that there is no advantage in feeding pigs of this size more frequently than twice a day. A single experiment is never conclusive, but similar experiments elsewhere tend, on the whole, to corroborate this conclusion.

The ration used, viz., 3 parts of ground barley to 1 part of feed flour to 2 parts of mangels, is one that gives rapid and cheaply produced gains with pigs of the size used in this experiment.

PIGGERY.

The accompanying plans of piggery erected at the Experimental Farm, Brandon, Man., during the summer of 1913, are for the most part self-explanatory. However, a few added notes regarding the same may make these more comprehensive.

This piggery is 82 feet long, 32 feet wide and with a 13-foot post above foundation wall. A wing 15 feet wide and 32 feet long gives ample accommodation for feed room, stairways, meal room, etc., with a root cellar below. The dimensions inside the piggery are as follows: passage, 6 feet wide; pens, 10 by 12 feet; feed room, 20 by 22 feet; and ceiling, 9 feet clear. In each of the pens is a small sleeping pen of the dimension 6 by 7 feet. In each of the farrowing pens is a guardrail composed of 2-inch iron pipe set 12 inches above the cement floor and 10 inches out from the wall. The troughs are of concrete and are 6 inches deep and 10 inches wide, inside measurements. The pen fronts are 8 inches high next the main passage and 10 inches high in pens, and are on the same level as the top of foundation wall.

SESSIONAL PAPER No. 16

FOUNDATION.

The foundation wall about the piggery is of concrete, same being 12 inches thick. Cement bolts were inserted in the cement wall with which to bolt down the sill. This cement foundation wall extends above the floor of pens to a height of 10 inches, and extends 2 feet below the grade line outside of building. This wall stands on a 12- by 15-inch concrete footing. Within the piggery a 4-inch cement wall supports the division, with somewhat heavier buttresses at corners of pens carrying the posts.

FLOORS.

The floors throughout this building are of concrete, excepting the floor of feed room over root cellar. All floors have ample drainage. Underneath floor of main passage is an 8-inch drain running lengthwise of the building, into which a 4-inch drain empties from each pair of pens. The floors of pens were given a rough finish, and the floor of main passage crowned 1 inch and rolled to give a rough finish.

LEVELS AND GRADES.

The floors of pens are 2 inches lower at the front than the level of main passage. The fronts of pens are 8 inches above the passage level next pens. The passage has a crown of 1 inch to centre. On the edge of passage, directly against the concrete pen fronts, is a gutter 2 inches wide, this grading alternately for each pair of pens, passing through the pen fronts and emptying into the 4-inch drain of each pair of pens. The floor of pens falls towards centres 2 inches in 3 feet from passage, from which there is a rise of 1 inch in 2 feet and 2 inches to the rear of pen. Each pair of pens drains to the 4-inch drain placed in the division between the two pens.

SUPERSTRUCTURE.

The superstructure is made of 2- by 6-inch planking throughout, excepting the joists and girths which are made of 2- by 10-inch planking. The walls are most economically constructed, as follows: On the outside of posts and studs is one ply of building paper, covered by vertical planed boards with battens over cracks. On the inside of posts and studs is a layer of specially prepared building paper called "Lino-felt," covered by $\frac{5}{8}$ -inch sheathing in the piggery below but not in the loft. All divisions between pens are of 1 $\frac{1}{4}$ -inch matched sheathing topped with grooved and bevelled header. A sliding door crossing the main passage at the south side of feed room completely shuts off one-half of the piggery, thus allowing the maintenance of higher temperature in the portion set aside for farrowing sows.

LIGHT.

As per illustration, all the light possible is installed in this piggery, in order to get it perfectly sanitary and cheerful. Although this necessitates storm windows for winter, yet a much more sanitary piggery for breeding purposes is the result.

VENTILATION.

The ventilation is of the Rutherford system. Each pair of pens has a fresh-air intake which brings the fresh air in 3 feet above floor. The foul-air outlets run from the ceiling of feed passage through the loft to the cupolas on roof. These outlets are made of two ply $\frac{3}{8}$ -inch matched sheathing with dead air space between in order to prevent condensation. Both incoming and outgoing air are controlled by dampers in ventilators.

CONVENIENCES.

Underneath the feed room is a root cellar with a capacity of approximately 2,000 bushels, with adequate ventilation for the same. The piggery is fitted with a litter carrier in order to facilitate the cleaning out of pens. Meal bins, with hopper-shaped bottoms, are installed over feed room, from which chutes convey the meal to the feed room below. A feed cooker is installed in the feed room, the same fitted with the necessary hoods, counter-weights, steam outlets, etc., in order to keep the piggery as free from steam and as dry and wholesome as possible.

A sink is also installed in the feed room for the washing of pails, etc.

A manure pit, 10 by 12 feet, 2 feet in depth, will eventually be placed at the end of piggery, but only in order to keep clean the location of the manure cart.

EXPERIMENTAL FARM,
BRANDON,
MAN.

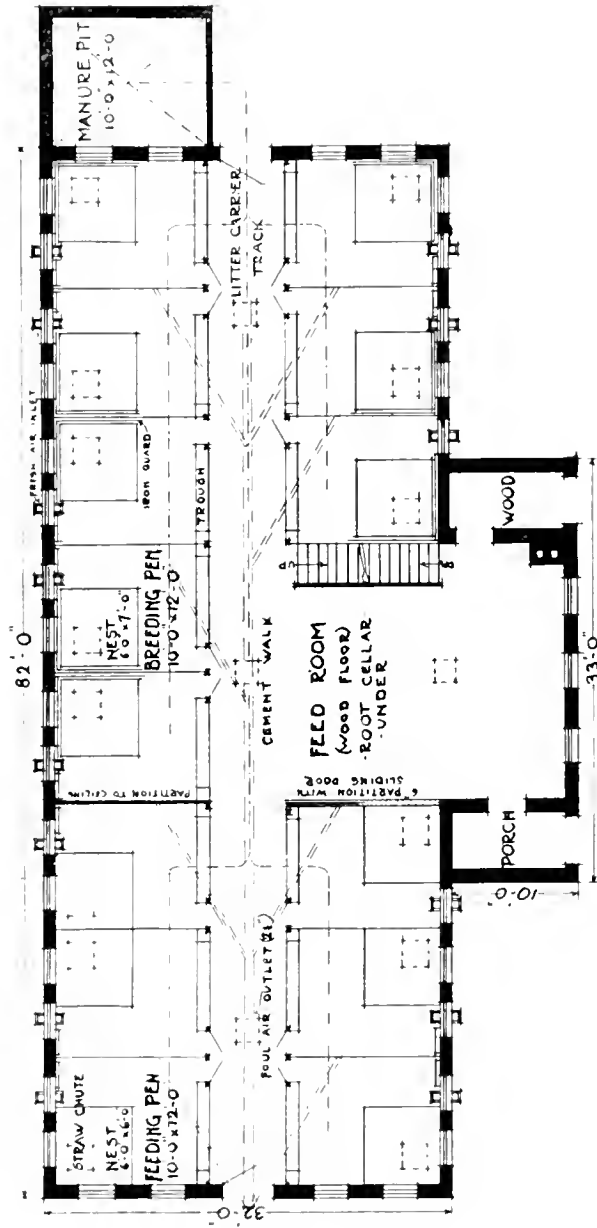

-PLAN OF PIGGERY -
1/8" IN SCALE.

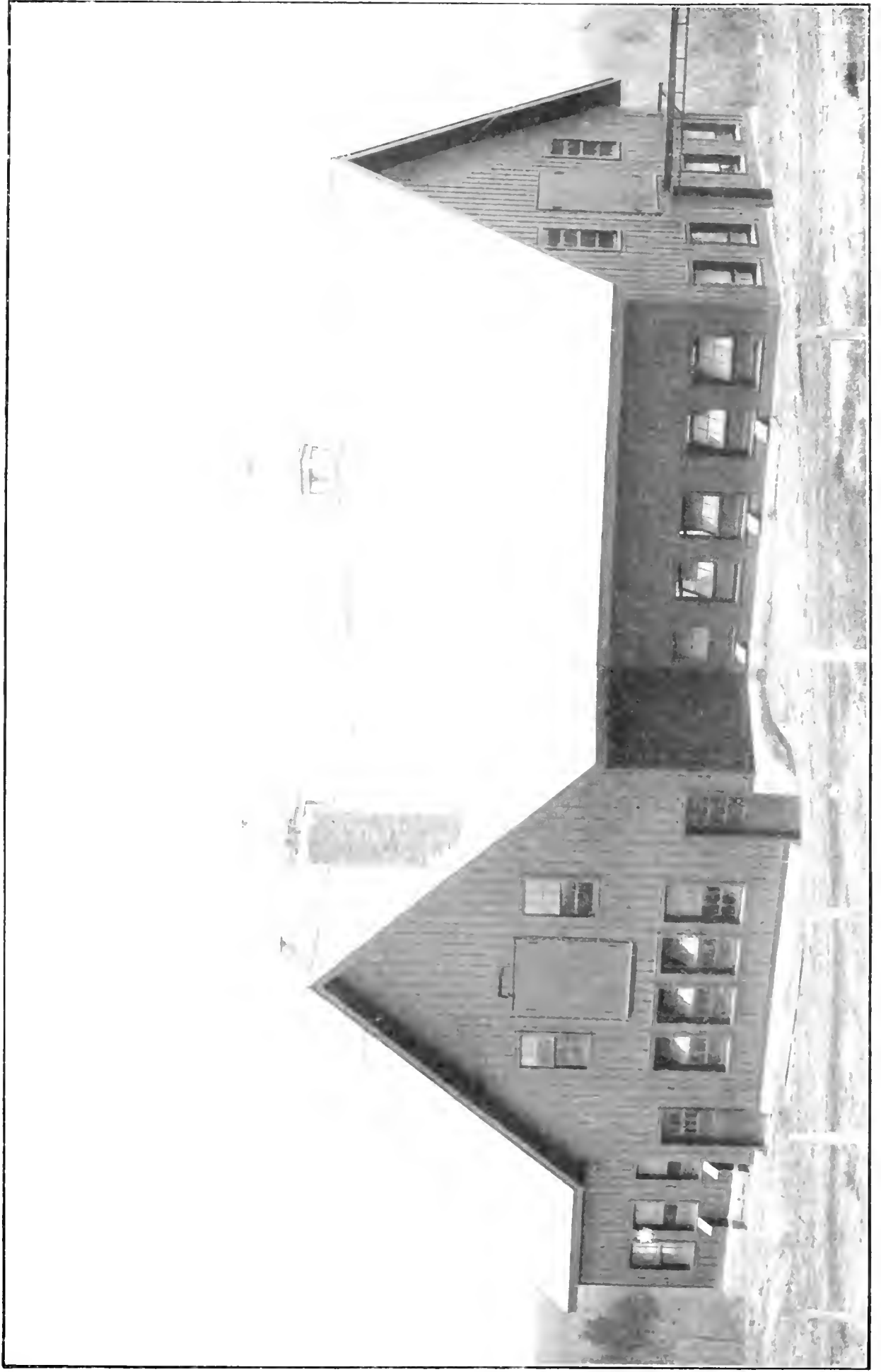

Exterior View of Piggery, Brandon, Man.

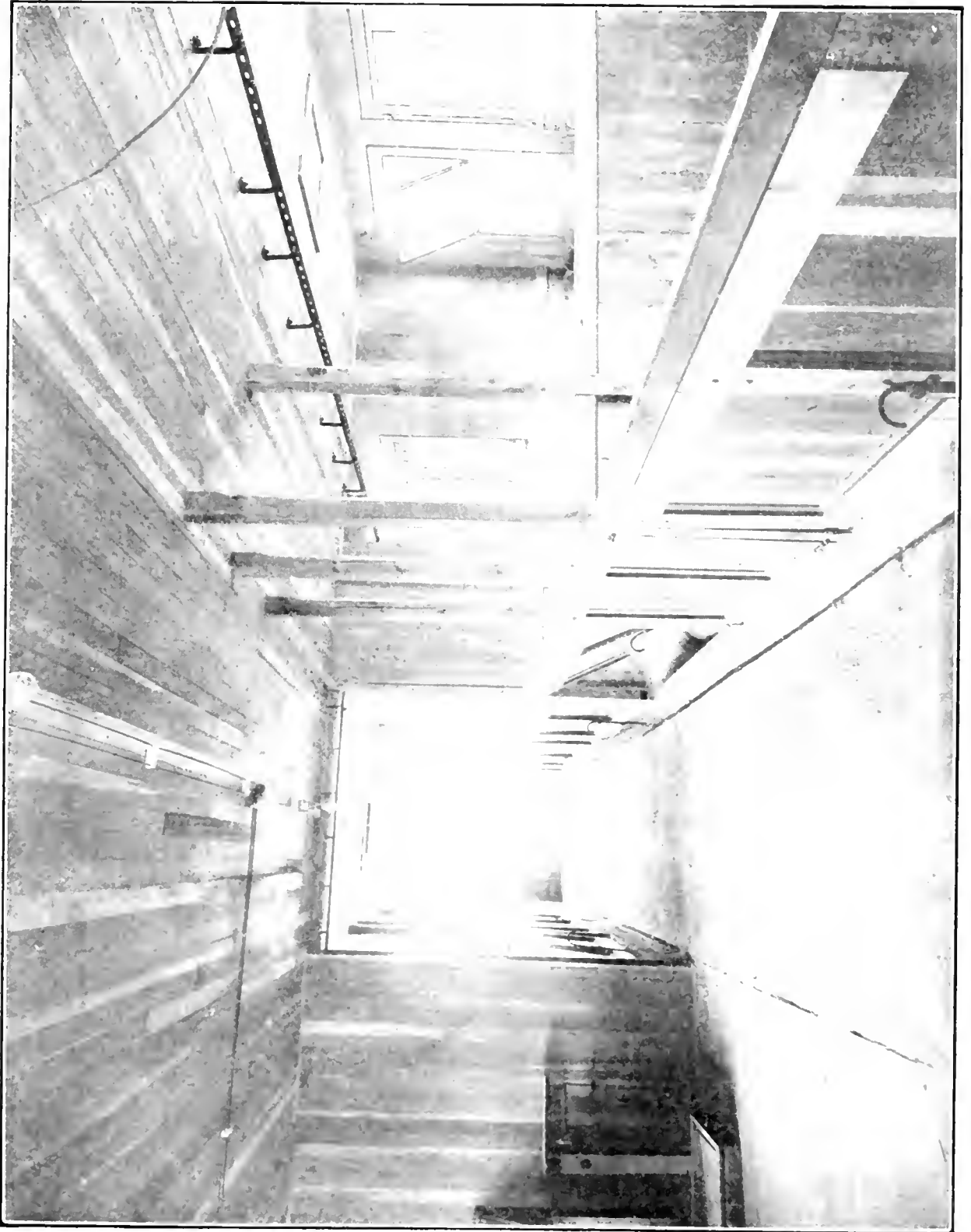

Brandon Experimental Farm. View of Interior of Piggery.

SESSIONAL PAPER No. 16

EXPERIMENTAL FARM, INDIAN HEAD, SASK.**REPORT OF THE SUPERINTENDENT, T. J. HARRISON, B.S.A.****SWINE.**

At this date the herd of swine on the Indian Head Experimental Farm consists of one Yorkshire boar, four Yorkshire sows and one Berkshire sow. The Berkshire boar was sold to the butcher some weeks ago for the reason that his usefulness was past.

During the year a number of young pigs were sold to farmers for breeding purposes. The following is a list of the animals sold: four Yorkshire boars and three Yorkshire sows. In this connection it may be well to note that the demand greatly exceeded the supply.

A very fair type prevails in the herd of bacon hogs, the Yorkshires being headed by a boar of splendid quality and conformation, and it is hoped that in the near future a Berkshire of equal standing may be procured. With the present equipment any extensive feeding experiments are impossible. The only work done in this connection was a test in regard to feeding sows in the piggery and outside in cabins. Two sows were kept in a single-board 6- by 8-foot cabin all winter, and thrived exceedingly well, one of them having already given birth to a healthy but small litter. Those kept inside were not under good conditions as the old piggery is dark and poorly ventilated. From the results so far it would seem to indicate that brood sows can be housed outside during the winter quite satisfactorily. With a more up-to-date piggery and a larger number of sows something more definite along this line may, during another season, be undertaken.

EXPERIMENTAL STATION, LACOMBE, ALTA.

REPORT OF THE SUPERINTENDENT, G. H. HUTTON, B.S.A.

SWINE.

Two pure breeds of hogs are kept, viz., Yorkshire and Berkshire. Six sows are being kept over and were wintered at a cost of 1.86 cents per head daily. These sows, however, ran in the corrals and no doubt secured a part of their ration there. What they got in this way would not be very great, as the stock in the corrals were fed finely-ground grain. It is hoped that we will be in a position next year to increase the number of sows kept.

The Yorkshire boar "Summerhill Gentleman 5th—39206", farrowed November 2, 1912, now weighs, in moderate condition, 665 pounds.

The following table shows the cost of a litter of pigs farrowed November 9, 1912, and marketed at \$8.65 per hundred on May 1, 1913. Though these pigs were produced on the Farm they were charged up at \$3.50 each at weaning:—

Six pigs at weaning at \$3.50 each.....		\$21 00
2,095 pounds chop at 1 cent per pound.....		20 95
200 pounds bran at \$1.35 per cwt.....		2 70
5,000 pounds skim-milk at 20 cents per cwt.....		10 00
		<hr/>
Total cost		\$54 65
1,085 pounds pork at \$8.65 per cwt.....	\$93.85	
Total profit		39 20
		<hr/>
	\$93 85	\$93 85

Profit per hog, \$5.53.

A number of pigs were sold for breeding purposes during the year.

EXPERIMENTAL FARM, AGASSIZ, B.C.**REPORT OF THE SUPERINTENDENT, P. H. MOORE, B.S.A.****BREEDING WORK.**

During this year the breeding stock of Yorkshire hogs has been greatly increased. There are at present twenty-seven head of breeders (one aged boar and two young ones, eight sows over 1 year, and sixteen sows 1 year or under). There will also be a number raised from the summer litters to still increase the herd and to replace some of the old sows that are becoming worn out.

All the young stock shows an improvement in both size and type on the older material. The breeding stock has all been kept in the "A"-shaped colony houses during the year, with the exception of two weeks at farrowing time. This method has proved most satisfactory, particularly for young, growing sows. These cots were tried, in a few cases, for farrowing sows, but they did not prove satisfactory for winter conditions. The greatest loss was with heavy, old sows, and, on the average, 10 per cent of the pigs farrowed were killed. No losses were experienced when the pigs have been farrowed in the piggery and put into the cots at two weeks of age; the young pigs grow stronger and the sows keep in better health than when they are kept in the piggery a longer period. The sows are all given pasture or mangels, according to the season, and they get a meal mixture of barley, peas, oats, and shorts. At times they get a little skim-milk, which, even in small quantities, is most beneficial.

The young pigs are weaned at 8 or 10 weeks, but are taught to feed on skim-milk and shorts when 3 weeks old, and, by the time they are taken from the sows, they seldom or never stop gaining.

The demand for breeding stock has been strong this year, so strong that the proportion of orders filled is not known. All surplus stock that was of the best quality were sold, and any inferior pigs were put into feeding pens.

Three grade Yorkshire sows were kept to breed pigs for the experimental work. They were good, young sows, and produced well, but pure-breds of the same age were more profitable. They were sold at the close of the year. There has not been any disease or loss from disease in the breeding stock this year.

The following short table will give in condensed form the work of the sows over 1 year old. Slightly better results were obtained in winter than in summer. The second table gives the food cost per pig weaned at 60 days and raised in winter. The figures were taken from the performance of two sows 2 years old. They were started, after weaning a litter, very thin in flesh, and at farrowing time they were in excellent condition. They were kept in a paddock and housed in a cot. The winter was mild and some food was obtained from the paddock, which is not accounted for in the table. Further work of a similar nature is being done to get the average of a greater number of sows and litters.

TABLE IA.

Year.	Number of sows.	Number of litters.	Number of pigs farrowed.	Average number farrowed, per sow.	Number of pigs raised.	Average number raised per sow.	Per cent. raised.
1913-14.	8	14	151	10.78	115	8.2	76.1
Summer litters.	6	7	71	10.14	54	7.7	76.05
Winter litters...	7	7	80	11.4	61	8.7	76.25
							%

TABLE IB.

Sow number.	Age.	Summer litters.		Winter litters.	
		Number farrowed.	Number raised.	Number farrowed.	Number raised.
	Years.				
2	6	18	9	10	8
3	4	11	8	11	5
10	2	12	10	12	11
11	2	9	6	10	9
12	1.5	7	7	13	10
13	1.5	14	8
17	1.2	14	14
19	1.2	10	10
.....	71	54	80	61

TABLE No 2.

Food cost to keep a sow and raise young pigs in winter. Average of two sows, each 2 years old:—

Sow—

Time from weaning summer litter to farrowing, 126 days.

Ration—

	\$	cts.	\$	cts.
Shorts, one-half; peas, oats and barley, one-half; 480 pounds at 1.3 cent.....	6	24		
Skim-milk, 250 pounds at .25 cent.....		62		
Mangels (whole) 300 pounds at .25 cent.....		75	7	61

Time from farrowing to weaning—60 days—

Mixed grain (shorts, peas, oats, and barley), 336 pounds at 1.3 cent...	4	36		
Skim-milk, 140 pounds at .25 cent.....		35		
Mangels (whole), 560 pounds at .25 cent.....	1	40	6	11

Young pigs while with sow—

Skim-milk, 350 pounds at .25 cent.....	0	87		
Wheat shorts, 70 pounds at 1.3 cent.....		91	1	78

Total cost of food for sow and litter.....			15	50
Average number of pigs raised, ten.....				
Average cost per pig raised.....			1	55

SESSIONAL PAPER No. 16

EXPERIMENT ON THE EFFECTS OF FEEDING RICE-MEAL TO FATTENING HOGS.

In the annual report for the year ending March 31, 1913, some preliminary experiments were described on the value of rice-meal as a food for swine.

This work was undertaken in response to numerous inquiries received from this section of the province concerning this food, it being evident that large quantities of rice-meal were being sold to farmers. The work done was of a preliminary nature and was necessarily not conclusive; but it indicated that further careful experiment was both desirable and necessary in order to prove: Firstly, whether this food was a profitable one for farmers to feed to pigs; and secondly, what was its effect on animal nutrition.

With these two main objects in view, a number of experiments have been carried on for the past twelve months. Twenty-five pens of four pigs each, a total of one hundred pigs, have been fed. The feeding period varied from fifty-seven days to one hundred days, but the majority of the pens were fed for the last-named period. The pigs used were, as nearly as possible, of uniform size, age, and condition for each experiment. In every case the best pigs were put on the rice-meal or mixture and the poorer ones used for controls.

All the pigs on the experiment were given every attention that our condition would permit. They were kept in rough, but light, clean, well-bedded, and well-ventilated pens. The pens were cleaned out every day and fresh straw was put in. They were fed three times a day, and were given clean water to drink at will. Green food, such as mangels, peas, oats and vetches, and green clover, was supplied every day. Three times each week, every pen was supplied with a liberal quantity of a mixture of soil, wood-ashes, charcoal, and salt. This mixture was greatly enjoyed by all the pigs.

The pigs used were very ordinary in breeding and condition. Grade and cross-bred pigs were bought and these were supplemented from our own litters by pure-bred ones that were not first-class breeding stock. They were always so arranged as to make the pens as uniform as possible.

In all the work now reported, rice-meal when fed in mixtures was used half and half with other meals, except alfalfa and dried blood. These last named foods were used in an endeavour to replace skim-milk. Dried blood at \$60 per ton, and ground alfalfa at \$28 per ton were both very expensive substitutes for skim-milk.

Thirteen pens were fed rice-meal and rice-meal mixtures. Twelve pens were used as controls and fed on wheat shorts, or shorts and the same mixtures as in the case of rice-meal. The different lots contain both summer- and winter-fed hogs.

In looking over the various lots of pens, one will notice quite a variation in the different points, but in every case the rice-meal fed hogs were less profitable than were the ones fed on the other grains. Not only were they less profitable but their general condition was not to be compared to the control pens. In some cases a definite disease developed, and when the hogs were slaughtered they were condemned on account of lack of condition.

Dr. Seymour Hadwen of the Health of Animals Branch inspected, both before and after slaughter, every hog put through the pens. As will be noted in a paragraph by Dr. Hadwen, this malady caused by the rice-meal resembles very closely the disease Beri-beri in man. When this trouble first occurred, it appeared due to some faulty method of housing or feeding; but, when experience proved that this malady could be produced or checked at will by changing the ration, this idea was given up. In every case where rice-meal has been fed, symptoms were produced of a like nature. This has been done with various classes of hogs at all seasons of the year, and with various foods mixed with rice-meal.

The grain foods used varied in price, and each pen was charged according to the food eaten. The prices charged were as follows:—

	Per Ton.
Wheat shorts	\$26 00 to \$28
Rice meal	22 40 to \$25
Peas, oats, and barley (home-grown).....	26 00
Ground alfalfa	28 00
Dried blood	60 00
Mangels and green food	4 00
Skim-milk	4 00
Potatoes (culls)	4 00

LOTS 1 AND 2.

In lot 1, all the pens were fed rice-meal as the grain ration, and all the pens in lot 2 were fed wheat shorts as a control. This experiment was made in the different seasons of the year, and the average represents all of our yearly conditions.

It will be noted that the periods vary in length. This irregularity was brought about by the rice-meal fed pigs becoming disabled and being killed when they began to lose weight. At the same time, the controls were gaining rapidly and had not yet reached the height of their production. This, to a great extent, lessens the difference between the two lots, but, even at this stage, there is more profit to the credit of the controls.

From a nutrition point of view, the difference is very marked. In pen 1, the pigs all became very stiff and sore and refused food at fifty days; their hair was rough and the skin yellow to brown. Pen 5, at a different season of the year, also went exactly the same way at the fifty-day stage. Pen 10 started to show symptoms of trouble at thirty days, and at fifty days the pigs were all unable to use their hind-feet and had very rough hair and brown skins. This pen was treated with Epsom salts, given shorts to eat, and in a few days they were on their feet. They were put back on rice-meal and all stiffened up again, becoming very bad before the period was up. They were all condemned before killing. Pen 12 had a slightly different history. At fifty-three days, one pig became very lame very suddenly as if attacked by a terrible cramp in the hind legs. He was exceedingly sore and noisy. Three days later the other pigs became gradually lame. All of them had very rough hair and dark skins. They gradually became worse until the end of the period. The first symptom one would notice was a uniform wild or staring expression of the eyes, next they would not clean their trough out, then they would get stiff and bury themselves in the straw and they would squeal vehemently if disturbed.

In contrast to this, there was no trouble at all with the pigs in lot 2, fed on straight shorts with all the other conditions exactly the same. In pen 2 the pigs were healthy and active every day, although they became very fat, and they were always hungry. Their trough was always clean, their skin and hair were pure white and they were making their best gains at the end of the period. Pen 6 has exactly the same history as pen 2, only that they started as much younger pigs and ran a longer period. Pen 9 started very young and ran the full 100 days, without the slightest trouble occurring. They varied from the other two pens in this lot because they were pushed to the limit throughout the trial. They were given every pound of shorts they would possibly eat, yet they never refused a meal or had anything wrong with them, except that they became very fat.

Several times during the various periods, the pigs changed places with one another to try to prove whether or not there was any difference in location in the piggery or anything contagious, but negative results were obtained at each time. The ration was the only factor in changing the condition. From the results obtained from lots 1 and 2, it must be said that rice-meal is not a safe food for fattening hogs.

SESSIONAL PAPER No. 16

LOT 1.—Rice-Meal, Skim-milk, and Mangels.

	Lot 1.				
	Pen 1.	Pen 5.	Pen 10.	Pen 12.	Average.
Number of animals.....	4	4	4	4	4
Age at beginning of feeding period days.	180	98	70	98	111.5
Total weight at beginning of feeding period. lb.	582	324	201	249	339
Nutritive ratio of ration	1:7.9	1:7.54	1:7.85	1:8.03	1:7.83
Duration of feeding period..... days.	57	78	100	100	83.75
Amount of meal consumed..... lb.	684	705	1291	1112	948
Amount of milk consumed..... "	570	780	1090	1000	837.5
Amount of mangels consumed..... "	1425	1560	1000	1000	1246.25
Amount of meal consumed for 100 pounds gain..... "	412.05	329.4	369.91	376.9	372.065
Amount of milk consumed for 100 pounds gain " "	343.3	364.48	286.5	338.98	333.315
Amount of mangels consumed for 100 pounds gain " "	858.43	728.9	286.5	338.98	553.202
Cost to produce 100 pounds gain..... \$	7.28	6.11	5.77	6.05	6.30
Total live weight at end of feeding period... lb.	748	538	550	544	595
Total gain in live weight during feeding period..... "	166	214	349	295	256
Daily gain per pig during feeding period.... "	728	685	872	737	7555
Total weight of viscera..... "	105	81.6	96.6	73.8	89.25
Weight of livers..... "	14.3	9.9	8.1	8.4	10.175
Weight of hearts and lungs..... "	9.3	7.5	8.6	8.1	8.375
Weight of remainder of viscera..... "	81.4	64.2	77.9	57.3	70.2

LOT 2.—Wheat Shorts, Skim-milk, and Mangels.

	Lot 2.			
	Pen 2.	Pen 6.	Pen 9.	Average.
Number of animals.....	4	4	4	4
Age at beginning of feeding period days.	180	98	70	116
Total weight at beginning of feeding period.. lb.	419	322	198	323
Nutritive ratio of ration	1:4.21	1:4.14	1:4.12	1:4.117
Duration of feeding period..... days.	64	78	100	80.66
Amount of shorts consumed..... lb.	768	696	1,339	934.3
Amount of milk consumed..... "	640	780	940	786.6
Amount of mangels consumed..... "	640	1,560	940	1,016.6
Amount of shorts consumed for 100 pounds gain " "	269.4	214.15	299.5	261.01
Amount of milk consumed for 100 pounds gain " "	224.5	240	210.2	224.9
Amount of mangels consumed for 100 pounds gain " "	224.5	480	210.2	304.9
Cost to produce 100 pounds gain \$	4.39	4.10	4.73	4.306
Total live weight at end of feeding period... lb.	734	647	645	675.3
Total gain in live weight during feeding period " "	285	325	447	352.3
Daily gain per pig during feeding period..... "	1.113	1.04	1.117	1.09
Total weight of viscera..... "	92.5	76.8	112	93.76
Weight of livers..... "	14.6	12.6	13.7	13.63
Weight of hearts and lungs..... "	11	8.2	10.1	9.76
Weight of remainder of viscera..... "	66.9	56	88.2	70.36

LOT 3 AND 4.

In lots 3 and 4, wheat shorts was used for the foundation ration. Lot 3 had one-half of the grain food made up of rice-meal and lot 4 had an equal portion of a home-grown mixture of oats, peas, and barley. This experiment was made to determine what effect rice-meal would have as compared with mixed grain, when used with equal

portions of wheat shorts. Speaking generally from the results obtained, the mixture of rice-meal and shorts is very little better than straight rice-meal and cannot be compared in regard to usefulness with oats, peas, barley, and shorts.

The same trouble was experienced in lot 3 as in lot 1, but it did not occur quite as early in the feeding period. The history of lot 3 is as follows: In pen 3, the pigs became fat but looked rough and had dark-coloured skins, but they did not show signs of weakness in the hind-legs until the eighty-third day, after which time they all went down and they were immediately killed. Pen 7 of this lot showed the first symptoms of trouble at fifty days, and at the 64th-day stage none could walk, and they were killed before they had finished their 100-day period.

The controls in lot 4 behaved very differently. Pen 4 did not begin to gain as rapidly as did pen 3 in lot 3, but the pigs always appeared in better condition. The last week of the period they made better gains than in any previous week. They were killed the same time as pen 3 of lot 3, and thus lost, to the advantage of that pen, their best producing period. They never missed a meal; they were always hungry, and were in perfect health when killed. The pigs in pen 8, lot 4, were from the same litter as those in pen 7, lot 3, and were 2 pounds heavier at the beginning, but the pen 7 pigs were the most robust looking. Instead of killing this pen when the ones they controlled went under, they were kept the full period to see if, by any chance, they could be pushed off their feet. At the end of 105 days, or 41 days longer than their rice-meal mates, they were still healthy and in perfect condition.

The same can be said of pen 15. They started slowly, grew for a long time, then began to fatten, and, for the whole period, they were in perfect health and were in show condition when killed.

Comparing lots 3 and 4, the cost of production differs but little. Lot 3 could only stand, on an average, 77.5 days' feeding; while lot 4 averaged 98.6 days and gave first-class block pork, as compared to having lot 3 pork condemned. This makes the very great difference in the two lots.

LOT 3.—Rice-meal, Wheat Shorts, Skim-milk, and Mangels.

	Lot 3.		
	Pen 3.	Pen 7.	Average.
Number of animals	4	4	4
Age at beginning of feeding period	98	84	91
Total weight at beginning of feeding period	271	202	236.5
Nutritive ratio of ration	1:5.6	1:5.5	1:5.55
Duration of feeding period	91	64	77.5
Amount of meal consumed	447	288	367.5
Amount of shorts consumed	447	288	367.5
Amount of milk consumed	920	640	780
Amount of mangels consumed	910	1,280	1,095
Amount of meal consumed for 100 pounds gain	111.45	150	130.725
Amount of shorts consumed for 100 pounds gain	111.45	150	130.725
Amount of milk consumed for 100 pounds gain	229.4	333.33	281.365
Amount of mangels consumed for 100 pounds gain	226.9	666.66	446.78
Cost to produce 100 pounds gain	\$ 3.75	5.65	4.70
Total live weight at end of feeding period	672	394	533
Total gain in live weight during feeding period	401	192	296.5
Daily gain per pig during feeding period	1.1	.75	.925
Total weight of viscera	109.8	47.8	78.8
Weight of livers	13	10.1	11.55
Weight of hearts and lungs	10.5	6.4	8.45
Weight of remainder of viscera	86.3	31.3	58.8



Pig from lot 7, pen 22. Fed rice meal, dried blood and mangels.



Pig from lot 7, pen 22. Fed rice meal, dried blood and mangels.

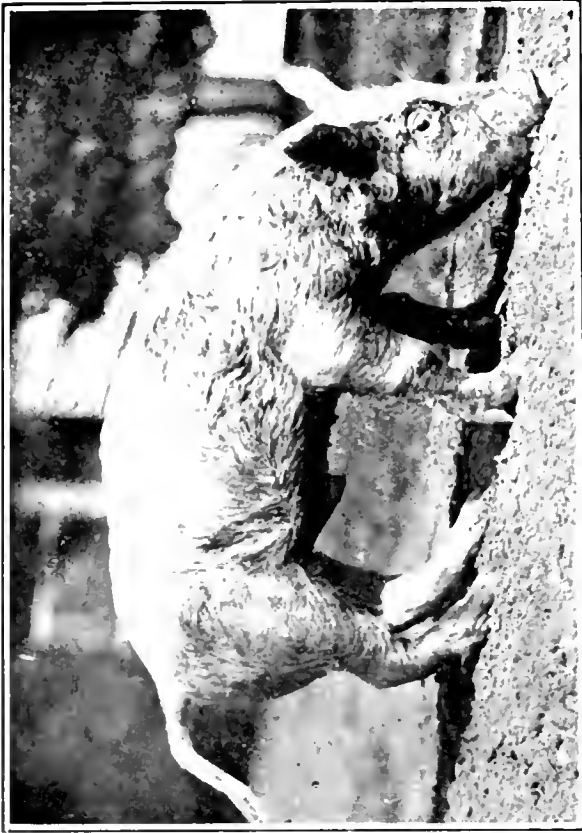

Pig from lot 7, pen 22. Fed rice meal, dried blood and mangels.



Pig from lot 8, pen 24. Fed on wheat shorts, chop and dried blood.

SESSIONAL PAPER No. 16

LOT 4.—Oats, Peas and Barley, Wheat Shorts, Skim-milk, and Mangels.

	Lot 4.			
	Pen 4.	Pen 8.	Pen 15.	Average.
Number of animals.....	4	4	4	4
Age at beginning of feeding period ... days.	98	84	98	93.3
Total weight at beginning of feeding period .. lb.	248	201	234	228.6
Nutritive ratio of ration.....	1:4.47	1:4.7	1:4.5	1:4.556
Duration of feeding period..... days.	91	105	100	98.6
Amount of grain consumed .. lb.	447	550.5	742.5	580
Amount of shorts consumed .. "	447	550.5	742.5	580
Amount of milk consumed .. "	920	1,050	1,000	990
Amount of mangels consumed .. "	910	2,120	1,000	1,343.3
Amount of grain consumed for 100 pounds gain .. "	114.6	131.07	173.48	139.71
Amount of shorts consumed for 100 pounds gain .. "	114.6	131.07	173.48	139.71
Amount of milk consumed for 100 pounds gain .. "	235.8	250	233.6	239.8
Amount of mangels consumed for 100 pounds gain .. "	233.33	504.76	233.6	323.896
Cost to produce 100 pounds gain .. \$	3.92	4.72	5.34	4.66
Total live weight at end of feeding period lb.	638	624	662	641.3
Total gain in live weight during feeding period .. "	399	420	428	412.6
Daily gain per pig during feeding period..... "	1.09	1	1.07	1.053
Total weight of viscera.....	93.7	87	89.9	90.2
Weights of livers.....	12	11.9	13	12.3
Weight of hearts and lungs.....	10.3	10.1	9.3	9.9
Weight of remainder of viscera.....	71.4	65	67.6	68

LOT 5 AND LOT 6.

In lots 5 and 6, ground alfalfa was substituted for skim-milk, and rice-meal was tried against the common grain mixture. The rations for both lots were of a bulky nature, yet they were eaten well, especially the control. The pigs on the control ration had not the smooth, fine finish of the milk-fed hogs, and the gain was costly.

Pen 13, lot 5, had very rough coats of hair and dark-coloured skins, and they grew very rough. After being fed for fifty-four days, one pig showed signs of stiffness, but it was several days longer before all the rest lost control of their hind-legs. This pen did not get as bad as previous rice-meal fed pens, and the pigs got about the pen to feed until the end of the period. Pen 23, lot 5, did not stand up so well, for in thirty-one days one pig was crippled. Gradually others went down, until, after sixty days, three pigs were stiffened up and very sore. One pig showed no signs of stiffness whatever during the entire period. He ate fairly well, had rough hair, and did not grow, but he remained on his feet the entire period. Just at the end, he had the peculiar staring expression, and his head was much out of proportion to the rest of his body.

In lot 6, pen 16 was not an extra good control, because two pigs when started had become runted and the rough ration did not improve them. All the pigs in this pen had an enormous appetite and they were given all they would eat. They were killed early, but were in perfect health, with the exception of one pig which had adhesions between the lungs and ribs.

Pen 25 of this lot was made up of much better pigs. They ate greedily and remained healthy throughout the entire period.

In these lots, even with poor pigs as controls, the rough grains were far superior to the rice-meal. The lack of milk made a great difference in the condition of the pigs.

Lot 5.—Rice-meal, Ground Alfalfa, and Mangels.

	Lot 5.		
	Pen 13.	Pen 23,	Average.
Number of animals	4	4	4
Age at beginning of feeding period	93	120	109
Total weight at beginning of feeding period	249	316	282.5
Nutritive ratio of ration	1:9.29	1:8.9	1:9.095
Duration of feeding period	100	100	100
Amount of meal consumed	1,197	909	1,053
Amount of alfalfa consumed	115	131	123
Amount of mangels consumed	1,000	1,000	1,000
Amount of meal consumed for 100 pounds gain	352.05	683.45	507.25
Amount of alfalfa consumed for 100 pounds gain	33.82	98.4	66.11
Amount of mangels consumed for 100 pounds gain	294.1	751	522.55
Cost to produce 100 pounds gain	5.32	11.047	8.1835
Total live weight at end of feeding period	589	449	519
Total gain in live weight during feeding period	340	133	236.5
Daily gain per pig during feeding period	.85	.33	.59
Total weight of viscera	93.7	71.2	82.45
Weight of livers	12.4	6.6	9.5
Weight of hearts and lungs	7.8	8.2	8
Weight of remainder of viscera	73.5	56.4	64.95

Lot 6.—Wheat Shorts, Peas, Oats and Barley, Ground Alfalfa, Mangels.

	Lot 6.		
	Pen 16.	Pen 25.	Average.
Number of animals	4	4	4
Age at beginning of feeding period	119	131	125
Total weight at beginning of feeding period	366	333	349.5
Nutritive ratio of ration	1:5.4	1:4.8	1:5.1
Duration of feeding period	50	100	75
Amount of shorts consumed	490.5	621.5	556
Amount of grain consumed	490.5	621.5	556
Amount of ground alfalfa consumed	123	150	136.5
Amount of mangels consumed	500	1,185	842.5
Amount of shorts consumed for 100 pounds grain	245.25	206.4	225.825
Amount of grain consumed for 100 pounds gain	245.25	206.4	225.825
Amount of ground alfalfa consumed for 100 pounds gain	61.5	49.83	55.665
Amount of mangels consumed for 100 pounds gain	250	393.6	321.8
Cost to produce 100 pounds gain	7.48	6.53	7.005
Total live weight at end of feeding period	566	634	600
Total gain in live weight during feeding period	200	301	250.5
Daily gain per pig during feeding period	1	.835	.9175
Total weight of viscera	101.3	92.1	96.7
Weight of livers	11.1	9.2	10.15
Weight of hearts and lungs	7.5	11.6	9.55
Weight of remainder of viscera	81.7	71.3	76.5

Lot 7 AND Lot 8.

With these two lots, dried blood was used as a substitute for skim milk, combined with the same grains as in lots 5 and 6.

The dried blood made a much better substitute for skim-milk than did the ground alfalfa, but, even by making the ration much narrower, it did not prevent the trouble with rice-meal.

SESSIONAL PAPER No. 16

In the rice-meal lot (No. 7), pen 14 showed the typical symptoms in sixty-two days, and at eighty-two days one pig was absolutely helpless and the rest badly crippled. They remained in this condition until the end of the period. Pen 22 was made up of very excellent, strong pigs, but at thirty days one pig showed signs of weakness, and at thirty-eight days, all showed dark-coloured skins and stiffness. At fifty days all were alike and crippled.

Lot 8 was very different. Both pens remained in perfect health until the end of the period and they were clean and smooth, although not as smooth as pigs getting skim-milk. The high price of the dried blood meal made the gain more expensive than it otherwise would have been. The pigs in both lots were very even and among the very best used.

Lot 7.—Rice meal, Dried Blood and Mangels.

	Lot 7.		
	Pen 14.	Pen 22.	Average.
Number of animals.....	4	4	4
Age at beginning of feeding period..... days.	98	127	112.5
Total weight at beginning of feeding period..... lb.	238	299	268.5
Nutritive ratio of ration.....	1 : 5.8	1 : 5.6	1 : 5.7
Duration of feeding period..... days.	100	100	100
Amount of meal consumed..... lb.	1159	833	1026
Amount of dried blood consumed..... "	97	85	91
Amount of mangels consumed..... "	1000	1000	1000
Amount of meal consumed for 100 lbs. gain..... "	375.08	572.46	473.77
Amount of dried blood consumed for 100 lbs. gain..... "	31.39	54.4	42.895
Amount of mangels consumed for 100 lbs. gain..... "	323.62	641.	482.31
Cost to produce 100 lbs. gain..... \$	6.10	9.74	7.92
Total live weight at end of feeding period..... lb.	547	455	501
Total gain in live weight during feeding period..... "	309	156	232.5
Daily gain per pig during feeding period..... "	.77	.39	.58
Total weight of viscera..... "	86.7	79.3	83.
Weight of livers..... "	10.2	6.6	8.4
Weight of hearts and lungs..... "	7.6	9.1	8.35
Weight of remainder of viscera..... "	68.9	63.6	66.25

LOT 8.—Wheat shorts, Oats, Peas and Barley, Dried Blood, and Mangels.

	Lot 8.		
	Pen 17.	Pen 24.	Average.
Number of animals.....	4	4	4
Age at beginning of feeding period..... days	98	129	113·5
Total weight at beginning of feeding period..... lb.	241	395	273
Nutritive ratio of ration.....	1 : 5·6	1 : 3·5	1 : 4·55
Duration of feeding period..... days	100	100	100
Amount of shorts consumed..... lb.	760·5	656·5	708·5
Amount of grain consumed..... "	760·5	656·5	708·5
Amount of dried blood consumed..... "	97	100	98·5
Amount of mangels consumed..... "	1,009	1,185	1,092·5
Amount of shorts consumed for 100 pounds gain..... "	366·5	295·15	285·825
Amount of grain consumed for 100 pounds gain..... "	366·5	205·15	285·825
Amount of dried blood consumed for 100 pounds gain..... "	23·37	31·25	27·31
Amount of mangels consumed for 100 pounds gain..... "	240·96	370·3	305·63
Cost to produce 100 pounds gain..... \$	5·35	6·72	6·035
Total live weight at end of feeding period..... lb.	656	625	640·5
Total gain in live weight during feeding period..... "	415	320	367·5
Daily gain per pig during feeding period..... "	1·03	·8	·915
Total weight of viscera..... "	87·3	89·	88·15
Weight of livers..... "	11·7	9·5	10·6
Weight of hearts and lungs..... "	8·3	7·9	8·1
Weight of remainder of viscera..... "	67·3	71·6	69·45

LOT 9 vs. LOT 10.

In lots 9 and 10, rice-meal was used against wheat shorts in a mixture of ground alfalfa and dried blood as a substitute for skim-milk. This trial was made to see if using one grain alone with the skim-milk substitute would have any effect on the control pigs. Both pens were fed all they could possibly eat three times a day, and no economy was practised, but with all the results were very similar to all the other work.

In pen 18, lot 9, one pig stiffened up after thirty-six days' feeding, and at sixty days all the pigs were diseased and were very rough-looking in hair and skin. They were kept on the remaining forty days, and, when killed, they were condemned. Pen 19, lot 10, did not miss a meal during the entire period. The pigs got very fat but they were in perfect health until the end.

Although lot 9 had the best balanced ration, containing rice-meal, which had been fed up until this time, and lot 10 had an absolutely narrow one, the evidence is very much against the rice-meal. Even when the other foods were abused by thus combining them, they failed to produce the disastrous results obtained in lot 9. It must be added that although the meat produced in lot 10 was very tender and sweet, the fat was soft and oily, but of good flavour.

SESSIONAL PAPER No. 16

Lot 9.—Rice meal, Ground Alfalfa, Dried Blood, and Mangels.

Lot 9—Pen 18.

Number of animals	4
Age at beginning of feeding period	105 days.
Total weight at beginning of feeding period	263 lb.
Nutritive ratio of ration	1:5.6
Duration of feeding period	100 days.
Amount of meal consumed	1,181 lb.
Amount of alfalfa consumed	100 "
Amount of dried blood consumed	100 "
Amount of mangels consumed	1,000 "
Amount of meal consumed for 100 pounds gain	434.19 "
Amount of alfalfa consumed for 100 pounds gain	36.76 "
Amount of dried blood consumed for 100 pounds gain	38.76 "
Amount of mangels consumed for 100 pounds gain	367.6 "
Cost to produce 100 pounds gain	\$ 7.76
Total live weight at end of feeding period	535 lb.
Total gain in live weight during feeding period	272 "
Daily gain per pig during feeding period	.68 "
Total viscera, weight of	92.6 "
Weight of livers	10.7 "
Weight of hearts and lungs	6.2 "
Weight of remainder of viscera	75.7 "

Lot 10.—Wheat Shorts, Ground Alfalfa, Dried Blood, and Mangels.

Lot 10—Pen 19.

Number of animals	4
Age at beginning of feeding period	105 days.
Total weight at beginning of feeding period	253 lb.
Nutritive ratio of ration	1: 3.3
Duration of feeding period	100 days.
Amount of shorts consumed	1,431 lb.
Amount of alfalfa consumed	100 "
Amount of dried blood consumed	100 "
Amount of mangels consumed	1,000 "
Amount of shorts consumed for 100 pounds gain	357.75 "
Amount of alfalfa consumed for 100 pounds gain	25 "
Amount of dried blood consumed for 100 pounds gain	25 "
Amount of mangels consumed for 100 pounds gain	250 "
Cost to produce 100 pounds gain	\$ 6.12
Total live weight at end of feeding period	653 lb.
Total gain in live weight during feeding period	400 "
Daily gain per pig during feeding period	1 "
Total weight of viscera	102.2 "
Weight of livers	12.9 "
Weight of hearts and lungs	9.5 "
Weight of remainder of viscera	79.8 "

Lot 11 vs. Lot 12.

With lots 11 and 12, rice-meal was used against wheat shorts, both being mixed with boiled potatoes, skim-milk, and mangels.

The pigs were very even in size, type, and condition, at the beginning, and the pens contained two sows and two barrows each; these were grade Yorkshires. With these two lots, there was a repetition of all previous trouble which was caused by rice-meal. The two rations are probably the most common ones in this section, and, since doing this work, we have learned that other feeders have experienced similar trouble.

In the rice-meal lot (No. 12), pen 21, the pigs showed signs of disease after thirty-four days. One pig took very violent cramps, the same as a pig in lot 1, pen 12. In a short time the three remaining pigs were attacked in the same way. They would

get relief and hobble about for a few days and then have a relapse. From the ninetieth to the hundredth day, they were totally disabled. All were condemned and some kept for veterinary examination. Their skins and hair were in very bad condition.

The pigs of lot 11, pen 20, were in show condition from the first. They got fat but ate greedily and never missed a meal nor showed any signs of being uncomfortable. When killed, the pork was thick but firm, and was an excellent quality of block pork.

Lot 11.—Wheat shorts, Boiled potatoes, Skim-milk, and Mangels.

	Lot 11.—Pen 20.
Number of animals.....	4
Age at beginning of feeding period..... days	98
Total weight at beginning of feeding period..... lb.	237
Nutritive ratio of ration.....	1 : 4·5
Duration of feeding period..... days	100
Amount of shorts consumed..... lb.	1,311
Amount of potatoes consumed..... "	876
Amount of milk consumed..... "	1,000
Amount of mangels consumed..... "	1,000
Amount of shorts consumed for 100 pounds gain..... "	316·6
Amount of potatoes consumed for 100 pounds gain..... "	211·5
Amount of milk consumed for 100 pounds gain..... "	241·5
Amount of mangels consumed for 100 pounds gain..... "	241·5
Cost to produce 100 pounds gain..... \$	5.18
Total live weight at end of feeding period..... lb.	651
Total gain in live weight during feeding period..... "	414
Daily gain per pig during feeding period..... "	1·035
Total weight of viscera..... "	111·6
Weight of livers..... "	12·7
Weight of hearts and lungs..... "	6·2
Weight of remainder of viscera..... "	92·7

Lot 12.—Rice-meal, Boiled potatoes, Skim-milk, and Mangels.

	Lot 12. Pen. 21.
Number of animals.....	4
Age at beginning of feeding period..... Days.	112
Total weight at beginning of feeding period..... lb.	237
Nutritive ratio of ration.....	1 : 8·1
Duration of feeding period..... Days.	100
Amount of meal consumed..... lb.	853
Amount of boiled potatoes consumed..... "	790
Amount of milk consumed..... "	1,000
Amount of mangels consumed..... "	1,000
Amount of meal consumed for 100 pounds gain..... "	364·5
Amount of potatoes consumed for 100 pounds gain..... "	337·6
Amount of milk consumed for 100 pounds gain..... "	427·3
Amount of mangels consumed for 100 pounds gain..... "	427·3
Cost to produce 100 pounds gain..... \$	6.75
Total live weight at end of feeding period..... lb.	471
Total gain in live weight during feeding period..... "	234
Daily gain per pig during feeding period..... "	·585
Total weight of viscera..... "	37·3
Weight of livers..... "	4·6
Weight of hearts and lungs..... "	3·1
Weight of remainder of viscera..... "	29·6
(Weights of viscera are those of 2 pigs only).	

SESSIONAL PAPER No. 16

LOT 13 AND LOT 14.

These two lots might be classed together as one, for the same pigs were used in both lots on two different rations. They were started in lot 13, pen 11, and were fed on rice-meal, skim-milk, and mangels. On this ration they became crippled and the ration was changed to oats, peas, and barley (lot 14, pen 11).

At fifty-one days from the beginning of the period, all of the pigs went off their feed and all but one became very stiff and sore. The three got extremely sore, and squealed vehemently when approached. They could not rise, but would drink water when lifted to the trough; their skins were yellow and their hair rough. After working with them in this condition for three weeks, the food was changed, and three days after the change the pigs could rise and make an attempt at walking. The three which were attacked the worst were horrible-looking specimens and were greatly emaciated. As soon as they could walk reasonably well, which took about a week, they began to eat greedily of the oats, peas, and barley ration, results of which are seen in period "B."

Although they were only kept on the oats, peas, and barley ration for twenty-two days, they made a greater daily gain and a cheaper gain than they did in the previous period, and almost completely recovered from the disease. There was not anything in the weather or conditions (outside of the ration), to help out in this change, because at the same time that this pen was recovering, other pens were developing the disease.

Lot 13.—Rice-meal, Skim-milk, and Mangels.

	Lot 13.
	Pen 11, (Period "A").
Number of animals.....	4
Age at beginning of feeding period..... Days	70
Total weight at beginning of feeding period..... lb.	205
Nutritive ratio of ration.....	1: 7.56
Duration of feeding period..... Days	78
Amount of meal consumed..... lb.	841
Amount of milk consumed..... "	780
Amount of mangels consumed..... "	780
Amount of meal consumed for 100 pounds gain..... "	357.87
Amount of milk consumed for 100 pounds gain..... "	331.9
Amount of mangels consumed for 100 pounds gain..... "	331.9
Cost to produce 100 pounds gain..... \$	5.78
Total live weight at end of feeding period..... "	440
Total gain in live weight during feeding period..... "	235
Daily gain per pig during feeding period..... "	.75

5 GEORGE V., A. 1915

LOT 14.—Peas, Oats and Barley, Skim-milk, and Mangels.

		Lot 14.
		Pen 11, (Period "B").
Number of animals		4
Age at beginning of feeding period	days.	148
Total weight at beginning of feeding period...	lb.	440
Nutritive ratio of ration		1:5.9
Duration of feeding period	days.	22
Amount of grain consumed	lb.	311
Amount of milk consumed	"	220
Amount of mangels consumed	"	220
Amount of grain consumed for 100 pounds gain	"	287.9
Amount of milk consumed for 100 pounds gain	"	203.7
Amount of mangels consumed for 100 pounds gain	"	203.7
Cost to produce 100 pounds gain	\$	4.47
Total live weight at end of feeding period	lb.	548
Total gain in live weight during feeding period	"	108
Daily gain per pig during feeding period	"	1.227
Total weight of viscera	"	85.8
Weight of livers	"	10.4
Weight of hearts and lungs	"	7.4
Weight of remainder of viscera	"	68

SUMMARY.

This concludes the work finished this year, but at the time of writing there are quite a number of pens still under test. The present condition of these would lead one to think that more evidence is soon to be available. Further work is being done in the feeding of rice-meal, with the object of finding out the cause of the trouble described. There has always been a variation in quality of the different shipments of rice-meal. Thus, though the ill effects of this product varied in intensity and in time of appearance, yet they all eventually resulted in the same condition.

In concluding this report, at the present stage of the work, one is forced to say that rice-meal is not a profitable food for fattening young hogs. Whether used alone or in mixtures, whether bought cheaply or otherwise, it is not as profitable as the grains grown or other common foods that can be obtained in this section. For fattening hogs it was not only unprofitable but caused absolute loss. When fed for one hundred days or more, it produced a definite state of malnutrition. More than this, it caused an actual disease, which could be intensified or checked at will by change of diet. It would seem that the ill effects of rice-meal were due to its chemical rather than its physical composition, since control rations of much rougher physical composition were used, and these failed to produce any bad effects.

In the trials made, rice-meal, when fed in mixtures, constituted half the grain. It is of course possible that, when fed in smaller proportions, it would have no ill effects. This, however, awaits proof. A pathological study of the disease produced reveals the fact that the symptoms and lesions are constant, and resemble those of beri-beri in human beings.



Agassiz. Lot 6, Pen 25. Fed Wheat Shorts, Mixed Chop, Ground Alfalfa and Mangel.

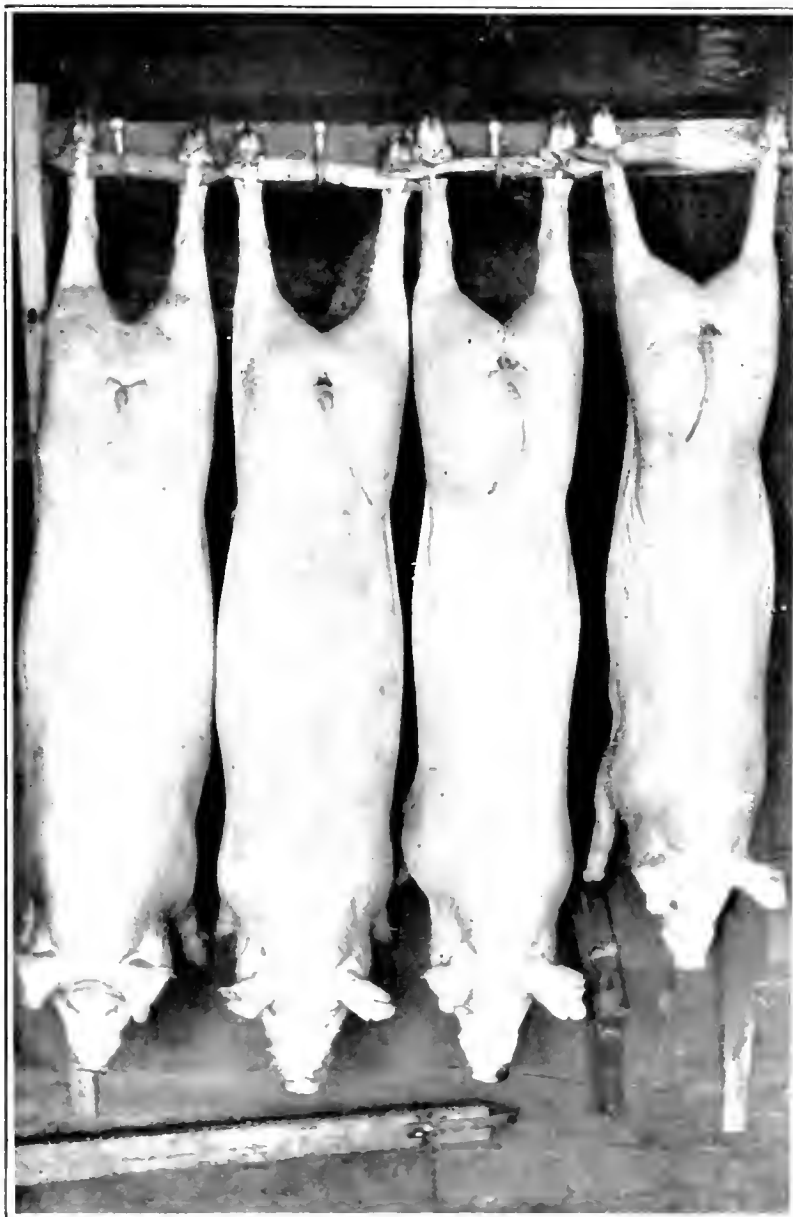

Agassiz: Four pigs from one litter and equal weight at beginning of period. Two pigs on left were fed shorts and chop; two pigs on right were fed rice meal and chop. The two best pigs from their respective pens.

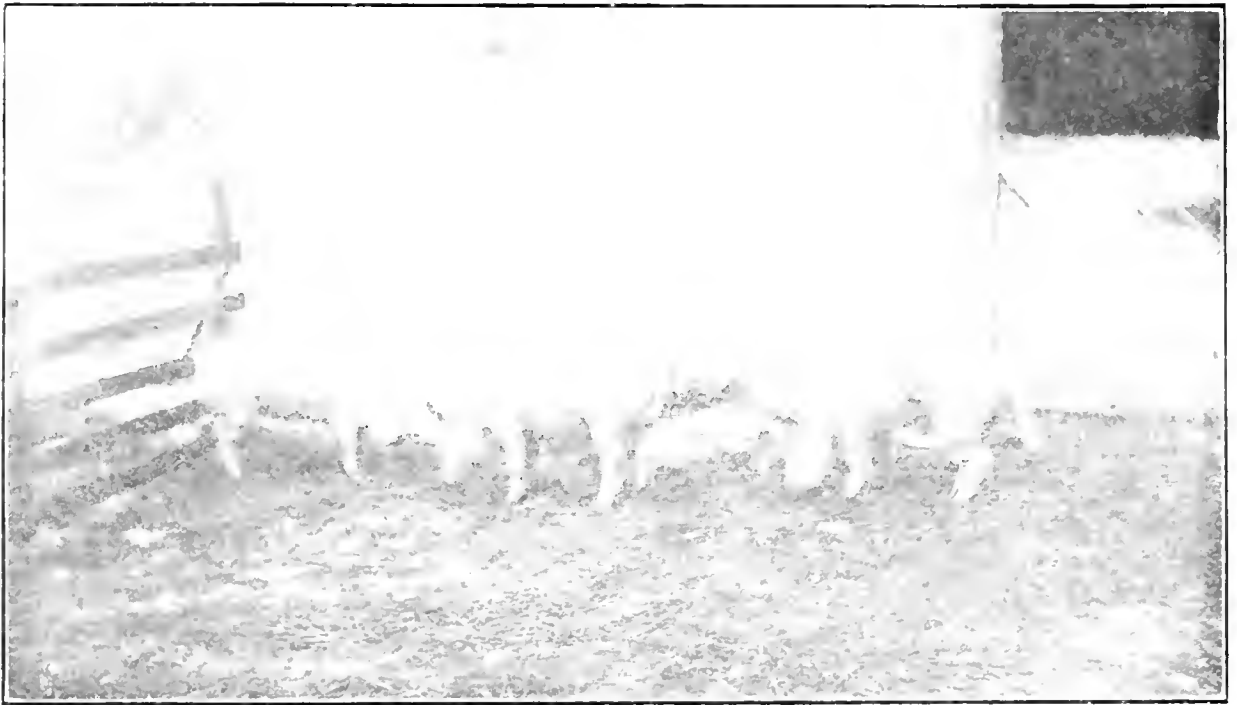

Lot 5, Pen 13. Fed Rice Meal, Ground Alfalfa and Mangels. The best pen fed on Rice Meal. Pig on right crippled; others only slightly so. On being let out they ate earth so fast that it was difficult to get even a snap shot of their heads. Note rough coats and dark colour.

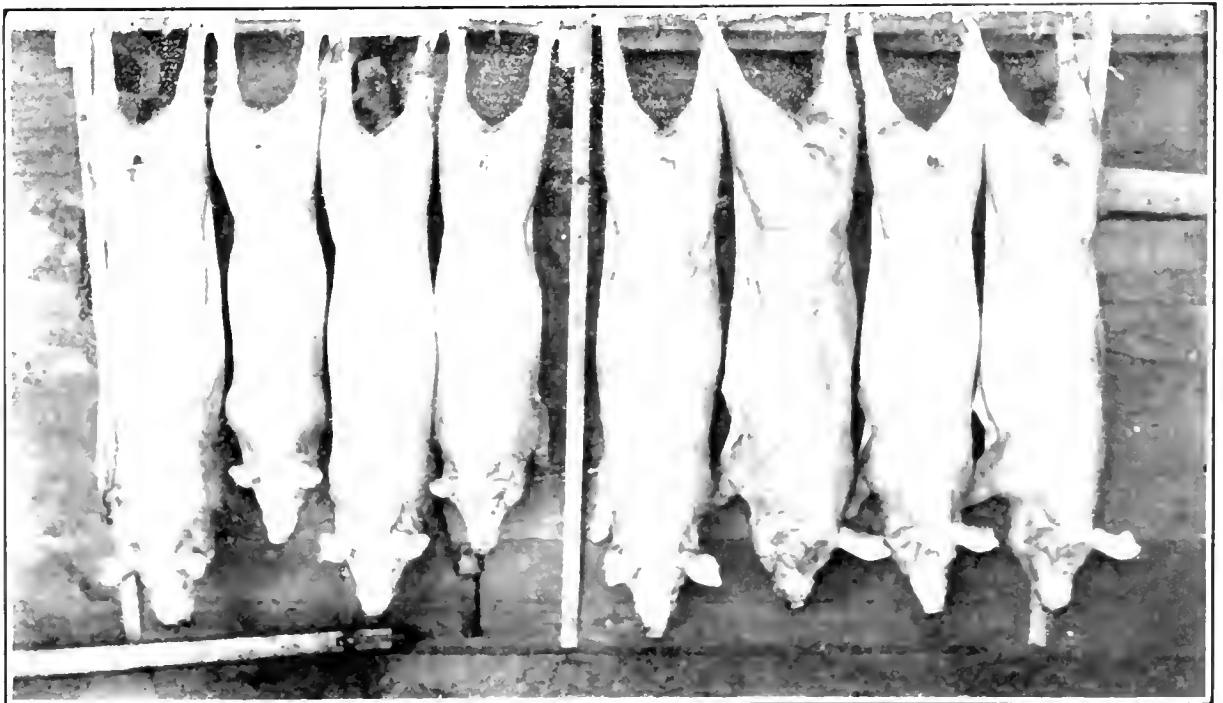

Agassiz: Four pigs on left, lot 5, pen 13. Note unevenness in size and condition as compared to pigs on right, lot 6, pen 25.

SESSIONAL PAPER No. 16

A DISEASE SIMULATING BERI-BERI IN PIGS FED ON RICE-MEAL.

*Seymour Hadwen, D.V.Sci.,
Veterinary Research Laboratory,
Experimental Farm,
Agassiz, B.C.*

During the course of the experiment, which Mr. Moore describes above, I was requested by him to undertake the pathological study of a disease in pigs produced by the feeding of rice-meal. This was sanctioned by Dr. F. Torrance, Veterinary Director General, and by Mr. J. H. Grisdale, Director of Experimental Farms, and the results of the work are here briefly given. The conditions of housing, feeding, watering, etc., are fully described in Mr. Moore's report, and I need concern myself only with the strictly pathological side of the question.

First, it seems necessary to say a word about the general health of the animals used in the feeding experiment. The stock came from perfectly healthy sires and dams. In addition, no disease of a contagious nature has appeared on the Farm since this laboratory was established, a period of three years. Breeding is carried on extensively here, and pigs are shipped to all parts of the province. No complaints on the score of ill-health have been received from any of the purchasers, a proof of the soundness of the stock. This proof is very necessary, since the disease I am about to describe might be mistaken for other affections. I was struck at first with the resemblance of the symptoms to those described for beri-beri in human beings, and all the evidence which has since come out strengthens this theory. I leave the reader to judge for himself the facts which have been gathered.

SYMPTOMS.

Mr. Moore had mentioned on several occasions that rice-meal was not a profitable food, and that his pigs were actually showing ill effects from its use. The first case I was called to examine was a young pig which the herdsman had just been weighing. In backing out of its crate it seemed to stumble or take a cramp. At least this was what the man in charge thought it was. He had been rubbing its leg to take the stiffness out, which seemed to cause it exquisite pain, as its squeals could be heard all over the Farm. At first it looked as though it might be a case of articular rheumatism, but later several more pigs showed similar symptoms. Most of these appeared suddenly, but a few were gradual in developing. They could be described as very painful lamenesses occurring almost invariably in the hind-legs. The pigs resented any attempt to handle them, an unusual occurrence in gentle pigs, which previously allowed one to do so with evident pleasure.

These painful lamenesses, together with a wild-staring expression are the first signs. Later a growing unthriftiness is noted. The animals lie buried in the straw and, after a time, are scarcely able to hobble to their trough. The skin and hair assumes a dirty colour. At first it was thought that this was simply a result of their lying so continuously, but this is not the case, because when a change of food is made the skin clears up rapidly. Emaciation appears in about two months and in some cases is very marked. In a few instances, though the pigs have not grown, they have not become actually thin. In some of the pigs heart-attacks have been quite common. They usually followed some slight exertion, such as walking over to the trough. The affected animal would give a cough or two and begin to breathe very heavily; its eyes would start out of its head and then it seemed to lose its breath; facial respiration continued. Then it would stiffen all its limbs and look as though it were going to die. After a time breathing would begin again. Some of the pigs have heart-attacks of this sort two or three times a day.

AGASSIZ.

In advanced stages the gait became most uncertain and staggery. As one would expect in poorly-nourished young animals, the bones became soft and rachitic. It is well to make an explanation here, that according to authorities on the subject, rickets is a non-painful affection, which fact separates it from the disease in question. Osler says that if there ever is pain it must be quite exceptional, that the "ricketty" symptoms which we have observed must be secondary, and the final and conclusive proof of this is that none of the controls ever showed any of these symptoms, though they were fed, housed, and cared for in exactly the same way, with the one exception that instead of rice-meal they were given other grains.

Again, as has been stated before, the attacks of lameness were for the most part sudden. A pig which had been quite active in the evening would be lame on the following morning. In rickets, on the other hand the symptoms, according to Moussu, are invariably insidious ("absolument insidieux").

In the foregoing experiments the stiffness took, on an average, fifty days to appear; in two cases it was seen at about thirty days. The lameness is usually in the hind legs, just as beri-beri in human beings produces neuritis of the feet and legs. It is said that beri-beri is not so common in children as in adults; as all the pigs used were young, Mr. Moore intends to do some further experiments on older animals.

All possibility that the disease might be contagious was eliminated early in the course of the experiment. Healthy control pigs were moved into pens which had lately been occupied by the diseased animals, no attempt at disinfection being made. None of these pigs ever showed any symptoms or ill effects.

It is important to emphasize the fact that when rice-meal was discontinued, and other grains substituted, the pigs recovered.

PATHOLOGY.

The pathological findings confirmed the resemblance of the disease to beri-beri. Temperature records of both healthy and control pigs have been kept and no important rises of temperature have ever been recorded. The average temperature of control pigs for a 43-day period, commencing in the middle of a test, was 102.5° F., that of rice-meal pigs for the same period, 101.4° F. The lower average in the case of the rice-meal fed pigs was due to the temperatures becoming sub-normal in the latter part of the experiment, when they fell as low as 99° F.

The pathological changes seen in the pigs fed for one hundred days were as a rule insignificant. There was, however, one lesion which was almost constant, a congestion of the duodenum, and a catarrhal, bile-stained condition of the lower end of the stomach. Thirteen pigs were kept over the hundred-day period; post mortem examinations were made on them and in these the lesions were much more marked. Four of these showed well-marked pericarditis and adhesions. In nearly all cases there was a considerable amount of fluid in the pericardial sac. The hearts were soft and flabby. Accompanying the heart lesions an oedematous condition of the lungs was seen. In one case gastric or peptic ulcers were encountered, and all but two showed congestion of the duodenum and a catarrhal condition of the stomach. Though other lesions were looked for in the viscera, none was encountered.

The bones were very soft, with the exception of four cases, where shorts had been substituted for rice-meal for about a fortnight. In these it was noticeable that the bone was getting harder. In the other cases the bone could be readily cut with a knife.

The blood was thin in the advanced cases, but in the differential count no variation from the normal was observed. The urine, removed from the bladders of three pigs after death, in one showed no albumen and in the other two small amounts. The muscles of the affected pigs were soft. The fat was slow in setting and in some did not set at all well.

SESSIONAL PAPER No. 16

According to Manson and Osler, the most characteristic lesions of beri-beri in man are: Hydropericardium, oedema of the lungs, and inflammation of the duodenum, degeneration of the nerves, and atrophy of the muscles. So that it seems evident that we are dealing with a very closely allied disease.

ETIOLOGY.

It is well-known that certain rice products produce beri-beri. It was evident that the different lots of pigs under experiment took the disease after a longer or shorter period of feeding. As different shipments of rice-meal were used, it appeared that there was a variation in its toxic properties. The exact nature of this harmful property remains to be proved. Caspari and Mozkowski (E.S.R. vol. xxx., No. 1, Jan. 19, 1914) adhere to this theory of a toxic substance in the diet leading to an intoxication. Chamberlain, Wedder and Williams (E.S.R. vol. xxviii., May 1913, No. 6) believe that beri-beri and polyneuritis of chickens result from some deficiency of substance in phosphorus in the diet. Many other authors have various theories concerning the deleterious substances in rice. The general opinion is that polished rice is harmful; these experiments tend to prove that rice-meal also either possesses the toxic quality or else is lacking in some necessary constituent. Personally, I incline to the theory that a toxic is the cause of the trouble. The strongest argument in favour of this theory is that immediately the rice-meal is stopped the pigs improve. Also it was found that after a purgative there was immediate improvement.



New York Botanical Garden Library



3 5185 00258 4108

