

The house or typhoid fly, *Musca domestica*. Greatly enlarged. (Howard and Pierce, photo by Dovener.)

SANITARY ENTOMOLOGY

THE ENTOMOLOGY OF DISEASE,
HYGIENE AND SANITATION

EDITED BY

WILLIAM DWIGHT PIERCE, PH.D.

*Consulting Entomologist, formerly Entomologist Southern Field Crop
Insect Investigations United States Department
of Agriculture, Bureau of Entomology*



BOSTON
RICHARD G. BADGER
THE GORHAM PRESS

COPYRIGHT, 1921, BY RICHARD G. BADGER

All Rights Reserved

RC115
P5

MAR 10 1921

Made in the United States of America

The Gorham Press, Boston, U. S. A.

©Cl. A608637

no 1

TO
DR. LELAND OSSIAN HOWARD

CHIEF OF THE BUREAU OF ENTOMOLOGY,

THIS BOOK IS
DEDICATED

TO HIM, MORE THAN TO ANY ONE ELSE, DO ENTOMOLOGISTS OWE
THE PRACTICAL DEVELOPMENT OF THEIR SCIENCE, WHICH
TOUCHES UPON EVERY HUMAN ACTIVITY. HE STOOD AMONG
THE FIRST TO EMPHASIZE THE IMPORTANCE OF SANITARY
ENTOMOLOGY. HE STANDS NOW THE CHIEF EXPONENT OF
ENTOMOLOGY THROUGHOUT THE WORLD.

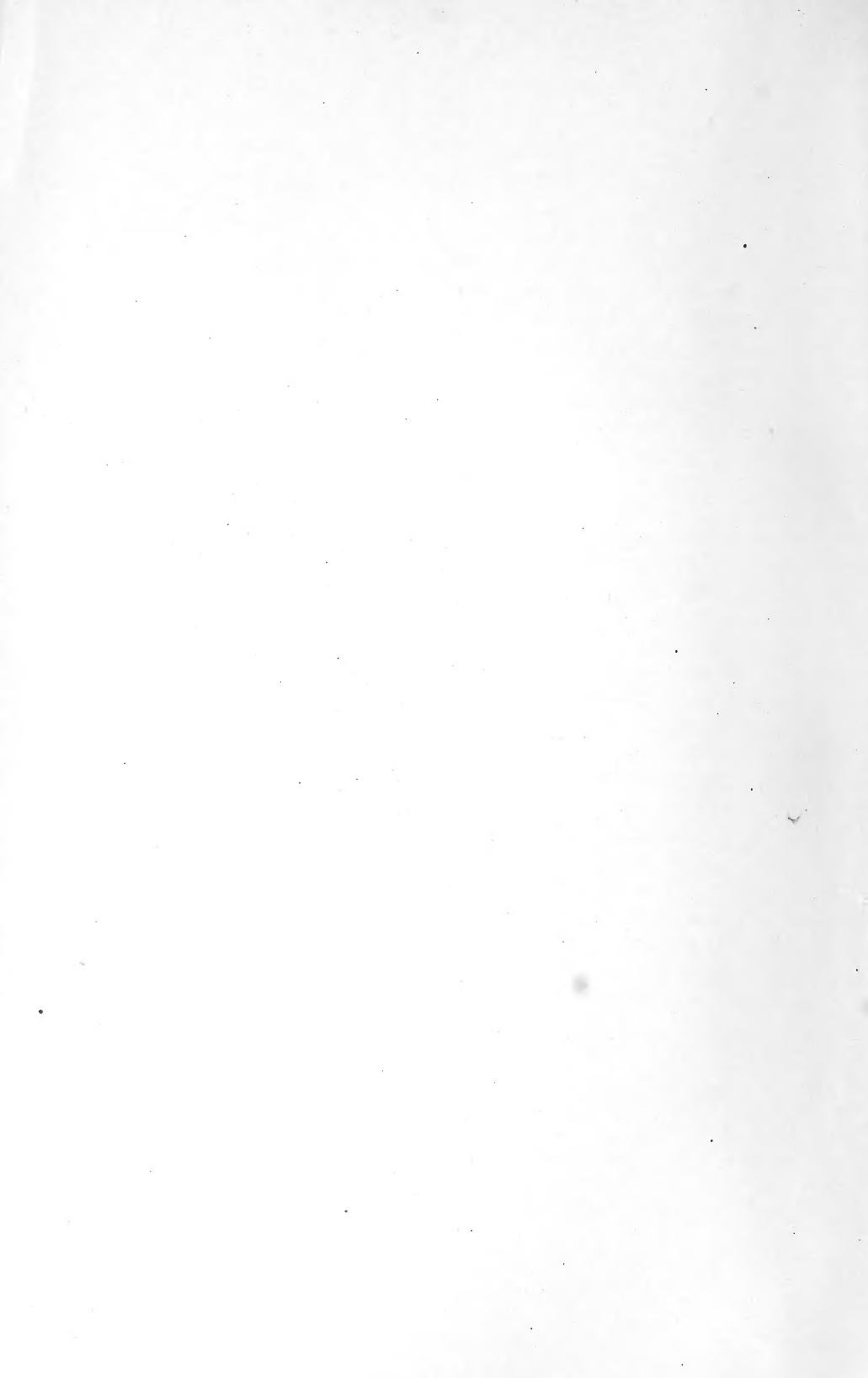

FOREWORD

IN May, 1918, a class was formed among the entomologists of the country to study the recent developments in the entomology of disease, hygiene, and sanitation, for the purpose of equipping themselves for any special service which they might be called upon to render during the war. The lectures were mimeographed week by week and mailed to the enrolled membership, which numbered in excess of 500.

The war emergency is over and the mimeographed lectures have practically all been distributed. These lectures, however, dealt as much with domestic as with military problems, and they have now been completely revised up to date of March 1, 1919, and are given forth as a series of lectures dealing with the entomological problems of peace times from the standpoint primarily of municipal, industrial, and household problems, and also with the hope that the course will be of assistance to teachers, and will stimulate research among investigators. Many important topics have been omitted, for we cannot hope to present the whole subject in a book of this size.

This phase of entomology is one which is destined to become very important as our knowledge of disease transmission increases. There are many unworked and insufficiently worked problems now in sight, and these lectures will be found to suggest numerous possible lines of research.

I wish at this time to express my appreciation of the services of Mr. Jacob Kotinsky, who served as Secretary of the Class, and of my collaborators in this course of lectures.

As nearly as possible the International Rules of Nomenclature are followed, but in Entomology the practice had not been followed of enclosing the original author's name in parenthesis followed by the name of the author responsible for the present combination, and it has been impossible in the present volume to obtain all of the necessary information.

W. DWIGHT PIERCE.

CONTENTS

CHAPTER	PAGE
I. HOW INSECTS CAN CARRY OR CAUSE DISEASE	19
CLASSIFICATION OF METHODS BY WHICH INSECTS CAN CARRY OR CAUSE DISEASE	20
WHY IT IS NECESSARY TO KNOW HOW INSECTS CARRY DISEASE	23
II. SOME NECESSARY STEPS IN ANY ATTEMPT TO PROVE INSECT TRANSMISSION OR CAUSATION OF DISEASE	25
I. COOPERATION	25
II. WHERE SHOULD THE INVESTIGATIONS OF INSECT TRANSMISSION BEGIN?	26
III. PLAN OF OPERATION	26
IV. HOW SHALL WE RECORD OUR OBSERVATIONS?	27
V. HOW CAN AN INSECT BE INVOLVED IN DISEASE TRANSMISSION?	27
1. What Kind of Organisms Can Insects Carry?	27
2. In What Manner May Insect Toxins Bring About Disease?	27
3. Can Insects Themselves Cause Disease?	28
4. Where May Insects Obtain the Organisms Which Cause Disease?	28
5. How Can the Insect Transmit the Organism?	28
6. What is the Course of the Organism in the Insect?	29
7. What is the Course of the Organism on Leaving the Insect?	29
VI. WHAT IS KNOWN ABOUT THE DISEASE TO BE INVESTIGATED?	30
VII. WHAT INSECTS SHOULD BE INVESTIGATED?	30
VIII. WHAT IS NECESSARY IN THE TRANSMISSION EXPERIMENTS?	31
IX. HOW SHOULD EXPERIMENTAL INSECTS BE HANDLED?	32
III. A GENERAL SURVEY OF THE NEEDS OF ENTOMOLOGICAL SANITATION IN AMERICA	34
THE INSANITARY FARM	35
HOW TO IMPROVE FARM SANITATION	36
THE INSANITARY TOWN	38
HOW TO IMPROVE SANITATION	38
SANITARY PROBLEMS OF CITIES	39
ENTOMOLOGICAL REQUIREMENTS OF MUNICIPAL SANITATION	40
INDUSTRIAL SANITATION	41
IV. A GENERAL SURVEY OF THE SERIOUSNESS OF INSECT BORNE DISEASES TO ARMIES	43
V. RELATION OF INSECTS TO THE PARASITIC WORMS OF VERTEBRATES	50
MODE OF INFECTION OF INSECT HOSTS	51
MODE OF INFECTION OF VERTEBRATE HOSTS	52
SPECIES OF WORMS FOUND IN INSECTS	52
CESTODA OR TAPEWORMS	53
<i>Dipylidium caninum</i> (Linnæus, 1758) Railliet, 1892	53
<i>Hymenolepis diminuta</i> (Rudolphi, 1819) Blanchard, 1891	54
<i>Hymenolepis nana</i> (Siebold, 1852) Blanchard, 1891	55
<i>Choanotænia infundibulum</i> (Bloch, 1779) Cohn, 1899	56
Other Tapeworms	57
TREMATODA OR FLUKES	57

	PAGE
NEMATODA OR ROUNDWORMS	58
1. Parasitic Nematodes Whose Eggs or Larvæ Leave the Body of the Final Host in the Feces	60
<i>Protospirura muris</i> (Gmelin, 1790) Seurat, 1915	60
<i>Spirocerca sanguinolenta</i> (Rudolphi, 1819) Railliet & Henry, 1911	60
<i>Spirura gastrophila</i> (Mueller, 1894) Marotel, 1912	61
<i>Gongylonema scutatum</i> (Mueller, 1869) Railliet, 1892	62
<i>Gongylonema muscronatum</i> Seurat, 1916	63
<i>Gongylonema brevispiculum</i> Seurat, 1914	63
<i>Gongylonema neoplasticum</i> (Fibiger and Ditlevsen, 1914) Ransom and Hall, 1916	63
<i>Arduenna strongylina</i> (Rudolphi, 1819) Railliet and Henry, 1911	64
<i>Physocephalus sexalatus</i> (Molin, 1860) Diesing, 1861	64
<i>Habronema muscæ</i> (Carter, 1861) Diesing, 1861	65
<i>Habronema microstoma</i> (Schneider, 1866) Ransom, 1911	67
<i>Habronema megastoma</i> (Rudolphi, 1819) Seurat, 1914	67
<i>Acuaria spiralis</i> (Molin, 1858) Railliet, Henry and Sisoff, 1912	67
<i>Filaria gallinarum</i> Theiler, 1919	68
<i>Ascaris lumbricoides</i> Linnæus, 1758	68
2. Parasitic Nematodes Whose First-Stage Larvæ Occur in the Blood or Lymph of the Final Host and Leave the Body Through Ingestion by Blood-Sucking Insects	69
<i>Filaria bancrofti</i> Cobbold, 1877	69
<i>Filaria (Loa) loa</i> (Cobbold, 1864)	71
<i>Filaria demarquayi</i> Manson, 1895	71
<i>Filaria philippinensis</i> Ashburn and Craig, 1906	72
<i>Filaria tucumana</i> Biglieri and Araújo, 1917	72
<i>Filaria cypseli</i> Annett, Dutton and Elliott, 1901	72
<i>Filaria martis</i> Gmelin, 1790	73
<i>Dirofilaria immitis</i> (Leidy, 1856) Railliet and Henry, 1911	73
<i>Dirofilaria repens</i> , Railliet and Henry, 1911	74
<i>Acanthocheilonema perstans</i> (Manson, 1891) Railliet, Henry and Langeron, 1912	74
<i>Acanthocheilonema grassii</i> (Noè, 1907) Railliet, Henry and Langeron, 1912	75
<i>Acanthocheilonema reconditum</i> (Grassi, 1890) Railliet, Henry and Langeron, 1912	76
<i>Setaria labiato-papillosa</i> (Alessandrini, 1838) Railliet and Henry, 1911	77
<i>Oncocerca</i>	77
3. Other Nematodes	77
4. Mermithidæ	78
GORDIACEA OR HORSE-HAIR WORMS	78
ACANTHOCEPHALA OR THORN-HEADED WORMS	79
<i>Macracanthorhynchus hirudinaceus</i> (Pallas, 1781) Travassos, 1916	79
<i>Moniliformis moniliformis</i> (Bremser, 1819) Travassos, 1915	79
COMPENDIUM OF PARASITES ARRANGED ACCORDING TO INSECT HOSTS	79
Aphaniptera (Siphonaptera)—fleas	79
Diptera—flies	80
Neuroptera	82
Trichoptera—hairy-winged insects	83
Lepidoptera—moths, butterflies	83
Coleoptera—beetles	84
Mallophaga—bird lice	86
Isoptera—termites	87
Odonata—dragonflies	87
Plecoptera—mayflies	87
Plecoptera—stoneflies	88
Orthoptera—cockroaches, etc.	88
Dermaptera—earwigs	88
Myriapoda—millipedes, centipedes	88
Acarina—ticks, mites	88
Isopoda—sowbugs	89
LIST OF REFERENCES	89

CHAPTER		PAGE
VI.	THE RELATIONS OF CLIMATE AND LIFE AND THEIR BEARINGS ON THE STUDY OF MEDICAL ENTOMOLOGY	97
VII.	DISEASES BORNE BY NON-BITING FLIES	105
	PLANT ORGANISMS CARRIED BY NON-BITING FLIES	107
	Thallophyta: Fungi: Schizomycetes: Coccaceæ	107
	Thallophyta: Fungi: Schizomycetes: Bacteriaceæ	109
	Thallophyta: Fungi: Schizomycetes: Spirillaceæ	115
	SUMMARY OF PLANT ORGANISMS	115
	DISEASES OF UNSETTLED ORIGIN PROBABLY CAUSED BY MICROORGANISMS	116
	ANIMAL ORGANISMS CARRIED BY NON-BITING FLIES	116
	Protozoa	116
	Sarcodina: Amœbina: Amœbidæ	116
	Mastigophora: Protomonadina: Bodonidæ	117
	Mastigophora: Polymastigina: Polymastigidæ	117
	Mastigophora: Binucleata: Leptomonidæ	117
	Mastigophora: Binucleata: Trypanosomidæ	119
	Mastigophora: Spirochætacea: Spirochætidæ	119
	Neosporidia: Myxosporidia: Nosemidæ	120
	Protozoa: Neosporidia: Myxosporidia: Thelohanidæ	120
	HIGHER ORGANISMS CARRIED BY FLIES	120
	Platyhelminthia: Cestoidea: Cyclophyllidea: Tæniidæ	120
	Platyhelminthia: Cestoidea: Cyclophyllidea: Hymenolepididæ	120
	Platyhelminthia: Trematoda: Malacotylea: Schistosomidæ	120
	Nemathelminthes: Nematoda: Spiruridæ	121
	Nemathelminthes: Nematoda: Ascaridæ	121
	Nemathelminthes: Nematoda: Oxyuridæ	121
	Nemathelminthes: Nematoda: Ancylostomidæ	122
	Nemathelminthes: Nematoda: Trichosomidæ	122
	IMPORTANT GENERAL TEXT BOOKS	123
	SPECIAL REFERENCES	123
VIII.	IMPORTANT PHASES IN THE LIFE HISTORY OF THE NON-BITING FLIES	126
	HOUSE FLY, MUSCA DOMESTICA LINNÆUS	127
	THE BLUE BOTTLE FLIES OF THE GENUS CALLIPHORA	130
	THE SHEEP MAGGOTS OR GREEN BOTTLE FLIES	131
	OTHER SCREW WORMS AND BLOW FLIES	132
	OTHER EXCREMENT BREEDERS	135
	REFERENCES	137
IX.	COMMON FLIES AND HOW TO TELL THEM APART	138
	TABLE TO SEPARATE THE ADULT FLIES	139
	THE LARVÆ OR MAGGOTS	141
	Descriptions of Larvæ or Maggots	141
	Table to Separate the Larvæ (Maggots)	142
	<i>Fannia canicularis</i> Linnæus and <i>Fannia scalaris</i> Fabricius	144
	<i>Musca domestica</i> Linnæus	144
	<i>Stomoxys calcitrans</i> Linnæus	145
	<i>Muscina stabulans</i> Fallen	146
	<i>Calliphora erythrocephala</i> Meigen	147
	<i>Calliphora vomitoria</i> Linnæus	148
	<i>Lucilia sericata</i> Meigen	148
	<i>Chrysomya macellaria</i> Fabricius	149
	Sarcophagidæ	150
	BIBLIOGRAPHY	151
X.	THE CONTROL OF THE HOUSE FLY AND RELATED FLIES	153
	REPRESSIVE MEASURES	153
	Striking the Source	153
	Manure	153

CHAPTER		PAGE
	Garbage	160
	Excreta	161
	Carcasses	161
	Miscellaneous Breeding Places	162
	PALLIATIVE MEASURES	162
XI.	CONTROL OF FLIES IN BARN YARDS, PIG PENS AND CHICKEN YARDS	167
	REPRESSION OF FLIES IN BARN YARD	167
	FLY CONTROL IN PIG LOTS AND PENS	170
	PREVENTION OF FLY BREEDING IN CHICKEN HOUSES AND YARDS	173
XII.	MYIASIS—TYPES OF INJURY AND LIFE HISTORY, AND HABITS OF SPECIES CONCERNED	175
	TISSUE-DESTROYING FORMS	176
	SUBDERMAL MIGRATORY SPECIES	182
	INTESTINAL AND UROGENITAL MYIASIS	190
	FORMS PRODUCING MYIASIS IN HEAD PASSAGES	193
	BLOODSUCKING FORMS	195
	SOME BIBLIOGRAPHICAL REFERENCES	196
XIII.	MYIASIS—ITS PREVENTION AND TREATMENT	200
	TISSUE-DESTROYING FORMS	200
	SUBDERMAL MIGRATORY SPECIES	204
	SPECIES CAUSING INTESTINAL AND UROGENITAL MYIASIS	205
	SPECIES INFESTING HEAD PASSAGES	207
	BLOODSUCKING SPECIES	208
XIV.	DISEASES TRANSMITTED BY BLOODSUCKING FLIES	209
	PLANT ORGANISMS CARRIED BY BLOODSUCKING FLIES	209
	Thallophyta: Fungi: Schizomycetes: Bacteriaceæ	209
	Thallophyta: Fungi: Schizomycetes: Coccaceæ	210
	DISEASES OF UNKNOWN OR UNCERTAIN ORIGIN	211
	ANIMAL ORGANISMS TRANSMITTED BY BLOODSUCKING FLIES	212
	<i>Protozoa</i>	212
	Mastigophora: Binucleata: Hæmoproteidæ	212
	Mastigophora: Binucleata: Leucocytozoidæ	214
	Mastigophora: Binucleata: Trypanosomidæ	214
	Mastigophora: Binucleata: Leptomonidæ	219
	Mastigophora: Spirochætacea: Spirochætidæ	216
	Telosporidia: Hæmogregarinida: Hæmogregarinidæ	219
	<i>Metazoa</i>	220
	Nemathelminthes: Nematoda: Filariidæ	220
	BIBLIOGRAPHY	220
XV.	BIOLOGICAL NOTES ON THE BLOODSUCKING FLIES	223
	FAMILY CHIRONOMIDÆ	223
	Midges	223
	FAMILY SIMULIIDÆ	224
	Buffalo Gnats	224
	FAMILY PSYCHODIDÆ	226
	Pappataci Flies	226
	FAMILY CULICIDÆ	228
	FAMILY TABANIDÆ	228
	Horse Flies	228
	FAMILY MUSCIDÆ	228
	Bloodsucking Fly Larvæ	228
	Biting Species of Musca	229
	True Biting Flies	229
	Stable Flies	230

CONTENTS

xiii

CHAPTER	PAGE
Horn Flies	232
Tsetse Flies	234
PUPIPARA	235
REFERENCES	235
XVI. BIOLOGY AND HABITS OF HORSE FLIES	236
EGGS AND EGG LAYING	237
LARVÆ	240
PUPE	243
LIFE CYCLE	243
HABITS OF ADULTS	244
CONCERNING CONTROL MEASURES	245
BIBLIOGRAPHY	246
XVII. DISEASES TRANSMITTED BY MOSQUITOES	247
DISEASES OF UNCERTAIN ORIGIN TRANSMITTED BY MOSQUITOES	248
PLANT ORGANISMS TRANSMITTED BY MOSQUITOES	249
Thallophyta: Fungi	249
Thallophyta: Fungi: Schizomycetes: Bacteriaceæ	249
ANIMAL ORGANISMS TRANSMITTED BY MOSQUITOES	249
<i>Protozoa</i>	249
Mastigophora: Binucleata: Hæmoproteidæ	249
Mastigophora: Binucleata: Leucocytozoidæ	250
Mastigophora: Binucleata: Trypanosomidæ	250
Mastigophora: Binucleata: Leptomonidæ	251
Mastigophora: Binucleata: Plasmodidæ	252
Mastigophora: Spirochætacea: Spirochætidæ	259
<i>Metazoa</i>	260
Platyhelminthia: Fasciolidæ	260
Nemathelminthes: Nematoda: Filariidæ	261
Nemathelminthes: Nematoda: Mermithidæ	262
REFERENCES	263
XVIII. WHAT WE SHOULD KNOW ABOUT MOSQUITO BIOLOGY	266
OVIPOSITION AND THE EGG STAGE	267
THE LARVÆ AND THEIR HABITS	268
THE PUPE	272
ADULT MOSQUITOES	272
Table of American Disease-Carrying Mosquitoes	273
REFERENCES	274
XIX. MOSQUITO CONTROL	275
PREVENTION OF MOSQUITO BREEDING	275
Scouting	275
Determination of Source of Mosquitoes	276
Leveling and Filling Water Holes	276
Ditching and Clearing Streams and Swamps	276
Clearing of Weed-Filled Bays and Lakes	277
Drainage	277
Larvicides	279
Oiling	280
Artificial Containers of Mosquito Larvæ	282
Fish as Mosquito Control	282
Destruction of Adult Mosquitoes	283
PROTECTION FROM MOSQUITOES	283
Protection of Dwellings from Mosquitoes	283
Protection of the Individual	283
BIBLIOGRAPHY	285

CHAPTER		PAGE
XX.	LOUSE BORNE DISEASES	286
	I. DIRECT EFFECT OF LOUSE ATTACK	286
	1. Types of Pediculosis Corporis	286
	2. Types of Pediculosis Capitis	287
	3. Types of Phthiriasis	287
	4. Effects of Attack of Other Lice	288
	II. TRANSMISSION OF DISEASES BY LICE	289
	1. Diseases of Plant Origin	289
	Thallophyta: Fungi: Ascomycetes: Gymnoascea	289
	Thallophyta: Fungi: Hyphomycetes	289
	Thallophyta: Fungi: Schizomycetes: Coccaceæ	289
	Thallophyta: Fungi: Schizomycetes: Bacteriaceæ	290
	Summary of Plant-Caused Diseases	290
	2. Diseases of Unknown or Uncertain Origin	291
	3. Diseases of Animal Origin	294
	<i>Protozoa</i>	294
	Mastigophora: Binucleata: Trypanosomida	294
	Mastigophora: Binucleata: Leptomonida	294
	Mastigophora: Spirochætacea: Spirochætida	295
	Telosporidia: Hæmogregarinida: Hæmogregarinida	296
	<i>Metazoa</i>	297
	Platyhelminia: Cestoda: Cyclophyllidea: Tæniida	297
	BIBLIOGRAPHY	297
XXI.	THE LIFE HISTORY OF HUMAN LICE	301
	REFERENCES	311
XXII.	THE CONTROL OF HUMAN LICE	312
	THE RAVAGES OF LICE	312
	RESERVOIRS OF LOUSE BREEDING	313
	CONTROL MEASURES	314
	CONTROL OF LICE ON THE BODY	316
	Control of Crab Louse	316
	Control of Head Louse	316
	Control of Body Louse	317
	CONTROL OF LICE IN CLOTHING	319
	1. Laundry	319
	2. Dry Cleaning	320
	3. Steam Sterilization	321
	4. Hot Air Delousing	324
	5. Fumigation	324
	6. Storage	326
	7. Impromptu Delousing Arrangements	326
	CONTROL OF LICE IN LIVING QUARTERS	327
	CONTROL OF LICE IN HOSPITALS	328
	Control of Lice in Hospitals	328
	Louse-Proof Garments for Medical Attendants, etc.	328
	BIBLIOGRAPHY	328
XXIII.	LICE WHICH AFFECT DOMESTIC ANIMALS	330
	PART I. CATTLE LICE AND THEIR CONTROL	330
	Sucking Lice	331
	Biting Lice	332
	Methods of Study of Life History	333
	Control Measures	334
	Oils	334
	Sprays	335
	Miscellaneous Remedies	337
	Time for the Application of Control Measures	338
	Skin Injuries	338

CONTENTS

XV

CHAPTER

PAGE

PART 2.	LICE AFFECTING CHICKENS, HOGS, GOATS, SHEEP, HORSES, AND OTHER ANIMALS	339
	Lice Infesting Domestic Fowls	339
	Lice Infesting Rabbits, Cats and Dogs	343
	The Hog Louse	344
	Lice Attacking Sheep	345
	Biting and Sucking Lice of Goats	346
	Lice of the Horse	347
	Important Bibliographical References	348

XXIV.	DISEASES CARRIED BY FLEAS	350
	PLANT ORGANISMS TRANSMITTED BY FLEAS	350
	Thallophyta: Fungi: Schizomycetes: Bacteriaceæ	350
	ANIMAL ORGANISMS TRANSMITTED BY FLEAS	352
	<i>Protozoa</i>	352
	Mastigophora: Binucleata: Trypanosomidæ	352
	Mastigophora: Binucleata: Leptomonidæ	354
	Mastigophora: Spirochæta: Spirochætoidæ	355
	Telosporidia: Gregarinida: Agrippinidæ	355
	Telosporidia: Hæmogregarinida: Hæmogregarinidæ	355
	<i>Metazoa</i>	355
	Platyhelminthes: Cestoidea: Cyclophillidæ: Tæniidæ	355
	Platyhelminthes: Cestoidea: Cyclophillidæ: Hymenolepididæ	356
	Nemathelminthes: Nematoda: Spiruridæ	357
	Nemathelminthes: Nematoda: Filariidæ	357
	SUMMARY	357
	REFERENCES	358

XXV.	THE LIFE HISTORY AND CONTROL OF FLEAS	360
	FACTORS INFLUENCING ABUNDANCE OF FLEAS	366
	CONTROL OF FLEAS	367
	LIST OF REFERENCES	371
	NOTES ON THE CHIGOE, <i>DERMATOPHILUS PENETRANS</i>	373

XXVI.	COCKROACHES	374
	BIOLOGY	375
	KEY TO THE FOUR PRINCIPAL HOUSEHOLD COCKROACHES	376
	<i>Blatta orientalis</i> (Linnæus)	376
	<i>Blattella germanica</i> (Linnæus), Caudell	377
	<i>Periplaneta americana</i> (Linnæus)	378
	<i>Periplaneta australasiæ</i> (Fabricius) Burmeister	380
	REMEDIES	380
	Fumigation	380
	Hydrocyanic Acid Gas	380
	Carbon Bisulphide	380
	Pyrethrum Powder	381
	Sulphur	381
	Poisons	381
	Sodium Fluoride	381
	Borax	381
	Pyrethrum Powder	382
	Phosphorus	382
	Sulphur	382
	Castor Oil	382
	Traps	382
	ENEMIES	382

XXVII.	DISEASES TRANSMITTED BY THE COCKROACH	383
	PLANT ORGANISMS	383
	Thallophyta: Fungi: Coccaceæ	383
	Thallophyta: Fungi: Bacteriaceæ	384
	Thallophyta: Fungi: Spirallaceæ	387

CHAPTER	PAGE
ANIMAL ORGANISMS	388
<i>Protozoa</i>	388
Sarcodina: Amœbina: Amœbidae	388
Mastigophora: Polymastigina: Tetramitidae	388
Mastigophora: Binucleata: Leptomonidae	388
Telosporidia: Gregarinida: Gregarinidae	388
Telosporidia: Coccidiidea: Eimeriidae	388
Neosporidia: Myxosporidia: Thelohaniidae	388
Ciliata: Heterotricha: Bursarinidae	388
<i>Metazoa</i>	389
Platyhelminia: Cestoidea: Hymenolepididae	389
Nemathelminthes: Acanthocephala: Gigantorhynchidae	389
Nemathelminthes: Nematoda: Spiruridae	389
Nemathelminthes: Nematoda: Oxyuridae	389
REFERENCES	390
XXVIII. THE BEDBUG AND OTHER BLOODSUCKING BUGS: DISEASES TRANSMITTED, BIOLOGY AND CONTROL	391
DISEASES OF THE PLANT KINGDOM TRANSMITTED BY BUGS	392
Thallophyta: Fungi: Bacteriaceæ	392
DISEASES OF UNKNOWN ORIGIN	393
DISEASES OF THE ANIMAL KINGDOM TRANSMITTED BY BUGS	393
<i>Protozoa</i>	393
Mastigophora: Binucleata: Trypanosomidae	393
Mastigophora: Binucleata: Leptomonidae	395
Mastigophora: Spirochætacea: Spirochætidae	398
LIFE HISTORY NOTES	399
TREATMENT OF BITES	401
CONTROL MEASURES	401
LIST OF REFERENCES	401
XXIX. DISEASES CAUSED OR CARRIED BY MITES AND TICKS	403
DISEASES CAUSED BY DIRECT ATTACK OF TICKS AND MITES	403
DISEASES CARRIED BY MITES AND TICKS	411
DISEASES CAUSED BY PLANT ORGANISMS	411
DISEASES OF UNKNOWN ORIGIN	412
DISEASES OF ANIMAL ORIGIN	414
<i>Protozoa</i>	414
Mastigophora: Binucleata: Trypanosomidae	414
Mastigophora: Binucleata: Leptomonidae	414
Mastigophora: Spirochætacea: Spirochætidae	418
Telosporidia: Hæmogregarinida: Hæmogregarinidae	420
SUMMARY	424
LIST OF REFERENCES	427
XXX. THE BIOLOGIES AND HABITS OF TICKS	430
BIBLIOGRAPHIC REFERENCES	438
XXXI. CONTROL OF TICKS	440
LIST OF REFERENCES	449
XXXII. FLIES AND LICE IN EGYPT	450
THE SULTAN'S FUNERAL	452
XXXIII. INSECTS IN RELATION TO PACKING HOUSES	453
INSECT-BREEDING PLACES AND THEIR TREATMENT	455
PROTECTION AGAINST INSECTS	458
A BIBLIOGRAPHY OF LITERATURE DEALING WITH SANITATION OF MEAT PACKING ESTABLISHMENTS	459

CONTENTS

xvii

CHAPTER	PAGE
XXXIV. INSECT POISONING AND MISCELLANEOUS NOTES ON THE TRANSMISSION OF DISEASES BY INSECTS	461
SCORPION POISONING	461
SPIDER POISONING	463
CENTIPEDE POISONING	464
CENTIPEDES IN NASAL CAVITIES AND ALIMENTARY CANAL	466
LEPIDOPTEROUS LARVÆ POISONING	466
BEE, WASP AND ANT STINGS	467
HONEY POISONING	468
ANAPHYLAXIS	468
POISONING FROM EATING INSECTS	469
KISSING BUGS	469
DERMATITIS CAUSED BY BEETLES	469
BEETLES AS CARRIERS OF DISEASE GERMS	469
LIST OF REFERENCES	470
SUMMARY	472
XXXV. A TABULATION OF DISEASES AND INSECT TRANSMISSION	473
INDEX	499



CONTENTS BY AUTHORS

By W. DWIGHT PIERCE—*Bureau of Entomology*

	PAGE
HOW INSECTS CAN CARRY OR CAUSE DISEASE	19
SOME NECESSARY STEPS IN ANY ATTEMPT TO PROVE INSECT TRANSMISSION OR CAUSATION OF DISEASE	25
A GENERAL SURVEY OF THE NEEDS OF ENTOMOLOGICAL SANITATION IN AMERICA	34
A GENERAL SURVEY OF THE SERIOUSNESS OF INSECT BORNE DISEASES TO ARMIES	43
RELATIONS OF CLIMATE AND LIFE, AND THEIR BEARINGS ON THE STUDY OF MEDICAL ENTOMOLOGY	97
DISEASES BORNE BY NON-BITING FLIES	105
IMPORTANT PHASES IN THE LIFE HISTORY OF THE NON-BITING FLIES	126
THE CONTROL OF THE HOUSE FLY AND RELATED FLIES	153
DISEASES TRANSMITTED BY BLOODSUCKING FLIES	209
BIOLOGICAL NOTES ON THE BLOODSUCKING FLIES	223
DISEASES TRANSMITTED BY MOSQUITOES	247
MOSQUITO CONTROL	275
LOUSE BORNE DISEASES	286
DISEASES CARRIED BY FLEAS	350
DISEASES TRANSMITTED BY THE COCKROACH	383
THE BEDBUG AND OTHER BLOODSUCKING BUGS: DISEASES TRANSMITTED, BIOLOGY AND CONTROL	391
DISEASES CAUSED OR CARRIED BY MITES AND TICKS	403
INSECT POISONING AND MISCELLANEOUS NOTES ON THE TRANSMISSION OF DISEASES BY INSECTS	461
A TABULATION OF DISEASES AND INSECT TRANSMISSION	473

By W. DWIGHT PIERCE AND C. T. GREENE, *Bureau of Entomology*

WHAT WE SHOULD KNOW ABOUT MOSQUITO BIOLOGY	266
--	-----

By W. DWIGHT PIERCE AND ROBERT H. HUTCHISON, M.A., *Bureau of Entomology*

THE LIFE HISTORY OF HUMAN LICE	301
THE CONTROL OF HUMAN LICE	312

By B. H. RANSOM, PH.D., *Zoologist, Bureau of Animal Industry*

RELATION OF INSECTS TO THE PARASITIC WORMS OF VERTEBRATES	50
---	----

By F. C. BISHOPP, B.S., *Bureau of Entomology, In Charge Animal Insect Investigations*

CONTROL OF FLIES IN BARN YARDS, PIG PENS AND CHICKEN YARDS	167
MYIASIS. TYPES OF INJURY AND LIFE HISTORY AND HABITS OF SPECIES CONCERNED	175

CONTENTS BY AUTHORS

	PAGE
MYIASIS. ITS PREVENTION AND TREATMENT	200
THE LIFE HISTORY AND CONTROL OF FLEAS	360
THE BIOLOGIES AND HABITS OF TICKS	430
THE CONTROL OF TICKS	440
By J. L. WEBB, M.S., <i>Bureau of Entomology</i>	
BIOLOGY AND HABITS OF HORSE FLIES	236
By G. H. LAMSON, JR., M.S., <i>Entomologist Storrs (Conn.) Agricultural Experiment Station</i>	
LICE WHICH AFFECT DOMESTIC ANIMALS	330
By A. N. CAUDELL, B.S., <i>Bureau of Entomology; Curator of Orthoptera, U. S. National Museum</i>	
COCKROACHES	374
By H. A. BALLOU, PH.D., <i>Imperial Entomologist, Barbados</i>	
FLIES AND LICE IN EGYPT	450
By E. W. LAAKE, B.S., <i>Bureau of Entomology</i>	
INSECTS IN RELATION TO PACKING HOUSES	453

LIST OF TEXT FIGURES

FIGURE	PAGE
1. CROSS SECTION OF MANN'S HILLSIDE INCINERATOR, USED AT U. S. MARINE CAMP, QUANTICO, VA. (MANN)	46
2. MODIFICATION OF MANN'S HILLSIDE INCINERATOR, ADAPTING IT TO LEVEL GROUND. (MANN)	46
3. SMALL INCINERATOR OF THE FERGUSON TYPE, FOR USE OF SMALL UNITS, AND CAPABLE OF TRANSPORTATION. (MANN)	46
4. STRADDLE TRENCH LATRINES, 1 FOOT WIDE, 2 FEET DEEP, 3 FEET LONG, FOR FIELD OPERATIONS AT TEMPORARY LOCATIONS. (MANN)	47
5. COVERED PIT LATRINE LEVEL WITH GROUND, A SEMI-PERMANENT TYPE. (MANN)	47
6. GARBAGE CAN WITH TOP CONVERTED INTO PORTABLE URINAL FOR USE IN COMPANY STREET AT NIGHT. (MANN)	47
7. URINE SOAKAGE PIT, IN CROSS SECTION. (MANN'S MODIFICATION FROM LELEAN)	48
8. CHART SHOWING THE ZONES OF LIFE REACTION TO TEMPERATURE AND RELATIVE HUMIDITY. (PIERCE)	98
9. SUGGESTED CURVES OF THE RESPONSES OF AVERAGE AMERICANS TO HUMID TEMPERATURES. (PIERCE)	102
10. MOUTH PARTS OF FLIES: <i>a</i> , suctorial type; <i>b</i> , biting type. (GREENE)	138
11. DIAGRAMMATIC SKETCH OF THE HOUSE FLY, <i>Musca domestica</i> . (GREENE)	139
12. ABDOMINAL MARKINGS OF THREE COMMON HOUSE FLIES: <i>a</i> , The house fly, <i>Musca domestica</i> ; <i>b</i> , little house fly, <i>Fannia canicularis</i> ; <i>c</i> , stable fly, <i>Stomoxys calcitrans</i> (GREENE). In these diagrams the relative size of the abdomen is shown. The light areas in <i>a</i> and <i>b</i> represent yellow markings and are variable in size. In fig. <i>c</i> the markings of the last segment may be present or absent	140
13. CHARACTERS OF A MUSCID FLY LARVA. (GREENE.) Segment 1 is the head; 2-4 are thoracic segments; 5-11 are abdominal. Segment 11 really contains the seventh to tenth abdominal segments, the spiracles being on the eighth, the anus is the tenth	142
14. LARVA OF THE LITTLE HOUSE FLY, <i>Fannia canicularis</i> . Greatly enlarged. (HOWARD AND PIERCE, DRAWING BY BRADFORD)	143
15. DORSAL VIEW OF EIGHTH ABDOMINAL SEGMENT OF THE LARVA OF <i>Fannia canicularis</i> . Very highly magnified. (DRAWING BY BRADFORD)	143
16. VENTRAL VIEW OF TERMINAL SEGMENTS OF <i>Fannia canicularis</i> ; the ninth and tenth segments are comprised in the small zone around the anus. Very highly magnified. (DRAWING BY BRADFORD)	143
17. LARVA OF <i>Fannia scalaris</i> , THE LATRINE FLY. Greatly magnified. (HOWARD AND PIERCE, DRAWING BY BRADFORD)	144
18. DORSAL VIEW OF EIGHTH ABDOMINAL SEGMENT OF <i>Fannia scalaris</i> . Very highly magnified. (DRAWING BY BRADFORD)	144
19. VENTRAL VIEW OF TERMINAL SEGMENTS OF <i>Fannia scalaris</i> ; the ninth and tenth segments are comprised in the small zone around the anus. Very highly magnified. (DRAWING BY BRADFORD)	144
20. LARVA OF <i>Musca domestica</i> : DORSAL VIEW OF HEAD AND PROTHORAX. (GREENE)	145
21. LARVA OF <i>Musca domestica</i> : LATERAL VIEW OF TERMINAL SEGMENTS. (GREENE) The spiracles are located on the eighth abdominal segment. The ninth and tenth segments are ventral and not very distinct, enclosing the anus	145
22. LARVA OF <i>Musca domestica</i> : Enlarged Sketch of Right Stigmal Plate. These plates are less than their breadth apart. (GREENE)	145
23. LARVA OF <i>Stomoxys calcitrans</i> : Enlarged Sketch of Thoracic Spiracles. (GREENE)	146

FIGURE	PAGE
24. LARVA OF <i>Stomoxys calcitrans</i> : Enlarged Sketch of Right Stigmal Plate. These plates are one and one-half times their breadth apart. (GREENE)	146
25. LARVA OF <i>Muscina stabulans</i> : <i>a</i> , Side view of head and prothorax; <i>b</i> , anterior or thoracic spiracles; <i>c</i> , side view of terminal segments of abdomen. (GREENE)	147
26. LARVA OF <i>Muscina stabulans</i> : Enlarged Sketch of Right Stigmal Plate. These plates are less than their breadth apart. (GREENE)	147
27. LARVA OF <i>Calliphora erythrocephala</i> : Side View of Head and Prothorax. (GREENE)	148
28. LARVA OF <i>Calliphora erythrocephala</i> : Enlarged Sketch of Left Stigmal Plate. These plates are one and one-quarter times their breadth apart. (GREENE)	148
29. LARVA OF <i>Chrysomya macellaria</i> : Enlarged Sketch of Side of Head and Prothorax. (GREENE)	149
30. LARVA OF <i>Chrysomya macellaria</i> : Enlarged Sketch of Left Stigmal Plate. These plates are less than their breadth apart. (GREENE)	149
31. LARVA OF <i>Lucilia sericata</i> : <i>a</i> , dorsal view of head and prothorax; <i>b</i> , lateral view of head and thorax; <i>c</i> , lateral view of last abdominal segments. (GREENE)	149
32. A MAGGOT TRAP FOR HOUSEFLY CONTROL. View of the maggot trap, showing the concrete basin containing water in which larvæ are drowned, and the wooden platform on which manure is heaped. (HUTCHISON)	155
33. USE OF FLYTRAP IN CONNECTION WITH MANURE BIN: <i>a</i> , Block of wood set in ground to which lever raising door is hinged	157
34. TOP OF GARBAGE CAN WITH SMALL BALLOON FLYTRAP ATTACHED	160
35. CONICAL HOOP FLYTRAP; SIDE VIEW: <i>a</i> , Hoops forming frame at bottom; <i>b</i> , hoops forming frame at top; <i>c</i> , top of trap made of barrel head; <i>d</i> , strips around door; <i>e</i> , door frame; <i>f</i> , screen on door; <i>g</i> , buttons holding door; <i>h</i> , screen on outside of trap; <i>i</i> , strips on side of trap between hoops; <i>j</i> , tips of these strips projecting to form legs; <i>k</i> , cone; <i>l</i> , united edges of screen forming cone; <i>m</i> , aperture at apex of cone. (BISHOPP)	163
36. PLANS OF OPEN HOG-FEEDING TROUGH. (BISHOPP)	171
37. FULL GROWN LARVA OF THE HUMAN BOT, <i>Dermatobia hominis</i> . (DRAWING BY BRADFORD.) Actual length 14.5 mm.	187
38. FULL GROWN LARVA OF THE TUMBU-FLY, <i>Cordylobia anthropophaga</i> . (GRÜNBERG.) Ventral view. x 6. (FROM AUSTEN)	189
39. THE TUMBU-FLY, <i>Cordylobia anthropophaga</i> . (GRÜNBERG) Female. x 6. (FROM AUSTEN)	189
40. NOSE PROTECTION FOR HORSE AGAINST ATTACKS OF THE NOSE FLY, <i>Gastrophilus hæmorrhoidalis</i> . (DOVE)	205
41. CHART ILLUSTRATING THE LIFE CYCLE OF <i>Hæmoproteus columba</i> , THE CAUSE OF PIGEON MALARIA. (PIERCE)	213
42. CHART ILLUSTRATING THE LIFE CYCLE OF <i>Trypanosoma gambiense</i> , THE CAUSE OF GAMBIAN SLEEPING SICKNESS. (PIERCE)	215
43. LARVA OF A BUFFALO GNAT, <i>Simulium</i> . (JOBBS-POMEROY)	225
44. EGGS OF THE STABLE FLY, <i>Stomoxys calcitrans</i> ATTACHED TO A STRAW. Greatly enlarged. (AFTER BISHOPP)	230
45. THE STABLE FLY: LARVA OR MAGGOT. Greatly enlarged. (AFTER BISHOPP)	230
46. THE STABLE FLY: ADULT FEMALE, SIDE VIEW, ENGORGED WITH BLOOD. Greatly enlarged. (AFTER BISHOPP)	230
47. LIFE CYCLE OF PLASMODIUM, CAUSE OF PERNICIOUS MALARIA. (PIERCE)	252
48. EGGS AND LARVÆ OF CULEX. Enlarged. (HOWARD)	268
49. EGGS OF MALARIA MOSQUITOES: <i>a</i> , <i>Anopheles punctipennis</i> ; <i>b</i> , <i>A. quadrimaculatus</i> ; <i>c</i> , <i>A. crucians</i> . (AFTER HOWARD, DYAR AND KNAB)	268
50. LARVA OF THE YELLOW-FEVER MOSQUITO. Much enlarged. (HOWARD)	269
51. LARVA OF THE MALARIA MOSQUITO, <i>Anopheles punctipennis</i> . (AFTER HOWARD, DYAR, AND KNAB)	271
52. PUPA OF CULEX. Greatly enlarged. (HOWARD)	272
53. PUPA OF <i>Anopheles quadrimaculatus</i> . Greatly enlarged. (HOWARD)	272

LIST OF TEXT FIGURES

xxiii

FIGURE	PAGE
54. PUPA OF <i>Aedes argenteus</i> , THE YELLOW FEVER MOSQUITO. Greatly enlarged. (AFTER HOWARD, DYAR, AND KNAB)	272
55. TYPES OF MOSQUITO MOUTH PARTS: <i>a</i> , Short palpus form; <i>b</i> , long palpus form (GREENE)	273
56. ADULT <i>Culex sollicitans</i> . Much enlarged. (HOWARD)	273
57. THE YELLOW FEVER MOSQUITO <i>Aedes argenteus</i> : ADULT FEMALE. Much enlarged. (HOWARD)	273
58. A MALARIAL MOSQUITO, <i>Anopheles quadrimaculatus</i> : MALE AT LEFT AND FEMALE AT RIGHT. Greatly enlarged. (HOWARD)	274
59. SUBMERSIBLE AUTOMATIC BUBBLER FOR DISTRIBUTING OIL OVER SURFACE OF WATER. (EBERT)	281
60. METHOD OF PETROLIZATION WITH OIL-SOAKED SAWDUST. (EBERT)	281
61. WRISTLET METHOD USED FOR BREEDING LICE. (HUTCHISON, PHOTO BY DOVENER)	303
62. CHART ILLUSTRATING THE LIFE CYCLE OF <i>Trypanosoma lewisi</i> . (PIERCE)	353
63. CHART ILLUSTRATING THE LIFE CYCLE OF THE DOG TAPE WORM, <i>Dipylidium caninum</i> . (PIERCE)	356
64. LARVA OF THE EUROPEAN RAT FLEA, <i>Ceratophyllus fasciatus</i> . Greatly enlarged. (BISHOPP)	361
65. THE DOG FLEA, <i>Ctenocephalus canis</i> : <i>a</i> , Egg; <i>b</i> , larva in cocoon; <i>c</i> , pupa; <i>d</i> , adult; <i>e</i> , mouth parts of same from side; <i>f</i> , antenna; <i>g</i> , labium from below. <i>b</i> , <i>c</i> , <i>d</i> , much enlarged; <i>a</i> , <i>e</i> , <i>f</i> , <i>g</i> , more enlarged. (FROM HOWARD)	362
66. THE HUMAN FLEA, <i>Pulex irritans</i> : ADULT FEMALE. Greatly enlarged. (BISHOPP)	362
67. THE HUMAN FLEA, <i>Pulex irritans</i> : ADULT MALE. Greatly enlarged. (BISHOPP)	363
68. THE EUROPEAN RAT FLEA, <i>Ceratophyllus fasciatus</i> : ADULT FEMALE. Greatly enlarged. (BISHOPP)	364
69. THE STICKTIGHT FLEA, <i>Echidnophaga gallinacea</i> : ADULT FEMALE. Greatly enlarged. (BISHOPP)	365
70. HEAD OF ROOSTER INFESTED WITH THE STICKTIGHT FLEA, <i>Echidnophaga gallinacea</i> . Somewhat reduced. (BISHOPP)	366
71. THE ORIENTAL ROACH, <i>Blatta orientalis</i> : <i>a</i> , Female; <i>b</i> , male; <i>c</i> , side view of female; <i>d</i> , half-grown specimen. All natural size. (MARLATT)	377
72. THE GERMAN ROACH, <i>Blattella germanica</i> : <i>a</i> , First stage; <i>b</i> , second stage; <i>c</i> , third stage; <i>d</i> , fourth stage; <i>e</i> , adult; <i>f</i> , adult female with egg case; <i>g</i> , egg case, enlarged; <i>h</i> , adult with wings spread. All natural size except <i>g</i> . (FROM RILEY)	378
73. THE AMERICAN ROACH, <i>Periplaneta americana</i> : <i>a</i> , View from above; <i>b</i> , from beneath. Enlarged one-third. (MARLATT)	379
74. BEDBUG: EGG AND NEWLY HATCHED LARVA: <i>a</i> , Larva from below; <i>b</i> , larva from above; <i>c</i> , claw; <i>d</i> , egg; <i>e</i> , hair or spine of larva. Greatly enlarged, natural size of larva and egg indicated by hair lines. (MARLATT)	396
75. BEDBUG: <i>a</i> , Larval skin shed at first molt; <i>b</i> , second larval stage immediately after emerging from <i>a</i> ; <i>c</i> , same after first meal, distended with blood. Greatly enlarged. (MARLATT)	396
76. BEDBUG: ADULT BEFORE ENGORGEMENT. Much enlarged. (MARLATT)	397
77. BEDBUG, <i>Cimex lectularius</i> : <i>a</i> , Adult female, engorged with blood; <i>b</i> , same from below; <i>c</i> , rudimentary wing pad; <i>d</i> , mouth parts. <i>a</i> , <i>b</i> , much enlarged; <i>c</i> , <i>d</i> , highly magnified. (MARLATT)	397
78. CHART OF LIFE CYCLE OF <i>Babesia canis</i> , THE CAUSE OF CANINE MALIGNANT JAUNDICE. (PIERCE)	416
79. LIFE CYCLE OF <i>Hæmogregarina canis</i> , THE CAUSE OF CANINE ANEMIA. (PIERCE)	421
80. TICK LIFE CYCLE, TYPE I. (AFTER NUTTALL)	423
81. TICK LIFE CYCLE, TYPE II. (AFTER NUTTALL)	423
82. TICK LIFE CYCLE, TYPE III. (AFTER NUTTALL)	425
83. TICK LIFE CYCLE, TYPE IV. (AFTER NUTTALL)	425
84. TICK LIFE CYCLE, TYPE V. (AFTER NUTTALL)	426
85. TICK LIFE CYCLE, TYPE VI. (PIERCE)	426
86. THE ROCKY MOUNTAIN SPOTTED FEVER TICK, <i>Dermacentor andersoni</i> . (BISHOPP)	437
87. MODEL CHICKEN ROOST. (BISHOPP)	446
88. A CENTIPEDE, <i>Scolopendra morsitans</i> . (BRADFORD)	453



LIST OF PLATES

PLATE	PAGE
THE HOUSE OR TYPHOID FLY, <i>Musca domestica</i> . Greatly enlarged. (HOWARD AND PIERCE, PHOTO BY DOVENER)	Frontispiece
I. SCREW WORMS AND BLOW FLIES. (HOWARD AND PIERCE, PHOTOS BY DOVENER)	133
Fig. 1. The blue bottle fly, <i>Calliphora vomitoria</i> .	
" 2. The green bottle fly, <i>Lucilia cæsar</i> .	
" 3. The American screw worm, <i>Chrysomya macellaria</i> .	
" 4. The black blow fly, <i>Phormia regina</i> .	
II. EGGS OF THE AMERICAN SCREW WORM, <i>Chrysomya macellaria</i> , ON MEAT. (BISHOPP)	134
III. FLIES WITH DANGEROUS HABITS. (HOWARD AND PIERCE, PHOTOS BY DOVENER)	136
Fig. 1. A flesh fly, <i>Sarcophaga sarraceniæ</i> .	
" 2. The non-biting stable fly, <i>Muscina stabulans</i> .	
" 3. The lesser house fly, <i>Fannia canicularis</i> .	
" 4. The brilliant green fly, <i>Pseudopyrellia cornicina</i> .	
IV. SCREW WORM INJURY TO A YEARLING CALF. (BISHOPP)	150
V. MANURE BOX WITH FLYTRAP ATTACHED. (BISHOPP)	155
VI. MANURE SPREADER. (BISHOPP)	157
VII. ROAD DRAG IN USE SCRAPING MANURE IN A COW LOT ON A TENNESSEE FARM. (BISHOPP)	159
VIII. UNDESIRABLE CONDITIONS WHICH ARE OVERCOME BY USE OF THE MAGGOT TRAP. A manure pile covering a large area and having little depth. Illustrating the conditions which favor the greatest loss of nitrogen, and at the same time offer the best breeding ground for flies. (HUTCHISON)	159
IX. CARCASS PARTLY DESTROYED BY LARVÆ OF THE AMERICAN SCREW WORM FLY, <i>Chrysomya macellaria</i> . (BISHOPP)	177
X. HORSE BOT FLIES. (DOVE)	183
Fig. 1. <i>Gastrophilus intestinalis</i> , the common bot.	
" 2. <i>Gastrophilus hæmorrhoidalis</i> , the nose fly.	
XI. PHASES OF THE LIFE CYCLE OF BOT FLIES. (BISHOPP)	184
Fig. 1. Empty eggs of the cattle bot, <i>Hypoderma lineata</i> .	
" 2. Eggs of the common horse bot, <i>Gastrophilus intestinalis</i> .	
" 3. Full grown larva of <i>Hypoderma lineata</i> .	
" 4. Empty puparium of <i>Hypoderma lineata</i> .	
" 5. Empty puparium of <i>Gastrophilus intestinalis</i> .	
XII. METHOD OF ATTACK BY THE COMMON HORSE BOT, <i>Gastrophilus intestinalis</i> . (BISHOPP)	185
Fig. 1. Eggs on horse's legs.	
" 2. Larvæ attached to walls of stomach, showing lesions caused by removed bots in center.	
XIII. METHOD OF ATTACK BY THE CATTLE BOT, OR HEEL FLY, <i>Hypoderma lineata</i> . (BISHOPP)	186
Fig. 1. Fly ovipositing on cow's leg.	
" 2. Portion of cow's back showing larvæ, empty holes, and pus exudate.	
" 3. Heavily infested cow.	
XIV. TRENCH PREPARED FOR BURNING CARCASS. (BISHOPP)	201

PLATE	PAGE
XV. PUPÆ OF <i>Simulium</i> . (AFTER JOBBINS-POMEROY)	227
Fig. 1. Respiratory filaments of pupa of <i>Simulium vittatum</i> .	
" 2. Pupa of <i>Simulium venustum</i> , in pupal case.	
" 3. Pupa of <i>Simulium bracteatum</i> : A. Side view of filaments.	
" 4. Pupa of <i>Simulium jenningsi</i> .	
" 5. Pupa of <i>Simulium pictipes</i> , in pupal case. All greatly enlarged.	
XVI. THE STABLE FLY, <i>Stomoxys calcitrans</i> . (BISHOPP)	231
Fig. 1. Eggs in straw.	
" 2. Pupæ in straw.	
" 3. Adults on leg of cow.	
XVII. STRAW STACK SHOWING PROPER METHOD OF BUILDING STRAW STACK. (BISHOPP)	232
XVIII. THE HORN FLY, <i>Lyperosia irritans</i> . (BISHOPP)	233
Fig. 1. Flies on cow.	
" 2. Cow pasture showing droppings improperly left to breed flies.	
XIX. TABANIDÆ ATTACKING CATTLE: <i>Tabanus phænops</i> on cow's jaw, and <i>T. punctifer</i> on top of shoulder. (BISHOPP)	236
XX. <i>Tabanus punctifer</i> . (WEBB, PHOTOS BY DOVENER)	238
Fig. 1. Egg masses on grass.	
" 2. Larva, dorsal view.	
" 3. Larva, lateral view.	
" 4. Pupa, lateral view.	
" 5. Pupa, ventral view.	
XXI. THE CLOTHING LOUSE, <i>Pediculus corporis</i> . (PIERCE AND HUTCHISON, PHOTOS BY DOVENER)	302
Fig. 1. Female, ventral view.	
" 2. Male, dorsal view.	
XXII. EGGS OF THE CLOTHING LOUSE, <i>Pediculus corporis</i>	305
Fig. 1. Mass of eggs, slightly reduced, between seams of trousers (PHOTO BY DOVENER.)	
" 2. Great enlargement showing eggs hatching. (PHOTO BY PAINE.)	
" 3. Very great enlargement showing structure of eggs with exuvie within. (PHOTO BY PAINE.)	
XXIII. STEAM STERILIZER IN DELOUSING STATION OF U. S. ARMY MEDICAL CORPS. The carriage is transferred along the rails in the foreground to rails leading into the other room where another carriage is seen. (HUTCHISON)	323
XXIV. SCALY LEG MITE ON CHICKENS. (BISHOPP)	406
Fig. 1. Scaly feet of chickens, caused by mite attack.	
" 2. Scaly leg mites, greatly enlarged.	
XXV. DIPPING SCALY LEGS OF CHICKEN IN CRUDE OIL. (BISHOPP)	407
XXVI. THE FOWL TICK, <i>Argas persicus</i> . (BISHOPP)	433
Fig. 1. Larvæ under feathers of chicken.	
" 2. Unengorged male, ventral view; much enlarged.	
" 3. Female with eggs, dorsal view; greater enlargement.	
" 4. Unengorged female, ventral view; same enlargement as fig. 2.	
XXVII. THE CATTLE TICK, <i>Boophilus annulatus</i> . (BISHOPP)	435
Fig. 1. Fully engorged female.	
" 2. Engorged female depositing eggs.	
XXVIII. SPRAYING CHICKEN HOUSE WITH OIL BY MEANS OF KNAPSACK SPRAY PUMP. (BISHOPP)	447

SANITARY ENTOMOLOGY

CHAPTER I

How Insects Can Carry or Cause Disease ¹

W. Dwight Pierce

Our nation, as well as all our world civilization, is facing the greatest crisis in its existence in these days of reconstruction. We must conserve human energy and keep it at its greatest possible point of efficiency. This means above all that questions of health are foremost today.

Entomology bears a twofold relationship to health. Adequate food supply upon which human and animal health are contingent is dependent to a greater or less degree upon insect depredations. This is the side of entomology which has in the past received most of the recognition, that is, agricultural entomology. It has been generally recognized that insects also bear a direct relationship to health, but the public has more or less discounted the relationship, with the result that our public appropriations for the study of insects affecting crops are approximately thirty times as great as the appropriations for the study of insects affecting the health of man and animals. The present course of lectures aims to give the latest views in this almost unworked field of medical entomology, with a view toward demonstrating the necessity of obtaining a better balance in the two great phases of economic entomology.

The scope of the course embraces studies of the relationship of insects to disease, the life history of the insects which cause disease, and the best methods of prevention of disease causation by insects. It is intended to be placed in the hands of the men who will conduct work along these lines, to show them why insects are dangerous, how they are dangerous, what their habits disclose as weak points subject to attack, and finally, how to go about controlling them.

In my opinion the near future will see a group of professional sanitary entomologists whose services will be available to solve the insect prob-

¹This lecture was given on May 20, 1918, and mimeographed copies were distributed May 22. It has been considerably revised for the present course.

lems of municipalities, communities, and armies, as well as household and commercial problems. Municipal entomology has already been recognized in a small way by certain cities. It will become better known only by the work of entomologists themselves who are men of vision. The problems involved in entomology sanitation demand an intensive and specialized training which few of us received in school. If we would fit ourselves for such work it will demand great effort on our part.

CLASSIFICATION OF METHODS BY WHICH INSECTS CAN CARRY OR
CAUSE DISEASE

Long before any one knew of causative organisms in medicine it was recognized that insects might be productive of disease. We may therefore assume as our first category the diseases actually caused by the insects themselves.

(I.) *Diseases caused directly by insects.*—We must recognize, for the sake of arrangement, all pathological conditions brought about by insects whether of a serious nature or not.

1. *Entomophobia.*—The fear of insects, both harmless and harmful, is a common ailment, amounting in many people to an obsession. I know of a young lady who became so frantic over the presence of a huge dragon fly in the automobile that the attempt to catch it led to a serious accident. Recently a serious automobile accident was caused by a bee sting. Many women become frantic at sight of large insects, and I have even seen men lose all sense of courage in the presence of an unknown species of insect. Obviously only patient and tactful education can ever cure such an obsession.

2. *Annoyance and worry.*—We have all probably experienced a sense of annoyance, amounting sometimes to worry, from insects. It frequently happens that the annoyance increases to the point of causing acute nervous troubles which, it is quite conceivable, might lead to insanity with certain people. Animals are frequently driven frantic by insects such as buffalo gnats, mosquitoes, and horse flies, and lose all control of themselves. We may classify these different cases of insect annoyance in accordance with the sense which perceives it and communicates its sensations to the brain. In this manner we have annoyance originating through sight, memory and imagination, sound, smell, taste, and feeling.

Sight worry is initiated by the occurrence of unwanted insects in home or garden, or on one's person, or by their constant swarming about until patience is exhausted and one loses control of the nerves. A recently recorded case tells of a lady whose house was badly infested with book lice and who was fast becoming a nervous wreck when

entomological service was sought and the house freed of its pests. The constant moving of streams of ants across a floor, the sight of bedbugs or fleas, and many other common insect occurrences may cause a nervous person great perturbation. Recently a young entomologist was nauseated and made very sick for hours by the sight of a louse infested man.

Memory and imagination worry may be exemplified by the person impressed by anti-house fly propaganda, whose imagination sees on every fly multitudes of fatal disease germs. A person once injured by an insect will often experience acute revulsions of feeling on sight of another similar insect.

Sound worry such as that induced by the singing of mosquitoes or the buzzing of horse flies will often lead to insomnia and in the cases of animals will cause great uneasiness.

Smell worry or annoyance from insects often takes the form of great embarrassment. A few years ago in Dallas, Texas, Calosoma beetles were so numerous that people walking on the streets frequently would have one alight on them, and, in brushing the beetle off, would cause it to expel a sufficient quantity of liquid to make the person's presence undesirable in polite society. Many people are so sensitive to bedbug odors that when they sleep in infested rooms they are constantly aware of the odor and are possessed of a fear that they will be attacked by the bugs.

Taste annoyance is often caused by eating berries containing bugs, or which bugs or cockroaches have contaminated. This may often cause nausea.

Finally, there is the *worry aroused by contact* of insects, the tingling sensation from insects crawling on the body, the peppery sting of gnats and mosquitoes, the itching sensations from vermin. Insomnia is a frequent result of such attacks.

Thus as results of insect annoyance, we may have worry, nervous exhaustion, excitability, hallucinations, frenzy, insanity, nausea, insomnia and nervous chills.

3. *Accidental injury to sense organs.*—There are numerous cases on record of insects accidentally obtaining access to the ear or nose and causing a stoppage of these organs, or of insects flying into the eyes causing severe irritation or even blindness. Certain species of gnats are especially annoying when there is any kind of catarrhal affection of these organs. Myriapods have frequently been recorded as entering the nose of a sleeping person.

4. *Poisoning.*—Insects and the related arthropods may poison in a variety of ways. The bite of a tick, flea, spider, mosquito, horse fly, etc., may cause a severe local irritation and poisoning. The poisonous

centipedes have a poison sac opening on the front pair of legs. The scorpion stings with the tip of its tail. The bee, wasp, and ant sting with the ovipositor. Many of these injuries are very painful. Certain lepidopterous larvæ are provided with barbed hairs which contain poisonous secretions, as the brown tail moth larva, and the larvæ of *Lagoa*, *Hyperchiria io*, etc. Some insects emit poisonous secretions which blister (Meloid beetles). Some of the South American honey bees (*Trigona*) store poisonous honey.

5. *Paralysis*.—The bite of several species of ticks (*Dermacentor andersoni* (*venustus*)), for example, may cause paralysis with sometimes fatal results. Some spiders, ants, bees, wasps, and caterpillars inflict such a poisonous wound that temporary paralysis of the limb follows.

6. *Dermatosis*.—Direct attack upon the body of men and animals, and parasitism thereon, is not unusual. We have as striking examples the dermatoses caused by lice (pediculosis), by the chigoe, the red bug (chiggers), the *Dermatobia hominis*, creeping worms, scab and itch mites (acariasis). Many of these attacks have serious after results, as for instance an acute attack by the chigoe may result in ainhum, the loss of a toe or a foot. Many secondary diseases obtain access to the body through the skin attack of insects.

7. *Myiasis and similar internal attacks*.—Under this heading are to be considered cases in which insects are present in the tissues of internal organs of the body. The occurrence of insects has been recorded in organs of the head, in the intestinal canal, the reproductive organs, and the body wall. When the insect is a fly the disease is called *Myiasis*. When a beetle is the cause, the disease is called *Canthariasis*, and if a lepidopterous larva is responsible it is known as *Scholeciasis*. Many species of flies have been recorded as occurring in the human body. These will be studied in detail in a later lesson.

(II.) *Diseases carried by insects*.—The ways in which insects may carry diseases are very diverse, due to the great differences not only in the habits of the insects, but also of the disease organisms and the hosts.

1. *Diseases carried by insects to food*.—When insects carry disease germs to food or water we speak of the transmission as contaminative. Contaminative transmission of disease organisms to food by insects is naturally the simplest manner of transmission. This is necessarily done by insects which frequent excretionary substances and also visit foods, such as certain flies, ants, roaches, and beetles. It is obvious that we must look upon all insects which breed in fecal matter, sputum, etc., as potential disease carriers. Considerable research has already been conducted to prove the actual rôle of many species of coprophagous insects. The rôle of the carrier may either be mechanical or biological.

Many disease organisms are transmitted by insects which exercise apparently only a mechanical rôle. Principal among these are bacteria and certain parasitic worms. Many of the bacteria may be taken up by fly and beetle larvae, and by adult flies, beetles, roaches, and ants, and be carried on the body or ingested and passed through the body and out in the feces without modification or multiplication. A number of species of parasitic worms may be taken up in the egg stage by insects and deposited in the insect's feces. If such infested feces happen to be deposited on food, contamination and infection may conceivably follow.

Certain other organisms which are carried by insects to food pass part of their life history in the insects. Such are some of the nematodes that may be ingested by coprophagous insects, which in turn are eaten by the animals that serve as final hosts of the parasites.

2. *Diseases carried by insects to wounds.*—We can make the same division of these diseases into mechanical and biological carriage. The transmission of anthrax, leprosy, ophthalmia, and such diseases, from sore to sore or from excreta to sore is purely mechanical. When the organism passes part of its life cycle in the insect we might call the transmission biological. As examples of such types of transmission we may cite European relapsing fever and trench fever, louse-borne diseases which gain access to the body by the scratching in of fragments of the lice or their excreta.

3. *Diseases gaining access through direct attack of insect.*—Most of the protozoal diseases and some of the parasitic worms gain access to the body of the vertebrate host by direct inoculation, or indirectly, at the time of feeding. When the organism is taken up by the insect it begins its development in the insect body and finally reappears in the salivary glands or some other position adjoining the mouth parts, the inoculation occurring during the blood feast. Such is the inoculation of malaria, yellow fever, and Rocky Mountain spotted fever. But other disease organisms pass through the intestinal canal of the insect and out in the feces and yet obtain access to the wound by being washed into it by body secretions of the insect, as is the case of the organism of African relapsing fever inoculated by the tick *Ornithodoros moubata*.

WHY IT IS NECESSARY TO KNOW HOW INSECTS CARRY DISEASE

In the foregoing discussion I have attempted to analyze the methods by which insects can cause or carry disease. There is also a practical side of the question. We must know the why and the wherefore and the what to do.

Without a conception of the rôle of the insect we cannot give sufficient force to our arguments, or reasons for taking a particular course

of action. For instance, if we were merely to go before the inhabitants of a Montana valley suffering from Rocky Mountain spotted fever and say: "We are going to put down this epidemic, you must dip your horses and trap all the rabbits and rodents on your place," what kind of an answer would we get? If the Public Health Service had stepped into New Orleans on the announcement of a plague case and ordered everybody to rat-proof their cellars, without further reason, they would have been driven away.

If a sanitary officer reports to his superior that a certain thing must be done, requiring a considerable outlay of money and the use of a good many men, he must be able to give him a strong, forceful argument to prove that he is right. Army officers, and in fact most executive officers, want brief answers. The subordinate must therefore have his information on the tip of his tongue.

We have seen by the above discussion that the bites of insects must be avoided. Where disease-carrying insects are present, the greater the concentration of human beings or animals, the greater the necessity of exercising control, whether it be in a municipality, a commercial establishment, an army, a stock yards, or a ranch. It is incumbent upon all men charged with entomological sanitation to learn the bloodsucking fauna about them. Without a knowledge of how mosquitoes, horse flies, bedbugs, lice, stable flies, gnats, and ticks breed, one can scarcely proceed to prevent their breeding and consequently cannot protect men and animals from their attacks.

One must always prevent insects from coming in contact with wounds. This is especially important in hospitals and during times of epidemics. It is at all times imperative to keep food untouched by anything in the form of insect life. Insects must not be tolerated in dwellings, no matter whether there is evidence against them or not. There is evidence against most of them.

Domestic animals must likewise be kept as free as possible from insects. Some day we will recognize that stables should be as well proofed against flies as dwellings are now. There are more inducements for flies and other noxious insects around a stable than anywhere else, and the stable is therefore the direct or indirect source of many of our troubles. The measures necessary for holding down insect infestation of stable and barn yards are therefore of primary importance. But to emphasize this importance there must be back of every measure taken or recommended an argument in the form of a proof of danger if the measure is not carried out.

CHAPTER II

Some Necessary Steps in Any Attempt to Prove Insect Transmission or Causation of Disease ¹

W. Dwight Pierce

The study of the causation of disease is attracting far more attention today than it ever has in the past, but it is to be regretted that there is not a larger proportion of this effort being directed toward locating the possible intermediate hosts and invertebrate carriers.

Many excellent investigations have been carried out with all other phases complete, but the question of invertebrate carriers is often left in a very indeterminate stage. The majority of the investigations which have been seriously undertaken to determine invertebrate carriers have been conducted on other continents than ours. There is a great field for investigation along these lines open to the investigators in America. In order to stimulate such research, I have attempted in this paper to set down some of the necessary steps for successful investigation.

I. COOPERATION

I consider essential to a thorough investigation of disease transmission, the establishment of a perfect working agreement and hearty cooperation between one or more physicians and diagnosticians, one or more parasitologists, and one or more entomologists. It is not safe, nor does the effort bring the proper amount of credence, when one man attempts to do the whole work. Each phase of such an investigation should be handled by an expert on that phase. The day of the solitary investigator is past and we are now in an era of group-investigations which carry with them weight and conviction. Of course certain preliminary steps may easily be taken by any one member of a proposed group or it may be possible that they may arrive at an advanced stage by independent work, but the time will come in each investigation when a cooperation of investigators will attain the most satisfactory results.

¹This lecture was printed in *Science*, n. s., vol. 50, No. 1284, pp. 125-130, August 8, 1919.

II. WHERE SHOULD THE INVESTIGATIONS OF INSECT TRANSMISSION BEGIN?

There are two distinct lines of approach to this problem of insect transmission. The first is to work from the known disease and to ascertain by experimentation what species of insects might be concerned in its transmission. The other line of approach is to make a study of all the insects which might be involved in disease transmission and to obtain, by cultures and microscopic studies, a knowledge of the parasitic organisms normally and occasionally found in these insects. Working on this line of investigation, one might in time of an epidemic start with insects visiting excreta and attempt to ascertain whether the organism of the disease at that time epidemic occurs in any of these insects.

The first line of investigations would arise from public necessity and probably be initiated by physicians and parasitologists, or by the suggestion of entomologists.

The second line of investigations would probably originate as problems assigned by a professor or head of a laboratory to students or investigators under his direction. It is highly desirable that such studies be commenced in as many institutions as practicable in the near future. Such investigations will include bacteriological studies, protozoological studies, and helminthological studies, as well as investigations of the life histories of the insects, and the possible connection between them and disease transmission.

III. PLAN OF OPERATION

Before starting out on any line of experiment in this subject, there should be written down in concise form the facts already gleaned, on the practical problems and the theories which have occurred to the various members of the group. A clearly outlined course of action should be made and be carefully discussed and then the various steps in the investigations thus outlined should be read and modified to meet the changing views resulting from the experiments. The course of the work should always be kept plainly in view. Each step should be rigorously and skeptically scrutinized for defects.

Inasmuch as the investigation from this point will consist of the answering by observation and experiment of a series of pointed questions, I shall proceed with my discussion in the form of queries. Probably many other vital queries will occur to the reader, but it is more than possible that he may overlook some of these if not set forth here. When each query is satisfactorily answered the problem is practically solved.

IV. HOW SHALL WE RECORD OUR OBSERVATIONS?

Undoubtedly the most satisfactory method of making a large series of records is to use some type of loose-leaf card or sheet filing system. By such means one can always keep in an orderly arrangement all the facts so far obtained. In the case of investigations of the causation of a given disease, one of the most satisfactory methods which has been used for recording observations is to prepare a little blank booklet, which will fit the filing system, in large quantities, each book to represent a case. This book should contain pages for each phase of the question, with blanks covering all kinds of minutiae about this phase. The whole series of observations can be tabulated for each point.

V. HOW CAN AN INSECT BE INVOLVED IN DISEASE TRANSMISSION?

Insects may be involved in disease transmission either by the transmission of an organism or the inoculation of a toxin, or they may be an intermediate host in the life cycle of an organism, but not come directly in contact with the final host.

1. *What Kind of Organisms Can Insects Carry?*

It has been demonstrated that insects can carry bacteria, fungi, many types of protozoa, and many species of parasitic worms, and also that certain species of insects may be instrumental in carrying eggs of other species of insects which cause disease.

2. *In What Manner May Insect Toxins Bring About Disease?*

Many species of insects which bite inoculate at the time of the bite a toxin which may at times cause serious trouble.

Some invertebrates inoculate the toxin by means of the mouth, some by means of a claw, some by means of a caudal appendage, others by means of the ovipositor. In some cases the invertebrate penetrates the skin with its mouth parts and as long as it is adhering, toxins are created which may in certain cases cause severe paralysis or death. The accidental eating of certain insects in food will cause poisoning because of the toxins contained in the bodies of the insects. It is believed, but not yet satisfactorily demonstrated, that the pollution of food by the excreta of certain insects may cause certain nutritional diseases.

The presence of certain insects in the tissues causes severe irritations and often the formation of toxins.

3. *Can Insects Themselves Cause Disease?*

Many species of insects are known to live parasitically upon the bodies of man and animals and by their constant sucking of blood or gnawing, cause skin diseases. Other species of insects habitually lay their eggs on or in the flesh and breed commonly or exclusively in living flesh, causing a destruction of the tissues. Many species of insects are dependent upon mammalian blood for the necessary nutriment to bring about reproduction. Some insect larvae are bloodsuckers. It is not at all uncommon for insect larvae to be ingested in food and for them to continue their development in the intestines or other organs, often at the expense of the tissues. In some parts of the world insects are eaten as food by the natives, sometimes in a raw state, and it is not uncommon in such case for the natives to be infected with parasitic worms which pass their intermediate stages in the bodies of these insects.

4. *Where May Insects Obtain the Organisms which Cause Disease?*

Disease organisms may be taken up by insects directly from the blood of an infected host, or they may be obtained by contact with infected surfaces of the body or taken up from the feces or other excretions of an infected host. The insect may take up the organisms from these excretions either in its larval or its adult stage.

5. *How Can the Insect Transmit the Organism?*

The organism may be transmitted by the insect by direct inoculation through the proboscis, involving the active movement of the parasite, or the passive transmission of the parasite in the reflex action which takes place in the sucking of blood. The organism may be externally carried on the beak of the insect and mechanically transmitted at the time of sucking. It may be located in the mouth parts of the insect and burrow through at the same time the insect is feeding. It may be in a passive state on the insect and become stimulated to attack the host when it comes in contact with the warm body. The organism may be regurgitated by the insect on the body of its host and obtain entrance by its own activity, or by being scratched in or by being licked up by the host.

On the other hand, the organism may pass through the insect, and pass out in its feces, or in Malpighian excretions. It may be washed into the wound made by the sucking of the insect, by fluids excreted at the time of the feeding. It may remain in the feces on the host and ultimately be scratched in or licked up by the host.

The organism may be taken up by the insect and never normally pass out of the insect, but be inoculated by the crushing of its invertebrate

host upon the body, and the scratching of infected portions of the insect's body into the blood; or may be transmitted only by the ingestion of the insect itself by its vertebrate host, or accidentally by some grazing animal. In fact quite a series of disease organisms find their way into their hosts because of the habit of the animals of feeding upon insects.

6. *What Is the Course of the Organism in the Insect?*

If the organism is taken up by the insect in its larval stage, it may pass directly through the larva and out in its feces and may quite conceivably pass in this manner through insect after insect larva before it finally finds a vertebrate host. The organism may be taken up by the larva and remain dormant in some portion of the larva's anatomy, or on the other hand, it might undergo considerable development and multiplication in the larva and remain there through all the metamorphosis of the insect until the latter arrives at maturity, at which time development of the organism may begin or may continue.

Upon being taken up in the blood by the bite of the insect, the organism may lodge in the esophagus and carry out all its metamorphosis there, or in some of the organs of the head and find its way into the salivary glands and through the salivary secretions into a new host.

It may, on the other hand, pass back into the gut, or into the stomach; from the stomach its path may lead in many directions. It may pass on in its course of development into the rectum and out in the feces, or it may enter the fatty bodies, or pass into the general cavity of the insect, or it may migrate forward into the esophagus and into the labrum; and it may pass into the Malpighian tubules, or into the ovaries.

The organism may enter the eggs and remain therein through their development into the larvae, nymphs or adults, and be transmitted at some stage of the development of the second generation. Some diseases can pass on even to the third generation.

7. *What Is the Course of the Organism on Leaving the Insect?*

The organism may leave the insect in the saliva and immediately enter the feeding puncture. It may bore through the labium of the insect at the time of feeding and enter the puncture. It may leave the rectum of the insect, or the Malpighian glands and be washed into the puncture by means of the secretions of the coxal glands, or some other excretions made at the time of feeding. It may be excreted in Malpighian secretions, or rectal feces, or regurgitated in vomit, and may lie dormant on the skin of the host, or on the food of the host, until it is scratched into the blood, or is taken into the mouth.

On the other hand, it may be possible that the organism requires another host after the insect, and before it reaches its final host. There are cases on record of the insect being the first host, and two or three vertebrates in succession being hosts of later stages.

VI. WHAT IS KNOWN ABOUT THE DISEASE TO BE INVESTIGATED?

It is a primary essential that all the workers be able to recognize the disease which they are trying to study and that they be fully informed about it, so that they may be able to grasp possible solutions of their problem. They will, therefore, seek first to answer the following questions:

1. What is the history of the disease and how long has it been known? How serious has it been?
2. What is its distribution?
3. Does it occur in pandemic, epidemic, endemic or sporadic form?
4. In what seasons of the year is it most prevalent?
5. Is there any apparent relationship between its distribution and the physical, biological or climatic features of the countries where it occurs?
6. Does it affect any particular group, occupation, sex, age, race or nation of people, or any particular species of animal?
7. May any wild animal be considered as a reservoir?
8. Has immunity or difference of susceptibility been recognized and under what circumstances?
9. What are the symptoms of the disease?
10. What is known regarding immuno-chemistry and bacteriology of the disease?
11. What have autopsies shown?
12. What treatment has been designated?
13. What is known or suspected about its causation and dissemination? What organisms have been connected with it?
14. What possible theories can be advanced to account for its causation and dissemination?

A little time spent in collecting these facts may save much effort later.

VII. WHAT INSECTS SHOULD BE INVESTIGATED?

A thorough entomological study of this question may prove a valuable short cut to the investigation. Many insects will be eliminated by the entomologist before he has finished his preliminary work. He will attempt to answer the following and many other questions and will probably have to answer them to the satisfaction of all his fellow workers.

1. What insects coincide in distribution with the general distribution of the disease?
2. What insects occur in peculiar habitats of the disease?
3. What bloodsucking insects occur in the locality under investigation?
4. What is the relative abundance of these insects?
5. Is there a coincidence between the season of abundance of any of these insects and of the disease?
6. What insects occur in the homes, nests, or haunts of infected hosts?
7. What insects are found on infected hosts?
8. What insects occur in the working quarters of the patients?
9. What insects would be most apt to affect the particular group of hosts most susceptible?
10. What insects breed in or frequent the excreta of the hosts?
11. What insects are found at the food of the hosts?
12. What insects are found at the sources of the food of the hosts, such as the milk?

VIII. WHAT IS NECESSARY IN THE TRANSMISSION EXPERIMENTS?

The investigations which have preceded will have narrowed the question down to certain species or groups of insects which need to be critically studied. All of those insects which come in contact with the blood or mucous membranes of the patient, or the food of the patient, or the feces of the patient, must be given special attention. At this point the bacteriologist, protozoologist, or the helminthologist finds his special work beginning. There will be many points which must be worked out by cooperation of the parasitologist and entomologist.

Considering first the bloodsucking insects, it is necessary to determine:

1. Can the particular insect take up the organism with the blood?
2. Does the organism pass into the intestinal canal or does it stop at some point en route?
3. To what extent is the organism digested by the insect?
4. In what organs of the insect can the parasite be demonstrated from day to day?
5. Are any changes in the organism demonstrable?
6. What path does the organism seem to follow in the insect's body from day to day?
7. Does this movement of the organism suggest whether the transmission is by inoculation or does it suggest that the organism will pass out of the body in some of the excreta?

8. Can the organism be demonstrated in the mouth parts of the insect at the time of feeding?
9. Can the organism be found in any of the excretions of the insect?
10. How long is it before the organism reaches the mouth or the rectum?
11. What is the earliest date at which it can be found in the feces?
12. What is the earliest date at which infectivity of the host can be obtained by the sucking of the blood?
13. What is the earliest date at which infectivity can be obtained by scratching in of the feces or portions of the insect?
14. Can infection be obtained by either natural or artificial inoculation without demonstration of the organism?
15. Is the infective organism, contagium or virus filterable?
16. Can the virus or organism be transmitted hereditarily by the insect?
17. At what stage of development in the second generation does hereditary transmission become possible?
18. Can the organism be taken up by the immature stages, feeding in infected excreta?
19. Can the organism be taken up by immature stages of an invertebrate feeding on the host?
20. How long can the immature forms of the invertebrate, infected by whatsoever manner, retain the organism in their system?
21. Does the organism stay in the insect during metamorphosis?
22. Does the organism undergo any changes preceding or following metamorphosis of its invertebrate host?
23. At what stage in the metamorphosis does the insect begin to be infective after taking up such organisms?
24. How long can the insect remain infected and infective?

IX. HOW SHOULD EXPERIMENTAL INSECTS BE HANDLED?

A large proportion of the failures in studies of insect transmission in the past have arisen from improper handling of the insects. The breeding and handling of the insects is an art in itself, just as is the culturing of bacteria or protozoa. In fact, there are more diverse requirements for handling insects of different species than can be found elsewhere in the animal kingdom.

1. *What must be known about the insect before beginning transmission experiments?*

The normal conditions of life of the insect must be ascertained:—its

reactions to heat and cold, moisture and dryness, disturbances, color, light, odor; its food, and the proper condition thereof; its methods of reproduction, and what food is necessary for reproduction; if soil should be provided, and what conditions it should be in; if water should be provided, and whether this water should be alkaline or acid, clear or containing foreign matter, and in such case what type of foreign matter; whether the water should be still or in motion, warm, moderate or cold.

2. *What type of breeding cage should be used?*

A breeding cage must be used which will most nearly enable the experimenter to keep the insects under control and yet reproduce essential conditions for maintaining normal, healthy life of the insects and normal reproduction. Much of this information is available in entomological literature. Many insects probably involved in disease transmission have not been properly studied and breeding technique is yet to be worked out.

3. *Water is necessary in some form in practically all insect breeding.*

There are more failures to properly breed insects traceable to improper humidity, or to the lack of moisture in the proper form for the insects to drink. Much detailed observation may be necessary to obtain this important information in the case of many insects.

4. *There is a combination of temperature and humidity most favorable for life, for each species, and differing from one species to another.*

5. *The food of an insect must be in a particular condition in order to obtain normal breeding.* It may require a certain degree of immaturity, ripeness, or fermentation. It may require a certain degree of desiccation.

Many other details must be attended to by each specialist involved in the investigation, and we probably have yet to see a single disease problem which has been completely rounded out and solved for the future generations.

CHAPTER III

A General Survey of the Needs of Entomological Sanitation in America ¹

W. Dwight Pierce

Notwithstanding the great amount of publicity which has been given the Anti-fly Campaign, one will find throughout our land a rather general disregard of the danger from flies. Certain newspapers keep the subject annually before their readers, but on the whole, public cooperation is slight. A few cities and communities have definitely organized mosquito control work, and the Public Health Service has done a wonderful amount of work in organizing such efforts. From an entomological standpoint our nation is not sanitary. The reason lies in the fact that the public does not yet realize that insects can and do carry disease. Science has apparently not put forward the idea in such a manner that it has gripped the average person. Until we do this we cannot expect public cooperation in the attempt to put down insect-spread diseases.

The problems we have to meet may be divided in several different manners. We may separate them into problems of municipalities, towns and villages, and rural communities. We may look at them from the standpoint of the farm, the home, the market, the factory, and the institution. They may be sorted out as problems of drainage, waste disposal, screening, animal control, etc.

Of course we have a greater diversity of entomological control problems in a municipality, but we also have more people who give attention to matters of health in a city, and who would complain against unhealthful conditions. On the other hand, while the problems of the rural community and town are fewer, the insect conditions often become greatly aggravated because of total carelessness as to sanitation. This carelessness in small towns and farms is usually due either to ignorance or lack of organized effort for community betterment.

The field of the sanitary entomologist who desires to tread virgin soil is therefore to solve the ways and means of obtaining better fly and mosquito conditions in rural communities. Educational work must be

¹This lecture was mimeographed and circulated to the class in January and appeared in parts in *The American City*, for February and March, 1919.

carried out which will be of such nature that it will bring results. We have the theories and the scientific facts but we must give the public practical demonstrations that freedom from insect pests means reduced sickness.

Any person informed on this subject who has traveled much in rural sections of this country and seen the unobstructed entrance of myriads of house-flies to the dwellings, especially the kitchens and dining rooms, and then has stepped outside and within a few feet found the open privies breeding these flies, cannot help but feel a sickening sensation and a revulsion toward eating anything that the flies could have polluted. It is not at all uncommon in rural sections to see babies exposed to the unrestricted visits of flies, and their milk bottles covered with them. The writer has been informed over and over by physicians in small towns that when infantile diarrhea or any other intestinal complaint visits a town it makes the rounds of every infant in the town, unless perchance, some mother is more advanced in her knowledge of such matters and keeps her baby constantly screened. When typhoid fever and dysentery visit towns with open privies and unscreened houses or hotels only the more cautious and more resistant escape. Such communities offer every conceivable opportunity for the spread of diseases by flies.

THE INSANITARY FARM

For fifteen years the writer has traveled extensively in rural communities, principally in the Southern States, where insanitary methods, if existent, aggravate disease conditions because of the more favorable climate and greater number of maladies present. We may picture, therefore, a few of the conditions which have been repeatedly seen in these travels, in order the better to show the problems to be met. We shall not claim that these pictures represent the predominant, or the usual, or the average condition. Let it suffice that they exist sufficiently often to make them worthy of serious attention.

The farm we will describe has been seen countless times. The house has no screens on the windows, in fact, often has no window panes, or may have wooden windows which are open all day. The house is one-storied with an outside chimney, and an open fireplace. The chimney and fireplace offer excellent day hiding places for mosquitoes, which are abundant if there is a slough or bayou nearby. The house is built on stumps or pillars raised above the ground. The pigs and chickens, dogs and cats, wander freely underneath. The house has a great open hallway through the middle, separating the bedrooms from the living rooms. On account of the numerous flea-breeding animals which pass under the house, fleas are not at all uncommon in the house. The well is usually

open and built into the back portion of the porch. Mosquitoes breed in it. There is a poorly constructed, dilapidated privy for the women not far from the house, but the men have none, or if they do, it is not fit to enter. They usually defecate in the open, in the fields or draws, or in a woodland patch. The barn is roughly constructed. The manure is piled in a great pile beside the barn, and breeds multitudes of flies. The stable floor is urine- and manure-soaked and affords excellent fly-breeding quarters.

Naturally, I have described the worst common type of farm, because on this must be built the structure for better sanitation in farm life. In many cases a large number of such places may exist on a single large plantation, for the use of the tenants. In such cases a single man is responsible, who himself lives in a house with all modern sanitary conveniences.

The problem of the sanitarian and the sanitary entomologist is to prove to the individual farmer and to the planter landlord the financial value of better sanitation. The planter must be shown that inasmuch as the efficiency hours of his tenants are increased, in proportion will their products be increased, and in like manner his rental, especially where the rental is based on certain proportions of the crop yield. He must see that reduction of mosquitoes means reduction of malaria incidence, that reduction of flies reduces the incidence of typhoid, dysentery, diarrhea, and other intestinal complaints, and that as the sickness rate on the plantation is decreased the labor output is increased.

It will do us no good to theorize if we do not set down clearly the ways and means of accomplishing this greater farm output by reducing fly and mosquito breeding. In the present course of lectures will be found the proofs which have accumulated against these various insects, brief statements of how these insects live, and detailed plans of the approved methods of control. Fortified with this ammunition and more which he will personally gain, the sanitary entomologist must fight for better sanitation.

HOW TO IMPROVE FARM SANITATION

At this time, however, we may in brief state a few measures which should be taken on every farm in order to accomplish greater farm labor efficiency and improve the health of the household and of the animals.

1. *The windows and doors should be screened* against flies and mosquitoes. During the months that fires are not used the chimneys should have a screen over the top and the fireplace screened. If wire screening cannot be afforded, mosquito bars can be used. In the majority of cases the expenditure of the necessary amount of money to properly

screen the place will be offset by a greater reduction in doctor's bills for the women and children at least.

2. Where there are many children passing in and out flies will get in. *The children should be taught to use fly swatters. No flies should ever be allowed to remain in the kitchen and dining rooms.* Flies which visit food will deposit on it any disease organisms they have picked up. If the water is pure, the fly is about the only common means of conveying intestinal diseases to the family.

3. Unless the babies and small children are kept indoors in screened rooms, the *helpless children should have a mosquito bar over the carriage or basket* so as to protect them from flies. This is absolutely essential if there is any sickness in the neighborhood.

4. *There should be installed sanitary pit or bucket privies* such as are recommended by the Public Health Service. Both men and women should be provided with such, and it should be a rule of every farm that indiscriminate defecation is absolutely forbidden. As many farms are quite large the most feasible plan would be to place at various places over the farm where they would be most convenient and best protected, some type of latrine, such as is used by armies, or better still a permanent privy.

5. *The well should be kept covered* to prevent as far as possible mosquito breeding and contamination.

6. The foundations of the house should be boarded up to prevent the access of animals and to eliminate a favorite mosquito hiding place. The ground around the house should be so drained that water will not flow under the house except in case of heavy rains, and in such cases will quickly drain off from under the house.

7. *All ditches, ponds, streams, and bayous on the farm should have the banks kept clear of obstructions to the free flow of the water.* There should not be any tree stumps, trees, roots, weeds, or logs in the stream. The banks should not have overhanging ledges, or puddle pits. Permanent ponds and lakes might be stocked with mosquito-eating fish. Places which habitually form puddles after rains should be filled and drained.

8. *The barns should have hard packed dirt floors or cement floors.* All manure should be removed daily from the barn. If possible the manure should be spread while fresh on fields lying fallow. Otherwise the manure should be piled in tightly packed stacks or on platforms over a cement basin containing water, in order to drown the fly larvae migrating for pupation.

9. *The garbage should be fed to pigs, preferably in sanitary feeding stalls* as described by Bishopp in the lecture on the control of flies in barn yards, pig pens and chicken yards (Chapter XI).

10. State Boards of Health should follow the California plan and forbid the marketing of fruit dried on farms with open sewage, or where exposed to visits of flies.

THE INSANITARY TOWN

In these same travels in which so many insanitary farms were seen, the writer has sojourned in or passed through many towns which might be described as follows: The streets are unpaved and are littered from one end to the other with papers, cans, and the accumulation of months of manure droppings, and are altogether filthy and unattractive. The removal of trash is nobody's business. The grocery stores and meat markets are unscreened and have open doors. The food is covered with flies. Farmers drive up and buy a side of salt pork or other meat, throw it into the pit of their wagon, uncovered, and drive down the dusty road, with a swarm of flies hovering over the meat. The small lunch rooms where the visiting farmer eats his noon or evening repast are dirty and full of flies. The stores have privies in the rear which are filthy and an offense to any decent person. Flies abound. Chickens and pigs wander unrestricted through the streets and are often found feeding under the privies. The hotel dining rooms and kitchens are always full of flies and are usually but a short distance from filthy privies, and flies are constantly passing back and forth. Cockroaches are served in the food and wander unrestricted everywhere. The bedding is often unclean and has been slept in by some one else. Bedbugs are not uncommon. The water pitchers contain mosquito wrigglers. The cisterns behind each house are unscreened, and contain rain water, full of mosquitoes. The livery stable has great piles of manure in the stable yards and sometimes right out on the sidewalk.

Sometimes the town is a little bigger and the people have become more civilized and installed interior plumbing, which empties the sewage into a ditch which runs down to a stream from which cattle drink, or quite often this sewage empties into the gutter on the street and fills the air with filthy odors. Such is not an uncommon thing in America. Only a few years ago we could have pointed out quite a number of cities in the 100,000 class with open sewage.

These small towns are often rat infested, and one can easily see the danger should an outbreak of plague, which is transmitted by the rat flea, get a start in such a town, by the advent of a plague infested rat.

HOW TO IMPROVE SANITATION

1. Organize the community for better sanitation, and call in an expert of the Public Health Service, which is giving a great deal of

attention to cooperative health work. In Russia, such organizations were springing up all over the land before that country became submerged in its present chaos.

2. Conduct a health publicity campaign.

3. Teach better sanitation in the schools and organize the children for clean-up work.

4. Require the screening of all stores selling food, and of all hotels and restaurants dispensing food. Do not allow food to be handled in such a way that it will attract great quantities of flies.

5. Require private stables to place manure in fly-tight boxes and to have same removed every 7 to 10 days.

6. Require livery stables to remove all accumulations of manure daily from the town limits.

7. Require the burning, feeding or removal of all garbage twice a week from homes and daily from hotels.

8. If garbage is hauled away and dumped the town should arrange for its daily incineration.

9. Require throughout the town limits, depending upon conditions, either sanitary plumbing and sewer connection, or sanitary box or pail privies. Do not allow pit privies or insanitary ones of any type. Do away as soon as possible with open sewer drainage, installing sewer pipe. Install sewage septic tanks of size adequate for the town. If there are no sewers laid it may be possible to arrange for individual installation of simple septic tanks.

10. Do not allow pigs and chickens to have access to privies.

11. Do not permit general roving of pigs, stock, chickens, etc., on the town streets.

12. Keep all ditches and waterways in the town free of obstruction, and if mosquitoes are breeding, have an oiling squad.

13. Fix strict penalties against defecation on streets, alleys, and vacant lots.

14. Install a town comfort station for strangers and people from the country.

SANITARY PROBLEMS OF CITIES

The sanitary entomological problems are multiple in large cities, and such that it would be an excellent practice to employ at least a consulting entomologist in all large cities. As a matter of fact many cities should have quite a corps of practical sanitary entomologists engaged primarily for this type of work.

City markets where meats, fish and all kinds of vegetables and produce are exposed for sale, are very attractive places for flies, and in many large cities there is gross neglect along these lines.

Sanitary inspectors need to exercise considerable vigilance in checking up obedience to ordinances relating to removal of trash, garbage, manure, excreta; installation of sewage or sanitary privies; proper sanitation among construction gangs; nuisances arising from stables, factories, sewage and garbage disposal plants, packing houses, stock yards, etc. Many manufacturing plants have waste products which are very attractive to insects. Insect conditions in restaurants, boarding houses and hotels should be frequently checked up.

Anti-fly and anti-mosquito propaganda should be conducted annually in every city until the people are so well educated to the necessity thereof that propaganda will no longer be necessary.

The sanitary department of large cities should directly supervise mosquito suppression within its bounds.

ENTOMOLOGICAL REQUIREMENTS OF MUNICIPAL SANITATION

The following points should be covered by ordinance in all large cities desirous of obtaining satisfactory sanitation. Not enough attention has been given by city health authorities to the insect side of their sanitary problems.

1. All foodstuffs, which are eaten raw, all raw meats, fish, birds, cooked foods, bread, cheese, dried fruits, etc., must be kept under cover of glass or screen or otherwise protected from insects, in all markets, stores, street stands, hotels, restaurants and boarding houses. Flies must not be allowed to congregate around food stalls. Cockroaches must be eliminated from all hotels, restaurants and boarding houses. Foods infested by insects should be subject to condemnation and destruction. Insect contamination of food is dangerous.

2. Hotels, public institutions, and lodging houses shall be required to keep their premises free of bedbugs. Bedbugs carry disease.

3. All school children shall be inspected at the beginning of each new school year for head lice, and oftener if circumstances warrant. In case the children are infested they should be isolated and sent to some clinic where they can be freed of the lice. All prisoners, patients in hospitals, and applicants at municipal lodging houses should be inspected for head, body, and crab lice, and if infested should be bathed and their clothing condemned or cleaned. Lice carry many diseases and every opportunity should be taken which will enable the authorities to reduce their incidence.

4. All livery stables shall be required to remove all manure to the country daily, unless specified places for dumping are set aside. All private stables should be provided with a fly-proof box or a maggot-

trap platform for the storage of manure and should have the manure removed at least every 10 days.

5. Garbage should be removed daily from all places where it accumulates in large quantities, and two or three times a week from private residences. All garbage awaiting removal should be kept in closed cans. Garbage must not be dumped within the city limits unless it is dumped on incinerators where fires will soon consume it. These requirements are necessary to keep down fly breeding.

6. Tin cans, bottles, and receptacles which will hold water, must not be allowed to accumulate in back yards, alleys or vacant lots, nor may they be dumped within the city limits or near residential sections in the suburbs, because they furnish excellent breeding quarters for mosquitoes.

7. The city should be connected for sewers as far into the suburbs as practicable, and all suburban properties not so connected should be required to install fly-proof cesspools, or septic tanks, or to arrange by neighborhoods for independent sewage with a common septic tank; or in the absence of water and necessary plumbing, to install sanitary privies, and be required to have all excreta removed once a week to an incinerator or other type of refuse disposal plant. Open vault privies should not be permitted in the city. Indiscriminate defecation on streets, alleys, vacant lots, etc., should be strictly forbidden and punishable by law.

8. Packing houses, candy factories, syrup factories, and all other manufacturing institutions producing food products should be required to screen windows and entrances, and to use fly traps in such a way as to minimize to the utmost the access of flies and other insects to the food products. Especial attention should be given to the prevention of insect breeding on such premises.

INDUSTRIAL SANITATION

Many industries have important entomological sanitary problems in the preservation of their products from insect contamination and in the efforts to conform to sanitary regulations. There are many times when they would be able to use the services of a consulting sanitary entomologist to advantage.

The keynote of industry today is the prevention or utilization of waste. Insect depredations on food products cause waste because the public does not want polluted food, and because sanitary inspectors are becoming more and more alive to the menace to health from insect polluted foods.

It is not generally understood that the presence of weevils and worms in cereal foods may do more than destroy the food. The evidence is

growing against these insects from the sanitary standpoint. Some of these insects contain substances in their bodies which are highly toxic, as for instance *Sitophilus granarius*, the granary weevil, contains the poisonous substance cantharidin. There are numerous instances of the sickening of animals from eating weevily grain. Still more important is the fact that where grain is accessible both to rodents and insects, certain parasitic worms pass out in the feces of the rodent in the egg stage, are eaten by the insect larvae in the grain, pass part of their life cycle in the insect, and the insect is then possibly eaten by a rodent, in which the worm completes its life cycle; or sometimes in our breakfast foods we eat these parasitized insects and become infected with the worms. For example, the rat tapeworm, *Hymenolepis diminuta* (Rudolphi) infests various species of rats, but sometimes is found in man. Joyeux has proved that its commonest intermediate host is the meal moth, *Asopia farinalis*, which becomes infected by eating the tapeworm eggs, in the larval stage. Grassi and Rovelli found the cysticeroid in the larva and adult of this moth and also in the earwig, *Anisolabis annulipes* and the beetles *Akis spinosa* and *Scaurus striatus*. Joyeux found that the adults of the granary beetle, *Tenebrio molitor*, easily took up the eggs. A cysticeroid or larval stage resembling the mouse tapeworm *Hymenolepis microstoma* (Dujardin) has been found by Grassi and Rovelli in the beetle *Tenebrio molitor*.

The whole problem, therefore, of the control of stored food product insects is of vital importance to the manufacturers of food.

Syrup factories, sugar mills and refineries, ice cream factories, creameries, and candy factories offer great attractions to flies which may alight on the exposed products and deposit with their feet, or in their vomit or excreta, germs of disease taken up elsewhere, perhaps days before when the fly was a larva breeding in excrement, and these germs may find the sweets excellent culture media for extensive growth. Extraordinary means must be devised to keep flies away from such products.

Packinghouses offer abundant attractions to many kinds of insects, many of which are serious disease carriers.

Railroad trains are the means of conveying from place to place disease-carrying mosquitoes, flies, roaches, fleas, lice, bedbugs, and mites. Fumigation of railway cars is an essential entomological control measure.

Dairies are often found to be the foci of the spread of typhoid fever, and knowing the propensity of the house fly we can see how readily it can carry the organisms from the stools of a sick person to the milk pails in the dairy. There needs to be rigid control of flies in all dairies.

These are but examples of many industries which have problems in sanitary entomology.

CHAPTER IV

A General Survey of the Seriousness of Insect-Borne Diseases to Armies ¹

W. Dwight Pierce

As this course of study is directed primarily toward obtaining a thorough knowledge of the relations of insects to diseases of men and the measures which must be taken to prevent these diseases, it is eminently proper for us to make a survey of the insect problems which confront the greatest aggregations of men, the modern army. From a study of military sanitation methods we may learn much which we need to know in practical municipal problems. Military methods are based on the necessity of quick returns and emergency efficiency, from which are built up in permanent establishments more perfect measures.

The discussion of military entomology immediately falls into two very distinct lines: first, the army training and concentration camps, and second, the active service camps and battle conditions.

Before the location of the average training camp, we may assume that it is possible to deliberate more or less on the desirability of one or more sites and that in a general way drinking water and general health conditions are considered. Not infrequently some other consideration will outweigh sanitation, as when it is considered essential to place a camp near a certain city or on a certain waterway or railway. In such cases of expediency, we are quite likely to find sanitation a serious problem from the outset.

The camp site is selected because of some important reason. From an entomologist's viewpoint a number of outstanding questions immediately arise as to this site. Is the ground open or wooded, level or sloping and well drained? Are there water holes, running streams, or swamps in the camp area or nearby? Are there farmhouses, stables, or other buildings on the site and what is the entomological situation in these buildings? What disease-carrying insects are naturally breeding about the camp site? If there has been any contagious disease of man or animals in the community before the camp was located, the entomologist's concern is the greater. He should if possible learn the focus of

¹This lecture was originally presented May 27, 1918, and distributed the same day. It has been revised for the present edition.

that disease and the insect conditions of that focus. The original health conditions on the site may have a distinct bearing on later events.

Often the first arrivals at the camp site are contractors with multitudes of laborers and animals collected from everywhere, and from every stratum of society. There are few hygienic arrangements for these men. In fact, the contractors are aiming to obtain as large profits as possible, and therefore hold down the expenses for sanitary waste disposal. Some among these laborers are almost certain to bring lice, bedbugs, fleas, and possibly also scabies mites, on their bodies and clothes. Thrown together indiscriminately in hastily constructed barracks, there is soon a general distribution of vermin. Their animals are quite likely to be infected with scabies mites and possibly other mites, and with bots and ticks. The undisciplined assembling of many animals and carelessness about manure disposal offers great attractiveness to all flies and insects attracted by animals. It is probable that many dogs accompany the laborers and contribute their quota of fleas. It is almost impossible with crude, uneducated laboring men to get them to maintain sanitary conditions. Indiscriminate defecation, the scattering of garbage, the accumulation of manure, personal uncleanliness, all contribute to make contractor camps sanitary sore spots.

Sooner or later the sanitarians arrive on the spot, very likely with a squad or company of raw untrained labor troops, and the clean-up begins. We can expect a constant lack of coordination between the military and the civilian. As for example, at one camp the sanitary officers had constructed drainage ditches to carry off surplus standing water, but the laborers persisted in throwing scraps of wood, underbrush and waste into the ditches so that they were of no avail, or rather so that they formed traps for water pools.

During the transition period when the camp is part civilian and part military there will be two very different types of conditions existing side by side, one good, one bad. Of course the army sanitarians have supervision over these civilian camps, but they find difficulty in enforcing sanitation.

When a camp is placed like Camp Humphreys, Virginia, on a tongue of land between two shallow bays of water that are known to fill up with vegetation, and which furnish breeding places for millions of mosquitoes, and with typical swamp lands at the heads of these bays, we may readily see that the task of the sanitary officer is not an easy one. These bays are moreover at tidal level and the daily fluctuations of the water add complications to the drainage problem. Each individual camp, wherever located, will present its own type of problems, and necessitates an early and thorough entomological survey.

The tremendous speed of construction and the rapid arrivals of fresh

contingents of troops and animals in a new army camp make the first months of the entomological sanitarian very busy ones. Common sense is one of the primary essentials in meeting the exigencies of the situation. The possibility of mosquito breeding must be kept at a minimum in spite of temporary drainage, multitudes of borrow pits, tree stumps, fire-water barrels, etc. A system of manure, garbage, refuse, and fecal disposal is of necessity hastily devised and must keep pace with the increasing numbers of men and animals. This waste disposal is handled by special units and the sanitarian acts only in an advisory capacity. He needs therefore to be very vigilant in his inspections. Army camps nowadays grow in such marvelous proportions that past experiences are of little avail. The man on the ground must be well versed in the principles of entomological sanitation and must use his judgment for all it is worth.

The constant accessions in troops and raw recruits call for constant scouting and prophylaxis to prevent admission of vermin. The work against vermin almost necessitates a specialist to take care of it alone. In fact it were best if three entomologists were located in each camp, one looking after the suppression of water and moist earth breeding insects, one looking after the suppression of fecal, waste, and manure breeding insects, and the third handling the vermin of the person and the barracks.

So serious is the vermin problem in all armies that elaborate measures have to be taken to combat it. The Germans developed great vacuum tubes that will contain an entire railroad coach. The Russians, and then other nations, developed bath trains sufficient to handle the cleansing of thousands of men a day. The Russians and Roumanians developed sod houses for heat sterilization of clothing. Heat and steam sterilizing plants of many types have been devised. A tremendous amount of experimentation has been directed toward chemical cleansing of the clothing.

The destruction of waste is such an acute problem that many types of incinerators have resulted (see figs. 1, 2, 3), but as a camp becomes permanently organized the sewage system does away with many of the early difficulties. Permanent incinerators, well kept drainage systems, organized removal of the manure, and disposal of garbage by the quartermaster's department, systematic inspection of quarters and grounds, and systematic bathing and cleansing of clothing, characterize the perfectly adjusted sanitation of a permanent camp. Every large army camp has its remount camp and company stables. The farther these stables are located from the soldiers' barracks the better will be the fly conditions in the living quarters of the men.

The actively engaged army, however, presents entirely different conditions. There is no possibility of developing sewage systems, but temporary latrines must be substituted (see figs. 4, 5, 6, 7). Manure and garbage cannot be farmed out to contractors, but must be disposed of

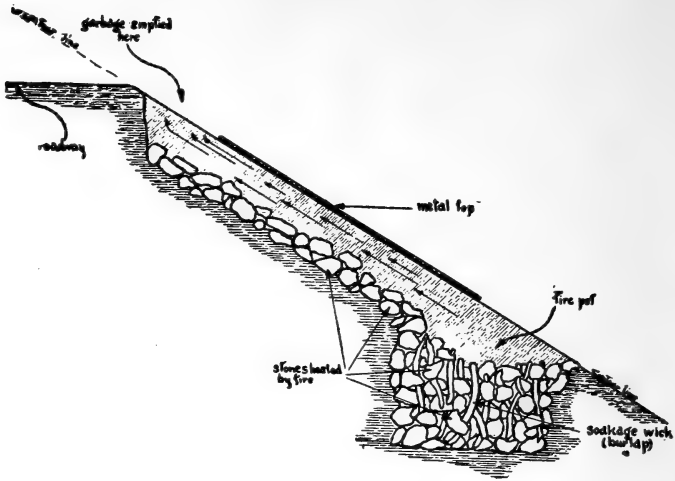

FIG. 1.—Cross section of Mann's hillside incinerator, used at U. S. Marine Camp, Quantico, Va. (Mann).

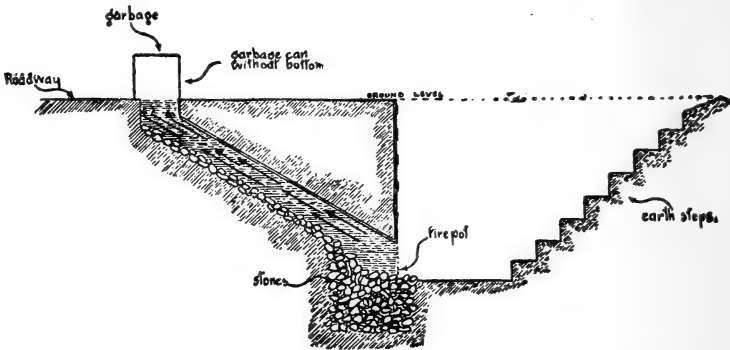

FIG. 2.—Modification of Mann's hillside incinerator, adapting it to level ground (Mann).

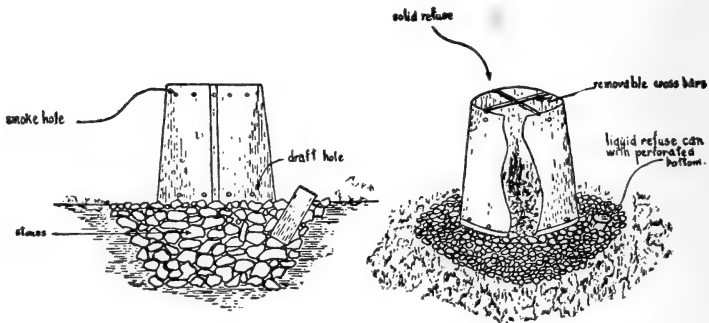

FIG. 3.—Small incinerator of the Ferguson type, for use of small units, and capable of transportation (Mann).

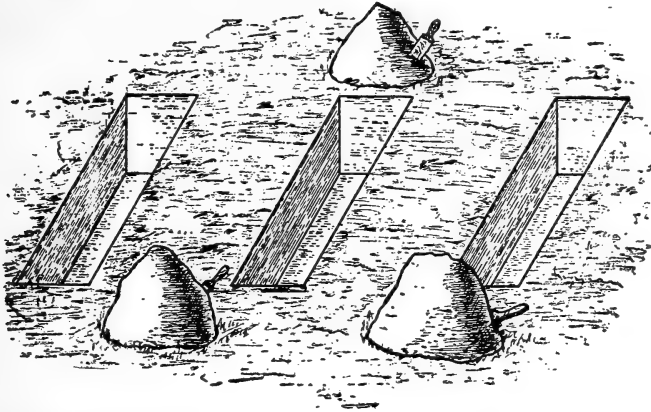

FIG. 4.—Straddle trench latrines, 1 foot wide, 2 feet deep, 3 feet long, for field operations at temporary locations (Mann).

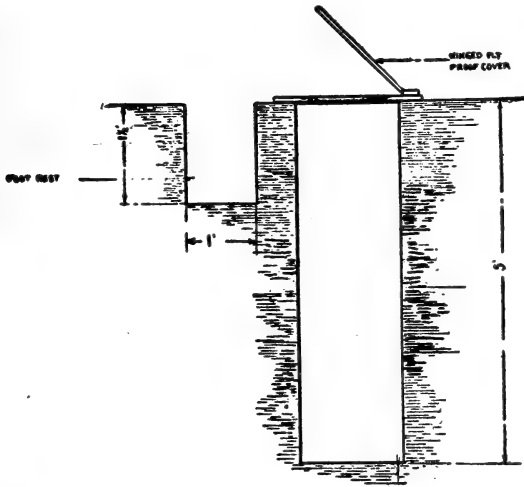

FIG. 5.—Covered pit latrine level with ground, a semi-permanent type (Mann).

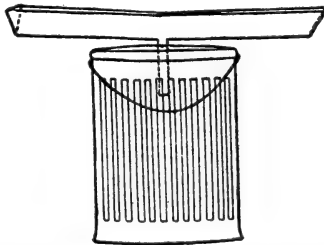

FIG. 6.—Garbage can with top converted into portable urinal for use in company street at night (Mann).

by hastily built incinerators, or the manure stacked and treated to kill flies. Ditches and standing water cannot be drained. They must be treated to kill insect life in them. Temporary hospitals abound and must be protected from flies and vermin. The men sleep out of doors or in scanty shelters, even in pig pens, barns, etc., wherever they can find shelter in inclement weather.

Insect infestation in these must be reduced to a minimum. When lice abound, hastily constructed devices must be installed or the clothing treated by chemicals. The trenches and dugouts have to be sprayed with creosote oils to keep away flies and kill vermin. Terrible stench arises from dead bodies and these must be buried or treated to prevent fly breeding. In other words, everything here must be done hastily but

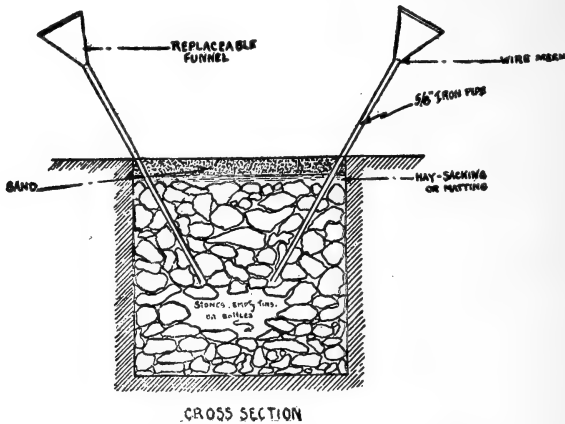

FIG. 7.—Urine soakage pit, in cross section (Mann's modification from Lelean).

effectively, for tomorrow the work may have to be done all over somewhere beyond or behind. The larger the body of men assembled and the greater the carnage, the more serious the diseases of all kinds and especially those carried by insects.

In the great European War the greatest diseases were those borne by lice. In fact there is plenty of evidence that louse-borne diseases have been among the worst in many wars of the past. Three serious diseases which ravaged the trenches are carried only by lice,—typhus fever, trench fever, and European relapsing fever. Millions of the Serbian nation were wiped out by typhus fever. The Roumanian nation was swept by typhus and relapsing fever. Russia, Germany, Austria and France suffered terribly from these louse-borne diseases. Trench fever spread back from the trenches into the cities. And yet all of these diseases can be controlled absolutely by suppressing the lice. It is easy to see how serious it is if a case of any of these diseases enters the

trenches. The lice spread from man to man, and they are noted for leaving a man with feverish conditions for a normal man.

Another disease which has been especially bothersome in the trenches is scabies. Both horses and men are seriously afflicted with this mite disease, and special veterinary hospitals were constructed in France solely for handling horse scabies.

In malarious countries where mosquitoes are breeding in great numbers, malaria is a very serious camp and army problem. Campaigns in tropical countries are endangered often by yellow fever, dengue and filariasis, which are also mosquito-borne diseases.

The troops engaged in Asia and some parts of the Mediterranean littoral had to contend with the possibilities of plague outbreaks. Troops engaged in the African campaigns had to deal with trypanosome and spirochæte diseases. Along the Mediterranean littoral pappataci fever is to be seriously considered. For example, a detachment of the British Army in Egypt was suddenly attacked by an outbreak of this disease.

We are all familiar with the disaster of our Spanish-American War in which so many thousands were carried away by typhoid fever, dysentery and diarrhea, all fly-borne diseases. In the present war, to these must be added Asiatic cholera, also borne by the fly.

The great quantity of carcasses on the battlefield gives rise to myriads of flesh and carrion flies and as a consequence of the habit of these flies of attacking wounds of living people, there were many cases of human as well as animal anthrax in the European War.

These are only the more important army diseases carried by insects. One of the greatest dangers to troops in active service lies in their moving into countries with obscure or little studied diseases, or diseases against which the men have had no chance to develop immunity.

CHAPTER V

Relation of Insects to the Parasitic Worms of Vertebrates ¹

B. H. Ransom

The only important part insects are known to play in the propagation of parasitic worms that affect human beings and other vertebrates is that of true intermediate hosts necessary to the existence of the parasites in some of their stages of development. Observations have been recorded in the literature showing that flies and other insects may swallow the eggs of various parasites of man such as hookworms, whipworms and other nematodes in whose life history no intermediate hosts are required, also the eggs of tapeworms in whose normal life history it is known that insects are not concerned, for example, *Taenia saginata*, whose intermediate host is the ox. It has been supposed that insects may thus act as mechanical carriers for such parasites, but as a matter of fact definite evidence of the importance of insects as mechanical carriers of the eggs or larvae of parasitic worms has not yet been brought forth. On the contrary there are reasons to suppose that in some cases at least the swallowing of the eggs or larvae of parasites by insects that can act only as mechanical carriers and not as intermediate hosts, reduces rather than increases the chances of the young parasites continuing their development and reaching a host in which they can become mature. Among the parasitic worms affecting man and other vertebrates it is those forms requiring intermediate hosts, so-called heteroxenous parasites, that are of special interest so far as insect transmission is concerned. The monoxenous parasites, or those requiring no intermediate host, may practically be left out of consideration, with the admission that the mechanical carriage of monoxenous parasitic worms by insects may in the future be proved to have an importance not yet demonstrated.

A complete demonstration of the part played by an insect in the life history of a given species of parasite is often a difficult matter. The animal which serves as the final host may be subject to infection not only with the species of parasite under investigation but also with other species liable to be confused with it in some of its stages. The insect

¹ This lecture was read to the class on December 16, 1918, and distributed January, 1919. It has been revised up to date. The names of insects have been revised by the editor.

may likewise harbor parasites other than the one that is being studied. The possibilities of confusion and of the entrance of extraneous factors into the problem are so many and so varied that in most cases it is only after the most rigorously controlled experiments, combined with careful comparative studies of the successive stages of the parasite, that conclusions may safely be drawn. Furthermore, in working out the life history of a parasitic worm it is not sufficient to prove that insects of a certain species can act as intermediate hosts under experimental conditions. Some species of parasitic worms are able to develop in more than one species of insect, and the fact that a certain parasite can develop in a certain insect does not necessarily mean that under natural conditions the species of insect in question serves as the intermediate host of the parasite. For example, one of the common parasites of sheep and cattle is able to pass through its larval stages in cockroaches. These insects become readily infected if the eggs of the parasite which occur in the feces of the final host animals are fed to them. Under natural conditions, however, cockroaches do not ingest the feces of sheep and cattle, nor are they found in places where they are likely to be picked up by sheep and cattle. Besides cockroaches, various species of dung beetles have been shown to be capable of acting as intermediate hosts of the parasite in question, and it is evident that these insects are the natural intermediate hosts. Unlike cockroaches they have plenty of opportunity both of becoming infected and of passing on their infection to the final hosts.

A more or less intimate environmental relationship between the insect host and the final host generally exists in the case of parasites transmitted by insects. In a number of cases the insects are coprophagous and also likely to be ingested by the final hosts, as in the instance just cited. Another highly interesting group of cases is that in which the insects are ectoparasites on the final hosts, or bloodsuckers that periodically visit them, and thus have particularly favorable opportunities for becoming infected with parasitic worms harbored by the animals they attack and in turn reinfesting the latter.

MODE OF INFECTION OF INSECT HOSTS

As already stated the part which insects may take in the propagation of parasitic worms of higher animals is that of intermediate hosts, in which certain larval stages of the parasites are passed before they are ready to enter the bodies of their final or definitive hosts in which they develop to maturity. The way in which the insects become infected varies with different species of parasites. In the case of some species which live in the alimentary tract of the final host the eggs or larvae are discharged from the body of the host in the feces. Coprophagous insects

swallow the eggs and if they are suitable intermediate hosts for the parasites the young worms go through several developmental stages and finally within the bodies of the insects reach a stage in which they are ready to be introduced into the body of the final host. Certain parasites whose adult stages live in relation with the blood vessels of the final host discharge their young into the blood stream whence they may be ingested by bloodsucking insects in whose bodies they undergo development to a stage infective for the final host. Aquatic insects may swallow free-living larval stages of parasites, or may be actively attacked by larval parasites which gain entrance to their bodies by penetrating the cuticle. These insects may in turn be eaten by other insects and the infection thus passed on to them.

In some cases the parasites may be taken up by insects or enter their bodies during an early stage of development of the insects and persist in later stages. Infection may thus occur during one stage of the insect but the development of the parasite to a stage infective for the final host may not be completed until after the insect has reached a later stage. Thus flies become infected with a certain parasite of the horse during the maggot stage, but the young parasites do not become sufficiently developed to be returned to the final host until the flies have reached the pupal or adult stage.

MODE OF INFECTION OF VERTEBRATE HOSTS

Parasitic worms that have insects for intermediate hosts reach their final hosts in various ways. In the case of some species the insect hosts are swallowed either as the habitual food of the final hosts, or incidentally with food or drink. In other instances the young worm may have already escaped from its insect host before it is taken in with food or drink by its final host. The cases of accidental infection with horse-hair worms not normally parasites of human beings are likely to have happened in this way. The parasites of which bloodsucking insects are intermediate hosts may be introduced into their final hosts as a result of the escape of the larval parasites from the insects at a time when the insects are drawing blood. Commonly the larvæ burst through a weak spot in the cuticle of the insect and then burrow into the skin of the final host.

SPECIES OF WORMS FOUND IN INSECTS

The parasitic worms of the higher animals in whose life history insects and insect-like organisms play a part, belong to two large zoological groups, Plathelminthes and Nemathelminthes. The former may be subdivided so far as concerns parasitic forms into Cestoda, or tapeworms,

and Trematoda, or flukes; the latter into Nematoda, or roundworms in the restricted sense, Gordiacea, or horse-hair worms, and Acanthocephala, or thorn-headed worms.

CESTODA OR TAPEWORMS

All tapeworms whose life history has been well established require an intermediate host, and are thus heteroxenous parasites. A typical life history of a tapeworm is as follows: The adult lives in the intestine of the final host. The eggs pass out of the body of the infested animal in the feces. The feces or food or drink contaminated by them are swallowed by an animal that can act as an intermediate host. The eggs thus reaching the intermediate host hatch in the alimentary tract and the embryos set free migrate into nearby or remote tissues of the body, developing finally into an intermediate stage, commonly of the type known as a cysticeroid, in the case of those tapeworms whose intermediate stages occur in insects. Having reached this stage further development of the parasite awaits the time when the intermediate host or infested portions of its body are swallowed by an animal that can act as the final host, whereupon it resumes its development and, becoming mature, completes the life cycle. About 100 species of tapeworms are known whose adult stages occur in man or domestic animals. Four of these, *Dipylidium caninum* (the double-pored tapeworm of the dog, cat, and man), *Hymenolepis diminuta* (the yellow-spotted tapeworm of rats, mice, and man), *Hymenolepis nana* (the dwarf tapeworm of rats, mice, and man), and *Choanotænia infundibulum* (one of the tapeworms of the domestic fowl), have insects as intermediate hosts, with the possible exception of the dwarf tapeworm, in whose life history the part played by insects has not been definitely determined.

Dipylidium caninum (Linnæus, 1758) Railliet, 1892

This tapeworm, sometimes called the double-pored dog tapeworm, is of very common occurrence in the small intestine of dogs and cats, and of occasional occurrence in human beings. Its larval stage (cysticeroid) occurs in the biting dog louse [*Trichodectes latus* (*canis*)] as determined experimentally by Melnikov (1869), and in fleas (*Ctenocephalus canis*, *C. felis*, and *Pulex irritans*). Fleas apparently are the usual intermediate hosts. Grassi and Rovelli (1888, 1889) followed the various stages of larval development in adult fleas, from the hexacanth embryo to the fully developed cysticeroid, and as they failed to find the parasite in larval fleas concluded that only adult fleas can act as hosts. Recently, however, Joyeux (1916) has reached the conclusion that adult fleas

are unable to swallow the eggs of the tapeworm. He finds that larval fleas readily swallow the eggs; these hatch in the intestine of the insect, and the embryos thus released penetrate into the body cavity. They persist in the hexacanth stage until the transformation of the flea into the adult, after which they proceed with their development and in a short time reach the cysticeroid stage. Infection of the dog, cat, or human being occurs naturally as a result of swallowing infested fleas. Fleas are exposed to infection owing to the fact that their larvæ live in an environment likely to be contaminated by the feces of infested dogs or cats. The eggs of the tapeworm as passed in the feces are grouped in capsules containing about a dozen eggs, so that infection of the insect host is likely to be multiple. The double-pored tapeworm is relatively uncommon in man and most of the cases recorded, of which there have been less than 100 all told, three in the United States, are among young children. Children are more likely than adult human beings to swallow fleas, which would explain the greater frequency of infestation among children. Another possible explanation of the more common occurrence of this parasite among children than among adults is that older persons may possess a greater immunity to infection. Prophylaxis against the double-pored tapeworm consists chiefly in keeping dogs and cats free from lice and fleas, and so far as human beings are concerned excluding dogs and cats, especially if they are lousy or infested with fleas, from human habitations.

Hymenolepis diminuta (Rudolphi, 1819) Blanchard, 1891

Hymenolepis diminuta (the yellow-spotted tapeworm) is of frequent occurrence in the small intestine of rats and mice, particularly the former, and of occasional occurrence in the intestine of man. The adaptability of the adult tapeworm to hosts so widely different as rodents and human beings is paralleled by the adaptability of the larval stage to various intermediate hosts. Cysticeroids belonging to this species have been recorded in various insects, a Lepidopteron, *Asopia farinalis*, in both larva and imago; a Dermapteron, *Anisolabis annulipes*; Coleoptera, *Akis spinosa*, *Scaurus striatus*, and *Tenebrio molitor*; and fleas *Ceratophyllus fasciatus*, *Xenopsylla cheopis*, *Pulex irritans*, and *Ctenocephalus canis*; also in myriapods, *Fontaria virginiensis* and *Julus* sp. Nicoll and Minchin (1911) found the cysticeroids in about 4 per cent of the rat fleas (8 out of 207) they examined during a period of thirteen months, and they succeeded in infecting rats with the tapeworm by feeding them fleas, as Grassi and Rovelli (1892) had previously done by feeding other insects. Joyeux (1916) infected the larvae of *Asopia farinalis* by feeding the eggs of *H. diminuta* and believes the cysticeroids recorded in the

adult moth by Grassi and Rovelli were carried over from the larval stage of the insect. He failed in his attempts to infect *Forficula auricularia*, *Blatta orientalis*, and *Blattella germanica*. He also failed to infect beetles belonging to the species *Blaps mortisaga*, but succeeded easily in infecting the adults of *Tenebrio molitor*. The larvæ of this latter beetle according to Joyeux are incapable of acting as intermediate hosts of *H. diminuta*. He was able to infect the larvæ of rat fleas and of *Pulex irritans* and *Ctenocephalus canis*. In these insects the embryos of *H. diminuta* begin immediately to develop into cysticercoids and do not wait for the transformation of the larval fleas into adults, as Joyeux found in the case of *Dipylidium caninum*, the embryos of which apparently lie dormant in the insect until after it transforms into the adult stage. In this country Nickerson (1911) has reared the cysticercoid in myriapods, *Fontaria virginiensis* and *Julus* sp., fed on the eggs of the tapeworm. He failed in his attempts to infect meal worms.

It is evident that infection of the definitive host with *H. diminuta* results from swallowing infested insects, the latter having become infested as a result of swallowing the eggs contained in the feces of animals harboring the tapeworms. As a parasite of man in the United States, so far as available statistics show, *H. diminuta* ranks about third in frequency among the tapeworms, the beef tapeworm (*Tænia saginata*) being the most common, and the dwarf tapeworm (*H. nana*) being next. Evident prophylactic measures are those directed toward the destruction of rats and mice and the avoidance of the ingestion by human beings of the various insects that may serve as intermediate hosts, especially the protection of farinaceous foods from insect infestation.

Hymenolepis nana (Siebold, 1852) Blanchard, 1891

Hymenolepis nana (the dwarf tapeworm) is a very common intestinal parasite of rats and mice and is of rather frequent occurrence in man, especially in children. In the United States it ranks second to the beef tapeworm in the order of frequency among the tapeworms of man. Its life history has not been fully worked out. Grassi (1887), however, has found that cysticercoids develop in the intestinal villi of rats that have been fed the eggs of the dwarf tapeworm. According to his view the cysticercoids later break out of the villi into the lumen of the intestine and grow into mature tapeworms. The rat thus acts both as intermediate and definitive host of the dwarf tapeworm, the parasite being spread from one rat to another through the medium of the eggs passed in the feces. The dwarf tapeworm, according to Grassi's version of the life cycle, is an exception to the rule among tapeworms that the adult stage occurs in one species of animal and the larval stage in another

species likely to be eaten by animals of the species that harbors the adult tapeworm.

Inasmuch as Nicoll and Minchin (1911) have found cysticercoids in a rat flea (*Ceratophyllus fasciatus*) that in details of head structure are apparently exactly similar to and specifically identical with the dwarf tapeworm, the question arises whether such insects may not act as intermediate hosts, and whether in addition to the life cycle of an exceptional type described by Grassi, the dwarf tapeworm also has a life cycle of the ordinary type. T. H. Johnston has found cysticercoids similar to those recorded by Nicoll and Minchin in another species of rat flea (*Xenopsylla cheopis*) as well as in *Ceratophyllus fasciatus*.

Joyeux (1916) has failed in experiments with fleas belonging to the species named and to related species, to infect them with *H. nana*. He states he used both larval and adult fleas. On the other hand he was able to confirm Grassi's results and succeeded in infecting a large number of rats and mice by feeding them the eggs of the tapeworm. The experimental evidence thus far available accordingly favors the view that insects do not play a necessary part in the life history of the dwarf tapeworm. Furthermore, considering the frequency of occurrence of *H. nana* as a parasite of man, and the enormous numbers of the parasites sometimes present, it would seem that infection is more likely to occur in the manner described by Grassi than as a result of swallowing rat fleas, there being of course a greater likelihood of human beings swallowing rat feces or fecal matter from other human beings containing large numbers of eggs of the tapeworm than of swallowing rat fleas containing a sufficient number of cysticercoids to develop into the large number of tapeworms that have been found in some cases.

Choanotænia infundibulum (Bloch, 1779) Cohn, 1899

Choanotænia infundibulum is a common tapeworm of chickens in various parts of the world. Grassi and Rovelli (1892) in Italy found cysticercoids in the common house fly (*Musca domestica*) which on account of their morphological similarity to *Choanotænia infundibulum* they inferred belonged to this species. From the results of experiments conducted in this country by Guberlet (1916) it appears safe to conclude that the common house fly acts as the intermediate host of the tapeworm, *Choanotænia infundibulum*, infection of the fly apparently occurring as a result of swallowing the eggs of the tapeworm, and the chicken in turn acquiring the parasite as a result of swallowing flies infested with the cysticercoid stage. Whether infection of the fly regularly occurs during the larval or during the adult stage, or during both stages, has not been definitely settled.

Prophylaxis in the case of this tapeworm is obviously largely dependent upon fly control measures.

Other Tapeworms

According to Villot (1883) the larval tapeworm observed by Stein (1852) in the larva of *Tenebrio molitor* belongs to the tapeworm of the mouse, known as *Hymenolepis microstoma*. The same writer (1878, 1883) also associates with certain tapeworms of shrews, two species of larval tapeworms which he found in myriapods, *Glomeris limbata*. Further investigations of these parasites appear necessary to substantiate the views held by Villot as to their specific identity. Ackert (1918, 1919) has recently recorded some experiments in which chickens were given house flies and became infested with tapeworms (*Davainea cesticillus* and *D. tetragona*). The immature stages of these parasites were not, however, seen in the flies and the possibility is not excluded that the chickens became infected from some source other than the flies, notwithstanding the precautions taken against extraneous infection. Guberlet (1919) caught stable flies (*Stomoxys calcitrans*) in poultry yards where the chickens were commonly infested with *Hymenolepis carioca* (Magalhães, 1898) and fed them to young chicks with the result that some of them became infested with this tapeworm. He concludes that the stable fly possibly serves as an intermediate host of this tapeworm.

TREMATODA OR FLUKES

All species of flukes whose life history is known depend upon molluscs as hosts for certain larval stages, and they may or may not require one or more additional intermediate hosts before they reach the definitive host. It is as intermediate hosts following the first intermediate host, a mollusc, that insects can play a part in the propagation of flukes. As yet it has not been shown that insects are concerned in the life history of any of the flukes (about 100 known species) that affect human beings or domestic animals, but as the life history of all of these parasites has not been determined it is quite likely that in the case of some species insects will be found to act as intermediate hosts. Different species and groups of species show various types of life history with reference to the number of larval stages through which the parasite passes and the number of intermediate hosts required. A comparatively simple life cycle is as follows: The mature fluke in the definitive host produces eggs which pass to the exterior in the feces. Under suitable conditions of moisture and temperature the egg hatches and a ciliated larva, the *miracidium*, issues. If this *miracidium* finds a suitable mollusc (different species of molluscs

attract different species of miracidia) it burrows into the soft tissues of the mollusc and reaching the respiratory chamber proceeds to develop into the next stage, the *sporocyst*. Within the sporocyst by a process of internal budding more or less numerous so-called *redia* develop. The *redia* finally leave the sporocyst and migrate into the liver of the mollusc. In the *redia* several generations of daughter *redia* may develop by budding. The next stage, developed also by internal budding from the *redia*, is the *cercaria*. The *cercaria* of some species is provided with a tail by means of which it swims about in the water when it finally escapes from the mollusc. The *cercaria* may be swallowed by or actively penetrate into some animal and become encysted in this animal. Finally when the animal harboring encysted immature flukes is swallowed by an animal which can serve as a host of the adult fluke, the young flukes thus reaching their definitive host develop to maturity and the life cycle is complete.

Following is given a partial list of the insects in which young flukes have been recorded. The species to which the young flukes in question have been assigned and the final host animals are also indicated. Further investigations are likely to show that some of the flukes from insects have been misidentified and do not belong to the species to which they have been supposed to belong, and the data given in the list should not be accepted as fully proved in any case, though there can be no doubt in some of the cases cited. No distinction has been made between certain and doubtful cases, except that a few that are doubtful are indicated by question marks. The determination of species of young flukes found in insects has generally been made solely upon their morphological similarity to adults occurring in vertebrate hosts and it is quite likely that mistakes have been made by investigators of these parasites just as mistakes have frequently been made in the association of immature and adult parasites belonging to other groups of worms.

NEMATODA OR ROUNDWORMS

Among parasitic worms the species of nematodes are more numerous than either the species of tapeworms or flukes. Nematodes as a group are not exclusively parasitic and thousands of free-living species are known to exist, although comparatively few have been described. Many species of nematodes are parasites of insects only and do not occur in other animals. Insects therefore harbor parasitic nematodes which belong to them exclusively as well as the larval stages of nematodes that occur in higher animals in their adult stage. The ubiquity of free-living nematodes introduces a frequently troublesome complication into the study of the life histories of monoxenous parasitic nematodes of which there are many species, and the common occurrence of parasitic nematodes

RELATION OF INSECTS TO THE LIFE CYCLE OF FLUKES

Insect Host	Adult Fluke	Final Host
Coleoptera		
<i>Ilybius fuliginosus</i> (Fabricius) (adult)	<i>Haplometra cylindracea</i>	Frogs
Water beetle (larva)	<i>Prototocus confusus</i>	"
" " "	<i>Pleurogenes medians</i>	"
	" <i>claviger</i>	"
Lepidoptera		
<i>Nymphula nymphæata</i> (Linnæus) (larva)	Unknown	Unknown
Diptera		
<i>Anopheles maculipennis</i> Meigen (<i>claviger</i> Fabricius) (adult)	"	"
<i>Anopheles rossi</i> Giles (adult)	"	"
<i>Chironomus plumosus</i> Linnæus (larva)	<i>Lecithodendrium ascidia</i>	Bats
<i>Culex quinquefasciatus</i> Say (<i>fatigans</i> Wiedemann) (adult)	Unknown	Unknown
Trichoptera		
<i>Anabolia nervosa</i> (Leach) Curtis	<i>Allocreadium isoporum</i>	Cyprinoid fishes
<i>Anabolia nervosa</i> (larva)	<i>Opisthioglyphe rastellus</i>	Frogs
<i>Chætopteryx villosa</i> (Fabricius) (larva)	<i>Allocreadium isoporum</i>	Cyprinoid fishes
<i>Drusus trifidus</i> McLachlan (larva)	Unknown	Unknown
<i>Limnophilus rhombicus</i> (Linnæus) (larva)	<i>Opisthioglyphe rastellus</i>	Frogs
" <i>griseus</i> (Linnæus) (larva)	" "	"
" <i>lunatus</i> (Curtis) (larva)	" "	"
" <i>flavicornis</i> (Fabricius) (larva)	" "	"
<i>Mystacides nigra</i> (Linnæus) (larva)	Unknown	Unknown
<i>Notidobia ciliaris</i> (Linnæus) (larva)	"	"
<i>Phryganea</i> sp.	<i>Lecithodendrium chilostomum</i>	Bats
<i>Phryganea grandis</i> (larva)	Unknown	Unknown
<i>Rhyacophila nubila</i> Zetterstedt (larva)	"	Bats
Neuroptera		
<i>Sialis lutaria</i> (Linnæus) (larva)	"	Unknown
Odonata		
<i>Æschna</i> (larva and adult)	<i>Prototocus confusus</i>	Frogs
<i>Agrion</i> (larva)	<i>Gorgodera pagenstecheri</i>	"
" "	" <i>varsoviensis</i>	"
" "	<i>Pleurogenes medians</i>	"
<i>Calopteryx virgo</i> (Linnæus) (larva and adult)	<i>Halipegus ovocaudatus</i>	"
" "	<i>Pneumonæces similis</i>	"
<i>Cordulia</i> (larva)	<i>Prototocus confusus</i>	"
<i>Epithea</i> "	<i>Gorgodera cygnoides</i>	"
" "	" <i>pagenstecheri</i>	"
" "	" <i>varsoviensis</i>	"
Plecoptera		
<i>Cloeon dipterum</i> (Linnæus) Stephens (larva)	? <i>Opisthioglyphe rastellus</i>	"
<i>Ephemera vulgata</i> Linnæus (larva)	<i>Allocreadium isoporum</i>	Cyprinoid fishes
" " "		
" " "	? <i>Opisthioglyphe rastellus</i>	Frogs
Ephemeridæ (larva)	<i>Lecithodendrium ascidia</i>	Bats
Plecoptera		
Perlidæ (larva)	<i>Lecithodendrium ascidia</i>	"
" "	Unknown	Unknown

among insects introduces an equally troublesome complication into the study of the life histories of the heteroxenous nematodes parasitic in higher animals, for which insects may serve as intermediate hosts. About 250 species of nematodes have been recorded as parasites of man and domestic animals. Many of these require no intermediate hosts, but some are heteroxenous parasites, and a number of these are known to have intermediate stages in insects and closely related arthropods. In the following discussion, in addition to the nematodes parasitic in man and domestic animals, certain species parasitic in other animals are also considered because of the part played by insects in their life history. For convenience they may be placed in two groups, (1) those in which the eggs or first-stage larvæ leave the body of the final host in the feces, and (2) those in which the first-stage larvæ occur in the blood or lymph of the final host and leave the body through ingestion by bloodsucking insects.

1. *Parasitic Nematodes Whose Eggs or Larvæ Leave the Body of the Final Host in the Feces*

Protospirura muris (Gmelin, 1790) Seurat, 1915

This nematode, parasitic in its adult stage in the stomach of various species of rats and mice, is of special interest historically as being the first parasite in whose transmission to its final host an insect was found to be concerned. Stein in 1852 recorded the presence of encysted nematodes in the larvæ of meal beetles (*Tenebrio molitor*). Leuckart (1867) and Marchi (1867) fed eggs of *Protospirura muris* (*Spiroptera obtusa*) to meal beetle larvæ and followed the development of the young nematodes up to the encysted stage found by Stein. This development is completed in about six weeks after ingestion of the eggs. The development to the adult stage was also followed in mice fed with the encysted nematodes from meal worms. Johnston (1913) has recorded encysted nematode larvæ which appeared to him identical with those of *P. muris* in the body cavity of a rat flea (*Xenopsylla cheopis*).

Spirocerca sanguinolenta (Rudolphi, 1819) Railliet & Henry, 1911

The adults of this nematode live in tumors of the stomach and esophagus of the dog and the wolf. The eggs unhatched pass out of the body of the dog in the feces. Grassi (1888) found encysted larval nematodes in cockroaches (*Blatta orientalis*) which he suspected were the larvæ of *S. sanguinolenta*. Dogs fed with these encysted nematodes after five days showed the larvæ free in the stomach; after ten days the young worms were further developed and were firmly attached to the mucosa

of the esophagus; and after fifteen days they had sunk themselves into the wall of the esophagus and had developed still further. Grassi concluded that cockroaches act as intermediate hosts, swallowing the eggs in the feces of infested dogs, and in turn being swallowed by dogs. Seurat (1913), however, believes that Grassi was mistaken as to the identity of the encysted nematodes found in the cockroaches, and that they were really the larvæ of *Spirura gastrophila*, the adult of which occurs in the stomach of the cat, hedgehog (*Erinaceus algirus*), and fox (*Vulpes vulpes atlantica*). Seurat (1912, 1916) finds what he considers to be the larvæ of *S. sanguinolenta* encysted in a great variety of animals including beetles, reptiles, birds, and mammals. The presence of the encapsulated larvæ in various vertebrates he explains as the result of the ingestion of insects infested with the larvæ. If the vertebrate is not a host in which the parasites can continue their development as they would in their normal host the dog, they migrate into the wall of the alimentary tract or mesentery and become reencysted without further development. If, however, the infested insect is swallowed by a dog the larvæ, after they have been freed by digestion of the cysts surrounding them, continue their development and finally reach maturity. Seurat in fact found that encysted larvæ in insects identified as those of *S. sanguinolenta* when fed to mice became reencysted in the manner described. Seurat (1916) records the following insects as hosts of the larvæ of *S. sanguinolenta*, all of them beetles: *Scarabæus (Ateuchus) sacer*, *Scarabæus (Ateuchetus) variolosus*, *Akis goryi*, *Geotrupes douei*, *Copris hispanus*, and *Gymno-pleurus sturmi*. According to Seurat the life cycle of *S. sanguinolenta* would be as follows: The eggs pass out of infested dogs in the feces, are ingested by beetles, hatch, and the larvæ after a period of growth and development become encysted. If infested insects are swallowed by dogs or wolves the larval worms are released from their capsules and develop to maturity. If the insects are swallowed by other animals, the larvæ may become freed from their cysts as in the alimentary tract of the dog, but they are unable to develop further and leave the lumen of the alimentary tract and become reencysted in the tissues to which they migrate. In such a case, of course, there is a possibility of their resuming their development if the infested animal should afterwards be devoured by a dog or a wolf, but this possibility apparently has not yet been substantiated.

Spirura gastrophila (Mueller, 1894) Marotel, 1912

This nematode in the adult stage occurs in the stomach and the lower end of the esophagus of the cat. It has also been recorded by Seurat (1913) from the stomach of a hedgehog (*Erinaceus algirus*) and the stomach and esophagus of a fox (*Vulpes vulpes atlantica*), and by the

same author (1918) in the esophagus of the mongoose (*Herpestes ichneumon*). This author identifies certain encysted larval nematodes found in a species of *Onthophagus*, in *Blatta orientalis*, in *Blaps strauchi*, and in *Blaps* sp. (near *appendiculata*) as belonging to *S. gastrophila*. He thinks the parasites found in the cockroach and called *Filaria rytipleurites* by Deslongchamps (1824), and those identified as such by Galeb (1878) who associated them with an insufficiently described adult nematode of the rat, are probably the same as those he identified as the larvæ of *S. gastrophila*. He also dismisses Grassi's experiments as insufficient to show that the nematodes encysted in cockroaches are the larvæ of *Spirocerca sanguinolenta* as Grassi believed, and concludes that Grassi was mistaken and was really dealing with the larvæ of *Spirura gastrophila*. Seurat (1919) adds *Akis goryi* to the list of insect hosts of the larvæ of *S. gastrophila*.

Gongyлонema scutatatum (Mueller, 1869) Railliet, 1892

This nematode in the adult stage is a common parasite in the mucous membrane of the esophagus of cattle, sheep, and other ruminants, and has also been recorded from the horse. Ransom and Hall (1915, 1916, 1917) have shown that various species of dung beetles (*Aphodius femoralis*, *A. granarius*, *A. fimetarius*, *A. coloradensis*, *A. vittatus*, *Onthophagus hecate*, and *O. pennsylvanicus*) act as intermediate hosts. Experimentally, cockroaches (*Blattella germanica*) can also be made to serve as intermediate hosts, a part of course which they do not play under natural conditions. The eggs of the parasite pass out of the body of the definitive host in the feces and are swallowed by dung beetles. They hatch in these insects, and the larvæ entering the body cavity undergo a certain growth and development, reaching their infective stage in about a month, meanwhile becoming enveloped in capsules in which they lie in a coiled-up position. Further development waits upon the swallowing of the infested insect by a cow, sheep, or other suitable host as may readily occur while the animal is grazing, the insect being ingested with the herbage upon which it happens to be. Following their ingestion by the definitive host, the larvæ are released from their capsules and develop to maturity. Seurat (1916) has described some larval nematodes from the abdominal cavity of *Blaps strauchi*, *Blaps appendiculata*, and *Blaps* sp. (near *appendiculata*) in Algeria that he identifies as *Gongyлонema scutatatum*. As pointed out by Ransom and Hall (1917), however, these evidently belong to another species as they do not correspond to the forms shown by these writers to be the larvæ of *G. scutatatum*. Seurat (1919) adds *Blaps emondi* to the list of insects in which he has found the larvæ in question.

Gongylonema mucronatum Seurat, 1916

This nematode occurs in the adult stage in the mucosa of the esophagus of the Algerian hedgehog (*Erinaceus algirus*). According to Seurat (1916) its larval stage is found encapsuled in the body cavity of various species of coprophagous beetles, *Ateuchus sacer*, *Chironitis irroratus*, *Onthophagus bedeli*, *Gymnopleurus mopsus*, *Gymnopleurus sturmi*, and *Geotrupes douei*, but there appears to have been some confusion as to the identity of the larvæ in question, and further investigation of the life history of this species is desirable (Ransom and Hall, 1917).

Gongylonema brevispiculum Seurat, 1914

Seurat (1916), in addition to forms found in different species of *Blaps* that he considers to be third stage larvæ of *Gongylonema scutatatum*, has described as second stage larvæ of *G. scutatatum* some larval nematodes found encysted in the abdominal cavity of *Blaps* sp. and *Blaps strauchi* in certain localities in Algeria. In a later paper, however (1919), he has expressed the opinion, based upon the morphology of the worms and a knowledge of the mammalian fauna in the region in which the parasites are found, that these larvæ are third stage larvæ and belong to the species *G. brevispiculum* the adult of which occurs parasitic in the cardiac portion of the stomach of a species of jerboa (*Dipodillus campestris*).

Further investigation seems desirable as to the identity of the supposed larvæ of *Gongylonema brevispiculum* as well as of the other larvæ of *Gongylonema* that have been assigned to various species on a basis of apparent morphological similarities and general considerations. A continuation of the excellent work already done by Seurat relating to the larval forms of *Gongylonema* will no doubt clear up the confusion that now exists.

Gongylonema neoplasticum (Fibiger and Ditlevsen, 1914) Ransom and Hall, 1916

This nematode occurs in the adult stage in the mucosa of the stomach, esophagus and mouth of the rat. It has been reared experimentally in the rabbit and guinea pig as well as in the rat and mouse. It is of special interest from the medical standpoint because it is commonly associated with and perhaps stands in etiological relationship to gastric carcinoma of rats. Fibiger and Ditlevsen (1914) have proved that cockroaches (*Periplaneta americana*, *Blatta orientalis*, and *Blattella germanica*), and a grain beetle (*Tenebrio molitor*) can act as intermediate hosts. The eggs are passed in the feces of infested rats and if ingested by one

of the insects named will hatch, the larvæ within twenty days after ingestion of the eggs developing to the infective stage. In this stage the larvæ are coiled up in cysts in the muscles of the prothorax and legs, differing in location from the larvæ of *G. scutatum* which in artificially infected cockroaches, as in their normal hosts, dung beetles, are found encysted in the body cavity.

Arduenna strongylina (Rudolphi, 1819) Railliet and Henry, 1911

This nematode in its adult stage occurs in the stomach of the pig. Seurat (1916) has recorded the presence of larval nematodes in the stomach of a pig associated with adults of *A. strongylina* which he considers belong to this species. He has found morphologically similar larval nematodes encapsuled in the body cavity of *Aphodius rufus castaneus* and states that they also occur in beetles of the genus *Onthophagus*. Apparently no feeding experiments have been carried out. Presumably the life history would be similar to that of *Gongylonema scutatum*, *Protospirura muris*, etc., that is, the eggs of the parasite passed in the feces are swallowed by beetles, the larvæ develop in these insects to the infective stage, and are transferred to the definitive host when the beetles are swallowed by a pig, after which the young worms complete their development to maturity. Seurat (1919) records the presence of encysted larvæ of *A. strongylina* in the stomach wall of the Algerian hedgehog (*Erinaceus algirus*). Apparently, therefore, the larvæ of this species that occur encysted in insects, like those of *Physocephalus sexalatus* and *Spirocerca sanguinolenta*, if ingested by vertebrates other than the normal hosts of the adult worms, migrate out of the lumen of the digestive tract and become reencysted in the neighboring tissues.

Physocephalus sexalatus (Molin, 1860) Diesing, 1861

The adults of this nematode live in the stomach of the pig, dromedary, and donkey. Seurat (1913) has found two successive larval stages preceding the adult in the stomach of the definitive host (donkey) and has also (1916) established the common occurrence of the earlier of these two stages in various dung beetles (*Scarabæus* [*Ateuchus*] *sacer*, *S.* [*Ateuchetus*] *variolosus*, *Geotrupes douei*, *Onthophagus nebulosus* and *O. bedeli*). Pigs of course are commonly known to be coprophagous in their feeding habits and Seurat states that the donkeys of Algeria, where his investigations were made, commonly devour fecal matter swarming with dung beetles. The way in which the larvæ of *P. sexalatus* reach their final host is therefore evidently through the ingestion of infested beetles by pigs, donkeys, or dromedaries. Presumably of course the beetles be-

come infested by eating the eggs of the parasite which are passed in the feces of infested pigs, donkeys, and dromedaries. As in the case of *Spirocerca sanguinolenta* Seurat finds encysted larvæ of *P. sexalatus* in various vertebrates in Algeria, particularly reptiles and insectivores. Their presence in these animals he would explain in the same way as he explains the presence of the encysted larvæ of *S. sanguinolenta* in such animals, that is, the larvæ present in insects devoured by the animals in question are unable to continue their development as they would in pigs and other suitable hosts. On the other hand they do not succumb in their strange environment nor do they pass through the alimentary tract with the feces but penetrate into the walls of the stomach and into other tissues and become reencysted, surviving in this condition more or less indefinitely. They may thus be considered parasites that have gone astray but still capable of existence in their abnormal environment. The possibility of their developing to maturity after reencystment in a strange host if this animal should be eaten by a pig has not been substantiated experimentally.

Seurat (1916) has counted 4,880 larvæ identified as *P. sexalatus* in a single beetle, *Scarabæus (Ateuchus) sacer*. In addition there were 68 larvæ of *Spirocerca sanguinolenta* in the same beetle, making a total of 4,948 larvæ in the one insect.

Habronema muscæ (Carter, 1861) Diesing, 1861

This nematode in the adult stage occurs in the stomach of horses and other equines, commonly in association with another closely related species, *H. microstoma*. The life history of *H. muscæ* has been shown to be as follows (Ransom, 1911, 1913; Hill, 1918; Bull, 1919): The eggs or the larvæ pass out of the body of the host in the feces. They enter the bodies of the larvæ of the common house fly, probably being swallowed, though the mode of entrance has not been determined by direct observation. The worm larvæ grow and develop in the developing flies and at about the time the adult insects emerge from the pupal stage the larvæ reach the infective stage. In this stage they are most commonly found in the proboscis. The ingestion by horses of flies harboring the larvæ brings the young parasites into the location where the adult occurs, and presumably this is the common method by which the larvæ reach their final host. The frequent swallowing of flies by horses is an undoubted fact. The mouths of horses are very attractive to house flies especially while the horses are eating, as any one can determine by a few minutes' observation of the animals during the fly season. There is also another possible and very probable way in which the larvæ are transferred to horses, suggested of course by the habit of the larvæ of congregating in the proboscis of the fly. We may expect that it will be demonstrated

in analogy with what has been shown to occur in *Filaria* transmission by mosquitoes, that the larvæ of *H. muscæ* can actively leave the proboscis of the fly while the insect is sucking moisture from the mouth or lips of the horse. There is already indirect evidence that this does occur. The researches of Descazeaux (1915), Bull (1916), and Van Saceghem (1917) have shown that the nematodes which occur in cutaneous granulomata and so-called summer sores of horses are morphologically similar to the larvæ of *Habronema muscæ* and in all probability belong to this or a closely related species. Recently Van Saceghem (1918) from investigations carried out in Africa has reached the conclusion that the nematode of summer sores is *Habronema muscæ* and that it is introduced by flies. Larvæ from infested flies were placed in the eye of a horse kept in an insect-proof enclosure, with the result that conjunctivitis and verminous nodules of the nictitating membrane developed. In another experiment two wounds were made on the skin of a horse, one protected against flies and the other left uncovered. The horse was placed in a stable in which 20 per cent of the flies were infested with *Habronema*. The unprotected wound became transformed into a typical summer sore. Bull (1919), who has made an extended study of cutaneous granulomata of horses in Australia, believes that the larvæ of *Habronema megastoma* are more often responsible for the production of habronemic granulomata than either *H. muscæ* or *H. microstoma*.

Whether the *Habronema* larvæ in summer sores are able to migrate ultimately to the stomach and complete their development to maturity remains to be determined. Bull (1919) thinks it unlikely that the larvæ of *Habronema* are able to reach the alimentary canal from the submucosa of the external mucous membranes or from the subcutaneous tissues, and Hill (1918) also notes that the evidence of the occurrence of such a migration is quite insufficient.

It is of interest to note that *Habronema muscæ* was known as a parasite of the fly long before its relation to the horse was demonstrated. Carter in 1861 was the first to record the presence of the nematodes in flies, following which they were frequently observed by entomologists and others who had occasion to examine the proboscis of the fly under the microscope.

Larval nematodes very similar to *H. muscæ* have been seen in the proboscis of *Stomoxys calcitrans* by Johnston and others. The researches of Hill (1918) and Bull (1919) have shown that as far as their experience has gone the larvæ in this species of fly have invariably been *Habronema microstoma* so that the occurrence of *H. muscæ* in *S. calcitrans* appears questionable.

The fact that these more or less injurious parasites of the horse depend upon flies for their existence is a point which may be added to

those commonly used in arguments for the necessity of fly eradication. The possibility is also not excluded that flies may introduce *Habronema* larvæ into human beings, in whose tissues they may perhaps be able to live for a time and do considerable damage. Though there is no evidence that this ever occurs, the possibility is one that deserves consideration from those who have opportunity to investigate the relation of flies to wounds and other lesions of the skin and mucous membranes.

Habronema microstoma (Schneider, 1866) Ransom, 1911

Hill (1918) and Bull (1919) have shown that *Habronema microstoma*, which, like *H. muscæ*, occurs in the adult stage in the stomach of the horse and other equines, has a life history similar to that of *H. muscæ*. Both of these writers have occasionally observed the presence of *H. microstoma* in *Musca domestica* under experimental conditions but find that the usual intermediate host is *Stomoxys calcitrans*. As they repeatedly failed to infect *S. calcitrans* with the larvæ of *H. muscæ* it is probable that the forms from *S. calcitrans* reported by Johnston (1912) and others as *H. muscæ* were *H. microstoma*. Bull (1919) is of the opinion that the larvæ of *H. microstoma* may sometimes be concerned in the production of cutaneous granulomata of horses and that presumably they are introduced into the skin by the proboscis of an infested fly.

Habronema megastoma (Rudolphi, 1819) Seurat, 1914

Habronema megastoma in its adult stage occurs in tumors in the stomach of horses and other equines. Hill (1918) and Bull (1919) have found that its life history is similar to that of *H. muscæ*, the house fly (*Musca domestica*) acting as intermediate host in both cases. Attempts to infect *Stomoxys calcitrans* with this species failed. Bull (1919) believes that the larvæ of *H. megastoma* introduced by infested flies are the usual cause of habronemic granuloma of horses. So far as the normal life history of *H. megastoma* is concerned he thinks that the presence of the larvæ in the skin or mucous membranes of horses is to be considered accidental and that it is unlikely that they can reach the alimentary tract from such locations and become mature. According to his view, therefore, which is shared by Hill (1918), *H. megastoma* and also the other species of *Habronema* reach the stomach of the horse as a result of the animal's swallowing infested flies.

Acuaria spiralis (Molin, 1858) Railliet, Henry and Sisoff, 1912

The adults of this nematode have been recorded as parasitic in the esophagus and stomach of the domestic fowl. Insects have not been

shown to act as intermediate hosts, but insect-like animals commonly known as sow-bugs apparently act as intermediate hosts, Piana (1897) having found larval nematodes in an isopod (*Porcellio laevis*) that corresponded in morphology with immature nematodes found in chickens harboring also the adult worms. Furthermore these larval nematodes occurred in sow-bugs only in the locality where the chickens were found to be infested. Although Piana identified the parasites that he found in chickens as *Dispharagus nasutus* (Rudolphi), it is apparent from his description and figures that they belonged to the species *Acuaria spiralis* (Molin).

Filaria gallinarum Theiler, 1919

Theiler (1919) has recorded the occurrence of larval nematodes in a species of termite (*Hodotermes pretoriensis*). Among the termites only the workers were found to harbor these parasites, no infested soldiers having been discovered. Infested termites can easily be distinguished by the swollen abdomen which gives the insect a sort of balloon-like appearance. According to Theiler, on many South African farms the custom exists of digging up nests of termites and allowing the chickens to feed on the insects, and the droppings of chickens running in the fields are naturally scattered about and serve as food for the termites. Infested termites were fed to young chickens that had been hatched in an incubator. Adult worms that had evidently developed from the larvæ parasitic in the termites were found in the intestine or stomach in 15 out of 16 chickens that had been thus fed, but none were found in control chickens. The proper generic position of this nematode described by Theiler as a *Filaria* remains to be determined.

Ascaris lumbricoides Linnæus, 1758

This common parasite of man has been definitely shown to have a direct life history without intermediate host. The opinion of Linstow (1886) that a species of *Julus* (*guttulatus*) acts as the intermediate host is without foundation. The common house fly may swallow eggs of this parasite as well as those of various other parasites which occur in the feces of infested human beings. The eggs pass through the intestine of the fly unhatched. Flies may thus scatter the eggs of *Ascaris* but there is no evidence that mechanical carriage of the eggs in this way assists materially in the spread of the parasite. There are various other natural agencies more effective than insects in spreading infection with parasites such as *Ascaris*. Stiles, however (according to Nuttall, 1899), fed females of *Ascaris lumbricoides* containing eggs to fly larvæ (*Musca domestica*) and afterwards found the eggs in later stages of development

in the pupæ and adult flies that developed from the larvæ. This suggested the possibility that flies having become infested as larvæ might convey the parasite to man by falling into or depositing their excreta on food. Apparently these experiments have not been repeated.

2. *Parasitic Nematodes Whose First-stage Larvæ Occur in the Blood or Lymph of the Final Host and Leave the Body Through Ingestion by Bloodsucking Insects*

Filaria bancrofti Cobbold, 1877

This important parasite of man is widely distributed throughout the world in tropical and subtropical countries. It occurs in the United States, though apparently it is by no means common. Historically it is of special interest because of the fact that it is the species which Manson (1878) showed passed through certain metamorphoses in the bodies of mosquitoes after the larvæ had been sucked up by these insects in the blood of human beings affected with filariasis. Manson's researches coupled with confirmatory work by other investigators established the novel fact of the transmission of an animal parasite by a bloodsucking insect, and may be taken as the starting point in the development of our knowledge concerning the part played by such insects in the spread of disease-causing organisms. Lewis had also observed the passage of the larvæ from the human host into mosquitoes. The first observation of these larvæ in man was recorded by Demarquay in 1864 in Paris, the adult female was discovered by Bancroft in 1876 in Queensland, and the adult male by Bourne in 1888.

The adults of this species live in the lymphatic system, both vessels and glands. The first-stage larvæ which are provided with a thin cuticular sheath, apparently the transformed egg shell, are found in the blood stream, usually periodically as first shown by Manson, that is, in considerable numbers only at night or rather during the hours of sleep, as the periodicity may be reversed by making the patient sleep during the day time. One of the names of the parasite, *Filaria nocturna*, is based upon the periodicity of the appearance of the larvæ in the blood. Various pathological conditions have been attributed to *Filaria bancrofti* such as adenitis, lymphangitis, abscesses, lymph scrotum, chyluria, and other disturbances of the lymphatic system. The connection between filariasis and elephantiasis is still a matter of argument among pathologists.

When taken into the stomach of a mosquito the larvæ lose their cuticular sheaths. Within 24 hours they leave the alimentary tract, pass into the body cavity, then into the muscles of the thorax. In the muscles they become shortened to about half their original length and meanwhile

increase to twice or more than twice their original thickness, developing into what is known as the sausage stage of general occurrence in the development of *Filaria* larvæ. Developing beyond this stage they increase rapidly in length, cast their skins at least once, and in one to two weeks after infection of the mosquito, or longer, according to temperature and the species of mosquito infected, they complete their larval development so far as the intermediate host is concerned, reaching a length finally about three to five times the length of the first-stage larvæ and a thickness about three or four times the original thickness. They leave the muscles, enter the body cavity, and migrate into various locations, posterior portions of the body, legs, palpi, but in greatest numbers into the labium. From the evidence afforded by the experiments of Noè (1900) with *Dirofilaria immitis* and additional experiments by Bancroft (1901), Lebedo (1904-1905), Fülleborn (1908), and others, it has been concluded by analogy in the case of *Filaria bancrofti* that when an infected mosquito bites a human being the filaria larvæ bore through a thin portion of the labium known as Dutton's membrane, and more rarely other thin portions of the proboscis, actively penetrate the skin of the individual attacked, and reach the lymphatic system where they complete their development to maturity.

Both anopheline and culicine mosquitoes can serve as intermediate hosts of *Filaria bancrofti* including the following species (see also Chapter XVII):

Anopheline mosquitoes

- Anopheles (Myzomyia) rossi* Giles.
 " (*Pyretophorus*) *costalis* Loew.
 " (*Myzorhynchus*) *sinensis* Wiedemann.
 " " " *peditæniatus* Leicester.
 " " *barbirostris* Van der Wulp.

Culicine mosquitoes

- | | |
|---|---|
| <i>Culex pipiens</i> Linnaeus | <i>Aedes argenteus</i> Poirret (<i>Stegomyia calopus</i> Meigen) |
| " <i>quinquefasciatus</i> Say (<i>fati-gans</i> Wiedemann) | <i>Aedes gracilis</i> Leicester (<i>Stegomyia</i>) |
| " <i>gelidus</i> Theobald | <i>Aedes scutellaris</i> Walker (<i>Culex albopictus</i> Skuse) |
| " <i>sitiens</i> Wiedemann | <i>Mansonioides uniformis</i> Theobald |
| | <i>Mansonioides annulipes</i> Theobald |
| | <i>Scutomyia albolineata</i> Theobald |
| | <i>Taeniorhynchus domesticus</i> Leicester |

Besides those named about a dozen other species of mosquitoes have been tested as hosts of *Filaria bancrofti* with negative results, or with results showing that the parasites would only develop imperfectly. Fleas, lice, and Stomoxys have been tested with negative results.

Prophylaxis against *Filaria bancrofti* evidently consists in measures similar to those employed in malaria eradication with reference to mosquito control.

Filaria (Loa) loa (Cobbold, 1864)

This parasite of man is a West African species. It has been brought to America in the slave trade but never established in the New World. The adults live usually in the subcutaneous connective tissue but have been found elsewhere in relation with the serous membranes of the abdominal and thoracic viscera. They move about from place to place and can change their location rather rapidly; for example, one of these worms has been seen to cross the bridge of the nose beneath the skin within a period of an hour or two. In their progress beneath the skin in various parts of the body they give rise to transient edematous areas known as Calabar swellings. The larvae produced by the females enter the blood stream where they are found in the peripheral vessels during the day time, contrary to the habits of the larvae of *Filaria bancrofti*. Because of this characteristic periodicity of the larvae, *Filaria loa* has been also named *F. diurna*. The larvae of *F. loa* are provided with a sheath relatively much longer than that of the larvae of *F. bancrofti*.

Experiments with various anopheline and culicine mosquitoes, and *Glossina palpalis* have given negative results as to the possibility of these insects acting as intermediate hosts. From Leiper's (1913) researches, it would appear that a species of *Chrysops* (probably *C. dimidiata* or *C. longicornis*) acts as the intermediate host of *Filaria loa*, the larvae undergoing their development in the salivary glands of the insect. According to Ringenbach and Guyomarc'h (1914), the intermediate host in the Congo is *Chrysops centurionis*. Kleine (1915) in West Africa found 32 out of 600 *Chrysops* examined to be infested with larval nematodes which he took to be the larvae of *F. loa* though he does not give sufficient evidence to support his claims.

Filaria demarquayi Manson, 1895

This parasite, generally considered identical with *Filaria juncea* and *F. ozzardi*, occurs in man in the West Indies and in British Guiana. The adult has been found in the mesentery and under the peritoneum of the abdominal wall. The first-stage larvae occur in the blood stream. Their appearance in the circulation is not periodic. According to Low (1902)

the larvae can be developed to the so-called "sausage" stage in *Aedes argenteus* (*Stegomyia calopus*). Experiments with *Anopheles albimanus* (*albipes*), *Culex taeniatus*, *C. quinquefasciatus* (*fatigans*), and other mosquitoes, fleas, and ticks failed to result in any development of the larvae. Fülleborn (1908) was able to develop the larvae to the sausage stage in *Anopheles maculipennis* and *Aedes argenteus* (*Stegomyia calopus*), but no development occurred in the tick, *Ornithodoros moubata*. Further investigations are necessary to determine what insects serve as intermediate hosts for *F. demarquayi*.

Filaria philippinensis Ashburn and Craig, 1906

The adult stage of this parasite of man is unknown. The first-stage larvae occurring in the blood of man are morphologically identical with those of *Filaria bancrofti*. Unlike the latter, however, they show no periodicity. Ashburn and Craig (1907) have shown that the larvae will undergo development in mosquitoes, *Culex quinquefasciatus* (*fatigans*), similar to that of the larvae of *F. bancrofti*. It is questionable whether *F. philippinensis* should be recognized as a distinct species.

Filaria tucumana Biglieri and Aráoz, 1917

This species, the adults of which are unknown, is based on microfilariae found frequently in the blood of human beings in Argentina. It appears to be comparatively harmless. Biglieri and Aráoz (1917) conclude that mosquitoes act as intermediate hosts and apparently consider *Aedes argenteus* (*Stegomyia calopus*) the most important vector, though definite proof of this has not been obtained.

Filaria cypseli. Annett, Dutton and Elliott, 1901

The adult stage of *Filaria cypseli* occurs in the subcutaneous tissue of the head of the swift, *Cypselus affinis*, also beneath the subcranial fascia. The embryos or first-stage larvae occur in the lymph and rarely in the peripheral blood of infested birds. Dutton (1905) has described various larval stages of the parasite which he finds in an undetermined species of bird-louse belonging to the subfamily Leiothinae that occurs on swifts. The first-stage larva as it is found in the blood of the bird and the stomach of the louse is provided with a sheath as in various other species of *Filaria*. This sheath is lost and the larva probably soon penetrates the stomach wall. The next stage of the parasite is found in the fat-body of the louse as are two later stages described by Dutton. The last stage of development seen by him is found free in the body

cavity and this is probably the stage in which the parasite is transferred to the bird; whether as a result of ingestion of the louse by the swift, or as a result of the active migration of the worm from the louse while the insect is engaged in biting, has not been determined.

Filaria martis Gmelin, 1790

Filaria martis (or *Filaria quadrispina*) according to various writers occurs in its adult stage beneath the skin and in the abdominal and thoracic cavities of *Mustela foinea*. Baldasseroni (1909) has found filaria embryos in the intestine of ticks (*Ixodes ricinus*) taken from a marten harboring the adult nematode, and he suggests that ticks may act as intermediate hosts. As in the case of *Acanthocheilonema grassii*, further evidence is necessary before ticks can be considered to play a part in the life history of *Filaria martis*.

Dirofilaria immitis (Leidy, 1856) Railliet and Henry, 1911

This nematode, sometimes erroneously listed as a parasite of man, lives in the right side of the heart and pulmonary artery of the dog. The larvae are found in the circulation, most numerous at night as in the case of *Filaria bancrofti*. As would be expected from the location of the adult parasite it may give rise to serious symptoms, and affected dogs commonly succumb to the disturbances which it causes. It is a troublesome parasite among hunting dogs in the Southern United States. Noè (1900) showed that the larvae of this nematode continue their development in certain species of mosquitoes when sucked up with the blood of infested dogs. In 24 to 36 hours after reaching the stomach of the mosquito the larvae pass into the Malpighian tubules. They undergo a certain growth and development in this location, and 11 or 12 days after reaching the mosquito they break out of the tubules, enter the body cavity, and migrate to the labium. From the labium of the mosquito they reach their final host, the dog, in the same manner as *F. bancrofti* reaches its human host, namely, by breaking through thin portions of the cuticle of the labium at the time the mosquito is engaged in biting its victim and then penetrate the skin, finally migrating to the heart. Mosquitoes infested with the larvæ of *D. immitis* are commonly killed by the parasites owing to their destructive action on the Malpighian tubules, Noè having observed that only about half the mosquitoes that become infested survive. In Italy the common intermediate hosts appear to be *Anopheles maculipennis*, *A. bifurcatus*, *A. (Myzorhynchus) sinensis pseudopictus*, and *A. (Myzomyia) superpictus* among anophelines; culicines, according to Noè such as *Culex penicillaris*, *C. malariae*, and exceptionally *C. pipiens*, can also act as intermediate hosts.

Dirofilaria repens, Railliet and Henry, 1911

In the adult stage this nematode, which is a very similar parasite to *D. immitis*, occurs in the subcutaneous connective tissue of the dog. Its larvae enter the blood stream whence they are liable to be ingested by blood-sucking insects. According to Bernard and Bauche (1913) the yellow fever mosquito *Aedes argenteus* (*Stegomyia calopus*) acts as the intermediate host. These investigators while admitting that other species of mosquitoes might act as intermediate hosts of *D. repens*, found that *A. argenteus* best fulfilled the natural conditions for the transmission of the parasite, and their experiments were carried out with this species of mosquito. They followed the various stages in the development of the larval nematodes in mosquitoes fed experimentally upon infested dogs. About 2 days after the mosquito has been fed the nematode larvae leave the lumen of the alimentary tract and penetrate into the Malpighian tubules where they undergo most of their growth and development. By the eighth day the larvae may be found in some cases to have migrated into the body cavity and thoracic muscles and the last stage of development in mosquitoes may be found in the proboscis as early as the ninth day. Six young dogs (10 days old) were submitted to the bites of *A. argenteus* (fed 10 to 15 days previously on infected dogs) every morning for fifteen days. Six young dogs of the same age were kept as controls, not exposed to mosquito bites. The bitten dogs all died within thirty days. Ecchymotic spots were found beneath the skin at the points of the mosquito bites, but no filarias were discovered. The other dogs all survived the experiment. Under natural conditions the youngest dogs found infested with *D. repens* by Bernard and Bauche were at least a year old, hence the writers conclude that the development of the parasite is very slow. Although they did not succeed in completing their experiments by recovering the adult stage of the parasite in dogs, following bites by infected mosquitoes, it appears safe to conclude that *D. repens* is transmitted by mosquitoes in a manner similar to that in which *D. immitis* is transmitted.

Acanthocheilonema perstans (Manson, 1891) Railliet, Henry and Langeron, 1912

This parasite occurs in man in tropical Africa and British Guiana, the adults in the intraperitoneal connective tissue and fatty tissue of the abdominal viscera and pericardium, and the first-stage larvae in the blood stream. The larvae exhibit no periodicity in their appearance in the circulation, the name *perstans* having reference to this fact.

Christy (1903) has suggested that *Ornithodoros moubata* may act as

the intermediate host of *Acanthocheilonema perstans*. Wellman (1907) has reported that the larvae of this parasite are taken up by *Ornithodoros moubata* and according to his statements develop very slowly in this tick, advanced stages not being found until more than two months after infection of the tick. The suggestion made by Feldmann (1905), influenced by Bastian (1904), that the larvae of *A. perstans* may pass out of the body of the tick with its eggs into bananas and afterwards being swallowed with this fruit by human beings is a mode of infection which requires no consideration as a possibility without more supporting evidence than has yet been advanced.

Hodges (1902) observed *Filaria* larvae in the thoracic muscles of the mosquitoes, *Panoplitus* sp. and *Aedes argenteus* (*Stegomyia calopus*), three days after they had been fed on *perstans* blood. Low (1903) was able in one case to obtain development of *perstans* larvae to the sausage stage in a mosquito (*Chrysoconops fuscopennatus*). Fülleborn (1908, 1913) obtained a similar development in *Anopheles maculipennis*. Fülleborn and Low obtained negative results with various species of mosquitoes, sand fleas, lice and simuliids.

Acanthocheilonema grassii (Noè, 1907) Railliet, Henry and
Langeron, 1912

The adults of this nematode occur in the subcutaneous and intermuscular connective tissue and peritoneal cavity of the dog. The larvae produced by the females are unusually large, about twice as long and thick as the average filaria larva, and according to Noè (1907, 1908) do not pass into the blood stream as is generally the case among the filarias. Noè assumed that the larvae are restricted to the lymphatic system, and accordingly concluded that the intermediate host would most likely be a tick or similar slow feeding ectoparasite. In fact he found nematode larvae corresponding to those of *A. grassii* in *Rhipicephalus sanguineus*, a tick of common occurrence in regions where the dogs are infested with the nematode in question. Furthermore he states that all of the ticks attached to dogs infested with the nematode become infested with the larval worms. Additional evidence that *R. sanguineus* acts as the intermediate host is that the larvae in the ticks undergo growth and development, at least one molting period having been observed between successive stages. As *R. sanguineus* is a tick which falls to the ground to transform from the nymphal to the adult stage, the necessary opportunity is afforded for the transmission of *A. grassii* from one dog to another. Noè remarks that the nymph of this tick ingests large quantities of lymph. The larval nematodes taken in with the ingested lymph penetrate the intestinal wall into the body cavity where they undergo the develop-

ment necessary before they are ready to be returned to the definitive host, after transformation of the nymphal tick to the adult stage. Noè believes that the dog becomes infected during the initial phase of attachment of the adult. He also suggests that adult males which, unlike adult females, may pass from one host to another are capable of acquiring infection from one dog and transferring it to another. He has found as many as 22 larvae of *A. grassii* in one male tick. Noè is of the opinion that the larvae escape through thin portions of the cuticle of the mouth parts of the tick and thus reach the final host in a way similar to that followed by the larvae of *D. immitis* and other filarias transmitted by mosquitoes.

It is of interest to note that Grassi and Calandruccio (1890) found larval nematodes in *Rhipicephalus sículus* (= *R. sanguineus*) which they identified as the larvæ of *Filaria recondita* (= *Acanthocheilonema reconditum*). Noè thinks that these larvae may have been *A. grassii* rather than *A. reconditum*.

Evidently further investigations into the life history of *A. grassii* are necessary before ticks can be accepted as the intermediate host of this parasite.

Acanthocheilonema reconditum (Grassi, 1890) Railliet, Henry and
Langeron, 1912

This nematode is a parasite of the dog and in the adult stage has been collected from adipose tissue in the neighborhood of the kidney. According to Grassi and Calandruccio (1890) the first-stage larvae occur in the blood stream, and are the so-called Haematozoa of Lewis which have been seen by many observers, first by Gruby and Delafond (1843), afterwards by Lewis and others. Apparently, however, the larvae seen in the blood of dogs by Grassi and Calandruccio as well as those known as Lewis's Haematozoa are in reality the larvae of *Dirofilaria repens*. Grassi and Calandruccio describe various stages of nematode larvae found in fleas (*Ctenocephalus canis*, *C. felis*, and *Pulex irritans*) and in a tick (*Rhipicephalus sículus*=*R. sanguineus*) as developmental stages in the life history of *A. reconditum*. According to Noè (1907, 1908), the larvae found in *R. sanguineus* by Grassi and Calandruccio were probably those of *Acanthocheilonema grassii*.

Owing to the confusion existing with reference to the identity of the parasite that Grassi and Calandruccio studied, the species to which the larval nematodes observed in fleas belong, is uncertain. Grassi and Calandruccio's experiments can not be considered conclusive so far as concerns the life history of *A. reconditum*.

Setaria labiato-papillosa (Alessandrini, 1838) Railliet and Henry, 1911

The adults of this nematode are common parasites in the peritoneal cavity of cattle in various parts of the world including the United States. The larvae enter the blood stream, and Noè (1903) identifies certain larval nematodes found in *Stomoxys calcitrans* as belonging to this species. That this fly actually serves as the intermediate host, however, remains to be proved.

The possibility is not excluded that Noè mistook *Habronema* larvæ for the larvæ of *S. labiato-papillosa*.

Oncocerca

About twelve species of this genus have been described. *Oncocerca volvulus* in the adult stage occurs in nodular tumors beneath the skin of man in Africa. *Oncocerca caecutiens* is found in subcutaneous nodules on the head among natives living at a certain altitude on the west coast of Guatemala and is the cause of so-called "Coast erysipelas." *O. gibsoni* causes worm nodules in the brisket and other locations in cattle in Australia. Two species occur in cattle in the United States: one undetermined species is found in relation with the ligaments of the legs and neck, the other (*O. lienalis*) is found in the gastrosplenic ligament. *Oncocerca* larvae have not been found in the blood stream but may be recovered from the lymph spaces in the neighborhood of the adult worms. The intermediate hosts of these nematodes are unknown but biting insects have been suspected. The results of experiments have been negative. Brumpt (1903) has suggested the possibility that *Glossina palpalis* acts as intermediate host of *O. volvulus*.

Robles (1919) suggests that two species of *Simulium* (close to *S. dinelli* and *S. samboni*) may be involved as vectors of *O. caecutiens* in view of the fact that these flies are most numerous in the places where the largest number of cases of *Oncocerca* occur. Furthermore these species of flies are absent in lower altitudes corresponding with the absence of *Oncocerca*.

3. Other Nematodes

Different investigators have recorded the occurrence of larval nematodes of unknown species in various insects. Usually these have been very poorly described and it is questionable in many cases whether if found again they could be recognized as the same forms. Some of them may be the larval forms of nematodes whose adults are already known as parasites of higher animals. Among such larvae of uncertain identity may be mentioned *Filaria geotrupis* in the abdominal cavity

of *Geotrupes stercorarius* (possibly the larva of *Physocephalus sexalatus*), *Filaria ephemeridarum* in the abdominal cavity of the larvae of *Ephemera vulgata* and *Oligoneuria rhenana*, *Filaria rytipleuritis* (of Magalhães, 1900, not Deslongchamps, 1824) in the abdominal cavity of *Periplaneta americana* (possibly a *Gongylonema* according to Seurat), *Filaria stomoxeos* in *Stomoxys calcitrans* (possibly the larva of *Habronema microstoma*), *Mastophorus echiurus*, and *Cephalacanthus monacanthus* in *Tenebrio molitor* (probably larvae of *Protospirura muris*), *Mastophorus globocaudatus* and *Cephalacanthus triacanthus* in *Geotrupes stercorarius* (possibly larvae of *Physocephalus sexalatus*).

4. Mermithidae

These worms which resemble the nematodes and are usually grouped with them are not known to be of importance in medical zoology. One species, of uncertain identity, is of interest, however, as it is the so-called "cabbage snake" whose presence among the leaves of cabbage has alarmed people who have encountered it. This worm, like others of the same family, undoubtedly passes through a portion of its development in the body of an insect, probably one of the common caterpillars that attack cabbage. Similar worms have been found in apples.

GORDIACEA OR HORSE-HAIR WORMS

The Gordiacea or horse-hair worms (as which they are popularly known from the superstitious belief that they are animated horse hairs) are of medical interest because several species have been recorded as parasites of man. They gain entrance to the alimentary tract by being swallowed in drinking water. The adults are of not uncommon occurrence in springs and other surface waters. When swallowed by human beings they are usually soon vomited up but they have in some cases apparently survived in the intestine for several months before they were finally expelled. In some species, and probably in all, insects serve as hosts for the larval stages. The adults deposit their eggs in the water in which they live. The larvae hatching from the eggs enter the bodies of insects such as grasshoppers (as for example, in the case of *Gordius robustus*) or crickets (as for example, in the case of *Paragordius varius*) or in the case of other species they may enter aquatic insect larvae, which may later be devoured by carnivorous water insects. In the latter the worms undergo their development until they have reached or approached maturity when they burst out of the infested insect and escape into the water. The following species of Gordiacea have been recorded as accidental parasites of man: *Gordius aquaticus*, *G. chilensis*, *Para-*

gordius varius (a common American species), *Paragordius tricuspидatus*, *Parachordodes tolosanus*, *Parachordodes violaceus*, *Parachordodes pustulosus*, and *Chordodes alpestris*.

ACANTHOCEPHALA OR THORN-HEADED WORMS

This highly specialized group of parasites, commonly classified in the Nematelminthes, with which it has little in common beyond a superficial resemblance in the general shape of the body, has been but little studied. Most of the known species are parasitic in birds.

Macracanthorhynchus hirudinaceus (Pallas, 1781) Travassos, 1916

This worm in the adult stage (sometimes called the giant thorn-headed worm) is a common parasite of the intestine of the pig and is said to occur as a parasite of man along the River Volga. Its eggs pass out of the body of the host in the feces. Swallowed by certain insects [larvae of *Melolontha melolontha*, *Cetonia aurata*, *Phyllophaga arcuata* (*Lachnosterna*), and *Diloboderus abderus*] the eggs hatch, and the larvae develop into an intermediate stage, which in turn completes its development to maturity when the infested grub is eaten by a pig.

Moniliformis moniliformis (Bremser, 1819) Travassos, 1915

This parasite in its adult stage (sometimes called the beaded thorn-headed worm) is of common occurrence in the intestine of rats and other rodents in tropical and subtropical regions, and has been found in man in Italy. The life cycle is similar to that of the giant thorn-headed worm except for the difference in hosts. According to Grassi and Calandruccio (1888), *Blaps mucronata* acts as an intermediate host. According to Magalhaes (1898) and Seurat (1912), the usual intermediate host is a cockroach (*Periplaneta americana*).

COMPENDIUM OF PARASITES ARRANGED ACCORDING TO INSECT HOSTS ²*Aphaniptera* (*Siphonaptera*)—fleas

Ceratophyllus fasciatus Bosc

Hymenolepis diminuta

? *Hymenolepis nana*

Ctenocephalus canis Curtis

? *Acanthocheilonema reconditum*

²The scientific names of the insects have been revised by the editor.

Dipylidium caninum
Hymenolepis diminuta

Ctenocephalus felis Bouché

? *Acanthocheilonema reconditum*

? *Dipylidium caninum*

Pulex irritans Linnaeus

? *Acanthocheilonema reconditum*

Dipylidium caninum

Hymenolepis diminuta

Xenopsylla cheopis Rothschild

Hymenolepis diminuta

? *Hymenolepis nana*

? *Protospirura muris*

Diptera—flies

Aedes argenteus Poirret (*Stegomyia calopus* Meigen)

Acanthocheilonema perstans (incomplete development)

Dirofilaria repens

Filaria bancrofti

Filaria demarquayi (incomplete development)

? *Filaria tucumana*

Aedes gracilis Leicester (*Stegomyia*)

Filaria bancrofti

Aedes scutellaris Walker (*Culex albopictus* Skuse)

Filaria bancrofti

Anopheles barbirostris Van der Wulp (*Myzorrhynchus*)

Filaria bancrofti

Anopheles bifurcatus Linnaeus

Dirofilaria immitis

Anopheles costalis Loew (*Pyretophorus*)

Filaria bancrofti

Anopheles maculipennis Meigen (*claviger* Fabricius)

Acanthocheilonema perstans (incomplete development)

Dirofilaria immitis

Filaria demarquayi (incomplete development)

Trematode

Anopheles rossi Giles (Myzomyia)

Trematode

Filaria bancrofti

Anopheles sinensis Wiedemann (Myzorhynchus)

Filaria bancrofti

Anopheles sinensis peditaeniatus Leicester (Myzorhynchus)

Filaria bancrofti

Anopheles sinensis pseudopictus Grassi (Myzorhynchus)

Dirofilaria immitis

Anopheles superpictus Grassi (Myzomyia)

Dirofilaria immitis

Chironomus plumosus Linnaeus

Lecithodendrium ascidia

Chrysoconops fuscopennatus (Theobald) (Taeniorhynchus)

Acanthocheilonema perstans (incomplete development)

Chrysops spp.

Filaria (Loa) loa

? Chrysops centurionis Austen

Filaria (Loa) loa

? Chrysops dimidiata Van der Wulp

Filaria (Loa) loa

? Chrysops longicornis Macquart

Filaria (Loa) loa

Culex gelidus Theobald

Filaria bancrofti

Culex malariae Grassi

Dirofilaria immitis

Culex penicillaris Rondani

Dirofilaria immitis

Culex pipiens Linnaeus

Dirofilaria immitis

Filaria bancrofti

Culex quinquefasciatus Say (skusei Giles) (fatigans Wiedemann)

Filaria bancrofti

Culex sitiens Wiedemann

Filaria bancrofti

Mansonioides annulipes Theobald

Filaria bancrofti

Mansonioides uniformis Theobald

Filaria bancrofti

Musca domestica Linnaeus

Choanotaenia infundibulum

Habronema muscae

Habronema microstoma

Habronema megastoma

? *Davainea cesticillus*

? *Davainea tetragona*

Panoplites sp.

Acanthocheilonema perstans (incomplete development)

Scutomyia albolineata Theobald

Filaria bancrofti

Stomoxys calcitrans Linnaeus

Filaria stomoxeos

Habronema microstoma

? *Habronema muscae*

? *Setaria labiato-papillosa*

? *Hymenolepis carioca*

Taeniorhynchus domesticus Leicester

Filaria bancrofti

Neuroptera

Sialis lutaria (Linnaeus)

Trematode

Trichoptera—hairy-winged insects

Anabolia nervosa (Leach) Curtis

Allocreadium isoporum

Opisthioglyphe rastellus

Chaetopteryx villosa (Fabricius)

Allocreadium isoporum

Drusus trifidus McLachlan

Trematode

Limnophilus flavicornis (Fabricius)

Opisthioglyphe rastellus

Limnophilus griseus (Linnaeus)

Opisthioglyphe rastellus

Limnophilus lunatus (Curtis)

Opisthioglyphe rastellus

Limnophilus rhombicus (Linnaeus)

Opisthioglyphe rastellus

Mystacides nigra (Linnaeus)

Trematode

Notidobia ciliaris (Linnaeus)

Trematode

Phryganea grandis

Trematode

Phryganea sp.

Lecithodendrium chilostomum

Rhyacophila nubila Zetterstedt

Trematode

Lepidoptera—moths, butterflies

Asopia farinalis (Linnaeus)

Hymenolepis diminuta

Nymphula nymphaeata (Linnaeus) (*Hydrocampa*)

Trematode

Coleoptera—beetles

- Akis goryi (Solier)
Spirocerca sanguinolenta
Spirura gastrophila
- Akis spinosa (Linnaeus)
Hymenolepis diminuta
- Aphodius rufus (Moll) var. castaneus Marsh
Arduenna strongylina
- Aphodius coloradensis Horn
Gongylonema scutatum
- Aphodius femoralis Say
Gongylonema scutatum
- Aphodius fimetarius Linnaeus
Gongylonema scutatum
- Aphodius granarius Linnaeus
Gongylonema scutatum
- Aphodius vittatus Say
Gongylonema scutatum
- Blaps appendiculata
Gongylonema sp. (*G. scutatum* according to Seurat)
- Blaps sp.
Gongylonema brevispiculum
- Blaps sp. (near appendiculata)
Spirura gastrophila
Gongylonema sp. (*G. scutatum* according to Seurat)
- Blaps emondi
Gongylonema sp. (*G. scutatum* according to Seurat)
- Blaps mucronata Latreille
Moniliformis moniliformis
- Blaps strauchi Reiche
Spirura gastrophila
Gongylonema sp. (*G. scutatum* according to Seurat)

Cetonia aurata (Linnaeus)

Macracanthorhynchus hirudinaceus

Copris hispanus (Linnaeus)

Spirocerca sanguinolenta

Diloboderus abderus Sturm

Macracanthorhynchus hirudinaceus

Geotrupes douei Gory

? *Gongylonema mucronatum*

Spirocerca sanguinolenta

Physocephalus sexalatus

Geotrupes stercorarius (Linnaeus)

Cephalacanthus triacanthus

Filaria geotrupis

Mastophorus globocaudatus

? *Physocephalus sexalatus*

Gymnopleurus mopsus (Pallas)

? *Gongylonema mucronatum*

Gymnopleurus sturmi Mac Leay

? *Gongylonema mucronatum*

Spirocerca sanguinolenta

Ilybius fuliginosus (Fabricius)

Haplometra cylindracea

Melolontha melolontha Linnæus (vulgaris Fabricius)

Macracanthorhynchus hirudinaceus

Chironitis irroratus Rossi (Onitis)

? *Gongylonema mucronatum*

Onthophagus spp.

Arduenna strongylina

Spirura gastrophila

Onthophagus bedeli Neitt.

? *Gongylonema mucronatum*

Physocephalus sexalatus

- Onthophagus hecate Panzer
Gongylonema scutatatum
- Onthophagus nebulosus Reiche
Physocephalus sexalatus
- Onthophagus pennsylvanicus Harold
Gongylonema scutatatum
- Phyllophaga arcuata Smith (Lachnosterna)
Macracanthorhynchus hirudinaceus
- Scarabaeus (Ateuchus) sacer Linnaeus
 ? *Gongylonema mucronatum*
Physocephalus sexalatus
Spirocerca sanguinolenta
- Scarabaeus (Ateuchetus) variolosus Fabricius
Physocephalus sexalatus
 ? *Spirocerca sanguinolenta*
- Scaurus striatus Fabricius
Hymenolepis diminuta
- Tenebrio molitor Linnaeus
Cephalacanthus monacanthus
Gongylonema neoplasticum
Hymenolepis diminuta
 ? *Hymenolepis microstoma*
Mastophorus echiurus
Protospirura muris
- Water beetles
Pleurogenes claviger
Pleurogenes medians
Prosotocus confusus
- Mallophaga*—bird lice
- Leiothinae (? genus ? species)
Filaria cypseli
- Trichodectes latus Nitzsch (canis DeGeer)
Dipylidium caninum

Isoptera—termites

Hodotermes pretoriensis Fuller
Filaria aallinarum

Odonata—dragonflies

Aeschna sp.
Prosotocus confusus

Agrion sp.
Gorgoderia pagenstecheri
Gorgoderia varsoviensis
Pleurogenes medians

Calopteryx virgo (Linnaeus)
Halipegus ovocaudatus
Pneumonoeces similis

Cordulia sp.
Prosotocus confusus

Epitheca spp.
Gorgoderia cygnoides
Gorgoderia pagenstecheri
Gorgoderia varsoviensis

Plecoptera—mayflies

Clæon dipterum (Linnaeus) Stephens
 ? *Opisthioglyphe rastellus*

Ephemera vulgata Linnaeus
Allocreadium isoporum
Filaria ephemeridarum
 ? *Opisthioglyphe rastellus*

Ephemeridae
Lecithodendrium ascidia

Oligoneuria rhenana Imhoff
Filaria ephemeridarum

Plecoptera—stoneflies

Perlidae

Lecithodendrium ascidia

Trematode

Orthoptera—cockroaches, etc.

Blattella germanica (Linnaeus) Caudell

*Gongylonema neoplasticum**Gongylonema scutatatum* (experimental infection)

Periplaneta americana (Linnaeus) Burmeister

Filaria rytipleritis of Magalhães, 1900*Gongylonema neoplasticum**Moniliformis moniliformis*

Blatta orientalis Linnaeus

Gongylonema neoplasticum? *Spirocerca sanguinolenta**Spirura gastrophila**Dermaptera*—earwigs

Anisolabis annulipes Lucas

*Hymenolepis diminuta**Myriapoda*—millipedes, centipedes ³

Fontaria virginiensis (Drury)

Hymenolepis diminuta

Glomeris limbata

Tapeworm larvae

Julus sp.

Hymenolepis diminuta

Julus guttulatus

Nematode larva

Acarina—ticks, mites ³

Ixodes ricinus (Linnaeus) Latreille

? *Filaria martis*³ Included in list because of their similarity to insects.

Ornithodoros moubata (Murray)

? *Acanthocheilonema perstans*

Rhipicephalus sanguineus (Latreille)

? *Acanthocheilonema grassii*

? *Acanthocheilonema reconditum*

Isopoda—sowbugs ⁴

Porcellio laevis Latreille

? *Acuaria spiralis*

LIST OF REFERENCES

Ackert, James E.

1918.—On the life cycle of the fowl cestode, *Davainea cesticillus* (Molin). (Preliminary communication.) Jour. Parasit. Urbana, Ill., Vol. 5, No. 1, Sept., pp. 41-43, pl. 5, figs. 1-4.

1919.—On the life history of *Davainea tetragona* (Molin), a fowl tapeworm. Jour. Parasit., Urbana, Ill., Vol. 6, No. 1, Sept., pp. 28-34.

Ashburn, P. M., and Craig, Charles F.

1907.—Observations upon *Filaria philippinensis* and its development in the mosquito. Philippine Journ. Sci., vol. 2B, No. 1, Mar., pp. 1-14, pls. 1-7, figs. 1-26.

Baldasseroni, Vincenzo.

1909.—“*Ixodes ricinus*” L. infetto da embrioni di *Filaria*. Bull. Soc. Entom. Ital., vol. 40, Nos. 3-4, pp. 171-174, Dec. 30.

Bancroft, Thomas L.

1901.—Preliminary notes on the intermediate host of *Filaria immitis* Leidy. Journ. Trop. Med. Lond., vol. 4, Oct. 15, pp. 347-349.

Bastian, H. Charlton.

1904.—Note on the probable mode of infection of the so-called *Filaria perstans*, and on the probability that this organism really belongs to the genus *Tylenchus* (Bastian). Lancet, vol. 166, No. 4196, vol. 1, No. 5, Jan. 30, pp. 286-287, figs. 1-3.

Bernard, P. Noël, and Bauche, J.

1913.—Conditions de propagation de la filariose sous-cutanée du chien. *Stegomyia fasciata* hôte intermédiaire de *Dirofilaria repens*. Bull. Soc. Path. Exot., vol. 6, No. 1, Jan. 8, pp. 89-99, figs. 1-9.

⁴Included in list because of their similarity to insects.

Biglieri, R., and Aráoz, J. M.

1917.—Contribución al estudio de una nueva filariosis humana encontrada en la República Argentina (Tucumán), ocasionada por la "*Filaria tucumana*." 1. Confer. Soc. sud-am. de hig. [etc.], Buenos Aires Sept. 17-24, 1916, pp. 403-422.

Brumpt, Émile.

1903.—Sur rôle des mouches tsé-tsé en pathologie exotique. Compt. Rend. Soc. Biol., vol. 55, No. 34, Dec. 4, pp. 1496-1498.

Bull, Lionel B.

1916.—A granulomatous affection of the horse—Habronemic granulomata (cutaneous habronemiasis of Railliet). Journ. Comp. Path. and Therap., vol. 29, No. 3, Sept. 30, pp. 187-199, figs. 1-5.

1919.—A contribution to the study of habronemiasis: A clinical, pathological, and experimental investigation of a granulomatous condition of the horse-habronemic granuloma. pp. 85-141, pls. 13-15, figs. 1-8. [Reprint from Tr. Roy. Soc. South Australia, v. 43.]

Christy, Cuthbert.

1903.—The distribution of sleeping sickness, *Filaria perstans*, etc., in East Equatorial Africa. (Preliminary report dated Oct. 31, 1902). Roy. Soc. Rep. Sleep.-Sick. Comm., No. 2, Nov., pp. 3-8, 3 maps.

De Magalhães, Pedro Severiano.

1898.—Notes d'helminthologie brésilienne. [5. note] Arch. Parasitol., vol. 1, No. 3, July, pp. 361-368, figs. 1-4.

1900.—Notes d'helminthologie brésilienne. [8. note] Arch. Parasitol., vol. 3, No. 1, May 15, pp. 34-69, figs. 1-25.

Descazeaux, J.

1915.—Contribution à l'étude de l' "esponja" ou plaies d'été des équidés du Brésil. (Rapport de Railliet, 17 juin). Bull. Soc. Centr. de Méd. Vét., vol. 69, Jan. 30-Sept. 30, pp. 468-486, figs. 1-3.

Deslongchamps, Eugène Eudes.

1824.—Filaire. *Filaira*. Encycl. Méthodique, vol. 2, pp. 391-397.

Dutton, J. Everett.

1905.—The intermediary host of *Filaria cypseli* (Annett, Dutton, Elliott); the *Filaria* of the African swift, *Cypselus affinis*. Thompson Yates & Johnston Lab. Rep., Lond., n. s., vol. 6, No. 1, Jan., pp. 137-147, pl. 5, figs. i-x.

Feldmann.

1905.—Ueber *Filaria perstans* im Bezirk Bukoba. Arch. f. Schiffs- u. Tropen-Hygr., vol. 9, No. 2, Feb., pp. 62-65, 2 pls.

Fibiger, Johannes, and Ditlevsen, Hjalmar.

1914.—Contributions to the biology and morphology of *Spiroptera* (*Gongylonema*) *neoplastica* n. s. Mindeskr. Japetus Steenstrups Fodsel, 2. Halvbind, 28 pp., figs. 1-3, pls. 1-4, figs. 1-32.

Fülleborn, Friedrich.

1908.—Ueber Versuche an Hundefilarien und deren Übertragung durch Mücken. Beihefte (8) z. Arch. f. Schiffs- u. Tropen-Hygr., vol. 12, Nov., pp. 313-351 (43 pp.), figs. 1-6, pls. 1-4, figs. 1-38.

1908.—Untersuchungen an menschlichen Filarien und deren Übertragung auf Stechmücken. Beihefte (9) z. Arch. f. Schiffs- u. Tropen-Hygr., vol. 12, Nov., pp. 357-388 (36 pp.), figs. 1-3, pls. 1-7, figs. 1-132.

1913.—Die Filarien des Menschen. Handb. d. path. Mikroorganism. (Kolle & Wassermann), Jena, 2. Aufl., vol. 8, pp. 185-344, figs. 1-41, pls. 1-6.

Galeb, Osman.

1878.—Observations et expériences sur les migrations du *Filaria rytiplerites*, parasite des blattes et des rats. Compt. Rend. Acad. Sc., vol. 87, No. 2, July 8, pp. 75-77.

Grassi, Giovanni Battista.

1887.—Entwickelungscyklus der *Tania nana*. Dritte präliminarnote. Centralbl. f. Bakteriol. (etc.), Jena, 1. Jahr., vol. 2, No. 11, pp. 305-312.

1888.—Ciclo evolutivo della *Spiroptera* (*Filaria*) *sanguinolenta*. Gior. di Anat., Fisiol. e Patol. d. Animali, vol. 20, No. 2, Mar.-Apr., pp. 99-101.

Grassi, Giovanni Battista, and Calandruccio, Salvatore.

1888.—Ueber einen *Echinorhynchus*, welcher auch im Menschen parasitirt und dessen Zwischenwirth ein *Blaps* ist. Centralbl. f.

- Bakteriol. (etc.), Jena, 2. Jahr., vol. 3, No. 17, pp. 521-525, figs. 1-7.
- 1890.—Ueber *Haematozoon* Lewis. Entwicklungscyklus einer *Filaria* (*Filaria recondita* Grassi) des Hundes. Centralbl. f. Bakteriologie. (etc.), Jena, vol. 7, No. 1, Jan. 2, pp. 18-26, figs. 1-16.
- Grassi, Giovanni Battista, and Rovelli, Giuseppe.
- 1888.—Intorno allo sviluppo cestodi. Nota preliminare. Atti R. Accad. d. Lincei, Roma, Rendic., an. 285, 4. s., vol. 4, 1. semestre, No. 12, June 3, pp. 700-702.
- 1888.—Bandwürmerentwicklung. Centralbl. f. Bakteriologie. (etc.), Jena, 2. Jahr., vol. 3, No. 6, p. 173.
- 1889.—Sviluppo del cisticerco e del cisticercoide. Nota preliminare. Atti R. Accad. d. Lincei, Roma, Rendic., an. 286, 4. s., vol. 5, 1. semestre, No. 3, Feb. 3, pp. 165-174, figs. 1-4.
- 1892.—Ricerche embriologiche sui cestodi. Atti Accad. Giornata di Sc. Nat. in Catania (1891-92), an. 68, 4. s., vol. 4, 2. mem., 108 pp., 4 pls.
- Gruby, David, and Delafond, Henri-Mamert-Onesius.
- 1843.—Note sur une altération vermineuse du sang d'un chien déterminée par un grand nombre d'hématozoaires du genre filaire. Compt. Rend. Acad. Sc., vol. 16, No. 6, Feb. 6, pp. 325-326.
- Guberlet, John E.
- 1916.—Morphology of adult and larval cestodes from poultry. Trans. Am. Micr. Soc., vol. 35, No. 1, Jan., pp. 23-44, pls. 5-8, figs. 1-30.
- 1919.—On the life history of the chicken cestode, *Hymenolepis carioca* (Magalhães). Journ. Parasit., vol. 6, No. 1, Sept., pp. 35-38, pl. 4, figs. 1-6.
- Hill, Gerald F.
- 1918.—Relationship of insects to parasitic diseases in stock. Pp. 11-107, pls. 2-8, figs. 1-49A. 8°. Melbourne. [Reprint from Proc. Roy. Soc. Victoria, new ser., v. 31, pt. 1.]
- Hodges, Aubrey.
- 1902.—Sleeping-sickness and *Filaria perstans* in Busoga and its neighborhood, Uganda Protectorate. Journ. Trop. Med., vol. 5, No. 19, Oct. 1, pp. 293-300, 1 map, 1 pl., figs. 1-2.
- Johnston, T. Harvey.
- 1913.—Notes on some Entozoa. Proc. Roy. Soc. Queensland, vol. 24, pp. 63-91, pls. 2-5, figs. 1-45. (Advance separate issued Nov. 1, 1912).

Joyeux, Ch.

- 1916.—Sur le cycle évolutif de quelques cestodes. Note préliminaire. Bull. Soc. Path. Exot., vol. 9, No. 8, Oct. 11, pp. 578-583.

Kleine, F. K.

- 1915.—Die Übertragung von Filarien durch *Chrysops*. Zeitschr. f. Hyg. u. Infektionskrankh., vol. 80, No. 3, Oct. 26, pp. 345-349.

Lebrede, Mario G.

- 1904.—Filariasis. Nota preliminar deducida de experiencias prácticas, que demuestran el sitio por donde la *Filaria nocturna* abandona el *Culex pipiens* infectado. Rev. Med. Trop., Habana, vol. 5, No. 11, Nov., pp. 171-172.
- 1905.—Metamorphosis of *Filaria* in the body of the mosquito (*Culex pipiens*). Journ. Infect. Dis., Suppl. (1), May, pp. 332-352, pls. 1-3, figs. 1-16.

Leiper, Robert T.

- 1913.—[Metamorphosis of *Filaria loa*.] [Telegram to London School Trop. Med., Dec. 27, 1912]. Lancet, No. 4662, vol. 184, vol. 1, No. 1, Jan. 4, p. 51.

Leuckart, Karl Georg Friedrich Rudolph.

- 1867.—Die menschlichen Parasiten und die von ihnen herrührenden Krankheiten. Ein Hand- und Lehrbuch für Naturforscher und Aerzte. Vol. 2, 1. Lief., vi, 256 pp., 158 figs. Leipzig & Heidelberg.

Low, George C.

- 1902.—Notes on *Filaria demarquaii*. Brit. Med. Journ., No. 2143, vol. 1, Jan. 25, pp. 196-197.
- 1903.—*Filaria perstans*. Brit. Med. Journ., No. 2204, vol. 1, Mar. 28, pp. 722-724, figs. 1-2.

Manson, (Sir) Patrick.

- 1878.—On the development of *Filaria sanguinis hominis*, and on the mosquito considered as a nurse. Journ. Linn. Soc. Lond., Zool. (75), vol. 14, Aug. 31, pp. 304-311.

Marchi, Pietro.

- 1867.—Monografia sulla storia genetica e sulla anatomia della *Spiroptera obtusa* Rud., 34 pp., 2 pls. fol. Torino. [Advance separate from Mem. R. Accad. Sc. Torino, Cl. d. Sc. Fis., Mat. e Nat., 2. s., vol. 25, issued in 1871.]

Melnikov, Nicolaus.

- 1869.—Ueber die Jugendzustände der *Tænia cucumerina*. Arch. f. Naturg., Berl., 35. Jahr., vol. 1, No. 1, pp. 62-70, pl. 3, figs. a-c.

Nickerson, W. S.

- 1911.—An American intermediate host for *Hymenolepis diminuta*. Science, n. s., No. 842, vol. 33, Feb. 17, p. 271.

Nicoll, W., and Minchin, E. A.

- 1911.—Two species of cysticercoids from the rat-flea (*Ceratophyllus fasciatus*). Proc. Zool. Soc. Lond., No. 1, Mar., pp. 9-13, figs. 1-2.

Noè, Giovanni.

- 1900.—Propagazione delle filarie del sangue esclusivamente per mezzo della puntura della zanzare. 2. Nota preliminare. Atti R. Accad. d. Lincei, Rendic. Cl. di Sc. Fis., Mat. e Nat., an. 297, 5. s., vol. 9, 2. semestre, No. 12, Dec. 16, pp. 357-362, figs. 1-3.
- 1903.—Studi sul ciclo evolutivo della *Filaria labiato-papillosa*, Alessandrini. Nota preliminare. Atti R. Accad. d. Lincei, Rendic. Cl. di Sc. Fis., Mat. e Nat., an. 300, 5. s., vol. 12, 2. semestre, No. 9, Nov. 8, pp. 387-393.
- 1907.—La *Filaria grassii*, n. sp. e la *Filaria recondita*, Grassi. Nota preliminare. Atti R. Accad. d. Lincei, Rendic. Cl. di Sc. Fis. Mat. e Nat., an. 304, 5. s., vol. 16, 2. semestre, No. 12, Dec. 15, pp. 806-810.
- 1908.—Il ciclo evolutivo della *Filaria grassii*, mihi, 1907. Atti R. Accad. d. Lincei, Rendic. Cl. di Sc. Fis., Mat. e Nat., an. 305, 5. s., vol. 17, 1. semestre, No. 5, Mar. 1, pp. 282-293, figs. 1-4.

Nuttall, George H. F.

- 1899.—On the rôle of insects, arachnids, and myriapods as carriers in the spread of bacterial and parasitic diseases of man and animals. A critical and historical study. Johns Hopkins Hosp. Rep., Baltimore, vol. 8, Nos. 1-2, pp. 1-154, pls. 1-3.

Piana, Giovanni Pietro.

- 1897.—Osservazioni sul *Dispharagus nasutus* Rud. dei polli e sulle larve nematoelmintiche delle mosche e dei porcellioni. Atti Soc. Ital. Sc. Nat. (etc.), Milano, vol. 36, No. 3-4, Feb., pp. 239-262, figs. 1-21.

Ransom, Brayton H.

- 1911.—The life history of a parasitic nematode—*Habronema muscae*. Science n. s., No. 881, vol. 34, No. 17, pp. 690-692.
- 1913.—The life history of *Habronema muscae* (Carter), a parasite of the horse transmitted by the house fly. U. S. Dept. Agric., Bureau Animal Indust., Bull. 163, Apr. 3, pp. 1-36, figs. 1-41.

Ransom, Brayton H., and Hall, Maurice C.

- 1915.—The life history of *Gongylonema scutatum*. Journ. Parasit., vol. 1, No. 3, Mar., p. 154.
- 1916.—The life history of *Gongylonema scutatum*. Journ. Parasit., vol. 2, No. 2, Dec., 1915, pp. 80-86.
- 1917.—A further note on the life history of *Gongylonema scutatum*. Journ. Parasit., vol. 3, No. 4, June, pp. 177-181.

Ringenbach, J., and Guyomarc'h.

- 1914.—La filariose dans les régions de la nouvelle frontière Congo-Cameroun. Observations sur la transmission de *Microfilaria diurna* et de *Microfilaria perstans*. Bull. Soc. Path. Exot., vol. 7, No. 7, July 8, pp. 619-626.

Robles, R.

- 1919.—Onchocercose humaine au Guatemala produisant la cécité et "l'érysipèle du littoral" (erisipela de la costa). Bull. Soc. Path. Exot., vol. 12, No. 7, July 9, pp. 442-460, 2 maps, figs. 1-6.

Seurat, L. G.

- 1912.—Sur le cycle évolutif du spiroptère du chien. Compt. Rend. Acad. Sc., vol. 154, No. 2, Jan. 8, pp. 82-84.
- 1912.—La grande blatte, hôte intermédiaire de l'échinorhynque moniliforme en Algérie. Compt. Rend. Soc. Biol., vol. 72, No. 2, Jan. 19, pp. 62-63.
- 1913.—Sur l'évolution du *Physocephalus sexalatus* (Molin). Compt. Rend. Soc. Biol., vol. 75, No. 35, Dec. 12, pp. 517-520, figs. 1-4.
- 1913.—Sur l'évolution du *Spirura gastrophila* Müll. Compt. Rend. Soc. Biol., vol. 74, No. 6, Feb. 14, pp. 286-289, figs. 1-3.
- 1916.—Contribution à l'étude des formes larvaires des nématodes parasites hétéroxènes. Bull. Scient. France et Belg., 7. s., vol. 49, No. 4, July 6, pp. 297-377, figs. 1-14.
- 1918.—Extension de l'habitat du *Spirura gastrophila* (Mueller). Compt. Rend. Soc. Biol., vol. 81, No. 15, July 27, pp. 789-791.

- 1919.—Contributions nouvelles a l'étude des formes larvaires des nématodes parasites hétéroxènes. Bull. Biol. France et Belg. (1918), vol. 52, No. 4, Mar. 25, pp. 344-378, figs. I-XII.

Theiler, (Sir) Arnold.

- 1919.—A new nematode in fowls, having a termite as an intermediary host. [*Filaria gallinarum* (nova species)]. 5. & 6. Rep. Director Vet. Research, Dept. Agric. Union South Africa (1918), Apr., pp. 695-707, 1 pl., fig. 1.

Van Saceghem, R.

- 1917.—Contribution à l'étude de la dermite granuleuse des équidés. Bull. Soc. Path. Exot., vol. 10, No. 8, Oct., pp. 726-729.
1918.—Cause étiologique et traitement de la dermite granuleuse. Bull. Soc. Path. Exot., vol. 11, No. 7, July 10, pp. 575-578.

Villot, François Charles Alfred.

- 1878.—Migrations et métamorphoses des ténias des musaraignes. Ann. Sc. Nat., Zool., vol. 49, 6. s., vol. 8, Nos. 2-3, art. 5, 19 pp., pl. 11, figs. 1-14.
1883.—Mémoire sur les cystiques des ténias. Ann. Sc. Nat., Zool., 6. s., vol. 15, art. 4, Oct., 61 pp., pl. 12, figs. 1-13.

Von Linstow, Otto Friedrich Bernhard.

- 1886.—Ueber den Zwischenwirth von *Ascaris lumbricoides* L. Zool. Anz., No. 231, vol. 9, Aug. 30, pp. 525-528.

Von Stein, Friedrich.

- 1852.—Beiträge zur Entwicklungsgeschichte der Eingeweidewürmer. Zeitschr. f. Wissensch. Zool., vol. 4, No. 2, Sept. 2, pp. 196-214, pl. 10, figs. 1-20.

Wellman, Frederick Creighton.

- 1907.—Preliminary note on some bodies found in ticks *Ornithodoros moubata* (Murray) fed on blood containing embryos of *Filaria perstans* (Manson). Brit. Med. Journ., No. 2429, vol. 2, July 20, pp. 142-143.

CHAPTER VI

The Relations of Climate and Life and Their Bearings on the Study of Medical Entomology.¹

W. Dwight Pierce

All animal and plant life has its being and reacts according to definite laws in which we find the climatic factor of primary importance. We cannot go far into a subject with as many inter-relationships as medical entomology without finding it necessary to know something of the climatic laws which govern the lives of the various organisms concerned.

In several of the lectures attention is especially called to apparent discrepancies in the interpretation of climatic effects on the life of the insects, and this is particularly true in case of the lice. Throughout our literature there is to be found a hazy notion of the importance of temperature and still hazier notions of humidity. There is a great deal about these factors which help to govern life, that no one knows, but it will pay us to have a clearly defined statement of some of the most important principles as now understood.

On a proper understanding of the relations of temperature and humidity to the life and development of insects, animals, and disease organisms, depend all transmission experiments, all efforts in keeping alive the various creatures involved, all interpretations of results and many practical measures of control.

This difficult subject will be stated in as simple language as possible so that all may see the basic principles at least.

Every one of us knows that cold and heat can cause pain. We have indeed a clear understanding that cold and heat kill. We recognize the fact that we seem to work best under conditions when we are absolutely oblivious of heat or cold, dryness or moisture. We have felt stupid in murky weather. We have felt parched and dried from extremely dry weather. In other words, we can now recognize four conditions which may affect our well-being, cold, heat, dryness, moisture. These can be expressed on two scales—temperature and relative humidity. In other words, we should be able to chart our own susceptibilities to these factors by running, for example, a temperature scale vertically on our

¹This lecture was read July 1, 1918 and issued the same day.

chart paper and a humidity scale from zero to one hundred per cent saturation horizontally.

If we picture our reactions or those of the creature being studied on such a chart (see figs. 8, 9), we will better understand the subject. In the lower part of the chart we will locate certain temperatures which always cause death from cold. These may be known as **ABSOLUTE FATAL TEMPERATURES**.

Now a common failing in the past has been to assume that humidity had nothing to do with the effect of temperature on life. It does have a very decided bearing. A creature which can stand a certain degree

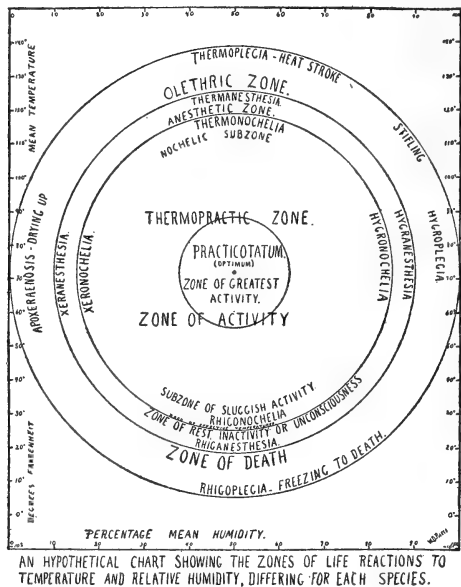

FIG. 8

of cold at a given humidity may be absolutely unable to stand that same temperature at another degree of saturation or relative humidity.

Our absolutely fatal temperatures therefore will form some sort of a zone on our chart and this zone will probably be bounded by a curve. We call the temperatures below this curve the **LOWER ZONE OF FATAL TEMPERATURES**. Death caused by cold is called **RHIGOPLEGIA**.

Slightly above these absolutely fatal temperatures will be a zone of temperatures which might cause death if experienced sufficiently long, but which at least cause a complete suspension of all activity. And still higher will be temperatures which also cause suspension of activity, but which do not cause death even when experienced for very long pe-

riods. Formerly, this suspension of activity by animal life on account of cold was called hibernation, which means winter rest. The writer has shown (Pierce, W. D., 1916, Journ. Agr. Res., vol. 5, pp. 1183-1191) that this same inactivity may be caused by dryness or heat and possibly by excessive humidity, and that a creature may remain in the same state of inactivity from the heat of summer through the cold of winter and be awakened from it only by the addition of a requisite amount of moisture at effective temperatures. We must seek other terms than hibernation, or winter rest, and aestivation, or summer rest. As this rest consists essentially of an almost complete cessation of all bodily functions, and is a state of insensibility, we may very properly designate the so-called hibernation as RHIGANESTHESIA, or insensibility due to cold. This state may be acquired naturally as winter sets in, or may be artificially induced at any time of the year by lowering the temperature. The temperatures inducing RHIGANESTHESIA are grouped into the LOWER ZONE OF INACTIVITY, or the ZONE OF RHIGANESTHESIA.

As the temperatures increase, a creature in the state of rest or rhiganesthesia, commences to show slow movements of the body fluids, and slight jerky motions, which increase with increase of temperature. This awakening or anastasis, when caused by temperature change, is a THERMANASTASIS.

The approximate point at any given humidity at which thermanastasis begins is the ZERO OF EFFECTIVE TEMPERATURE. It must be firmly fixed in your minds that there is not a single zero of effective temperature, as so often claimed, but a different one for every degree or portion of a degree of relative humidity. In other words, at one humidity the awakening may occur at one temperature, and under other conditions of humidity the temperature may be considerably higher or lower. These points can be connected by a curve which represents the lower limit of the ZONE OF ACTIVITY, or the THERMOPRACTIC ZONE, meaning a zone of effective temperatures.

Many authors have manifested considerable confusion in their writings and have even claimed that other authors were incorrect because a certain developmental period or reaction was accomplished in their experiments at a given temperature in a certain period of time while the other investigators obtained totally different results. A man working in a moist coastal section could not justly compare his results with those of a man working in a drier section unless the conditions of humidity were recorded also. For this reason, the writer has maintained that laboratories attempting to correlate temperature with life history, must at least be equipped with maximum and minimum thermometers and a sling psychrometer for determining humidity, and that accurate results are

based only on a recording hygrothermograph, checked by the above mentioned instruments.

The great bulk of work naturally is upon the reactions which take place in the zone of activity.

It must not be forgotten, however, that control work depends often upon a correct knowledge of the lower zone of fatal temperatures, and that successful storage of breeding material, until the investigator is ready to use it, depends often upon a knowledge of the requirements of rhiganesthesia.

Following the awakening, the body takes up all its natural functions and we must assume that sustenance is available. The first activities, at temperatures just above the zero of activity, are naturally very sluggish and this state of sluggishness may be known as RHIGONOCHELIA, or sluggishness caused by cold.

Some creatures are very sensitive to cold, usually when the humidity is high. Pain produced by the application of cold is called CRYALGESIA. An abnormal sensitiveness to cold is known as CRYESTHESIA, and a morbid sensitiveness as HYPERCRYALGESIA. These sensations are probably only experienced with a descent of temperatures.

In the zone of effective temperatures or thermopractic zone there is a point or a small restricted zone of temperatures at which all activities are most effective, that is, the greatest amount of work is accomplished with the least amount of exertion and the least loss of energy. This is the so-called OPTIMUM, or perhaps better, PRACTICOTATUM, meaning most effective. As temperatures ascend to the practicotatum any given function is performed in proportionately shorter time. As the temperatures ascend above the practicotatum a particular function may be exercised more rapidly but less accurately or less effectively, as for instance, more eggs may be laid but fewer hatch; but the activity is feverish and soon exhaustion takes place, or the individual gradually becomes more stupid and sluggish. This heat sluggishness is therefore called THERMONOCHELIA.

Different reactions to heat may be experienced and these have all received appropriate designations. As for example, a stifling sensation is called THERMOPNIGIA; an unusual sensibility to heat THERMALGESIA, and a more intense sensibility HYPERTHERMALGESIA. The ability to recognize changes of temperature is THERMESTHESIA, and its extreme is designated as THERMOHYPERESTHESIA, an abnormal sensitiveness to heat stimuli. A fondness for heat or requiring great heat for growth is called THERMOPHILIC, while resistance to heat is called THERMOPHYLIC. When a stifling temperature is experienced rapid breathing or THERMOPOLYPNEA is often experienced. Contraction under the action of heat is designated as THER-

MOSYSTALTIC. The adaptation of the body temperature to that of the environment is **PECILOTHERMAL**. A morbid dread of heat is **THERMOPHOBIA**. The determination of the direction or rate of locomotion by heat is called **THERMOTAXIS** and movement brought about by heat is **THERMOTROPISM**.

As the temperatures increase sluggishness increases until sleep or inactivity is induced and this condition once known as aestivation or summer rest may better be known as **THERMANESTHESIA** or insensibility caused by heat.

The point at which anesthesia begins at any given humidity is the upper boundary of the thermopractic or effective zone. Those temperatures at which successful Thermanesthesia may be experienced embrace the **UPPER ZONE OF INACTIVITY**, or the **ZONE OF THERMANESTHESIA**. This quickly merges into those high temperatures which may with sufficient duration of time cause death, and finally, those temperatures which are absolutely fatal under all conditions. The highest zone is therefore the **UPPER ZONE OF FATAL TEMPERATURES**. Death from heat is known as **THERMOPLEGIA**, or heat stroke.

Most investigators have stopped with a more or less hazy acknowledgment of the existence of these various zones of reactions on the ascending scale of the thermometer, but the literature contains few references to similar zones of reactions on the scale of relative humidity. However, if we stop to think we must acknowledge that similar reactions do take place.

We may have death from absolute dryness at almost any temperature, in other words, we have a condition which is called **APOXERAE-NOSIS**, or drying up. At very low humidities one may become insensible and thus we have **XERANESTHESIA**. Likewise, a little higher humidity induces sluggishness or a state of **XERONOCHELIA**. We have most of us experienced this condition of stupidity in a living room at normal temperatures in the winter due to lack of sufficient moisture. So also there is the humidity which enables each individual to accomplish the greatest results in the least time with the least amount of exhaustion and this is the **PRACTICOTATUM**. With increase of humidity the activity lessens until an excessively humid atmosphere brings about **HYGRONOCHELIA** or sluggishness due to moisture; then **HYGRANESTHESIA** may be experienced by some species and finally death due to excessive moisture or **HYGROPLEGIA**.

This makes it obvious therefore that when we plot the reactions of a species to temperature and humidity, we are likely to find a series of closed figures delineating concentric zones of fatal, inactive, active and optimum conditions. Thus it is apparent that Rhigoplegia, Apoxeraenosis, Thermoplegia, and Hygroplegia form a single zone of

temperature-humidities which cause death—this whole zone is the fatal or OLETHRIC ZONE. All conditions of life lie within it, the next zone being that which includes Rhiganesthesia, Xeranesthesia, Thermanesthesia, and Hygranesthesia; the whole zone therefore being the ANESTHETIC ZONE, or zone of rest, which includes the conditions known as hibernation and aestivation. Within this is the THERMOPRACTIC ZONE or zone of effective temperatures, which is naturally made up of sub-zones representing degrees of activity, as the NOCHELIC SUB-ZONE of sluggish activities on the outside and the PRACTICOTATUM at the center.

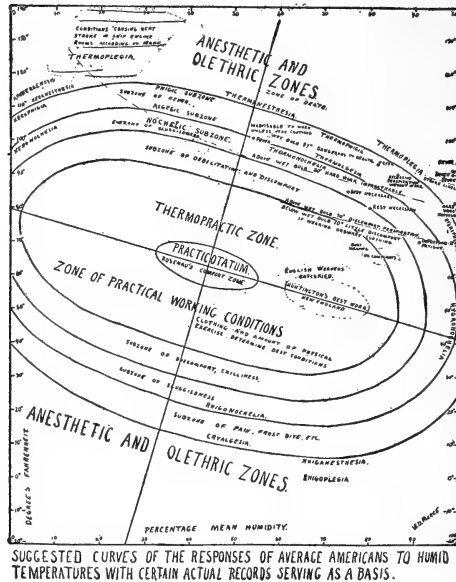

FIG. 9

Temperature and humidity affect every bodily function of every creature of the plant and animal kingdom. Some creatures may love cold, some heat, some dryness, some moisture. The pattern of their reactions will therefore shift from one place to another on the chart. Some creatures may be so resistant to cold that fatal temperatures are never normally experienced and rarely artificially. Some may be very resistant to dryness and others capable of standing any degree of humidity. In case of plants the root system receives one set of stimuli and the upper portion another, so that the interpretation is not as simple as with animals.

In the different stages of growth a creature may have different ability to withstand extremes.

If the approach to unfavorable or noneffective conditions is gradual,

the body gradually adjusts and adapts itself for entrance into a dormant state. We find adaptations against cold, heat and dryness, often in cysts or in cases constructed by the creature, and in fact some of these protective cases are made of substances impervious to water. In the state of encystment far greater extremes can be experienced than in the normal state, because of the impervious nature of the cyst.

Successful dormancy often depends upon the rapidity with which it was brought about. Most creatures practically free the intestinal canal before entering a resting stage.

A sudden lowering or raising of temperature may be fatal at temperatures which would normally be easily withstood if approached gradually.

Alternation of high and low temperatures, if sudden, is often fatal at normally effective temperatures. A creature may become dormant with descending temperatures at a higher temperature than it would awaken with ascending temperatures.

A continuous maintenance of an even temperature and humidity is more or less enervating. A climate which has sufficient variation to allow certain periods of rest from cold at night and heat in the day is probably productive of better results. It is possible in a given day for a creature to have two active and two dormant periods. As for example, observations of many insects will show that they sleep during the cold parts of a night, are active during the morning, sleep during the hottest part of the day, are again active in the evening and early parts of the night. It is also noticeable that on humid days many insects are inactive but as soon as the air dries they again resume activity, and the reverse is found in arid regions.

Many investigators have failed in keeping insects alive for experiment because of failure to keep sufficient water present for drinking purposes and maintenance of proper humidity.

As long as any creature is experiencing effective temperatures it must have food available to take when needed and this food must be in proper condition. Long periods without food at noneffective temperatures can be experienced, but at effective temperatures the length of life is relatively short. This is a very important point in control work with all insects. If you can deprive them of food for a sufficient period when the climatic conditions enforce activity, then control is easy.

There are many very difficult points in this question. Inasmuch as noneffective temperatures and also noneffective humidities may be experienced each day, it becomes necessary to make elaborate studies to ascertain the boundaries of the thermopractic and hygropractic zones, and only a thermo-hygrograph record sheet will enable one to make any kind of a satisfactory study.

There is a rule which receives much support, that a given reaction or stage of development is accomplished at an almost constant total effective temperature, which is the multiple of time units by temperature units accumulated above the zero of effective temperature. Since the zero varies with the humidity, the total effective temperature obtained by this rule does likewise. We must therefore reword the rule to read: *A given reaction or stage of development is accomplished at any given mean humidity at a constant total effective temperature, which is the multiple of effective time units by temperature units accumulated within the zone of effective temperatures at a given atmospheric pressure.* To compute this one must first eliminate all time, temperature, and humidity which was noneffective, whether at the top or bottom of the scale. For instance, if at 60% humidity the temperatures 65° to 85° are effective, and during the day the temperature ranged from 50° to 90°, but only during eight hours at the effective temperatures; we must multiply the period 8 hours by the mean temperature experienced between 65° and 85°, considering 65 as 0 and 85 as 20. The result is the total effective temperature of that day. Adding these total effective temperatures during the total period of the stage, we obtain the total effective temperature necessary to bring about the perfection of the stage. Necessarily this is a very complicated proposition, requiring very careful computations. Nevertheless, once worked out we can establish laws of control which are of utmost value.

Some of the following lectures will refer to the principles laid down in this lecture and lines of research will be suggested leading toward control measures. The charts (figs. 8, 9) should be studied in connection with the lecture.

CHAPTER VII

Diseases Borne by Non-Biting Flies¹

W. Dwight Pierce

It will be necessary in discussing the rôle of flies in the transmission of disease to divide the flies into several categories, because so many species of the order Diptera are involved. The flies can be divided into two large groups, those which bite and those which do not bite, but, rather, sip their food. Two excellent monographs on the relations of flies and disease have been published, that on the non-bloodsuckers by Graham-Smith, and that on the bloodsuckers by Hindle.

This lecture deals with the non-biting flies only. Among these flies are to be found the principal house-visiting flies, foremost among which is the house or typhoid fly, *Musca domestica* Linnaeus, followed by the blue bottle blow flies, *Calliphora vomitoria* Linnaeus and *C. erythrocephala* Meigen, the green bottle blow fly *Lucilia caesar* Linnaeus, and various other species. The mouth parts of these flies are constructed only for sucking or sipping liquid or semi-liquid foods.

In this lecture can only be given a very condensed statement of the relationship of these flies to disease. A more extensive study should involve the reading of the books by Hewitt and Graham-Smith quoted in the bibliography. In these volumes the evidence is given in great detail.

Among the most striking of the investigations into the capacity of non-biting flies for the carriage of disease germs, are a series of three excellent papers by the Italian investigator, Cao, whose work is overlooked by many subsequent writers. In fact, there has been but one good review of his results in English. And yet his investigations opened up the way for practically all of the work on bacterial transmission by insects. Working with larvae and adults of *Musca domestica* Linnaeus, *Calliphora vomitoria* Linnaeus, *Lucilia caesar* Linnaeus and *Sarcophaga carnaria* Linnaeus, he proved that the larvae of these flies could take up and pass through their intestines any bacteria occurring in their food, and that all four species acted exactly alike in this regard. Except where he specifically stated, his results applied to all four species in

¹This lecture was presented in two parts on July 8 and 15 and distributed entire on July 15, 1918. It has been revised for this edition.

every instance. Step by step, he proved that *fly-larvæ take up bacteria from their food, and when breeding in flesh may take up disease germs as well as non-pathogenic germs; that these germs may pass unaltered through the insects' intestines and out in their feces; that some of them may remain for a long period in the intestinal canal, and some even may multiply therein; that they may be taken up by the larva and persist through its metamorphosis until it arrives at the adult stage, and for days thereafter, and may be carried by this adult and deposited with its feces on food or excrement; and that these bacteria will also be found in the glutinous substances surrounding the eggs when deposited, and thus contaminate the substance in which the newly born larvæ will feed; and of course be taken up by this second generation and possibly be distributed farther by it.*

These facts were worked out by Cao in 1905 and 1906, and yet Graham-Smith credits Faichnie (who worked in India in 1909) with being the first one to suggest that bacteria ingested by the larva might survive the pupal stage and be present in the intestine of the adult. Later, Bacot, and also Ledingham in 1911 and Graham-Smith in 1912, corroborated these claims that the bacteria could persist in the body throughout the metamorphosis.

Ledingham (1911), Nicholls (1912), and Graham-Smith (1912) have shown that the fly larvæ have great powers of destroying micro-organisms due to the fact that many of these organisms are not adapted to the conditions prevailing in the interior of the larva and pupa, or perhaps more correctly due to the hostile action of bacteria which more normally frequent the intestines of the larvæ. These normal inhabitants of the fly intestine are principally non-lactose fermenting organisms.

Not only bacteria but also protozoa, such as the amoebæ of dysentery, and the eggs of parasitic worms, may be taken up by the fly larvæ or adults and deposited in the feces. Roubaud (1918) has brought out the fact that multitudes of the amoebic dysentery germs taken up by adult flies and deposited in their feces die because of the rapid drying of the feces, and he credits the fly with being a great agent in the destruction of multitudes of protozoa, while granting the equally great opportunity of the fly to contaminate food therewith.

Stiles in 1889 fed larvæ of *Musca domestica* with female *Ascaris lumbricoides*, which they devoured, together with the eggs they contained. The larvae as well as the adult flies contained the eggs of *Ascaris* (Nuttall, 1899, p. 39). Nicoll (1911) has very thoroughly investigated the relationships of flies to the possible carriage of eggs of worms and demonstrated the ability of adult flies to ingest the eggs of various species of worms, provided these are small enough, and to pass

them out whole in the feces, but in all his experiments with the larvae he found that the eggs were crushed.

In addition to the ability of flies to carry disease germs in their body, there are multitudes of proofs of their ability to carry them also on their body and to deposit them when they feed.

The transmission of disease by non-bloodsucking flies is exclusively by contamination either of food, water or wounds. Most of the flies which frequent houses and food or visit man because of attractive secretions or injuries also are attracted to and breed in excreta or garbage. Hence the contamination of food by direct transportation from infected excreta is a very simple matter.

This contamination may be by the simple depositing of disease germs carried on the body of the flies, or by regurgitation, or the deposition of feces. Wherever a fly alights and remains a few minutes it deposits either vomit or feces. By the nature of its breeding it is hardly to be expected that these deposits will not contain some kind of bacteria, and possibly protozoa or worm eggs. If these deposits are made on the moist media offered by foods the germs may easily retain their virulence until eaten.

As flies can travel considerable distances, at least thirteen miles, the existence of a single disease case with insanitary conditions in the vicinity enabling fly breeding, might easily infect an entire city or army camp if the flies were permitted to reach the food of the inhabitants. It is because of the total lack of sanitary waste disposal in country districts that diseases like typhoid fever and dysentery usually become very widespread. We can not know the source of the flies which enter our houses. We must not let them visit our food. They must be kept away from the eyes and mouths of babies. Our markets where meats and vegetables are sold must be better protected. Only through influencing public opinion will we be able to have the fly nuisance in our own public markets abated. Food offered for sale should be kept under glass or screen at all times.

There are so many organisms transmitted by the non-blood-sucking flies that we shall have to deal with them rather briefly and preferably according to their classification. A thorough digest of the mass of matter submitted below should impress the readers with the necessity of fly prevention.

PLANT ORGANISMS CARRIED BY NON-BITING FLIES

Thallophyta: Fungi: Schizomycetes: Coccaceae

Streptococcus equinus Andrewes and Horder, a non-pathogenic organism found in horse dung, was found by Torrey (1912) in a number of cases on the surface of city caught flies.

Streptococcus fecalis Andrewes and Horder, an organism occurring normally in the human intestine and occasionally pathogenic has been isolated from city caught *Musca domestica* by Scott (1917), Cox, Lewis and Glynn (1912) and Torrey (1912).

Streptococcus pyogenes Rosenbach, an organism causing ERYSIPELAS, SUPPURATION and SEPTICAEMIA was isolated by Scott (1917) from city caught *Musca domestica* in Washington.

Streptococcus salivarius Andrewes and Horder, an organism frequently found in the mouth, but rarely pathogenic, has been isolated from the intestines of city caught *Musca domestica* by Torrey (1912), and was also found on flies by Cox, Lewis and Glynn (1912).

Diplococcus gonorrhoeae Neisser (*Gonococcus*), the cause of GONORRHOEA, was found by Welander (1896) carried on the feet of a fly for three hours after they had been soiled with secretion.

Diplococcus intracellularis meningitidis Weichselbaum (*Meningococcus*), the cause of CEREBROSPINAL MENINGITIS, is thought to be possibly carried by flies by MacGregor (1917).

Micrococcus flavus was isolated by Torrey (1912) from the intestinal content as well as the surface of city caught flies.

Micrococcus tetragenus Gaffky, commonly found in the human body, sometimes pathogenic, sometimes saprophytic, was isolated from *Musca domestica* by Scott (1917).

Staphylococcus pyogenes albus Rosenbach, a cause of SEPTICAEMIA, was isolated by Cao (1906B) from the mucilaginous envelope covering the eggs of *Musca domestica*, *Sarcophaga vomitoria*, *Lucilia caesar* and *Calliphora vomitoria* at the time of deposition. Scott (1917) isolated it from the bodies of *Musca domestica*.

Staphylococcus pyogenes aureus Rosenbach, a frequent cause of ABSCESSSES, etc., was shown by Celli (1888) to retain its virulence after passing through the flies' intestines. Herms (1915) proved by experiment that *Musca domestica* can carry great numbers of this organism on its feet. Torrey (1912) and Scott (1917) isolated it from the bodies of city caught flies. Cao (1906B) isolated it from the eggs at the time of deposition of laboratory caught flies of *Musca domestica*, *Calliphora vomitoria*, *Sarcophaga carnaria* and *Lucilia caesar*.

Staphylococcus pyogenes citreus Passet, a pathogenic, chromogenic, pus-forming organism, was isolated by Scott (1917) from bodies of house flies *Musca domestica* in Washington. Cao (1906B) fed larvae of *Musca domestica*, *Sarcophaga carnaria*, *Calliphora vomitoria*, and *Lucilia caesar* on meat polluted with this organism and recovered it from the feces of mature flies bred from these larvae.

Sarcina aurantiaca Lindner and Koch, a zymogenic, chromogenic (orange yellow) organism found in air and water, rarely pathogenic,

was found by Cao (1906B) to be capable of passing through the intestines of larvæ of *Musca domestica*, *Calliphora vomitoria*, *Sarcophaga carnaria*, and *Lucilia caesar*, in all stages of larval growth and of remaining in the body through pupation to maturity.

Thallophyta: Fungi: Schizomycetes: Bacteriaceæ

Bacillus of Koch-Weeks, the cause of an acute infectious CONJUNCTIVITIS (pink eye), is thought by Castellani and Chalmers (1913, p. 700) to be frequently carried by the little Oscinid gnat, *Microneurum funicola* Meijere, which causes great annoyance by hovering in front of the eyes and attacking the eyes and ears. The flies may be driven away by the odor of Odol.

Bacillus A of Ledingham, a nonlactose fermenter from the feces of children, has been found by Tebbutt (1912) to be normal to the house fly, *Musca domestica*, being found on the ova, and in the larvæ, pupæ and adults, and when fed to the larvæ survived through the metamorphosis to the adult stage.

Bacillus of Morgan, which is frequently found in cases of INFANTILE DIARRHEA, has been found in various strains commonly in the intestines of *Musca domestica* by Nicoll (1911), Morgan and Ledingham (1909), Cox, Lewis and Glynn (1912) and Graham-Smith (1912), and the latter found that when fed to larvæ of the house fly it could survive through the metamorphosis to the adult fly.

Bacillus acidi lactici Hueppe, a bacillus common to cows' milk, has been isolated from the bodies and from the intestinal contents of *Musca domestica* in New York, Washington, London and Liverpool by Torrey (1912), Scott (1917), Nicoll (1911), and Cox, Lewis and Glynn (1912).

Bacillus aerogenes capsulatus Welch and Nuttall is a pathogenic organism gaining entrance to the body chiefly through wounds and causing severe infections resulting often in GANGRENE. In the surgery of the Great War this organism has been a very important one. It occurs as a normal inhabitant of the intestine of man and some of the animals. It has been isolated by Torrey (1912) from the surface as well as the intestinal contents of city caught flies.

Bacterium anthracis Davaine, the cause of ANTHRAX, although probably more often carried by biting flies, has been shown by Davaine (1870) to be capable of carriage by *Calliphora vomitoria*. He fed flies on anthracic blood and inoculated guinea pigs with parts of these flies 40 hours to 3 days later, obtaining fatal results in 4 out of 7 cases. From flies of *Calliphora vomitoria* caught in his laboratory Cao (1906B) isolated virulent germs of *B. anthracis* adhering to the glutinous secretion surrounding the eggs as they were deposited. He later placed on flesh

of animals dead from anthrax externally sterilized eggs of *Musca domestica*, *Calliphora vomitoria*, *Lucilia cæsar* and *Sarcophaga carnaria* and from day to day dissected the larvæ feeding on this flesh, always demonstrating anthrax germs in their bodies, and he further proved that these larvæ retained the germs in their bodies through pupation to maturity and for at least nine days after maturity. He fed flies on meat polluted with anthrax and demonstrated twenty-four hours later the bacilli in the feces and on the eggs. Graham-Smith (1912) found that many blow flies (*Calliphora erythrocephala* and *Lucilia cæsar*) which emerged from larvæ fed on meat infected with anthrax spores were infected and remained so for 15 days or more. He also found that a large proportion of house flies (*Musca domestica*) which develop from larvæ fed on spores of *B. anthracis* are infected. Because of the habit of blow flies of breeding in and attacking wounds there have been many cases of human anthrax on the battle front in Europe. The ease with which this may occur is quite evident in view of the above quoted investigations.

Bacillus cloacæ Jordan has been found in the alimentary canal of *Musca domestica* in London by Nicoll (1911).

Bacillus coli Escherich, an organism normally found in the alimentary canal of man, but often found causing secondary infections, was found by Cao (1906B) in various strains adhering to the eggs at the time of oviposition of flies caught in the laboratory (*Musca domestica*, *Sarcophaga carnaria*, *Lucilia cæsar*, and *Calliphora vomitoria*).

Bacillus coli anaërogenes was isolated by Scott (1917) from *Musca domestica* caught in Washington.

Bacillus coli communior Dunham, an abundant inhabitant of the human and animal intestine, has been isolated from the body and intestinal contents of *Musca domestica* in New York and Washington by Torrey (1912) and Scott (1917).

Bacillus coli communis Escherich, an organism common in the intestine of man and animals and associated with a large variety of lesions, has been isolated from the body and intestinal contents of *Musca domestica* by Torrey (1912), Nicoll (1911), Scott (1917) and Cox, Lewis and Glynn (1912).

Bacillus coli mutabilis was found on the body and in the intestines of *Musca domestica* in London by Nicoll (1911).

Bacillus "colisimile" Cao was fed by Cao (1906B) to larvæ of *Musca domestica*, *Calliphora vomitoria*, *Lucilia cæsar* and *Sarcophaga carnaria* in flesh and he later demonstrated its abundant presence in the feces of the larvæ.

Bacillus cuniculicida Koch and Gaffky, the cause of *SEPTICÆMIA* in rabbits and guinea pigs, was isolated by Scott (1917) from house flies (*Musca domestica*) caught in Washington, and he looks upon the fly

as the carrier of laboratory epidemics of rabbit and guinea pig septicæmia experienced for several years.

Bacillus diphtheriæ Klebs, the cause of DIPHTHERIA, according to experiments performed by Graham-Smith (1910) may be taken up by flies feeding on infected saliva or sputum and may live in the crop and intestines of the fly for over 24 hours, and in fact in one experiment he twice recovered it from the feces of flies 51 hours after feeding on bacilli emulsified in broth.

Bacillus dysenteriæ "Y" Hiss and Russell, one of the organisms found in DYSENTERY and INFANTILE DYSENTERIC DIARRHEA, was experimented with by Tebbutt (1913) who fed it with blood to larvæ of *Musca domestica*. The eggs from which these larvæ were hatched were washed in weak carbolic acid or lysol to disinfect them. Before feeding the larvæ on the organism they were carefully washed in weak lysol solution. In a limited number of cases the bacillus was recovered from the pupæ and adults of larvæ thus fed.

The Shiga bacillus, Flexner bacillus and parabacillus of dysentery were all isolated on flies in Macedonia and a decided correlation between the incidence of flies and dysentery was established by Col. Dudgeon (1919) and associates. They found the examination of fly feces the most suitable method for the isolation of dysentery bacilli.

Bacillus enteritidis Gaertner, the cause of FOOD POISONING in man, and epizootic diseases among animals, was experimented with by Graham-Smith (1912), who fed it to the larvæ of *Calliphora erythrocephala* and *Musca domestica*, but did not recover it in the adults matured from these larvæ. Cox, Lewis and Glynn (1912) isolated a similar bacillus from flies caught in Liverpool.

Bacillus fecalis alkaligenes Petruschky, a not infrequent inhabitant of the human intestine, which has been associated with a case of severe gastroenteritis, was isolated by Torrey (1912) from the intestinal content of city caught flies in two different instances.

Bacillus fluorescens liquefaciens Fluegge, a common organism found in water and air, was fed by Cao (1906B) to larvæ of *Musca domestica*, *Calliphora vomitoria*, *Lucilia cæsar*, and *Sarcophaga carnaria*, on flesh containing the organisms, and found among the predominant bacteria in the feces of the larvæ. He found that this organism taken up by the larvæ could persist through the pupal stage and be obtained from the feces of flies immediately after their emergence, and when fed to adults it was demonstrated on their eggs when deposited.

Bacillus fluorescens nonliquefaciens Eisenberg and Krueger, found in water and in butter, was fed by Cao (1906B) to larvæ of *Musca domestica*, *Calliphora vomitoria*, *Lucilia cæsar*, and *Sarcophaga carnaria*, and later demonstrated in the feces of the larvæ.

Bacillus gasoformans nonliquefaciens was found on the body and in the alimentary canal of *Musca domestica* caught in London by Nicoll (1911).

Bacillus grünthal was found on the body and in the intestines of *Musca domestica* by Nicoll (1911).

Bacillus lactis acidi Marpmann, a zymogenic bacillus found in cows' milk, was isolated by Torrey (1912) from the surface of city caught flies.

Bacillus lactis aërogenes Escherich, which is almost constantly found in milk and is one of the chief causes of souring of milk, was isolated from flies by Cox, Lewis and Glynn (1912).

Bacillus lepræ Hanson, cause of LEPROSY, may be carried by *Musca domestica*, according to Leboeuf (1913).

Bacillus mallei Löffler and Shutz may be transmitted by flies according to Rosenau (1916).

Bacillus neapolitanus has been found on the body of *Musca domestica* by Nicoll (1911) and Cox, Lewis and Glynn (1912).

Bacillus oxytocus perniciosus Wyssokowitsch, a pathogenic organism found in milk, has been isolated from the intestines of *Musca domestica* by Nicoll (1911).

Bacillus paracoli Duval and Schorer, a pathogenic organism found frequently in the stools of children suffering from summer diarrhea, has been isolated several times by Torrey (1912) in New York, both from the surface and intestines of city caught flies.

Bacillus paratyphosus "A" Schottmüller, cause of PARATYPHOID A fever was isolated from the intestinal contents of city caught flies by Torrey (1912).

Bacillus paratyphosus "B" Schottmüller, cause of PARATYPHOID B fever, was recovered from the body and intestines of *Musca domestica* caught in London by Nicoll (1911), with the evidence that it had been carried by the flies at least for 11 days.

Bacillus pestis Kitasato, the cause of BUBONIC PLAGUE, although normally carried by fleas, has been shown by Yersin (1894) and Nuttall (1897) capable of remaining in the intestines of flies in a virulent condition for at least 48 hours after infection. Nuttall's experiments indicated that this bacillus is fatal to *Musca domestica*.

Bacillus prodigiosus Ehrenberg, a nonpathogenic, zymogenic, and chromogenic organism, was fed by Cao (1906B) to adult flies of *Musca domestica*, *Calliphora vomitoria*, *Lucilia casar*, and *Sarcophaga carnaria* and was demonstrated in their feces and on their eggs 24 hours later. Larvæ fed on polluted meat contained the germs in their bodies and carried them through pupation and they could be demonstrated in the intestines of the adult up to nine days after emergence. Ledingham (1911) corroborated Cao's findings of the persistence of this bacillus

throughout the metamorphosis of *Musca domestica*. Graham-Smith (1913) found that flies of *Musca domestica* fed on this bacillus may infect milk for several days, while *Calliphora vomitoria* flies when infected constantly produced infection in milk up to the eighth day and in syrup up to the twenty-ninth day.

Bacillus proteus vulgaris Hauser, *B. p. mirabilis* Hauser, and *B. p. zenkeri* were fed by Cao (1906B) to larvæ of *Musca domestica*, *Calliphora vomitoria*, *Sarcophaga carnaria*, and *Lucilia cæsar*, and were found abundantly in the feces of the larvæ so fed. Species of *Proteus* were also found deposited with the eggs of flies fed on infected flesh. *Bacillus proteus vulgaris* was isolated by Scott (1917) from *Musca domestica* caught in Washington.

Bacillus pyocyaneus Gessard associated with SUPPURATING WOUNDS in which blue-green pus is present was isolated in two strains from flies caught in Liverpool by Cox, Lewis and Glynn (1912). Bacot and Ledingham (1911) by carefully controlled experiments have proved that the larvæ of *Musca domestica* fed on infected food retain this bacillus in the gut through the metamorphosis to the adult stage and may distribute it in their excreta.

Bacillus radiciformis Tataroff, a saprophytic organism found in water, was fed by Cao (1906B) to larvæ of *Musca domestica*, *Calliphora vomitoria*, *Lucilia cæsar* and *Sarcophaga carnaria*, and recovered from the feces of the larvæ.

Bacillus ruber kielensis Breunig, a chromoparous (red) bacillus found in water at Kiel, was fed by Cao (1906B) to larvæ of *Musca domestica*, *Sarcophaga carnaria*, *Calliphora vomitoria*, and *Lucilia cæsar*, and he demonstrated that the larvæ could take it up in all stages of growth, and that the bacilli persisted in their bodies through pupation to maturity.

Bacillus schafferi Freudenreich, a nonpathogenic, zymogenic organism, found in "puffy" and "Nissler" cheese, has been found by Nicoll (1911) in London on the body and in the intestines of *Musca domestica*.

Bacillus septicus agrigenus Nicolaier, a pathogenic organism, was fed by Marpmann (1897) to flies, and 12 hours later the contents of the flies were inoculated into mice, producing fatal infection in a large per cent of the inoculations (Nuttall 1899).

Bacillus "similcarbonchio" Cao, a pathogenic organism similar to *Bacillus anthracis*, which produces CARBUNCLES when inoculated, was fed by Cao (1906B) to larvæ of *Musca domestica*, *Calliphora vomitoria*, *Lucilia cæsar* and *Sarcophaga carnaria* and isolated from the feces of the larvæ in a very virulent strain. In examinations of many flies caught in the laboratory he occasionally isolated a non-pathogenic, mobile strain of this organism.

Bacillus subtilis Ehrenberg, an organism frequently found in air,

water, and soil, and seldom pathogenic, was fed by Cao (1906B) to larvæ of *Musca domestica*, *Calliphora vomitoria*, *Lucilia cæsar* and *Sarcophaga carnaria* and was among the predominant bacteria recovered from the feces of the larvæ.

Bacillus suispestifer Salmon and Smith, often found in cases of FOOD POISONING and SUMMER DIARRHEA, is recorded by Scott (1917) from the house fly, *Musca domestica*.

Bacillus "tifosimile" Cao, a pathogenic organism strongly resembling *B. typhosus*, was fed by Cao (1906B) to larvæ of *Musca domestica*, *Calliphora vomitoria*, *Lucilia cæsar*, and *Sarcophaga carnaria* and later demonstrated in the feces of the larvæ as among the predominant forms in strains of differing virulence. From flies caught around the laboratory he isolated pathogenic strains adhering to the eggs when deposited.

Bacillus tuberculosis Koch, the cause of TUBERCULOSIS, was found in four out of six flies caught by Hofmann (1888) in the room of a tuberculosis patient, whose sputum had contained many germs. Flies fed artificially with sputum died in a few days. Within twenty-four hours of their being fed on the sputum, the tubercle bacilli appeared in their excreta. A guinea pig inoculated with the intestines of flies developed tuberculosis. Celli (1888) reports Alessi's experiments of inoculating the feces of flies fed on tubercular sputum, and causing the development of tuberculosis in two rabbits. Spillman and Haushalter (1887) were, however, the first to find the tubercle bacilli in the intestines and feces of flies which had fed on sputum.

Bacterium tularense McCoy and Chapin, cause of a fatal RODENT PLAGUE of which a few human cases are on record, may be transmitted by *Musca domestica*. Wayson (1915) inoculated the crushed bodies of flies fed on the viscera of an animal dead 48 hours and obtained fatal results in three series of experiments with guinea pigs.

Bacillus typhosus Eberth, the cause of TYPHOID FEVER, was first shown by Celli (1888) to be capable of passing through the intestines and into the feces of flies. Many authors have added proofs of the rôle of the fly in the transmission of this disease and these are ably summarized by Graham-Smith (1913) and Hewitt (1914). Faichnie (1909) proved that flies could carry this bacillus in their intestines for 16 days. Ledingham has isolated the bacillus from the intestines of *Musca domestica* which had fed on it in the larval stage, but found that the normal bacilli in the larval intestines usually prevent its successful survival through metamorphosis.

Bacillus vesiculosus, which is very frequently found in human excrement, was found on the body of *Musca domestica* caught in London by Nicoll (1911).

Bacillus xerosis Kutschert and Neisser, a presumably nonpathogenic

organism, usually found in the eyes, and often associated with conjunctivitis, was isolated by Torrey (1912) on the surface of city caught flies.

Thallophyta: Fungi: Schizomycetes: Spirillaceae

Spirillum (Vibrio) cholerae Koch, the cause of ASIATIC CHOLERA, may be carried by flies. The connection of flies with the prevalence of cholera was first noted by Nicholas (1873). Maddox (1885) first performed experiments with *Calliphora vomitoria* Linnaeus and *Eristalis tenax* Linnaeus as well as other insects and determined microscopically the presence of the motile cholera vibrios in the feces. Tizzoni and Cattoni (1886) caught flies in cholera wards and after several hours obtained characteristic cultures of the organism. Many other authors, as Sawtchenko (1892), Simmonds (1892), Uffelmann (1892), Macrae (1894), have furnished proofs of fly dissemination of the cholera vibrio, a summary of which can be found in the books by Graham-Smith and Hewitt.

SUMMARY OF PLANT ORGANISMS

A brief survey of the data presented above will perhaps help to imprint the gravity of the fly menace on all who read this. Sixty-three minute plant organisms have been shown to be transmissible by domestic flies. Forty-four of these organisms have been found on or in flies caught in cities or buildings, in other words, were naturally carried by so-called "wild flies." Among these forty-four organisms naturally carried by flies were several normal inhabitants of milk, also various normal inhabitants of the human and of animal intestines, which could only be taken up from excrement. Some of these organisms are taken from eyes, some from sputum, some from decaying vegetable matter, others from dairy products. The fly containing such organisms betrays its habits. We find the organisms of conjunctivitis, infantile diarrhea, sour milk, gas gangrene, enteritis, guinea pig septicaemia, leprosy, paratyphoid A, and paratyphoid B fevers, bubonic plague, green pus, food poisoning, tuberculosis, typhoid fever, anthrax, rodent plague, gonorrhoea, abscesses, erysipelas, bacillary dysentery, and cholera, and possibly cerebrospinal meningitis, normally carried by flies which frequent our houses, visit our bodies and pollute our food with their excreta. We also find experimental evidence that these same flies can carry the organisms of diphtheria, gastroenteritis, and other pathogenic conditions.

In other words, it would seem that non-blood-sucking flies can carry any bacterial or coccal disease in which the organism may be reached by the fly on the body of the person, in his sputum, or his excreta, and undoubtedly the same is true of such diseases of animals.

It is of interest to note that in nineteen species the organism has been proven to pass freely through the intestinal canal of the larvæ, in thirty-seven species through the intestines of the adult, and in eleven species to be capable of persisting in the larvæ through metamorphosis to the adult. What greater argument could be found that flies are dangerous not only because of what they as flies have fed on, but also because of food they took while larvæ, possibly a long distance away?

We have not, however, gauged the depth of the fly's infamy, as we have so far only listed the evidence of plant diseases transmitted.

DISEASES OF UNSETTLED ORIGIN PROBABLY CAUSED BY
MICROORGANISMS

PURULENT OPHTHALMIA is said to be carried by flies in Egypt. Brumpt accused *Musca domestica* of being a carrier of TRACHOMA. Rosenau stated that flies have been found breeding in open lesions of SMALLPOX, and that flies may transmit MEASLES and SCARLET FEVER. Definite experiments certainly should be carried out with a view to determining the exact relationship of flies to these diseases, seeking first the possibility of transmission by fecal contamination.

Howard and Clark (1912) found that *Musca domestica* flies can retain the virus of INFANTILE PARALYSIS or POLIOMYELITIS either in or on their bodies for 24 and 48 hours. The virus may remain alive in the body of the fly six hours after ingestion. The fly can obtain the virus from secretions of nose and throat and discharge of intestines.

Very recently Dorset (1919) and associates have experimentally transmitted HOG CHOLERA by inoculating with crushed bodies of infected *Musca domestica* and *Fannia canicularis*, and also by bringing such flies in contact with abraded surfaces.

ANIMAL ORGANISMS CARRIED BY NON-BITING FLIES

We will now consider in a similar manner the evidence of transmission of animal organisms by these same flies.

Protozoa

Sarcodina: Amoebina: Amoebidae

Löschia coli (Lösch) (*Endamoeba*) a supposedly harmless commensal in the alimentary canal of man, where it feeds on the contents of the bowels, may be carried in the encysted form by *Musca domestica*, accord-

ing to Roubaud (1918), who finds that the cysts readily pass through the fly intestines at laboratory temperatures of 15-18° C. (59-65° F.) in 24 hours. It may be carried from infected stools to food but must be deposited in moist substances, as all cysts dry rapidly in dry fly feces.

Löschia histolytica (Schaudinn), the cause of AMOEBIC DYSENTERY, may be carried in the encysted form by *Musca domestica* and *Calliphora erythrocephala* according to Flu (1916). Roubaud (1918) has carefully investigated and finds that the free amoeba is quickly digested by the fly, but the cysts may pass readily through the intestines within 24 hours and may be demonstrated up to 40 hours. The cysts die rapidly in dry fly feces, and therefore to live must be placed on moist substances, or on food.

Mastigophora: Protomonadina: Bodonidae

Prowazekia sp. is found in *Fannia canicularis* (Dunkerly 1912).

Mastigophora: Polymastigina: Polymastigidae

Giardia intestinalis (Lambl) (*Lambli*a), the cause of LAMBLIAN DYSENTERY of rodents and man, may be carried in the encysted form by *Musca domestica*, according to Roubaud (1918), but must be deposited in the feces on moist substances, or directly on food.

Mastigophora: Binucleata: Leptomonidae

Crithidia calliphorae Swellengrebel is described as a parasite of *Calliphora erythrocephala* Meigen.

Crithidia muscae-domesticae Werner is described as a parasite of *Musca domestica* Linnaeus.

Leptomonas calliphorae (Swingle) is a parasite of *Calliphora erythrocephala* Meigen.

Leptomonas drosophilae Chatton and Alilaire is a parasite of *Drosophila confusa*.

Leptomonas homalomyiae (Brug) is a parasite of *Fannia scalaris* Fabricius.

Leptomonas lineata (Swingle) is a parasite of *Sarcophaga sarraceniae* Riley.

Leptomonas luciliae (Strickland) is a parasite of *Lucilia* sp.

Leptomonas luciliae (Roubaud) is described as a parasite of *Lucilia serenissima* Walker.

Leptomonas mesnili Roubaud is a parasite of *Lucilia* sp.

Leptomonas muscae-domesticae (Burnett) is a parasite of *Musca domestica* Linnaeus, *M. nebulo* Fabricius, *Fannia scalaris* Fabricius, *Pollenia rudis* Robineau-Desvoidy, *Teichomyza fusca* Macquart, *Lucilia* sp., *Pycnosoma putorium* Wiedemann, *Scatophaga lutaria* Fabricius, *Neuroctena anilis* Fallen, *Homalomyia corvina* Verrall, and *Sarcophaga murus*, undergoing complete metamorphosis in the bodies of the flies. Patton (1910) has demonstrated that the disease may be transmitted from fly to fly as follows: the food becomes infected from the feces of the infected flies which have fed on it; uninfected flies may become infected by ingesting either the long flagellates, the short encysting forms, or the cysts, in the feces of other flies, or in food contaminated by other flies.

Leptomonas pycnosomae Roubaud is a parasite of *Pycnosoma putorium*.

Leptomonas roubaudi Chatton is a parasite in the Malpighian glands of *Drosophila confusa* Staeger.

Leptomonas sarcophagae (Prowazek) is a parasite in the gut of *Sarcophaga haemorrhoidalis* Fuller and another species of *Sarcophaga*.

Leptomonas soudanensis Roubaud is a parasite of *Pycnosoma putorium*.

Leptomonas stratiomyiae (Fantham and Porter) is a parasite of *Stratiomyia chameleon* Linnaeus and *S. potamida* Meigen. Fantham and Porter (1916) proved it experimentally pathogenic by inoculation to *Mus musculus*.

Leishmania tropica (Wright), the cause of ORIENTAL SORE of man, may be taken up in the crithidial stage by *Musca domestica* and the organism demonstrated 48 hours after feeding, according to Carter (1909). According to Wenyon (1911) who investigated BAGDAD SORE, *Musca domestica* may readily feed on the sores and take up *Leishmania*, but there is no development of the organism and no parasites were found in the feces. On the other hand, Row, working with CAMBAY SORE believed the organism transmissible by *Musca domestica* up to three hours after the fly had fed on infected sores. He found the gut contents of flies infective for a monkey three hours after the fly had taken up *Leishmania*, but Patton (1912) maintains that Cambay sore never commences in a cut, scratch or abrasion, and failed to transmit the disease in this manner in numerous experiments with *Musca nebulo* and *Musca* sp. A new investigation, however, is warranted by Row's statement, seeking fecal infection of wounds.

Rhynchoidomonas luciliae Patton is parasitic in the Malpighian tubules of *Musca nebulo* and *Lucilia serenissima*.

Mastigophora: Binucleata: Trypanosomidae

Castellanella evansi (Steel) Chalmers (*Trypanosoma*)², the cause of SURRA, an African disease of horses and other mammals, may be carried by *Musca domestica* by contact with wounds.

Castellanella hippicum (Darling) Chalmers (*Trypanosoma*),² the cause of MURRINA, a disease of horses and mules in the United States and Panama, may be carried according to Darling (1911, 1912) by *Musca domestica*, *Chrysomya* and *Sarcophaga*, from wounds by mechanical transmission. He ascertained that the trypanosomes remained alive in the proboscis of the fly at least two hours, and he also successfully inoculated a mouse with the crushed portions of a proboscis of a fly which had fed on infected blood. Isolation of the animals from fly attack, and binding up of wounds wiped out the epidemic. He did not ascertain whether the trypanosome might pass out of the fly's feces and contaminate lesions in this manner, which naturally is the normal method of fly transmission.

Mastigophora: Spirochaetacea: Spirochaetidae

Treponema pertenue (Castellani), the cause of YAWS, an infectious disease of men, may be transmitted by the house fly, *Musca domestica*. Castellani in Ceylon (1907) found that flies eagerly crowd around the open sores of yaws patients. In the hospitals as soon as the dressings were removed from the yaws ulcerations, they became covered with flies, sucking with avidity the secretion, which they may afterward deposit in the same way on ordinary ulcers on other people. He conducted experiments which proved that the flies do take up the organism, which he recovered from the dissected mouth parts. He fed flies on the organism, then removed their appendages and fastened them over scarified areas of skin of monkeys, and obtained in two experiments positive lesions by this organism. Robertson (1908) also definitely obtained this spirochaete from flies collected on yaws lesions. Nicholls (1912) ascribes most of the cases of yaws in the West Indies to inoculation of surface injuries by *Oscinis pallipes* Loew. *Sarcophaga* is also considered a carrier. None of the experiments have been directed at obtaining infection through the deposition of the spirochaetes, taken up by the fly in feeding, in its feces on other ulcers or injuries. This would appear to be the most likely method of infection.

²The classification of the Trypanosomes has recently been modified by Chalmers, including several genera composed of species with similar morphological and biological characteristics.

Neosporidia: Myxosporidia: Nosemida

Nosema apis Zander, a bee disease, may be communicated to *Calliphora vomitoria* and other insects through feeding on the bee excreta around beehives.

Protozoa: Neosporidia: Myxosporidia: Thelohanidae

Octosporaea monospora Chatton and Krempf is a parasite of *Fannia scalaris*.

Thelohania ovata Dunkerly is also a parasite of *Fannia scalaris*.

HIGHER ORGANISMS CARRIED BY FLIES

As pointed out in the introduction of this lecture, flies can carry the eggs of higher organisms. The evidence is presented below, but reference should be made to Dr. Ransom's lecture (Chapter V).

Platyhelminia: Cestoidea: Cyclophyllidea: Taeniidae

Taenia (Taeniarhynchus) saginata Goeze, the FAT-TAPEWORM of cattle and rarely of man, has been commonly found in the egg stage in *Musca domestica* in British East Africa according to Shircore (1916). It is necessary that the eggs, passed in human or animal feces, reach the food or water of the next host (cattle). This may occur by means of insanitary sewage disposal, possibly under exceptional circumstances by the agency of flies.

Platyhelminia: Cestoidea: Cyclophyllidea: Hymenolepididae

Choanotaenia infundibulum (Bloch) Cohn, the FOWL TAPEWORM, developed to the cysticeroid stage in *Musca domestica* fed on the eggs, and Guberlet (1916) succeeded in infecting new-born chicks by feeding them on infected *Musca domestica*.

Davainea cesticillus Molin, a fowl tapeworm, was tested with negative results by Guberlet (1916), using *Musca domestica* and *Calliphora vomitoria* in his search for the intermediate host.

Davainea tetragona Molin, another chicken tapeworm, likewise gave Guberlet (1916) negative results with the same two species of flies.

Platyhelminia: Trematoda: Malacotylea: Schistosomidae

Schistosoma mansoni Sambon, the trematode worm causing intestinal Schistomiasis of man or BILHARZIOSIS, may be found in the egg stage

in *Musca domestica*, according to Shircore (1916), who recorded eggs of this species in flies in British East Africa. The cercaria stage is passed in a snail.

Nemathelminthes: Nematoda: Spiruridae

Habronema muscae (Carter) Diesing, a STOMACH WORM OF HORSES, passes its earlier stages in *Musca domestica*, according to Ransom (1913). Either the egg or first-stage larva is ingested by the fly larva breeding in horse manure. Development goes on within the fly larva and pupa, the last stage being found in the proboscis of the adult fly. It passes to horses through the swallowing of infested flies and probably may also leave the proboscis of the fly while the insect is feeding on the mucous membranes of the horse.

Van Saceghem (1917, 1918) placed flies bred from larvæ fed on infected manure, on skin lesions of a horse and produced infections of EQUINE GRANULAR DERMATITIS, caused by the presence of *Habronema* larvæ in the skin.

Habronema microstoma (Schneider) Ransom and *H. megastoma* (Rudolphi) Seurat have also been shown to pass their developmental stages in *Musca domestica*. (See Chapter V.)

Nemathelminthes: Nematoda: Ascaridae

Ascaris lumbricoides Linnaeus, the cause of HUMAN ASCARIASIS, does not require an intermediate host. Stiles in 1889 fed *Musca domestica* larvæ on female *Ascaris* and later found the eggs in different stages of development in both larvæ and adult flies (Graham-Smith, 1913). Shircore (1916) in British East Africa found the eggs in the intestines of *Musca domestica* in nature. Nicholls (1912) in St. Lucia found the eggs in the abdomens of flies, *Borborus punctipennis* Macquart (*Limosina*), taken at fecal matter. (See Chapter V.)

Nemathelminthes: Nematoda: Oxyuridae

Oxyuris Curvula Rudolphi, the EQUINE PINWORM, is recorded by Patton and Cragg (1913), as probably the species of *Oxyuris*, which in Madras is often found in the embryo stage heavily infesting the larvæ of *Musca nebulo*.

Oxyuris vermicularis Linnaeus, the HUMAN PINWORM, can be ingested in the egg stage by flies, according to Grassi (1883).

Nemathelminthes: Nematoda: Ancylostomidae

Ancylostoma duodenale Dubini, cause of HOOK WORM disease of man, has been found in the egg stage in house flies, *Musca domestica*, by Shircore (1916) in British East Africa, and it is therefore possible that the eggs may be placed on food, in which the hook worm larva could hatch and be directly conveyed into the body with the food. No development takes place in the flies.

Necator americanus Stiles, the American HOOK WORM, was collected in the egg stage in the intestines of *Limosina punctipennis* in St. Lucia by Nicholls (1912). Galli-Valerio (1905) found that flies could carry on the surface of their bodies not only the eggs but also the larvæ of this worm.

Nemathelminthes: Nematoda: Trichosomidae

Trichiuris trichiura (Linnaeus), the WHIP WORM of man, was collected in the egg stage by Shircore (1916) in British East Africa in the abdomen of *Musca domestica* and by Nicholls (1912) in St. Lucia in the abdomen of *Borborus punctipennis* (*Limosina*), and the latter succeeded in feeding *Musca domestica* on the eggs. It probably does not require the flies as immediate hosts, but is undoubtedly distributed in this manner.

Thus to the already long list of serious diseases in whose spread the non-blood-sucking flies may play some part we may now add hog cholera, poliomyelitis, amoebic dysentery, Lamblian dysentery, Oriental sore, surra, murrina, yaws, purulent ophthalmia, trachoma, the fat-tapeworm of cattle, the fowl tapeworm, bilharziosis of man, the stomach worm of horses, equine granular dermatitis, human ascariasis (not normal method), equine pinworm, pin itch, two hook worms, and the whip worm, and possibly also smallpox, measles and scarlet fever.

We found that the bacteria were only mechanically carried by the flies, except in the case of *Bacillus anthracis*. Among the protozoa also those organisms parasitic in vertebrates all seem to be mechanically transmitted. The various parasites mentioned, however, pass complete life cycles in the body of the fly. Among the worms, however, there are cases of external mechanical carriage, transmission of eggs through the intestinal canal, retention of the egg from larva to adult fly (*Ascaris lumbricoides*), and also cases of the fly serving as an intermediate host (*Choanotaenia infundibulum*, and *Habronema* spp.). The last named worms are the only organisms known to be transmitted by the fly which work forward into the proboscis for transmission at time of feeding.

A bibliography of the works cited in the lecture follows:

IMPORTANT GENERAL TEXTBOOKS

- Fantham, H. B., Stephens, J. W. W., and Theobald, F. V., 1916.—The Animal Parasites of Man. Wm. Wood & Co., New York, 900 pp.
- Graham-Smith, G. S., 1913.—Flies in Relation to Disease. Non-Blood-Sucking Flies. Cambridge Univ. Press, 292 pp.
- Herms, Wm. B., 1915.—Medical and Veterinary Entomology. The Macmillan Company, New York.
- Hewitt, C. Gordon, 1914.—The House Fly, *Musca domestica* Linn. Its Structure, Habits, Development, Relation to Disease and Control. Cambridge Univ. Press, 382 pp.
- Hindle, Edward, 1914.—Flies in Relation to Disease. Blood-Sucking Flies. Cambridge Univ. Press, 398 pp.
- Patton, Walter Scott, and Cragg, Francis William, 1913.—A Textbook of Medical Entomology. Christian Literature Society for India, London, Madras and Calcutta, 764 pp.
- Riley, W. A., and Johannsen, O. A., 1915.—Handbook of Medical Entomology. Comstock Publishing Company, Ithaca, N. Y.

SPECIAL REFERENCES

- Cao, G., 1898.—L'Ufficiale San. Riv. D'Igiene di Med. Patr., vol. 11, pp. 337-348, 385-397.
- Cao, G., 1906A.—Annali D'Igiene Sper., vol. 16, n. s., pp. 339-368.
- Cao, G., 1906B.—Annali D'Igiene Sper., vol. 16, n. s., pp. 645-664.
- Carter, R. M., 1909.—Brit. Med. Journ., vol. 2, pp. 647-650.
- Castellani, A., 1907.—Journ. Hygiene, vol. 7, p. 567.
- Castellani, A., and Chalmers, A. J., 1913.—Manual of Tropical Medicine, 2nd edit., p. 700.
- Celli, A., 1888.—Bullet. d. Soc. Lancisiana d. Ospedali di Roma, fasc. 1, p. 1.
- Cox, G. L., Lewis, F. C., and Glynn, E. E., 1912.—Journ. Hygiene, vol. 12, No. 3, pp. 306-309.
- Darling, S. T., 1911.—Journ. Infect. Diseases, vol. 8, No. 4, pp. 467-485.
- Darling, S. T., 1911.—Parasitology, vol. 4, No. 2, pp. 83-86.
- Darling, S. T., 1912.—Journ. Exper. Med., vol. 15, No. 4, pp. 365-366.
- Darling, S. T., 1912.—Trans. 15th Internat. Congress Hyg. and Demog., Washington.
- Davaine, C., 1870.—Bullet. de l'Acad. de Méd., Paris, vol. 35, pp. 471-498.

- Dorset, M., McBryde, C. N., Nile, W. B., and Rietz, I. H., 1919.—*Amer. Journ. Vet. Med.*, vol. 14, No. 2, pp. 55-60.
- Dudgeon, L. S., 1919.—*Brit. Med. Journ.*, No. 3041, April 12, pp. 448-451.
- Dunkerly, J. S., 1912.—*Central. f. Bakt., Paras. und Infekt.*, vol. 62, p. 138.
- Faichnie, N., 1909.—*Journ. Royal Army Med. Corps*, vol. 13, pp. 580-584, 672-675.
- Fantham, H. B., and Porter, A., 1916.—*Journ. Parasit.*, vol. 2, No. 4, pp. 149-166.
- Flu, P. C., 1916.—*Geneesk. Tijdschr. v. Nederl.-Indie*, vol. 56, No. 6, pp. 928-939.
- Galli-Valerio, B., 1905.—*Centralbl. f. Bakt. Orig.*, vol. 39, p. 242.
- Graham-Smith, G. S., 1910.—*Repts. Local Govt. Bd., on Public Health and Medical Subjects*, n. s., No. 40, pp. 1-40.
- Graham-Smith, G. S., 1912.—*Forty-first Ann. Rept. Local Govt. Bd. 1911-12, Suppl. Rept. Medic. Off.*, pp. 304-329, 330-335.
- Grassi, B., 1883.—*Arch. Ital. de Biol.*, vol. 4, pp. 205-208.
- Guberlet, J. E., 1916.—*Journ. Am. Vet. Med. Assn.*, vol. 49, pp. 218-237.
- Hofmann, E., 1888.—*Correspondenzbl. d. arztl. Kreis- und Bezirksvereine im Königr. Sachsen*, vol. 44, No. 12, pp. 130-133.
- Howard, C. W., and Clark, P. F., 1912.—*Journ. Exper. Med.*, vol. 16, No. 6, pp. 850-859.
- Leboeuf, A., 1913.—*Bull. Soc. Path. Exot.*, vol. 6, No. 8, pp. 551-556.
- Ledingham, J. C. G., 1911.—*Journ. Hygiene*, vol. 11, No. 3, pp. 333-340.
- MacGregor, M. E., 1917.—*Journ. Trop. Med. and Hygiene*, vol. 20, No. 18, p. 207.
- Macrae, R., 1894.—*Indian Med. Gazette*, pp. 407-412.
- Maddox, R. L., 1885.—*Journ. Roy. Microsc. Soc., Ser. 2*, vol. 5, pp. 602-607, 941-952.
- Marpmann, G., 1897.—*Centralbl. f. Bakteriologie*, 1 Abt., vol. 22, pp. 127-132.
- Morgan, H. deR., and Ledingham, J. C. G., 1909.—*Proc. Roy. Soc. Med.*, vol. 2, pt. 2, pp. 133-149.
- Nicholas, G. E., 1873.—*Lancet*, vol. 2, p. 724.
- Nicoll, W., 1911.—*Journ. Hygiene*, vol. 11, No. 3, pp. 381-389.
- Nicholls, L., 1912.—*Bull. Ent. Research*, vol. 3, No. 1, p. 85.
- Nuttall, G. H. F., 1897.—*Centralbl. f. Bakteriologie*, vol. 22, pp. 87-97.
- Nuttall, G. H. F., 1899.—*Johns Hopkins Hospital Reports*, vol. 8, Nos. 1-2, pp. 1-154.
- Patton, W. S., 1910.—*Bull. Soc. Path. Exot.*, vol. 3, pp. 264-274.

- Patton, W. S., 1912.—Sci. Mem. Officers Med. & Sanit. Dept., Govt. India, No. 50, 21 pp.
- Ransom, B. H., 1913.—U. S. Dept. Agr., Bur. Anim. Ind., bull. 163, pp. 1-36.
- Robertson, A., 1908.—Journ. Trop. Med. and Hygiene, vol. 11, p. 213.
- Rosenau, M. J., 1916.—Preventive Medicine and Hygiene, pp. 206-252.
- Roubaud, E., 1918.—Bull. Soc. Path. Exot., vol. 11, No. 3, pp. 166-171.
- Sawtchenko, J. G., 1892.—Review in Ann. Inst. Pasteur, vol. 7.
- Scott, J. R., 1917.—Journ. Med. Research, vol. 37, No. 164, pp. 115, 121-124.
- Shircore, J. O., 1916.—Parasitology, vol. 8, No. 3, pp. 239-243
- Simmonds, M., 1892.—Deutsch. med. Wochenschr., No. 41, p. 931.
- Spillman and Haushalter, 1887.—Compt. Rend. Acad. Sci., vol. 105, pp. 352-353.
- Tebbutt, H., 1913.—Journ. Hygiene, vol. 12, pp. 516-526.
- Tizzoni, G., and Cattani, J., 1886.—Centralbl. f. d. med. Wissensch., Berlin, pp. 769-771.
- Torrey, J. C., 1912.—Journ. Infect. Diseases, vol. 10, No. 2, pp. 169-176.
- Uffelmann, J., 1892.—Berliner klin. Wochenschr., pp. 1213-1214.
- Van Saceghem, R., 1917.—Bull. Soc. Path. Exot., vol. 10, p. 726; 1918, vol. 11, p. 575.
- Wayson, N. E., 1915.—U. S. Public Health Service, Pub. Health Repts., vol. 29, No. 51, pp. 3390-3393.
- Welander, 1896.—Wien. klin. Wochenschr., No. 52.
- Wenyon, C. M., 1911.—Kala Azar Bull., vol. 1, No. 1, pp. 36-58.
- Yersin, A., 1894.—Ann. Inst. Pasteur, vol. 8, pp. 662-667.

CHAPTER VIII

Important Phases in the Life History of the Non-Biting Flies ¹

W. Dwight Pierce

In the preceding lecture there was brought together an accumulation of evidence against the common flies that frequent our houses which should convince any one of the absolute necessity of keeping flies from our food, our houses and our bodies. We can only hope to accomplish this object by becoming familiar at least with the more important features in the life history of the flies. From the study of the transmission of diseases we may pick out for example a few points in the biology which need to be stressed, such as feeding habits, regurgitation of food, excreta, breeding places, oviposition, flight, attraction to odor.

We are dealing in this lecture not only with the common house fly but also with most of the common flies which frequent our houses and are known as domestic flies. Of the common household flies, only one, the biting stable fly, *Stomoxys calcitrans*, is omitted for future discussion.

Students would do well to examine some book in which the different species are illustrated, so as to become familiar with the characteristic markings. It will then be a good plan to collect the various flies around the house and determine their species.

Fairly good illustrations of common household flies are given by Howard and Hutchinson (1915), and Richardson (1917).

The best illustrations of the flies are contained in Patton and Cragg's textbook (1913).

Tables to species of common flies and also illustrations are presented by Riley and Johannsen (1915).

It is also desirable to know how to identify the fly larvæ when found. The best American work on this subject is by Banks (1912). See also Riley and Johannsen, p. 315.

For general information on the life history, morphology, and anatomy of the house fly refer to Hewitt (1917).

The flies are classified largely on the characters of the proboscis, antennæ, wing veins, eyes and the arrangement of hairs. The larvæ are classified on the characters of the spiracles, the cephalo-pharyngeal skeleton, tubercles, hairs and processes.

¹This lecture was read July 22 and distributed July 29, 1918.

HOUSE FLY, *MUSCA DOMESTICA* LINNAEUS²

(See Frontispiece)

The common house fly, *Musca domestica*, is that insect charged with the carriage of the greatest number of diseases, and probably justly, because of its frequentation of all types of excreta, garbage and waste, its common visitations to places where foods are handled, and also its visits to the human body. We have shown in the preceding lecture how it and its allies can carry disease and what diseases are charged against each. Now we will take a brief review of its life history in order to arrive at important data for handling its control.

The house fly adult is yellowish to dark gray in color, with four equally broad longitudinal stripes on the thorax; first three abdominal segments yellowish with a central black stripe and with two less distinct discal stripes. The males measure 5.8 to 6.5 mm. in length, and the females 6.5 to 7.5 mm. The eyes in the male are nearly contiguous and in the female are widely separated.

This fly has been distributed by commerce to almost all parts of the civilized world.

Certain features of its anatomy are of interest in the present study.

The head is prolonged to form a proboscis which is enlarged at tip into the haustellum bearing apically the oral lobes or labella. These lobes bear a large number of channels kept open by incomplete chitinous rings called pseudotracheae, which are fully described by Graham-Smith (1913). The proboscis of the house fly is adapted to sucking and the absorption of liquid or liquefied food. It cannot take up very large particles of solid food. Nicoll (1911) found that the flies could not ingest particles larger than .045 mm. This therefore determines the size of worm eggs which can be ingested by the adult. We must assume therefore that when flies contain larger eggs, these were taken in by the larva. Normally, however, the food must pass between the bifid extremities of the chitinous rings of the pseudotracheal channels and pass along these to the mouth. These openings measure from .003 to .004 mm. in diameter. Solid particles, however, are heaped up in a slight ridge in the channel between the oral lobes and are probably sucked into the oral pit and into the mouth.

When the fly feeds on dry substances such as sugar, dried specks of milk, or sputum, etc., it first liquefies the substance by a salivary secretion which flows into the oral pit and onto the substance, being distributed by the pseudotracheal channels. The moistening is also aided

² An appeal has been made to the International Commission for Zoological Nomenclature for the retention of *Musca* in this sense with *domestica* as type.

by the regurgitation of food from the crop, as proven by Graham-Smith, who fed flies upon carmine colored food, and found carmine stains on semi-fluid material upon which these flies later fed, for 22 hours.

The intestinal canal is composed of pharynx, esophagus, crop, proventriculus, ventriculus or chyle stomach, proximal and distal intestine and rectum. The esophagus passes from the pharynx through the cervical region into the thorax, in the anterior part of which it opens into the proventriculus, and from this same point a duct which is continuous with the esophagus passes back into the abdomen to the crop which is a bilobed sac, capable of considerable distention. This crop serves as a food reservoir. The fly feeds until it has engorged the crop, and often will continue feeding, the food then passing directly into the proventriculus. The opening of the proventriculus into the esophagus is ventral. This organ is circular, flattened dorsoventrally. The ventriculus is tubular, narrowest in front and narrowing again in passing through the thoraco-abdominal foramen. The proximal intestine is the longest region of the gut, being considerably coiled. The distal intestine begins at the entrance of the Malpighian tubules, and is only curved once. It is separated from the rectum by a valve. The rectum is composed of three parts, the intermediate of which is swollen to form the rectal cavity into which the four rectal glands empty.

Food may remain in the crop for several days, and even when no further food is given, it requires many hours to empty the crop completely. After feeding the fly usually retires to a quiet spot and cleans its head and proboscis. It frequently regurgitates its food from the crop in the form of large drops of liquid which are subsequently slowly drawn up again and probably pass into the proventriculus. These drops of regurgitated food frequently are deposited, often for the purpose of moistening sugar and similar dry foods.

We may now see how easy it is for a fly which has fed on infected substances to contaminate other substances for days by regurgitation from the crop, as well as through fecal deposits. Experimental evidence has proven contamination by both the feces and the vomit.

The fly's body is externally constructed so as to further aid in disease carriage. There are numerous hairs or setæ on the body, especially on the legs. The last joint of the tarsus of each leg bears two claws and a pair of membranous pyriform pads or pulvilli. These pulvilli are covered beneath with innumerable, closely set, secreting hairs by means of which the fly is able to walk in any position on highly polished surfaces. These sucker-like pads or pulvilli and the setæ of the legs are excellent bacteria carriers, and not infrequently larger organisms as mites, worm eggs, etc., are thus carried.

The sexes of the house fly are about equal in number. Copulation

may take place, according to Hutchison (1916), as early as the day following emergence. Oviposition may begin on the third day.

He cites a large series of observations on the preoviposition period showing that eggs may be laid from 2½ to 23 days after emergence, and that the period corresponds to temperature and humidity changes. At Washington the shortest period was obtained at 82° to 84° F., and in general the length of period increased with the decrease of temperature. Increase in humidity seems to hasten egg laying.

The eggs are white, cylindrically oval, slightly broader at the posterior end with two distinct curved rib-like thickenings on the dorsal surface, along one of which the egg splits on hatching. These eggs are laid in masses averaging about 120, and a female may lay as many as four such batches, and probably under favorable conditions more. The eggs usually hatch in less than 24 hours, the time of course depending upon the climatic conditions. At 10° C. (40° F.) the egg period is two or three days; at 15 to 20° C. (59-68° F.) it is 24 hours; at 25-35° C. (77-95° F.) only 8 to 12 hours, according to Hewitt (1917).

The larvæ are white, smooth, cylindrical maggots, tapering at the head end and considerably enlarged at the tail end. When viewed by transmitted light a dark chitinous structure can be seen in the anterior regions. This is called the cephalopharyngeal skeleton and is partially extrusible. Each species of fly larva is distinguished by the form of this skeleton and hence if a slide mount is made of a skin boiled in potash, the species can be identified by this and one or more other characters. The three larval stages differ somewhat in the form of this skeleton so that it becomes possible to determine exactly the stage of development. The body is composed of fourteen segments of which the second is the prothorax. This segment at its posterior margin bears the anterior spiracles which are fan-shaped and have six or seven lobes. This segment is followed by the mesothorax, metathorax, and eight abdominal segments. The ninth and tenth (anal) segments are small and ventral. The anterior portion of the venter of each of the first eight abdominal segments bears spiniferous pads which assist in locomotion. The eighth or last apparent segment bears the spiracular plates. These spiracular plates afford the best means of identification of fly larvæ. In the first two stages each plate consists merely of two oblique slits on a slight prominence. In the third stage they are well defined plates, D-shaped, closer together than their width, with flat faces opposed, each with three sinuous slits.

In connection with this larval description, we may call attention to errors existing in many larval descriptions. The thoracic spiracles belong to mesothorax but often appear to have migrated to the prothorax. The large terminal spiracles of Dipterous larvæ are always on the eighth

segment, as in almost all orders of insects. The ninth and tenth segments are apt to be small and obscure and center around the anus, which belongs to the tenth.

The larval period varies in response to climatic stimuli, but under favorable conditions is about four days in length. When full grown the larva varies from 10 to 12 mm. in length. Pupation takes place within the last larval skin which shrinks and hardens to form a reddish case or puparium. This period lasts from 3 to 10 days. When the fly is ready to emerge it pushes off the cap or head end. The entire developmental period may require from eight to eighteen or more days. Kisliuk has found pupae of the fly in manure piles at various times during the winter, which of course indicates that the developmental period may occupy an entire winter if the pupa is caught by cold weather. Bishopp, Dove and Parman found that adults emerged from immature stages which had been in manure for six months. Hutchison's observations at Washington, D. C., confirm these findings.

The adult flies are capable of considerable flight. Parker demonstrated a migration of two miles in his Montana studies. Bishopp and Laake (1919) record the flight of marked house flies of thirteen miles. In this connection the most interesting contribution is that of Ball (1918) in which he shows that house flies apparently migrated with the wind from 46 to 95 miles from mainland to a tiny island.

The house fly has been found breeding in horse manure, human excrement, and hog manure very freely and to some extent in cow and chicken manure. It lays its eggs in a great variety of decaying animal and vegetable materials, such as slops, spent hops, moist bran, ensilage, rotting potatoes, dead animals, excreta-soiled straw, paunch contents of slaughtered animals, soiled paper and rags, etc.

THE BLUE BOTTLE FLIES OF THE GENUS *CALLIPHORA*³

The large blue bottle fly, *Calliphora vomitoria* Linnaeus (plate I, fig. 1) and its near relative *C. erythrocephala* Meigen are often found in houses. These flies have also been shown to be dangerous insects because of their ability to transmit disease. In fact they are much more likely to directly transmit disease organisms than the house fly because of their habits of breeding in flesh which gives them also the name blow flies. The adults are grayish on the thorax and dark metallic blue with suggestions of silver on the abdomen. In *vomitoria* the genæ are black and beset with golden red hairs, while in *erythrocephala* the genæ are fulvous to golden yellow and beset with black hairs.

³ An appeal has been made to the International Commission for Zoological Nomenclature for the retention of *Calliphora* in this sense with *vomitoria* as type.

These flies are necrophagous and deposit their eggs upon any fresh, decaying or cooked meat, and upon dead insects; they breed occasionally in human excrement and sometimes will deposit their eggs in open flesh wounds. On the battle fronts of Europe and Asia where the wounded lay for long periods and where many dead bodies remained uncared for, these flies multiplied to tremendous numbers and were largely responsible for the carrying of infections to wounds. When a fly lays its eggs in living flesh and the larvæ develop therein, the infection is called myiasis. This subject is of such importance that two entire lectures is devoted to it (Chapters XII and XIII).

Important as they are, the blow flies are usually subordinated to the house fly in the discussion of dangerous flies, but thorough investigations of these species are more than likely to greatly increase their standing as disease carriers.

The eggs are deposited in masses of as many as 300 and a single fly may possibly deposit three batches. They hatch in from 10 to 24 hours after deposition.

The larvæ of *C. erythrocephala* may be distinguished from the house fly larvæ by having usually nine but sometimes up to twelve lobes in the anterior (thoracic) spiracles; an anterior scabrous swollen ring on each of the first eight segments of the abdomen, and a ventral groove on each segment beneath; the stigmal field concave, surrounded by three pair of tubercles above, and two large and one small pair below; the stigmal plates about once and a fourth their diameter apart, each with three straight slits, directed principally toward the opposite plate; and also, by having an anal pair of tubercles. The larval characters are illustrated by Hewitt and also by Banks.

The larval period requires seven and a half to eight days at 23° C. (73.5° F.) and the pupal period fourteen days, according to Hewitt. Bishopp and Laake found the larvæ to attain full growth in three to four days and the time from deposition of eggs to emergence of adults was 15 to 20 days.

THE SHEEP MAGGOTS OR GREEN BOTTLE FLIES

The European sheep maggot fly, *Lucilia sericata* Meigen, is primarily an outdoor fly but occasionally is found indoors, especially in farm and country houses. It is more brilliant than the Calliphoras, being of a burnished gold with a shining, bluish-green color. The flies are strongly attracted to meat and carcasses in which they lay their eggs. They also occur on human and animal excrement. The larvæ breed readily in all these substances. In Europe the flies very commonly lay their eggs in matted wool and on the flesh on the backs of sheep, and the larvæ

breed in the flesh causing external myiasis. This species attacks ulcers and sores of men and animals. Its most common attack on sheep and calves is made on the soiled rumps of animals suffering from diarrhea. No doubt the flies also serve as distributors of the diarrhea.

The larva has eight-lobed anterior spiracles. The same number of tubercles margin the stigmal plate behind as in *Calliphora*, but they are smaller and sharper. The stigmal plates are about one-half their diameter apart, each with three straight slits, directed somewhat toward each other, but also downward.

Undoubtedly under battle front conditions this fly can be expected to visit human wounds and breed in them even more readily than *Calliphora*. It has been shown by Cao to transmit anthrax with equal ease.

Several other species of *Lucilia* have like habits, and the larvæ of two of these, *L. caesar* Linnaeus (not *sericata* Meigen), and *L. sylvarum* Meigen have been described and illustrated by Banks.

The larvae of *L. caesar* measure 10 to 11 mm. in length and have not adequately been separated from *Calliphora erythrocephala*. The larval period averages about fourteen days and the pupal stage about the same. Bishopp and Laake state that in Texas, during warm weather, the larval period ranges from three to twelve days, the pupal stage five to sixteen days and the total developmental period eleven to twenty-four days. This fly is illustrated in plate I, Fig. 2.

OTHER SCREW WORMS AND BLOW FLIES

The question of myiasis, which covers screw worms and blow flies, is to be considered in separate lectures (Chapters XII and XIII), but mention must be made of them at present because undoubtedly many infectious diseases are carried by these insects which attack alike live flesh through wounds, and dead animals. I would hardly hesitate to claim that probably all such flies may carry anthrax at least, and probably do carry other diseases.

Bishopp, Mitchell, and Parman (1917) describe quite fully the habits of the common American screw worm, *Chrysomya macellaria* Linnaeus⁴ (plate I, fig. 3, plate II) which breeds in both carcasses and flesh wounds (plate IV). They also treat the black blow fly *Phormia regina* Meigen (plate I, fig. 4), and other species. The large hairy blow fly, *Cynomyia cadaverina*, Robineau-Desvoidy, and the gray flesh flies *Sarcophaga texana* Aldrich, *S. tuberosa* var. *sarracenioides* Aldrich, *S. sarraceniae*

⁴An appeal has been made to the International Commission on Zoological Nomenclature to retain *Chrysomya* in the sense with *macellaria* as type.

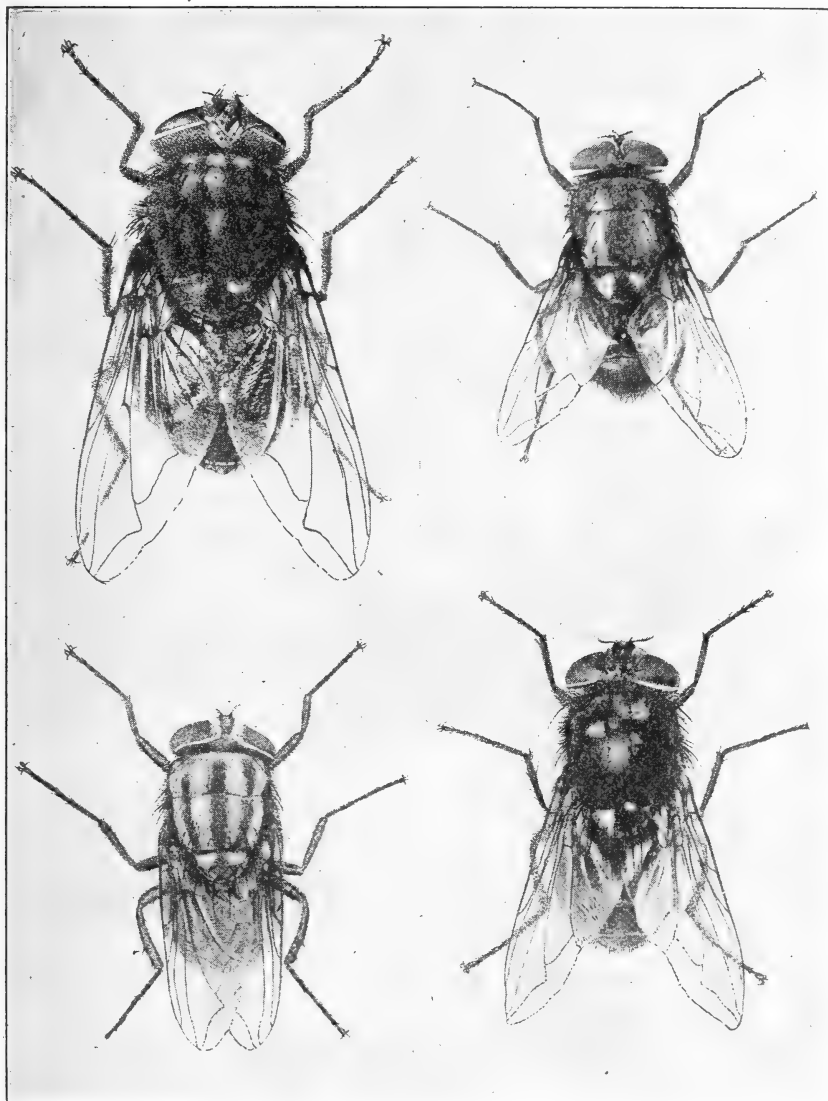

PLATE I.—Screw worms and blow flies. Fig. 1 (upper left).—The blue bottle fly, *Calliphora vomitoria*. Fig. 2 (upper right).—The green bottle fly, *Lucilia caesar*. Fig. 3 (lower left).—The American screw worm, *Chrysomya macellaria*. Fig. 4 (lower right).—The black blow fly, *Phormia regina*. (Howard and Pierce, photos by Dovener.)



PLATE II.—Eggs of the American screw worm, *Chrysomya macellaria*, on meat.
(Bishopp.)

Riley (plate III, fig. 1) and *S. robusta* Aldrich are also among the most common flesh flies.

Froggatt (1915) has given a very fine treatment of the most important sheep maggot flies and has presented colored illustrations of some of them.

All of these flies are likely to be found in houses and markets and when given the opportunity will lay eggs on meat offered for sale or exposed in kitchens or mess halls. If this meat is already cooked there is a good chance of the eggs being ingested and giving rise to gastrointestinal myiasis. But the danger from flesh flies is greater than the mere causation of external or internal myiasis. The flies which lay the eggs may have bred in diseased carcasses, and if so, probably will deposit with the eggs a glutinous film containing bacteria from these carcasses, for it will be remembered that the fly larva takes up these bacteria and they may remain in its body until it as a mature fly lays its eggs, and even longer. It must be borne in mind that because conditions in the immediate vicinity are sanitary, does not mean that the flies which come are sanitary, because Bishopp and Laake (1919) record the flight of marked *Chrysomya macellaria* flies for 15 miles, and of *Phormia regina* for 11 miles.

OTHER EXCREMENT BREEDERS

Others of our house flies, as the non-biting stable fly, *Muscina stabulans* Macquart (plate III, fig. 2), the lesser house fly *Fannia canicularis* Linnaeus (plate III, fig. 3), and the latrine fly *F. scalaris* Fabricius breed in decaying vegetables and animal matter.

Muscina stabulans looks very much like the house fly, but it is a little more robust. It is gray and the thorax is marked with four longitudinal black lines. Parts of the legs and scutellum are reddish. The principal differential character is in the wing venation. The larva, however, is easily distinguished from *Musca domestica*, by the six-lobed anterior spiracles and the anal stigmal plates scarcely elevated, less than their diameter apart, each with three very short slits pointing towards those of the opposite plate. It breeds in decaying and live vegetable matter, human and animal excreta, and has even been reared from insect puparia. It breeds likewise in raw and cooked meats and on carcasses. It is therefore a very potential disease carrier, possessing all the opportunities of the house fly, with which it may already be mixed in medical literature.

Fannia canicularis and *F. scalaris* are two flies commonly found in houses, which greatly resemble the house fly, but the former may be distinguished by the presence of only three dark stripes on the thorax instead of the four found in the house fly. The larvæ of these flies are very

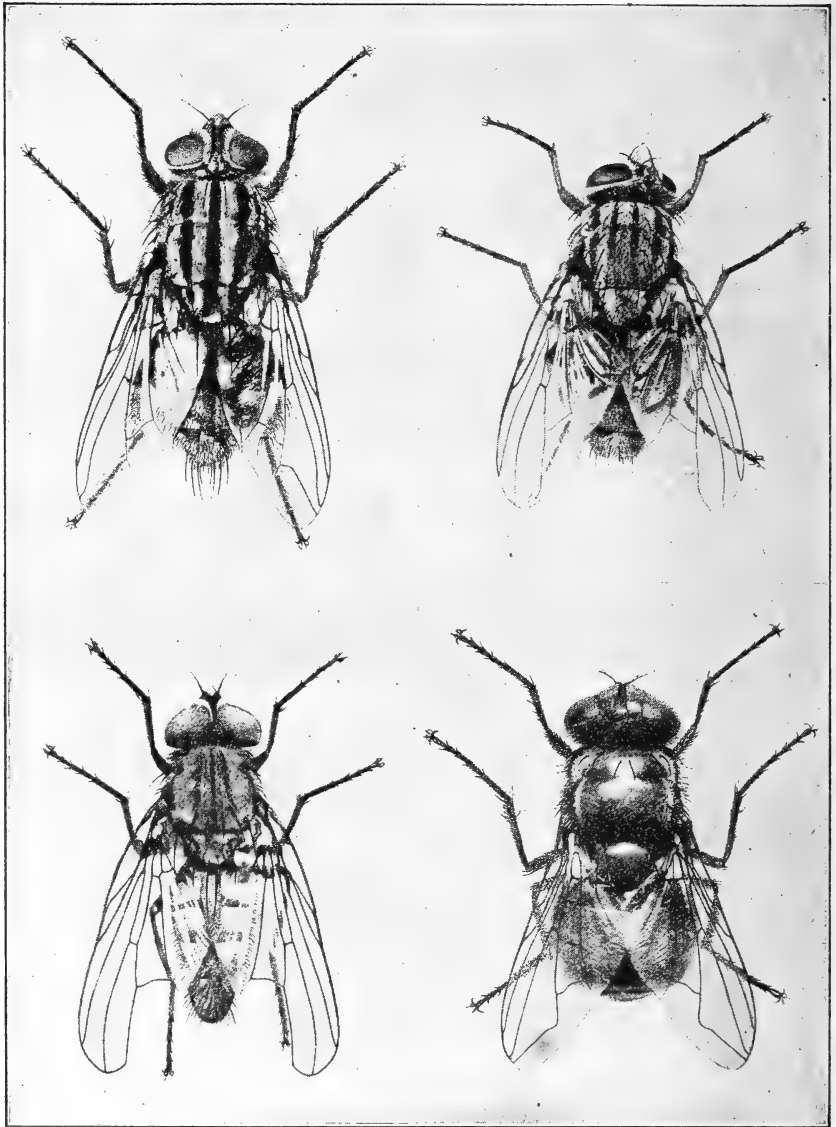

PLATE III.—Flies with dangerous habits. Fig. 1 (upper left).—A flesh fly, *Sarcophaga sarraceniae*. Fig. 2 (upper right).—The non-biting stable fly, *Muscina stabulans*. Fig. 3 (lower left).—The lesser house fly, *Fannia canicularis*. Fig. 4 (lower right).—The brilliant green fly, *Pseudopyrellia cornicina*. (Howard and Pierce, photos by Dovener.)

readily separated by the large number of processes on all the segments. The posterior spiracles are located on raised processes and are not plates as in the species mentioned above. In *F. canicularis* there are four lobes to the posterior spiracles and six finger-like lobes to the anterior spiracles (see Hewitt, 1917) (see figs. 14 to 19).

These flies breed in excrement, and in all kinds of decaying vegetable matter and are often found in cases of intestinal myiasis.

REFERENCES

- Ball, S. C., 1918.—Migration of Insects to Rebecca Shoals Light Station and the Tortugas Islands, with Special Reference to Mosquitoes and Flies. Carnegie Inst., Washington, Publ. 252.
- Banks, Nathan, 1912.—The Structure of Certain Dipterous Larvæ with Particular Reference to Those in Human Foods.
- Bishopp, F. C., 1915.—Flies Which Cause Myiasis in Man and Animals. Some Aspects of the Problem. Journ. Econ. Ent., vol. 8, pp. 317-329.
- Bishopp, F. C., and Laake, E. W., 1919.—The Dispersion of Flies by Flight. (Abstract) Journ. Econ. Ent., vol. 12, pp. 210-211.
- Bishopp, F. C., Mitchell, J. D., and Parman, D. C., 1917.—U. S. Dept. Agr., Farmers' Bull. 857.
- Froggatt, W. W., 1915.—Sheep Maggot Flies. Dept. Agr., New South Wales, Farmers' Bull. 95.
- Graham-Smith, G. S., 1913.—Flies in Relation to Disease. Non-blood-sucking Flies. Cambridge Univ. Press.
- Hewitt, C. G., 1917.—The House Fly. Cambridge Univ. Press.
- Howard, L. O., and Hutchison, R. H., 1915.—House Flies, U. S. Dept. Agr., Farmers' Bull. 679.
- Hutchison, R. H., 1916.—U. S. Dept. Agr. Bull. 345.
- Nicoll, W., 1911.—Journ. Hygiene, vol. 11, No. 3, pp. 381-389.
- Parker, R. R., 1916.—Dispersion of *Musca domestica* under City Conditions in Montana. Journ. Econ. Ent., vol. 9, pp. 325-354.
- Patton, W. S., and Cragg, F. W., 1913.—A Textbook of Medical Entomology.
- Richardson, C. H., 1917.—The Domestic Flies of New Jersey. New Jersey Agric. Exp. Sta., Bull. 307.
- Riley, W. A., and Johanssen, O. A., 1915.—Handbook of Medical Entomology.

CHAPTER IX

Common Flies and How to Tell Them Apart ¹

C. T. Greene

Only a few of the very common flies have been included in this chapter; the flies that are likely to appear near any house or in any camp. All of them may be attracted by the odors of fresh and cooking foods. In the following pages are presented two tables, one to separate the different species of the adult flies, and the other to separate the different larvæ or maggots of the flies. All the terms for the different parts of the flies and maggots have been made as plain as possible so that the

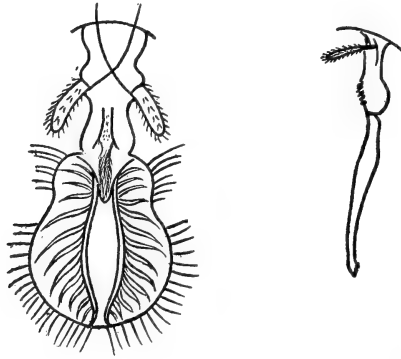

Suctorial type. Biting type.

MOUTH PARTS.

FIG. 10.—Mouth parts of flies: *a*, Suctorial type; *b*, biting type. (Greene.)

tables can be used by a non-entomologist. In the first table for the adult flies is given the style of the mouth-parts (see fig. 10), that is, whether they are adapted for biting or are simply suctorial, then the common name is given, and then the scientific name. In the second table the larvæ or maggots can be separated into different species. Under the name of each species, the larva or maggot is described in further detail and here mention is made as to where the species will breed.

¹This lecture was presented September 9, and issued September 11, 1918. It has been somewhat modified.

All the Sarcophagid or "flesh flies" can be readily separated from all the other flies in the following table because their bodies are entirely gray. The head is rather a bright red, the top of the back has three parallel dark stripes and the top of the abdomen has lighter reflecting areas, giving it somewhat of a checkered appearance.

TABLE TO SEPARATE THE ADULT FLIES

- I. Grayish flies with from two to four longitudinal stripes more or less indicated on the thorax.
1. Dark gray, medium sized fly; top of thorax with four parallel, black stripes; sides of abdomen with a large yellow area (variable in size and never definitely outlined); mouth-parts of the suction type (see fig. 10a), never for biting; variable in size but

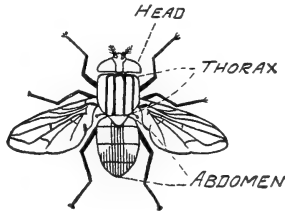

MUSCA DOMESTICA L

FIG. 11.—Diagrammatic sketch of the house fly, *Musca domestica*. (Greene.)

average about one-quarter inch in length. The common house fly (Frontispiece, figs. 11, 12a) also called typhoid fly.

Musca domestica Linnaeus.

2. Brownish-gray fly, slightly larger and broader than the house fly. Top of thorax with two long, parallel, black stripes and on each side of these is a large black dot, below which is a black stripe about half as long as the two long stripes. Abdomen with two or three cone-shaped dark brown spots in the center and two or three round spots on each side (fig. 12c). Mouth-parts piercing or biting type (fig. 10b). Stable fly, also called biting house fly (fig. 46).
Stomoxys calcitrans Linnaeus.
3. Very dark gray fly, smaller and more slender than the house fly. Abdomen pointed and more conical in shape. Yellow spots on the sides definitely outlined (fig. 12b). Mouth-parts are of the suction type (fig. 10a). The small house fly (plate III, fig. 3).
Fannia canicularis Linnaeus.
4. Gray fly, a little larger than the house fly. (About the size of *Stomoxys calcitrans*.) Top of thorax has two short, black

stripes. Joints of legs reddish at base. Abdomen is gray and in certain lights there are paler gray areas which look like spots but there are never any definitely outlined spots. Mouth-parts suctorial type (fig. 10a). Another stable fly (plate III, fig. 2). *Muscina stabulans* Linnaeus.

II. Bluish, or greenish flies.

1. Large blue fly, with grayish thorax (average length three-eighths to seven-sixteenths of an inch). This fly is rather broad and robust and in certain lights the abdomen shows paler, reflecting areas but not definite spots. Mouth-parts suctorial type (fig. 10a). The common blow fly. Lower part of head (cheeks) reddish and the beard black. *Calliphora erythrocephala* Meigen.
2. A slightly larger fly than the preceding but more shiny and a deep greenish blue. Abdomen slightly more pointed and of an



FIG. 12.—Abdominal markings of three common house flies: a, the house fly, *Musca domestica*; b, little house fly, *Fannia canicularis*; c, stable fly, *Stomoxys calcitrans*. (Greene.) In these diagrams the relative size of the abdomen is shown. The light areas in a and b represent yellow markings and are variable in size. In fig. c the markings of the last segment may be present or absent.

even coloration (no reflecting spots). Mouth-parts suctorial type (fig. 10a). Lower part of head black and the beard red. Another blow-fly (plate I, fig. 1). *Calliphora vomitoria* Linnaeus.

3. Much smaller fly, shiny green with a decided whitish bloom on the thorax and abdomen. Mouth-parts suctorial (fig. 10a). A green bottle fly. *Lucilia sericata* Meigen.
4. A slightly smaller fly, shiny, metallic green with a decided bluish tinge and no white bloom. Mouth-parts suctorial (fig. 10a). Green bottle fly (plate I, fig. 2). *Lucilia caesar* Linnaeus.
5. A dark green fly, little larger than the above species. It is shiny with bluish tinge. Top of thorax with three dark longitudinal stripes. Thorax often has a bronze tinge. (Average length five-sixteenths to three-eighths of an inch.) Mouth-parts of the suctorial type (fig. 10a). The "screw-worm fly" (plate I, fig. 3). *Chrysomya macellaria* Fabricius.

6. Deep, shiny blue fly often with a blackish tinge (about five-sixteenths of an inch in length). Mouth-parts of the suctorial type (fig. 10a). The black blow fly (plate I, fig. 4).

Phormia regina Meigen.

- III. Ashen gray to deep gray flies. Top of thorax with three blackish, longitudinal stripes. The abdomen has lighter gray reflecting spots (in certain lights). The different species vary in size from a small fly up to a half inch in length. Mouth-parts are of the suctorial type (fig. 10a). Flesh flies (plate III, fig. 1).

Sarcophagidae.

THE LARVAE OR MAGGOTS

There is a considerable number of flies whose larvæ or maggots either regularly or occasionally live in substances used by man as food. The great majority pass through the intestinal tract without our knowledge, for most of them cause little or no trouble. Many dipterous larvæ occur in decaying fruits and vegetables and on fresh and cooked meats. The blow fly, for example, will deposit on meats in a pantry; while other maggots occur in cheese, etc. Pies and puddings in restaurants are often accessible and very suitable places for flies to deposit their eggs and no doubt a great many maggots are swallowed in this way. The occurrence of dipterous larvae in man is known as "myiasis." Various names or divisions are given, as "myiasis externa" or "myiasis dermatosa" for larvæ in the skin or wounds; "myiasis intestinalis" for those in the alimentary canal; and "myiasis narium" for larvæ in the nose. The presence of larvæ in the nose is rather accidental in this country and usually due to the "screw-worm." In tropical countries this type of myiasis is quite common.

The larvae of the ox-warble or bot-fly (*Hypoderma lineata* Villers) sometimes occur in man. There are various cases recorded, mostly of children, where, in the winter time, a larva is observed under the skin, usually in the neck or shoulders, and upon removal proves to be the larva of the heel fly in the second stage. Bot infestation is sometimes called "creeping worms," and many cases have been recorded by army surgeons on the Mexican border. These cases are probably contracted by men sleeping in stable yards.

*Descriptions of larvae or maggots*²

All the larvæ mentioned here are broadest near the tip or tail of the body, and taper forward to the head.

²In the following discussion the visible body segments are numbered from head to anus irrespective of their scientific nomenclature.—W. D. Pierce.

The larva is divided into fourteen parts, of which eleven are distinct, called segments, and the first segment is the head. The head appears to be bilobed, or divided into two parts when viewed from above, and each lobe bears a minute cylindrical tubercle or papilla (fig. 13). Below is the mouth opening; at one side and above it is the pair of mandibles or great hooks (fig. 13). The second segment or prothorax bears on each side, in the full grown larvæ, a short fan-shaped process called the anterior spiracle. The eleventh body segment which might be taken for the last is often a fusion of the seventh to tenth abdominal segments. The eighth abdominal segment can always be identified by the stigmal plates

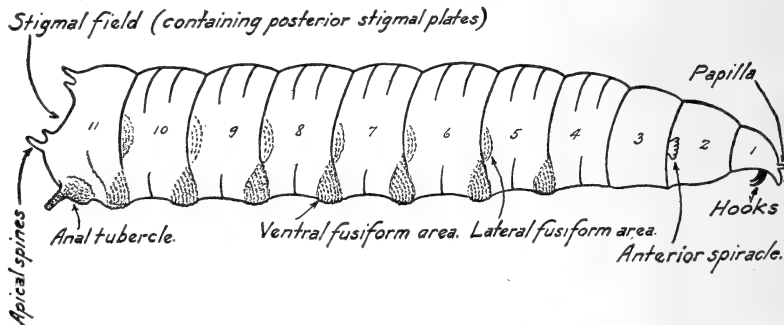

FIG. 13.—Characters of a muscid fly larva. (Greene.) Segment 1 is the head; 2-4 are thoracic segments; 5-11 are abdominal. Segment 11 really contains the seventh to tenth abdominal segments, the spiracles being on the eighth, the anus in the tenth.

or lobes. The ninth and tenth are usually small and ventral and enclose the anus. For further details see fig. 13.

Table to Separate the Larvæ (Maggots)

I. Spiny larvæ.

1. A larva with the body flattened; down the middle of the back are two rows of spines or processes, there are also two rows along the under side and a single row of spines along each side. These spines or processes are pointed and covered with many bristles. There are also two stigmal plates on top of the last segment. (Figs. 14-16.) *Fannia canicularis*.
2. The larvæ of *Fannia scalaris* are similar (figs. 17-19), but the processes have fewer side branches.

II. Smooth larvæ.

A. With one great mouth-hook; slits in stigmal plate winding.

1. Body broadly rounded at rear end, without spines. Stigmal plate with three winding slits (figs. 20 to 22). *Musca domestica*.

2. Body same as above species, stigmal plate with three S-shaped slits (figs. 23, 24).
Stomoxys calcitrans.

B. *Two great mouth-hooks; slits in stigmal plate not winding.*

1. Body slightly rounded at rear end, faintly spined and with three short, pointed slits in stigmal plate (figs. 25, 26).
Muscina stabulans.

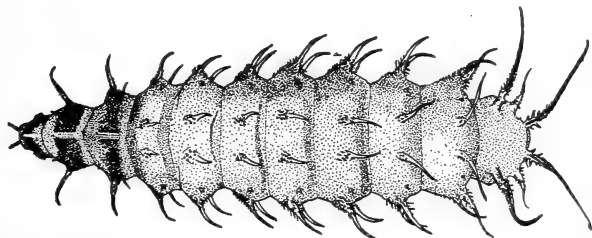

FIG. 14.—Larva of the little house fly, *Fannia canicularis*. Greatly enlarged. (Howard and Pierce, drawing by Bradford.)

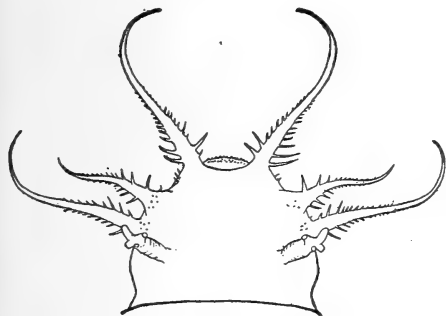

FIG. 15.—Dorsal view of eighth abdominal segment of the larva of *Fannia canicularis*. Very highly magnified. (Drawing by Bradford.)

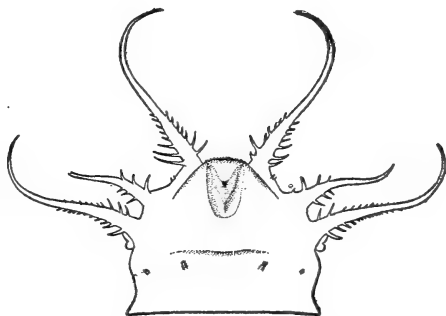

FIG. 16.—Ventral view of terminal segments of *Fannia canicularis*; the ninth and tenth segments are comprised in the small zone around the anus. Very highly magnified. (Drawing by Bradford.)

2. Stigmal plates wide apart, each with three straight slits nearly transverse to the body and a distinct button (figs. 27, 28).

Calliphora erythrocephala. Calliphora vomitoria.

3. Stigmal plates about half their diameter apart, each with three straight slits directed somewhat downward (fig. 31).

Lucilia sericata.

4. Stigmal plates less than their own diameter apart, each with three straight slits pointed downward; no button (figs. 29, 30).

Chrysomya macellaria.

5. Stigmal plates at bottom of a deep pit; each plate has three slits pointing downward, plates less than their diameter apart; no button. *Sarcophagidae*.

Fannia canicularis Linnaeus and *Fannia scalaris* Fabricius

These larvæ are brownish yellow in color. The body is quite flattened, narrow and pointed in front. The peculiar spines or projections on the body will separate them from the other species. The larva averages nearly three-eighths of an inch in length (figs. 14-19). (See Chapter VIII.)

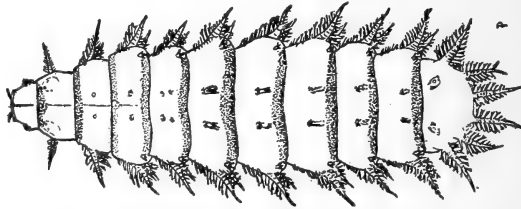

FIG. 17.—Larva of *Fannia scalaris*, the latrine fly, greatly magnified. (Howard and Pierce, drawing by Bradford.)



FIG. 18.—Dorsal view of eighth abdominal segment of the *Fannia scalaris*. Very highly magnified. (Drawing by Bradford.)



FIG. 19.—Ventral view of terminal segments of *Fannia scalaris*; the ninth and tenth segments are comprised in the small zone around the anus. Very highly magnified. (Drawing by Bradford.)

Since the larvæ of this genus feed on fruit and vegetables that are just beginning to decay, one can readily see that they are often swallowed by people. There are many records of the passage of larvæ or maggots of this genus. At least some species of this genus breed in human feces, therefore they may be possible conveyers of disease.

Musca domestica Linnaeus

The larva of the house fly is slender and tapering in front and large and somewhat rounded behind. From above, the head is divided into two

parts with a tiny papilla on each side (fig. 20) and there is but one great hook. The anterior spiracles (fig. 21) show six or seven lobes; on the under side of the sixth and following segments there is a transverse, swollen area, wider in the middle and somewhat pointed toward each end. These areas are provided with minute teeth. The area is slightly prominent and shows two approximate processes. The stigmal field is barely if at all concave and not outlined by tubercles; the posterior spiracles (fig. 22) are prominent, less than their own diameter apart and each with three winding slits and a button at the base. In some cases two of the winding slits are apparently connected. The second-stage larvæ has two straight slits in each stigmal plate, while in the first larval stage there are two smaller slits on a tubercle each side of the



FIG. 20 (left).—Larva of *Musca domestica*; dorsal view of head and prothorax. (Greene.)

FIG. 21 (center).—Larva of *Musca domestica*; lateral view of terminal segments. (Greene.) The spiracles are located on the eighth abdominal segment. The ninth and tenth segments are ventral and not very distinct, enclosing the anus.

FIG. 22 (right).—Larva of *Musca domestica*; enlarged sketch of right stigmal plate. These plates are less than their breadth apart. (Greene.)

middle and in this stage there are no anterior spiracles. (See Chapter VIII.)

The larva of the house fly is rarely swallowed, but there are records to that effect. It sometimes breeds in decaying fruits and vegetables. The principal breeding place is in horse manure. It also breeds in human excrement and because of this habit it is very dangerous to human beings.

Stomoxys calcitrans Linnæus

The larva of this species is very similar to that of the house fly, with a single great hook; the anterior spiracles have five lobes (fig. 23); the sixth and following segments have each an area on the under side provided with tubercles; this area is wider in the middle; anal area has two submedian tubercles and three each side of these; above them is a row

of minute granules, ending each side in a larger granulate tubercle; there are no tubercles outlining the stigmal field; the stigmal plates are subtriangular, about one and one-half times their diameter apart, black, and each with three pale areas containing an S-shaped slit (fig. 24). These slits are never near each other like in the house fly, and there is no apparent button.

This larva commonly breeds in manure of various kinds, but also in



FIG. 23.—Larva of *Stomoxys calcitrans*: enlarged sketch of thoracic spiracles. (Greene.)

decaying matter, and is not often passed by people, but there is one record. Horse manure, cow manure, and warm, decaying vegetation, like old straw and grass heaps, are common breeding places.

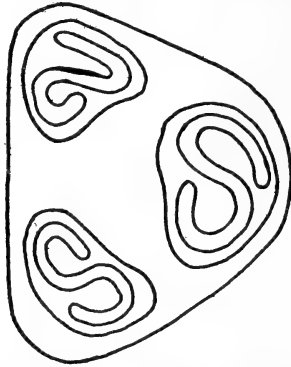

FIG. 24.—Larva of *Stomoxys calcitrans*: enlarged sketch of right stigmal plate. These plates are one and one-half times their breadth apart. (Greene.)

Muscina stabulans Fallen

Head of larva (fig. 25) divided into two parts from above, no distinct papilla; two great hooks close together; anterior spiracles with about six lobes (fig. 25b). The surface of the segments is mostly smooth. Beginning with the fifth segment, on the under side, there is a basal, transverse, swollen area, furnished on the crest with rows of teeth; each of these areas is divided on the median line. On the next to the last segment there is a similar area at the tip, but not divided. The segments below also show a transverse line before the middle. The last segment has the anal basal area with spines, but not very prominent, and bears a median and three lateral tubercles with spines. The tubercles

are nearly in a transverse row. The rounded tip of the body (fig. 25c) shows, across the middle, faint traces of four low cones. The stigmal plates (fig. 26) are scarcely elevated, black, less than their own diameter apart, and each with three very short slits pointing towards those of the opposite plate.

This larva is common in decaying vegetable matter; and has been reared from rotten apples, pears, squash, mushrooms and dead insect

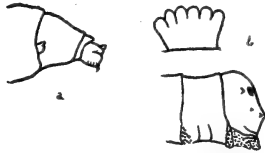

FIG. 25.—Larva of *Muscina stabulans*: a, Side view of head and prothorax; b, anterior or thoracic spiracles; c, side view of terminal segments of abdomen. (Greene.)

larvæ. In one case a considerable number were passed by a child suffering with summer complaint. Laboulbène records larvæ of this species vomited by a person suffering from bronchitis.

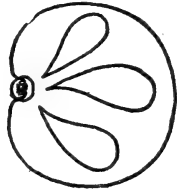

FIG. 26.—Larva of *Muscina stabulans*: enlarged sketch of right stigmal plate. These plates are less than their breadth apart. (Greene.)

Calliphora erythrocephala Meigen

The head of this larva is distinctly divided into two parts from above (fig. 27, side view of head); each part or lobe has a tiny papilla. There are two well separated mouth hooks. The anterior spiracles have from nine to twelve lobes. Beginning with the third, each segment shows an apical swollen ring or girdle, whose surface is scabrous (roughened like a file); these rings are broader below than above, and are here notched on the posterior middle. Each ventral segment, beginning with the fifth, is divided by a transverse groove near the middle. The anal area shows a smooth median process, divided in the middle, and at each outer corner is a cone. The stigmal field is rather concave, the upper lip with three small tubercles on each side, the lower lip with two larger tubercles on each side, and a median pair smaller and lower down. The stigmal plates are about once and a fourth their diameter apart, each with three

simple straight slits directed slightly downward but mostly toward those of the opposite plate; the button is distinct (fig. 28).

The blow-fly deposits eggs on dead animals, and also on fresh and cooked meats. As such are often accessible to them in pantries, it is readily seen that many larvæ are swallowed by people each year; there are, however, comparatively few records published, probably because the polluted food causes no trouble.

Calliphora vomitoria Linnaeus

This larva appears to be identical with that of *Calliphora erythrocephala*. There seem to be no visible characters to separate it from this latter species (figs. 27 and 28). The habits are about the same.



FIG. 27.—Larva of *Calliphora erythrocephala*: side view of head and prothorax. (Greene.)

Lucilia sericata Meigen

Body rather stout, not slender in front. The head is distinctly divided into two parts or lobes, with distinct papilla (figs. 31a, b). The

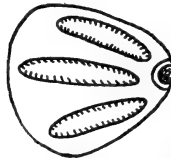

FIG. 28.—Larva of *Calliphora erythrocephala*: enlarged sketch of left stigmal plate. These plates are one and one-quarter times their breadth apart. (Greene.)

two great mouth hooks are well separated. The anterior spiracles are provided with about eight lobes. The surface of the body is mostly smooth; the sides of segments 3, 4 and 5 are bilobed; beginning with segment 6 there is a basal ring girdle, roughened. These girdles on segments 6 to 9 are widened on the middle of the under side of the larva; the sides are also swollen, but not plainly bilobed, except those near the tip. The under sides of the segments are transversely divided by a line or furrow in the middle. The last segment is short, the stigmal field occupying most of the tip. The stigmal field has a slightly depressed, upper lip with three sharp tubercles on each side, the intermediate one hardly smaller than the others; and a lower lip with two large,

sharp tubercles on each side, and a median pair more remote from the margin (fig. 31c). The anal area is rather sunken with a small rounded tubercle at each outer corner. The stigmal plates are about one-half their diameter apart, each with three straight slits, directed somewhat towards each other, but also downward.



FIG. 31.—Larva of *Lucilia sericata*: a, dorsal view of head and prothorax; b, lateral view of head and thorax; c, lateral view of last abdominal segments. (Greene.)

This larva is mentioned on account of the adult which is very likely to be met with. This larva is mostly injurious to sheep. Meinert has reared another *Lucilia* (*L. nobilis* Meigen, of Europe) from larvæ taken from the ears of a sailor.

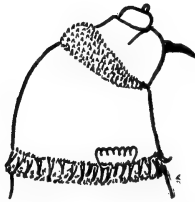

FIG. 29.—Larva of *Chrysomya macellaria*: enlarged sketch of side of head and prothorax. (Greene.)

Chrysomya macellaria Fabricius

The head from above is distinctly bilobed (fig. 29). There are two distinct hooks. The anterior spiracles are very short, and contain only



FIG. 30.—Larva of *Chrysomya macellaria*: enlarged sketch of left stigmal plate. These plates are less than their breadth apart. (Greene.)

7 lobes (fig. 29). The posterior upper part of segment 1 is swollen and with many spines (fig. 29). Each of the following segments (except 2) has a basal, swollen ring, armed with teeth pointing backward, the teeth of the front rows are always larger. Beginning with segment 6 the under

part of each ring is much broadened and divided transversely by a narrow smooth space. On segments 5 to 10 there is on each side behind a fusiform swollen area pressing against the swollen ring of the next segment; this area also has spines. The tip of the body shows on the dorsal part a great cavity, in the bottom of which are the stigmal plates, each with three straight slits, those of one sub-parallel to those of the other; there is no button (fig. 30). Behind this cavity is a high, transverse, spiny crest; and the ventral part of the tip shows an area covered with spines bearing two rather widely separated, prominent, smooth tubercles. The upper edge of the tip shows four small conical tubercles.

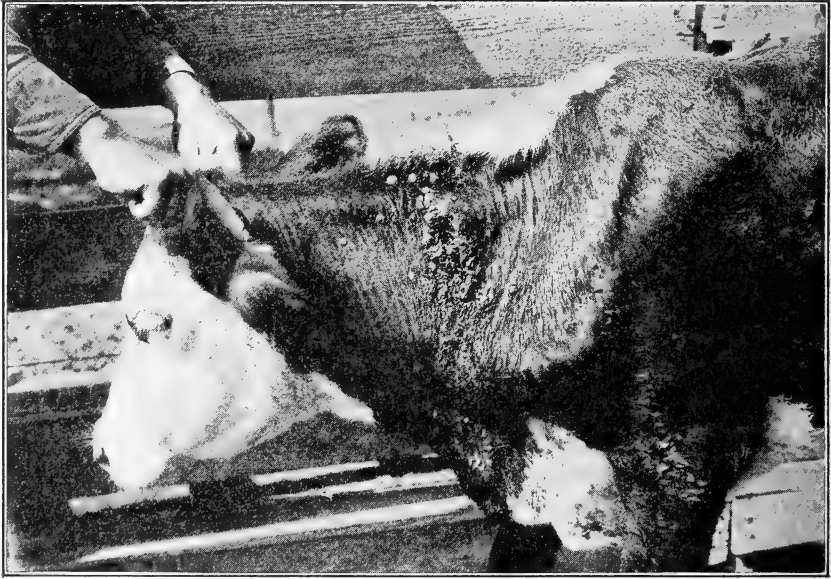

PLATE IV.—Screw worm injury to a yearling calf. (Bishopp.)

The larva of this insect is called the "screw-worm," and occurs in sores and wounds of domestic animals and also in man. There are various records of its presence in the ears and nose, or nasal cavities, of people; in swellings near the nose; in a boil under the arm; under the skin of a child; and in the navel of a child. It is hardly a possible factor in intestinal myiasis of man, and most of such recorded cases probably belonged to some species of *Sarcophaga* whose larvæ are very similar in appearance to those of the screw-worm.

Sarcophagidae

The *Sarcophagidae* have two great hooks, and the posterior stigmal plates have three slits as in *Calliphora erythrocephala* and *Lucilia seri-*

cata. However, these slits are not directed toward those of the opposite plate but are sub-parallel to them. The stigmal field is strongly depressed to form a deep pit, and the stigmal plates are at the bottom of this pit. The segments of the body bear complete rings of spinose areas, and often supplementary pads on the sides.

Sarcophaga larvæ prefer animal matter, breeding extensively in carcasses. They have been found in cheese, oleomargarine, pickled herring, dead insects, and human feces. A species was also reared from decaying vegetables.

BIBLIOGRAPHY

- Banks, N., 1912.—The Structure of Certain Dipterous Larvæ with Particular Reference to those in Human Foods. U. S. Dept. Agr., Bur. Ent., Tech. Bull. 22.
- Hewitt, C. G., 1910.—The Structure, Development and Bionomics of the House Fly, *Musca domestica* Linn.
- Howard, L. O., 1910.—A Contribution to the Study of the Insect Fauna of Human Excrement. Proc. Wash. Acad. Sci., vol. 2, pp. 541-604.
- Howard, L. O., and Hutchison, R. H., 1915.—House Flies. U. S. Dept. Agr., Farmers' Bull. 679.
- Howard, L. O., and Hutchison, R. H., 1917.—The House Fly. U. S. Dept. Agr., Farmers' Bull. 851.
- Lallier, P., 1897.—Étude sur la Myase du Tube Digestif chez l'Homme. Thèse Faculte de Médecine de Paris, pp. 120, 1 pl.
- Lintner, J. A., 1882.—Injurious Dipterous Insects. 1st Rept. Inj. Ins., New York, pp. 168-227, figs. 45-67. (Anthomyiidae.)
- Lowne, B. T., 1892, 1895.—The Anatomy, Physiology, Morphology, and Development of the Blow-fly (*Calliphora erythrocephala*). 2 vols., London, 778 pp. 52 pls., 108 figs.
- Newstead, R., 1907.—Preliminary Report on the Habits, Life-cycle, and Breeding Places of the Common House Fly (*Musca domestica*), as Observed in the City of Liverpool, with Suggestions as to the Best Means of Checking Its Increase. Liverpool, 23 pp., 14 figs.
- Packard, A. S., 1874.—On the Transformation of the Common House Fly, with Notes on Allied Forms. Proc. Bost. Soc. Nat. Hist., vol. 16, pp. 136-150, 1 pl.
- Patton, W. S., and Cragg, F. W., 1913.—A Textbook of Medical Entomology.
- Perez, C., 1910.—Recherches Histologiques sur la Metamorphose des Muscides (*Calliphora erythrocephala*). Arch. Zool. Exp., 274 pp., 16 pls.

Riley, W. A., and Johannsen, O. A., 1915.—Handbook of Medical Entomology.

Walsh, B. D., 1870.—Larvae in Human Bowels. Amer. Ent., vol. 2, pp. 137-139. (Homalomyia.)

CHAPTER X

The Control of the House Fly and Related Flies ¹

W. Dwight Pierce

We have now come to one of the greatest problems in Sanitary Entomology; the control of the treacherous flies that visit our homes but to bring sickness and death. The anti-fly measures may be classed as repressive and palliative, and of course the first are the most important.

THE FLY MUST BE FOUGHT WHILE BREEDING AND BEFORE IT HAS A CHANCE TO SPREAD DISEASE. Many persons object to the anti-fly-breeding measures because of cost, but no cost is too great if thereby we prevent epidemics and the loss of thousands of lives.

Inasmuch as we are dealing with the fly as a municipal, industrial, rural, home, and army problem, the subject will have to be handled topically.

REPRESSIVE MEASURES

Striking the Source

Manure

The house fly normally breeds in horse manure, but may also breed in the manure of other domestic animals. It is apparent that this then is the first and most difficult point to strike.

The disposal of manure is a matter which must be controlled in all municipalities and wherever there are large congregations of people. For this reason it is an acute problem of army camps and cantonments. In cities it is most acute in stockyards, sales stables, livery stables, and contractor camps. It is a problem on every farm and with every individual who owns a horse, or hog.

Chemical Treatment.—Manure is a valuable product and every effort should be made to conserve and utilize it, first rendering it unfit for flies. Realizing this, the United States Department of Agriculture had

¹ This lecture was read August 5, 1918, and has been more or less modified to its present form.

a long series of careful studies made of many chemicals which might be applied to manure, in order to determine the effects upon the fly larvæ, the bacterial activity of the manure, and the fertilizer value of the manure. The results have been published in various bulletins by Hutchison, Cook, and Scales with the principal recommendation in favor of the daily treatment of fresh manure with *powdered borax* at the rate of 1 pound to 16 cubic feet, or 0.62 pound per 8 bushel of manure. This will kill about 90 per cent of the larvæ, and is harmless to the manure. Larger amounts, however, may have a deleterious effect.

They also found that a water extract of *hellebore*, prepared by adding $\frac{1}{2}$ pound of powder of hellebore to 10 gallons of water, which after stirring is left for 24 hours, is effective at the rate of 10 gallons to every 8 bushels (10 cubic feet). Likewise a mixture of $\frac{1}{2}$ pound of *calcium cyanamid* and $\frac{1}{2}$ pound of *acid phosphate* to each bushel of manure gives a larvicidal action of 98 per cent. Unfortunately these last two remedies are not available at the present writing.

Creosote has been recommended by British authorities, but the investigators mentioned above have found a deleterious effect upon the manure. If the primary essential is destruction of fly breeding, and the other chemicals are not available for treatment, creosote treatment is effective, and there will still unquestionably be fertilizing value to the manure. Army sanitarians, especially, can not always use the most approved methods, but must rather obtain immediate results with materials and means at hand.

Maggot Traps.—Hutchison discovered an application of the habit of the fly maggots of migrating from the manure piles before pupation, when he developed the maggot trap which consists of a slatted platform over a cement or metal water-filled basin (fig. 32). Such platforms can be built of sufficient size and number to hold the accumulations of manure for a period of about two weeks, after which time it is unfavorable for house fly development. The larvæ migrate from the pile and fall into the water and drown (plate VIII).

Storage in Bins.—The house fly is averse to darkness and various contrivances have been devised for the dark storage of manure, in pits, tightly closed boxes, windowless rooms, etc. (see plate V). For small stable accumulations, especially in cities, perhaps this furnishes one of the best means of temporary storage. It is a good plan to use fly traps in connection with manure bins (see fig. 33).

Stacking.—Manure may be stacked in such a way as to greatly minimize, if not entirely prevent fly breeding. A stack built up by the driving of the wagons over the pile and dumping thereon becomes very compact and the internal heating is quite destructive to the fly larvæ. The sides of such a pile should be compacted and the loose materials on the ground

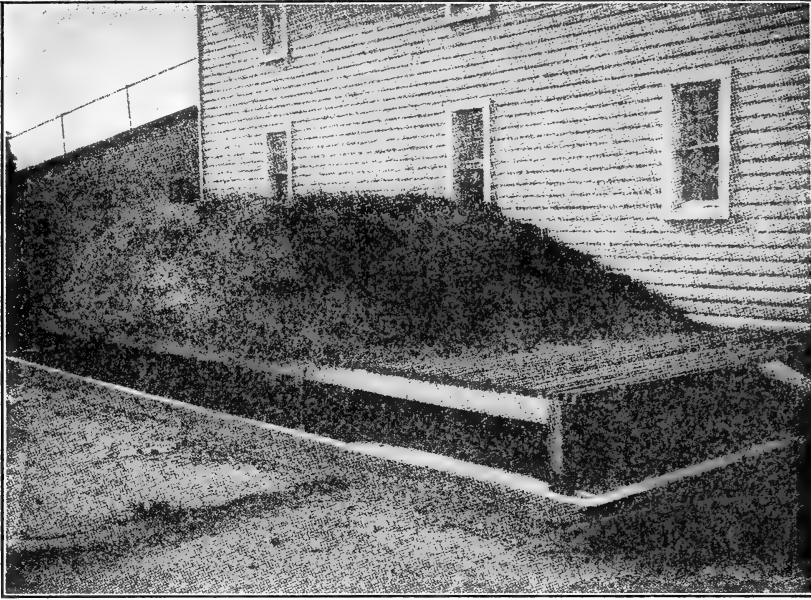

FIG. 32.—A maggot trap for house-fly control. View of the maggot trap, showing the concrete basin containing water in which larvae are drowned, and the wooden platform on which manure is heaped. (Hutchison.) From U. S. Dept. Agr. Bull. 200, plate 1 (larger), or farmer's bull. 851, fig. 14 (as above).

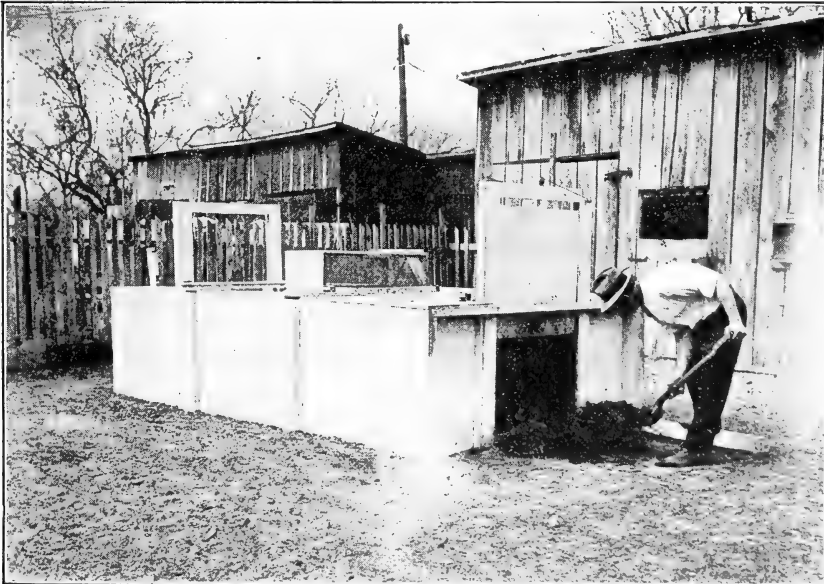

PLATE V.—Manure box with fly trap attached. (Bishopp.)

thrown onto the pile or raked up and burned. The edges of the pile and the ground around it may be treated with borax or oiled with creosote or crude oil.

In Panama it is a custom to set fire to the manure pile and burn it down about a foot, thus covering the entire pile with ash.

Broadcasting.—Often on farms it is practicable to take the daily accumulation of manure and spread it over the fields. When the weather is dry, or very hot, or too cold for fly breeding, this method is a very desirable means of handling the manure problem, but the broadcasting of fresh manure on moist ground in cloudy or moist weather may give rise to great quantities of flies unless it is spread very thinly and the larvæ are not well matured when the manure is scattered. An illustration of a manure spreader is given in plate VI. An undesirable method of spreading manure is shown in plate VIII.

Collection of Manure.—It is important that manure be collected and removed from the vicinity of habitations at regular periods, sufficiently frequent to remove the possibility of its becoming a source of fly breeding. In army camps it is imperative that manure be daily removed from all stables, picket lines and stable yards. In cities the ordinary accumulations of private stables should be required to be removed once each week, but in the meanwhile it must be either stored in bins or on maggot traps, or daily treated with borax. The accumulations of large stables, livery and feed stables, stockyards, etc., should be required to be removed daily.

We may obtain some of our best illustrations of the proper handling of manure from army practices followed during the Great War. Army discipline makes it possible, when the command is properly educated to the importance of it, to control the manure problem more effectively than under any other condition on a large scale. Tremendous quantities of manure were produced in cantonments and shipped in car or train loads daily. Most of the larger cantonments that were located in progressive rural sections were able to farm out the manure to individual farmers or to sell to contractors who shipped it by the carload daily and distributed it to the rural population. When unable to do this the army officials were compelled to resort to storage or destruction of the manure as discussed in other paragraphs.

Loading platforms for shipment of manure need to be carefully watched and kept under strict supervision. If these platforms are loosely built of framework elevated above the cars, much of the manure falls through the cracks and over the edges, and great accumulations arise at the sides of the tracks and between the tracks. A properly constructed loading platform should have a cement base with the tracks imbedded in the cement and should be daily flooded, the washings being swept into piles and oiled, and burned when dry enough. The writer has found the

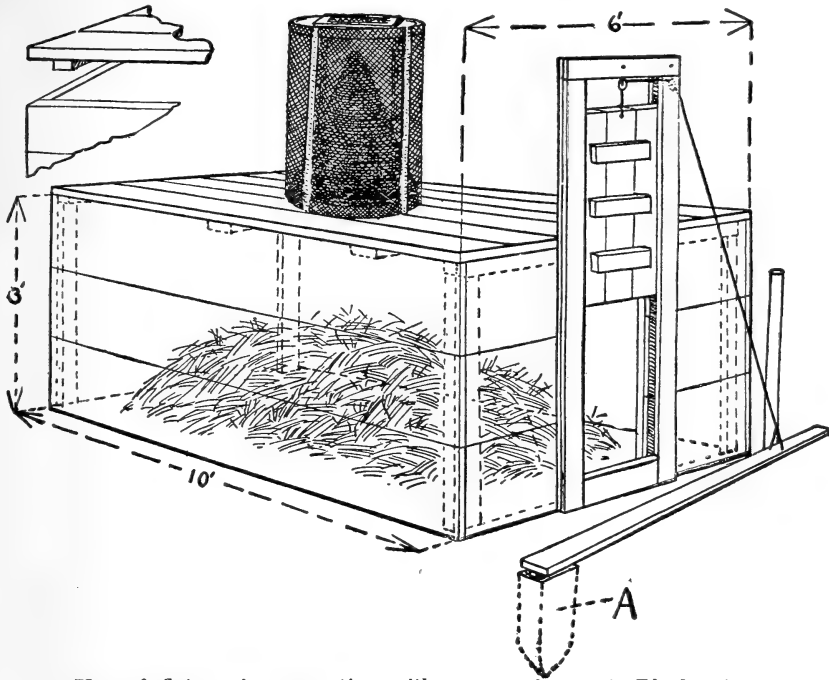

FIG. 33.—Use of flytrap in connection with manure bin. *A*. Block of wood set in ground to which lever raising door is hinged. (Bishopp.) From Farmer's Bull., U. S. Dept. Agr., No. 734, fig. 6.



PLATE VI.—Manure spreader (Bishopp.)

accumulations under loosely built platforms to be a fertile fly breeding condition.

Shipment of Manure.—When manure is shipped by car, the railroads should be required to remove it promptly and the contractors should be required to unload promptly and distribute it in such a manner that it will not be a source of flies to the community where it is unloaded. If unavoidable delays do not permit prompt handling of this manure, it should be treated with borax water.

Cleaning Up.—Well drained cement floors in stables are by all means the most sanitary and lend themselves best to cleanliness. If it is impracticable to have cement floors, the dirt floors should be sloped to drain well and should be made hard by saturation with oil or mixing with other soils which pack better, as certain types of clay. The floors should be swept daily after removal of the manure, and sprinkled with borax water, or limed. Frequent treatment with a creosote compound is of value. The ground around hitching posts and picket lines becomes soggy with urine and manure, unless treated by digging up the soil for several inches and saturating it with oil, and then tamping it hard. Stable yards should not be allowed to become filled with manure. They should be swept, or raked or scraped up daily and the manure removed (see plate VII). A filthy stable yard may be the source of scourges of flies.

Incineration.—When manure cannot be sold, chemically treated, farmed out, or stacked to prevent fly breeding, it must be burned. This is often a necessity in army encampments. In dry sections the *windrow incineration* may be practiced. The teams drop their loads in great, long windrows, the horses straddling the rows. These are spotted with oil and set afire. The *wooden chimney windrow* which was practiced at Edgewood Arsenal consists of a windrow of logs piled to form a horizontal chimney over which the manure is piled and then fire is set to the wood. The *hillside incinerator* devised by Dr. Mann at Quantico, Virginia, consisting principally of iron rails and chicken wire screen or gratings under which a fire is burning, is practical for small camps. The *hammock incinerator*, a woven wire hammock or two suspended over a fire, will do as a temporary expedient for a small detachment on temporary duty, or for field parties of hunters or investigators. *Furnace incinerators* can reduce the manure to an ash and save whatever is of value in the ash.

Need of Rigid Inspection.—It is not only army camps that need to have a rigid inspection system as regards manure disposal. Every city which has any regard for the public health should insist on proper inspection and regulation of stables and places where manure accumulates. It is not uncommon in many cities to see boxes of manure in alleys swarm-



PLATE VII.—Road drag in use scraping manure in a cow lot on a Tennessee farm. (Bishopp.)



PLATE VIII.—Undesirable conditions which are overcome by use of the maggot trap. A manure pile covering a large area and having little depth. Illustrating the conditions which favor the greatest loss of nitrogen, and at the same time offer the best breeding ground for flies. (Hutchison.) From U. S. Dept. Agr. Bull. 200, Plate III.

ing with fly larvæ, or to find piles of manure standing for weeks in front of livery stables, even on the sidewalks.

In one small city, the writer, in passing by a side track where certain grain companies unloaded straw and feed, using horse drawn wagons, noticed that the ground along these tracks was a thick mixture of rotting straw, grain, and horse droppings. This was across the street from the city market where flies were swarming in the fish stalls especially. Only a personal tour of inspection by a trained observer would turn up many of the most important sources of fly breeding.

Garbage

Needless to say it is necessary that garbage be kept in fly-tight cans and that it be removed daily, or every third day when the amount is small. The army method of building a screened box for holding the

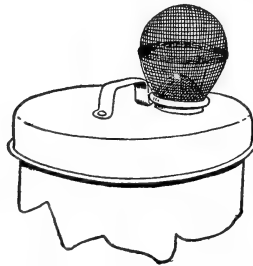

FIG. 34.—Top of garbage can with small balloon fly-trap attached. (Bishopp.)

garbage cans is very good, and would be an excellent plan for hotels and restaurants especially. A fly trap on a garbage can will catch many flies (fig. 34). Empty garbage cans are very attractive to flies. The writer has seen many wagons full of empty cans which had been washed in lye water, swarming with flies, returning to camp. It is necessary to wash the cans in a creosote compound. Householders are very careless of the cleanliness of their garbage cans. If they can not wash them they can rinse them with a hose and treat with a creosote compound or lye water. When garbage is farmed out for *feeding to pigs* the farmers should be bound by contract not to take more than their pigs can consume in a day. The feeding pen should have a cement foundation so that it can easily be cleaned. The remains of the day's feeding should be burned. Many municipalities, as well as army camps, dispose of the garbage by *incineration*. Others sell to contractors for *reclamation*. Some parts of the garbage are not of value for feeding or reclamation and the writer has seen instances where such material was thrown on dumps with tin cans and trash and not burned. Great vigilance is necessary at all waste

dumps to see that no fly-breeding material is dumped anywhere except on incinerators.

Grease traps at kitchens of mess halls, and at garbage can washing-platforms are attractive places for fly breeding and should be kept clean and treated with creosote compounds.

Excreta

The disposal of human excreta is a great problem in all communities, but becomes acute in army and construction camps and at camping resorts. In temporary army camps where latrines are necessary, the excreta must be disposed of daily. The excreta may be saturated with oil, covered with straw and burned daily. They may be treated with lime or borax or creosote, and buried, gradually filling the latrine. They may be removed daily, hauled to an incinerator and burned. Private and public camping grounds should be as carefully protected in this manner as an army encampment. Probably much education is necessary to accomplish this practice. When a sewage system is available, the difficulties are less, but care must be exercised to maintain the sewers in good repair. If a *manhole* does not operate properly and sewage accumulates on the walls, flies will breed there. If the main leaks and washes away the covering soil, flies will breed in the seepage. The writer has personal knowledge of just such insanitary conditions. At some point in the system, unless septic tanks are installed, the sewage will empty into a stream. *The stream bed must be kept free of obstructions*, with straight banks. No trees, shrubs, grass or other obstacles must interfere with the steady flow of the sewage, for behind every branch, or root, or weed solid excreta will accumulate and flies will breed. In case excrement accumulates in spite of all vigilance, it should be oiled, burned off and moved on with all expedition, immediately upon discovery. The most revolting sight the writer has ever experienced was caused by the damming up of a sewage-carrying stream, causing a tremendous accumulation of solid excreta which was fairly alive with wriggling maggots and black with swarms of flies, and this was but a scant quarter mile from a great army camp, and typhoid fever was present. Only quick measures averted an epidemic.

Carcasses

Bodies of animals offer great opportunities for the breeding of many species of flies and especially for the spread of disease. Carcasses should be removed as soon as possible after discovery. The best way to dispose of them is to burn them. If they cannot be burned they should be treated with quicklime and buried. On the battlefield it is often impossible to

burn or bury. Foreman and Graham-Smith have ably shown the value of coal tar creosote oil as a deodorizer, preventive of decomposition, and fly destroyer in carcasses. This subject is fully treated by Mr. Bishopp in the chapter on myiasis (Chapter XIII).

Miscellaneous breeding places

Factory waste, rotting vegetable matter, the accumulation of débris along shore lines, chicken yards, pig pens, alleys, streets which are not swept, gutters, etc., furnish fly-breeding places (see Chapter XI). Mr. Laake's able presentation of packing-house problems in another lecture covers that subject sufficiently (see Chapter XXXIII).

PALLIATIVE MEASURES

In view of the fact that flies can come great distances, possibly even over 50 miles as indicated by Ball at Rebecca Shoal, the sanitarian is not always responsible for all the flies that visit the locality under his jurisdiction. There is therefore always the necessity of taking measures against the flies themselves, although this is entirely secondary to the prevention of breeding.

Screening.—All foods must be protected from flies because many of the flies which visit foods lay eggs therein. This is especially true of meats which are attacked by blow flies, and cheeses which are attacked by skippers. City markets should not expose meats for sale uncovered, as the attraction to flies is too great. A well-screened house will have the least trouble from flies. In army camps anywhere in the United States all sleeping quarters, kitchens, and mess halls should be well screened against flies. All hotels throughout the country, especially in rural communities, should be required to screen all windows and doors.

The fly situation around small country hotels is by far the most repulsive that can ordinarily be found in any community. Very little, if any, care is taken of the privies and the flies come directly from there to the kitchen and dining rooms.

Screening of garbage cans has been mentioned and is an admirable procedure. A screened enclosure around privies and latrines would assist in keeping flies away.

Fly Traps.—Fly traps of many different designs have been devised. The most efficient is the cone and cylinder type devised by Bishopp (fig. 35). The Hodge window trap is good. A small cone and cylinder trap may be inserted in the lid of garbage cans (fig. 34). The principle of all different traps is the attraction of the flies by a good bait, and the arrangement of the trap so that once there the fly can not get away. At

all places where flies congregate, as markets, eating places, packing houses, etc., the liberal use of good fly traps is a very good measure. As baits for such traps the following suggestions have been made.

1. Milk.
2. Overripe or fermenting bananas, crushed and placed in the bait pan.
3. Bananas and milk are better than either separately.
4. A mixture of 3 parts water, 1 part molasses, is good after it has fermented for a day or two.

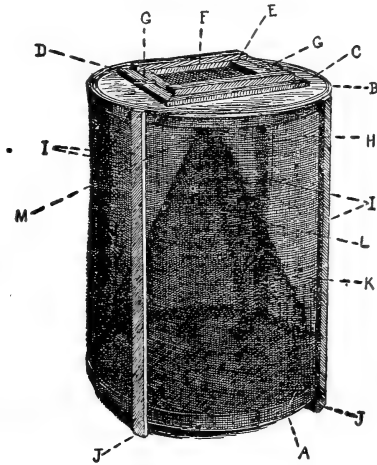

FIG. 35.—Conical hoop fly trap; side view. *A*, Hoops forming frame at bottom. *B*, Hoops forming frame at top. *C*, Top of trap made of barrel head. *D*, Strips around door. *E*, Door frame. *F*, Screen on door. *G*, Buttons holding door. *H*, Screen on outside of trap. *I*, Strips on side of trap between hoops. *J*, Tips of these strips projecting to form legs. *K*, Cone. *L*, United edges of screen forming cone. *M*, Aperture at apex of cone. (Bishopp.) From Farmer's Bull, U. S. Dept. Agr., No. 734, figs. 5, 1.

5. A mixture of equal parts brown sugar and cheese or curd of sour milk, thoroughly moistened, is good after it has been allowed to stand three or four days.
6. Mucous membrane from the lining of hogs' intestines is attractive to blow-flies and other meat-infesting flies, as well as the house fly. This is available for fly traps at packing houses.
7. Ordinary fish and meat scraps.
8. Moistened garbage.

These baits are of little value if allowed to dry out. It is not uncommon to see fly traps standing out in the sun near garbage cans, with no flies within but plenty of flies around, and the bait dried out by the sun. The fly trap must be more attractive than its surroundings. When baits are used which will permit of the development of maggots in them,

the pans should be scalded and then emptied, and rebaited, every three days.

Fly Paper.—Sticky fly paper has distinct merits and in the presence of abundance of flies should be used. The hanging pyramid strips are considered better by some sanitarians than the flat papers.

Poisoned Baits.—Many fly poisons are on the market. Any kind of poisoned bait is dangerous in the presence of children or ignorant persons as there are many recorded fatalities to children from drinking fly liquids or licking poisoned papers.

Phelps and Stevenson, 1917,² have given a very thorough presentation of the question of fly poisons. Their bulletin should be consulted by any one desiring to go very far into this phase of the subject.

The most efficient strength of formaldehyde is 0.5 to 1 per cent, which is equivalent to 1.25 to 2.5 per cent of the 40 per cent solution sold as formalin.

A muscicide considered by them as even superior to formaldehyde in many ways is an aqueous solution of 1 per cent sodium salicylate plus 10 per cent brown sugar.

They used sodium arsenite as the basis for their experiments. This was made up in stock solution as follows:

Dissolve 4.95 grams pure sublimed arsenious oxide As_2O_3 and 20 grams pure sodium carbonate in about 300 cc. of distilled water by heating. When the solution is complete the liquid is cooled to 20° C. and the volume made up to 1,000 cc. with distilled water. Ten cc. of the stock solution are diluted to 1,000 cc. with distilled water and this is called by them the standard arsenite solution, or one-thousandth normal solution.

Sodium fluoride solution, 1 per cent, gave a mortality equal to that of the standard arsenite solution.

An interesting feature of their investigation was the reduced effectiveness of these poisons with lowered temperatures.

Fly Sprays.—In the armies flies often congregate in tremendous numbers and some kind of spray is necessary to kill them. Maxwell-Lefroy handed me the following formula:

1 tablespoon formaldehyde.

1/2 pint lime water.

1/2 pint water.

Kirk recommends as a spray in latrines and tents a light oil mixed with three or four parts of water well shaken. Rubber tubing should not be used in the spray. A coarse atomizer such as is used in greenhouses is serviceable.

² Experimental Studies with Muscicides and Other Fly Destroying Agencies, Hygienic Lab., Bull. 108.

Bacot recommends a kerosene emulsion of 3 parts soft soap completely melted by heat in 15 parts of water and the addition up to 100 parts of kerosene or other light burning oil, and churning up to an emulsion. This may be kept indefinitely and diluted with water to about 1 part emulsion to 10 parts water content.

Protection of Animals.—Animals are seriously bothered by the pestering of flies. Any kind of netting that the animal can shake to disturb the flies is of some value. The question of repellents is one upon which many investigators have labored. Graybill, 1914,³ summarizes the results of these investigations. Those formulæ most in use all contain crude petroleum oil and usually soap.

A good stock emulsion recommended by Graybill is made of:

- Hard soap, 1 pound,
- Soft water, 1 gallon,
- Beaumont crude petroleum, 4 gallons,
- Dilute to 1 part emulsion to 3 parts water.

Bishopp's fly repellent consists of:

- Fish oil, 1 gallon,
- Oil of tar, 2 ounces,
- Oil of pennyroyal, 2 ounces,
- Kerosene, $\frac{1}{2}$ pint.

For dairy cattle, Jensen makes a stock solution of crude petroleum with the addition of 4 ounces powdered naphthalin, and applies with a brush once or twice a week.

Jensen has also given three formulæ of repellents for protecting wounds from flies.

Formula No. 1:

- Oil of tar, 8 ounces,
- Cotton seed oil to make 32 ounces.

Formula No. 2:

- Powdered naphthalin, 2 ounces,
- Hydrous wool fat, 14 ounces,
- Mix into an ointment.

Formula No. 3:

- Coal tar, 12 ounces,
- Carbon disulphid, 4 ounces,
- Mix; keep in a well stoppered bottle and apply with a brush.

It is of the utmost importance that flies be kept at a minimum in army camps. We can do no better than cite a few authorities of the various armies in support of this. Ainsworth considers the presence of the house fly the greatest danger signal to an army in the field. Savas has called

³ Repellents for Protecting Animals from the Attacks of Flies, U. S. Dept. Agr. Bul. 131.

attention to the connection of flies with the great cholera outbreak in the Greek army. At Gallipoli the flies were in amazing numbers, the food was black with them as soon as it was set on the table. They filled the tents and shelters, settled on the refuse of the camp, and on the unburied dead, and by their annoyance multiplied the sufferings of the wounded and spoiled the tempers of the hale. The flies have been very bad in France. Kirschner states that in the hospitals near the front the enormous number of flies presented a serious danger. Maxwell-Lefroy says that in Mesopotamia the tents and trenches were full of flies. The troops at Salonika suffered greatly from diarrhea and dysentery which coincided in appearance with the abundance of flies. Wenyon and O'Connor found flies in Egypt largely responsible for outbreaks of amoebic dysentery among the troops. In this connection Dr. Ballou's lecture on flies and lice in Egypt (Chapter XXXII) will give an excellent first-hand view of conditions in that country.

CHAPTER XI

Control of Flies in Barn Yards, Pig Pens and Chicken Yards ¹

F. C. Bishopp

The question of the control of flies in their various breeding media or places of breeding can not be well divided in the discussion. Attention has been given in a previous lecture (Chapter X) to the general aspects of house fly control and the most favorable breeding media and methods of handling them have been discussed in a general way. Therefore I shall take up the special problems under the three situations listed in the title. Adequate care of the manure and other refuse in these situations will not only result in the prevention of breeding of house flies in them but will also reduce the number of certain other flies which play a part in disease dissemination among man and animals, notably the horn fly, stable fly, *Muscina* spp., *Fannia* spp., certain Sarcophagids and lesser numbers of Muscidae known as blow flies, which occasionally breed in hog manure and freely in unconsumed animal matter in garbage.

REPRESSION OF FLIES IN BARN YARD

The discussion of this problem is bound up closely with that of the control of the house fly through the care of horse manure, etc. If manure is promptly disposed of as removed from the barn the yards are kept in better condition and the scattered droppings either of horses or cattle are less dangerous as regards fly breeding. In drier regions of the country these droppings may be practically neglected. Where large numbers of horses are kept in sheds or yards, the entire area requires treatment. The manure should be scraped up at least as frequently as three-day intervals and scattered thinly on fields or composted and treated with borax or other larvicides.

In large stock concentrating points where stockyards and mule sales stables are of great extent the problem of disposing of the manure from the yards is a difficult one. In the Eastern States it has been the usual practice to contract the manure to certain companies or to permit farmers and truckers to enter the yards and get manure when they desire it. One

¹This lecture was read September 9 and distributed September 11, 1918, and is now reproduced practically in its original form.

difficulty has been that stock are often kept in a single pen for feeding for some time and during this time it has been the rule not to clean up the pen. The provision of ample room so that stock may be removed from one pen to another to permit cleaning is important. This also applies to horse and mule sales stables. The restrictions placed on the horse and mule dealers who handle stock for the army have tended to greatly improve fly breeding conditions in these stables and yards. I have frequently observed these sales stables to be filled with tightly packed manure from eighteen inches to three feet deep. In the case of an East St. Louis mule sales stable where one company has thirty-five acres under cover, the removal of all this manure was an enormous task. Yet it was accomplished so that the company might continue handling stock for government use. The manure was hauled several miles to a fertilizer plant where the well decayed part was piled and subsequently dried, ground and sold as sheep manure for lawn dressings, while the parts with considerable straw were thrown from cars onto rail incinerators and burned, the ash being used in fertilizer mixtures. The entire barns and fences were then gone over with a sand blast machine which cleaned them of all accumulation of dust and saliva which had in some cases become quite thick and highly glazed. An effort is being made by the authorities in charge to have the manure from these stables throughout the country moved at weekly intervals.

The drying of manure and its sale in powdered condition for lawn dressings, etc., has attained rather large proportions as a commercial enterprise in some of the large cities. This is a satisfactory means of disposal of manure and there are good reasons why the practise should be extended.

It appears that where shavings are used for bedding less trouble arises from fly breeding than where straw is utilized. This would undoubtedly favor reduction in the breeding of *Stomoxys* also.

Returning to the question of handling manure in cow lots and small barn lots, it is advisable when labor is at hand, especially in dairy yards, to pick up the droppings daily or even twice a day. This is greatly facilitated by having the yard where cattle congregate in greatest numbers concreted. In large dairy lots it has been found feasible to bring the manure together by means of an iron road drag (see plate VII): This leaves the manure in windrows so it can be easily shoveled into a wagon.

For the disposal of manure from dairies and even on the farm no method is better than the use of a manure spreader (see plate VI) and the scattering of the material thinly on open fields. Of course in cases where all land is cropped it is not convenient to employ this method during certain parts of the year, although it is usually possible to have one portion of the farm available for manuring at all times.

The use of manure pits and boxes has been mentioned in a previous lecture, as has also the Hutchison maggot trap. It appears to the writer that any attempt to construct pits or boxes which are so tight as to prevent the escape of newly emerged flies is likely to meet with failure. In practically all instances the manure is infested more or less when placed in the box or pit, and following this suggestion the writer has been advocating the placing of the manure in boxes and pits which will not allow flies to gain entrance from the outside and which are provided with a cone or tent trap to capture the flies which breed out (see plate V). In the absence of the trap feature these would almost surely escape to the light from the most tightly constructed box or pit which it is feasible to build and maintain. A manure box of this type has been tried by the Dallas laboratory and found to work admirably. The number of flies caught is often surprisingly large.

For small pastures and meadows it is sometimes feasible to utilize a brush drag to break up the cow droppings. This serves three purposes—preventing the breeding of the horn fly, scattering the manure evenly over the ground, and permitting the grass to grow where it would otherwise be prevented by the piles.

While the house fly does not breed readily in pure cow manure the writer has reared the species from this substance and has also found that where cow manure is mixed with a certain amount of straw it is a fairly good breeding medium for this species. The horn fly, *Lyperosia irritans* (*Haematobia*) Linnaeus, breeds exclusively in cow droppings either in large piles or individual droppings. Blow flies are not known to breed in cow manure, but a number of species of Sarcophagids, most of which, however, do not have scavenger habits, breed in considerable numbers. The brilliant green fly, *Pseudopyrellia cornicina* Fabricius (plate III, fig. 4), is very commonly seen on fresh cow droppings; in fact this is usually the most abundant species in this situation in the country. It may be readily mistaken for *Lucilia* when not examined carefully. This species is of no importance as a human disease carrier as it does not enter houses or visit food.²

In preventing flies breeding in yards it is very essential that water troughs be kept from running over and whenever overflows or leaks do occur they should be fixed promptly and the moistened manure and earth cleaned up and hauled away immediately. Special attention should be given to accumulations of horse manure in yards along feeding racks. Here the mixture of horse manure, waste hay and urine forms a satisfactory mixture for fly production.

² Unquestionably its larvae must have an important rôle as regards organisms taken up from the manure and passed through their bodies, but whether this rôle is to destroy the organisms or to propagate and distribute is yet to be learned.—W. D. Pierce.

The use of larvicides and other chemical compounds in barn yards is usually inadvisable. Thorough cleaning ordinarily will handle the situation. Crude oil has been used in yards where considerable numbers of horses are kept to permit firm packing of the ground and keep down dust in dry weather. Borax, either dry or in solution, may be used in breeding places which can not be cleaned thoroughly. Poultry and hogs consume large numbers of larvæ and pupæ and scatter the manure so it will dry out rapidly. These agencies should not be depended upon, however, to effect control.

The employment of conical fly traps about stables and dairy barns, if they are kept properly baited, will aid in reducing the number of house flies. Cheap molasses and water (1 to 3), or milk curd, brown sugar and water in equal parts form good baits. The latter, if kept moist, will remain attractive for two or three weeks. It is comparatively unattractive for the first few days. Hodge type window traps aid in reducing the house fly and stable fly troubles within barns if the barns are closely built and the other windows darkened or screened.

FLY CONTROL IN PIG LOTS AND PENS

The hog has been looked upon from time immemorial as a filthy animal and he is usually compelled to live in surroundings which would never be tolerated for any other beast.

One of the special problems which confronts the municipal and the army sanitarian is the utilization on a large scale of city and camp garbage by hog feeders. There appears to be no more economical way of disposing of garbage than by this method, but the conditions under which the feeding is to be done must be given strict attention by sanitarians. In the vicinity of nearly every city and large army camp is located one or more of these garbage feeding plants, the number of hogs ranging from a few hundred to several thousand. For the most part the garbage is sold to feeders under annual contract. Army garbage at least is supposed to be free from glass, cans, coffee grounds, and liquids. The contractors furnish the garbage cans, remove the garbage daily and return empty cans which are supposed to be thoroughly cleaned. If the orange, grapefruit, and lemon peels could be eliminated from the garbage, the mass of material not eaten by the hogs would be materially reduced. Garbage feeding plants should be operated under approximately the following set of rules:

1. *Location of Feeding Stations.*—Station should be located as far from habitations as possible and also well removed, two miles or more, from the city limits or the precincts of an army camp. Our recent experiments show that flies of various species, including the house fly, travel thirteen

miles or more under rural conditions, but that there is a rapid decline in the number of flies which reach points two miles or more from the source of production. It is also desirable that the pens be located a considerable distance from main highways, as passing vehicles help to disseminate the flies.

2. *Drainage.*—Adequate drainage is essential. It is preferable to have hog-feeding stations located on hilly ground and never on flat areas.

3. *Adequate Room.*—In feeding garbage it is essential in order to maintain sanitary conditions that the hogs be given a considerable acreage. I would place this at a minimum of 225 sq. ft. per hog, or approximately 190 hogs to the acre. Of course as a general principle in fattening hogs it is considered necessary to reduce activity by close penning. It has been proven, however, that hogs make satisfactory gain when heavily fed if kept in large pastures.

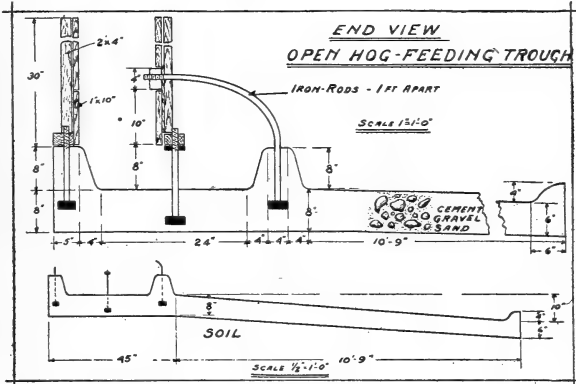

Fig. 36.—Plans of open hog-feeding trough. (Bishopp.)

4. *Feeding Troughs and Platforms.*—Concrete feeding troughs and platforms are essential under present inadequate labor conditions. A number of forms of troughs and platforms may prove satisfactory from a sanitary standpoint. In some cases feeding floors are used without any troughs but this necessitates daily cleaning. Under outdoor conditions such as exist in the South, it is advisable to locate the feeding troughs on land with pronounced slope. A simple form of construction consists of a concrete platform about 15 feet wide, length in proportion to number of hogs (fig. 36). This should have a backward slope of about 10 inches. The trough can be formed by setting a plank on edge in the concrete about three feet from the upper side and parallel with it or by a concrete ridge several inches high to form the lower edge of the trough. The upper edge of the platform should be raised so as to prevent water from washing into the trough and the feed racks to receive the garbage should be constructed over the front edge of the trough in such a way as to

receive all drip. The lower side should be provided with a concrete ridge projecting about five inches. This edge along the back will hold most of the unconsumed garbage, bones, etc., as they are worked backward, and facilitates thorough cleaning which should be done at not to exceed three-day intervals.

5. *Shade*.—If location with plenty of trees can be chosen, this is preferable to sheds for protection from the sun. Where sheds are needed for protection either from sun or rain, they should be built on well drained land and never placed over the feeding troughs. They should be seven feet above the ground so as to permit of easy cleaning. Temporary shade can be constructed extending a few feet over the troughs if desired.

6. *Contracts*.—Annual or longer contracts with the Army or with municipalities are far more desirable than monthly contracts as they enable the contractor to put up proper feeding facilities which he would not do under short contracts. Contracts should specify the character of feeding arrangements and penalize failure to keep the premises in satisfactory sanitary condition. The pens should be given frequent inspection by sanitary officers.

7. *Cleaning of Yards*.—In addition to the cleaning of the unconsumed garbage from feeding platform the manure should be scraped up and disposed of, especially during rainy weather. During hot dry weather where ample pasturage is used manure is the source of very little fly trouble.

8. *Disposal of Bones*.—Bones which are not retained on the feeding platform and those which are mixed with uneaten garbage should be collected at four-day intervals and placed in fly-proof bone racks. These can be built of lumber and screened on the outside and provided with fly-proof cover. It is desirable that the bones be removed entirely from the premises at frequent intervals.

9. *Avoidance of Transporting Flies on Vehicles*.—If garbage cans are properly cleaned there is less tendency for flies to follow them than if left dirty. Washing in a moderately weak solution of cresol tends to repel flies from them. The trucks should be washed off occasionally. There is less danger of flies following trucks back to camps when they are provided with covers.

10. *Quantity Fed*.—Feeding so much garbage to hogs that it will not be cleaned up should be discouraged.

11. *Final Disposal of Hog Manure and Unconsumed Garbage*.—This material may be scattered thinly over cultivated ground and exposed to the sun or promptly plowed under. Where material is found to be heavily infested with maggots, it is advisable to dump it in piles some distance from the feeding plant and treat it with borax solution. About one pound of borax should be used to each 8 bushels. If the mass is very wet

the borax may be applied dry, but if the material will absorb liquid the borax should be dissolved in water at the rate of one pound to five gallons and sprinkled over it.

12. *Dead Hogs*.—Dead hogs should be promptly disposed of either by burning on the ground or by hauling to rendering plants.

13. *Treatment of Hog Pens Where Flies Are Breeding*.—All manure should be scraped up thoroughly, holes cleaned out and the ground sprinkled with borax solution made as above. The holes should then be filled and packed; crude oil will assist in this. Lime has little value in destroying fly maggots but will tend to dry up moist areas and reduce odor. Ringing the hogs' noses reduces the number of holes formed and is said to help keep them quiet in fattening.

Fly Traps.—Each hog-feeding establishment should be provided with a number of well constructed fly traps, preferably of the conical type, and kept well baited. Black strap molasses and water at the rate of 1 part molasses to three parts water may be used as bait, or 1 part dark brown sugar to 1 part vinegar and 3 parts water may be used. The traps should be set in situations where flies tend to congregate and away from danger of being disturbed.

Hogs should not be tolerated in towns or cities. On farms the same general rules for elimination of fly troubles should be followed as applied to garbage-feeding stations. For brood sows, good, dry, clean housing is essential from both the fly control standpoint and that of successful breeding.

PREVENTION OF FLY BREEDING IN CHICKEN HOUSES AND YARDS

Comparatively little attention has been given to control of flies in poultry houses and yards. This source of fly breeding is one which should not be ignored as it is present even in far more premises than are manure piles from horses and cattle. Several species of flies breed in chicken manure, but the house fly, stable fly and lesser house fly seem to predominate. The writer has found many cases in the South in which these species seemed to be passing the winter in chicken manure. This appears to be a favorable place for the larvæ to pass the winter as little heat is generated to hasten transformation and sufficient protection is afforded to prevent the destruction of the immature stages by cold.

With small flocks of poultry in the back yard the prevention of fly breeding is not difficult but is very likely to be neglected. We have found that flies will breed in rather small accumulations of chicken manure on dropping boards but are produced in greatest numbers if the accumulations are on the soil itself. The weekly cleaning of all excrement from the dropping boards and floor is sufficient to prevent fly breeding. Usually

it requires more than a few days' droppings to produce a very favorable breeding situation. The cleaning of houses is of course facilitated by having the dropping boards readily removable or the roosts hinged so as to give free access to the boards. In the South, dropping boards are not being advocated and very few places are provided with them. In such houses a concrete floor is very desirable to make cleaning easy, but seldom found. Sprinkling the dropping boards or floors with air-slaked lime or dry sand helps to take up the moisture from the manure and reduce the attraction for flies.

In small places where gardens are available chicken manure can be used to advantage as fertilizer. Where it cannot be disposed of in this way promptly it should be placed in a box under cover from rain and treated with borax as previously recommended.

Dead fowls breed many dangerous species of flies and they should be disposed of promptly either by a scavenger wagon in a city, or by burning in rural districts.

The care of yards and houses on large poultry farms should be handled in practically the same way as the small one just discussed. There is usually less trouble, however, from these large plants as they receive more constant attention than the small ones. Pigeonries are also a source of some fly breeding as the pigeon coops usually are placed in an inaccessible place and become very filthy. The houses should be made readily accessible and cleaned occasionally. Pigeons should be kept under control, and porcelain dishes provided for nests will facilitate cleaning.

The frequent and thorough cleaning up of the manure from all domestic animals and fowls tend to reduce the troubles among them from intestinal parasites. Spraying with standard disinfecting solutions has the effect of reducing the attractiveness for flies, of excrement, soiled floors, etc., in addition to the germicidal action. Cleanliness and spraying of premises also increase the efficiency of fly traps.

CHAPTER XII

Myiasis—Types of Injury and Life History, and Habits of Species Concerned¹

F. C. Bishopp

Myiasis is a term applied to the attack of living man or animals by fly larvæ. The medical profession usually assigns specific names to the infestations according to their location—as dermal (in or under the skin), nasal (nose infestation), auricular or otomyiasis (ear attack), intestinal, etc. These names are not entirely satisfactory as often one form will develop into another or one species of larvæ may be concerned in attacks in many different regions. And again several species may attack the same region but produce different types of injury, or the point of attack may vary with the stage of the larvæ.

Any attempt to classify the different types of myiasis according to character or place of attack or species of fly concerned seems to have its objections and difficulties. For convenience in discussion an attempt is made to divide the subject from the standpoint of method of attack into the following groups:

First, **TISSUE-DESTROYING FORMS**, including those species which are ravenous feeders and destroy living tissues. For example the screw-worm, *Chrysomya macellaria* Linnaeus. The species which are included in this group with the exception of *Wohlfahrtia magnifica* Schiner attack living animals secondarily, the main source of breeding being in dead animal matter.

Second, **SUBDERMAL MIGRATORY FORMS** which are parasitic in animals or man and occur during the major part of their lives beneath the skin. For example, the ox warble, *Dermatobia* or "torcel," in man, etc.

Third, **LARVÆ INFESTING THE INTESTINAL OR UROGENITAL TRACTS**. These usually feed to a lesser or greater degree on food or excrementitious matter within the body. For example the larvæ of the latrine flies of the genus *Fannia* and of certain flesh flies of the family *Sarcophagidae*. Infestations largely accidental, except horse bots and related species in animals which are truly parasitic.

Fourth, **FORMS INFESTING HEAD PASSAGES**. True parasites

¹This lecture was presented November 18 and distributed December 20, 1918.

of animals or man occurring in the head sinuses, throat, or occasionally the eye. For example, the sheep bot, *Oestrus ovis* Linnaeus, and the deer bots, *Cephenomyia* spp.

Fifth, BLOOD-SUCKING SPECIES. Highly specialized forms with blood sucking as a normal habit, exclusively parasites of man or animals, such as the Congo floor maggot attacking man, and larvæ of the genus *Protocalliphora* attacking birds.

Myiasis is caused by many species in several families. The habits, in regard to myiasis, of the species of any single family vary widely as might be expected in groups which have become more or less specialized. For instance, the family Oestridæ, which is the only family having all its species concerned in myiasis, has members which infest the stomach, others which develop in the nasal passages and still others which produce cutaneous myiasis. The family Muscidae also exhibits very diverse habits in this regard, some members being concerned in destructive myiasis, others in specialized dermal cases and still others are blood suckers.

Myiasis in animals is not generally considered in connection with human cases. There exists, however, a very intimate interrelationship; in fact, the prevention of myiasis in man is largely dependent upon the control of the trouble in animals. Entomologists engaged in sanitary work must be prepared to handle insect attack on animals as well as on man.

Owing to the need for careful determination of the exact species concerned in cases of myiasis, both for the immediate needs of the case and for the benefit of science, it is highly desirable that the larvæ concerned be bred to adults whenever possible. Specific determination of the larvæ, especially when small, is, to say the least, very difficult, but a few should be preserved in alcohol for record and future identification when larval characters are better understood. Some suggestions as to breeding methods are apropos. There is no use endeavoring to rear Oestrids after extraction unless well matured. Most of the larvæ from wounds will usually develop on beef. Care must be exercised in rearing the flies to avoid infestation of the material by other species, especially Sarcophagids which will drop larvæ through screen wire onto meat or excrement. A double cage is best to avoid this; one of these should have a solid top. Good ventilation is important and sand slightly moist but not wet should be provided beneath the meat. The meat may be partially buried to retain moisture and reduce odor. It should be remembered that the larvæ have a strong tendency to migrate when ready to pupate.

TISSUE-DESTROYING FORMS

It should be said that most forms of larvæ attacking man or animals may destroy body cells to some extent but not in the sense of the rapid

tearing away of tissues, as exhibited by species in this group. This is the most dangerous type of myiasis in man and one of the most important sources of loss due to insects among domestic animals. As previously pointed out, practically all the flies included in this group attack living animals as a secondary method of reproduction.

It should be stated most emphatically that cases of myiasis, either in man or animals due to species in this group, are more or less intimately associated with violations of the best sanitary principles. The vast majority of cases of this type of myiasis occur in the warmer parts

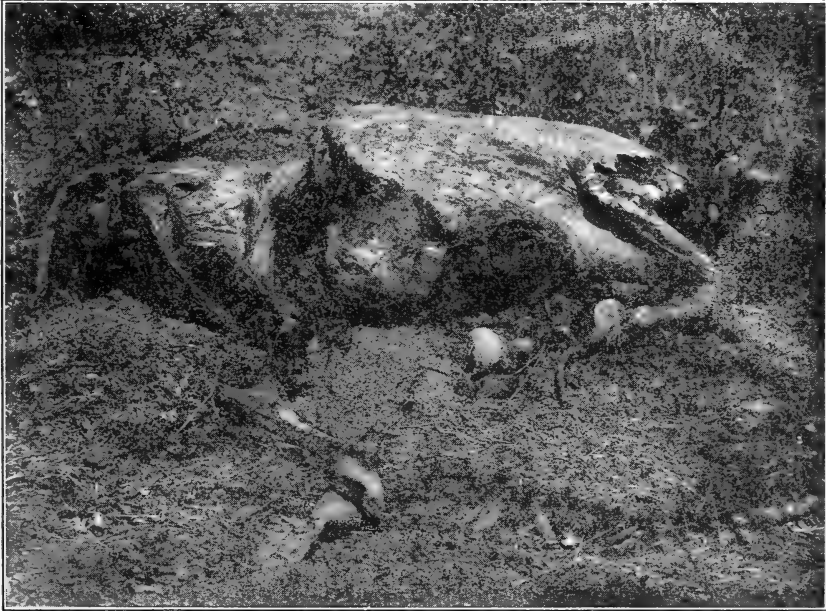

PLATE IX.—Carcass partly destroyed by larvae of the American screw-worm fly, *Chrysomya macellaria*. (Bishopp.)

of the world. In the United States, as is well known, our principal source of trouble is due to the Muscoid fly, *Chrysomya macellaria* Linnaeus, commonly spoken of as the screw-worm (see plate I, fig. 3; plate II; plate IX). Several other species are concerned to a greater or less degree, among these should be mentioned the black blow fly, *Phormia regina* Meigen (plate I, fig. 4), the green bottle flies, *Lucilia casar* Linnaeus (plate I, fig. 2) and *L. sericata* Meigen, certain of the flesh flies (*Sarcophaga* spp. (plate III, fig. 1) and occasionally some of the hairy blow-flies of the genera *Cynomyia* and *Calliphora*.

Fortunately from the standpoint of the sanitary entomologist, the methods of control are in general very much the same for all species of this group, owing to the similar habits and not vastly different life his-

tories. All of the species, except *Wohlfahrtia magnifica* Schiner, are carrion breeders although the adult flies are attracted to various kinds of food, especially those with strong pungent odors as come from the cooking of cabbage or turnips. A few develop occasionally in human excrement; normally, however, the decomposition of animal matter has the strongest attraction for them and in many regions it is with great difficulty that animals can be slaughtered without having the meat contaminated by their presence in large numbers (see plate II). Garbage containing meat and bone will attract and breed them.

AMERICA.—The screw-worm fly occurs throughout the United States, but is of little importance as a pest except in the Southwest where in some sections it is a veritable scourge to the raisers of livestock. The life history of this species will serve as an illustration for this group of flies in the United States. The eggs are deposited on carrion, especially on animals which have died recently. These hatch in a few hours into maggots which enter the tissues rapidly and become mature in about six to twenty days. In living animals development seems to be rather more rapid. Pupation takes place in the soil from the surface to three or four inches deep and the flies emerge in from three to fourteen days. The total development period from attack to adult has been found to vary from seven to thirty-nine days. The activity of this species is confined to the warmer part of the year, usually from about April first to November first in the Southern States. The black blow fly, *Phormia regina*, on the other hand, appears more resistant to cool weather and becomes most numerous in the southern region during early spring and late fall. This is also true to a large extent with the large hairy blow-flies. These latter entirely disappear during the summer months in the southern latitudes.

Infestations of screw-worms in animals occur on any portion of the body where there is broken skin or even on sound skin where blood spots occur. For the most part, however, the infestations follow mechanical injury or where ticks have been crushed on the host. In man practically any part of the body may be attacked, but the most common type of myiasis is nasal. This is especially true in Central and South America. Such infestations are usually associated with malignant catarrh or bleeding from the nose, and practically always with careless modes of living. The larvæ enter the nose and penetrate the tissue, rapidly producing extensive cellulitis and usually accompanied by considerable serous or bloody discharge. If not detected for two days the injury is likely to be very serious. The frontal and ethmoid sinuses may be entered and the cartilage and even the bone attacked. Often the tissues of the nose and beneath the eyes begin to collapse and sometimes excavation reaches to the surface, giving permanent disfiguration. This

extensive destruction of tissues often results in septicaemia or meningitis. Infestation of wounds on the battlefield or even in hospitals is not at all infrequent, but such cases are much more easily treated than nasal infestations.

The black blow fly, *Phormia regina* Meigen, usually infests only old suppurating wounds. In livestock it is commonly found following dehorning and has also been proved to be a common source of wool infestation of sheep in the Southwest. In the latter case the soiled wool following lambing attracts flies and the maggots feed on this for some time but later may enter the sheep itself and cause its destruction.

The green bottle flies, *Lucilia sericata* Meigen and *L. casar* Linnaeus, which are commonly known as the wool maggots in the British Isles, occur throughout the United States. They have been known to infest wounds in man and animals but the main source of trouble has been the infestation of soiled wool on sheep. The method of attack in wounds is similar to that of screw-worms, but the tissue destruction is less rapid although this depends largely in either case upon the number of larvæ present. They are more abundant in towns than in open country.

In South and Central America and the West Indies, *Chrysomya macellaria* abounds and gives similar troubles to those in the United States. In Brazil, *Sarcophaga lambens* Wiedemann and *S. pyophila* N. & F. have been reported by Neiva and De Faria to infest wounds. In Hawaii *Calliphora dux* (Thompson) has caused considerable loss by attacking soiled wool and scabs on sheep.

EUROPE.—In Europe the principal trouble from myiasis occurs in southern Russia. A considerable number of cases occur in the Mediterranean region and some farther north in Australia and Germany. In southeastern Russia, according to Portchinsky, the vast majority of cases of this type are caused by the flesh fly, *Wohlfahrtia magnifica* Schiner, which appears to have habits of attack on man and animals very similar to that of the screw-worm fly in America. He speaks of its attack usually following wounds on the bodies of cattle, horses, pigs, dogs, and poultry. It also commonly infests the feet of animals suffering from foot-and-mouth disease. The cases in man occur most commonly in the nose, ears, and eyes. The injury is often serious, resulting in deafness, blindness, or facial disfiguration, and not infrequently in death. This fly deposits living larvæ, and infestations in man are usually the result of sleeping outdoors during the warm part of the day. The fly is most abundant in fields and woods rather than in towns. It is said to breed in living animals only, thus differing in an important respect from the screw-worm fly.

While this species is not commonly spoken of as a pest in western Europe, Lütje reports considerable trouble from it in the western war

theater, especially during 1915. It infested wounds and interfered with their proper treatment and also was responsible for many infestations of the genitalia of cows in that region.

Next in importance comes the flesh fly, *Sarcophaga carnaria* Linnaeus. This form does not seem so prone to attack living animals as *Wohlfahrtia magnifica* Schiner, but there are numerous cases of myiasis in old suppurating sores. These may occur in any part of animals or man. In the Petrograd district *Lucilia caesar* Linnaeus is responsible for some cases of myiasis, while in Denmark, Holland, and parts of Germany and France, *L. sericata* Meigen is concerned in the infestation of wounds. *Calliphora erythrocephala* Meigen, *Musca domestica* Linnaeus and *Muscina stabulans* Fallén (plate III, fig. 2) are said to oviposit on corpses on the battlefield soon after death but before putrefaction sets in.

The larvæ of *Anthomyia pluvialis* Linnaeus has been reported as being concerned in auricular myiasis. Probably this species should be considered as a feeder on excreta rather than placed with tissue-destroying forms.

AFRICA.—*Wohlfahrtia magnifica* Schiner is reported by Gough in Egypt as being taken from ulcers behind the ears and from orbits of patients in the ophthalmic hospitals. In tropical Africa *Lucilia argyrocephala* Wiedemann commonly attacks mammals, man, and birds. Members of the genus *Pycnosoma*, which has been included with *Chrysomya* by some authors, cause myiasis in numerous cases. *Pycnosoma megacephala* and *P. bezziana* Vill. are frequently mentioned in literature in connection with cases of myiasis in cattle, horses, camels, and other animals, as well as man. *P. putorium* Wiedemann, *P. marginale* Wiedemann and *Chrysomya chloropyga* (Wiedemann) Townsend are also concerned. Sarcophagids have been recorded as infesting wounds; *S. haemorrhoidalis* Fuller and *S. regularis* Wiedemann being mentioned in particular.

ASIA.—While there are numerous references to myiasis cases in Asia, our knowledge of the species concerned is limited. Members of the genus *Pycnosoma*, particularly *P. flaviceps* Walker, are concerned with cases in India. This species and *Lucilia serenissima* Fabricius have been mentioned particularly as being troublesome by attacking cattle after outbreaks of foot-and-mouth disease. It is possible that they may be concerned with the spread of this disease in addition to the injury wrought by their burrowing into the tissues. The cosmopolitan *Lucilia caesar* Linnaeus is responsible for some cases of myiasis. Several Sarcophagidae have been reported as causing nasal myiasis of man in parts of India, but most of these have not been specifically determined. *S. ruficornis* Fabricius seems to be among those most frequently concerned.

AUSTRALIA.—While reports of destructive myiasis in man are comparatively few from Australia, certain parts are subjected to veritable

plague of myiasis among sheep. The center of the region where this scourge occurs is in New South Wales, where work for the commonwealth government has been carried on by Professor W. W. Froggatt for several years. Only a brief mention of the species concerned and the character of attack can be given.

The loss is brought about through the blowing of the soiled wool, particularly around the vents of the ewes. The infestation, if not promptly treated, spreads forward in the wool, resulting in a large loss in the clip and often the larvæ gain entrance to the bodies of sheep and cause their death. Even though penetration does not occur, the skin is acutely inflamed and gives rise to fever, loss of appetite, and sometimes death. Froggatt states that he has bred 1,050 flies from the maggots in one pound of wool.

Froggatt holds that the blowing of wool is largely an acquired habit on the part of Australian flies, as practically no cases of this kind were noted up to 1903 or 1904. He attributes the acquisition of this habit to the extended drought which destroyed large numbers of animals of all kinds and resulted in the production of myriads of flies. He thinks that during this period several species of flies acquired the habit of depositing in "smelly" wool. He also considers the more extensive breeding of heavy woolled sheep to be a contributory factor. It is certain that injury from blow-flies has developed from an almost unnoticed trouble to a problem of first magnitude within the space of a few years. During the first few years of the acute trouble the small yellow house fly, *Anastellorhina augur* Linnæus, and the golden hair blow-fly, *Neopollenia stygia* (Fabricius) Townsend (*Pollenia villosa* Robineau-Desvoidy) appeared to be the principal culprits. In 1913, when the work was taken up more extensively it was found that the "green and blue" sheep maggot fly, *Chrysomya rufifacies* Macquart (*Pycnosoma*), was assuming first importance in connection with the infestation of sheep. The difference in apparent injuriousness is probably governed largely by the seasonal conditions as in the case of species in our own country, *C. rufifacies* apparently being concerned largely with cases of myiasis in summer and *A. augur* during the cool weather. The life histories of these flies do not differ materially from that of the screw-worm fly, the life cycle being completed in about two weeks under favorable conditions. Other species which have been bred from wool in Australia are *Microcalliphora varipes* (Macquart) Townsend, the Anthomyid, *Ophyra nigra* Wiedemann, *Sarcophaga aurifrons* Macquart, and the cosmopolitan *Lucilia sericata* and *L. cæsar*, and possibly *L. tasmaniensis*.

SUBDERMAL MIGRATORY SPECIES

The species concerned in this form of myiasis are truly parasitic. In the cases of man they can not be considered as especially dangerous, but in animals they assume first rank as destructive parasites.

The type of myiasis produced by these larvæ is described under various names in medical literature but especially mentioned as creeping disease. This is owing to the movement of the larvæ in the subcutaneous tissues. In the United States we have little concern for cases of myiasis in man produced by this group of flies as they are comparatively infrequent. The species concerned are *Hypoderma*, probably mostly *lineata* DeVillers and *Gastrophilus*, probably mostly *intestinalis* DeGeer (plates X, XII). Unfortunately the larvæ concerned usually have not been preserved, and in a very few cases have any larvæ from man been reared to maturity.

The sanitary entomologist is not particularly concerned with the Oestrids infesting cattle, but on account of their importance to the veterinary entomologist they are here briefly discussed (see plates XI, XIII). There are two species in this country, *H. lineata* De Villers and *H. bovis* DeGeer. The former is the predominant form in the United States, especially in the southern three-fourths of the country, while the latter is more restricted to the northern tier of States, New England and Canada. The adults are known as heel flies and oviposit on the hairs, principally on the legs of cattle. These eggs hatch in three or four days and the larvæ penetrate the skin at the point of attachment or in some instances may be taken in by licking. After several months spent in the body of the animal they appear during the late fall and winter months under the hide along the back, forming subcutaneous tumors. When full grown these grubs emerge from the host, drop to the ground and after about twenty-five to thirty-five days spent in the pupal stage produce flies which are ready to attack cattle the first warm days during spring.

Several cases have recently come under the observation of Mr. E. W. Laake and the writer of the occurrence of this species in the backs of horses. These are responsible for the production of lesions which practically render the use of the infested animals as saddle horses impossible for a few weeks.

There are a number of records of the occurrence of the young larvæ of these flies in man, especially children. Attention is usually first called to them on account of pain, soreness or itching in the region of the shoulders or face. The irritation is sometimes rather acute and its location moves with the burrowing of the larvæ. Before becoming mature the grubs appear near the surface under the skin or beneath the mucous membranes of the mouth and can there be extracted with ease.

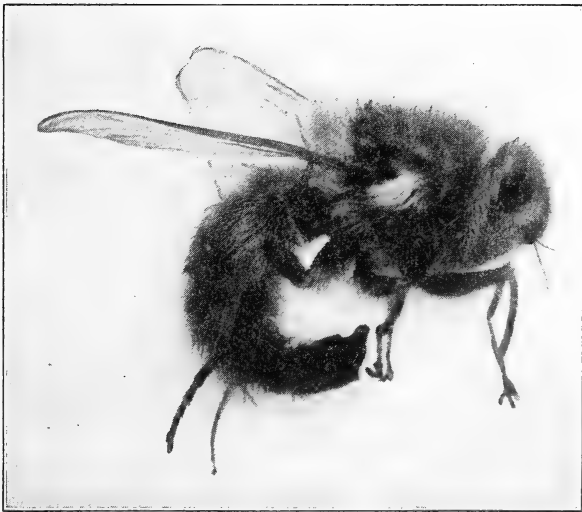

PLATE X.—Horse bot flies. Fig. 1 (upper).—*Gastrophilus intestinalis*, the common bot. Fig. 2 (lower).—*Gastrophilus haemorrhoidalis*, the nose fly. (Dove.)

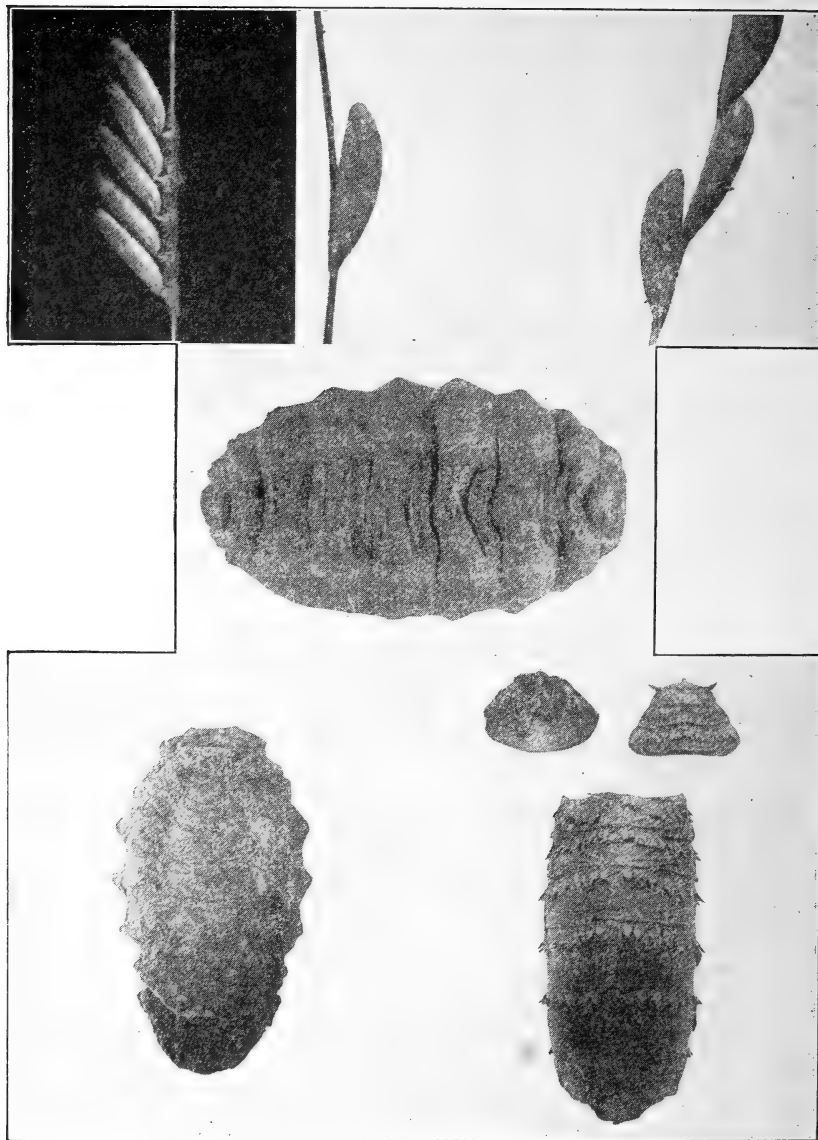

PLATE XI.—Phases of the life cycle of bot flies. Fig. 1 (upper right).—Empty eggs of the cattle bot, *Hypoderma lineata*. Fig. 2 (upper left).—Eggs of the common horse bot, *Gastrophilus intestinalis*. Fig. 3 (center).—Full grown larva of *Hypoderma lineata*. Fig. 4 (lower right).—Empty puparium of *Hypoderma lineata*. Fig. 5 (lower left).—Empty puparium of *Gastrophilus intestinalis*. (Bishopp.)

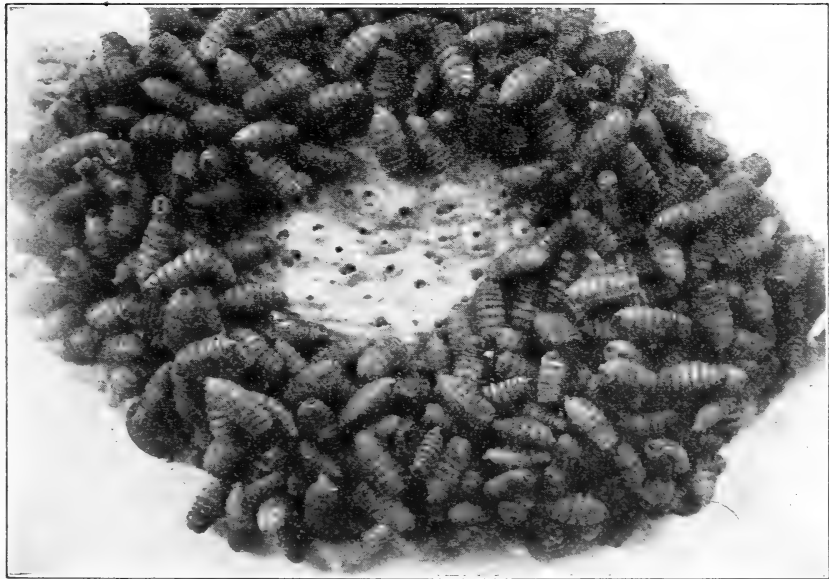

PLATE XII.—Method of attack by the common horse bot, *Gastrophilus intestinalis*.
Fig. 1 (upper).—Eggs on horse's legs. Fig. 2 (lower).—Larvae attached to walls
of stomach, showing lesions caused by removed bots in center. (Bishopp.)

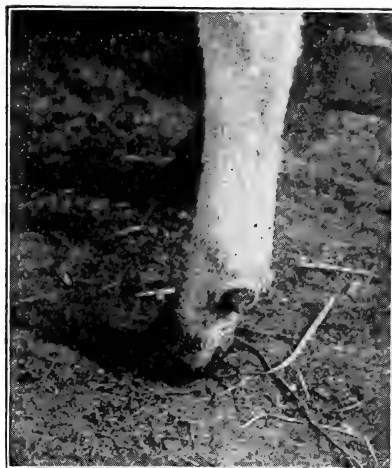

PLATE XIII.—Method of attack by the cattle bot, or heel fly, *Hypoderma lineata*. Fig. 1 (upper right).—Fly ovipositing on cow's leg. Fig. 2 (upper left).—Portion of cow's back showing larvae, empty holes and pus exudate. Fig. 3 (lower).—Heavily infested cow. (Bishopp.)

These infestations probably come about through the accidental depositions of eggs on the bodies or clothing of man, especially children. The possibility of this method of infestation is emphasized through the experience of Dr. Gläser, who while studying ox warbles in Germany had a fly deposit an egg on his trousers which in due time hatched and the young larva penetrated the skin of his leg. Later its presence in the oesophageal region was detected by an uncomfortable feeling. The larva apparently passed up the oesophagus and later was extracted at the base of one of the molar teeth.

In instances where the Oestrid fly of the genus *Gastrophilus* attacks man the conditions surrounding the infestation as well as the exact identity of the larva are less well understood. It is supposed that the young larvæ are in some way brought in contact with the mucous mem-

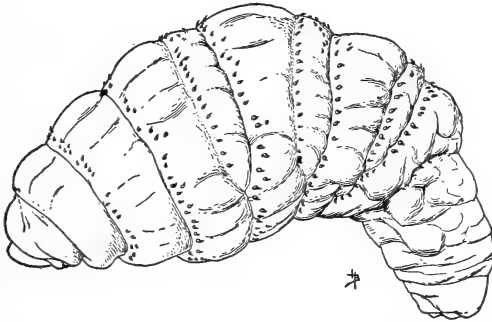

FIG. 37.—Full grown larva of the human bot, *Dermatobia hominis*. (Drawing by Bradford.) Actual length 14.5 mm.

branes of the lips, mouth or eyes and penetrate them, later appearing under the skin and moving about in a manner somewhat similar to Hypoderma. The life history of the species of this genus will be discussed under intestinal myiasis.

AMERICA.—In America in addition to the Hypodermas we have among the lower mammals dermal myiasis produced by several different species of Oestrids in the genus *Cuterebra*. These are most commonly met with in rabbits, squirrels and certain field mice. Usually they appear to cause no serious injury except in the case of one form, which is prone to attack the testicles of squirrels and was given the name of *Cuterebra emasculator* Fitch (equals *C. fontinella* Clark).

In South America a very interesting and more important form of myiasis in man occurs. This is produced by the Oestrid, *Dermatobia hominis* (Carl Linné, Jr.) (*noxialis* Goudot, *cyaniventris*, Macquart) (fig. 37). This form appears to be normally the parasite of cattle, horses, donkeys and certain wild animals. It is reported as being a serious pest

of cattle, in some cases causing the death of many calves, especially when the cutaneous tumors become infested with larvæ of *Chrysomya*.

The life history and habits of the species have not been fully elucidated, although a number of important contributions have been made. It is generally concluded that the infestation of man is brought about in the following indirect but very interesting manner: The eggs of the fly are deposited on the bodies of certain bloodsucking insects, especially the mosquito known as *Psorophora lutzi* Theobald (*Janthinosoma*), or attached to leaves frequented by these insects whence they adhere to them. The eggs are attached vertically on the under side of the abdomen or the legs. The embryos appear to remain dormant though fully developed within the egg and when the bloodsucking dipteron finds a host, the heat of the animal or the blood taken up stimulates the larvæ to break from the shell and penetrate the skin of the host. Dermal tumors are formed by the larvæ, a well-marked hole opening to the outside as in the case of the ox warble. When the grubs become full grown they leave the host, drop to the ground and transform to adults. The period in the host ranges from two to six months. During this time there is more or less inflammation and sometimes acute pain. This form is widely distributed through tropical America. Lieut. L. H. Dunn has recorded cases of apparent transmission of the eggs by ticks.

In South America Dr. J. C. Nielson has reported the occurrence of the Anthomyid flies (*Mydaea anomala* and *M. torquens*) as producing subcutaneous tumors in various birds in parts of Argentina, and Dr. C. H. T. Townsend records *M. spermophilae* as parasitic on nestlings in Jamaica.

EUROPE.—Several cases of dermal myiasis have been reported, especially from Russia. These are attributed to infestations of larvæ of *Hypoderma* and *Gastrophilus*.

The infestation of reindeer in Lapland and farther south in Norway by larvæ of the Oestrid fly, *Oedemagena tarandi* Linnaeus, should be mentioned. The infestations are almost analogous to those in cattle caused by *Hypoderma*. The eggs are laid on the hair during the spring and later the larvæ appear in the submucous tissues of the back. As many as 300 have been reported as occurring in a single animal. This same species no doubt infests the reindeer in Alaska and Canada.

AFRICA.—In Africa the outstanding form of dermal myiasis is produced by the Muscid fly, *Cordylobia anthropophaga* Grünberg, commonly spoken of as the Tumbu fly (figs. 38, 39). The larvæ are known as "Ver du Cayor." These develop in the skin of man and various other hosts including dogs (probably the preferred host), cats, horses, and other domestic and wild animals. The attack is painful but not serious, though no doubt when numerous specimens are present unpleasant symptoms follow. The life history of this form has not been entirely elucidated, but

it is generally believed that the eggs are deposited on the ground in places frequented by hosts and the larvæ hatch and penetrate directly through the skin. In some cases it appears that eggs have been deposited on clothing, especially if moist with perspiration. They appear in March

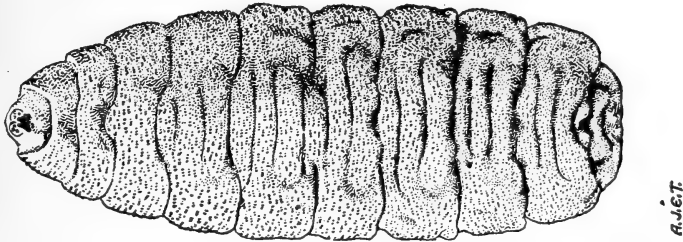

FIG. 38.—Full-grown larva of the Tumbu-fly (*Cordylobia anthropophaga*, Grünberg). Ventral view. $\times 6$. (From Austen.)

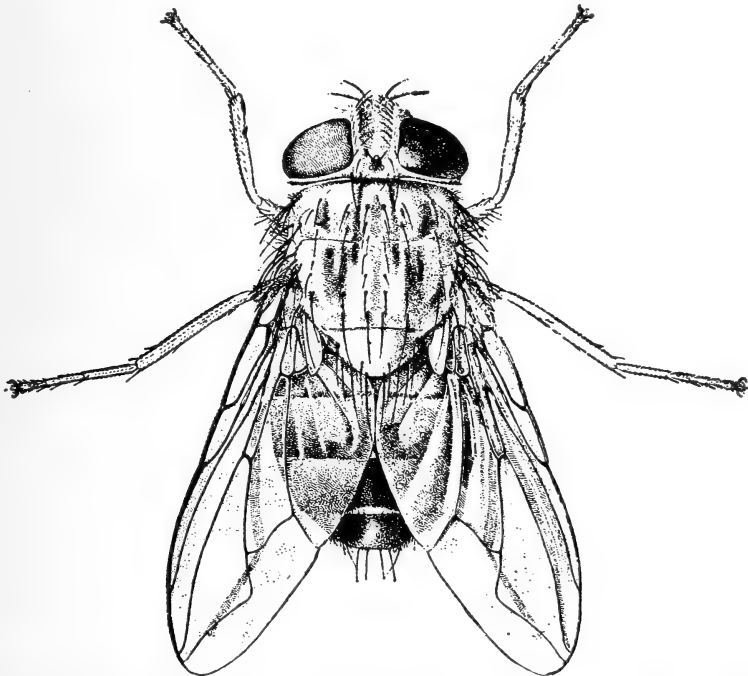

FIG. 39.—The Tumbu-Fly (*Cordylobia anthropophaga*, Grünberg). Female. $\times 6$. (From Austen.)

and diminish until some time in September when they entirely disappear. Experiments conducted by Roubaud indicate that the choice of host depends mainly on body temperature, the high temperature of hogs and fowls being fatal to the larvæ.

Cordylobia rodhaini Gedoelst is the cause of cutaneous myiasis in the

forest regions of Africa. Man is an accidental host, the species normally infesting thin skinned wild mammals. According to Rodhain and Bequaert, who have given much attention to the biologies of this and related species, the eggs are deposited on the ground in the burrows frequented by the animals, the larvæ hatch out and penetrate the skin when the hosts are lying upon them. The larvæ develop within the host in twelve to fifteen days. The pupal stage, which is passed in the ground, ranges from twenty-three to twenty-six days, the life cycle being about forty days. Another Muscid genus, *Bengalia* (especially *B. depressa* Walker), causes cutaneous myiasis in man in Rhodesia and other parts of Africa. The eggs are deposited on the clothing or person of man and on the hair of animals.

Another interesting form is *Neocuterebra squamosa* Grünberg, which develops in the adipose tissues in the soles of the feet of the African elephant.

INTESTINAL AND UROGENITAL MYIASIS

There is every reason to believe that myiasis of the intestinal tract and urogenital openings results largely from careless modes of living. The types of myiasis included in this group should not be confused with urogenital myiasis caused by *Chrysomya* and related forms. A large percentage of these cases is purely accidental and there is no doubt that a great many larvæ are ingested with food which never produce symptoms to attract attention to their presence. Several different families of flies have been recorded as causing intestinal myiasis, one of the most common being the rat-tail larvæ of the family Syrphidae. Records of intestinal myiasis due to Sarcophagidae are also numerous, but it should be borne in mind, especially with this fly, that there are many opportunities for mistakes. With little doubt, in many instances, the larvæ are not passed, but are deposited in the excrement by flies which have the habit of visiting and depositing larvæ almost instantly after defecation.

The whole group may be subdivided into those forms which are directly parasitic, such as horse bots, and others which are more or less accidental.

AMERICA.—The importance of the horse bots in infesting equines is such that brief discussion is necessary. In this country there are three species, all of which are of considerable economic importance. These are the common horse bot, *Gastrophilus intestinalis* DeGeer, the chin fly or throat bot fly, *G. nasalis* Linnaeus and the nose fly, *G. haemorrhoidalis* Linnaeus (plates X, XII). These three species are widely distributed throughout the world and were met with as pests in many of the recent war theaters. Certain other species are also present in European and Asiatic countries but these are of less importance.

The life history of the common bot fly is about as follows: The eggs are attached to the hairs of the host, mainly on the legs, but frequently on other parts. These are ready to hatch in from nine to forty days. The larvæ are removed from the eggs by the biting and licking of the host. They take up their abode in the stomach, remaining attached to the mucous coatings of the pyloric end of this organ until fully grown several months later. They then detach and pass out with the manure, pupate near the surface of the ground and produce the so-called bot flies three to six weeks later. The cycle is completed in about a year. The life histories of the nose fly and throat bot are similar but differ especially in the method of oviposition. The former deposits its eggs, which are nearly black, on the very minute hairs around the lips. The young larvæ gain access to the mouth and develop as in the common bot fly, but before passing out they usually catch hold of the mucous membrane of the rectum and are often seen protruding from the anus a few days before dropping. The annoyance produced by the oviposition of this fly is very severe. The throat bot deposits its eggs mainly under the jaws and the larvæ are often found in the duodenum and also attach in the stomach.

In addition to the annoyance produced at the time eggs are deposited, heavy infestations in the stomach interfere with digestion and cases are recorded where the larvæ caused death by stopping the pyloric opening. The irritation of bots, which may be present in numbers exceeding 1,000, must be detrimental to the host. The throat bot also attaches in the pharynx in its early stages and is accredited with causing the death of animals from this habit.

Cases of dermal myiasis in man attributable to these species have already been mentioned. European writers have also reported the occurrence of larvæ of *Gastrophilus* in the eye of man.

Passing to those forms which are more or less accidental, the Sarcophagidae demand first attention. Hasseman has reported a case in which an entire family was infested with the larvæ of *Sarcophaga haemorrhoidalis*, the maggots being passed in considerable numbers during warm weather. Numerous other similar instances have occurred and in practically every instance they are traceable to leaving foods exposed to flies between meals. Since the Sarcophagids deposit living larvæ on meats, etc., they may be easily overlooked.

Cases of intestinal myiasis due to *Eristalis* larvæ are common in this country. A good summary of these cases has been made by Hall & Muir. It appears that they sometimes give rise to acute colicky pains but no serious symptoms. As is well known, the rat-tail larvæ are to be found in decaying vegetation and in water, and the source of infestation must be through the swallowing of uncooked and poorly cleaned food such as watercress and lettuce, and the drinking of unclean water. The follow-

ing species have been recorded in this connection: *Eristalis tenax* Linnaeus, *E. arbustorum* Fabricius, *E. dimidiatus* Wiedemann, and *Helophilus pendulinus* Meigen.

The cheese maggot or skipper *Piophilæ casei* Linnaeus, is referred to in a number of instances as the cause of intestinal myiasis, often producing intense colic, and this form has also been recorded from the nose. On account of the common habit of this fly of depositing its eggs in cheese and smoked meat, it is no doubt often eaten in considerable numbers and the cases where it gives trouble must be comparatively few. This insect passes its complete life cycle in the foods mentioned above, usually attaining the adult stage in about three weeks. It is world-wide in distribution.

Species of *Muscina*, especially *M. stabulans* Macquart, have been met with frequently in cases of intestinal myiasis, especially in Europe.

Mydæa vomiturationis Robineau-Desvoidy is charged with a case of fatal intestinal myiasis.

Hydrotaea meteorica Linnaeus, a fly probably normally predaceous in the larval stage, has been found to produce intestinal myiasis, in which case blood is sometimes passed accompanied with severe pain.

Larvæ of the common house fly have been passed in living condition, sometimes preceded by pain. Most of these cases have been in infants and the larvæ no doubt usually gain access through the anus. These cases usually result from improper care.

The cluster fly, *Pollenia rudis* Robineau-Desvoidy of the family *Muscidæ*, has been reported in a case of intestinal myiasis. It is difficult to see how this form could gain access to the human alimentary tract since it is normally found only as a parasite of earthworms.

In certain parts of tropical America and the West Indies, India, Ceylon, and the Malay States, the small Phorid, *Aphiochaeta ferruginea* Brunetti, has been found infesting the human intestinal canal in many instances. Brunetti states that specimens of this fly were sent to the Indian Museum by Crombe with a statement that "eggs, grubs, and flies were all voided together." This occurrence, together with observations made by Baker and reported by Austen, indicate that the flies are capable of living and depositing eggs in the human intestines. This is also substantiated by the fact that larvæ of this fly may be passed with excrement for as long as a year with symptoms similar to those of beri-beri. Other members of the family *Phoridae* have been found in human corpses buried for two or more years; living larvæ, pupæ, and adult flies being found together. *Aphiochaeta ferruginea* breeds in excrement and often frequents various foods including fresh meat. It also breeds in carrion. Its small size enables it to pass through ordinary screen wire and thus increases its potentialities for producing disease.

The Anthomyid flies of the genus *Fannia* have been recorded as causing serious gastric disorders. Among the symptoms are abdominal pains, nausea, and vomiting, and sometimes vertigo, headache, and bloody diarrhea. *Fannia canicularis* (plate VII, fig. 3; text figs. 14-16), commonly called the lesser house fly, and *Fannia scalaris* (text figs. 17-19) are widely distributed and breed in various types of decaying vegetable matter and excrement. We find that the larvæ will feed upon and penetrate meat, and they may attack the living tissues to some extent.

In the urogenital infesting group the above-mentioned species of *Fannia*, which are also known as the latrine flies, figure most prominently. These species are rather strongly attracted to human excrement, especially urine. This habit is undoubtedly responsible for the infestation of the genitalia. Such infestations must certainly be attributed to the exposure of the genitals in sleep by drunken or careless persons, or occasionally infants. Robineau-Desvoidy has reported a case in which an Oestrid larva was passed from the bladder by a woman. Kollar has reported the occurrence of a large number of larvæ of the common house fly in the vagina of a diseased woman. Chevral has brought together a number of records of cases of myiasis of the genitalia.

EUROPE.—Nearly all the above-mentioned forms are to be encountered in parts of Europe. In the Mediterranean countries one would expect to find a greater number of forms leading to these types of myiasis.

AFRICA.—Several of the previously mentioned forms occur in Africa. The Oestrid larva, *Pharyngobolus africanus* Brauer, commonly attaches to the walls of the esophagus of the African elephant, and an Oestrid of the genus *Cobboldia* (*C. loxodontis* Brauer and *C. chrysidiformis* Rodhain and Bequaert) are found in the stomach of the African elephant, and *C. elephantis* (Steel) Cobbold, attacks the Indian elephant in a similar way. Species of *Girostigma* in the same family infest the stomach of the Rhinoceros. *Anthomyia disgordiensis* is said to be not infrequently passed from the intestines of man in Angola.

FORMS PRODUCING MYIASIS IN HEAD PASSAGES

All of the species included in this group are normally parasitic on animals, and infestation of man, although not uncommon, must be considered accidental. In the lower animals the attack of these larvæ is often quite injurious though not usually fatal in itself. In man the principal injury sustained is in the effects on the eye when it happens to be attacked.

AMERICA.—In the United States as well as in all parts of the world, the sheep head maggot, *Oestrus ovis* Linnaeus, is the most important

form in this group. The fly deposits living larvæ on the nose of the sheep and the young maggots work upward through the nasal passage, later entering the head sinuses. The maggots are quite spiny and hence must produce much irritation. They appear to subsist upon the mucous secretions of the head cavity. Several months are passed in the host and the larvæ drop out and pupate in protected places on the ground, producing flies a few weeks later.

I know of no record of the attack of man by this species in the United States, but in other countries it frequently attacks the eyes, nose, mouth, and ears. The fly deposits the larvæ so quickly that there is little opportunity to protect one's self. The most serious symptoms develop from infestation of the eye where larvæ produce severe conjunctivitis and in some cases, if not promptly removed, cause the loss of sight.

In this country the Cervidae (deer, elk, etc.) are attacked by Oestrids of the genus *Cephenomyia* (*C. pratti* Hunter, and *C. phobifer* Clark). The larvæ of these flies are found in the head passages, pharynx, and even in the lungs.

EUROPE.—The sheep head bot has a wide distribution in Europe and is responsible for loss among sheep and infestation of man as above described.

Probably the most important species in this group is *Rhinoestrus purpureus* Brauer, which is a very common parasite of the horse in Russia, Hungary, and Italy. This form is also responsible for cases of myiasis in the eyes of man, the attack apparently being similar to that of *Oestrus ovis*. Horses are infested by the flies which deposit larvæ in the nose or eyes. They are much annoyed by the deposition of the insect and the larvæ give rise to fits and other symptoms, mistaken for strangles, sometimes resulting in death. The species is also known to attack the zebra. Cases of the occurrence of this species in the eyes of man have been reported from Jerusalem, and are not infrequent in southern Russia.

The reindeer in Europe are subject to the attack of *Cephenomyia trompe* Linnaeus in a way similar to the infestation of sheep by *Oestrus ovis*. Nativig reports the finding of as many as 100 larvæ in the nasal cavity and larynx of a young reindeer.

AFRICA.—In Algiers, especially, *Oestrus ovis* is very destructive to sheep and many cases have been reported by the Sergeants and others of the infestation of man by this species. The horse head bot, *Rhinoestrus purpureus*, occurs in the Egyptian region. The camels are infested by the Oestrid, *Cephalomyia maculata* Wiedemann (*Cephalopsis titillator* Clark). Larvæ thought to be *Rhinoestrus nasalis* are common in the head sinuses of cattle in parts of Africa.

Many species of Oestrids occur in the head passages of African animals. *Rhinoestrus hippopotami* Grünberg occurs in the skulls of hippopotami and apparently this species attacks hogs. The genera *Gedoelestia* and *Kirkioestrus* each contain species which infest the head sinuses of African wild mammals.

BLOODSUCKING FORMS

This mode of attack is not generally considered myiasis but it seems to have a logical place in this discussion. All of the species having bloodsucking habits developed among their larvæ are to be found in the family Muscidae. Up to the present time there seems to be comparatively little importance attached to them, although such forms as the Congo floor maggot may be responsible for the introduction of disease germs into man.

AMERICA.—The only representatives of this group found in North America are *Phormia azurea* (Fallén) Villeneuve and *P. chrysorrhæa* (Meigen) Rodhain and Bequaert. The first mentioned species is found commonly in Europe where it was first recorded as feeding in the larval stage on nestlings of the sparrow and other birds. This same habit has been observed in the United States. The second form, which is quite common in the nests of larks and other birds in the southwestern states, appears to cause a definite dermal myiasis as the larvæ are frequently found partially imbedded in the wings, legs and body tissues of fledglings. The fly, *Mydaea pici* Macquart, is reported as infesting young birds in a similar way in Brazil.²

EUROPE.—*Phormia azurea* (above mentioned) is quite common in the nests of birds in France and *P. sordida* (Zetterstedt) Roubaud has similar habits.

AFRICA.—The form which is especially interesting and important in this group is the African floor maggot, *Auchmeromyia luteola* (Fabricius). This fly appears to be very closely associated with man. The adults are found in the dwellings and about latrines in tropical and sub-tropical Africa. The eggs are deposited on the dry soil of the floors of native huts, especially under sleeping mats. The larvæ come out at night and attack the sleepers, filling with blood in a very short time. The adult is also a blood-sucker. The larval stage occupies about fifteen days and the pupal stage about eleven days. The larvæ do not burrow into the tissues but simply attack the skin with the mouth hooks and suck the blood.

²Plath has reported recently on the occurrence in the nest of a robin larvæ of a new species, *Phormia metallica* Townsend. He also discovered in birds' nests, larvæ of a new species of Anthomyiidae, *Hylemyia nidicola* Aldrich. The latter probably feeds on dead birds only.

The related genus *Choeromyia* contains three or four species including *C. choerophaga* Roubaud and *C. boueti* Roubaud which occasionally bite man but normally live in the burrows of such hairless animals as the warthog and ant bear. The habits are similar to the floor maggot.

Certain birds are attacked by the larvæ of *Passeromyia heterochaeta* Villeneuve in a way similar to that reported for *Phormia*. This form occurs in Central Africa and also in China.

SOME BIBLIOGRAPHICAL REFERENCES

- Austen, E. E., 1912.—British flies which cause myiasis in man. Repts. Local Govt. Bd. on Pub. Health, and Med., n. s., No. 66, pp. 5-15.
- Bishopp, F. C., 1916.—Flies which cause myiasis in man and animals. Some aspects of the problem. Journ. Econ. Ent., vol. 8, No. 3, pp. 317-329.
- Bishopp, F. C., and Laake, E. W., 1915.—A preliminary statement regarding wool maggots of sheep in the United States. Journ. Econ. Ent., vol. 8, No. 5, pp. 466-474.
- Bishopp, F. C., Mitchell, J. D., and Parman, D. C., 1917.—Screw-worms and other maggots affecting animals. U. S. Dept. Agr., Farmers' Bull. 857.
- Carpenter, G. H., and Hewitt, T. R., 1915.—The warble flies. Fourth Rept., Journ. Dept. Agric. & Tech. Instr. for Ireland, vol. 15, 30 pp.
- Cheval, Rene, 1909.—Sur la Myase des voies urinaires. Arch. de Parasit., vol. 12, pp. 369-450.
- Cooper, W. F., and Walling, W. A. B., 1915.—The effect of various chemicals on blow-fly. Annals of Applied Biology, vol. 2, Nos. 2 and 3, pp. 166-182. July.
- Coutant, A. F., 1916.—The habits, life-history, and structure of a blood-sucking Muscid larva. Journ. Parasit., vol. 1, pp. 135-150, 7 figs.
- De Stefani, T., 1915.—Notes on myiasis in animals and man. Il Rinascimento Economico-Agrario, Trapani, vol. 9, Nos. 5 and 6, May-June, pp. 89-92, 110-113.
- Dove, W. E., 1918.—Some biological and control studies of *Gastrophilus haemorrhoidalis* and other bots of horses. U. S. Dept. Agr., Bull. 597.
- Dunn, L. H., 1918.—Studies of the screw-worm fly, *Chrysomya macellaria* F., in Panama. Journ. Parasit., vol. 4, No. 3, pp. 111-121.
- Foreman, F. W., and Graham-Smith, G. S., 1917.—Investigations on the prevention of nuisances arising from flies and putrefaction. Journ. Hyg., vol. 16, No. 2, pp. 109-226.

- Froggatt, W. W., 1915.—Sheep-maggot flies. Dept. Agric. New South Wales, Farmers' Bull. 95, 52 pp.
- Froggatt, W. W., and Froggatt, J. L., 1917.—Sheep-maggot flies, No. 3. Dept. Agr. New South Wales, Farmers' Bull. 113, 37 pp.
- Froggatt, W. W., and Froggatt, J. L., 1918.—Sheep-maggot flies, No. 4. Dept. Agr. New South Wales, Farmers' Bull. 122, 24 pp.
- Fuller, C., 1914.—The skin maggot of man. Agric. Journ. Union S. Africa, vol. 7, No. 6, pp. 866-874.
- Gläser, Hans, 1912-13.—Über Dasselfliegen mit des ausschusses zur Bekämpfung der Dasselfliege. Nos. 3, 4, 5.
- Hadwen, S., 1915.—A further contribution on the biology of *Hypoderma lineatum* and *Hypoderma bovis*. Parasit., vol. 7, pp. 331-338.
- Hadwen, S., and Bruce, E. A., 1916.—Observations on the migration of warble larvæ through the tissues. Health of Animals Branch, Dept. Agr. Canada, Sci. Ser., Bull. 22, pp. 1-14.
- Hall, C. M., and Muir, J. T., 1913.—A critical study of a case of myiasis due to *Eristalis*. Arch. Internat. Med., vol. 11, No. 2, pp. 193-203.
- Hewitt, C. Gordon, 1912.—An account of the bionomics and the larvæ of the flies *Fannia canicularis* L. and *F. scalaris* Fab., and their relation to myiasis of the intestinal and urinary tracts. Repts. Local Govt. Bd. on Pub. Health and Med. Subjects, n. s., No. 66, pp. 15-22.
- Keilin, D., 1917.—Recherches sur les Anthomyides a larves carnivores. Parasit., vol. 9, 125 pp., 11 pl., 41 figs., May.
- Knab, F., 1916.—Egg disposal in *Dermatobia hominis*. Proc. Ent. Soc. Wash., vol. 18, pp. 179-183.
- Lallier, P., 1897.—Étude sur la myase du tube digestif chez l'homme. Thèse Faculte de Médecine de Paris, 120 pp., 1 pl.
- Lefroy, H. M., 1916.—The control of flies and vermin in Mesopotamia. Agric. Journ. of India, vol. 11, pt. 4, pp. 323-331.
- Lutze, 1915.—Diseases caused by flies and their larvæ. Deutsch. Tierarzt. Wochenschr. Hanover, vol. 23, No. 46, pp. 395-397, 7 figs., Nov.
- Marlatt, C. L., 1897.—The ox warble. U. S. Dept. Agric., Bur. Entom., n. s., Cir. 25, 10 pp.
- Neiva, Dr. A., and De Faria, G., 1913.—Notes on a case of human myiasis caused by larvæ of *Sarcophaga pyophila*, sp. n. Mem. Inst. Oswaldo Cruz, vol. 5, No. 1, pp. 16-23.
- Nielson, J. C., 1913.—On some South American species of the genus *Mydaea*, parasitic on birds. Vidensk. Meddell. fra Dansk naturh. Foren., vol. 65, pp. 251-256, 4 figs., May.
- Palazzolo, G., 1916.—*Hypoderma bovis* and the fly *Dermatobia noxialis*

- or *cyaniventris* of Brazil. Nuovo Ercolani, Turin, vol. 21, Nos. 26-27, pp. 433-437, Sept.
- Patton, W. S., and Cragg, F. W., 1913.—A Textbook of Medical Entomology.
- Phelen, J. M., 1917.—U. S. Army Methods of disposal of camp refuse. Amer. Journ. Pub. Health, vol. 7, No. 5, pp. 481-484, May.
- Portchinsky, I. A., 1913.—*Oestrus ovis* L.; its life history and habits, the methods of combating it and its relation to human beings. Mem. Bur. Ent. Sci. Comm. Cent. Bd. Land Admin. and Agric., St. Petersburg, vol. 10, No. 3, 63 pp., 28 figs.
- Portchinsky, I. A., 1914.—A review of the spread of the chief injurious animal pests in Russia in 1913. Yearb. Dept. Agric. for 1913, Petrograd, 14 pp., 4 figs.
- Portchinsky, I. A., 1915.—*Rhinoestrus purpureus* Br., a parasite of the horse, injecting its larvæ into the eyes of men. Bur. Ent. Sci. Comm. Central Bd. Land Admin. and Agric., Petrograd, vol. 6, No. 6, 42 pp., 9 figs., 1 pt.
- Portchinsky, I. A., 1916.—*Wohlfahrtia magnifica* Schin., and allied Russian species. The biology of this fly and its importance to man and domestic animals. Mem. Bur. Ent. Sci. Comm. Agric., Petrograd, vol. 11, No. 9, 108 pp., 39 figs., 2 pl.
- Rodhain, M. J., 1915.—On the biology of *Cordylobia rodhaini* Gedoelst. C. R. Hebdom. Ac. Sci., Paris, vol. 161, No. 11, pp. 323-325.
- Rodhain, J., and Bequaert, J., 1915.—On some Congo Oestrids. Bull. Soc. Path. Exot., Paris, vol. 8, No. 9, pp. 687-695.
- Rodhain, J., and Bequaert, J., 1916.—Materials for a monograph on the parasitic Diptera of Africa. Bull. Sci. France et Belgique, Ser. 7, vol. 49, No. 3, pp. 236-289, 14 figs., April 29.
- Rodhain, J., and Bequaert, J., 1916.—Materials for a monograph on the parasitic Diptera of Africa. Second Part. A revision of the Oestrinae of the African Continent. Bull. Sci. France et Belgique, Ser. 7, vol. 50, Nos. 1-2, pp. 53-165, 29 figs., 1 pl., November 25.
- Rodhain, J., and Bequaert, J., 1919.—Materials for a monograph on the parasitic Diptera of Africa. Third Part. Bull. Sci. France et Belgique, vol. 52, No. 4, pp. 379-465, 21 figs., 3 pls.
- Roubaud, E., 1913.—Researches on *Auchmeromyia*, Calliphorine flies with blood-sucking larvæ from tropical Africa. Bull. Sci. France et Belgique, Ser. 7, vol. 47, fasc. 3, pp. 105-202, 2 pls., 32 figs., June 24.
- Roubaud, E., 1914.—Stomach- and sinus-inhabiting Oestrids of French West Africa. Bull. Soc. Path. Exot., vol. 7, No. 3, pp. 212-215, March 11.

- Roubaud, E., 1914.—Studies of the parasitic fauna of French West Africa. Part I. The producers of myiasis and similar disorders in man and animals. Paris: Masson & Co., 251 pp., 4 col. pls., 70 figs.
- Roubaud, E., 1915.—Muscids, the larvæ of which bite and suck blood. C. R. Soc. Biol., Paris, vol. 78, No. 5, pp. 92-97, 2 figs., March 19.
- Sambon, L. W., 1915.—Observations on the life history of *Dermatobia hominis*. Rept. Adv. Com., Trop. Diseases Research Fund for 1914, London, pp. 119-150.
- Sergent, Ed., and Sergent, Et., 1913.—“Tamne”—the “Thimni” of the Kabyles—the human myiasis of the Taureg Mountains in the Sahara, caused by *Oestrus ovis*. Bull. Soc. Path. Exot., No. 7, pp. 487-488, July 9.
- Ward, Henry B., 1903.—On the development of *Dermatobia hominis*. Rep. from the Mark Anniversary Volume, Article XXV, pp. 483-512, plates 35-36.

CHAPTER XIII

Myiasis—Its Prevention and Treatment¹

F. C. Bishopp

In the preceding lecture the habits and biologies of the various species concerned in myiasis in man and animals have been briefly outlined. An accurate knowledge of the species concerned and a good general idea of its biology and habits are essential to the proper handling of myiasis, especially when the cases are numerous.

In discussing control of the flies concerned and the treatment of cases the same general grouping as made in the previous lecture will be followed. Where various species of blow flies and related forms are numerous, immediate steps should be taken to determine the source of supply and energetic measures applied to prevent it without waiting for the appearance of cases of myiasis in man or animals.

TISSUE-DESTROYING FORMS

Prevention of Breeding.—Since practically all species concerned in the production of this form of myiasis develop within decaying animal matter, first attention must be given to this point.

Burning of Carcasses.—The carcasses of large animals are sources of tremendous numbers of flies. We have estimated that over a million specimens may be produced in the body of one cow. Nothing is as satisfactory as complete destruction of carcasses by burning. This not only prevents fly breeding but reduces the chances of the propagation of such diseases as black-leg, anthrax and tuberculosis. Carcass burning can be carried out under practically any condition with which the sanitary entomologist will have to deal and the process is by no means difficult nor expensive. Various methods have been advocated but we have found nothing equal to the following: Dig a trench about eighteen inches wide, twelve or fourteen inches deep and equal to the length of the carcass to be burned (plate XIV). This trench should be dug with the direction of the prevailing wind and along the back of the carcass; fill the trench with wood and then turn the animal over on top of it. Start the fire in the windward end of the trench and no further

¹ This lecture was presented November 18, 1918, and distributed January 20, 1919.

attention is necessary for several hours, when the extremities may be piled in the center to complete burning. The placing of wood on top of the carcass and addition of wood after the fire has started are unnecessary. About one-quarter of a cord of wood is adequate, and where wood is scarce, burning may be accomplished by using crude oil. Of course a few sticks of wood beneath the carcass will help hold the heat but this is not necessary. Ten to twenty-five gallons of crude petroleum are sufficient. The odor from carcass burning is not very objectionable, especially if the animal is destroyed soon after death.

In cities it is usually feasible to have all large carcasses promptly



PLATE XIV.—Trench prepared for burning carcass. (Bishopp.)

removed and effectually destroyed by commercial rendering and fertilizer plants. These establishments should be subject to sanitary inspection.

Carcass Burial.—Burial is generally unsatisfactory, especially if bodies are well infested with maggots. We have found that at least twenty-four inches of finely packed earth are necessary to prevent their escape. The free use of quicklime on the body after it has been placed in the grave helps to destroy the maggots and reduce chances of disease spread. We have not yet undertaken experiments with the treatment of carcasses before burial with creosote oil, but judging by results obtained from treating those on the surface, this should be a good method of destroying larvæ, reducing odor and killing disease organisms.

Treating with Chemicals.—Nearly all maggots of this class of flies are exceptionally resistant to the action of chemicals. We have found some to survive submergence in very destructive insecticides. Foreman and Graham-Smith, working in England, have found that creosote oil, which is one of the higher distillates from coal tar, is quite efficacious in the treatment of carcasses. Two things are accomplished—the majority of the larvæ are actually hit by the spray and destroyed and decomposition is practically stopped with corresponding reduction in odor. In recent experiments conducted at the Dallas Laboratory, we have found that several American makes of creosote oil are excellent for this purpose. Small carcasses thoroughly sprayed before infestation takes place will remain free from infestation, the flies being repelled by the substance and odor practically prevented. The carcass usually shrinks and assumes a mummified condition. Such creosote oils are manufactured by a number of concerns and usually sold at prices ranging from sixty-five cents to one dollar per gallon, according to the per cent of coal tar acids contained. Rather high percentage of these ingredients (at least 12 per cent) is best.

Since direct sunlight is a powerful destructive agent in the semiarid and arid regions, if burning cannot be accomplished, the carcasses should be left in the most exposed place possible—not in a gully under shade as is usual. This will often result in about 85 per cent control.

Disposition of Garbage.—The question of garbage disposal has been discussed briefly in other lectures (Chapters X, XI). Nearly all garbage is attractive to blow flies as well as other forms and the bone and meat scraps become infested. Where incineration is practicable it is most desirable. When fed to hogs the bones should be picked out and placed in a screened compartment or treated with borax or creosote oil.

Destruction of Flies.—In general the destruction of flies should be considered as secondary to the elimination of breeding places, but under certain conditions this method of attack has its place.

Traps.—Various types of traps have been devised for destruction of flies but a careful comparison of many different forms in experiments carried out at the Dallas Laboratory shows that there is much difference in their efficiency and also that some minor changes in the construction of a trap may greatly improve the size of the catch. As a result of these experiments the fly trap described in Farmers' Bulletin No. 734 is being recommended by the Bureau. This trap appears to be the best all round form for catching both house flies and blow flies. Of course the framework of the trap need not be made of hoops and barrel heads, as suggested in that bulletin, although those prove very satisfactory. The essential principles are to have the high cone, comparatively

large opening at the top of the cone, screened area over the cone to admit light from above, screened sides so as not to cast shadow around the bait, and legs about one inch high. The tent traps are not as efficient as the cone traps and this inefficiency is especially marked in some makes of traps now being furnished the Army, which are built with a broad bottom on either side of the tent. This repels the flies to such an extent as to make the traps almost worthless. For blow flies this darkened area is not so objectionable as for the house fly. While not strictly a trap, the method of covering carcasses with burlap as recently suggested by Froggatt in Australia may be of value. Four stakes are driven into the ground around the carcass, and the tops of these are connected with a heavy wire. A canopy is then put over the stakes, brought to the ground and dirt piled on the edges. When the flies emerge they are imprisoned and soon die. If the canopy is not sufficiently large, there is danger of many escaping through the migratory habit of the larvæ.

Kind of Bait to Use.—This point has been discussed in a previous lecture. Animal matter is best for blow flies, and the packing-house refuse known as "gut slime" is best of all. It is removed from intestines when sausage casings are made. Good baits and proper attention to killing and rebaiting are essential to best results.

Poisons.—It is possible to destroy large numbers of flies by means of poisoned baits. Arsenic solution (made by boiling arsenic in water) mixed with defibrinated blood, gut slime, or some other attractive bait will kill large numbers. This bait may be placed in covered containers to prevent dilution by rain. Cobalt may be substituted for arsenic. When carcasses can not be burned, Froggatt has advocated slashing them and spraying with arsenic solution. This poisons large numbers of flies and maggots and reduces the attractiveness of the carcass; so much so, in fact, that birds and animals will not touch it.

Avoidance of Attack on Man.—To prevent fly attack it is necessary to have wounds promptly and properly dressed. Man should avoid exposure by sleeping in the open during hot weather, especially if there is any trouble from catarrh or nose bleeding. Properly screened hospitals are of much importance and individual blow flies found within should be promptly killed.

Avoidance of Attack to Animals.—In preventing screw-worm attack in cattle and other livestock, there are several important points to be considered. Breeding should be done so as to have calves come during fall, winter or early spring months. Branding and surgical operations should also be done out of screw-worm season. Care should be taken to avoid mechanical injury to stock. As the screw-worm flies are worst in brushy pastures, clearing out all underbrush will be found beneficial. Since many cases develop from infestation of ticks and mange, the de-

struction of ticks and mange mites on animals is important. Care should be taken to guard against extensive saddle or harness sores on army animals.

Methods of preventing blowing of wool on sheep hardly need to be discussed fully here. Shearing early in the spring, avoiding the soiling of wool, raising hornless breeds and the crutching, that is clipping the wool at the vent and behind the hind legs greatly reduces infestation.

Treatment of Infestations in Man.—Nasal myiasis is the most difficult to handle. The larvæ should be removed mechanically as far as possible. A number of different treatments have been resorted to, the administration of chloroform into the nose being the most used. After all larvæ have been taken away, it is usually necessary to exercise care to prevent breaking of blood vessels which are frequently greatly exposed by destruction of the surrounding flesh. In most wounds the larvæ are quite easily removed. Of course the details of the care of the patient are to be determined by the physician in charge.

Treatment of Wounds in Animals.—Chloroform is the most generally used of all reagents and is usually satisfactory. The chloroform is poured directly into the holes and the wounds closed up. This benumbs the larvæ so that they can be taken out with a forceps. Carbon tetrachloride is also satisfactory for this use and considerably cheaper. After the larvæ have been taken out antiseptic astringent dressing should be applied and pine tar or pine oil and vaseline applied to the outside to repel flies. Oil of camphor is an excellent fly repellent and aids in the healing process. Bleeding wounds should be dusted with tannic acid before applying the repellent.

SUBDERMAL MIGRATORY SPECIES

The reduction of the number of ox warbles in cattle is important from the standpoint of the raiser as well as to lessen the chances of infestation of man and horses. The most feasible method yet devised consists in the squeezing out of the larvæ from the backs of the animals after they have formed the subcutaneous tumors. This should be done at intervals of about three weeks, all animals being gone over carefully. The period for beginning extraction varies according to latitude from October 15 to March 1.

The question of controlling *Dermatobia hominis* in tropical America, and also its African analogue, *Cordylobia anthropophaga*, has not been sufficiently worked out to make satisfactory recommendations. No doubt where livestock are under control, systematic extraction will reduce the number of these, both in animals and man. When humans become infested it is usually advisable to allow the larva to become stationary and

then remove it through the hole in the skin. It may be necessary to enlarge the hole to get it out more easily. In the case of the American forms the bite from various bloodsucking Diptera should be prevented as far as possible. Having the body well protected with clothing will also probably reduce injury from both of these species. On account of the probability that some of the African parasites of this class deposit eggs on exposed clothing, especially if wet with perspiration, this should be guarded against.

SPECIES CAUSING INTESTINAL AND UROGENITAL MYIASIS

CONTROL OF TRULY PARASITIC SPECIES.—*In Animals.*—There are three principal methods of attack against the bots of horses. The de-

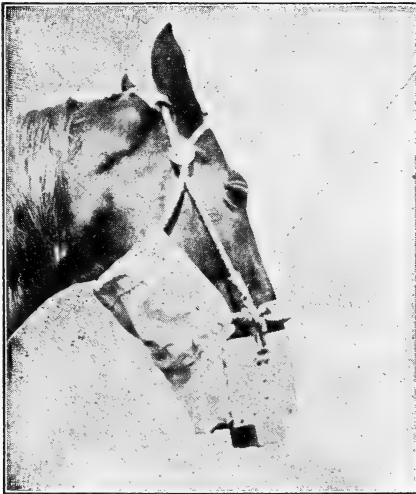

FIG. 40.—Nose protection for horse against attacks of the nose fly, *Gastrophilus haemorrhoidalis*. (Dove.)

struction of eggs will accomplish much good in the case of *Gastrophilus intestinalis* and is applicable to some extent to *G. nasalis*, but apparently can not be practiced in *G. haemorrhoidalis*. Dove has found that the common practice of washing the legs of horses with kerosene oil has but little beneficial effect. The creosote derivatives containing about two per cent phenols destroyed the eggs readily. A miscible creosote compound reduced with water to this strength and applied with a rag or brush at the time the horses are groomed will destroy practically all eggs present. Such treatment repeated weekly should accomplish almost complete control. In this way horses and mules may be kept practically free from infestation. Of course the grooming itself will tend to hatch

eggs and get rid of larvæ. Clipping of the hair on the legs has also been recommended but is not entirely satisfactory. Dove has experimented with certain halter devices for the protection of horses in pastures and also with various types of guards to be used on horses in harness to prevent the attack of the nose fly (fig. 40). In the first case he used a halter, from which is suspended a box-like arrangement that covers the nose when the horse has its head up, but permits of grazing and drinking. A canvass extends back under the jaw to prevent deposition of eggs by the throat bot, and of course the covering of the mouth prevents the ingestion of eggs of the common bot. The main difficulty has been the production of a durable device of this kind. The nose fly attack is best prevented by a rectangular piece of belting being suspended from the bit rings immediately below the lips, when horses are at work.

The internal treatment of infested animals with carbon disulphide has been found to be very effective if properly done. Three three-dram doses at hourly intervals are given in capsules succeeding a period of starvation and followed by a purgative.

Prevention of Attack in Man.—The reduction of the number of bots by treatment of the lower animals will greatly reduce the chances of infestation in man. Care should be taken not to ingest eggs or larvæ when infested horses are being clipped or groomed.

PREVENTION OF ATTACK BY OTHER FORMS.—This group includes those species accidentally infesting man such as the Muscids *Musca domestica*, and *Muscina* spp., *Fannia*, and *Syrphus* flies.

Destruction of Breeding Places.—Since most of these forms are breeders in excrementitious matter and decaying vegetation, the proper care of manure of all kinds is important. This has been discussed in other lectures. Since some of the species, especially *Fannia*, breed in accumulations of decaying vegetation such as straw, roots, etc., these should receive attention, especially when close to camps.

Destruction of Flies.—The use of traps is effective against most of the species concerned except the small Phorids and Syrphids which are not inclined to enter traps baited with usual baits. Poison baits and fly paper will also destroy some species other than the house fly.

Food and Water.—The careful preparation of uncooked food such as cress, lettuce, etc., is important. No doubt many of the cases of infestation by *Fannia* and *Eristalis* have been due to the eating of improperly washed foods of this kind. Drinking promiscuously from streams and pools should not be permitted. During the Great War the provision of a good water supply for the men received first consideration. Of course this is important to prevent infestation with various disease organisms. Distillation, filtration and chlorination are the preferred methods of

producing pure water. Where it is essential that water must be taken from streams care should be exercised not to drink near vegetation.

Use of Screens.—Proper screening of houses will do much to protect foods after preparation from infestation, although some of the small forms can not be kept out in this way. A coarser mesh than 16 per inch should not be used. The use of screened toilets of course can not be too strongly emphasized.

Cleanliness and Careful Habits.—Many infestations of the digestive system and genitalia could be avoided by not sleeping in unscreened places in an exposed condition. Prompt attention to infants is important.

SPECIES INFESTING HEAD PASSAGES

Infestations in Animals.—The parasitic forms are very difficult to control and no very satisfactory control measures have been devised. Nearly all of the recommendations made are of little value. Some of these consist of the use of repellents in the case of sheep to protect them from infestation by *Oestrus ovis*. Pine tar is most frequently used and this is applied by the sheep themselves. Holes in logs are used for salting and the sides are smeared with tar. The provision of plowed furrows where the sheep can protect their noses probably gives some relief. For very valuable animals screened pens are no doubt warranted, the animals being placed in these during the portion of the day when the flies are most active. There seems to be considerable difference in effect of attacks on breeds. Attempts to remove the larvæ from the nose by causing sneezing or with fumigants are more likely to drive the larvæ deeply into the head than to remove them. Trephining the skull and removing the larvæ in that way may give some relief but is usually not advisable as other infestations are likely to follow and all the grubs can not be reached. Destruction of adults has been advocated and is especially applicable to plains areas, as in such places flies are inclined to congregate on any objects which extend well above the ground. The flies assemble on such objects and remain there except during the warmer part of the day and many can be killed.

Many of the control measures suggested for the control of the sheep bot can be used against the horse infesting species, *Rhinoestrus purpureus*. It might also be possible to utilize muzzles similar to those advocated for the horse bots to protect against infestations from this species.

Infestations in Man.—Infestations of man are so infrequent that preventive measures need receive little attention. Where such infestations either by the sheep head maggot or horse head maggot are common the use of nets on the hats similar to those used by apiarists would give protection. Medical attention should be given promptly for removal of larvæ, especially if in the eye.

BLOODSUCKING SPECIES

In Birds.—Since these dipterous parasites are often highly injurious to birds, and especially to certain beneficial varieties, control measures should be considered although nothing has been done along this line. In the Southwest it is stated that the mortality among birds is very high owing to these parasites.

Possibly trapping of the adults in connection with the control of other destructive species would be feasible.

In Man.—The Congo floor maggot is the only species in this group requiring special attention. The use of beds instead of sleeping mats laid directly on the floor will give immediate relief. Where beds are not at hand hammocks may be used. The avoidance of sleeping in huts is advisable. Thorough cleansing and disinfection of the floor should destroy many maggots and the elimination of cracks in the dirt will check their breeding. Where sleeping mats are used by the natives they should be sunned and aired frequently. It is said that the maggots are carried from one hut to another in these mats, so that moving the place of abode does not eliminate the trouble.

CHAPTER XIV

Diseases Transmitted by Bloodsucking Flies¹

W. Dwight Pierce

As stated before it was necessary to discuss the transmission of diseases by flies in three lectures, non-bloodsucking flies, mosquitoes and other bloodsucking flies. This is therefore the second lecture on fly-borne diseases, and embraces quite a different category of diseases. For convenience of reference and study it will be likewise handled from the standpoint of the organism transmitted. The most important volume on the subject of this lecture is by Hindle.

PLANT ORGANISMS CARRIED BY BLOODSUCKING FLIES

Thallophyta: Fungi: Schizomycetes: Bacteriaceae

Bacterium tularensis McCoy and Chapin, the causative organism of a RODENT PLAGUE, is probably normally carried by fleas, but Wayson records some interesting experiments with the stable fly, *Stomoxys calcitrans* Linnaeus. He found that a fly after biting an acutely diseased guinea pig eight times, if applied to a healthy animal within an hour, will effectively transmit the disease to the healthy animal and cause its death in five to nine days. Washings of the flies in normal salt solution, and also washings of the flies slightly crushed, when injected subcutaneously will produce similar results. The transmission by bites occurs only from those animals having an advanced stage of the bacteremia, as indicated by their death within 24 to 48 hours after the fly feeding. The flies have not been proven infective as long as 24 hours. This same organism has been isolated from cases of DEER FLY FEVER or PAHVANT VALLEY PLAGUE in Utah by Francis (1919). The disease is local and one case in 1919 was fatal. The fever, lasting from 3 to 6 weeks, is said to be initiated by the bite of deer flies (Chrysops).

Bacterium anthracis Davaine, the causative organism of ANTHRAX or charbon, can be carried by bloodsucking flies. Nuttall (1899) cites many early references to the rôle of bloodsucking flies in the transmis-

¹This lecture was presented October 7, 1918, and distributed October 19. It has been somewhat modified for the present edition.

sion of anthrax, the earliest being by Montfils in 1776. Hintermayer (1846) studied an epidemic which raged among the deer in the Park of Duttstein. The horse flies, *Tabanus bovinus* Loew, *Haemotopota pluvialis* (Linnaeus), and *Chrysops coecutiens* (Linnaeus) assembled usually in thousands on the carcasses of the fallen animals and sucked the profluvia which escaped from the mouth, nose, and vent. Leaving the bodies they immediately sought the healthy animals, thrust their proboscides soiled with the virus into the skin and in this way inoculated the poison of the disease. Mitzmain (1914) proved that *Tabanus striatus* Fabricius and the stable fly, *Stomoxys calcitrans* Linnaeus, can transmit the disease by their bites. Schuberg and Kuhn (1912) transferred anthrax infection from a cadaver to a living animal through the bite of *Stomoxys calcitrans*.

Morris (1918) working on anthrax in Louisiana proved that the horn fly *Lyperosia irritans* Linnaeus (*Haematobia*) when biting an infected guinea pig four hours or less before its death and up to fifteen minutes after death can transmit infection. One hundred and eighty-four experiments on different guinea pigs were made during these time limits and infection was conveyed in 34 per cent of the cases. Forty experiments outside of these time limits were unsuccessful. One out of two tests with the flies feeding on an infected sheep thirty minutes before death yielded infection in a guinea pig, and all tests of biting in the quarter hours before and after death of the sheep yielded infection in guinea pigs.

He also tested a species of *Tabanus* and proved transmission in 40 per cent of 70 cases in which the flies bit between four hours before death and five minutes after death. Virulent cultures of anthrax were obtained in nature by Morris from *Tabanus atratus* Fabricius caught feeding on a carcass. This species will feed on a carcass thirty minutes or more after death.

He likewise determined the spores in the feces of the *Lyperosia* up to six hours after feeding, of the *Tabanus* one to twelve hours after feeding, and of mosquitoes 48 to 72 hours after feeding.

The above cited evidence should be sufficient to emphasize the absolute necessity of isolating and protecting from bloodsucking insects, animals sick with anthrax. Valuable animals should likewise be kept in screened buildings during outbreaks of the disease.

Thallophyta: Fungi: Schizomycetes: Coccaceae

Staphylococcus pyogenes albus and *aureus* Rosenbach, the causative organisms of various types of SEPTICAEMIA, were obtained by Joly (1898) from a *Tabanus* on a heifer near a municipal vaccine station.

Streptococcus sp., causative organism of SEPTICAEMIA, was recorded from *Stomoxys calcitrans* Linnaeus by Schuberg and Böing (1914).

DISEASES OF UNKNOWN OR UNCERTAIN ORIGIN

PAPPATACI FEVER, also known as Three-day and Phlebotomus fever, a disease of the Mediterranean regions, which has caused considerable disability to the troops, especially in Egypt and Greece, is transmitted by the bite of the sand fly, *Phlebotomus papatasi* Scopoli, and possibly other species in the genus. This disease is considered very closely related to dengue, if not identical, by Megaw (1919) and others. Its transmission has been clearly demonstrated by Doer, Franz and Taussig (1909). The blood is infective for only about 24 hours. During this period the flies become infected by feeding on the patient. After ingesting the virus, there is an incubation period of seven to ten days before the insects become infective, and beyond this after an indeterminate period they may again become non-infective. Following the bite of an infected fly, there is an incubation period in man of from 3½ to 7 days, during which time the patient is non-infective. The virus is filterable. Lizards and reptiles are the wild reservoirs of the disease.

VERRUGA PERUVIANA, or Carrion's disease, a Peruvian disease, thought to be caused by *Bartonella bacilliformis* Strong, Tyzzer, Brues, and Sellards is claimed by Townsend (1916) to be carried by *Phlebotomus verrucarum* Townsend, and he advances evidence to support his claim.

EQUINE INFECTIOUS ANEMIA, or swamp fever of horses, a disease caused by a filterable virus in Japan, was thought to be carried by *Chrysops japonicus* Wiedemann, *Chrysozona pluviatilis* Linnaeus (*Haemotopota tristis* Bigot), *Tabanus chrysurus* Loew, *T. trigonus* Coquillett, *T. trigeminus* Coquillett, and *Atylotus rufidens* Bigot, according to the Horse Administration Bureau (1914); and in America was claimed by Scott (1915) to be carried by *Stomoxys calcitrans* Linnaeus. Howard (1917) conducted an experiment with *Stomoxys calcitrans* which indicated the probability that this fly transmitted the disease.

HOG CHOLERA, a disease caused by a filterable virus, has recently been transmitted by inoculating animals with infected *Stomoxys calcitrans* (Dorset, et al., 1919).

GLANDERS is associated by Fuller (1913) with *Stomoxys calcitrans* outbreaks.

POLIOMYELITIS, or infantile paralysis, a disease of unknown origin, has been suspected by various authors of being transmitted by biting insects, especially *Stomoxys calcitrans* and Tabanids. Rosenau

and Brues (1912) conducted experiments with this fly and reported successful inoculations of six monkeys by bites of the flies. Anderson and Frost (1912) repeated these experiments and as a result three monkeys exposed daily to the bites of several hundred *Stomoxys*, which at the same time were allowed daily to bite two intracerebrally inoculated monkeys, developed quite typical symptoms of poliomyelitis eight, seven, and nine days, respectively, from the date of their first exposure. Autopsy of all proved the presence of typical poliomyelitis lesions. On the other hand these same authors in further experiments (1913) and Sawyer and Herms (1913) record negative results with this fly. Fuller (1913) reports that it has been shown that epidemics of infantile paralysis usually occur with an abundance of the stable fly.

PELLAGRA, a disease of unknown origin, introduced from Europe to America, was for a long time thought to be caused by eating spoiled corn. At present sentiment seems to favor considering that it is caused by lack of vitamins. However, it is important that we discuss in this lecture rather briefly the theories propounded regarding bloodsucking flies as possible transmitters of the disease.

Sambon (1910) brought forward the theory that the disease is carried by the buffalo gnats *Simulium* spp. Jennings and King (1913b) and Jennings (1914) are inclined to believe that the incidence of this genus and of pellagra affords sufficient evidence to exclude *Simulium* from the consideration. On the other hand Jennings and King in their three papers point out very strongly the possibility of *Stomoxys calcitrans* being concerned in the transmission of the disease.

RICKETTSIA MELOPHAGI Nöller, a body similar to those found in typhus, trench fever, etc., is found in the bodies of *Melophagus ovinus*, the sheep tick, but is not known to be associated with any disease.

ANIMAL ORGANISMS TRANSMITTED BY BLOODSUCKING FLIES

Protozoa

Mastigophora: Binucleata: Haemoproteidae

Haemoproteus columbae Celli and San Felice, the cause of PIGEON MALARIA or haemoproteasis of *Columba livia*, is transmitted by the pigeon flies *Lynchia maura* Bigot in Algeria and India, and *L. brunea* Olivier in Brazil. Mrs. Adie (1915) worked out the complete life cycle in the fly, and Acton and Knowles (1914) in the pigeon. Mrs. Adie succeeded in transmitting the disease to uninfected pigeons by the bites of *Lynchia* flies. The flies used were dissected and found to contain

zygotes and sporozoites. Parasites were found in the blood of the pigeons 28 days after the flies were first put on them.

In the pigeon the asexual cycle is passed. The sporozoites are inoculated by the bite of the fly. They enter the red blood corpuscles in the lung capillaries where they develop into trophozoites and schizonts and divide into merozoites, which may continue the asexual cycle by entering other corpuscles and becoming trophozoites. On the other hand they may remain in peripheral circulation and develop into the sexual forms, the macro- and microgametocytes. These forms may persist in the pigeon's blood over winter. They are ultimately taken up from the

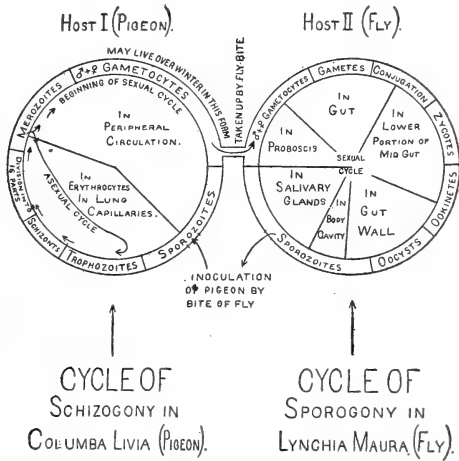

LIFE CYCLE OF HAEMOPROTEUS COLUMBAE

THE CAUSE OF PIGEON MALARIA.

FIG. 41. (Pierce.)

pigeon's blood by the fly and pass from its proboscis into the gut. They develop into gametes which conjugate to form zygotes in the lower portion of the mid-gut. These become oökinetes and develop into oöcysts in the gut wall. The oöcysts divide into a multitude of sporozoites which find their way through the body cavity into the salivary glands and are ready for inoculation.

The life cycle is graphically shown in the chart (fig. 41) which should be compared with that of *Plasmodium* (fig. 47) in the lecture on mosquito-borne diseases.

Haemoproteus masoni Sambon, the cause of HAEMOPROTEASIS OF THE RED GROUSE, is transmitted by the grouse fly, *Ornithomyia lagopidis* Sharp in which Sambon found oökinetes in the stomach.

Certain species of Haemoproteus are mentioned in another lecture as transmitted by mosquitoes (see Chapter XVII).

Mastigophora: Binucleata: Leucocytozoidae

Leucocytozoon lovati Sambon and Seligman, the cause of LEUCOCYTOZOASIS OF THE RED GROUSE, *Lagopus scoticus*, is supposed by Fantham to be likewise transmitted by the grouse fly, *Ornithomyia lagopodis* Sharp, in which he found vermicules.

Mastigophora: Binucleata: Trypanosomidae

As has been mentioned before, Chalmers' new classification of Trypanosome genera is used in this volume, although criticized by Mesnil. The value of this classification can be seen in the various lectures in that it groups together species with similar host relationships. The two genera involved definitely in biting fly transmission are *Castellanella* and *Duttonella*. In the former the final stage in the insect takes place in the salivary glands, and in the latter, elsewhere in the anterior portions of the insects. Those species which can not be definitely assigned to a genus are left in *Trypanosoma* (sens. lat.).

Castellanella annamense (Laveran), cause of an EQUINE TRYPANOSOMIASIS in Annam, is believed to be carried by Tabanidae and Hippoboscidae according to Castellani and Chalmers.

Castellanella brucei (Plimmer and Bradford) Chalmers, cause of NAGANA, an African disease affecting many wild and domestic animals, is transmitted normally by bites of the tsetse flies, *Glossina morsitans* Westwood, *G. brevipalpis* Newstead, *G. pallidipes* Austen, *G. tachinoides* Westwood, and *G. fusca* Walker, and may also be transmitted by the horse flies *Atylotus nemoralis* Meigen, and a Tabanus, and by the stable flies *Stomoxys calcitrans* Linnaeus, and *S. glauca*. The organism must undergo part of its development in the alimentary canal of the fly. When fully developed it is found in the proboscis and is then capable of being inoculated into animals by the bite of the fly. *Trypanosoma* sp., cause of AINO, an African disease of cattle probably identical with *C. brucei*, is suspected by Brumpt to be carried by *Glossina longipennis* Corti.

Castellanella dimorphon (Laveran and Mesnil), Chalmers, cause of an African ANIMAL TRYPANOSOMIASIS, is carried by the tsetse flies, *Glossina palpalis* Robineau-Desvoidy, *G. tachinoides* Westwood, *G. morsitans* Westwood, and *G. longipalpis* Wiedemann, and possibly by *Lyperosia*. The trypanosomes upon being taken up by the fly become established in the hind intestine and gradually extend forward until they reach the proboscis, when they become fixed and assume the leptomonad or crithidial form.

Castellanella equiperdum (Dofflein) Chalmers, cause of DOURINE of horses, has been experimentally transmitted by interrupted feedings of the stable fly, *Stomoxys calcitrans* Linnaeus and *Atylotus tomentosus* Macquart by Sèrgent and Sèrgent (1906).

Castellanella evansi (Steel) Chalmers, cause of SURRA of cattle and horses, has been experimentally transmitted by bites of *Stomoxys calcitrans* Linnaeus, *S. geniculatus* Bigot and *S. nigra* Macquart. Either experimental evidence or strong suspicion points to transmission by the horse flies, *Tabanus tropicus* Linnaeus, *T. striatus* Fabricius, *T. lineola* Fabricius, *T. atratus* Fabricius, *T. fumifer* Walker, *T. partitus* Walker,

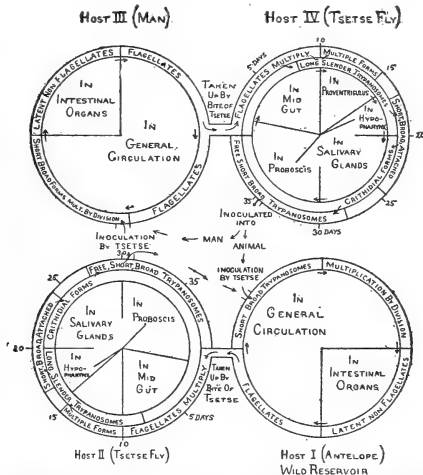

LIFE CYCLE OF TRYPANOSOMA GAMBIENSE.

THE CAUSE OF GAMBIAN SLEEPING SICKNESS OF MAN

- HOST I. TRAGELAPHUS SPRELI (ANTELOPE).
- HOST II. GLOSSINA PALPALIS (TSETSE FLY).
- HOST III. HOMO SAPIENS (MAN).

FIG. 42. (Pierce.)

T. vagus Walker, *T. minimus* Van der Wulp, and other species of *Tabanus* and *Haematopota*. Certain writers have also suspected *Lyperosia minuta* Bezzi, *Philaematomyia crassirostris* Stein and *Lyperosia exigua* Meigen (*Haematobia*). The parasite has also been found in the stomach of *Stomoxys geniculatus*.

Castellanella evansi mborii (Laveran), cause of MBORI, a camel trypanosomiasis of Africa, is believed to be carried by *Tabanus taeniatus* Macquart and *T. biguttatus* Wiedemann.

Castellanella gambiense (Dutton) Chalmers (*nigeriense* Macfie), cause of GAMBIAN AND NIGERIAN SLEEPING SICKNESS of man, has wild animals for its reservoir, and is principally transmitted by *Glossina palpalis* Robineau-Desvoidy and its variety *fuscipes*. Experimental

evidence indicates that it can be carried by *Glossina morsitans* Westwood, *G. fusca* Walker, *G. longipennis* Corti, *G. pallidipes* Austen, *G. brevipalpis* Newstead, *G. tachinoides* Westwood, as well as *Stomoxys calcitrans* Linnaeus, and the mosquitoes mentioned in another lecture. After the trypanosomes are ingested in the blood of the fly, multiplication begins, usually in the midgut (fig. 42). After the tenth or twelfth day, many long, slender trypanosomes are found which gradually move forward into the proventriculus. Such long, slender forms represent the limit of development in the lumen of the main gut. The proventriculus type, developed about the eighth to the eighteenth or twentieth day, is not infective; it may occur in the crop, but is not to be found permanently there. Between the tenth and fifteenth days multinucleate forms of trypanosomes are found, and may be styled multiple forms. Some of these latter may be degenerative. Long slender forms from the proventriculus pass forward into the hypopharynx. They then pass back along the salivary ducts, about sixteen to thirty days after the fly's feed. In the salivary glands they become shorter and broader, attach themselves to the surrounding structures and assume the crithidial facies. They remain attached to the wall and multiply. These crithidial stages differentiate into the short, broad trypanosome forms, capable of swimming freely. These forms only are infective.

After inoculation into the vertebrate these forms multiply by longitudinal division. Repeated division occurs until the blood swarms with parasites. They then disappear from the blood and become latent non-flagellate bodies in the intestinal organs. These latent bodies again become flagellate and enter the general circulation, and may be taken up by a bloodsucking fly. The above life cycle was worked out by Miss Robertson as well as other workers and briefed by Fantham, Stephens and Theobald.

Castellanella pecaudi (Laveran), cause of BALERI, a fatal equine trypanosomiasis of Africa, is usually spread by *Glossina longipalpis* Wiedemann and *G. morsitans* Westwood, but *G. tachinoides* Westwood and exceptionally *G. palpalis* Robineau-Desvoidy may be infected. *Stomoxys calcitrans* Linnaeus and *S. nigra* Macquart are recorded as possible carriers. The incubation period in *G. longipalpis* is 23 days. The trypanosomes multiply in the fly intestine up to 48 hours after ingestion in a modified form, called by Roubaud the "intestinal trypanosome form." Under favorable conditions these multiply very rapidly and in seven to nine days invade the whole of the intestine as far as the pharynx. These flies are not infective until the parasites have invaded the proboscis and passed through the crithidial and leptomonad phases. These proboscis forms multiply and some reach the hypopharynx, where

they assume the "salivary trypanosome form" and are then capable of infecting any susceptible animal (Hindle).

Castellanella rhodesiense (Stephens and Fantham) Chalmers, cause of RHODESIAN SLEEPING SICKNESS of man, is carried by *Glossina morsitans* Westwood, *G. palpalis* Robineau-Desvoidy, and *G. brevipalpis* Newstead. The insect becomes infective after an incubation period of about 14 days and is infective throughout the remainder of its life. The life cycle is not completely worked out, but it is known that the trypanosomes first become established in the intestines and later invade the salivary glands (Hindle).

Castellanella soudanense (Laveran) Chalmers, cause of TAHAGA of dromedaries in Sudan, EL DEDAB of dromedaries in Algeria, and ZOUSFANA of horses in Sud Oranais, has been experimentally transmitted by *Stomoxys calcitrans* Linnaeus, *S. nigra* Macquart, *Atylotus nemoralis* Meigen, and *A. tomentosus* Macquart.

Duttonella caprae (Kleine) Chalmers, cause of an African goat Trypanosomiasis, is transmitted by *Glossina brevipalpis* Newstead and *G. morsitans* Westwood.

Duttonella cazalboui (Laveran) Chalmers, cause of SOUMA, an African animal trypanosomiasis, is principally carried by the tsetse flies *Glossina palpalis* Robineau-Desvoidy, *G. longipalpis* Wiedemann, *G. morsitans* Westwood, and *G. tachinoides* Westwood, but may also be transmitted by *Stomoxys calcitrans* Linnaeus, *Tabanus biguttatus* Wiedemann, and *T. taeniatus* Macquart, and possibly *Stomoxys nigra* Macquart. Development of the organism is restricted to the proboscis of the tsetse fly, the flagellates never multiplying in any other part of the alimentary canal. They may change in the proboscis into leptomonad or crithidial forms, attach to the walls of the labrum and undergo rapid multiplication. Under the influence of the salivary secretion some of these fixed flagellates develop into small, actively motile trypanosomes closely resembling the blood forms. This becomes infective from six to ten or more days after ingestion of the parasites.

Duttonella cazalboui pigritia (Van Saceghem), cause of ZAMBIAN SOUMA of cattle, is carried by *Haematopota perturbans* according to Van Saceghem who found the organism in the intestinal tract of flies taken on infected animals.

Duttonella congolense (Broden) Chalmers, cause of GAMBIAN HORSE SICKNESS, is carried by *Glossina morsitans* and possibly by *G. palpalis* and species of *Glossina*, *Tabanus* and *Stomoxys*. The various forms of the parasite have been demonstrated in the alimentary canal of *G. morsitans* 23 days after ingestion.

Duttonella nanum (Laveran) Chalmers, cause of a fatal BOVINE TRYPANOSOMIASIS of Africa, is carried by *Glossina palpalis*, and

possibly *G. morsitans*. The development in the gut of *palpalis* is similar to that described above for *T. gambiense*. Multiplication begins in the hind intestine and by the tenth day numerous parasites are found in the hind and middle intestine. The slender forms begin to be produced from the tenth to the fourteenth day onward, and the proventriculus is usually invaded about the twentieth day. About the 25th day they invade the proboscis, where they may be found attached to the labrum, often lying in clusters. They then pass through the crithidial phase, many of them being extremely long and slender. Subsequently trypanosome forms are produced which may be found free, sometimes in the hypopharynx and at other times in the labrum. The salivary glands never become infected. (Taken from Hindle who summarizes the work of Duke and others.)

Duttonella pecorum (Bruce, Hamerton, Bateman and Mackie), cause of a WILD ANIMAL TRYPANOSOMIASIS, is carried by *Glossina morsitans*, *G. tachinoides*, *G. palpalis*, and *G. brevipalpis*, in the alimentary canal of which it undergoes its cyclical development.

Duttonella simiae (Bruce, Harvey, Hamerton, Davey and Lady Bruce), cause of SIMIAN TRYPANOSOMIASIS, is carried by *Glossina morsitans* and *G. brevipalpis*.

Duttonella uniforme (Bruce, Hamerton and Mackie), a fatal TRYPANOSOMIASIS of cattle, with wild animal reservoirs, is naturally carried by *Glossina palpalis*, which becomes infective in from 27 to 37 days. The infection of the fly is always limited to the proboscis.

Duttonella vivax (Ziemann) Chalmers, cause of a bovine and ovine TRYPANOSOMIASIS, is carried by *Glossina tachinoides*, and probably by *G. palpalis* and *G. morsitans*. Stomoxys and Lyperosia are suspected carriers. The incubation period of the fly is from five to eight days.

Trypanosoma franki Frosch, cause of a TRYPANOSOMIASIS OF WILD GAME in Europe, is believed to be transmitted by *Hippoboscidae* and *Tabanidae*.

Trypanosoma gallinarum, cause of FOWL TRYPANOSOMIASIS of the domestic fowl, is carried by *Glossina palpalis*, according to Duke (1912).

Trypanosoma grayi Novy, cause of CROCODILE TRYPANOSOMIASIS in Africa, is carried by *Glossina palpalis* and *G. brevipalpis*.

Trypanosoma theileri Laveran, thought to cause GALL SICKNESS of cattle by some authors, was experimentally transmitted by Theiler in South Africa by bite of *Hippobosca rufipes* Von Olfers and *H. maculata* Leach.

Trypanosoma tullochii Minchin is native to *Glossina palpalis* in Africa, and no vertebrate host is as yet known.

Mastigophora: Binucleata: Leptomonidae

Crithidia melophagia Flu is normally a parasite of the sheep tick fly, *Melophagus ovinus* Linnaeus, and has been experimentally transmitted to rats and mice. Flu (1908) describes in the fly an asexual and sexual reproduction. The latter is characterized by a process of reduction, followed by conjugation with the formation of an oökinete and the infection of the eggs of the insect, which may cause a second generation of flies to carry the organism.

Crithidia nycteribiae Chatton is found in the parasite fly, *Cyclopodia sykesi* Westwood.

Crithidia pangoniae Rodhain, Vandenbranden, Bequaert and Pons occurs naturally in *Tabanus hilaris* Walker, *T. striatus* Fabricius, and a *Tabanus* sp.

Crithidia tenuis Rodhain, Pons, Vandenbranden and Bequaert is native to *Haematopota duttoni* Newstead, and *H. vandenbrandeni* Rodhain, Pons, Vandenbranden and Bequaert in Belgian Congo.

Leishmania brasiliensis Vianna, cause of BOUBA or oral leishmaniasis of Brazil and Paraguay, is believed by Brumpt and Pedröso to be carried by bloodsucking flies, either Tabanidae or Culicidae.

Leishmania tropica (Wright), cause of BISKRA SORE in Algeria, and BAGDAD SORE in Bagdad, is believed by Wenyon (1911) and Sergent and Sergent (1914) to be transmitted by *Phlebotomus minutus africanus* Newstead.

Leishmania uta Escomel, cause of UTA, a dermal lesion peculiar to the western face of the Andes in Peru, is believed by Townsend to be carried by *Forcipomyia utae* Knab and *F. townsendi* Knab.

Leptomonas minuta (Leger) occurs naturally in the intestine and Malpighian tubules of *Tabanus tergustinus* Egg.

Leptomonas phlebotomi (Mackie) occurs in nature in *Phlebotomus minutus* Rondani in India.

Leptomonas simuliae (Georgewitch) occurs in nature in *Simulium columbaczense* Schönberg in Europe.

Leptomonas subulata (Leger) attacks *Haematopota italica* Meigen in Southern France.

Mastigophora: Spirochaetacea: Spirochaetidae

Spiroschaudinna glossinae (Novy and Knapp) occurs in the stomach of Glossina.

Telosporidia: Haemogregarinida: Haemogregarinidae

Haemogregarina francae De Mello, a parasite of the dove, *Columba livia*, is suspected of being carried by *Lynchia maura* Bigot.

Haemogregarina sp. passes its sporogony in *Glossina palpalis* but its vertebrate host is unknown.

Metazoa

Nemathelminthes: Nematoda: Filariidae

Filaria (Loa) loa (Guiyot), cause of a human filariasis, was found by Ringenbach and Guyomarc'h in the Congo to pass part of its life cycle in *Chrysops centurionis* Austen, and by Leiper in West Africa in *Chrysops dimidiata* Van der Wulp, and *C. silacea* Austen. Leiper obtained a slight degree of infection but development was unequal and slow in *Haematopota cordigera* Bigot and *Hippocentrum trimaculatum* Newstead. He obtained only negative results with *Stomoxys nigra* Macquart, *S. calci-trans* Linnaeus, *Glossina palpalis* Robineau-Desvoidy, *Tabanus par* Walker, *T. socialis* Walker, *T. fasciatus* Fabricius, and *T. secedens* Walker.

Thus it will be seen that many of the most dangerous diseases of animals and some of the most dreaded human diseases are carried by bloodsucking flies, and furthermore, that the transmission is principally biological, that is, the insect is a necessary intermediate host. In this case the parasite invariably passes its cycle of sporogony in the invertebrate and its cycle of schizogony in the vertebrate, if it passes through such a cycle.

A number of organisms found only in the insects are recorded. It is quite possible that some of these will ultimately be linked up with pathological species. Any one studying disease transmission must know in advance what organisms he might encounter in the insects he is studying.

BIBLIOGRAPHY

- Anderson, J. F., and Frost, W. H., 1912.—U. S. Treas. Dept., Public Health Report, vol. 27, No. 43, Reprint No. 99, 5 pp.
- Anderson, J. F., and Frost, W. H., 1913.—U. S. Treas. Dept., Public Health Report, vol. 28, p. 833.
- Brumpt, E., 1902.—Arch. de Parasit., vol. 5, p. 158.
- Castellani, A., and Chalmers, A. J., 1913.—Manual of Tropical Medicine, 2nd edit.
- Doer, Franz, and Taussig, 1909.—Das Pappatacifeber. Franz Deuticke, Leipzig and Wien.
- Dorset, M., McBryde, C. M., Nile, W. B., and Rietz, I. H., 1919.—Amer. Journ. Vet. Med., vol. 14, No. 2, pp. 55-60.
- Duke, H. L., 1912.—Proc. Roy. Soc., vol. B 85, No. B 580, pp. 378-384.

- Fantham, H. B., Stephens, J. W. W., and Theobald, F. V., 1916.—The Animal Parasites of Man. William Wood & Co.
- Flu, P. C., 1908.—Arch. f. Protistenk, vol. 12, pp. 147-153.
- Francis, Edward, 1919.—U. S. Treas. Dept., Public Health Reports, vol. 34, No. 37, pp. 2061, 2062.
- Fuller, C., 1913.—Fly Plagues. An unusual outbreak of *Stomoxys calcitrans* following floods. Union of South Africa, Dept. Agr., circ. 32, 1913.
- Hindle, E., 1914.—Flies in Relation to Disease. Blood-Sucking Flies. Cambridge Univ. Press., 398 pp.
- Hintermayer, 1846.—Centralarchiv. f. d. gesamte Staatsarzneikunde, Band 3, pp. 437, 441.
- Horse Administration Bureau, 1914.—Tokyo. Reviewed in Bull. Inst. Pasteur, vol. 12, No. 14, p. 634.
- Howard, C. W., 1917.—Journ. Parasit., vol. 4, pp. 70-79.
- Jennings, A. H., 1914.—Journ. Parasit., vol. 1, pp. 10-21.
- Jennings, A. H., and King, W. V., 1913.—(1) Journ. Amer. Med. Assoc., vol. 65, pp. 271-274; (2) Amer. Journ. Med. Sci., vol. 146, pp. 411-440.
- Joly, P. R., 1898.—Importance du rôle des insectes dans la transmission des maladies infectieuses et parasitaires.—Du formol comme insecticide. Bordeaux. Imprimerie du Midi. 90 pp. Thesis.
- Leiper, R. T., 1914.—Rept. Advis. Comm. Tropical Research Fund for 1913, London, p. 86.
- Megaw, J. W. D., 1919.—Indian Med. Gaz., vol. 54, No. 7, pp. 241-247.
- Mitzmain, M. B., 1914.—U. S. Treas. Dept., Hygienic Laboratory, Bull. 94, 53 pp.
- Morris, Harvey, 1918.—Blood-Sucking Insects as transmitters of Anthrax or Charbon. La. Agr. Exp. Sta., Bull. 163, 15 pp.
- Nuttall, G. H. F., 1899.—On the Rôle of Insects, Arachnids and Myriapods as carriers in the spread of bacterial and parasitic diseases of man and animals. A critical and historical study. Johns Hopkins Hospital Reports, vol. 8, Nos. 1, 2, pp. 1, 152.
- Ringebach, J., and Guyomarc'h, 1914.—Bull. Soc. Path. Exot., vol. 7, pp. 619-626.
- Rosenau, M. J., and Brues, C. T., 1912.—Mo. Bull. State Bd. Health Massachusetts, vol. 7, No. 9, pp. 314-317.
- Sambon, L. W., 1910.—Journ. Trop. Med. and Hyg., vol. 13, No. 19.
- Sawyer, W. A., and Herms, W. B., 1913.—Journ. Amer. Med. Assoc., vol. 61, pp. 461-465.
- Schuberg, A., and Böing, W., 1914.—Arb. Kais. Gesundheitsamte, Band 47, Heft. 3, pp. 491-512.

- Schuberg and Khan, 1912.—*Arb. Kais. Gesundheitsamte*, Band 40, Heft 2, pp. 209-234.
- Scott, J. W., 1915.—*Science*, vol. 42, No. 1088, p. 659.
- Sergent, Ed., and Sergent, Et., 1900.—*Ann. Inst. Pasteur*, vol. 20, pp. 665-681.
- Sergent, Ed., and Sergent, Et., 1914.—*Bull. Soc. Path. Exot.*, vol. 7, pp. 577-579.
- Townsend, C. H. T., 1916.—*Journ. Parasit.*, vol. 2, pp. 67-73.
- Townsend, C. H. T., 1916.—*Bull. Ent. Res.*, vol. 6, pt. 4, pp. 409-411.
- Wayson, N. E., 1915.—*U. S. Public Health Service, Public Health Reports*, vol. 29, No. 51, pp. 3390-3393. Reprint No. 242.
- Wenyon, C. M., 1911.—*Kala Azar Bull.*, vol. 1, pp. 36-58.

CHAPTER XV

Biological Notes on the Bloodsucking Flies¹

W. Dwight Pierce

Mr. Webb, in his lecture which follows (Chapter XVI), has given us a very comprehensive view of the life history and habits of the horse flies of the genus *Tabanus*. In another lecture we presented the data on transmission of diseases by the bloodsucking flies and by reference to this (see Chapter XIV) it will be seen that quite a number of genera belonging to several families of flies are concerned in disease transmission. It will be the aim of this lecture to present some of the salient biological facts concerning these genera so as to prepare the sanitarian for controlling those species in his territory, which might cause disease.

The insects we have especially to deal with in this lecture are the sand flies of the genus *Phlebotomus*, in the family *Psychodidae*; the horse flies of the genera *Tabanus*, *Atylotus*, *Haematopota*, *Chrysops*, and *Chrysozona*, of the family *Tabanidae*; the biting flies of the genera *Stomoxys*, *Lyperosia*, *Haematobia*, and *Glossina*, of the family *Muscidae*; and the parasitic flies of the genera *Melophagus*, *Lynchia*, *Hippobosca*, and *Ornithomyia*, of the family *Hippoboscidae*.

There are of course many other genera of bloodsucking flies which may contain potential disease carriers. Interesting discussions of these flies are to be found in the books by Hindle, and Patton and Cragg.

FAMILY CHIRONOMIDAE

Midges

The little midges of this family are often mistaken for mosquitoes, to which they are somewhat related. Their young are the well-known blood worms in streams and stagnant pools. Of the five subfamilies only one, the *Ceratopogoninae*, contains bloodsucking forms. The eggs of *Chironomidae* are small and ovoid, or long and pointed at their extremities, and are laid either in a gelatinous string of mucus or separately. The larva consists of thirteen segments, with head directed downwards, and mandibles well developed. On the ventral surface of the eleventh

¹This lecture was presented October 14, and issued October 22, 1918.

segment and the extremity of the twelfth, there are delicate finger-like processes, usually four in number, which serve as tracheal gills. The pupa is free and either lives floating in water without any movement or rests on the bottom of the pool. It has a tuft of delicate white threads on the dorsum of the thorax, which serve as breathing tubes; or it may have a pair of respiratory trumpets.

Tersesthes torrens Townsend, a mountain form in North America, is a voracious bloodsucker, attacking man and animals, usually on the head, ears, and eyes. Its life history is unknown.

Mycterotypus bezzii and *M. irritans* of Southern Europe are voracious bloodsuckers, biting human beings, as well as animals, and causing inflammatory swellings.

Ceratopogon is a large genus containing a number of bloodsucking gnats called "punkies," found in various parts of the world. Some of the Asiatic species attack bloodsucking mosquitoes and draw blood from them. It is therefore possible that these insects may play a rôle in disease transmission. They are very small, measuring less than 3 mm. in length. Only the females are bloodsuckers. They bury themselves often among the hairs of the host and are not recognized until they become replete with blood. They often cause great distress on account of their numbers and the irritation produced by their bites. The different species choose different parts of the host for attack, as for example, some select the face, especially the margins of the ears and eyes, while others may attack the arms or legs.

Forcipomyia utae Knab is thought by Townsend to cause the South American disease, uta. *Forcipomyia* is considered to be a subgenus of *Ceratopogon*. Larvæ have been found in crab holes and below the algal crust on the sand along the seashore in South America.

Culicoides is another large genus of midges very similar to *Ceratopogon*, and contains many bloodsuckers. Only the females bite. The larvæ are found in water under various conditions. When searching for larvæ where the adults are abundant, they may be found by gathering in a white tray some of the green vegetable matter found at the edges of streams. The flies can be bred by placing the pupæ on moist filter paper in tubes closed with moist cotton.

The genera *Johannseniella* and *Haematomyidium* also contain blood-sucking midges.

FAMILY SIMULIIDÆ

Buffalo Gnats

The buffalo gnats of the genus *Simulium* are sometimes also called sand flies and turkey flies. This is a large genus of voracious flies which often are so numerous as to cause great distress and even death to men

and animals. Sambon considered *Simulium* as the carrier of pellagra, but his theory has not been substantiated. Jobbins-Pomeroy has given quite a full treatment of the life history of several species of this genus, and Malloch has presented a classification of our American forms. The larvæ breed usually in swift-flowing water.

The eggs are small, rather triangular or ovoid objects, and somewhat yellowish in color after a few days. They are laid in masses on grass blades, or leaves, or on stones and other forms of debris at the surface of the water or under the surface. The egg stage varies in each species according to the temperature, but in Jobbins-Pomeroy's studies of five

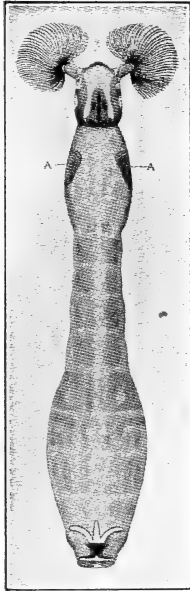

FIG. 43. Larva of a buffalo gnat, *Simulium*. (Jobbins-Pomeroy.)

species, the incubation period ranged from 7 to 13 days. A single female may lay from 500 to 1500 eggs according to published claims.

The larvæ are invariably aquatic, and are quite characteristically marked by the possession of two large appendages on the head in front of the antennæ, which are provided with fans of long hairs. These fans serve to brush food particles into the mouth of the larva (fig. 43).

The mesothorax is provided with a single retractile proleg armed at its apex by a circular row of short hooklets or spines. This pseudopod with its sucker is used by the larva in attaching itself to objects. A similar but larger sucker-like disk is situated on the caudal extremity of the larvæ. Respiration takes place through rectal gills located dorsally to the caudal sucker. These gills are retractile into the rectum, but are

usually extended in running water. They function both as blood gills and tracheal gills. The structure of these gills affords characters of value for the identification of the species.

The larvæ attach themselves by the caudal suckers and float in the stream, catching their food by means of the fan-like processes on the head. When disturbed, or if the stream diminishes, the larvæ let themselves float down the stream attached by a silken thread to a permanent object, by which they can regain their former position. When about to pupate the larva spins over itself a pocket-shaped pupal case. The pupæ are provided with respiratory organs on each side of the thorax. These are composed of long chitinous tubes with a single main stalk and four or more divisions. Good specific characters for identification are found in the structure of these respiratory organs (plate XV).

The development period of *Simulium* in South Carolina is about 7 days for the egg, 17 days for the larvæ, and 4 days for the pupæ. The number of generations depends upon the species and the season and may range from one to six or more generations.

FAMILY PSYCHODIDAE

Pappataci Flies

The owl midges are small moth-like flies. Only the genus *Phlebotomus* contains bloodsucking flies, which are often called sand flies. The pappataci fly, *Phlebotomus papatasi* Scopoli, cause of pappataci fever; *P. minutus* Rondani, a possible carrier of Bagdad sore, and *P. verrucarum* Townsend, supposed carrier of verruga, are the only species definitely charged with carriage of disease. Only the females suck blood. They deposit their eggs in damp, dark places, in clusters or singly, to the number of from 30 to 80. The eggs are covered with a thin coating of a sticky substance which causes them to adhere to any surface. They are very elongate, dark brown, with longitudinal, black, wavy lines. The incubation period is from six to nine days. The larvæ live in damp earth. They are very peculiar, having large, well marked heads with big jaws, which have four distinct teeth. The body is covered with toothed spines and the posterior end bears two pairs of very black caudal bristles, one pair of which are as long as the body. The larva feeds on semi-decaying vegetable matter. The pupa is remarkable for the large ridges and excrescences on its thorax. The larval skin usually remains adhering to the caudal extremity.

These flies breed in crevices of stone walls and fissures between rocks in caves, in dirty, damp cellars, and on the damp walls of latrines and cesspools, and wherever there is damp ground in dark places. Lizards fre-

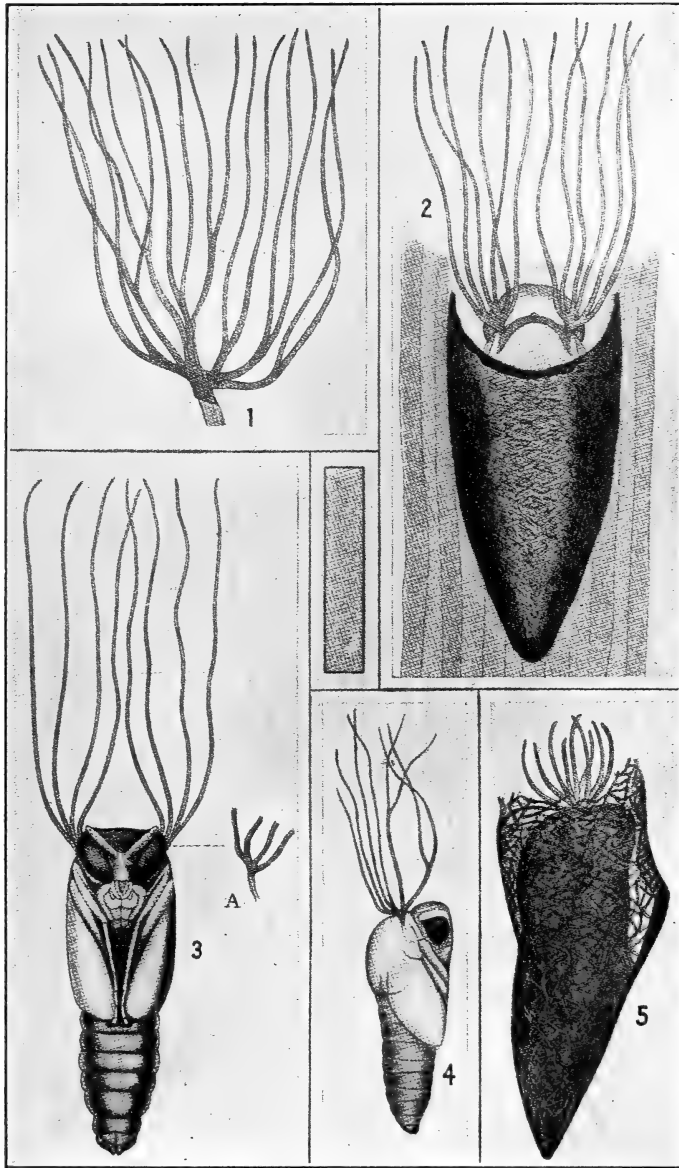

PLATE XV.—Pupae of *Simulium*. Fig. 1.—Respiratory filaments of pupa of *Simulium vittatum*. Fig. 2.—Pupa of *Simulium venustum*, in pupal case. Fig. 3.—Pupa of *Simulium bracteatum*: A, side view of filaments. Fig. 4.—Pupa of *Simulium jenningsi*. Fig. 5.—Pupa of *Simulium pictipes*, in pupal case. All greatly enlarged. (After Jobbins-Pomeroy.) From U. S. Dept. Agr. Bull. 329, Plate V.

quently serve as blood hosts and are considered the reservoirs of the fevers carried, especially pappataci fever.

FAMILY CULICIDAE

The mosquitoes which in an orderly arrangement would be treated here have been considered in other lectures (Chapters XVII to XIX).

The families so far discussed belong to the Nematocera; the next family belongs in the Brachycera.

FAMILY TABANIDAE

Horse Flies

The family Tabanidae contains the horse flies, gad flies, deer flies, many genera and species of bloodsuckers. The males throughout the family are flower feeders or feed on vegetable juices, and so likewise are the females in many genera. The eggs of Tabanidae are commonly laid in large, shapely masses on the leaves and stems of plants growing in marshy ground, or overhanging water. In some species they are deposited on stones or rocks above the water of streams, and are very difficult to discover.

Mr. Webb has discussed for us the habits of *Tabanus* (Chapter XVI). We have seen also that species of *Tabanus* can carry the animal diseases anthrax, nagana, souma, surra, and mbori. The genus *Atylotus* can carry nagana and dourine; *Haematopota*, surra and equine infectious anemia; *Chrysops* and *Chrysozona* are probable carriers of equine infectious anemia. Various other genera are bad bloodsuckers, especially *Pangonia*.

Tabanid larvæ grow very slowly, feeding at first on small crustaceans which are abundant in water and moist earth. The larger larvæ of many species feed almost exclusively on earth worms, whose body juices they suck out. Although the larval stage may require months for development, the pupal stage will usually be short.

FAMILY MUSCIDAE

The flies of the family Muscidae are mostly not bloodsucking flies. Principal among these genera which have the mouth shaped for sucking blood are the genera *Glossina*, *Stomoxys*, *Lyperosia*, *Philaematomyia* and *Haematobia*.

Bloodsucking Fly Larvæ

The genus *Auchmeromyia* of Africa is very peculiar in that both larvæ and adults are bloodsuckers. The adult flies are sensitive to light and are

usually found in the darkest parts of the native huts. The females have two periods of oviposition about one month apart, and may deposit a total of as many as 83 eggs. They oviposit on the ground in the huts, preferably where urine has been voided. The larvæ are exclusively blood feeders. They are able to resist starvation for long periods. If fed regularly they may mature in about 15 days. They remain in hiding during the day and suck the blood of sleepers at night. Pupation occurs in the puparium or last larval skin. The fly is probably spread from village to village in the egg or larval stage in the dirty mats which the natives carry about with them.

Travelers in Africa should always avoid sleeping in native huts or on the ground in the vicinity of corrals or native villages, because of these larvæ and also many other venomous and disease-bearing pests.

The African genus *Choeromyia* also has bloodsucking larvæ, the attack of which is not to be confused with the myiasis caused by the larvæ of related genera, because these larvæ are free living and do not remain attached to the host.

Biting Species of Musca

The genus *Musca* apparently is a transitional genus as it contains both non-bloodsucking and bloodsucking flies. *Musca pattoni* Austen, *M. gibsoni* Patton and Cragg, *M. convexifrons* Thomson, *M. nigrithorax* Stein, *M. bezzii* Patton and Cragg and *M. corvina* Fabricius, all of India except the last, which is European, are bloodsucking. But these flies are incapable of puncturing the skin of an animal. They feed on the blood and serum exuding from the bites of other bloodsucking flies. These flies breed in cow dung. *M. pattoni* always deposits in dung where it is collected in heaps, while *gibsoni* and *convexifrons* deposit in isolated patches of cow dung.

True Biting Flies

The true biting Muscids belong to the subfamilies Stomoxydinae, Glossininae and Philaematomyinae.

Philaematomyia is a genus closely resembling *Musca* in appearance. It contains three Asiatic species, of which the best known is *P. insignis* Austen, which only attacks cattle. It breeds in cow dung where it is collected in heaps. Both sexes feed on blood although they have also been seen feeding on cow dung. This habit would surely make it possible for the fly to mechanically carry infectious diseases from dung to blood. It breeds quite rapidly.

Stable Flies

Stomoxys is a genus found principally in Asia and Africa, although *S. calcitrans* Linnaeus, the well-known biting stable fly, is almost worldwide in its distribution (figs. 44-46, plate XVI). This species is capable of carrying rodent plague, anthrax, septicaemia, nagana, souma, dourine, surra, baleri, and Gambian sleeping sickness, and has been connected by Scott with the transmission of equine infectious anemia and seriously suspected as a possible carrier of poliomyelitis and pellagra.

A very complete bulletin by Bishopp is available for free distribution, describing the life history and control of the stable fly, so that it is not

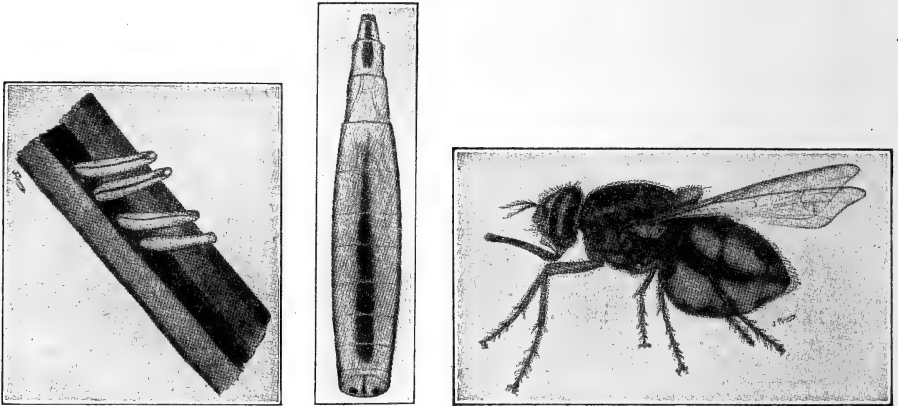

FIG. 44 (left).—Eggs of the stable fly (*Stomoxys calcitrans*) attached to a straw. Greatly enlarged. (After Bishopp.)

FIG. 45 (center).—The stable fly: Larva or maggot. Greatly enlarged. (After Bishopp.)

FIG. 46 (right).—The stable fly: Adult female, side view, engorged with blood. Greatly enlarged. (After Bishopp.) From U. S. Dept. Agr., Farmers' Bull. 540, figs. 1, 2, 5.

necessary to give a full discussion in this lecture. It generally breeds in moist straw and hay. Stacked straw which has been wet and partly rotted and hence is no longer available for stock food is a very favorable place for the fly to breed. Such straw should be dried as soon as possible by scattering, and then either be burned or plowed under. The stable fly does not often develop in manure, but where it does it may be controlled by measures taken against the house fly. This species is very annoying to mules, horses, and cattle and often to man. Horses and mules often become frantic in their efforts to escape the flies.

As much care should be taken to prevent the breeding of the stable fly as the house fly. They are carriers of entirely different series of diseases and both are dangerous. Especial care must be observed to



PLATE XVI.—The stable fly, *Stomoxys calcitrans*. Fig. 1 (upper).—Eggs in straw. Fig. 2 (lower right).—Pupae in straw. Fig. 3 (lower left).—Adults on leg of cow. (Bishopp.)

prevent breeding in straw which falls out of the stalls and windows of the stables. Where the stables adjoin a road, considerable straw may fall out of the windows and remain outside the building in a place where the horses do not come, and no one may think of removing this straw with the daily removal of manure. Here is an excellent place for *Stomoxys* to breed. Wherever marine weeds and debris are washed ashore and form considerable masses, *Stomoxys* is likely to breed. In plate XVII is shown the proper method of stacking straw to prevent fly breeding.



PLATE XVII.—Straw stack showing proper method of building strawstack. (Bishopp.)

Horn Flies

Haematobia sanguisugens is an Indian bloodsucker, which attacks cattle and horses. The principal species of horn flies belong to the genus *Lyperosia*,² of which *L. irritans* Linnaeus (plate XVIII) and *L. exigua* Meijere are the two commonest bloodsuckers. The latter is oriental. The horn fly was treated very fully by Marlatt in a circular now out of print. This species is so called because of the habit of the adults of clustering on the base of a cow's horn. The flies also cluster on other parts of the animal and cause great annoyance. Even when not feeding the flies rest on the cattle. The eggs are laid singly on the surface of wet dung. The moment the dung is dropped a swarm of flies dart from the animal to the dung and remain there a few seconds, during which time

²Dr. J. M. Aldrich does not recognize *Lyperosia*, but places our American species in *Haematobia*.—W. D. Pierce.

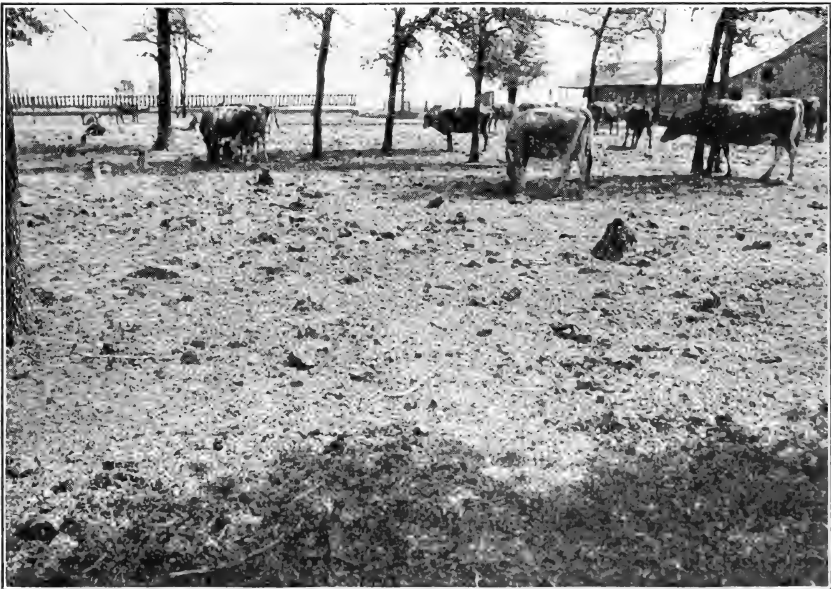
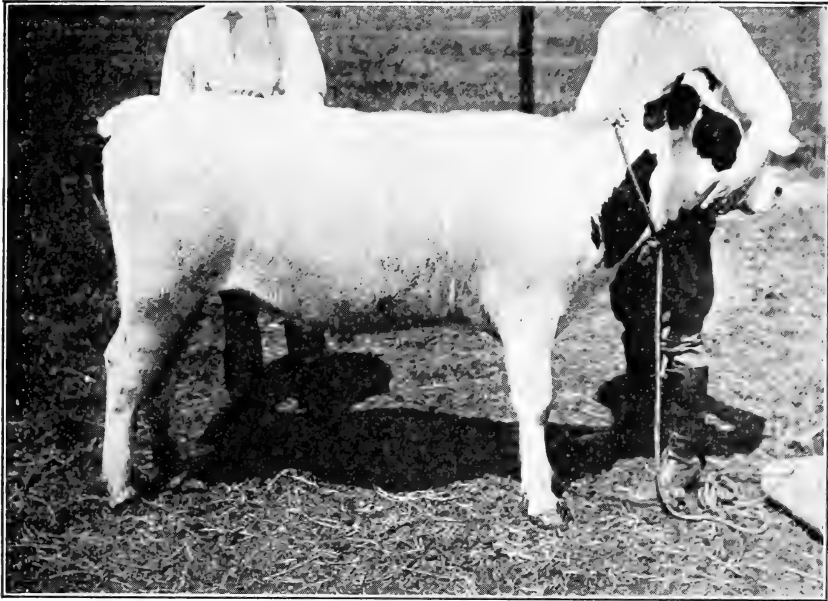

PLATE XVIII.—The horn fly, *Lyperosia irritans*. Fig. 1 (upper).—Flies on cow. Fig. 2 (lower).—Cow pasture showing droppings improperly left to breed flies. (Bishopp.)

many eggs are deposited. The flies immediately return to the cow. The larvæ migrate from the dung when about to pupate and the puparia are usually found at some distance away or under the sides of the patch of dung. The horn fly in America requires about 17 days from egg to adult.

Protection of the animal from the horn fly by the use of repellents is suggested. In this connection Graybill's bulletin on repellents should be consulted. Dipping vats and the cattle dip of the Bureau of Animal Industry (see Chapter XXXI, p. 442), now used in the control of the Texas fever tick, aid materially in reducing horn fly numbers.

Two practical methods are available for attacking the larvæ and pupæ. One is to throw lime on the dung, but the better method is to spread out the dung so as to favor its rapid drying or to allow a number of pigs to run with the cattle. In their efforts to obtain undigested food particles the pigs will effectively destroy the dung as breeding places for the fly.

Tsetse Flies

The tsetse flies of the genus *Glossina* are among the most dreaded insects of Africa. They are the carriers of three or more types of sleeping sickness, of aino, nagana, souma, horse sickness, baleri, and other trypanosomiasis of many domestic and wild animals. There are quite a number of species, and probably all are important, but *G. morsitans* Westwood and *G. palpalis* Robineau-Desvoidy, are the best known. Excellent discussions of each of the important species and tables for differentiation are given in the textbooks of Hindle, and Patton and Cragg.

The reproduction in this genus is very remarkable, resembling that of the Pupipara and is probably the result of their exclusively blood-sucking mode of life. The female lays a single larva at a time, which is retained and nourished in the oviduct until it is full grown. After the larva is born it at once burrows into the ground and pupates. The larva is generally of a yellowish white color and bears at its posterior extremity a pair of large dark-colored protuberances between which is a depression into which open the spiracles of the eighth segment. It pupates within the puparium or last larval skin. The puparium is broadly ovoid in shape and by its caudal appendages affords a means of distinguishing the species.

The habitats of the various species should be rather thoroughly studied by any one expecting service in the African tropics. In general the flies are found in moist forest regions, especially along river courses, but the temperature, moisture, and shade requirements seem to vary for the different species.

PUPIPARA

The suborder Pupipara is composed of several families of the queerest flies in the order. The insects of the families Nycteribiidae, Streblidae and Hippoboscidae are all ectoparasites on warm blood vertebrates. All of the Streblidae and Nycteribiidae of which the life history is known, are parasitic on bats and some of them are quite probably the carriers of bat diseases. In the family Hippoboscidae we find the genera *Lynchia*, *Hippobosca* and *Ornithomyia*, mentioned as carriers of disease, and also *Melophagus* to which belongs *M. ovinus* Linnaeus, the sheep tick. The flies of the genus *Lynchia* which carry pigeon malaria, live almost exclusively on pigeons. They deposit larvæ in the pigeon houses; these larvæ become puparia in an hour. *Hippobosca* is composed principally of species parasitic on mammals, one of which is thought to carry the gall sickness of horses in South Africa. The females deposit larvæ which are incapable of movement. They slowly darken until the puparium resembles a seed. *Lipoptena cervi* is parasitic on deer. *Melophagus ovinus*, which is wingless, lives on sheep, sometimes proving to be an important pest. This insect may be eradicated by giving two thorough dippings at 24-day intervals in lime-sulphur-arsenic solution or in standard coal tar-creosote or cresol dips, or nicotin solution (Imes).

Outside of the stable fly and sheep tick, control measures for biting flies are not well worked out. Of course the primary essentials are protection of the animals from the bites of the flies and prevention of breeding.

REFERENCES

- Bishopp, F. C., 1913.—The Stable Fly. U. S. Dept. Agric., Farmers' Bull. 540. Available for free distribution.
- Graybill, H. W., 1914.—Repellents for Protecting Animals from the Attacks of Flies. U. S. Dept. Agric., Bull. 131.
- Hindle, Edward, 1914.—Flies in Relation to Disease. Blood-Sucking Flies. Cambridge Univ. Press.
- Imes, Marion, 1917.—The Sheep Tick and Its Eradication by Dipping. U. S. Dept. Agric., Farmers' Bull. 798. Available for free distribution.
- Jobbins-Pomeroy, A. W., 1916.—Notes on Five North American Buffalo Gnats of the Genus *Simulium*. U. S. Dept. Agric., bull. 329.
- Malloch, J. R., 1914.—American Black Flies or Buffalo Gnats. U. S. Dept. Agric., Bur. Entom., Tech. Bull. 26.
- Marlatt, C. L., 1910.—The Horn Fly. U. S. Dept. Agric., Bur. Entom., Circ. 115.
- Patton, W. S., and Cragg, F. W., 1913.—A Textbook of Medical Entomology.

CHAPTER XVI

Biology and Habits of Horse Flies¹

J. L. Webb

In various parts of the United States and in many foreign countries horses, cattle, and similar animals suffer severely from the bloodsucking habit of the so-called horse flies of the genus *Tabanus* (plate XIX).

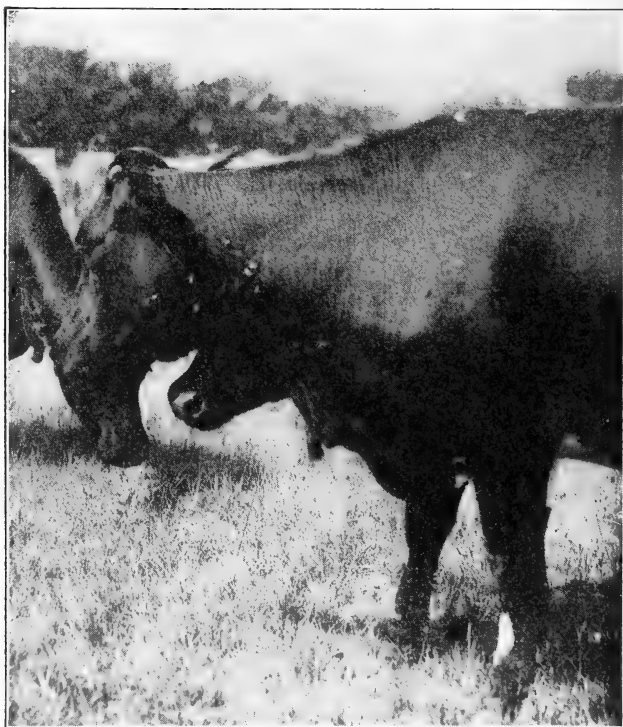

PLATE XIX.—Tabanidae attacking cattle: *Tabanus phaeops* on cow's jaw, and *T. punctifer* on top of shoulder. (Bishopp.)

The life history and habits of different species may vary greatly. Yet there are certain conditions common to all species. In general, the flies of this genus are to be found in or near swampy areas of the country.

¹This lecture was read October 7, 1918.

The larval stage of most species is passed in the ground, and a certain degree of moisture is necessary for proper growth and development. Most species require very wet, or saturated soil, others are able to develop in moderately moist earth.

EGGS AND EGG LAYING

The eggs are deposited by the female fly in clumps of several hundred each, on vegetation, rocks, or other objects overhanging suitable places for development of the larvæ. When the eggs hatch, the young larvæ drop to the soil or water beneath and disappear from sight. Here they remain for several months, sometimes for one or two years, when, after passing through a short pupal period, they emerge as adult flies.

In some cases the egg mass as well as the place of oviposition is characteristic of the species, and renders identification easy, once the observer sees one of which he knows the identity.

In the Sierra Nevada Mountains of Eastern California where I have been studying tabanids for the past two years, the egg masses of the two most important species are very easily distinguished. The egg mass of *Tabanus punctifer* Osten Sacken is oblong, somewhat pyramidal in shape, and about the size of the end of a man's little finger (plate XX, fig. 1). It is usually deposited upon a bullrush or coarse grass stem, and from one to three feet above the surface of the soil or water. When deposited, as is the case with all horse fly eggs, the mass is milk white. In a day or so, however, the color darkens to a mottled gray and white. Eggs of this species are found most abundantly along lake shores. The egg mass of *Tabanus phaenops* Osten Sacken is to be found on grass blades, three or four inches above the soil in swampy places in meadows. This mass is considerably smaller than that of *Tabanus punctifer*, is elongate, and usually contains but two layers of eggs, while the other species usually has about five layers. The egg mass of *T. phaenops* is black a day or two after oviposition. This mass is inconspicuous and extremely hard to locate in nature.

In the Egyptian Sudan, Harold King found the eggs of *Tabanus kingi* Austen deposited in rounded masses on rocks rising from the edge of a stream, generally overhanging the water, and from 6 inches to 15 inches above the water level. He also found the masses of *Tabanus ditaeniatus* Macquart on grass growing in rain pools. The shape of the egg mass of this species was variable,—some being long and narrow, others short and broad. The same worker secured ovipositions of *Tabanus par* Walker in a cage, on the under sides of leaves of a water weed growing in a vessel of water. He also secured the egg masses of *Tabanus taeniola* Palisot de Beauvois, the tabanid most frequently



PLATE XX.—*Tabanus punctifer*. Fig. 1 (upper left).—Egg masses on grass. Fig. 2 (upper center).—Larva, dorsal view. Fig. 3 (upper right).—Larva, lateral view. Fig. 4 (lower left).—Pupa, lateral view. Fig. 5 (lower right).—Pupa, ventral view. (Webb, photos by Dovener.)

accused of causing the death of camels, from grasses and weeds overhanging rain pools. These masses were placed on the upper sides of the plants as they hung over the water.

In Ohio, Hine records finding the egg masses of *Tabanus stygius* Say principally on the leaves of *Sagittaria* standing in shallow water, the female fly habitually placing the eggs just above the point where the petiole meets the expanded part of the leaf.

Mitzmain, working in the Philippines, used a large cage to secure ovipositions of *Tabanus striatus* Fabricius. He found that egg laying invariably took place in the early afternoon, never later than 2 o'clock. Under cage conditions egg masses were deposited on projecting splinters of wood, suspended fibers of jute sacking, fine brass wire, a single animal hair, coarse iron wire, leaves of trees, and the woodwork on sides and ceiling of the cage, invariably upon the shaded portions,—as the undersides of beams and partitions. The egg mass in some cases entirely surrounded the object on which it was deposited. The cage contained a tank of water with growing water plants. Apparently Mitzmain did not find eggs in the open.

In Southern Nigeria, Neave found the eggs of *Tabanus corax* Loew in the bush on reeds or grasses overhanging mud.

Near Alturas, California, during the past two seasons, I have found the egg masses of an unidentified *Tabanus*, to be very abundant on the undersides of leaves overhanging a small creek. They were found on the leaves of willow, alder, and rose bush; also occasionally on the leaves of *Populus* and on coarse grass blades.

I have never been fortunate enough to observe the process of egg laying, although on one occasion I came upon a female of *Tabanus punctifer* which had just finished ovipositing, and was still in position, head downwards on a stem of coarse grass. She was occupied at the time in brushing the end of the abdomen over the pure white egg mass, apparently covering it with a kind of transparent cement. She was not disturbed by my close approach. In fact, I broke off the stem on which she rested and observed the brushing process at close range for some little time before she took flight.

Neave mentions the fact that the eggs of *Tabanus corax* in Southern Nigeria are covered with an almost impervious cement. On one occasion an egg mass of this species, after being kept for two days in 70 per cent alcohol, produced a few larvæ after being taken out of the alcohol. However, not all species of *Tabanus* cover the eggs with cement. The eggs of *Tabanus phaenops* in the Sierra Nevada Mountains are not so covered, and fall from their place of attachment soon after hatching.

The number of eggs contained in the mass varies considerably. The easiest way of ascertaining the number in any given mass is by counting

the larvæ that issue therefrom. During the past summer the larvæ emerging from ten masses of *Tabanus phaenops* eggs were counted. The number per mass ranged from 156 to 385, giving an average of 281 + per mass. Larvæ from fifteen masses of *Tabanus punctifer* eggs were counted. The range was found to be from 159 to 701 larvæ,—an average of 366 + per mass. However, this method of arriving at the number of eggs per mass was very inaccurate in the case of *Tabanus punctifer*, as practically all these egg masses were, to a greater or less extent, parasitized, and in several of the masses a large per cent of the eggs failed to hatch.

Larvæ from a series of five unidentified *Tabanus* egg masses collected near Alturas, California, were also counted. Here the range was from 326 to 890,—an average of 509 + per mass, with no parasitism.

Mitzmain records that the number of eggs per mass of *Tabanus striatus* in the Philippines varies from 270 to 425. He observed the oviposition under cage conditions and found that the eggs were deposited at the exact rate of 10 per minute.

References in literature to the incubation period are extremely scarce. King gives the period for *Tabanus kingi* as about 5 days, and for *Tabanus par* as 5 to 6 days. These species occur in the Egyptian Sudan. Neave gives the incubation period of *Tabanus corax* in Southern Nyasaland as about 5 days. Mitzmain determined the period for *Tabanus striatus* in the Philippines to be from 3 to 5 days.

In my own experience in the Sierra Nevada Mountains, I have found that the eggs of *Tabanus phaenops* under laboratory conditions hatch in from 6 to 7 days, while those of *Tabanus punctifer* require 14 days. However, in one case, a mass of *T. punctifer* eggs, after being kept a few days in the laboratory, was placed outdoors in the sun, with the result that the incubation period was shortened to 11 days. No doubt if the mass had been kept in the open from the time of oviposition a still shorter incubation period would have been recorded. The eggs of the unidentified species collected near Alturas, California, hatched in from 7 to 8 days under laboratory conditions.

Usually most of the eggs in a mass hatch at about the same time, but in the case of *Tabanus phaenops* I have found straggling larvæ emerging several hours after the majority of the larvæ were in the water at the bottom of the incubation vial.

LARVÆ

In arranging for the incubation of *Tabanus* eggs I am accustomed to use a large glass vial with water in the bottom. The egg mass is then suspended in the vial over the water, usually by placing the stem or leaf, to which the mass is attached, against the side of the vial, and press-

ing a cotton stopper into the mouth of the vial tight enough to hold the egg mass in position. When the larvæ emerge they fall into the water where they will remain alive for several days if undisturbed. The young larvæ of *Tabanus phaenops* and those of the unidentified species from Alturas sink to the bottom of the water and remain there alive and in good condition, without rising to the surface for air. On the other hand, newly emerged larvæ of *Tabanus punctifer* (plate XX, fig. 2) remain at the surface of the water constantly. In all these three species, the first molt occurs within a very few hours after hatching, and the cast skins are to be found floating in the water.

Mitzmain is the only author I find mentioning the molting of *Tabanus* larvæ. He noted 3 molts in the case of the larvæ of *Tabanus striatus* in the Philippines. The first molt begins with larvæ 7 days old, the majority molting before the 10th day. The second molt usually occurs after an interval of at least 4 days, and in some larvæ as much as 8 days, that is, when 15 to 18 days old. The third molt, which discloses the pupa, is very variable as to the time of its occurrence, some individuals not pupating until 3 months after the larvæ emerge from the eggs, the majority, however, pupating in a much shorter time. In fact, Mitzmain reared flies from deposition of egg to adult in 52 days.

As was stated in the beginning, the eggs are deposited above situations suitable for the development of the larvæ, so that the young larvæ when they drop from the egg mass immediately find themselves at home. If it is a species which lives in mud under water, the eggs will be found overhanging water, and upon dropping from the eggs the young larvæ will simply sink through the water to the mud beneath. If it is a species which prefers mud not submerged, the eggs will be found in the right position and the larvæ upon dropping to the mud, immediately burrow into it.

The food of *Tabanid* larvæ consists of small crustaceans and other minute forms of animal life of a soft texture. As the larvæ increase in size they may take coarser food. In breeding jars, I have seldom used any other food than earth worms cut into sections, and such small forms of life as may be gathered up with the mud placed in the jar. The larvæ are cannibalistic and eat each other readily. Mitzmain states that the larvæ of *Tabanus striatus* seem to prefer their own kind even when other food is available. For this reason it is well in attempting to rear larvæ of this genus, to place but one larva in each rearing jar. I have, however, in some cases successfully reared more than one individual in the same jar.

Sometimes it is much easier to locate the larvæ of a given species than the eggs. In most cases in my own experience, I have found the larvæ first. In the mountain valleys of Eastern California where considerable areas of pasture land are irrigated, the larvæ of *Tabanus phaenops* are to

be found in low places where the ground is continuously wet. They are usually quite near the surface, and can be located by scratching in the mud and grass humus with the fingers. Where there is an accumulation of old dead grass matted down in water, larvæ are frequently found in this grass. While this species prefers quite wet conditions, it is capable of withstanding considerable drought. In making a test of drought resistance I allowed one or two breeding jars containing larvæ of this species to dry out completely. One larva survived these conditions and produced a perfect adult. The exact length of the larval stage of this species has not yet been determined.

I have found the larvæ of *Tabanus punctifer* to be quite numerous along the shore of a lake in the Sierra Nevada Mountains. There was considerable debris,—weeds, grass, and bulrushes washed up on the shore. It was in this mass of partially decomposed vegetation kept saturated by the waves of the lake, that the larvæ seemed to flourish.

Another *Tabanus* larva of an unidentified species was found in the same general locality in the moist earth along the sides of small rivulets high up on the lower mountain slopes.

Prof. Hine records finding the larvæ of *Tabanus vivax* Osten Sacken in Ohio in the mud of a stream bed under riffles.

Likewise, King found larvæ of *Tabanus kingi* in the Egyptian Sudan, under stones in a shallow stream where the water rippled over and around the stones. The larvæ were usually found under rocks not covered by water. These larvæ possessed pseudopodia specially fitted for clinging to the stones and crawling up to the surface of the water to breathe.

The same writer found the larvæ of *Tabanus ditaeniatus* living in mud at the bottom of a more sluggish stream, and coming to the surface of the water periodically to breathe.

King also mentions rearing adults of *Tabanus par* from eggs obtained in a cage. The larvæ were kept in jars of mud, and this mud was allowed to dry up several times, and for a period of 57 days no growth was made, yet when normal conditions were restored, the larvæ began to grow and completed development. This is somewhat in line with my own experience with *Tabanus phaenops*, already mentioned.

In the Philippines, Mitzmain found larvæ and pupæ of *Tabanus striatus* in large numbers in sand at many points on the shore of Laguna de Bay.

Neave records finding *Tabanus* larvæ in Northern Rhodesia in July and August in the sand and mud of river banks. They often occurred, especially if the mud was inclined to be dry, at a depth of as much as 6 or 8 inches.

According to Hine some species of *Tabanus* larvæ live in water for a time and crawl out into dry ground, consequently one often finds Tabanid

larvæ by digging in dry ground along the borders of ponds. He also states that the larvæ of *Tabanus atratus* Fabricius are sometimes found in rotten logs. It is probable that Hine uses the term "dry ground" in a comparative sense, and that both the dry ground referred to and the rotten logs contained some degree of moisture.

The length of the larval period varies greatly in different species, and even among different individuals of the same species. The shortest periods for this stage are found, as might be expected, in the tropics. Thus, Mitzmain records a minimum larval period of 9 days for *Tabanus striatus* in the Philippines. The maximum period is given for this species as 3 months. Neave gives the larval period for Nyasaland Tabanids as 6 months or more.

In Ohio, Hine found in rearing *Tabanus lasiophthalmus* Macquart under laboratory conditions that in one instance the larval period was from June 30 to March 10, approximately 8½ months. In the case of the species which I have been studying in the Sierra Nevada Mountains, the larval periods have not yet been determined, but all signs point to periods extending over two winters. As a matter of fact, data on the larval periods of species of *Tabanus* are very meager.

PUPÆ

When the time for pupation arrives, the larva usually seeks drier quarters, though some moisture is usually necessary to maintain life during this period. Larvæ living in the mud of stream beds usually work their way to the drier soil of the stream banks in preparation for pupation. Pupæ of most species are much more difficult to locate in nature than larvæ. The length of the pupal period is usually comparatively short. Mitzmain gives the period for *Tabanus striatus* in the Philippines as from 3 to 7 days, while King records that of *Tabanus par* in the Anglo-Egyptian Sudan as 6 to 8 days. Neave states that this period in Nyasaland Tabanids varies from 10 to 16 or 18 days. In rearing *Tabanus lasiophthalmus* in Ohio, Hine found the pupal period to be 15 days.

My records show that under laboratory conditions in the Sierra Nevada Mountains this period in *Tabanus phaenops* is from 14 to 22 days, while that of *Tabanus punctifer* (plate XX, fig. 3) is 27 to 28 days.

LIFE CYCLE

The shortest life cycle from egg deposition to emergence of adult, which I find recorded, is 48 days, in the case of *Tabanus ditaeniatus* in the Anglo-Egyptian Sudan. King gives the life cycle as 48 to 131 days.

Mitzmain found the minimum life cycle of *Tabanus striatus* in the Philippines to be 52 days.

The life cycle of *Tabanus lasiophthalmus* was found by Hine in one instance to be about 9 months. He states that the cycle of *Tabanus stygius* probably requires two years.

As has already been indicated in discussing larval periods, it is probable that the species of *Tabanus* in the Sierra Nevada Mountains require two seasons for their life cycles.

HABITS OF ADULTS

Only female adult horse flies attack stock (plate XIX). The males are never found taking any interest whatever in warm-blooded animals. Their food consists of the nectar of flowers and other sweet substances. Females also feed readily on sweet substances. I have quite often captured a few in a fly trap baited with banana. It appears that the primary object of the blood meal is to enable the female to develop eggs, although this diet may also be taken for nourishment.

The males are usually to be found in the grass, or the foliage of trees, or on the trunks of trees, and when the females are not sucking blood they will usually be found in the same situations.

In temperate climates females are most active on still, sunshiny days. It is unusual to find them flying on cloudy days or when strong wind is blowing.

In taking a meal of blood a female *Tabanus* will usually insert and withdraw the beak several times, puncturing the skin of the host in a new place each time, before finishing the meal. The length of time occupied in taking a meal in cases observed by the writer has varied from about 3 to 11 minutes, and during this time the position may be changed 5 or 6 times. Mitzmain has seen *Tabanus striatus* in the Philippines feed for 23 minutes. I have allowed flies to bite my arm and feed to satiety. It is not a continuously painful process. The only part of the performance that is painful is the insertion of the beak, which takes but a few seconds. After that the drawing of the blood by the fly causes no sensation whatever in the arm. However, the habit of changing position so often during a meal is somewhat annoying.

Horses are much more nervous under the attacks of *Tabanus* than cows. The latter often allow the flies to feed without much of any attempt to brush them off, but a horse fights constantly. Where the attack is severe, the horses in a pasture will bunch up together for mutual protection in rubbing against each other. Under such conditions it is possible that each fly will attack several horses, being brushed off several times before the meal is finished. This makes an ideal condition

for the spread of disease, if there are diseased animals in the herd. This habit of bunching up under fly attack applies also to cattle, where the attack is severe.

I have never succeeded in obtaining any data on the number of blood meals a female will take. Mitzmain states that in the Philippines females of *Tabanus striatus* bite not oftener than once in 2 days.

CONCERNING CONTROL MEASURES

No universal remedy, or control measure, for horse flies can be given, owing to the diverse habits of the different species. In all cases, some knowledge of the life histories and habits of the species involved is necessary before any one can intelligently set in motion control measures, and I may say here that the life histories of very few species of *Tabanus* are now known.

In some cases drainage of the larval habitat would undoubtedly be a good control measure. But the degree of drought resistance of the species in question should be ascertained before placing reliance upon this method of control.

In Russia a species of *Tabanus* has the habit, in the adult form, of flying to water and dipping the abdomen. Porchinski, the Russian entomologist, advocates the oiling of the surface of the water as a control for this species. It appears that Porchinski has used this method with good results. He applied the equivalent of a half pint of kerosene to six square feet of water surface. If this was not sufficient to do the work, a like amount was used the next morning. It must be borne in mind, however, that not all species of *Tabanus* have this dipping habit, and that in order to make the measure effective, the water would have to be comparatively still, as otherwise the oil would soon pass off with the current.

Occasionally the importation of egg parasites may be an effective control measure. At the present time, *Tabanus punctifer* in the Antelope Valley, Mono County, California, is apparently largely controlled by an unidentified hymenopterous egg parasite.

Hine mentions the fact that in confinement small catfish eat the larvæ of *Tabanus stygius*. It is possible that the stocking with catfish of streams inhabited with *Tabanus* larvæ might have good results.

In the way of protection of animals from the attacks of adult flies, various devices have been tried, such as nets, hoods, etc. In the Sierra Nevada Mountains, I found in one locality, a very useful horse hood in use to ward off the attack of *Tabanus phaenops*. This species attacks most viciously about the head and neck of horses. The hood is a simple arrangement made of light canvas to slip over the head and neck, with eye and breathing holes at the proper places.

Various repellents, mostly of an oily nature, have been tried as sprays, by different investigators, but none of these has proven very satisfactory as the effect is not lasting.

BIBLIOGRAPHY

- Hine, J. S., 1903.—*Tabanidae of Ohio with a Catalogue and Bibliography of the Species from America North of Mexico.* Ohio State University Dept. Zool. and Ent., spec. paper, No. 5. 57 pp.
- Hine, J. S., 1904.—*Tabanidae of the Western United States and Canada.* Ohio State University, Contrib. Dept. Zool. and Ent., No. 21, pp. 217-248.
- King, H. H., 1908.—*Third Report of the Welcome Research Laboratories, Gordon Memorial College, Khartoum.*
- King, H. H., 1911.—*Some Observations on the Bionomics of *Tabanus ditaeniatus* Macquart, and *Tabanus kingi* Austen.* Bull. Ent. Research, vol. 1, pp. 265-274, fig. 7.
- Mitzmain, M. B., 1913.—*The Biology of *Tabanus striatus* Fab., the Horse Fly of the Philippines.* Philippine Journ. Sci., vol. 8 B, pp. 197-222.
- Neave, S. A., 1915.—*The Tabanidae of Southern Nyasaland with Notes on Their Life Histories.* Bull. Ent. Res., vol. 5, pp. 287-320.

CHAPTER XVII

Diseases Transmitted by Mosquitoes ¹

W. Dwight Pierce

Probably more entomologists and sanitarians are familiar with the facts of mosquito transmission of disease than with any other phase of our subject, but a review of their rôle will not be amiss, especially as it will be presented in a different form from that usually adopted in text books. In this volume all of the chapters on disease transmission are handled in one manner, that is, by a systematic arrangement of the organisms transmitted. We may perhaps get a new conception of the relation of mosquitoes to parasitic organisms by this arrangement. Those organisms which are parasitic only need to be listed in order that students take into account the possibility of confusing them with the pathogenic organisms being sought.

Teachers using these lectures as material for the study of their classes may find it of value to have the students make rearrangements of the subject by the name of the disease or the species of insects involved, or by the method of transmission.

In our study of the non-bloodsucking flies we found that the disease transmission was principally through the feces, although also through the vomit, but never by direct inoculation. In the discussion of the bloodsucking flies it was shown that they usually transmitted disease while in the act of sucking blood. All known cases of disease transmission by mosquitoes are by direct inoculation at the time of the bite. In dengue fever the organism has not been demonstrated; in malaria of all types we have a known organism which undergoes a definite life cycle in the mosquito; in filariasis we also have the mosquito serving as an intermediate host for the early stages of the worm.

For complete studies of the life history of the malaria organism in the mosquito refer to Hindle (1914) in which you will also find lists of *Anopheles* of the world, with tables for identification, tables of malaria carriers and much more of a valuable nature, which should be carefully studied. Many other works deal very carefully with the subject, however. The names of mosquitoes used in this and following lectures are on the authority of the late Frederick Knab.

¹This lecture was presented August 19 and issued August 23, 1918, and has been more or less modified to its present form.

DISEASES OF UNCERTAIN ORIGIN TRANSMITTED BY MOSQUITOES

DENGUE FEVER, one of the severe fevers of the tropics, sometimes called break-bone fever, occasionally occurs in the United States. It is undoubtedly caused by a living organism which requires over two days to reach the stage necessary to produce the symptoms of the disease when inoculated into human beings. It is so small that it will pass through the pores of a filter which will retain *Micrococcus melitensis*, which is only 0.4 micron in diameter. This minute organism is taken up by mosquitoes and transmitted to man. Graham-Smith and Ardate have observed small bodies in the red blood corpuscles, which are described as small, usually round, but sometimes elongate, bodies about one-fifth to one-third of the size of a red corpuscle. They divide up into minute granules, which become extra-corpuscular, and complete a cycle of schizogony. Graham (1903) fed *Culex quinquefasciatus* Say (*fatigans* Wiedemann), on dengue patients and claimed to have found his organism in the mosquitoes up to the fifth day after feeding. He succeeded, after an incubation period of four to six days, in infecting healthy people by the bites of mosquitoes fed on dengue patients in two series of experiments, claiming the transmission to be due to the *Culex*, but he states that *Aedes argenteus* Poirret (*Stegomyia fasciata* Fabricius) were present in many if not all of his experiments. Ashburn and Craig (1907) in the Philippines also claimed to have proved transmission by the bite of the same mosquito, but Cleland and Bradley (1918) challenge the results of both these investigations. Nevertheless, Bancroft (1906) conducted experiments obtaining two apparently successful cases of transmission of the disease by *Aedes argenteus*, ten and twelve days after these had bitten dengue patients, while in the three failures the test patients were bitten fifteen, fifteen and seventeen days after the mosquitoes fed on individuals suffering from dengue.

Observations made by Legendre in Hanoi led him to suggest *Aedes* (*Stegomyia*) as probably a carrier of the virus.

Cleland, Bradley, and McDonald (1918, 1919) conducted extensive experiments (1918) with both *Culex quinquefasciatus* (*fatigans*) and *Aedes argenteus* (*fasciata*) and obtained positive results with the latter in four out of seven tests, and negative results with the former in two tests. The mosquitoes after biting dengue patients were conveyed to districts where dengue fever did not exist. The incubation period in man in these cases was from six to nine and a half days. Later experiments (1919) corroborated this work.

Poliomyelitis was experimented on with negative results by Howard

and Clark, using *Culex pipiens* Linnaeus, *C. sollicitans* Walker and *C. cantator* Coquillett.

PLANT ORGANISMS TRANSMITTED BY MOSQUITOES

Thallophyta: Fungi

Myxococcidium stegomyiae Parker, Beyer and Pothier (1903) is a yeast normal to the mosquito *Aedes argenteus* (*Stegomyia calopus* Meigen). It was thought by its describers to be the causative organism of yellow fever, but this was disproven by the work of subsequent authors (Castellani and Chalmers, p. 1005).

Thallophyta: Fungi: Schizomycetes: Bacteriaceae

Bacterium anthracis Davaine, cause of ANTHRAX, was experimented upon with mosquitoes by Morris. *Psorophora sayi* (Dyar and Knab) and *Aedes sylvestris* (Theobald) Dyar and Knab commonly bite livestock in Louisiana and are very annoying. Out of 86 tests with these mosquitoes, feeding them on guinea pigs for different periods and at different times, from three hours before death to ten minutes after death, Morris obtained infection by the bite of the mosquito in 40 per cent of his tests.

ANIMAL ORGANISMS TRANSMITTED BY MOSQUITOES

Protozoa

Mastigophora: Binucleata: Haemoproteidae

Haemoproteus danilewskyi (Grassi and Feletti 1890), cause of an AVIAN ANEMIA, passes its cycle of schizogony or asexual multiplication in sparrows, larks, ravens, and birds of prey, and its cycle of sporogony or sexual multiplication in a species of *Culex*. It occurs in Europe, Africa, India, and America.

Haemoproteus noctuae Celli and San Felice (1901), cause of an AVIAN ANEMIA, passes its cycle of schizogony in the owls, *Glaucidium noctuae*, *Strix flammea*, and *Scops gin*, and its cycle of sporogony in *Culex pipiens* Linnaeus. Castellani and Chalmers (p. 295) give a detailed description of the life cycle as presented by Schaudinn, but in view of the fact that there is a belief that Schaudinn has confused this species with a Trypanosoma we will omit discussion. It is supposed to occur in Europe, North Africa, and America.

Haemoproteus syrni Mauer (1910), cause of an AVIAN ANEMIA, passes its cycle of schizogony in the wood owl, *Syrnium aluco*, and its sporogony in the mosquito, *Culiseta annulata* Schrank (*Theobaldia*).

Mastigophora: Binucleata: Leucocytozoidae

Leucocytozoon danilewskyi Ziemann (1898), cause of an AVIAN ANEMIA, passes its schizogony in the owls *Glaucidium noctuae* and *Syrnium aluco*, and its sporogony in the mosquito *Culex pipiens* Linnaeus. The mosquito sucks up from the blood of the bird the gametocytes or preliminary stages of the sexual forms. These are taken into the stomach of the mosquito. The microgametocytes or male forms escape from their capsules, and the nuclei break up into eight double chromosomes, which are reduced to eight simple chromosomes. These travel to the periphery and form the microgametes. The macrogametocytes develop into macrogametes. The gametes then conjugate and form the oökinetes, which are of three forms, male, female, and indifferent. These break up into very minute trypanosome-like bodies of the three forms which may divide by longitudinal fission. These are the forms which are inoculated into the owl by the bite of the mosquito. (See Castellani and Chalmers, p. 303.)

Mastigophora: Binucleata: Trypanosomidae

Throughout this volume Chalmers' new classification of the Trypanosome genera is adopted, as it gives an arrangement which most nearly corresponds to the biological relationships.

Castellanella brucei (Plimmer and Bradford 1899) (*Trypanosoma*), the cause of NAGANA and JINJA, African animal diseases, is normally transmitted by species of Glossina, but Martin, Lehoeuf, and Roubaud (1908) successfully transmitted the disease from an infected to a healthy cat by a species of *Mansonia*.

Castellanella evansi (Steel 1885) (*Trypanosoma*), the cause of SURRA in animals, is normally carried by biting flies, especially the Tabanidae, but Mitzmain (1914) records experiments with mosquitoes in which the parasite lived 42 hours in *Aedes argenteus* (*calopus*) and 30 hours in *Culex quinquefasciatus* (*fatigans*) and *C. ludlowi* Blanchard.

Castellanella gambiense (Dutton 1902) (*Trypanosoma*), the cause of GAMBIAN SLEEPING SICKNESS of man, is normally carried by tsetse flies of the genus Glossina, but Roubaud and Lafont (1914) gave experimental evidence that it can be transmitted by *Aedes argenteus* (*Stegomyia calopus*). Heckenroth and Blanchard (1913) succeeded in transmitting the disease by the bite of *Mansonioides uniformis* Theobald from guinea pig to guinea pig, when both were in the same cage, and also when not in contact, 24 hours after the mosquito had bitten the infected animal.

Castellanella rhodesiense (Stephens and Fantham 1910) (*Trypanosoma*), the cause of RHODESIAN SLEEPING SICKNESS, is

normally carried by the tsetse flies of the genus *Glossina*, but Roubaud and Lafont (1914) have obtained experimental transmission with *Aedes argenteus* (*Stegomyia calopus*).

Trypanosoma (*sens. lat.*) *noctuae* Schaudinn (1904), which may be confused with *Haemoproteus noctuae* Celli and San Felice, mentioned above, passes its schizogony in the owl, *Glaucidium noctuae*, and its sporogony in the mosquito, *Culex pipiens*.

Trypanosoma (*sens. lat.*) *ziemanni* Schaudinn, another organism badly confused with *T. noctuae* and *Leucocytozoon danilewskyi*, is recorded from *Culex pipiens* fed on the owl, *Glaucidium noctuae*.

A *Trypanosoma* sp. was recovered by Durham from *Aedes argenteus* (*Stegomyia fasciata*) which had fed on bats (*Phyllostomus* sp.), and another *Trypanosoma* was recovered from a *Culex* by Mathis.

Mastigophora: Binucleata: Leptomonidae

Crithidia fasciculata Leger (1902) is a parasite of *Anopheles maculipennis* Meigen and *Culex quinquefasciatus* (*fatigans*). Laveran and Franchini (1914) record *Leishmania*-form bodies, possibly of this species, in mice infected from *Anopheles maculipennis*.

Leishmania brasiliensis Vianna (1911), the cause of ulcers known as BOUBA or ORAL LEISHMANIASIS of man in Southern Brazil and Northern Paraguay, is thought by Brumpt and Pedroso to be carried by Tabanidae or Culicidae.

Leishmania donovani (Laveran and Mesnil 1903) is the cause of INDIAN KALA AZAR. It has been proven that the bedbug can carry it, but the normal carrier is unproven. Franchini (1911) fed *Anopheles* near *claviger* Fabricius on cultures of this organism and found that the parasite persisted and developed in the mosquitoes for at least 48 hours. Patton (1907) obtained no results in experiments with *Culex quinquefasciatus* (*fatigans*), *Stegomyia ingens* and *Anopheles stephensi* Liston. Mackie (1915) also failed in his experiments with *Culex* and *Anopheles*.

Leishmania tropica (Wright 1903) is the cause of ORIENTAL SORE of man, which goes under various names, and it may really be a complex species. In investigating Bagdad sore Wenyon (1911a) fed *Aedes argenteus* (*Stegomyia fasciata*) on sores, and demonstrated in the mosquitoes the flagellate forms of the parasite up to 48 hours, but his transmission experiments failed. He later (1911b) succeeded in getting this mosquito to take up the parasites and demonstrated developmental stages in the gut. No evidence of infection could be found in experiments with *Culex quinquefasciatus* (*fatigans*).

Leptomonas algeriense Sargent and Sargent (1906) is parasitic in *Culex pipiens* and *Aedes argenteus* (*calopus*).

Leptomonas culicis (Novy, MacNeal, and Torrey, 1907) is native to *Culex pipiens* and *Culex quinquefasciatus* (*fatigans*). Fantham and Porter (1915, 1916) fatally infected birds by feeding them on infected insects, proving it experimentally pathogenic to *Passer domesticus* and *Chelidon urbica*.

Mastigophora: Binucleata: Plasmodiidae

The Plasmodiums are the causative organisms of malaria, which are all carried by the bite of mosquitoes. The cycle of schizogony occurs in man,

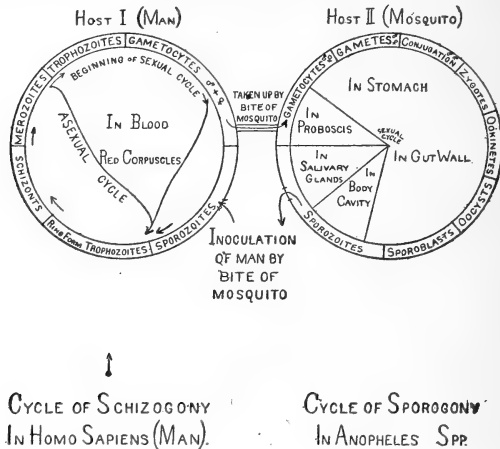

LIFE CYCLE OF PLASMODIUM

THE CAUSE OF PERNICIOUS MALARIA.
FIG. 47. (Pierce.)

and of sporogony in the mosquito (fig. 47). This life cycle is very clearly set forth in many textbooks and should be studied carefully by all students. Briefly it takes place as follows, starting with the minute sporozoite inoculated in man by the mosquito. This sporozoite is an elongate sickle-shaped body which bores into a red blood cell, and there forms an amoeboid shaped body known as the trophozoite, which gives off pseudopodia that absorb nourishment from the cell. At first this trophozoite is of uniform mass, but soon a vacuole is formed, and it may assume a ring form. The trophozoite grows, withdraws its pseudopodia and becomes a schizont. This divides into many merozoites, which burst the cell and escape into the blood stream. This completes the cycle of schizogony which may begin again by the merozoite entering a red blood cell and becoming a trophozoite. On the other hand it may develop into

a type of trophozoite which forms sexual bodies known as macrogametocytes and microgametocytes. These are the bodies which, when taken up by a mosquito, develop in the mosquito's body through the cycle of sporogony. In the stomach of the mosquito the microgametocytes divide into many tiny, elongate microgametes. The macrogametocytes change into macrogametes, and then conjugation of the gametes takes place. The resulting zygote is spherical, but it soon elongates into a small, worm-like body which is actively motile. It is then known as the oökinete. In this stage it bores into the epithelium of the gut wall and becomes rounded and thinly encysted. When encysted it is known as the oöcyst. In this form it grows considerably in size and divides into sporoblasts, which divide into sporozoites. These tiny forms migrate into the salivary glands and are inoculated into a man at the time of a blood feast.

The species of human malaria are *Plasmodium vivax* Grassi and Feletti (1892) causing the tertian disease, *Plasmodium malariae* Laveran (1881), causing the quartan disease, and *Laverania falciparum* (Welch, 1897) (also known as *Laverania malariae* Grassi and Feletti, 1890, or *Plasmodium falciparum*), causing subtertian, malignant tertian, or aestivo-autumnal malaria.

Many species of mosquitoes of the group Anophelinæ have been charged with carriage of malaria but in many cases the evidence does not show what species of organism is carried. The evidence is briefly summarized below (see also Hindle, pp. 96-107).

MALARIA OF UNKNOWN SPECIES.—The following species of mosquitoes are recorded as carriers or thought to be carriers of some form of malaria. These Anopheles are often arranged in various subgenera, which are, however, omitted from our discussion.

Anopheles aitkeni James (*fragilis* Theobald) is suspected as a malaria carrier by Daniels and Christophers (Hindle, p. 29).

A. algeriensis Theobald was found by Sergent and Sergent in Algeria to be a carrier in nature, the sporozoite state being found.

A. apicimaculata Dyar and Knab has been suspected to be a carrier in Central America, but Darling records negative results.

A. arabiensis Patton was found in nature carrying sporozoites by Patton in Aden Hinterland (Hindle).

A. ardensis Theobald appears to Castellani and Chalmers (p. 665) as a probable carrier of malaria in Natal.

A. boliviensis Theobald (*lutzii* Theobald) is suspected by Lutz to be a carrier in Brazil on what Knab (1913) considers insufficient grounds.

A. braziliensis Chagas is cited by Brumpt (1913, p. 748) as a possible carrier of malaria in Brazil.

A. coustani Laveran of Madagascar is listed as a malaria carrier by Castellani and Chalmers.

A. culicifacies sergentii Theobald of Algeria is listed as a malaria carrier by Castellani and Chalmers.

A. farauti Laveran is recorded as carrying malaria in the New Hebrides (Brumpt, p. 741).

A. grabhamii Theobald, of the West Indies and South America, is listed by Castellani and Chalmers as a malaria carrier (p. 665).

A. jamesii Theobald is listed by Castellani and Chalmers as a carrier of malaria (p. 665).

A. jeyporensis James is a carrier of malaria in India (Brumpt, p. 746).

A. karwari James and Liston was suspected by Staunton as a carrier, but Christophers (1916) states that there is no evidence against it.

A. maculipes Theobald is cited by Brumpt as a possible carrier in Brazil.

A. martini Laveran is regarded on epidemiological grounds by Laveran as a malaria carrier in Cambodia. (Castellani and Chalmers, p. 665.)

A. mauritanus Grandprè (*ziemanni* Grünberg) is regarded by Ross as a doubtful carrier, not actively transmitting in Mauritius. Its synonym *ziemanni* is recorded by Castellani and Chalmers as a carrier in Africa.

A. mauritanus paludis Theobald is recorded as a carrier in West Africa by Castellani and Chalmers.

A. minimus Theobald (*febrifer*) is according to Walker and Barber (1914, the most important mosquito concerned in the epidemiology of malaria in the Philippines, being susceptible to infection and having a high avidity for blood.

A. minimus christophersi Theobald is recorded by Castellani and Chalmers as a carrier in India.

A. nimba Theobald of Brazil is listed by Castellani and Chalmers as a carrier.

A. pitchfordi Tower of Africa is recorded as a probable carrier by Castellani and Chalmers.

A. punctulata Dönitz is listed as a carrier in New Guinea by Castellani and Chalmers.

A. pursati Laveran is considered by Laveran on epidemiological evidence a carrier in Cambodia.

A. rhodesiensis d'thali Patton at Aden is cited as a possible carrier by Patton (Hindle).

A. sinensis pseudopictus Grassi is recorded by Castellani and Chalmers as a carrier in Italy.

A. turkhudi chaudoyei Theobald of Algeria is recorded by Castellani and Chalmers as a carrier.

A. turkhudi myzomyifacies Theobald was taken in nature carrying sporozoites of Plasmodium in Algeria by Sergent and Sergent (Hindle).

A. vincenti Laveran is recorded by Laveran as a carrier in Tonkin (Castellani and Chalmers).

A. willmori James of Tonkin was taken by Mrs. Adie in nature carrying sporozoites of Plasmodium (Hindle).

Of the above list we may consider therefore as proven malaria carriers *algeriensis*, *arabiensis*, *minimus*, *turkhudi myzomyifacies*, and *willmori*. In the other cases the evidence is not sufficient.

SUBTERTIAN MALARIA.—Caused by *Laverania falciparum* Welch (1897) (*Laverania malariae* Grassi and Feletti 1890). This fever is also called tertian aestivo-autumnal and malignant tertian malaria. Records of transmission have been made for the following mosquitoes:

Anopheles albimanus Wiedemann (*albipes* Theobald) is the commonest carrier in Central and Tropical South America. Seventy per cent of those fed by Darling (1910) became infected. He traced development to the sporozoite stage.

A. annulipes Walker, a common Australian species, has been shown by Kinoshita to carry this organism.

A. argyrotarsis Robineau-Desvoidy is regarded as an undoubted carrier by Knab (1913) and Ludlow (1914) in the West Indies and South America. Although Darling found zygotes in nature, Hindle questions the species of organism.

A. barbirostris Van der Wulp of India, Malaysia, and China was recorded as carrier by Stephens and Christophers (Hindle).

A. costalis Loew was shown by Ross, Annett, and Austen (1900) to carry this organism in Tropical Africa.

A. crucians Wiedemann was definitely proven a carrier in Louisiana by King (1916) who found oöcysts and sporozoites in his experimentally-fed mosquitoes. He found 75 per cent of his mosquitoes infected.

A. culicifacies Giles was shown by Stephens and Christophers to be the commonest Indian carrier.

A. formosaensis II Tsuzuki was found to be a carrier in Formosa by Tsuzuki (1902) who proved the presence of sporozoites.

A. fuliginosus Giles was shown to be the carrier in India by Stephens and Christophers who demonstrated zygotes in the mosquito.

A. funestus Giles is an active and important malaria carrier in Tropical Africa, its connection with this organism being demonstrated by Daniels.

A. maculatus Theobald is a common carrier in India and the Malay States, its relation to this organism being shown by Staunton.

A. maculipalpis indiensis Theobald a common carrier in Northwest Terai, India, was proven a carrier by Stephens and Christophers who demonstrated zygotes.

A. maculipennis Meigen is the common malaria carrier in Europe, proven by many authors since Grassi.

A. minimus aconitus Dönitz and its synonyms *albirostris* Theobald, *cohæsus* Dönitz, and *formosaensis I* Tsuzuki, has been shown to be a carrier of malaria in Malaysia and India. Staunton proved the carriage of this organism by *albirostris* and Tsuzuki by *formosaensis I*.

A. pseudopunctipennis Theobald (*franciscanis* McCracken) was proven a carrier in Panama by Darling (1910) who found zygotes in his experimental mosquitoes.

A. punctipennis Say was first proven a carrier of this organism in Louisiana by King (1916) who found 20 per cent of his experimental mosquitoes infected, and later Mitzmain (1917) corroborated this by finding 27 per cent of his experimental mosquitoes infected.

A. quadrimaculatus Say was first proven a carrier of this organism in the United States by Thayer (1900), and later corroborated by Woldert in 1901, and Hirshberg (1904), and finally by King (1916) who found 23 per cent of his mosquitoes, fed on a certain case, infected.

A. rossii Giles was shown by Stephens and Christophers to be a carrier in India, but not commonly.

A. sinensis Wiedemann of Southeastern Asia was recorded as a carrier by Christophers (1916).

A. tarsimaculatus Goeldi was found by Darling (1910) in Panama to be infected in 100 per cent of his experiments with this organism.

A. theobaldi Giles was shown to be a carrier in India by Stephens and Christophers, who demonstrated zygotes in the experimental mosquitoes.

A. turkhudi Liston was shown to be a carrier in India by Stephens and Christophers, who demonstrated zygotes in the experimental mosquitoes.

A. umbrosus Theobald was shown to be a carrier in the Malay States by Staunton, who demonstrated zygotes in the experimental mosquitoes.

For American students of aestival-autumnal or subtertian malaria, the following species are therefore of importance—*albimanus*, *argyrotarsis*, *crucians*, *pseudopunctipennis*, *punctipennis*, *quadrimaculatus*, and *tarsimaculatus*. For those of our troops who go abroad the other species listed above are of greater importance.

QUARTAN MALARIA.—This type of malaria is caused by *Plas-*

modium malariae Laveran (1881). The following species of mosquitoes have been proven to be carriers:

Anopheles algeriensis Theobald was proven by Sergent and Sergent (1906) to be a carrier in Algeria.

A. costalis Loew was shown by Ross, Annett, and Austen (1900) to be a carrier in Africa.

A. culicifacies Giles is the most common Indian carrier and its relationship to this organism was proven by Stephens and Christophers.

A. fuliginosus Giles is not an active carrier in India but Stephens and Christophers demonstrated the zygotes of this organism.

A. funesta Giles is an active and important carrier in Africa, its rôle being proven by Ross, Annett, and Austen (1900).

A. maculipennis Meigen is the common European carrier.

A. myzomyiifacies Theobald is a carrier in Algeria according to Sergent and Sergent (1906).

A. quadrimaculatus Say was proven a carrier in the United States by Beyer, Pothier, Couret, and Lemann (1902).

A. rossii Giles was proven capable of transmitting this organism in India by Stephens and Christophers.

A. sinensis Wiedemann was shown to be a carrier in China and South-eastern Asia by Tsuzuki.

A. stephensi Liston is claimed to be a carrier in India by Christophers (1916).

A. theobaldi Giles was proven a carrier in India by Stephens and Christophers, who demonstrated zygotes in experimental mosquitoes.

Thus it will be seen that only one species of mosquito in America, *quadrimaculatus*, has been demonstrated to be a carrier of quartan malaria.

TERTIAN MALARIA.—Tertian malaria is caused by *Plasmodium vivax* Grassi and Feletti (1892). It has been shown to be carried in various parts of the world by the following mosquitoes:

Anopheles albimanus Wiedemann was found to be a common carrier in Panama by Darling (1910), who demonstrated zygotes and sporozoites.

A. barbirostris Van der Wulp is recorded by Christophers (1916) as a carrier in India.

A. bifurcatus Linnaeus is recorded as a carrier in Europe by Grassi.

A. costalis Loew was shown by Ross, Annett, and Austen to be a carrier in Africa.

A. crucians Wiedemann was proven by Mitzmain (1916) to be capable of carrying this organism in Louisiana. Sporozoites were obtained.

A. culicifacies Giles is recorded as the commonest carrier in India by Stephens and Christophers.

A. fuliginosus Giles is recorded as a carrier in India by Christophers (1916).

A. funesta Giles is the most active and important common carrier in Africa according to Ross, Annett, and Austen.

A. intermedium Chagas is a carrier in Brazil according to Cruz.

A. jesoensis Tsuzuki is recorded as a carrier by Christophers (1916).

A. listoni Liston is an active and important carrier in certain terai tracts in India, recorded by Kinoshita.

A. maculatus Theobald is recorded as a carrier in India by Christophers (1916).

A. maculipalpis Giles is recorded as a carrier in Asia by Christophers (1916).

A. maculipennis Meigen is a common carrier in Europe.

A. mediopunctatus Theobald is a carrier in Brazil according to Cruz (1910).

A. minimus Theobald is recorded as a carrier in India by Christophers (1916).

A. pharoensis Theobald is recorded as a carrier in Egypt by Newstead, Dutton, and Todd (1907).

A. pseudomaculipes Chagas is recorded as a carrier in Brazil by Cruz (1910).

A. punctipennis Say was first proven a carrier in the United States by King (1916). Sporozoites were found. Later Mitzmain (1916) corroborated this record.

A. quadrimaculatus Say was first proven a carrier in the United States by Thayer (1900). This was subsequently proven by other authors, including King (1916).

A. rossii Giles is recorded as a carrier in India by Christophers (1916).

A. sinensis Wiedemann is recorded as a carrier by Kinoshita in China.

A. stephensi Liston is recorded as a carrier in India by Liston and by Bentley.

A. superpictus Grassi is recorded as a carrier in Europe by Grassi and by Bignami and Bastianelli.

A. theobaldi Giles is recorded as a carrier in India by Christophers (1916).

A. turkhudi Liston is recorded as a carrier in India by Christophers (1916).

A. turkhudi hispaniola Theobald is a common carrier in Algeria and Southern Spain according to Sergent and Sergent.

Thus we find tertian malaria in America carried by *albimanus*, *cru-*

cians, *intermedium*, *mediopunctatus*, *pseudomaculipes*, *punctipennis*, and *quadrifasciatus*, three of which species occur in the United States.

AVIAN MALARIA.—Several forms of avian malaria are known.

Plasmodium danilewsky Grassi and Feletti (1890), a malaria of sparrows, partridges, finches, and crows is carried by *Culex quinquefasciatus* (*fatigans*), *C. pipiens*, *Aedes nemorosus* Meigen, and *A. argenteus* (*calopus*) according to various textbooks.

Plasmodium relictum, a malaria of the canary, was proven by Sargent and Sargent (1918) to be carried by *Culex pipiens*.

Mastigophora: Spirochaetacea: Spirochaetidae

Spiroschaudinna culicis Jaffé (1907) was found by Jaffé in the gut and malpighian tubules of *Culex pipiens* and *Anopheles maculipennis*.

Leptospira icteroides Noguchi (1919) has been proven to be the causative organism of YELLOW FEVER in investigations made in Ecuador. Noguchi obtained pure cultures by inoculation of guinea pigs with blood of yellow fever patients. He isolated the organisms from three patients and also from mosquitoes and inoculated them into guinea pigs, dogs, and marmosets (*Midas oedipus* and *M. geoffroyi*). The organism is filterable.

This dread disease of the tropics has been studied for years and many other investigators have sought the organism without success. Seidelin, in 1909, described a parasite belonging to the Babesiidae in the blood and organs of yellow fever patients, as *Paraplasma flavigenum*, which he considered to be the cause of yellow fever, but this organism was not generally accepted as the causative organism. The incubation period in man is three days and the mosquito to become infected must bite a patient during the first three days of his illness, and then twelve days must elapse before the infected mosquito can transmit the disease to man.

The organism of yellow fever may pass through the pores of a Pasteur Chamberlain B. filter. The disease can be conveyed by subcutaneous injection of the blood taken from the general circulation of a person sick with the disease during the first three days of the disease, but can be carried naturally only by the bite of a mosquito (*Aedes argenteus*, usually called *Stegomyia fasciata*), that at least 12 days before has fed on the blood of a person sick with this disease, during the first three days of his illness. But Noguchi transmitted it by the bite of a mosquito from a diseased to a healthy guinea pig in 8 days and 8-12 days, and from man to guinea pig, 23 days after biting man. Prophylaxis therefore consists in prevention of biting by mosquitoes, and mosquito extermination.

There is no definite proof that the virus can be transmitted heredita-

rily in the mosquito. There is indication of a granular stage of development. The optimum temperature for development is 26° C.

The earliest suggestions of the possibility of mosquito carriage of yellow fever were made by Josiah C. Nott in 1848, and Dowler in 1855. In 1881 Dr. Carlos J. Finlay made definite claims that the fever is carried by the bite of a mosquito. In 1900 during the American occupation of Cuba a commission composed of Doctors Walter Reed, James Carroll, Aristides Agramonte, and Jesse W. Lazear began the investigation of the causation of yellow fever by first definitely discrediting the theory of the Italian bacteriologist, Dr. Giuseppe Sanarelli, that his *Bacillus icteroides* was the cause. This they proved to be identical with *Bacillus sui-pestifer*. They then conferred with Dr. Finlay and began a thorough investigation of the mosquito transmission theory. Dr. Finlay suggested the common house mosquito, *Aedes argenteus* (*Stegomyia fasciata*) as the cause. The members of the commission submitted themselves to the making of the tests. Dr. Carroll was the first to take the fever, being bitten twelve days after a mosquito had bitten a yellow fever patient. In four days he took the fever. A week later Dr. Lazear, while conducting experiments, was bitten by a mosquito, which he allowed to engorge, but to which he paid little attention. In five days he took the fever and died in a week. In the course of experiments ten cases of fever were produced at will by the application of infected mosquitoes, and all other possible means of infection proved useless (see Reed, etc.).

Dr. Guiteras (1901) confirmed the transmission of yellow fever by *Aedes argenteus* (*Stegomyia fasciata*) in seven cases, three of which proved fatal. Later a French commission, Marchoux, Salimbeni and Simond (1903) in Brazil, and American commissions composed of Parker, Beyer, and Pothier in Mexico (1903), and Rosenau, Parker, Francis, and Beyer (1905), corroborated the transmission of the disease by this mosquito. The last named authors tabulate the whole series of transmission experiments showing that in 40 cases of transmission by mosquito bite, the incubation period after the bite exceeded three days and a fraction in only ten cases, and was possibly less than three whole days in only two cases. The maximum authentic record of the incubation period is six days and two hours.

Metazoa

Platyhelminia: Fasciolidae

A *Clinostomum* is recorded by Soperker (1918) which passes its first stage in a snail, *Planorbis exustus*, and is found as a cercaria in the larvæ and adults of *Culex quinquefasciatus* (*fatigans*) and *Anopheles*

rossii. Fish swallowing the mosquito larvæ take up the worm, which continues its development toward maturity. The final host is not known.

*Nemathelminthes: Nematoda: Filariidae*²

Acanthocheilonema perstans (Manson 1891), the cause of a form of human FILARIASIS in Africa, is probably carried by biting flies. Hodges in Uganda obtained an incomplete cycle in *Mansonioides africanus* Theobald (*Panoplite*), *Aedes argenteus* (*calopus*), *A. sugens* Wiedemann, *Anopheles costalis* Loew, and a *Culex*, and negative results with a long series of mosquitoes (Dyé, 1905). Low (1903) obtained incomplete development in *Taeniorhynchus fuscopennatus*.

Dirofilaria immitis (Leidy, 1856), cause of CANINE FILARIASIS, has been proven by Noè, Dyé (1908), Grassi, and Fülleborn (1912) to pass its intermediate stages in the following mosquitoes—*Anopheles maculipennis* Meigen (*claviger* Fabricius), *A. algeriensis* Theobald, *A. bifurcatus* Linnaeus, *A. sinensis* Wiedemann (*pseudopictus* Grassi), *A. superpictus* Grassi, *Culex quinquefasciatus* Say (*fatigans* Wiedemann), *C. malariae* Grassi, *C. penicillaris* Rondani, and *Aedes vexans* Meigen (*Culex*) exceptionally in *C. pipiens*, and with difficulty in *Aedes argenteus* (*Stegomyia calopus*). The microfilaria or embryo worms are taken up by the mosquito with the blood of the dog. They soon pass from the stomach into the Malpighian tubules. In ten days their development is complete and they migrate towards the head and into the proboscis. When an infected mosquito containing filariæ in its proboscis feeds on a dog, the worms escape by boring through a delicate membrane which unites the labellæ, and thus get on the surface of the skin. If this is sufficiently moist they penetrate the epidermis and may be found in the subcutaneous tissues, whence they work toward the heart and great vessels of the dog and there develop into adults.

Dirofilaria repens Railliet and Henry (1911), cause of SUBCUTANEOUS CANINE FILARIASIS, passes its intermediate stages in the mosquito *Aedes argenteus*, its development having been demonstrated by Bernard and Bauche (1913). Its life history is quite similar to that of *D. immitis*.

Filaria bancrofti Cobbold (1877), the cause of HUMAN FILARIASIS or ELEPHANTIASIS, passes its intermediate stages in the mosquitoes. Complete development has been demonstrated in *Anopheles rossi* Giles in India by James; *A. costalis* Loew in West Africa by Annett, Dutton, and Elliot; *Culex pipiens* in China by Manson; *C. quinquefasciatus* Say (*fatigans* Wiedemann, *ciliaris* Bancroft, *nigrithorax skusei* Giles) in China by Manson, in South Carolina by Francis, in Australia by Ban-

²For further discussion of the following worms see Chapter V.

croft, in the West Indies by Lebrede (under the name *pipiens*) and also by Law, in the Philippines by Ashburn and Craig, and in India by Cruikshank and Wright; *Aedes pseudoscutellaris* Theobald in Fiji; *Mansonioides africanus* Theobald by Daniels in Nyasaland; *M. uniformis* Theobald, and *Aedes argenteus* Poirret (*Stegomyia calopus* Meigen, *A. fasciata* Fabricius, *Culex taeniatus* Meigen) in Nigeria by Daniels, and in the West Indies by Law.

Complete development has not been demonstrated as forms have not been actually seen in the proboscis, although advanced stages have been recorded in *Anopheles sinensis* Wiedemann (*minutus* Theobald, *pseudopictus* Grassi, *peditaeniatus* Leicester, *nigerrimus* Giles) and *barbirostris* Van der Wulp in Malaysia by Leicester; *A. argyrotarsis* Robineau-Desvoidy in West Indies by Law; *A. albimanus* Wiedemann (*albipes* Theobald) in West Indies by Vincent; *Mansonioides annulipes* Theobald in Malaysia by Leicester, and in Australia by Bancroft; *Mansonia pseudotitillans* Theobald; *Culex microannulatus* Skuse; *C. gelidus* Theobald, and *C. sitiens* Wiedemann, *Aedes perplexa* Leicester, *A. scutellaris* Walker, *Scutomyia albolineata* Theobald and *Taeniorhynchus domesticus* Leicester in Malaysia by Leicester.

Francis (1919) reports absolutely negative results with *Aedes argenteus* (*calopus*) in South Carolina.

The embryo microfilaria enter the mosquito's stomach with the blood. They rupture the sheaths which contain them, pierce the walls of the stomach and find their way to the muscles of the thorax, where they develop. They finally work into the proboscis and escape during the act of feeding, through Dutton's membrane, as worked out by Lebrede (1905). They enter the skin through the bites or through pores.

Filaria demarquayi Manson (1897), another cause of HUMAN FILARIASIS, was found by Fülleborn to pass its immature stages in the thoracic muscles of *Aedes argenteus* (*calopus*). Mense also records *Culex quinquefasciatus* and *Anopheles albimanus* as hosts.

Nemathelminthes: Nematoda: Mermithidae

Agamomermis culicis Stiles (1903) is recorded from *Culex sollicitans* Walker in the United States.

From a purely American standpoint we must guard against mosquitoes as carriers of malaria, yellow fever, dengue, and filariasis, but troops operating in Mediterranean countries would also have to consider possible transmission of tropical sores and Kala Azar. In South America other forms of sores; in Africa sleeping sicknesses may be carried by mosquitoes.

The burden of all this evidence is that mosquitoes should not be

permitted to breed near human habitations, and especially near Army establishments.

REFERENCES

- Ashburn, P. M., and Craig, C. F., 1907.—*Philippine Journ. Science*, vol. 2B, pp. 1-14, 93-152.
- Bancroft, T. L., 1906.—*Australian Med. Gaz.*, vol. 25, pp. 17, 18.
- Bernard, P. N., and Bauche, F., 1913.—*Bull. Soc. Path. Exot.*, vol. 7, No. 1, pp. 89-99.
- Beyer, G. E., Pothier, O. L., Couret, M., and Lemann, I. I., 1902.—*New Orleans Med. and Surg. Journ.*, vol. 54, pp. 419-480.
- Brumpt, E., 1912.—*Précis de Parasitologie*.
- Castellani, A., and Chalmers, A. J., 1913.—*Manual of Tropical Medicine*, 2nd edit.
- Chalmers, A. J., 1918.—*Journ. Trop. Med. and Hyg.*, vol. 21, No. 22, pp. 221-224.
- Christophers, S. R., 1916.—*Indian Journ. Med. Research*, vol. 3, No. 3, pp. 454-488.
- Cleland, J. B., Bradley, B., and McDonald, W., 1918.—*Journ. Hygiene*, vol. 16, No. 4, pp. 317-418, 9 charts.
- Cleland, J. B., Bradley, B., and McDonald, W., 1919.—*Journ. Hygiene*, vol. 18, No. 3, pp. 217-254.
- Darling, S. T., 1910.—*Studies in Relation to Malaria. Isthmian Canal Commission*, pp. 1-38.
- Dyé, L., 1905.—*Archiv. de Parasit.*, vol. 9, pp. 5-77.
- Fantham, H. B., and Porter, A., 1915.—*Ann. Trop. Med. and Parasit.*, vol. 9, No. 4, pp. 543-558.
- Fantham, H. B., and Porter, A., 1916.—*Journ. Parasit.*, vol. 2, No. 4, pp. 149-166.
- Franchini, G., 1911.—*The Lancet*, vol. 2, p. 1268.
- Francis, Edward, 1919.—*U. S. Treas. Dept., Hygienic Lab., Bull.* 117, 34 pp., 10 plates.
- Graham, H., 1903.—*Journ. Trop. Med.*, vol. 6, pp. 209-214.
- Grassi, B., and Feletti, 1891.—*Centralbl. f. Bakt. und Parasitenk.*, vol. 9, p. 463.
- Guiteras, J., 1900-1901.—*Revista de Med. Trop.*, vol. 2, No. 10, pp. 157-182.
- Heckenroth, F., and Blanchard, M., 1913.—*Bull. Soc. Path. Exot.*, vol. 6, pp. 442-443.
- Hindle, E., 1914.—*Flies in Relation to Disease. Blood-sucking Flies.* Cambridge Univ. Press. (Gives Bibliography of Malaria Transmission, pp. 163-165.)

- Howard, C. W., and Clark, P. F., 1912.—*Journ. Exper. Med.*, vol. 16, No. 6, pp. 850-859.
- Jaffé, J., 1907.—*Arch. f. Protistenk.*, vol. 9, pp. 100-107.
- King, W. V., 1916a.—*Amer. Journ. Trop. Dis. and Prev. Med.*, vol. 3, No. 8, pp. 426-432.
- King, W. V., 1916b.—*Journ. Exper. Med.*, vol. 23, No. 6, pp. 703-716.
- Knab, F., 1913.—*Amer. Journ. Trop. Dis. and Prev. Med.*, vol. 1, pp. 33-43.
- Laveran, A., and Franchini, G., 1914.—*Bull. Soc. Path. Exot.*, vol. 7, pp. 605-612.
- Law, G. C., 1903.—*Brit. Med. Journ.*, vol. 1, pp. 722-724.
- Lebrede, M. G., 1905.—*Journ. Infect. Diseases*, Suppl. No. 1, pp. 332-352.
- Ludlow, C. S., 1914.—U. S. War Dept., Office Surgeon Genl., bull. 4, pp. 1-94.
- Mackie, F. P., 1915.—*Indian Journ. Med. Research*, vol. 2, pp. 942-949.
- Marchoux, E., Salimbeni, A., and Simond, P. L., 1903.—*Rapport de la Mission Française*, Ann. Inst. Pasteur, November, vol. 17, pp. 665-731.
- Martin, G., Leboeuf, and Roubaud, E., 1908.—*Bull. Soc. Path. Exot.*, vol. 1, pp. 355-358.
- Mitzmain, M. B., 1914.—U. S. Treas. Dept., Hygienic Lab., bull. 94.
- Mitzmain, M. B., 1916.—*Public Health Reports*, May 12, pp. 1172-1177.
- Mitzmain, M. B., 1917.—*Public Health Reports*, July 6, pp. 1081-1083.
- Morris, H., 1918.—*Louisiana Agr. Exp. Sta.*, bull. 163, 11 pp.
- Noguchi, H., 1919.—*Journ. Amer. Med. Assoc.*, vol. 72, No. 3, pp. 187-188.
- Noguchi, H., 1919.—*Journ. Exper. Med.*, vol. 29, No. 6, pp. 547-596; vol. 30, No. 1, pp. 1-29; No. 2, pp. 87-107; No. 4, pp. 401-410.
- Parker, H. B., Beyer, G. E., and Pothier, O. L., 1903.—U. S. Publ. Health & Marine Hosp. Serv., Yellow Fever Institute, bull. 13, 48 pp.
- Patton, W. S., 1907.—*Scient. Mem. Officers Med. and Sanit. Depts.*, Govt. India, n. s., Nos. 27, 31.
- Reed, Walter, 1901.—*Am. Med.*, July 6.
- Reed, Walter, and Carroll, J., 1902.—*Am. Med.*, vol. 3, February 22.
- Reed, W., Carroll, J., Agramonte, A., and Lazear, J. W., 1900.—*Phila. Med. Journ.*, Oct. 27, vol. 6, pp. 790-796.
- Reed, W., Carroll, J., and Agramonte, A., 1901.—*Journ. Am. Med. Assoc.*, February 16, vol. 36, pp. 431-440.
- Rosenau, M. J., Parker, H. B., Francis, E., and Beyer, G. E., 1904.—

- U. S. Publ. Health & Marine Hosp. Serv., Yellow Fever Inst., bull. 14, pp. 49-101.
- Ross, R., Annett, H. E., and Austen, E. E., 1902.—Report of the Malaria Expedition of the Liverpool School of Tropical Medicine, Liverpool Sch. Trop. Med., Memoir 2, pp. 1-58.
- Roubaud, E., and Lafont, A., 1914.—Bull. Soc. Path. Exot., vol. 7, No. 1, pp. 49-52.
- Sergent, Ed. and Sergent, Et., 1906.—Ann. Inst. Pasteur, vol. 20, pp. 241-255, 364-388.
- Sergent, Ed. and Sergent, Et., 1918.—Bull. Soc. Path. Exot., vol. 11, No. 4, p. 281.
- Soparker, M. B., 1918.—Indian Journ. Med. Research, vol. 5, No. 3, pp. 512-515.
- Staunton, 1913.—Journ. London School Trop. Med., vol. 2.
- Stephens, J. W. W., and Christophers, S. R., 1908.—The Practical Study of Malaria, University Press, Liverpool School Trop. Med., pp. 1-414.
- Stephens, J. W. W., and Christophers, S. R., 1899-1902.—Reports to the Malaria Committee of the Royal Society. Nos. 1. to 8.
- Thayer, W. S., 1900.—Philadelphia Med. Journ. vol. 5, pp. 1046-1048.
- Tsuzuki, J., 1902.—Arch. f. Schiff's- u. Trop. Hyg., vol. 6, pp. 9, 285-295.
- Walker, E. L., and Barber, M. A., 1914.—Philippine Journ. Science, Manila, vol. 9B, No. 5, pp. 381-439.
- Wenyon, C. M., 1911a.—Kala Azar Bull., vol. 1, pp. 36-58.
- Wenyon, C. M., 1911b.—Parasitology, vol. 4, No. 3, pp. 273-344.

CHAPTER XVIII

What We Should Know About Mosquito Biology¹

W. Dwight Pierce and C. T. Greene

Entomologists are generally better informed about the life history of mosquitoes than of most of the insects which carry disease. It is therefore more essential at this time to sketch over some of the points to which we as sanitary entomologists must pay attention. Any one studying mosquitoes must, before completing his study, digest the wonderful mass of material in Howard, Dyar, and Knab's Monograph, especially volume 1.

All mosquitoes pass their early stages in water. They cannot develop in any other medium.

The adult mosquito is known to every one, but its eggs deposited on the water are the least known. The larvæ, commonly known as wiggletails, and the peculiar shaped pupæ are fairly well known.

The different species of mosquitoes are more or less selective as to the type of water in which they breed, and careful study of mosquito habitats is essential to all who have to do with mosquito sanitation. Therefore we must, at least in this lecture, consider the habits of all our American disease-carrying mosquitoes. Many of the others may be capable of carrying disease, but no proof has been brought forward against them.

In the preceding lecture it was shown that the following mosquitoes of the United States are disease carriers:

Dengue fever is carried by *Culex quinquefasciatus* (*fatigans*), and *Aedes argenteus* (*Stegomyia calopus* or *fasciatus*).

Yellow fever is carried by *Aedes argenteus*.

Subtertian or aestivo-autumnal malaria is carried by *Anopheles crucians*, *pseudopunctipennis*, *punctipennis*, and *quadrimaculatus*.

Quartan malaria is carried by *Anopheles quadrimaculatus*.

Tertian malaria is carried by *Anopheles crucians*, *punctipennis* and *quadrimaculatus*.

Filariasis is carried by *Culex quinquefasciatus* and *Aedes argenteus*.

These six species of mosquitoes are then the ones most to be feared

¹This lecture was presented to the class September 16, 1918.

in our own country. One traveling in other countries must guard against entirely different species.

OVIPOSITION AND THE EGG STAGE

Mosquitoes lay their eggs in various ways. The mode of deposition best known is that of laying all the eggs at once in a so-called raft. The eggs are cylindrical, rounded at the ends and tapering toward the upper end. They are placed in an upright position and fastened together by a viscous secretion. They are deposited upon the water or near it. Such is the type of oviposition of *Culex* and several other genera.

Some mosquitoes, as *Culex jenningsi*, surround the eggs with a gelatinous mass which furnishes the first food to the newly-hatched larvae.

The various species of *Anopheles* deposit the eggs separately in small numbers on the surface of the water. The eggs lie upon their sides and are kept afloat by a peculiar hydrostatic organ, a partial envelope which is more or less expanded, particularly along the median portion of the egg. This organ is variously shaped in the different species of *Anopheles* and is called a float.

Of the mosquitoes which lay single eggs, some fasten them by a gelatinous substance at the margin of the water, others lay them on the ground where they remain until rains provide sufficient moisture for hatching. Some of these eggs are enabled to float because of spinose tubercles which hold the air between them. The species of *Aedes* lay their eggs singly and not all at once. It often happens that eggs laid in the summer in northern latitudes lay over to the next spring.

Aedes argenteus Poirret, the yellow fever mosquito, lays eggs measuring 0.53 mm. long and 0.15 mm. in diameter. They are black, fusiform, very slightly flattened on one side, slightly more tapered toward the micropylar end; sculptured with rough, somewhat irregular rhomboidal callosities forming spiral rows. Under natural conditions the eggs are laid singly in small irregular groups some distance above the margin of the water. They are laid in from one to seven days after the female has fed upon blood, and usually at intervals after successive blood meals.

Culex quinquefasciatus Say, the dengue fever mosquito, lays its eggs in boat-shaped masses floating on the surface of the water. It may lay from 180 to 350 in a mass in 7 to 11 rows. The eggs hatch after one to three days. An egg mass of a *Culex* mosquito is shown in fig. 48.

Anopheles crucians Wiedemann has an elongate fusiform egg (fig. 49c) slightly more tapered toward one end, both ends rounded. The dorsal surface is granular, the ventral surface coarsely hexagonally reticulate. The floats occupy about half the sides in top view, and are separated at the middle by nearly one-third the diameter of the egg.

These eggs are laid singly, a small number at a time, upon the surface of the water.

Anopheles punctipennis Say (fig. 49a) has an elongate fusiform egg, reticulate ventrically, finely granular dorsally. The floats are large, extending nearly to the apices, closely approximated medianly on the dorsal surface, arcuately produced at the sides to the apical fourths,

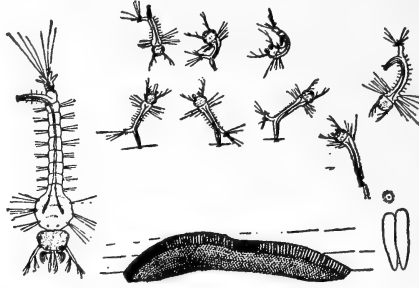

FIG. 48.—Eggs and larvae of *Culex*. Enlarged. (Howard.) From U. S. Dept. Agr., Farmers' Bull. 155, fig. 5.

widely separated on the ventral surface, and showing only on middle third of sides. The eggs are laid singly or in small groups upon the surface of the water.

Anopheles quadrimaculatus egg is shown in fig. 49b.

THE LARVÆ AND THEIR HABITS

All mosquito larvæ are aquatic. By far the most of the larvæ occur in small deposits of water, although certain species occur in large bodies

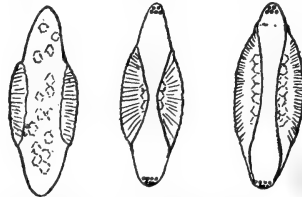

FIG. 49.—Eggs of malaria mosquitoes: a, *Anopheles punctipennis*; b, *A. quadrimaculatus*; c, *A. crucians*. (After Howard, Dyar and Knab.)

of water. Those species which lay their eggs on the ground in dry regions, hatch as soon as rains occur, and the larvæ go through a very rapid development. Such species show a rather marked periodicity in broods. Species which have abundance of water breed continuously during the warmer seasons. One is apt to find mosquito larvæ wherever water occurs.

The food of the larvæ varies, but usually consists of the minute forms

of plant and animal life in the water, although certain species are predaceous, and some are scavengers upon the dead animals and insect life in their habitat.

The larvæ of mosquitoes are very peculiarly constructed. The mouth is furnished with tufts of filaments which are constantly in vibration. The head is large, the antennæ long, the thorax somewhat swollen, and the abdomen slender. The sides of the body are furnished with stiff bristles. From the next to the last segment there protrudes a long tube nearly as thick as the body itself, and it is this tube that touches the surface of the water when the larva rises to breathe. When in this position the larva ranges downward in various attitudes characteristic of the species. The object of this tube is to get air. At the extremity is a breathing hole, or spiracle, and into it run two main tracheæ which extend through the body of the insect with many branches which carry air to all parts

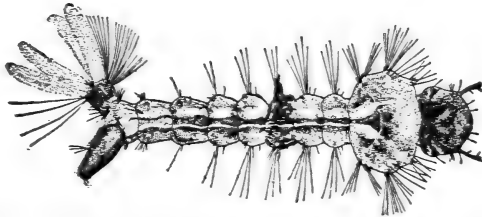

FIG. 50.—Larva of the yellow-fever mosquito. Much enlarged. (Howard.) From U. S. Dept. Agr., Office Secy., Cir. 61, fig. 14.

of its tissues. The true anal end of the body is furnished with four more or less developed tracheal gills.

When suspended from the surface the wriggler's mouth parts are constantly in vibration, bringing into its mouth any minute particles which float in suspension in the water.

It is when the larva extends its breathing tube from the surface of the water that it offers the greatest opportunity for control. All efforts to maintain an oil film on the surface of the water are aimed at clogging up this tube when it comes to the surface, and thus cutting off the air supply.

Occasionally the larva descends to the bottom, jerking its body violently from side to side. The anal tracheal gills undoubtedly assist in this motion. The larvæ are active and move backward through the water by these jerky movements. They can move slowly forward by the action of the mouth brushes. Some species are specially equipped for obtaining air from the water or from plants and do not come to the surface. This is fortunately not the case with those we are most interested in.

Aedes argenteus larva (fig. 50) has the head rounded, widest behind the eyes. The thorax is rounded, wider than long, with moderate, rather

sparse hairs. The abdomen is rather long, the tracheal tubes are broad, band-shaped. The air-tube is stout, short, strongly tapered on outer half, over twice as long as wide, with the pecten running nearly halfway, followed by a single tuft of a few hairs. Each single pecten-tooth is a rather long spine with two large and some small teeth within and small ones without. The lateral comb of the eighth segment is composed of ten scales in a single row. The anal segment is short, wider than long, almost ringed by the plate, which nearly touches ventrally, but is not united. The ventral brush is moderate, directed posteriorly. The anal gills are long, wide, tracheate, with rounded tips.

The larvæ live in accumulations of water in artificial receptacles. Originally it was a tree-hole-inhabiting species, but is now wholly domesticated and is found in houses and in the vicinity of human habitations. The larvæ thrive very well in water containing food refuse and in muddy water.

Culex quinquefasciatus larva (see fig. 48) has the head rounded, widest through the eyes. The thorax is rounded, wider than long. The abdomen is moderate, with the anterior segments shorter. The tracheæ are rather broad. The air tube is rather stout, tapered on outer half, four times as long as wide, with the pecten running about one-third, each pecten-tooth is broad with three to six branches. The lateral comb of the eighth segment is composed of many spines in a triangular patch. The anal segment is a little longer than wide, ringed by the plate. The ventral brush is well developed, confined to the barred area. The anal gills are rather short and broad, longer than the segment, tapered toward tips.

The larvæ are found most frequently in artificial receptacles, but also in ground pools in the vicinity of habitations when the water is sufficiently polluted. The species thrives best in water charged with animal matter and shows a preference for filthy water. Breeding goes on continuously while conditions are favorable. Under the most favorable conditions the larval period may be five or six days.

Anopheles crucians larva has the head rounded, elongate, bulging at the sides, with the frontal portion before the antennæ conically produced. The thorax is rounded quadrate, about as long as wide. The abdomen is stout, with the anterior segments shorter. The air tube is sessile, subquadrate, roundedly angled posteriorly. The lateral plates of the eighth segment are posteriorly armed with a series of about eight long, stout spines, separated from each other by from one to four short spines. The anal segment is about as long as wide, with a small dorsal plate. The ventral brush is well developed, of long branched tufts. The anal gills are moderate, about as the segment, slightly constricted centrally, blunt pointed.

The larvæ live in ground-pools, usually in tidal marshes. Breeding also occurs inland. Below New Orleans it is an abundant pest in the salt and brackish water marshes, where it occurs in undiminished numbers even in the winter.

Anopheles pseudopunctipennis larva differs but little from the preceding but may be separated in the table which follows.

This species is somewhat discriminating in choice of breeding place. It prefers as a rule water of great purity and rapidity of current. The larval food is by preference the soft green algæ. It has been found, however, in irrigating ditches, in clear quiet pools formed by the overflow of a watering trough, in ditches, pools and puddles, in tanks, well-holes and spring-holes full of algæ.

Anopheles punctipennis larvæ (fig. 51) are found in all sorts of water in ground-pools and streams and occasionally in artificial receptacles. The larvæ are found all the season, breeding being continuous until winter.

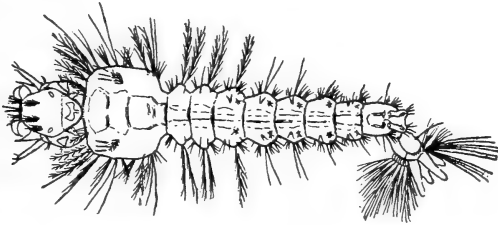

FIG. 51.—Larva of the malaria mosquito, *Anopheles punctipennis*. (After Howard, Dyar and Knab.)

The larvæ occur most commonly in swamps containing algæ. Larvæ have been found repeatedly in rain puddles, the water muddy and without trace of algal growths.

Anopheles quadrimaculatus larva is most like that of *punctipennis*. The larvæ occur in natural collections of water of a more or less permanent nature. They often occur in the same locations as *punctipennis* but are more addicted to permanent stagnant water, such as the edges of sluggish rivers and marshes containing algæ, less to springs and running water, and do not occur in temporary ground-pools filled by rains.

The larvæ of *Anopheles* are to be distinguished from *Culex* and *Aedes* by the habit of feeding. The two latter genera have larvæ with long breathing tubes by which they hang from the surface of the water with the head downward, and feed on the life under the surface. *Anopheles* larvæ have very short breathing tubes. They are surface feeders and are held to the surface by the tube and the fan-shaped abdominal tufts. The head is turned completely over with the mouth uppermost in the act of feeding.

The American disease-carrying *Anopheles* larvæ may be partially separated by the following table:

- | | |
|---|--|
| 1. Abdomen with five pairs of fan-shaped tufts, the first pair small, | |
| | <i>punctipennis</i> Say, <i>quadrifasciatus</i> Say. |
| Abdomen with five pairs of fan-shaped tufts, | 2. |
| 2. First and last pair of fan-shaped tufts smaller than the others, | |
| | <i>crucians</i> Wiedemann. |
| Fan-shaped tufts all equal, each element in the tuft with long, | |
| slender apical portion, | <i>pseudopunctipennis</i> Theobald. |

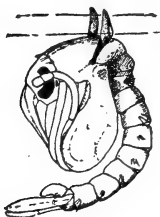

FIG. 52 (left).—Pupa of *Culex*. Greatly enlarged. (Howard.) From U. S. Dept. Agr. Farmers' Bull. 155, fig. 8.

FIG. 53 (center).—Pupa of *Anopheles quadrifasciatus*. Greatly enlarged. (Howard.) From U. S. Dept. Agr. Office Secy., Circ. 61, fig. 12.

FIG. 54 (right).—Pupa of *Aedes argenteus*, the yellow fever mosquito. Greatly enlarged. (After Howard, Dyar, and Knab.)

THE PUPÆ

Unlike other insect pupæ, the mosquito pupæ are active and capable of moving rapidly through the water. They depend upon communication with the air for respiration. The respiration takes place through a pair of appendages on the thorax, called the respiratory trumpets. By lashing the pair of chitinous plates at the apex of the eighth segment, called paddles, the pupa can descend rapidly. It rises to the surface as soon as it ceases its efforts. The mosquito pupa is also peculiar in that it possesses eyes, which enable it to see the approach of an enemy and make its escape. Figures of the three genera discussed in the paper are given (figs. 52-54).

ADULT MOSQUITOES

The adult mosquitoes are known to all of us. The males take only vegetable food, but the females also require a blood feed, in many species, before they can oviposit. Various species attack insects, frogs, birds, and all types of mammals for their blood feed. *Culex quinquefasciatus* feeds at night, *Aedes argenteus* in the day time, and the *Anopheles* during the twilight hours of early morning and evening.

Table of Adult American Disease-Carrying Mosquitoes

1. Palpus of female as long as the beak (see fig. 55b) and the wings brown with yellowish-white spots or markings, (*Anopheles*), 3.
 Palpus of female shorter than beak (see fig. 55a) and wings without definite spots or markings, (*Aedes*, *Culex*), 2.

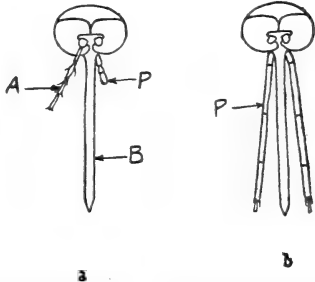

FIG. 55.—Types of mosquito mouthparts: a, Short palpus form; b, Long palpus form. (Greene.) A = antenna, B = beak, P = palpus.

2. A dark brown species with two curved, silvery white lines (resembling an inverted lyre) on top of body. Yellow fever mosquito (fig. 57), *Aedes argenteus*.

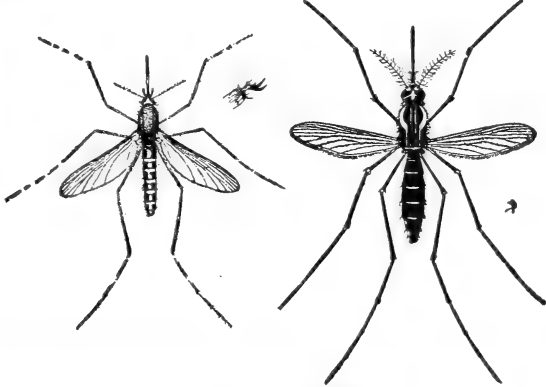

FIG. 56 (left).—Adult *Culex sollicitans*. Much enlarged. (Howard.) From U. S. Dept. Agr. Farmers' Bull. 155, fig. 1a.

FIG. 57 (right).—The yellow fever mosquito, *Aedes argenteus*: adult female. Much enlarged. (Howard.) From U. S. Dept. Agr. Office of Secy., circ. 61, fig. 13.

Pale reddish-brown species with top of abdomen much darker and with five yellowish-white bands across the top (for a *Culex* see fig. 56), *Culex quinquefasciatus*.

3. A dark brown species with a vein near the base of the wing yellowish-white and this vein having three distinct dark spots, *Anopheles crucians*.

- A dark brown species with the wings mostly brown having a large, yellowish-white spot on the front edge of wing towards the tip, and a smaller light spot close to the tip. Fringe at the tip of wing dark, *Anopheles punctipennis*.
- A species very slightly smaller. Wings clear except along front edge where there are three large, yellowish-white spots towards the tip. The third spot is at the tip and the fringe at the tip of the wing is yellowish-white, *Anopheles pseudopunctipennis*.
- A brown species with the wings without pale, conspicuous markings. Wings with four dark-gray to black spots on outer half (fig. 58), *Anopheles quadrimaculatus*.

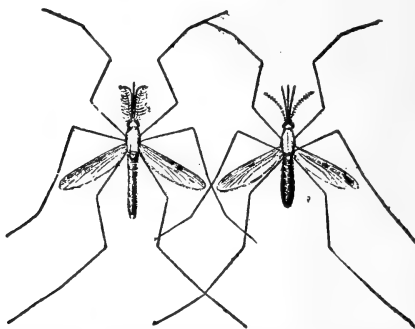

FIG. 58.—A malarial mosquito, *Anopheles quadrimaculatus* Male at left and female at right. Greatly enlarged. (Howard.) From U. S. Dept. Agr., Office of Secy., Circ. 61, fig. 8.

The yellow fever mosquito is more definitely marked than any other species of mosquito known. The general color is a dark-brown. On top of the thorax or back there are two silvery-white, curved lines which resemble an inverted lyre.

REFERENCES

- Howard, L. O., Dyar, H. G., and Knab, F., 1912-1917.—The mosquitoes of North and Central America and the West Indies, 4 vols. This very fine monograph is the largest and most complete on this subject.
- Dyar, H. G., and Knab, F., 1917.—The genus *Culex* in the United States. *Insector Inscitiae Menstruus*. Vol. 5, Nos. 10-12.

CHAPTER XIX

Mosquito Control¹

W. Dwight Pierce

Probably more money and more concentrated effort has been devoted to mosquito control throughout the world than to the control of any other disease-bearing insects. The anti-mosquito work now under way in the United States, under direction of the Public Health Service, is the biggest sanitary undertaking this country ever has gone into. When we consider the vast efforts of India, Italy, Panama, Cuba, and other countries against these insects we realize the importance of the problem.

PREVENTION OF MOSQUITO BREEDING

By far the most important measures to be taken are those which prevent the breeding of mosquitoes, and therefore, we have to deal in some manner with water. If general mosquito control is sought, it is not essential to ascertain the species breeding, but when large communities or armies are to be protected against disease-bearing mosquitoes, time may not permit of general mosquito control but may necessitate particular attention to the haunts of the disease bearers.

Scouting

The preliminary measures to be taken, therefore, are the organization and training of scouting parties designated primarily to search out the breeding haunts of these species, and report them to the details or squads designated for control work. The scouts must be trained entomologists skilled in the knowledge of mosquito haunts. They must examine the water in all receptacles in and around buildings, and in discarded vessels. They must seek out all puddles, hoof prints, wagon ruts, tree holes, ditches, and streams, and carefully examine these. A chart should be kept showing the location of all water and this can be marked in various ways to indicate the species present. Colored pin-markers on a wall chart are very serviceable. A field chart would have to be marked otherwise.

¹This lecture was read September 30 and distributed October 7, 1918. It has been greatly revised.

Determination of Source of Mosquitoes

It is of primary importance in planning a mosquito campaign to determine the direction and distance of flight and behavior of mosquitoes in the area to be controlled. Zetek (1913, 1915) has elaborated methods for determining these points. He uses as dyes aqueous solutions of eosin, fuchsin, gentian-violet, bismarck-brown, methylene-blue, and orange-g, mixing one gram of dry stain to 50 c.c. of water. By means of an atomizer a fine spray is allowed to fall upon the mosquitoes. They should not be sprayed directly. Evening hours are best for their release and care must be taken not to carry away individuals on the body of the agent. There should be careful observations of wind, climatic condition, direction of flight of the mosquitoes, and the movement of human beings. To determine the flight window traps, examination of buildings and general sweeping are necessary. The place and hour of collection must always be noted. To detect the dye a testing solution is made of three parts glycerin, three parts alcohol, and one part chloroform and the specimens are individually touched with a camel's-hair brush moistened therein.

Leveling and Filling Water Holes

Details of men may be designated to look after the leveling of ground where water is apt to gather and remain, and to fill up small puddles, pools, hoof marks, ruts, etc., which serve no useful purpose and where drainage is inadvisable. Holes in trees should be filled up with cement. Stumps which hold water should be grubbed out and the stump holes filled. In rocky streams pot-holes in the rocks often breed many mosquitoes. If possible the rock should be grooved, or removed, or the holes may be filled with cement.

Ditching and Clearing Streams and Swamps

Other details may be designated to clear stream beds and drain low lands. Spring lands, bogs, and swamps furnish an abundance of mosquitoes and are the first places to receive the attention of the ditching squads. Ditches must be constructed to carry off standing water. These should be laid out by an engineer. The ditches must have straight banks and even bed and must be kept free of vegetation. Sometimes it is necessary to spray the vegetation along the ditches with oil, and burn. All borrow-pits and puddles caused by grading roads and railways should be connected up by a ditching system or filled. Flowing streams usually have trees along their sides. Under such trees water is often trapped and forms a quiet, undisturbed place for mosquito larvæ. Trees must not

grow on the edge of the bank. Tree roots must be removed from the stream. Any kind of vegetation growing in the bed of a stream favors mosquito breeding as it affords some protection against natural enemies, and prevents adequate artificial control. The stream bed must be clear of vegetation. The banks must be straightened and without overhanging ledges. There should be no obstruction to the free flow of the stream. If it meanders, a new and straight course ought to be constructed and the old course filled. Springs which furnish good water should be boxed and protected. Le Prince and Orenstein very ably describe in their book the method of clearing streams and propagation areas in jungles in the tropics.

Clearing of Weed-Filled Bays and Lakes

Large bodies of water in which dense growths of grass and weeds occur furnish great problems in many localities, and in tropical countries especially, where feasible, it is often desirable to furnish the mosquito squad with two motor boats and submarine saws or other implements for cutting and removing vegetation. If this cut vegetation remains it aggravates the situation. Large lily leaves, which when alive furnish no place for breeding, will often, when dry, form cups for water in which mosquitoes breed prolifically.

Drainage

The construction of drainage systems should be done preferably by a sanitary engineer who understands the mosquito phases of the problem. The main ditches should be constructed first and later the laterals added. Sometimes where weed growth is rapid it is desirable to have a double parallel series of ditches, one only operating at a time except during heavy rains, with the idea that the idle ditch can be cleaned and shaped up. It is essential that the floor level of the ditch affords no opportunities for puddles to form after the greater part of the water has passed off. In permanent ditching it is sometimes feasible and advisable to line the ditch with concrete or at least to line the bottom. Weep-holes should be made at sufficient intervals to carry into the drain water which gathers on the outside of it. Branch ditches should enter the main ditch at an acute angle or on a curve. At the junction of ditches there should be a splash wall to confine the water within the ditch. Pot-holes formed in dirt ditches should be filled up after rains with gravel or stone and tamped hard (see Le Prince and Orenstein, pp. 137-144).

In certain soils where seepage water outcrops abundantly on hill-sides, it is sometimes practicable to install an intercepting tile drainage

system. The tiles are laid at right angles to the flow of the seepage at the highest seepage water level, with a space of one-eighth to a quarter inch between joints. The grade of the trench bottom must be true. Tiles must not be located on soft mud where they may sink. The outlet should be well above the ground surface (see Le Prince and Orenstein, pp. 130-136).

Dr. C. W. Metz (1919) has set down certain very valuable principles in drainage, and describes the methods of surface and vertical drainage used by the Public Health Service. The treatment depends upon the sources of the water. The methods described above will suffice for rain water. For seepage water where tile drainage is not to be used the ditches must be dug at right angles to the flow of the seepage water, that is, across the exposed end of the water table. These ditches may be connected to main ditches which will carry the flow down the hillside parallel to the seepage flow. If the water table is too deep to be intercepted by one ditch, it may be necessary to dig additional intercepting laterals at intervals lower down. A swiftly running ditch is better than a sluggish one. Water confined in a narrow channel will run more swiftly, give less surface, and be easier to oil, hence V-shaped ditches are usually preferable to wide-bottomed ones. The shape of the ditch will largely depend upon the nature of the soil. Where wide ditches are apt to form puddles in dry season, a small V-shaped ditch the width of a shovel may be made down the middle of the large ditch.

Vertical drainage consists of sinking wells to conduct the water through relatively impervious soil into water-bearing sand or gravel. Such drainage is advisable only where surface drainage is difficult or expensive. In case the underlying stratum is deep down, holes should be bored and drain heads installed. The drain head will consist of a culvert-like box at the level of the bottom of the lake or pond which will conduct the water to the well. The receiving end will be screened to keep out debris with a coarse screen and a fine screen. The other end of the culvert is closed. Over the well will be a hole about one-fourth or one-third the diameter of the well, and this likewise will be covered with a screen. A pipe or funnel from the hole in the culvert into the well will reduce washing and crumbling of the sides of the hole. Soft soils will require that the well be cased with tile or iron pipe.

Any one engaged in marsh drainage should familiarize himself with the methods in vogue in the great salt marsh drainage work of the State of New Jersey (Headlee, 1915).

When ditches become matted with algæ and other matter and contain mosquito larvæ, in some localities it is possible to construct water gates to permit temporary impounding of water, which will enable the ditch

squads to thoroughly flush the ditch below the gate and remove all mosquito larvæ and algæ.

Larvicides

The ditching, draining, and clearing of waterways insure a regular flow, carry off all surplus water, and reduce but do not prevent mosquito breeding. It is necessary to use some additional means of control and for this purpose various larvicides have been applied, but principally kerosene, crude oils of paraffin and asphaltum base, as well as creosote oils.

The question of the effect of oils on mosquito larvæ is most thoroughly discussed by Freeborn and Atsatt, who find that the toxicity of the petroleum oils as mosquito larvicides increases with an increase in volatility, the more volatile oils producing the more marked lethal effects. The volatile constituents of the oils contain the principles that produce the primary lethal effects. The lethal effects are produced by the penetration of the tracheal tissue by the volatile gases of the oils. In the heaviest and least volatile oils having a boiling point greater than 250° F., this action may be supplementary or apparently secondary to the effect of actual contact of the oil with the body tissue, or perhaps to mechanical means such as suffocation or plugging of the tracheæ. They found that oils which killed very quickly did so by means of the volatile gases, whereas in the case of oils with slow effectiveness the mechanical suffocation may be the cause of death.

This paper is so recent that it has not been possible to obtain a mass of evidence on the practical effectiveness of different grades of oils used as larvicides. Kerosene and crude oil are the oils most commonly used in general practice. Le Prince and Orenstein prefer crude oil to kerosene because of the film made by kerosene, its greater expense, inflammability, and liability to be wasted because of its transparency.

These authors have set down a number of requirements for a good larvicide:

1. It shall have a high toxic power, so that a small quantity may suffice for a large volume of water.
2. It shall kill rapidly in order that subsequent dilution and weakening by rain have as little effect as possible.
3. It must be uniform in its toxic power and capable of standardization.
4. It should mix freely with brackish and alkaline waters.
5. It must be harmless to man and domestic animals, when in the dilution necessary for larvicidal action.
6. It shall not be susceptible to rapid deterioration.
7. It must be inexpensive.

They did not find any substance which fulfilled all these conditions, but found a soap (now known as the Panama larvicide) to meet most of their requirements. This was made of the following ingredients:

Resin	150 to 200 pounds
Soda (caustic)	30 "
Carbolic acid (sp. gr. 0.97)	150 gallons

This makes a liquid soap which freely emulsifies with fresh water. The carbolic acid must have at least 15 per cent of phenols and no greater specific gravity than 0.97.

This larvicide is manufactured as follows: Heat the carbolic acid in a steel tank with steam coil. When steaming hot add the resin and continuously stir the mixture by means of a paddle agitator until complete solution is effected. Dissolve the caustic soda in 6 gallons of water and add to the mixture. Heat and stir for five minutes. Draw a sample and pour into water. If it emulsifies the process is complete, and the product may be put into shipping drums which must be tightly closed.

Oiling

There are many ways of applying the oil. The most common method is by knapsack sprayer or, where the ditch is along the road, by horse-drawn tanks fitted with a spraying bar. For slow-moving water and stagnant water, as well as the treatment of ruts, puddles, hoof prints, and so forth, these methods are satisfactory. Dr. Metz found that he got excellent results in boggy lands especially by applying a thin mist of commercial creosote. A very small quantity will kill mosquito larvæ.

For moving water there are many devices for maintaining a regular dripping of oil from a suspended vessel upon the surface of the water. Such devices can easily be rigged up by any practical man. Dr. M. J. White of the Public Health Service modified this method by conducting the oil to the water by means of a wick (Metz 1919).

The war has brought about the new and even more efficient methods of oiling which have been developed along many angles by Dr. W. L. Mann, the Post Surgeon, and Lieut. E. C. Ebert of the Marine Corps at Quantico, Va., with the assistance of Pharmacist's Mate Carl Duncan. They have found that sawdust impregnated with crude oil will hold it for a long time and will slowly give it up to the water. They therefore place the sawdust impregnated with oil in a box and sink it in a flowing stream (fig. 60); or they throw a few grains of sawdust in a hoof print, or a handful on a puddle; or they fix a floating boom to hold back of it a

quantity of sawdust and give off a constant film. Thus for each condition, with a slight modification of the application, they obtain an excellent and lasting film not destroyed by rains. Dr. Metz modified this method by putting the oil-soaked sawdust in bags which he fastened to the bottom of streams. Probably no other system of oiling is as adaptable or as satisfactory as this sawdust method. Geiger and Purdy (1919)

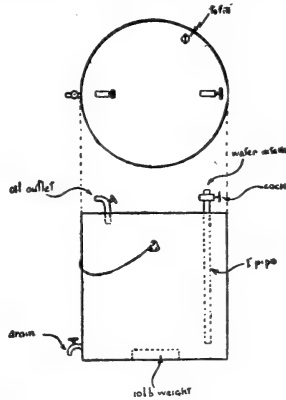

FIG. 59.—Submersible automatic bubbler for distributing oil over surface of water. (Ebert.)

have just reported success in reduction of mosquito incidence in rice fields by broadcasting oil-impregnated sawdust and without injury to the rice.

Dr. Ebert, early in 1918, developed an automatic oiler (fig. 59) consisting of a cylinder sunk beneath the water which takes in water and

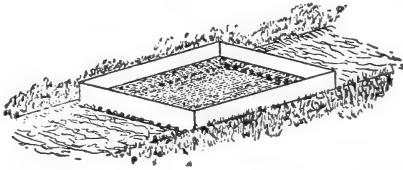

FIG. 60.—Method of petrolization with oil soaked sawdust. (Ebert.)

displaces the oil, the amount of displacement being regulated by spigots. This oiler dropped under a bridge in a big river or placed in a large tidal bay amidst rank vegetation produces a constantly, evenly distributed film of oil which is very effective. The size of the cylinder is gauged by the size of the stream. The distance to be placed apart must depend upon the film obtained. Lieut. Brigham (1918) of the Army Medical Corps used the same principle when he filled a bottle with crude oil, cut two grooves in the cork and poured oil in one groove. When dropped in the water this automatically bubbled. To reach inaccessible

pools he fitted a parachute to the bottle and shot it with a bow gun, using rubber bands for power.

Artificial Containers of Mosquito Larvæ

In mosquito work much attention must be given to all types of artificial water containers, as rain barrels, cisterns, latrines, tin can dumps, garbage cans, gutters, water pitchers, flower vases, aquaria, table isolation receptacles in tropical countries, cesspools, sewers, toilets and flushing boxes, traps in sinks, drinking fountains, water troughs, etc. Flushing, periodic emptying, covering with oil film, stocking with fish, are among the possible expedients available in one or another of the cases. Capt. D. L. Van Dine and Dr. W. V. King have devised a new treatment for water in fire barrels and water tanks for storage of water to be used in cleansing cans, in each of which cases oil is very undesirable. These receptacles may be treated with borax at the rate of $\frac{1}{2}$ pound to 10 gallons of water; or with 1 pound of salt to 10 gallons of water.

Fish as Mosquito Control

Among the principal natural enemies of mosquitoes are fish and in permanent ponds and lakes and streams, the stocking with the proper species of fish may be considered as one of the most satisfactory methods of mosquito control. In this country top minnows and goldfish are commonly used for this purpose. The Bureau of Fisheries lists the following fresh water fish available for introduction in American waters infested by mosquitoes: The killifishes, *Fundulus diaphanus*, *F. dispar*, *F. notatus*, *F. chrysotus*, and *F. nottii*; the top minnow, *Gambusia affinis*; *Heterandria formosa*, *Mollienisia latipinna*, *Enneacanthus obesus*, *E. gloriosus*, *Mesogoniatius chaetodon*, *Centrarchus macropterus*, *Lepomis cyanellus*, *L. gibbosus*, *Elassoma zonatum*, *Notemigonus crysoleucas*, *Labidesthes sicculus*, and *Carassius auratus* (goldfish). (Radcliffe 1915.)

For use in salt water or brackish water the following fishes are available: *Fundulus majalis*, *F. heteroclitus*, *F. similis*, *Lucania parva*, *L. venusta*, and *Cyprinodon variegatus*. (Radcliffe.)

The most complete summary of the species of fish available in various parts of the world is given by Hegh (pp. 140-150). Howard, Dyar and Knab and also Le Prince and Orenstein discuss the subject. The methods used in distributing fish in various types of water in India are described by Wilson (1917).

In this country any one desiring to stock a reservoir or other body of water with fish should immediately communicate with the Bureau of Fisheries at Washington.

The Panama larvicide and creosote are toxic to fishes, and

undoubtedly some of the volatile oils are also, although the literature speaks only in general terms on this subject:

Destruction of Adult Mosquitoes

Howard, Dyar and Knab, and also Hegg, cite various methods of destruction of adult mosquitoes in dwellings, such as puffing powdered pyrethrum into nooks frequented by mosquitoes, fumigation by burning pyrethrum, sulphur or cyanide fumigation, vapors of cresyl and of creoline. Le Prince and Orenstein describe a labyrinth trap for windows, quite similar to the Hodge window fly trap. Hegg figures and describes other fly traps.

PROTECTION FROM MOSQUITOES

Protection of Dwellings from Mosquitoes

In mosquito sections the screening of all habitations against mosquitoes is essential. This must be done thoroughly and the screens must be carefully examined and repaired. When holes or openings occur in the screening, the mosquitoes enter and are trapped and the building is often worse off than if unscreened.

For protection against *Anopheles* alone, a 16-mesh wire screen is sufficient, but small *Aedes* can pass through this and therefore 17 or 18-mesh is necessary. Le Prince and Orenstein give the specifications for the 18-mesh screen to be of 90 per cent pure copper and not more than one-half of one per cent of iron for damp tropical countries, the gauze having eighteen strands of wire of one one-hundredth of an inch diameter in each linear inch. The best type of screen for salt or acid air will probably be a screen coated with an acid proof, noncorrosive alloy such as Gageite. In many parts of the United States other types of wire screening are thoroughly efficient.²

Where mosquitoes are abundant the double door vestibule arranged so that the two doors can not be opened at the same time is highly desirable when practicable. In tropical countries with verandas around the entire house, the entire screening of the verandas is essential. Lieut. Brigham (1918) describes an ingenious mosquito electrocutor.

Protection of the Individual

Campers are in the habit of using almost anything that will make a dense smudge to drive away mosquitoes. The fumes of burning pyrethrum

²Mr. F. C. Bishop has for several years been making tests of serviceability of many types of screening in various parts of the country, and although he has not submitted a final report, will gladly advise any one desiring this information for official purposes. His address is Box 208, Dallas, Texas.

powder are not obnoxious to most persons and are very effective in freeing a room of mosquitoes. The powder slightly moistened and moulded into a candle will burn slowly like punk. The essential oil of the powder may be volatilized by placing on a metal screen above a lamp chimney. The odor is only slightly perceptible and not unpleasant.

For protection of the body, camphor, oil of citronella, oil of cassia, and other essential oils are found efficacious. Howard, Dyar, and Knab recommend as the best in their experience:

Oil of citronella	1 oz.
Spirits of camphor	1 oz.
Oil of cedar	1/2 oz.

This may be rubbed on the clothes or body. A few drops on a bath towel hung over the bed will keep *Culex pipiens* away for a whole night.

Graybill lists many repellents against flies which have been tried on animals. The most successful substances tried by him were 50 per cent pine tar in cotton seed oil, or 10 per cent oil of tar in cotton seed oil, when applied lightly. Fish oil is a very effective repellent. Bishopp's fish oil repellent is very effective in keeping flies from livestock when applied lightly. It consists of:

Fish oil	1 gallon
Oil of tar	2 ounces
Oil of pennyroyal	2 ounces
Kerosene	1/2 pint

Mosquito nets for the bed are used in many parts of the South where the buildings are unscreened. Campers who sleep in hammocks may easily arrange a good sleeping net by tying a rope to the hammock supports and hanging from this a tent-shaped net which can be fastened at the ends and tucked in beneath the blankets.

Hegh illustrates mosquito bars for tent coverings, for tent doors, and soldiers' cots, and also a mosquito bar fastened inside a soldier's small field-tent so that the sides of the tent can be raised to give air. Various type of protective headgear have been described for troops in tropical countries, two of which are illustrated by Hegh. Simpson illustrates a new headgear invented by his wife, which can be worn by day and at night.

The references cited below are worthy of study in connection with this lecture. There are many other works in all languages on the special problems of different countries, most of which are listed by Howard, Dyar and Knab.

BIBLIOGRAPHY

- Brigham, P. H., 1918.—An automatic oiling device. Mosquito electro-cuter. *Military Surgeon*, vol. 43, No. 2, pp. 224-226.
- Freeborn, Stanley B., and Atsatt, Rodney F., 1918.—The effects of petroleum oils on mosquito larvæ. *Journ. Econ. Ent.*, vol. 11, No. 3, pp. 299-307.
- Geiger, J. C., and Purdy, W. C., 1919.—Experimental mosquito control in rice fields. *Journ. Amer. Med. Assoc.*, vol. 72, No. 11, pp. 774-779.
- Graybill, R. W., 1914.—Repellents for protecting animals from the attacks of flies. *U. S. Dept. Agr. Bull.* 131, 26 pp.
- Headlee, T. J., 1915.—The mosquitoes of New Jersey and their control. *N. J. Agric. Expt. Sta., Bull.* 276, pp. 10-135. Illustrates common mosquitoes.
- Hegh, E., 1918.—Comment nos Planteurs et nos Colons peuvent-ils se protéger contre les Moustiques qui transmettent des maladies. *Minister of Colonies, Service of Agriculture of Belgium, Etudes de Biologie agricole*, No. 4, 200 pp.
- Howard, L. O., Dyar, H. G., Knab, F., 1912.—The Mosquitoes of North and Central America and the West Indies. *Carnegie Institution of Washington*, vol. 1, pp. 320-449.
- Howard, L. O., 1911.—Remedies and Preventives against Mosquitoes. *U. S. Dept. Agr., Farmers' Bull.* 444.
- Le Prince, Joseph A., and Orenstein, A. G., 1916.—Mosquito Control in Panama, The Eradication of Malaria and Yellow Fever in Cuba and Panama. *G. P. Putnam's Sons*, 355 pp.
- Mann, W. L., and Ebert, E. C., 1918.—Some suggested improvements in methods of petrolization of mosquito breeding areas. *Military Surgeon*, November 1918.
- Metz, C. W., 1919.—Some aspects of malaria control through mosquito eradication. *Public Health Reports*, vol. 34, No. 5, January 31, pp. 167-183.
- Radcliffe, L., 1915.—Fishes destructive to the eggs and larvæ of mosquitoes. *U. S. Department Commerce, Bur. Fisheries, econ. circ.* 17, pp. 1-19.
- Simpson, W. J. R., 1919.—The sanitary aspects of warfare in South-eastern Europe. *Journ. Trop. Med. and Hyg.*, vol. 22, No. 7, pp. 58-66.
- Zetek, J., 1913.—Determining the flight of mosquitoes. *Ann. Ent. Soc. Amer.*, vol. 6, No. 1, pp. 5-21.
- Zetek, J., 1915.—Behavior of *Anopheles albimanus* Wiede, and *tarsimaculata* Goeldi. *Ann. Ent. Soc. Amer.*, vol. 8, No. 3, pp. 221-271.

CHAPTER XX

Louse Borne Diseases ¹

W. Dwight Pierce

The parasitic lice belong to two closely related orders, the Anoplura or Siphunculata, commonly called sucking lice or vermin, and the Mallophaga, called biting lice, differing principally by the formation of the mouth parts. The sucking lice are parasitic principally on mammals, and the biting lice on birds, but some of the latter also attack mammals. They are more or less definitely limited according to their species to definite species or genera of animal hosts. All cause great annoyance and worry and probably by their attack frequently cause death of the host, especially young hosts.

We are especially concerned with the sucking lice in this lecture, but will include a few notes on the biting lice. Some of the most serious diseases of man, especially when congested in crowded populations or in armies, are caused or carried by lice. Probably many fatalities among wild animals and birds are due to inoculable diseases carried by lice, which have never been investigated.

I. DIRECT EFFECT OF LOUSE ATTACK

The attack of lice on the body is in itself exceedingly annoying and leads to a great deal of itching and scratching. The attack by the various species of lice is differentiated by terms applicable to each. The attack by the body louse, *Pediculus corporis* DeGeer, or as it is known by Nuttall (1917), *Pediculus humanus* var. *corporis*, is known as PEDICULOSIS CORPORIS. The attack by the head louse, *Pediculus humanus* Linnaeus, commonly known as *capitis* DeGeer is called PEDICULOSIS CAPITIS. Attack by the pubic louse, *Phthirus pubis* Linnaeus, is known as PHTHIRIASIS.

1. *Types of Pediculosis Corporis*

Nuttall (1917) has described a considerable number of recorded types of dermatitis caused by louse attack.

¹A lecture on this subject was delivered June 3, 1918, and distributed in mimeographed form, but on account of the great change in the subject since then, the present lecture is practically rewritten.

URTICARIA.—The attack of the body louse, popularly called “cootie,” produces minute haemorrhagic spots which are accompanied by more or less urticaria, the itching leading to scratching. The bites are principally distributed over the neck, back and abdomen. Peacock found louse rash distressingly common among the British troops.

MELANODERMIA.—In tramps, chronic drunkards, and vagabonds who have harbored lice for many years, the skin over the areas most frequently bitten becomes rough, hardened, and deeply pigmented, a condition known as *morbus errorum* or vagabond’s disease. This skin pigmentation, also called melanoderma, may extend to the mucous membranes, being visible in the mouth and is sometimes confused with Addison’s disease (Nuttall 1917).

ECZEMA.—Frequently the attack of the lice causes an eczematous inflammation of the skin, with exudation of lymph.

PYODERMIA.—Nuttall records **PUSTULAR DERMATITIS** and **PRURIGO SENILIS** due to louse bite. Smith (1918) considers the pyoderma (ecthyma, etc.) caused by the body louse a more serious disabling skin disease than scabies. Various authors have claimed that the lice sometimes burrow under the epidermis forming so-called “covered louse-ulcers,” which on opening liberate many lice.

TOXEMIA.—Moore cites instances of intoxication of the system from louse injected toxins.

2. *Types of Pediculosis Capitis*

Head lice may produce urticaria, eczema and pyoderma, of which the most important type is mentioned in the next paragraph. Pinkus states that the inflammation of the scalp may lead to falling out of the hair.

PLICA POLONICA.—As results of eczema or pustular dermatitis of the scalp the exudations of the skin lead to formation of scabs and crusts in the hair especially at the nape of the neck, and this condition has been called *plica polonica* because it is so frequently observed among the poor Jewish population of Poland. (Nuttall 1917.)

3. *Types of Phthiriasis*

The pubic lice occur in the pubic regions principally, but are also found in the axillae, eyebrows, and other parts of the body. They cause great discomfort unless the host is hardened to them. (Nuttall 1918.)

PRURITUS.—The attack of this louse causes a pruritus which can be violent and leads to much scratching day and night. It is thought that the itching is primarily caused by the toxic saliva of the louse.

PYODERMIA.—Crab louse attack may result in papular eruptions complicated by eczematous inflammation.

BLEPHARITIS.—Dubreuilh and Beille state that when the lice are abundant on the upper eyelids they may cause blepharitis of the ciliary borders of the lids with a variable amount of pruritus.

TOXEMIA.—Payne attributes fevers and headaches to toxic action of *Phthirus*. Nuttall has also recorded a rise in bodily temperature due to the attack.

MACULAE COERULEAE.—The occurrence of this louse upon the body is usually indicated by the presence of bluish spots on the skin due either to a genuine pigmentation according to Oppenheim or a toxic erythema according to Huguenay. Nuttall (1918) gives quite a discussion of the subject.

MELANODERMIA.—Nuttall (1918) states that this louse may also cause a discoloration of the skin amounting almost to blackness and involving the mucous membranes and nails.

4. *Effects of Attack of Other Lice*

Railliet has seen *Haematopinus* form real subepidermal nests in an old horse.

Imes states that biting cattle lice, *Trichodectes scalaris* often form colonies around the base of the tail, over the withers, and on other parts of the animal, and produce lesions resembling those of scab. These lesions vary in size from one to five inches in diameter. The skin over these areas appears to be raised and ringworm may be suspected, but when the lesion is manipulated the scarf skin falls off, exposing the lice grouped on the raw tissues beneath. Under such conditions the irritation may be fully equal to that caused by scab.

The sucking cattle lice, *Haematopinus eurysternus* and *Linognathus vituli*, act as a contributing cause to increase the death rate among poorly nourished cattle of low vitality. Even mature cattle of full vigor when very lousy will not gain weight and there is a loss in the production of meat and milk.

Chickens, turkeys, pigeons, and all other poultry as well as wild birds, are abundantly parasitized by biting lice and are seriously injured by the attack. The first symptoms of lice infestation usually are droopiness, lowered wings and ruffled feathers. Diarrhea follows and the chickens often die in a few days. Older fowls may not show ill effects other than decrease in egg production.

II. TRANSMISSION OF DISEASES BY LICE

1. Diseases of Plant Origin

Thallophyta: Fungi: Ascomycetes: Gymnoasceae

Achorion schoenleini (Lebert 1845), the cause of FAVUS, or PORRIGO, a fungus disease of the hair follicles, may be spread by head lice according to Aubert (1879).

Thallophyta: Fungi: Hyphomycetes

Malassezia species, causing the scaly skin diseases called PITYRIASIS, are claimed to be spread by lice by Aubert (1879).

Thallophyta: Fungi: Schizomycetes: Coccaceae

Staphylococcus pyogenes aureus and *albus*, the cause of IMPETIGO CONTAGIOSA, an acute contagious pustular inflammation of the skin can be carried by head lice, as was proven by Dewevre (1892) by removing lice from impetigo cases and placing them on the heads of healthy children, who some days later developed the disease. This claim has been supported by various authors. Widmann (1915) attempted to transmit *Staphylococcus septicaemia* by louse bite and failed although he recovered living cocci from the louse feces after 60 hours but not later. In view of recent findings with other louse-borne diseases, we may expect that infection could have been obtained by slightly abrading the surface on which the lice had defecated.

Diplococcus intracellularis meningitidis Weichselbaum. Pizzini (1917) found a strong parallel in two Italian outbreaks of CEREBROSPINAL MENINGITIS with the occurrence of lice on soldiers and civilians who contracted the disease. Some patients were found to have in their underclothing louse vectors of the Meningococcus, or they were found to have handled garments infested with such lice. The months during which the disease is prevalent are those during which lice are definitely parasitic.

Diplococcus pemphigi contagiosi Manson, the cause of TROPICAL IMPETIGO, is said by MacGregor (1917) to be carried by lice.

Pneumococcus.—In experiments conducted by Widmann (1915), he succeeded in making lice bite mice in which he had produced *Pneumococcus septicaemia*. He could not infect other mice by means of the louse bites but found the louse feces infective during the first 24 hours. The cocci were confined to the intestinal tract and did not multiply therein.

CONJUNCTIVITIS.—DeFont Reaulx (1912) and other writers regard head lice as the cause of **PHLYCTENULAR CONJUNCTIVITIS**, and Hudson (1914) states that its sequela **PHLYCTENULAR KERATITIS** prevails among Board School children in England, causing much suffering and corneal scars with resultant disabilities. He refers severer cases primarily to head lice, infective material being carried from the scalp to the eyes by the hands.

OTHER SEPTICAEMIAS.—Sobel in 1913 as a result of eleven years' experience with New York school children states that head lice are the indirect cause of pyogenic infection, frequently leading to involvement of the lymphatic glands followed by suppuration, and that lice also indirectly cause **IMPETIGO CONTAGIOSA**, **DERMATITIS**, **FURUNCULOSIS**, **ECZEMA AND FOLLICULITIS**. Pinkus in 1915 describes similar results and states that the inflammation of the scalp may lead to the falling out of the hair.

Thallophyta: Fungi: Schizomycetes: Bacteriaceae

Bacillus pestis Kitasato, the cause of **PLAGUE**, is referred to by various authors. Swellengrebel and Otten (1914) experimenting with clothes lice from plague patients in Dutch East India, and DeRaadt (1916) have succeeded in causing death by plague in experimental animals by subcutaneous inoculations of crushed lice. Herzog in Manila found *Bacillus pestis* in three head lice from a child dead of plague (Bulloch and Douglas, 1909). There is no evidence that plague can be carried by the bite of lice.

Bacillus typhosus Eberth.—In like manner Abe (1907) claims to have recovered *Bacillus typhosus* from body and head lice fed on **TYPHOID FEVER** patients in 75 per cent of the insects examined.

Bacillus leprae Hanson.—McCoy and Clegg (1912) have likewise found *Bacillus leprae* in two head lice out of many examined from patients suffering with **LEPROSY**.

Summary of Plant-Caused Diseases

All of the various cases cited above are probably to be considered purely as examples of mechanical transmission by scratching of the feces of the lice containing the organism into the skin. The organisms of impetigo contagiosa, tropical impetigo, favus, pityriasis, Pneumococcus and Streptococcus septicaemias, phlyctenular conjunctivitis and keratitis, plague, typhoid fever, leprosy, and meningitis are all bacteria or fungi. It is to be hoped that experiments in inoculation of feces will be carried out with those organisms in which the exact rôle of the louse is still unde-

terminated. The almost irresistible desire to scratch a louse bite should make louse transmission of any organism taken up from the blood, which can successfully pass through the lice in their feces, a very easy matter. In case of typhoid fever, if there is transmission it might be through soiling fingers on crushed lice. This consideration leads me to suggest that some one take up the question of louse transmission of gonorrhoea, syphilis, smallpox, and other diseases, giving special attention to inoculation of infected feces.

2. *Diseases of Unknown or Uncertain Origin*

BERI-BERI.—Manson (1909) has advanced the hypothesis that lice may possibly transmit beri-beri or polyneuritis, a disease whose cause is undetermined. Bradford, Bashford, and Wilson (1919) have found a filterable virus in acute infective polyneuritis. Daniels conducted an unsuccessful attempt in transmitting beri-beri from man to an orang-outang by means of lice, due probably to the inability of the lice to live on the host. (Castellani and Chalmers, p. 1216.) He did not attempt inoculation of the feces, apparently expecting to convey the disease by the louse bite. The majority of writers treat beri-beri as a nutritional disease due to absence of vitamins.

TYPHUS FEVER.—Acting on the suggestion of Sergent and Foley in Algeria, the transmission of typhus fever by the louse was first proven by Nicolle, Comte, and Conseil (1909) working in Tunis. They successfully transmitted typhus from monkey to monkey by means of the bites of infected lice (*Pediculus corporis*) that had fed on a typhus fever patient 1-7 days previously. A few months later Ricketts and Wilder (1910) working independently in Mexico reported successful infection of monkeys that were bitten by *Pediculus corporis* previously fed on typhus patients, and they also infected monkeys by placing the gut contents of such lice on scarified skin, three days after the lice had fed upon a typhus monkey. Shortly thereafter Ricketts succumbed to an attack of typhus.

Further proofs of transmission of typhus fever by louse bites were published by Wilder (1911), Goldberger (1912), and Anderson and Goldberger (1912); proofs of transmission by inoculation of crushed lice were published by Wilder (1911), Goldberger (1912), Prowazek (1913) and Nicolle, Blanc, and Conseil (1914). The last named authors proved that the feces of lice when inoculated were infective at least 6 days after the lice had fed on a typhus fever patient.

Wilder (1911), Sergent, Foley, and Vialatte (1914) and Da Rocha-Lima (1916) claim that typhus fever is hereditarily transmitted by lice, but Anderson and Goldberger (1912) and Nicolle, Blanc, and Conseil (1914) hold that there is no proof of hereditary transmission.

No definite organism has been finally fixed on as the cause of typhus fever although several have been described. Plotz (1914) and others, with excellent reasons, regard *Bacillus typhi exanthematici* as the cause. Bodies called *Rickettsia prowazeki* Da Rocha-Lima (1916), are described by Da Rocha-Lima, Noeller (1916), and others, as the causative organism, and it is claimed that they undergo multiplication in the cells of the midgut of infested lice. Whether *Rickettsia* is the cause of the disease or a product of the contagium is still uncertain. Stempell (1916) describes a Protozoan, *Strickeria jürgensi*, which he suspects to be the cause of typhus, and claims that it undergoes part of its development in the intestines of *Pediculus corporis*, and is sometimes transmitted to man in large numbers. Rabinowitch (1914-1916) regards *Diplobacillus exanthematicus* as the cause; Penfold (1916) describes a Micrococcus; Proescher (1915) describes minute Diplococci and Diplobacilli as present in the endothelial cells of the human subject. Finally Futaki (1917) has described *Spiroschaudinnia exanthematotyphi* from the liver and urine of patients dying of typhus and has found the same organism in lice. Brumpt (1918) discusses *Rickettsia prowazeki* Da Rocha-Lima, the so-called cause of typhus fever, and claims that it is a coccobacillus and that he found it in 73.6 per cent of the lice (*Pediculus corporis*) from healthy prisoners in France. He found that these lice infected with this organism remained infective all their lives and therefore concludes that *Rickettsia* cannot be the cause of typhus fever, even though it may be transmitted by the lice to men and again taken up by them. In experiments on himself with infected lice he did not produce any infection. Brumpt perhaps found the *Rickettsia pediculi* which is associated with normal lice.

TRENCH FEVER.—This disease has only recently been recognized, having passed even in the early days of the war under the initials P. U. O., or pyrexia of unknown origin. Many of the greatest investigators in the various armies concentrated attention on this baffling disease of the trenches which stood among the highest of the disabling diseases of the Western front. The first records of the connection of the louse were contained in statements of Davies and Weldon (1917, 1918) that one of them had produced the disease in himself by permitting infected lice (*Pediculus corporis*) to bite him. The incubation period was 12 days. Early in 1918 two separate committees, the British under Sir David Bruce and Major W. Byam, and the American under Dr. R. P. Strong, succeeded in proving louse transmission. The English committee (Bruce 1918) in an experiment in which lice were crushed on a scarified area of skin of volunteer patients incubated the disease in eight and ten days. In experiments with the feces of lice fed on trench fever patients, a small amount of dried excreta rubbed on a scarified area of skin, incubated the disease in three men on the sixth, seventh and eighth days. Blood from

one of these men on the second day of fever inoculated in another volunteer produced a typical attack after an incubation period of five days. As the lice will usually leave a man with fever and migrate to a man with normal temperature, it is easy to see how the disease is propagated.

The British Trench Fever Committee's reports presented by Major Byam and others (1918) summarize the findings of the committee under 18 paragraphs. They proved transmission of the fever by the feces of lice, that the disease is not native to the louse, and that it is not hereditarily transmitted. The feces of the lice were only infective on the eighth to twelfth day after the lice had taken up the virus, proving a developmental cycle in the lice. Transmission by the bite alone was not obtained. The incubation period after inoculation is at least eight days.

On the other hand the American Trench Fever Committee (Opie 1918; Strong, etc., 1918) claims that the fever is transmitted by the bite of the lice from 19 to 25 days after the virus was taken up by the lice. This is probably the sum of the developmental period in the louse and the incubation period after inoculation. They claimed that the virus is not filterable, but is inoculable. The patients were allowed to scratch, and probably this was the way inoculation took place. It is quite possible, however, after lice have been confined on the skin for a time and have consequently covered the entire surface with their excreta, that they may inoculate the virus when they puncture the skin through this film of excreta.

Arkwright, Bacot, and Duncan (1918) published a long series of studies with *Rickettsia* bodies which they think show a very possible connection with trench fever. Apparently these bodies occurred principally in lice capable of causing infection. The lice do not show these bodies in their feces nor do their feces become infective until five to ten or twelve days after feeding on infective blood. The majority of lice whose feces showed *Rickettsia* were infective and caused trench fever, while the majority which did not show *Rickettsia* were not infective. These same authors (1919) continued their studies with *Rickettsia quintana*, the bodies found associated with trench fever. *Rickettsia* is found in the lice on the fifth to twelfth days after feeding on a trench fever patient. Lice are infective on the fifth to twelfth days. Infected lice contain *Rickettsia* and their feces are high in the bodies. There is no hereditary transmission in lice. Whether *Rickettsia* is the cause or the product of the contagium is undetermined.

L. Convy, and R. Dujarric de la Rivière (1918) described *Spirochaeta gallica* as a probable cause of trench fever.

The *Haemogregarina gracilis* Wenyon, suspected to be connected with the disease, has since been proven not to have any connection.

Bradford, Bashford, and Wilson claim to have found a filterable virus

in trench fever, the organism measuring 0.3μ to 0.5μ , and being anaerobic. A similar organism was recovered from four separate supplies of infected louse excreta.

VOLHYNIAN FEVER.—This obscure European fever also called the Hiss-Werner disease, is claimed by Töpfer (1916) to be carried by lice. Jungmann and Kuczynski (1917) have confirmed this, claiming that an early diagnosis of Volhynian fever is possible by examination of the lice taken from patients. Da Rocha-Lima (1917) points out the similarity of this disease to typhus fever, and described *Rickettsia pediculi* which he believes is the causative organism, and which develops on the epithelial cells in the lumen of the stomach of the louse. Arkwright, Bacot and Duncan (1919) regard *R. pediculi* as normal to lice. Five-day fever, also called *Febris quintana*, is identical with Volhynian fever. Werner and Benzler (1917) describe two cases of transmission by bites and lice.

3. Diseases of Animal Origin

Protozoa

Mastigophora: Binucleata: Trypanosomidae

Trypanozoon lewisi Kent (Trypanosoma, Lewisonella), a common parasite of rodents, often nonpathogenic, is transmitted by several species of fleas but Von Prowazek has demonstrated that it may also complete its development in the rat louse, *Polyplax spinulosa* Burmeister. The rat becomes infected by licking up the insect dejections.

Mastigophora: Binucleata: Leptomonidae

Leptomonas pediculi (Fantham) (*Herpetomonas*) is the only true louse parasite described. Fantham and Porter (1916) have even demonstrated this organism experimentally pathogenic to *Mus musculus*. It occurs in the alimentary tract of *Pediculus corporis* and *P. humanus*.

Leishmania donovani (Laveran and Mesnil) is the cause of Tropical Leishmaniasis or INDIAN KALA AZAR. The normal carrier is undetermined, but positive results have been obtained with the bedbugs, *Cimex hemipterus* and *C. lectularius*. Patton and also Mackie have failed to get results with lice. Possibly these failures were also due to the conduct of the biting experiments rather than scratching in experiments with lice and their feces. It would pay to reinvestigate the lice in connection with the disease.

Mastigophora: Spirochaetacea: Spirochaetidae

Spiroschaudinnia carteri (Mackie) is the cause of ASIATIC RELAPSING FEVER. Mackie (1907) in India was the first to investigate the transmission of relapsing fever by lice. He found a striking coincidence between the cases of fever among Indian school children and the prevalence of lice (*Pediculus corporis*). Mackie found the spirochaete in 14 per cent of the lice from the boys and 2.7 per cent of the lice from the girls. He noted that the spirochaetes multiplied within the gut of the lice and that they could be found in the ovary, testis and Malpighian tubules of the insects, but did not find them in the ova laid by infected insects. Bisset (1914) only found Spirochaetes in the gut and coelomic cavity of the lice. The organism, *Spiroschaudinnia carteri* Mackie, is considered as a biological species not morphologically separable from *S. recurrentis*.

Spiroschaudinnia berbera (Sergent and Foley) is the cause of NORTH AFRICAN RELAPSING FEVER. Following up Mackie's work, Sergent and Foley (1908) in Algeria carried out experiments with lice and obtained positive results by the inoculation of a monkey (*Cynomolgus cynocephalus*) with a single, crushed, infected louse (*Pediculus corporis*). *Pediculus humanus* has also been recorded as an intermediate host. Nicolle, Blaizot and Conseil (1912), also working in North Africa, found that when body lice were fed upon infected blood, the spirochaetes disappeared rapidly from the insects' intestinal tract within 24 hours. On the eighth to tenth day, typical, active spirochaetes reappeared in the lice. Thousands of lice were allowed to bite monkeys and a man with only negative results. Infection was obtained in one of the authors by crushing an infected louse on excoriated skin, the incubation period of the fever being five days. They determined in one experiment that the infectivity of the lice was hereditarily transmitted. Eggs laid 12 to 20 days after the parent lice had fed on relapsing fever blood were placed at 28° C. and began to hatch on the seventh day. The young larval lice and some unhatched eggs were now crushed and inoculated into a monkey which subsequently developed relapsing fever. The spirochaetes were not discoverable microscopically in the eggs. As the result of the work of Sergent, Foley, Nicolle, Blaizot, Conseil and others, it is proven that the lice are infective, though inconstantly, up to five days after an infective meal, and constantly on the sixth day, although during this period spirochaetes are absent; on the eighth to ninth days the spirochaetes may or may not be present and infectivity is exceptional. After the spirochaetes become fully developed in the lice infectivity vanishes. They may be infective up to the fifteenth day. The apyrexial stage of the spirochaete in man and the developmental or granule stage in the

insect are so minute that they have not yet been demonstrated. The organism *Spiroschaudinnia berbera* Sargent and Foley is considered as a biological species, not morphologically separable from *S. recurrentis*.

Spiroschaudinnia recurrentis (Lebert) causes EUROPEAN RELAPSING FEVER. Although many authors consider the above mentioned relapsing fevers as identical with the European fever, the evidence of louse transmission was slow in coming. Manteufel (1907) found that the rat louse, *Polyplax spinulosus*, may carry the disease from rat to rat, and suggested that possibly *Pediculus corporis* could carry it to man. Other authors made similar suggestions. Finally Toyada (1914) found crushed lice infective for mice up to three days after they had fed on infective blood. Since the outbreak of the great war the conviction of the rôle of the louse as a vector of European relapsing fever has become very strong. In fact repressive measures used in Roumania against the louse were effective against the fever. This disease can also be carried by the bedbug, *Cimex lectularius*.

Spiroschaudinnia duttoni (Novy and Knapp) causes RELAPSING FEVER OF TROPICAL AFRICA which normally is transmitted to man by the tick *Ornithodoros moubata*, but Neumann (1909) found that it could occasionally be transmitted from rat to rat by means of the rat louse, *Polyplax spinulosus*.

Spiroschaudinnia sp., cause of MANCHURIAN RELAPSING FEVER, is claimed by Toyada (1917) to be transmitted by lice.

Leptospira icterohemorrhagiae (Inada and Ido) causes INFECTIVE OR EPIDEMIC JAUNDICE, also known as Weil's disease which is infective to man and rats. In the European trenches the rat is regarded as the reservoir of the disease. The spirochaete is excreted by way of the urine or feces of rats or men and is consequently easily communicated through the trenches. It is readily communicated through the mouth or through abrasions in the skin (Dawson, Hume and Bedson, 1917). Stokes conducted negative experiments with *Pediculus corporis*, but these experiments were not directed toward obtaining infection through crushing or scratching lice or feces into abrasions of the skin. This phase of the subject will bear further investigation especially since Dietrich (1917) declares that the disease can be carried by *Pediculus corporis*.

Telosporidia: Haemogregarinida: Haemogregarinidae

Haemogregarina (*Hepatozoon*) *gerbilli* (Christophers) cause of the ANEMIA OF THE JERBOA, *Gerbillus indicus* in India, is believed by Christophers (1905) to pass its cycle of sporogony in the rat louse *Polyplax stephensi* C. and N.

Haemogregarina (*Hepatozoon*) *funambuli* (Patton), cause of the ANEMIA OF THE PALM SQUIRREL, *Funambulus pennatii* in India was found in the vermicle stage in the gut and coelome of the louse, *Haemotopinus* sp., but further development was not observed.

Metazoa

Platyhelminia: Cestoda: Cyclophyllidea: Taeniidae

Dipylidium caninum (Linnaeus), the DOUBLE-PORED DOG TAPEWORM, may have as an intermediate host the biting louse of the dog, *Trichodectes latus* Nitzsch (*canis* De Geer) according to Melnikow, although it usually passes its intermediate stages in fleas.

This completes the summary of the evidence which has so far been presented against the lice. There are many species of sucking lice of wild and domestic animals, and there are many obscure or little known animal diseases. It is naturally to be expected that the literature of animal disease transmission by lice will grow.

I have attempted also to show that the majority of the louse-borne diseases pass through the body of the louse and out through the feces and that they gain access to the host in the following ways: the rubbing or scratching into a skin abrasion of infective portions of the insect body, or its dried or fresh feces; the carrying of the contamination on fingers which have scratched the louse or its feces, and transfer of the contamination on the fingers to the mouth or the eye; the licking up of the lice or their feces by animals which cleanse themselves with the tongue. Direct transmission by bite apparently does not occur except possibly in typhus fever.

It remains therefore to reiterate that all types of skin diseases and blood diseases in which the louse might be suspected should be reinvestigated in case the usual types of inoculation mentioned above have not been tried.

BIBLIOGRAPHY

- Abe, Nakao, 1907.—Münc. med. Wochenschr., vol. 54, p. 1924.
 Anderson, J. F., and Goldberger, J., 1912.—U. S. Treas. Dept., Hyg. Lab., bull. 86, pp. 101-130.
 Arkwright, J. A., Bacot, A., and Duncan, F. M., 1918.—Brit. Med. Journ., Sept. 21, pp. 307-309.
 Arkwright, J. A., Bacot, A., and Duncan, F. M., 1919.—Journ. Hyg., vol. 18, No. 1, pp. 76-94, plates 2, 3.
 Aubert, 1879.—Les poux et les ecoles. Unpoint d'hygiene scolaire Lyon. Rev. in Ann. de Dermatol., 1880, 2 ser., vol. 1, p. 292.

- Bisset, E., 1914.—Proc. 3rd All-India Sanit. Conference, Lucknow, vol. 4, pp. 114-119. Suppl. to Indian Journ. Med. Research.
- Bradford, J. R., Bashford, E. F., and Wilson, J. A., 1919.—Brit. Med. Journ. No. 3031, Feb. 1, pp. 127-128.
- Bruce, Sir David, and Committee, 1918.—Brit. Med. Journ. No. 2986, pp. 354, 355.
- Brumpt, E., 1918.—Bull. Soc. Path. Exot., vol. 11, No. 3, March 13, pp. 249-258.
- Bulloch, W., and Douglas, S. R., 1909.—In Allbutt and Rolleston's System of Medicine, London (Macmillan), vol. 2, pt. 2, p. 374.
- Byam, W., 1918.—Brit. Med. Journ, May 25, pp. 590-591.
- Byam, W., Carroll, J. H., Churchill, J. H., Diamond, L., Lloyd, L., Sorapure, V. N., and Wilson, R. M., 1918.—Journ. Amer. Med. Assoc., vol. 71, No. 1, pp. 21-26; No. 2, pp. 110-113.
- Castellani, A., and Chalmers, A. J., 1913.—Manual of Tropical Medicine, 2nd edit., pp. 1216, 1460, 1463.
- Christophers, S. R., 1905.—Sci. Mem. Officers' Med. & San. Dept., Govt. India, n. s., No. 18.
- Convy, L., and Dujarric de la Rivière, R., 1918.—C. R. Soc. Biol., vol. 81, Jan. 12, pp. 22-23.
- Da Rocha-Lima, H., 1916.—Münch. med. Wochenschr., vol. 63, No. 39, pp. 1381-1384.
- Da Rocha-Lima, H., 1917.—Münch. med. Wochenschr., vol. 64, No. 44, pp. 1422-1426.
- Davies, F. C., and Weldon, R. P., 1917.—The Lancet, Feb. 3, pp. 183-184.
- Davies, F. C., and Weldon, R. P., 1918.—Journ. Royal Army Med. Corps, vol. 30, No. 1, pp. 92-94, Jan.
- Dawson, B., Hume, W. E., and Bedson, S. P., 1917.—Brit. Med. Journ. No. 2959, pp. 345-354.
- DeFont Reaulx, P., 1912.—Arch. de Parasitol., vol. 15, pp. 385-397.
- DeRaadt, O. L. E., 1916.—Meded. Burg. Geneesk. Dienst. Ned. Indie, Batavia, 1915, pt. 4, pp. 39-40.
- Dewevre, 1892.—C. R. Soc. Biol. Paris, No. 11, pp. 232-238.
- Dietrich, W., 1917.—Zeitschr. f. Immunitätsf., I. Origin., vol. 26, Dec. 28, pp. 563-581.
- Dubreuilh, W., and Beille, L., 1895.—Parasites animaux de la peau humaine. Paris, Masson et Cie, pp. 107-140.
- Fantham, H. B., and Porter, Annie, 1916.—Journ. Parasit., vol. 2, No. 4, pp. 149-166.
- Futaki, K., 1917.—Review in Brit. Med. Journ., No. 2963, p. 491.
- Goldberger, J., and Anderson, J. F., 1912.—U. S. Treas. Dept., Public Health Reports, vol. 27, pp. 297-307.

- Hudson, A. C., 1914.—*Lancet*, vol. 2, p. 966.
- Huguenay, 1902.—*Gaz. des hôp.*, p. 591.
- Jungmann, P., and Kuczynski, M. H., 1917.—*Deutsche med. Wochenschr.*, vol. 43, No. 12, pp. 359-362.
- Lambert, A., 1918.—*Columbia Alumni News*, pp. 1038-1039.
- MacGregor, M. E., 1917.—*Bul. Ent. Res.*, vol. 8, pt. 2, pp. 157-163.
- Mackie, F. P., 1907.—*Brit. Med. Journ.*, vol. 2, pp. 1706-1709.
- Manson, Sir P., 1909.—In *Allbutt and Rolleston's System of Medicine*, London (Macmillan), vol. 2, pt. 2, p. 627.
- Manteufel, 1907.—*Arb. a. d. kais. Gesundheitsamte*, vol. 29, p. 355.
- McCoy, G. W., and Clegg, M. T., 1912.—*U. S. Treas. Dept., Public Health Reports*, vol. 27, pp. 1464-1465.
- Moore, W., 1918.—*Journ. Amer. Med. Assoc.*, vol. 71, No. 18, pp. 1481-1482.
- Neumann, R. O., 1909.—*Münch. med. Wochenschr.*, vol. 56, p. 477.
- Nicolle, C., Blaizot, L., and Conseil, E., 1912.—*C. R. Acad. Sci. Paris*, vol. 154, pp. 1636-1638; vol. 155, pp. 481-484.
- Nicolle, C., Blanc, G., and Conseil, E., 1914.—*Arch. Inst. Pasteur, Tunis*, vol. 9, pp. 84-121.
- Nicolle, C., Comte, C., and Conseil, E., 1909.—*C. R. Acad. Sci. Paris*, vol. 149, pp. 486-489.
- Noeller, W., 1916.—*Berlin. klin. Wochenschr.*, vol. 63, No. 28, pp. 778-780.
- Nuttall, G. H. F., 1917.—*Parasitology*, vol. 10, No. 1, pp. 1-188.
- Nuttall, G. H. F., 1918.—*Parasitology*, vol. 10, No. 3, pp. 375-381.
- Opie, E. L., 1918.—*Journ. Amer. Med. Assoc.*, vol. 70, No. 24, p. 1888.
- Oppenheim, M., 1901.—*Verhandl. d. Gessellsch. deutsche Naturf. u. Aerzte*, vol. 73, pt. 2, Med. Abt., p. 451.
- Payne, J. F., 1890.—*Brit. Journ. Dermatol.*, vol. 2, pp. 209-212.
- Penfold, W. J., 1916.—*Trans. Soc. Trop. Med. and Hyg.*, vol. 9, pp. 105-115.
- Pinkus, F., 1915.—*Med. Klinik, Berlin*, vol. 11, No. 9, pp. 239-241.
- Pizzini, L., 1917.—*Il Policlinico, Rome*, vol. 24, Sez. Med., No. 5, pp. 212-228.
- Proescher, F., 1915.—*Berlin. klin. Wochenschr.*, vol. 52, pp. 805-807.
- Prowazek, S., 1913.—*Berlin. klin. Wochenschr.*, vol. 50, pp. 2037-2040.
- Rabinowitch, M., 1916.—*Review in Trop. Dis. Bull.*, vol. 8, pp. 484-485.
- Ricketts, H. T., and Wilder, R. M., 1910.—*Journ. Amer. Med. Assoc.*, vol. 54, pp. 1304-1307.
- Sergent, E., and Foley, H., 1908.—*Bull. Soc. Path. Exot.*, vol. 1, pp. 174-176.

- Sergent, E., Foley, H., and Vialatte, C., 1914.—C. R. Acad. Sci., Paris, vol. 158, pp. 964-965.
- Smith, J. F., 1918.—Journ. Royal Army Med. Corps, vol. 30, No. 5, p. 519.
- Sobel, J., 1913.—New York Med. Journ., vol. 98, pp. 656-664.
- Stempell, W., 1916.—Deutsche med. Wochenschr., vol. 62, No. 15, pp. 439-442.
- Strong, R. P., Swift, H. F., Opie, E. L., MacNeal, W. J., Baetjer, W., Pappenheimer, A. M., and Peacock, A. D., 1918.—Journ. Amer. Med. Assoc., vol. 70, No. 22, pp. 1597-1599.
- Swellengrebel, N. H., and Otten, L., 1914.—Centralb. f. Bakt., 1 Abt., Orig. vol. 74, pp. 592-603.
- Töpfer, H., 1916.—Münch. med. Wochenschr., vol. 63, No. 42, pp. 1495-1496.
- Toyada, H., 1914.—Zeitschr. f. Hyg. u. Infektionskr., vol. 76, pp. 313-320.
- Toyada, H., 1916, 1917.—Saikingaku Zasshi, Nos. 250 and 259, Sept. 10, 1916, and April 20, 1917. Reviewed in Trop. Dis. Bull., vol. 10, p. 271, and vol. 11, p. 203.
- Werner, H., and Benzler, J., 1917.—Münch. med. Wochenschr., vol. 64, No. 21, p. 695.
- Widmann, E., 1915.—Münch. med. Wochenschr., vol. 62, pp. 1336-1338.
- Wilder, R. N., 1911.—Journ. Infect. Dis., vol. 9, pp. 9-101.

CHAPTER XXI

The Life History of Human Lice¹

R. H. Hutchison and W. Dwight Pierce

Until the outbreak of the great war there had been a great mass of desultory writing upon the three species of human lice, but this was in all languages and few had made any attempt to classify and arrange the knowledge thus obtained. Since the beginning of the war, however, the louse has been a major problem and there have been more titles published on it than on any other disease-carrying insect. The first comprehensive work was published by Hase (1915-1916) in a series of papers. These were followed by several excellent monographs by Professor Nuttall (1917-1918), the second of which gives a complete bibliography of the literature on human lice, a summary of the evidence of disease transmission, exclusive of the recent work on trench fever, and extensive biological studies. With the large number of students recently concentrating on these vermin, we may expect that our literature will be greatly enriched with many more fine contributions.

The human lice have generally been regarded as belonging to three different species, *Pediculus humanus* Linnaeus (*capitis* DeGeer), *P. corporis* DeGeer (*vestimenti* Nitzsch) (plate XXI), and *Phthirus pubis* Linnaeus (*inguinalis* Redi). Bacot carried out hybridizing experiments with *humanus* (*capitis*), and *corporis*, carrying the offspring to the third generation. It is on the strength of such studies that Nuttall united the two under the name *humanus*, and for convenience, designated one *capitis* (head louse), and the other *corporis* (body louse) as varieties of this species. Other writers are not wholly convinced in regard to the union of the two species and we shall await further studies with interest.

The true *P. humanus*, or head louse, is usually confined to the head, mostly about the occiput and ears, but it may spread over the body, establish itself on other hairy parts, and may be confined to the pubic hairs and multiply there. The body louse, *P. corporis*, lives usually on the body and in the clothing and is very rarely found on the head. The pubic louse, *Phthirus pubis*, is usually found on the hairs in the pubic region but may occur in other hairy parts of the body.

¹This lecture was presented June 17, 1918, and distributed the same day. It has been greatly revised.

The body, head, and pubic lice are found on all races of men and seem to show some varietal differences according to the host. None of these species occurs on any other host than man, although a closely related species *Pediculus consobrinus* Piaget occurs on a monkey (*Ateles pentadactylus*).

Children and old people are much more likely to be affected with head lice than active men and women, and girls because of their long hair are much more frequently infested than boys. On the other hand, men seem to be more often the subjects of attack by *corporis* and *pubis*.

In the civilian population of this country there are indications of im-

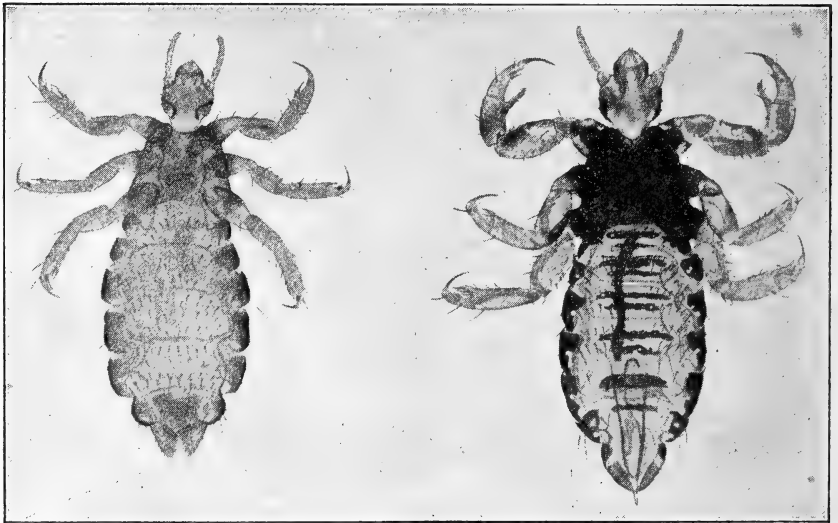

PLATE XXI.—The clothing louse, *Pediculus corporis*. Fig. 1.—Female, ventral view. Fig. 2. Male, dorsal view. (Pierce and Hutchison, photos by Dovener.)

portant changes in the general problem. In times of peace the louse problem is most acute in jails, poorhouses, and like institutions; among vagrants and the extremely poor classes; among gangs of laborers, as in construction camps, lumber camps, threshing gangs, etc.; and among immigrants. Since our entrance into the war there have been economic changes which have shifted some of these centers of infestation. For example, there have been many camps of laborers engaged in temporary construction work. Reports indicate that lice give considerable trouble in some of these. There has probably been an increase in the size and number of lumber camps. On the other hand, we have been informed by the captain in charge of the House of Detention at New Orleans, that the vagrant population, which has always been their worst source of

infestation, has been reduced more than two-thirds. It is also well known that immigration has been greatly reduced.

The urgency of the problem in the armies led to extensive investigations of control measures and of the biology of lice. The knowledge of the biology of the body louse was surprisingly meager up to the time the war began. It is our purpose in this lecture to call attention to some of the vital points in the biology of lice, and to point out their relation to practical control work, for without a knowledge of these points, one cannot expect to intelligently interpret the results of control work. Some

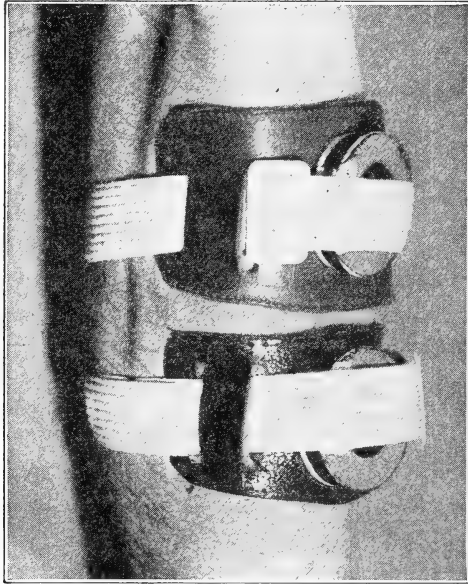

FIG. 61.—Wristlet method used for breeding lice. (Hutchison, Photo by Dovener.)

of the more important and recent additions to our knowledge of louse biology are due in no small measure to the improved technique for rearing lice as evolved by Bacot, Sikora, and Nuttall. Warburton's method of placing the insects on cloth in plugged tubes, feeding them twice daily and placing the tube in the pocket or incubator between feeds, has been largely followed, with modifications by other workers, but after many attempts at rearing lice under more normal conditions and providing them with unlimited opportunities for feeding, Nuttall finally worked out the two methods which he describes under the names of the "felt cell method" and the "wristlet method" (fig. 61). For the details of these methods it is best to consult the original description in Nuttall's (1917b) article on the biology of *Pediculus humanus*. In fact, we have avoided giving a

stereotyped account of the life history, on the assumption that this article will be read by all those interested.

The first point to be noted is the fact that body lice may occur on the body as well as on the clothing. Nuttall has brought out convincing evidence that nits as well as lice themselves are often found upon the body hairs, especially in the axillae, the hairs of the breast, and at times on the pubic hairs and even the hairs of the thigh and leg. We have seen two cases in which both lice and nits were present in the axillae. The importance of this point as regards control measures is obvious. Disinfection of the clothing is not sufficient, but must be accompanied by a thorough bath with some insecticidal liquid, such as cresol-soap, or the kerosene soap used by Boyd in his work with the Mexican laborers of the Sante Fe Railroad.

Moreover, it was soon discovered from actual experience in this war that a disinfection of a part of the clothing was entirely ineffective; for example, if clean shirts are provided, while the trousers have not been cleaned, lice quickly migrate from the trousers to the clean shirt which affords them new areas for deposition. Thus conditions are soon as bad as before.

A second point having an important bearing on control measures is the number of eggs laid per female and their rate of development. The importance of the improved technique for rearing lice, mentioned above, consists in showing that previous statements, regarding the number of eggs laid, clearly underestimated their power of reproduction. When the lice are fed but twice a day only four to five or six eggs are obtained per day, while by the wristlet method Nuttall obtained as high as twelve eggs per day per female, the average being about ten. He states that *corporis* may lay 275 to 300 eggs during its lifetime. By the same method the senior writer has obtained as high as fourteen eggs per day, with an average of about eleven per day over a period of twenty-five days.

The eggs are elongate, oboval, with a granulated cap or operculum at the outer end (plate XXII). They are cemented singly to a hair (in all three species), or a thread (*P. corporis*). Occasionally a single hair will be covered with them. Oviposition usually commences in *P. corporis* within two days after maturing.

When a female is ready to oviposit she clings to a hair or thread, and slipping backward, grasps it also with the gonopods and the posterior lobes of the last segment. A drop of cement is excreted, followed by the egg, which is thus firmly cemented to the hair and the insect moves away. The entire operation consumes about 17 seconds. The operculum is usually directed away from the root of the hair.

Oviposition takes place most readily at about 30° C. (86° F.) and ceases at 20° C. (68° F.). They lay rapidly at 37° C. (99° F.) although



PLATE XXII.—Eggs of the Clothing Louse, *Pediculus corporis*. Fig. 1 (upper).—Mass of eggs, slightly reduced, between seams of trousers. (Photo by Dovener.) Fig. 2 (center).—Great enlargement showing eggs hatching. (Photo by Paine.) Fig. 3 (lower).—Very great enlargement showing structure of eggs, with exuviae within. (Photo by Paine.)

this temperature shortens their lives. Infected persons who remove their clothing at night consequently become less heavily infested than those who wear their clothing continuously. The periodic cooling of the clothing and the lice therein leads to their progeny being materially reduced.

Nuttall and Bacot are both agreed that *capitis* prefers to lay its eggs on hairs, but they do not agree as to whether *corporis* prefers cloth to hairs for oviposition.

The length of the egg period varies from 5 to 16 days under normal conditions and may be retarded to the 35th day, or possibly later, by cold periods. Under European conditions of humidity, apparently 30° C. (86° F.) gives about the optimum condition for hatching, although the shortest period experienced was at 37° to 38° C. (99-101° F.). In experiments at New Orleans at 37° C., hatching occurred in four to eight days; while the eggs hatched in six to seven days at temperatures of 33° to 34° C., and in eight days at 30° C. The effective zone for the egg stage is from slightly under 20° to 40° C. (68-108° F.). At temperatures of 40° to 45° C. the embryo dies. In this connection, Nuttall has made some very unfortunate remarks. He discredits the seven-day record with two individuals at 20° C. made by Widmann, the ten to twelve-day records at the same temperature made by Heymann, and Legroux's statement that they rarely hatch at 16-18° C., because Sikora and Hase recorded failures at 20° and Nuttall and Hindle failed to hatch eggs at 22° C. It is quite possible at 20° C. at one humidity to obtain death; at another humidity, 12-day development; at another, 7-day development; and at still a different humidity, possibly a very long developmental period. All of Nuttall's remarks on temperature effects must be more or less discounted because of his ignoring the important humidity factor. In fact, he states that there is no evidence that eggs maintained at 22° C. or under are capable of hatching, but he quotes quite a series of retarded development records in which the eggs were maintained for more or less long periods at low temperatures. For instance, Widmann kept eggs for 24 hours at 10° C., and then transferred them to 26-30° C., and they hatched in 17 days. After keeping eggs at 9° C. for two or three weeks, Heymann transferred them to a favorable temperature and they developed in 15 days. The length of time the eggs can stand a given low temperature will depend to a large measure on the humidity. At a given temperature it appeared that dryness may retard development two or three days or more. Thus it may be seen that there is still work to be done on the effect of humidity on the incubation period.

In testing various insecticides for their effect on the eggs, it is necessary to provide the proper temperature conditions; otherwise, failure to

hatch may be due to low temperature rather than to the chemical or other agent tested.

In interpreting results from control experiments, it is important to bear in mind that lice will lay infertile eggs. Isolated females to which males have not had access will lay eggs at about the normal rate. Such eggs are all sterile and show no development. There is no evidence of any parthenogenesis. But even females to which males have had access will lay some infertile eggs especially near the beginning and end of their lives. Nuttall says that at constant temperature of 30° C. we may expect about 70 per cent of a given lot of eggs to hatch. Of those which fail to hatch, some are fertile, some undergo partial development, but for some unexplained reason fail to complete development. He points out that "hatching alone is not therefore a true test of fertility." For accurate work, eggs of known age should be used, preferably after they have reached the stage when the eyes appear as faint brown spots on each side of the head of the embryo. By examination with the binocular, the presence of these eye-spots will indicate the number which are fertile, and their absence, the number sterile.

The freshly laid egg is almost transparent, but as the embryo develops, the egg assumes a yellowish color and the eyes first appear as pinkish spots, gradually turning red or brown in color, finally becoming black. After the limbs become clearly defined and the claws and eyes darken, there are slight movements of the limbs, and of particles within the body of the embryo, and periodic pumping movements of the pharynx begin to appear. These pumping movements become more frequent as time for emergence approaches. Sikora and Nuttall were the first to grasp the meaning of these pumping movements and show that they are intimately concerned with the act of emergence. When the larva is ready to emerge, the air is pumped in rapidly through the so-called air canals of the operculum. The air is accumulated in the anterior end of the shell, the body of the embryo completely filling the remainder. As pumping continues, the air is passed on through the gut, "the bubbles being distinctly seen through the transparent glassy shell as they pass backward" and are expelled through the anus and accumulate in the posterior end, thus pushing the embryo up against the operculum. "This pressure of the air cushion finally overcomes the resistance of the operculum and the latter springs open." The head of the larva is thus forced out and assumes a normal position. Soon the first pair of legs is withdrawn. These are quickly brought into action and with their aid the remainder of the body is soon withdrawn. This highly interesting process is important in its relation to control measures. In the first place, if oily or greasy substances are used they occlude the air canals of the operculum and the larva dies. Some substances when applied to

young eggs, may evaporate without acting directly on the embryo and leave the air canals open by the time the embryo has reached the stage of pumping movements. In control experiments results have been obtained which indicate this, the mature eggs being destroyed and the younger eggs emerging some days later, showing that the chemical had not affected the contents of the egg, but killed the older eggs by occlusion of the air canals, and passed off in time to permit the younger ones to hatch.

Another point of importance is that proper temperature conditions must be provided in such experiments, to permit normal emergence as well as normal incubation. If the temperatures are too low the process of emergence is slow and the vitelline membrane will dry before the larva has freed itself. As a result the larva dies with the head and first pair of legs and part of the thorax outside the shell, but the posterior end of the body and the second and third pairs of legs stick to the dried membrane, or it may be that the larva will die without bursting the membrane. In some cases larvæ have been found with all but one leg free from the membrane, but this so firmly stuck fast as to prevent escape. It is important, therefore, to bear in mind that the effect of low temperatures may entirely outweigh the effect of the control measure under trial. Effective temperature is higher than for most other insects.

The egg shell is very tough and resistant to chemicals as is also the cement by which it is fastened and there is no known way of removing them without first destroying the fibers or hair to which they are attached. Hase describes how the Russian prisoners tried to reduce infestation by hanging shirts on a wire and beating with sticks, and Legendre recommends vigorous brushing with a stiff brush. Hase is doubtless correct in pointing out that beating fails to dislodge many of the lice or to crush any of the eggs and that brushing may tear loose some fibers with attached eggs, but actually destroys very few. On the contrary, it is pointed out that this may be the means of spreading the infestation to other men rather than affecting any reduction. Hase carried out experiments showing that lice can crawl up to the surface after burial in several inches of dry sand or earth. If shaken or beaten out of the clothing to the ground and pressed into the sand under the heel they will crawl to the surface and attach to the first host near them, which they have abundant opportunity to do in a crowded prison or prison camp, especially when the weather permits the prisoners to lie down on the ground. Eggs brushed from clothing will hatch if temperatures are favorable, and the issuing larvæ reach new hosts in the same way.

Many experiments have been carried out by Hase and Nuttall with a view to determining what kind of materials lice prefer for oviposition. They agree in showing that rough materials such as felt, wool, and flannel

are preferred. However, in case of necessity, the lice can and will oviposit on smooth materials such as silk and sateen. It has been suggested that infestation could be greatly reduced and even remedied entirely by wearing for one to twenty-four hours a broad band of felt or rough wool under the clothes, with the idea that lice would collect on this, and they and their eggs could then be destroyed by burning. But the preference of lice for such material and the difference between this and the uniform is not marked enough to make it really effective.

In practical control work the question is likely to arise as to how long discarded but untreated clothing will remain infective. The answer to this, of course, depends on how long lice can live without food and how long it takes for all the eggs to hatch. Experiments show that lice can live without food from two to three days at 35° C., three days at 30° C., three to five days at 22° C., and about seven days at 10° C. The lice cannot live long without food unless at ineffective temperatures, the longest period recorded being ten days at 5° C. (41° F.). The longest record of fed adults is 46 days for a female recorded by Bacot. One male lived 32 days and fertilized eighteen females.

As stated above, eggs will hatch in sixteen days at 25° C., but below 22° C. they usually do not hatch. How long a period of low temperatures they can endure, and still hatch when the temperature is again raised, is not known beyond a statement by Nuttall that he delayed hatching to 35 days by low temperatures. Certainly the safest plan would be to allow 30 to 40 days of cool weather or two weeks of hot weather for all the eggs in discarded clothing to hatch.

There are three larval stages, or possibly we may call the last the nymphal stage. The larvae suck blood from their human host. The first molt occurs on the third to eighth day, and the other stages are correspondingly long.

In molting, the skin splits longitudinally from base to apex of thorax and along the base of the head to near the base of the palpi.

The entire life cycle of *corporis* on the human body may be as short as sixteen days, eight for the egg, two each for the first and second larval stages, three for the third stage, and one day preovipositional period. The head louse has been carried through its entire life cycle in seventeen days.

The frequency with which lice feed is dependent upon the rate of digestion, which is dependent upon climatic conditions. They feed more frequently at body temperatures than when kept cool. They feed at all times of the day. Lice which have not had a feed for some time become ravenous and often feed to excess, rupturing the intestines and causing death.

The lice seem to avoid light except when hungry. They seem to be quite sensitive to excessive warmth and will leave a fever patient.

In the absence of definite humidity data we may roughly describe the zones of climatic influence on the lice as follows: The zone of minimum fatal temperatures for eggs is below 20° C. (68° F.) and for adults lies below zero centigrade (32° F.). The zone of the dormancy in adults extends from about -10° to 5° C. (14° to 41° F.). The zone of sluggish movement without reproductive activity and with practically no digestive processes extends from 5° to 20° C. (41 to 68° F.). Digestion ceases at 12° C. The zone of optimum activity lies between 20° and 40° C. (68° to 140° F.) with the optimum about 30° C. Practically all egg hatching occurs within this zone, as does all oviposition, practically all assimilation of food, and all normal activity. From 40° to 44° C. the lice are wildly active. This zone represents one of exhaustion in which death of eggs occurs. Above 44° C. (112° F.) lies the zone of maximum fatal temperatures. In control work 54° C. (131° F.) for one-half hour is sufficient to kill all stages, and 60° C. (140° F.) for one-quarter of an hour gives a very thorough control.

There are several other phases of the biology of lice which may be mentioned briefly. For example, the locomotory powers would repay study. Their inability to make any headway on clean smooth metal or glass when inclined at an angle of more than 2° to 3° , and their inability to crawl on smooth vertical surfaces such as rubber gloves or boots, as contrasted with their gymnastic skill on threads or fibrous materials and their power of clinging to anything which they can clasp with their claws, explain the different protective uniforms worn by those who have had to do with typhus epidemics.

Their different reactions to light when fully fed or when hungry have a bearing on the question as to how they find new hosts.

There are yet many phases of the biology which need elucidation. For example, the question as to the state of development of the olfactory sense and whether this comes into use in finding a new host. Hase concludes that they have a fairly keen olfactory sense because they are quickly repelled by substances like tar and ethereal oils. According to him, they recognize and avoid the odor of horses,—the clothing of those artillery men who drive and care for the horses is saturated with the horse odor and free from lice, while others in the same battery without the horse odor are infested. On the other hand, a hungry louse placed on a glass slide near a freshly drawn drop of blood is apparently entirely unaware of the proximity of food. Likewise a hungry louse on a piece of cloth is apparently unaware of the presence of a human hand and a chance to feed, until a finger has been pushed within one-half inch or

less of it, and that may be a positive reaction to the heat radiation from the hand rather than an odor reaction.

REFERENCES

- Hase, A., 1915.—Beiträge zu einer Biologie der Kleiderlaus. *Zeitschr. f. angelwandte Entomol.*, Band. 2, Heft 2, pp. 265-359, 47 figs.
- Hase, A., 1915.—Weitere Beobachtungen über die Läuseplage. *Centralb. f. Bakteriol. Parasitenk u. Infektionskr.*, 1 Abt., Orig., Band. 77, pp. 153-163.
- Hase, A., 1916.—Ueber die Entwicklungsstadien der Eier und ueber die Larven der Kleiderlaus. *Naturw. Wochenschr.*, Band. 31, pp. 1 et seq. (inaccessible).
- Nuttall, G. H. F., 1917.—Studies on *Pediculus*. *Parasitology*, vol. 9, pp. 293-324, 2 pl., 12 text figures.
- Nuttall, G. H. F., 1917b.—*Parasitology*, vol. 10, No. 1, pp. 1-183. Several articles including complete bibliography.
- Nuttall, G. H. F., 1918.—*Parasitology*, vol. 10, No. 3, pp. 375-405, figs. 1-5.

CHAPTER XXII

The Control of Human Lice¹

W. Dwight Pierce and R. H. Hutchison

Never in the history of the world has the subject of insect-borne diseases become so prominent as it has since the discovery that several of the great diseases which ravage nations and armies are borne by lice, and that personal prophylaxis alone will combat these diseases.

The knowledge of the means of conveyance of a disease is the first requisite for the successful preventive measures. Had the scientists not known how typhus fever was spread the entire nation of Serbia, and possibly most of the peoples of eastern Europe and the poor peoples of all the war-stricken nations as well as the men in the trenches might have been wiped out by now. As a matter of fact, probably one-third of the Serbian nation and hundreds of thousands of Roumanians, Austrians, Russians, Germans, and Turks were lost before the medical authorities obtained the necessary grip on the situation. The lice would have gone on disabling the men in western trenches with trench fever if they had not been proven to be the vectors.

THE RAVAGES OF LICE

The eastern theatre of war has long been scourged with louse-borne epidemics. During the Crimean war the British troops became seriously infested, becoming anaemiated and debilitated and death carried off many of them. The only remedy available was to put the wet flannels in the snow for two days—this killing all but the nits (Shipley).

Typhus fever ravaged the Bulgarian troops during the two Balkan wars to such an extent that it was estimated by a staff officer that they lost more soldiers in a short period of time from fleck typhus than from all other diseases combined.

During the present war, the lice at first were most serious in the eastern theatre, probably due to the greater congestion of population among the Slavic peoples. The Germans first had to combat them among the Russian prisoners, finding the French almost completely free. But

¹This lecture is a modification of one read June 24 and distributed June 27 and of a synopsis presented September 18 and distributed October 4, 1918.

by mixing the prisoners, and the exchange among them of souvenirs, especially shoulder straps under which the lice clung in masses, the lice became generally distributed. It was not long before the German armies found the louse a very live problem and their scientific journals are full of papers on the control of the vermin.

In Serbia a few cases of typhus fever occurred in October, 1914, and in January, 1915, the disease was epidemic among Austrian prisoners who were greatly crowded and necessarily compelled to live under very unsanitary conditions. The disease quickly spread from them to other individuals, and as there was no quarantine, and the Austrian prisoners and the infected individuals were sent or allowed to go to various parts of the country, Serbia was soon afflicted with a terrible and widespread epidemic. Weakened by the ravages of war, the country was not prepared for an epidemic and for a time typhus raged almost at will. The majority of the Serbian doctors, who were few in number, became afflicted. The epidemic was at its height in April when the number of cases was at least 9000 a day, but it was impossible to gauge the number of cases in the rural districts. At least 100,000 men, or a quarter of the army, were destroyed in this epidemic which was checked by the energetic efforts of the medical officers, assisted by Dr. R. P. Strong and his American colleagues. The work of the Serbian Sanitary Commission is briefly detailed by Doctor Strong in various reports.

In Roumania typhus fever and relapsing fever became epidemic in the winter of 1916-17 and the conditions which occurred there are very vividly portrayed by Wells and Perkins (1918). Rulison (1918) gives the history and statistics of the epidemic from its beginning through the greater part of 1918, estimating 26,000 deaths from typhus fever up to February 13, 1919.

It was inevitable that the louse should reach the western trenches and contaminate them with disease, and we find that trench fever was soon considered the most disabling disease of this front. Reports show that a very high percentage of the men in the trenches became verminous.

RESERVOIRS OF LOUSE BREEDING

Before discussing the control measures, we must also know whence arise these infestations of lice which can infect whole nations, because prophylaxis must take into account the reservoirs of the pest. In the United States, where cleanliness and bathing are more or less the general rule, there have never been great outbreaks of these vermin except in time of war. In certain parts of the world, however, the louse is an ever-present associate of man. This is especially true of the ignorant and the densely populated portions of the world, the Mexican and South

American peons, the European peasants, the Mohammedan populations of Africa and Asia. Among the Mohammedans, their religion forbids killing insects and from childhood they become inured to their attack. War serves to aggravate conditions by concentrating refugees and prisoners in crowded, unhygienic zones, and by mixing troops from all stations of life and from all races. Among our own people, lumber camps, mining communities, jails, poorhouses, lodging houses, construction camps, ghettos, negro communities, Mexican colonies, Indian reservations, tramps, and vagabonds are the principal reservoirs of infection which infect our armies and the civil population. Ignorant, degraded people everywhere are sources of lice. Our public schools, where children from all strata of society mingle, furnish constant trouble as distributing centers of head lice, as the children's hats and clothing hanging on racks afford easy means of spreading the vermin. Infection from lice may occur as just mentioned in clothes racks, public transportation, public halls, public toilets, hotels and lodging houses, and by coming in direct contact with lousy individuals.

CONTROL MEASURES

Out of conditions as described above have arisen heroic methods of treatment. When things are done in armies they must be done on a large scale. Consequently we find that Dr. Strong's commission began to educate the Serbian nation on the necessity of bathing and cleansing the wearing apparel, and similar efforts were later made in Roumania. And furthermore, with the cleansing came the control of the epidemics.

The British in 1915 began isolating German prisoners for 14 days after capture, for observation, and they treated or destroyed their clothing and bathed them as promptly as possible. The isolation of prisoners was later practiced quite generally.

It has become a well-defined principle now that new acquisitions to a military camp must be treated for lice. This treatment is called delousing or disinsection. Men returning from the trenches, prisoners of war, men who have been on furlough, new recruits, and new units must be inspected and given a complete delousing treatment on general principles. This treatment often varies in detail but consists of thorough bathing, cleansing of the clothes and accoutrements, and disinfection of bedding and baggage.

On the Mexican border the United States Public Health Service has found it necessary to exercise a rigid supervision over refugees from Mexico, as the disturbed political conditions in that country have resulted in a spreading of typhus fever from the plateau regions, where it is endemic, to all parts of the country. The immigrants are stripped and given identification tags for their clothing and baggage, and then they

themselves are given thorough spraying with kerosene or gasoline emulsion, and then baths with warm water, and if lice are present, the hair of the men and boys is clipped and burned. The women have a mixture of equal parts of kerosene and acetic acid applied to the hair for half an hour with a towel covering the head. The acetic acid loosens the eggs from the hair and the kerosene kills or stupefies the lice. Before entering the bath, liquid soap is sprayed on each person. The soap is made by boiling one part of soap chips in four parts of water and then adding two parts of kerosene oil, or four parts of gasoline. This jellies when cold, and one part of this soap jelly is added to four parts of warm water, making a good liquid soap at very small cost. The clothing is disinfected by being placed in bundles in the steam chamber, in which a vacuum of 10 to 15 inches is created, and live steam is then introduced until the gauge shows 20 pounds, which gives a temperature of 259° F. This is maintained for 10 minutes to insure penetration. The creation of a second vacuum of 10 inches and holding it for 10 minutes will dry the clothing completely. (Pierce, C. C., 1917.)

Recent studies have shown the inadequacy of gasoline and gasoline emulsion as an insecticide, and it is therefore our recommendation that only kerosene emulsion be used in delousing. (See Hutchison and Pierce 1919.)

There are certain general methods by which much of value in insect control can be gained, and many of these can be classed as educational. An educational propagandum has been conducted in practically every one of the nations most seriously affected and also in the United States. Press statements, magazine articles, bulletins and lectures, posters, and personal demonstrations have done much to reduce louse incidence, and finally, the moving pictures used by the War Department to educate the American troops, have vividly brought to their minds the dangers and the means of control.

Personal prophylaxis, when one is subject to louse infection, may be regarded as one of the best means of keeping free of them. This should consist of daily or weekly baths, according to convenience; frequent change and laundering of underclothing, and dry-cleaning of outer garments; frequent personal inspection of clothing, especially along the seams. In military commands where practicable, there should be weekly official inspection of a very thorough nature. Many inspectors make the mistake of looking at the man for body lice, instead of in his clothing. For crab or head lice an inspection of the person is of course the only means of detection.

Inspection for lice must not be considered essentially an army practice. Any jail, hospital, lodging house, poorhouse, orphanage, or other charitable institution, is more than likely to receive many lousy inmates.

Either there must be a thorough system of inspection on entrance, or all applicants must be assumed to be infected, and accordingly bathed and have their clothing sterilized.

CONTROL OF LICE ON THE BODY

Control of Crab Louse

The crab or pubic louse is confined usually to the hairy portions of the body, including the head and the eyebrows. Its eggs are attached to the hairs, and the lice themselves remain fixed to the body, with the head imbedded. Prophylaxis for it is therefore largely personal. The infected person should bathe in hot water and use an insecticidal soap such as the kerosene emulsion soap described above, and then anoint the infected parts with yellow oxide of mercury ointment, mercurial ointment (blue ointment), carbolic acid 2 per cent followed by olive oil, or vermijelly made up by the following formula:

Texas fuel oil, sp. grav. 0.86, b. p. 250 to 350° C.....	50 parts
Crude vaseline	20 parts
Soft soap	30 parts

The cutting or shaving of pubic or axillary hairs is to be avoided because of the discomfort caused. Powders such as N. C. I., etc., should not be used in the pubic regions.

Control of Head Louse

The head louse is usually confined to the head and lays its eggs on the hairs. The usual approved prophylaxis consists of daily combing and brushing and periodic washing. It is well to keep children's hair short. Many children's institutions clip the boys' hair, and clipping of hair is a common military practice. Several insecticidal hair washes are used:

1. Wash head with equal parts of kerosene and vinegar or 25 per cent acetic acid for one half hour, keeping the head covered with a towel. The vinegar separates the eggs from the hairs, while the kerosene kills them. Use a fine-toothed comb to remove the eggs and lice. Wash the head with warm water and soap containing kerosene (Nuttall).

2. Have patient lie down with the head over edge of bed above a basin resting on a chair, so that the hair lies in the basin. Pour the carbolic water over the hair so that it falls into the basin and sluice it about until the hair is soaked, for ten minutes. Drain, wring out moderately, and wrap head in flannel towel. After an hour wash the hair or

let it dry with the carbolic in it. To remove the eggs, apply 25 per cent acetic acid and use fine comb (Nuttall).

3. Anoint head with a mixture of equal parts of kerosene and olive oil, wrap the head in a towel and sleep in it. Apply vinegar and remove eggs with a fine comb, then wash out with warm water and soap. This may be repeated for two or three nights if necessary.

4. Hair oil and pomades, as used in certain classes and races, are efficient.

Control of Body Louse

The body louse occasionally lays its eggs on the hairs of the body, but most of the measures involving treatment of the body are aimed at preventing attack. In handling this louse it must be borne in mind that simultaneous with freeing the body there must be control of the infection in the garments and living quarters.

The bath is the first important step in control of the body louse.

Bath Outfits.—Early in the war it became apparent that portable bathing and disinsecting apparatus must be developed. In Russia, Brink (1915) late in November, 1914, devised a portable traveling bath capable of bathing a regiment of 4000 to 4500 men in 1½ to 2 days.

Many modifications of this have been devised but we may give in general a composite of these, which may serve as the model.

The outfit may consist of a wagon train with tents or portable huts, or a train, or at halting stations may consist of permanent structures. The portable wagon or tractor-drawn outfit can most nearly approach the trenches and is considered the best by Brink. The equipment should be capable of washing and cleaning the clothing and equipment of at least 100 men an hour and to discharge each man in about half an hour, thus making it possible to wash an army unit in the course of a short time.

There is also supposed to be a distinct separation between unclean and clean, and the cleaned men must not mix with the uncleaned.

Disrobing.—In a bathing unit, the men come into the receiving tent, car, or room, and undress, receiving numbered tags for identification of their belongings. In the disrobing room each man places his clothing in a bag, his accoutrements in another receptacle, personal belongings which do not need fumigation in still another, all of these receptacles bearing the number given to him. These articles may be treated in various ways as described under the various headings.

Bath.—The men proceed into the bathroom and receive either shower or tub bath, and in some cases pass through several baths. In the Russian portable outfits the bath equipment consists of folding benches, zinc covered tubs, wash basins, spoon measures for liquid soap, sacks for

sterilization of clothes, little numbered tags, canvas folding tanks for water, kerosene lamps to be used at night, and a barber shop. Naphtha soap is used as the cleansing agent. On the Mexican border at El Paso the men are first sprayed with gasoline soap (for which kerosene soap should be substituted) and then walk through a continuous spray in a tank of water about a foot deep. On the Sante Fe Railroad, according to Boyd, the Mexicans are given a ten-minute bath in kerosene and soap-suds (equal parts), with a kerosene and vinegar bath for the hair. Our own army has now established elaborate bath and disinfection houses.

In at least one of the baths hot water should be used. The liquid soap described above, applied as a spray, is a very good method and prevents contamination by means of the soap.

Either before or after the bath, they enter the barber shop, where the hair is clipped if there is any evidence of head lice. Bags should be tied around the neck to catch the hair, which is burned. The men may also be shaved.

They then pass into the dressing room where they receive clean underclothes and their outer garments and other possessions disinfected and disinfected.

Soaps.—In the bath, soap is one of the essentials. All soaps are not insecticidal, and others are not sufficiently effective. Recent tests have shown that gasoline and gasoline soap emulsion are not thoroughly effective remedies (Hutchison and Pierce). The following soap formulae are considered effective:

1. Liquid kerosene soap emulsion made by boiling one part soap chips in four parts water and then adding two parts kerosene oil. This jellies when cold, and one part of this jelly added to four parts of warm water makes a good liquid soap at very small cost.
2. Five per cent carbolic acid and soft soap, equal parts.
3. 5 per cent cresol and soft soap, equal parts.
4. Two per cent lysol and soft soap, equal parts.

For wounded men, after a shower, Adler-Herzmark recommends soaping down with a brush, using an emulsion of petroleum 1 part, soft soap 2 parts, and lysol solution 1 part. Afterwards apply 3 per cent cresol ointment to the hairy parts.

Sponge Baths.—It is often impossible for soldiers, especially, to get a genuine bath, so they must resort to sponge baths and treatment of the body and garments to reduce, at least, the infestation.

A good treatment consists of sponging off the body with water, using the above-mentioned kerosene emulsion soap, or sponging with 2 per cent crude carbolic acid solution, and then anointing the body with ordinary grease or with vermijelly, which we have already described.

Vermicides and Repellents.—When unable to follow out the plan of

bathing and cleaning the clothing, the only means left is to use some kind of vermicide or repellent. Nuttall has described experiments with many chemicals, but Moore has gone into the subject much more exhaustively. Both reported unfavorably regarding sachets, although the following substances have been found to exert repellent action on the lice: oils of anise, cloves, eucalyptus, naphthalene and carbolic acid. Insecticidal powders are frequently favored. Moore (1918a) lists many effective powders but reports the most effective to be made of:

Creosote	1	cc.
Sulphur	1/2	gr.
Talc	20	gr.

Naphthalene is very commonly used and is effective, but its continuous use may injure the eyes. One of the commonest powders in general use is known as N. C. I. powder and is made of:

Naphthalene	96	per cent
Creosote	2	per cent
Iodoform	2	per cent

The specialists of all the nations have sought to find a substance with which clothing could be impregnated and rendered vermicidal. Moore has suggested wearing a cheesecloth suit impregnated with saturated solution of sulphur in creosote on the outside of the underwear, but on the whole he reports (Moore, 1918b) after testing many substances, that the cost of application is too high for the results obtained, and none are effective longer than a week. Moore and Hirschfelder subsequently reported more hope of success from naphthalene and cresol compounds than from anything else.

CONTROL OF LICE IN CLOTHING

In order to properly delouse a unit, the cleansing of the clothing is of utmost importance. There are many satisfactory systems of treatment and it is therefore a question of choosing the one which is most practicable under the existing conditions.

1. *Laundry*

The laundry method of disinsection as described by Pierce, Hutchison, and Moscowitz, is the best and most efficient, given sufficient time and the necessary equipment. In this process the clothes are deloused, disinfected, cleaned, and pressed. Every step in the laundry is in-

secticidal. Laundries are to be found in all American cities and have been installed in practically all American cantonments and are found in many European centers. Portable steam laundries were used by the American army, and in the future (should always be a part of an army's equipment. There is no resulting damage to the garments if carried out as described below, which is according to standard laundry practice. In all ordinary cases, the following formula is sufficient for the treatment of woolen goods:

1. Wash fifteen minutes at 131° F. in heavy suds and light load.
2. Rinse three times, three minutes each, at 131° F.
3. Extract.
4. Run in drying tumbler fifteen minutes, at a minimum of 140° F.

The goods should not be perfectly dry when removed.

5. Iron.

In case the garments are suspected of containing very resistant disease germs, the regular washing formula may be preceded by one of the following measures:

a. In the washer, run a current of live steam fifteen minutes, revolving cylinder every five minutes, and discharging water of condensation every five minutes. Remove the garments and shake until almost dry. Then turn the hot water into the washer and when the proper temperature is reached, put in the garments for the wash as described above.

b. In the washer, submerge in water at 165° F. for twenty minutes without motion, except a few revolutions every five minutes. Remove the garments until the new water has been brought to 131° F. and then begin the wash as described above.

Flat work, khaki and cotton underwear are washed by formulae requiring hotter water and are hence thoroughly disinfected and disinfected.

2. *Dry Cleaning*

Uniforms and overcoats may be preferably dry cleaned rather than washed because of the stain-removing value of the dry cleaning process (Hutchison and Pierce, 1919). In this process the garments are deloused, disinfected, cleansed, have stains removed, and are pressed. Dry cleaning establishments exist in most large cities. Many of the army cantonments had them installed and some units went overseas with our troops.

This process is not insecticidal in every step, but is essentially so in a complete process. The gasoline wash, contrary to expectations, will not kill all submerged eggs, even after 54 hours.

a. For an establishment fully equipped with rotary washers and dry tumblers, we recommend the following cleansing formula:

1. Wash goods 30 minutes in new, distilled, or clarified benzole, naphtha, or gasoline, having a specific gravity not less than 56° Baumé by hydrometer test; using one gallon of cleaning fluid to every two pounds of goods, two ounces of standard dry cleaning soap to every ten pounds of goods, one ounce of 26 per cent ammonia to every twenty-five pounds of goods.

2. Extract 3 minutes.

3. Rinse 15 minutes in new or distilled fluid.

4. Extract 3 minutes.

5. Dry in tumbler 30 minutes at a temperature not less than 160° F. at point of discharge from tumbler.

6. Iron.

In case drying rooms are used in place of tumblers follow the first four steps and then:

5. After thoroughly drying and deodorizing, hang in dry room at temperature of not less than 160° F. for 30 minutes.

6. Run in dust wheel 20 minutes.

7. Iron.

b. In case the dry cleaning establishment is not equipped with modern machinery, the following method will be practicable:

1. Soak in benzole 3 hours.

2. Wring out and dry.

3. Iron thoroughly.

This modified process is too long for army practice but will do for small commercial trade.

c. Dry cleaning establishments equipped with Barbe system machinery in which hot gasoline is used in the wash, have a thorough insecticidal process in every step.

3. *Steam Sterilization*

The process of sterilization most commonly used in army practice involves the use of steam in some form. There is probably more danger to clothes from the use of steam than from any other method of treatment. Unless properly applied, steam will shrink, wrinkle and discolor woollens. It is probably by a few minutes the quickest process of sterilization, but steam does not cleanse or remove stains. When we consider that a uniform must often be subsequently treated either by laundry or dry cleaning to make it look presentable, we can readily see the advantage of using one of these processes for the entire operation of sterilization and cleansing. There is a proper way of handling each of the steam pro-

cesses to avoid the greater part of the damage. Nuttall (1918) has given a very exhaustive study of the methods of steam sterilization, especially with reference to autoclaves, so we will content ourselves with merely citing the most approved formulae.

a. Live or current steam fumigation was proposed by Stammers, who devised the Serbian barrel. Hunter (1918) has given a rather full description of several of the dominant types. Exposure to live steam 20 minutes in any kind of chamber is sufficient if the clothes are loose and permit circulation of the steam. Care must be taken not to overload.

The first method described below utilizes the laundry wash wheel and was devised by Pierce, Hutchison and Moscovitz. It is probably the quickest method yet proposed. The three other methods were described by Hunter.

1. The live steam sterilization in the wash wheel has been described in the discussion of the laundry process, and only requires fifteen minutes. The clothes must not be packed any tighter than for a normal washing load. They must not be tumbled except once in five minutes to remove water of condensation. When taken out of the wheel they should be shaken well before hanging up to dry.

2. Stammers' barrel disinfection, called the Serbian barrel, is a practicable field disinfector available often where no other sterilization can be carried out. It consists of an old wine barrel with five or six round holes in the bottom, placed on a circular boiler of cast iron or galvanized iron. The space between the boiler and the barrel is filled with a narrow sausage ring filled with sand to prevent escape of the steam except through the barrel. A fire is built in a pit beneath the boiler. Cross bars are placed in the bottom of the barrel to keep the clothes from the holes. When the steam is escaping too hot for the hand, the time required for delousing is one hour. The barrel is covered with a heavy wooden lid.

3. A galvanized iron bin with water in bottom and a grid to keep the clothes from the water, placed over a fire, will serve for a small quantity of garments on the same principle as the barrel. An ordinary garbage can as used in the army will serve.

4. In Egypt and Serbia, trains were fitted out and connected by steam pipes from the engine so that steam could be released in the cars through perforated tubes. The steam has exit through cracks about the doors, and reaches within the car a temperature about 105° C. (221° F.). The clothing is placed in bags or on shelves and may almost fill the car. Sterilization lasts one hour.

b. Enclosed steam has been more commonly used and has likewise been the cause of most of the trouble. It may be applied either at normal

or increased pressure, and in normal atmospheres or in vacuums (plate XXIII). Fulton and Stamford recommend the following procedure:

1. Place woolen blankets or uniforms on hangers or loosely on trays in the sterilizer.
2. Introduce 60 pounds steam into the outer jacket to prevent subsequent condensation within the sterilizing chamber.
3. Create a 15 or 20-inch vacuum to facilitate penetration of the clothing by the steam.
4. Sterilize with steam.
 - a. No pounds (atmospheric pressure) for one hour.
 - b. Twelve pounds steam for 10 minutes.

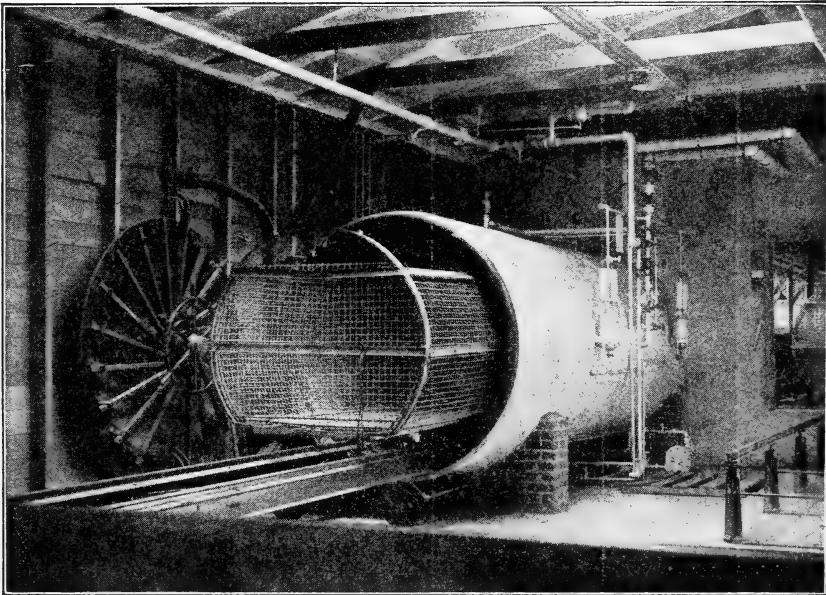

PLATE XXIII.—Steam sterilizer in delousing station of U. S. Army Medical Corps. The carriage is transferred along the rails in the foreground to rails leading into the other room where another carriage is seen. (Hutchison.)

5. Produce 15 to 20-inch vacuum to facilitate drying.
6. Open the door of the sterilizer about 4 inches for 10 minutes to allow gradual cooling of the contents of the sterilizer.

Steam under pressure will disintegrate woolens if the exposure is prolonged. The bacterial sterilization requires preliminary vacuum and loose packing. Garments placed in bags are likely to have the wrinkles set, if water of condensation settles in them when the steam has not penetrated at a sufficiently high temperature. If the cooling or drying is very rapid, wrinkles and shrinkage are quite likely to result.

4. *Hot Air Delousing*

Hot air was used very extensively for delousing the armies, especially on the eastern front. This system is not sterilizing, nor is it especially dangerous to the garments except when allowed to get too hot. Stagnant hot air has less effect than fresh hot air. The garments must be hung loosely. Provision should be made for circulating the air so that all of the clothes will receive the necessary amount of heat, which is 131° F. (55° C.) for 30 minutes, or 140° F. (60° C.) for 15 minutes. The heat chamber may be a portable box such as a fireless cooker; a room heated by steam pipes or hot air; a sod hut; a steel autoclave; or an improvised oven. Very high heat must not be used on dry garments as it will disintegrate the fibers of woollens and cause shrinkage.

5. *Fumigation*

When fumigation chambers are available and the clothing is needed for immediate wear, this is one of the quickest means of delousing. The fumigation chamber may be:

- a. A room, with cracks tightly sealed, and with vestibuled doors. A sign of warning should be posted and the door kept locked during fumigations. Only persons understanding fumigation should be permitted around, and they should wear gas masks.
- b. A chest or box is sufficient for carbon bisulphide or chlorpictin.
- c. A portable unit, such as an automobile with an air-tight chamber, and with hangers or shelves. The gas generator may be placed behind the chauffeur's seat.
- d. A vacuum chamber as in steam sterilization. The same cylinder may be made available for either steam or gas.

The fumigation may be either at normal atmospheric pressure or in a vacuum. When a room is to be fumigated one should see that there are no persons in the building, as few buildings are constructed so that the gas can not penetrate to other rooms.

To fumigate an entire building, or a room, close tightly all openings in building and seal up cracks with paper, unless the insects are in the double walls, in which case seal the cracks on the outside. It may be necessary, if the building is too loosely constructed, to increase dosages or make a tarpaulin to cover the entire structure. Such measures should only be taken in case the normal fumigation is unsuccessful. Any of the following methods are practicable. Entomologists prefer cyanide but many army officials prefer sulphur.

- a. Sulphur corrodes metal, so all movable metal should be taken out of the building. Sulphur fumigation is described in Public Health Bull.

34 (1910) with special reference to ships, and in Entomology Bull. 60 (1906) with reference to general fumigation.

1. Clayton gas is generated by burning common roll brimstone in an oven or generator outside of the building. A very high heat is generated. The gas is passed over two baffle plates before reaching the outlet pipe which is cooled by water circulating in pipes around it in an ordinary steam boiler tank. The gas then is passed into the building to be fumigated. This gas is a mixture of sulphur dioxide and sulphur trioxide. As the gas is heavier than air there must be circulation through the roof of a building or hatch of a ship until the gas begins to come out in quantity.

2. Burn sulphur candles, being careful to isolate them by sufficient metal from all woodwork, at rate of 4 pounds per 1,000 cubic feet for 6 hours.

b. Cyanide is one of the best known gases used for fumigation.

1. Sodium cyanide only is now available. Generate in earthen jars, placing in the jar $1\frac{1}{2}$ oz. sulphuric acid and 2 oz. water to every ounce of cyanide to be used. Arrange the cyanide in a package suspended over the jar so that it can be released by the operator at a distance by pulling or releasing a cord. *The gas is generated very rapidly and is exceedingly dangerous.* Use 10 oz. of cyanide for each 1,000 cubic feet and expose for 2 hours. This will kill all other insects present.

2. Potassium cyanide should be used at the rate of 1 oz. cyanide to 1 oz. sulphuric acid, and 3 oz. of water.

3. Chlorocyanogen (ClCN), in experimental work, gives promise of being fully as effective as HCN and much safer to use, because the irritation of the membranes of the nose and eyes gives warning of any leak long before sufficient gas has escaped to produce any toxic effect.

The most practical method for fumigation of any kind would be a mobile motor fumigator with hose attachments capable of treating any building, tent, or car. If this unit had a tight fumigation room, garments could be hung therein and practically fumigated. The installation should be equipped with generators for cyanide, formaldehyde, or sulphur fumigation, and be placed in charge of practical fumigation experts.

Vacuum fumigation has received several very successful trials. On the Mexican border it has been used by the Public Health Service, where a hydrocyanic acid gas fumigation is used. Many steam sterilizers now in use are available for gas fumigation. The following formulæ have been tested and proven satisfactory:

1. For chests, trunks, and tightly-packed garments 25-inch vacuum,

30 minutes exposure, 4 ounces sodium cyanide per 100 cubic feet (Lamson).

2. For loosely-hung clothes, 20-inch vacuum, 30 minutes exposure, 3 ounces cyanide per 100 cubic feet (Lamson).

3. The hydrocyanic acid gas (DANGEROUS) is generated in an air-tight generator, which is connected by a pipe with the fumigation chamber, by combining $2\frac{1}{2}$ parts of sodium cyanide solution (made by dissolving 4 lbs. of sodium cyanide, guaranteed to contain 51 per cent. cyanogen, in 1 gallon of water), 1 part of commercial sulphuric acid (184 sp. gr., or 66° Baumé) and 1 part of water.

Create 25-inch vacuum. Generate gas 5 minutes in generator. Wash over into fumigation chamber. Break vacuum so as to fumigate in normal atmospheric pressure 25 minutes. Remove gas by producing 25-inch vacuum. Return to normal pressure. Open door slightly and run vacuum pump a few minutes. Remove material. (Sasscer.) (See Fed. Hort. Bd., Service and Reg. Announcement 21, Dec. 4, 1915.) **ONLY EXPERIENCED MEN CAN BE PERMITTED TO HANDLE.** In case of asphyxiation from cyanide it is imperative to walk the patient up and down in the open air or to resort to artificial respiration. Few fatalities result under such treatment.

For fumigation in boxes the following gases are available:

a. Chlorpicrin in galvanized cans using 4 cc. to 1 cu. ft. for 30 minutes and applying a little heat. DANGEROUS GAS. (Moore.)

b. Carbon bisulphide is an inflammable but efficient fumigant but too slow for most army purposes. Place garments in any kind of tight box and pour in the liquid at the rate of 1 lb. to 1000 cu. ft. of space. Leave for 24 hours.

6. Storage

Storage of infested garments, dry at 54°-68° F. (12°-20° C.), for two or three weeks is effective. Bedding and clothing may be put away in naphthalene crystals or moth balls.

7. Impromptu Delousing Arrangements

Under temporary conditions none of the above-mentioned methods can be used to cleanse the garments and in such cases hot water washing or the use of other expedients is necessary. The outer clothing should be ironed and brushed at least once a week.

A great number of remedies have been suggested and tried, but from these we may select a few which appear to be especially good. There probably will be times when one or another will be more practicable.

- a. Boil clothes in water five minutes.
- b. Soak woolens in hot water at 131° F. (55° C.) 15 minutes.
- c. Soak clothes in insecticides.
 1. Immerse in benzole bath for 3 hours.
 2. Wash for 15 minutes in 10 per cent solution of one of the following soaps; then wring out and dry.

To obtain a 10 per cent solution dissolve 3 pounds in a bucket of water. The odor will be retained a long time and keep lice away.

a. Naphtha soap	65%
Cresol	35%
b. Naphtha soap	65%
100% crude carbolic acid	35%
c. Naphtha soap	65%
Xylol	35%

3. Soak for 10 minutes in 2 per cent solution of cresol, wring out and dry. A quart of cresol in 12½ gallons of water is enough to kill the lice in the body linen of 62 men, each garment being wrung out to recover as much as possible of the liquid.

- d. Handpicking, if done thoroughly and regularly, is often effective.
- e. Hot ironing if done well is effective.

CONTROL OF LICE IN LIVING QUARTERS

In addition to control of the lice on the man and his garments, it is necessary to control them in his lodgings, for the lice are quite likely to be scattered through bedding and clothing, especially in army quarters, and in lodging houses, and places where men subject to lice infestation are likely to congregate.

The quarters should be treated as follows:

1. Cleanse beds with gasoline or kerosene. Permit no fires.
2. Send bedding and linen to laundry.
3. Fumigate mattresses and pillows in fumigation chamber with cyanide as described for clothing; or,
4. Fumigate the quarters as described above.

When men are on active duty in war time, lice become very abundant in the trenches and dugouts. The men brush themselves off and the eggs and lice fall to the ground to reinfect other men. The following control measures will be of assistance:

1. Spray walls with cresol or phenol solutions 2 to 5% strength.
2. Scrape walls, sprinkle the dust with corrosive sublimate and remove.

3. When possible provide in dugouts a disinfecting kettle or box or barrel in which clothes can be treated with an insecticide as described under clothing.

4. When possible, remove bedding and other comforts in which lice might lurk, to the rear, for disinfection.

CONTROL OF LICE IN HOSPITALS

When working in communities or camps where louse-borne diseases are common, it is imperative that the hospital attendants take every measure possible to prevent infection of themselves from patients and prevent spread of lice from patient to patient. The following recommendations are therefore of value in such cases.

Control of Lice in Hospitals

1. Moisten floors and walls with cresol or phenol.
2. If possible patients should be washed before placing on clean beds.
3. Attendants should wear clothes with few openings.
4. Band legs of wooden beds with corrosive sublimate to prevent infection from other beds.
5. Cleanse each bed before putting a new patient on it.
6. Obtain free ventilation with fresh air.
7. Have bedding disinfected for each case.

Louse-Proof Garments for Medical Attendants, Etc.

1. Smooth clothing, preferably rubber or oiled silk.
2. Long coats, extending below the knee and buttoning behind.
3. Sleeves narrow at the wrists.
4. Rubber gloves drawn up to overlap edges of sleeves.
5. Collars to button close around the neck.
6. Head covered by a hood.
7. Rubber or smooth leather top boots.
8. A one-piece suit fastened at shoulders by buttons, with trousers closed at ends like stockings. Wear sandals over the feet. Rubber cap.
9. Smooth capes are sometimes of value.
10. Smooth silk underwear may afford a measure of protection.

BIBLIOGRAPHY

- Boyd, Mark S., 1917.—Am. Journ. Pub. Health, vol. 7, No. 8, pp. 667-671.
- Brink, 1915.—Voyenno Med. J., Petrograd, vol. 264, Med. spec. pt., pp. 440-449.

- Fulton, Dudley, and Staniford, K. J., 1918.—*Journ. Amer. Med. Assoc.*, vol. 71, No. 10, pp. 823-824.
- Hunter, William, 1918.—*Brit. Med. Journ.*, Aug. 24, No. 3008, pp. 198-201.
- Hutchison, R. H., and Pierce, W. Dwight, 1919.—*Proc. Ent. Soc. Wash.*, vol. 21, No. 1, pp. 8-20.
- Moore, W., 1918a.—*Journ. Lab. Clin. Med.*, vol. 3, No. 5, pp. 260-268.
- Moore, W., 1918b.—*Journ. Amer. Med. Assoc.*, vol. 71, No. 7, pp. 530-531.
- Nuttall, G. H. F., 1918.—*Parasitology*, vol. 10, No. 4, pp. 411-586.
- Pierce, C. C., 1917.—*U. S. Public Health Reports*, vol. 32, No. 12, pp. 426-429.
- Pierce, W. D., Hutchison, R. H., and Moscovitz, A., 1919.—*National Laundry Journal*, Chicago, vol. 81, No. 1, pp. 4-14.
- Rulison, R. H., 1918.—*New York State Journ. Med.*, vol. 18, No. 11, pp. 443-451.
- Shiple, A. E.—*Brit. Med. Journ.* No. 2807, p. 679.
- Strong, R. P., 1915a.—*Boston Med. and Surg. Journ.*, vol. 173, No. 7, pp. 259-262.
- Strong, R. P., 1915b.—*Med. Rec.*, Nov. 20, p. 892.
- Wells, H. G., and Perkins, R. G., 1918.—*Journ. Amer. Med. Assoc.*, vol. 70, No. 11, pp. 743-753.

CHAPTER XXIII

Lice Which Affect Domestic Animals

Part 1. Cattle Lice and Their Control¹

G. H. Lamson, Jr.

Nearly every species of animal bearing hair or feathers is subject to the attack of from one to a dozen species of lice. A given species does not infest all kinds of animals, but is confined to certain related kinds.

Lice are divided into two cardinal groups, according to their method of feeding. One order, the Mallophaga, includes biting lice like the bird lice and the small red lice on dairy animals, which feed on the dry skin, hair or feathers, but do not suck the blood. The other order, the Siphunculata, the sucking lice, fatten themselves by sucking the animal's blood. These of course are the most annoying, injurious, and dangerous. Some of the sucking lice, under certain conditions, may transmit fatal diseases, but none of the cattle lice are known to do this. The present lecture deals only with the species which infest dairy and beef cattle.

The place where stock is kept has a part in the degree of infestation, for cows that are placed near other badly infested cows have a greater opportunity for becoming lousy than those that are stabled with cattle that are comparatively free from lice. Where lice have occurred year after year, there is a greater danger of infestation than where the stables have been kept clean, well ventilated, and well lighted. The lice cannot maintain life for any extended period of time away from the cows. If the stables are kept clean, well lighted, and ventilated there is somewhat less danger of infestation.

Too much stress, however, has been placed upon the condition of bedding and stables and not enough upon the condition of the stock, for it is doubtful if any cow is ever entirely free from lice for the whole year, even where the stables are kept scrupulously clean and well managed. Careful examination of the infested herd will show that there is considerable difference in the number of lice on different cows; some are very

¹This lecture was presented November 11, 1918. It is based primarily upon conditions in dairy herds, and therefore all of the recommendations may not be applicable to range conditions.—W. D. Pierce.

badly infested early in the winter, some will have a few lice on them, and others will seem to be free from them.

The degree of dryness of the skin is often closely related to the numbers of lice on the different cows. When cows are not in good physical condition this results in a lack of natural oiliness of skin and makes conditions ideal for lice to increase. It will be noted that the variation in the numbers of lice on cows varies with the breed; that Holsteins are notably among the most infested; that Ayrshires and Guernseys are intermediate; and that Jerseys are not so badly infested. Calves, which have less oily skin than older stock, are more generally infested with lice.

There is a marked difference in the season of the year when lice are more numerous. The skin secretions are reduced in the winter and it is then that the lice are most numerous. In the summer only a few can be found. Certain cows in a herd will be infested early and will continue infested through the winter. The fact that Holsteins, being usually either black and white, or having the combined markings, make the lice more conspicuous, seemed at first to offer a solution for the reason why they have been generally conceded to be the most heavily infested breed of cows. Considerable study has, however, borne out the fact that this greater susceptibility is due to the general lack of skin secretion of the breed. For these reasons, it is believed that not only should we try to keep the stables clean, well lighted, and well ventilated, but also keep the stock in good physical condition. The fact that the lack of oiliness of skin tends toward lousiness indicates a logical control measure for these parasites.

Cattle lice are by no means uniformly distributed over a cow, particularly if they are of the sucking species. The upper portions of the neck, shoulder tops or withers, escutcheon and the switch of the tail are usually the parts that are infested with the largest numbers.

The forehead, portions between the horns, and the throat are places where the lice are next most likely to be found. It is these places, especially the upper portions of the neck and withers, that the dairymen should watch for indications of their presence and it is to these places that the insecticide or control measure should be applied most liberally and most thoroughly. While the small red biting lice move about somewhat, the sucking lice remain stationary during the greater portion of the time before reaching maturity, feeding continually.

SUCKING LICE

The short-nosed cattle louse, *Haematopinus eurysternus* Nitzsch, is the best known of the cattle lice. It is very broad and measures in the

female about one-eighth to one-fifth of an inch, while the males are a little smaller and a little narrower.

The eggs or nits are white and can be distinctly seen glued tightly to the hairs along the shoulders. From thirty-five to fifty eggs are laid by the mature females and these are laid a few each day. The egg-laying period may extend over a period of ten to fifteen days. These eggs hatch in from seven to eight days and the young lice commence drawing the cow's blood near the point where they were hatched. The rate of growth depends somewhat upon the blood supply in the portion of skin where they work. They mature in from fifteen to eighteen days, when the females in turn lay eggs.

The long-nosed cattle louse, *Haematopinus vituli* Linnaeus, is often spoken of as the "blue louse," or the louse attacking calves, though it occurs frequently on older stock. It is distinguished by being darker in color and slender in shape with a long pointed head. When seen on the cattle it seems to be literally standing on its head with mouth-parts buried in the skin, feeding on the blood of the animal that it infests. It is found more commonly on the neck and shoulders of the animal.

The mature insects are a dark bluish gray in color, giving them an appearance of being either blue or black, and they are about one-eighth of an inch long. Their color and their small size allow them to pass unnoticed especially on stock of a darker color. If one will turn back the hair until the skin of the animal can be seen, their presence may be made out by the shining surfaces of the abdomen. If they can be made out on the calves having white markings, they can usually be assumed to be present on the others, and there should at least be a close observation of all the calves.

The eggs of this louse are dark, nearly black, and hatch in from eight to nine days. Like the previously mentioned species, these lice move about but little before maturity, but continue feeding near the point where they were hatched. They in turn lay eggs in fifteen to eighteen days.

BITING LICE

The little red cattle louse, *Trichodectes scalaris* Nitzsch, is perhaps the most generally found on cattle. It seems to be out of place as it is of the biting group, and this group is most commonly found on birds. It feeds on the hair and loose scales of the skin, and the drier the skin of the cow, the more numerous these lice become, until they can be made out by the thousand, closely matted in the hair. They are most commonly found on the neck and shoulders, though in bad cases they are found pretty generally over most parts of the animal. Unlike the two previ-

ously mentioned species, they move about considerably among the hairs, having feet well adapted for this purpose.

These lice are small, yet visible with the naked eye, measuring about one-thirteenth of an inch. They are reddish in color, having distinct bands across the abdomen. The general shape of the body is quite different from that of the sucking lice, for their heads are broad and blunt, while those of the sucking lice are much more pointed.

The problem of working out the life history of these lice was much more difficult, and the length of time during the various stages could not be worked out with the degree of accuracy that was possible with the less active sucking species.

The eggs hatch in from five to seven days. The period from hatching until the lice are mature and eggs are laid again, is about fourteen days. The eggs are delicate white, flask-shaped forms, having a small cap or lid on one end that is removed when the egg hatches, while the other end is firmly glued to the hair.

It was found more difficult to exterminate these small red lice either with sprays, oils or fumigations than it was to kill the larger sucking lice. This was possibly due to their more resistant chitinous covering, their large numbers and their activity.

METHODS OF STUDY OF LIFE HISTORIES

Much time was taken to determine the periods of incubation of the eggs of different species of the cattle lice and the length of time necessary for the lice to mature, because this was considered an important feature that would determine the proper length of time between applications of control measures. It would be difficult to find any substance active enough to kill the embryo louse in the egg, thus preventing it from hatching, and at the same time not be so active as to do injury to the skin of the cow. The control must therefore be based on some other phase of the life cycle.

In order to make sure of no previous infestation, the method was to isolate a new-born calf and place adult female lice that had been fertilized upon the shoulders of the calf and watch for the first presence of eggs. As a rule these were found a few days after the lice were placed on the calf. Eggs were examined each day and as many of the old lice as could be found were removed from the animal. It was surprising how many of the sucking lice could be found after they had been placed on the shoulders of the calf, for they moved but little from where they were first placed. The calf was thrown on a bundle of hay each day at the same hour and the caps on the eggs were watched. Where these were found removed, the period of incubation was recorded.

After the young had developed for several days and were sufficiently large to handle readily, they were placed upon the escutcheon of a cow that had been inspected thoroughly and found free from lice. Other lice were left on the calf. In a given number of days eggs could be found on both the calf and on the escutcheon of the cow. These eggs were again watched until they hatched and in this way the periods of time were recorded, and checked often enough to be reasonably sure of the accuracy of the results.

With the biting lice the work was much more difficult because these do not remain in one place. Celluloid caps, somewhat like those used for protecting vaccination points, were used to confine the lice. Areas were shaved leaving small tufts of hair on which the lice could breed, and adhesive tape bound the caps to the calf. The electric incubator kept at the approximate temperature of the cow's skin was used to supplement the observations made on the animal itself.

CONTROL MEASURES

A control measure or remedy for cattle lice, in order to be practical, must be cheap, reasonably easy to apply, effective in killing the lice, and at the same time do no injury to the cow. It should not be so poisonous that the accidental consumption by animals would endanger their life. At the same time the material used for control should be commonly sold, and thus be within the reach of purchasers even in the remoter country villages.

Clipping.—Clipping the stock over the portion of the animal most likely to be infested is not an uncommon practice, and, where the hair is long and the animal is very badly infested, it helps to bring the oil or wash where it will be most effective. We have found, however, that animals that have been clipped are more liable to show a considerable scurfing of the skin because the application reaches the skin more quickly and in larger quantities than when it is held on the hair and thus reaches the skin gradually. There are those who feel that the animals do not look as well when clipped.

If control measures are used early, thoroughly, and repeated throughout the winter, clipping will be unnecessary.

OILS

Raw Linseed Oil.—Of the many different measures for the control of lice on dairy cows and young stock, raw linseed oil gave the best results from the standpoint of economy of material and labor of application, killing the lice, but not injuring the skin, and at the same time not

making it necessary to thoroughly drench the cow. It has no poisonous properties. It is a logical remedy, since the lack of oiliness in the skin of the cow is a fundamental reason for her being lousy. Linseed oil can be put on at the time of grooming or cleaning the cows, thus doing two things in one application. From four to five cows can be treated with a pint.

Raw linseed oil can be best applied with a brush having bristles of unequal length, of which the rice fibre brushes are probably most durable. When applied with a sponge, the shedding hairs become matted on the sponge, making application a little more difficult.

It takes about five minutes to apply linseed oil to the cow's coat and a slight oiliness will remain for several days, which is a desirable feature. On some animals the loose skin may scurf or lift, giving one the impression that some little irritation has been caused. But if one will give the condition study, he will see that there has been no inflammation or reddening of the tissues, but that the loose epidermis has lifted.

The use of raw linseed oil as a control for cattle lice is neither new nor patent. It has been used by scores of dairymen in the past with good results. Some have used it once and expected that application should last for the whole year and have been anxious to get some one treatment that would do for all the time. A few others have possibly noticed a slight scurfing of the skin on some animal and have decided that it was burned by the application. If, however, raw linseed oil is applied in the right manner and repeated at necessary intervals, it will be found to be one of the most effective agencies for the control of cattle lice, and will save time, labor, and injury to the animals.

The use of boiled linseed oil is not recommended as there is some little danger of burns in using it, particularly if it is rubbed forcibly into the skin.

To avoid any danger of raw linseed oil scurfing or burning the skin observe the following directions. *Do not rub the skin too vigorously when applying the oil. Do not allow the animals that have been treated to go out in the strong sunlight until at least twelve hours after applying the oil. Do not exercise the animal after the treatment. Do not cover the cow. Do not use the boiled or refined linseed oil.*

Linseed oil is used internally for other purposes and is a safe remedy if properly applied.

SPRAYS

Many dairymen practice spraying cows and some have obtained good results from using spray materials such as creolin, kerosene emulsion, tobacco solution, and arsenical washes. A small bucket pump an-

swers for this spraying. Thoroughness is essential and it is sometimes necessary for two or three to work on the same animal at the same time brushing the spray material into the hair before it runs off.

Some dairymen do not take measures against the lice on their cows because they feel that spraying is the only method that will reach these insects, and that the danger from the animals catching cold after such a treatment more than offsets the injury of the lice. There is but little danger of cows catching cold if they are in good health, particularly if the day is not too cold, and if the cows are covered well after the treatment.

Our trials indicate that the average spraying material such as creolin, kerosene emulsion, or an arsenical wash, together with the labor factor, costs about ten cents per animal for each treatment.

There are disadvantages in this treatment, including the labor and time factors: the amount of equipment necessary; and the fact that a number of these sprays are not effective enough to kill the lice, or they are too strong for the cow's skin, or their effectiveness does not last for any considerable time after the application. The most important of these control measures are listed and their advantages and disadvantages mentioned.

Creolin.—Of the materials used for spraying cows a solution of creolin is one of the most common. The strength should not be less than four per cent to kill the lice, and not more than five per cent, as this will cause some scurfing. A four and one-half per cent solution will give the best results for creolin.

Kerosene Emulsion.—This emulsion has been used with satisfactory results by some dairymen. It is made by shaving one-half pound of laundry soap in one gallon of soft water that has previously been brought to the boiling point. When the soap is all dissolved, remove from the fire and add two gallons of kerosene oil. Stir this thoroughly, and if you have a bucket pump, place this in the mixture, turning the nozzle back into the bucket so the material is constantly passing through the pump. This will form a cream emulsion. If any free oil separates from this mixture continue pumping until the oil ceases to show. Then mix this amount with twenty gallons of water and apply either with a spray pump or with a brush, preferably the former. In using kerosene emulsion we have observed that the lice were not killed with a mixture that was so weak that it would not do injury to the skin of the animals to which it was applied. For this reason the linseed oil gives much better results.

Arsenical Washes.—Arsenical washes are also used for the control of cattle lice, but owing to the great care necessary in using them, both from the danger of poisoning and the possible injury that may occur by using

them too strong or in applying them too vigorously, it has been felt that less dangerous applications can be made with even better results.

One thing can be said for them, however, and that is regarding their effectiveness. That the lice are killed by the application of arsenical washes there is no doubt.

One formula recommended is as follows:

- 1/4 lb. caustic soda (85% pure).
- 1/2 lb. white arsenic (99% pure) fine powder.
- 1/2 lb. sal soda.
- 1/2 pt. pine tar.
- 30 gallons water.

In preparing and using any arsenical dip or wash one should remember that arsenic is a poison and take precaution to avoid injury. If animals are allowed to drain where they may drink the solution, or feed when the solution is dripping off of them, they are liable to be poisoned.

Care should be taken too that the hands should not be exposed any more than necessary.

The arsenical washes may be necessary to use for dips for large herds and under range conditions, where tick infestations also occur, but their use is questioned for smaller tick-free herds.

For fuller information regarding arsenical dips and washes for cattle on range see Farmers' Bulletins Nos. 608 and 909.

Nicotin washes.—These are questionable owing to the fact that extreme care must be taken in order to keep the wash away from the cows so that they will not get some of it internally. Cows are particularly susceptible to poisoning from tobacco decoctions.

MISCELLANEOUS REMEDIES

Greases.—Mercurial ointment is one of the most effective of lice killers though it is very liable to cause burns even when it is diluted considerably. This ointment diluted with twelve parts of vaseline was used on some cows and burns resulted from the application.

Kerosene Oil and Lard have been used considerably for cattle lice but the danger of injury to the skin with the use of kerosene oil, unless very thoroughly mixed with some diluent, is always present.

With the majority of the greases, the inability to spread properly makes their application expensive because of the quantities of material required to cover the regions infested by lice.

Powders.—Dusting powders are usually sulphur, naphthalene, and

pyrethrum. These are not recommended. Cattle lice are too difficult to control for such methods to be effective.

TIME FOR THE APPLICATION OF CONTROL MEASURES

Though cows are infested with the largest numbers of cattle lice during the months of January and February, yet the measures for their control should be applied long before that time; in fact, they should be used within a week after they have been brought into the barn for the fall and winter. A second application should follow twelve or thirteen days afterward. The purpose of these two applications is to rid the cows of the lice that are on them before they become numerous and spread to more susceptible animals. The lice may not be seen at this time but the dairymen should not reason that the lice are not present. This gives a proper length of time for all of the three species of cattle lice to hatch from eggs, but not long enough for them to lay eggs again and be in a resistant stage where the treatment will not reach them.

Treatment should be repeated at intervals of a month from the second treatment. In case animals show any great number of lice, treatment should be given and repeated in twelve or thirteen days.

Treatment with linseed oil can be made at the usual time when the cows are being groomed and cleaned.

From five to six treatments during the fall and winter should control the lice in the average herd.

SKIN INJURIES

One of the most troublesome phases of the study of the control of cattle lice was to determine the strength of insecticides that would kill the lice but would not injure the skin, thus causing the hair to come out badly or making distinct burns.

The skin of the cow is very susceptible to injury when compared with the skin of other animals. It is known that cows have been killed by the application of certain insecticides recommended for the control of cattle lice. This indicates that caution must be taken in the use of control measures that have not been sufficiently tested. Caustic washes cannot be used without danger of their doing considerable injury, unless they are very accurately measured and applied very carefully to the skin of the animal.

It is known that exposure to direct sunlight and active exercise after application contributes to cause skin injury with nearly every one of the control measures for cattle lice.

It is doubtful if there is any application that will kill lice on cows

that will not cause a slight degree of scurfiness on the cows at times. If one will look at a condition of scurfiness carefully he will find that loose portions of the epidermis have lifted, and fragments are thick in the hairs, yet there is no irritation or reddening of the tissues and hence no real injury. Scurfiness is a condition that may occur without any application to the skin and it should not deter the dairyman from using a control measure that does not cause a real injury. Scurfiness passes in a short time and leaves the skin clean underneath.

Part 2. Lice Affecting Chickens, Hogs, Goats, Sheep, Horses, and Other Animals

F. C. Bishopp

The habits and control of lice on cattle have been discussed in another lecture. Owing to the marked economic importance of lice on other animals, the diversity of their habits and the great difference in the methods of handling the hosts, an additional lecture is devoted to the subject.

LICE INFESTING DOMESTIC FOWLS

Fowls are infested with biting lice (order Mallophaga) only. There are a large number of species living on the various domestic fowls. The chicken is infested with about ten species (seven of these commonly), the turkey with four, the pigeon with eight (three commonly), the duck five, the goose seven, the guinea fowl six, and the peafowl four.

Of course in listing the number of lice on the different hosts enumerated there is some duplication. We find that under certain conditions chicken lice are to be found on several of the other domestic fowls and this is true to some extent with forms which are found on other species. There are a number of factors which influence the transference of any of these parasites from their normal hosts. Ordinarily most of them are quite closely restricted to one species of fowl and the habits of the louse and the host are so interrelated that it is doubtful if many of them will continue to breed successfully on strange hosts, although of course they may be harbored for a time. When several species of fowls are closely associated, especially on roosts, there is a considerable chance for the interchange of the different species of parasites and we can not always say that when a given species is found on an unusual host it will succeed in establishing itself and breeding thereon. Furthermore we have observed that the young of a species seems to be attacked by a smaller number of species than the adult fowls. In fact some of the species of lice most commonly found on adults do not seem capable of

breeding on the young. This has been observed in the shaft louse of chickens. On the other hand some of the species, for instance the head louse of chickens, appear to thrive better on the young than on the adults.

Life Histories.—Very few of the so-called bird lice have been studied fully. Our lack of knowledge of the life histories and habits of these parasites is partly due to the difficulty of successfully rearing them under control. There is a marked difference in the habits of the different species of lice occurring on the same host. This may be explained by the fact that the parasite has become modified in structure and function of body parts to live under certain restricted conditions. For instance, on the chicken we find the head louse breeding largely on the head of chickens and seldom occurring on other parts. This species hangs to the down on young chickens and is usually found closely adhering to the base of the feathers on the heads of grown fowls. The body louse on the other hand has adapted itself to living on the skin of the host and is not commonly found on the feathers. This species is very active and depends for protection on its agility on the comparatively bare parts of the skin. The shaft louse usually rests along the shaft of the feathers but can run freely on the skin, going from one feather to another. The wing louse is ordinarily found between the barbules on the larger wing and tail feathers, and the fluff louse, a very awkward and sluggish species, clings to the fluffy parts of the feathers, principally on the thighs and sides.

The eggs of the different lice are laid in the regions where the lice are usually found. The head lice eggs are attached singly to the feathers on the head and neck. The body lice attach their eggs to the base of feathers and are usually found in masses, especially on the base of the feathers below the vent where sometimes the masses become exceedingly large—nearly half an inch in diameter.

The life histories of a few of the common species have been worked out by Mr. H. P. Wood and the writer. The head louse will serve as an example. The eggs of this species hatch in from four to five days into minute pale rather active larvae and these after molting their skins several times become adults in from 17 to 20 days, and egg laying begins a few days later. As far as we have observed, the length of the developmental period of the different species is quite similar.

It is difficult to get any accurate record of the longevity of lice on the host but we believe they live for several weeks if not months. When removed from the host the longevity is comparatively short and this of course assists in the application of control measures. The body lice usually die within a few hours, while the head and wing lice are more persistent. Professor Theobald records keeping the shaft louse alive for

nine months apart from the host. This seems exceptional as we have never observed longevity to exceed three weeks. While specimens of lice may drop off with feathers, we find in the method of treatment which is described below that no concern need be felt for the reinfestation of a flock from this source. It also appears that wild birds play very little part in the carrying of these pests. Of course it is possible that sparrows or other birds intimately associated with domestic fowls might accidentally carry a few specimens from one yard to another.

Injury and Losses.—It is difficult to weigh the loss produced by lice. It is generally believed by poultrymen that where they are at all abundant they materially affect the development and egg production in fowls. Certain it is that young chicks are frequently killed by the attack of the head louse and this also applies to young turkeys and ducks. Just how the injury is produced is still a matter of debate. Since the lice do not suck blood it is generally believed that the injurious effects are produced by the irritation caused by the gnawing and running about of the parasites. We have seen repeated instances of the rapid increase in weight of grown fowls after they have been freed of lice and experiments now under way seem to indicate clearly that egg production is markedly affected by even moderate infestations of lice. In addition to these adverse effects it has also been found that lice, especially when present in numbers, mutilate the plumage of the fowls. This is of special importance in show birds.

While no disease has been demonstrated to be carried by poultry lice, it is not improbable that they may play a part in the transmission of some maladies of fowls. They have been suspected of being concerned in the spread of the so-called chicken pox, or sore head, and favus.

Methods of Control.—While there are a number of insecticides which are fairly satisfactory in reducing the number of lice on poultry, experiments carried out by Mr. H. P. Wood and the writer at Dallas, Texas, indicate that none of them are as satisfactory as sodium fluoride. The commercial grade ranging from 90 to 97 per cent NaF is used. This is a white powder readily soluble in water and with comparatively low toxic effect on the higher animals. It has been found that one light application is sufficient to completely rid a fowl of all species of lice. The action of the material is rather slow, especially when it is used in the dust form. Usually it takes about four days for all lice to disappear from the feathers. Since the lice chew their food and since other parasites which suck the blood from the host are not destroyed to a large extent, it is believed that the material acts largely as a stomach poison. Hatching of the eggs does not appear to be prevented but the young lice succumb very soon after emerging from their shells.

Sodium fluoride may be applied either as a powder or in solution.

When comparatively few fowls are to be treated or if chicks or unhealthy individuals are concerned, it is advisable to follow what we term the pinch method of application. For grown fowls about twelve pinches of the powder are placed on different regions of the bird at the base of the feathers and distributed as follows: One pinch on the head, one on the neck, one on the throat, two on the back, one on the breast, one below the vent, one on the tail, one on either thigh, and one scattered on the under side of each wing when spread. With young chickens usually one pinch is sufficient, this being distributed on the head, neck, along the throat and on the back. A few people have reported loss of young chicks through the application of the powder to them at night. We are therefore recommending that the treatment be done during the early part of the day while the chicks are active. This gives opportunity for excess dust to be shaken off before roosting time. Another precaution is to apply the treatment where the dust will not have opportunity to get into the food or water. As the dust is very irritating to the nose and throat it is advisable to wear a dust guard or a moistened cloth tied over the nose and mouth when applying it.

By the dry method one pound is sufficient to treat 100 grown fowls and they can be gone over at the rate of about one to every two or three minutes, with one man working.

In following the dipping method, the sodium fluoride is dissolved in water at the rate of one ounce or three level tablespoons to each gallon. A tub is well filled with this solution which should be tepid (70° to 80° F.) but not warm, and the fowl, held by grasping the base of the wings over the back, is lowered quickly into the water. With the other hand the feathers are ruffled so as to allow the liquid to penetrate to the skin. The head is then ducked, lightly rubbed to induce penetration and the fowl released. By this method the danger of not treating all portions of a fowl is practically eliminated, the time of treatment is reduced to about three-fourths minute per fowl and the amount of material also markedly reduced. The irritating effect of the dust on the operator is also avoided.

It is of course necessary to chose a warm day so that the feathers will dry quickly. It should be stated, however, that the plumage is not thoroughly wet as would be the case with most dips. The feathers become completely dry in a couple of hours. There is absolutely no staining or injury to the feathers, no tainting of flesh and no skin irritation produced either by the dipping or dusting methods. As the material is corrosive it is inadvisable for one doing the dipping to subject lesions on the hands to the liquid and the utensils used should be emptied immediately after completing the work.

Since one application will completely destroy all forms of lice on a

fowl, there is absolutely no reason why lice should not be completely eradicated from a flock. Of course to accomplish this every bird must be treated at about the same time. All that is necessary to maintain a louse-free condition is not to allow infested fowls to come in contact with the clean flock.

It has been found that a thorough application of flowers of sulphur will destroy all lice, but since a much larger amount is necessary the expense of treatment is greater than when sodium fluoride is used and there are also said to be some deleterious effects from the free use of sulphur although this has not been observed by the writer. Mercurial ointment or blue ointment is extensively used against lice. If applied as generally recommended it will not accomplish the complete destruction of the lice present and repeated applications are necessary to keep them in check, which would be expensive. There is also some danger of producing mercurial poisoning by the free use of this material. The so-called "Cornell Powder," consisting of a mixture of carbolic acid, gasoline and plaster of Paris, is quite effective, but as the eggs of the lice are not destroyed two or more applications are necessary to accomplish what can be done with one application of sodium fluoride and the trouble of mixing the material is considerable.

For the treatment of pigeons it is advisable to dip them individually in sodium fluoride solution made as above described but with the addition of one ounce of laundry soap to each gallon of water in order to increase the wetting power. The squabs must also be treated.

Turkeys may be treated precisely as are chickens, either by the pinch or dipping methods. The large birds should receive about eighteen pinches of powder and of course a large tub is necessary for proper dipping.

It is recommended for exterminating lice from a flock, that the treatment be given if convenient in the late summer after the young chickens have matured and the flock has been culled and reduced to a minimum. Of course if lice are present there is no objection to treating at any time during the year and the quicker the treatment can be given the better. As poultrymen generally recommend hatching of chicks early in the spring this tends to reduce the loss from lice and other poultry parasites, but of course this should not be depended upon when so simple a method as the sodium fluoride treatment is available.

LICE INFESTING RABBITS, CATS AND DOGS

Domestic rabbits are not infrequently infested with an elongate, blue sucking louse. They seem occasionally to become sufficiently numerous, especially on young rabbits, to retard growth and reduce vitality. The

writer knows of no experiments which have been carried out with the control of this species. No doubt care would have to be exercised in choosing insecticides to apply to rabbits.

Cat lice are comparatively uncommon. A few cases of infestations of cats with sucking lice have been observed by agents of the Bureau, but the species concerned has not been determined. The biting louse, *Trichodectes subrostratus* Nitzsch, seems more common and occasionally cats which have not received proper care are heavily infested.

Complete freedom from the biting lice should be secured by a light but general application of sodium fluoride to the host. Dips containing phenols should be used guardedly, as cats are sensitive to their action.

Dogs are occasionally observed heavily infested with the sucking louse, *Haematopinus piliferus* Burmeister. The biting louse, *Trichodectes latus* Nitzsch, is far more common than the sucking form and it is especially annoying to puppies. This parasite has been found to yield readily to a single application of sodium fluoride in the dust form. When sucking lice are present two dippings in kerosene emulsion or in one of the standard coal tar dips should be given at ten-day intervals.

THE HOG LOUSE

Throughout the entire United States and in fact throughout the greater portion of the world hogs are infested with a large and repulsive appearing louse with sucking mouth-parts. The species is known scientifically as *Haematopinus suis* Linnaeus. This parasite assumes its greatest importance in the warmer portions of the country and is especially injurious to hogs which are poorly fed or kept in insanitary crowded pens.

Although the species may live for a few days (about five) apart from the host we need consider only the treatment of the host in controlling it. Of course it is well to remove hogs from the pens where they have been kept for five or six days after each treatment. The eggs are laid on the hair, especially behind the shoulders, in the flanks along the belly, and behind the ears. They hatch in about thirteen to twenty days, according to Watts, the lice mature in about ten to twelve days, and the first eggs are deposited a day or two later.

Little need be said here regarding the injurious effect of the louse. It is generally accepted as an important retarding factor in hog raising. Where it is allowed to multiply uncontrolled the skin becomes inflamed, scabby and thickened and the animals present an unthrifty appearance, growth is retarded and fattening is practically impossible. It has been held by a number of authors that the species may play a part in the

transmission of different diseases of hogs including cholera, although they are now generally believed to be of little importance in this connection.

Control Measures.—For the breeder of hogs in considerable numbers there is undoubtedly no better method for controlling hog lice than through the use of the dipping vat. A number of insecticides have been found effective against them, including crude petroleum (two inches floating on water in the vat), kerosene emulsion, and many of the standard coal tar dips. It is important to get the hogs completely under the dip. In order to insure complete destruction of the species it is necessary to repeat the dipping a second time after a lapse of ten days.

For the small raisers the expense of installing a vat is unnecessary as the application of any effective material with a spray pump or by hand with a brush is satisfactory. The concrete hog wallow containing water on which is floated a film of crude petroleum is fairly satisfactory, although if these wallows are not properly kept they may be objectionable from a sanitary point of view. Others use various types of hog oilers by which the oil is applied to the animals as they rub against the appliance. Still others simply sprinkle the oil on the backs of the hogs from a watering pot. Other insecticides are sometimes applied in the same way. Many oils, including kerosene oil, seem to be quite effective.

The application of insecticides by the use of wallows, hog oilers, sprinkling cans and similar methods can not be relied upon to destroy all lice but will give a moderate degree of control if repeatedly attended to.

To avoid burning the hogs, or other injurious effects, they should be treated towards evening or on cloudy days and should not be overheated either before or after applications.

It has been observed that hogs fed on garbage are comparatively or entirely free of lice. This condition is undoubtedly the result of continual application of grease by the wallowing of the hogs in the garbage.

LICE ATTACKING SHEEP

The lice infesting sheep seldom become so abundant as to be considered of much importance. The so-called foot louse, *Linognathus pedalis* Osborn, a suctorial species, was found by Osborn at Ames, Iowa, on sheep imported from Canada. It was present only on a comparatively few of the sheep. Evidently the species is not at all common in the United States. It occurs, so far as known, only on the legs, especially in the region of the dew claws and not on the heavy wool-parts of the host. This immediately suggests the use of a shallow wade vat by which a good delousing agent might be applied without coming in contact with the wool on the body of the host.

The biting louse, *Trichodectes sphaerocephalus* Nitzsch, of sheep is much more frequently met with than the sucking species and has been taken in various parts of the United States. It never seems to become abundant on the heavily woolled breeds.

It has been reported that the thin woolled sheep raised by the Indian tribes in northern New Mexico and Arizona are often heavily infested with lice. Undoubtedly there is a close correlation between the character and amount of wool and the reproduction of lice on the host.

Sodium fluoride may be successfully employed against the biting louse but on account of the close covering of wool the application must be thorough. The same method of application as suggested for the biting lice of goats should be used. Of course where sheep are dipped for the sheep tick (*Melophagus ovinus*), or scabies, the lice will be kept under control. Nicotine sulphate or lime-sulphur arsenic dip seem very effective against both the lice and the sheep tick. The former should contain about 0.07 per cent of nicotine sulphate. The latter consists of a lime-sulphur dip of the formula: 8 pounds unslacked lime, 24 pounds flowers of sulphur, and water to make 100 gallons. Take 150 gallons of this concentrate and 350 gallons of warm water and add a concentrated arsenical solution containing 12 gallons water, 12 pounds sal soda and 4 pounds white arsenic.

BITING AND SUCKING LICE OF GOATS

Goats of all breeds are subject to the attack of lice but this tendency seems especially marked among the angoras. The biting lice consisting of two species, *Trichodectes climax* Nitzsch and *T. hermsi* Kellogg and Nakayama, are the principal species. The former of these is the predominant form.

Practically every flock of goats in the Southwest is infested and some years the injury is very marked. The annoyance retards the growth of the kids and injures the condition of flesh of the goats, but the most obvious loss is brought about in the reduction of the mohair clip. The irritation produced by the lice induces much rubbing, which of course pulls out and mats the mohair and there also appears to be considerable loss through the actual cutting of the hair by the lice themselves. Certain large goat raisers in Texas estimate a loss of twenty per cent in the clip some years and often individual goats are so denuded that shearing is not profitable. The quality of the mohair is also said to be materially affected when the lice are abundant.

The lice are present on all parts of the host, especially on the heavily haired portions and the whitish eggs are attached to the hairs next to the skin.

The sucking louse, *Linognathus stenopsis* Burmeister, frequently be-

comes a pest of importance in goat flocks. The lice are especially injurious to the kids, and their attack together with that of the biting lice is thought to cause material reduction in the number of kids raised to maturity. On the kids the lice are present on all parts of the body but on the mature goats they are usually more numerous where the hair is not very thick.

Control.—In proceeding against goat lice it is important to determine whether biting or sucking lice are giving trouble. In many flocks the former are practically the only kind present and in such cases it is more economical to treat the flock with sodium fluoride in the dust form than to dip it. This is especially true when dipping vats are not at hand. We have found that a high degree of effectiveness (90 to 100 per cent destruction) may be obtained by applying the sodium fluoride with a dust gun to the flock in a pen or as the goats are driven through a chute. It does not seem to be necessary to drive the dust into the mohair especially and only a small amount—about one-third of an ounce per head—is necessary.

In the experiments carried out by Mr. D. C. Parman at Uvalde, Texas, nicotine sulphate used at a strength of 0.07 per cent nicotine was found to give complete control of sucking lice but was less effective against the biting species. On the other hand the standard arsenical dip (white arsenic 8 pounds, sal soda 24 pounds, pine tar one gallon, and water 500 gallons) gave complete destruction of both forms of lice with one dipping. As the arsenical dip is probably the cheapest material obtainable it should be recommended above all others where both biting and sucking lice occur in a flock. Goats are usually bunched and sheared in the spring and fall, and following shearing is a good time to treat the entire flock for lice.

LICE OF THE HORSE

Horses are quite commonly infested with one biting and one sucking species, *Hamatopinus asini* Linnæus and *Trichodectes parumpilosus* Piaget. It is the writer's impression that the biting louse predominates throughout this country, however, it is not an infrequent occurrence to find herds heavily infested with the sucking louse. It is probable that a careful study of the lice of horses will show that in certain regions one predominates, while in others the other form may be more abundant.

While it is probable that both forms can breed on asses and mules it is certainly true that these animals are much less subject to louse attacks than the horse.

Horses which are worked more or less regularly and properly groomed are usually troubled very little from lice, but colts and animals on the

range are frequently so heavily infested as to produce injurious effects. One's attention is usually attracted to the lice on account of the rubbing and biting of the animals which may in some cases become almost a mania. The hair is frequently rubbed off in spots so as to expose the skin in the regions where the lice are most abundant, notably around the base of the tail and on the neck.

Control Measures.—On farms where comparatively few horses are kept the lice can most conveniently be brought under control by careful grooming of the animals, and an occasional light application at grooming time of lard with a small amount of kerosene added or raw linseed oil. This treatment would undoubtedly answer in the case of army horses, although it would probably be advisable in such instances as well as on ranges where horses are raised extensively, to install dipping vats and dip all animals twice at an interval of two weeks. The standard arsenical solution is the best for this purpose. This treatment is also effective against cattle lice.

Where biting lice alone are concerned sodium fluoride can be applied very conveniently and will give complete control with one application at a very low cost. A powder gun may be employed and each animal should be generally dusted using about one ounce. This is especially adapted to the treatment of animals in the winter when the greasing or wetting of the host is undesirable. It is the winter season, too, when the lice are most abundant and injurious.

IMPORTANT BIBLIOGRAPHICAL REFERENCES

- Bishopp, F. C., and Wood, H. P., 1917.—Mites and lice on poultry. U. S. Dept. Agr., Farmers' Bull. 801, pp. 1-26, May.
- Bishopp, F. C., and Wood, H. P., 1917.—Preliminary experiments with sodium fluoride and other insecticides against biting and sucking lice. *Psyche*, pp. 187-189, December.
- Hall, Maurice C., 1917.—Notes in regard to horse lice, *Trichodectes* and *Haematopinus*. *Journ. Am. Vet. Med. Assoc.*, vol. 51, n. s., vol. 4, pp. 494-504, July.
- Herrick, G. W., 1915.—Some external parasites of poultry. *Cornell Exp. Sta.*, Bulletin 359, pp. 229-268, April.
- Imes, Marion, 1918.—Cattle lice and how to destroy them. U. S. Dept. Agr., Farmers' Bull., pp. 1-27, February.
- Lamson, G. H., Jr., 1916.—Some lice and mites of the hen. *Conn. Agr. Exp. Sta.*, Storrs, Conn., Bull. 86, pp. 171-196, March.
- Lamson, G. H., Jr., 1918.—Cattle lice and their control. *Conn. Agr. Exp. Sta.*, Storrs, Conn., Bull. 97, pp. 1-17, November.

- Osborn, Herbert, 1896.—Insects affecting domestic animals. U. S. Dept. Agr., Div. Ent., Bull. 5, pp. 1-302.
- Stevenson, E. C., 1905.—The external parasites of hogs. U. S. Dept. Agr., Bur. Anim. Ind., Bull. 69, pp. 1-44.
- Watts, H. R., 1918.—The hog louse. Tenn. Agr. Exp. Sta., Bull. 120, pp. 1-15.

CHAPTER XXIV

Diseases Carried by Fleas¹

W. Dwight Pierce

Fleas pass their immature stages in filth outdoors and indoors. The larvæ breed in dirt and are usually to be found where animals are common, but they may breed in the dirt of kennels and stables, in the open country, in carpets, and closets of houses and especially in cellars. They are always to be found where rats or mice are common.

Because of the fact that the larva imbibes filth and the adult sucks blood, we should seek other possibilities of disease transmission which have not hitherto been investigated. Past investigations with fleas have dealt principally with the possibility of conveying disease by the bite of the adult flea. The work which has been done on flies and which was quoted in a preceding lecture showed that larvæ could take up bacteria and that these would persist into the adult stage. It is therefore essential in the future investigations of disease transmission by fleas that account be taken of the possibility of the flea larvæ taking up the organism from the filth in which they breed and retaining these organisms to be transmitted by the adult. That they may do this is demonstrated in the case of the tape worms mentioned below.

Fleas do carry disease, that we know. But probably they can carry diseases which they have never been credited with. There lies our field of investigation.

The arrangement of organisms transmitted by fleas follows that adopted for previous lectures.

PLANT ORGANISMS TRANSMITTED BY FLEAS

Thallophyta: Fungi: Schizomycetes: Bacteriaceæ

Bacillus pestis Kitasato, the cause of BUBONIC PLAGUE of man and rodents, is carried by fleas. Nine species of rodents, mainly rats and

¹This lecture was presented on October 28, 1918. It is considerably modified for the present edition.

mice, are proven hosts of plague. The following fleas have been proven to be carriers of the organism: *Xenopsylla cheopis* Rothschild, *Ceratophyllus fasciatus* (Bosc) Curtis, *C. acutus* Baker, *C. silantiewi* Wagner, *Pulex irritans* Linnaeus, *Ctenocephalus canis* (Curtis) Baker, *Lep-topsylla musculi* Dugès and *Pygiopsylla ahalae* Rothschild.

The first successful record of transmission of plague by fleas was made by Simond in 1898, and corroboration was first obtained by Verjbitski in 1903 and Liston in 1904.

Many other workers have since then proven the rôle of the flea in carrying this disease. A synopsis of the evidence is presented by Herms in his textbook. The flea takes up the organism with the blood of the host. The stomach of the rat flea, *Xenopsylla cheopis*, is capable of receiving as many as 5000 germs while imbibing the blood from a plague rat. Both males and females may carry the infection and they may remain infective during an epidemic for 20 days. The Indian Plague Commission found the bacilli only in the stomach and rectum of the fleas and never in the salivary glands or body cavity and rarely in the esophagus. They conclude that the normal course of the bacilli is to be voided in the feces and to be inoculated by scratching in of the feces. Bacot and Martin, however, have come to the conclusion that plague can be transmitted during the act of biting when a temporary blocking or obstruction of the proventriculus takes place, causing bacillus-laden blood to be forced back or regurgitated into the wound, thus producing infection.

Bacterium tularense McCoy and Chapin, cause of a fatal RODENT PLAGUE which affects the California ground squirrel, *Citellus beecheyi*, may also be transmitted by fleas. McCoy and Chapin placed fleas (*Ceratophyllus acutus* Baker and *C. fasciatus* Bosc) with an inoculated guinea pig and allowed them to remain there until the animal died. They were then collected, and crushed and inoculated into healthy guinea pigs. The four animals inoculated with crushed *C. fasciatus* immediately after the fleas were removed from the dead guinea pig, died of the disease; two of four inoculated after 24 hours, died; and one out of four inoculated after 48 hours, died. Two out of four animals inoculated with crushed *C. acutus* immediately after removal from the dead guinea pigs, died, but none died that were inoculated on subsequent days, although some developed an apparently chronic form of the disease. They also succeeded in obtaining one actual case of transmission. About 100 fleas collected from an animal dead of the disease were placed in a clean cage with a healthy ground squirrel. It died 15 days later and presented the usual lesions of the plague-like disease, the bubo being in the neck.

ANIMAL ORGANISMS TRANSMITTED BY FLEAS

Protozoa

Mastigophora: Binucleata: Trypanosomida

As stated elsewhere the classification here used was recently proposed by Chalmers. It is especially interesting that all flea-borne diseases belong to the genus *Trypanozoon* Luhe (*Lewissonella* Chalmers)² in which the final stage of development in the definitive host (the insect) occurs in the hind gut, and infection is contaminative.

Trypanozoon blanchardi (Brumpt), cause of a trypanosomiasis, supposedly nonpathogenic, in rodents of the genera *Myoxus* and *Microtus* has been found by Brumpt (1913) to develop in the flea, *Ceratophyllus laverani* Laveran and Pettit. The life cycle is identical with that of *T. lewisi* and *T. nabiasi* and is effected entirely in the large intestine of the flea. Metacyclic trypanosomes occur in the rectal ampulla and are found in the dejections. It is not found in the salivary glands.

Trypanozoon duttoni (Thiroux), cause of a trypanosomiasis, supposedly nonpathogenic, in mice of the genus *Mus*, has been found by Brumpt (1913) to develop in the flea, *Ceratophyllus hirundinis* Curtis. The evolution of this species occurs in the large intestine of the flea and is comparable to that of *T. lewisi*, *T. nabiasi*, and *T. blanchardi*. It is not found in the salivary glands.

Trypanozoon lewisi (Kent), cause of a trypanosomiasis, rarely pathogenic, in rodents of the genera *Epimys*, *Acanthomys*, *Mus*, *Myoxus*, and *Meriones*, etc., passes its cycle of sporogony in fleas (fig. 62). The life cycle has been investigated in *Ceratophyllus fasciatus* (Bosc) Curtis, *Ctenocephalus canis* (Curtis) Baker, and *Ctenopsyllus musculi* (Dugès) Wagner, and it has been shown that *Pulex irritans* Linnaeus, and *Xenopsylla cheopis* Rothschild may serve as true hosts. In addition *Ceratophyllus lucifer* Rothschild, *C. hirundinis* Curtis, *Ctenophthalmus agyrtes* (Heller) Baker, and *Pulex brasiliensis* Baker are recorded as carriers. Fantham, Stephens and Theobald summarize the life cycle in the flea. When infected blood is taken up by the flea, the parasites pass with the ingested blood direct to the mid-gut of the flea. In the stomach they penetrate the cells of the lining epithelium and multiply by division inside the epithelial cells. They first grow to a large size, then form large spherical bodies within which nuclear multiplication occurs. Any one of these large spherical bodies contains at first a number of nuclei, kinetonuclei, and developing flagella, the original flagellum still remaining attached for a time. The cytoplasm then divides into daughter

²This synonymy is according to Mesnil. Bull. Inst. Past. vol. 17, p. 190.

trypanosomes which are contained within an envelope, formed by the periblast of the parent parasite. Inside the periblast envelopes are a number of daughter trypanosomes wriggling very actively; the envelope finally bursts and releases them, usually about eight, in the host cell. The daughter forms escaping from the host cell into the stomach of the flea are fully formed, long trypanosomes. They then pass into the rectum, where they assume a crithidial phase, and become pear-shaped. The kinetonucleus has traveled anteriorly past the nucleus toward the flagellum. The crithidial forms attach themselves to the wall of the rectum and multiply by binary fission. In this form the parasite probably

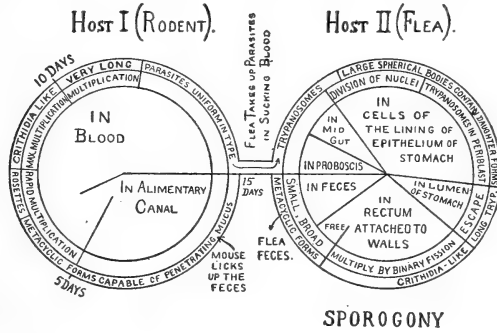

HOST I MICE, RATS (*EPIMYS*, *ACANTHOMYS*, *MUS*, *MYOXUS*, *MERIONES*).
 HOST II FLEAS (*CERATOPHYLLUS*, *CTENOCEPHALUS*, *CTENOPSYLLA*, *PULEX*,
XENOPSYLLA).

LIFE CYCLE OF *TRYPANOSOMA LEWISI*.

FIG. 62. (Pierce.)

exists throughout the life of the insect. From the crithidial forms small infective trypanosomes develop. These are small, broad, and stumpy, with the kinetonucleus behind the nucleus, and the flagellum longer. Brumpt (1913) declares that transmission occurs exclusively by rodents licking up the feces of infected fleas. These feces contain little metacyclic trypanosomes which are able to traverse healthy mucous membranes.

The life cycle as described has been figured graphically in the same scheme as used in previous lectures.

Trypanozoon nabiasi (Railliet), a rabbit trypanosome, presumably nonpathogenic, attacks the genus *Lepus* and was found by Brumpt (1913) to be transmitted by the rabbit fleas *Ctenocephalus leporis* (Leach) Baker and *Spilopsyllus leporis* (Leach) Baker. The life cycle

is identical with that of *T. lewisi* and has metacyclical forms in the rectum. It is never found in the salivary glands.

Trypanozoon rabinowitschi (Brumpt), a trypanosomiasis affecting the genus *Cricetus*, is carried by the fleas *Ctenocephalus canis* (Curtis) Baker, *Ctenophthalmus assimilis* (Taschenburg) Baker and *Ceratophyllus fasciatus* (Bosc) Curtis. According to Brumpt (1913) Nöller has proven the development of this organism in the rectum of fleas. The little metacyclic trypanosomes are found in the rectal ampulla.

Mastigophora: Binucleata: Leptomonidae

Crithidia ctenophthalmi Patton and Strickland is parasitic in *Ctenophthalmus agyrtes* (Heller) Baker.

Crithidia hystriehopsyllae Mackinnon is parasitic in *Hystriehopsylla talpae* (Curtis) Rothschild.

Crithidia pulicis Porter (1911) not Wenyon (1908) is parasitic in *Pulex irritans* Linnaeus. Miss Porter described its life cycle in the flea. The preflagellate stage is probably taken up by feeding on dejecta of infected fleas. The preflagellates have a somewhat frail appearance. Division rosettes are frequent. The flagellates have relatively short free flagellum and a large undulating membrane. These are followed by a postflagellate stage in which multiplication is by longitudinal division. Infection is contaminative, the postflagellates in the feces being the source of infection. There is no evidence of hereditary transmission.

Crithidia pulicis Wenyon is parasitic in *Xenopsylla cleopatrae*.

Leishmania infantum Nicolle the cause of INFANTILE KALA AZAR of the Mediterranean region and Asia, is, according to experiments of Basile, probably naturally transmitted by the fleas *Ctenocephalus canis* and *Pulex irritans*. He apparently obtained the disease by taking fleas from bed clothes of infected people, and also from infected dogs, and feeding them on healthy dogs.

Castellani and Chalmers inclined towards the Basile theory but Wenyon is not convinced. Basile found *Leishmania*-like forms in the mid-gut of the flea. He also found other forms, some with flagella and some without, and concludes that there is a cycle of development with preflagellate, flagellate and postflagellate forms.

Leptomonas sp. Balfour (1906) is described from *Xenopsylla cleopatrae*.

Leptomonas ctenocephali (Fantham) is parasitic in the gut of the *Ctenocephalus canis*. Fantham has described preflagellate and flagellate forms. In experiments of Laveran and Franchini (1913) dogs, inoculated from mice infected with this organism by feeding on feces of the flea, died. The disease caused by this organism cannot be distinguished

from canine kala azar, which suggests to some writers the insect origin of that disease. Fantham, however, does not consider this organism related to *Leishmania*.

Leptomonas ctenophthalmi (Mackinnon) is described as a parasite of *Ctenophthalmus agyrtes*.

Leptomonas ctenopsyllae (Laveran and Franchini) occurs in the gut of *Ctenopsyllus muscili*.

Leptomonas debreuii (Brumpt) is a parasite in the squirrel flea.

Leptomonas pattoni (Swingle) is a native to *Ceratophyllus fasciatus*, *C. lucifer*, and *Xenopsylla cheopis*. According to Fantham and Porter it has been found naturally in the blood of mice. Ingestion of feces of fleas infected with this organism has caused death or disease in white mice, according to Laveran and Franchini (1914).

Mastigophora: Spirochaetacea: Spirochaetidae

Spiroschaudinnia ctenocephali (Patton) has been described from *Ctenocephalus canis* in India.

Telosporidia: Gregarinida: Agrippinidae

Agrippina bona Strickland occurs in the gut of the larvae of the rat flea, *Ceratophyllus fasciatus* in England.

Telosporidia: Haemogregarinida: Haemogregarinidae

Haemogregarina (Hepatozoon) jaculi Balfour, the cause of ANAEMIA of the jerboas, *Jaculus gordonii* and *J. orientalis*, is thought to be carried by the flea *Xenopsylla cheopis*. Balfour noted large cysts in *X. cleopatrae* which Christophers thinks possibly belong to this species.

Metazoa

Platyhelminia: Cestoidea: Cyclophillidea: Taeniidae

Dipylidium caninum (Linnaeus), the DOG TAPEWORM, has for its intermediate hosts the dog flea, *Ctenocephalus canis* (Curtis) Baker, the cat flea, *C. canis felis* (Bouché), and the human flea, *Pulex irritans* Linnaeus. It may also be carried by the dog louse *Trichodectes latus* (*canis*). Neumann, however, regards the fleas as most important. The ripe proglottids which contain the eggs of the tapeworm, by their own movement, pass through the host's anus and get into the fur where they become partly dried and disintegrated and fall to the ground. Part of

the segments, the oncospheres, are released by the disintegration and are then ingested by the flea larva or the louse. Sonsino contended that the adult flea could not ingest the egg of this worm and Joyeux (1916) has demonstrated this fact. He was able to demonstrate that the larvae can and do ingest the egg easily. The embryos when they reach the intestine escape from their envelopes, the oncospheres, and penetrate into the general cavity. They are imbedded in the adipose tissues and are very difficult to demonstrate. Here they remain during the metamorphosis. When the adult flea is formed the hexacanth immediately begins to develop, even before its host begins to feed. On the second and third days

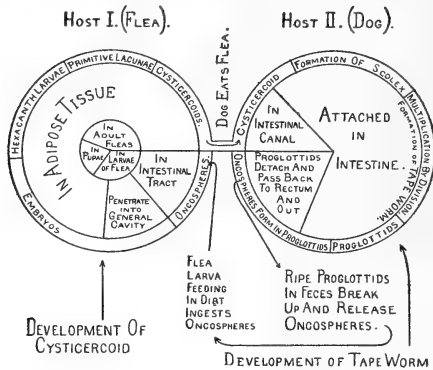

LIFE CYCLE OF DIPYLIDIUM CANINUM.

THE DOG TAPE WORM.

HOST I. FLEAS (*Ctenocephalus canis*, *C. felis*,
Pulex irritans).

HOST II. DOG (*Canis familiaris*),
CAT (*Felis catus*),
JACKAL (*Canis aureus*).

FIG. 63. (Pierce.)

it is enlarged and the primitive lacuna begins to form. From this point it develops into the cysticeroid. The dog or cat becomes infested by biting or licking up the infected fleas or lice on its body. The flea can spread the infection to human beings that accidentally swallow the insects. Possibly in case of children, infection takes place by kissing pets or by pets stealing a drink from a bowl, the contents of which are afterwards given to children.

Platyhelminia: Cestoidea: Cyclophilidae: Hymenolepididae

Hymenolepis diminuta (Rudolphi), the YELLOW-SPOTTED TAPE-WORM of the rat, may pass its intermediate stage in larvae of a number of insects of different orders. Nicoll and Minchin found the cysticeroid

in four per cent of rat fleas, *Ceratophyllus fasciatus*, and succeeded in infecting rats by feeding them on fleas. Johnston in Australia has corroborated the fact that this flea is a host, while Joyeux has proven that infection takes place easily in the larval stage, but is impossible in the adult flea. Johnston has found *Xenopsylla cheopis* to be a host. Joyeux has infected larvae of *Pulex irritans* and *Ctenocephalus canis*. He found that the embryo develops independently of the metamorphosis of its host. The rodents become infected by licking up infected insects.

Hymenolepis nana (Von Siebold), the dwarf tapeworm of rats and man, may possibly pass its intermediate stage in fleas. Nicoll and Minchin found a cysticeroid in *Ceratophyllus fasciatus* resembling this species, and Johnston in Australia also found a similar cysticeroid in *Xenopsylla cheopis*.

Nemathelminthes: Nematoda: Spiruridae

Protospirura muris (Gmelin), a STOMACH PARASITE of rats and mice, has a larva similar to one found by Johnston encapsuled in the general cavity of the rat flea, *Xenopsylla cheopis*.

Nemathelminthes: Nematoda: Filariidae

Acanthocheilonema reconditum (Grassi), a cause of CANINE FILARIASIS, possibly passes its embryonic development in fleas. Grassi and Calandruccio found larval nematodes in fleas, *Ctenocephalus canis*, *C. felis*, and *Pulex irritans* that they assumed belonged to the species *A. reconditum*. The embryos, according to Grassi, perforate the intestinal wall of the flea which has ingested blood containing the parasites. The latter make their way into the fatty tissue where they are almost always to be found lying singly in the fat cells. The fat cells increase in size as the parasites grow, the latter being curled up once or twice within the cell, the nucleus of which remains uninjured. The embryo undergoes four stages of development in the flea. There is no positive proof of the method of transmission.

SUMMARY

In summary, therefore, we may call attention especially to the fact that the flea carries plague, is apparently the carrier of infantile kala azar, and is an intermediate host of one of the human tapeworms. In addition it is intermediate host of various animal diseases.

Unlike the louse-borne diseases, the life cycles of the organisms causing flea-borne diseases are quite variable.

The bacilli of plague and rodent plague are taken up by the bite

of the flea and are voided in its feces and obtain entrance to the host by the scratching in of feces of infected fleas, or by the licking up of the feces or the flea.

The five trypanosomes are all taken up from the blood and pass through a definite life cycle in the flea, passing out of its feces, and obtain entrance to the host by being licked up in the feces. This may also happen in the case of leptomonads.

The crithidias and leptomonads belong primarily to the fleas alone, and pass through their cycle of existence in the flea body and out of its feces and are taken up by feeding on the infected feces, probably by the larva.

The tapeworms are taken up as eggs by the larvæ feeding in filthy dirt. They develop in the flea and are taken into the vertebrate host when it licks up the flea from its body.

The filaria is taken from the blood of the host as an embryo, and develops in the flea, but we do not know how it gets back to the host.

In addition to all these diseases caused by organisms, fleas may cause a dermatitis. This is especially true of the chigoe, *Dermatophilus penetrans*, which becomes fixed to its host and sometimes even causes AIN-HUM, or the loss of a member, such as a toe. It will be discussed in the next lecture on fleas.

REFERENCES

- Bacot, A. W., and Martin, C. J., 1914.—Journ. of Hygiene, Plague Supplement III, Jan. 14, 1914, pp. 423-439.
- Brumpt, E., 1913.—Bull. Soc. Path. Exot., vol. 6, pp. 169-170.
- Fantham, H. B., Stephens, J. W. W., and Theobald, F. V., 1916.—The Animal Parasites of Man.
- Hermes, W. B., 1915.—Medical and Veterinary Entomology. Macmillan Co., 393 pp.
- Johnston, J. H., 1913.—Proc. Roy. Soc. Queensland, vol. 24, pp. 63-91.
- Joyeux, Charles, 1916.—Bull. Soc. Path. Exot., vol. 9, No. 8, pp. 578-579.
- Laveran, A., and Franchini, G., 1913.—C. R. Acad. Sci., Paris, vol. 47, No. 18, pp. 744-747.
- Laveran, A., and Franchini, G., 1914.—Bull. Soc. Path. Exot., vol. 7, pp. 605-612.
- Liston, W. G., 1905.—Journ. Bombay Nat. Hist. Soc., vol. 16, pp. 253-273.
- McCoy, G. W., and Chapin, C. W., 1912.—Journ. Infect. Diseases, vol. 10, No. 1, pp. 61-72.

Porter, Annie, 1914.—Parasitology, vol. 4, No. 3, pp. 237-254.

Seurat, L. G., 1916.—Bull. Scient. France et Belgique, ser. 7, vol. 49, fasc. 4.

Simond, P. L. S., 1898.—Ann. de l'Inst. Pasteur, vol. 12, p. 625.

Verjbitski, D. T., 1908.—Journ. of Hygiene, vol. 8, p. 162.

CHAPTER XXV

The Life History and Control of Fleas¹

F. C. Bishopp

The importance of flea control probably needs no further emphasis than that already apparent after reading the lecture on the relation of fleas to disease. It should be borne in mind that the plague has been one of the most terrible scourges in the history of the world and that its reduction to an inconspicuous place in Europe and the western hemisphere has been the result of the knowledge of the relationship between rats and fleas and *Bacillus pestis*, the causative organism of the disease. Aside from the part which fleas play in the transmission of this dreaded malady and certain other human ailments, they are often of decided importance on account of the annoyance to man produced by their crawling about over the body and biting. The susceptibility to attack of individuals seems to vary greatly. In many cases a few fleas produce but little annoyance and the bites leave no after effect. In other instances the crawling of the fleas produces much annoyance and the bites have been known to form lesions of more or less serious character and often slow to heal.

To proceed intelligently with flea control it is important to have a good general knowledge of their habits and distribution. Eleven species of fleas have been shown capable of carrying plague. Eight of these have been found to occur on one or more species of rat (*Epimys* spp.) and two on ground squirrels. Of these, the Indian rat flea undoubtedly plays the principal rôle in the transmission of bubonic plague. The following list includes most of the forms which may be considered important to man either as vectors of disease organisms or as annoyers: *Pulex irritans*, *Ctenocephalus canis*, *Ct. felis*, *Ceratophyllus fasciatus*, *C. anisus*, *C. acutus*, *Xenopsylla cheopis*, *X. scopulifer*, *Ctenophthalmus agyrtes*, *Dermatophilus penetrans*, *Echidnophaga gallinaceus*, *Hoplopsyllus anomalus*.

The host relations of fleas are very important, as has been seen by considering the relationship of the insect to disease transmission. Unfortunately most of the fleas are not very closely restricted to certain hosts, especially when forced by hunger to seek blood. It might be stated at

¹This lecture was read November 4, 1918.

the outset that all fleas are dependent upon blood for their existence. There is considerable variation in the degree to which certain species are restricted as regards their host, and we should not go too far in drawing conclusions as to whether certain species will not feed on certain hosts as our judgment is based usually on a comparatively small number of experiments under more or less artificial conditions, or upon examinations of a small number of host species, often in restricted districts.

Fleas pass through four distinct stages—egg, larva, pupa (in a cocoon), and adult. The eggs are readily seen with the naked eye, especially when on a dark background. Most of them are deposited by the females while the latter are on the host. They fall off the host, mostly dropping in the bedding material where they hatch in from two to twelve days. This is responsible for a concentration of the adults about the sleeping places of the hosts, and favors them by being within easy reach of the hosts, both old and young, and also in supplying the larvæ with the partially digested blood excreted by the adult fleas, for food. The number of eggs laid varies greatly according to species, availability of,

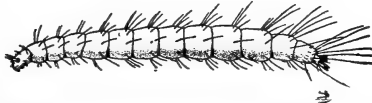

FIG. 64.—Larva of the European rat flea, *Ceratophyllus fasciatus*. Greatly enlarged. (Bishopp.) From U. S. Dept. Agr., Bull. 248, fig. 3.

food for adults, etc. Bacot, of the Lister Institute, has counted as many as 448 eggs deposited by a female human flea. Comparatively few are deposited each day but the egg laying may be extended over many weeks.

The Larvæ.—The larvæ are whitish, legless, and eyeless maggots, distinctly segmented and provided with numerous hairs (fig. 64). They are usually less than one-fourth of an inch in length when grown, and quite active, disappearing quickly in breeding material. Larvæ of some of the larger species may considerably exceed this length. They are to be found in the dust in which vegetable and animal particles are mixed. The larval stage is extremely variable, mostly depending on temperature, abundance of food, and degree of moisture and humidity. The length of this stage has been found to range from one to twenty weeks. Under favorable conditions from one to three weeks may be taken as the usual length of the period.

The Pupa.—All flea larvæ spin cocoons in which the pupa is formed. These are oval and not easily seen on account of the numerous particles of dust, sand, etc., which is woven in or stuck to the silken cocoon. This stage ranges from a week to nearly a year. The extreme long periods were observed by Bacot to take place only in cool weather.

With the Indian rat flea the period was greatly lengthened when the mean temperature fell below 65° F., human flea below 50° F., and the European rat flea below 40° F. In cooler climates the winter is probably passed in this stage but in warmer countries adult activities never cease.

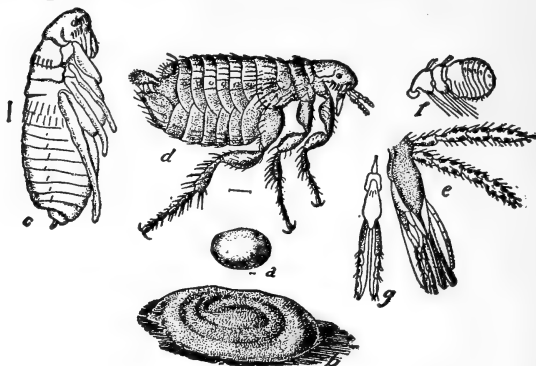

FIG. 65.—The dog flea (*Ctenocephalus canis*): a, Egg; b, larva in cocoon; c, pupa; d, adult; e, mouth parts of same from side; f, antenna; g, labium from below; b, c, d, much enlarged; a, e, f, g, more enlarged. (From Howard.) From U. S. Dept. Agr., Bull. 248, fig. 3.

The adult fleas often remain in the cocoons for weeks and emerge when disturbed.

Life Cycle.—The cycle is completed under favorable conditions in

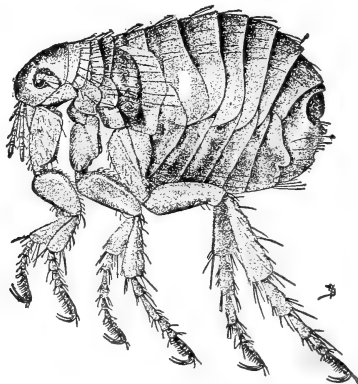

FIG. 66.—The human flea, *Pulex irritans*: Adult female. Greatly enlarged. (Bishopp.)

one to four weeks, but it may extend to one and one-third years in extreme cases.

Length of Life of Adult Fleas.—A knowledge of the length of life of the adults is of much importance in relation to control measures and disease dissemination. Under cool, moist conditions Bacot found the human flea to live 125 days, the European rat flea 95 days, the dog flea

58 days, the Indian rat flea 38 days, and the bird or chicken flea (*Ceratophyllus gallinae*) 127 days. When fed daily this longevity was greatly increased; human flea 513 days, European rat flea 106 days, dog flea 234 days, Indian rat flea 100 days, and the bird flea 345 days. Mitzmain found the European rat flea to live 160 days in California and the ground squirrel flea (*Ceratophyllus acutus*) 64 days. In warm weather the longevity without food is but a few days.

The human flea (*Pulex irritans*) (figs. 66, 67) was formerly thought to restrict its attention largely to man. Investigators have found, however, that it probably develops normally on the hedgehog and others state that it is occasionally found on dogs and cats, especially during the winter. Our own observations indicate that it is a very common parasite of hogs; so much so in fact that it might be called the hog flea instead

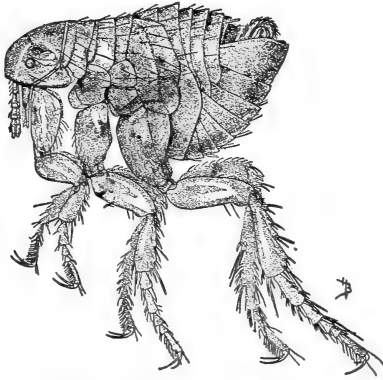

FIG. 67.—The human flea, *Pulex irritans*: Adult male. Greatly enlarged. (Bishopp.)
From U. S. D. A. Bull. 248, figs. 5, 6.

of the human flea. Also that it may be found in considerable numbers on dogs at all times of the year even in regions where it is not a pest of importance to man. It has been taken on several species of rats, but in limited numbers. This form appears to be well adapted to a free existence, usually leaving the host after partaking of a blood meal and this habit may tend to make it of greater importance as a disseminator of disease. It has almost world-wide distribution but its abundance in different regions varies greatly. In the United States it is very prevalent in California and the Southwestern States where it is the principal cause of flea annoyance to man.

The dog and cat fleas (*Ctenocephalus canis* Curtis and *Ct. felis* Bouché (fig. 65) may be discussed together as their habits appear to be very similar and as some authors still believe they are not distinct species but only varieties. They have a rather wide range of hosts, including the dog, cat, man, and a number of wild animals, especially of the dog and

cat family. They are occasionally found on rats. They are quite widely distributed throughout the temperate and tropical parts of the world. In the United States they often occur as household pests, and in the Central and Eastern States they usually take the place of the human flea as parasites of man, most of the outbreaks in these regions being from either one or the other of these species.

The European rat flea *Ceratophyllus fasciatus* Bosc is rather closely restricted to the several species of rats and mice but it has been found to bite man in the absence of its preferred hosts and probably also will feed on other animals. It is the predominant rat flea in the United States and over the greater part of Europe, and in this region must be considered one of the principal vectors of plague. In the tropics it is much less abundant, occurring only in the cool season.

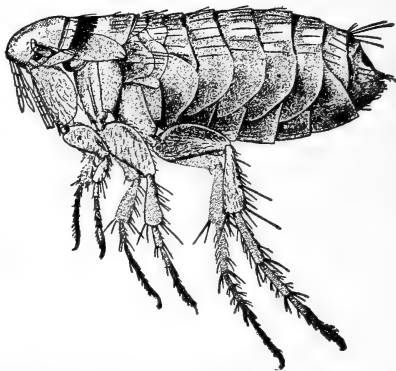

FIG. 68.—The European rat flea, *Ceratophyllus fasciatus*: Adult female. Greatly enlarged. (Bishopp.)

The Tropical or Indian rat flea (*Xenopsylla cheopis* Roth.) is undoubtedly the principal disseminator of bubonic plague in India and other parts of Asia. It is also now to be found in practically all the other tropical and subtropical countries of the world, but it is often restricted to the seaport towns, as in the case of the United States, where it appears not to have penetrated far inland. This species is primarily a rat flea, being taken on all species of rats and mice, but it feeds readily upon man and also will attack small domestic animals and some wild ones.

The mouse flea (*Ctenopsylla musculi* Dugès) is to be found in many parts of the world but is especially abundant in Mediterranean Europe, Australia, and the southern part of the United States. It is often found in numbers on rats as well as mice, but rarely bites man even in the absence of its preferred hosts.

The Asiatic rat flea (*Ceratophyllus anisus* Roth.) appears to take the place to a large extent of the European rat flea, in Japan and portions of northeastern China. A species of groundhog flea (*Ceratophyllus*

silantiewi Wagner) occurs in numbers on the "tarbagan" or groundhog in Manchuria and was thought to be concerned in the transmission of plague from that host to man in the recent Manchurian outbreak. However, subsequent investigations apparently failed to substantiate this theory.

The field mouse flea (*Ctenophthalmus agyrtes* Heller) occurs in England and other parts of Europe. It is common on voles and field mice and also on rats living in the open. It has no inclination to bite man. This species probably plays little part in the dissemination of plague, but when the disease gets among wild rodents it no doubt would aid in spreading it from animal to animal.

Pygiopsylla ahalae Rothschild has been shown capable of carrying plague. It is an East Indian Island species and according to De Raadt

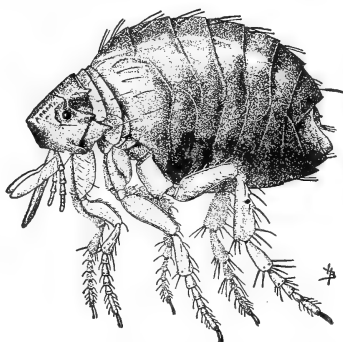

FIG. 69.—The sticktight flea, *Echidnophaga gallinacea*: Adult female. Greatly enlarged. (Bishopp.) From U. S. Dept. Agr. Bull. 248, figs. 2, 8.

it is abundant on rats in coffee plantations in Java, but rare on rodents in buildings. He avers that the species of fleas found on rats may be used as an index to the source of the rat population of a given place.

The squirrel fleas (*Ceratophyllus acutus* Baker and *Hoplopsyllus anomalus* Baker) are abundant in the western United States on ground squirrels. They have been shown capable of transmitting plague, and both feed readily on man and will feed on rats.

The sticktight flea (*Echidnophaga gallinacea* Westwood) (figs. 69, 70) is an important pest of poultry in the southern United States. This species is widely distributed in the subtropical and tropical parts of the world. It attacks several wild birds in addition to domestic species and has been taken on rats in numbers. It bites man with avidity.

The chigoe or penetrating flea (*Dermatophilus penetrans* Linnaeus) is troublesome in the West Indies, Mexico, and northern South America, and has been introduced into West Africa and from there to India. It burrows into the skin of the feet, especially around the toenails. Many

animals, including man, hogs, dogs, cats and the larger domestic animals, are attacked.

The flea (*Xenopsylla scopulifer* Rothschild) occurs on rats in German East Africa. It is closely allied to *X. cheopis* and partially replaces that species in the region mentioned. Its possible relations with plague transmission have not been determined.

FACTORS INFLUENCING ABUNDANCE OF FLEAS

There is a very close correlation between various climatic factors and flea abundance. This applies to practically all species in greater or less degree. In the United States it may be said that in general fleas



FIG. 70.—Head of rooster infested with the sticktight flea (*Echidnophaga gallinacea*). Somewhat reduced. (Bishopp.) From U. S. Dept. Agr., Bull. 248, fig. 7.

are more abundant during moderately warm weather when there are frequent rains or high humidity. The effect of seasonal and climatic conditions on fleas has a very important bearing on the plague. This has been well shown by the Indian Plague Commission which found that there is a rather close correlation between the abundance of fleas and the prevalence of the disease, and that flea abundance in turn depended upon climatic conditions. They showed that in the case of the European rat flea there is a marked decrease in numbers with the oncoming of the hot, dry season. These fleas begin to disappear in early April and from May 15 to November not a single specimen is seen. The Indian rat flea, which is the principal plague conveyer in that region, was found to be above the mean average in number during the period from November to May, with the maximum about April. During the rest of the year—June to September—the flea prevalence is below the mean, the absolute minimum

being reached in August to September, the maximum being six times less than in April. The plague season in the districts where these observations were made is from February to May, inclusive. The maximum is usually reached early in May, sudden decline being experienced with the dropping off in numbers of the fleas early in June.

The degree of annoyance to man from fleas depends to a large extent upon the relative abundance. Thus in the southern part of the United States, while fleas are active throughout the year, they are reduced so low during the winter months that they confine their attacks largely to smaller animals. During the spring the breeding increases rapidly and often severe outbreaks are experienced. In the Northeastern States these outbreaks are more frequent during the latter part of summer and early fall.

There is also marked correlation between the character of soil and flea abundance. Sandy land is uniformly more conducive to flea development than the heavy soils. However, soils with a large amount of humus seem also to favor flea breeding. We do not expect to encounter widespread flea abundance in black land regions, but this does not interfere with severe local outbreaks.

CONTROL OF FLEAS

The general consideration of flea control must be governed by the conditions under which one is working. When we consider regions where plague is known certainly not to exist, little concern need be felt over the presence of an occasional flea, and all that is necessary is to take precautions that they do not become annoyingly abundant. Occasionally premises already infested may be encountered and in such cases it is necessary to know what steps to take to reduce the numbers immediately. On the other hand, in regions where the presence of plague may be suspected, the elimination of all fleas is desirable, and one must give attention to the scattered fleas as well as the heavy infestations. Of course in such situations the prime move should be against the rats which act as hosts for both the plague bacillus and the fleas which carry it. In cases where the plague has become established in rural districts among ground squirrels or other native rodents, their destruction also requires attention. The procedure in such cases must necessarily be governed by the duration of occupancy of a given place. For permanent elimination rat-proofing is essential. This consists in the elimination of all loosely constructed buildings and the concreting of floors, basements and wharves. While the rat-proofing is going on war should be waged against the rats by poisoning, shooting, and trapping. Where plague is known to exist in a city or village being cleared of rats, every precaution should

be taken against flea bites. Workers should be provided with closely-fitting clothes and leggings and certain other methods of body isolation as discussed in a subsequent paragraph.

When operating in regions where plague is suspected, it is also important to choose locations for troops which are apt to be free from rats. The billeting of men in old buildings, warehouses, barns, etc., should under such conditions be entirely avoided.

Control of Hosts.—To keep down heavy infestations of those species of fleas which are annoying to men and animals, one of the essential steps is to exercise control over the hosts. Of course, this principle is involved in the elimination of rats and squirrels in plague areas. When an infestation is encountered, the first thing that should be inquired into is the possible hosts and their haunts. Usually the main trouble can be traced to the sleeping places of dogs, cats, hogs, or to hen houses, or spaces beneath houses and barns frequented by poultry. In the case of the human flea the infestation may be more or less general over the premises, but there are nearly always centers where they are concentrated and often these are associated with pet animals. When the principal breeding places have been located the hosts should be destroyed if possible, or freed from adult fleas, and kept under control. A definite sleeping place should always be provided for dogs and cats, and these may be kept free from fleas, after treatment, by cleaning out the beds regularly and spraying with coal tar disinfectant. The host animals may be freed of fleas by washing them thoroughly in a 3 per cent solution of creolin and water, or by using any other standard saponified creosote compound. Kerosene emulsion made according to the formula: One pound soap, two gallons kerosene, one gallon water, reduced one to nine, is also very effective. In the case of cats these substances must be washed out of the fur with warm water and soap shortly after treatment to avoid burning of the skin.²

Where premises are heavily infested with adults it is first necessary to destroy this stage and this may be accomplished by fumigation, if the building is fairly tight, either with hydrocyanic gas, five ounces cyanide per thousand cubic feet; or by burning sulphur at the rate of four pounds per thousand cubic feet. As has been pointed out, many adults remain quiet in pupa cases or may be buried in sand or cracks where they are somewhat protected from the effects of the gas. In destroying the immature stages we can take advantage of the destructive effect of extremes in moisture or dryness. Where complete flooding of infested areas is feasible, this has been known to accomplish the destruction of all stages. In other cases, loose boards and trash should be removed and burned and the

² Powdered derris has been found very efficacious in destroying fleas on animals. One grain scattered in the hair of a dog will kill all fleas present.

infested areas sprinkled heavily with salt and wet down by sprinkling. Repeat the wetting operation at intervals of five to ten days, according to the condition of the soil. Usually two or three treatments are sufficient.

Where fumigation can not be practiced and it is desirable to get rid of the adults at once without waiting for them to starve, a number of procedures may be followed. If in habitations, sprinkling flaked naphthalene over the floor at the rate of four or five pounds to each two or three hundred feet, closing the rooms up for a few hours, and then sweeping the material to the next room together with the stunned fleas is very effective. Pyrethrum may be used in a similar way. In barns and basements spraying with kerosene emulsion will accomplish the destruction of most of the active adults.

Where adults are abundant in sheds, barns, and hog yards, we have found that the light but general spraying of the infested areas with creosote oil (at least 10 per cent tar acids) will accomplish striking results.

In buildings where fleas are breeding in the cracks of the floors or under rugs and carpets, these should be removed, the house thoroughly swept and the floors washed with strong soap or lye water, or if feasible, they may be sprayed with gasoline or kerosene emulsion. The free use of sweeping compounds and floor oils will largely eliminate subsequent trouble.

In treating premises infested with sticktight fleas it is important that all fowls be excluded from beneath houses and barns. These conditions prevail largely in the South where this pest becomes annoying. If this precaution is taken and the fowls are kept in sheds which admit plenty of sunshine and air, and the infested places be treated with salt and water no attention need be given to the fleas upon the host.

Repellents, Isolation and Trapping.—The wearing of shoes and leggings will largely exclude the chigoe flea. While cleaning up infested premises it has been found that the laborers can exclude the fleas and at the same time catch large numbers of them by wrapping the legs with paper covered with tanglefoot. To prevent fleas attacking one at night the use of flaked naphthalene or pyrethrum dusted in the bed clothing will give a degree of immunity.

Since fleas are comparatively limited in their ability to jump (greatest height of any species about eight inches, greatest horizontal distance about thirteen inches) cots and beds may be protected by isolating their legs in pans of water or by wrapping them with paper or cloth treated with tanglefoot. The bed clothing should, of course, be kept tucked up so as not to reach near the floor and individuals should remove all clothing and be free from fleas when entering the bed.

To prevent spread of fleas from regions where plague is present, care should be taken not to allow rats and mice to gain access to packed materials, and fumigation of clothing and other articles should be practiced en route or at destination. Precautions against the transference of rats from ships to land or from the docks to ships when in port are very essential. All boats should be kept at least four feet away from the docks and all hawsers should be provided with rat guards. These are metal discs at least two feet in diameter fastened to the rope between the ship and dock. Gangplanks should never be left down day or night, except when actually in use and care should be taken not to transfer rats with cargo. This is often very difficult, if not impossible.

Fumigation of ships when entering port is, of course, the safest plan to follow, especially if they have touched ports where plague may be present. At the present time this is practiced in nearly all the important ports of the world. Sulphur dioxide applied under pressure by the so-called Clayton method, and hydrocyanic acid gas are employed. This fumigation, if properly done, accomplishes the destruction of the rats, fleas and other life aboard. The hydrocyanic acid gas appears to be giving best results and danger of damaging cargoes is lessened.

Since fleas are largely attracted to moving objects it is possible to collect great numbers of them by allowing men with their legs wrapped in paper treated with tanglefoot to walk about over the infested area. Where fleas are less abundant, and especially in places where plague is suspected, the use of animal hosts to collect the fleas may be employed. Guinea pigs, white rats, or rabbits may be used for this purpose. After being in the infested premises for some time, the fleas may be killed by placing the trap animal in a jar and applying chloroform and when the anesthesia is complete, the fleas will either drop off or remain on the surface of the hair where they can readily be picked off and placed in containers before reviving. Of course the animal may be treated with kerosene emulsion or other insecticides. The effectiveness of animals as traps varies with the species of fleas concerned. The Indian rat fleas and European rat fleas do not go freely to guinea pigs but are caught in great numbers on tanglefoot on man. The squirrel flea will go to guinea pigs very readily.

Dr. Hindle has described a flea trap used in China. It consists essentially of a cylinder covered with tanglefoot, and protected against sticking to objects by an outside cylinder with openings to allow the fleas to strike the sticky surface. This can be rolled about on the floor of the infested rooms.

Medical Treatments for Flea Attack.—Flea bites seldom need medical treatment. However, some people are so susceptible that irritation and itching follow the bites, and some develop ulcers. The use of disinfectant

solutions are advised for the latter, and cooling applications, such as mentholized or camphorated ointments for the itching. In the case of infestations of the chigoe the insect should be promptly removed by excision and the part kept as free from infection as possible.

LIST OF REFERENCES

- Bacot, A. W., 1914.—A study of the bionomics of the common rat fleas and other species associated with human habitations. With special reference to the influence of temperature and humidity at various periods of the life history of the insect. *Journ. Hyg., Plague Supplement III*, Jan. 14, pp. 447-654.
- Bacot, A. W., 1914.—The effect of the vapors of various insecticides upon fleas at each stage in their life history and upon the bedbug in its larval stage. *Journ. Hyg., Plague Supplement III*, Jan. 14, pp. 665-681.
- Bacot, A. W., and Ridewood, W. G., 1914.—Observations on the larvae of fleas. *Parasitology*, vol. 7, No. 2, June 19, pp. 157-175.
- Bacot, A. W., and Petrie, G. F., 1914.—The fleas found on rats and other rodents living in association with man and trapped in the towns, villages and Nile boats of Upper Egypt. *Journ. Hyg.*, vol. 14, No. 4, pp. 498-508, Dec. 23.
- Bishopp, F. C., 1915.—Fleas. *U. S. Dept. Agr., Bull. No. 248*, Aug. 14, 31 pp.
- Bishopp, F. C., 1915.—Fleas as pests to man and animals, with suggestions for their control. *U. S. Dept. Agr., Farmers' Bull. 683*, Nov. 8, 15 pp.
- Canalis, P., 1916.—Some experiments on the insecticidal action of Clayton Gas. *Bull. Mens. Office Internat. d'Hyg. Publique*, vol. 7, No. 3, March, pp. 457-463.
- Chick, Harriette, and Martin, C. J., 1911.—The fleas common on rats in different parts of the world and the readiness with which they bite man. *Journ. Hyg.*, vol. 11, No. 1, April 8, pp. 122-136.
- Conradi, A. F., 1902.—Remedies for fleas. *N. H. Agric. Exp. Station, Bull. No. 94*, October, pp. 89-92.
- Creel, R. H., 1915.—Hydrocyanic acid gas; its practical use as a routine fumigant. *U. S. Pub. Health Rpts.*, vol. 30, No. 49, Dec. 3, pp. 3537-3550.
- Creel, R. H., and Faget, F. M., 1916.—Cyanide gas for the destruction of insects. *U. S. Pub. Health Rpts.*, vol. 31, No. 23, June 9, pp. 1464-1475.
- De Raadt, O. L., 1915.—Contribution to the knowledge of the epidemi-

- ology of plague in Java. Meded. Burgerlijk. Geneesk. Dienst Ned.-Ind., pt. 4, pp. 20-38.
- Howard, L. O., 1909.—House Fleas. U. S. Dept. Agr., Cir. No. 108, 4 pp.
- Illingsworth, J. F., 1915.—Hen Fleas. The Hawaiian Forester and Agriculturist, vol. 12, No. 5, May, pp. 130-132.
- Jennings, A. H., 1910.—Rats and Fleas in relation to bubonic plague, with special reference to Panama and the Canal Zone. Sept. 14, 12 pp.
- Kitasato, 1909.—Rat fleas, with their special reference to the transmission of plague in Japan. Trans. Bombay Med. Congr., p. 93.
- Liston, W. G., 1904.—Plague, rats and fleas. Journ. Bombay Nat. Hist. Soc., vol. 16, p. 253.
- Liston, W. G., 1914.—Report of the Bombay Bacteriological Laboratory for the year 1913. Bombay, Govt. Central Press, 24 pp.
- McCoy, G. W., and Mitzmain, M. B., 1909.—Experimental investigation of biting of man by fleas from rats and squirrels. U. S. Pub. Health Repts., vol. 24, No. 8, Feb. 19, 7 pp.
- Martin and Rowland.—Observations on rat-plague in East Suffolk. Appendix to the report of the medical officer to the Local Govt. Board.
- Mitzmain, M. B., 1910.—General observations on the bionomics of the rodent and human fleas. U. S. Pub. Health Bull. No. 38, 34 pp.
- Neumann, L. G., 1914.—Parasites and parasitic diseases of the dog and cat. Paris: Asselin et Houzeau, 348 pp.
- Nuttall, G. H. F., Strickland, C., and Merriman, G., 1913.—Observations on British rat fleas. Parasitology, vol. 6, No. 1, April 17, 19 pp.
- Raynaud, L., 1909.—Prophylaxis de la peste en Algerie. Revue D'Hyg. et de Police Sanit., vol. 31, p. 101.
- Reports on Plague Investigations in India, Journ. Hyg. (1906), vol. 6, No. 4; (1907), vol. 7, No. 3, pp. 323-476; vol. 7, No. 6, p. 693; (1908), vol. 8, No. 2, pp. 162-308; (1910), vol. 10, No. 3, pp. 315-568; (1912), vol. 12, Plague Supplement II, pp. 300-325.
- Rothschild, N. C., 1906.—Note on the species of fleas found upon rats in different parts of the world. Journ. Hyg., vol. 6, p. 483.
- Shipley, A., 1908.—Rats and their animal parasites. Journ. Econ. Biol., vol. 3, No. 3, p. 61.
- Swellegrebel, N. H., 1913.—Record of observations on the bionomics of fleas and rats and other subjects, bearing on the epidemiology of plague in Eastern Java. Meded. Burgerlijk. Geneesk. Dienst Ned.-Ind., vol. 2, pt. 1, 90 pp.
- Tiraboschi, C., 1904.—Les rats, les souris et leurs parasites cutanes. Archiv. Parasit., vol. 8, p. 161.
- Van Dine, D. L., 1908.—Report of the Entomologist. Ann. Rept. Hawaii Agr. Exp. Sta. for 1907, May 26, pp. 35-37.

- Verjbitski, D. T., 1908.—The part played by insects in the epidemiology of plague. *Journ. Hyg.*, vol. 8, p. 162.
- Waterston, J., 1916.—Fleas as a menace to man and domestic animals, their life history, habits, and control. British Museum (Natural History) Economic Series No. 3, 20 pp.

NOTES ON THE CHIGOE, *DERMATOPHILUS PENETRANS*

W. Dwight Pierce

Mr. Bishopp has mentioned the chigoe in his lecture, but I believe this exceedingly interesting flea is deserving of a more extended statement. In South and Central America it is also known as La Nigua. It breeds in the flesh of man and animals, attacking the pig, cow, goat, sheep, horse, dog, cat, lion, and gorilla and probably other vertebrates.

When the female is impregnated she attaches herself to the skin, bores in and remains stationary. When the eggs are mature they are either passed out while the female is fixed to the skin, or the flea may become detached. The female while attached swells to a great size. The larvae breed in dirt and pupate in a cocoon. The favorite points of attack are on the heels, balls of foot, palm of hand, and between the fingers, although they attack other parts of the body.

The attack is very painful, and in severe cases may result in antrum, the loss of a member, especially a toe. Brumpt says this flea frequently inoculates the germs of tetanus, *Bacillus tetani*. This belief is also held by Quiros, who notes the large number of cases of tetanus following nigua attack.

In cases of heavy infestations Quiros uses a pomade composed as follows:

Salicylic acid	2.5 grams.
Ictiol (ichthyol)	10.0 “
Yellow vaseline	10.0 “

In a few days the infested area encrusts and falls off, leaving the skin free from parasites.

In cases which might lead to amputation Quiros bathes in petroleum. He advises against the use of iodine, which is dangerous in these cases.

Prevention of breeding, restriction of hogs from wandering around habitations, wearing of shoes, and cleanliness are prophylactic measures.

CHAPTER XXVI

Cockroaches

A. N. Caudell

Contending with bedbugs for general unpopularity come cockroaches, noisome creatures scarcely less widely known, or less thoroughly disliked, than those smaller odorous and odious pests. The importance of roaches in houses and camps is considerable, not only as unsanitary and disgusting vermin, but as mechanical carriers of disease, and also very likely as intermediary hosts to certain disease-causing organisms. Experiments have shown these insects eminently fitted for both rôles, and their importance warrants attention by housekeeper and sanitarian.

No more offensive insect frequents the habitation of man than the cockroach. These insects have long been known as pests of the household and are found throughout most of the civilized world, especially in temperate and tropical regions. The ancients are said to have called them *lucifuga*, by reason of their nocturnal habits, but the more modern name cockroach, or the briefer designation roach, is the one by which they are now universally known. Certain species are, however, given special common names, which may vary in different regions, as water bug, Croton bug, German roach, etc., which are names by which the little, brown, house roach is known in various places.

Not all cockroaches are loathsome creatures of disgust, in fact there are very few of the many hundreds of described forms that are of any material economic importance. Some species of roaches are handsome in form and color, in some cases resembling certain beautifully colored beetles, a decided contrast to the flat noisome creatures of the kitchen.

Economically, roaches are of importance only as household pests and disease disseminators, there being but comparatively few instances of their injuring living plants or doing other damage to things out of doors. But in houses and camps they injure many things, defile food in pantries, eat paint from pictures, covers from books, glue from stamps, and gnaw holes in clothing. They will devour almost anything, and have been recorded as biting off eyelashes, gnawing toenails, and biting the greasy fingers of sleeping children.

As a rule but one species of roach occurs at one place in injurious abundance, two or more forms rarely occurring together in any number.

When numerous they congregate, especially in kitchens where it is warm, damp, and not overly clean. On shipboard they often abound to such an extent as to cause much damage, in some cases entire supplies of certain foods being spoiled by eating, or rendered nauseous by their contact, a disagreeable odor being imparted by secretions from certain scent-glands situated in the bodies of the insects. The readiness with which they are transported with food supplies make their introduction into military and other camps a matter of great probability, and when once infested, such places are soon thoroughly stocked with these skulking creatures.

BIOLOGY

The life histories of our household roaches are very similar. The eggs are deposited incased in an oblong, leathery pod, called an oötheca, and containing several eggs each, arranged in two longitudinal rows. In some cases this oötheca is carried around for some time by the mother roach, partially protruding from the tip of the abdomen. But generally they are deposited in some cranny and sometimes the oötheca of *Periplaneta* is glued in folds of clothing, or in a leaf if of outdoor occurrence, and covered over with bits of material chewed off by the insect. I have myself seen instances of this, once on a garment and twice on leaves, and the recognition of the oötheca in such cases is not at all clear until it is uncovered.

When first hatched from the egg the young roach resembles the adult in general form, but is apterous and the body is soft and whitish in color. Soon, however, the chitin becomes oxidized and the normal color appears. A number of molts occur during growth, the old skin splitting along the dorsal line of the thorax, and through this slit the insect emerges, the process being one requiring some considerable exertion: every part of the body sheds its old covering, antennae, feet and all. The freshly molted roach, like one newly hatched, is whitish in color, but a few hours serve to restore the natural colors. In the last two instars the wings appear in a rudimentary condition, at the last molt appearing fully developed. This appearance of rudimentary wings is the only character separating the stages of the roach which correspond to larva and pupa of insects with complete metamorphoses. The terms larva and pupa are not generally applied to insects with incomplete metamorphoses, the term nymph being there used, the degree of development being indicated by the number of the instar, or period between two molts. A single roach may produce several egg-masses in a season, and in the common house species the period of development from egg to adult varies with the food supply, climatic conditions, etc.

While in some tropical and subtropical regions certain species of

Blaberus, *Leucophaea*, etc., occur in houses, the main forms with which the sanitarian has to deal comprise but four species, *Blatta orientalis*, *Blattella germanica*, *Periplaneta americana*, and *Periplaneta australasiae*, especially the first two. These four domesticated species are easily separated, being very distinctive in appearance, the two species of *Periplaneta* only offering any difficulty in this respect. But even their differentiation is easy by the figures and descriptive notes given herein, and by use of the following key, which is based upon easily appreciated characters.

KEY TO THE FOUR PRINCIPAL HOUSEHOLD COCKROACHES

1. Size small, total length usually no more than one-half inch; pronotal disk with two, longitudinal, parallel, blackish stripes; last ventral segment of the abdomen of both sexes entire (fig. 72).

Blattella germanica (Linnaeus) Caudell.

Size medium or large, rarely much less than one inch in length, usually more; pronotal disk not marked as above; last ventral segment of the abdomen of the male entire, of the female longitudinally divided— 2.

2. Size medium, length about one inch; color black or dark brown, the pronotum unicolorous above; tegmina and wings abbreviated, in the male covering about two-thirds of the abdomen, in the female the tegmina forming mere lateral pads and the wings absent (fig. 71).

Blatta orientalis (Linnaeus).

Size large, generally considerably more than an inch in length; color reddish brown, the pronotum above distinctly bordered with yellowish color; tegmina and wings fully developed in both sexes—3.

3. Tegmina with a yellowish, humeral stripe in distinct contrast to the color of the rest of the surface; central dark area of the pronotal disk sharply outlined— *Periplaneta australasiae* (Fabricius).
Tegmina not marked as above; central area of pronotal disk less sharply outlined (fig. 73) *Periplaneta americana* (Linnaeus).

Blatta orientalis (Linnaeus) (fig. 71)

One of the most prevalent and widely distributed roaches is the *Blatta orientalis* of Linnaeus, in the Old World sometimes called the black beetle, a name now fortunately less used, for though it is black, the roach is not a beetle. The common name oriental roach is preferable for this species.

Blatta orientalis is a medium sized roach of a blackish color. The male is an inch, or a little less, in length, of a very dark-brown color, and furnished with both tegmina and wings, covering about two-thirds of the

abdomen, the tegmina often showing a reddish yellow cast. The female is noticeably larger than the male, of a more uniformly black color and provided with tegmina only, and these very short, being only about as long as the pronotum. In addition to the larger size and the shorter tegmina, the female can be readily distinguished from the male by the ventral surface of the terminal segment of the abdomen, which is plane in the male and divided longitudinally for its entire length in the female. This species is truly a gregarious insect, all stages living amicably together and often in incredible numbers where conditions are favorable for its occurrence. It is especially prevalent in cities, being, like the

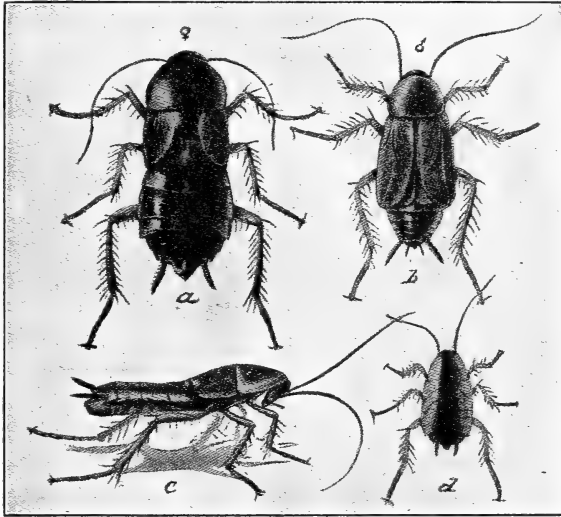

FIG. 71.—The Oriental roach, *Blatta orientalis*: a, Female; b, male; c, side view of female; d, half-grown specimen. All natural size. (Marlatt.) From U. S. Dept. Agr., Farmers' Bull. 658, figs. 1, 4.

other domesticated species, less generally abundant in rural sections. It is a lover of warm, damp, unclean locations and often abounds in cheap restaurants and such places. The female may deposit a number of egg-cases a season, each containing about sixteen eggs, and breeding is continuous when conditions of warmth, etc., are favorable.

Blattella germanica (Linnaeus), Caudell (fig. 72)

The German roach, or Croton bug, vies with the oriental roach in its importance as a household pest. It enjoys about as wide a distribution as its larger relative and in some sections it is the more important of the two. It is decidedly smaller than *orientalis*, the male being about one-half inch long and the female a little longer. The general color is yellowish

brown with two, usually conspicuous, longitudinal, blackish stripes on the pronotum. Both sexes are fully winged, both tegmina and wings exceeding the tip of the abdomen in both sexes. The male is more slender than the female but the last abdominal segment does not exhibit sexual differences as in the case of the above species. It is a more active insect than *orientalis*, breeds faster, and is no less prevalent in houses, but, being less restricted to filthy surroundings, is more often found in houses of a better class. But no home, no matter how well kept, is immune from invasion now and then by one or more of these roaches, as not a store of food, bundle of laundry, or lot of supplies of any kind can be brought in without danger of one or more roaches being introduced.

This species seldom occurs in company with the oriental roach, a house overrun with one species usually being free from the other.

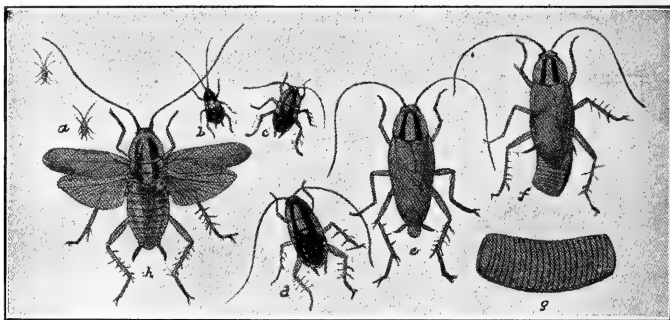

FIG. 72.—The German roach, *Blattella germanica*: a, First stage; b, second stage; c, third stage; d, fourth stage; e, adult; f, adult female with egg case; g, egg case, enlarged; h, adult with wings spread. All natural size except g. (From Riley.)

Periplaneta americana (Linnaeus) (fig. 73)

This, the American roach, is less frequently abundant in houses than the smaller forms, at least usually so, though in the warmer parts of the world it is frequently the prevalent household species. It is more frequently reported as doing damage to plants in greenhouses, etc., and very often it creates havoc indoors with books, clothing, and other material.

This roach is decidedly larger than either of the foregoing species, both sexes being about one and one-half inches in total length, often somewhat longer and rarely as much as a quarter of an inch shorter. Both sexes are fully winged, the wings usually surpassing somewhat the tip of the abdomen. The general color is reddish brown with the pronotum generally bordered around the disk with lighter yellowish color, usually in distinct contrast to the darker central portion. The ventral surface of the last abdominal segment of the two sexes here differ as in

the case of *Blatta orientalis*, being plane in the male and longitudinally divided in the female.

This species is thoroughly cosmopolitan in distribution, having been recorded from almost every portion of the world except the colder regions. In some sections it is the most common house species, though in the eastern United States it is not usually so common as either of the smaller species discussed above.

As stated in the first part of this paper, the egg-cases of *Periplaneta*, the exact species not determined, are glued to various substances and covered over with particles chewed off by the insect. The egg-cases of

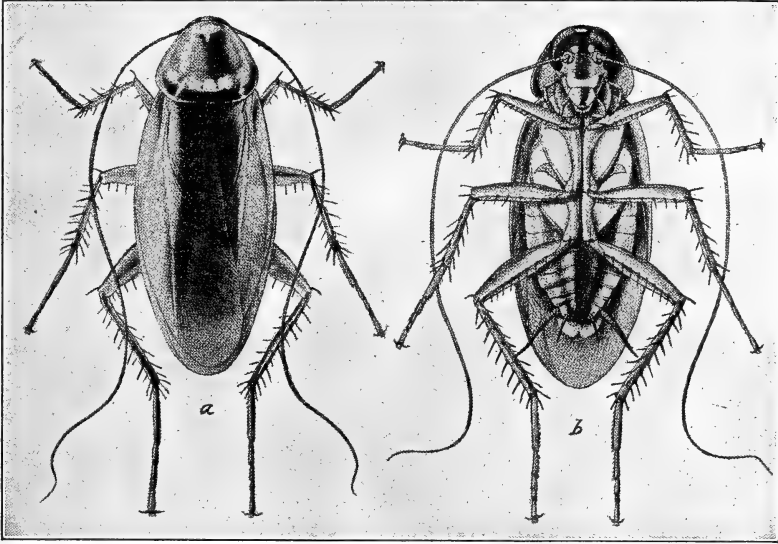

FIG. 73.—The American roach, *Periplaneta Americana*: a, View from above; b, from beneath. Enlarged one-third. (Marlatt.)

americana have been found, by actual count, to vary considerably in the number of eggs contained, the average, however, being about a score. The adult insect lives well over a year, one in captivity having died only after a confinement of one and one-third years.

Nothing is inviolable to injury by this large roach, and it, as well as other forms discussed here, will even eat its own eggs, or a disabled individual of its own kind, to say nothing of other insects, even the ill-smelling bedbug. This species is often reported as damaging living plants, a thing seldom charged to the account of the smaller roaches.

Periplaneta americana is the only one of our common house species indigenous to the New World, its original home probably being Tropical America.

Periplaneta australasiae (Fabricius) Burmeister

This species is of the same general size and appearance as *americana* and has practically the same habits. It is readily distinguishable from that species by the elytra, which have an elongate yellowish spot bordering the outer margin next the pronotum. The yellowish margins of the pronotal disk is in greater contrast to the more clearly delineated central portion than in *americana* and the general size is also somewhat less.

This roach is found mostly in warmer regions and is more often than any other species reported as injurious to plants in greenhouses, conservatories, etc.

REMEDIES

Remedies galore, good, bad, and indifferent, mostly the latter, have been recommended for use against roaches. No extended discussion of the divers methods proposed for the discouragement or destruction of these household pests will be here entered into. Only a few of the more promising methods of eradication will be considered.

*Fumigation**Hydrocyanic Acid Gas*

In extreme infestation the best method of ridding a premise of roaches is by fumigation, the best fumigant being hydrocyanic acid gas at the rate of 10 ounces per 1,000 cubic feet for one hour. While thoroughly effective, this treatment involves considerable cost, and, owing to its extremely dangerous qualities, necessitates extreme care in its application. *Before attempting fumigation with this POISONOUS gas, detailed directions should be carefully studied.* Such directions are given in the lecture on the control of human lice (p. 324).

Carbon Bisulphide

A fumigant less dangerous to use than the above, but one requiring much precaution because of its inflammability, is carbon bisulphide. This highly volatile material distributed in open vessels, one pound to each 1,000 cubic feet of space, will destroy roaches, but the rooms fumigated must be ones that can be very tightly sealed up, as indeed must be the case in any fumigation. This method is well adapted for use in the holds of ships and other vessels. A fumigation of twenty-four hours will kill all vermin in a tightly sealed room. The *violently explosive nature* of this material necessitates extreme care in its use. *No fire of any kind* must be about when it is in use.

Pyrethrum Powder

A safer, and sometimes as effective, fumigant is pyrethrum powder burned in infested quarters. The only precautions here needed is to see that the places under fumigation are tightly closed.

Sulphur

Fumigation for a period of six hours with fumes created by burning sulphur, four pounds per 1,000 cubic feet of space, is also recommended for the extermination of roaches. There are other substances possessing some value as fumigants but the above-mentioned materials comprise the most promising of them.

Poisons

In cases of moderate infestation, or occurrence in situations inconvenient for fumigation, some one of several substances poisonous to roaches can be employed. Our household species, however, especially the alert Croton bug, are not always easily persuaded to partake of poisoned food, as they appear to possess an uncanny knowledge of what materials are unhealthy for them to eat. In their ability to look out for themselves, and foil the attempts of man to destroy them, they have been compared to that wily bird, the crow. But in spite of their intelligence in avoiding pitfalls set in their way, they are more or less subject to control by various poisons and repellents.

Sodium Fluoride

This material has but recently come into prominence as a roach exterminator, but it is very surely the best remedy in the way of poisons now known. This powder probably kills both by contact and certainly as an internal poison, and by its use an infested apartment may be soon completely cleared of roaches. It is used either pure or diluted with one-half part flour or some other such substance. It is not injurious to man unless taken in considerable quantities and thus its use is not attended with danger. The powder is scattered about the haunts of roaches and blown into cracks and crannies occupied by them with a dust gun, or blower.

Borax

Powdered borax, used pure as a repellent, or mixed with some substance attractive to roaches as a poison, is an effective remedy in many cases. One part of borax to three parts of pulverized chocolate is said to be a good mixture.

Pyrethrum Powder

Dusting with pyrethrum powder is often recommended against roaches but experiments show that for the best results it should be used full strength. It is not to be compared with sodium fluoride in its effectiveness.

Phosphorus

A standard remedy for roaches, and one long in use, is phosphorus. This substance is used in the form of a paste composed of sweetened flour containing 1 or 2 per cent of phosphorus. This paste is spread on bits of cardboard and set about where it is easily accessible to the roaches.

Sulphur

Sulphur, in the powdered form, scattered about where roaches abound is said to be an effective repellent.

Castor Oil

One would scarcely expect this oil to be repellent to the omnivorous roach, but articles smeared with it are said to be rarely attacked by them.

Of all the poisons and repellents mentioned above, sodium fluoride ranks the highest as an effective roach remedy.

Traps

Various sorts of traps have been recommended for catching roaches, but at the best such means only serve to lessen the numbers of roaches, probably never resulting in extermination.

ENEMIES

Certain hymenopterous parasites destroy the eggs of cockroaches and there are a number of predaceous insects and other enemies noted as feeding on the roaches themselves. The house centipede is recorded as killing the Croton bug and it is said that a toad or a tree frog will clear a room of roaches in one night.

CHAPTER XXVII

Diseases Transmitted by the Cockroach

W. Dwight Pierce

As cockroaches are so often found in houses and especially apt to frequent garbage and waste about a house, and frequent the food in the kitchen and on the table, it can readily be seen how easily they might transmit disease in case they are capable of carrying the organisms on their body or of retaining them in their systems. The cockroach feeds on filth of many kinds and goes straight from this filth to food. As it feeds on the food it contaminates the same with its feces causing noxious odors which often ruin the food. We owe to Cao, the Italian investigator, our principal knowledge of the manner in which the cockroach can transmit disease organisms. Cao worked with the bacteria which might be found in food and in carcasses and he may be said to have covered the greater part of the bacterial organisms which the cockroach is most likely to be able to transmit. There can be no question of the desirability of controlling roaches in houses, hotels, and eating places. The necessity of this is the greatest in public eating houses where the roaches can feed on sputum and debris left by customers or by employees. A filthy employee and a cockroach-infested restaurant make a combination to be feared.

In the following pages will be found a summary of the records which have been made of the rôle of cockroaches in the transmission of organisms, especially disease organisms.

PLANT ORGANISMS

Thallophyta: Fungi: Coccaceae

Micrococcus nigrofasciens Northrup, cause of an insect bacteriasis, has been experimentally transmitted to *Periplaneta americana* by Northrup.

Sarcina alba Eisenberg has been isolated from the feces of *Blatta orientalis* by Cao in several series of experiments, but in no case was it found to be pathogenic after passage through the cockroach, even when fed in pure culture, or with other foods. In experiments with other

insects, Cao has found this organism derived from the feces fatal to animals (Cao 1906a).

Sarcina aurantiaca Lindner and Koch. Cao (1906a) isolated this organism from the feces of *Blatta orientalis*, and found it nonpathogenic. In various experiments he fed it to roaches, finding that when fed in connection with a diet of bread and an infusion of putrid beef liver, a diet of bread and an infusion of 1 per cent peptone, and a diet of bread with a putrid infusion of beef flesh, it became slightly pathogenic after recovery from the feces of the roach.

Sarcina lutea Schroeter was isolated by Cao (1906a) from the feces of *Blatta orientalis* and found nonpathogenic. In various experiments he fed it to roaches in connection with other foods, finding it nonpathogenic in all but four tests when it was given with infusion of putrid liver, peptone, or beef, in which cases it was slightly pathogenic after recovery from the feces of the roach.

Staphylococcus pyogenes albus (Rosenbach) and *S. p. aureus* (Rosenbach), the causes of many forms of SEPTICEMIA, have been proven by Herms to be capable of carriage by the Croton bug, *Blattella germanica*, on its feet, and he has shown that it can contaminate food on which it feeds, or with which it comes in contact, and also that both varieties can be found on the cockroach in nature.

Thallophyta: Fungi: Bacteriaceae

Bacterium anthracis (Davaine), the cause of ANTHRAX, was fed by Küster to *Blatta orientalis* and later recovered from its feces.

Bacterium cholerae gallinarum (Perroncito), the cause of FOWL CHOLERA, was experimented with by Cao (1906a) in an attenuate form by feeding it to the cockroach *Blatta orientalis*. When fed to starved roaches without their food it passed through the intestines without an increase in virulence, but when fed to the roach in conjunction with a diet of bread with a putrid infusion of beef liver the organism partially regained its lost virulence. Küster also fed this organism to *B. orientalis* and recovered it from the feces.

Bacillus coli Escherich, a pathogenic organism normally found in the alimentary canal of man and animals, sometimes causing various types of diseases, has been isolated readily by Cao (1906a) from the feces of *Blatta orientalis*. He found that it remains in the intestines of the roach even after prolonged fasting. The various strains obtained varied in pathogenicity. When fed to the roaches in connection with other food it sometimes greatly increased its virulence by passage through the insects.

Bacillus fluorescens liquefaciens Fluegge, a fluorescent organism, was isolated by Cao from a series of *Blatta orientalis*, but he obtained no

pathogenic results from inoculations in this series. In another series of *Blatta* which had fasted for 45 days and whose feces contained no fluorescent bacilli and only a mildly pathogenic strain of *Bacillus coli*, he fed the roaches with this organism. One strain derived from the feces of a pigeon which had proven absolutely innocuous was fed to roaches for five days. The feces of the *Blatta* collected aseptically by squeezing the abdomen, killed a guinea pig in five days, with production of an abscess at the site of inoculation. From the pus was isolated a fluorescent bacillus which, when inoculated in pure culture subcutaneously, appeared pathogenic and killed a guinea pig and a cony in four and five days respectively, with production of a large purulence. Another strain isolated from an infusion of putrifying flesh was fed to three roaches and after eight days their feces were inoculated and killed a guinea pig in seven days, with production of an abscess at the site of inoculation. The fluorescent bacilli isolated from the feces were equally pathogenic. A third strain obtained from the air did not acquire perceptible virulence in passing through the roaches. A fourth strain isolated from earth in which were living many *Lumbricus*, acquired in the *Blatta* a notable pathogenicity. The feces contained germs which when isolated and inoculated killed a guinea pig in 54 hours with subcutaneous edema and slight enlargement of the spleen, and exhibited its presence in the blood. He also conducted a considerable series of experiments in feeding this organism with other foods to the roaches, and demonstrated increased pathogenicity in many cases after recovering it from the feces.

Bacillus fluorescens nonliquefasciens Eisenberg and Krueger was isolated by Cao in two series of experiments from the feces of *Blatta orientalis* and when inoculated into a guinea pig caused its death in 48 hours without striking pathological symptoms, although the organism may be recovered from the blood. It was not so virulent in the cony, causing death in eight days without purulence at the site of inoculation. When cultures of this organism were fed to starved *Blatta* one strain recovered from the feces of the guinea pig passed through the intestines of the roach remaining innocuous, but a strain isolated from the earth had a moderate pathogenicity in the *Blatta*, producing abscess and death of a guinea pig; the inoculation of pure culture killing a guinea pig in four days, with production of a large subcutaneous abscess. The germs were recovered from the spleen and from the pus. Quite a series of experiments were conducted with three strains of this bacillus, feeding them in connection with other foods, and in a number of these experiments two of the strains became moderately pathogenic.

Bacillus megatherium Ravenel, a chromogenic organism found in soil, was isolated by Cao from the feces of a *Blatta orientalis* in a single series of experiments. In all of his experiments with this organism he did not

find that it acquired pathogenicity by passage through the intestines of the insect with or without other foods.

Bacillus "proteisimile" Cao. An organism virtually described under this name was isolated by Cao from the feces of *Blatta orientalis* in two or more series of experiments in three different strains of varying virulence. One strain retained its virulence in successive passages for five months. In two experiments in which starved cockroaches with nonpathogenic feces were fed on nonvirulent cultures of this germ and on a diet of bread with putrid infusion of beef liver, and on a diet of 1 per cent infusion of peptone, this germ became intensely pathogenic in the first case, killing, when inoculated, a guinea pig in two or three days, and in the second case in 36 to 40 hours, with acute septicemia.

Bacillus "pseudoedema maligno" Cao, cause of MALIGNANT PSEUDOEDEMA, was isolated by Cao in one instance from a series of *B. orientalis*, and he found it retaining its virulence in successive passages through many months.

Bacillus radiciformis Tataroff, a saprophytic organism found in water, was isolated by Cao from the feces of *Blatta orientalis* in a single series of experiments. In all of his tests with this organism, he did not find that it acquired pathogenicity by passage through the intestines of the insect with or without other foods.

Bacillus "similcarbonchio" Cao, an organism described by Cao as similar to *B. anthracis*, was isolated in pathogenic strains from *Blatta orientalis* by Cao. In one series of experiments it was isolated from a number of *B. orientalis*, the feces of which, when inoculated into a guinea pig, caused its death in 42 hours. From pure cultures isolated from the feces, it was inoculated into a guinea pig and caused its death in 40 hours, with intense sero-sanguinolent edema and an enormous spleen. The organism was recovered from the heart blood. A cony inoculated with pure culture died in 48 hours, with symptoms similar to those found in hematic carbuncle. The germs were still found in the feces of the cockroaches after 21 days fasting and retained their virulence, causing death with formation of a tumor on the spleen, but less intense. It maintained its virulence in successive passages through many months. When fed to starved cockroaches with nonpathogenic feces, two nonpathogenic strains (one from soil and one from the feces of *Calliphora vomitoria*) failed to increase their pathogenicity when eaten alone, or when combined with sterile bread, sour milk, putrid milk, rotten egg, and fresh flesh; but one strain obtained slight pathogenicity when eaten with putrid flesh, moderate pathogenicity when combined with human feces, and intense pathogenicity when eaten with a diet of bread and putrid beef liver, a diet of bread and 1 per cent infusion of peptone, or a diet of bread and an infusion of putrid beef flesh.

Bacillus subtilis Ehrenberg, an organism frequently found in air, water, and soil, seldom pathogenic, was fed in three series of experiments, by Cao, in conjunction with other foods to starved roaches of *Blatta orientalis*. In two cases he obtained slight pathogenicity inducing local suppurations but no killing of the experimental host.

Bacillus "tifosimile" Cao, a bacillus described by Cao resembling *B. typhosus*, was isolated by Cao in three out of four series of experiments from the feces of *B. orientalis* in strains of varying virulence, which could in some cases be increased by feeding to the cockroaches in connection with other foods.

Bacillus tuberculosis Koch, the cause of TUBERCULOSIS, was fed by Küster to *Blatta orientalis* and later recovered from its feces.

Bacillus typhosus Eberth, the cause of TYPHOID FEVER, is considered by Herms and Nelson, and also by Longfellow, as capable of being transmitted by the cockroach.

Thallophyta: Fungi: Spirillaceae

Spirillum cholerae Koch, the cause of ASIATIC CHOLERA, can be carried by cockroaches as demonstrated by Barber in the Philippines. He fed *Periplaneta americana* on human feces infected with the cholera vibrios and these roaches passed living vibrios in their feces up to 79 hours, and when fed on cholera cultures, up to 24 hours. Active, motile, cholera vibrios often appeared in enormous numbers in the insects' feces. A cockroach was also observed to disgorge portions of its meals at intervals of ten, twenty, and sixty minutes after feeding, sufficient time for it to travel from the closet to the human food. The sixty minute sample contained many cholera vibrios. No vibrios were found in the salivary discharge of the insect.

Spirillum metchnikovi (Gamaleia). This organism, cause of a FOWL DIARRHEA, was experimented with by Cao, who determined that *Blatta orientalis* which had not fed for 45 days and of which the feces only contained a mild strain of *Bacillus coli*, when fed on a feeble strain of this organism, passed it through its feces deprived of its pathogenicity. He fed cultures of the organism at the same time with sterile bread and also with fresh flesh with the same result; but when cultures of this feeble strain were fed in connection with a diet of bread and an infusion of putrid beef liver, a diet of bread and a 1 per cent infusion of putrid peptone, and a diet of bread and an infusion of putrid beef liver, they regained intense pathogenicity.

ANIMAL ORGANISMS

Protozoa

Sarcodina: Amoebina: Amoebidae

Endamoeba blattae (Bütschli) passes both its sexual and asexual cycles in the intestines of *Blatta orientalis*.

Mastigophora: Polymastigina: Tetramitidae

Trichomonas orthopterum Parisi is parasitic in *Blatta* species.

Mastigophora: Binucleata: Leptomonidae

Leptomonas blattarum (Stein) is parasitic in endoderm of *Blatta orientalis*.

Telosporidia: Gregarina: Gregarinidae

Clepsidrina blattarum Von Siebold is a parasite in the intestine of *Periplaneta americana*.

Clepsidrina serpentula DeMagalhães is also a parasite in the intestine of *Periplaneta americana*.

Gamocystis tenax Schneider is a parasite in the intestine of *Blattella lapponica*.

Gregarina legeri Pinto is a parasite in the intestine of *Periplaneta americana*.

Gregarina blattarum Von Siebold is a parasite in the intestine of *Blatta orientalis*, *Periplaneta americana* and *Blattella germanica*.

Telosporidia: Coccidiidea: Eimeriidae

Diplocystis schneideri Künstler is a parasite in *Periplaneta americana*.

Neosporidia: Myxosporidia: Thelohaniidae

Plistophora periplaneta Lutz and Splendore is parasitic in *Blatta orientalis* and *Periplaneta americana*.

Plistophora sp. causes neoplasia of the adipose tissue in *Blatta orientalis*.

Ciliata: Heterotricha: Bursarinidae

Nyctotherus ovalis is parasitic in the intestine of *Blatta orientalis*.

Metazoa

Platyhelminthes: Cestoidea: Hymenolepididae

Davainea madagascariensis (Davaine) is a tapeworm of man of which the life history is unknown but Castellani and Chalmers suggest that the cysticercus may be found in the cockroaches *Blatta orientalis* and *Periplaneta americana*.

Nemathelminthes: Acanthocephala: Gigantorhynchidae

Moniliformis moniliformis (Bremser), a parasite of rodents and occasionally of man, may pass its larval stage in *Periplaneta americana*, according to De Magalhães.

Nemathelminthes: Nematoda: Spiruridae

A larval nematode, evidently one of the Spiruridae, is described from the visceral cavity of *Periplaneta americana* by De Magalhães.

Gongylonema pulchrum Molin is a parasite of the hog. Ransom and Hall report feeding eggs of a *Gongylonema* of the hog, presumably of this species, to Croton bugs, *Blattella germanica*, and finding that the eggs hatched and developed to encysted larvae.

Gongylonema neoplasticum (Fibiger and Ditlevson), a human parasitic worm which produces cancer-like tumors in the stomach of the rat, passes its intermediate stages in *Blattella germanica* and *Blatta orientalis*. It develops as far as an encapsuled larva in the cockroach, according to Fibiger and Ditlevson.

Gongylonema scutatatum (Müller), a very common parasite of cattle, can pass its first stages in the cockroach *Blattella germanica*, under experimental conditions, according to Ransom and Hall.

Spirura gastrophila (Müller), a parasite in the alimentary canal of the hedgehog, has been found by Seurat in the fourth stage encapsuled in the general cavity of *Blatta orientalis*.

Nemathelminthes: Nematoda: Oxyuridae

Oxyuris blattaorientalis Hammerschmidt is found in the cockroaches *Blatta orientalis* and *Periplaneta americana* according to De Magalhães.

Oxyuris bulhoesi De Magalhães is also found in the intestine of *Periplaneta americana* according to De Magalhães.

Oxyuris diesingi Hammerschmidt is found, according to De Magalhães in *Blatta orientalis* and *Periplaneta americana*.

Oxyuris kunckeli Galeb is, according to De Magalhães, found in *Periplaneta americana*.

It will be seen by the evidence presented that the cockroach is a potential carrier of many disease organisms, but, however, it has not yet been proven to be definitely a regular carrier of many. Those diseases which you can most surely expect to be transmitted from time to time by cockroaches are those in which the organism can be taken up from the feces of man or animals and carried by the roaches to food.

You can also see that the danger from cockroach transmission of diseases is in small towns where there is little care about sanitation, and where there is no sanitary sewerage. Any one who has traveled extensively in the small towns of America can readily see how cockroaches could transmit diseases by polluting food in hotel kitchens and even dining rooms, and even by polluting the bread and food in the grocery stores and meat markets.

No one has really made a consistent study of the possibilities of cockroach transmission of diseases and there is very little doubt that, if such studies could be conducted in a locality where disease transmission is possible, much evidence against the roach could be obtained.

REFERENCES

- Barber, M. A., 1914.—Philippine Journ. Science, Manila, vol. 9 B, No. 1, pp. 1-4.
- Cao, G., 1906a.—Annali D'Igiene Sper., vol. 16, n. s., pp. 339-368.
- De Magalhães, P. S., 1900.—Arch. de Parasit., vol. 3, p. 45-69.
- Fibiger, J., and Ditlevson, H., 1914.—Anat. Path. Inst. and Zool. Mus. Univ. Copenhagen, vol. 25, 28 pp., 4 plts.
- Herms, W. B., 1915.—Medical and Veterinary Entomology, pp. 41-43.
- Herms and Nelson, 1913.—Am. Journ. Pub. Health, September.
- Küster, H. A., 1902.—Inaugural Dissertation Doctorwürde Univ. Heidelberg, 43 pp.
- Longfellow, R. C., 1913.—Am. Journ. Pub. Health, January, p. 58.
- Northrup, Z., 1913.—Michigan Agr. Exp. Sta., Tech. Bull. 18, 32 pp.
- Ransom, B. H., and Hall, M. C., 1915.—Journ. Parasitol., vol. 2, No. 2, pp. 80-86.
- Seurat, L. G., 1916.—Bull. Scient. France et Belgique, ser. 7, vol. 49, fasc. 4, pp. 310-314, 350.

CHAPTER XXVIII

The Bedbug and Other Bloodsucking Bugs: Diseases Transmitted, Biology and Control¹

W. Dwight Pierce

Probably no species of bloodsucking insect is better known throughout all the world than the bedbug, *Cimex lectularius* Linnaeus. This species and its congener, *C. hemipterus* Fabricius (*rotundatus*) Signoret, live in the beds of man and suck human blood. There are a number of related species, among which *C. boueti* Brumpt, in French Guinea, is also said to suck the blood of man. The other species are bird and bat parasites.

On account of the habit of the bedbug of sucking the blood of man, but hiding by day in houses and vehicles, this species has many opportunities of transmitting diseases, provided that its methods of life conform with the requirements of the disease organisms. Girault has pointed out that the bedbug will feed on mice, living or dead. This is a very important point in considering its ability to transmit disease.

Any disease which should be shown to be spread exclusively by the bedbug will undoubtedly have a localized distribution, and is very likely to be confined to certain buildings or groups of buildings, but on the other hand may be spread long distances by travelers carrying the bugs in their baggage and on their clothes. It will never be possible for a disease carried by bedbugs to spread rapidly like a fly-borne or mosquito-borne disease. As bedbugs have been found in houses without human occupants for two years or more, we must assume that they obtain blood from rodents, and it is possible that in this way an infection might be maintained in a dwelling. There is some very interesting literature on the possible disease-transmitting rôle of bedbugs and this has been briefed and arranged below in the same manner that the discussions of diseases transmitted by other insects have been arranged in preceding lectures. Certain other blood-sucking bugs are included in the discussion.

¹ This lecture was presented November 18, 1918, and distributed January 25, 1919.

DISEASES OF THE PLANT KINGDOM TRANSMITTED BY BUGS

Thallophyta: Fungi: Bacteriaceae

Bacillus leprae Hanson, the cause of LEPROSY, has been considerably experimented upon with a view to determining the possibility of bedbug transmission. Carmichael, in 1899, suggested the possible connection between bedbugs and leprosy. Long, in 1911, conducted experiments. He allowed two bedbugs to bite lepers, in the neighborhood of leprosy nodules, and then examined the alimentary canal of the bugs and found them to contain the bacilli. He cites in one of his papers the case of a certain man who slept in a hut formerly occupied by a leper. He was bitten by bugs while sleeping there and later developed the disease. Skelton and Parham think transmission by bedbugs in Zanzibar to be improbable. Thomson has conducted a few experiments with this organism, and Smith, Lynch, and Rivas have also published an article on the transmissibility of the leper bacillus by the bedbug. Ehlers found the leprosy bacillus in the digestive tract of bedbugs in the West Indies in 1909 (see Cumston 1918). Sanders in South Africa found the bacillus in 20 out of 75 bugs fed, when starved, on leprosy patients. The bacilli occurred in the proboscis up to the fifth day, in the digestive tube to the sixteenth day, and also in the feces. Goodhue also found the lepra bacillus in bugs which have bitten leprosy patients. It still is incumbent upon some one to attempt the transmission of the leper bacillus by inoculation of feces of the bedbug in skin abrasions. It would appear that scratching after a bite would be the logical means of inoculating the disease.

Bacillus pestis Kitasato, the cause of BUBONIC PLAGUE, has been experimented on by a number of authors to determine the possibility of transmission by bedbugs. Vubitski conducted certain experiments which are reviewed by Manning. Cornwall and Menon have also written on the possibility of transmission of plague by bedbugs.

Cumston (1918) reviews the literature, but signally fails to grasp the significance of the records he quotes. Like most other investigators he was looking primarily for evidence of transmission by bite. Jordansky and Klodnitzky succeeded in inoculating mice with plague by having them bitten by infected bedbugs. They found large numbers of plague bacilli in the digestive tube of one bedbug and a few in another on the 36th day after they had bitten a pestiferous mouse. Nuttall and Wierzbitzky also found the bacillus in the digestive tube. In India Walker found 22% of the bugs in huts of natives infected with plague, to be infected with the bacillus. He also transmitted the plague to a rat by a bug which had bitten a pestiferous patient.

Bacillus typhosus Eberth, cause of TYPHOID FEVER, may possibly be transmitted by the bedbug, according to Riggs.

DISEASES OF UNKNOWN ORIGIN

POLIOMYELITIS or INFANTILE PARALYSIS has been suspected by various authors of being insect-transmitted. Manning has made a contribution to the study of the possible agency of the bedbug in the transmission of this disease and claims that the bedbug fulfills the necessary requirements as a carrier of this disease. Howard and Clark (1912) obtained definite experimental evidence of the possibility of the bedbug as a carrier. In one out of several experiments, ten bedbugs fed on a patient took up the virus and when, seven days later, these were killed, ground up in salt solution, filtered, and injected, the monkey became paralyzed and an autopsy showed typical lesions. A second monkey inoculated from this one developed a definite paralysis on the 6th day and an autopsy showed characteristic lesions.

DISEASES OF THE ANIMAL KINGDOM TRANSMITTED BY BUGS

Protozoa

Mastigophora: Binucleata: Trypanosomidae

Castellanella brucei (Plimmer and Bradford) Chalmers (*Trypanosoma*), the cause of NAGANA of animals, and probably identical with the causative organism of SLEEPING SICKNESS, was experimentally transmitted, according to Sangiorgi, to white mice by the bite of *Cimex lectularius*. This organism is normally transmitted by tsetse flies and horse flies.

Castellanella equinum (Voges) (*Trypanosoma*) the cause of MAL DE CADERAS, a South American disease of horses, of which the wild animal reservoir is probably the capybara, is probably transmitted by the kissing bug, *Triatoma infestans*, but Sangiorgi succeeded in transmitting it to white mice by the bite of *Cimex lectularius*.

Schizotrypanum cruzi Chagas (*Trypanosoma*) the cause of CHAGAS FEVER, a disease of man in South America, is carried by sucking bugs. The disease has its reservoir in the armadillo and related animals. Chagas and Brumpt have proven that the natural invertebrate hosts are the kissing bugs *Triatoma megista* Burmeister, *T. sordida* Stål, *T. geniculata* Latreille, and *T. chagasi*, and, undoubtedly also *Rhodnius prolixus* Stål. Gonzales-Lugo has obtained experimental transmission with the last

named bug and Brumpt has proven it a durable host. Brumpt has also demonstrated development in the bedbugs *Cimex lectularius*, *C. boueti*, and *C. hemipterus*.

There are two types of reproduction of the organism in the insects. In the sexual method, about six hours after ingestion of blood the kinetonucleus moves close to the trophonucleus with which it possibly blends; the flagellum and undulating membrane are now usually lost, but some forms retain the flagellum. The parasite becomes rounded and multiplies repeatedly by division. After this has ceased it becomes pear-shaped, develops a flagellum and becomes a crithidial form and then passes into the cylindrical portion of the intestine where it can be seen in about 25 hours after the ingestion of blood. The final stage is a small, trypaniform type, long and slim with band-like trophonucleus and large kinetonucleus. This form is found in the hind gut in the body cavity and in the salivary glands, and is the form by which the parasite is transmitted to a new vertebrate host. The development in the bug requires at least eight days for its completion.

The asexual method of reproduction is a constant process and is a simple multiplication, giving rise to the crithidial forms which are found principally in the hind gut.

Originally the disease was supposed to be transmitted by the sucking of blood by insects. Brumpt declares that transmission is exclusively by dejections. As *Rhodnius prolixus* passes its dejections immediately after removing its beak, while the *Triatoma* species do not pass dejections during their repast, Brumpt thinks it likely that *Rhodnius* is a more potent transmitter, in view of the fact that dejections are infective. In this connection the bedbug has a very interesting habit which bears upon the possibility of its transmitting the disease. Patton and Cragg have pointed out that it defecates immediately after a feed, but unlike the majority of bloodsucking insects, does not pass out red blood, but only the remains of the last meal, a semi-solid sticky material. This black fluid is passed out just after the proboscis is withdrawn, and the bug has a very characteristic habit of turning around and moving backwards in such a way that the excreta fall in the neighborhood of the wound made by the proboscis. Blacklock has studied the multiplication and infectivity of *S. cruzi* in *Cimex lectularius*, and concludes that the organism is capable of living and multiplying in the bedbug for long periods. The parasites found in the bedbug are infective on inoculation as early as 21 hours and as late as 77 days from the infecting feed. Transmission of the disease to healthy animals by feeding an infected bug on them is of very rare occurrence. It was only once observed in the course of these experiments. In the light of Brumpt's work, we can now see that feeding experiments were almost naturally to be expected not to

succeed, as the transmission of the disease is apparently only by contamination through scratching in or inoculation of infected feces.

Trypanozoon duttoni (Thiroux) (*Trypanosoma*), an organism usually found in mice, has been shown by Brumpt to be capable of developing in *Cimex lectularius*. It is usually parasitic in fleas and is transmitted to the mice by their licking up the feces of the fleas or the fleas themselves. It is probably infective by means of bedbugs in the same manner.

Trypanozoon lewisi (Kent) (*Trypanosoma*), the cause of RAT TRYPANOSOMIASIS, is usually carried by fleas, but Brumpt (1913a) finds that it can complete its cyclical development in *Cimex lectularius*, and he infected a rat with an inoculation of the rectal contents of a bug after six days and also after 38 days.

Trypanosoma (sens. lat.) vespertilionis Battaglia, the cause of BAT TRYPANOSOMIASIS, is transmitted by the bat bedbug, *Cimex pipistrelli* Jenyns, according to Pringault.

Mastigophora: Binucleata: Leptomonida

Leishmania species, the cause of NON-ULCERATING ORIENTAL SORE, passes part of its life cycle in the bug, *Erthesina fullo* (Thunberg), according to Carter.

Leishmania donovani (Laveran and Mesnil), the cause of INDIAN KALA AZAR, has been thought by many to be transmitted by insects. There is considerable conflicting evidence on the subject, a greater part of which is reviewed very thoroughly by Wenyon. Patton has demonstrated the development of the organism in the bedbugs *Cimex hemipterus* (*rotundatus*) and *C. lectularius* in India. Cornwall and La Frenais fed *Cimex hemipterus* on citrated rabbit blood containing this organism, through a membrane, and obtained infection of the bugs and development of the parasites for a period of at least 29 days. Cornwall and Menon having shown in previous papers that the bedbug can not regurgitate the contents of its stomach in the act of feeding and therefore can not transmit kala azar or Oriental sore by its bite, and being unable to find evidence of any intracellular stage of the parasite in the bug, turned their attention to the contents of the rectum. No one has been able to demonstrate the presence of any resistant stage in the feces of the bugs, although these authors have found active flagellates, and occasionally rounded forms, as far down as the lower intestines of the infected bugs, in a fairly large proportion of those examined. They failed to find any form which could suggest an extra corporeal resistant stage. They have found active flagellates in the stomach contents of the bugs for 29 days.

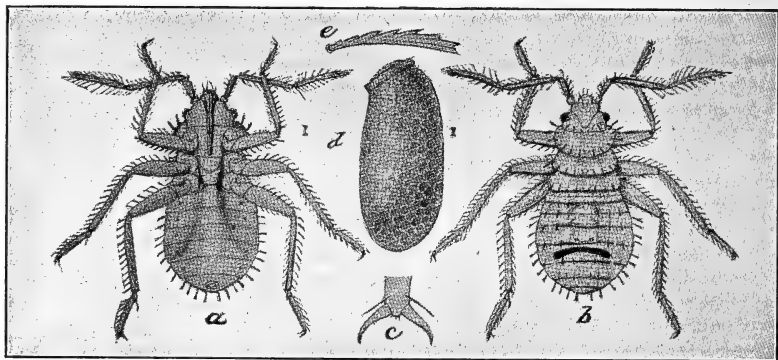

FIG. 74.—Bedbug: Egg and newly hatched larva: *a*, Larva from below; *b*, larva from above; *c*, claw; *d*, egg; *e*, hair or spine of larva. Greatly enlarged, natural size of larva and egg indicated by hair lines. (Marlatt.)

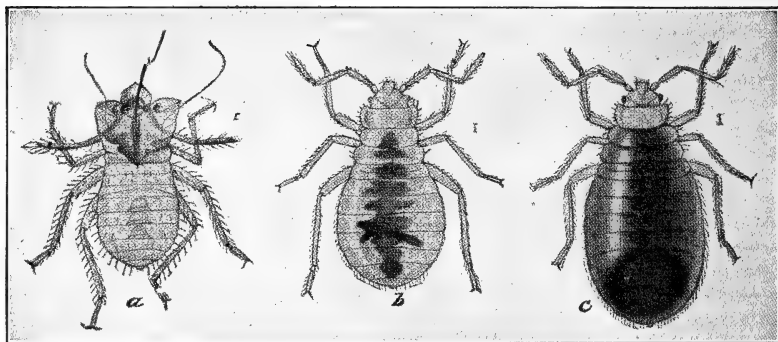

FIG. 75.—Bedbug: *a*, Larval skin shed at first molt; *b*, second larval stage immediately after emerging from *a*; *c*, same after first meal, distended with blood. Greatly enlarged. (Marlatt.)

The life cycle in *Cimex hemipterus* and *C. lectularius* has been demonstrated by Patton. The parasites are ingested by the bug, enclosed in the large cells or leucocytes, and develop into fully flagellated forms without reference to the temperature of the external air. The size increases from 4 to 7 micra and vacuolation of the cytoplasm occurs on or after the second day. The single parasite may proceed directly to flagellation, by the appearance of an area stained bright pink by Giemsa solution and called the flagellar vacuole. This vacuole which has a dark center rapidly increases in size up to 1 to 3 micra and, passing to the surface, sends out a pink brush which forms the flagellum by merely growing longer. The flagellate form has a dark blue, granular cytoplasm with a circular trophonucleus which stains deeply in the center; and a kinetonucleus lying across the long diameter and situated near the

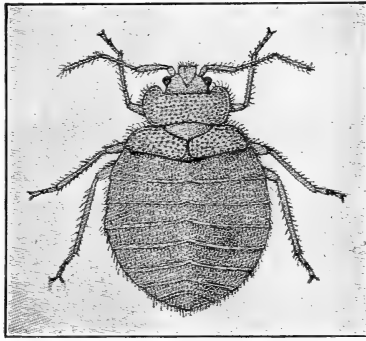

FIG. 76.—Bedbug: Adult before engorgement. Much enlarged. (Marlatt.)

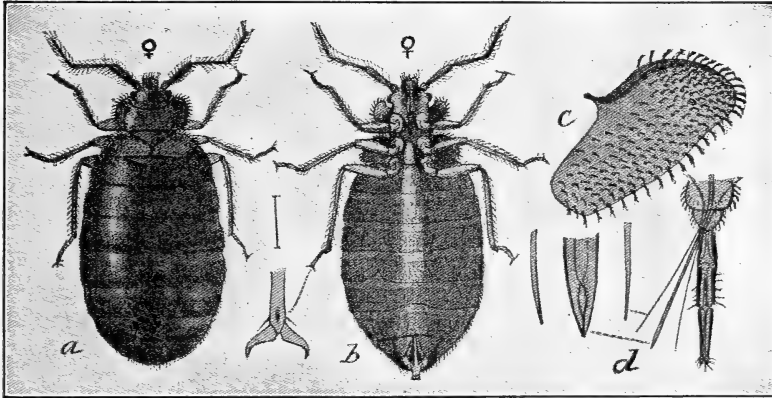

FIG. 77.—Bedbug, *Cimex lectularius*: a, Adult female, engorged with blood; b, same from below; c, rudimentary wing pad; d, mouth parts. a, b, Much enlarged; c, d, highly magnified. (Marlatt.)

(All from U. S. Dept. Agr. Farmers' Bull. 754, figs. 3, 4, 2, 1.)

trophonucleus, and possesses a long flagellum consisting of a number of filaments adhering closely together, inserted into a pale area near the kinetonucleus. These parasites may divide into two equal flagellate forms and apparently may go on dividing for some time. Instead of proceeding directly to flagellation, the parasite may show a division of its nuclei into two, with the formation of two flagella, and then division into two flagellate parasites, or the nuclei may multiply without division of the cytoplasm, so that forms containing four to eight nuclei may be together, which eventually break up into separate flagellate forms. If the bug feeds on blood before the development is completed, the flagellates are destroyed. Development is completed in ten to twelve days after a single feed.

Cornwall and La Frenais describe a thick-tailed form in the bug after the 20th day. Cornwall and Menon state that the flagellate form

thrives only at temperatures from 16° to 26° C. (61° to 79° F.) and is therefore unfitted to exist in the human body. This is further evidence that the flagellate is a typical insect form. They have failed to find a postflagellate cystic form in the stomach of the bug.

Transmission by insects has not been demonstrated, although there is considerable evidence that it can not be transmitted by the bite of the bedbug in which the organism normally flagellates. Cornwall and Menon claim that there are only two possible means of transmission left; rupture of a bug containing flagellates in the neighborhood of a puncture or abrasion, and passage of cystic forms into the feces, and there is no direct evidence for either. They lean to the rupture theory because it seems to account for the peculiar distribution of kala azar. It is comparatively rare and often localized in certain dwellings. The bug does not live on the person, but in buildings and furniture. It does not generally crawl over the skin when feeding but attacks exposed parts from a fairly safe position. It must therefore be a comparatively rare event for a bug to be ruptured on the skin of its occasional host. They may be transported from place to place in furniture and clothing, and may go from house to house in search of food. The bug is also more or less localized. As the bug would be sacrificed in the act of transmission, it is clear that a human reservoir of the disease must be at hand if the bugs in a building are to remain dangerous. Knowles suggests the possibility of hereditary transmission in the bedbug or in intestinal worms.

Leishmania tropica (Wright), the cause of ORIENTAL SORE, is also thought to be transmitted by insects. Wenyon found that the bedbug *Cimex lectularius* could take up the parasites and that developmental stages were demonstrable in its gut. Patton (1912) obtained development of the parasite into flagellate forms in *Cimex hemipterus* at low temperature (22° to 25° C.) and produces considerable evidence in favor of these species as the natural carrier.

Mastigophora: Spirochaetacea: Spirochaetidae

Spiroschaudinnia berbera (Sergent and Foley), the cause of NORTH AFRICAN RELAPSING FEVER, is spread by the body louse. Sergent and Foley have obtained negative results with *Cimex lectularius*.

Spiroschaudinnia duttoni (Novy and Knapp), the cause of TROPICAL AFRICAN RELAPSING FEVER, is normally spread by ticks. Breinl, Kinghorn and Todd in 1906 and Nuttall in 1907, were unsuccessful with transmission experiments with *Cimex lectularius*.

Spiroschaudinnia recurrentis (Lebert), the cause of EUROPEAN RELAPSING FEVER, is normally transmitted probably by the body

louse. Nuttall in 1907 experimented with the Russian strain of this disease and succeeded in transmitting relapsing fever, in one experiment, to a mouse by the bite of *Cimex lectularius*. He found that usually the spirochaetes were digested by the bugs, the time depending upon the temperature. Flügge, in 1897, infected monkeys with the contents of bugs, removed twenty-four hours after they had fed on relapsing fever blood. Karlinski and also Schaudinn observed the survival of spirochaetes in two bugs for 30 days or more. Various authors have failed to transmit spirochaetes by bugs, but it is probable that these failures were because they attempted to transmit by means of the bite, rather than by crushing or scratching in the contents of a bug or its feces. Tictin, however, while suggesting that the bedbugs might transmit the disease by their bite, also suggested that it might be by their being crushed and the contents entering the skin through excoriations due to scratching.

In summary we may draw the conclusion that probably all disease organisms which are capable of passing part of their cycle in the bedbug will be found to be transmitted through the scratching in of the feces of the bug, or by the rupturing of a bug while in the act of feeding, or over an excoriation of the skin. It is quite possible that any organism which the bug may take up from the blood and which in like manner is infective to the blood can be transmitted under favorable conditions in this manner.

There is most certainly a very promising field for research in the working out of the possibilities of disease transmission by blood-sucking bugs.

LIFE HISTORY NOTES

This lecture deals primarily with the bedbugs of the genus *Cimex*, family Cimicidae, but also contains mention of the false bedbugs, or kissing bugs of the genus *Triatoma* (*Conorhinus*), family Reduviidae.

The best discussion in English, with illustrations, of the genus *Triatoma* (*Conorhinus*) is given by Patton and Cragg. These bugs live on human and mammalian blood. The egg of *Triatoma rubrofasciata* (De Geer) of India is rounded at one end and flattened at the other, which forms a kind of operculum. It measures 2 mm. by 1 mm. The incubation period varies from 20 to 30 days. The development is similar to that of all winged Reduviids, each stage showing more developed wing pads, until the fully winged adult stage is reached. The development requires several months from eggs to adult.

Triatoma megista (Burmeister) of South America is almost entirely a domestic insect. The adults enter inhabited houses, but never those which have been abandoned. In old houses they are to be found in cracks and

holes in the walls, where they lay their eggs. The early stages, which are wingless, crawl out of their resting places in the walls as soon as the lights are put out, and make their way to the beds of the occupants of the house. The adults behave in the same manner, but as they are powerful fliers they can reach people who sleep in hammocks. The bite is said to be painless and to leave no mark; this is quite unlike the bite of *Triatoma rubrofasciata*, which, in the case of some people, leaves a distinct mark for weeks. The eggs of *T. megista* are laid in batches of from 8 to 12, and as many as 45 such batches may be laid. They hatch in from 25 to 50 days. A generation requires about 324 days.

Triatoma sanguisuga (Le Conte) is a native of the United States and is called the Texas bedbug, or the "blood-sucking cone nose." It comes into the houses and sucks the blood of man. It is also found in chicken houses and horse stalls, but its normal food is supposed to be the body juices of other insects, including the bedbug.

A number of other species are recorded as causing severe bites on man.

The bedbugs *Cimex lectularius* Linnaeus, *C. hemipterus* Fabricius (*rotundatus* Signoret), and *C. boueti* Brumpt, attack man, while *C. hirsutinus* Jenyns attacks the swallow, *C. columbarius* Jenyns the pigeon, and *C. pipistrelli* Jenyns the bat. The first named is cosmopolitan, the second tropical and subtropical, the third South American. The first two are essentially domestic species. During the daytime these species hide in cracks and crevices in the beds, furniture, and walls of bedrooms. They usually feed at night but will not uncommonly feed in the daytime if they can do so without detection. The most characteristic feature of the bedbug is the very distinct and disagreeable odor which it exhales. The absence of wings in the bedbug is of great advantage in control work, as it confines its range to those points it can reach in its roaming. The eggs are white, oval objects having a little projection run around one edge, and may be found in batches of from 6 to 50 in cracks and crevices where the parent bugs go for concealment. A single female may lay as many as 190 eggs. The eggs hatch in a week or ten days in warm weather, but require a considerably longer time in cold weather. The young are yellowish white at first, but in succeeding molts become darker and darker brown. There is very little important difference in the appearance of nymphal and adult stages. There are five molts covering varying lengths of seven to eleven or more weeks. The bedbug is capable of living for long periods without food. Normally fed bugs may live almost a year, and partly grown specimens have been kept 60 days without food. The bite of the bedbug is very poisonous to some persons, and their presence is sufficient to cause uneasiness and loss of sleep. (Figs. 74-77.)

Hæmatosiphon inodora Dugès is a native American bug related to the bedbug, found in the Southwestern States and Mexico. It was probably originally a parasitic messmate of birds and bats, but has now become an important poultry pest, and in those regions, due to the close associations between poultry and human beings, is often a serious house pest.

TREATMENT OF BITES

To allay the irritation caused by the bite of the bedbug peroxide of hydrogen, or dioxygen, may be used with good results.

Tincture of iodine is also a good counterirritant.

CONTROL MEASURES

There is practically no information on adequate methods of controlling the Triatomas.

The bedbug when badly infesting houses may be controlled by fumigation with hydrocyanic acid gas at the rate of 10 ounces of cyanide for each 1,000 cubic feet, or fumes of sulphur at the rate of five pounds per 1,000 cubic feet. Such fumigation should be carried out as described elsewhere (p. 325).

In cases of moderate infestation it is possible at a slightly greater cost of time and personal effort, to eradicate the bugs by a liberal use of benzine or kerosene, introduced with small brushes or feathers, or by injecting with syringes into all crevices of beds, furniture, or walls where the insects may have concealed themselves.

Corrosive sublimate and also oil of turpentine may be used in the same way.

Careful inspection of beds and bedding, particularly mattresses, is important in any attempt to free a house of the bugs. The use of iron bedsteads and bedding which is easily examined and treated facilitates control.

Travelers frequently have their luggage infested while at hotels and in trains. On arrival at home it would be well to carefully examine the clothing before putting it away.

Very frequently bedbugs are introduced into homes with laundry work which is carried to the home of the washwoman. Such wash work should be carefully inspected on receipt.

LIST OF REFERENCES

- Blacklock, B., 1914.—*Brit. Med. Journ.*, April 25, pp. 912-913.
 Brumpt, E., 1912.—*Bull. Soc. Path. Exot.*, vol. 5, No. 6, pp. 360-367.

- Brumpt, E., 1913a.—Bull. Soc. Path. Exot., vol. 6, pp. 167-169.
- Brumpt, E., 1913b.—Bull. Soc. Path. Exot., vol. 6, p. 170.
- Brumpt, E., 1913c.—Bull. Soc. Path. Exot., vol. 6, pp. 382-383.
- Carmichael, 1899.—Med. News, Jan. 21.
- Carter, R. M., 1911.—Trop. Med. and Parasit., ser. T. M., vol. 5, pp. 15-32.
- Chagas, C., 1909.—Arch. Schiffs. u. Tropenhyg., Sept. 4.
- Cornwall, J. W., and La Frenais, H. M., 1915.—Ind. Journ. Med. Res., vol. 3, pp. 698-724.
- Cornwall, J. W., and Menon, T. K., 1917.—Ind. Journ. Med. Res., vol. 5, pp. 137-159.
- Cornwall, J. W., and Menon, T. K., 1918.—Ind. Journ. Med. Res., vol. 5, pp. 541-547.
- Fuller, C., 1919.—Report on Typhus Conditions in Native Dwellings. Union of South Africa. Dept. Agric., local series bull. 57.
- Howard, C. W., and Clark, P. F., 1912.—Journ. Exper. Med., vol. 16, No. 6, pp. 850-859.
- Knowles, R., 1918.—Ind. Journ. Med. Res., vol. 5, pp. 548-566.
- Long, E. C., 1911a.—Journ. Trop. Med. and Hyg., vol. 14, p. 17.
- Long, E. C., 1911b.—Brit. Med. Journ., Sept. 2.
- Manning, J. V., 1912a.—Med. Times, vol. 60, April.
- Manning, J. V., 1912b.—Med. Rec., vol. 82, No. 4, pp. 148-150.
- Marlatt, C. L., 1916.—U. S. Dept. Agr., Farmers' Bull. 754.
- Patton, W. S., 1907.—Scient. Mem. Officers' Med. & Sanit. Depts., Govt. India, n. s., Nos. 27, 31.
- Patton, W. S., 1912.—Scient. Mem. Officers' Med. & Sanit. Depts., Govt. India, n. s., No. 50.
- Patton, W. S., and Cragg, F. W., 1913.—A Text Book of Medical Entomology, pp. 486-526.
- Pringault, E., 1914.—C. R. Soc. Biol., Paris, vol. 76, No. 19, pp. 881-884.
- Riggs, R. E., 1912.—Military Surgeon, vol. 31, pp. 279-288.
- Sangiorgi, G., 1910.—Centralb. f. Bakt. Paras. und Infekt., vol. 57, pp. 81-84.
- Skelton, D. S., and Parham, J. G., 1915.—Journ. Roy. Army Med. Corps, vol. 20, No. 3, pp. 291-292.
- Smith, A. J., Lynch, K. M., and Rivas, D., 1913.—Amer. Journ. Med. Sci., vol. 146, No. 5, pp. 671-681.
- Thompson, David, 1913.—Brit. Med. Journ., Oct. 4, pp. 847-849.
- Thompson, David, 1914.—Am. Trop. Med. and Parasit., vol. 8, No. 1, pp. 19-28.
- Wenyon, C. M., 1911.—Kala Azar Bull., vol. 1, No. 1.

CHAPTER XXIX

Diseases Caused or Carried by Mites and Ticks ¹

W. Dwight Pierce

The Arachnid order Acarina, composed of mites and ticks, contains many of the most serious carriers of causative agents of disease. As all ticks are parasitic on animals and derive their entire nourishment from the blood of their hosts, it is naturally to be expected that in this group we will find a great proportion of the carriers of animal blood diseases. The mites are not all parasitic, but there are quite a number of families in which parasitic mites are found, and some of the families are parasitic exclusively in their habits.

The most familiar of all the tick-borne diseases is the disease known as **TEXAS FEVER OF CATTLE** which has cost the southern states millions of dollars, and has been the cause of restricting the shipment of cattle from southern to northern states. The discovery of the rôle of the tick in the transmission of Texas Fever by Smith and Kilborne of the Bureau of Animal Industry, was one of the earliest discoveries in medical entomology. Since that time the Department of Agriculture, through the investigations of the Bureaus of Animal Industry and Entomology has devoted a great deal of attention to this problem. The Bureau of Animal Industry has had charge of the eradication of the cattle tick in America and has succeeded in eliminating this pest from large areas and from at least one state, the State of Mississippi.

In South Africa tick-borne diseases are the principal limiting factors to animal industry. The **RELAPSING FEVERS** of man in Africa are carried almost exclusively by ticks. In our own country one of the most serious local diseases is **ROCKY MOUNTAIN SPOTTED FEVER** in the northern Rocky Mountains. The relationship of the ticks and mites to disease can best be shown by an arrangement of these diseases according to their causative organism.

DISEASES CAUSED BY DIRECT ATTACK OF TICKS AND MITES

ACARINE DERMATOSIS or **ACARIASIS**. A great many different species of mites are capable of causing various types of **DERMATOSIS**

¹This lecture was prepared for the present edition.

in man and animals. The BICHO-COLORADO ITCH is caused by the mite *Tetranychus molestissimus* Weyenbergh, which thrusts its hypostoma into the skin of man and animals in Argentine and Uruguay. In Europe a similar dermatosis is caused by the related species *T. telarius* Linnaeus, variety *russeolus* Koch. These two species belong to the family Tetranychidae.

The disease known as "GONONE" in Celebes and New Guinea is caused by the Trombidian mites *Microtrombidium wichmanni* Oudemans and *Schöngastia vandersandei* Oudemans. This attack occurs both on man and animals. In Europe and America attack by various allied species is very common. The ordinary name for the attack is RED BUGS or CHIGGERS. The principal species which have been described as causing this attack are *Microtrombidium tlalsahuate* Lamaire in Mexico; *Trombidium holosericeum* Linnaeus, *T. inopinatum* Oudemans, and *T. autumnalis* Shaw in Europe; *T. batatas* Linnaeus in the West Indies; *Leptus americanus* Riley, and *L. iritans* Riley in North America; and also *Trombidium striaticeps* H. & O., *Metatrombidium poriceps* H. & O., *Microtrombidium pusillum* Hermann, and *Allotrombidium fuliginosum* Hermann. The attack of chiggers is very painful and also difficult to relieve. Dusting of flowers of sulphur in the clothes is a good preventive. I have had fairly good success in taking a hot bath immediately after coming from the field and then rubbing in ammonia.

The allied species *Leptus akamushi* Brumpt not only causes a dermatosis, but also a definite disease which will be treated in a later paragraph. This is a Japanese species.

A troublesome acarine dermatosis, which frequently causes swelling which may be dangerous, is caused by *Holothyryus coccinella* Gervais in Mauritius, which normally attacks dogs and geese, but also attacks children.

In the family Parasitidae quite a number of species are charged with causing dermatosis. *Dermanyssus gallinae* Redi and *D. hirundinis* Hermann, common avian parasites may also cause dermatosis in man. *D. gallinae* sometimes causes papular eczematous dermatosis. *Liponyssus bacoti* Hirst, a rat parasite in Australia, Africa and South America, occasionally causes dermatosis of people working in stores and granaries.

URTICARIASIS is caused by various species of the family Tarsonemidae. The mite, *Pediculoides ventricosus* Newport, causes a disease known under a number of different names, as GRAIN ITCH or ERYTHEMA URTICARIA. This mite becomes globular and reproduces its young at a very rapid rate. It burrows under the skin and is very painful. Many workers in harvest fields are attacked by this mite, especially in Europe. It occurs quite commonly in America. A similar dermatosis is caused by *Tarsonemus uncinatus*, *T. intectus*, and *Crithoptes*

monunguiculosus Geber. These three species may all be synonyms of *Pediculoides ventricosus*.

A disease known as VANILLISMUS is caused in Europe by mites of the family Tyroglyphidae, *Aleurobius farinae* DeGeer, which is found in corn, *Tyroglyphus siro* Linnaeus, and *Histiogaster entomophagus* Laboulbène. In this same family are found other mites which cause diseases, posing under special names such as COPRA ITCH, caused by *Tyroglyphus longior castellanii* Hirst, in Ceylon; GROCER'S ITCH, caused by *Glyciphagus prunorum* Hermann, in Europe; COOLIE ITCH or GROUND ITCH, caused by *Rhizoglyphus parasiticus* Dalgetty, in India.

The itch or scab mites belong to the family Sarcoptidae. SCABIES or SARCOPTIC ITCH is caused by a species of the genus *Sarcoptes*, of which various species are described for the different animal hosts as follows: *Sarcoptes scabiei hominis* Raspail, causing scabies of man in Europe and America, with the variety *crustosae* Fürstenberg causing NORWEGIAN ITCH of man; *S. bovis* of cattle (Sarcoptic Scab is comparatively common in cattle in the United States, frequently a serious disease among bulls and dairy cattle); *S. canis* Gerlach of the dog; *S. ovis* Mègnin of the sheep; *S. equi* Gerlach of the horse; *S. suis* Gerlach of the pig; *S. aucheniae* Railliet of the llama; *S. dromedarii* Gervais of the camel and dromedary and frequently of man; *S. caprae* of the goat and rarely of man; *S. leonis* Canestrini of the lion and rarely man; *S. vulpis* Fürstenberg of the fox. A similar itch is caused by *Notoedres cati cati* Hering and other varieties which attack felines, rodents, horses, and man. The sarcoptic mites live in burrows in the epidermis. Ointments containing sulphur are the best for these mites.

PSOROPTIC ITCH or MANGE is caused by a species of the genus *Psoroptes*, of which *Psoroptes communis ovis* Hering causes SHEEP SCAB; variety *bovis* causes TEXAS ITCH of cattle; variety *equi* causes mange of horses and dogs. The psoroptic mites have piercing mandibles but do not burrow, although they may be greatly protected by scab formation over them. Among the dips used for the control of this itch are an 8 per cent kerosene emulsion used by Gillette; and the Rutherford dip prepared by steeping 1 pound tobacco and adding thereto 1 pound of sulphur and 4 gallons of water, to be applied at 6 or 8-day intervals.

CHORIOPTIC ITCH in the horse is caused by *Chorioptes equi* Gerlach (*sympiotus* Verheyen) which attacks the hocks of the horse and causes the hair to fall out and sores to form. It also causes an itch of cattle, goats, and sheep. This species has piercing mandibles but does not burrow. According to Banks a mixture of 1 part carbolic acid to 15 or 20 parts of oil will destroy the mite.

SCALY LEG of chickens is caused by *Cnemidocoptes mutans* Robin.



PLATE XXIV.— Scaly leg mite on chickens.

FIG. 1 (Upper).—Scaly feet of chicken, caused by mite attack. FIG. 2 (Lower)—Scaly leg mites, greatly enlarged. (Bishopp.)

The mites form a crust of dead skin on the legs of the chickens (plate XXIV). The related species, *Cnemidocoptes gallinae* Railliet, causes the hens to pluck their feathers. The mites work at the base of the feathers



PLATE XXV.—Dipping scaly legs of chicken in crude oil (Bishopp.)

and are called depluming mites. These mites are controlled by dipping in crude petroleum (plate XXV).

DEMODECTIC MANGE, when caused by *Demodex folliculorum* Simon, gives rise to **BLEPHARITIS**, **SEBORRHEA** or **BLACK-HEADS**. Many animals and man are attacked by this mite. Probably a majority of persons harbor this mite. Demodectic mange is a common and practically incurable disease in dogs. *Demodex phylloides* Csoker

causes white tubercles on the skin of swine in the United States and Canada; *Demodex bovis* Stiles causes swellings in the hide of cattle in the United States and other countries, damaging the hide.

GUANO ITCH of man and dogs is caused by *Tydeus molestus* Moniez in Peru and Belgium; it is found in guano.

SEBACEOUS TUMORS in birds are caused by species *Harpyrynchus*. *H. longipilus* Banks attacks the crossbill. Mice are attacked by the mites *Psorergates simplex masculinus* Mich, which lives in cavities beneath the surface of the skin, and *Myobia musculi* Schrank which develops in the hair follicles.

ACARIASIS OF THE SENSE ORGANS. OTOACARIASIS is caused in man by *Cheyletus eruditus* Schrank and *Acaropsis mericourti* Laboulbène which attack the external auditory meatus. *Rhizoglyphus parasiticus* has also been recorded as causing Otoacariasis. *Psoroptes cuniculi* Mègnin causes a rabbit ear mange which may result in death. *Otodectes cynotis* causes an otoacariasis of the dog and cat, which torments the animals, resulting in convulsions and fits. *Demodex folliculorum* Simon is also credited with causing otoacariasis.

Some of the ticks are also responsible for attacks of otoacariasis, as for instance the spinose ear tick *Ornithodoros megnini* (Dugès) Neumann, which very commonly attacks the ears of cattle and horses and sometimes man in the southwestern United States.

A fatal otoacariasis in the cow is charged to *Dermanyssus gallinae* Redi, but there is reason to question this.

OCULAR ACARIASIS of the cornea may also be caused by *Dermanyssus gallinae*.

INTERNAL ACARIASIS. CATARRHAL INFLAMMATION which may produce ASPHYXIA in chickens may be caused by *Sternostomum rhinolethrum* Trouessart and by a *Rhinonyssus* in birds. BRONCHIAL INFLAMMATION which may produce asphyxia may be caused by *Halarachne americani*, *H. attenuata*, and *H. halichaeri*, all of which attack seals. INFLAMMATION OF THE LUNGS, which may produce asphyxia, may be caused by *Pneumonyssus simicola* of the monkey. *Cytoleichus nudus* Vizioli occurs in the air passages of chickens and turkeys, penetrating the tissues, and may produce asphyxia. *C. sarcoptoides* Héguin also attacks the air sacs in fowls.

Nephrophages sanguinarius Miyake and Scriba is a doubtful parasite passed in bloody urine. *Carpoglyphus alienus* Banks has been found in purulent urine. A case of a cyst in the testis containing *Histiogaster spermaticus* Trouessart is recorded from India. *Cytoleichus sarcoptoides* Héguin is sometimes found in the liver and kidneys of the fowl. *C. nudus* Vizioli is suspected of producing PERITONITIS and ENTERITIS in chickens and turkeys. *C. banksi* Wellman also produces an internal

acariasis in the squirrel. *Laminosioptes cysticola* produces a calcareous cyst in the subcutaneous tissues of chickens.

GENERAL EFFECTS OF TICK BITE. The mites in attacking a host usually attack in numbers, or if individually, will be found to burrow into the skin, but the ticks merely attach themselves to the skin and draw blood. Tick bites are very likely to cause a PRURITIS which in some cases will be painful for months or sometimes years. This is especially true in the case of *Argas reflexus* (Fabricius) Latreille which causes a painful bite marked for years by a cicatrix at the site of the attack. *Argas brumpti* Neumann causes a pruritis the site of which remains indurated for years. The bite of *Ornithodoros coriaceus* Koch is very painful; the bites are slow healing. The bite of *Ornithodoros turicata* (Dugès) Neumann may cause dermatitis and lymphangitis. The bite of *Ixodes ricinus* (Linnaeus) Latreille may cause in man abscesses, edema, lymphangitis, and fever; it may penetrate beneath the skin and produce a tumor. The bite of *Ixodes (Ceratiixodes) putus* (Picard-Cambridge) Neumann is painful to man. It normally attacks birds. The bite of the "conchuda," *Ixodes bicornis* Neumann, is sometimes fatal to infants.

TICK PARALYSIS. The bite of certain ticks causes paralysis of man and animals. The NORTH AMERICAN HUMAN TICK PARALYSIS is caused by the same tick which causes Rocky Mountain Spotted Fever, *Dermacentor andersoni* Stiles (*venustus* Banks)² in the northwestern States, and British Columbia, but a case is recorded from California caused by *Ornithodoros coriaceus* Koch. Todd has described a typical case of paralysis in children as follows: an active and apparently healthy child suddenly develops a paresis or paralysis of the legs; neither abnormal temperature nor any other symptoms of paralysis is constant. After the discovery of the tick and its removal the symptoms disappear in a few hours with a possible exception of a more or less local reaction, often probably due to a secondary bacterial infection at

² In view of the contention of Mr. Bishop that *venustus* is the name of the fever tick it is necessary to give my reasons for the adoption of *andersoni*.

Dermacentor venustus Marx in Neumann (1897) is cited as an undescribed synonym of *D. reticulatus* Fabricius.

In 1905 Stiles named the Rocky Mountain Spotted Fever tick as *D. andersoni*, strengthening his description in 1908 and 1910.

In 1908 Banks drew up the description, as a new species, of *Dermacentor venustus* (Marx) from the Marx material, which was subsequently examined by Stiles and found to consist of three lots of material of at least two species. Stiles definitely picked from Banks' type material Marx No. 122 as type of species *D. venustus*. Since both Marx and Banks confused more than one species and neither designated a type from the material, Stiles' type designation is valid.

In 1910 Stiles differentiates between the two species *andersoni* and *venustus*.

Even if he should be found to be wrong in considering these as two species, *andersoni* antedates *venustus*. But in order to set this question at rest an appeal has been made to the International Commission of Zoological Nomenclature for a ruling on the name of this tick. (W. D. Pierce.)

the site of the tick's bite. In some cases which have been reported the tick was not removed and in these the paralysis progressively involved the whole body until reflexes and control of the sphincters were lost and death ensued. Abscesses following a tick bite are probably due to the head of the tick remaining in the wound. The symptoms suggest infantile paralysis but they may be distinguished from cases of that disease by the invariably transitory nature of the paralysis. The tick paralysis never leaves permanent disability. Various doctors practicing in the Northwest have described cases, some of which have been fatal. In case of paralysis it is always well to make a thorough search of the body, especially in the vicinity of the spinal column, for the ticks. They are quite commonly found in the hair at the base of the head. The exact cause of the paralysis is unknown, but it is believed that it is caused either by the injection of a specific poison into the body by the tick, or by the reactions which take place, forming poisons during the presence of the tick's head in the body. The only treatment necessary is the removal of the tick by excision in order to make sure that the mouth parts are removed, and the dressing of the wound antiseptically. Purgatives and stimulants should be given. *Dermacentor andersoni* also causes a paralysis of animals similar to that in man; in the case of sheep the effect on the body is a loss of balance, causing the sheep to fall in places from which they cannot extricate themselves. If the tick is removed in time the animal will recover.

South African TICK PARALYSIS in animals is caused by the bite of *Ixodes pilosus* Koch which attacks sheep principally. The effect of this paralysis is to cause the sheep to become very unsteady on their feet and to lie down frequently. They seem to recover rather rapidly, death being usually caused by their becoming prostrated in the open where they fall victims of jackals. There are no fever reactions. Dipping with Cooper's Dip is considered a very effective control measure.

HUMAN TICK BITE FEVER of Lourenço Marques is caused principally by the larva of *Amblyomma hebraeum* Koch but occasionally by *Rhipicephalus simus* Koch and *Boophilus annulatus* (Say) Stiles and Hassell³ and *B. annulatus (decoloratus)* Koch). The patient at first complains of general weakness, muscular pains and especially of considerable difficulty in moving his arms and legs. The glands in the neck become swollen in a short time, those situated in the nape of the neck

³Mr. Bishopp writes that he prefers *Margaropus* to *Boophilus* for this tick and its allies. My reasons for adopting *Margaropus* are as follows:

1. *Margaropus* Karsch and *Boophilus* Curtice are considered by Nuttall, Warburton, Cooper, and Robinson (1911) to be two distinct genera. The type of the former is designated by them as *Margaropus winthemi* Karsch, and of the latter *Boophilus annulatus* (Say) Curtice.

2. *Boophilus annulatus* is a name well established in medical literature. (W. D. Pierce.)

being chiefly involved. The patient suffers from severe occipital headache with considerable rigidity of the muscles of the nape of the neck, so that the head may be turned to one side as in torticollis. The superficial glands in the groin and axilla are found to be enlarged and acutely painful. The acute neck symptoms begin to subside from the eighth to tenth day and recovery takes place spontaneously, but the glandular enlargement persists a month or more after recovery. The glands become hard and painless.

AUSTRALIAN HUMAN TICK PARALYSIS is caused by either *Ixodes ricinus* (Linnaeus) Latreille or *Ixodes holocyclus* Neumann and is very similar to the American tick paralysis. Eaton considers that there are three possibilities as the cause of the paralysis: pre-formation of the poison by the tick, development of the infective organism in the blood, or liberation mechanically or biologically (by bacterial introduction) at the site of the bite, of some poison subsequently absorbed.

DISEASES CARRIED BY MITES AND TICKS

Ticks and mites are the carriers of many diseases.

DISEASES CAUSED BY PLANT ORGANISMS

There are undoubtedly many cases of SEPTICEMIA due to the introduction of plant organisms at the site of the bite of the tick. These are most likely to be streptococcal and staphylococcal infections. For instance, the bite of *Argas reflexus* (Fabricius) Latreille has been known to give rise to FURUNCULOSIS caused by *Staphylococcus pyogenes* (Nuttall, Warburton, Cooper, and Robinson, 1908). *Ixodes ricinus* (Linnaeus) Latreille may also carry infections of *Staphylococcus pyogenes* (Nuttall, Warburton, Cooper, and Robinson, 1911).

Demodex folliculorum Simon, the blackhead mite, causes an irritation giving rise to papules which become infected with *Bacillus necrophorus*.

Jarvis has just published an article in which he claims that EPIZOOTIC LYMPHANGITIS is an inoculable disease through the agency of the ticks of the genus *Amblyomma*. The disease is characterized by supuration, ulceration, and necrosis. He believes that the lesions are caused by a variety of micro-organisms including the Priesz-Nocard organism, the *Cryptococcus farciminosus*, the *Bacillus necrophagus*, and Staphylococci, and that these organisms are introduced through the agency of the mouth parts of the ticks which are very long and pierce the whole integument, reaching the subcutaneous layers where the bacteria can easily set up lesions.

Hadwen has just published an article in which he shows that ticks play

an important rôle in producing FISTULOUS WITHERS. He considers *Dermacentor albipictus* Packard as the worst offender, but also considers *D. andersoni* Stiles (*venustus* Banks) as a cause. *D. albipictus* is commonly called a winter tick and in some regions of British Columbia where poll evil and fistulous withers are common, horses are heavily infested with these ticks. The favorite site of attachment is along the whole length of the mane from the poll to the withers. At the point of attachment there is often a necrotic spot if the tick has been attached for a few days. It is easy to see that these necrotic spots should be a favorite point of entrance for bacteria.

It is quite probable that most of the cases of abscesses and irritation resulting from tick bites are due to secondary infections by bacteria which may possibly be mechanically introduced by the tick itself. No one has given this question serious attention.

DISEASES OF UNKNOWN ORIGIN

There are quite a number of instances of so-called tick fever caused by the bite of ticks, of which the exact cause is unknown. Among these are unnamed TICK FEVERS caused by *Ornithodoros savignyi* Audouin (Koch) and *Hyalomma aegyptium* (Linnaeus) Koch.

HEART WATER, a disease of sheep, caused by a filterable virus, is transmitted by *Amblyomma hebraeum* Koch.

The TICK FEVER OF MIANA is caused by the bite of *Argas persicus* Oken.

INTERMITTENT FEVER of Wyoming, which is possibly identical with Rocky Mountain Spotted Fever, is thought by Castellani and Chalmers to be caused by *Dermacentor andersoni* Stiles (*venustus* Banks).

ROCKY MOUNTAIN SPOTTED FEVER, a disease characteristic of the Rocky Mountains of Montana and Idaho and occasionally other nearby states, was proven by Ricketts to be transmitted by the tick *Dermacentor andersoni* Stiles (*venustus* Banks), by *D. variabilis* (Say) Banks and possibly by *D. modestus* Banks.

The first scientific article in which the tick is mentioned as a possible carrier of this disease was published by Wilson and Chowning in 1902. They subsequently published the reports of their investigations but they did not prove that the tick was actually the transmitting agent. Anderson (1903) was so convinced that the tick was the cause of the fever that he published an article calling it the SPOTTED FEVER or TICK FEVER of the Rocky Mountains. Stiles in 1905 did not attribute the disease to ticks. Finally Ricketts in 1906 began a thorough investiga-

tion of the cause of the disease and proved transmission of the disease to a guinea pig by *Dermacentor andersoni* Stiles (*occidentalis* Stiles, not Marx). This preliminary report by Ricketts was followed by numerous other papers by himself on the subject, until he had definitely proven the relationship of the tick to the disease. The organism causing spotted fever has just been described. Wilson and Chowning described *Piroplasma hominis* as the causative organism, but their work has not been corroborated by others. Very recently Wolbach (1919) has found bodies somewhat similar to the Rickettsia bodies found in typhus fever and trench fever. He describes his organism as *Dermacentroxenus rickettsi* Wolbach, but is uncertain as to its location in classification. It is intracellular in mammal and tick, and intranuclear in ticks. Two multiplicative forms and an infective form are found in the tick, and only the latter is regularly found in mammals. Wolbach's volume is the latest and most complete treatise on all phases of the disease and is well illustrated.

Mayer (1911) conducted transmission experiments and was successful in transmitting the disease by *Dermacentor marginatus* Banks, *Amblyomma americanum* (Linnaeus) Koch and *Dermacentor variabilis* (Say) Banks.

The rôle of wild animals in acting as reservoirs for the disease has not been definitely determined although several wild mammals have been shown to be susceptible. It is probable that it is by this means that the disease is perpetuated. The ticks which carry the disease are normally found on wild animals in the immature stages and the adults usually engorge on the larger domestic animals and to some extent on the larger wild mammals. The Rocky Mountain Spotted Fever is transmitted hereditarily by the tick. Control of the disease must be effected by destruction of the adult ticks on domestic animals, reduction of the numbers of wild hosts, and prevention of tick attack on man.

TSUTSUGAMUSHI DISEASE, sometimes called JAPANESE RIVER FEVER or KEDANI DISEASE, has been proven to be carried by the mite *Leptus akamushi* Brumpt (*Trombidium*). Kitashima and Miyajima have proven that this disease is not caused by the bite of all mites of this species, but only by certain ones, and consider that the evidence is sufficiently strong to assume that the disease is caused by a non-filterable virus which can be inoculated by the mites only after they have become infected. They conducted a large number of experiments to prove the rôle of the mite. The field mouse, *Microtus montebelli*, is susceptible and is believed to be the important natural host of the virus. (It is interesting to note that another Japanese disease, Seven Day Fever, caused by *Leptospira hebdomadis* Ido, Ito and Wani has the same mouse, *Microtus montebelli* as its reservoir.)

DISEASES OF ANIMAL ORIGIN

Protozoa

Mastigophora: Binucleata: Trypanosomidae

Schizotrypanum cruzi Chagas, the cause of CHAGAS FEVER, while normally transmitted by the kissing bugs of the genus *Triatoma*, has been shown by Brumpt to develop in the tick *Ornithodoros moubata* (Murray) Pocock, and by Neiva (1913) to develop in *Rhipicephalus sanguineus* (Latreille) Koch.

Trypanosoma sp. which is supposed to cause a reptilian disease, is carried by *Amblyomma testudinis* (Conil) Neumann.

Trypanosoma christophersi Novy is an organism probably native to *Rhipicephalus sanguineus* (Latreille) Koch and was originally recovered from ticks fed on dog.

Mastigophora: Binucleata: Leptomonidae

Some authors are inclined to separate the genera of tick organisms to form the family Piroplasmidae. These organisms do seem to form a rather consistent family which contains the genera *Theileria*, *Nuttallia*, *Babesia*, *Piroplasma*, *Rossiella*, and *Anaplasma*.

Anaplasma argentinum, the cause of ARGENTINE ANAPLASMOSIS of cattle, is carried by *Boophilus annulatus australis* Fuller (*microplus* Canestrini) (Lignières 1914).

Anaplasma marginale Theiler, cause of ANAPLASMOSIS of many African and Australian animals, is transmitted according to Theiler (1910) by *Boophilus annulatus (decoloratus)* Koch), and according to Castellani and Chalmers by *Rhipicephalus simus* Koch.

Babesia argentinum, cause of Argentine BABESIASIS OF CATTLE, is carried by *Boophilus annulatus australis* Fuller (*microplus* Canestrini) (Lignières 1914):

Babesia bovis Babès (*Piroplasma bigeminum* Smith and Kilborné),⁴ the cause of TEXAS CATTLE FEVER which is also known as RED WATER, SPLENIC FEVER, SOUTHERN CATTLE FEVER and under various other names, is normally transmitted by the cattle tick *Boophilus annulatus* (Say) Stiles and Hassall in North America. The first proofs of tick transmission were published by Smith and Kilborne (1893). Crawley (1915) believes the organism is pathogenic to this tick. The organism may also be transmitted by *Boophilus annulatus australis* Fuller (*decoloratus* Koch) in South America, Cuba, Porto Rico,

⁴*Babesia bovis* and *B. bigeminum* are separated by some authors as two distinct species, *bovis* causing the European disease, and *bigeminum* the American.

Philippines, and Australia, according to various authors, and by *Boophilus annulatus australis* (*microplus*) in South America (Lignières), and *B. annulatus decoloratus* and *Rhipicephalus capensis* Koch in Africa. Carpano (1915) suspects *Hyalomma aegyptium* (Linnaeus) Koch to be the carrier of *Babesia annulatum*, a synonym of *bovis* which is recorded as the causative organism of MEDITERRANEAN COAST FEVER OF CATTLE.

The first contributions to the life history of this organism were made by Smith and Kilborne. It is found in the blood of the animal hosts in the first stage, being inside the red blood cells near its margin, and is non-motile and pale. This single body develops incompletely into two small roundish bodies which are partially connected by a narrow intervening strand. In the next stage the minute, double, rounded bodies become enlarged and spindle-shaped. They probably remain attached, however. The two bodies enlarge uniformly and assume a pear-shaped appearance. At this stage of the life cycle, the disease is in its most acute form. The parasites occupy nearly one-fourth of the body of the red blood cells and from 0.5 to 2 per cent of the red cells are usually invaded. The blood cells finally break up, liberating the parasites which may be observed as free bodies in the circulation. The parasites are taken up by the tick, according to Koch, in the red blood cells. In the body of the tick the parasites leave the red cell and become long and club-shaped. From the club pseudopodia project. This club then becomes spherical and immense numbers of amoeba-like forms appear, which are said to grow into clubs. The disease can only be transmitted by seed ticks, that is, by the first stage of the tick. The adult tick which sucked up the infected blood drops to the ground and lays its eggs. The organism passes into the eggs and is transmitted to other animals by the offspring of the tick which became infected. The disease can be given to a host almost immediately after attachment. The tick remains on the animal throughout its development (Mohler 1905).

Babesia caballi (Nuttall), the cause of EQUINE BILIARY FEVER, is considered by Marzinowski and Bielitzer (1909) to be carried by *Dermacentor reticulatus* (Fabricius) Koch in Russia. According to Valladares (1914), there is a possibility that *Hyalomma aegyptium* (Linnaeus) Koch is the carrier in India.

Babesia canis (Piana and Galli-Valerio) the cause of a CANINE BABESIASIS, also known as MALIGNANT JAUNDICE OF DOGS, is transmitted by several ticks. The life cycle has been traced in *Rhipicephalus sanguineus* (Latreille) Koch by Christophers in India (fig. 78). Lounsbury proved the transmission of the disease in South Africa by *Haemaphysalis leachi* (Audouin) Neumann. According to various authors *Dermacentor reticulatus* (Fabricius) Koch carried the disease in

France. *Ixodes hexagonus* Leach (*reduvius* Audouin), and *I. ricinus* (Linnaeus) Latreille, are suspected to be carriers. The life cycle in the dog was worked out by Nuttall and Graham-Smith (1904-7). The cycle of schizogony is passed in the dog. The free pyriform parasite enters a normal red blood corpuscle and becomes rounded in shape. The parasite throws out pseudopodia and appears as an amoeba. This stage lasts a long time, at the end of which the parasite enters upon a quiescent stage. Finally the organism takes a form called the trefoil stage, in which the main mass of the chromatin, much reduced in size, lies at the base of the two processes. Two nuclei are formed, finally the cytoplasm divides

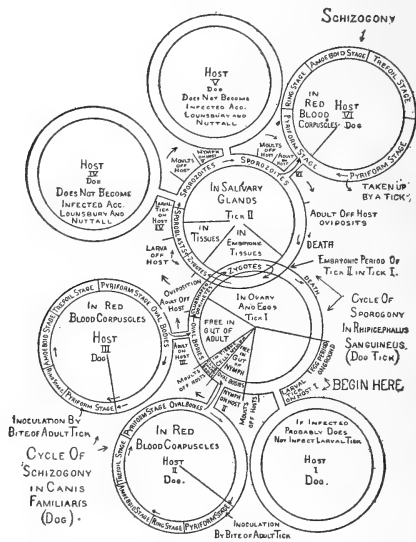

LIFE CYCLE OF BABESIA CANIS

THE CAUSE OF CANINE MALIGNANT JAUNDICE.

FIG. 78.—(Pierce).

and two pyriform parasites are found lying side by side in one corpuscle. The corpuscle now ruptures and liberates the two parasites.

Christophers has worked out the cycle of sporogony in the tick. When an adult or nymphal tick bites a dog and takes in blood containing the oval parasites, these develop in the gut into round or oval bodies which finally assume the form of a club-shaped body which gradually becomes oökinete. In the adult these oökinetes wander into the ova, while in the nymph they simply pass into the embryonic tissues. In either case they become rounded and form a zygote which breaks up into sporoblasts, and these again into sporozoites which infect the salivary glands of the nymph and the adult of the second generation.

A parent tick having gorged with blood falls to the ground and

lays her eggs which develop into six-legged larvae. They do not infect the dog, which they attack as soon as possible and on which they remain two days sucking blood. After dropping off they in due time shed their larval skin and become eight-legged nymphs which again attack the dog, but do not infect it. The nymph, after dropping off, undergoes metamorphosis and sheds its nymphal skin, and becomes the sexually mature tick, which is the only form that spreads the infection, according to Lounsbury (1901), and Nuttall.

Babesia divergens (McFadyean and Stockman), the cause of **RED WATER OF CATTLE**, is principally carried by *Ixodes ricinus* (Linnaeus) Latreille, although McFadyean and Stockman succeeded in transmitting the disease by means of *Haemaphysalis cinnabarina punctata* Canestrini and Fanzago (Nuttall, Warburton, Cooper, and Robinson, 1915).

Babesia gibsoni (Patton), cause of **BABESIASIS OF THE JACKAL AND DOG**, is said by Neumann to be carried by *Rhipicephalus simus* Koch. Patton found infested jackals with *Haemaphysalis birmaniae* Supino (*bispinosa*) and *Rhipicephalus simus* Koch but did not prove that they were infected.

Babesia minense Yakimoff, the cause of **BABESIASIS OF THE HEDGEHOG**, is said by Doflein to be carried by *Dermacentor reticulatus* (Fabricius) Koch.

Babesia ovis (Babes), the cause of **CARCEAG** of sheep, is hereditarily transmitted by *Rhipicephalus bursa* Canestrini and Fanzago. The daughter adult tick, developed from a tick which sucked the blood, is the stage which transmits the disease. The disease has been transmitted by *Haemaphysalis cinnabarina punctata* Canestrini and Fanzago experimentally.

Crithidia haemaphysalidis Patton is hereditary in *Haemaphysalis birmaniae* Supino (*bispinosa*) in India.

Crithidia hyalommae O'Farrel is hereditary in *Hyalomma aegyptium* (Linnaeus) Koch in the Sudan.

Nuttallia equi (Laveran), the cause of **NUTTALLIOSIS OF EQUINES**, was demonstrated by Theiler to be transmitted in South Africa by *Rhipicephalus evertsi* Neumann. Considerable evidence points towards *Hyalomma aegyptium* (Valladares 1915).

Rossiella rossi (Nuttall), the cause of **JACKAL ANEMIA**, is thought by Nuttall to be possibly carried by *Haemaphysalis leachi* (Audouin) Neumann.

Theileria parva (Theiler), the cause of **EAST COAST FEVER** or **RHODESIAN FEVER**, has been known by Theiler (1903, 1904, 1908) and Lounsbury (1906) to be transmitted by *Rhipicephalus appendiculatus* Neumann, *R. simus* Koch, *R. evertsi* Neumann, *R. capensis* Koch

and *Dermacentor nitens* Neumann. It is also recorded from *Hyalomma aegyptium* (Linnaeus) Koch by Carpano (1915) and *Dermacentor reticulatus* (Fabricius) Koch (Doflein 1911). The ticks do not produce an infection during the first two days after they have taken up the infective organism. They may transmit the organism in the instar following that in which they ingested the blood containing the organisms.

Mastigophora: Spirochaetacea: Spirochaetidae

Spiroschaudinnia sp. (*duttoni* Brumpt, not Novy and Knapp), the cause of ABYSSINIAN RELAPSING FEVER, was transmitted by Brumpt to monkeys, rats, and mice by means of *Ornithodoros savignyi* (Audouin) Koch.

Spiroschaudinnia anserina (Saccharoff), the cause of GOOSE SPIROCHAETOSIS, Transcaucasia, is carried by *Argas persicus* (Oken) Fischer Von Waldheim (Saccharoff 1891).

Spiroschaudinnia duttoni (Novy and Knapp), the cause of RELAPSING FEVER of tropical and west Africa, is hereditarily transmitted by *Ornithodoros moubata* (Murray) Pocock. The transmission by this tick was first proven by Dutton and Todd in 1905. Many others have corroborated this. Möllers in 1907 showed that infected ticks, fed successively on six clean animals, after each feed may lay a batch of infected eggs. The ticks hatched from these eggs are capable of conveying the infection to the animals they feed upon. Moreover, not only is the infection carried through the second generation, but also through their offspring, ticks of the third generation being found to be infective even though their parents have never fed on an infected animal. Schuberg and Manteufel (1910) and Hindle (1911) found that about 30 per cent of the ticks are immune to spirochaetal infection. In man the parasite is ribbon-shaped on transverse section and though it is in spirals, may be simply waved. A narrow undulating membrane is sometimes present. Reproduction is by longitudinal as well as transverse fission and also by granular formation. The latter method occurs just before the crisis, when the blood is swarming with parasites. They are then to be seen coiling themselves up in the spleen, bone marrow, and liver, and becoming surrounded by a thin cyst wall. In this cyst the parasite becomes more and more indistinct and breaks up into filterable granules.

Leishman found that when the organism finds its way into the intestinal sac of the tick it loses its mobility and characteristic appearance, and chromatic masses escape into the lumen of the gut in the form of small rods or rounded bodies. These multiply and pass into the cells of the Malpighian tubules. Hindle found the spirochaetes always present in the gut of infected ticks, often in the Malpighian tubules and sexual

organs, very seldom in the salivary glands, and not at all in the coxal fluid. Leishman in 1910 proved that the organism is voided in Malpighian excrement while the tick is feeding, and, by means of an anticoagulin coxal fluid voided at the same time, is washed into the wound. Infection does not take place through the proboscis. Leishman's experiments were completely checked and substantiated by Hindle (1911), who demonstrated that the infection was due to the presence of the spirochaetes in the white Malpighian secretions, and entered the feeding punctures with uninfected coxal fluid; and, furthermore, dissections prove that the salivary glands of these particular ticks were not infected, while the gut contents, sexual organs and Malpighian tubules were. Inoculation of these various organs gave incubation of spirochaetes in 7 to 9 days.

Spiroschaudinnia granulosa (Balfour), cause of Sudanese or North African FOWL SPIROCHAETOSIS, was proven by Balfour to be transmissible by *Argas persicus* (Oken) Fischer Von Waldheim.

Spiroschaudinnia marchouxi (Nuttall), the cause of Brazilian or South American FOWL SPIROCHAETOSIS, was shown by Marchoux and Salimbeni to be carried by *Argas persicus*. This has been corroborated by Nuttall, Hindle, and others. Shellack transmitted the disease by *Argas reflexus* (Fabricius) Latreille. In experiments conducted at Hamburg, Fülleborn and Mayer transmitted the disease by *Ornithodoros moubata*. Nuttall working with the Brazilian strain, found that when the spirochaetes first enter the tick they soon disappear from the gut; a certain number degenerate while others traverse the gut wall and enter the coelomic cavity to circulate all over the body. They enter various organs, especially the cells of the Malpighian tubules and sexual organs, in which they break up into a large number of small particles or coccoid bodies which multiply by fission and give rise to large agglomerations. These coccoid bodies may also be found in the lumen of the gut and Malpighian tubules and in the excreta. According to Nuttall, the tick in the act of feeding occasionally voids excrement and exudes a few drops of secretion from the coxal glands situated in the first intercoxal space, the fluid pouring out of a wide duct and being rapidly secreted from the freshly imbibed blood serum. This fluid, as well as the salivary and intestinal secretions of *Argas*, contains an anticoagulin. The coxal fluid dilutes the escaped excrement and facilitates its getting into the wound inflicted by the tick. This is doubtless the usual mode of infection, the coccoid bodies in the excrement gaining access to the body of the host and afterwards developing into spirochaetes, though the latter development has not actually been followed. The bird begins to show symptoms after a period of incubation of about four days following upon the bite of the infected tick.

Hindle has found the coccoid bodies within the Malpighian cells of the embryo tick. If the eggs are maintained at 37° C. the coccoid bodies grow out and assume a form which suggests that they are on the way to forming spirochaetes. This indicates hereditary infection.

Spiroschaudinnia neveuxii (Brumpt), the cause of Senegal FOWL SPIROCHAETOSIS, is spread by *Argas persicus*, according to Brumpt.

Spiroschaudinnia novyi (Shellack), the cause of American or Colombian RELAPSING FEVER, may be transmitted by *Ornithodoros turicata* (Dugès) Neumann according to Brumpt, *O. megnini* (Dugès) Neumann according to Dofflein, *O. moubata* (Murray) Pocock according to Nuttall, and *Argas persicus* (Oken) Fischer Von Waldheim according to Dofflein.

Spiroschaudinnia recurrentis (Lebert), the cause of European RELAPSING FEVER, is normally transmitted by lice and bedbugs, but Manteufel found that the disease could be easily transmitted by *Ornithodoros moubata*.

Spiroschaudinnia rossii (Nuttall), the causing of East African RELAPSING FEVER, may be spread by *Ornithodoros moubata*, according to Nuttall.

Spiroschaudinnia theileri (Laveran), the cause of BOVINE SPIROCHAETOSIS, was proven by Theiler to be transmitted by *Boophilus annulatus decoloratus*. It may also be transmitted by *Rhipicephalus evertsi* Neumann. The organism is hereditary in *B. annulatus (decoloratus)* as proven by Laveran and Vallee. The disease appears in 14 days after inoculation by a larval tick (Nuttall 1913).

Telosporidia: Haemogregarinida: Haemogregarinidae

Haemogregarina (Hepatozoon) canis (James), the cause of CANINE ANEMIA, has been shown by Christophers to pass its cycle of sporogony in *Rhipicephalus sanguineus* (Latreille) Koch; the cycle of schizogony is passed in the dog (fig. 79). Schizogony appears to take place only in the bone marrow and does not take place in the liver or spleen. When a tick sucks the blood of the dog it takes up the encapsuled forms which pass into the stomach. The parasite escapes from the blood of the corpuscles but is still inside its own envelope. By elongation and passage of the protoplasm behind the nucleus, the oval parasite becomes a vermicule. The vermicules enter young epithelial cells lining the lumen of the gut in whose cytoplasm they divide by fission, which often takes place several times, resulting in the secondary formation of four to eight vermicules lying in a pocket in the cytoplasm of the cell. Two of these secondary vermicules, which apparently do not differ in appearance,

conjugate and the nuclei fuse, and then follows a throwing out of two large masses of chromatin from the nucleus and the separation of a portion of cytoplasm resulting in the formation of an oöcyst with a synkaryon. The oöcyst, still imbedded in the epithelial cell, grows rapidly, becoming irregular in form. Later stages of development are only found in ticks which ingest vermicules during their nymphal stage. The oöcyst divides into four cysts which grow very large. These may rupture and release into the body cavity the sporocysts which contain the sporozoites.

After sucking the blood of a dog from two to four days, the adult

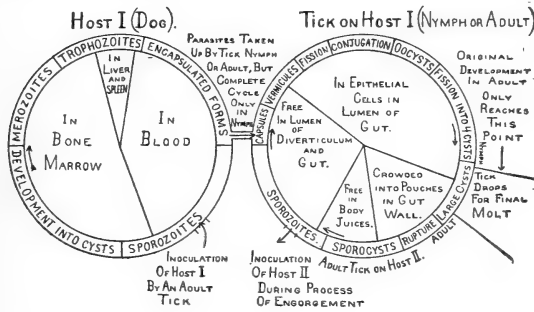

CYCLE OF SCHIZOGONY IN CANIS FAMILIARIS (DOG) CYCLE OF SPOROGENY IN RHIPICEPHALUS SANGUINEUS (DOG TICK).

LIFE CYCLE OF HAEMOGREGARINA CANIS.

THE CAUSE OF CANINE ANEMIA.

(CONSTRUCTED AFTER DESCRIPTIONS AND DRAWINGS BY CHRISTOPHERS)

FIG. 79.—(Pierce).

tick drops off never to feed again. It is apparent then, that the adult tick taking up infected blood for the first time in this stage of its development, cannot of itself transmit the disease, as the parasite has been shown by Christophers not to complete its development in the adult. We must, therefore, look to the life history of the tick to find the possible method of transmission. Christophers found that complete development in the tick only occurs when the parasite is taken up in the nymphal stage. He did not find any parasite in larvæ fed on infected dogs. After the nymphal stage the ticks drop off from the host for molting. They then reattach as adults and engorge. The possibility of infecting a new host is very great because of this change of host during the development of the parasite in the tick.

Haemogregarina (Haemogregarina) mauritanica (Sergent and Sargent), a parasite of *Testudo mauritanica*, is transmitted by *Hyalomma aegyptium* (Linnaeus) Koch, according to Von Prowazek.

Haemogregarina (Hepatozoon) jaculi (Balfour), parasite of the jerboas (*Jaculus gordonii* and *J. orientalis*), while usually carried by the flea, may be carried by the mite, *Dermanyssus gallinae* Redi, according to Von Prowazek.

Haemogregarina (Hepatozoon) leporis (Patton), a parasite of the rabbit *Lepus nigricollis*, may be mechanically carried by *Haemaphysalis flava* Neumann in India, according to Von Prowazek.

Haemogregarina (Hepatozoon) muris (Balfour) the cause of RAT ANEMIA, was found by Miller to pass its schizogony in the rat and its sporogony in the rat mite *Laelaps echidninus* Berlese. In sucking the blood of the rat the mite takes up the leucocytes containing the gametocytes of this organism, which are then liberated from their cells by the digestive action of the mite's gut. They arrange themselves in couples which are at first quite similar, but which later differentiate into macrogametes and microgametes. Zygotis now takes place forming an oökinete which grows, and, leaving the gut by piercing the wall, forces its way into the body cavity and further into the sheaths of the muscles and into the investing membrane of the salivary glands. In the tissues it encysts and becomes the oöcyst which grows rapidly in size and undergoes nuclear division. The daughter nuclei migrate to the periphery which becomes covered with 50 to 100 bud-like projections, in each of which a nucleus is to be found. These buds break off from the central mass and form sporoblasts, the nuclei of which divide to form daughter nuclei which gather at the poles, while the whole sporoblast encysts. Short rod-like processes of cytoplasm, each containing a nucleus, now break off from the sporoblast and become sporozoites, of which there are on an average 16 to each sporoblast.

Infection of the rat takes place by ingestion of the mites, when the sporozoites are liberated by the juices of the duodenum and become actively motile, striated vermicules which penetrate the intestinal villi, enter the blood system, and are carried to the liver, into the cells of which they penetrate and start the cycle of schizogony. As the mites leave the rats during the daytime, only feeding on them during the night, it is easy to understand the manner in which the disease spreads from the sick to the healthy.

Haemogregarina (Karyolysus) lacertarum (Danilewsky), a parasite of lizards of the genus *Lacerta*, is recorded by Chatton and Roubaud from nymphs of mites of the family *Dermanyssidæ*, in which the cycle of sporogony takes place.

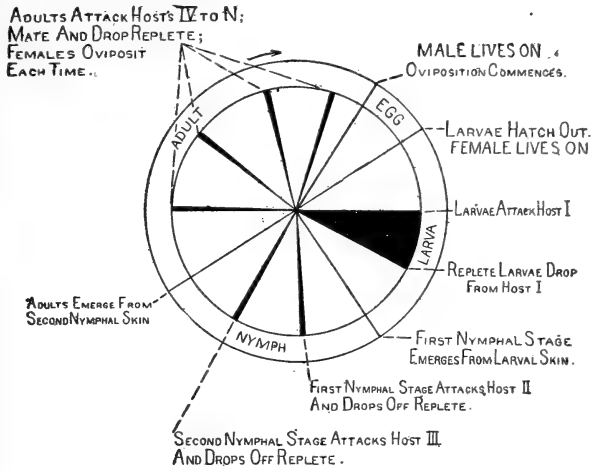

TICK LIFE CYCLE - TYPE I

LIFE CYCLE OF *ARGAS PERSICUS*, ALSO PROBABLY *A. REFLEXUS*,
AVESPERTILIONIS AND SOME OTHER SPECIES OF *ARGAS* AND *ORNITHODOROS*.
(AFTER NUTTALL 1911)

FIG. 80.

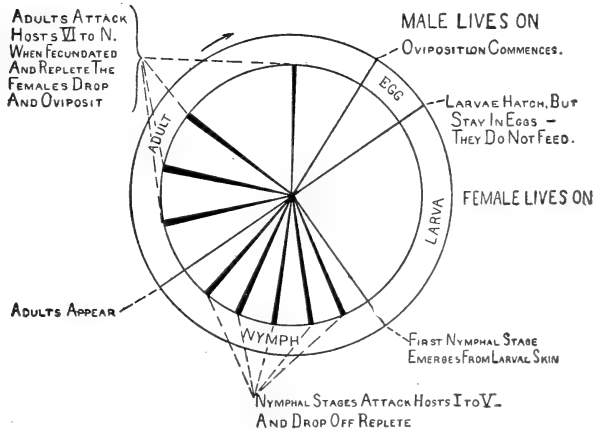

TICK LIFE CYCLE - TYPE II

THE LIFE CYCLE OF *ORNITHODOROS MOUBATA* AND *O. SAVIGNYI*.
(AFTER NUTTALL 1911)

FIG. 81.

SUMMARY

A good idea of the diversity of life cycle and of the interrelationship of the tick to its host and its parasite can be obtained by a comparison of the life cycles of *Hæmogregarina canis* and *Babesia canis*, both of which pass their cycle of sporogony in the dog tick *Rhipicephalus sanguineus* and their cycle of schizogony in the dog. Two charts are presented to illustrate the life cycles of these two parasites (figs. 78, 79). It will be noticed that a certain tick, taking up both of these parasites in its nymphal stage from a given dog, would communicate the *Hæmogregarina* to its adult host, but the *Babesia* would not be transmitted until the tick's offspring had reached the adult stage, possibly on the third dog host of the offspring. The best way in which to understand how ticks can carry disease organisms is to study the types of life cycles which were worked out by Nuttall, and charts of which are presented. In the first type (fig. 80), found in various species of the genera *Argas* and *Ornithodoros*, there are one larval host, two nymphal hosts, and an indefinite number of adult hosts. Thus, it is apparent that organisms which can be taken up by any one of these stages can be transmitted to quite a number of other hosts by the same tick.

In type two (fig. 81) there is no larval host but there are five nymphal hosts and any number of adult hosts. This type is found in *Ornithodoros moubata* and *O. savignyi*. It is therefore apparent that the diseases transmitted by these ticks can be conveyed to a number of successive hosts by the same tick.

The third type (fig. 82), found in the genera *Ixodes*, *Hæmaphysalis*, *Dermacentor*, *Rhipicephalus*, and *Amblyomma*, consists of a development with just three hosts, one for the larva, one for the nymph, and one for the adult. Therefore, if the parasite is taken up by the nymph it may be transmitted to the host of the adult, but if the parasite is taken up by the adult, it must either die or be transmitted hereditarily by the offspring of the tick.

Type four (fig. 83), found in *Rhipicephalus evertsi* and *Hyalomma ægyptium*, consists of a development with only two hosts. The larva develops into a nymph on the host and the nymph drops when replete. It reattaches as an adult. The possibilities of transmission are similar to those in type three, but tend more toward hereditary transmission.

Type five (fig. 84), represented by the genus *Boophilus*, has only one host. The larva attaches and goes through its entire transformation on the host. It is, therefore, apparent that any organism transmitted by these ticks must be transmitted hereditarily.

Type six (fig. 85) is similar in that there is but one host. It is represented by *Ornithodoros megnini*, which is on the host during its larval

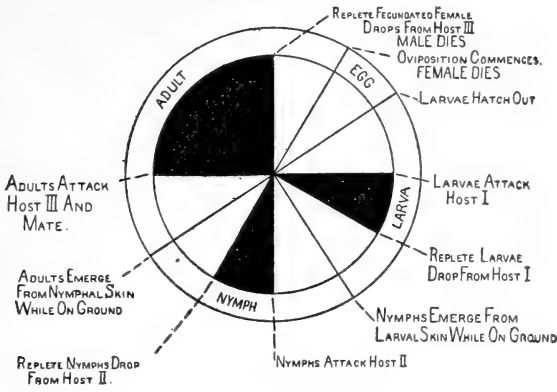

TICK LIFE CYCLE - TYPE III

THE LIFE CYCLE OF *IXODES HEXAGONUS*, *I. RICINUS*, *I. CANISUGA*, *HAEMAPHYSALIS LEACHI*, *H. PUNCINATA*, *DERMAGENTOR RETICULATUS*, *D. OCCIDENTALIS*, *D. VARIABILIS*, *RHIPICEPHALUS APPENDICULATUS*, *R. SANGUINEUS*, *R. SIMUS* AND *AMBLYOMMA HEBRAEUM*.
(AFTER NUTTALL 1911)

FIG. 82.

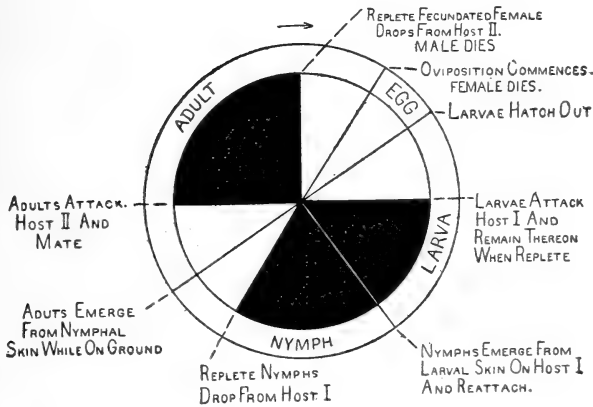

TICK LIFE CYCLE - TYPE IV

THE LIFE CYCLE OF *RHIPICEPHALUS EVERTSI* AND *HYALOMMA AEGYPTIUM*.
(AFTER NUTTALL 1911)

FIG. 83.

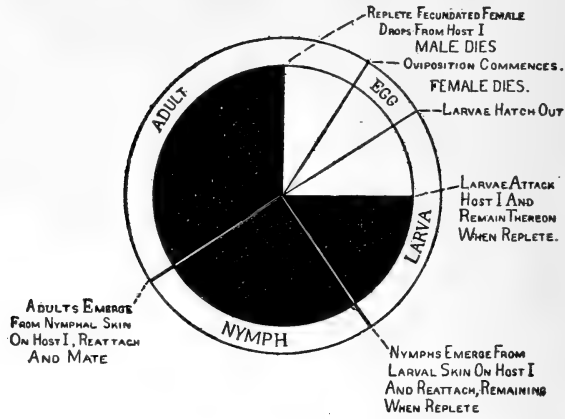

TICK LIFE CYCLE = TYPE V

THE LIFE CYCLE OF THE GENUS BOOPHILUS
(AFTER NUTTALL 1911)

FIG. 84.

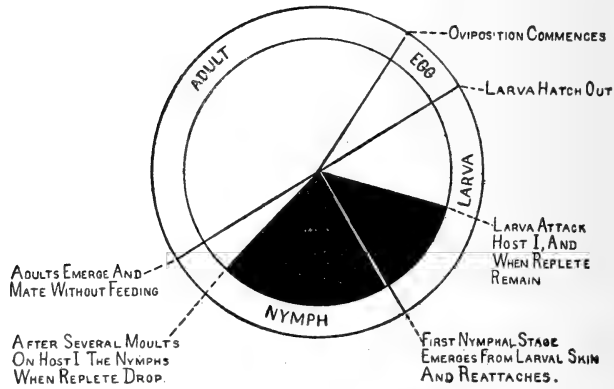

TICK LIFE CYCLE = TYPE VI

THE LIFE CYCLE OF ORNITHODOROS MEGNINI.
(ORIGINAL)

FIG. 85—(Pierce).

and nymphal stages, and does not reattach during the adult stage. The organism, if taken up, must be taken up by the larva or nymph and remain in the body during transformation, entering the eggs, thus to be transmitted by the offspring of the tick.

It is quite evident from this that any one who studies the transmission of disease by ticks, must first take into account the life cycles of the ticks which he is studying, in order to arrive at any understanding of the life cycles of the parasites. Perhaps we may learn a valuable lesson from the ticks in our search for the life cycles of parasites in other forms of invertebrates.

LIST OF REFERENCES

- Anderson, John F., 1903.—U. S. Treas. Dept., Hyg. Lab., Bull. 14, pp. 1-41.
- Balfour, A., 1912.—Parasitology, vol. 5, pp. 122-126.
- Banks, N., 1915.—U. S. Dept. Agric., Office of the Secretary, Report 108, 153 pp.
- Brumpt, E., 1908.—Bull. Soc. Path. Exot., vol. 1, pp. 577-579.
- Brumpt, E., 1913.—Précis de Parasitologie, pp. 133, 136.
- Brumpt, E., 1914.—Bull. Soc. Path. Exot., vol. 7, No. 2, pp. 132-133.
- Carpano, M., 1915.—Ann. Igiene Speriment, Turin, vol. 25, No. 4, pp. 343-410.
- Castellani, A., and Chalmers, A. J., 1913.—A Manual of Tropical Medicine, 2nd Edit., p. 950.
- Christophers, S. R., 1907.—Sci. Mem. Officers Med. & Sanit. Dept., India, n. s., No. 29.
- Christophers, S. R., 1912.—Parasitology, vol. 5, No. 1, pp. 37-44, 48.
- Crawley, H., 1915.—Journ. Parasit., vol. 2, No. 2, pp. 87-92.
- Doflein, F., 1911.—Lehrbuch der Protozoenkunde, p. 817.
- Dutton, J. E., and Todd, J. L., 1905.—Liverpool School Trop. Med., Mem. 17, pp. 1-18.
- Fülleborn and Mayer, M., 1908.—Arch. f. Schiffs- u. Trop.-Hyg., vol. 12, p. 31.
- Hadwen, S., 1919.—Journ. Amer. Vet. Med. Assoc., vol. 54, No. 6, pp. 639-642.
- Hindle, E., 1911.—Parasitology, vol. 4, No. 2, pp. 133-149. Contains Bibliography on Transmission of Relapsing Fever.
- Hindle, E., 1911.—Parasitology, vol. 4, pp. 463-477.
- Jarvis, E. M., 1919.—Vet. Journ., Feb.
- Kitashima, T., and Myajima, 1918.—Kitasato Arch. Exper. Med., vol. 2, No. 2, July, pp. 91-146, Plts. 1-4; No. 3, pp. 237 for'd.
- Leishmann, W. B., 1910.—Lancet, vol. 177, pp. 11-14.

- Lignières, J., 1914.—*Centralbl. Bakt. Parasit. u. Infekt.-Krankh., Abt. 1*, vol. 74, pp. 133-162.
- Lounsbury, C. P., 1901.—*Agric. Journ. (Cape of Good Hope)*, Nov. 21, 1901. Reprint as *Bull. 7. Dept. Agr., Cape of Good Hope*.
- Lounsbury, 1906.—*Agric. Journ. Cape of Good Hope*, vol. 28, pp. 634-643.
- Manteufel, 1907.—*Arb. a. d. kais. Gesundheitsamte*, vol. 29, p. 355.
- Marchoux, E., and Salimbeni, A., 1903.—*Ann. Inst. Pasteur*, vol. 17, pp. 569-580.
- Marzinowski, and Bielitzer, 1909.—*Zeitschr. f. Hyg. u. Infekt.-Krankh.*, vol. 63, pp. 17-33.
- Maver, M. B., 1911.—*Journ. Infectious Diseases*, vol. 8, pp. 327-331.
- Mohler, J. R., 1905.—*U. S. Dept. Agric., Bur. Anim. Ind., Bull. 78*, 48 pp.
- Möllers, B., 1907.—*Zeitschr. f. Hyg. u. Infekt.-Krankh.*, vol. 58, pp. 277-285.
- Neiva, A., 1913.—*Brazil Medico*, vol. 27, No. 46, p. 498.
- Neumann, L. G., 1914.—*Parasites et Maladies, Parasitaires du Chien et du Chat. Paris*, p. 293.
- Nuttall, G. H. F., 1904.—*Lancet*, vol. 167, pp. 1785-1786.
- Nuttall, G. H. F., 1905.—*Tr. Epidem. Soc. Lond., n. s.*, vol. 24, pp. 12-26.
- Nuttall, G. H. F., 1908.—*Journ. Roy. Inst. Pub. Health*, vol. 16.
- Nuttall, G. H. F., 1912.—*Parasitology*, vol. 5, No. 1, pp. 61-64.
- Nuttall, G. H. F., 1913.—*Parasitology*, vol. 5, No. 4, p. 268.
- Nuttall, G. H. F., and Graham-Smith, G. S., 1904-1907.—*Canine Piroplasmiasis, I-VI. Journ. Hygiene*, vols. 4-7.
- Nuttall, G. H. F., Warburton, C., Cooper, W. F., and Robinson, L. E., 1908.—*Ticks. A Monograph of the Ixodoidea. Cambridge Univ. Press, Part I*.
- Nuttall, G. H. F., Warburton, C., Cooper, W. F., and Robinson, L. E., 1911.—*Ticks. A Monograph of the Ixodoidea. Cambridge Univ. Press, Part II*.
- Nuttall, G. H. F., Warburton, C., Cooper, W. F., and Robinson, L. E., 1915.—*Ticks. A Monograph of the Ixodoidea. Part III*, p. 519.
- Patton, W. S., 1910.—*Bull. Soc. Path. Exot.*, vol. 3, pp. 274-281.
- Piana and Galli-Valerio, 1895.—*Moderno Zooiatre*, No. 9, p. 163.
- Ricketts, H. F., 1906.—*Journ. Amer. Med. Assoc.*, vol. 47, p. 358.
- Saccharoff, 1891.—*Ann. Inst. Pasteur*, vol. 5, pp. 564-566.
- Shellack, C., 1908.—*Centralbl. f. Bakt.*, vol. 46, pp. 486-488.
- Smith, T., and Kilborne, F. L., *U. S. Dept. Agric., Bur. Anim. Ind., Bull. 1*, 301 pp.
- Stiles, C. W., 1905.—*U. S. Treas. Dept., Hyg. Lab., Bull. 20*, pp. 1-119.

- Theiler, A., 1904.—*Journ. Royal Army Med. Corps*, vol. 3, pp. 599-620.
- Theiler, A., 1905.—*Transvaal Dept. Agr., Rept. Govt. Vet. Bact.*, 1903-1904.
- Theiler, A., 1908.—*Transvaal Dept. Agr., Rept. Govt. Vet. Bact.*, 1906-1907.
- Theiler, A., 1909.—*Transvaal Dept. Agr., Rept. Govt. Vet. Bact.*, 1907-1908.
- Theiler, A., 1910.—*Transvaal Dept. Agr., Rept. Govt. Vet. Bact.*, 1908-1909.
- Theiler, A., 1910.—*Bull. Soc. Path. Exot.*, vol. 3, pp. 135-137.
- Von Prowazek, S., 1912-1914.—*Handbuch der Pathogenen Protozoen*.
- Valladares, J. F., 1914.—*Parasitology*, vol. 7, No. 1, pp. 88-94.
- Valladares, J. F., 1915.—*Parasitology*, vol. 7, pp. 88-94.
- Wilson, L. B., and Chowning, W. M., 1902.—*Journ. Amer. Med. Assoc.*, vol. 39, July 19, pp. 131-136.
- Wolbach, S. B., 1919.—*Journ. Med. Res., Boston*, vol. 41, No. 1, November, pp. 1-193, plates 1-21.

CHAPTER XXX

The Biologies and Habits of Ticks¹

F. C. Bishopp

The importance of ticks as vectors of disease and as simple parasites has directed the attention of many workers to this group. Although the superfamily Ixodoidea, which comprises the ticks, is comparatively small, the species numbering about 300, the life-histories and habits of the species are quite varied. Many forms exhibit a close correlation between their habits and habits of their hosts. There is often also a marked relationship between seasonal and climatic conditions and the presence and abundance of different species.

Knowing the intimate interdependency between ticks, their hosts, and several serious diseases of man and animals, and also considering the fact that all important control measures are based upon the life histories of the species concerned, we cannot too strongly emphasize the need of a thorough knowledge of host relations, distribution, and life histories of the more important species.

Stages in the Life of Ticks.—There are two distinct families comprising the ticks. One of these, known as the Argasidæ, may be recognized by the absence of any highly chitinized parts, while the other, the Ixodidae, is supplied with a definite, highly chitinized scutum or shield (on the dorsum anteriorly), and highly chitinized legs and other parts.

There are usually four distinct stages in the life of all ticks. The egg, which is more or less oval in shape and usually brown in color, the larva or six-legged stage, the nymph or second stage (with eight legs), and the adult tick in which the sexes are well defined. In several species we have a second or even third nymphal stage. In the Ixodidae the males and females are usually readily distinguished in the unengorged state. The female has a chitinized shield covering almost the entire dorsal side. In this group of ticks the female is the only one which becomes greatly distended with blood, and being quite conspicuous when engorged, is the form usually observed by the layman. In practically all the species the males attach and imbibe some blood, but do not become greatly swollen.

Habits.—There are certain general habits which are peculiar to the two families of ticks. Most species in the family Argasidae remain free

¹This lecture was prepared for this edition only.

from the host the greater part of the time, imbibing blood rapidly when favorable opportunity offers, such as when the hosts are at rest at night. The first or seed tick stage of this group of ticks, however, usually remains on the host for several days. The adults of this family partake of blood meals several times and the females deposit a number of batches of eggs. The total number of eggs deposited is usually much smaller than in the case of the ticks in the other family.

Among the Ixodid ticks we find but one species which has the habit of feeding rapidly, as in the Argasidae. In the other species each stage remains on the host for at least several days. Even in the same genus, however, we find widely different habits as regards feeding. There are some forms in which the larvae and nymphs leave the host for molting. In several species molting takes place on the host and the tick does not drop off until it has become replete as an adult, while in still other instances, the first molt takes place on the host and the second on the ground. In all cases in this family the engorged females deposit a large number of eggs and die soon after. In most species copulation takes place on the host. The males may remain some time after the females have dropped. In certain species of the genus *Ixodes*, however, it appears that the males never attach to the host, but remain in the places frequented by the host and when the females drop off they are fertilized by them. A few species have been found to deposit fertile eggs without the intervention of the male. The eggs of practically all Ixodids are deposited in a single mass in some protected place. They hatch almost simultaneously in a few weeks' time and the larvae or seed ticks usually crawl upon vegetation and there await the passing of a suitable host. In the case of those species which drop from the host for each molt, sometimes spoken of as three-host species, it is necessary for the ticks to secure a host on three different occasions, hence undoubtedly increasing the mortality before maturity is reached.

Many species show a predilection for attachment to certain regions of the host. Structure or habits are sometimes modified to fit the conditions under which the ticks live on the host. There is a tendency with all ticks to choose the more tender portions of the skin upon which to attach. Hence with many of our common forms we find groups of ticks between the forelegs, on the brisket or the inguinal region. The habit of attaching in the ears has already been mentioned in connection with *Ornithodoros megnini* (Dugès) Neumann. The tropical horse tick, *Dermacentor nitens* Neumann, also has this habit well developed. The Gulf Coast tick, *Amblyomma maculatum* Koch, is usually found in the ear but never in the deeper portions of that organ. On small animals there is also frequently exhibited a tendency of the ticks to attach in the region where they are least in danger of being destroyed by scratching or biting.

Host Relations.—Ticks develop upon a great variety of species among the higher animals. Toads, lizards, snakes, and turtles are infested to a considerable extent, birds are attacked by a number of species and especially by immature stages of forms which when mature attack larger animals. Practically all mammals, from the small field mice to the pachyderms, ruminants, and man, are infested by ticks. In general those ticks which remain on the host for their molts attack fewer species of animals than those forms which pass their molt on the ground, and nearly all ticks attack more than one host, but many species develop successfully only on certain related animals. These points are made use of largely in practicing control or eradication.

Relation Between Stages and Disease Transmission.—In connection with the transmission of disease, the infective stages of ticks vary with the species and the disease organism concerned. In the case of a number of diseases, the organism passes from one generation to the other through the egg. This is true in the case of the cattle tick and Texas fever and also with Rocky Mountain spotted fever. With certain diseases the adults only are infective and these derive the infection from the adult of the preceding brood. Some disease organisms are taken up by the larvæ and transmitted by the nymphs or adults of the same generation.

Life History and Habits.—Owing to the wide diversity in life history, habits, and economic considerations among the ticks, it is thought best to briefly outline some of the principal points along this line, treating the matter according to species.

The Fowl Tick, Argas persicus (Fischer Von Waldheim) *miniatus* Koch (plate XXVI).—This is a serious pest of various kinds of poultry and is tropicopolitan in distribution, usually being most abundant in the semi-arid regions. In the United States it occurs in Florida, and from Central Texas westward to the Pacific. It not only acts as a simple parasite but is responsible for the transmission of a disease of fowls known as spirochaetosis. It has been reported as attacking man, but can not be considered of any special importance in this regard.

The seed ticks remain attached to the fowls from four to ten days, dropping at night and spending the remainder of their life hidden away about the roosting places of the fowls, only venturing out to feed at night. Several batches of eggs are deposited, engorgement taking place after each deposition. These ticks are remarkable on account of the fact that they can live over two years without food. They are also very resistant to insecticides.

There is another species of *Argas* *A. reflexus* (Fabricius) Latreille, which is of considerable economic importance. This attacks pigeons. Most of the other members of this genus feed upon birds and bats.

The African Relapsing Fever Tick: Ornithodoros moubata (Murray)

Pocock.—This tick is a common parasite of man in a large part of tropical Africa. It also feeds on domesticated animals. It lives in the huts and is carried about by the natives in their mats, etc. As the name indicates, it is the carrier of relapsing fever or tick fever of man in Africa. The tick hides and breeds in the cracks, feeding at night. This

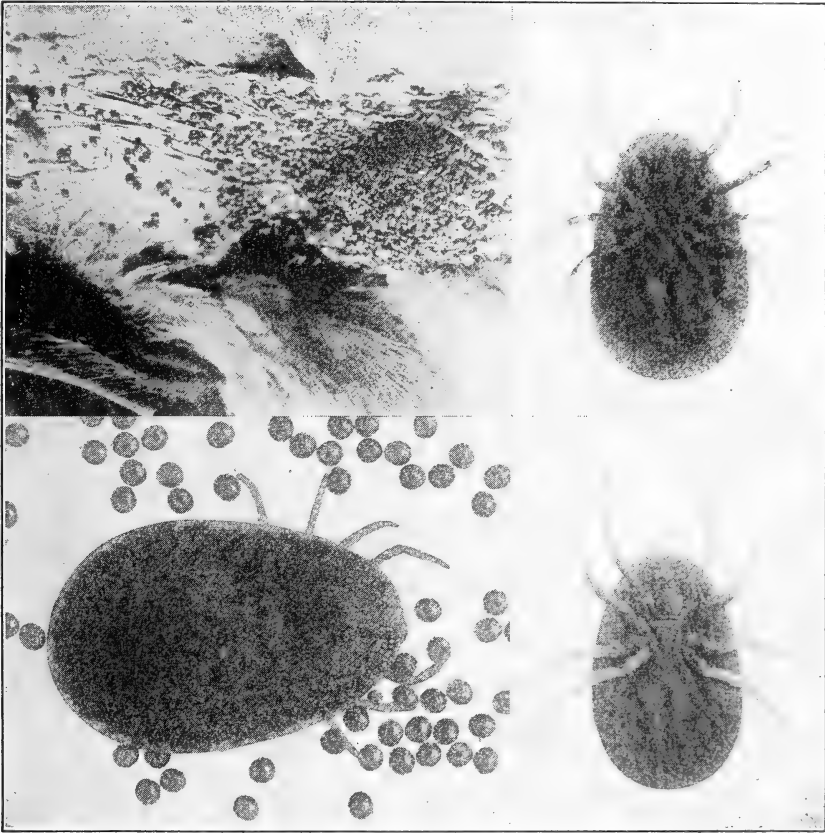

PLATE XXVI. Fig. 1—(Upper left) Larvae of fowl tick under feathers of chicken. Fig. 2 (Upper right)—Unengorged male. Fig. 3 (Lower left)—Female with eggs. Fig. 4 (Lower right)—Unengorged female.

species is peculiar in that it does not have an active seed tick stage, the first molt taking place within the egg shell.

The Spinose Ear Tick, Ornithodoros megnini (Dugès) Neumann.—This is an American species. It is an important pest of live stock in the semi-arid Southwestern United States and throughout Mexico. It also occurs in the ears of certain wild animals and not infrequently attacks man, producing severe earache. The tick normally attacks deep in the ears of the host. The first or larval stage is very active. This is the

stage which enters the ears. The larvæ molt to nymphs within the ears in from seven to twelve days. The nymphal stage is covered with spines, hence the common name. Engorgement in this stage requires from 31 to over 200 days. The nymphs then crawl out of the ears, hide about barns, posts, trees, etc., and molt their skins, copulate, and lay eggs, no food being taken in the adult stage. The eggs are deposited in these hiding places and the larvae remain on the objects until brushed off by an animal.

There are several other species in this genus, some of which are of importance as parasites of man and animals. One which is common in the Southwest infests the burrows of prairie dogs and other wild rodents and may attack man at night. The species *O. savignyi* (Audouin) Koch is widely distributed in Africa and southern Asia. It normally feeds on the camel but often attacks man. Certain other species in the tropics of Asia bite man, but the transmission of disease has not been definitely connected with them.

In the family Ixodidae there are many important species. Only a few will be mentioned.

The Castor Bean Tick or Black-Legged Tick, Ixodes ricinus (Linnaeus).—This species is common throughout the greater part of Europe and Asia and two varieties of it occur in the United States. The mouth-parts are long, thus often producing a troublesome bite. The hosts are many, including both domestic and wild animals and man. While it has not been connected with any disease in America, it has been clearly shown to carry red water or bovine piroplasmiasis in Europe. This tick drops from the host to molt, the larvæ engorge in from three to nine days and molt in three to four weeks. The period of engorgement of the nymphs is practically the same as in the larvæ. The nymphs require somewhat longer to molt to adults. The females require about eight to fifteen days to become engorged, and begin depositing eggs in about two weeks. The eggs hatch in from forty days to several months.

The Genus Haemaphysalis—*H. leachi* (Audouin) Neumann, which is common in Africa, has been shown to carry malignant jaundice (*Babesia canis*) of dogs. The common rabbit tick in the United States belongs to this group. Another species *H. cinnabarina* (Koch) *punctata* Canestrini and Fanzago is sometimes of importance as a parasite on cattle, sheep, and other domestic animals. All of the ticks of the group drop for molts, and the developmental periods are somewhat similar to those outlined for *Ixodes ricinus*, with the exception of the species *H. inermis* Birula, which occurs on deer in Europe. The immature stages of this tick engorge very rapidly, becoming replete in from 1½ to 24 hours.

The Cattle Tick, Boophilus annulatus (Say) Stiles and Hassall (*Margaropus*) (plate XXVII) and *Varieties of This Species*.—This is probably the most important tick in relation to live stock. *B. annulatus*

proper occurs in southern United States and parts of Mexico while varieties of this species are present in tropical America, Africa, Australia, and other parts of the world. It is not only a species which produces heavy losses on account of its occurrence in tremendous numbers, but it is especially important on account of being the intermediate host of the piroplasma which produces Texas or splenic fever in cattle.

Our form is very restricted in host relations. It can complete development only on cattle, horses, mules, and deer, rarely on a few smaller animals. This habit has greatly facilitated eradication. The molts are

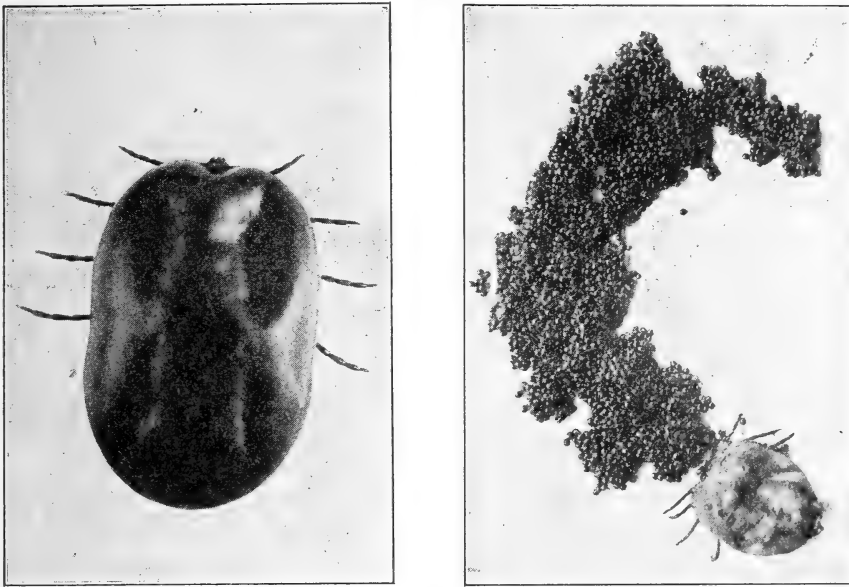

PLATE XXVII.—The cattle tick, *Boophilus annulatus*. Fig. 1 (Left)—Fully engorged female. Fig. 2 (Right)—Engorged female depositing eggs. (Bishopp.)

passed on the host. The females deposit from 2,500 to 4,500 eggs. In summer these hatch in from 20 to 30 days, while in the fall and winter the incubation period may extend to 200 days. The longevity of the seed tick varies according to temperature and humidity from about two to eight months, and the period from dropping of the engorged female to the death of all of her progeny, or the nonparasitic period, ranges from 28 days in summer to 279 days in cooler weather. The period of attachment of the seed tick to the host until the engorged female detaches ranges from 20 to 59 days. Both of these periods are of considerable importance in connection with control by the so-called pasture rotation methods.

The Genus Rhipicephalus.—This group, though small, contains many

species of importance. The species are most abundant in Africa where several of them are connected with the transmission of disease. *R. appendiculatus* Neumann is the principal transmitting agent of East Coast Fever, a malignant disease of cattle in Africa, and four other related species play some part in the dissemination of this malady. *R. evertsi* Neumann is credited with the transmission of *Nuttallia equi*, or biliary fever of equines, in South Africa. *R. bursa* Canestrini and Fanzago transmits *Babesia ovis* of sheep in southern Europe and *R. sanguineus* (Latreille) Koch, a species which is present in extreme southern Texas and Florida and generally distributed throughout the tropical parts of the world, plays some part in the transmission of babesiasis or malignant jaundice of dogs. The biologies of the ticks in this group are quite similar to that outlined for Ixodes and need not be repeated. With most species the molts are passed off the host. *R. bursa*, the sheep tick, and *R. evertsi*, the horse tick, of South Africa, are exceptions, the larval molt being passed on the host and the nymphal molt on the ground. For the most part, the ticks of this group are general feeders.

The Genus Amblyomma.—This group reaches its maximum development in South America. In the United States we have three species of some economic importance. The Lone Star tick, *A. americanum* Linnaeus, is the commonest of these. It is widely distributed through the country and extends into South America. The females are readily recognized by the single white spot on the scutum, from which the common name is derived. All of our species are general feeders and attack man freely but are not known to carry disease. In tropical America, *A. cajennense* Fabricius is tremendously abundant and is often the cause of much annoyance to man, the larvae and nymphs attaching to the skin by the hundreds and frequently ulcerated sores develop from scratching. The best known species of this group all drop from the host to molt. Engorgement of the different stages is comparatively rapid, ranging from three days to three weeks. The Bont tick, *A. hebraeum* Koch, a South African species, is capable of carrying the disease known as heart water of sheep. Lounsbury's studies indicate that the organism of this disease does not pass through the egg but is taken up by the larvæ or nymphs and subsequently transmitted by the following stage.

The Genus Dermacentor.—This group reaches its highest development in North America. About half of the species drop from the host to molt while the others pass the molts on animals. The most important species economically is the Rocky Mountain spotted fever tick, *D. venustus* Banks (or *D. andersoni* Stiles of many authorities²). This species drops

²The editor has chosen to adopt *andersoni* as the name for the Rocky Mountain spotted fever tick on the grounds of priority and absolute identification. (See footnote on this species in Chapter XXIX, p. 409.—W. D. Pierce.

from the host to molt and is a very general feeder in the immature stages, practically every rodent of the region being attacked. The species is widely distributed in the Rocky Mountain and intermountain region, but the disease of man which it carries is somewhat more limited in range. In the Bitter Root Valley in Western Montana occurs the most virulent form of the disease. Investigations conducted by the Bureau there, indicate that the adult ticks develop almost exclusively on the larger domestic animals and this point has been utilized in control. In other regions, however, the jack rabbit plays a considerable part in the engorging of adults. This species is commonly known as the "wood tick" and in the region where spotted fever is not known it is considered of little importance, although occasionally it becomes so abundant as to injure live stock through irritation and blood loss. It also occasionally produces a form of paralysis in man and animals.

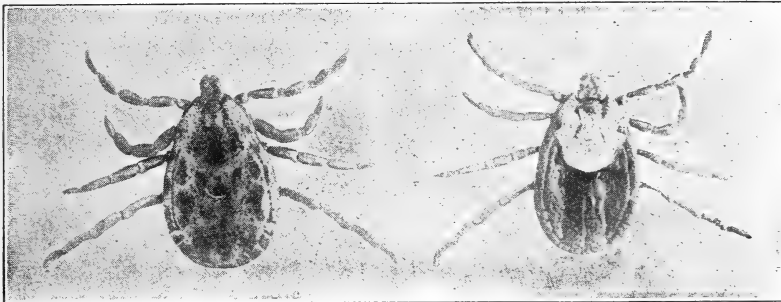

FIG. 86.—The Rocky Mountain Spotted Fever Tick, *Dermacentor andersoni* (Bishopp.)

The larvae are comparatively short lived but the nymphs and adults live for many months. In fact it is possible for individual ticks which have access to hosts in the nymphal stage to live so long as to carry the species over three years. The larvae develop on the animals in from three to eight days and these molt their skins in from one to three weeks. The nymphal engorgement is practically the same as in the larval stage, but the molting requires from eleven days to two months or even longer. The females become filled with blood in from one to three weeks. From 4,000 to 7,000 eggs are deposited. The winter is usually passed in the nymph and adult stages, and these stages, especially the adult, are markedly active in the spring months. Seldom are any of the adults to be seen on hosts after the middle of July, and practically all cases of spotted fever occur in March, April and May. The disease may pass from one generation to the next through the egg and all stages are capable of transmitting the malady. However, the immature stages are seldom found on man and only occasionally on the large domestic animals.

The species is very variable in abundance, wooded or brushy lands being most favorable for it, particularly when close to cultivated fields, and of course where small mammals are present upon which the immature stages may engorge, and domestic animals for the engorgement of the adults.

Other species of *Dermacentor* include the American dog tick, *D. variabilis* (Say) Banks, which occasionally attacks man, and the Pacific Coast tick, *D. occidentalis* (Marx) Neumann, which infest various hosts, including man, in the Pacific region. The life histories of these species are quite similar to that of the spotted fever tick. Many animals serve as hosts, especially for the immature stages.

The winter tick or elk tick, *D. albipictus* Packard, is a representative of the group which remains on the host to molt. This form is often a serious pest of horses and cattle and is probably the cause of the death of many elk on account of its occurrence in great numbers on the animals during the winter season. The eggs hatch in the summer or late fall and the ticks attach in the long winter coat of the host, becoming mature and detaching in one to three months.

In tropical America another species of *Dermacentor*, *D. nitens* Neumann, is often the cause of considerable annoyance to horses by its attack of that host deep in the ears.

It was first suggested that a simple scheme for the separation of the more important species by morphological characters, host, and distribution might be desirable, but on further consideration this idea was dropped. In the first place, it is very essential, especially in considering disease transmission, that the exact species of the possible vector be determined. This can always be accomplished best by submitting specimens to a specialist. In the second place there is a general lack of familiarity among sanitarians and even among entomologists with ticks and the characters utilized in distinguishing different forms.³

In collecting specimens it is well to attempt to secure both sexes. The males are usually rather smaller and less conspicuous than the females, especially when the latter are engorged. The specimens may be preserved in 70 per cent alcohol or 3 per cent formalin solution.

BIBLIOGRAPHIC REFERENCES

Literature on ticks has become quite voluminous. Fortunately there is a very complete bibliography available. This appeared in two parts,

³ The writer (Box 208, Dallas, Texas) is prepared to make determinations of the ticks of North America on short notice. In Europe there are a number of systematists in this group. Dr. G. H. F. Nuttall of Cambridge University, Cambridge, England, would no doubt be glad to determine specimens sent to him. Professor L. G. Neumann, Laboratoire d'Histoire Naturelle, Toulouse, France, is a leading tick authority on the continent. Prof. C. P. Lounsbury, Pretoria, South Africa, is well acquainted with the ticks of that region.

July, 1911, and May, 1915, as a part of "Ticks. A Monograph of Ixodoidea" by Nuttall, Warburton, Cooper, and Robinson (Cambridge University Press). Those who wish to go into the systematic or biologic studies of ticks further should consult the monograph above mentioned. Three parts of it have been issued. These cover the Argasidæ and the genera *Ixodes* and *Hæmaphysalis*. Dr. Nuttall has also published a number of important papers on habits and notes on biologies of the ticks. Most of these appeared in the *Journal of Parasitology*, Cambridge. In South Africa, Prof. C. P. Lounsbury has done a large amount of work, especially on the biologies of ticks. Many of his articles appeared in the *Agricultural Journal* of Capetown, in the *Transvaal Agricultural Journal*, and in the reports of the Government Entomologist, Cape of Good Hope Department of Agriculture. A summary of Prof. Neumann's systematic work with descriptions and tables for differentiating species has been published as "Ixodidae" (in *Das Tierreich*, 26 Lieferung, published by T. E. Schulze, in Auftrage der K. Preuss. Akad. d. Wiss., Berlin, 1911. R. Friedlander & Sohn). In the United States the principal papers are a "Revision of the Ixodoidea" by Nathan Banks, 1908, Bureau of Entomology, Technical Series, Bulletin 15, and several papers on tick biologies by Hunter, Hooker, Bishopp, and Wood, the most important of these being issued as Bulletin 106 of the Bureau of Entomology.

CHAPTER XXXI

Control of Ticks ¹

F. C. Bishopp

Methods of destroying ticks may be divided into two general heads—starvation and destruction with insecticides. The former is much more limited in its practical application owing to the long life of many species of ticks and the fact that many of them are capable of developing on a number of different hosts. Furthermore, destruction with chemical agents appeals to most stockmen owing to the fact that they can actually see the destruction of individuals.

Knowing the ill effects produced by tick infestation, both through blood loss and the irritation due to gross infestations and by disease transmission, one would think there would be little difficulty in inducing people to proceed with control or eradication measures. However, this is not the case. In practically all parts of the world it has been found that stockmen will attempt to destroy ticks when they become grossly abundant but their efforts relax when the numbers are reduced to a considerable extent. In this connection it might be well to mention some of the benefits which are derived from tick control or eradication. By keeping the number of ticks reduced to a minimum, the growth of animals and the milk flow in cattle are increased. Death loss through gross infestation is avoided and, by accomplishing eradication, several of the most dangerous diseases of live stock and some of those of man would disappear. This would permit of more rapid agricultural development of many regions of the world.

By following either the method of repression or eradication, the bringing under control of the herds of live stock is an important consideration. This is greatly facilitated by fencing and clearing of brush lands. Clearing also has a direct influence on the abundance of ticks, as the worst infestations in the case of many species are to be found in lands more or less covered with woods and brush.

It is important in many instances to maintain effective quarantines to prevent the uncontrolled movement of stock and the consequent spread of the ticks which transmit disease. The effectiveness of this procedure has been fully demonstrated by the result of the quarantine maintained on

¹This lecture was prepared especially for this edition.

tick-infested cattle in our Southern States. This has prevented the ravaging of the nonimmune cattle of the Northern States by this disease, and also has the effect of hastening the eradication of the tick in the South. In South Africa quarantines are doing much to reduce the losses produced by East Coast fever, but there the control of the movement of man from infected to uninfected areas is also needed, though not easily enforced. The infected ticks may also be shipped in hay cut on infected meadows.

With many species of ticks which have the habit of developing in one or more stages on wild animals, the question of the destruction of such hosts is at once apparent. Fortunately in the case of our cattle tick in the Southern States these wild animal hosts play a very unimportant part in the maintenance of an infestation, and, in the instance of the Rocky Mountain spotted fever tick and a number of ticks concerned in transmitting East Coast fever of Africa, and other species, much can be accomplished by the systematic treatment of domestic animals with little attention being given to the destruction of native hosts. However, with the majority of species the control, and especially eradication, can be facilitated by the destruction of wild hosts.

Since the procedure necessary to accomplish the destruction of ticks must be varied according to the habits of the species concerned, the discussion will now be taken up by species.

The Cattle Tick, Boophilus annulatus, and Varieties of the Species.—The accomplishment of our own Department of Agriculture in the eradication of this tick in the Southern States is especially notable and presumably familiar to all. In this eradication work, which has been carried on by the Bureau of Animal Industry, the dipping of cattle has been relied upon almost exclusively. However, since it is both possible and practical to accomplish eradication of this species by the starvation plan and since this method may be utilized in a practical way, in combating other species, those concerned with tick control should become familiar with the principles involved. The system is dependent essentially upon the proper division of the farm by fences usually placed 10 or 15 feet apart to avoid infestation from one field to another, and the knowledge of the time required both for ticks to complete development on the host and for the seed ticks to die from starvation under different seasonal conditions when proper hosts are not present for them to feed upon. By various modifications of the plan the cattle and certain fields on the farms may become tick free in from 4½ to 9 months. The entire farm will be tick free in from 13½ to 15 months.

Destruction of ticks by the use of chemicals has been practiced for many years and hand dressings with various decoctions have been resorted to in reducing gross infestations. Spraying is practiced where but few animals are treated, but dipping must be relied upon if large numbers of

animals are to be treated, or if complete destruction of ticks is to be accomplished.

Dipping vats of various designs and built of several kinds of material have been utilized. The size of course is dependent somewhat on the number of animals to be treated. The question of vat construction is discussed in several bulletins of the Department and these should be consulted by those contemplating vat building.

In the early days of tick control work crude petroleum was utilized almost entirely against the cattle tick, but this had many disadvantages. At present arsenicals are relied upon exclusively. These consist of either sodium or potassium arsenite. The usual formula used in making up the dip is as follows: Sodium carbonate (sal soda) 24 pounds, arsenic trioxide (white arsenic) 8 pounds, pine tar one gallon, and water to make 500 gallons. Under certain conditions a stronger dip, consisting of 25 pounds of sal soda and 10 pounds arsenic, is used. A concentrated or stock solution is made by dissolving the sal soda in about 25 gallons of water, adding the white arsenic and boiling until it is all combined; then after cooling the dip to about 140° F. the pine tar is slowly added while stirring.

Several modifications of this dip and methods of making it have been introduced, among them the addition of caustic soda to produce the combination of the arsenic and sal soda without boiling. The self-boiled dip is prepared in two parts which should not be combined except in the diluted condition in the vat. These are the arsenic stock and the tar stock. The ARSENIC STOCK is made as follows: Caustic soda (at least 85 per cent pure, dry, granulated) 4 pounds, white arsenic (99 per cent pure) 10 pounds, sal soda (crystals) 10 pounds. In a large metal container place the 4 pounds of caustic soda, add one gallon cold water and stir until the caustic is practically all dissolved. Immediately begin adding white arsenic, a pound or two at a time as fast as it can be dissolved without causing boiling. If the mixture begins boiling stop stirring and cool slightly before adding more arsenic. If the proper kind of chemicals are used a clear solution, except for dirt, should result. When the solution is cool add cold water to make 5 gallons. This stock solution may be used immediately or kept indefinitely. The TAR STOCK is prepared by dissolving $\frac{3}{4}$ of a pound dry caustic soda in 1 quart of water, add 1 gallon pine tar and stir until a uniform fluid resembling molasses results. It should mix perfectly with water. In filling the vat, first add the necessary amount of water then add the concentrated dip in a thin stream in various parts of the vat. The tar stock should be mixed with several times its volume of water before being added to the vat. Stir the mixture in the vat thoroughly.

Another modification of this dip which should be mentioned is the

addition of soap and kerosene oil. This was devised by Watkins-Pitchford for the frequent dippings necessary to destroy ticks in South Africa. It has been utilized also by the Bureau of Entomology in the weekly dipping of animals against the spotted-fever tick. The destructive effect of the material on the tick is increased and the caustic action on the host is reduced by this addition. This formula is as follows, English measure: Arsenite of soda (80 per cent arsenious oxide) $8\frac{1}{2}$ pounds, soft soap $5\frac{1}{2}$ pounds, paraffin (kerosene oil) 2 gallons, water 400 gallons.

It is important that the proper strength of the solution be maintained at all times, both to secure efficiency in tick destruction and to avoid injury to the stock. A simple outfit has been devised by the U. S. Bureau of Animal Industry for determining the percentage of arsenic present.

To accomplish the eradication of the cattle tick the frequency of dipping is important. It should never be longer than the period required for the ticks to become mature and drop from the host. This is about 20 days. Usually it is safer to dip at intervals of two weeks. Eradication may be accomplished if systematic dipping of all stock is kept up for a period of about six months in the summer, or sufficient time to allow all of the seed ticks which have not gained access to the host to die of starvation. Thorough dipping of every individual is important; the animals should be completely submerged.

Owing to the poisonous effect of arsenicals, both when taken internally and under certain conditions when applied externally, the following precautions should be exercised in dipping live stock. Have the bath of the proper strength, water the animals a short time before dipping, avoid heating the cattle by long drives or otherwise just before or after dipping, dip during the cool part of the day or provide shade when convenient. The latter point is not nearly so important in connection with the use of arsenicals as with oil dips. The poisonous effect of arsenicals has been mentioned in dealing with the control of cattle lice. It need not be dwelt upon further here. It is certain that dipping in arsenical solutions is the most satisfactory method of destroying ticks and lice of all kinds on cattle and horses, and the experience of stockmen in the South in connection with the cattle tick eradication indicates that, if the proper precautions are exercised, thousands of cattle may be dipped without the loss or injury of even a single animal.

The Rocky Mountain Spotted Fever Tick.—As was pointed out in the lecture upon the biologies of ticks this species has the habit of dropping from the host for each of its molts. It also develops on a large number of different species of animals, but the adults, especially in the Bitter Root Valley where the disease is the most virulent, practically all engorge on the larger domestic animals. This species appears to be

somewhat more resistant to arsenical dips than the cattle tick, and it was found best to add kerosene emulsion to the arsenical, following the Watkins-Pitchford formula. In order to prevent the dropping of replete females, the dipping must be practiced at weekly intervals. Fortunately the spotted fever tick confines its activity in the adult stage to the spring months, so that it is not necessary to continue the dipping later than about the first of July.

Since practically all of the immature stages of this species develop on small rodents, notably the ground squirrels, wood rats, pine squirrels, rabbits, etc., the importance of rodent destruction, both from the standpoint of tick control and protection of crops, is apparent. In much of the territory where the spotted fever tick abounds, it is, however, impracticable to reduce the number of rodents to a very low point. In other words, in the scheme of eradication dipping of live stock should come first and the destruction of rodents be taken up as a secondary step.

Aside from the destruction of this tick on animals, it is necessary for man to protect himself against its attack. This can be accomplished to some extent by avoiding cut-over woodlands or brushy areas, by wearing clothing calculated to exclude the ticks and by examination of one's person at frequent intervals. It was found by Dr. Ricketts that a tick must be attached to a guinea pig for one hour or longer to produce the disease, thus it would seem that there is little danger of infection in man if the ticks are removed promptly. Since no successful remedy for the treatment or prevention of the disease has been devised, the importance of exercising care in preventing infection by keeping free of ticks can not be too strongly emphasized.

The Spinose Ear Tick.—We are concerned with this species both on account of its injurious effect on horses, cattle, dogs, and other animals, and the frequency of its attachment in the ears of man. Furthermore we should be familiar with this tick since a considerable part of our military activities in this country have been and will probably continue to be in the Southwest where the species abounds.

It is probable that by exercising some care in locating camps and in choosing places for sleeping, some degree of immunity from attack will result. The seed ticks are, of course, concentrated about feed lots, corrals and watering places of live stock and these should be avoided in choosing a camp site.

The effect on animals of heavy infestations of this species is very marked. The ears are droopy, the hair rough and the animal presents an unthrifty appearance. Fattening is difficult if not impossible, and under range conditions the loss by death is not infrequent. In horses and mules there is a marked shyness on the part of the animals when attempt is made to touch the ears or put on a bridle. This is sometimes so extreme

that it is almost impossible to halter or bridle an infested animal. In man there are seldom more than one or two ticks present, yet the pain is described as excruciating at times, and a sensation of tickling, ringing, and fulness at others. The ticks are usually so far in the ear that they can not be discerned readily from the outside and hence frequently they are overlooked for weeks.

In man the removal of the ticks with forceps will usually give complete and permanent relief. In horses and cattle mechanical removal with a rather blunt instrument may be practiced, but in general it is better to depend upon the application of some material to destroy the ticks. Unfortunately the dipping of live stock in the ordinary tickicides will not reach or destroy this species, hence we must depend upon individual treatment. The Bureau of Animal Industry (Farmers' Bulletin 980) has found that a mixture of pine tar and cottonseed oil (2 to 1) will destroy all ticks if properly worked into the ear. It may be applied with a long-spouted oil can or hard rubber syringe, the base of the ear being manipulated as the material is injected. About one-half an ounce is required for each ear. It also has the advantage of protecting the animals against reinfestation for about a month.

The Chicken Tick.—Although this is an important poultry pest, the comparative freedom of man from its attack will not justify a lengthy discussion here. While spirochaetosis of fowls, known to be carried by this species, appears not to be present in the United States, it is a source of considerable loss in many other parts of the world, in the tropics and subtropics. In this country the main loss is due to the weakening of the fowls by the loss of blood and irritation. This often is sufficient to completely stop egg production, reduce the fowls in flesh, and sometimes cause death.

Owing to the resistance of this species to the action of chemicals, and on account of the habits of the species, it has been found best not to attempt to destroy the larvae while attached to the host but to proceed against the infested roosting or nesting places of the fowls. In one instance only is it necessary to give consideration to the individuals, and this is in protecting an uninfested yard or premises from introduction of the tick in the seed tick stage on poultry. Fowls brought in should be kept in quarantine in a crate or small yard for about ten days. During this time all of the seed ticks upon them will have become engorged and hidden in the roosting places and may there be destroyed by fire or some material as recommended for treating roosts.

It usually pays to destroy heavily infested houses which are of little value. In other cases, the houses should be thoroughly cleaned and sprayed with the wood preservative known as carbolineum, or with crude

petroleum (plate XXVIII). It is usually best to thin each of these substances with one-third kerosene. Following this treatment a simple roost (fig. 87) should be constructed, preferably supported by four posts driven into the ground or attached to the floor, the roost poles being held in place by notches on cross bars resting in similar notches in the supporting posts. None of the roosts or supports should touch the walls. One or two applications of the carbolineum or petroleum to these roosts with a brush will usually suffice in destroying the infestation, although it is advisable to make frequent examinations to determine if all of the ticks are destroyed. The chicken mite *Dermanyssus gallinae* is controlled by the same procedure.

Other American Species of Ticks.—There are several other kinds of

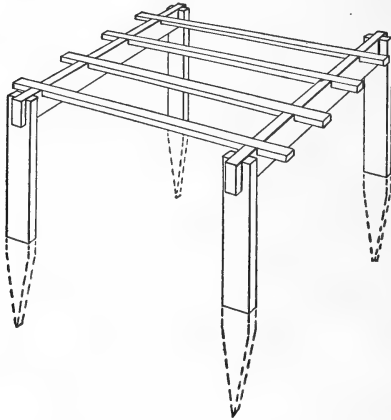

FIG. 87.—Model chicken roost (Bishopp).

ticks of economic importance in this country. Among them should be mentioned the Lone Star tick which is frequently met with in the South, East, and Central States; the Gulf Coast tick which produces considerable irritation by attacking the inside of the external ear of horses and cattle in the coastal region; the tropical horse tick which is to be found only in extreme southwestern Texas, usually attached deeply in the ears of horses and mules; and the widely distributed American dog tick which is sometimes sufficiently abundant to greatly annoy man and other animals. All of these species except the tropical horse tick, drop for their molts and are therefore rather difficult to control. Dipping in arsenicals, especially if carried out at weekly intervals, will of course reduce their numbers considerably. In regions where dipping vats are not generally available, hand picking or the application of kerosene emulsion, some of the creosote stock dips, or arsenical dips with a rag or spray pump are advisable. The treatment of dogs should receive special attention. The tropical

horse tick requires local treatment similar to that for the spinose ear tick.

South African Ticks.—In South Africa the so-called blue tick, a variety of our common cattle tick, carries bovine piroplasmiasis and probably other diseases and may be controlled by the same procedure outlined for our species. However, in South Africa this is not considered the most

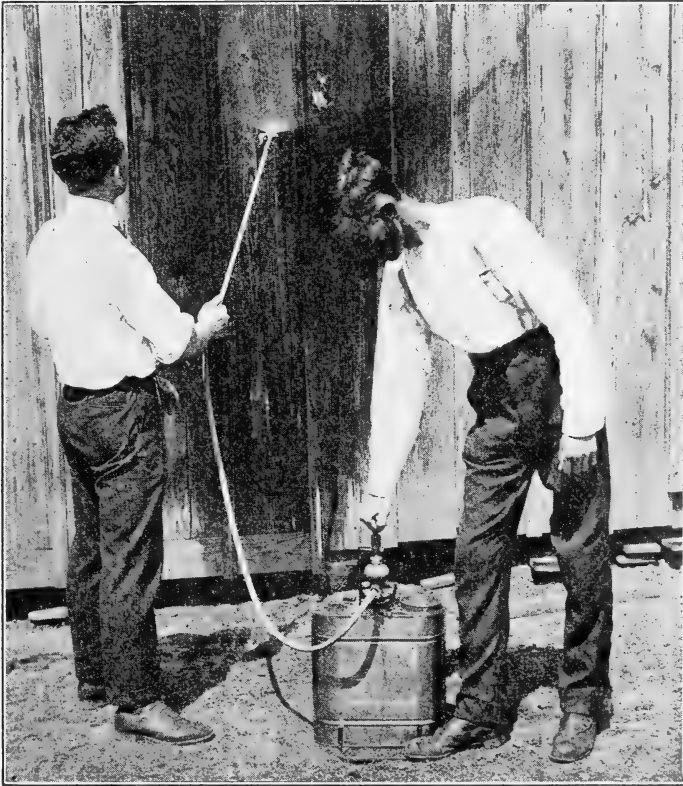

PLATE XXVIII.—Spraying chicken house with oil by means of knapsack spray pump. (Bishopp).

important tick parasite of live stock, since certain species of *Rhipicephalus* carry the much more deadly disease, East Coast fever. Since the immature stages of the brown tick (*R. appendiculatus*), the principal agent in the dissemination of the disease, become engorged and leave the host in three days or less, it becomes necessary to dip at very short intervals to prevent the escape of specimens which may infect other animals. The larvae or nymphs which engorge on cattle infected with East Coast fever are the only direct source of propagation of the disease in other animals, hence the main attack must be directed against them.

Watkins-Pitchford found that these stages can be killed with dip much weaker than is necessary to destroy the adults. He thus determined on a strength which would destroy these young stages with one dipping and yet produce no injury to the host if applied at three-day intervals. The adults are subjected to two dippings, as they remain on the host 7 days. This was found to give 100 per cent destruction. The formula (English measure) for this dip is: 4 pounds arsenite of soda (80 per cent arsenic), 3 pounds soft soap, 1 gallon paraffin, 400 gallons water. The majority of stockmen, however, do not resort to either the three- or five-day dipping except when in fear of an outbreak of the disease. There is no doubt that by dipping at weekly intervals during the warmer period of the year and at intervals of two or three weeks through the cooler weather, if practiced consistently for two or three years, the ticks can be reduced to a negligible quantity, if not eradicated.

African Relapsing Fever Tick.—While this species has received considerable attention from the disease transmission and biologic standpoint, little work has been done on control practices. No doubt control of the tick in native huts will be very difficult on account of lack of interest and cooperation on the part of the natives; however, it would appear to be comparatively easy to protect the houses of white inhabitants from infestation, and for the traveler to avoid attack. The latter could be accomplished best by avoiding infested huts and improvising methods of isolation either in hammocks or otherwise. In native villages the free use of strong tickicides on the floors, and cleaning and airing of mats would undoubtedly reduce infestation and of course the provision of some sort of isolated bedsteads, which suggestion would probably not be taken up by the natives, would also prevent attack.

The Control of Ticks in Other Parts of the World.—In Australia much progress has been made in the destruction of the cattle tick, but in other parts of the world outside of the United States little systematic work has been done against ticks. The hand application of insecticides or hand picking of adult ticks has been the principal method followed. No doubt many of the control practices put into effect in this country could be adapted to European and Asiatic conditions.

Treatment of Tick Bites.—There are many references in literature and popular ideas regarding the painfulness and poisonous nature of bites of various species of tick. Literature contains references to deaths within a few hours following the bite of some tick in the region of Persia. In Mexico there is also an opinion entertained that certain species of *Ornithodoros* produce very painful, if not deadly bites. In the experience of the writer and various other workers, most of these reports appear to be unfounded or exaggerated. No doubt the effect varies in different individuals and possibly there is a relationship between the symptoms pro-

duced and the kind or health of the host upon which the tick has been feeding previously. Certainly some species of ticks produce forms of paralysis, authentic cases having been recorded as resulting from the bite of the spotted fever tick, and in the case of certain other species in South Africa and Australia. It thus appears important that tick bites be avoided as far as possible, and should paralytic symptoms develop, a search of the patient for ticks, especially around the occiput, should be made immediately.

In regions where tick-borne diseases are known to occur, it is advisable to treat the bite with iodine or some other antiseptic. In the absence of a physician, this may be done by inserting the point of a sharpened tooth pick or match after it has been dipped in the iodine, in the place where the proboscis entered. Before treatment, examination should be made to be sure that the mouth-parts are completely removed, as they sometimes break off when pulling out the tick.

LIST OF REFERENCES

- Chapin, R. M., 1914a.—Arsenical Cattle Dips. U. S. Dept. Agr., Farmers' Bull. 603, 16 pp.
- Chapin, R. M., 1914b.—Laboratory and Field Assay of Arsenical Dipping Fluids. U. S. Dept. Agr., Bull. 76, 17 pp.
- Cooley, R. M., 1911.—Tick Control in Relation to Rocky Mountain Spotted Fever. Montana Agr. Expt. Sta., Bull. 85, 29 pp.
- Graybill, H. W., 1912.—Methods of Exterminating the Texas Fever Tick. U. S. Dept. Agr., Farmers' Bull. 489, 42pp.
- Hunter, W. D., and Bishopp, F. C., 1911.—The Rocky Mountain Spotted Fever Tick. U. S. Dept. Agr., Bur. of Ent., Bull. 105, 47 pp.
- Theiler, A., 1909.—Diseases, Ticks and Their Eradication. Transvaal Agr. Journ., vol. 7, pp. 685-699.
- Theiler, A., 1913.—Inquiry into Dips and Dipping in Natal. Agr. Journ. Union of South Africa, vol. 4, pp. 814-829 (1912) : vol. 5, pp. 51-67, 249-263.
- Watkins-Pitchford, R., 1911.—Dipping and Tick-Destroying Agents. Agr. Journ., Union of South Africa, vol. 2, pp. 33-79, with figs., July.

CHAPTER XXXII

Flies and Lice in Egypt¹

H. A. Ballou

Egypt, among its other characteristics, is a land of flies. Whether they have been abundant there ever since the days of the plague of flies of Moses and Rameses may be open to argument, but there can be no doubt that in these times the abundance of flies is one of the things that strikes the visitor to the land of the Pharaohs.

I had the good fortune to live in a small village where flies were not very troublesome, and that, in spite of the fact that a fairly large veterinary camp was situated in the village. This camp was in charge of British Army officials and the village itself had been planned and built by a company, most of the stockholders and officials of which were British subjects, if not indeed actually natives of Great Britain.

The native villages in the agricultural districts and the native sections of all the large cities and towns are, and I suppose always have been, infested with swarms of flies. This state of affairs results from the manner of living of the people, the nature of their religion and their superstitions. As to the first of these points, the Egyptians have always been an agricultural people, that is to say, they live on the land and by the land. Most of them are peasants or small proprietors, a comparatively few are wealthy. In the past few years a fairly large number of them has become well-to-do.

Egypt is a country practically without a rainfall. Within present geological time it has never been forested. The people throughout the whole of their history have been accustomed to live in dirt and dust, and they have not had wood for building houses or for fuel. They live in houses of sun-dried mud and they burn for fuel the manures of their domestic animals.

The space available for village sites is limited to slightly elevated spots, which are generally too high to be irrigated and are thus useless for planting, and they are to some extent above the reach of flood and infiltration of water. Very often these mounds are the covered-down ruins of forgotten cities or towns. The houses are close together, often

¹This lecture was presented to the class Oct. 7, 1918. It was written immediately after Dr. Ballou's return from Egypt and gives a good idea of an unsanitary nation.

there are no proper streets and the villages are walled about as a protection against thieves and robbers. There are usually no barns or sheds for the animals and these are sheltered in the houses with the family or on the house top.

The dung for fuel is mostly made up into small cakes and these are dried in the sun and stored in the houses, often in an ornamental parapet. For making these cakes the dung of cows and the water buffalo is used. This is mixed with leaves, straw, etc. Horse or donkey manure is used by itself, mostly as a fine dry dust to produce a quick fire for baking. It will be seen from this that the Egyptian has no idea that manure is unclean as we understand it. In the absence of rain, the Egyptian village is always dusty and the dust is a mixture of soil, manure, and anything that can be dried by the fierce sun into dust.

The Egyptian has no idea of sanitation. It is one of the commonest sights in all parts of Egypt where I have been, to see in the morning hours the men squatting in the open for their morning relief. The very wealthy and the residents in the larger towns and cities may have some form of privies, but the open field is the habitual scene of operation for the great bulk of the people. They have no more idea of the proper disposal of garbage of any sort than of the manure of their animals and their own ordure.

The moisture necessary to maintain all life in these situations comes from irrigation canals supplied by the waters of the Nile. Every village is situated on or near a canal which supplies drinking water, serves as a place for washing clothes, for bathing, and as a place for disposing of anything that is to be thrown away, from a dead calf to a broken water vessel.

As to the second point. One of the tenets of the Mohammedan religion is that the good Muslem is not allowed to take life, not even of the least of God's creatures.

In connection with the third of these points, it need only be stated that the Egyptians are very superstitious about the Evil Eye. This applies particularly to the children, who must not on any account be admired or called pretty. It would be difficult to keep them clean, but nobody wants them to be clean.

It is unnecessary to give details as to the degree of fly infestation that may be seen in a native village or in the native quarters of the towns and cities. The relations of flies and children may be mentioned.

Very young children are often to be seen with their faces so covered with flies that it is difficult to tell the color of the child's skin. They swarm in the eyes, nostrils and mouth, and cover the whole face. I have often seen a small child being held or tended by another not much bigger, raise its hand to brush away the mass of flies on its face and be prevented

from doing it. They are from the earliest childhood accustomed to the presence of these insects, and after being prevented from disturbing them during the early months of life they do not seem to mind them.

As a result of this condition of things, eye diseases are very prevalent in Egypt. I should not think there could be any place in the world where bad eyes are so often seen as in Egypt. The natives are often short-sighted. For instance, very few of them can read their newspapers without bringing them up to two or three inches of their eyes and then it is obvious that only one eye is used in reading. It is a curious sight to see these people reading in the trains and other public places.

This condition is probably the result of some form of ophthalmia and is quite different from the one-eyed condition so often seen in Egypt in consequence of wilful mutilation of an eye for the purpose of evading military conscription or the payment of the small sum required to purchase exemption.

THE SULTAN'S FUNERAL

On the day of the funeral of the late Sultan, His Highness, Hussein Kamil Pasha, in October, 1917, a party of us gained admission to a balcony overlooking the street in the business part of Cairo. When we arrived, there were a number of people already there. They seemed to be Italians or perhaps Syrians, we couldn't tell. They spoke French.

Among them were a number of children, six or seven in number, the eldest being about 16 or 17 years and the youngest some 7 or 8 years of age. After a time I noticed in the hair of the eldest, a girl of the brunette type with very dark hair, a whitish streak across the side of the head from near the forehead well back to where the hair was gathered into the long braid which hung down her back. This white streak must have been about an inch and a half to two inches in width and some five or six inches long. I saw that the whitish appearance was due to the presence of masses of nits of the head louse. I then noticed the heads of the other children there and found that they were all the same. Every head was full of nits.

I actually saw the lice crawling about in the hair of these children, and though I watched them pretty constantly for about two hours, except for a few minutes when some parts of the funeral procession were passing, I did not once see anyone of them attempt to scratch or in any way take notice of the irritation which must have been caused by the lice.

The general appearance of these children was one of a fair degree of neatness and cleanliness, and yet they were so inured to the attacks of these parasites that they paid not the slightest attention to them. I have never seen anywhere such a heavy infestation of these vermin.

CHAPTER XXXIII

Insects in Relation to Packing Houses ¹

E. W. Laake

Before the meat packing establishments of the United States were placed under government inspection, there was very little attention paid to insects and their control in such establishments, unless there was a direct loss to the packer, and even then only such methods as were necessary to meet the immediate situation, rather than the requirements of permanent sanitation, were employed. During the first years following the institution of inspection by the Bureau of Animal Industry under the law of 1906, packing plants were remodeled or rebuilt according to government specifications, and conditions were vastly improved from a sanitary standpoint, although the insect question was not handled vigorously until during the past few years. The importance of safeguarding from contamination and infection the millions of tons of meat and meat products prepared by the numerous packing houses in the United States is indeed a task worthy of attention, especially during the present time when our products are so direly needed at home and abroad. That insects play as great a rôle by contamination or actual destruction of meats and meat products as they do in other branches of agricultural industries, is easily demonstrated when one becomes familiar with the ravages of these pests in the numerous establishments in our country.

Flies are the principal cause of annoyance and loss around packing houses. The house fly is probably of first importance. It is especially troublesome around the loading docks, in sausage kitchens and in markets. The blow flies are often very abundant, especially in departments handling inedible materials. In this country the black blow fly, *Phormia regina* Meigen, is probably the most important. The green bottle flies, *Lucilia sericata* Meigen and *L. caesar* (Linnaeus), rank second, and in the southern half of the United States the screw worm fly, *Chrysomya macellaria* (Fabricius), is the predominant species in the summer months. Others concerned are the bluebottle flies, *Calliphora* spp. and *Cynomyia cadaverina* Robineau-Desvoidy; flesh flies, *Sarcophaga* spp.; *Muscina stabulans* Macquart, *M. assimilis* Fallén, *Ophyra* spp., *Chrysomyza* spp., and the

¹This lecture was read July 29, and issued August 8, 1918, and is now reproduced practically in its original form.

skipper fly *Piophilina casei* Linnaeus. Hide and ham beetles, mostly of the family Dermestidae, are of local importance, especially as destructive to hides. The three common cockroaches are to be found, especially the American roach and the Croton bug.

Associated with all the larger packing houses are large stock yards, horse and mule barns, rendering plants, and thickly populated districts, all of which are prolific insect breeding places. These furnish part of their millions of flies, with those produced on the premises of the packing plants themselves, to constantly attack the fresh products of the establishments. Sanitation throughout the establishments and premises under government inspection, and in railway cars and other vehicles used in transporting meats, is rigidly enforced, but government inspectors have no jurisdiction over sanitary matters beyond that, no matter how bad the existing conditions may be.

With efficient city health departments a great deal can be done cooperatively with the sanitary force of the packing establishments, but this is not always possible and as a result the production of myriads of flies goes on constantly in the immediate neighborhood of the plants and the task of protecting meat products and controlling flies at packing houses becomes proportionately more perplexing. In our Southern States this is an all-year-round work; due to the fact that our winters are rarely sufficiently severe to cause the death of immature stages and during warm days numerous adults emerge and seek food and protection in the constantly heated tankage and blood-drying rooms or other favorable departments. Here they also find large stores of excellent breeding material and can develop to maturity in a comparatively short time during the winter months. The breeding of blow flies in large accumulations of tankage and blood in drying rooms, as it is found in many packing houses, may take place during the winter even in the more northern latitudes as there are many species of blow flies that are quite resistant to cold and have the advantage of many warm, protected places during severe winter.

That flies are carriers of many different diseases is well known. The germ-laden flies can easily contaminate many different cured meat products which are sometimes consumed without being cooked, or contaminate fresh meat products with putrefactive, non-pathogenic and pathogenic bacteria, in this way hastening decomposition, and rendering the meat unfit for food. There is also loss of much meat that is "blown" with eggs or damaged by skipper fly larvæ.

Next in importance to flies in meat packing establishments are cockroaches. Although they are not as numerous as flies, they are present in almost all establishments just as they are more or less plentiful in dwelling houses. The damage done by cockroaches is due not so much

to what they actually consume, which is necessarily a small amount, but to losses of portions of food which are contaminated and rendered nauseous. The presence of roaches leaves a fetid odor which is persistent and foods so tainted are almost beyond redemption. This odor comes chiefly from a dark-colored fluid excreted through the mouth of the insect and perhaps also from the scent glands occurring between certain segments on the bodies of both sexes, from which an oily liquid of a disagreeable odor is secreted. Favorable conditions for the existence of cockroaches are found within all packing houses, namely, abundant food supplies of all kinds, good protection in the winter, and many good breeding places.

Skipper larvae and hide beetles are often found by the millions in the bone storage houses, especially in stores of bones collected at large in the country, where pieces of dried muscular tissue and skin are attached. These insects are not so often found in the department of edible supplies of the packing plants, as the packers are well aware of the damage done by them, especially in cured and dried products, and a constant watch is kept to prevent their appearance or to quickly exterminate them when they do appear in such departments.

INSECT-BREEDING PLACES AND THEIR TREATMENT

The importance of proper construction and arrangement of abattoirs and packing plants with a view to eliminating insect breeding places and protecting the food products from insect contamination can not be overestimated. In plants already in operation many bad fly-breeding places can be permanently eliminated by construction work. For instance much future trouble can be avoided by constructing concrete catch basins, paving docks, loading tracks, and stock pens, providing adequate driers for bones, fertilizers, etc., and ample dry storage facilities for inedible products. Excellent breeding media of both vegetable and animal matter are almost constantly present and are often found in huge quantities in various places on the premises of establishments or on "dumps" near the plants. Too often these large accumulations are neglected for some cause or other, and insects, especially flies, have ample time to develop and emerge by the millions, and many such places, especially those not under government supervision, are constant producers of myriads of flies throughout the warmer seasons of the year.

The undigested food of cattle, called paunch manure, and the contents of hog stomachs, together with the horse manure and stable cleanings from the horse barns, partly blood-saturated sawdust from the meat coolers and sediment from catch basins saturated with bloody water, are usually hauled to a general dumping ground. These dumps are thus

rendered very attractive to house and blow flies and nearly all of this material is wet when it is dumped and must have a day or two of hot weather in order to dry sufficiently to burn well. If it remains as long as four days before burning, which is often the case during rainy weather, fly larvae have sufficient time to develop before the material becomes dry enough to be burned, and migrate to a nearby place where they enter the ground and complete their life cycle.

For the destruction of paunch manure, etc., incinerators of various types are used by some packing plants and stock yards. At Omaha, Nebraska, the Stock Yards Company has erected a huge incinerator of a special type that contains sixteen large cells equipped with water pipes throughout. As the contents of some of the cells are slowly burning, the water pipes are heated and the hot circulating water dries the contents of the freshly filled cells which are later also slowly burned. The ashes and charred material are then removed, mixed with finely ground, dry, sheep manure and sold for fertilizer. At least six men are constantly employed filling the cells and removing the charred contents and the returns realized from the fertilizer are said to be sufficient to pay for all labor and pay a reasonable amount of dividends on the investment of the incinerator plant, which was erected at a cost of \$40,000.

Other types of incinerators in use, which are operated mostly by packing plants for the disposal of paunch manure and refuse of all kinds, are single and double cell brick structures where everything is completely consumed and the ashes are used for fillers of various fertilizers. At Chicago one plant hauls all its paunch manure and refuse on railroad cars a short distance away to an incinerator made of a series of old discarded iron rails which slope from the top of the track embankment to the ground, leaving a considerable air space below. Here a fire is constantly kept burning and consuming the manure and waste piled on the rails above. Ashes filling the space below the rails are removed when necessary and are mixed with other fertilizers. At a few large plants the paunch manure is loaded daily on railroad cars and is shipped out two or three times a week to places in the country where the manure is sold to truck farmers. The trackage beneath the cars along the loading docks is paved with concrete to prevent full grown larvæ from escaping from the loaded cars when they are held over several days. The paving extends well around and beyond the length of the cars and near the outer edge it is provided with a narrow, deep gutter filled to half its depth with water where it is connected with the sewer. This arrangement carries off the excess water and traps the maggots as they endeavor to migrate to a place for pupation.

When treatment of infested dumps is necessary, borax solution or crude oil is mostly used. Spent fuller's earth, a waste product from oil

and lard refineries at packing houses, is also used at some plants with fairly good results, if the earth is thoroughly mixed with the paunch manure and waste, or is used as a covering. Spent fuller's earth, when it is discarded at the refineries, contains about 8 per cent of oil and acts as a larvicide besides being a repellent for several days. In experiments at a Dallas packing house a saturated solution of arsenic was also found to be very effective for killing larvæ in paunch manure.

Many other breeding places of importance exist around the plants, such as the hog hair, tankage, blood cooking, and drying rooms; in fertilizer buildings; along fertilizer loading docks where pulverized tankage and blood and bone meal accumulate on the ground under the docks; and along car tracks where the soil becomes moistened by rain or by open sewage disposal lines, quite often found under such docks. Often the soil so covered with moist animal matter is found to be heavily infested with blow fly larvae. Borax treatment for such infestations is very effective but must be repeated frequently as fresh material is always accumulating and is readily reinfested. Crude oil or fuller's earth applied heavily on such breeding places packs the soil down well and also renders it less attractive for flies for a much longer period. It has repeatedly been observed by the writer that where enough oil or fuller's earth had been applied there was no fly breeding going on. When the capacity of a packing plant is overtaxed, or when labor is short, large stores of bones and hog hair do not get thoroughly dried in the hot air driers and these then become heavily infested with blow fly and skipper fly larvae. The same condition is also often found in storage houses containing bones, hair, blood, and tankage that have been thoroughly dried, but again moistened by water leaking through a bad floor or bad roof above. To prevent fly breeding in any of this material it must be thoroughly dried and then stored in an absolutely dry place.

Another common source of fly production found at packing plants is under and around stick-water vats where the glue stock is manufactured. Steel and wooden vats are used for boiling stick-water and sooner or later these vats may become leaky or are heated to such an extent that the stick-water boils over and saturates the soil below. Prolific fly breeding then takes place. Borax solution or crude oil treatment for such infestations is very effective. In the stock yards the hog pens are usually all paved and the manure is washed into sewers leading to a nearby stream. In many instances the sewer outlet is not directly into the water and the manure is deposited in large quantities along the banks of streams where it becomes heavily infested with fly larvæ which develop in the moist manure, thence migrating to dry places for pupation and emergence. The manure mixed with hay and straw from cattle pens is usually hauled to nearby

dumping grounds and is there allowed to decompose, or is occasionally burned over, but very seldom incinerated.

Cockroaches are found in the blood and tankage rooms, dressing rooms, and other departments that are not under refrigeration. Modern steel and concrete construction has much to do with eliminating these insects. The use of steam and hot water in cleaning up the machinery, walls and floors of all the departments and rooms containing edible goods destroys most of them that come in during the night and do not return to their better protected hiding places in the departments of inedibles where there are also good breeding places. Where steam and hot water cannot be used freely against roaches, the dusting of sodium fluoride is very effective. About four pounds of sodium fluoride, applied with a dust gun by the writer in a dry salt cellar and tankage drying room at a certain packing house, killed over 5,000 roaches and thoroughly cleaned away the pest. A thorough inspection of these same departments months later revealed only a few roaches which probably came in from other departments of the plant that were not treated.

When skipper fly larvae are found in cured meats the products infested are trimmed and the storage rooms thoroughly cleaned, or if the infestation is severe, the meat products are rendered for inedible purposes, the uninfested products removed and the storage rooms fumigated.

PROTECTION AGAINST INSECTS

That flies can be kept out of packing houses to such an extent that they are not objectionable is well demonstrated in some of the large plants at Kansas City, Missouri; Davenport, Iowa; Omaha, Nebraska; Milwaukee, Wisconsin, and Topeka, Kansas; which are completely and thoroughly screened and remain remarkably free from flies on the inside although flies are plentiful on the outside.

For the protection of meats against skippers it is necessary to screen closely with twenty-mesh wire. It is also necessary to keep the store-rooms darkened. The use of fly traps around packing plants is fully justified. Even though everything possible is done to eliminate breeding places on the premises, great numbers of flies come from the surrounding district to the attractive conditions which are to be found around packing establishments. Our investigations have shown that flies quickly come to slaughter houses when liberated at nearly a mile distant. No doubt they often travel much farther to such establishments. Traps of various models are used extensively at packing plants and where traps are well handled great quantities of flies are captured. Accurate records kept by some plants show that as high as 285 pounds of flies were captured in

one week with 65 traps of the conical hoop type. This type is by far the most efficient all-round fly trap of some twenty different kinds tested at packing plants.

The most attractive bait for blow flies is the mucous membrane which is freed from intestines after it has become sour. At packing plants this material is known as "gut slime" and when it becomes warm it ferments rapidly, giving off a very obnoxious odor that is especially attractive to blow flies and also a very good bait for house flies. However, on account of its bad odor it cannot be used in departments of edible foods or on loading or shipping docks. Sugar or molasses, one part, to three parts of water, makes a very good bait, especially for house flies. A cheap, black molasses mixed with three parts of water and allowed to stand a day or two before it is used to bring it to fermentation is a very cheap and effective bait.

Fly paper used extensively in screened rooms catches practically all flies that have gained entrance through doors which are necessarily opened and closed where much trucking is done. Screening of some doorways which are constantly in use by in and outgoing trucks is not practicable as flies light on trucks and follow them through the doors, and soon congregate on the inside of such rooms or departments.

To exclude flies from entrances of such doorways a rapidly revolving ceiling fan or rotary blade fan operated at a high rate of speed has been found to expel flies very effectively. When they enter the air current, which should be directed down and outwardly, they are driven out through the entrance.

Where breeding places are reduced to a minimum, where the plant is well protected by thorough screening, and where flies are effectively trapped, there is very little loss of meat or meat products, and the plant is in a sanitary condition from an entomological standpoint.

A BIBLIOGRAPHY OF LITERATURE DEALING WITH SANITATION OF MEAT
PACKING ESTABLISHMENTS

- Allen, R. M., and McFarlan, J. W., 1913.—The Municipal Abattoir. Kentucky Agr. Exp. Sta., Bul. 173.
- Anon, 1913.—The Protection of Meat from Flies. Australian Medical Gazette, vol. 33, No. 18, May 3.
- Bishopp, F. C., 1915.—Flies Which Cause Myiasis in Man and Animals. Some Aspects of the Problem. Journ. Econ. Ent., vol. 8, No. 3, pp. 317-329.
- Bishopp, F. C., 1916.—Flytraps and Their Operation. U. S. Dept. Agr. Farmers' Bulletin 734.

- Bishopp, F. C., 1917.—Some Problems in Insect Control About Abattoirs and Packing Houses. *Journ. Econ. Ent.*, vol. 10, No. 2, pp. 269-277.
- Bureau of Animal Industry, 1906.—Regulations Governing the Meat Inspection of the United States Department of Agriculture. Order No. 137.
- Bureau of Animal Industry, 1912.—Service Announcements, June.
- Bureau of Animal Industry, 1914.—Regulations Governing the Meat Inspection of the United States Department of Agriculture, Order No. 211.
- Bureau of Animal Industry, 1915.—Service and Regulatory Announcements, March.
- Farrington, A. M., 1908.—The Need of State and Municipal Meat Inspection to Supplement Federal Inspection. Bureau of Animal Industry, Circular 154.
- Melvin, A. D., 1908.—The Federal Meat Inspection Service, Bureau of Animal Industry, Circular 125.
- Melvin, A. D., 1912.—State and Municipal Meat Inspection and Municipal Slaughterhouses. Bureau of Animal Industry, Circular 185.
- Parks, G. H., 1911.—The Sanitary Construction and Equipment of Abattoirs and Packing Houses. Bureau of Animal Industry, Circular 173.
- Shaw, Geo. H., 1914.—The Federal Meat Inspection Service and Sanitation of Packing Houses under Its Supervision. *American Journal of Public Health*, vol. 5, No. 3, pp. 236-245.

CHAPTER XXXIV

Insect Poisoning and Miscellaneous Notes on the Transmission of Diseases by Insects

W. Dwight Pierce

In the various lectures which have preceded this one, most of the large groups of disease-carrying insects have been discussed in full but there are a number of cases of carriage of disease by insects of other groups and there are many cases of insect poisoning which have not been covered. As a matter of fact the majority of species of insects which are chargeable with poisoning have not been mentioned.

In the present course of lectures, for convenience, all arthropods have been considered under the popular term insects. The general public does not discriminate between a spider, a scorpion, a mite, a tick, and an insect as far as the general nomenclature is concerned. In fact the disease relationship in these different groups are so similar that any discussion of them from a sanitary standpoint should include all of the groups which belong to the Phylum Arthropoda. The scorpions belong to the order SCORPIONIDEA, the spiders to the order ARANEAE, and the mites and ticks to the order ACARINA, all in the class ARACHNIDA, characterized by eight legs. It is also well to consider the very nearly related class CHILOPODA, which includes the centipedes and millipedes with one or two pair of legs to each segment. The insects all belong to the INSECTA, characterized by six legs.

SCORPION POISONING

There is great popular fear of the sting of the scorpion. These creatures are found largely in semitropical and tropical countries and are possessed of a tail with a sting at the tip. The effect of the poisoning is more or less severe and in some cases is fatal. The method of stinging is to bring the tail forward over the body so that the curved spine on the last segment penetrates the skin and inflicts the wound. On either side of this curved barb is an opening from which the duct from the poison gland discharges the venom. Very little has been done on the toxicity of the poisons of the various species of scorpions. Castellani and Chalmers have summarized in a few pages the subject of scorpion

venom. In the majority of cases when a person is stung by a scorpion, they fail to retain the specimen or to have a scientific identification made so that the records of actual species causing scorpion sting are very small, only twelve species having come to the attention of the writer. The purpose of the scorpion venom is not necessarily as a means of defense, but rather as a method by which it kills its prey, which usually consists of small animals. In man the symptoms depend upon the size and nature of the scorpion.

The small European scorpion, *Isometrus europaeus* Linnaeus, causes only pain, redness, and local swelling. Some of the larger tropical scorpions cause intense pain of a burning character radiating from the skin, associated often with violent convulsions, mental disturbances and hallucinations, profuse perspiration, secretion of saliva, and perhaps vomiting. The pulse is weak and quick and the respiration is hurried and shallow. These symptoms gradually diminish in three to eight hours and by about nineteen to twenty hours the person usually is normal. Death may ensue due to collapse or stoppage of respiration which is more apt to happen in children than in adults. Wilson states that the mortality in children under five is 60 per cent for *Buthus quinquestriatus* H. & E., a species of Upper Egypt and the Sudan. Fatal poisoning is also charged against *Buthus maurus* and other North African scorpions. Cararoz has stated that as many as two hundred persons die annually from scorpion sting in the neighborhood of Durango, Mexico. The species which is responsible for this is *Centrurus exlicaude* Wood. In addition to the species already mentioned, *Buthus martensi* Karshi of Manchuria; *Buthus occitanus* Amour of South Europe and North Africa; *Buthus afer* Leach, *Prionurus citrinus*, *P. amoureuni* Savigny, *Androctonus funestus* Ehrenberg, and *Heterometrus maurus*, all of South Africa, have been recorded as causing severe poisoning. Kubota found the Durango scorpion many times more toxic than the Manchurian. The common southern species in the United States, *Buthus carolinianus* Beauvois, which ranges from the Southern Atlantic States into Texas, north into Kansas, inflicts a very severe sting which hurts for many hours.

Castellani and Chalmers recommend as treatment for scorpion sting the application of a proximal ligature and incision and treatment of the wound with permanganate of potash in the same manner as used for snake bite. C. V. Riley in 1887 recommended the use of ammonia applied over the sting, or a small dose of ipecacuanha. Simpson recommends the local application of a paste of ipecacuanha. Colonel Duke recommends that 5 to 10 minims of a 5 per cent solution of cocaine be injected subcutaneously, close to the sting, for adults, and 1 to 5 minims for infants and children. Murthy (1919) considers that larger quantities of a weak solution of cocaine hydrochloride are better than smaller quantities

of stronger solution. He has used successfully a dosage of 20 to 30 minims of a solution of 20 grains cocaine to the ounce, injected exactly on the sting. A number of different writers have prepared antivenoms or serums which are capable of neutralizing the venom. Villala reports the preparation of an antiserum in Brazil which was successfully used in the case of a child affected with a very severe scorpion poisoning.

SPIDER POISONING

There is more or less general fear among the public, due to many legends which have been passed down, as to the severity of spider poisoning. The majority of spiders are not poisonous but there are certain species which are extremely poisonous. The spiders most feared in America are the tarantulas, large hairy spiders. The tarantulas, like other spiders, have poison jaws for killing or paralyzing their prey. There are very few scientific records of tarantula poisoning in America. Vorhies has cited four without mentioning the species. The American tarantula which has been regarded as poisonous is *Phidippus audax* Hentz. In Europe, tarantula poisoning is caused by *Lycosa tarantula* Linnæus, *L. narbonensis* Walckenaer, *Epeira diadema* (Moritz-Herold) Walckenaer, and *Trochosa singoriensis* (Laxmann). *Epeira diadema* is the common garden spider of Europe and is not as large as the American tarantula. The bite of *Lycosa tarantula* produces wheals surrounded by red areola but no general symptoms result.

The evidence against the hour-glass spider, *Latrodectes mactans* Fabricius, and its allies is far more convincing and there is no doubt that these are dangerous spiders. This species is coal black and marked with red or yellow or both. It is quite variable in markings. The full grown female is about a half-inch in length and its globose abdomen is usually marked with one or more red spots on the dorsal line. This spider occurs in old buildings, stables and wood piles. It spins an irregular web which is composed of very coarse, silk threads. It is an exceedingly aggressive spider. Severe and sometimes fatal poisoning follows the bite. Kolbert has isolated a substance from the poison gland (Arachnolysin) which is a powerful hemolysin. Dr. E. H. Coleman, Los Altos, California, has conducted quite a series of experiments with Arachnolysin and with a toxalbumen which occurs throughout the body of the insect. He dissected the poison glands and made various triturations from which he prepared powders which he took himself and noted the effects upon himself after each dose. After taking twenty-five powders, his heart rate was reduced to 48 and his temperature was 99. He experienced a severe headache, clonic spasms of the thoracic and abdominal muscles, marked distress about the heart with radiating pains extending

to the left arm pit and down to the elbow. He had no bowel action for two days and the pupils were markedly dilated. His symptoms appeared to him a perfect picture of angina pectoris. The symptoms subsided and in three days he felt normal. He repeated this experiment twice with the same results.

Doctor Coleman had a patient aged 54 years suffering from angina pectoris. During an attack he gave him a powder of one of the triturations of the spider venom and in ten minutes the symptoms passed leaving the patient more comfortable than after any previous attack.

At least one case of death is recorded from the bite of this species and several cases of severe poisoning have come to the attention of the Bureau of Entomology.

Houssay gives quite a description of the symptoms and literature. He counsels the use of morphine, bromide, or camphor oil. He cites also the use of chloral and as cardiac tonics, caffeine, and acetate of ammonia, aiding any of these by milk diet and theobromine.

Doctor Coleman records treating a case by hypodermic injections of strychnine 1/40, followed in ten minutes by nitroglycerine 1/100, and local applications to the site of bite of crystals of potassium permanganate. By repeated injections of strychnine the heart rate was increased to 45. He then substituted the use of brandy hypodermically. Heat was applied to the feet and back. Nine and one-half hours after the attack the heart rate had been increased to 55 and the pains were still severe. A $\frac{1}{4}$ morphine with 1/150 atropine was given. The pains eased up and the patient dropped asleep. The next day he was covered with a fine rash. The heart rate was 60. This rash disappeared in four days. He suffered from insomnia for several days and a stubborn constipation that took a very active purge to affect. After three years his heart rate was 64, he was troubled with insomnia, and a marked bulimia.

Fatal spider poisoning has been recorded as caused by *Latrodectes geometricus* Koch in California, *L. hasseltii* Thorell (*scelio* Thorell) (the "katipo") in New Zealand, *Theraphosa javanensis* Walckenaer in Java, *Chiracanthum nutrix* Walckenaer in Europe. *Theridium 13-guttatum* Fabricius in France and Italy, and *T. lugubre* Koch ("kara kist") in Russia.

CENTIPEDE POISONING

The centipedes, on account of their large size and many sharp legs, have given rise to numerous popular legends as to their poisonous nature. It is a common saying that when a centipede grips hold of a person, the impression made by each claw gives rise to a sloughing of the flesh. This opinion is quite erroneous as the centipede has only one pair of poison glands, located in the head, having their external opening through a pair

of venom claws which are large-clawed appendages lying beneath the head. The opening of the venom duct in *Ethmostigmus spinosus*, which has been carefully studied by Cornwall, is on the dorsal surface of the claw a little way from the apex and somewhat near the external side. There is one venom gland in each of two venom claws. This species is nocturnal in habit and is not naturally vicious and will not bite unless hurt or worried. A centipede's bite may be merely a snap, but once he finds his fangs sink into the fine tissues his main idea, if other portions of him are not being mistreated, seems to be to eat. To this end he digs as many legs as he can apply into the subject, the posterior ones to obtain a firm hold, and the anterior ones to knead the tissues. The venom claws are worked in and out and with the help of the first pair of legs the skin of the subject is pushed into the mouth. In five minutes a centipede will thus consume a length of rabbit skin nearly one centimeter long. The main function of the venom claws is to hold the food tightly against the mouth-parts to facilitate mastication. The slow but regularly continued

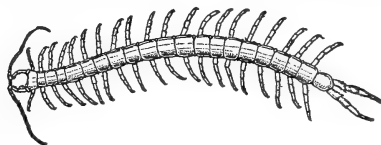

FIG. 88.—A centipede, *Scolopendra morsitans* (Bradford).

relaxation and closing of the venom claws is designed to permit the flow of venom into that part of the food which is to be taken into the mouth. The toxic action is so slow that the venom would be practically useless for destruction or defense. Cornwall believes therefore that the venom principally serves as a digestive juice.

Other species of centipedes which have been recorded as venomous are *Scolopendra cingulata* Latreille, *S. gigantea* Linnaeus, *S. morsitans* Linnaeus (fig. 88), *S. heros* Girard, and *Geophilus similis* Leach.

The centipede bite may cause some local pain, swelling, and erythema lasting a few hours. The general symptoms are great mental anxiety, vomiting, irregular pulse, dizziness, and headache. When severe local inflammation follows a centipede bite, it is chiefly due to septic infection. A large centipede which has secured a firm hold of the skin by digging in its fangs and legs can almost be torn in half before it can be induced to let go, and in delicate skins each leg can, under such circumstances, make a punctured wound which will admit infective organisms. The use of disinfectants to prevent infection by outside organisms is therefore necessary.

Vorhies has described two cases of Arizona centipede bite, in both of which the pain was severe and prevented sleep.

Castellani and Chalmers recommended for centipede bites the bathing of the parts with a solution of ammonia (1 in 5, or 1 in 10). After bathing apply a dressing of the same alkali, or if there is much swelling and redness, an ice bag. If necessary give hypodermic injections of morphia to relieve the pain.

CENTIPEDES IN NASAL CAVITIES AND ALIMENTARY CANAL

There are in literature quite a number of references to the occurrence of small centipedes in the nasal cavities and in the alimentary canal. In the nasal cavities they have been charged with causing considerable inflammation and in the alimentary canal have caused pain, cramps, and nausea. Very little is known of the cause of this attack but presumably it is more or less accidental, probably when the person is asleep out of doors. The following species have been recorded from the nasal cavities: *Geophilus carpophagus* Leach, *G. electricus* Linnaeus, *G. cephalicus* Wood, *G. similis* Leach, *Lithobius forficatus* Linnaeus, *L. melanops* Newport, *Scutigera coleoptrata* Linnaeus, *Chaetechelyne vesuviana* Newport, *Polydesmus complanatus* Latreille, *Iulus terrestris* Linnaeus, *I. londinensis* Leach, *Himantarium gervaisi*, *Stigmatogaster subterraneus* (Leach). There is no evidence that these parasites cause any inflammation by their venom. They are generally expelled from the nose in attacks of sneezing or spontaneously. The best method of making them leave the nostrils is the use of snuff, Eau de cologne, or turpentine, but in some instances surgical operations are necessary.

This subject has been more fully treated by Blanchard in vols. 1 to 6 and 14 of the Archives de Parasitologie.

LEPIDOPTEROUS LARVÆ POISONING

It is not uncommon for persons to be more or less badly poisoned by the barbed hairs of lepidopterous larvæ. In some cases these hairs contain minute drops of poison. The most famous poisoning of this kind is known as "BROWNTAIL RASH" which, when it attacks the eyes, is called OPTHALMIA NODOSA. This is caused by the browntail moth *Euproctis chrysorrhoea* Linnaeus. There have been numerous cases of browntail rash in New England. The stinging hairs sometimes penetrate into the lungs, as well as entering the eyes. This is most likely to happen at the time the caterpillars are molting and the air is filled with hairs. Entomologists working in laboratories where this species is being studied have suffered considerably from this poisoning. The larva is provided with four rows of setigerous tubercles which bear barbed hairs, larger at the apex than at the base. These hairs are connected with

poison glands, one of which lies beneath each papilla or tubercle. The poison is liberated in the blood through the sharp basal point of the hairs when they come in contact with the human skin. One case of death has been reported. The structure of the poison glands and hairs is discussed by Miss Kephart.

Ellingham has described poison hairs on the larva of *Porthesia similis* Fuessly, the swan moth.

The processionary caterpillar *Cnethocampa pityocampa* Borowaki, according to Beille, is provided with poison-secreting, setigerous tubercles which are divided into four areas by two bands, which cross the tubercles at right angles to each other and which are free from hairs. The four sectors thus made are covered with chitinous papilla which bear poison hairs and which are connected with the subjacent parts by pore canals in the cuticle. The glandular part exists only under the sectors covered with hairs. These glands are unicellular and in the form of very elongate pears. These poisonous hairs, when they come in contact with the flesh, cause an urtication.

In a similar manner the larva of the nun moth, *Lymantria monacha* (Linnaeus); the gipsy moth, *Porthetria dispar* (Linnaeus), the Io moth *Automeris io* (Fabricius), *Hemileuca maia* Drury, *Lasiocampa pini* (Linnaeus), *Macrothylacia rubi* (Linnaeus), *Sibine stimulea* Clemens, are provided with poisonous hairs. *Lagoa crispata* Packard and *Megalopyge opercularis* (Smith and Abbott) are known as flannel moths, and are covered with long, silky hairs and do not look like caterpillars. Interspersed among the long hairs are numerous short spines connected with the underlying poison glands. These hairs are capable of producing a marked nettling effect when they come in contact with the skin.

Riley and Johannsen present a very interesting discussion of nettling insects and suggest for treatment the application of weak solutions of ammonia or a paste of ordinary baking soda. In the browntail district, one remedy which is commonly used was recommended by Kirkland:

Carbolic acid	1/2	gram
Zinc oxide	1/2	oz.
Lime water	8	oz.

BEE, WASP, AND ANT STINGS

Many species of bees, wasps, and ants are capable of inflicting painful stings. These insects sting by means of the ovipositor. Only the female is capable of inflicting injury. All persons who have handled bees are familiar with the sting of the honey bee, *Apis mellifera* Linnaeus, and most boys are familiar with bumble bee (*Bombus* spp.) stings.

The wasps most likely to sting are species of *Vespa* and *Polistes*.

The most aggressive stinging insects in America are the Texas Agricultural ants of the genus *Pogonomyrmex*, especially *P. barbatus* Smith and *P. californicus* Buckley. These ants will attack any one who comes in the vicinity of their large nests or who stands in their path. The immediate effect of their sting is a paralysis of the limb affected. The pain is very severe, and it is recorded that the sting of these ants is fatal to young pigs.

HONEY POISONING

In South and Central America one very frequently sees the stingless honey bees of the genera *Melipona* and *Trigona* at meat. The honey of these bees is eagerly collected by the natives for food. According to Wheeler and Von Ihering there are numerous cases of poisoning from eating this honey. This poisoning is manifested by intestinal disorders, sometimes causing paralysis and vomiting, while the honey of other species causes eczema and skin diseases and death has been recorded.

Wheeler states that *Trigona bipunctata* Lepeletier, *T. amalthea* (Olivier) Jurine, and *T. ruficrus* (Latreille) Jurine make the wax of moist earth collected along streams and drains or from the feces of animals and man. He noted *T. ruficrus* at Gatun, Canal Zone, visiting garbage barrels in great numbers in company with house flies and blow flies. He has observed *T. bipunctata* at Guatemala collecting human excrement in open latrines and along railway tracks, and *T. pallida* Latreille was noted at Gatun collecting crude black oil used as a mosquito larvicide.

According to Von Ihering the honey of *T. limao* Smith is frequently if not always poisonous, causing vomiting, convulsions, pains, and weakening of the joints. He cites several cases. Von Martius claims that there is a bee whose honey causes tetanus. He may have referred to this or related species. The cerumen or wax of this bee is sometimes so liquid that it mixes with the honey.

It is easy to see that there are abundant opportunities for contamination of the honey of this group of bees. In fact it is not uncommon to see our own honey bee at excrement and there is a possibility that at times it may contaminate its honey.

Dr. Kebler has recorded cases of poisoning in New Jersey from eating honey. Honey may also be poisoned by nectar gathered from poisonous plants, of which Morley lists several.

ANAPHYLAXIS

Hadwen and Bruce have contributed to medical entomology another type of disease caused by insects in showing that bot larvæ when crushed

may cause anaphylaxis in an animal. Anaphylaxis essentially consists in the development under certain circumstances in an animal of a hypersensitiveness to foreign albuminous materials which in themselves are not essentially toxic. The larvæ of the bots *Hypoderma bovis* DeGeer, *H. lineata* DeVillers, and *Oestrus ovis* Linnaeus are not normally toxic although by living in an animal they produce a sensitiveness. When crushed in the animal or when the protein material contained in the larvæ is injected into the jugular vein of a sensitive animal, anaphylactic shock results. Both in natural and experimental anaphylaxis death may result. Recovery from the reaction gives immunity for varying periods.

POISONING FROM EATING INSECTS

Cornelius (1919) reports an instance of eleven cases of acute native poisoning in India following a feast on cooked garden bugs, *Aspongopus nepalensis* Westwood, which were collected from under stones. Recovery takes place in from three to ten days. Continued consumption is said by the natives to immunize against poisonous effects. The bug gives off an odor resembling sulphuretted hydrogen, but when cooked is regarded as a delicacy.

KISSING BUGS

Various species of reduviid bugs have been charged with inflicting severe injury with their bite. The species of *Triatoma* have been discussed in Chapter 28. The black kissing bug, *Melanolestes picipes* inflicts a very painful bite. Probably foreign matter is often introduced by the bite.

DERMATITIS CAUSED BY BEETLES

A number of species of beetles have been recorded as excreting an irritant liquid which causes a dermatitis to the skin which they touch. As an example we may cite *Paederus columbinus* Lap. of Brazil, which causes an acute dermatitis, a species of Staphylinid of the Belgian Congo which causes a vesicular dermatitis, and the Meloid beetles, *Cantharis flavicornis* Dufour and *C. vestitus* Dufour. The substance secreted by *Cantharis* is sometimes used as a cauterizing agent.

BEETLES AS CARRIERS OF DISEASE GERMS

We are not apt to think of beetles as carriers of disease, but there are a number of ways in which beetles may readily be concerned in disease transmission. There are quite a number of species of beetles which breed in carcasses and which can readily carry disease germs from one

carcass to another, thus enabling the flies and other insects which visit food to further distribute the germs. Proust found quantities of living *Dermestes vulpinus* Fabricius in goat skins taken from anthracic animals. He found virulent anthrax bacillus in their excrement and also in their eggs and in the larvae. Heim also had occasion to examine some skins which were suspected of having caused anthrax in persons engaged in handling leather. He found the larvae of *Attagenus pellio* Linnaeus, *Anthrenus museorum* Linnaeus, and *Ptinus* also fully developed insects of the latter species on the skins. All these insects had virulent anthrax bacillus (spores) on their bodies and in their excreta.

The greater proportion of the cases of beetle transmission of disease are those in which the beetle serves as an intermediate host of a parasitic worm. In most of these cases the beetle larvæ are found in excreta. They ingest the eggs of the worms and the transformation takes place within their bodies. The worms are then eaten by animals and the infection is carried on. Since Doctor Ransom, in his lecture, has summarized all of the evidence, it is unnecessary to repeat at this time.

We are not apt to associate the transmission of plant diseases by insects but the cases are strongly analogous. Just recently F. B. Rand has demonstrated the transmission of cucurbit wilt, which is caused by *Bacillus tracheiphilus*, by means of the cucumber beetle, *Diabrotica vittata* Fabr. He has found that the beetles take up the bacillus in eating an injured leaf and has been able to demonstrate the presence of the bacillus in the body of the insect by dissection and culture with subsequent inoculation. He has conclusively proven that the disease can be transmitted only by means of this and closely related beetles. He has found also that the normal bacillus content of the abdomen may, in a large proportion of cases, destroy the wilt bacillus. It is quite probable that infection in this case is similar to that caused by the house fly, in that the infected excreta come in contact with the recently eaten surfaces of the leaf as the beetle moves forward.

It has been found that beetles can transmit mosaic disease of tobacco. It is not at all out of the way to expect that we will find ultimately a similar transmission in this case and in many other plant diseases.

LIST OF REFERENCES

- Castellani, A., and Chalmers, A. J., 1913.—Manual of Tropical Medicine.
- Cornelius, H. B., 1919.—Indian Med. Gaz., vol. 54, No. 2, pp. 72, 73.
- Cornwall, J. W., 1916.—Indian Journ. Med. Research, vol. 3, pp. 52-57, and 540-557.
- Ellingham, E. H., 1914.—Tr. Ent. Soc. Lond., 1913, pt. 3, p. 423.

- Heim, F., 1894.—Compt. Rend. Soc. Biol., Paris, pp. 58-61.
- Kephart, Cornelia F., 1914.—Journ. Parasit., vol. 1, No. 2, pp. 95-102.
- Morley, M. W., 1915.—The Honey Makers. A. C. McClurg & Co., Chicago, pp. 188-194.
- Murthy, S. S., 1919.—Indian Med. Gaz., vol. 54, No. 2, p. 73.
- Proust, A., 1894.—Bull. L'Acad. Med., vol. 34, pp. 57-66.
- Riley, C. V., 1887.—Hand Book of Medical Science, vol. 5, pp. 741-760.
- Villela, E., 1917.—Brazil Med. Journ., vol. 31, No. 43.
- Von Ihering, H., 1904.—Revista Mus. Paulista, p. 11.
- Vorhies, C. T., 1917.—Poisonous Animals of the Desert. Arizona Agr. Exp. Sta., Bull. 83, pp. 373-392.
- Wheeler, W. M., 1914.—Journ. Trop. Diseases and Prevent. Med., vol. 2, pp. 166-167.

SUMMARY

Throughout this course of lectures my main object has been to show the diverse manner in which insects may cause pathological conditions or may transmit pathogenic organisms. Unquestionably the majority of species which carry disease organisms have not yet been recorded in this rôle. In the past we have attempted to minimize the possible rôle of the insect as a carrier of disease. In the future it would be wise to take the stand that insect transmission of a disease should be one of the first methods of transmission investigated and that the investigation should be carried out on logical lines suggested by the habits of the insects concerned. It is to be regretted that a large part of the study of insect transmission of disease has been aimed at proving or denying transmission by means of the bite of the insect. We have seen from the evidence presented that a large proportion of the cases of insect transmission are not by the bite but rather through the feces of the insect. We may therefore consider that many of the conclusions that insects are not involved in the transmission of certain diseases are unwarranted and that the cases should be reopened and studied more scientifically.

Any insect which visits excreta or which visits food or the person of man or animals is to be considered a suspicious object in a disease transmission inquiry. Naturally we will look to the blood-suckers as the first means of transmitting disease of which the organism is found in the blood, but when the diseases are of the intestinal or genital organs, we are more apt to find that the disease is carried by insects which become contaminated by contact with infected excretions. Another unexplored field of study is the determination of toxins in foods, produced by contamination of insects feeding therein.

If through this series of lectures we have succeeded in interesting a few investigators to look into the subject of transmission of certain diseases more thoroughly, we shall feel that we have been successful in our efforts.

CHAPTER XXXV

A Tabulation of Diseases and Insect Transmission

W. Dwight Pierce

In view of the fact that a very large number of diseases have been mentioned in these lectures, and that the same disease has often been mentioned in several lectures, it was thought desirable to prepare a tabulation of the information presented in this volume in the most concrete form possible. In the fourth column under method of insect transmission, I have drawn frequent conclusions as to the probable mode of transmission, based on analogy. In each such case a modifying word makes it clear that the statement is not proven. Unquestionably we must draw such conclusions and test them out, for by such methods we can greatly facilitate progress in investigation. Unquestionably in many of the diseases cited below, insect transmission is not the most important mode, but on the other hand, I am just as confident that insect transmission will prove to be the most important mode in other diseases now considered to be carried otherwise. In no wise in this entire course do I claim responsibility for proving insect transmission, nor am I able to justly repudiate the claims made by others. The evidence is presented for what it is worth and occasionally with theoretical suggestions by myself, but each reader must seek the original evidence and weigh it himself. Undoubtedly there are many inaccuracies of fact in this tabulation and in the chapters on disease transmission. Some of them may have been corrected but overlooked in compiling the present work.

There is always a danger that people will accept a tabulation as authoritative. It is not, in this case at least, a critical compilation.

Disease	Causative organism	Insect transmitter	Method of insect transmissions	Nature of insect rôle
Acariasis, human and animal (acarine dermatosis)	<i>Dermanyssus gallinæ</i> " <i>hirundinis</i> <i>Holothyrus coccinella</i> <i>Liponyssus bacoti</i> <i>Tetranychus telarius</i>	Same as preceding column.	Direct attack in skin.	Parasites
Acariasis, internal (parasitism of liver, kidneys, etc., producing peritonitis, enteritis, purulent urine, etc.)	<i>Carpoglyphus alienus</i> <i>Cytolichus banksi</i> " <i>nudus</i> " <i>sarcoptoides</i> <i>Histiogaster spermaticus</i> <i>Laminosiptes cysticola</i> <i>Nephrophages sanguinarius</i>	Same as preceding column.	Direct attack in various internal organs.	Parasites.
Acariasis, see also Chiggers, Depluming mite, Gonone, Inflammation (bronchial, lungs, catarrhal), Itch, Mange, Ocular acariasis, Otoacariasis, Paralysis (tick), Scabies, Scaly leg.				
Ainhum	<i>Dermatophilus penetrans</i> .	<i>Dermatophilus penetrans</i> .	The flea burrows into the skin, causing toes and fingers to slough off.	Direct attack.
Amœbiasis, see Dysentery (amœbic)				
Anaplasmosis, African and Australian	<i>Anaplasma marginale</i>	<i>Boophilus annulatus decoloratus</i> <i>Rhipicephalus simus</i>	Transmitted by tick bite	Intermediate host.
Anaplasmosis, Argentine	<i>Anaplasma argentinum</i>	<i>Boophilus annulatus australis</i>	Transmitted by tick bite	Intermediate host.
Aino	<i>Castellanella Brucei</i> (?)	<i>Glossina longipennis</i>	Transmitted by fly bite	Intermediate host.
Anemia, canine	<i>Hæmogregarina canis</i>	<i>Rhipicephalus sanguineus</i>	Taken up by bite of tick. Transmitted by bite of adult which was infected in its nymphal stage.	Intermediate host.
Anemia, equine infectious	Filterable virus	<i>Atylotus rufidens</i> <i>Chrysops japonicus</i> <i>Chrysozona pluviatilis</i> <i>Stomoxys calcitrans</i> <i>Tabanus chrysurus</i> " <i>trigeminus</i> " <i>trigonus</i>	Thought to be carried by bite of fly.	Undetermined.
Anemia, jackal	<i>Rossella rossi</i>	<i>Hæmaphysalis leachi</i> is possibly the host	Possibly transmitted by bite of tick	Possibly intermediate host
Anemia, jerboa (<i>Gerbillus indicus</i>)	<i>Hæmogregarina gerbilli</i>	<i>Polyplax stephensi</i> is believed to be the host.	Not definitely known, but probably through excreta of insect which takes it up from blood.	Possibly intermediate host
Anemia, jerboa (<i>Jaculus gordoni</i> and <i>J. orientalis</i>)	<i>Hæmogregarina jaculi</i>	<i>Xenopsylla cheopis</i> is believed to be the host. <i>Dermanyssus galinæ</i> can carry but is not the usual carrier.	Not proven but probably through excreta of insect which takes it up from blood. The mite may carry but its method of transmission is not demonstrated.	Possibly intermediate host Intermediate host.

TABULATION OF DISEASES AND INSECT TRANSMISSION 475

Disease	Causative organism	Insect transmitter	Method of insect transmissions	Nature of insect rôle
Anemia, owl (<i>Syrnium aluco</i>)	<i>Hæmoproteus syrnii</i>	<i>Culiseta annulata</i> .	Transmission by bite of mosquito.	Intermediate host.
Anemia, owl (<i>Syrnium aluco</i> and <i>Glaucidium noctuæ</i>)	<i>Leucocytozoon danilewskyi</i>	<i>Culex pipiens</i> .	Transmission by bite of mosquito.	Intermediate host.
Anemia, palm squirrel (<i>Funambulus pennatii</i>)	<i>Hæmogregarina funambuli</i>	<i>Hæmatopinus</i> sp.	Transmission not worked out but probably through excreta.	Intermediate host.
Anemia, rabbit (<i>Lepus nigricollis</i>)	<i>Hæmogregarina leporis</i>	<i>Hæmaphysalis flava</i>	Transmission probably mechanical but not proven.	Mechanical carriers.
Anemia, rat	<i>Hæmogregarina muris</i>	<i>Laelaps echidninus</i> .	Taken up in blood by mites. Infection by ingestion of mites by rats.	Intermediate host.
Anemia, turtle (<i>Testudo mauritanica</i>)	<i>Hæmogregarina mauritanica</i>	<i>Hyalomma ægyptium</i> .	The manner of transmission is not determined.	Intermediate host.
Anthrax, animal and human	<i>Bacterium anthracis</i>	<i>Chrysops cœcutiens</i> <i>Hæmatopota pluvialis</i> <i>Lyperosia irritans</i> <i>Stomoxys calcitrans</i> <i>Tabanus atratus</i> " <i>bovinus</i> " <i>striatus</i>	Transmission by bite of fly.	Probably mechanical carrier.
		<i>Aedes sylvestris</i> <i>Psorophora sayi</i>	Transmission by bite, experimental.	Mechanical carrier.
		<i>Calliphora erythrocephala</i> <i>Calliphora vomitoria</i> <i>Lucilia cæsar</i> <i>Sarcophaga carnaria</i>	Insects swallow bacilli in feeding on carcasses or wounds and deposit in their feces on wounds.	Mechanical and possibly biological carriers
		<i>Anthrenus museorum</i> <i>Attagenus pello</i> <i>Dermeestes vulpinus</i> <i>Ptinus</i> spp.	Beetles ingest spores and bacilli in feeding on carcasses and skins.	Mechanical carrier.
		<i>Blatta orientalis</i>	Passes through intestinal tract intact. Infection by contamination.	Mechanical carrier.
		<i>Borborus punctipennis</i> have been found to carry the eggs.	Larvæ swallow the eggs. Flies might deposit the eggs on food. Insect transmission is not regarded as important.	Mechanical carrier. No intermediate host is necessary.
		<i>Ascaris lumbricoides</i>		
Babesiasis, bovine, Argentine	<i>Babesia argentinum</i>	<i>Boophilus annulatus australis</i> .	Transmitted by bite of tick, probably in the same manner as cattle fever.	Intermediate host.

Disease	Causative organism	Insect transmitter	Method of insect transmissions	Nature of insect rôle
Babesiasis, canine (malignant jaundice)	<i>Babesia canis</i> .	<i>Rhipicephalus sanguineus</i> . <i>Hæmaphysalis leachi</i> . <i>Dermacentor reticulatus</i> and possibly <i>Ixodes hexagonus</i> " <i>ricinus</i>	Taken up in the nymphal or adult stage and transmitted by the bite of nymph or adult of the next generation.	Intermediate host.
Babesiasis, canine and jackal	<i>Babesia gibsoni</i> .	<i>Rhipicephalus simus</i> is suspected.	Transmitted by bite of tick.	Intermediate host.
Babesiasis, hedgehog	<i>Babesia minense</i> .	<i>Dermacentor reticulatus</i> .	Transmitted by bite of tick.	Intermediate host.
Babesiasis. See also Biliary fever (equine), Carceag, Cattle fever				
Baleri	<i>Castellanella pecaudi</i> .	<i>Glossina longipalpis</i> " <i>morsitans</i> " <i>tachinoides</i> " <i>palpalis</i> and possibly <i>Stomoxys calcitrans</i> " <i>nigra</i> .	Transmitted by fly bite.	Intermediate host.
Biliary fever, equine	<i>Babesia caballi</i> .	<i>Dermacentor reticulatus</i> <i>Hyalomma ægyptium</i> are suspected	Transmitted by bite of tick.	Intermediate host
Blackheads.	<i>Bacillus necrophorus</i> .	<i>Demodex folliculorum</i> .	The papules caused by the attack of the mite become infected.	Irritation giving entrance to infection.
Blackheads. See Mange (demodectic)				
Blepharitis.	<i>Phthirus pubis</i>	<i>Phthirus pubis</i> .	Direct attack on eyelids.	External parasite.
Blepharitis. See Mange (demodectic)				
Browntail rash. See Poisoning (Lepidoptera)				
Cattle fever, Texas (Southern cattle fever, Splenic fever, Red water, Piroplasmosis, Mediterranean coast fever, Babesiasis)	<i>Babesia bovis</i> " <i>bigeminum</i> .	<i>Boophilus annulatus australis</i> <i>Boophilus annulatus</i> " <i>annulatus decoloratus</i> <i>Rhipicephalus capensis</i> and possibly <i>Hyalomma ægyptium</i>	Transmitted by bite of second generation.	Intermediate host.
Carceag	<i>Babesia ovis</i> .	<i>Rhipicephalus bursa</i> .	Transmitted by bite of adult tick which became infected as larva or nymph.	Intermediate host.
Chagas fever	<i>Schizotrypanum cruzi</i> .	<i>Triatoma megista</i> " <i>sordida</i> " <i>geniculata</i> " <i>chagasi</i> <i>Rhodnius prolixus</i> <i>Cimex lectularius</i> " <i>boueti</i> " <i>hemipterus</i>	Taken up by the bugs from the blood and passed out in their feces. Transmission by inoculation of feces.	Intermediate host.
		<i>Ornithodoros moubata</i> . <i>Rhipicephalus sanguineus</i>	Experimental transmission.	Intermediate host.

TABULATION OF DISEASES AND INSECT TRANSMISSION 477

Disease	Causative organism	Insect transmitter	Method of insect transmissions	Nature of insect rôle
Chiggers (red bugs) (acarine dermatosis). See also Gonone	Allotrombidium fuliginosum Leptus akamushi " americanum " irritans Metatrombidium poriceps Microtrombidium pusillum " talsahuatense Trombidium autumnalis " batatas " holosericeum " inopinatum " striaticeps	Same as preceding column.	Direct attack in skin.	Parasite.
Cholera, Asiatic	Spirillum cholerae.	Calliphora vomitoria. Eristalis tenax. Musca domestica. Periplaneta americana.	Taken up from stools by larval and adult flies, deposited in feces or on food. May be carried in the roach body for at least 60 minutes and deposited in viable condition in its feces.	Mechanical carrier. Mechanical carrier.
Cholera, fowl	Bacterium cholerae gallinarum.	Blatta orientalis.	Passes through intestinal tract intact. Infection by contamination.	Mechanical carrier.
Cholera, hog	Filterable virus.	Musca domestica. Fannia canicularis. Stomoxys calcitrans	Taken up by fly from animal manure. Was experimentally transmitted by contact with wounds and by inoculation of crushed flies. Experimentally transmitted by inoculation of crushed infected flies.	Mechanical carrier. Mechanical carrier (?)
Colitis	Bacillus coli.	Calliphora vomitoria Lucilia caesar Musca domestica Sarcophaga carnaria Blatta orientalis.	Flies or larvæ take up from stools. Deposited in their feces on food. Passes through intestinal tract intact. Infection by contamination.	Mechanical carrier. Mechanical carrier.
Conjunctivitis	Bacillus of Koch-Weeks.	Microneurum funicola.	Insect takes up from eye and carries to eye	Mechanical carrier.
Conjunctivitis, phlyctenular	Various bacteria.	Pediculus humanus	Deposited in louse feces, carried to eye by hands.	Mechanical carrier.
Deerfly fever (See plague, rodent)				
Dengue	Filterable virus.	Aedes argenteus Culex quinquefasciatus.	Transmitted by mosquito bite.	Intermediate host.

Disease	Causative organism	Insect transmitter	Method of insect transmissions	Nature of insect rôle
Depluming mite, chicken	<i>Cnemidocoptes gallinæ.</i>	<i>Cnemidocoptes gallinæ.</i>	Direct attack at base of feathers.	Parasite.
Dermatitis, beetle	<i>Cantharis flavicornis.</i> " <i>vestitus.</i> <i>Pæderus columbinus</i> other Meloid and Staphylinid beetles.	Same as preceding column.	These beetles secrete powerful irritant liquids which they emit when attacked.	Producers of irritant secretions.
Diarrhea, fowl	<i>Spirillum metchnikovi.</i>	<i>Blatta orientalis.</i>	Passes through intestinal tract intact. Infection by contamination.	Mechanical carrier.
Diarrhea, infantile	Bacillus of Morgan.	<i>Musca domestica.</i>	Taken up by fly larva from stools. Survives through metamorphosis. Deposited in feces on food.	Mechanical carrier. Possibly also biological.
Diarrhea, summer. See Paracolitis, Poisoning (food)				
Diphtheria	<i>Bacillus diphtheriæ.</i>	<i>Musca domestica.</i>	Flies take up from sputum and deposit in feces on food.	Mechanical carrier.
Dourine	<i>Castellanella equiperdum.</i>	<i>Stomoxys calcitrans</i> <i>Atylotus tomentosus</i>	Experimental transmission by interrupted feeding.	Mechanical carrier (?)
Dysentery, amœbic	<i>Löschia histolytica.</i>	<i>Calliphora erythrocephala</i> <i>Musca domestica.</i>	Taken up from stools in encysted stage. Deposited in feces on food.	Mechanical carrier.
Dysentery, bacillary	<i>Bacillus dysenteriæ.</i>	<i>Musca domestica.</i>	Taken up by larvæ from stools. Survives through metamorphosis. Deposited in feces on food.	Mechanical carrier.
Dysentery, lamblian	<i>Giardia intestinalis.</i>	<i>Musca domestica.</i>	Taken up from stools in encysted stage. Deposited in feces on food.	Mechanical carrier.
East Coast fever (Rhodesian fever)	<i>Theileria parva.</i>	<i>Rhipicephalus simus</i> " <i>appendiculatus</i> " <i>evertsi</i> " <i>capensis</i> <i>Hyalomma ægyptium</i> <i>Dermacentor reticulatus.</i> <i>Dermacentor nitens</i>	Transmitted by the tick in the instar following that in which taken up, or by next generation.	Intermediate host.
Eczema	<i>Pediculus corporis.</i>	<i>Pediculus corporis.</i>	Direct attack.	External parasite.
Elephantiasis. See Filariasis (human)				
Enteritis. See Acariasis.				

TABULATION OF DISEASES AND INSECT TRANSMISSION 479

Disease	Causative organism	Insect transmitter	Method of insect transmissions	Nature of insect rôle
Erysipelas	<i>Streptococcus pyogenes.</i>	<i>Musca domestica.</i>	Insect feeds on organism. Deposits in its feces on wounds.	Mechanical carrier.
Favus (porrigo)	<i>Achorion schoenleini.</i>	<i>Pediculus humanus.</i>	Manner of carriage not demonstrated.	Mechanical carrier.
Fevers, tick (including tick fever of Miana and intermittent fever of Wyoming)	Exact cause of the fever unknown.	<i>Amblyoma hebræum</i> <i>Argas persicus</i> <i>Dermacentor andersoni</i> <i>Hyalomma ægyptium</i> <i>Ornithodoros savignyi</i>	Inoculation by bite of tick.	Uncertain whether as parasite or as carrier.
Filariasis, canine	<i>Acanthocheilonema reconditum.</i>	<i>Ctenocephalus canis felis</i> <i>Pulex irritans.</i>	Possibly taken up by flea in blood. The method of transmission is unknown.	Possibly intermediate host
Filariasis, canine	<i>Dirofilaria immitis.</i>	<i>Anopheles maculipennis</i> <i>Anopheles bifurcatus</i> " <i>algeriensis</i> " <i>sinensis</i> " <i>superpictus</i> <i>Culex penicillaris</i> " <i>malariae</i> " <i>pipiens</i> " <i>quinqüefasciatus</i> <i>Aedes vexans</i> " <i>argenteus.</i>	Insects take up in blood. Worms migrate from insect proboscis to host at time of bite.	Intermediate host.
Filariasis, canine	<i>Dirofilaria repens.</i>	<i>Aedes argenteus.</i>	Insects take up in blood. Worms migrate from insect proboscis to host at time of bite.	Intermediate host.
Filariasis, human	<i>Acanthocheilonema persans.</i>	Partial development recorded in <i>Mansonioides africanus</i> <i>Aedes sugens</i> <i>Aedes argenteus</i> <i>Anopheles costalis</i> <i>Panoplites</i> sp. <i>Tæniorhynchus fuscopennatus</i> <i>Ornithodoros moubata.</i>	Transmission by bite of mosquito, the exact manner is not described.	Intermediate host (?)
Filariasis, human (elephantiasis)	<i>Filaria bancrofti.</i>	Complete development in <i>Anopheles rossi</i> " <i>costalis</i> <i>Culex pipiens</i> " <i>quinqüefasciatus</i> <i>Aedes pseudo-scutellaris</i> <i>Aedes argenteus</i> <i>Mansonioides africanus</i> <i>Mansonioides uniformis</i> Incomplete development in <i>Anopheles sinensis</i> " <i>barbirostris</i> " <i>argyrotarsis</i> " <i>albimanus</i>	Transmission by mosquito bite.	Intermediate host.

Disease	Causative organism	Insect transmitter	Method of insect transmissions	Nature of insect rôle
Filariasis, human (cont'd) (elephantiasis)		Mansonioides annulipes Mansonia pseudotitillans Culex microannulatus Culex gelidus " sitiens Aedes perplexus " scutellaris Scutomyia albolineata Tæniorhynchus domesticus.		
Filariasis, human	Filaria demarquayi.	Partial development is recorded in Aedes argenteus Anopheles maculipennis Anopheles albimanus	Insect takes up in blood but transmission is not proven.	Probably intermediate hosts.
Filariasis, human	Filaria (Loa) loa	Culex quinquefasciatus Chrysops centurionis " dimidiata " silacea Partial development in Hæmatopota cordigera Hippocentrum trimaculatum.	Insect takes up in blood. Inoculates at time of biting.	Intermediate host.
Foot and Mouth Disease	Filterable virus.	Wohlfahrtia magnifica Lucilia serenissima	The fly commonly breeds in infected feet.	Possibly mechanical carrier.
Furunculosis, animal	Staphylococcus pyogenes	Argas reflexus Ixodes ricinus.	Infection at site of bite.	Mechanical carrier.
Gall sickness, bovine	Trypanosoma (sens. lat). theileri	Hippobosca rufipes.	Experimentally transmitted by bite.	Intermediate host.
Gangrene	Bacillus aerogenes capsulatus	Musca domestica.	Taken up from wounds. Deposited in feces on wounds	Mechanical carrier.
Gonone (Acarine dermatosis)	Microtrombidium wichmanni Schöngastia vandersandei	Microtrombidium wichmanni. Schöngastia vandersandei	Direct attack in skin.	Parasite.
Gonorrhæa, human	Diplococcus gonorrhæe	Fly	Insect visited excreta. Carried on legs.	Mechanical carrier.
Granuloma, equine cutaneous. See nematode equine				
Hæmoproteasis of red grouse (Lagopus scoticus)	Hæmoproteus mansonii.	Ornithomyia lagopodis.	Transmission by bite of fly.	Intermediate host.
Heartwater of sheep	Filterable virus.	Amblyomma hebraeum Hæmaphysalis cinabarina punctata	Transmitted by bite of tick.	Intermediate host.
Hookworm	Ancylostoma duodenale.	Musca domestica.	Insects swallow eggs. Deposit eggs on food.	Mechanical carrier of no serious importance.
Hookworm	Necator americanus.	Limosina punctipennis.	Insects swallow eggs. Deposit eggs on food.	Mechanical carrier of no serious importance.
Horse sickness, Gambian	Duttonella congolense.	Glossina morsitans and possibly Glossina palpalis.	Transmission by fly bite.	Intermediate host.
Impetigo contagiosa	Staphylococcus pyogenes (aureus and albus).	Pediculus humanus.	Deposited in louse feces.	Mechanical carrier.

TABULATION OF DISEASES AND INSECT TRANSMISSION 481

Disease	Causative organism	Insect transmitter	Method of insect transmissions	Nature of insect rôle
Impetigo, tropical	Diplococcus pemphigi contagiosi.	Pediculus	Manner of carrying not demonstrated but probably through louse feces.	Mechanical carrier.
Inflammation, bronchial and lungs, in animals (internal acariasis)	Halarachne americana " attenuata " halichæri Pneumonyssus simicola Cytolichus nudus " sarcoptoides.	Same as preceding column.	Direct attack of mites in air passages producing asphyxia.	Parasite.
Inflammation, catarrhal (in chickens) (internal acariasis)	Sternostomum rhinoethrum.	Sternostomum rhinoethrum.	Direct attack of mites in throat and nose producing asphyxia.	Parasite.
Itch, bicho-colorado (acarine dermatosis)	Tetranychus molestissimus	Tetranychus molestissimus.	Direct attack in skin.	Parasite.
Itch, choriopic, animal (acarine dermatosis)	Chorioptes equi " symbiotes.	Same as preceding column.	Direct attack in skin.	Parasite.
Itch, coolie (ground) (acarine dermatosis)	Rhyzoglyphus parasiticus.	Rhyzoglyphus parasiticus.	Direct attack in skin.	Parasite.
Itch, copra (acarine dermatosis)	Tyroglyphus longior castel lanii.	Tyroglyphus longior castel lanii.	Direct attack in skin.	Parasite
Itch, grocer's (acarine dermatosis)	Glyciphagus prunorum.	Glyciphagus prunorum.	Direct attack in skin.	Parasite.
Itch, guano (acarine dermatosis)	Tydeus molestus.	Tydeus molestus.	Direct attack in skin.	Parasite.
Itch. See Mange (demodetic), Scabies				
Jaundice, infective	Leptospira icterohæmorrhagæ.	Pediculus corporis is suspected.	Infection would occur through louse feces.	Intermediate.
Jaundice, malignant. See Babesiasis (canine)				
Kala azar, Indian	Leishmania donovani.	Cimex hemipterus " lectularius.	Experimentally fed to bugs and partial development demonstrated but no successful transmission. Is probably transmitted through feces.	
Kala azar, infantile	Leishmania infantum.	Ctenocephalus canis Pulex irritans.	The disease has been experimentally transmitted by fleas but the exact method is not proven.	Intermediate host.
Kedani disease. See Tsutsugamushi disease				
Leprosy	Bacillus lepræ.	Musca domestica.	Taken up from lesions and probably deposited in fly feces.	Mechanical carrier.

Disease	Causative organism	Insect transmitter	Method of insect transmissions	Nature of insect rôle
Leprosy (cont'd)		Pediculus humanus.	Organism has been found in lice. Transmission would be effected through feces.	Mechanical carrier.
		Cimex lectularius.	The bacilli may be taken up by the bugs, but transmission has not been proven although it is suspected. It would take place by fecal contamination of wounds.	Mechanical carrier.
Loasis. See Filariasis (human)				
Leishmaniasis. See Kala azar, Sore (Bagdad, Biskra, and Oriental)				
Lymphangitis, epizootic (animal)	Cryptococcus farciminosus Priesz-Nocard organism Bacillus necrophagus Staphylococci.	Amblyomma spp.	Inoculated by bite of tick, probably by contamination.	Mechanical carrier.
Maculæ cœruleæ	Phthirus pubis.	Phthirus pubis.	Direct attack.	External parasite.
Mal de caderas	Castellánella equinum.	Triatoma infestans Cimex lectularius.	Experimental transmission by bites of bugs.	Intermediate host.
Malaria, avian	Plasmodium danilewskyi.	Culex quinquefasciatus Culex pipiens Aedes nemorosus " argenteus.	Transmission by mosquito bite.	Intermediate host.
Malaria, canary	Plasmodium relictum.	Culex pipiens.	Transmission by mosquito bite.	Intermediate host.
Malaria, pigeon	Hæmoproteus columbæ	Lynchia maura " brunea.	Transmission by fly bite.	Intermediate host.
Malaria, quartan	Plasmodium malarie.	Anopheles algeriensis " costalis " culicifacies " fuliginosus " funesta " maculipennis " myzomyifacies " quadrimaculatus " rossii " sinensis " stephensi " theobaldi.	Transmission by mosquito bite.	Intermediate host.
Malaria, subtertian	Laverania falciparum.	Anopheles albimanus " annulipes " argyrotarsis " barbirostris " costalis " crucians " culicifacies " formosaensis II " fuliginosus " funestus " maculatus	Transmitted by bite of mosquito.	Intermediate host.

TABULATION OF DISEASES AND INSECT TRANSMISSION 483

Disease	Causative organism	Insect transmitter	Method of insect transmissions	Nature of insect rôle
Malaria subtertian (cont'd)		Anopheles maculipal- pis indiensis " maculipennis " minimus aconit- us " pseudopuncti- pennis " punctipennis " quadrimaculatus " rossii " sinensis " tarsimaculatus " theobaldi " turkhudi " umbrosus.		
Malaria, tertian	Plasmodium vivax.	Anopheles albimanus " barbirostris " bifurcatus " costalis " crucians " culicifacies " fuliginosus " funesta " intermedium " jesoensis " listoni " maculatus " maculipalpis " maculipennis " mediopunctatus " minimus " pharoensis " pseudomaculipes " punctipennis " quadrimaculatus " rossii " sinensis " stephensi " superpictus " theobaldi " turkhudi.	Transmitted by bite of mosquito.	Intermediate host.
Malaria, unclassified	Plasmodium spp.	More or less evidence has been produced against Anopheles aitkeni " algeriensis " apicimaculata " arabiensis " ardensis " boliviensis " braziliensis " coustani " culicifacies sergentii " farauti " grabhamii " jamesii " jeyporensis " karwari " maculipes " martini " mauritanus and var. paludis " minimus and var. christophersi " nimba " pitchfordi " puctulata " pursati " rhodesiensis " d'thali " sinensis pseudo- pictus " turkhudi chau- doyei " turkhudi myzo- myifacies " vincenti " willmori		

Disease	Causative organism	Insect transmitter	Method of insect transmissions	Nature of insect rôle
Mange, demodectic (Seborrhea, blepharitis, blackheads) (acarine dermatosis)	<i>Demodex folliculorum</i> " <i>phylloides</i> " <i>bovis</i>	Same as preceding column.	Direct attack in hair follicles.	Parasite.
Mange, psoroptic (Acarine dermatosis) (sheep scab, Texas itch, etc.)	<i>Psoroptes communis ovis</i> " " <i>bovis</i> " " <i>equi</i> .	Same as preceding column.	Direct attack in skin.	Parasite.
Mbori	<i>Castellanella evansi mbori</i> .	<i>Tabanus tæniatus</i> " <i>biguttatus</i> .	Transmission by bite.	Intermediate host.
Measles	Virus.	Flies suspected.	From sores.	Mechanical carrier.
Mediterranean coast fever. See Cattle fever				
Melanodermia	<i>Pediculus corporis</i> <i>Phthirus pubis</i> .	<i>Pediculus corporis</i> <i>Phthirus pubis</i> .	Direct attack.	External parasites.
Meningitis, cerebrospinal	<i>Diplococcus intracellularis meningitidis</i> .	<i>Pediculus corporis</i> .	Taken up by bite of louse deposited in feces.	Mechanical carrier.
Miana, tick fever. See Fevers (tick)				
Murrina, equine	<i>Castellanella hippicum</i> .	<i>Musca domestica</i> <i>Chrysomya</i> <i>Sarcophaga</i> .	Taken up by flies from sores, carried to sores.	Mechanical carrier.
Myiasis, blood-sucking larvæ	<i>Auchmeromyia luteola</i> <i>Chæromyia boueti</i> " <i>chærophaga</i> <i>Mydæa pici</i> <i>Passeromyia heterochæta</i> <i>Phormia azurea</i> " <i>chrysoorrhœa</i> " <i>sordida</i> .	Same as preceding column.	Free living larvæ attack mammals and suck blood.	Blood-sucking parasites.
Myiasis of the head passages	<i>Cephalomyia maculata</i> <i>Cephenomyia phobifer</i> " <i>pratti</i> " <i>trompe</i> . <i>Oestrus ovis</i> <i>Rhinestrus hippopotami</i> " <i>nasalis</i> " <i>purpureus</i>	Same as preceding column.	Flies deposit living larvæ in nose. Larvæ feed on tissues in head passages.	True parasite (internal).
Myiasis intestinal and urogenital	<i>Anthomyia disgordiensis</i> <i>Aphiochæta ferruginea</i> <i>Cobboldia chrysidiformis</i> " <i>elephantis</i> " <i>loxodontis</i> <i>Eristalis arbutorum</i> " <i>dimidiatus</i> " <i>tenax</i> <i>Fannia canicularis</i> " <i>scalaris</i> <i>Gastrophilus intestinalis</i> " <i>hæmorrhoidalis</i> " <i>nasalis</i> <i>Helophilus pendulinus</i> <i>Hydrotæa meteorica</i> <i>Muscina stabulans</i> <i>Mydæa vomiturationis</i> <i>Pharyngobolus africanus</i> <i>Piophila casei</i> <i>Pollenia rudis</i> <i>Sarcophaga hæmorrhoidalis</i>	Same as preceding column.	Accidental ingestion. Some of these species may breed in the intestines or elsewhere.	Accidental parasite (internal).
Myiasis, subdermal (truly parasitic) (human, animal)	<i>Bengalia depressa</i> <i>Cordylobia anthropophaga</i> " <i>rodhaini</i> <i>Cuterebra emasculator</i> <i>Gastrophilus intestinalis</i> <i>Hypoderma bovis</i> " <i>lineata</i>	Same as preceding column.	Eggs laid on skin. Larvæ penetrate under tissue and burrow.	Parasite.

Disease	Causative organism	Insect transmitter	Method of insect transmissions	Nature of insect rôle
Nematode, canine	<i>Spirocerca sanguinolenta</i>	<i>Akis goryi</i> <i>Copris hispanus</i> <i>Geotrupes douei</i> <i>Gymnopleurus sturmi</i> . " <i>Scarabæus sacer</i> . " <i>variolosus</i> .	Insects swallow eggs. Animals swallow insects.	Intermediate host.
Nematode, equine (granuloma)	<i>Habronema megastoma</i> .	<i>Musca domestica</i> .	Insects swallow eggs. Animals swallow insects.	Intermediate host.
Nematode, equine (granuloma)	<i>Habronema microstoma</i> .	<i>Stomoxys calcitrans</i>	Insects swallow eggs. Animals swallow insects.	Intermediate host.
Nematode, equine	<i>Habronema muscæ</i> .	<i>Musca domestica</i> .	Fly larvæ swallow eggs. Animals swallow insects. Possibly also larvæ leave proboscis of fly to attack wounds and eyes.	Intermediate host.
Nematode, fowl	<i>Acuaria spiralis</i> .	<i>Porcellio lævis</i> .	Eggs eaten by sow bugs. Sowbugs eaten by chickens	Intermediate host.
Nematode, fowl	<i>Filaria gallinarum</i> .	<i>Hodotermes pretoriensis</i> .	Insects swallow eggs. Chickens swallow insects.	Intermediate host.
Nematode hedgehog	<i>Gongylonema mucronatum</i> .	<i>Ateuchus sacer</i> <i>Chironitis irroratus</i> . <i>Onthophagus bedeli</i> <i>Gymnopleurus mopsus sturmi</i> . " <i>Geotrupes douei</i> .	Insects swallow eggs. Animals swallow insects.	Intermediate host.
Nematode, hedgehog (fox, mongoose)	<i>Spirura gastrophila</i> .	<i>Blaps sp.</i> <i>Blaps strauchi</i> <i>Onthophagus spp.</i> <i>Blatta orientalis</i> . <i>Akis goryi</i>	Insects swallow eggs. Animals swallow insects.	Intermediate hosts.
Nematode, hog	<i>Gongylonema pulchrum</i> .	<i>Blattella germanica</i> .	Eggs eaten by roaches developed to encysted larvæ.	Possible intermediate host
Nematode, hog	<i>Arduenna strongylina</i> .	<i>Aphodius rufus castaneus</i> <i>Onthophagus spp.</i>	Insects swallow eggs. Animals swallow insects.	Intermediate hosts.
Nematode, hog, donkey, dromedary	<i>Physocephalus sexalatus</i> .	<i>Geotrupes douei</i> <i>Onthophagus bedeli</i> <i>Scarabæus sacer</i> " <i>variolosus</i>	Insects swallow eggs. Animals swallow insects.	Intermediate hosts.
Nematode, jerboa (probably)	<i>Gongylonema brevispiculum</i> probably	<i>Blaps sp.</i> <i>Blaps strauchi</i> .	Insects swallow eggs. Animals swallow insects.	Intermediate host.
Nematode, rodent	<i>Gongylonema neoplasticum</i> .	<i>Blatta orientalis</i> <i>Blattella germanica</i> <i>Periplaneta americana</i> <i>Tenebrio molitor</i> .	Insects swallow eggs. Animals swallow insects.	Intermediate hosts.

TABULATION OF DISEASES AND INSECT TRANSMISSION 487

Disease	Causative organism	Insect transmitter	Method of insect transmissions	Nature of insect rôle
Nematode, rodent	<i>Protospirura muris</i> .	<i>Tenebrio molitor</i> . <i>Xenopsylla cheopis</i> .	Insect swallows egg. Animal swallows insect.	Intermediate hosts.
Nuttalliosis, equine	<i>Nuttallia equi</i> .	<i>Rhipicephalus evertsi</i> and possibly <i>Hyalomma ægyptium</i> .	Transmitted by bite of tick.	Intermediate host.
Ocular acariasis	<i>Dermanyssus gallinæ</i> .	<i>Dermanyssus gallinæ</i> .	Direct attack on cornea.	Parasite.
Ophthalmia nodosa. See Poisoning (Lepidoptera)				
Ophthalmia, purulent		<i>Musca domestica</i> .	From eye to eye.	Mechanical carrier.
Otoacariasis, human and animal	<i>Acaropsis mericourti</i> <i>Cheyletus eruditus</i> <i>Demodex folliculorum</i> <i>Dermanyssus gallinæ</i> <i>Ornithodoros megnini</i> <i>Otodectes cynotis</i> <i>Psoroptes cuniculi</i> <i>Rhizoglyphus parasiticus</i> .	Same as preceding column.	Direct attack on ear.	Parasite.
Pappataci fever	Filterable virus.	<i>Phlebotomus papatasi</i> .	Transmission by bite of fly.	Intermediate host.
Paracolis (summer diarrhœa)	<i>Bacillus paracoli</i> .	<i>Musca domestica</i> .	Taken up by flies from stools. Deposited in feces or food.	Mechanical carrier.
Paralysis, infantile. See Poliomyelitis				
Paralysis, tick (human and animal)	<i>Amblyomma hebræum</i> <i>Boophilus annulatus</i> <i>annulatus decoloratus</i> <i>Dermacentor andersoni</i> <i>Ixodes holocyclus</i> " <i>pilosus</i> " <i>ricinus</i> <i>Ornithodoros coriaceus</i> <i>Rhipicephalus simus</i> .	Same as preceding column.	Attachment of tick causes paralysis which may become fatal. Removal of tick head by excision terminates paralysis.	Parasite.
Paratyphoid fever (A and B)	<i>Bacillus paratyphosus</i> (A and B).	<i>Musca domestica</i> .	Taken up by flies from stools. Deposited in feces on food.	Mechanical carriers.
Pellagra	Unknown cause.	<i>Simulium</i> spp. <i>Stomoxys calcitrans</i> have been suspected.	No positive evidence.	
Peritonitis. See Acariasis				
Pinworm, equine	<i>Oxyuris curvula</i> (probably)	<i>Musca nebulosa</i> .	Larvæ swallow eggs of worms.	Possibly intermediate host.
Piroplasmiasis. See Cattle Fever				
Pityriasis	<i>Malassezia</i> sp.	<i>Pediculus corporis</i> .	Manner of carriage not demonstrated.	Mechanical carrier.

Disease	Causative organism	Insect transmitter	Method of insect transmissions	Nature of Insect rôle
Plague, bubonic	<i>Bacillus pestis</i> .	<i>Ceratophyllus acutus</i> " <i>fasciatus</i> " <i>silantiewi</i> <i>Ctenocephalus canis</i> <i>Leptopsylla musculi</i> <i>Pulex irritans</i> <i>Pygiopsylla ahalse</i> . <i>Xenopsylla cheopis</i> .	The bacillus is taken up from the blood by the flea, and may be transmitted by regurgitation at the time of biting, or by inoculation through scratching in of infected feces.	Mechanical carrier
		<i>Musca domestica</i> .	Taken up by flies from stools. Deposited in feces and food.	Mechanical carrier.
		<i>Pediculus corporis</i> .	Experimental transmission obtained by subcutaneous inoculation of crushed lice.	Mechanical carrier.
Plague, rodent (sometimes human, as Deerfly fever, Pahvant Valley Plague)	<i>Bacterium tularense</i> .	<i>Ceratophyllus acutus</i>	The bacillus is taken up from the blood. Experimental infection has been obtained by inoculation of crushed fleas.	Mechanical carrier.
		<i>Musca domestica</i> .	Taken up from carcass.	Mechanical carrier.
		<i>Stomoxys calcitrans</i> .	Experimental transmission only has been obtained by bite of fly and by inoculation of crushed flies.	Probably mechanical carrier.
		<i>Chrysops</i> sp.	Inoculation by bite of fly is suspected.	Mechanical carrier.
<i>Plica polonica</i>	<i>Pediculus humanus</i> .	<i>Pediculus humanus</i> .	Direct attack of lice on the scalp.	External parasite.
Poisoning, bee, wasp and ant	<i>Apis mellifera</i> <i>Bombus</i> spp. <i>Pogonomyrmex barbatus</i> <i>Polistes</i> spp. <i>Vespa</i> spp. Many other ants, bees and wasps.	Same as preceding column.	The poison is injected by sting of ovipositor.	Direct attack.
Poisoning, bug (used as food)	<i>Aspongopus nepalensis</i>	<i>Aspongopus nepalensis</i> .	The bugs are cooked and eaten as a delicacy but cause severe rigors.	Toxic poisoning.
Poisoning, centipede	<i>Ethmostigmus spinosus</i> <i>Geophilus similis</i> <i>Scolopendra angulata</i> " <i>gigantea</i> " <i>heros</i> " <i>morsicans</i> .	Same as preceding column.	The poison is injected from glands located in the head and having their opening in a pair of venom claws lying beneath the head.	Direct attack.

TABULATION OF DISEASES AND INSECT TRANSMISSION 489

Disease	Causative organism	Insect transmitter	Method of insect transmissions	Nature of Insect rôle
Poisoning, food (summer diarrhoea)	<i>Bacillus suispester</i> .	<i>Musca domestica</i> .	Taken up from stools. Deposited on food.	Mechanical carrier.
Poisoning, honey	<i>Apis mellifera</i> <i>Melipona</i> spp. <i>Trigona bipunctata</i> " <i>amalthæa</i> " <i>ruficrus</i> " <i>limao</i>	Same as preceding column.	The honey of these bees is contaminated by poisons derived from their foods, and may often contain disease organisms. Honey poisoning is often fatal to the natives of Central America.	The rôle of the bee is that of contaminating its honey which becomes food of man.
Poisoning, kissing bug	<i>Melanolestes picipes</i> .	<i>Melanolestes picipes</i>	Bite of insect.	Direct attack.
Poisoning, lepidopterous larval. (Brown tail rash, ophthalmia nodosa)	<i>Automeris io</i> <i>Cnethocampa pityocampa</i> <i>Euproctis chrysoorrhæa</i> <i>Hemileuca maia</i> <i>Lagoa crispata</i> <i>Lasiocampa pini</i> <i>Lymantria monacha</i> <i>Macrothylacia rubi</i> <i>Megalopyge opercularis</i> <i>Porthesia similis</i> <i>Porthetria dispar</i> <i>Sibine stimulea</i> .	Same as preceding column.	Inflammation of skin and mucous membrane caused by spined or barbed hairs containing poison.	The insect's rôle is neutral. The injury is due to contact of the body with the hairs or to wind blown hairs at the time of molting.
Poisoning, scorpion	<i>Androctonus funestus</i> <i>Buthus afer</i> " <i>carolinianus</i> " <i>martensi</i> " <i>maurus</i> " <i>occitanus</i> " <i>quinquestriatus</i> <i>Centrurus exlicaude</i> <i>Heterometrus maurus</i> <i>Isometrus europæus</i> <i>Prionurus amoureuni</i> " <i>citrinus</i>	Same as preceding column.	The poison is injected by sting of poisonous spine at tip of tail.	Direct attack.
Poisoning, spider	<i>Chiracanthum nutrix</i> <i>Epeira diadema</i> <i>Latrodectes geometricus</i> " <i>hasseltii</i> " <i>mactans</i> <i>Lycosa narbonensis</i> " <i>tarantula</i> <i>Phiddipus audax</i> <i>Theraphosa javanensis</i> <i>Theridium lugubre</i> " <i>13-guttatum</i> <i>Trochosa singoriensis</i>	Same as preceding column.	The poison is injected by the mandibles which contain a poison gland.	Direct attack.
Poliomyelitis (Infantile paralysis)	Filterable virus.	<i>Musca domestica</i> . <i>Cimex lectularius</i> . <i>Stomoxys calcitrans</i> .	Taken up by fly from mucus discharges. Deposited in feces. The virus taken up in blood by the bug. Experimental inoculation of crushed bugs produced disease A few experimental transmissions by bite.	Mechanical carrier. Mechanical carrier. Mechanical carrier (?)

Disease	Causative organism	Insect transmitter	Method of insect transmissions	Nature of Insect rôle
Porrigo. See Favus				
Pseudœdema, malignant	Bacillus "pseudœdema maligno" Cao.	<i>Blatta orientalis</i> .	Passes through intestinal tract intact. Infection by contamination.	Mechanical carrier.
Pseudoparasitism of nasal and alimentary passages by centipedes	<i>Chaetechelyne vesuviana</i> <i>Geophilus carpophagus</i> "cephalicus "electricus "similis <i>Himantarium gervaisi</i> <i>Julus londinensis</i> "terrestris <i>Lithobius forficatus</i> "melanops <i>Polydesmus complanatus</i> <i>Scutigera coleoptrata</i> <i>Stigmatogaster subterraneus</i>	Same as preceding.	Inflammation is caused in the nasal and alimentary passages due to the accidental entrance of centipedes, probably during sleep or in fresh vegetable foods.	Direct attack.
Pyodermia	<i>Pediculus corporis</i> .	<i>Pediculus corporis</i> .	Direct attack.	External parasite.
Redwater of cattle, British	<i>Babesia divergens</i> .	<i>Ixodes ricinus</i> <i>Hæmaphysalis cinabarina punctata</i> .	Transmitted by bite of tick.	Intermediate host.
Redwater. See Cattle Fever				
Relapsing fever, Abyssinian	<i>Spiroschaudinnia</i> sp.	<i>Ornithodoros savignyi</i>	Experimental transmission by bite of tick. Transmission is probably by the washing into the wound of the organism in Malpighian excrement.	Intermediate host.
Relapsing fever, American	<i>Spiroschaudinnia novyi</i> .	<i>Ornithodoros turicata</i> "megnini "moubata. <i>Argas persicus</i> are suspected.	Probably taken up by bite of tick and voided in Malpighian excrement, to be washed into wounds by coxal fluids.	Intermediate host.
Relapsing fever, Asiatic	<i>Spiroschaudinnia carteri</i> .	<i>Pediculus corporis</i> .	Deposited in feces of lice.	Intermediate host.
Relapsing fever, East African	<i>Spiroschaudinnia rossi</i> .	<i>Ornithodoros moubata</i> .	Probably taken up by bite of tick and voided in Malpighian excrement to be washed into wounds by coxal secretions.	Intermediate host.

TABULATION OF DISEASES AND INSECT TRANSMISSION 491

Disease	Causative organism	Insect transmitter	Method of insect transmissions	Nature of Insect rôle
Relapsing fever, European	Spiroschaudinnia recurrentis	Cimex lectularius.	Taken up by bug from blood and passed in feces. Inoculation by scratching at site of bite.	Intermediate host.
		Pediculus corporis Polyplax spinulosus (experimental).	Infection by scratching in feces or body of louse.	Intermediate host.
		Ornithodoros moubata.	Easily transmitted by the tick. Probably taken up by the bite of tick and voided in Malpighian excrement, to be washed into wound by coxal fluids.	Intermediate host.
Relapsing fever, North African	Spiroschaudinnia berbera.	Pediculus corporis.	Infection by scratching in feces of louse.	Intermediate host.
Relapsing fever, Tropical African	Spiroschaudinnia duttoni.	Ornithodoros moubata.	Taken up by the bite of the tick and may be transmitted in subsequent attachments of the adult, or of the second and even the third generation of ticks. The organism is voided in the Malpighian excrement and washed into the bite wound.	Intermediate host.
		Polyplax spinulosus (experimental).	Rat infected experimentally.	Intermediate host.
Rhodesian Fever. See East Coast Fever	Dermacentroxenus rickettsi	Dermacentor	Taken up by bite of tick and transmitted by bite of next generation.	Intermediate host.
Rocky Mountain Spotted Fever		andersoni " variabilis " modestus " marginatus Amblyomma americanum.		
Scab. See Mange (demodectic)	Sarcoptes scabiei hominis " crustosae " auchenisæ " bovis " canis " capræ " dromedarii " equi " leonis " ovis " suis " vulpis Notoedres cati cati. " muris	Same as preceding column.	Direct attack of mites in skin.	Parasitic.

Disease	Causative organism	Insect transmitter	Method of insect transmissions	Nature of insect rôle
Scaly leg, chicken (acarine dermatosis)	<i>Cnemidocoptes mutans</i> .	<i>Cnemidocoptes mutans</i> .	Direct attack of mites on legs.	Parasite.
Scarlet fever	Virus.	Flies suspected.	Flies might carry virus from sore to sore.	Mechanical carrier.
Seborrhea. See Mange (demodectic) Septicæmia	<i>Staphylococcus pyogenes</i> vars. <i>albus</i> , <i>aureus</i> , <i>citreus</i> .	<i>Calliphora vomitoria</i> <i>Lucilia cæsar</i> <i>Musca domestica</i> <i>Sarcophaga carnaria</i> <i>Tabanus</i> sp.	Insects take up from pus, carry in body or on legs. Deposit in feces on wounds.	Mechanical carriers.
Septicæmia	<i>Streptococcus</i> .	<i>Stomoxys calcitrans</i> .	Found in body of fly.	Mechanical carrier.
Septicæmia, rabbit	<i>Bacillus cuniculicida</i> .	<i>Musca domestica</i> .	Flies take up from rabbit feces and distribute in their feces.	Mechanical carrier.
Sleeping sickness Gambian and Nigerian	<i>Castellanella gambiense</i> .	<i>Glossina palpalis palpalis</i> " <i>fuscipes</i> " <i>morsitans</i> " <i>fusca</i> " <i>longipennis</i> " <i>pallidipes</i> " <i>brevipalpis</i> " <i>tachinoides</i> . <i>Stomoxys calcitrans</i> .	Transmitted by fly bite.	Intermediate host.
Sleeping sickness, Rhodesian	<i>Castellanella rhodesiense</i> .	<i>Glossina morsitans</i> " <i>palpalis</i> " <i>brevipalpis</i> . <i>Aedes argenteus</i> .	Transmitted by fly bite. Experimental transmission by mosquito bite.	Intermediate host. Mechanical (?)
Smallpox	Virus.	Flies.	Flies have been found breeding in open lesions and can probably transmit the virus through their feces.	Mechanical carrier.
Sore, Bagdad	<i>Leishmania tropica</i> .	<i>Aedes argenteus</i> .	Mosquitos took up parasites. Transmission unsuccessful.	Uncertain
Sore, Biskra	<i>Leishmania tropica</i> .	<i>Phlebotomus minutus africanus</i> is suspected.	Transmission by bite of fly.	Mechanical carrier (?)
Sore, Orienta	<i>Leishmania tropica</i> .	<i>Cimex lectularius</i> " <i>hemipterus</i> .	Taken up by bug from blood and capable of complete development in gut. No successful transmission. Transmission is probably effected by fecal contamination.	Experimental intermediate host.
		<i>Musca domestica</i> .	Can probably be taken up by flies from sores and deposited in their feces on wounds or mucous membrane.	Mechanical carrier.

TABULATION OF DISEASES AND INSECT TRANSMISSION 493

Disease	Causative organism	Insect transmitter	Method of insect transmissions	Nature of insect rôle
Souma	Duttonella cazalboui.	Glossina palpalis " longipalpis " morsitans " tachinoides Stomoxys calcitrans " nigra Tabanus biguttatus " tæniatus.	Transmitted by fly bite.	Intermediate host.
Souma, Zambian	Duttonella cazalboui pigritia.	Hæmatopota perturbans.	Transmission by fly bite.	Intermediate host.
Spirochætosis, bovine	Spiroschaudinna theileri.	Boophilus annulatus australis Rhipicephalus evertsi.	Taken up by bite of tick. It appears 14 days after inoculation by larval tick. Is hereditary in B. decoloratus. The manner of inoculation is not determined but is probably by the washing into the wound of the organisms in the Malpighian excrement.	Intermediate host.
Spirochætosis, fowl, of North America	Spiroschaudinna granulosa.	Argas persicus.	Transmitted by bite of tick. The inoculation is probably accomplished by the washing into the wound of the organisms in the Malpighian excrement.	Intermediate host.
Spirochætosis, fowl, of Senegal	Spiroschaudinna neveuxii.	Argas persicus.	Transmitted by bite of tick, probably by being washed into the wound by coxal fluid from the Malpighian excrement in which it is voided.	Intermediate host.
Spirochætosis, fowl, of South America	Spiroschaudinna marchouxi.	Argas persicus " reflexus Ornithodoros moubata.	Taken up by the bite of tick and voided in Malpighian excrement which is washed into the wound made by bite, by coxal fluids. Is probably hereditarily transmitted in the tick.	Intermediate host.

Disease	Causative organism	Insect transmitter	Method of insect transmissions	Nature of insect rôle
Spirochaetosis, goose	<i>Spiroschaudinnia anserina</i> .	<i>Argas persicus</i> .	Transmitted by bite of tick. Transmission is probably the washing into the wound of the organism in Malpighian excrement.	Intermediate host.
Spirochaetosis. See Relapsing fever				
Splenic fever. See Cattle fever				
Suppurating wounds (blue-green pus)	<i>Bacillus pyocyaneus</i> .	<i>Musca domestica</i> .	Taken up from wounds and carried to wounds. Deposited in feces on wounds.	Mechanical carrier.
Surra	<i>Castellanella evansi</i> .	Experimentally transmitted by <i>Stomoxys calcitrans</i> " <i>geniculatus</i> " <i>nigra</i> . Strong suspicion points to <i>Tabanus tropicus</i> " <i>striatus</i> " <i>lineola</i> " <i>fumifer</i> " <i>partitus</i> " <i>vagus</i> " <i>minimus</i> The following are also suspected: <i>Lyperosia minuta</i> <i>Phlebotomyia crassirostris</i> <i>Lyperosia exigua</i> .	Transmitted by fly bite.	Intermediate host.
		<i>Musca domestica</i> .	Taken up from wounds and transmitted to wounds.	Mechanical carrier.
		<i>Aedes argenteus</i> .	Mosquitoes experimentally took up organism which persisted for hours.	Mechanical carrier.
Tahaga (el dedab, zousfana)	<i>Castellanella soudanense</i> .	<i>Stomoxys calcitrans</i> " <i>nigra</i> <i>Atylotus nemoralis</i> " <i>tomentosus</i>	Transmission by bite of fly (experimental).	Intermediate host.
Tapeworm, canine and human	<i>Dipylidium caninum</i> .	<i>Trichodectes latus</i> <i>Ctenocephalus canis</i> " <i>felis</i> . <i>Pulex irritans</i> .	Insect swallows eggs. Animals swallow insects.	Intermediate host.
Tapeworm, cattle and man	<i>Tænia saginata</i> .	<i>Musca domestica</i> .	Insect swallows eggs. Deposits on food.	Mechanical carrier.
Tapeworm, fowl	<i>Choanotænia infundibulum</i> .	<i>Musca domestica</i> .	Insect larvæ swallow eggs, chicken swallows fly.	Intermediate host.
Tapeworm, fowl	<i>Davainea cesticillus</i> <i>Davainea tetragona</i> .	<i>Musca domestica</i> .	Insect swallows eggs. Chicken swallows fly.	Possibly intermediate host

TABULATION OF DISEASES AND INSECT TRANSMISSION 495

Disease	Causative organism	Insect transmitter	Method of insect transmissions	Nature of insect rôle
Tapeworm, fowl.	<i>Hymenolepis carioca.</i>	<i>Stomoxys calcitrans</i>	Insect swallows eggs. Chicken swallows fly.	Possibly intermediate host
Tapeworm, human	<i>Davainea madagascariensis.</i>	<i>Blatta orientalis.</i>	The cysticercus has been found in these roaches.	Mechanical carrier or possibly biological.
Tapeworm, rat and human	<i>Hymenolepis nana.</i>	<i>Ceratophyllus fasciatus.</i> <i>Xenopsylla cheopis.</i>	Insect swallows eggs. If the insect is the true intermediate host then infection is probably by the animal swallowing insect.	Intermediate host (possibly, but not proved).
Tapeworm, rodent and human	<i>Hymenolepis diminuta.</i>	<i>Akis spinosa</i> <i>Anisoblabis annulipes</i> <i>Asopia farinalis</i> <i>Fontaria virginiensis</i> <i>Julus sp.</i> <i>Scaurus striatus</i> <i>Tenebrio molitor.</i>	Insect swallows eggs, animal swallows insect.	Intermediate host.
		<i>Ceratophyllus fasciatus.</i> <i>Ctenocephalus canis</i> <i>Pulex irritans</i> <i>Xenopsylla cheopis.</i>	The flea larva swallows the egg, which persists through metamorphosis. The animal is infected by eating the flea.	Intermediate host.
Tetanus	<i>Bacillus tetanus.</i>	<i>Dermatophilus penetrans.</i>	The attack of this flea frequently leads to attacks of tetanus.	Mechanical carrier.
Thorn headed worm, rodent and human	<i>Moniliformis moniliformis.</i>	<i>Blaps mucronata</i> <i>Periplaneta americana.</i>	The larval stage has been found in these insects.	Intermediate hosts.
Thorn headed worm, pig and man	<i>Macracanthorhynchus hirudinaceus.</i>	<i>Cetonia aurata</i> <i>Diloboderus abderus</i> <i>Melolontha vulgaris</i> <i>Phyllophaga arcuata</i>	Insects swallow eggs. Animals eat insects.	Intermediate hosts.
Toxemia	<i>Pediculus corporis</i> <i>Phthirus pubis.</i>	<i>Pediculus corporis</i> <i>Phthirus pubis.</i>	Direct attack.	External parasite.
Trachoma		<i>Musca domestica.</i>	From eye to eye.	Mechanical carrier.
Trench fever	Filterable virus. Possibly <i>Rickettsia quintana</i>	<i>Pediculus corporis.</i>	Organism is deposited in feces of lice.	Intermediate host
Trypanosomiasis, animal	<i>Castellanella dimorphon.</i>	<i>Glossina palpalis</i> " <i>tachinoides</i> " <i>morsitans</i> " <i>longipalpis.</i>	Transmission by fly bite.	Intermediate host.
Trypanosomiasis, bat	<i>Trypanosoma vespertilionis.</i>	<i>Cimex pipistrelli.</i>	Manner of transmission not demonstrated.	Intermediate host.
Trypanosomiasis, bovine	<i>Duttonella nanum.</i>	<i>Glossina palpalis</i> and possibly <i>Glossina morsitans.</i>	Transmission by fly bite.	Intermediate host.

Disease	Causative organism	Insect transmitter	Method of insect transmissions	Nature of insect rôle
Trypanosomiasis, bovine	<i>Duttonella uniforme.</i>	<i>Glossina palpalis.</i>	Transmission by bite.	Intermediate host.
Trypanosomiasis, bovine and ovine	<i>Duttonella vivax.</i>	<i>Glossina tachinoides</i> and probably <i>Glossina palpalis morsitans.</i>	Transmission by bite.	Intermediate host.
Trypanosomiasis, crocodile	<i>Trypanosoma grayi.</i>	<i>Glossina palpalis brevipalpis.</i>	Transmission by bite.	Intermediate host.
Trypanosomiasis, equine	<i>Castellana annamense.</i>	Tabanidæ Hippoboscidæ are suspected.	Transmission by bite.	Intermediate host.
Trypanosomiasis, fowl	<i>Trypanosoma (sens. lat.) gallinarum.</i>	<i>Glossina palpalis.</i>	Transmission by bite	Intermediate host.
Trypanosomiasis, goat	<i>Duttonella capræ.</i>	<i>Glossina brevipalpis morsitans.</i>	Transmission by bite.	Intermediate host.
Trypanosomiasis, rabbit	<i>Trypanozoon nabiasi.</i>	<i>Ctenocephalus leporis</i> <i>Spilopsyllus leporis.</i>	Taken up by the flea from the blood. Licked up by the rabbit in the feces of the flea.	Intermediate host.
Trypanosomiasis, rodent	<i>Trypanozoon blanchardi.</i>	<i>Ceratophyllus lavrani.</i>	Taken up by the flea from the blood. Licked up by the rodent in the feces of the flea.	Intermediate host.
Trypanosomiasis, rodent	<i>Trypanozoon duttoni.</i>	<i>Ceratophyllus hirundinis.</i>	Taken up by the flea from the blood. Licked up by the rodent in the feces of the flea.	Intermediate host.
		<i>Cimex lectularius.</i>	Experimentally fed to bed-bugs and capable of development therein.	Experimental intermediate host.
Trypanosomiasis, rodent	<i>Trypanozoon rabinowitschi.</i>	<i>Ctenocephalus canis</i>	Taken up by the flea from the blood. Licked up by the rodent in the feces of the flea.	Intermediate host.
Trypanosomiasis, rodent	<i>Trypanozoon lewisi.</i>	<i>Ceratophyllus fasciatus</i> " <i>hirundinis</i> " <i>lucifer</i> <i>Ctenocephalus canis</i> <i>Ctenophthalmus agyrtes</i> <i>Ctenopsylla musculi</i> <i>Pulex brasiliensis</i> " <i>irritans</i> <i>Xenopsylla cheopis.</i> <i>Polyplax spinulosus.</i>	Taken up by the flea from the blood. Licked up by the rodent in the feces of the flea.	Intermediate host.
			Rat is infected by licking up insect's dejections.	Intermediate host.
		<i>Cimex lectularius.</i>	Experimentally fed to bugs and completed development. Inoculation of rectal contents produced disease.	Experimental intermediate host.
Trypanosomiasis, simian	<i>Duttonella simiæ.</i>	<i>Glossina morsitans brevipalpis.</i>	Transmitted by bite.	Intermediate host.

TABULATION OF DISEASES AND INSECT TRANSMISSION 497

Disease	Causative organism	Insect transmitter	Method of insect transmissions	Nature of insect rôle
Trypanosomiasis. See Aino, Baleri, Chagas fever, Dourine, Horse sickness (Gambian), Mal de caderas, Nagana, Sleeping sickness, Souma, Surra, Taha-ga				
Tsutsugamushi disease (Japanese river fever, Kedani disease)	Filterable virus.	Leptus akamushi.	Transmission by bite of mite.	Intermediate host.
Tuberculosis	Bacillus tuberculosis.	Musca domestica.	Taken up from sputum. Deposited on food.	Mechanical carrier.
		Blatta orientalis.	Passes through intestinal tract intact. Infection by contamination.	Mechanical carrier.
Tumors, sebaceous (in birds and animals)	Harpyrynchus longipilus Psorergates simplex musculinus Myobia muscili.	Same as preceding column.	Direct attack in hair follicles.	Parasite.
Typhoid fever	Bacillus typhosus.	Musca domestica.	Taken up by larva or adult from stools. Survives metamorphosis. Deposited in feces on food.	Mechanical carrier possibly also biological.
		Pediculus corporis " humanus.	Organism was found in the lice.	Mechanical carrier.
Typhus fever	Filterable virus. Possibly Rickettsia prowazeki.	Pediculus corporis.	Organism is deposited in feces of lice.	Intermediate host.
Urticaria	Pediculus corporis.	Pediculus corporis.	Direct attack.	External parasite.
Urticariasis (grain itch, erythema urticaria) (acarine dermatosis)	Pediculoides ventricosus Tarsonemus uncinatus intactus Crithoptes monunguiculatus.	Same as preceding column.	Direct attack in skin.	Parasite.
Uta	Leishmania uta.	Forcipomyia uta. " townsendi are suspected.	Transmission by bite.	Mechanical carrier (?)
Vanillismus (acarine dermatosis)	Aleurobius farinae Tyroglyphus siro Histiogaster entomophagus.	Same as preceding column.	Direct attack in skin.	Parasite.
Verruga peruviana (Carrion's disease)	Bartonella bacilliformis (?)	Phlebotomus verrucarum (?)	Transmission by bite (?)	Intermediate host (?)
Volhynian fever	Rickettsia pediculi possibly	Pediculus corporis.	Experimental transmission obtained; method uncertain.	Intermediate host.
Whip worm	Trichuris trichiura.	Musca domestica Borborus punctipennis.	Insects swallow eggs. Deposit eggs on food.	Mechanical carrier.
Withers, fistulous (equine)	Dermacentor albipictus " venustus.	Same as preceding column.	The attack of the tick produces necrotic spots which permit infection.	Produces lesions for entrance of infection.
Wyoming Intermittent fever. See Fevers (tick)	Treponema pertenu.	Musca domestica Oscinis pallipes Sarcophaga (possibly).	Taken up from ulcers, carried to sores.	Mechanical carrier.
Yaws				
Yellow fever	Leptospira icteroides	Aedes argenteus.	Transmission by bite.	Intermediate host.

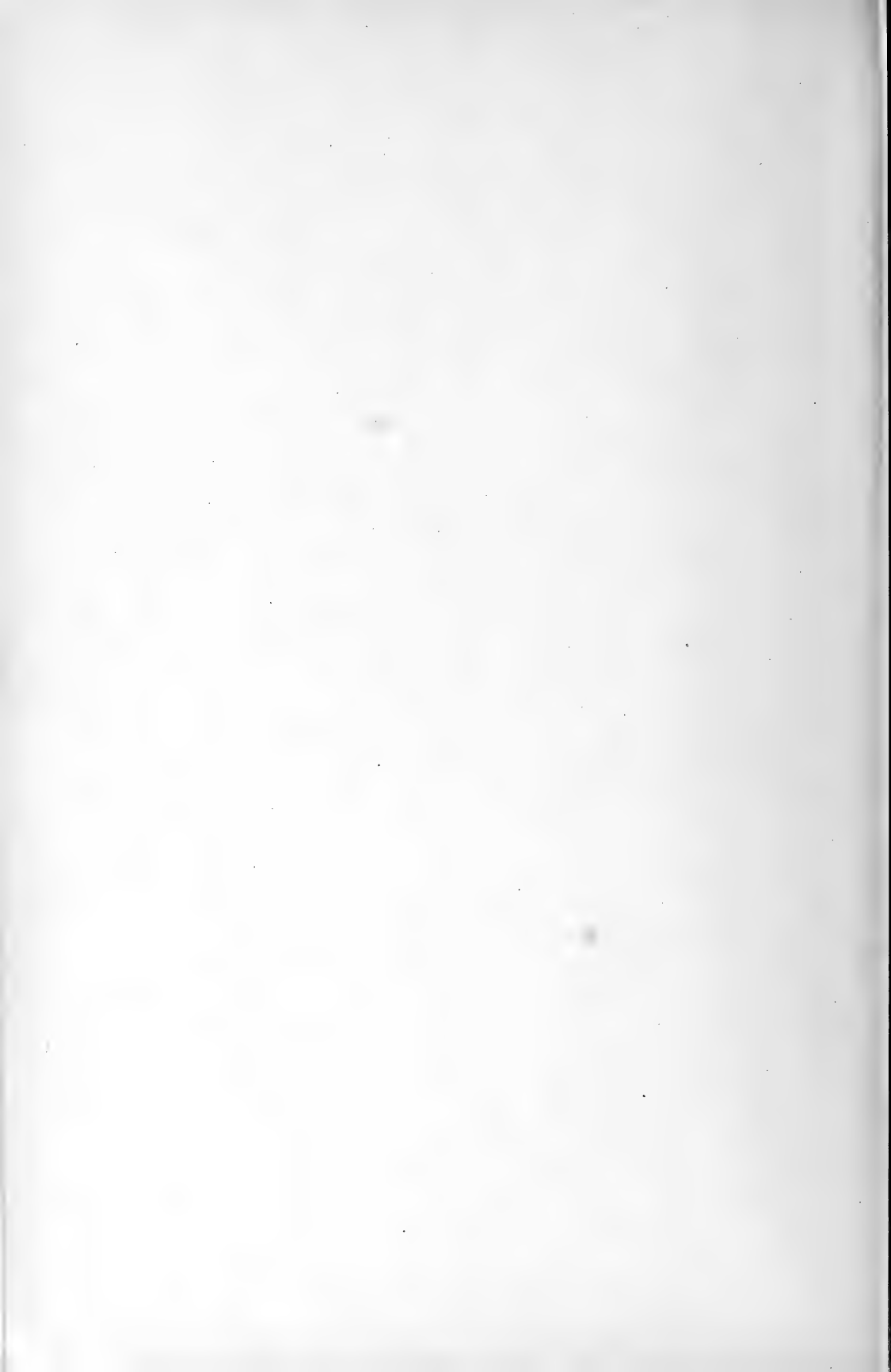

INDEX

- Abscess, 69, 108, 115, 409
 Acanthocephala, 79, 389
Acanthocheilonema grassii, (*Filaria*), nematode, 75, 76, 89, 94
perstans, (*Filaria*), human nematode, 74, 75, 80, 81, 82, 89, 90, 91, 92, 93, 95, 96, 261, 479
reconditum, (*Filaria*), dog nematode, 76, 80, 89, 92, 94, 357, 479
Acanthomys spp., rodents, 353
 Acariasis, 474
 internal, 408
 ocular, 408
 sense organ, 408
 Acarina, ticks, mites, 88, 89, 403-429, 461
 Acarine dermatosis, 403
Acaropsis mericourti, mite, 408, 487
Achorion schoenleinii, fungus, 289, 479
 Activity, zone of, 99
Acuaria spiralis, fowl nematode, 66, 67, 89, 486
 Adenitis, 69
Aedes argenteus (*calopus*, *fasciatus*), yellow fever mosquito, 70, 72, 74, 75, 80, 89, 248, 249, 250, 251, 259, 260, 261, 262, 266, 267, 269, 270, 272, 273, 477, 479, 480, 482, 492, 494, 497
gracilis, mosquito, 70, 80
nemorosus, mosquito, 259, 482
perplexus, mosquito, 262, 480
pseudoscutellaris, mosquito, 262, 479
scutellaris, mosquito, 70, 80, 262, 480
sugens, mosquito, 261, 479
sylvestris, mosquito, 249, 475
vexans, mosquito, 261, 479
Aeschna sp., dragon fly, 59, 87
 African relapsing fever tick (see *Ornithodoros moubata*)
Agamomermis culicis, mermithid, 262
Aggrippina bona, gregarine, 355
 Aggrippinidae, 355
Agrion sp., dragon fly, 59, 87
 Ainhum, 22, 373, 474
 Aino, 214, 474
Akis goryi, beetle, 61, 62, 84, 486
spinosa, beetle, 42, 54, 84, 495
Aleurobius farinae, mite, 405, 497
Allocreadium isoporum, fluke, 59, 83, 87
Allotribidium fuliginosum, mite, 404, 477
Amblyomma spp., ticks, 411, 424, 482
americanum, Lone Star tick, 413, 436, 491
Amblyomma spp., *cajennense*, tick, 436
hebraeum, tick, 410, 425, 436, 479, 480, 487
maculatum, Gulf Coast tick, 431
testudinis, tick, 414
 Amoebiasis, 474
 Amoebidae, 116, 117, 388
 Amoebina, 116, 117, 388
Anabolia nervosa, caddice fly, 59, 83
 Anaphylaxis, 468, 469
Anaplasma spp., piroplasmids, 414
argentinum, piroplasmids, 414, 474
marginale, piroplasmids, 414, 474
 Anaplasmosis, 414, 474
 Argentine, 414
Anastellorhina augur, fly, 181, 485
Ancylostoma duodenale, hook worm, 122, 480
 Ancylostomidae, 122
Androctonus funestus, scorpion, 462, 489
 Anemia, avian, 249, 250
 canine, 420, 421, 474
 equine infectious, 211, 228, 230, 474
 jackal, 417, 474
 jerboa, 296, 355, 474
 owl, 475
 palm squirrel, 297, 475
 rabbit, 475
 rat, 422, 475
 turtle, 475
 Anesthetic zone, 98, 102
Anisobasis annulipes, earwig, 42, 54, 88, 495
 Annoyance caused by insects, 20, 21
Anopheles sp., mosquito, 252
 near *claviger*, 251
aitkeni, mosquito, 253, 483
albimanus, mosquito, 72, 255, 256, 257, 258, 262, 285, 479, 480, 482, 483
albipes (see *A. albimanus*)
albirostris (see *A. minimus aconitus*)
algeriensis, mosquito, 253, 255, 257, 261, 479, 482, 483
annulipes, mosquito, 255, 482
apicimaculata, mosquito, 253, 483
arabiensis, mosquito, 253, 255, 483
ardensis, mosquito, 253, 483
argyrotarsis, mosquito, 255, 256, 262, 479, 482
barbirostris (*Myzorhynchus*), 70, 80, 255, 257, 262, 479, 482, 483
bifurcatus, mosquito, 73, 80, 257, 261, 479, 483

- Anopheles* sp., *boliviensis*, mosquito, 253, 483
braziliensis, mosquito, 253, 483
claviger (see *A. maculipennis*)
cohaesus (see *A. minimus aconitus*)
costalis (*Pyretophorus*), 70, 80, 255, 257, 261, 479, 482, 483
coustani, mosquito, 254, 483
crucians, mosquito, 255, 256, 257, 258, 266, 267, 268, 270, 271, 272, 273, 482, 483
culicifacies mosquito, 255, 257, 482, 483
sergentii, 254, 483
farauti, mosquito, 254, 483
febrifer (see *A. minimus*)
formosaensis I (see *A. minimus aconitus*)
II, mosquito, 255, 482
fragilis (see *A. aitkeni*)
franciscanus (see *A. pseudopunctipennis*)
fuliginosus, mosquito, 255, 257, 258, 482, 483
funestus, mosquito, 255, 257, 258, 482, 483
grabhamii, mosquito, 254, 483
intermedium, mosquito, 258, 259, 483
jamesii, mosquito, 254, 483
jesoensis, mosquito, 258, 483
jeyporensis, mosquito, 254, 483
karwari, mosquito, 254, 483
listoni, mosquito, 258, 483
lutzii (see *A. boliviensis*)
maculatus, mosquito, 256, 258, 482, 483
maculipalpis, mosquito, 258, 483
indiensis, 256, 483
maculipennis, mosquito, 59, 72, 73, 75, 80, 251, 256, 257, 258, 259, 261, 479, 480, 482, 483
maculipes, mosquito, 254, 483
martini, mosquito, 254, 483
mauritanus, mosquito, 254, 483
paludis, 254, 483
mediopunctatus, mosquito, 258, 259, 483
minimus, mosquito, 254, 255, 258, 483
acomitus, mosquito, 256, 483
christophersi, mosquito, 254, 483
minutus (see *A. sinensis*)
myzomyifacies (see *A. turkhudi myzomyifacies*)
nigerrimus (see *A. sinensis*)
nimba, mosquito, 254, 483
peditaeniatus (see *A. sinensis*)
pharoensis, mosquito, 258, 483
pitchfordi, mosquito, 254, 483
pseudomaculipes, mosquito, 258, 259, 483
pseudopunctipennis, mosquito, 256, 266, 271, 272, 274, 483
punctipennis, mosquito, 256, 258, 259, 266, 268, 271, 272, 274, 483
punctulata, mosquito, 254, 483
pursati, mosquito, 254, 483
quadrinaculatus, mosquito, 256, 257, 258, 259, 266, 267, 271, 272, 274, 482, 483
- Anopheles* sp., *rhodesiensis d'thali*, mosquito, 254, 483
rossii (*Myzomyia*), mosquito, 59, 70, 81, 256, 257, 258, 260, 261, 479, 482, 483
sinensis (*Myzorhynchus*), mosquito, 70, 81, 256, 257, 258, 262, 479, 482, 483
sinensis peditaeniatus, mosquito, 70, 81
sinensis pseudopictus, mosquito, 73, 81, 255, 261, 262, 483
stephensi, mosquito, 251, 257, 258, 482
superpictus (*Myzomyia*), mosquito, 73, 81, 255, 261, 479, 483
tarsinaculatus, mosquito, 256, 285, 483
theobaldi, mosquito, 256, 257, 258, 482, 483
turkhudi, mosquito, 256, 258, 483
chaudoeyi, mosquito, 255, 483
hispaniola, mosquito, 258
myzomyifacies, mosquito, 255, 257, 482, 483
umbrosus, mosquito, 256, 483
vincenti, mosquito, 255, 483
willmori, mosquito, 255, 483
ziemanni (see *A. mauritanus*)
- Ant bear, 196
Antelope (see *Tragelaphus spekei*)
Anthomyia disgordiensis, fly, 193, 484
pluvialis, fly, 180, 485
Anthrax, 49, 109, 110, 115, 209, 210, 228, 230, 249, 384, 470, 475
Anthrenus museorum, beetle, 470, 475
Aphaniptera, fleas, 79, 80
Aphiochaeta ferruginea, fly, 192, 484
Aphodius coloradensis, beetle, 62, 84, 485
femoralis, beetle, 62, 84, 485
finetarius, beetle, 62, 84, 485
granarius, beetle, 84, 485
rufus castaneus, beetle, 64, 84, 486
vittatus, beetle, 62, 84, 485
Apis mellifera, honey bee, 467, 468, 488, 489
Apoxeraenosis, 98, 101
Aquaria, 282
Arachnida, 461
Araneae, 461
Arduenna strongylina, pig nematode, 64, 84, 85, 486
Argas spp., ticks, 424
brumpti, tick, 409
miniatus, tick, 432
persicus, fowl tick, 418, 420, 423, 445, 446, 479, 490, 493, 494
reflexus, tick, 409, 411, 419, 423, 432, 480, 493
vespertilionis, tick, 423
Armadillo, 393
Army diseases carried by insects, 43-48
Army sanitation, 43-48
Arsenic dip, 442
Arsenic wash, 337
Ascariasis, 121, 122, 475
Ascaridae, 121
Ascaris lumbricoides, human nematode, 68, 96, 106, 121, 475

- Ascomycetes, 289
Asopia farinalis, meal moth, 42, 54, 83, 495
 Asphyxia, 408
Aspongopus nepalensis, bug, 469, 488
Ateles pentadactylus, monkey, 302
Ateuchus sacer (see *Scarabaeus*)
Attagenus pello, beetle, 470, 475
Atylotus spp., horseflies, 228
 nemorialis, horsefly, 214, 217, 485, 494
 rufidens, horsefly, 211, 474
 tomentosus, horsefly, 215, 217, 478, 494
Auchmeromyia spp., flies, 228
 luteola, Congo floor maggot, 195
Automeris io, moth, 467, 489
- Babesia* spp., piroplasmids, 414
 argentinum, piroplasmid, 414, 475
 bigeminum, piroplasmid, 414, 475
 bovis, piroplasmid, 414, 415, 475
 caballi, piroplasmid, 415, 475
 canis, piroplasmid, 415, 424, 434, 475
 divergens, piroplasmid, 417, 490
 gibsoni, piroplasmid, 417, 475
 minense, piroplasmid, 417, 475
 ovis, piroplasmid, 417, 436, 475
 Babesiasis, bovine, Argentine 414, 475
 canine, 415, 417, 476
 hedgehog, 417, 475
 jackal, 475
Bacillus of Koch-Weeks, bacterium, 109, 477
 of Morgan, bacterium, 109, 478
 A of Ledingham, bacterium, 109
 acidi lactici, bacterium, 109
 aerogenes capsulatus, bacterium, 109, 480
 anthracis (see *Bacterium*)
 cloacae, bacterium, 110
 coli, bacterium, 110, 384, 385, 387, 477
 coli anaerogenes, bacterium, 110
 coli communior, bacterium, 110
 coli communis, bacterium, 110
 coli mutabilis, bacterium, 110
 colisimile, bacterium, 110
 cuniculicida, bacterium, 110, 492
 diphtheriae, bacterium, 111, 478
 dysenteriae, bacterium, 478
 dysenteriae, Flexner, bacterium, 111
 dysenteriae, Shiga, bacterium, 111
 dysenteriae Y Hiss and Russell, bacterium, 111
 enteritidis, bacterium, 111
 fecalis alkaligenes, bacterium, 111
 fluorescens liquifaciens, bacterium, 111, 384
 fluorescens nonliquefaciens, bacterium, 111, 385
 gasoformans, nonliquefaciens, bacterium, 112
 grünthal, bacterium, 112
 icteroides, bacterium, 260
 lactis acidi, bacterium, 112
 lactis aerogenes, bacterium, 112
 leprae, bacterium, 112, 392, 481
 mallei, bacterium, 112
- Bacillus megatherium*, bacterium, 385
neapolitanus, bacterium, 112
necrophagus, bacterium, 482
necrophorus, bacterium, 411, 475
oxytocus perniciosus, bacterium, 112
paracoli, bacterium, 112, 487
paradysenteriae, bacterium, 111
paratyphosus A, bacterium, 112, 487
paratyphosus B, bacterium, 112, 487
pestis, bacterium, 112, 350, 351, 360, 392, 393, 488
 prodigiosus, bacterium, 112
 proteismile, bacterium, 386
 proteus mirabilis, bacterium, 113
 proteus vulgaris, bacterium, 113
 proteus zenkeri, bacterium, 113
 pseudoedema maligno, bacterium, 386, 490
 pyocyaneus, bacterium, 113, 494
 radiciformis, bacterium, 113, 386
 ruber kielensis, bacterium, 113
 schafferi, bacterium, 113
 septicus agrigenus, bacterium, 113
 similicarbonchio, bacterium, 113, 386
 subtilis, bacterium, 113, 387
 suispestifer, bacterium, 114, 260, 489
 tetani, bacterium, 373, 495
 tifosimile, bacterium, 114, 387
 tracheiphilus, bacterium, 470
 tuberculosis, bacterium, 114, 387, 497
 typhi-exanthematici, bacterium, 292
 typhosus, bacterium, 114, 387, 393, 497
 vesiculosus, bacterium, 114
 xerosis, bacterium, 114, 115
- Bacteriaceae, 109-114, 209, 210, 249, 350, 351, 384-387, 392, 393
Bacterium anthracis, bacterium, 109, 110, 113, 122, 209, 210, 249, 384, 386, 475
 cholerae-gallinarum, bacterium, 384, 477
 tularensis, bacterium, 114, 209, 351, 488
- Baleri, 216, 230, 475
 Barns, 37
 Barn yards, 167-170
Bartonella bacilliformis, microörganism, 211, 497
 Bat, 59, 395
 Bat (see *Phyllostomus* sp.)
 Bath outfits, 317, 318
 Bays, 276
 Bedbug (see *Cimex* spp.)
 bite, 401
 control, 401
 Bee disease (see *Nosema apis*)
 Beef tapeworm (see *Taenia saginata*)
Bengalia depressa, fly, 190, 484
 Beri-beri, 291
 Bibliography, 89-96, 123-125, 137, 151-152, 196-199, 220-222, 235, 246, 263-265, 274, 285, 297-300, 311, 328, 329, 348, 358-359, 371-373, 390, 401, 402, 427-429, 438, 439, 449, 459, 460, 470, 471
 Bilharziosis, 120, 122
 Biliary fever, equine, 436, 475

- Binucleata, 117-119, 212-219, 249-259, 294,
352-355, 388, 393-398, 414
- Bird lice, 288
- Blaberus* sp., cockroach, 376
- Blackheads, 407, 411, 475
- Blaps* sp., beetle, 63, 84, 486
sp., near *appendiculata*, beetle, 62, 84
appendiculata, beetle, 62
emondi, beetle, 62, 84
mortisaga, beetle, 55
macronata, beetle, 79, 84, 495
strauchi, beetle, 62, 63, 84, 486
- Blatta* sp., cockroach, 388
orientalis, cockroach, 55, 60, 62, 63, 88,
376, 377, 378, 379, 383, 384, 385, 386,
387, 388, 389, 475, 477, 478, 486, 490,
495, 497
- Blattella germanica*, cockroach, 55, 62, 63,
88, 376, 377, 378, 384, 388, 389, 485,
486
lapponica, cockroach, 388
- Bléphantitis, 288, 407, 475
- Blood-sucking fly larvae, 195, 196
- Bodonidae, 117
- Body louse (see *Pediculus corporis*)
- Bombus* spp., bumble bees, 467, 488
- Boophilus* spp., ticks, 424, 426
annulatus, cattle tick, 410, 414, 434, 435,
441, 476, 487
annulatus australis, cattle tick, 414, 474,
475, 476, 493
annulatus decoloratus, cattle tick, 415,
420, 474, 476, 487
microplus (see *B. annulatus australis*)
- Borax, 381
- Borborus punctipennis* (*Limosina*), fly,
121, 122, 475, 497
- Bots, 182-186
- Bouba, 219, 251
- Bovine trypanosomiasis, 217, 218
- Bronchial inflammation, 408
- Browntail rash, 466, 475
- Bubonic plague (see Plague, Bubonic)
- Buffalo gnats (see *Simulium* spp.)
- Bug-borne diseases, 392
- Bugs, 391-402
- Bursarinidae, 388
- Buthus afer*, scorpion, 462, 489
carolinianus, scorpion, 462, 489
martensi, scorpion, 462, 489
maurus, scorpion, 462, 489
occitanus, scorpion, 462, 489
quinquestriatus, scorpion, 462, 489
- Cabbage snake (see Mermithidae)
- Caddice flies (see Trichoptera)
- Calliphora* spp., flies, 177, 453
dux, fly, 179, 485
erythrocephala, fly, 105, 110, 111, 117,
130, 131, 132, 140, 143, 147, 148, 151,
180, 475, 478, 485
vomitoria, fly, 105, 108, 109, 110, 111, 112,
113, 114, 115, 120, 130, 131, 133, 140,
143, 148, 386, 475, 477, 492
- Calopteryx virgo*, dragon fly, 59, 87
- Camel, 405
- Camel head bot (see *Cephalomyia macu-
lata*)
- Camel trypanosomiasis, 215
- Canary, 259
- Candy factories, 41
- Canis aureus*, jackal, 356
familiaris, dog, 260, 344, 373, 405, 408,
414, 415, 416, 420, 421, 436
- Cantharidiasis, 22
- Cantharidin, 42
- Cantharis flavicornis*, beetle, 469, 478
vestitus, beetle, 469, 478
- Capybara, 393
- Carassius auratus*, goldfish, 282
- Carbon bisulphide, 324, 326, 380
- Carcass disposal, 161, 162, 200, 201, 202
- Carceag, 417, 475
- Carpoglyphus alienus*, mite, 474
- Carrión's disease, 211
- Castellanella annamense*, trypanosome, 214,
496
brucei, trypanosome, 214, 250, 393, 474,
485
dimorphon, trypanosome, 214, 495
equiperdum, trypanosome, 215, 478
equinum, trypanosome, 393, 482
evansi, trypanosome, 119, 215, 250, 494
evansi mborii, trypanosome, 215, 484
gambiense, trypanosome, 215, 250, 492
hippicum, trypanosome, 119, 484
nigeriense (see *C. gambiense*)
pecaudi, trypanosome, 216, 475
rhodesiense, trypanosome, 217, 250, 492
soudanense, trypanosome, 217, 494
- Castor-bean tick (see *Ixodes ricinus*)
- Castor oil, 382
- Cat, 344, 373, 408
flea (see *Ctenocephalus felis*)
nematode (see *Spirura gastrophila*)
- Catarrhal inflammation, 408
- Caterpillars, 78
- Cattle (see also bovine), 373, 405, 408, 414
fever, Southern or Texas, 414, 475
head bot (see *Rhinoestrus nasalis*)
lice, 330-339
nematode (see *Gongylonema scutatum*)
nematode (see *Oncocerca* sp.)
nematode (see *Oncocerca gibsoni*)
nematode (see *Oncocerca lienalis*)
nematode (see *Setaria labiato-papillosa*)
sprays, 335-337
susceptibility to lice, 331
- Centipede poisoning, 464-466
- Centipedes in nasal cavities, 466
- Centrarchus macropterus*, fish, 282
- Centrurus elicaude*, scorpion, 462, 489
- Cephalacanthus monacanthus*, worm, 78, 86
triacanthus, worm, 78, 85
- Cephalomyia maculata*, bot, 194, 484
- Cephalopsis tibillator* (see *Cephalomyia
maculata*)
- Cephenomyia* spp., bots, 176

- Cephenomyia* spp., *phobifer*, bot, 194, 484
pratti, bot, 194, 484
trompe, bot, 194, 484
Ceratophyllus acutus, flea, 351, 360, 363, 365, 488
anisus, flea, 360, 364
fasciatus, rat flea, 54, 55, 56, 79, 94, 350, 351, 352, 354, 355, 357, 360, 361, 364, 488, 495
gallinae, flea, 363
hirundinis, flea, 352, 496
laverani, flea, 352, 496
lucifer, flea, 352, 355, 496
silantiewi, flea, 351, 365, 488
Ceratopogon spp., midges, 224
Ceratopogoninae, 223
 Cesspools, 282
 Cestoda, tapeworms, 53-57, 88, 297
 Cestoidea, tapeworms, 120, 355, 356, 357, 389
Cetonia aurata, beetle, 79, 85, 495
Chaetechelyne vesuviana, centipede, 466, 490
Chaetopteryx villosa, caddice fly, 59, 83
 Chagas fever, 393, 414, 475
 Cheese bacteria, 113
 maggot (see *Piophilidae casei*)
Chelidon urbica, bird, 252
Cheyletus eruditus, mite, 408, 487
 Chickens (see also Fowl), 405, 406, 407, 408
 house and yard, 173, 174, 445, 446, 447
 roosts, 445, 446
 tick (see *Argas persicus*)
 Chiggers, 22, 404, 477
 Chigoe (see *Dermatophilus penetrans*)
 Children, protection from insects, 37
 Chilopoda, 461
Chiracanthum nutrix, spider, 464, 489
Chironitis irroratus, beetle, 63, 85, 486
 Chironomidae, 223
Chironomus plumosus, midge, 59, 81
 Chlorocyanogen, 325
 Chlorpicrin, 324, 326
Choanotaenia infundibulum, fowl tapeworm, 53, 56, 57, 82, 120, 122, 494
Choeromyia spp., flies, 229
 boueti, fly, 196, 484
 choerophaga, fly, 196, 484
 Cholera, 49
 Asiatic, 115, 387, 477
 fowl, 384, 477
 hog, 116, 122, 211, 477
Chordodes alpestris, horse-hair worm, 79
Chorioptes equi (*symbiotes*), mite, 405, 481
symbiotes (see *C. equi*)
Chrysoconops fuscipennis, mosquito, 75, 81
Chrysomya sp., fly, 119, 484
 chloropyga, fly, 180
 macellaria, screw worm fly, 132, 133, 134, 135, 140, 143, 149, 150, 175, 177, 178, 179, 196, 453, 485
 rufifacies, fly, 181, 485
Chrysomyza spp., flies, 453
Chrysops spp., horseflies, 81, 93, 209, 228, 488
 centurionis, horsefly, 71, 81, 210, 220, 475, 480
 dimidiata, horsefly, 71, 81, 220, 480
 japonicus, horsefly, 211, 474
 longicornis, horsefly, 71, 81
 silacea, horsefly, 220, 480
Chrysozona spp., horseflies, 228
 pluvialitis, horsefly, 211, 474
 Chyluria, 69
 Ciliata, 388
Cimex spp., bedbugs, 251
 boueti, bedbug, 391, 394, 400, 476
 columbarius, bedbug, 400
 hemipterus, bedbug, 294, 391, 394, 395, 396, 398, 400, 476, 481, 492
 hirundinis, bedbug, 400
 lectularius, bedbug, 294, 296, 391, 392, 393, 394, 395, 396, 397, 398, 399, 400, 476, 481, 482, 485, 489, 491, 492, 496
 pipistrelli, bedbug, 395, 400, 495
 rotundatus (see *C. hemipterus*)
 Cimicidae, 399
 Cisterns, 282
Citellus beecheyi, ground squirrel, 351
 City sanitation, 39-41
 Clayton gas, 325
Cleptidrina blattarum, gregarine, 388
 serpentula, gregarine, 388
 Climate and life, 97-104
Clinostomum sp., trematode, 260
 Clipping of hair of cattle, 334
Cloeon dipterum, mayfly, 59, 87
Cnemidocoptes gallinae, mite, 478
 mutans, mite, 405, 406, 407, 492
Cnethocampa pityocampa, moth, 467, 489
Cobboldia chrysidiformis, bot, 193, 484
 elephantis, bot, 193, 484
 lowdantis, bot, 193, 484
 Coccaceae, 107-109, 210, 211, 289, 290, 383, 384
 Coccidiidea, 388
 Cockroach control, 380-382
 Cockroaches, 51, 374-390, 458
 Coleoptera, beetles, 59, 84, 85, 86, 469, 470
 Colitis, 477
Columba livia, dove, 212, 213, 219
 Comfort stations, 39
Conorhinus spp. (see *Triatoma*)
 Conchuda (see *Ixodes bicornis*)
 Conjunctivitis, 109, 115, 477
 phlyctenular, 290, 477
 Cootie (see *Pediculus corporis*)
Copris hispanus, beetle, 61, 85, 486
 Coprophagous insects, 51, 52
Cordulia sp., dragon fly, 59, 87
Cordylobia anthropophaga, fly, 188, 189, 204, 484
 rodhaimi, fly, 189, 198, 484
 Cow pasture, 233
 Crab louse (see *Phthirus pubis*)
 Creolin, 336
Cricetus spp., rodents, 354

- Crickets, 78
Crithidia calliphorae, leptomoniid, 117
ctenophthalmi, leptomoniid, 354
fasciculata, leptomoniid, 251
haemaphysalidis, leptomoniid, 417
hyalommae, leptomoniid, 417
hystrichopsyllae, leptomoniid, 354
melophagia, leptomoniid, 219
muscae-domesticae, leptomoniid, 117
nycteribiae, leptomoniid, 219
pangoniae, leptomoniid, 219
pulicis Porter, leptomoniid, 354
pulicis Wenyon, leptomoniid, 354
tenuis, leptomoniid, 219
Crithoptes monunguiculosus, mite, 404, 497
Crocodile trypanosomiasis, 218
Crossbill, 408
Crow, 259
Cryalgnesia, 100
Cryesthesia, 100
Cryptococcus farciminosus, microorganism, 411, 482
Ctenocephalus canis, dog flea, 53, 54, 55, 76, 79, 80, 351, 352, 354, 355, 356, 357, 360, 362, 363, 479, 481, 488, 494, 495, 496
felis, cat flea, 53, 76, 80, 355, 357, 360, 363, 479, 494
leporis, rabbit flea, 353, 496
Ctenophthalmus agyrtes, flea, 352, 354, 355, 360, 365, 496
assimilis, flea, 354
Ctenopsylla musculi, flea, 352, 355, 364, 496
Culex sp., mosquito, 249, 251, 261, 268
albopictus (see *Aedes scutellaris*)
cantator, mosquito, 249
ciliaris (see *C. quinquefasciatus*)
fatigans (see *C. quinquefasciatus*)
gelidus, mosquito, 70, 81, 262, 480
jenningsi, mosquito, 269
ludlowi, mosquito, 250
malariae, mosquito, 73, 81, 261, 479
microannulatus, mosquito, 262, 480
nigrithorax skusei (see *C. quinquefasciatus*)
penicillaris, mosquito, 73, 81, 261, 479
pipiens, mosquito, 70, 73, 82, 93, 248, 249, 250, 251, 252, 259, 261, 284, 475, 479, 482
quinquefasciatus, mosquito, 59, 70, 72, 82, 248, 250, 251, 252, 259, 260, 261, 262, 266, 267, 270, 272, 273, 477, 479, 480, 482
sitiens, mosquito, 70, 82, 262, 480
sollicitans, mosquito, 249, 262, 273
taeniatus (see *Aedes argenteus*)
vexans (see *Aedes*)
Culicidae, 219, 228
Culicoides spp., midges, 224
Culiseta annulata, mosquito, 249, 475
Cuterebra emasculator, bot, 187, 484
fontinella, bot, 187
Cyanide fumigation, 325, 326
Cyclophyllidea, 120, 247, 355, 356, 357
Cyclopodia sykesi, fly, 219
Cynomolgus cynocephalus, monkey, 295
Cynomyia spp., flies, 177, 485
cadaverina, fly, 132, 453
Cyprinodon variegatus, fish, 282
Cyprinoid fish flukes, 59
Cypselus affinis, swift, 72
Cytolcichus banksi, mite, 408, 474
nudus, mite, 408, 474, 481
sarcoptoides, mite, 408, 474, 481
Davainea cesticillus, fowl tapeworm, 57, 82, 89, 120, 489
madagascariensis, tapeworm, 388, 495
tetragona, fowl tapeworm, 57, 82, 89, 120, 494
Deer fly fever, 209, 477, 488
Deer head bots (see *Cephenomyia*)
Defecation, 39
Delousing, 314-316
Demodex bovis, mite, 407, 484
folliculorum, mite, 407, 408, 411, 476, 484, 487
phyllodes, mite, 407, 484
Dengue, 43, 243, 262, 477
Depluming mite, chicken, 478
Dermacentor spp., ticks, 424
albipictus, tick, 412, 436, 497
Dermacentor andersoni, Rocky Mt. spotted fever tick, 22, 409, 410, 412, 413, 436, 437, 438, 443, 479, 487, 491
marginatus, tick, 413, 491
modestus, tick, 412, 491
nitens, tick, 418, 431, 436, 478
occidentalis, tick, 412, 425, 436
reticulatus, tick, 409, 415, 417, 418, 425, 476, 478
variabilis, tick, 412, 413, 425, 436, 491
venustus (see also *D. andersoni*), 409, 497
Dermacentrozeus rickettsi, microorganism, 413, 491
Dermanyssidae, 422
Dermanyssus gallinae, mite, 404, 408, 422, 474, 487
hirundinis, mite, 404, 474
Dermaptera, 88
Dermatitis, 286, 290, 469
beetle, 478
equine granular, 121, 122
Dermatobia sp., fly, 175
cyaniventris (see *D. hominis*)
hominis, fly, 22, 187, 197, 199, 204, 485
noxialis (see *D. hominis*)
Dermatophilus penetrans, chigoe, 22, 360, 365, 373, 474, 495
Dermatosis, 22, 403
papular eczematous, 404
Dermestes vulpinus, beetle, 470, 475
Diabrotica vittata, beetle, 470
Diarrhea, 49
fowl, 387, 478
infantile, 109, 115, 478
infantile dysenteric, 111, 115

- Diarrhea, summer, 112, 114, 478
Diloboderus abderus, beetle, 79, 84, 495
 Dip, 442, 443
 Diphtheria, 111, 115, 478
Diplobacillus exanthematicus, bacterium, 292
Diplococcus sp., microorganism, 292
 gonorrhoeae, microorganism, 108, 480
 intra-cellularis meningitidis, microorganism, 108, 289, 484
 pemphigi contagiosi, microorganism, 289, 481
Diplocystis schneideri, coccidian, 388
Dipodillus campestris, jerboa, 63
 Diptera, flies, 59
Dipylidium caninum, dog tapeworm, 53, 54, 80, 86, 297, 355, 356, 494
Dirofilaria immitis, nematode, 73, 80, 81, 82, 89, 261, 479
 repens, dog nematode, 74, 76, 80, 89, 261, 479
 Disease, how carried by insects, 19-24
 transmission, how to prove, 25-33
 Diseases carried or caused by beetles, 469-470
 carried or caused by bugs, 392-399
 carried or caused by caterpillars, 466, 467
 carried or caused by cockroaches, 383-390
 carried or caused by fleas, 350-359
 carried or caused by flies, 104-125, 209-222
 carried or caused by lice, 286-360
 carried or caused by mites, 402-429
 carried or caused by mosquitoes, 247-265
 carried or caused by ticks, 402-429
 carried to food by insects, 22
 carried to wounds by insects, 23
 inoculated by insects, 23
Dispharagus nasutus, nematode, 68, 94
 Ditching, 276, 277
 Dog (see *Canis familiaris*, and canine)
 Dog flea (see *Ctenocephalus canis*)
 louse (see *Trichodectes latus*)
 nematode (see *Acanthocheilonema grassii*)
 nematode (see *Acanthocheilonema reconditum*)
 nematode (see *Dirofilaria immitis*)
 nematode (see *Dirofilaria repens*)
 nematode (see *Spirocerca sanguinolenta*)
 Donkey nematode (see *Physocephalus sexalatus*)
 Dourine, 215, 228, 230, 478
 Dragon flies (see Odonata)
 Drainage, 37, 39, 277-279
 Dromedary, 405
 nematode (see *Physocephalus sexalatus*)
 trypanosomiasis, 217
Drosophila confusa, fly, 117, 118
Drusus trifidus, caddice fly, 59, 83
 Dry cleaning, 320, 321
Duttonella caprae, trypanosome, 217, 496
Duttonella cazalboui, trypanosome, 217, 493
cazalboui, *pigritia*, trypanosome, 217, 493
congolense, trypanosome, 217, 480
nanum, trypanosome, 217, 495
pecorum, trypanosome, 218
simiae, trypanosome, 218, 496
uniforme, trypanosome, 218, 496
vivax, trypanosome, 218, 496
 Dysentery, 49
 amoebic, 117, 478
 bacillary, 111, 115, 478
 Lamblian, 117, 478
 East Coast fever, 417, 436, 447, 478
Echidnophaga gallinaceus, flea, 360, 365, 366
Echinorhynchus sp., worm, 91
 Eczema, 287, 290, 478
 Effective temperature, 99-104
 Eimeriidae, 388
Elassoma zonatum, fish, 282
 El dedab, 217
 Elephant bots, 193
 foot bot (see *Neocuterebra squamosa*)
 Elephantiasis, 69, 261, 478
 Elk, 436
Endamoeba blattae, amoebid, 388
 coli (see *Löschia*)
Enneacanthus gloriosus, fish, 282
 obesus, fish, 282
 Enteritis, 115, 408, 478
 Entomophobia, 20
Epeira diadema, spider, 463, 489
Ephemera vulgata, mayfly, 59, 78, 87
Ephemeridae, mayflies, 59, 87
Epimys spp., rats, 353, 360
Epithea sp., dragon fly, 59, 87
 Equine biliary fever, 415
 trypanosomiasis, 214
Erinaceus algirus, hedgehog, 61, 63, 64
Eristalis spp., flies, 191, 197
 arbustorum, fly, 192, 484
 dimidiatus, fly, 192, 484
 tenax, fly, 115, 192, 477, 484
Erthesina fullo, bug, 395
 Erysipelas, 95, 108, 115, 479
 Coast, 77
 Erythema urticaria, 404
Ethmostigmus spinosus, centipede, 465, 488
Euproctis chrysoorrhoea, browntail moth, 466, 489
 Excitability, caused by insects, 20, 21
 Excreta disposal, 161
Fannia canicularis, lesser house fly, 116, 117, 135, 136, 139, 142, 143, 144, 192, 197, 477, 484
 scalaris, latrine fly, 117, 118, 135, 144, 192, 197, 484
 Farm, insanitary, 35, 36
 Farm sanitation, 36-38
 Fasciolidae, 260, 261
 Favus, 289, 290, 479

- Febris quintana, 294
 Fevers, tick, 479
 Field mouse (see *Microtus montebelli*)
Filaria bancrofti (*nocturna*), human nematode, 69, 70, 71, 80, 81, 82, 93, 261, 479
 cypseli, nematode, 72, 86, 91
 demarquaii (see *F. demarquayi*)
 demarquayi, nematode, 80, 93, 262, 480
 diurna (see *Filaria (Loa) loa*)
 ephemeridarum, nematode, 78, 87
 gallinarum, fowl nematode, 68, 87, 96, 486
 geotrupis, nematode, 77, 85
 grassii (see *Acanthocheilonema*)
 immitis (see *Dirofilaria*)
 juncea, nematode, 71
 labiato-papillosa (see *Setaria*)
 loa (see *Filaria (Loa) loa*)
 (*Loa*) *loa*, human nematode, 71, 81, 93, 95, 220, 480
 martis, rodent nematode, 73, 88
 nocturna (see *F. bancrofti*)
 ozzardi, nematode, 71
 perstans (see *Acanthocheilonema*)
 philippinensis, human nematode, 72, 89
 quadrispina (see *F. martis*)
 rytiplerites Deslongchamps, nematode, 62, 91
 rytipleritis De Magalhães, nematode, 78, 88
 sanguinis hominis, nematode, 93
 stomoxeaeos, nematode, 78, 82
 tucumana, human nematode, 72, 80, 90
 Filariasis, 48, 69, 70, 71, 72, 261, 262
 canine, 261, 479
 human, 220, 478, 480
 Filariidae, 220, 261, 262, 357
 Finch, 259
 Fish, 282
 Five day fever, 294
 Flea abundance, 366, 367
 bite treatment, 370, 371, 373
 control, 367-371
 trapping, 369, 370
 Flea-borne diseases, 350-359
 Fleas (see also Aphaniptera), 350-373
 Flesh fly (see *Wohlfahrtia magnifica*)
 Flies (see Diptera)
 bloodsucking, 208-285
 flies, non-biting, 105-208
 flies in Egypt, 450, 451, 452
 Floor maggot (see *Auchmeromyia luteola*)
 Flower vases, 282
 Flukes (see Trematoda)
 Fly attack, avoidance, 203
 baits, 164, 202
 control, 153-174
 paper, 164
 poisons, 202
 repellents, 165
 sprays, 164
 traps, 162, 163, 173, 202
 Folliculitis, 290
Fontaria virginicensis, myriapod, 54, 55, 88, 495
 Food protection, 39, 40, 41, 206
 Foot-and-mouth disease, 180, 480
Forcipomyia tozensendi, midge, 219, 497
 utae, midge, 219, 224, 497
Forficula auricularia, earwig, 55
 Fountains, drinking, 282
 Fowl (see also chicken), 366
 lice, 339-343
 nematode (see *Acuaria spiralis*)
 nematode (see *Filaria gallinarum*)
 tapeworm (see *Choanotaenia infundibulum*)
 tapeworm (see *Davainea cesticillus*)
 tapeworm (see *Davainea tetragona*)
 tapeworm (see *Hymenolepis carioca*)
 tick (see *Argas persicus*)
 trypanosomiasis, 218
 Fox (see also *Vulpes vulpes atlantica*), 405
 Frenzy caused by insects, 20, 21
 Frog flukes, 59
 Fumigation, 324, 380
Funambulus pennatii, palm squirrel, 297, 475
Fundulus chrysolus, fish, 282
 diaphanus, fish, 282
 dispar, fish, 282
 majalis, fish, 282
 notatus, fish, 282
 nottii, fish, 282
 similis, fish, 282
 Fungi, 107-115, 209, 210, 211, 249, 289, 290, 350, 351, 383, 387, 392, 393
 Furunculosis, 290, 411, 480
 Gall sickness, bovine, 218, 480
Gambusia affinis, top minnow, 282
Gamocystis tenax, gregarine, 388
 Gangrene, 480
 gas, 109, 115
 Garbage, 37, 39, 40, 41, 160, 202, 282
 Garments, louse-proof, 328
 Gastroenteritis, 115
Gastrophilus haemorrhoidalis, horse nose fly, 183, 190, 196, 205, 484
 intestinalis, horse bot, 182, 183, 184, 185, 190, 191, 205, 484
 nasalis, horse chin fly, 190, 205, 484
Gedoelstia spp., flies, 195
Geophilus carpophagus, centipede, 466, 490
 cephalicus, centipede, 466, 490
 electricus, centipede, 466, 490
 similis, centipede, 465, 466, 488, 490
Geotrupes douei, beetle, 61, 63, 64, 85, 486
 stercorarius, beetle, 78, 85
Gerbillus indicus, jerboa, 296, 474
Giardia intestinalis, protozoan, 117, 478
 Gigantorhynchidae, 389
Girostigma spp., flies, 193
 Glanders, 211
Glaucidium noctuae, owl, 249, 250, 251, 475
Glomeris limbata, myriapod, 57, 58

- Glossina* sp., tsetse fly, 219
brevipalpis, tsetse fly, 214, 216, 217, 218, 485, 492, 496
fusca, tsetse fly, 214, 216, 485, 492
longipalpis, tsetse fly, 214, 216, 217, 476, 485, 493, 495
longipennis, tsetse fly, 214, 216, 474, 492
morsitans, tsetse fly, 214, 216, 217, 218, 234, 476, 480, 492, 493, 495, 496
pallidipes, tsetse fly, 214, 216, 492
palpalis, tsetse fly, 71, 77, 214, 215, 216, 217, 218, 220, 234, 476, 480, 492, 493, 495, 496
palpalis fuscipes, tsetse fly, 215, 492
tachinoides, tsetse fly, 214, 216, 217, 218, 476, 485, 492, 493, 495, 496
- Glossininae, 234.
- Glyciphagus prunorum*, mite, 405, 481
- Goat, 373, 405
 lice, 346, 347
 trypanosomiasis, 217
- Goldfish (see *Carassius auratus*)
- Gongylonema* sp., nematode, 78
brevispiculum, nematode, 63, 84, 486
mucronatum, nematode, 62, 85, 86, 486
neoplasticum, nematode, 63, 86, 88, 91, 389, 486
pulchrum, nematode, 389, 486
scutatum, nematode, 62, 84, 86, 88, 95, 389, 485
- Gonococcus (see *Diplococcus gonorrhoeae*)
- Gonore, 404, 480
- Gonorrhoea, 108, 115, 291, 480
- Gordiacea, horse-hair worms, 78
- Gordius aquaticus*, horse-hair worm, 78
chilensis, horse-hair worm, 78
robustus, horse-hair worm, 78
- Gorgodera cygnoides*, fluke, 59, 87
pagenstecheri, fluke, 59, 87
varsoviensis, fluke, 59, 87
- Gorilla, 373
- Granary beetle (see *Tenebrio molitor*)
 weevil (see *Sitophilus granarius*)
- Granuloma, equine cutaneous, 480
- Grasshoppers, 78
- Grease-traps, 161
- Gregarina blattarum*, gregarine, 388
legeri, gregarine, 388
- Gregarinida, Gregarinidae, 355, 388
- Ground squirrel (see *Citellus beecheyi*)
- Grouse, red, haemoproteasis, 213
- Guinea pig, 63, 259
- Gulf Coast tick (see *Amblyomma maculatum*)
- Gutters, 282
- Gymnoasceae, 289
- Gymnopleurus mopsus*, beetle, 63, 85, 486
sturmi, beetle, 61, 63, 85, 486
- Habronema* spp., nematodes, 77, 122
megastoma, horse nematode, 66, 67, 82, 121, 486
microstoma, horse nematode, 66, 67, 78, 82, 121, 486
- Habronema* spp., *muscae*, horse nematode, 65, 66, 67, 82, 95, 121, 486
- Habronemic granulomata, 90
- Haemaphysalis* spp., ticks, 424
birmaniae, tick, 417
bispinosa (see *H. birmaniae*)
cimbarina punctata, tick, 417, 434, 480, 490
flava, tick, 422, 475
leachi, tick, 415, 417, 425, 434, 474, 476
punctata, tick, 425
- Haematobia exigua* (see *Lyperosia*)
irritans (see *Hyperosia*)
sanguisugens, fly, 232
- Haematomyidium* spp., flies, 224
- Haematopinus* spp., lice, 297, 475
asini, horse louse, 347
eurysternus, cattle louse, 288, 331, 332
piliferus, dog louse, 344
suus, hog louse, 344, 345
vituli, cattle louse, 332
- Haematopota* spp., horseflies, 228
cordigera, horsefly, 220, 480
duttoni, horsefly, 219
italica, horsefly, 219
perturbans, horsefly, 217, 493
pluvialis, horsefly, 210, 475
tristis (see *Chrysozona pluvialilis*)
vandenbrandeni, horsefly, 219
- Haematosiphon inodora*, bug, 400
- Haematozoon* sp., worm, 92
- Haemogregarina* sp., protozoan, 220
francae, protozoan, 219
gracilis, protozoan, 293
(Haemogregarina) mauritanica, protozoan, 422, 475
(Hepatozoon) canis, protozoan, 420, 421, 424, 474
(Hepatozoon) funambuli, protozoan, 296, 475
(Hepatozoon) gerbilli, protozoan, 296, 474
(Hepatozoon) jaculi, protozoan, 355, 422, 474
(Hepatozoon) leporis, protozoan, 422, 475
(Hepatozoon) muris, protozoan, 422, 475
(Karyolysus) lacertarum, protozoan, 422
- Haemogregarinida, Hemogregarinidae, 219, 220, 296, 297, 355, 420, 421, 422
- Haemoproteidae, 212-214, 249
- Haemoproteus columbae*, protozoan, 212, 482
danilewskyi, protozoan, 249
mansoni, protozoan, 213, 480
noctuae, protozoan, 249, 251
synnii, protozoan, 249, 475
- Halarachne americani*, mite, 408, 481
attenuata, mite, 408, 481
halichaeri, mite, 408, 481
- Haliplus ovocaudatus*, fluke, 59, 87
- Hallucinations caused by insects, 21
- Haplometra cylindracea*, fluke, 59
- Harpyrynychus longipilus*, mite, 408, 497

- Head louse (see *Pediculus humanus*)
 Heartwater, 436, 480
 Hedgehog (see also *Erinaceus algirus*), 417
 nematode (see *Gongylonema mucronatum*)
Helophilus pendulinus, fly, 192, 484
Hemileuca maia, moth, 467, 489
Herpestes ichneumon, mongoose, 62
Herpetomonas spp. (see *Leptomonas*)
Heterandria formosa, fish, 282
Heterometrus maurus, scorpion, 462, 489
 Heterotricha, 388
 Hide beetles, 454, 455
Himantarium gervaisi, centipede, 466, 490
Hippobosca spp., flies, 235
 maculata, fly, 218
 rufipes, fly, 218, 480
 Hippoboscidae, 214, 218, 235, 496
Hippocentrum trimaculatum, horsefly, 220, 480
 Hippopotamus head bot (see *Rhinoestrus hippopotami*)
 Hiss-Werner disease, 294
Histiogaster entomophagus, mite, 405, 497
 spermaticus, mite, 474
Hodotermes pretoriensis, termite, 68, 87, 486
 Hog (see also pig), 389, 408
 louse (see *Haematopinus suis*)
 Hog-feeding trough, 171, 172
Holothyrus coccinella, mite, 404, 474
Homalomyia corvina, fly, 118
 Honey poisoning, 468
 Hookworms (see *Ancylostomidae*)
Hoplopsyllus anomalus, flea, 360, 365
 Horse (see also equine), 373, 405, 412
 bot (see *Gastrophilus intestinalis*)
 chin fly (see *Gastrophilus nasalis*)
 diseases, 119, 122
 head bot (see *Rhinoestrus purpureus*)
 lice, 347, 348
 nematode see *Gongylonema scutatum*)
 nematode (see *Habronema megastoma*)
 nematode (see *Habronema microstoma*)
 nematode (see *Habronema muscae*)
 Horse nose fly (see *Gastrophilus haemorrhoidalis*)
 sickness, Gambian, 217, 480
 trypanosomiasis, 215, 216, 217
 Horse-hair worms (see *Gordiacea*)
 Hospitals, 328
 Hot air delousing, 324
 House fly (see *Musca domestica*)
 Human flea (see *Pulex irritans*)
 nematode (see *Acanthocheilonema perstans*)
 nematode (see *Ascaris lumbricoides*)
 nematode (see *Filaria bancrofti*)
 nematode (see *Filaria demarquayii*)
 nematode (see *Filaria (Loa) loa*)
 nematode (see *Filaria philippinensis*)
 nematode (see *Filaria tucumana*)
 nematode (see *Oncocerca caecutiens*)
 nematode (see *Oncocerca volvulus*)
 Human tapeworm (see *Dipylidium caninum*)
 tapeworm (see *Hymenolepis diminuta*)
 tapeworm (see *Hymenolepis nana*)
 tapeworm (see *Taenia saginata*)
 thorn-headed worm (see *Macracanthorhynchus hirudinaceus*)
 thorn-headed worm (see *Moniliformis moniliformis*)
 Humidity, 97-104
Hyalomma aegyptium, tick, 412, 415, 417, 418, 422, 424, 425, 475, 478, 479, 487
Hydrocampa nymphaeata (see *Nymphula*)
 Hydrocyanic acid gas, 325, 326, 380
Hydrotaea meteorica, fly, 192, 484
 Hygranesthesia, 98, 101
 Hygromochelia, 98, 101
 Hygroplegia, 98, 101
Hylemyia nidicola, fly, 195
 Hymenolepididae, 120, 356, 357, 389
Hymenolepis carioca, fowl tapeworm, 57, 82, 92, 495
 diminuta, rat tapeworm, 42, 53, 54, 55, 79, 80, 83, 84, 86, 88, 94, 356, 495
 microstoma, mouse tapeworm, 42, 86
 nana, dwarf tapeworm, 53, 55, 56, 79, 80, 91, 357, 495
 Hypercralgesia, 100
 Hyperchiria io, moth, 22
 Hyperthermia, 100
 Hyphomycetes, 289
Hypoderma bovis, bot, 197, 469, 484
 lineata, bot, 141, 182, 184, 186, 197, 469, 484
Hystriehopsylla talpae, flea, 354

Ilybius fuliginosus, beetle, 59, 85
 Immigrant inspection, 314, 315
 Impetigo contagiosa, 289, 290, 480
 tropical, 289, 290, 481
 Impromptu delousing, 326, 327
 Inactivity, zone of, 98, 99, 101
 Incineration, 158
 Incinerators, 45, 46, 456
 Industrial sanitation, 41, 42
 Inflammation, bronchial, 481
 catarrhal, 481
 Insanity caused by insects, 21
 Insomnia caused by insects, 21
 Insect breeding, 32, 33
 stings, 467, 468
 Insecta, 461
 Intermittent fever, 412
Isometrus europaeus, scorpion, 462, 489
 Isopoda, sowbugs, 89
 Isoptera, termites, 87
 Itch, bicho-colorado, 403, 481
 chorioptic, 405, 481
 coolie, 405, 481
 copra, 405, 481
 grain, 405
 grocer's, 405, 481
 ground, 405
 guano, 408, 481

- Itch, Norwegian, 405
 psoroptic, 405
 sarcoptic, 405
 Texas, 405
- Ixodes* spp., ticks, 424
bicornis, tick, 409
(Ceratiixodes) putus, tick, 409
hexagonus, tick, 416, 425, 476
holocyclus, tick, 411, 487
pilosus, tick, 410, 487
reduvius (see *I. hexagonus*)
ricinus, castor-bean tick, 73, 88, 89, 409,
 411, 417, 425, 434, 476, 487, 480, 490
- Jackal (see *Canis aureus*), 417
- Jaculus gordonii*, jerboa, 355, 422, 474
orientalis, jerboa, 355, 422, 474
- Janthinosoma lutzi* (see *Psorophora*)
- Japanese river fever, 413
- Jaundice, canine malignant, 415, 416, 417,
 436, 475
 infective or epidemic, 296, 481
- Jerboa (see *Dipodillus campestris*)
 (see *Gerbillus indicus*)
 (see *Jaculus*, spp.)
- Jinja, 250
- Johannsemiella* spp., midges, 224
- Julus* sp., myriapod, 54, 55, 88, 495
guttulatus, myriapod, 68, 88
londinensis, myriapod, 466, 490
terrestris, myriapod, 466, 490
- Kala azar, 262
 Indian, 251, 294, 395, 396, 397, 398, 481
 infantile, 354, 481
- Kara kist (see *Theridium lugubre*)
- Katipo (see *Latrodectes hasseltii*)
- Kedani disease, 413, 481
- Keratitis, phlyctenular, 290
- Kerosene emulsion, 336
- Killifish (see *Fundulus* spp.)
- Kirkioestrus* spp., bots, 195
- Kissing bugs, 469
- Labidesthes sicculus*, fish, 282
- Lacerta* spp., lizards, 422
- Lachnosterna* spp. (see *Phyllophaga*)
- Laelaps echidninus*, mite, 422, 475
- Lagoa* sp., moth, 22
crispata, moth, 467, 489
- Lagopus scoticus*, red grouse, 214
- Lakes, 276
- Lamblia intestinalis* (see *Giardia*)
- Laminosioptes cysticola*, mite, 409, 474
- Lark, 249
- Larvicides, 279, 280
- Lasiocampa pini*, moth, 467, 489
- Latrines, 45, 47, 48, 282
- Latrodectes geometricus*, spider, 464, 489
hasseltii, katipo, 464, 489
mactans, hour-glass spider 463, 489
scelio (see *L. hasseltii*)
- Laundry, 319, 320
- Laverania falciparum*, plasmodid, 253, 255,
 256, 482
malariae (see *L. falciparum*)
- Lecithodendrium ascidia*, fluke, 59, 81, 87,
 88
chilostomum, fluke, 59, 83
- Leiothinae, biru lice, 72, 73, 86
- Leishmania* sp., leptomoniid, 395
brasiliensis, leptomoniid, 219, 251
donovani, leptomoniid, 251, 294, 395-398,
 481
infantum, leptomoniid, 354, 481
tropica, leptomoniid, 118, 219, 251, 398,
 492
uta, leptomoniid, 219, 497
- Leishmaniasis, 482
 oral, 219, 251
- Lepidoptera, moths, 59, 83
- Lepidopterous larva poisoning, 466
- Lepomis cyanellus*, fish, 282
gibbosus, fish, 282
- Leprosy, 112, 115, 392, 481, 482
- Leptomonas* sp., leptomoniid, 354
algeriense, leptomoniid, 251
blattarum, leptomoniid, 388
calliphorae, leptomoniid, 117
ctenoccephali, leptomoniid, 354
ctenophthalmi, leptomoniid, 355
ctenopsyllae, leptomoniid, 355
culicis, leptomoniid, 252
debreuili, leptomoniid, 355
drosophilae, leptomoniid, 117
homalomyiae, leptomoniid, 117
lineata, leptomoniid, 117
luciliae Roubaud, leptomoniid, 117
luciliae Strickland, leptomoniid, 117
mesnili, leptomoniid, 117
minuta, leptomoniid, 219
muscae-domesticae, leptomoniid, 117
pattoni, leptomoniid, 355
pediculi, leptomoniid, 294
phlebotomi, leptomoniid, 219
pycnosomae, leptomoniid, 118
roubaudi, leptomoniid, 118
sarcophagae, leptomoniid 118
simuliae, leptomoniid, 219
soudanensis, leptomoniid, 118
stratiomyiae, leptomoniid, 118
subulata, leptomoniid, 219
- Leptomoniidae, 117, 118, 219, 251, 252, 294,
 354, 355, 388, 395-398, 414-418
- Leptopsylla musculi*, flea, 351, 488
- Leptospira hebdomadis*, spirochaete, 413
icterohaemorrhagiae, spirochaete, 296,
 481
icteroides, spirochaete, 259, 260, 497
- Leptus akamushi*, mite, 404, 413, 477, 497
americanus, mite, 404, 477
irritans, mite, 404, 477
- Lepus* spp., rabbits, 353
nigricollis, rabbit, 422, 475
- Leucocytozooidae, 214, 250
- Leucocytozoon danilewskyi*, protozoan, 250,
 251, 475

- Leucocytozoon lovati*, protozoan, 214
Leucophaea sp., cockroach, 376
Lewisonella spp. (see *Trypanozoon*)
 Lice, 286-348
 animal, 330-348
 in Egypt, 452
 Life zones of temperature and humidity, 98-104
Limnophilus flavicornis, caddice fly, 59, 83
 griseus, caddice fly, 59, 83
 lunatus, caddice fly, 59, 83
 rhombicus, caddice fly, 59, 83
Limosina punctipennis (see *Borborus*)
Linognathus pedalis, sheep foot louse, 345
 stenopsis, goat louse, 346, 347
 vituli, cattle louse, 288
 Linseed oil for cattle lice, 334, 335
 Lion, 373, 405
Liponyssus bacoti, mite, 404, 474
Lipoptena cervi, fly, 235
Lithobius forficatus, centipede, 466, 490
 melanops, centipede, 466, 490
 Living quarters, 327
 Lizards, 226
 Llama, 405
 Loasis, 482
 Lone Star tick (see *Amblyomma americanum*)
Löschia coli, amoebid, 116
 histolytica, amoebid, 117, 478
 Louse, body (see *Pediculus corporis*)
 crab (see *Phthirus pubis*)
 control, 312-329
 head (see *Pediculus humanus*)
 ravages, 312, 313
 Louse reservoirs, 313, 314
 Louse borne diseases, 286-297
 Louse-ulcers, 287
Lucania parva, fish, 282
 venusta, fish, 282
Lucilia spp., flies, 117, 118
 argyrocephala, fly, 180, 485
 caesar, green bottle fly, 105, 108, 109, 110, 111, 112, 113, 114, 132, 133, 140, 177, 179, 180, 181, 453, 475, 477, 485, 492
 nobilis, fly, 149
 serenissima, fly, 117, 118, 180, 480, 485
 sericata, green bottle fly, 131, 132, 140, 143, 148, 149, 177, 179, 180, 181, 453, 485
 sylvarum, fly, 132
 tasmaniensis, fly, 181, 485
 Lungs, inflammation of, 408
Lycosa narbonensis, spider, 463, 489
 tarantula, spider, 463, 489
Lymantria monacha, moth, 467, 489
 Lymphangitis, 69, 409
 epizootic, 411, 482
 Lymph-scrotum, 69
Lynchia spp., flies, 235
 brunea, fly, 212, 482
 maura, fly, 212, 213, 219, 482
Lyperosia sp., fly, 214, 218
 exigua, horn fly, 215, 232, 494
 irritans, horn fly, 169, 210, 232, 233, 234, 475
 minuta, fly, 215, 494
Macracanthorhynchus hirudinaceus, thorn-headed worm, 79, 85, 86, 495
Macrothylacia rubi, moth, 467, 489
 Maculae coeruleae, 288, 482
 Mal de caderas, 393, 482
 Malacotylea, 120, 121
 Malaria, 48, 262
 aestivo-autumnal, 253, 255, 256
 avian, 259, 482
 canary, 482
 malignant tertian, 253, 255, 256
 pernicious, 252
 pigeon, 212, 213, 482
 quartan, 253, 256, 257, 482
 subtertian, 253, 255, 256, 482, 483
 tertian, 253, 257, 258, 259, 483
 unclassified, 253, 254, 255, 482
Malassezia spp., fungi, 289, 487
 Mallophaga, biting lice, 86
 Mange, 405
 demodectic, 407, 484
 pscroptic, 484
Mansonía sp., mosquito, 250, 485
 pseudotillans, mosquito, 262, 480
Mansonioides africanus, mosquito, 261, 262, 479
 annulipes, mosquito, 70, 82, 262, 480
 uniformis, mosquito, 70, 82, 250, 262, 479
 Manure, 153-160
 bin, 157
 broadcasting, 156
 clean-up, 158
 collection, 156
 hog, 172, 173
 incineration, 158
 inspection, 158, 160
 loading platforms, 156, 158
 piles, 159
 scraper, 159
 shipment, 158
 spreader, 157
Margaropus winthemi, tick, 410
 Marmoset (see *Midas* spp.)
 Mastigophora, 117-119, 212-219, 249-260, 294-296, 352-355, 388, 393-399, 414-420
Mastophorus echiurus, nematode, 78, 86
 globocaudatus, nematode, 78, 85
 Mayflies (see *Plectoptera*)
 Mbori, 228, 251, 484
 Meal moth (see *Asopia farinalis*)
 Measles, 116, 122, 484
 Mediteranean Coast Fever of cattle, 415, 484
Megalopyge opercularis, moth, 467, 489
 Melanoderma, 287, 288, 484
Melanolestes picipes, kissing bug, 469, 489
Melipona spp., bees, 489
 Meloidae, 469, 478

- Melolontha melolontha*, June beetle, 79, 85, 495
vulgaris (see *Melolontha melolontha*)
Melophagus ovinus, sheep tick, 212, 219, 235, 346
Meningitis, cerebrospinal, 108, 115, 289, 290, 484
Meningococcus sp., microorganism, 289
Mercurial ointment, 337
Meriones spp., rodents, 353
Mermithidae, 78, 262
Mesogoniatus chaetodon, fish, 282
Metatrombidium poriceps, mite, 404, 477
Metazoa, 220, 260, 297, 355, 389, 390
Miana tick fever, 484
Mice, 355, 395
white, 393
Microcalliphora domestica, fly, 485
varipes, fly, 181, 485
Micrococcus sp., microorganism, 292
flavus, microorganism, 108
melitensis, microorganism, 248
nigrofasciens, microorganism, 383
tetragenus, microorganism, 108
Microfilaria diurna (see *Filaria (Loa) loa*)
perstans (see *Acanthocheilonema*)
Microneurum funicola, fly, 109, 477
Microtrombidium pusillum, mite, 404, 477
tlalsahuatl, mite, 404, 477
wichmanni, mite, 404, 480
Microtus spp., mice, 352
montebelli, field mouse, 413
Midas geoffroyi, marmoset, 259
oedipus, marmoset, 259
Midges (see Chironomidae)
Milk bacteria, 112, 115
Minnow, top (see *Gambusia affinis*)
Mites, 403-429
Mollienisia latipinna, fish, 282
Mongoose (see *Herpestes ichneumon*)
Moniliformis moniliformis, thorn-headed worm, 79, 84, 88, 389, 495
Monkey, 291, 408
(see *Ateles pentadactylus*)
(see *Cynomolgus cynocephalus*)
Morbus errorum, 287
Mosquito control, 275-285
repellents, 284
sources, 276
stains, 276
traps, 283
Mosquitoes, 69, 70, 71, 247-285
Mouse, 408
nematode (see *Protospirura muris*)
tapeworm (see *Hymenolepis diminuta*)
tapeworm (see *Hymenolepis microstoma*)
tapeworm (see *Hymenolepis nana*)
Municipal boarding houses, 41
Murrina, 119, 122, 484
Mus spp., mice, 352, 353
musculus, mouse, 118, 294
Musca sp., fly, 118
bezzii, fly, 229
Musca sp., *convexifrons*, fly, 229
corvina, fly, 229
domestica, house fly, Frontispiece, 56, 57, 65, 66, 67, 68, 82, 105, 106, 108, 109, 111, 112, 113, 114, 116, 117, 118, 119, 120, 121, 122, 127-130, 139, 140, 142, 144, 145, 151, 180, 477, 478, 479, 480, 481, 484, 486, 487, 488, 489, 492, 494, 495, 497
gibsoni, fly, 229
nebulosa, fly, 118, 121, 487
nigrithorax, fly, 229
pattoni, fly, 229
Muscidae, 228-234
Muscina assimilis, fly, 453
stabulans, non-biting stable fly, 135, 136, 140, 143, 146, 147, 180, 192, 453, 484, 485
Mustela foina, weasel, 73
Mycterotypus bezzii, fly, 224
irritans, fly, 224
Mydaea anomala, fly, 188, 485
pici, fly, 195, 484
spermophilae, fly, 188
torquens, fly, 188, 485
vomiturationis, fly, 192, 484
Myiasis, 22, 175-208
auricular, 180
bloodsucking larvae, 195, 196, 484
classification, 175, 176
head passage, 193-195, 484
intestinal, 190-193, 484
ocular, 180
prevention and treatment, 200-208
subdermal, 175, 182-190, 484
tissue destroying, 175, 176-181, 485
urogenital, 190, 193, 484
Myobia musculi, mite, 408, 497
Myoxus spp., rodents, 352, 353
Myriapoda, millipedes, centipedes, 88
Mystacides nigra, caddice fly, 59, 83
Mycococcidium stegomyiae, microorganism, 249
Myxosporidia, 120, 388
Nagana, 214, 228, 230, 250, 393, 485
Nasal myiasis, treatment, 204
Nausea, caused by insects, 21
N.C.I. powder
Necator americanus, hookworm, 122, 480
Nemathelminthes, 121, 122, 220, 261-263, 357, 389
Nematoda, nematodes, 59-78, 88, 121, 122, 220, 261-263, 357, 389, 390
Nematode, bovine, 484
canine, 486
donkey, 486
dromedary, 486
equine, 486
fowl, 486
fox, 486
hedgehog, 486
hog, 486
jerboa, 486

- Nematode, mongoose, 486
 rodent, 486, 487
Neocuterebra squamosa, bot, 190, 485
Neopollenia stygia, fly, 181, 485
 Neosporidia, 121, 388
Nephrophages sanguinarius, mite, 408, 474
 Nervous exhaustion, caused by insects, 20,
 21
Neuroctena anilis, fly, 118
 Neuroptera, 59, 82
 Nicotin wash, 337
 Nigua (see *Dermatophilus penetrans*)
 Nochelic subzone, 98, 102
 Nose protection, 205
Nosema apis, protozoan, 120
 Nosemidæ, 120
Notemigonus crysoleucas, fish, 282
Notidobia ciliaris, caddice fly, 59, 83
Notoedres cati cati, mite, 405, 491
 muris, mite, 491
Nuttallia spp., piroplasmid, 414
 equi, piroplasmid, 417, 436, 487
 Nuttalliosis, equine, 417, 487
 Nycteribiidae, 235
Nyctotherus ovalis, ciliate, 388
Nymphula nymphæata, moth, 59, 83

Octospora monospora, protozoan, 120
 Ocular acariasis, 487
 Odonata, dragon flies, 59, 87
Oedemagena tarandi, reindeer bot, 188,
 485
Oestrus ovis, sheep bot, 176, 193, 198, 207,
 469, 484
 Oilters, 281
 Oiling, 280
 Oils for treating cattle, 334, 335
 Olethric zone, 98, 102
Oligoneuria rhenana, mayfly, 78, 87
Oncocerca sp., cattle nematode, 77
 caecutiens, nematode, 77
 lientalis, cattle nematode, 77
 volvulus, human nematode, 77
Onitis irroratus (see *Chironitis*)
Onthophagus spp., beetle, 62, 64, 85, 486
 bedeli, beetle, 63, 64, 85, 486
 hecate, beetle, 62, 86, 485
 nebulosus, beetle, 64, 86, 486
 pennsylvanicus, beetle, 62, 86, 485
 Ophthalmia, purulent, 116, 122, 487
 nodosa, 466, 487
Ophyra spp., flies, 453
 nigra, fly, 181, 485
Opisthoglyphe rastellus, fluke, 59, 83, 87
 Optimum temperature, 100
 Organisms carried by insects, 27, 28, 29
Ornithodoros spp., ticks, 423, 424
 coriaceus, tick, 409, 487
 megmini, tick, 408, 420, 424, 426, 431,
 433, 434, 444, 445, 487, 490
 moubata, African relapsing fever tick,
 72, 74, 75, 89, 96, 414, 418, 419, 420,
 423, 424, 432, 433, 448, 476, 479, 490,
 491, 493
 Ornithodoros spp., *savignyi*, tick, 412,
 418, 423, 424, 434, 479, 490
 turicata, tick, 409, 420
Ornithomyia spp., flies, 235
 lagopodis, fly, 213, 214, 480
 Orthoptera, 88
Oscinis pallipes, gnat, 119, 497
 Otoacariasis, 408, 487
Otodectes cynotis, mite, 408, 487
 Otomyiasis, 149
 Ovine trypanosomiasis, 218
 Owls, 249
 Oxyuridae, 121, 389, 390
Oxyuris blattaorientalis, worm, 389
 bulhoesi, worm, 389
 curvula, worm, 121, 487
 diesingi, worm, 389
 kunckeli, worm, 389
 vermicularis, worm, 121

 Packing house insects, 40, 453-460
Paederus columbinus, beetle, 469, 478
 Pahvant Valley plague, 209
 Palm squirrel (see *Funambulus pen-*
 natii)
 Panama larvicide, 280
Pangonia spp., horseflies, 228
Panoplitis sp., mosquito, 75, 82, 479
 africanus (see *Mansonioides*)
 Pappataci fever, 49, 211, 226, 487
 flies (see *Phlebotomus* spp.)
Parachordodes pustulosus, horse-hair worm,
 79
 tolusanus, horse-hair worm, 79
 violaceus, horse-hair worm, 79
 Paracolititis, 487
Paragordius tricuspidatus, horse-hair worm,
 79
 varius, horse-hair worm, 78, 79
 Paralysis, Australian human tick, 411
 infantile (see also Poliomyelitis), 116,
 487
 insect, 22
 North American human tick, 409, 410
 South African tick, 410
 tick, 487
Paraplasma flavigenum, protozoan, 259
 Paratyphoid A fever, 112, 115, 487
 B fever, 112, 115, 487
 Partridge, 259
Passer domesticus, English sparrow, 252
Passeromyia heterochaeta, fly, 196, 484
 Pasture rotation, 441
 Paunch manure, 456
 Pecilothermal, 101
Pediculoides ventricosus, mite, 404, 405,
 497
 Pediculosis, 22
 capitis, 286, 287
 corporis, 286, 287
Pediculus spp., lice, 481
 capitis (see *P. humanus*)
 consobrinus, monkey louse, 302

- Pediculus* spp., *corporis*, body louse, 286, 289, 290, 291, 292, 293, 294, 296, 301, 302, 304, 305, 306, 307, 308, 309, 310, 317-28, 478, 479, 481, 484, 487, 488, 490, 491, 495, 497
humanus, head louse, 286, 289, 290, 294, 295, 301, 302, 306, 316, 317, 477, 480, 482, 488, 497
vestimenti (see *P. corporis*)
Pellagra, 212, 225, 230, 487
Periplaneta sp., cockroach, 375
americana, 63, 78, 79, 88, 376, 378, 379, 383, 387, 388, 389, 477, 486, 495
australasiae, 376, 380
Peritonitis, 408, 487
Perlidae, stoneflies, 59
Personal prophylaxis, 315
Pharyngobolus africanus, bot, 193, 484
Phidippus audax, spider, 463, 489
Philaematomyia crassirostris, fly, 215, 494
insignis, fly, 229
Philaematomyiinae, 229
Phlebotomus fever, 211
minutus, fly, 219, 226, 492
minutus africanus, fly, 219
papatasi, pappataci fly, 211, 226, 487
verrucarum, fly, 211, 226, 497
Phormia azurea, fly, 195, 484
metallica, fly, 195
regina, black blowfly, 132, 133, 135, 141, 177, 178, 179, 453, 485
sordida, fly, 195, 484
Phosoborus, 382
Phryganea sp., caddice fly, 59, 83
grandis, caddice fly, 59, 83
Phthiriasis, 286, 287, 238
Phthirus inguinalis (see *P. pubis*)
pubis, crab louse, 286, 301, 302, 316, 475, 476, 482, 484, 495
Phyllophaga arcuata, June beetle, 79, 86, 495
Phyllostomus sp. (bat), 251
Physocephalus sexalatus, nematode, 64, 65, 78, 85, 86, 95, 486
Pig (see also hog), 373, 405
nematode (see *Arduenna strongylina*)
nematode (see *Physocephalus sexalatus*)
pens and pig lots, 170, 171, 172, 173
thorn-headed worm (see *Macracantho-rhynchus hirudinaceus*)
Pigeon lice, 343
Pin itch, 122
Pink eye, 109
Pinworm, equine, 487
Pinworms (see Oxyuridae), 121, 389, 390
Piophilu casei, cheese maggot, 192, 454, 484
Piroplasma spp., protozoa, 414
bigeminum (see *Babesia*)
hominis, protozoan, 413
Piroplasmidae, 414
Piroplasmosis, 487
Pityriasis, 289, 290, 487
Plague, 49
Plague, bubonic, 112, 115, 350, 351, 360, 365, 392, 393, 488
rodent, 114, 115, 209, 230, 351, 488
Planorbis exustus, snail, 260
Plasmodidae, 252, 259
Plasmodium sp., malaria organism, 252, 483
danilewskyi, malaria organism, 259, 482
falciparum (see *Laverania*)
malariae, malaria organism, 253, 257, 482
relictum, malaria organism, 259, 482
vivax, malaria organism, 253, 257, 258, 259, 483
Platyhelminia, 120, 121, 260, 261, 355, 356, 357, 389
Plecoptera, stoneflies, 59, 88
Plectoptera, mayflies, 59, 87
Pleurogenes claviger, fluke, 59, 86
medians, fluke, 59, 86, 87
Plica polonica, 287, 488
Plistophora sp., protozoan, 388
periplaneta, protozoan, 388
Pneumococcus septicaemia, 289, 290
Pneumonoecus similis, fluke, 59, 87
Pneumonyssus simicola, mite, 408, 481
Pogonomymex barbatus, ant, 468, 488
californicus, ant, 468
Poisoning, bee, wasp and ant, 488
bug, 488
centipede, 464-466, 488
food, 111, 114, 115, 489
honey, 468, 489
insect, 21, 22, 461-471
kissing bug, 489
lepidopterous larvae, 466, 489
scorpion, 461-463, 489
spider, 463, 464, 489
Poliomyelitis, 116, 122, 211, 212, 230, 248, 249, 393, 489
Polistes spp., wasps, 468, 488
Pollenia rudis, fly, 118, 192, 484
villosa (see *Neopollenia stygia*)
Polydesmus complanatus, centipede, 466, 490
Polymastigidae, 117
Polymastigina, 117, 388
Polyneuritis, 291
Polyplax spinulosus, rat louse, 294, 296, 491, 496
stephensi, jerboa louse, 296, 474
Porcellio laevis, sowbug, 68, 89, 486
Porrijo, 289, 490
Porthesia similis, moth, 467, 489
Porthetria dispar, gipsy moth, 467, 489
Pot-holes, 277
Practicotatum, 98, 100, 101, 102
Priesz-Nocard organism, 411, 482
Prionurus amoureuini, spider, 462, 489
citrinus, spider, 462, 489
Prisoners, inspection, 41
Privies, 37, 39
Prosotocus confusus, fluke, 59, 86, 87
Protection of body against mosquitoes, 283, 284

- Protomonadina, 117
Protospirura muris, rodent nematode, 60, 78, 80, 86, 93, 357, 487
 Protozoa, 116-120, 212-220, 249-260, 294-297, 352-355, 388, 393-399, 414-423
Prowazekia sp., protozoan, 117
Prurigo senilis, 287
 Pruritis, 287, 288, 409
 Pseudoedema, malignant, 386, 490
 Pseudoparasitism of nasal passages, etc., 490
Pseudopyrellia cornicina, fly, 136, 169
Psorergates simplex musculus, mite, 408, 497
Psorophora lutzi, mosquito, 188
sayi, mosquito, 249, 475
Psoroptes communis bovis, mite, 405, 484
cuniculi, 408, 487
equi, mite, 405, 484
ovis, mite, 405, 484
 Psychodidae, 226, 228
Ptinus spp., beetles, 475
Pulex brasiliensis, flea, 352, 496
irritans, human flea, 53, 54, 55, 76, 80, 351, 352, 354, 355, 356, 357, 360, 362, 363, 479, 481, 488, 494, 495, 496
 Pupipara, 235
 Pus, green, 113, 115
 Pustular dermatitis, 287
Pycnosoma bezziana, fly, 180, 485
chloropyga, fly, 485
flaviceps, fly, 180, 485
marginale, fly, 180, 485
megacephala, fly, 180, 485
putorium, fly, 118, 180, 485
ruffacis (see *Chrysomya*)
Pyggiopsylla ahalae, flea, 351, 365, 488
 Pyodermia, 287, 288, 490
 Pyrethrum powder, 381, 382

 Rabbit, 63
 fleas, 353
 lice, 343, 344
 Rain barrels, 282
 Rat (see also rodent), 389, 395, 404, 422
 fleas, 350, 351
 louse (see *Polyplax spinulosa*)
 nematode (see *Gongylonema neoplasticum*)
 nematode (see *Protospirura muris*)
 tapeworm (see *Hymenolepis diminuta*)
 tapeworm (see *Hymenolepis nana*)
 thorn-headed worm (see *Moniliformis moniliformis*)
 Rat-tail maggots (see *Eristalis* spp.)
 Raven, 249
 Red bug, 404
 grouse (see *Lagopus scoticus*)
 Reduviidae, 399
 Redwater, 414
 British, 417, 490
 Reindeer bot (see *Cephenomyia trompe*)
 (see *Oedemagena tarandi*)
 Relapsing fever, 48, 403
 Abyssinian, 418, 490
 American, 420, 490
 Asiatic, 295, 490
 East African, 420, 490
 European, 296, 313, 398, 399, 420, 491
 Manchurian, 296
 North African, 295, 296, 398, 491
 Tropical African, 296, 398, 418, 491
 Rhiganesthesia, 98
 Rhigonochelia, 98, 100
 Rhigoplegia, 98, 101
 Rhinoceros bots, 193
Rhinoestrus hippopotami, bot, 195, 484
nasalis, bot, 194, 484
purpureus, bot, 194, 198, 207, 484
Rhipicephalus spp., ticks, 424, 435
appendiculata, tick, 417, 425, 436, 447, 478
bursa, tick, 417, 436, 476
capensis, tick, 415, 417
evertsi, tick, 417, 420, 424, 425, 436, 478, 487, 493
sanguineus, tick, 74, 76, 89, 414, 415, 420, 421, 424, 425, 436, 474, 476
siculus, tick, 410, 414, 417, 425, 474, 476, 478, 487
Rhizoglyphus parasiticus, mite, 405, 408, 481, 487
 Rhodesian fever, 417, 491
Rhodnius prolixus, bug, 394, 476
Rhyacophila nubila, caddice fly, 59, 83
Rhynchoidomonas luciliae, protozoan, 118
Rhizoglyphus parasiticus (see *Rhizoglyphus*)
Rickettsia melophagi, microorganism, 212
pediculi, microorganism, 292, 294, 497
provazeki, microorganism, 292, 497
quintana, microorganism, 293, 495
 Robin, 195
 Rocky Mountain spotted fever, 403, 412, 491
 tick (see *Dermacentor andersoni*)
 Rodent trypanosomiasis, 294
Rossiella spp., protozoa, 414
 rossi, protozoan, 417, 474

 Sanitation, entomological, 34-42
Sarcina alba, microorganism, 383
aurantiaca, microorganism, 108, 384
lutea, microorganism, 384
 Sarcodina, 116, 117, 388
Sarcophaga spp., flies, 119, 453, 484, 497
aurifrons, fly, 181, 485
caritaria, fly, 105, 108, 109, 110, 111, 112, 113, 114, 180, 475, 477, 485, 492
haemorrhoidalis, fly, 118, 180, 191, 484, 485
lambens, fly, 179, 485
murus, fly, 118
pyophila, fly, 179, 197, 485
regularis, fly, 180, 485
robusta, fly, 135
ruficornis, fly, 180
saraceniae, fly, 117, 132, 136

- Sarcophaga* spp., *texana*, fly, 132.
tuberosa sarracenioides, fly, 132
 Sarcophagidae, 141, 144, 150, 151, 177
Sarcoptes aucheniae, mite, 405, 491
bovis, mite, 405, 491
canis, mite, 405, 491
caprae, mite, 405, 491
dromedarii, mite, 405, 491
equi, mite, 405, 491
leomis, mite, 405, 491
ovis, mite, 405, 491
scabiei crustosae, mite, 405, 491
scabiei hominis, mite, 405, 491
suis, mite, 405, 491
vulpis, mite, 405, 491
 Sarcoptidae, 405
 Sawdust, oil-soaked, 281
 Scab, 491
 sheep, 405
 Scabies, 48, 405, 491
 Scaly leg, 405, 406, 407, 492
Scarabaeus (Ateuchetus) variolosus, beetle,
 61, 64, 86, 486
 (*Ateuchus*) *sacer*, beetle, 61, 63, 64, 65,
 86, 486
 Scarlet fever, 116, 122, 492
Scatophaga lutaria, fly, 118
Scaurus striatus, beetle, 42, 54, 86, 495
Schistosoma mansoni, worm, 120, 121
 Schistosomiasis, 120
 Schistosomidae, 120, 121
 Schizomycetes, 107-115, 209-211, 249, 289,
 290, 350, 351
Schizotrypanum cruzi, trypanosome, 393,
 394, 395, 414, 475
 Scholeciasis, 22
Schöngastia vanderaesandei, mite, 404, 480
 School children, inspection, 40
Scolopendra cingulata, centipede, 465, 488
 gigantea, centipede, 465, 488
 heros, centipede, 465, 488
 morsitans, centipede, 465, 488
Scops gin, owl, 249
 Scorpion poisoning, 461-463
 Scorpionidea, 461
 Scouting for mosquitoes, 275
 Screening, 162, 206, 283
 of food, 39
 of houses, 36
 Screw worms (see *Chrysomya macellaria*)
Scutigera coleoptrata, centipede, 466,
 490
Scutomyia albolineata, fly, 70, 80, 262, 480
 Sebaceous tumor, 408
 Seborrhoea, 407, 492
 Seepage water, 277
 Sense organ injury, 21
 Septicaemia, 108, 110, 111, 115, 211, 230,
 289, 290, 411, 492
 Serbian barrel disinfectant, 322
Setaria labiata-papillosa, cattle nematode,
 77, 82, 94
 Seven-day fever, 413
 Sewage, 40, 41, 161
 Sewers, 282
 Sheep, 373, 405, 410
 bot (see *Oestrus ovis*)
 lice, 345, 346
 Sheep maggots, 181
 nematode (see *Gongylophora scutatum*)
 tick (see *Melophagus ovinus*)
 Shrew tapeworm, 57
Sialis lutaria, dobson fly, 59, 82
Sibine stimulea, moth, 467, 489
 Simian trypanosomiasis, 218
 Simuliidae, 224, 225, 226
Simulium spp., buffalo gnats, 212, 224,
 225, 226, 487
 bracteatum, buffalo gnats, 227
 columbaczense, buffalo gnats, 219
 dinelli, buffalo gnats, 77
 jenningsi, buffalo gnats, 227
 pictipes, buffalo gnats, 227
 samboni, buffalo gnats, 77
 venustum, buffalo gnats, 227
 vittatum, buffalo gnats, 227
 Siphonaptera (see Aphaniptera)
Sitophilus granarius, beetle, 42
 Sleeping sickness, 262
 Gambian, 215, 230, 250, 492
 Nigerian, 215, 492
 Rhodesian, 217, 250, 492
 Smallpox, 116, 122, 291, 492
 Soaps, 318
 Sodium fluoride, 341, 342, 343, 381
 Sore, Bagdad, 118, 219, 226, 492
 Biskra, 219, 492
 Cambay, 118
 non-ulcerating oriental, 395
 Oriental, 118, 251, 398, 492
 tropical, 262
 Souma, 217, 228, 230, 493
 Zambian, 217, 493
 Sowbug (see *Porcellio laevis*)
 Sparrow, 249, 259
 Spider poisoning, 463, 464
Spilopsyllus leporis, flea, 353, 496
 Spinose ear tick (see *Ornithodoros megnini*)
 Spirillaceae, 115, 387
Spirillum (Vibrio) cholerae, microorganism,
 115, 387, 477
 metchnikovi, microorganism, 387,
 478
Spirocerca sanguino lenta, dog nematode,
 60, 65, 84, 85, 86, 88, 91, 486
Spirochaeta gallica, spirochaete, 293
 Spirochaetacea, 219, 259, 260, 295, 296, 355,
 398, 418-420
 Spirochaetidae, 119, 219, 259, 260, 295-296,
 355, 398, 418-420.
 Spirochaetosis, 49
 bovine, 420, 493
 goose, 418, 494
 North American fowl, 493
 Senegal fowl, 420, 493
 South American fowl, 493
 Sudanese fowl, 419

- Spiroptera obtusa* (see *Protospirura muris*)
(Filaria) sanguinolenta (see *Spirocerca*)
(Gongylonema) neoplasticum (see *Gongylonema*)
Spiroschaudinmia spp., spirochaetes, 296, 418, 490
anserina, spirochaete, 418, 494
berbera, spirochaete, 295, 398, 491
carteri, spirochaete, 295, 490
ctenocephali, spirochaete, 355
culicis, spirochaete, 259
duttoni, spirochaete, 296, 398, 491
duttoni, Brumpt, spirochaete, 418
duttoni, Novy and Knapp, spirochaete, 418, 419
exanthematotyphi, spirochaete, 292
glossinae, spirochaete, 219
granulata, spirochaete, 419, 493
marchouxi, spirochaete, 493
neveuuii, spirochaete, 420, 493
novyi, spirochaete, 420, 490
recurrentis, spirochaete, 295, 296, 398, 420, 491
rossii, spirochaete, 420, 490
theileri, spirochaete, 420, 493
Spirura gastrophila, cat nematode, 60, 61, 84, 85, 95, 389, 486
Spiruridae, 121, 357, 389
Splenic fever, 414, 494
Sponge baths, 313
Sprays for cattle, 335, 336
Squirrel, 355, 409
 bot, 187
Stable fly (see *Stomoxys calcitrans*)
Stables, 39, 40
Staphylinidae, 469, 478
Staphylococcus spp., microorganisms, 482
pyogenes, microorganisms, 411, 480
pyogenes albus, microorganisms, 108, 210, 289, 384, 480, 492
pyogenes aureus, microorganisms, 108, 210, 289, 384, 480, 492
pyogenes citreus, microorganisms, 108, 492
Steam, enclosed, 322, 323
 live, 322
 sterilization, 321-323
Stegomyia calopus (see *Aedes argenteus*)
fasciata (see *Aedes argenteus*)
gracilis (see *Aedes*)
ingens, mosquito, 251
Sterilization, steam, 321-323.
Sternostomum rhinolethrum, mite, 408, 481
Stigmatogaster subterraneus, centipede, 466, 490
Stomoxydinae, 229, 230, 232, 233
Stomoxys spp., flies, 217, 218
 caloitrans, stable fly, 57, 66, 67, 77, 78, 82, 126, 139, 140, 143, 145, 146, 209, 210, 211, 212, 214, 215, 216, 217, 220, 221, 230, 231, 232, 474, 475, 476, 477, 478, 485, 487, 488, 492, 493, 494, 495
 geniculatus, fly, 215
 glauca, fly, 214, 485
 Stomoxys spp., *nigra*, fly, 215, 216, 217, 220, 476, 493, 494
Stoneflies (see Plecoptera)
Stratiomyia chameleon, fly, 118
 potamida, fly, 118
Straw, 231, 232
Streams, clearing, 276
Streblidae, 235
Streptococcus sp., microorganism, 211, 492
 equinus, microorganism, 107
 fecalis, microorganism, 108
 pyogenes, microorganism, 108, 499
 salivarius, microorganism, 108
Strickeria jürgensi, protozoan, 292
Strix flammea, owl, 249
Submarine saws, 277
Submersible automatic oil bubbler, 281
Sulphur flowers, 343, 382
 fumigation, 381
 gas, 324, 325
Suppurating wounds, 113, 494
Suppuration, 108
Surra, 119, 122, 215, 228, 230, 250, 494
Swamp fever, 211
Swamps, 276
Swift (see *Cypselus officinis*)
Swine (see hog)
Syphilis, 291
Syrnium aluco, owl, 249, 250, 475
Syrup factories, 41
 Tabanidae, 211, 214, 218, 219, 228, 236-246, 251, 496
 Tabanus spp., horseflies, 210, 214, 217, 219, 228, 485, 492
 atratus, horsefly, 210, 215, 475
 biguttatus, horsefly, 215, 217, 484, 493
 bovinus, horsefly, 210, 475
 chrysurus, horsefly, 211, 474
 corax, horsefly, 239, 240
 ditaeniatus, horsefly, 237, 242, 243, 246
 fasciatus, horsefly, 220
 fumifer, horsefly, 215, 494
 hilaris, horsefly, 219
 kingi, horsefly, 237, 240, 242, 246
 lasiophthalmus, horsefly, 243, 244
 lineola, horsefly, 215, 494
 minimus, horsefly, 215, 494
 par, horsefly, 220, 237, 240, 242
 partitus, horsefly, 215, 494
 phaenops, horsefly, 236, 237, 239, 240, 241, 242, 243, 245
 punctifer, horsefly, 236, 237, 238, 239, 240, 241, 243, 245
 secedens, horsefly, 220
 socialis, horsefly, 220
 striatus, horsefly, 210, 215, 219, 240, 241, 242, 243, 244, 245, 246, 475, 494
 stygius, horsefly, 239, 244, 245
 taeniatus, horsefly, 215, 217, 484, 493
 taeniola, horsefly, 237
 tergestinus, horsefly, 219
 trigeminus, horsefly, 211, 474
 trigonus, horsefly, 211, 474

- Tabanus* spp., *tropicus*, horsefly, 215, 494
vagus, horsefly, 215, 494
vivax, horsefly, 242
- Taenia cucumerina*, tapeworm, 94
nana (see *Hymenolepis*)
(*Taeniarhynchus*) *saginata*, beef tapeworm, 120, 494
- Taeniidae, 120, 297, 355, 356
- Taeniorhynchus domesticus*, mosquito, 70, 82, 262, 480
fuscopennatus, mosquito, 261, 479
- Tahaga, 217, 494
- Tapeworm, bovine, 494
canine, 494
fowl, 494, 495
human, 494, 495
rodent, 495
- Tapeworms (see Cestoda)
- Tarsonemidae, 404
- Tarsonemus intectus*, mite, 404, 497
uncinatus, mite, 404
- Teichomyza fusca*, fly, 118
- Telosporidia, 219, 220, 355, 388, 420-422
- Temperature, 97-104
and louse development, 304, 306, 307, 309, 310
- Temperatures, absolute fatal, 98, 101
- Tenebrio molitor*, granary beetle, 42, 54, 55, 57, 60, 63, 78, 86, 486, 487, 495
- Tersesthes torrens*, fly, 224
- Testudo mauritanica*, turtle, 422, 475
- Tetanus, 373, 495
- Tetramitidae, 388
- Tetranychidae, 404
- Tetranychus molestissimus*, mite, 404, 481
telarius, mite, 474
telarius russeolus, mite, 404
- Texas fever of cattle, 403, 414
- Thallophyta, 107-115, 209, 210, 211, 249, 289, 290, 350, 351, 383-387, 392, 393
- Theileria* spp., piroplasmids, 414
parva, piroplasmid, 417, 478
- Thelohamia ovata*, protozoan, 120
- Thelohaniidae, 120, 388
- Theobaldia annulata* (see *Culiseta*)
- Theraphosa javanensis*, spider, 464, 489
- Theridium lugubre*, kara kist spider, 464, 489
13-guttatum, spider, 464, 489
- Thermalgesia, 100
- Thermanastasis, 99
- Thermanesthesia, 98, 101
- Thermesthesia, 100
- Thermohyperesthesia, 100
- Thermonochelia, 98, 100
- Thermophilic, 100
- Thermophobia, 101
- Thermophylic, 100
- Thermoplegia, 98, 101
- Thermopnigia, 100
- Thermopolypnea, 100
- Thermopractic zone, 98, 99, 102
- Thermosystaltic, 101
- Thermotaxis, 101
- Thermotropism, 101
- Thorn-headed worms (see *Acanthocephala*)
- Three-day fever, 211
- Tick bite, 409
bite fever, human, 410
bite treatment, 448, 449
control, 440-449
dip, 442
fever of Miana, 412
fevers, 412
paralysis (see Paralysis)
- Ticks, 403-429
- Tile drainage, 277, 278
- Tin can dumps, 282
- Toilet flushing box, 282
- Town, insanitary, 38
sanitation, 38, 39
- Toxemia, 287, 288, 495
- Toxins, insect, 27
- Trachoma, 116, 122, 495
- Tragelaphus spekei*, antelope, 215
- Train disinfection, 322
- Traps in sinks, 282
- Trash, 41
- Trematoda, flukes, 57, 58, 59, 81, 82, 83, 88, 120, 121
- Trench fever, 48, 292, 293, 294, 312, 313, 495
- Treponema pertenuae*, spirochaete, 119, 497
- Triatoma* spp., kissing bugs, 414, 469
chagasi, kissing bugs, 394, 476
geniculata, kissing bugs, 394, 476
infestans, kissing bugs, 393, 482
megista, kissing bugs, 394, 399, 400
rubrofasciata, kissing bugs, 399, 400
sanguisuga, kissing bugs, 400
sordida, kissing bugs, 394, 476
- Trichodectes canis* (see *T. latus*)
climax, goat louse, 346
hermsi, goat louse, 346
latus, dog louse, 53, 86, 297, 344, 355, 494
parumpilosus, horse louse, 347
scalaris, cattle louse, 288, 322, 333
sphaerocephalus, sheep louse, 346
subrostratus, cat louse, 344
- Trichomonas orthoptera*, protozoan, 388
- Trichoptera, caddice flies, 59, 83
- Trichosomidae, 122
- Trichuris trichiura*, whipworm, 122, 497
- Trigona* sp., honey bee, 22
amalthea, honey bee, 468, 489
bipunctata, honey bee, 468, 489
limao, honey bee, 468, 489
ruficrus, honey bee, 468, 489
- Trochosa singoriensis*, spider, 463, 489
- Trombidium akamushi* (see *Leptus*)
autumnalis, mite, 404, 477
batalas, mite, 404, 477
holosericeum, mite, 404, 477
inopinatum, mite, 404, 477
striaticiceps, mite, 404, 477
- Troughs, water, 282

- Trypanosoma* sp., trypanosome, 214, 251, 414
 spp. (see *Castellanella*, *Duttonella*, *Schizotrypanum*, *Trypanozoon*)
christophersi, trypanosome, 414
franki, trypanosome, 218
gallinarum, trypanosome, 218, 496
grayi, trypanosome, 218, 496
noctuae, trypanosome, 251
theileri, trypanosome, 218, 480
tullochi, trypanosome, 218
vespertilionis, trypanosome, 395, 495
ziemannii, trypanosome, 251
- Trypanosomiasis, 49
 animal, 495
 bat, 395, 495
 bovine, 495, 496
 crocodile, 496
 equine, 496
 fowl, 496
 goat, 496
 ovine, 496
 rabbit, 496
 rat, 395
 rodent, 496
 simian, 496
- Trypanosomidae, 119, 214-218, 294, 352-354, 393-395, 414
- Trypanozoon blanchardi*, trypanosome, 352, 496
duttoni, trypanosome, 352, 395, 496
lewisii, trypanosome, 294, 352, 353, 395, 496
nabiasi, trypanosome, 353, 496
rabinowitschi, trypanosome, 354, 496
- Tsetse fly (see *Glossina* spp.)
 Tsutsugamushi disease, 413, 497
 Tuberculosis, 114, 115, 387, 497
 Tumbu fly (see *Cordylobia anthropophaga*)
 Tumors, 389
 sebaceous, 497
- Turkey, 408
 lice, 343
- Tydeus molestus*, mite, 408, 481
Tylenchus sp., worm, 89
 Typhoid fever, 49, 114, 115, 290, 291, 387, 393, 497
 Typhus fever, 48, 291, 292, 312, 313, 497
 Tyroglyphidae, 405
Tyroglyphus longior castellanii, mite, 405, 481
siro, mite, 405, 497
- Urine soakage pit, 48
 Urticaria, 286, 497
 Urticariasis, 404, 497
 Uta, 219, 224, 497
- Vagabond's disease, 287
 Vanillismus, 405, 497
 Ver du Cayor (see *Cordylobia anthropophaga*)
 Vermicides, 318, 319
 Vermijelly, 316
 Vermin problem in armies, 45
 Verruga peruviana, 211, 226, 497
 Vertical drainage, 278
Vespa spp., wasps, 468, 488
 Volhynian fever, 294, 497
Vulpes vulpes atlantica, fox, 61
- Warbles, treatment, 204, 205
 Wart hog, 196
 Waste disposal in armies, 44-48
 Water beetles, 59, 86
 gates, 278, 279
 holes, 276
 pitchers, 282
 Weed-filled bays and lakes, 277
 Weep-holes, 277
 Weil's disease, 296
 Wells, 37
 Whipworm (see *Trichuris trichiura*)
 Withers, fistulous, 412, 497
Wohlfahrtia magnifica, flesh fly, 175, 178, 179, 180, 198, 480, 485
 Wolf nematode (see *Spirocerca sanguinolenta*)
 Wood owl (see *Syrnium aluco*)
 Wool blowflies, 181
 Worms, parasitic, 50-96
 Worry caused by insects, 20, 21
 Wound treatment for myiasis, 204
 Wristlet method of breeding lice, 303
 Wyoming intermittent fever, 497
- Xenopsylla cheopis*, flea, 54, 56, 60, 80, 350, 351, 352, 355, 357, 360, 474, 487, 488, 495, 496
cleopatrae, flea, 354, 355
scopulifer, flea, 360, 366
 Xeranesthesia, 98, 101
 Xeronocheilia, 98, 101
- Yaws, 119, 122, 497
 Yellow fever, 48, 259, 260, 262, 497
- Zero or effective temperature, 99
 Zousfana, 217

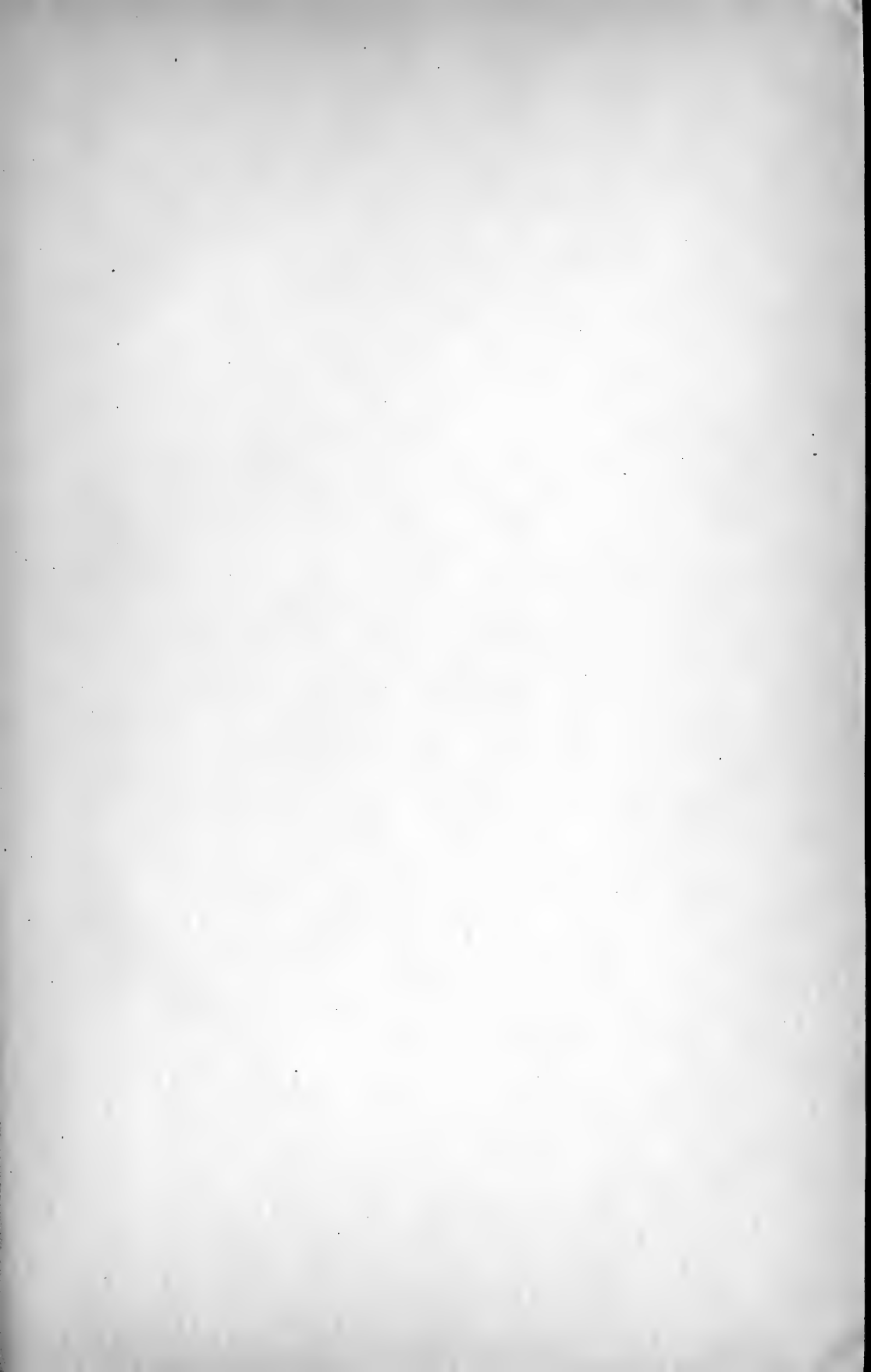







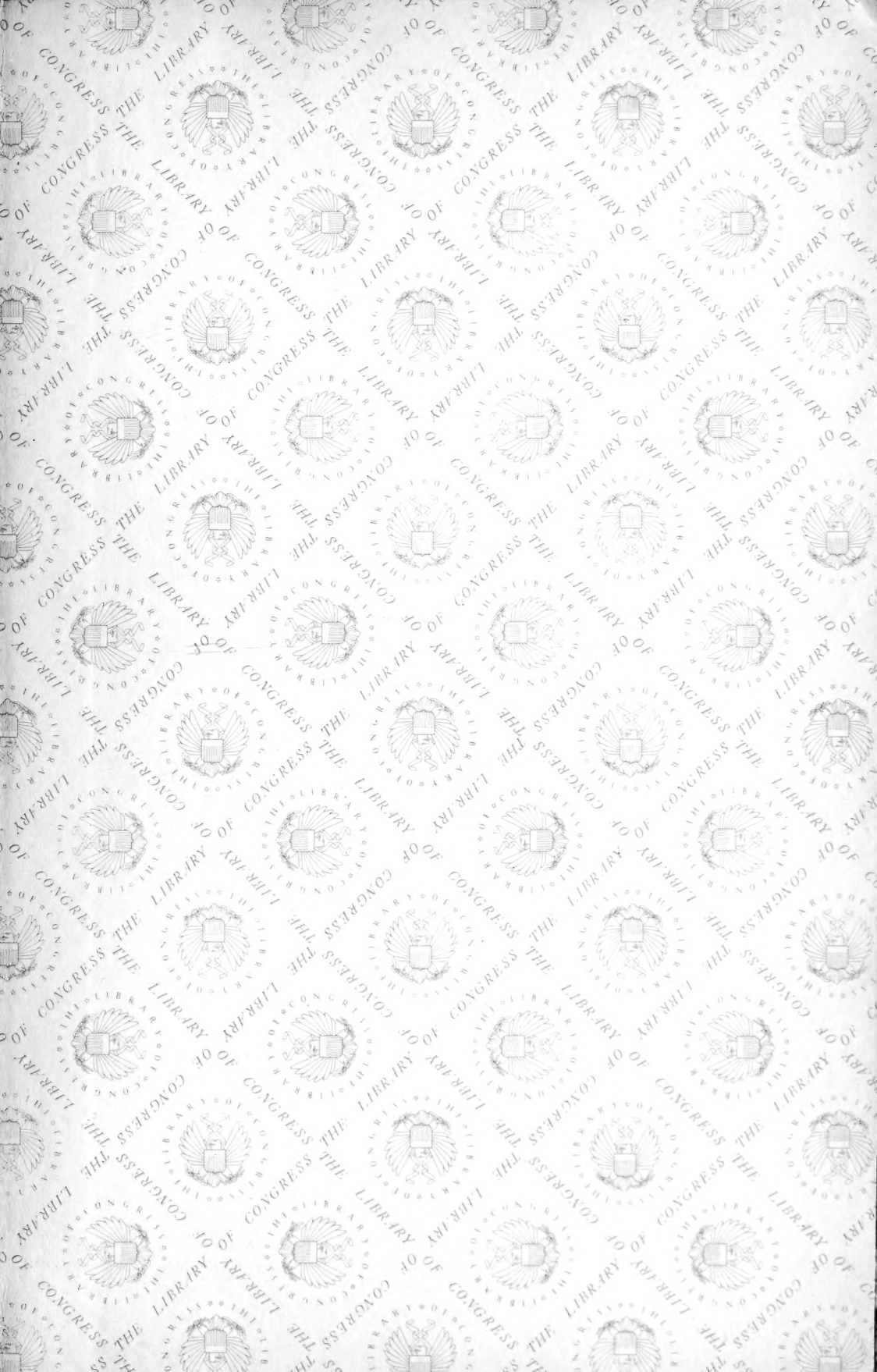

LIBRARY OF CONGRESS



0 022 169 343 7