

Historic, archived document

Do not assume content reflects current scientific knowledge, policies, or practices.

62.81
SCHWILL'S FIFTIETH ANNUAL
: CATALOGUE :

1869 *Bluff City Seeds* 1919

NURSERY STOCKS, POULTRY & BEE SUPPLIES, SPRAYERS & INSECTICIDES

SCHWILL'S
RED MAJESTIC
TOMATO

SCHWILL'S
PIMENTO
PEPPER



SCHWILL'S
SELECT BIG BOSTON
LETTUCE

OTTO SCHWILL & CO., MEMPHIS,
T E N N.

1869 **FIFTIETH YEAR** 1919

SCHWILL'S SURE SEEDS

GENERAL INFORMATION AND SUGGESTIONS TO CUSTOMERS

PRICES

The Prices We Quote on Vegetable Seeds will hold good as long as stocks last. The prices on Grass Seed, Grains and all Farm Seeds are those ruling January 1, 1919, and are subject to changes. As far as possible we will fill in full all orders for Seeds that are quoted subject to variation in price, but if market value will not permit this, we will send all that money remitted will pay for.

Notice Carefully the Prices. Be sure to know whether we or you are to pay the carrying charges, and bear in mind that we do not pay the express or freight charges on pecks or bushels, nor on any Tools, Bulbs, Grass Seeds, Field Seeds or Fertilizers, except where we so state on the pages where the goods are priced.

POSTAGE

We Pay Postage on all Seeds quoted by the package, ounce, quarter-pound and pound, and upon all goods quoted in our catalogue where it says parcel post paid.

MARKET GARDENERS

And Those Using Large Quantities of Seed should send us a list of their requirements. Prices will be furnished promptly, and we can frequently make a substantial reduction on large orders.

ERRORS

While We Exercise the Greatest Care in filling orders, endeavoring to do a little more than we offer, yet in the press of business errors will sometimes be made, in which event we wish to be promptly notified of the fact and will make such corrections as will be entirely satisfactory. Customers should be very clear and explicit in making out all orders, which will help us to avoid errors we so much dislike to make. Please keep copies of all orders for comparison.

OUR RELIABILITY

New Customers May Hesitate to send money to a firm they know nothing about. We should be pleased to have you inquire as to our responsibility of Bradstreet's or Dun's Commercial Agencies, the Commercial Trust & Savings Bank, or the Central-State National Bank of this city.

CASH WITH ORDER

Please Send Money With the Order sufficient to cover the whole bill, and remit by express money order or registered letter. Checks covering payment of goods must include 10 cents for collecting them. You will avoid delay by remitting by express or postoffice money order. We decline sending goods "Collect On Delivery" unless remittances be made on account to guarantee acceptance. Our terms are cash; we do not open any accounts.

NON-WARRANTY

Most of the Failures With Seeds, plants and bulbs are due to causes entirely beyond our control, such as unfavorable weather or soil conditions, too deep or shallow planting, etc., which renders it impossible for us to guarantee success, and, although we take all possible care to supply only such goods as will, under proper conditions, produce satisfactory results, we will give no warranty as to description, quality or productiveness of any of the Seeds, Plants or Bulbs we send out, and will not be in any way responsible for the crop, and every order for articles named in this catalogue will be executed on these conditions only. If they are not accepted on these conditions, they must be returned at once. It must, however, be plain to every one who gives the matter the slightest thought, that it is to our best interest to send out only such stock as will not only grow, but prove true to name and description.

INDEX

	Page		Page		Page
Alfalfa Seed	40	Fly Sprays	85	Peas, Garden	26-27
Asparagus Seed and Roots	3	Fountains for Poultry	86-87	Pumpkin	29
Artichokes	3	Field Beans	45	Plant Protectors	66
Barley	47	Garlic	17	Plants, Vegetable	37
Baby Chick Feed	93	Grass Seed	42-43	Planet, Jr., Tools	70
Buckwheat	47	Gold Fish and Supplies	77	Potatoes, Irish and Sweet	25
Beans, Bush and Pole	4-7	Grit for Poultry	80	Poultry Supplies	78-95
Beets	8-9	Herb Seed	17	Poultry Food	78
Bee Hives and Supplies	72-73-74-75	Horse Radish	17	Poultry Netting	91
Broom Corn	47	Hog Oilers	71	Rat Poison	77
Bird Cages and Supplies	76	Hotbed Sash	71	Radish	30-31
Books	96	Incubators	94-95	Rhubarb, Seed and Roots	32
Brooders	94-95	Insecticides	62-63	Rice	47
Bulbs, Flowering	55	Kaffir Corn	46	Rutabaga	36
Broccoli	9	Kale	18	Rape, Essex	47
Brussels Sprouts	9	Kohl Rabi	18	Red Comb Feeds	78
Chick Greasers	93	Lawn Grass Seed	42	Seed Sowers	71
Calf Meal	78-79	Leek	18	Spinach	32
Cauliflower	12	Leg Bands for Poultry	93	Salsify	32
Canada Field Peas	45	Lettuce	19-20	Squash	33
Celery	12	Lespedeza Seed	41	Sorghum Seed	46
Chervil	16	Millet Seed	46	Soy Beans	44
Chicory	16	Mangel Wurzel	9	Speltz	47
Cress	16	Mustard	20	Spray Pumps	64-65
Chufas	45	Musk Melon	21	Stock Peas	45
Charcoal for Poultry	80	Mills, Grinding	92	Strawberry Boxes	68
Cabbage	10-11	Milo Maize	46	Sudan Grass	43
Clover Seed	40-41	Mushroom Spawn	18	Sunflower Seed	47
Carrots	12	Mulford Culture	60	Sweet Peas	49
Collards	15	Nasturtium Seed	52	Sweet Potato Plants	37
Corn, Garden and Field	14-15-38-39	Nursery Department	56 to 59	Swiss Chard	33
Corn Salad	16	Nests and Nest Eggs	91	Swell	32
Cow Peas	45	Oats, Seed	47	Sugar Beets	9
Cucumber	13	Okra	24	Teosinte	47
Cotton Seed	48	Oat Sprouters	92	Tobacco	35
Cantaloupe	21	Onion Seed and Sets	24	Tomatoes	34-35
Dandelion	16	Oyster Shell for Poultry	80	Thermometers	93
Dog Food and Supplies	77	O. K. Poultry Litter	84	Turnips	36
Egg Plant	17	Pasture Grass Mixture	42	Tree Protectors	66
Egg Shipping Boxes	90	Peppers	28	Tools, Garden	68-69-70
Endive	17	Peanuts	45	Vegetable Plants	37
Fertilizers	61	Parsley	28	Velvet Beans	44
Flower Seeds	50-54	Parsnip	29	Vetch	47
Flower Pots	67			Wire Plant Stands	65
Peterita	46			Wheat	47
Flax Seed	47			Watermelons	22-23

WE PAY THE POSTAGE

In considering our prices in this Catalogue, please bear in mind that we pay the postage on all vegetable and flower seeds by the packet — ounce, quarter pound, pound, pint and quarts.

WE HAVE THE MOST COMPLETE STOCK OF POULTRY AND BEE SUPPLIES IN THE SOUTH

QUANTITY		NAMES OF ARTICLES WANTED	PRICE
			<i>Amount Brought Forward</i>
		<i>Total</i>	

← PLEASE DO NOT WRITE IN THIS SPACE →

Filled by _____ Shipped by _____ No. _____
 Checked by _____ Date _____ Pkgs. _____

Otto Schwill & Co

1869-1919

FIFTIETH ANNIVERSARY

To Friends and Customers:

IT is with great pleasure that we present to you, our friends and customers, our Fiftieth Annual Catalogue, which, in a large measure, is due to your hearty support and co-operation, and we have endeavored to make it better than any heretofore issued, as well as more useful and instructive.

With the continued high cost of living it will pay every one who has a garden to make it produce more, and for those who have never had a garden, to start one, as there is nothing more healthful, or profitable than a home garden, even though small.

During the past season, owing to greatly increased garden movement, and shortage of help, there were times when we were unable to maintain our reputation for promptness, even by using a day and night force. However, we hope to overcome all our difficulties this season by enlarging our Mail Order Department in advance of the demand.

There will be some seed shortages again this season, due to unfavorable weather conditions, especially Cabbage and English Peas, however, we will always try and fill all orders entrusted to us with best of seeds, and when unable to do so, will promptly advise, as Schwill's Seeds are Sure Seeds.

Our Fifty Years of Success has been built, not only on the Quality of our seeds themselves, but also on our treatment of Customers, and it is our earnest desire at all times to please.

Thanking our many friends for their Hearty Support during our Fifty Years of Business, and asking a continuation of their support for the years to come, we remain,

Faithfully yours,

OTTO SCHWILL & CO.

Memphis, Tennessee, January 1, 1919.

WHEN AND WHAT TO SOW FARM AND GARDEN CALENDAR

Monthly Operation for the Farm and Garden for the Different Months of the Year

THE TIME FOR PLANTING SEEDS, Etc., AS GIVEN IN THE DIFFERENT MONTHS BELOW MUST, OF COURSE, BE GOVERNED BY THE WEATHER AND CONDITIONS OF THE GROUND.

January **IN THE GARDEN**—Get the hotbeds ready and sow Cabbage, Tomatoes, Lettuce, Cauliflower, Beets, Onions, and Kohl Rabi. Sow out doors Spring Turnips, Mustard, Spinach and Extra Early Peas, if weather is moderate and ground pulverizes when plowed or spaded.

February **IN THE GARDEN**—Plant Extra Early and Marrowfat Peas. Plant Potatoes for a general crop. Sow Radishes, Turnips, Mustard, Spinach and Onion Seed in open ground. Sow in hotbeds Beets, Pepper, Egg Plant and Tomato Seeds. Plant Onion Sets. Plant your Sweet Peas in the Flower Garden now.

IN THE FIELD—Lawns should be looked after. Give a top dressing of Bone Meal. Sow Emerald Lawn Grass, Red Rust Proof and Burt Oats, Grass Seeds, Canada Field Peas, Lespedeza—can be sown on oat or wheat field.

IN THE ORCHARD—Set out all kinds of Fruit Trees and other Nursery Stock.

March **IN THE GARDEN**—This is an active month in this section. Sow English Peas—the wrinkled varieties can now be planted. Sow out doors Carrots, Parsley, Cabbage, Beets, Lettuce, Salsify, Parsnips, Leek and Onion Seeds. Early Corn can be planted about the 15th. Onion Sets can yet be planted. This is also a good month for planting potatoes. Put out Asparagus, Rhubarb, and Horse Radish Roots. Set Cabbage and Cauliflower Plants. Sow Hardy kinds of Flower Seeds, also Sweet Peas. Plant Roses.

IN THE FIELD—Sow all sorts of Clover Seeds, Grasses, Oats, Alfalfa, Lawn Grass Seeds, Sorghum, Field Corn and Artichokes, also Lespedeza.

IN THE ORCHARD—Continue to set out Fruit Trees, Raspberry, Blackberry, Strawberry Plants, Figs.

April **IN THE GARDEN**—Sow Beets, Carrots, Lettuce, Parsley, Endive, Parsnips, Salsify, Radishes, Leek, Mustard, Turnips, Cress, Swiss Chard, Celery, Tomatoes, Cucumbers, Squash, Sweet Corn—in fact, most everything can now be planted. Plant Bush Snap Beans. Potatoes can be planted. Do not fail to plant our Early Surprise Corn for roasting ears; it will please you. Cabbage, Lettuce, Beets, Cauliflower and Tomato Plants should be set out. Plant Tuberose, Dahlia, Gladiolus and Canna Bulbs; Flower Seeds, Flowering Plants.

IN THE FIELD—Sow Mangel Wurzel and Sugar Beets for Stock, Corn, Sorghum, Kaffir Corn, German Millet, Grass Seeds, Clovers and Artichokes; also sow Lespedeza this month.

IN THE ORCHARD—Strawberry, Raspberry, Blackberry Plants can still be set out.

May **IN THE GARDEN**—Seeds of all kinds can now be planted. Bush Beans, Pole Beans, Lima Beans, Sugar Corn, Beets, Salsify, Parsnips, Squash, Cucumber, Okra, Cantaloupes, Watermelons, Pumpkins, Egg Plant, Peppers, Cress, Carrot, Lettuce, Endive and Kohl Rabi; Herbs of all sorts. Set out Tomato, Egg Plants, Pepper Plants.

IN THE FIELD—Sow German and Hungarian Millet, Stock Peas, Sorghum, Chufas. Plant Cotton, Corn, Peanuts, Pearl or Cat Tail Millet, Sudan and Bermuda Grass. Put some Land Plaster on young Clover.

June **IN THE GARDEN**—Plant Sugar and other Early Corns, Cucumbers, Melons, Squash, Pumpkins. Set out Sweet Potatoes, Egg and Pepper Plants. Sow Radishes, Endive, Col-

lards and Cabbage for late use. Bunch Beans, Pole Beans, Tomato Seed for late use; Okra.

IN THE FIELD—Continue planting Field Corn, Mexican June Corn will do well planted in this month. Soja Beans, Pearl Millet, Sudan and Bermuda Grass, Stock Peas of all sorts, German and Hungarian Millet.

July **IN THE GARDEN**—Plant Cucumbers, Tomatoes and Cabbage Seed for late crop, also Pole and Bush Beans. Corn for roasting ears. Commence sowing Rutabagas and a few Turnips. Plant Okra, Squash, and Summer Radishes.

IN THE FIELD—Cow Peas, Millet, Hungarian; Sorghum and Field and Mexican June Corn can be planted. Sow Buckwheat for Bees. Plant Potatoes the latter part of the month for raising the second crop.

August **IN THE GARDEN**—Now is the time to start a fall garden. Bush Beans, all kinds, will do well. Sow Kale, Lettuce, Early and Winter Radishes, Turnips and Rutabagas, Mustard, Beets, Parsley, Cucumbers, Squash, Collards and late Cabbage. Plant Potatoes for a second crop; the old crop or cold storage seed are best.

IN THE FIELD—German Millet can be sown as late as the 15th of the month. Sow some Crimson and Burr Clover, Dwarf Essex Rape and Seed Rye for winter pasture.

September **IN THE GARDEN**—Sow Radishes, Corn Salad, Lettuce, Mustard, Kale, Spinach, Endive, Turnips of all sorts; Onion Seed for transplanting. Set out Shallots and Onion Sets; also Late Cabbage Plants.

IN THE FIELD—This should be an active month on the farm. Sow Crimson Clover as early as you can this month; all kinds of Grass Seeds, Red Clover, Alfalfa and Burr Clover now. Sow Vetch, Rye, Barley, Appler and Winter Turf Oats, Dwarf Essex Rape.

October **IN THE GARDEN**—Sow Kale, Spinach, Corn Salad and Winter Radishes. Sow outside Cabbage for transplanting into cold frames next month. Lettuce in beds for Winter use. Set out Shallots and Onion Sets.

IN THE FIELD—Continue to sow Rye, Barley, Winter Turf Oats, Wheat. Sow some Winter Hairy Vetches with Oats; all kinds Grass Seeds for Lawn and Field. Timothy, Alfalfa, Burr and Red Clover, Dwarf Essex Rape, Crimson Clover and Vetch.

November **IN THE GARDEN**—Shallots and Onions can be planted, and cover the rows with some fresh manure. Sow out doors Spinach, Corn Salad. In the hotbed Beets, Cabbage, Cauliflower. Put out doors all kinds of Dutch Bulbs.

IN THE FIELD—The season is now drawing to a close. Sow as early in the month as possible Rye, Barley, Turf Oats, Wheat Grass Seeds, Timothy and Clovers.

IN THE ORCHARD—This will be an active month as November is the best month for planting all sorts of Nursery Stock. Asparagus Roots, Apple, Pear, Peach, Cherry, Plum, Quince, Strawberry Plants, and all kinds of Shade Trees are now ready to set out.

December **IN THE GARDEN**—Very little can be done this month. Sow Cauliflower and Cabbage and Beets for spring use. Sow in frames some early forcing Radish, also Lettuce. Dutch Bulbs can be put out.

IN THE ORCHARD—Set out Fruit, Shade and Ornamental Trees of all kinds, and Strawberry Plants.

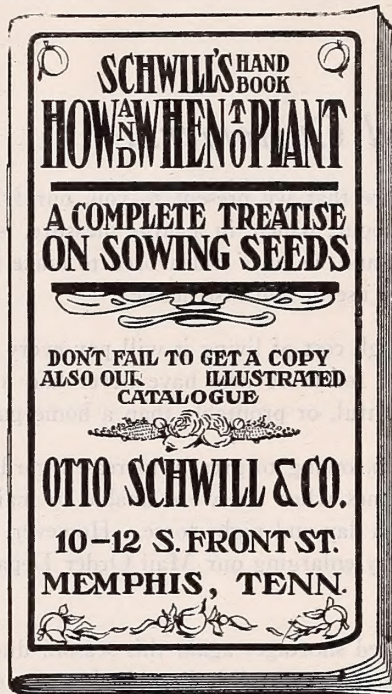

This Book Free to All Patrons—Ask For It.



For Fifty Years Schwill's Seeds have been a standard among the Best Gardeners of the South for their Unexcelled Purity and Excellence.

The Cultural Directions given in this book for growing Vegetables are for the latitude of Memphis. Persons living farther south should start earlier, while those living farther north should begin to plant later.

ASPARAGUS

CULTURE.—One ounce will produce about 200 plants, or plant 40 feet of drill; 5 pounds will plant an acre. Sow early in spring 2 inches deep in rows of 18 inches apart. When one or two years old transplant into permanent bed, in furrows 4 to 5 feet apart and 2 feet between the plants. Deep loamy soil, thoroughly cultivated and heavily manured, is required for permanent bed. Complete directions for planting both seed and roots free on request.

Columbian Mammoth White A new and entirely distinct kind whose shoots are white and stay white as long as fit for use. Pkt. 5c; 1 oz. 10c; 2 oz. 15c; ¼ lb. 25c; 1 lb. 75c, parcel post paid.

Palmetto A fine variety, producing very large asparagus. Very early and adapted to all climates. Pkt. 5c; 1 oz. 10c; 2 oz. 15c; ¼ lb. 25c; 1 lb. 75c, parcel post paid.

Palmetto Asparagus Roots A saving of 1 to 2 years is effected by planting roots. For private use or for marketing on a small scale, beds should be formed 5 feet wide, with 3 rows planted in each, one in the middle and one on each side a foot from the edge; distance between the plants in the rows, 9 inches. Price, parcel post paid, 2-year Roots, doz. 40c; 50 for \$1.25; 100 for \$1.85. 3-year Roots, doz. 60c; 50 for \$1.50; 100 for \$2.50. Price, by express, purchaser's expense, 2-year Roots, doz. 30c; 50 for \$1.00; 100 for \$1.50. 3-year Roots, doz. 50c; 50 for \$1.25; 100 for \$2.00.

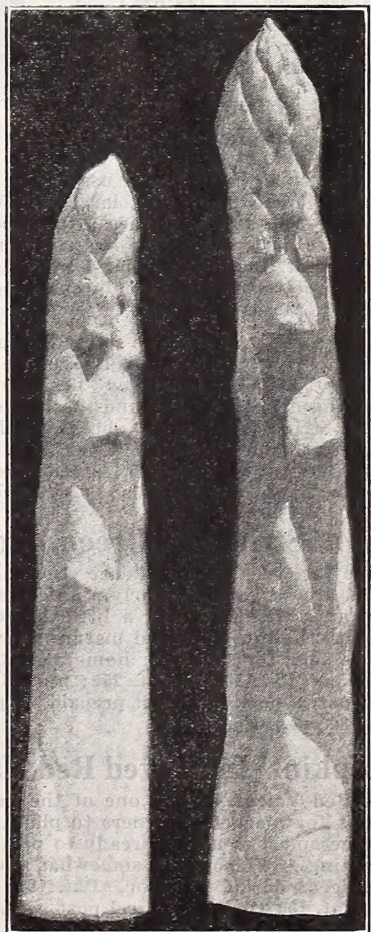

Palmetto Asparagus

ARTICHOKE

CULTURE.—One ounce will produce 500 plants; ¼ lb. to the acre. Seed should be sown in hotbed early in February to get plants that will bear first year. Transplant to open ground in April. They require deep, rich, sandy loam with plenty of well rotted manure.

Large Green Globe Produces heads like flowers, which are cooked like Asparagus. Highly esteemed. Pkt. 10c; oz. 60c, parcel post paid.

Artichoke, Jerusalem Excellent for fattening hogs. Plant in rows 4 feet wide, any time in March and April, dropping the tubers 18 inches apart in the row; immensely productive; 3 bushels will plant an acre. Price, 1 lb. 25c, parcel post paid. For Quantity Price, see Pink Price List, page 97.

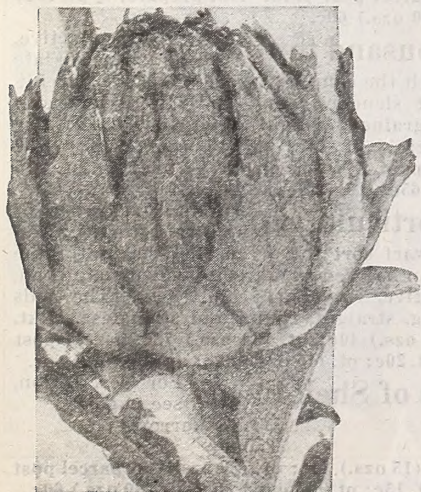

Green Globe Artichoke

BEANS — DWARF OR BUSH GREEN PODDED VARIETIES

CULTURE.—One quart will plant 100 feet of drill. Beans are somewhat tender, but it often pays to take some risks. Plant in warm, loamy soil at the beginning of settled, warm weather in spring, and at intervals for succession until September. Rows may be made 2 feet apart, and the Beans planted a few inches apart in the drills, or 3 or 4 Beans in hills 6 to 8 inches apart. Cultivate and hoe frequently, always, however, when the vines are perfectly dry. In hoeing draw the soil up towards the rows or plants. For String Beans, gather the pods clean as soon as fit for use. The plants will remain all the longer in bearing.

Black Valentine This Bean has beautiful large pods about 6 inches long, slender, round and nearly straight; stringy, fibrous though fine grained, dark green in color. Seed black. An early, productive, profitable gardener's variety. The plant is more vigorous and productive than the Red Valentine and pods darker green. Pkt. 10c; ½ pt. 20c; 1 pt. (15 ozs.) 35c; qt. (30 ozs.) 70c, parcel post paid. Not prepaid, ½ pt. 15c; 1 pt. (15 ozs.) 30c; qt. (30 ozs.) 60c.

Stringless Green Pod (Burpee's) This is one of the most popular and best of the stringless varieties. It is earlier than the Valentine, absolutely stringless, hardy, vigorous and productive. Pods are long and straight, round, meaty, of pale green color, and remain tender and crisp a long time after maturity, and are of excellent flavor. Pkt. 10c; ½ pt. 25c; 1 pt. (15 ozs.) 40c; qt. (30 ozs.) 75c, parcel post paid. Not prepaid, ½ pt. 20c; 1 pt. (15 ozs.) 35c; qt. (30 ozs.) 65c.

Early Mohawk This hardy variety can be planted earlier than others and in this way will often furnish beans fit for use before any other green podded variety. The plants are large and with coarse dark green leaves. The snap pods are 5 to 6 inches long, very straight and flat, dark green and stringy, very attractive in appearance. Pkt. 10c; ½ pt. 20c; 1 pt. (15 ozs.) 35c; qt. (30 ozs.) 70c, parcel post paid. Not prepaid, ½ pt. 15c; 1 pt. (15 ozs.) 30c; qt. (30 ozs.) 60c.

Full Measure A fine stringless early variety of high quality. The pods are of medium green color, straight, 6 inches long, very fleshy, round, creasebacked and showing depressions around the beans. It is as early as Burpee's Stringless, though not as productive. The seed bean much resembles Red Valentine. Pkt. 10c; ½ pt. 25c; 1 pt. (15 ozs.) 40c; qt. (30 ozs.) 75c, parcel post paid. Not prepaid, ½ pt. 20c; 1 pt. (15 ozs.) 35c; qt. (30 ozs.) 65c.

Giant Stringless Green Pod This is an exceedingly productive and handsome variety. The plants are very hardy and productive. The pods are large and nearly round, somewhat similar to the Burpee's Stringless, but a little longer and straighter and a slightly lighter color and mature a few days later. The quality is good for snaps for home use as well as suitable for the market. Pkt. 10c; ½ pt. 25c; pt. (15 ozs.) 40c; qt. (30 ozs.) 75c, parcel post paid. Not prepaid, ½ pt. 20c; pt. (15 ozs.) 35c; qt. (30 ozs.) 65c.

Hopkins' Improved Red Valentine An improved strain of the Red Valentine, and one of the best of the green podded snaps for market gardeners to plant. It is earlier than Valentine and it is usually ready to pick in forty-five days from planting. The pods are somewhat longer and more round and the seeds darker in color. Pkt. 10c; ½ pt. 25c; pt. (15 ozs.) 40c; qt. (30 ozs.) 75c, parcel post paid. Not prepaid, ½ pt. 20c; pt. (15 ozs.) 35c; qt. (30 ozs.) 65c.



Bush Bean, Giant Stringless Green Pod.

Improved Extra Early Red Valentine A standard variety, extra early, and for snaps there is nothing superior to this variety among the green podded sorts, both for home use or the market. The pods are round, long, slightly curved and of excellent quality. The seed we supply is produced from stock seed that was selected for both earliness and quality. Pkt. 10c; ½ pt. 25c; pt. (15 ozs.) 40c; qt. (30 ozs.) 75c, parcel post paid. Not prepaid, ½ pt. 20c; pt. (15 ozs.) 35c; qt. (30 ozs.) 65c.

Refugee Extra Early A very hardy, extremely early and productive green podded sort. The pods are 4 to 5 inches long, uniform, round and slightly creasebacked, slightly stringy, brittle and fine grained, of light green color. It is of good quality and an excellent variety for early markets and ships well. Pkt. 10c; ½ pt. 25c; pt. (15 ozs.) 40c; qt. (30 ozs.) 75c, parcel post paid. Not prepaid, ½ pt. 20c; pt. (15 ozs.) 35c; qt. (30 ozs.) 65c.

Round Yellow Six Weeks This is a round podded, round seeded type of the Six Weeks. It is early and moderately productive. The pods are 4 to 5 inches long, oval-round, light green in color, almost stringless, fleshy and of good quality. Pkt. 10c; ½ pt. 20c; pt. (15 ozs.) 35c; qt. (30 ozs.) 70c, parcel post paid. Not prepaid, ½ pt. 15c; pt. (15 ozs.) 30c; qt. (30 ozs.) 60c.

Tennessee Green Pod This early midseason variety is very popular in some sections of the South and elsewhere after a trial. The plant is vigorous, hardy, midseason and very productive. The pods are extremely large and often 6 to 7 inches long, flat, irregular in shape, dark green in color and of exceptionally fine flavor, and very near stringless. Pkt. 10c; ½ pt. 20c; pt. (15 ozs.) 35c; qt. (30 ozs.) 70c, parcel post paid. Not prepaid, ½ pt. 15c; pt. (15 ozs.) 30c; qt. (30 ozs.) 60c.

Refugee, or Thousand to One A very productive, hardy, vigorous late sort, much in favor with the canning trade. Pods are 5 to 5½ inches long, somewhat slender, round and slightly curved; almost stringless, fine grained, of light green color and of very good quality. Pkt. 10c; ½ pt. 25c; pt. (15 ozs.) 40c; qt. (30 ozs.) 75c, parcel post paid. Not prepaid, ½ pt. 20c; pt. (15 ozs.) 35c; qt. (30 ozs.) 65c.

Ruby Dwarf Horticultural An improved type of the Dwarf Horticultural and the best of the dwarf sort for green shell beans for the home or market and can be used as a green-podded snap bean. The plants are productive, very hardy and early. The pods are about 5 inches long, straight, round and stringless. Pkt. 10c; ½ pt. 25c; pt. (15 ozs.) 40c; qt. (30 ozs.) 75c, parcel post paid. Not prepaid, ½ pt. 20c; pt. (15 ozs.) 35c; qt. (30 ozs.) 60c.

Dwarf Varieties of Shell Beans For description, see page 45.

White Kidney	White Marrow
White Navy	Tepary

Pkt. 10c; ½ pt. 20c; pt. (15 ozs.) 35c; qt. (30 ozs.) 70c, parcel post paid. Not prepaid, ½ pt. 15c; pt. (15 ozs.) 30c; qt. (30 ozs.) 60c.

FOR PRICES IN LARGER QUANTITIES, SEE PINK PRICE LIST, PAGE 97.



BEANS — DWARF OR BUSH

WAX PODDED VARIETIES

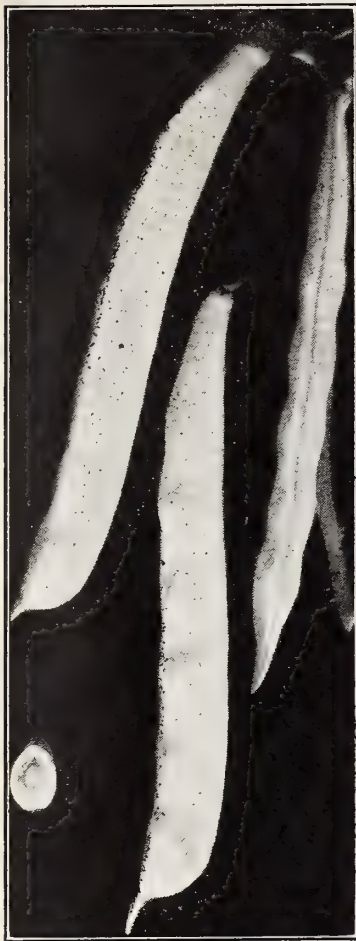

Wardwell's Kidney Wax Bush Bean

Prolific Black Wax This improved strain of Black Wax is exceptionally productive and early. The pods are round, about 5 inches long, fleshy, brittle and stringless, deep yellow in color and attractive, and one of the standard sorts. Pkt. 10c; ½ pt. 20c; pt. (15 ozs.) 35c; qt. (30 ozs.) 70c, parcel post paid. Not prepaid, ½ pt. 15c; pt. (15 ozs.) 30c; qt. (30 ozs.) 60c.

Currie's Rust Proof

Wax One of the most popular of the wax sorts with the market gardeners as it is not only early and productive but absolutely rust proof. The pods are 5 to 6 inches long, flat and straight of bright yellow color. Pkt. 10c; ½ pt. 20c; pt. (15 ozs.) 35c; qt. (30 ozs.) 70c, parcel post paid. Not prepaid, ½ pt. 15c; pt. (15 ozs.) 30c; qt. (30 ozs.) 60c.

Davis White Kidney

Wax This is a well known market sort, being early and productive, and a good shipping variety. The pods are 6 to 7 inches long, large and flat, very uniform and straight, stringy and fibrous, of fair quality. Pkt. 10c; ½ pt. 25c; pt. (15 ozs.) 40c; qt. (30 ozs.) 75c, parcel post paid. Not prepaid, ½ pt. 20c; pt. (15 ozs.) 35c; qt. (30 ozs.) 65c.

Flageolet Violet Wax

A vigorous, hardy, and productive mid-season variety. The pods are very large, sometimes over 7 inches long, slightly curved and flat, a trifle stringy and fibrous. Color greenish yellow. Pkt. 10c; ½ pt. 25c; pt. (15 ozs.) 40c; qt. (30 ozs.) 75c, parcel post paid. Not prepaid, ½ pt. 20c; pt. (15 ozs.) 35c; qt. (30 ozs.) 65c.

Improved Golden Wax

This is probably the most popular of the wax varieties and one of the best. It is early, productive and rust proof. The pods are about 4 inches long, very stout, and more straight than the old Golden Wax. Pkt. 10c; ½ pt. 20c; pt. (15 ozs.) 35c; qt. (30 ozs.) 70c, parcel post paid. Not prepaid, ½ pt. 15c; pt. (15 ozs.) 30c; qt. (30 ozs.) 60c.

This variety resembles the Wardwell's Kidney Wax, but the pod is longer and thicker, though not so broad; fairly productive and of high quality; stringless, fiberless, very fleshy and brittle. Pods 6 inches long and clear yellow color; mid-season. Pkt. 10c; ½ pt. 25c; pt. (15 ozs.) 40c; qt. (30 ozs.) 75c, parcel post paid. Not prepaid, ½ pt. 20c; pt. (15 ozs.) 35c; qt. (30 ozs.) 65c.

Burpee's New Kidney Wax

fleshy and brittle. Pods 6 inches long

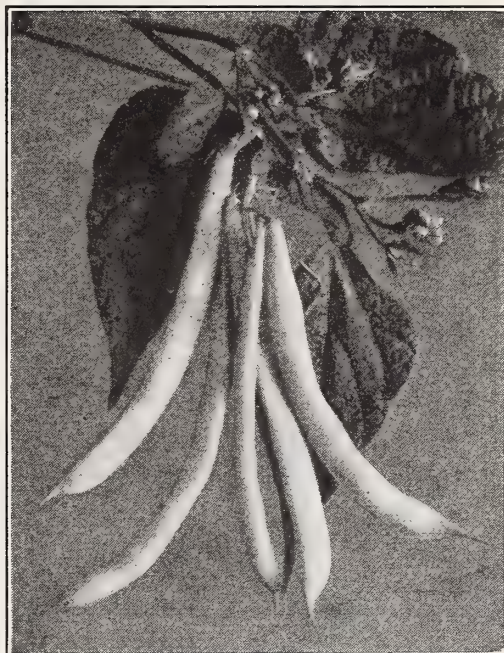

Prolific Black Wax Bush Bean



Improved Golden Wax Bush Bean

Round Pod Kidney Wax

(Brittle Wax). An excellent early, round podded, stringless variety, of high quality. The pods are from 5 to 6 inches long and of light yellow wax-like color. Pkt. 10c; ½ pt. 25c; pt. (15 ozs.) 40c; qt. (30 ozs.) 75c, parcel post paid. Not prepaid, ½ pt. 20c; pt. (15 ozs.) 35c; qt. (30 ozs.) 65c.

Sure Crop Wax

An improvement from the Currie's Wax, having black seed and differing from that sort in that it is stringless, more hardy and rust-resistant. Pods flat, about an inch longer and somewhat thicker than the Currie's. Pkt. 10c; ½ pt. 25c; pt. (15 ozs.) 40c; qt. (30 ozs.) 75c, parcel post paid. Not prepaid, ½ pt. 20c; pt. (15 ozs.) 35c; qt. (30 ozs.) 65c.

Webber Wax

A high quality, flat podded, stringless variety of the season of Wardwell's Wax. Pods 6 to 6½ inches, broad, and uniformly curved, fleshy, stringless, and brittle. More vigorous and productive than Wardwell's. Pods bright yellow color. Pkt. 10c; ½ pt. 25c; pt. (15 ozs.) 40c; qt. (30 ozs.) 75c, parcel post paid. Not prepaid, ½ pt. 20c; pt. (15 ozs.) 35c; qt. (30 ozs.) 65c.

Wardwell's Kidney Wax

A very popular, early gardeners' variety. Pods large, 5 to 6 inches long, moderately stout, straight and flat, fleshy, brittle, fine-grained and nearly stringless, and of good quality. Pkt. 10c; ½ pt. 25c; pt. (15 ozs.) 40c; qt. (30 ozs.) 75c, parcel post paid. Not prepaid, ½ pt. 20c; pt. (15 ozs.) 35c; qt. (30 ozs.) 65c.

BEANS — POLE OR RUNNING

GREEN AND WAX PODDED VARIETIES

CULTURE.—One quart will plant about 150 hills. Pole Beans require warm, rich, loamy soil and, in the South, should not be planted until two weeks later than Bush Beans. Plant in rows 4 feet apart each way, or in drills if wire trellis is used. Plant 4 to 6 beans around each pole, or 2 to 3 beans may be planted in hills a foot apart under a wire trellis. Cultivate freely and, if possible, top dress around each hill with a small quantity of commercial fertilizer. When hoeing, work this dressing well into the soil.



Kentucky Wonder Pole Bean

Kentucky Wonder Sometimes called Old Homestead. This is no doubt the most popular and practically useful of the green podded pole beans for use as snaps. It is early, very prolific, with showy pods of the most excellent quality. The vines are vigorous, climbing well and very productive, bearing pods in large clusters. The pods are very long, often measuring 9 to 10 inches, and are light green in color, curved and twisted nearly round, and very crisp when young, becoming irregular and spongy as they ripen. Pkt. 10c; ½ pt. 25c; pt. (15 ozs.) 40c; qt. (30 ozs.) 80c, parcel post paid. Not prepaid, ½ pt. 20c; pt. (15 ozs.) 35c; qt. (20 ozs.) 70c.

White Creaseback This variety is valuable for its extreme earliness and its habit of perfecting all its pods within a short time. The vines are medium-sized, hardy and moderately productive. The pods measure 5 to 6 inches long, uniform, round and slender, slightly stringy, very fleshy, brittle and fine grained, good quality and dark green color. Pkt. 10c; ½ pt. 25c; pt. (15 ozs.) 40c; qt. (30 ozs.) 80c, parcel post paid. Not prepaid, ½ pt. 20c; pt. (15 ozs.) 35c; qt. (30 ozs.) 70c.

Red Speckled Cut Short Sometimes called Corn Hill owing to its being largely planted in the South among the corn. It will give a good crop when planted among the corn, as the vines are medium size but very hardy and productive but somewhat late. The pods are nearly 4 inches long, stout, straight and flat, stringy, fine grained and light green color, of fair quality. Pkt. 10c; ½ pt. 25c; pt. (15 ozs.) 40c; qt. (30 ozs.) 80c, parcel post paid. Not prepaid, ½ pt. 20c; pt. (15 ozs.) 35c; qt. (30 ozs.) 70c.



Scotia or Cornfield Pole Bean

Scotia or Cornfield A very hardy and productive cornfield bean. The vines are of good climbing habit with small deep green leaves. The pods are often over 6 inches long, round, straight and creasebacked; slightly stringy, very fleshy, fine-grained and of good quality. Pkt. 10c; ½ pt. 25c; pt. (15 ozs.) 40c; qt. (30 ozs.) 80c, parcel post paid. Not prepaid, ½ pt. 20c; pt. (15 ozs.) 35c; qt. (30 ozs.) 70c.

Southern Prolific An old standard sort and a vigorous, hardy, late and productive variety. Pods 5 to 6 inches long, flat, slender and slightly curved; stringy, fine-grained, fair quality; grayish-green color. Pkt. 10c; ½ pt. 25c; pt. (15 ozs.) 40c; qt. (30 ozs.) 80c, parcel post paid. Not prepaid, ½ pt. 20c; pt. (15 ozs.) 35c; qt. (30 ozs.) 70c.

Lazy Wife One of the best of the late green podded sorts for snaps or green shell use. The pods are born in large clusters, are nearly 6 inches long,



Golden Cluster Wax Pole Bean

broad, straight and flat, stringless, very fleshy, brittle, fine-grained and of excellent quality. The dry beans are excellent for winter use. Pkt. 10c; ½ pt. 25c; pt. (15 ozs.) 40c; qt. (30 ozs.) 80c, parcel post paid. Not prepaid, ½ pt. 20c; pt. (15 ozs.) 35c; qt. (30 ozs.) 70c.

Tennessee Wonder Somewhat similar to Kentucky Wonder, but with immensely larger, straighter, smoother and more creasebacked green pods. More suitable as a shell rather than a snap bean. Pkt. 10c; ½ pt. 25c; pt. (15 ozs.) 40c; qt. (30 ozs.) 80c, parcel post paid. Not prepaid, ½ pt. 20c; pt. (15 ozs.) 35c; qt. (30 ozs.) 70c.

Horticultural Pole An old, well known standard sort. Mid-season in maturity, hardy and productive. Pods 5 to 6 inches long, straight, flat, stringless and of fine quality; color dark green, splashed with bright red. Pkt. 10c; ½ pt. 25c; pt. (15 ozs.) 40c; qt. (30 ozs.) 80c, parcel post paid. Not prepaid, ½ pt. 20c; pt. (15 ozs.) 35c; qt. (30 ozs.) 70c.

Golden Cluster Wax An excellent early wax podded pole bean. The vines are large, vigorous and hardy, with large, light-green leaves. The pods are 6 to 8 inches long, extremely straight and flat; very fleshy fine-grained, good quality; color light waxy-yellow. Pkt. 10c; ½ pt. 25c; pt. (15 ozs.) 40c; qt. (30 ozs.) 80c, parcel post paid. Not prepaid, ½ pt. 20c; pt. (15 ozs.) 35c; qt. (30 ozs.) 70c.

Kentucky Wonder Wax This is one of the earliest of the wax podded sorts, and similar to the green podded Kentucky Wonder, but the pods are broader. The pods are very long, handsome light yellow, often over 8 inches long, very fleshy, brittle but stringy. Pkt. 15c; ½ pt. 25c; pt. (15 ozs.) 45c; qt. (30 ozs.) 85c, parcel post paid. Not prepaid, ½ pt. 20c; pt. (15 ozs.) 40c; qt. (30 ozs.) 75c.

FOR PRICES ON LARGER QUANTITIES, SEE PINK PRICE LIST, PAGE 97.



LIMA BEANS — POLE VARIETIES

CULTURE.—One quart will plant about 150 hills. Pole Limas require warm, rich, loamy soil. Plant when the soil has become well warmed through in the spring as the seed will rot in cold, soggy soil. When poles are used for support they should be set not less than 4 feet apart each way. Plant 4 to 6 beans around each pole 2 inches deep and thin out to three plants to the pole. Cultivate frequently but shallow and use a top dressing of good commercial fertilizer or poultry manure, working same well into the soil.

Carolina Sieva or Small Lima This is the true Butter Bean. The seed beans are very small and white, on the order of Henderson's Bush Lima. The plants are of large growth, very early, vigorous and productive, and will stand more heat and drouth than any other of the Limas, and is one of the best for planting in the South. Pkt. 10c; ½ pt. 25c; pt. (15 ozs.) 45c; qt. (30 ozs.) 85c, parcel post paid. Not prepaid, ½ pt. 20c; pt. (15 ozs.) 40c; qt. (30 ozs.) 75c.

King of the Garden An improved strain of the Large White Lima. The pods are about an inch longer, proportionately wider, and uniformly 4-seeded. The vines are hardy and bear abundantly. This is a standard sort and one of the best for main crop. The seed are very large, ovoid, flat, white, with slight greenish tinge. Pkt. 10c; ½ pt. 25c; pt. (15 ozs.) 45c; qt. (30 ozs.) 85c, parcel post paid. Not prepaid, ½ pt. 20c; pt. (15 ozs.) 40c; qt. (30 ozs.) 75c.

Large White Lima This well known variety is one of the best of the larger varieties for planting in the South. The vines are tall and vigorous but slender, with medium-sized, smooth, medium green leaves. The pods are borne in clusters and are over 5 inches long, broad, very thin. Pkt. 10c; ½ pt. 25c; pt. (15 ozs.) 45c; qt. (30 ozs.) 85c, parcel post paid. Not prepaid, ½ pt. 20c; pt. (15 ozs.) 40c; qt. (30 ozs.) 75c.

Schwill's Monstrous Lima The pods of this variety are very large, often measuring 8 inches long and containing seven beans of the most excellent quality, and bearing about the same time as the Large Lima, and the vines are vigorous and strong-growing and are exceptionally productive. The seed are very large. Pkt. 10c; ½ pt. 25c; pt. (15 ozs.) 45c; qt. (30 ozs.) 85c, parcel post paid. Not prepaid, ½ pt. 20c; pt. (15 ozs.) 40c; qt. (30 ozs.) 75c.

Calico or Irish The most wonderful producer in the world. The beans are all colors, blotched, blue and red mottled; medium in size and superb in quality. This is an old garden variety that was lost track of for some time, but we have been fortunate in having a nice stock grown the past season. Don't miss Calico Beans when making up your order. Pkt. 10c; ½ pt. 25c; pt. (15 ozs.) 45c; qt. (30 ozs.) 85c, parcel post paid. Not prepaid, ½ pt. 20c; qt. (15 ozs.) 40c; qt. (30 ozs.) 75c.

Schwill's Ideal Butter Bean This is an improved strain of the small type regular Butter Bean. Both pods and beans are larger than the Sieva, in fact they are very near as large as Large White Lima, and are wonderfully productive; vines always loaded with delicious, tender beans, and cook soft as butter. Pkt. 10c; ½ pt. 25c; pt. (15 ozs.) 45c; qt. (30 ozs.) 85c, parcel post paid. Not prepaid, ½ pt. 20c; pt. (15 ozs.) 40c; qt. (30 ozs.) 75c.

DWARF OR BUSH VARIETIES

CULTURE.—One quart will plant 100 feet of row, or 3 pecks to the acre. Bush Limas require the same cultivation as stated above

Pole Limas, except that the rows should be 2 feet apart and 6 inches of space between each plant in the row.

Henderson's Bush One of the most valuable of the bush varieties owing to its extreme earliness, hardness and productiveness. The plants are without runners but continue to grow and set until stopped by frost. The leaves are small and very dark green. The pods are small, about 3 inches long, containing 3 to 4 beans, which are of excellent quality either green shelled or dry. This variety is much in favor with the canners and none better for the home garden. Pkt. 10c; ½ pt. 25c; pt. (15 ozs.) 45c; qt. (30 ozs.) 85c, parcel post paid. Not prepaid, ½ pt. 20c; pt. (10 ozs.) 40c; qt. (30 ozs.) 75c.

Burpee's Improved Bush This is one of the earliest of the large seeded Limas. The plants are vigorous and productive. The pods are medium green, very large, about 5 inches long, containing 4 unusually thick and very large beans of excellent quality. Seed very large, thick and usually show a greenish tinge which is generally considered an indication of quality. Pkt. 10c; ½ pt. 25c; pt. (15 ozs.) 45c; qt. (30 ozs.) 85c, parcel post paid. Not prepaid, ½ pt. 20c; pt. (15 ozs.) 40c; qt. (30 ozs.) 75c.

Fordhook Bush This is the only variety with a stiffy, erect bush form habit, branching freely, but branches of upright growth. The pods are produced in large clusters, medium green about 5 inches long and each containing 4 to 5 large beans of the finest quality. Seed large, irregular oval, very thick, white with greenish tinge. Pkt. 15c; ½ pt. 25c; pt. (15 ozs.) 45c; qt. (30 ozs.) 85c, parcel post paid. Not prepaid, ½ pt. 20c; pt. (15 ozs.) 40c; qt. (30 ozs.) 75c.

Wood's Prolific This variety is very similar to Henderson's Bush, being quite similar in character and habit of growth, though the beans are somewhat larger and thicker. Pods are ready for use a week earlier than Burpee's Bush Lima. Pkt. 15c; ½ pt. 25c; pt. (15 ozs.) 45c; qt. (30 ozs.) 85c, parcel post paid. Not prepaid, ½ pt. 20c; pt. (15 ozs.) 40c; qt. (30 ozs.) 75c.

FOR PRICES ON LARGER QUANTITIES, SEE PINK PRICE LIST, PAGE 97.

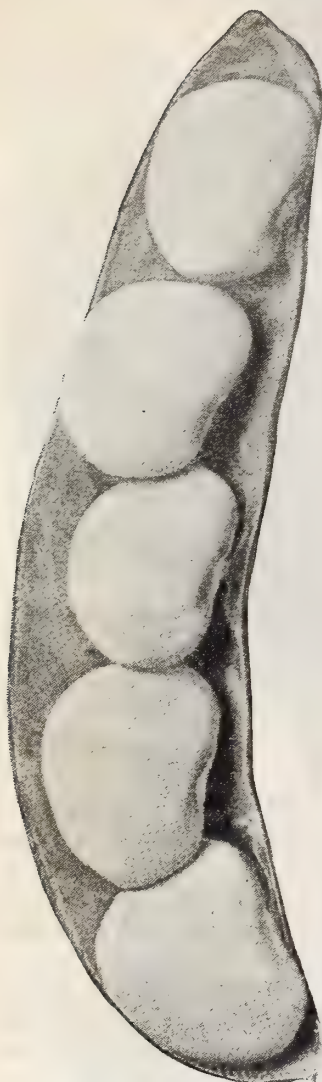

King of the Garden Pole Lima

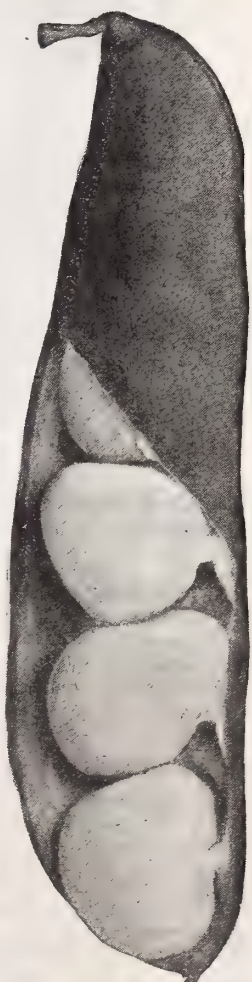

Fordhook Bush Lima
(Pod Natural Size)

SCHWILL'S TABLE BEETS

CULTURE.—One ounce will sow 50 feet of drill; 5 to 6 pounds to an acre. Fibrous loam, well drained and well enriched, will raise good beet crops. For early table beets, have drills 16 to 20 inches apart, and sow the seed about 1 inch deep, as early as the ground can be put in good shape. Or, seed may be sown under glass four weeks sooner and the young seedlings transplanted to open ground to give an extra early crop. Give thorough and clean cultivation, and thin the plants to 3 to 4 inches apart in the rows.

Extra Early Egyptian One of the very earliest with small tops and best for forcing or early outdoor planting. Roots distinctly flat and moderately thick, very dark red; flesh dark purplish red, zoned a lighter shade. Pkt. 5c; 1 oz. 15c; 2 oz. 25c; ¼ lb. 45c; 1 lb. \$1.50, parcel post paid.

Crosby's Egyptian This is the earliest in the market. It does not closely resemble the original Egyptian except in its extreme earliness. Roots a flattened globe shape; skin very dark red, flesh a trifle lighter in color and lightly zoned; tops small. Pkt. 5c; 1 oz. 15c; 2 oz. 25c; ¼ lb. 50c; 1 lb. \$1.75, parcel post paid.

Detroit Dark Red One of the very best for home or market garden and for canning purposes. Roots uniformly smooth, of medium size, and globe-shaped; skin dark red, flesh solid vermillion red. Tops are small, upright, dark green, shaded red. It is unsurpassed in quality. Pkt. 5c; 1 oz. 15c; 2 oz. 25c; ¼ lb. 50c; 1 lb. \$1.75, parcel post paid.



Detroit Dark Red Beet



Early Eclipse Beet

Early Eclipse An early variety, especially desirable for the home garden and used for bunching. The roots are medium size, round, bright deep red with small tops. The flesh is bright red, zoned with pinkish white, very sweet, crisp and tender. Pkt. 5c; 1 oz. 15c; 2 oz. 25c; ¼ lb. 45c; 1 lb. \$1.50, parcel post paid.

Early Blood Turnip, Improved An extra select stock of the old standard table beet; roots nearly round or slightly flattened, bright red, zoned and of good quality. Not as early as Detroit, with a larger, coarser top. Pkt. 5c; 1 oz. 15c; 2 oz. 25c; ¼ lb. 45c; 1 lb. \$1.50, parcel post paid.

Schwill's Market Gardener Our gardeners' favorite owing to its extreme earliness and uniformity in both shape and color. It is without a doubt the best beet, for the home, gardener, or for canning. The tops are small and upright in growth. The leaves dark green, shaded red. The roots are medium size, globular, very smooth and of dark blood red color, while the flesh is a deep vermillion red zoned with lighter shade. It is unsurpassed in quality. Pkt. 5c; 1 oz. 15c; 2 oz. 25c; ¼ lb. 50c; 1 lb. \$1.75, parcel post paid.

Dirigo A new variety, darker in color than Eclipse and slightly larger; flesh tender and sweet. Pkt. 5c; 1 oz. 20c; 2 oz. 35c; ¼ lb. 60c; 1 lb. \$2.00, parcel post paid.

Early Bassano A second early variety having large leaf tops which may be used for greens. The roots grow to good size and are very sweet while in young state of growth. Flesh is pink, zoned creamy white. Pkt. 5c; 1 oz. 15c; 2 oz. 25c; ¼ lb. 45c; 1 lb. \$1.50, parcel post paid.

Long Smooth Blood A standard long, late variety, roots smooth, rather slender, flesh deep purplish red. It is of good quality and keeps well through the winter. Pkt. 5c; 1 oz. 15c; 2 oz. 25c; ¼ lb. 45c; 1 lb. \$1.50, parcel post paid.

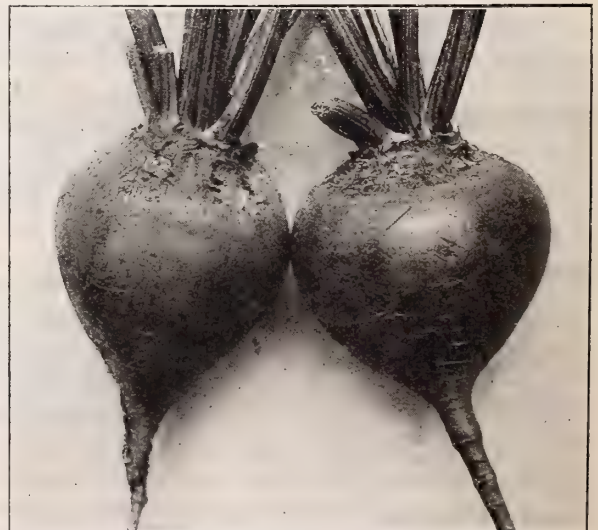

Schwill's Market Gardener Beet

BEE T PLANTS—See Page 37.

SUGAR BEETS

CULTURE.—One ounce will sow 50 feet of drill; 6 pounds for an acre. The Sugar Beets are desirable not only for sugar making but are valuable for stock feeding and when small may be used for the table. The best soil is a rich, friable sandy, or clayey loam. Rich, mucky soil will often give immense yield of roots which, though excellent for feed, are of little value for sugar making. Plant early in spring in drills 2 to 2½ feet apart, and about 1 inch apart in the row, covering with about 1½ inches of fine soil firmly pressed down. Cultivate frequently. When about 3 inches high begin thinning and continue at intervals until the roots stand about 10 inches apart.

The culture of the Mangel Wurzel, also called Mangel, Cattle Beet and Field Beet, is much the same as for Sugar Beets.

Lane's Imperial This beet will yield almost as much in bulk as the best mangels and contains more sugar. The roots are smooth, broad at the top and gradually taper. Flesh snow white and crisp. Pkt. 5c; 1 oz. 15c; 2 oz. 25c; ¼ lb. 45c; 1 lb. \$1.25, parcel post paid.

Klein Wanzleben The roots are larger than Vilmorin's Improved and is harder and easier grown. The tops are rather large and the leaves slightly waved. It is the largest yielding and best for sugar making. Pkt. 5c; 1 oz. 15c; 2 oz. 25c; ¼ lb. 45c; 1 lb. \$1.25, parcel post paid.

Vilmorin's Improved An improvement on the White French Sugar and one of the richest in sugar content. The tops are medium size, with smooth, bright green leaves. The roots are medium size, white with tinge of gray, half long and very uniform in type. The flesh is white and often yields over ten tons to the acre. Pkt. 5c; 1 oz. 15c; 2 oz. 25c; ¼ lb. 45c; 1 lb. \$1.25, parcel post paid.

Giant Feeding Sugar Sometimes called Half Sugar Mangel, and one of the most desirable for stock feeding, affording much larger crops and easier harvested than other sorts. It has high nutri-

tive value, being especially rich in sugar. The upper portion of the roots are soft pink, shading lighter toward the bottom, where the lower portion for more than a third of the length is white. Flesh pure white. Pkt. 5c; 1 oz. 15c; 2 oz. 25c; ¼ lb. 45c; 1 lb. \$1.25, parcel post paid.

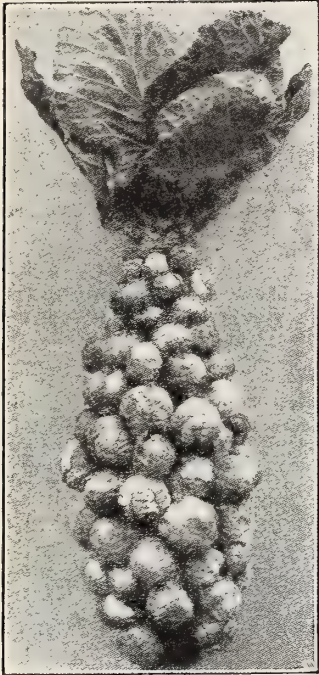

Brussels Sprouts

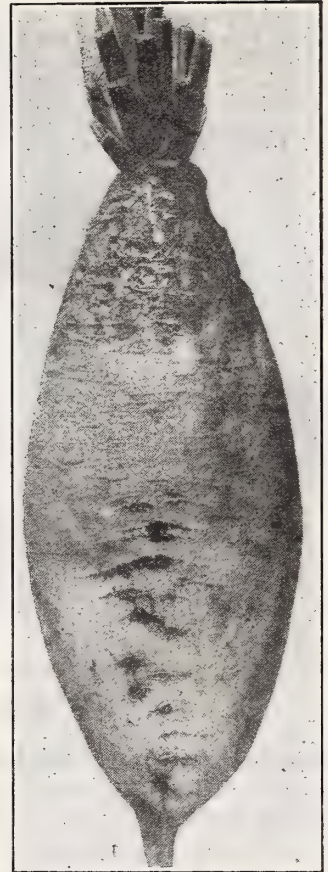

Giant Feeding Sugar Beet

MANGEL WURZEL

Mammoth Long Red The largest stock beet, yields 40 to 50 tons to the acre. Will grow in land containing more alkali than any other beet. All stock except horses eat it readily. The roots are very large, uniformly straight and the flesh is white tinged with rose. Pkt. 5c; 1 oz. 15c; 2 oz. 25c; ¼ lb. 45c; 1 lb. \$1.25, parcel post paid.

Golden Tankard The tops are comparatively small, with the 1-leaf stalk and veins distinctly tinged with yellow. The neck is small. The roots are large, ovoid, but with bottom usually of larger diameter than top, light gray above the ground, deep orange below. The flesh is yellow, zoned with white. Pkt. 5c; 1 oz. 15c; 2 oz. 25c; ¼ lb. 45c; 1 lb. \$1.25, parcel post paid.

BRUSSELS SPROUTS

CULTURE.—One ounce will sow 200 feet of drill, or produce 2,000 plants. Sow seed for plants in frames or open ground. Set plants in early spring, and for succession up to July, making rows 3 feet apart and having the plants stand 1½ to 2 feet apart in the row.

Brussels Sprouts are a very delicate vegetable, and deserve a more general cultivation than they receive. The plant belongs to the cabbage family, and should be grown and cultivated like cabbage. The "sprouts" which grow around the strong, upright stems of the plant look like miniature cabbage. Very hardy; improved by frost.

Dwarf Improved Bearing a large crop of small solid, tender heads. Pkt. 10c; 1 oz. 50c; 2 oz. 75c; ¼ lb. \$1.25.

BRUSSELS SPROUTS, See Page 37.

BROCCOLI

CULTURE.—One ounce seed will produce about 2,000 plants. Give them the culture required for cauliflower, as it is very similar. It is generally taller and the heads are more divided. Broccoli stands greater extremes of temperature than cauliflower and is better adapted for late fall planting. Broccoli can be sown either in the spring or fall same as cabbage.

Early White Cape The best variety; heads white, compact and hardy; a hardy, vigorous and easily grown sort. Pkt. 15c; ½ oz. 75c; 1 oz. \$1.25, parcel post paid.



Mammoth Long Red Mangel Wurzel



AMERICAN GROWN CABBAGE

CULTURE.—One ounce will produce 3,000 plants. For early use the seed should be started in the house or hotbed January or February. When the young plants are well started, transplant so as to stand 3 inches apart each way. About the end of March they may be transplanted into the garden in rows 3 feet apart, setting the plants 18 inches apart each way. For late use, sow the seed about the middle of May, or sowings can be made up to July 10, in a finely prepared seed bed, later transplanting to rows 3 feet apart, setting the plants 2½ feet apart. Protect against ravages of insects as follows: For cut worms, use Slug Shot and Warnecke's Cut Worm Food; for lice, Tobacco Dust; for cabbage beetle and green aphid, use Kerosene Emulsion, well diluted.



Charleston or Large Wakefield Cabbage

EARLY VARIETIES

Charleston Large Wakefield This is a few days later than the Early Jersey Wakefield, but makes a larger and firmer head. We strongly recommend it as the best main crop early cabbage grown, for the home garden and market. Our seed of this is grown from a specially selected stock. Pkt. 15c; 1 oz. 90c; 2 oz. \$1.60; ¼ lb. \$3.00, parcel post paid.

Early Jersey Wakefield A leading variety and one of the best for private or market gardeners' use; conical shape. Pkt. 15c; 1 oz. 90c; 2 oz. \$1.60; ¼ lb. \$3.00, parcel post paid.

Early Spring The earliest flat headed variety. The plants are vigorous, very compact, with few outer leaves and a short stem. The leaves are nearly round, broad, smooth and of distinctive light green color, almost without bloom. The heads are broad, round, slightly flattened. Pkt. 10c; 1 oz. 60c; 2 oz. \$1.15; ¼ lb. \$2.25, parcel post paid.



Succession Cabbage

SECOND EARLY VARIETIES

All Head Early The largest heading of the second early sorts, of excellent quality. The deep flat heads are remarkably solid, and very uniform in size, of a very compact growth, having a few outer leaves; can be planted as close as the Wakefield. Pkt. 10c; 1 oz. 75c; 2 oz. \$1.25; ¼ lb. \$2.25, parcel post paid.

Solid South A magnificent cabbage, resembling the Early Summer, but is earlier, larger, more uniform, has fewer outside leaves. Pkt. 10c; 1 oz. 75c; 2 oz. \$1.25; ¼ lb. \$2.25, parcel post paid.

Early Winningstadt Conical shape; quality very good. This variety is especially adapted for light soils, where it does better than other sorts. Pkt. 10c; 1 oz. 75c; 2 oz. \$1.25; ¼ lb. \$2.25, parcel post paid.



Early Flat Dutch Cabbage

Early Drumhead A second early, large, round, solid-heading variety. This we consider the best for following Charleston Wakefield; it matures about ten days later. Pkt. 10c; 1 oz. 65c; 2 oz. \$1.20; ¼ lb. \$2.25, parcel post paid.

Early Flat Dutch This is a grand second early cabbage, of large size and A No. 1 quality. Larger than Early Summer. Pkt. 10c; 1 oz. 65c; 2 oz. \$1.20; ¼ lb. \$2.25, parcel post paid.

Early Summer A second early cabbage, which matures about ten days after the Jersey Wakefield. It makes a large, solid, flattish head. Pkt. 10c; 1 oz. 65c; 2 oz. \$1.20; ¼ lb. \$2.25, parcel post paid.

All-Seasons An early Drumhead cabbage, yielding heads of the largest size. Pkt. 10c; 1 oz. 65c; 2 oz. \$1.20; ¼ lb. \$2.25, parcel post paid.

Succession A good second early round-headed sort, heads very evenly. Pkt. 10c; 1 oz. 65c; 2 oz. \$1.20; ¼ lb. \$2.25, parcel post paid.



CABBAGE

LATE OR WINTER VARIETIES

Surehead This variety produces large heads, weighing 15 to 20 pounds. The quality is good, and it can be grown either as a second early or late sort. Pkt. 10c; 1 oz. 65c; 2 oz. \$1.20; ¼ lb. \$2.25, parcel post paid.

Improved Large Late Flat Dutch Heads large, bluish green, round, solid and broad on top, more extensively planted than any other variety. Pkt. 10c; 1 oz. 65c; 2 oz. \$1.20; ¼ lb. \$2.25, parcel post paid.

Schwill's Ideal Winter The very best late Cabbage in existence. It never fails to make a crop; runs heavy in weight owing to its size and solidity; resists drouth and insects by its sturdy constitution. Pkt. 10c; 1 oz. 65c; 2 oz. \$1.20; ¼ lb. \$2.25, parcel post paid.

Schwill's Matchless Late Flat Dutch This is the finest strain of Late Flat Dutch Cabbage on the market. The heads are flat, and grow remarkably large, even, very solid and are of fine texture; stems grow short and the quality of the cabbage is very fine. Pkt. 10c; 1 oz. 65c; 2 oz. \$1.20; ¼ lb. \$2.25, parcel post paid.



Surehead Cabbage

RED CABBAGE

Mammoth Rock Red This is the largest variety of Red Cabbage and produces heads which are remarkably solid, more so than any other kind. The heads are round with spreading outer leaves and matures at a late season. It is the best and most attractive Red Cabbage grown. Pkt. 15c; 1 oz. \$1.00.

CHINESE, OR CELERY CABBAGE

Chinese Cabbage, Pi-Tsai Makes a rapid growth and has a very attractive appearance. It is the best of the Chinese vegetables for American conditions. It does best where there are warm days and cool nights. Although the Chinese name is translated Cabbage-in-English, it is not the same habit of growth as the vegetable familiar to us by that name. Pi-Tsai grows like loose lettuce. When cooked it has a splendid flavor, and gives out no offensive odor when cooking. In preparing "Pi-Tsai" for the table, it should not be cooked too long, as its tendency is to become soft. It may be used in soup or boiled whole, or prepared as a slaw or salad. Pkt. 10c; 1 oz. 75c, parcel post paid.



Schwill's Frost Proof Drumhead Cabbage

Improved Large Late Drumhead We recommend this for late market. For heading, evenness of crop and size, our strain of this cannot be surpassed. Pkt. 10c; 1 oz. 65c; 2 oz. \$1.20; ¼ lb. \$2.25, parcel post paid.

Schwill's Frost-Proof Drumhead This splendid sort was introduced by us a few years ago, and has proven the very best large hardy cabbage; stands out in the open field all winter without the slightest protection. It is by far the hardiest of any cabbage grown. Frost-proof, has a short stem and makes a deep blue and wide leaf, making a broad, flat, hard head, all very uniform in size. Pkt. 10c; 1 oz. 75c; 2 oz. \$1.25; ¼ lb. \$2.40, parcel post paid.

SAVOY CABBAGE

Drumhead Savoy This is undoubtedly the finest type of Winter Cabbage. After having been frosted it boils like marrow, and is not surpassed even by the cauliflower in its best condition. Pkt. 10c; 1 oz. 65c; 2 oz. \$1.20; ¼ lb. \$2.25, parcel post paid.

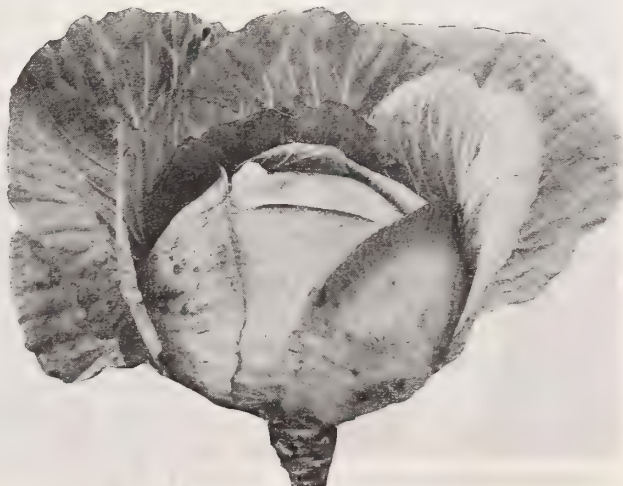

Schwill's Matchless Late Flat Dutch Cabbage.



CARROTS

CULTURE.—The Carrot, like other root crops, delights in a sandy loam, deeply tilled. For early crops, sow in spring, as soon as the ground is in good working order; for late crops they may be sown any time until the middle of July. Sow in rows about 15 inches apart, thinning out to 3 inches between plants.

One ounce of seed will sow 100 feet of drill; 2 to 3 pounds to the acre.

Improved Long Orange An old standard and very popular variety, growing to large size; fine for market; one of the best varieties for stock feeding. Pkt. 5c; 1 oz. 20c; 2 oz. 35c; ¼ lb. 50c; 1 lb. \$1.75, parcel post paid.

Danvers Half Long Flesh dark orange; smooth, handsome roots of medium length; tapering uniformly to a blunt point; very productive and a great favorite with market gardeners. Pkt. 5c; 1 oz. 20c; 2 oz. 35c; ¼ lb. 50c; 1 lb. \$1.75, parcel post paid.

Chantenay Half Long Very early and productive, always smooth, orange red, flesh crisp and tender. Pkt. 5c; 1 oz. 15c; 2 oz. 25c; ¼ lb. 40c; 1 lb. \$1.50, parcel post paid.

Half Long Scarlet Very popular variety, a deep red color, of perfect form. Pkt. 5c; 1 oz. 15c; 2 oz. 25c; ¼ lb. 40c; 1 lb. \$1.50, parcel post paid.

Early Scarlet Horn Not large, but a favorite for early crop. Small tops, stump rooted, orange flesh and fine grain. Pkt. 5c; 1 oz. 15c; 2 oz. 25c; ¼ lb. 40c; 1 lb. \$1.50, parcel post paid.

Ox Heart Stump rooted; 3 or 4 inches in diameter, flesh bright orange, fine grained and sweet; very productive. Where other varieties require digging, Ox Heart can be easily pulled. Pkt. 5c; 1 oz. 15c; 2 oz. 25c; ¼ lb. 40c; 1 lb. \$1.50, parcel post paid.

Yellow Belgian Carrot Large yellow root, with green top, grown exclusively for feeding stock. Pkt. 5c; 1 oz. 15c; 2 oz. 25c; ¼ lb. 40c; 1 lb. \$1.25, parcel post paid.

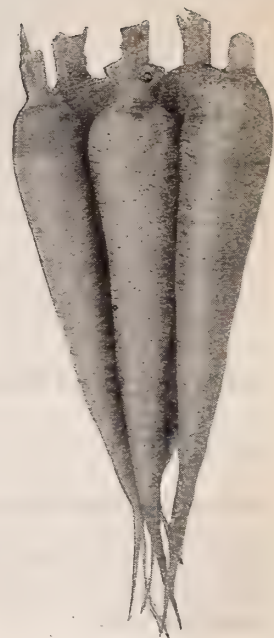

Improved Long Orange Carrot

CELERY

CULTURE.—Sow the seed (which is slow to germinate) in shallow boxes indoors or in a finely prepared seed bed out of doors early in the spring. Do not cover the seed too deep and keep the soil moist, almost wet, until the seed germinate. When the young plants are well started transplant in shallow trenches 3 ft. apart and 6 ins. apart in the trench. To insure crisp, well blanched stalks, bank up only when the soil is dry enough to crumble. One ounce of seed will produce from 5,000 to 10,000 plants.

Golden Self-Blanching A favorite everywhere. It is a robust grower of dwarf habit, very stocky and compact, color a rich golden yellow. Is as self-blanching as White Plume, and simply needs a slight earthing up. Pkt. 5c; 1 oz. 65c; 2 oz. 90c; ¼ lb. \$1.75, parcel post paid.

Columbian White A standard well known variety. Pkt. 5c; 1 oz. 40c; 2 oz. 70c; ¼ lb. \$1.25, parcel post paid.

Giant Pascal Thick, solid stalks, golden hearts; blanches quickly; keeps well, good flavor; one of the most popular varieties. Pkt. 5c; 1 oz. 30c; 2 oz. 50c; ¼ lb. 90c, parcel post paid.

White Plume One of the best for early use; handsome, good quality and blanches easily. Pkt. 5c; 1 oz. 40c; 2 oz. 70c; ¼ lb. \$1.25, parcel post paid.

Perfection Heartwell An excellent large, solid growing variety of creamy white color, one of the very best market sorts and a good keeper. Pkt. 5c; 1 oz. 30c; 2 oz. 50c; ¼ lb. 90c, parcel post paid.

Celeriac Large Smooth An improved sort, with nearly round roots, which have but few side roots. Pkt. 5c; 1 oz. 35c; 2 oz. 60c; ¼ lb. \$1.00, parcel post paid.

CELERY PLANTS—See Page 37.

CAULIFLOWER

CULTURE.—One ounce will produce about 2,000 plants. Sow in hotbed early in January and transplant any time suitable after the first of March, the earlier the better, as cauliflower thrives best in moderate cool weather. For late crop, sow at same time as for late cabbage and treat in the same manner.

Early Snowball (Danish Grown)

A fine variety, great favorite and standard throughout the country; very early, close growing, of compact habit. It is without doubt one of the most satisfactory early varieties. The heads are large. For early or late planting, for family or market garden, this kind can be depended on. Pkt. 25c; ¼ oz. \$1.25; ½ oz. \$2.40; 1 oz. \$4.75, parcel post paid.

CAULIFLOWER PLANTS
See Page 37.



Golden Self Blanching Celery



Early Snowball Cauliflower



SCHWILL'S CUCUMBER SEED

CULTURE.—One ounce will plant 50 hills; 2 pounds will plant one acre. For very early cucumbers plant in paper pots or dirt bands, in hotbeds, about the second week in March. Transplant as soon as the weather permits. In the open, plant about the first of April, as soon as the weather becomes settled, in hills 4 feet each way; thin to 3 of the sturdiest plants when they begin to vine. The soil should be a rich, sandy loam. Continue to plant for succession until the middle of July. Cucumbers should be gathered when large enough for use, whether required or not, as ripening destroys their productiveness.

Extra Early Green Prolific

Fruit short, symmetrical and bright green; very productive, making a good pickle, a little shorter and thicker than most pickling sorts. The young cucumbers are thickly set with small spines, and possess the distinctly roughened surface so much desired for small pickles. The large fruits average 9 to 10 inches in length by 2½ inches in diameter, with full rounded ends, and good quality for slicing. Pkt. 5c; 1 oz. 15c; 2 oz. 25c; ¼ lb. 40c; 1 lb. \$1.25, parcel post paid.

Cumberland Pickle

A straight, medium long variety; skin densely covered with fine, hair-like spines. Color light green, makes a good, very solid cucumber for slicing, but not adapted for pickling. Pkt. 5c; 1 oz. 20c; 2 oz. 35c; ¼ lb. 50c; 1 lb. \$1.50, parcel post paid.

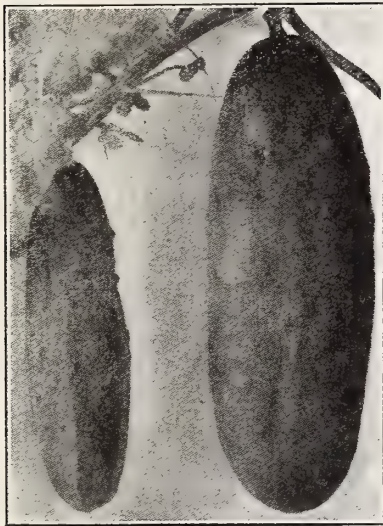

Cumberland Pickle Cucumber

Davis Perfect

An extra long, dark green type of White Spine; retains its color and good qualities long after being picked; fruits exceptionally long, smooth, and tapering at both ends; flesh crisp, solid, with few seeds; mid-season. Pkt. 5c; 1 oz. 15c; 2 oz. 25c; ¼ lb. 40c; 1 lb. \$1.25, parcel post paid.

Early Green Cluster

Very early; fruit short, chunky, small and borne in clusters in the center of the plant; light green in color; prolific. Pkt. 5c; 1 oz. 15c; 2 oz. 25c; ¼ lb. 40c; 1 lb. \$1.25, parcel post paid.

Early Fortune

The finest type of White Spine yet produced. Early, very prolific and disease-resistant. Fruits 8 inches long, slightly tapering; flesh white, very firm and crisp, with very few seeds; color rich dark green, which does not fade when shipped long distances. Pkt. 5c; 1 oz. 15c; 2 oz. 25c; ¼ lb. 40c; 1 lb. \$1.25, parcel post paid.

Early Frame

Vigorous and productive; medium in size and earliness; good for pickling and slicing; fruit light green and is inclined to be three-cornered rather than round. Pkt. 5c; 1 oz. 15c; 2 oz. 25c; ¼ lb. 40c; 1 lb. \$1.25, parcel post paid.

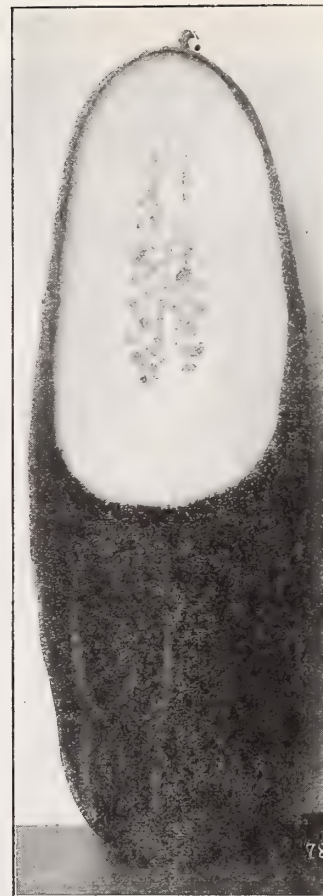

Improved Early White Spine Cucumber

Japanese Climbing

A distinct climbing sort for covering fences or trellises; fruit 10 inches long, thick, crisp and fine quality; color dark green. Pkt. 5c; 1 oz. 20c; 2 oz. 30c; ¼ lb. 50c; 1 lb. \$1.50, par. post paid.

Klondyke

A medium early, very good strain of White Spine; skin very dark green, slightly striped at the ends. Pkt. 5c; 1 oz. 15c; 2 oz. 25c; ¼ lb. 40c; 1 lb. \$1.25, parcel post paid.

Improved Long Green

A standard late, well-known table sort, 12 to 14 inches long, slender, more or less warted, tapering toward stem end; color dark green, flesh white and firm. Pkt. 5c; 1 oz. 20c; 2 oz. 35c; ¼ lb. 50c; 1 lb. \$1.50, parcel post paid.

Henderson Perfected

An extra early, dark green White Spine strain, producing very uniform fruit in great abundance. The vine is vigorous and produces fruit for a long season. Fruit averages 8 to 10 inches long and is of the finest quality. Pkt. 5c; 1 oz. 15c; 2 oz. 25c; ¼ lb. 35c; 1 lb. \$1.25, parcel post paid.

Gherkin or Burr

Grown exclusively for pickles and should be picked while young and tender. Fruit small, oval, covered with spines; color light green. Pkt. 5c; 1 oz. 25c; 2 oz. 40c; ¼ lb. 60c; 1 lb. \$2.00, par. post paid.

Extra Long White Spine

An extra long type of White Spine; fruits 8 to 10 inches long, cylindrical, dark green in color; mid-season. Pkt. 5c; 1 oz. 20c; 2 oz. 35c; ¼ lb. 50c; 1 lb. \$1.50, par. post paid.

Improved Early White Spine

One of the very earliest and best known of the White Spines; a short, square-ended, rather three-cornered type; very productive; fine for slicing or pickles; medium green color with white spines. Pkt. 5c; 1 oz. 15c; 2 oz. 25c; ¼ lb. 40c; 1 lb. \$1.25, parcel post paid.

Extra Early Long Green

This is one of the best general purpose cucumbers in cultivation, the young fruit being very symmetrical in shape; color deep green, and very crisp. Pkt. 5c; 1 oz. 20c; 2 oz. 35c; ¼ lb. 50c; 1 lb. \$1.75, parcel post paid.



Extra Early Long Green Cucumber

CORN — SWEET AND ROASTING EAR

EXTRA EARLY VARIETIES

CULTURE.—One quart will plant 200 hills; 8 quarts will plant one acre. Sweet Corn varies greatly in hardiness, earliness, size and sweetness. The early sorts grow only 3 to 5 feet high and may be planted when the trees are starting out in leaf, about the middle of March, in rows 3 feet apart, making the hills about 1 foot apart. The later and sweeter varieties are more tender and should not be planted until the trees are in full leaf or the seed will rot in the ground. Plant garden corn in rows 3 feet apart, making the hills 18 inches apart in the rows.



Golden Bantam Sweet Corn

Extra Early Adams Not a sugar corn, but owing to its extreme earliness it is used for a first early table corn in the South. The stalks are about 4 feet high, with small tassel, very few leaves, and without suckers. The ears are short, very full, 12 or 14-rowed, often nearly as thick as they are long and are well covered with coarse husks. The kernels are white and smooth. This is an extremely hardy variety which can be grown closer together than most sorts. $\frac{1}{2}$ pt. 15c; pt. (14 ozs.) 25c; qt. (28 ozs.) 45c, parcel post paid. Not prepaid, $\frac{1}{2}$ pt. 10c; pt. (14 ozs.) 20c; qt. (28 ozs.) 35c.

Golden Bantam A very early variety. The ears are of medium size, and are thickly set with delicious yellow kernels. The quality of this variety is superb, and it has become a general favorite early sweet corn with all who have tried it. Golden Bantam and Golden Cream have a flavor distinct from other sorts, and if you have never tried these two sorts from your own garden you must plant them this year. The stalks are dwarf and sturdy in habit, growing to a height of 4 feet and can be planted thickly; they bear 2 to 3 good ears. $\frac{1}{2}$ pt. 20c; pt. (12 ozs.) 35c; qt. (24 ozs.) 60c, parcel post paid. Not prepaid, $\frac{1}{2}$ pt. 15c; pt. (12 ozs.) 30c; qt. (24 ozs.) 50c.

Early Fordhook This is one of the largest-eared of the extra early varieties, the ears averaging 6 to 7 inches in length. The stalks are a little less than medium height, vigorous and prolific, usually averaging 2 ears to the stalk. The ears are 8-rowed, with quite small white cob and deep grains of white. $\frac{1}{2}$ pt. 20c; pt. (12 ozs.) 35c; qt. (24 ozs.) 60c, parcel post paid. Not prepaid, $\frac{1}{2}$ pt. 15c; pt. (12 ozs.) 30c; qt. (24 ozs.) 50c.

MEDIUM EARLY VARIETIES

Golden Cream A very fine corn, being a cross between Golden Bantam and Country Gentleman, following the former sort in maturity. Ears about the size of Golden Bantam, but grain is smaller, deep and zig-zagged, and rich golden yellow, of the most delicious flavor. The stalks grow 4 to 5 feet high and bear two ears. $\frac{1}{2}$ pt. 20c; pt. (12 ozs.) 35c; qt. (24 ozs.) 60c, parcel post paid. Not prepaid, $\frac{1}{2}$ pt. 15c; pt. (12 ozs.) 30c; qt. (24 ozs.) 50c.

Kendall's Early Giant A large-eared, second early sort, having ears measuring from 8 to 10 inches long and 12-rowed. The kernels are pure white, and very sweet and tender. The large and well-filled ears command a quick sale in any market that demands really choice early sweet corn. $\frac{1}{2}$ pt. 20c; pt. (12 ozs.) 35c; qt. (24 ozs.) 60c, parcel post paid. Not prepaid, $\frac{1}{2}$ pt. 15c; pt. (12 ozs.) 30c; qt. (24 ozs.) 50c.

Early Minnesota This deservedly popular variety is one of the best second early sorts for the market and the home garden. The stalks are about 6 feet high bearing 1 or 2 ears well covered with husks. The ears are about 8 inches long, 8-rowed; kernels very broad, white, sweet and tender, not shrinking much in drying. By careful selection we have developed a stock of this standard variety which is remarkably uniform and in which all the good qualities that have made this sort so desirable are intensified. $\frac{1}{2}$ pt. 20c; pt. (12 ozs.) 35c; qt. (24 ozs.) 60c, parcel post paid. Not prepaid, $\frac{1}{2}$ pt. 15c; pt. (12 ozs.) 30c; qt. (24 ozs.) 50c.

Adams' Large Early Similar to Adams' Extra Early, but two weeks later, and has much larger ears. This and the Adams' Extra Early are very hardy and can be planted earlier than sweet corns. Has small stalks and can be planted close. More valuable for the market than for home gardens, as this, as well as the Adams' Extra Early, lacks fineness of flavor found in sweet varieties. Unless given the best cultivation and rich soil, they are not sure croppers. $\frac{1}{2}$ pt. 15c; pt. (14 ozs.) 25c; qt. (28 ozs.) 45c, parcel post paid. Not prepaid, $\frac{1}{2}$ pt. 10c; pt. (14 ozs.) 20c; qt. (28 ozs.) 35c.

Schwill's Improved Large Adams This is not a sugar corn, but a selection from the Adams' Early; is as early in season and produces a larger and finer ear filled to the extreme tip of the cob. It produces the largest and finest ear of the Adams varieties. $\frac{1}{2}$ pt. 15c; pt. (14 ozs.) 25c; qt. (28 ozs.) 45c, parcel post paid. Not prepaid, $\frac{1}{2}$ pt. 10c; pt. (14 ozs.) 20c; qt. (28 ozs.) 35c.

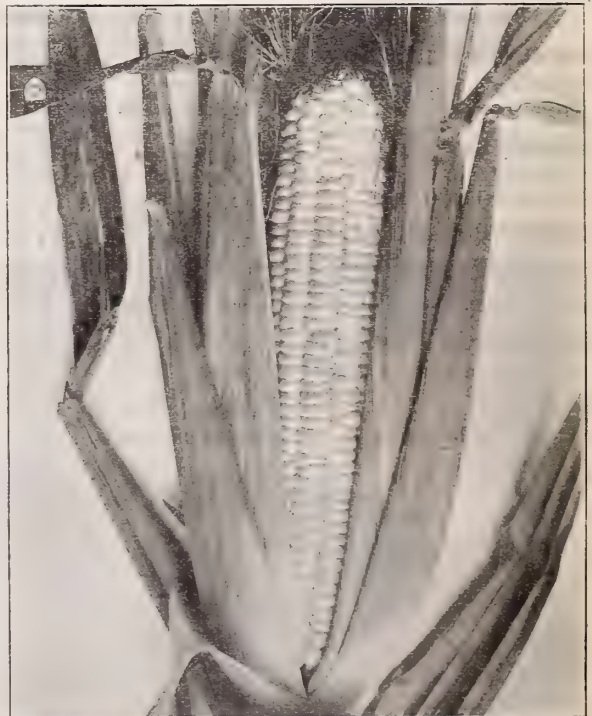

Early Large Adams Corn

FOR PRICES IN LARGER QUANTITIES, SEE PINK PRICE LIST, PAGE 97.

CORN — SWEET AND ROASTING EAR MEDIUM EARLY VARIETIES — CONTINUED

Schwill's Delicious A medium early large sweet corn, often producing ears 12 inches long. The kernels are pure white, very sweet and tender; remains a long time in suitable condition for roasting ears. If you want but one variety for table use, and something that will surely please, plant Schwill's Delicious. $\frac{1}{2}$ pt. 20c; pt. (12 ozs.) 35c; qt. (24 ozs.) 60c, parcel post paid. Not prepaid, $\frac{1}{2}$ pt. 15c; pt. (12 ozs.) 30c; qt. (24 ozs.) 50c.

Schwill's Early Surprise Our own introduction, now too well known to give any lengthy description. It is not a sugar corn, but ranks almost equal. A favorite for early market, larger than the early Adams corn and only a few days later; ears about 8 inches, always well filled to the tip; grains pure white, tender and makes the very best roasting ears. The genuine stock from our own grower can only be obtained from us. No other dealer can supply Schwill's Early Surprise Corn. $\frac{1}{2}$ pt. 15c; pt. (12 ozs.) 25c; qt. (24 ozs.) 45c, parcel post paid. Not prepaid, $\frac{1}{2}$ pt. 10c; pt. (12 ozs.) 20c; qt. (24 ozs.) 35c.

LATE, OR MAIN CROP VARIETIES

Black Mexican This corn, when young, is very white, but the ripe grain is bluish black. For home use it is unexcelled, being very tender and sweet of quality; it is getting more popular every year. The stalks are about 7 feet high; the ears are 8-rowed, and about 8 inches long. $\frac{1}{2}$ pt. 20c; pt. (12 ozs.) 35c; qt. (24 ozs.) 60c, parcel post paid. Not prepaid, $\frac{1}{2}$ pt. 15c; pt. (12 ozs.) 30c; qt. (24 ozs.) 50c.

Country Gentleman This variety has a small, white cob, densely covered with irregular rows of very long, slender, white grains of excellent quality. The ears are 7 to 9 inches long. The stalks are from 6 to 7 feet high. It is well adapted for canning as well as the home garden and market, and many consider it the best of the late varieties. $\frac{1}{2}$ pt. 20c; pt. (12 ozs.) 35c; qt. (24 ozs.) 60c, parcel post paid. Not prepaid, $\frac{1}{2}$ pt. 15c; pt. (12 ozs.) 30c; qt. (24 ozs.) 50c.

Mammoth or Large Sugar This tall-growing sugar corn produces the largest ears of any sweet corn. The ears are often 12 inches long and are noted for their sweetness and delicious quality. The grain is pure white, and the ears remain long in the green state. The ears are 16 to 18-rowed; an excellent sort for canning and for the late garden. $\frac{1}{2}$ pt. 20c; pt. (12 ozs.) 35c; qt. (24 ozs.) 60c, parcel post paid. Not prepaid, $\frac{1}{2}$ pt. 15c; pt. (12 ozs.) 30c; qt. (24 ozs.) 50c.

Stowell's Evergreen A most popular main crop variety, and splendid for table use, the quality being excellent. The stalks are of strong growth, about 6 feet high; the 12-rowed ears are about 8 inches long and keep in table condition a remarkably long time. Our stock has been carefully grown and selected. This is one of the best known of the late sorts. $\frac{1}{2}$ pt. 20c; pt. (12 ozs.) 35c; qt. (24 ozs.) 60c, parcel post paid. Not prepaid, $\frac{1}{2}$ pt. 15c; pt. (12 ozs.) 30c; qt. (24 ozs.) 50c.

White Evergreen This corn has ears fully as large as those of the regular Stowell's and is about five days earlier, while the grain remains tender for a longer period. Its most valuable feature is the paper whiteness of the grains, which makes not only a more attractive ear when served on the table, but is most important for the canner. It retains its whiteness when put up in cans, as distinct from the yellowish tinge of the still popular original Stowell's Evergreen. $\frac{1}{2}$ pt. 20c; pt. (12 ozs.) 35c; qt. (24 ozs.) 60c, parcel post paid. Not prepaid, $\frac{1}{2}$ pt. 15c; pt. (12 ozs.) 30c; qt. (24 ozs.) 50c.

FOR PRICES IN LARGER QUANTITIES, SEE PINK PRICE LIST, PAGE 97.

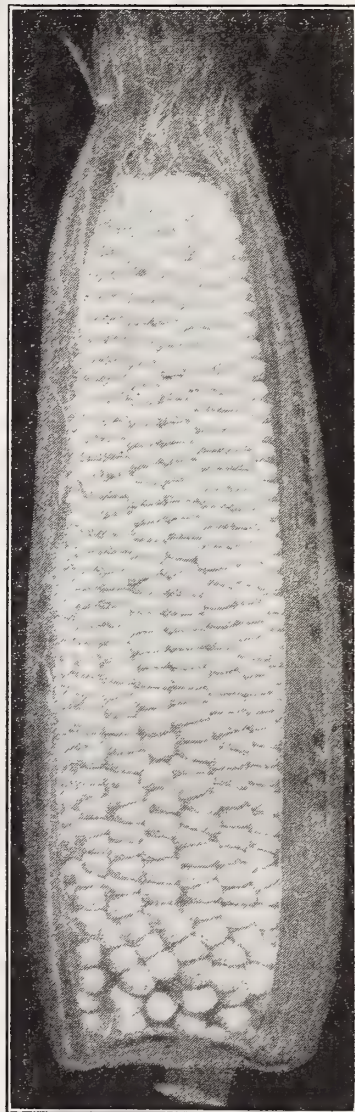

Stowell's Evergreen Corn

POP CORN

Pop Corn ranks favorably in yield to the acre with the other corns, as it will stand closer planting. Always finds a ready market at a good price for popping purposes. Plant some for the children to pop during next winter's evenings. It will furnish them many hours of amusement. CAUTION.—Do not plant pop corn near any other variety of corn, as it is inclined to mix badly; this will spoil the popping qualities.

Queen's Golden The largest pop corn. The stalk grows 5 to 6 feet high and bears 2 to 3 large ears each. It is yellow, but pops perfectly white. Pkt. 15c; $\frac{1}{2}$ lb. 25c; 1 lb. 40c, parcel post paid. Not prepaid, 1 lb. 30c; 5 lb. \$1.25.

White Pearl This is a small grain variety, being a smaller kernel than the Queen's Golden or White Rice. It also has a small cob, but is a very prolific variety and seems to do best in the southwest. Pkt. 15c; $\frac{1}{2}$ lb. 25c; 1 lb. 40c, parcel post paid. Not prepaid, 1 lb. 30c; 5 lb. \$1.25.

White Rice A very handsome and prolific white variety. The ears are 5 to 7 inches long. The kernels are long, pointed and somewhat resembling rice. This excellent, rather late maturing variety, yields heavily, and is considered the best pop corn for parching. Pkt. 15c; $\frac{1}{2}$ lb. 25c; 1 lb. 40c, parcel post paid. Not prepaid, 1 lb. 30c; 5 lb. \$1.25.

Red Beauty An extra early variety which pops very large and is the most tender and crisp of all. Although the kernels are very dark red, this color does not seem to show at all when popped, being then a pearly white. Extremely early, ripening so it may be popped the same year as grown without being kiln-dried. Pkt. 15c; $\frac{1}{2}$ lb. 25c; 1 lb. 40c, parcel post paid. Not prepaid, 1 lb. 30c; 5 lb. \$1.25.

FIELD CORN—See Pages 38-39.

SOUTHERN COLLARDS

CULTURE.—One ounce will produce about 1,500 plants, or 150 feet of row. It produces a plant bearing a mass of leaves on the top of a stout stalk, and is a species of cabbage, and the flavor is the same. It is extensively used for the table, for winter greens, throughout the South. Sow the seed thickly in drills, in rich ground, transplanting when about four inches high. In the South, seed may be sown from January to May and from August to October.



Georgia White Cabbage Collard

Georgia White Cabbage Whiter and more tender than the Blue Stem. Introduced 15 years ago. Three-fourths of them bunch or head up in winter, weighing 10 pounds or more. Plants grow 30 to 40 inches high and as much across. Pkt. 5c; 1 oz. 15c; 2 oz. 30c; ¼ lb. 50c; 1 lb. \$1.50, parcel post paid.

Southern or Georgia This variety is the old-time favorite. It stands all sorts of adverse conditions without injury and will make a good crop where the soil is too poor to grow cabbage, and it makes an excellent substitute for that vegetable. Is very hardy, stands winter without serious injury. Pkt. 5c; 1 oz. 15c; 2 oz. 30c; ¼ lb. 50c; 1 lb. \$1.50, parcel post paid.

North Carolina A decided improvement, and has proved very popular wherever grown. Has short stem, large spreading leaves, very hardy, withstanding drought in summer and cold in winter. Its flavor and cooking qualities are the very best. Pkt. 5c; 1 oz. 15c; 2 oz. 30c; ¼ lb. 50c; 1 lb. \$1.50, parcel post paid.

CORN SALAD A small, quick-growing salad plant for late fall, winter and spring use. Leaves are used as a substitute for lettuce and spinach. During August and September sow the seed in shallow drills about 1 ft. apart, covering with about ¼-inch of fine soil firmly pressed down. On the approach of severe cold weather, cover with straw or coarse litter. The plants will also do well if the seed is sown very early in spring and, like most salad plants, are greatly improved if sown on very rich soil. The seed we offer is extra cleaned.



Corn Salad

Large Round-Leaved, Large Seeded parcel post paid.

Pkt. 10c; 1 oz. 25c; 2 oz. 40c; ¼ lb. 75c; 1 lb. \$2.50.

CRESS As early in spring as ground can be worked sow the seed in well-prepared, rich soil, in shallow drills about 16 ins. apart, covering with about ½ inch fine soil, firmly pressed down. When the young plants are well started thin to 4 to 6 inches apart in row. For succession, plant every two weeks, thinning out as required for use. Keep off insects by dusting with Pyrethrum powder.

Curled or Pepper Grass Grows very quickly and readily from seed sown thinly in drills during the spring and fall



Curled Cress, or Pepper Grass

months. Leaves are finely curled and quite ornamental in appearance, but, as the plant soon runs to seed, frequent plantings should be made to keep up a supply. Flavor is warm and pungent; very agreeable. Pkt. 10c; 1 oz. 35c; 2 oz. 50c; ¼ lb. 75c, par. post paid.

True Water A hardy plant which can be grown easily in a shallow pond of fresh water or along the edges of shallow running streams. It is in great demand during the winter and spring months. Seed may be started readily in pans or boxes of very moist earth, and when young plants are well started, they can be transplanted to the stream or pond where you wish them to grow. Pkt. 10c, parcel post paid.

CHICORY

Chicory is grown for the large, thick roots, which are dried, roasted, and ground, as a substitute or adulterant for coffee. The leaves are also used as a salad during the early spring months. To secure large, smooth roots, the soil should be light, rich, and deeply worked, and the plants should be thinned out to stand 4 to 6 inches apart. One ounce will sow 100 ft. of row.

Large-Rooted or Coffee Pkt. 10c; 1 oz. 50c, parcel post paid.

Witloof-Chicory, or French Endive Witloof is used principally as a winter salad, and is most delicious served with French Dressing and eaten like Cos Lettuce. The seed should be sown in the open ground not later than June in drills 12 to 18 inches apart, and the seedlings should be planted to stand not closer than 3 inches. The plants form long, parsnip-shaped roots which are lifted in the fall, trimmed of leaves, and stored in soil in a cool place until wanted for forcing. It requires about one month to force the roots. The heads are then cut off with a small portion of the neck of the root attached. Pkt. 10c; 1 oz. 75c; 2 oz. \$1.25, parcel post paid.

CHERVIL

A hardy annual with aromatic leaves somewhat resembling parsley and, by many, considered superior to it in flavor. The young leaves are used in soups and for flavoring and garnishing meats and vegetables. Sow in early spring in rich, well prepared soil. The seed is slow to germinate, sometimes remaining in the earth four or five weeks before the plants appear. When the plants are about 2 inches high, transplant or thin to about a foot apart. They are ready for use in six to ten weeks from sowing.

Curled This very finely curled, double sort is much superior to the plain variety, being early maturing, handsomer and having fully as fine fragrance and flavor. Pkt. 10c; 1 oz. 50c, parcel post paid.

DANDELION

Sow early in spring, in very warm, rich soil, in drills 18 inches apart; thin to 5 inches apart and cultivate well; they will be fit for cutting the next spring. When grown for the roots, sow in September and cultivate well during the fall and the following summer; the roots will be fit to dig in October.

Improved Thick-Leaved Unsurpassed in thickness of leaf and deep green color. It is compact and forms an upright regular tuft at the center. This cabbaging sort is much superior to the common or uncultivated dandelion. Pkt. 10c; ½ oz. 35c; 1 oz. 60c, parcel post paid.



EGG PLANT

EGG PLANT PLANTS
See Page 37

CULTURE.—One ounce will produce one to two thousand plants. Start the seed in hotbed early in March and when all danger from frost is over and the nights are warm transplant to open ground, allowing 3 feet space between the rows and 2 feet space between the plants in the row. The soil for Egg plants cannot be too rich. Egg plant seed require a higher temperature for germination than any other garden vegetables and this temperature should be maintained right along in the hotbed in order to secure strong and healthy plants.

Black Beauty This variety is earlier than the New York Purple, however not quite as large. The fruits are rich dark purple, large and symmetrical, and of the finest quality. The fruits set most freely and develop quickly. Pkt. 10c; ½ oz. 40c; 1 oz. 75c; 2 oz. \$1.25; ¼ lb. \$2.00; 1 lb. \$7.00, parcel post paid.

New York Improved Purple A most popular variety; vigorous and productive. Fruits of large size, with smooth, glossy deep purple skin. A most popular variety. Pkt. 10c; ½ oz. 40c; 1 oz. 75c; 2 oz. \$1.25; ¼ lb. \$2.00; 1 lb. \$7.00, parcel post paid.

Florida Highbush Of strong, upright growth, holding its fruit well above the ground; fruit similar in form and size to New York Purple, though not as dark in color. Pkt. 10c; ½ oz. 40c; 1 oz. 75c; 2 oz. \$1.25; ¼ lb. \$2.00; 1 lb. \$7.00, parcel post paid.

ENDIVE

CULTURE.—One ounce will sow 300 feet of row. Endive is one of the best and most wholesome salads for fall and winter use. Sow in shallow drills in April for early use and, for late use, in August and September. When 2 or 3 inches high transplant into good ground or thin out to 1 foot apart. When nearly full grown and before they are fit for the table they must be bleached. This is done by gathering the leaves together with jute twine to exclude the light and air from the inner leaves, which must be done when quite dry or they will rot. By covering fresh plants every few days a succession may be kept up.

Large Green Curled A hardy, vigorous growing Endive with bright green, finely cut leaves. The dense mass of deeply divided leaves formed in the center blanches very readily to a rich cream color. This is a most popular variety. Pkt. 5c; 1 oz. 25c; 2 oz. 40c; ¼ lb. 75c; 1 lb. \$2.25, parcel post paid.

Giant Fringed or Oyster This variety is so named on account of it being largely used to decorate or display oysters during the winter in the larger restaurants and oyster houses. It is exceptionally handsome and grows exceedingly large in good soil. When fully grown the center portion can be blanched creamy white in color. Pkt. 10c; 1 oz. 30c; 2 oz. 50c; ¼ lb. 80c; 1 lb. \$2.50, parcel post paid.

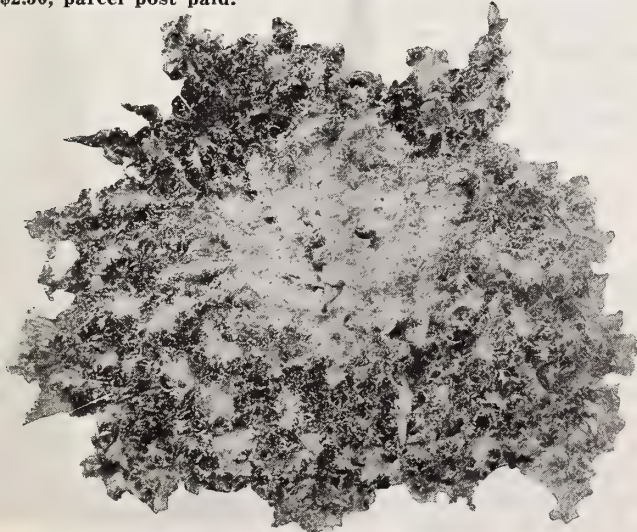

Endive—Large Green Curled

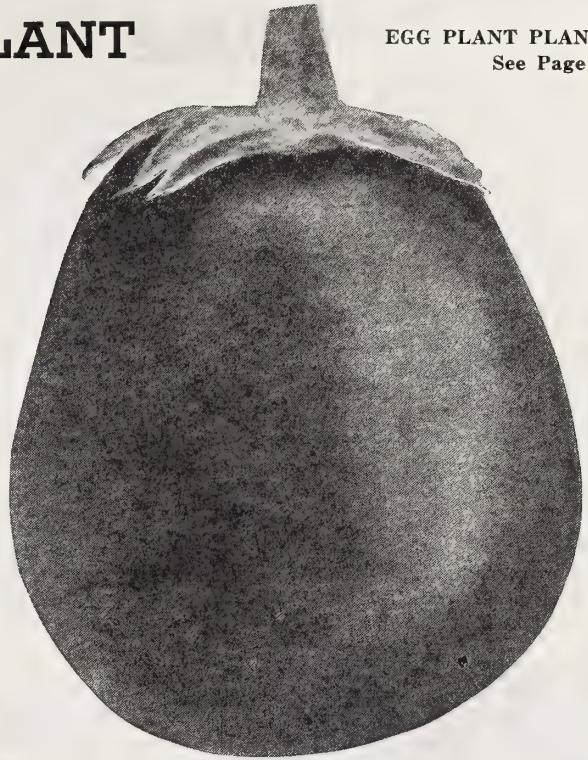

Egg Plant—Black Beauty

GARLIC

A bulbous rooted plant of the onion family with a strong, penetrating odor but much esteemed by some for flavoring soups, stews, etc. We frequently receive orders for garlic seed but we can supply bulbs only. Prepare ground the same as for onions, plant bulbs in drills 8 inches apart and 4 inches apart in row, covering 2 inches deep. When the leaves turn yellow take up the bulbs, dry in shade and lay them up in a dry loft as you would onions. ¼ lb. 20c; 1 lb. 50c, parcel post paid.

HERB SEEDS

Sow seeds in shallow drill a foot apart, and when up thin out and transplant to a few inches apart.

	Packet, Parcel Post Paid
Basil Sweet—For flavoring soups	\$0.10
Dill, Mammoth—Used for flavoring pickle10
Lavender—For oil and distilled water10
Marjoram, Sweet—Used in seasoning meats10
Rosemary—Aromatic leaves are used for seasoning10
Savory, Summer—Used as a culinary herb10
Sage, Broad Leaved—A popular flavoring plant10
Thyme—Much used for seasoning10

HORSE RADISH

Horse Radish rarely produces seed but is grown from pieces of the root. For the home garden they may be set wherever a few feet of space is available, but when grown as a crop they should be set in rich, moist, well prepared ground in rows 2½ feet apart and about 18 inches apart in the row. Set the roots vertically, small end down, and the top of the root 1 to 3 inches below the surface of the ground. Cultivate thoroughly until the tops cover the ground, when their shade will keep down the weeds.

Large White The standard market variety. Doz. 30c; per 100 \$1.50, parcel post paid. By express, doz. 25c; 100 for \$1.25.

New Bohemian Horseradish A much earlier and better producer than the common sort. The roots grow larger and whiter, and the quality is superior. Doz. 40c; per 100 \$1.75, parcel post paid. By express, doz. 35c; 100 for \$1.50.



KALE, OR BORECOLE

CULTURE.—One ounce to 200 feet of row; 4 pounds to the acre. Kale is extensively grown in the South during the fall, winter and spring. The leaves used principally for greens and there is nothing better than a pot of kale boiled with bacon. Where climate permits seed may be sown any time from August to October and again during February and March, broadcast or in drills, 18 inches apart so that the plants when small may be cultivated. The quality is improved rather than injured by frost if not too heavy.

Dwarf Curled Siberian A very hardy and vigorous growing variety of spreading habit, its foliage having a distinct bluish tinge. This is the most popular variety grown, especially in the South. Pkt. 5c; 1 oz. 15c; 2 oz. 25c; ¼ lb. 45c; 1 lb. \$1.50, parcel post paid.

Dwarf Curled Scotch This variety is extensively grown in the South for shipment North. The leaves are finely curled, long and attractive. Pkt. 5c; 1 oz. 20c; 2 oz. 35c; ¼ lb. 60c; 1 lb. \$2.00, parcel post paid.

Tall Green Curled Scotch The plant of this variety grows 3 to 4 feet high, bearing long plume-like light green leaves, which are deeply cut, also finely curled at edges. Pkt. 5c; 1 oz. 20c; 2 oz. 35c; ¼ lb. 60c; 1 lb. \$2.00, parcel post paid.

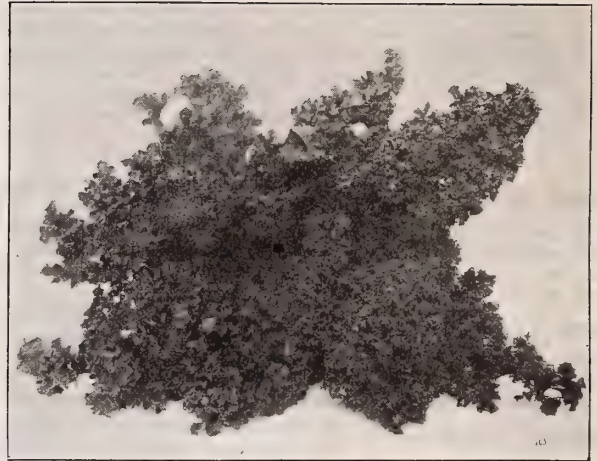

Dwarf Curled Kale

KOHL RABI

CULTURE.—One ounce will sow 200 feet of row. Seed should be sown in light, rich soil, as early in spring as possible, in row 1½ feet apart and when well established thin to 6 inches apart in the row. Plantings at intervals of ten days will give a succession until hot weather, when they fail to grow well. Plantings may be made the latter part of August for fall use. The edible part of Kohl Rabi is the turnip-shaped bulb formed above the ground. It is tender and excellent when used before fully grown, combining somewhat the flavors of cabbage and turnips.

Early White Vienna This variety is extremely early with distinctly small tops. The bulbs are of medium size, very light green or nearly white, and are of best quality for the table if used when about 2 inches in diameter. Pkt. 10c; 1 oz. 35c; 2 oz. 50c; ¼ lb. 90c; 1 lb. \$3.25, parcel post paid.



Early White Vienna Kohl Rabi

of mild flavor. The stems are 2 inches in diameter and blanch 10 inches from the root. An excellent sort. Pkt. 5c; 1 oz. 30c; 2 oz. 50c; ¼ lb. 75c; 1 lb. \$2.50, parcel post paid.

London Flag This well known broad-leaved leek is hardy, productive, of good quality and is extremely cultivated in this country and is a favorite sort with the market gardeners and is also extensively used for the home garden. Pkt. 5c; 1 oz. 30c; 2 oz. 50c; ¼ lb. 75c; 1 lb. \$2.50, parcel post paid.

LEEK

CULTURE.—One ounce will sow 100 feet of row. This belongs to the onion family, and is a good fall and winter substitute for green onions. The leaves are flat and the stems are very large, cylindrical and bulbous. Sow early in spring in drills 12 to 15 inches apart, covering ½-inch deep, in good rich light soil. Thin plants to 6 inches apart in the row and draw the earth about them when cultivating. If one desires very white and tender leeks transplant when about 6 inches high, setting 4 inches apart in the trenches and about 2 feet apart and gradually earth-up like celery.

American Flag A very fine, early, productive variety, a strong, quick-grower



London Flag Leek

MUSHROOMS

Mushrooms are considered a great delicacy by everyone and are always in much demand at fancy prices. Many are devoting their spare time to mushroom culture and are getting big returns for their labor. Nearly everyone has some unused place that might be devoted to mushroom growing. They can be grown in dark rooms, caves, cellars or under greenhouse benches, where the temperature can be maintained at from 50 to 60 degrees.

We furnish with each order a leaflet giving complete cultural directions. One brick is required for 10 square feet of bed. It is put up in bricks weighing about 1¼ lbs. each.

Lambert's Pure Culture Spawn A new departure in the cultivation of mushroom spawn. This method insures the reproduction of a certain type, free from all inferior sorts, that will largely increase the yield and produce the very best mushrooms. 1 brick 40c; 5 bricks \$1.75, parcel post paid. Not prepaid, 1 brick 35c; 5 bricks \$1.50. Price in large quantities on application.



SCHWILL'S SELECTED LETTUCE

CABBAGE, OR HEADING VARIETIES

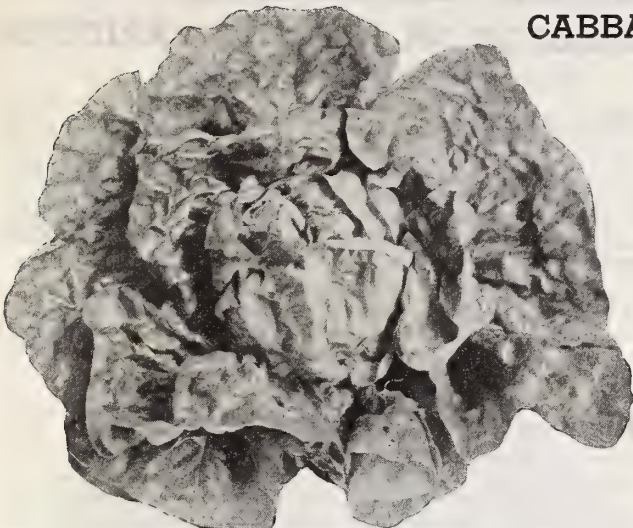

Schwill's Select Big Boston Lettuce

CULTURE.—One ounce will produce 3,000 plants. For early use sow under glass in January or early February, and transplant as early as the ground can be put in good shape. Sowings may be made in open ground from April until July and again at the end of August for fall supply. Lettuce should be transplanted in rich, moist ground in rows 2 feet apart and plants 1 foot apart in the row. As the quality depends largely upon quick growth, frequent cultivation should be given to encourage it. When wanted as a cut salad, sow the seed thickly in rows or broadcast.

May King This is a handsome, extremely early, compact, cabbage or heading variety for the home garden and market, forming very firm heads of medium size and excellent quality. The color is light yellowish green, tinged with reddish-brown when mature. The inner leaves blanch rich golden yellow, very tender and buttery. The plant is very compact for so large a head. The variety is exceptionally early outdoors, attaining a size suitable for use before other sorts and is also very satisfactory for forcing. Pkt. 5c; 1 oz. 20c; 2 oz. 35c; ¼ lb. 60c; 1 lb. \$1.75, parcel post paid.

Hubbard's Market An excellent heading variety for forcing or open ground; heads globular, very firm and well blanched; leaves broad, fairly blistered and crumpled, thick and stiff; color medium green; quality the best. Pkt. 5c; 1 oz. 20c; 2 oz. 35c; ¼ lb. 60c; 1 lb. \$1.75, parcel post paid.

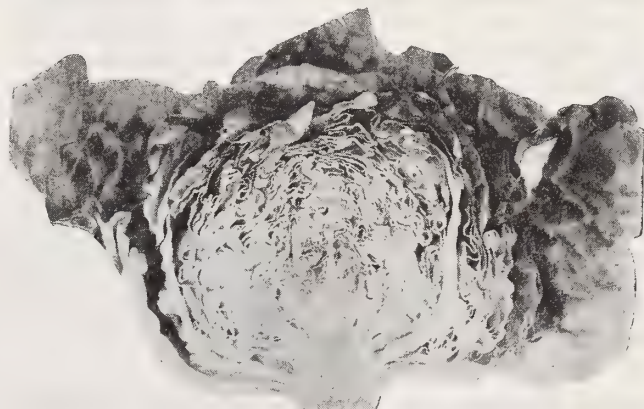

Schwill's Perfection Lettuce

Schwill's Perfection A very large, medium late heading sort; plant rather globular, heart well bleached; leaves broad and peculiarly smooth and unusually thick; color light grayish-green, never spotted or brownish; quality excellent. Pkt. 5c; 1 oz. 25c; 2 oz. 40c; ¼ lb. 75c; 1 lb. \$2.00, parcel post paid.

Large White Cabbage Head A desirable variety for summer or fall use, forming very large, compact and beautiful heads. Color light green, stands both heat and drouth remarkably well; very highly recommended. Pkt. 5c; 1 oz. 20c; 2 oz. 35c; ¼ lb. 50c; 1 lb. \$1.60, parcel post paid.

Hanson A fine, large-heading variety. Leaves curled on the edges; light yellowish-green in color. The head is crisp and brittle and flavor excellent. Is the very best house garden variety in existence, and much the finest variety of its class. Allow 12 inches for each head. Pkt. 5c; 1 oz. 20c; 2 oz. 35c; ¼ lb. 55c; 1 lb. \$1.75, parcel post paid.

Schwill's Largest of All One of the largest varieties grown. The heart blanches beautifully and is crisp, tender and delicious. It is robust-growing, roots deeply and is thus able to resist hot, dry weather; is slow to run to seed, and a sure header. The outer color is a distinct apple-green. It has been extensively grown in all sections of the country, and as a standard Summer Lettuce it is in every way desirable. Pkt. 5c; 1 oz. 25c; 2 oz. 40c; ¼ lb. 75c; 1 lb. \$2.00, parcel post paid.

Schwill's Big Boston Our strain of this very popular variety is unsurpassed. Plants are large and vigorous. Can be sown in the open ground in the spring or fall, or in frames for early spring planting, does particularly well in cold weather, and is especially recommended for fall planting in the South. Is very popular with gardeners and truckers. Pkt. 5c; 1 oz. 25c; 2 oz. 40c; ¼ lb. 75c; 1 lb. \$2.00, parcel post paid.

Deacon This is an excellent summer variety. The head is of large size, is very firm and remains in condition for use a long time. The plant is very compact, with few outer leaves which are usually very smooth, thick and of light green color. The inner leaves blanch to a bright, rich yellow and are crisp, buttery and very well flavored. Pkt. 5c; 1 oz. 20c; 2 oz. 35c; ¼ lb. 60c; 1 lb. \$1.75, parcel post paid.

Iceberg A large crisp lettuce, always tender. Iceberg stands hot weather remarkably. Give each head 14 inches in a row. The color is light green, lightly tinged with brown. Try this either for home or market garden. Pkt. 5c; 1 oz. 20c; 2 oz. 35c; ¼ lb. 60c; 1 lb. \$1.75, parcel post paid.

California Cream Butter A popular variety for autumn and winter use. Forms a very large head, which is very buttery, and of a rich golden-yellow inside. The leaves are thick and bright green, slightly tinged with brown on top of head, and the outer leaves are slightly spotted with inconspicuous brown spots. Easy to grow and a good shipping variety. Pkt. 5c; 1 oz. 25c; 2 oz. 40c; ¼ lb. 60c; 1 lb. \$1.75, parcel post paid.



Schwill's Largest of All Lettuce



SCHWILL'S SELECTED LETTUCE

CABBAGE OR HEADING VARIETIES CONTINUED

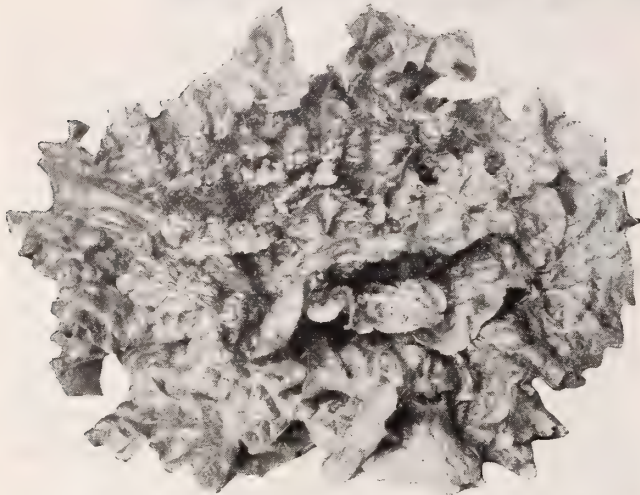

Early Curled Simpson Lettuce

Way-Ahead This is one of the earliest and one of the surest heading of all early lettuce. It is of the very finest quality and handsome in appearance. The outer leaves are a light green, with the inner head finely blanched to a rich, buttery yellow. Way-Ahead stands a longer time before running to seed than any other early head variety. Pkt. 10c; 1 oz. 30c; 2 oz. 50c; ¼ lb. 90c; 1 lb. \$3.25, parcel post paid.

Golden Queen An early, small heading variety; heads compact, somewhat pointed and well blanched; leaves broad, blistered and crumpled; color beautiful rich, very light green, with no brownish tinge; quality very fine. Pkt. 10c; 1 oz. 40c, parcel post paid.

Mignonette Is small and has tightly set leaves which makes a small extremely solid head. It is sweet in flavor and tender. Mignonette is excellent when forced in a hot house or grown in the open. The plants can be set closely, 5 inches apart, because of the compact growth. Early, tender and delicious. Pkt. 10c; 1 oz. 30c; 2 oz. 50c; ¼ lb. 90c, parcel post paid.

CURLED, OR LOOSE-LEAVED VARIETIES

Early Curled Simpson or Silesia This is the old favorite popular loosehead variety, of dwarf, compact habit and quick growth. The curly leaves are large, yellowish green with finely curled edges. Very crisp and tender. Matures early, quite hardy and withstands heat and drought. Pkt. 5c; 1 oz. 20c; 2 oz. 35c; ¼ lb. 60c; 1 lb. \$1.75, parcel post paid.

Black Seeded Simpson One of the best for sowing outdoors where an exceedingly tender leaf is desired and for those markets which demand a very large loose clustering sort. The color is an attractive light yellowish green. It is used also for growing under glass or in frames. The leaves are ruffled and blistered and even the large outer ones are very tender. The curly and thin-leaved, bunching variety is uniformly attractive and remains of excellent quality a very long time. Pkt. 5c; 1 oz. 20c; 2 oz. 35c; ¼ lb. 60c; 1 lb. \$1.75, parcel post paid.

Early Prize Head A large clustering, non-heading lettuce, most excellent for the home garden and undoubtedly the most easily grown variety in cultivation. It is too tender, however, to stand shipping or handling on the market. The leaves are finely curled and crumpled, bright green tinged with brownish red, and are very crisp, tender and sweet. Pkt. 5c; 1 oz. 25c; 2 oz. 40c; ¼ lb. 75c; 1 lb. \$2.00, parcel post paid.



Field of Prize Head Lettuce

COS LETTUCE, OR ROMAINE SALAD

These are distinct from the ordinary lettuce, and much liked on account of their crisp, tender quality and delicate flavor.

Paris White Cos Grows to very large size, producing long-pointed, compact bunches. The inner leaves blanch readily and are of fine flavor. Pkt. 5c; 1 oz. 25c; 2 oz. 40c; ¼ lb. 60c, parcel post paid.



Southern Giant Curled Mustard

LETTUCE PLANTS
See Page 37

MUSTARD

CULTURE.—One ounce will sow about 80 ft. of drill. For early salad sow in February, and for general crop, at intervals through the spring, in rows 6 inches apart, and rather thick in rows.

Chinese Mammoth A European variety, with light green very large leaves. It has not the same taste as the large-leaved or the large curled, but will stand longer before going to seed. Pkt. 5c; 1 oz. 10c; 2 oz. 20c; ¼ lb. 30c; 1 lb. 75c, parcel post paid.

Southern Giant Curled The favorite kind here, sown largely for the market. Leaves are pale green, large and curled or scalloped on the edges. Pkt. 5c; 1 oz. 10c; 2 oz. 20c; ¼ lb. 30c; 1 lb. 75c, parcel post paid.

Elephant Ear This is a splendid variety for the market gardeners and amateurs, and will surely give satisfaction wherever planted. The leaves are smooth, very large, and always tender and succulent, makes a large plant. Pkt. 5c; 1 oz. 15c; 2 oz. 25c; ¼ lb. 40c; 1 lb. \$1.25, parcel post paid.



MUSKMELON, OR CANTALOUPE

CULTURE.—One ounce will plant about 50 hills; 2 pounds to the acre. Melons thrive best in a light, rich soil. Plant late in April or early in May, when ground has become warm and dry, hills about 5 ft. apart each way. Previous to sowing seed mix a few shovelfuls of well-rotted manure in each hill, plant in each 12 to 15 seeds; when they begin to vine, thin to 3 or 4 of most thrifty plants.

GREEN-FLESHED VARIETIES

Mammoth Rocky Ford The general type of this melon is similar to the regular Rocky Ford, but they grow somewhat larger in size, making it a splendid variety for market. Pkt. 5c; 1 oz. 20c; 2 oz. 35c; ¼ lb. 50c; 1 lb. \$1.75, parcel post paid.

Early Netted Gem Grows medium size, and in flavor and sweetness, is unexcelled by any other sort; shape nearly globular; well covered with coarse netting; well ribbed; flesh sweet and sugary to the rind. One of the earliest. Pkt. 5c; 1 oz. 15c; 2 oz. 25c; ¼ lb. 40c; 1 lb. \$1.25, parcel post paid.

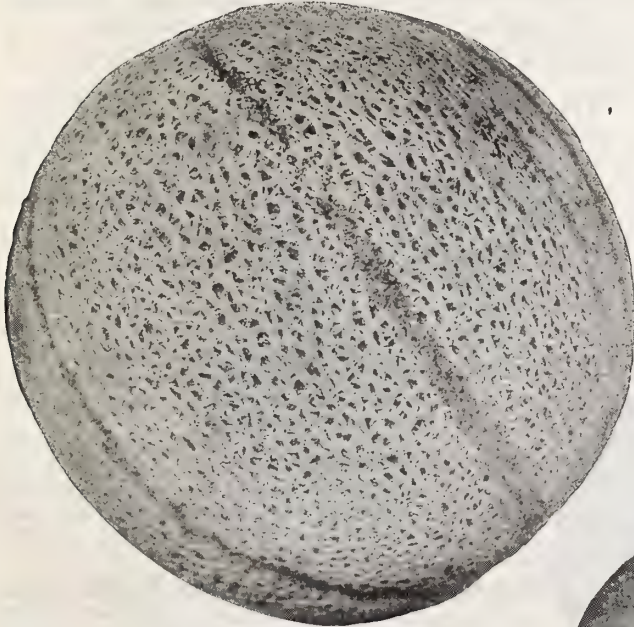

Mammoth Rocky Ford Cantaloupe

Rocky Ford We have an especially fine, improved strain of this popular melon as now grown at Rocky Ford. The fruit is small, almost round, smooth, showing no ribs, and densely covered with a heavy gray netting; flesh thick and deep green, showing a faint lining of pink or gold at the center; of the highest quality. An excellent shipping sort. Pkt. 5c; 1 oz. 15c; 2 oz. 25c; ¼ lb. 40c; 1 lb. \$1.25, parcel post paid.

Schwill's Magnificent Ten days earlier than the Rocky Ford. The melons are regular in size, form nearly round or slightly oval, and very closely netted; flesh bright green; luscious flavor and ripens close to the rind. Pkt. 5c; 1 oz. 20c; 2 oz. 35c; ¼ lb. 50c; 1 lb. \$1.75, parcel post paid.

Baltimore or Acme A fine early, oblong, green-fleshed variety, of good size; noticeably ribbed and heavily netted. Pkt. 5c; 1 oz. 15c; 2 oz. 25c; ¼ lb. 35c; 1 lb. \$1.00, parcel post paid.

Improved Large Baltimore An improvement on Baltimore or Acme; of general form, but somewhat larger; green-fleshed. Pkt. 5c; 1 oz. 15c; 2 oz. 25c; ¼ lb. 50c; 1 lb. \$1.50, parcel post paid.

Prolific Netted Nutmeg This splendid melon is one of the very best varieties for either home use or the market. It has a very small seed cavity, deep green flesh and is of very uniform shape, average about 5 inches. Pkt. 5c; 1 oz. 15c; 2 oz. 25c; ¼ lb. 40c; 1 lb. \$1.25, parcel post paid.

Cannon Ball A late, perfectly round and heavily netted sort; flesh light green. Pkt. 5c; 1 oz. 15c; 2 oz. 25c; ¼ lb. 40c; 1 lb. \$1.25, parcel post paid.

SALMON-FLESHED VARIETIES

Banana Shaped somewhat as name indicates; grows about 2½ feet long; flesh deep salmon colored and of only fair quality. Pkt. 5c; 1 oz. 20c; 2 oz. 35c; ¼ lb. 50c; 1 lb. \$1.75, parcel post paid.

Burrell's Gem An excellent small melon of the Netted Gem type; somewhat later than that variety and a fourth larger; fruit oblong, distinctly ribbed and heavily netted; flesh deep salmon, of fine quality. Pkt. 5c; 1 oz. 15c; 2 oz. 25c; ¼ lb. 40c; 1 lb. \$1.25, parcel post paid.

Hoodoo A splendid, small, mid-season variety; fruit round with tendency to heart shape, densely covered with fine gray netting; flesh very thick, with small seed cavity; of a rich orange color and highest quality. A fine shipping sort. Pkt. 5c; 1 oz. 15c; 2 oz. 25c; ¼ lb. 40c; 1 lb. \$1.25, parcel post paid.

Tip Top In shape varies from round to slightly oblong; rather large in size and somewhat late in maturing. Skin pale green, distinctly ribbed and lightly netted; flesh deep rich salmon, sweet and spicy. Pkt. 5c; 1 oz. 20c; 2 oz. 35c; ¼ lb. 45c; 1 lb. \$1.50, parcel post paid.

Osage, or Miller's Cream A rather large, main crop, oval melon of very superior quality; fruit dark green, slightly ribbed and well covered with a shallow, gray netting; flesh rich orange-salmon, exceedingly thick, with a small seed cavity. One of the best melons to grow. Pkt. 5c; 1 oz. 15c; 2 oz. 25c; ¼ lb. 40c; 1 lb. \$1.25, parcel post paid.

Pink Meat Rocky Ford This is very similar to Rocky Ford, excepting it has a yellow or salmon-colored flesh instead of the green flesh. It grows to a very desirable size, is closely netted, slightly ribbed, with a dark green skin. Pkt. 5c; 1 oz. 20c; 2 oz. 35c; ¼ lb. 45c; 1 lb. \$1.50, parcel post paid.



Honey Dew Melon

HONEY DEW MELON

This new melon is unlike the ordinary muskmelon or cantaloupe, both in appearance and flavor, the outer skin being smooth, hard and nearly white. The melons are large, round to oval in shape, extremely thick-meated and have a very small seed cavity; flesh is light green, very solid and of a rich honey-like flavor, luscious and juicy, much more so than any variety of muskmelons. It is an excellent keeping melon and fruits may be laid away for use late in the fall when they will be greatly appreciated, not only for their delightful flavor, but because the other varieties of melons are gone. On account of the hard shell it is an excellent shipper, carrying safely for long distances without being bruised or damaged in any manner. Pkt. 10c; 1 oz. 50c; 2 oz. 75c; ¼ lb. \$1.25, parcel post paid.



SCHWILL'S WATERMELONS

CULTURE.—An ounce will plant 40 hills; 2 to 3 pounds will plant an acre. Watermelons delight in a light sandy soil. Plant when danger from frost is over, in hills 8 to 10 feet apart each way. Put from 10 to 15 seeds in each hill and when well started thin out to the two best plants. In this latitude we plant the seed about the middle of April. The bugs will require careful watching or they will eat up the plants before they get started. Do not make a big "hill" when sowing the seed; it is much better to have the "hills" level with the surface of the ground.

Kolb's Gem Fruit nearly round, medium size; skin marked with irregular stripes of light and dark green. A good shipper, and one of good quality. Pkt. 5c; 1 oz. 10c; 2 oz. 15c; ¼ lb. 25c; 1 lb. 85c, par. post paid.

Alabama Sweet This is an excellent shipping melon. The rind is dark green, marked with a still larger green mottled stripe, and while thin it is very tough. The flesh is bright red, fine grained, sweet and luscious. Pkt. 5c; 1 oz. 15c; 2 oz. 25c; ¼ lb. 35c; 1 lb. \$1.00, parcel post paid.

The Bradford A fine flavored melon, oblong in shape, with rather square ends. The skin is very dark green with darker stripes. Dark red in color and of excellent flavor. Pkt. 5c; 1 oz. 10c; 2 oz. 15c; ¼ lb. 30c; 1 lb. \$1.00, parcel post paid.

Kleckley's Sweet This very popular melon is one of the best for nearby markets. Fruits are medium size, oblong, of a dark green color and have very thin rind. Flesh bright scarlet with solid heart, crisp, sugary and melting, and entirely free from stringiness. Pkt. 5c; 1 oz. 15c; 2 oz. 25c; ¼ lb. 35c; 1 lb. \$1.25, parcel post paid.

Tom Watson Shape long, color of rind dark green, which is thin but very firm, making it a fine shipper. Flesh is bright red, firm and very sweet; has taken the lead over all other shipping melons. Pkt. 5c; 1 oz. 15c; 2 oz. 25c; ¼ lb. 35c; 1 lb. \$1.10, parcel post paid.

Halbert Honey A large, attractive, oblong shape; rind dark green, flesh crimson; very sweet and tender. Pkt. 5c; 1 oz. 15c; 2 oz. 25c; ¼ lb. 35c; 1 lb. \$1.25, parcel post paid.

Jackson Watermelon If asked to name the sweetest melon for home use, we would name the Jackson. It is a long melon, with mottled green skin, firm red meat and ripens close to the rind. Pkt. 5c; 1 oz. 10c; 2 oz. 20c; ¼ lb. 30c; 1 lb. \$1.00, parcel post paid.

Branch's Superb Georgia Rattlesnake Quite superior to the old original Rattlesnake Melon. Rind green, with darker green stripe. Pkt. 5c; 1 oz. 15c; 2 oz. 25c; ¼ lb. 35c; 1 lb. \$1.10, par. post paid.

Georgia Rattlesnake Large, oblong, striped; flesh red, of fine quality. Pkt. 5c; 1 oz. 10c; 2 oz. 20c; ¼ lb. 30c; 1 lb. \$1.00, parcel post paid.

Sugar Stick Watermelon A large, light green or grayish melon of oblong form, two feet in length, and will average 30 lbs. Flesh red, very sweet and tender. Pkt. 5c; 1 oz. 10c; 2 oz. 20c; ¼ lb. 35c; 1 lb. \$1.00, parcel post paid.

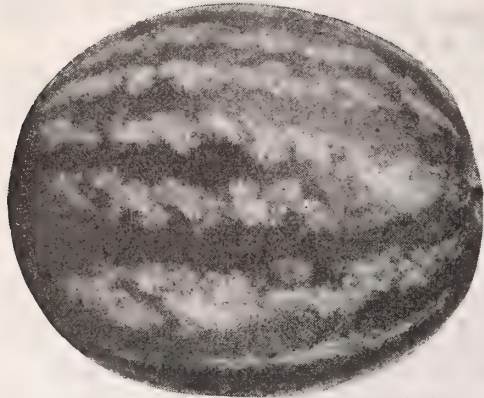

Kolb Gem Watermelon

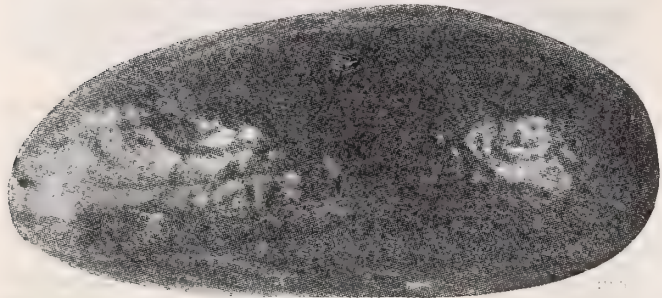

Kleckley Sweet Watermelon



Halbert Honey Watermelon

Monte Cristo Unequaled for the home patch or for nearby markets. Vine very productive; of the most luscious medium-sized, oblong melons, with a dark green rind. Flesh is bright red, sweet and tender. Pkt. 5c; 1 oz. 15c; 2 oz. 25c; ¼ lb. 35c; 1 lb. \$1.25, parcel post paid.

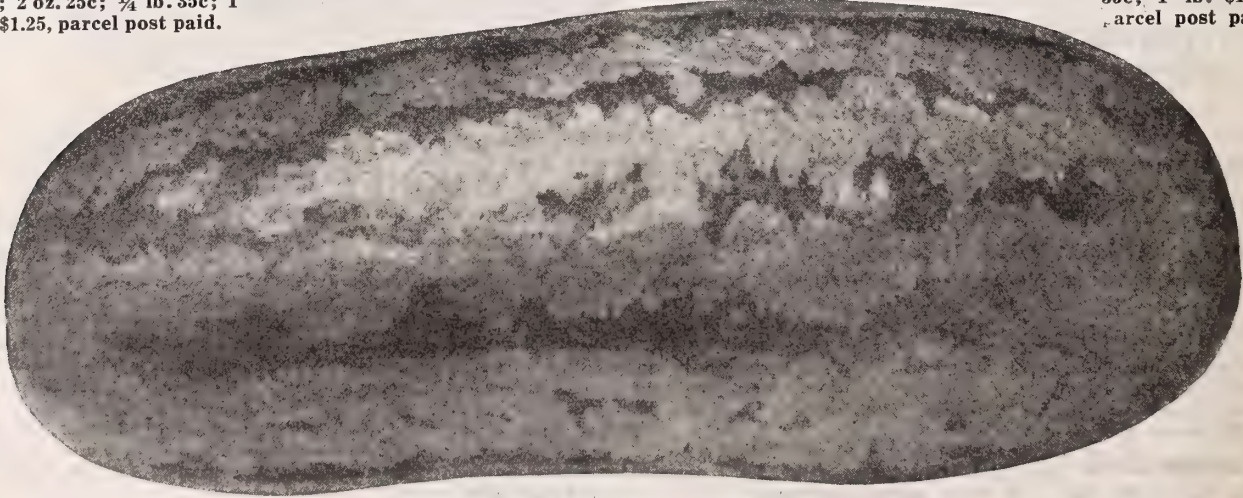

Branch's Superb Rattlesnake Watermelon



SCHWILL'S WATERMELONS

New Excel Produces very long and large melons, weighing from 40 to 60 pounds each. Deep red flesh, crisp and melting, of the finest flavor, entirely free from any strings or hard cores. Rind is medium light green, with tracings of a darker shade. Pkt. 5c; 1 oz. 10c; 2 oz. 20c; ¼ lb. 30c; 1 lb. \$1.00, parcel post paid.

Sweet Heart Popular for market. Large heavy fruits of oval or round form; skin very pale green, with distinct netted lines of a slightly darker shade. The melons bear shipping well. The solid flesh is a deep red. Pkt. 5c; 1 oz. 10c; 2 oz. 20c; ¼ lb. 30c; 1 lb. \$1.00, parcel post paid.

Florida Favorite Fruit long, dark green, mottled and striped with a lighter shade. Rind thin but firm. Pkt. 5c; 1 oz. 10c; 2 oz. 20c; ¼ lb. 30c; 1 lb. \$1.00, parcel post paid.

Cuban Queen Grows to a large size, oval in shape, skin marked regularly, flesh crisp, juicy and sugary. Pkt. 5c; 1 oz. 10c; 2 oz. 15c; ¼ lb. 25c; 1 lb. 90c, parcel post paid.

Peerless (Ice Cream) Of medium size, thin rind, light mottled green, flesh bright scarlet, solid to the center and sweet as honey. Pkt. 5c; 1 oz. 10c; 2 oz. 15c; ¼ lb. 25c; 1 lb. 90c, parcel post paid.

Jordan's Gray Monarch Long in shape, with skin of mottled gray color and bright crimson flesh. Pkt. 5c; 1 oz. 10c; 2 oz. 15c; ¼ lb. 25c; 1 lb. 90c, parcel post paid.

Black Diamond Immense size; grows to average 75 to 90 pounds; rich, dark green, uniform, round to oval shape; flesh deep red, of fine quality. Pkt. 5c; 1 oz. 10c; 2 oz. 15c; ¼ lb. 25c; 1 lb. 90c, parcel post paid.

Harris' Earliest Extra early, medium size, oval shaped with mottled broad stripes of light and dark green. Pkt. 5c; 1 oz. 10c; 2 oz. 15c; ¼ lb. 25c; 1 lb. 90c, parcel post paid.

Preserving Citron Planted only for preserving. Round, striped fruit; flesh white and very solid; makes an excellent preserve. Red seeded. Pkt. 10c; 1 oz. 25c; 2 oz. 40c, parcel post paid.

Green and Gold Flesh bright golden yellow, skin beautiful green, shape slightly elongated. No melon is as sweet and delicious. Pkt. 5c; 1 oz. 15c; 2 oz. 25c; ¼ lb. 40c; 1 lb. \$1.25, parcel post paid.

Special Tom Watson By request our grower in Florida is saving out some special select stock of this splendid variety. This seed is saved from the most perfect melons, none weighing less than 40 pounds each and from many that weighed 70 pounds each. This seed is then graded and cleaned, and consequently will produce finer and larger melons than the regular stock. If you want something extra, order this special stock this season. Pkt. 10c; 1 oz. 20c; 2 oz. 35c; ¼ lb. 60c; 1 lb. \$2.00, parcel post paid.

Angel Kiss One of the earliest and best tasting melons in existence. With flesh of the deepest indescribable crimson, delightfully sweet and refreshing. It grows from medium to very large, very long in shape and grayish white in color; handsome and attractive. Pkt. 5c; 1 oz. 15c; 2 oz. 25c; ¼ lb. 40c; 1 lb. \$1.25, parcel post paid.



Sweet Heart Watermelon



Green and Gold Watermelon

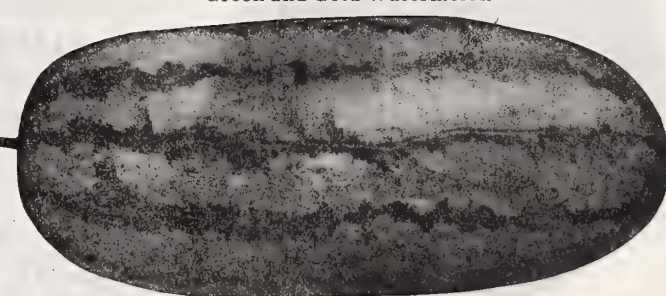

Angel Kiss Watermelon

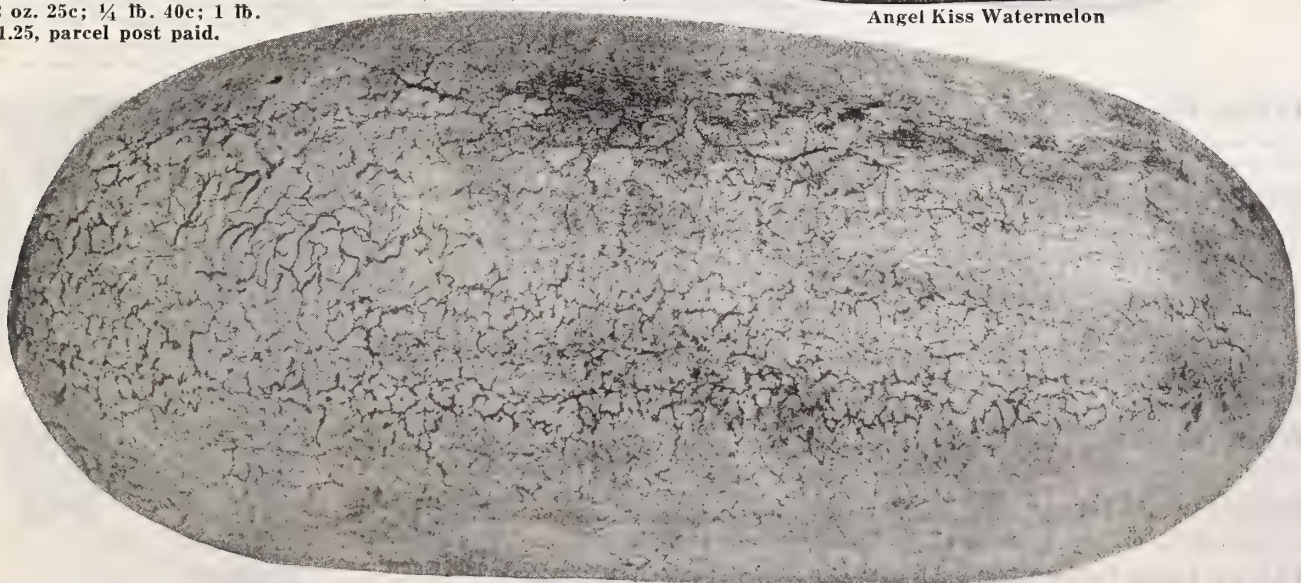

Tom Watson Special Watermelon



SCHWILL'S SUPERIOR ONION SEED

CULTURE.—One ounce will sow 100 feet of drill; 6 pounds will plant 1 acre. A deep, rich soil, thoroughly worked is best for this crop. For large, fancy onions, sow in January or February, in hotbeds or trays. As soon as the weather opens and the sets are the size of a goose quill plant in rows, 12 inches apart and 4 to 6 inches between the onions. For main crop, sow in the open ground in March and April in drills 12 inches apart, thinning out afterwards to 3 or 4 inches apart.

Prizetaker One of the largest onions grown and the mildest; is productive and a sure cropper; bulbs are globe-shaped and of light straw color. Pkt. 5c; 1 oz. 40c; 2 oz. 65c; ¼ lb. \$1.15; 1 lb. \$4.00, parcel post paid.

Yellow Globe Danvers A well known standard sort of excellent color, and because of its small neck, cures well and makes a splendid keeper. Pkt. 5c; 1 oz. 35c; 2 oz. 60c; ¼ lb. \$1.10; 1 lb. \$3.75, parcel post paid.

Large Red Weathersfield A fine, large, rather flat sort, of a deep purplish-red color; noted for its productiveness and keeping qualities. Pkt. 5c; 1 oz. 35c; 2 oz. 60c; ¼ lb. 95c; 1 lb. \$3.50, parcel post paid.

Southport Red Globe The finest type and most popular of the red onions. The bulbs are distinctly globe-shaped, with small neck, and are excellent keepers; color a deep purplish red. Pkt. 5c; 1 oz. 35c; 2 oz. 60c; ¼ lb. \$1.10; 1 lb. \$4.00, parcel post paid.

Southport White Globe Of true Southport Globe form, with thin, delicate skin of purest paper whiteness; flesh very crisp, fine-grained and snowy white in color, and exceedingly mild. Pkt. 5c; 1 oz. 40c; 2 oz. 65c; ¼ lb. \$1.15; 1 lb. \$4.00, parcel post paid.

White Silverskin Sometimes called Portugal. A large flat, white onion, of mild and pleasant flavor; hard and fine-grained. Pkt. 5c; 1 oz. 40c; 2 oz. 65c; ¼ lb. \$1.15; 1 lb. \$4.00, parcel post paid.

Mammoth Silver King One of the largest of the foreign onions; the bulbs are flat, of pure silvery white color, both skin and flesh, and are remarkably mild. Pkt. 5c; 1 oz. 50c; 2 oz. 75c; ¼ lb. \$1.25; 1 lb. \$4.50, parcel post paid.

Crystal White Wax Earliest of the Bermuda varieties; makes large, flat onions so mild and sweet can be eaten like apples. Pkt. 5c; 1 oz. 30c; 2 oz. 50c; ¼ lb. 90c; 1 lb. \$3.25, parcel post paid.

Red Bermuda In shape and size, also in flavor, exactly like Yellow Bermuda, differing only in color, which is pale red. Pkt. 5c; 1 oz. 25c; 2 oz. 40c; ¼ lb. 60c; 1 lb. \$2.50, parcel post paid.

ONION SETS

CULTURE.—Plant 4 ins. apart, in rows ½-in. deep and 1 ft. between rows, but do not cover sets entirely, except the Potato Onion, which should be planted in rows 2 ft. apart and 9 ins. apart in row, cover 1 inch. All onion sets are sold 32 lbs. to bu. and are subject to market changes. One qt. weighs 1 lb.

White Silverskin 1 qt. 35c; 4 qts. 90c, parcel post paid
 Red Weathersfield 1 qt. 30c; 4 qts. 85c, parcel post paid
 Yellow Danvers 1 qt. 30c; 4 qts. 85c, parcel post paid

Yellow Potato Large, reddish onions of mild flavor. Never makes seed, but divides from the root; the smallest sets produce one or two large onions; medium-sized sets produce as many as 12 medium to small sets. Qt. 40c; 4 qts. \$1.25, parcel post paid.

White Multiplier These are of pure silvery white color, enormously productive. Of excellent quality and size for bunching green. They are extremely early, being ready for the market in from three to four weeks. Qt. 40c; 4 qts. \$1.25, parcel post paid.

OKRA

CULTURE.—One ounce sows 50 ft. of drill. Extensively grown in the South, and should be better known, as it is a delicious vegetable. The young green pods make a healthful and delicious soup and, when pickled, are a fine salad. Sow after the weather has become warm in rows 3 feet apart, 2 feet apart in the rows. Will succeed in any good garden soil.

White Velvet Bears round, white, smooth pods, unlike other varieties, which are ridged or square-edged. Pods are large and are produced in great abundance. The market gardeners' favorite. Pkt. 5c; 1 oz. 10c; 2 oz. 15c; ¼ lb. 25c; 1 lb. 75c, parcel post paid.

Early Dwarf Green Of dwarf growth but immensely productive. The pods are tender, of best quality, and are borne throughout the season. Pkt. 5c; 1 oz. 10c; 2 oz. 15c; ¼ lb. 25c; 1 lb. 75c, parcel post paid.

Tall or Long Green Pods long, slender, dark green, and ridged; very tender and is a most popular green variety. Pkt. 5c; 1 oz. 10c; 2 oz. 15c; ¼ lb. 25c; 1 lb. 75c, parcel post paid.

Southport
Red Globe
Onion

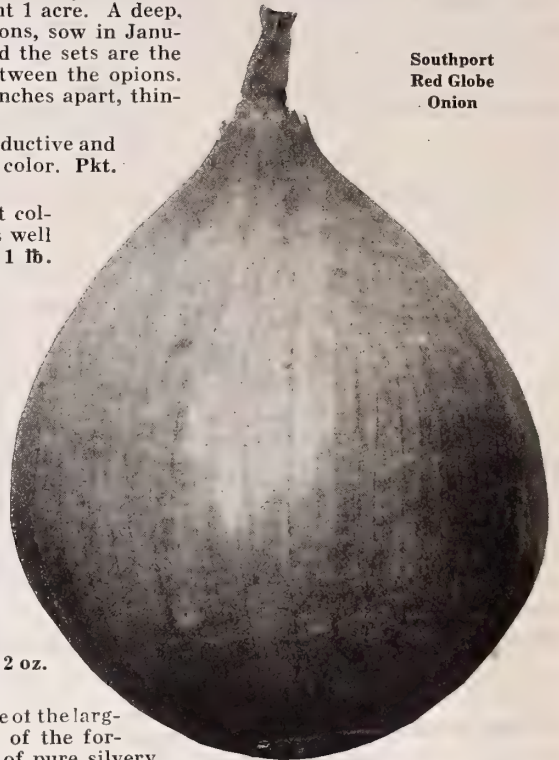

Prizetaker
Onion

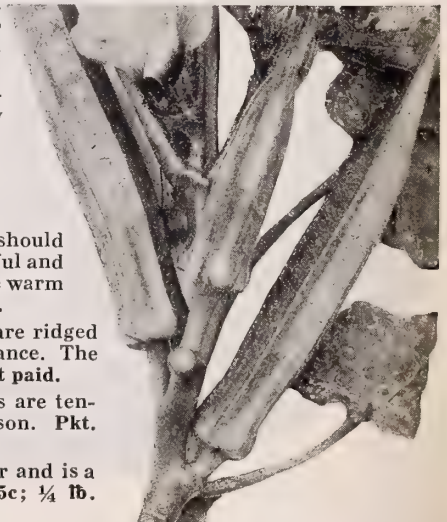

White Velvet Okra

SEED POTATOES



Irish Cobbler Potato

CULTURE.—One peck will plant 125 feet of row; 8 to 10 bushels will plant 1 acre. The land should be gotten into fine mellow condition. Mark it off into rows 3 feet apart and run a furrower along so as to make a furrow about 4 inches deep. Apply Schwill's Truck Fertilizer along this furrow with a distributor or by hand. The furrower should be run along 2½ inches deep, after the fertilizer is applied, to mix it with the soil. Drop the seed 15 inches apart and cover with a cultivator arranged to throw the earth back into the furrow. Cultivate frequently after the potatoes come up, and do not "hill up" more than just enough to cover the potatoes which form near the surface. If there is danger of frost soon after the potatoes come up, they may be covered with earth without injuring them at all.

Red Triumph One of the earliest potatoes grown, round in shape, pink skin, white flesh, with deeply indented eyes and of handsome appearance. It seems to be specially adapted to the southern soil and climate and is a great favorite with southern truckers for an extra early variety. It is also largely grown as a second crop sort.

Tennessee Second Crop Red Triumph Southern grown seed and will make bigger yields than the northern grown seed, and, as the seed are usually smaller, will therefore go farther in planting. Our stock of this variety is usually extra fine.

Irish Cobbler This is one of the most reliable, and is fast becoming one of the most popular of the early varieties for a white skin potato in the South. It is of a handsome cream-white color and of excellent quality, making it most desirable for the best trade. It is a vigorous grower, ripens uniformly and is a good keeper. In fact it is one of the best all-round early potatoes now on the market.

Early Ohio This is one of the standard varieties, and is credited with being the very earliest potato on the market. It matures a week earlier than the Early Rose. The tubers average large in size, are oval, oblong and round at seed end. A fine yielder, but does best for planting in loamy or stiff soils. Irish Cobbler seems to do best in light or sandy soils.

Early Rose The Early Rose still continues one of the most popular varieties. It is productive and of most excellent table qualities, and a most satisfactory all-round early sort. It is too well known to give any lengthy description.

Peerless A favorite general crop variety; specially adapted for light and medium soils. It is round in shape and skin is dull white. Very productive.

Burbank Of the late sorts this is more largely used than any other. It is of good size, fine form and an excellent yielder. The flesh is white and is very mealy and of fine flavor.

Lookout Mountain A distinctive type potato, and planted only in the summer for second crop. Very prolific, late and long keeping variety. Grows large, pure white tubers, very smooth and of good quality. No other variety stands out hot climate as well. We will book orders at any time for shipment during June and July, or will ship any time earlier you may order.



Early Rose Potato

FOR PRICES ON IRISH POTATOES, SEE PINK PRICE LIST, PAGE 97.

SEED SWEET POTATOES

All Seed Sweet Potatoes will be shipped about the 15th of March, as weather before that time is entirely too cold, and potatoes will rot when handled or bedded too early. We absolutely make no guarantee whatever on them. They leave our store in good condition, and will be shipped at buyer's risk only.

Nancy Hall Skin yellow; meat, which is a clear amber color, is as sweet as honey.

Bunch Yellow Yam Finest quality, yellow skin and flesh.

Early Triumph Sweet Potato Flesh bright light yellow, of good size, very prolific and three weeks earlier than any other variety; very large, smooth skin, cook soft; vine running.

Gold Coin Bunch Yam Dark yellow flesh; matures early; vine bushy habit.

Genuine Yellow Yam The old reliable running yam, deep yellow; flesh cooks soft.

Southern Queen Matures very early; very productive; white flesh; vine running.



Nancy Hall Sweet Potato

Porto Rica Yam This is a new Sweet Potato and a good one. The skin is golden color with a slight pinkish tinge. Meat deep orange yellow, soft and sweet, tubers long and smooth, a very desirable shape. It is one of the sweetest sweet potatoes that we have ever tried. Take our word for Porto Rica; it is a superb and desirable variety. You will like it.

Florida Yam Sweet Potatoes A new variety from the South, which has been tested by some of our growers the past two seasons, and found to be one of the best. The Florida Yam is earlier, has deeper yellow flesh and is more productive than the latter variety. They will make 300 bushels to the acre and come early, and when you have a deep yellow meated variety that is ready for the market early in August it will make the grower money.

SWEET POTATO SLIPS
See Page 37.

FOR PRICES ON SWEET POTATOES, SEE PINK PRICE LIST, PAGE 97.



SCHWILL'S GARDEN PEAS

CULTURE.—One quart will sow about 125 feet of drill. Sow the extra early, smooth varieties as early in spring as possible, in rows 3 feet apart. Peas should be rather crowded in the rows. The soil should be rich, but light and warm; cultivate several times, as this increases the yield considerable. Most peas do best if given a support of brush or other material. The wrinkled sorts marked (*) are more sensitive to cold and should never be planted before March 1st.

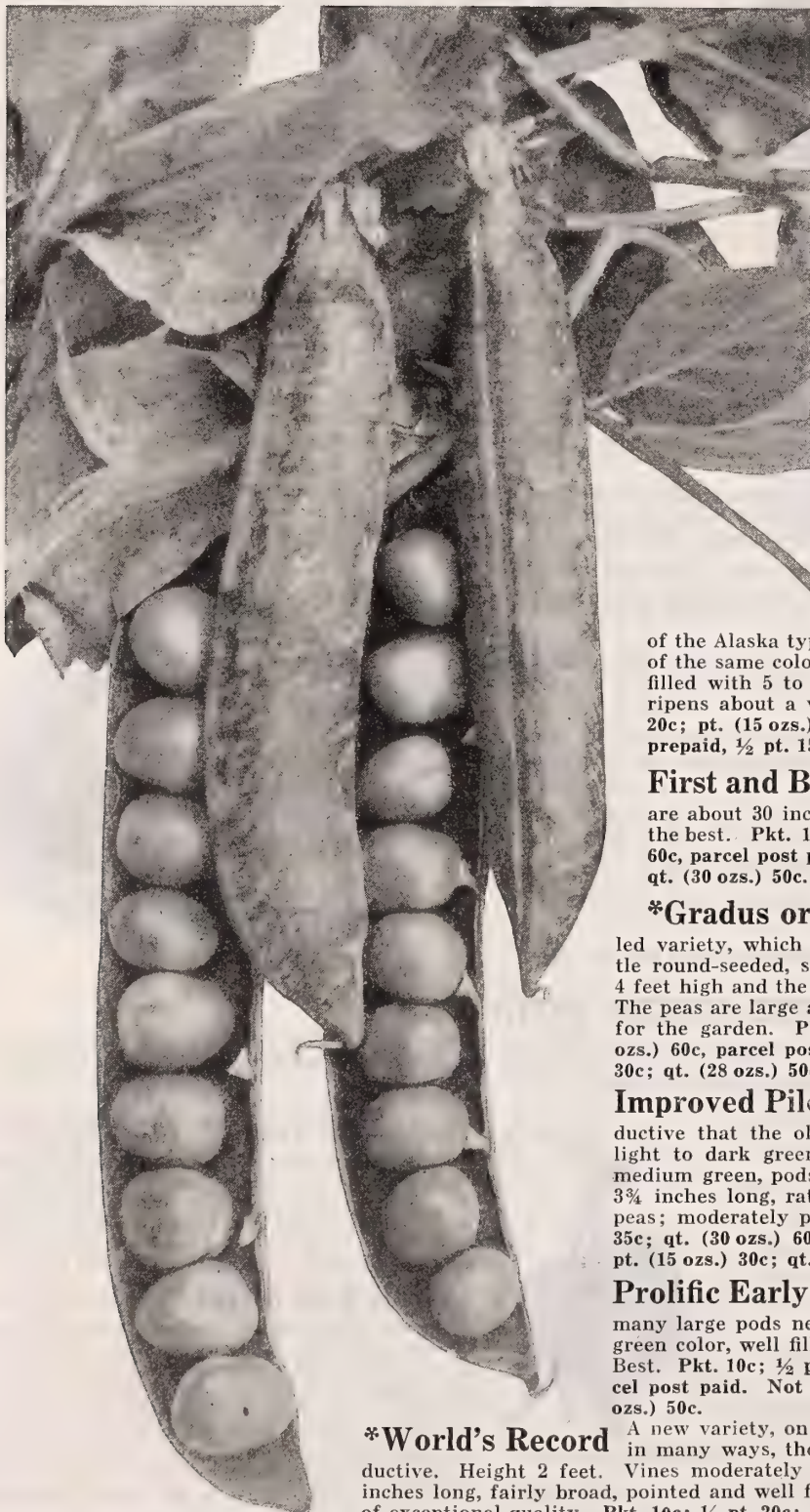

World's Record

EXTRA EARLY AND EARLY VARIETIES

***American Wonder** The earliest of the dwarf, wrinkled sorts. The vines are 9 to 12 inches high and produce a good crop of well filled pods, nearly 3 inches long, containing 5 to 7 large peas. Very sweet and tender. The seed is pale green, flattened and wrinkled. Pkt. 10c; ½ pt. 20c; pt. (14 ozs.) 35c; qt. (28 ozs.) 60c, parcel post paid. Not prepaid, ½ pt. 15c; pt. (14 ozs.) 30c; qt. (28 ozs.) 50c.

Alaska This is the earliest of all small podded peas. Universally used for first planting; the vines are a distinctive light green, and from 2 to 3 feet high. Pods are dark green, about 2½ inches long, straight and well filled with small, smooth blue-green peas of excellent flavor. This pea is a heavy yielder and a favorite among market gardeners. Pkt. 10c; ½ pt. 20c; pt. (15 ozs.) 35c; qt. (30 ozs.) 60c, parcel post paid. Not prepaid, ½ pt. 15c; pt. (15 ozs.) 30c; qt. (30 ozs.) 50c.

Ameer, or Large Alaska A fine variety which is rapidly becoming more popular with those who want a larger podding pea of the Alaska type. The vine is 3 feet high, more vigorous and of the same color as the Alaska. Pods are one-third larger and filled with 5 to 7 large round peas of fine flavor. The crop ripens about a week later than the Alaska. Pkt. 10c; ½ pt. 20c; pt. (15 ozs.) 35c; qt. (30 ozs.) 60c, parcel post paid. Not prepaid, ½ pt. 15c; pt. (15 ozs.) 30c; qt. (30 ozs.) 50c.

First and Best Extra Early; one of the earliest tall varieties, with smooth, white peas. Vines are about 30 inches high; pods short and well filled; quality the best. Pkt. 10c; ½ pt. 20c; pt. (15 ozs.) 35c; qt. (30 ozs.) 60c, parcel post paid. Not prepaid, ½ pt. 15c; pt. (15 ozs.) 30c; qt. (30 ozs.) 50c.

***Gradus or Prosperity** This pea is an extremely early large-podded, wrinkled variety, which matures only a few days later than the little round-seeded, small-podded varieties. The vines are nearly 4 feet high and the pods are very large, well shaped and pointed. The peas are large and light green in color. One of the best sort for the garden. Pkt. 10c; ½ pt. 20c; pt. (14 ozs.) 35c; qt. (28 ozs.) 60c, parcel post paid. Not prepaid, ½ pt. 15c; pt. (14 ozs.) 30c; qt. (28 ozs.) 50c.

Improved Pilot A popular market gardeners' large podded extra early, smooth pea, much more productive than the old type Pilot, with larger pods. Seed large, light to dark green in color. Height about 2½ feet. Foliage medium green, pods a shade darker, peas dark green. Pods are 3¼ inches long, rather long and pointed and containing 6 to 7 peas; moderately productive. Pkt. 10c; ½ pt. 20c; pt. (15 ozs.) 35c; qt. (30 ozs.) 60c, parcel post paid. Not prepaid, ½ pt. 15c; pt. (15 ozs.) 30c; qt. (30 ozs.) 50c.

Prolific Early Market A smooth white seeded variety variety, extra early, bearing very many large pods nearly 3 inches long, blunt-ended and of light green color, well filled. This is a productive strain of First and Best. Pkt. 10c; ½ pt. 20c; pt. (15 ozs.) 35c; qt. (30 ozs.) 60c, parcel post paid. Not prepaid, ½ pt. 15c; pt. (15 ozs.) 30c; qt. (30 ozs.) 50c.

***World's Record** A new variety, on the order of the Gradus, which it resembles in many ways, though slightly earlier, more dwarfed and productive. Height 2 feet. Vines moderately stout, light green; pods medium green, 3½ inches long, fairly broad, pointed and well filled with 7 to 9 very large, dark green peas, of exceptional quality. Pkt. 10c; ½ pt. 20c; pt. (14 ozs.) 35c; qt. (28 ozs.) 60c, parcel post paid. Not prepaid, ½ pt. 15c; pt. (14 ozs.) 30c; qt. (28 ozs.) 50c.

FOR PRICES IN LARGE QUANTITIES, SEE PINK PRICE LIST, PAGE 97.



SCHWILL'S GARDEN PEAS

EXTRA EARLY AND EARLY VARIETIES

CONTINUED

New Saxonia The pods are 3½ to 4 inches long, and appear in great quantities, mostly in pairs. Matures quite early, and is of good quality. Pkt. 10c; ½ pt. 20c; pt. (15 ozs.) 35c; qt. (30 ozs.) 60c, parcel post paid. Not prepaid, ½ pt. 15c; pt. (15 ozs.) 30c; qt. (30 ozs.) 50c.

Schwill's Leader An extra early pea; produces large, well-filled pods of luscious peas. Vines 2½ to 3 feet in height. Pods as large as the Telephone, containing 6 to 9 peas of large size. Pkt. 10c; ½ pt. 20c; pt. (15 ozs.) 35c; qt. (30 ozs.) 60c, parcel post paid. Not prepaid, ½ pt. 15c; pt. (15 ozs.) 30c; qt. (30 ozs.) 50c.

***McLean's Little Gem** An early wrinkled variety, maturing a little later than the American Wonder. A dwarf pea; bears profusely and of excellent quality. Pkt. 10c; ½ pt. 20c; pt. (14 ozs.) 35c; qt. (28 ozs.) 60c, parcel post paid. Not prepaid, ½ pt. 15c; pt. (14 ozs.) 30c; qt. (28 ozs.) 50c.

***Nott's Excelsior** This fine early pea has strong, vigorous vines, is uniform in growth and a heavy yielder. This is a dwarf variety. The pod measure nearly 3 inches, and are straight and round. Very sweet and of fine quality. Pkt. 10c; ½ pt. 20c; pt. (14 ozs.) 35c; qt. (28 ozs.) 60c, parcel post paid. Not prepaid, ½ pt. 15c; pt. (14 ozs.) 30c; qt. (28 ozs.) 50c.

MEDIUM AND LATE VARIETIES

***Champion of England** A very productive standard main crop variety, one of the best flavored of the late peas. The vines are 4 to 5 feet high, and the foliage is medium green. The pods are medium dark green, broad and nearly straight, and about 3 inches long. We have a fine stock of these peas. Pkt. 10c; ½ pt. 20c; pt. (14 ozs.) 35c; qt. (28 ozs.) 60c, parcel post paid. Not prepaid, ½ pt. 15c; pt. (14 ozs.) 30c; qt. (28 ozs.) 50c.

Large White Marrowfat This variety is very tall, about 5 feet, and of strong growth. The pods are about 3 inches long, round, light green and somewhat rough. The peas are large, round, smooth and creamy yellow. It is a very desirable variety for summer use and is undoubtedly one of the most productive of the garden peas. Pkt. 10c; ½ pt. 20c; pt. (15 ozs.) 35c; qt. (30 ozs.) 60c, parcel post paid. Not prepaid, ½ pt. 15c; pt. (15 ozs.) 30c; qt. (30 ozs.) 50c.

Pride of the Market A handsome, large podded, smooth-seeded blue pea. Grows to the height of 2½ feet. A good late variety. Pkt. 10c; ½ pt. 20c; pt. (15 ozs.) 35c; qt. (30 ozs.) 60c, parcel post paid. Not prepaid, ½ pt. 15c; pt. (15 ozs.) 30c; qt. (30 ozs.) 50c.

Mammoth Melting Sugar (Edible Pods) This is a tall variety, bearing large, flat, brittle pods, which are entirely stringless; which are cooked like string beans. This fine pea should be more generally used. Pkt. 15c; ½ pt. 30c; pt. (15 ozs.) 45c; qt. (30 ozs.) 80c, parcel post paid. Not prepaid, ½ pt. 25c; pt. (15 ozs.) 40c; qt. (30 ozs.) 70c.

***Telephone** A standard variety, grows tall and large; peas are wrinkled and of fine quality. Vines and foliage are strong and heavy, medium green. One of the best main crop varieties. Pkt. 10c; ½ pt. 20c; pt. (14 ozs.) 35c; qt. (28 ozs.) 60c, parcel post paid. Not prepaid, ½ pt. 15c; pt. (14 ozs.) 30c; qt. (28 ozs.) 50c.

***Potlatch** Strong, vigorous vines of even growth, about 2 feet high, with luxuriant dark foliage, bearing pods medium green in color 3½ to 4 inches in length. Seed green, wrinkled, large in size. Pkt. 10c; ½ pt. 20c; pt. (14 ozs.) 35c; qt. (28 ozs.) 60c, parcel post paid. Not prepaid, ½ pt. 15c; pt. (14 ozs.) 30c; qt. (28 ozs.) 50c.

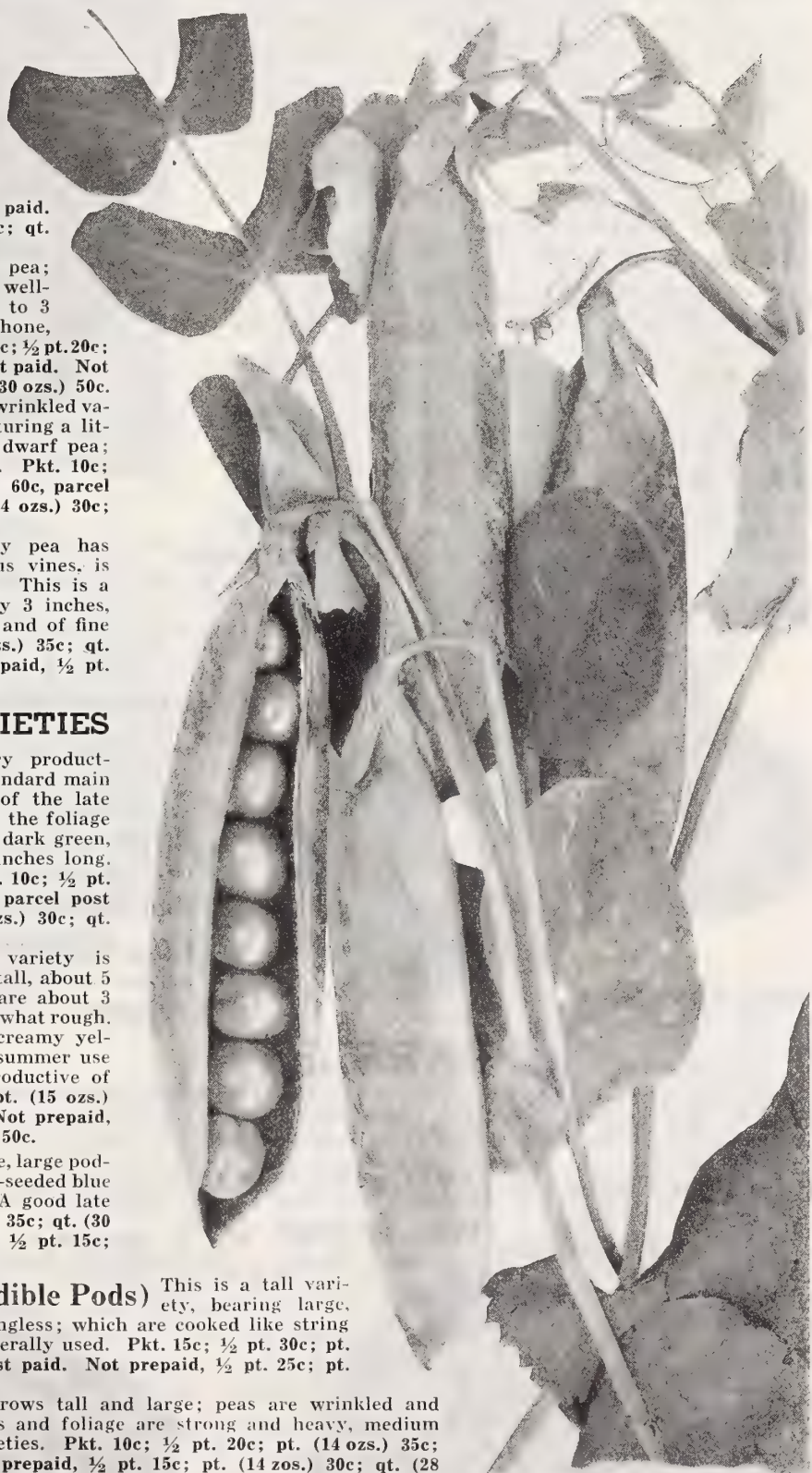

Champion of England Peas



PEPPERS SWEET AND HOT

CULTURE.—One ounce will produce about 1,000 plants. Sow in hot bed in March and transplant to the open ground as soon as the weather is warm and settled. Set in 3-foot rows about 2 feet apart. Cultivate well and keep free from weeds; hen manure or Schwill's Truck Grower Fertilizer worked into the soil when the plants are young will greatly increase the yield.

Chinese Giant Plant dwarf, fruit of mammoth size, very broad but rather short. It is very late and a rather shy yielder. Popular on account of its large size and mild flavor. Pkt. 10c; ½ oz. 50c; 1 oz. 90c; 2 oz. \$1.70; ¼ lb. \$2.50; 1 lb. \$9.00, parcel post paid.

Crimson Giant An early maturing large size sweet pepper, similar in shape to Chinese Giant, but much longer, and flesh thicker. It is exceptionally mild and very prolific; earlier than the Chinese Giant. Pkt. 10c; ½ oz. 50c; 1 oz. 90c; 2 oz. \$1.70; ¼ lb. \$2.50; 1 lb. \$9.00, parcel post paid.

Ruby King A pepper of large size, well known and much esteemed by truck growers. When ripe, its color is a beautiful ruby red, very attractive and of good quality. Pkt. 10c; ½ oz. 40c; 1 oz. 80c; 2 oz. \$1.50; ¼ lb. \$2.25; 1 lb. \$7.50, parcel post paid.

Bell, or Bull Nose A well known variety; large and oblong, bright crimson, and a good bearer; not as sweet as the Chinese Giant. Pkt. 10c; ½ oz. 40c; 1 oz. 80c; 2 oz. \$1.50; ¼ lb. \$2.25; 1 lb. \$7.50, parcel post paid.



Chinese Giant Pepper

Pimento Pepper

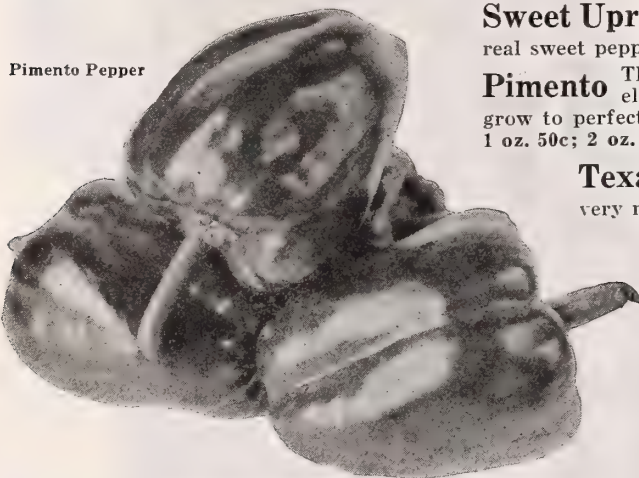

Sweet Upright Fruits as early as Bell or Bull Nose, but larger, thick-meat-ed, and always mild; the most productive variety of all real sweet peppers. Pkt. 10c; ½ oz. 40c; 1 oz. 80c; 2 oz. \$1.50; ¼ lb. \$2.75.

Pimento This is a heart-shaped variety, most all meat. Very mild and of elegant flavor. Requires rich and plenty of moisture to make fruits grow to perfection. This is the variety used by canners. Pkt. 10c; ½ oz. 30c; 1 oz. 50c; 2 oz. 90c; ¼ lb. \$1.50; 1 lb. \$5.50, parcel post paid.

Texas, or Sweet Italian A new sort, of recent introduction. The fruits are nearly heart-shaped, very mild and exceedingly prolific. They mature quite early, are green first, turning to red at maturity. It has become quite popular on account of its being both early and prolific. Pkt. 10c; ½ oz. 40c; 1 oz. 80c; 2 oz. \$1.50; ¼ lb. \$2.75; 1 lb. \$10.00, parcel post paid.

Bird's Eye, or Creole Very hot, small, roundish pods; used for pepper vinegar. Pkt. 10c; ½ oz. 40c; 1 oz. 75c, parcel post paid.

Red Chili Small and very pungent, used for chili sauces. Pkt. 10c; ½ oz. 40c; 1 oz. 75c, parcel post paid.

Long Red Cayenne Bright red, long in shape, very pungent. Pkt. 10c; ½ oz. 40c; 1 oz. 60c; 2 oz. \$1.00; ¼ lb. \$1.75; 1 lb. \$5.50, parcel post paid.

Tabasco Very pungent and strong. Pkt. 10c; ½ oz. 40c; 1 oz. 75c; 2 oz. \$1.40; ¼ lb. \$2.50, parcel post paid.

PEPPER PLANTS—See Page 37.

PARSLEY

CULTURE.—One ounce will sow 150 feet of drill. Sow early in the spring in drills a foot apart. The seed germinate slowly, often 2 or 3 weeks will elapse before the plants will make their appearance. Often it fails entirely in dry weather. Thin to 6 or 8 inches and keep the soil loose.

Double, or Curled Leaves crimped or curled; used principally as a garnish. Pkt. 5c; 1 oz. 15c; 2 oz. 25c; ¼ lb. 40c; 1 lb. \$1.00, parcel post paid.

Plain, or Single Stronger in flavor than the curled varieties. Pkt. 5c; 1 oz. 15c; 2 oz. 25c; ¼ lb. 40c; 1 lb. \$1.00, parcel post paid.



Double Curled Parsley



Bell or Bull Nose Pepper

SCHWILL'S PUMPKINS

CULTURE.—One pound will plant 40 to 50 hills; 5 pounds will plant one acre. Plant in hills 8 to 10 feet apart each way, four seed to the hill. For a good crop the soil should be rich. Cultivate same as cucumbers or melons. Pumpkins should not be planted in the garden, as they will readily mix with squash, much to the detriment of same. Many pumpkins are raised between corn hills, where they should be planted about 15 feet apart.

Kentucky Field Large, round, flattened fruits, much ribbed and creamy-buff in color; flesh is salmon color and very deep; of fine quality and one of the best for canning. Also grown extensively for stock, in the South. Pkt. 5c; 1 oz. 10c; 2 oz. 15c; ¼ lb. 30c; 1 lb. 85c, parcel post paid.

King of Mammoth The giant among pumpkins; specimens have been grown to weigh 250 pounds and reaching 2 feet or more in diameter. Fruits are almost round, skin orange-colored and slightly rough. Flesh deep and yellow, quality excellent. A fine variety to plant, where only a few hills are wanted. Pkt. 5c; 1 oz. 20c; 2 oz. 30c; ¼ lb. 50c; 1 lb. \$1.75, parcel post paid.

Connecticut Field Generally used for planting in corn for stock feeding, and also for making pies. Fruit rather oblong, flattened at the ends; often 15 inches in diameter; smooth, hard, reddish-orange skin with rich orange-yellow flesh. Pkt. 5c; 1 oz. 15c; 2 oz. 25c; ¼ lb. 35c; 1 lb. \$1.00, parcel post paid.

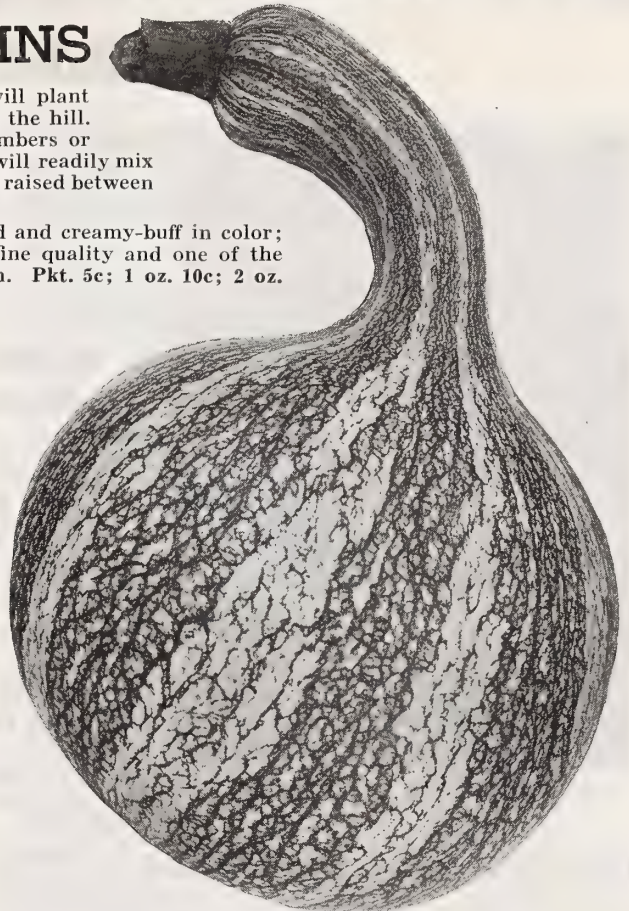

Striped Cushaw Pumpkin

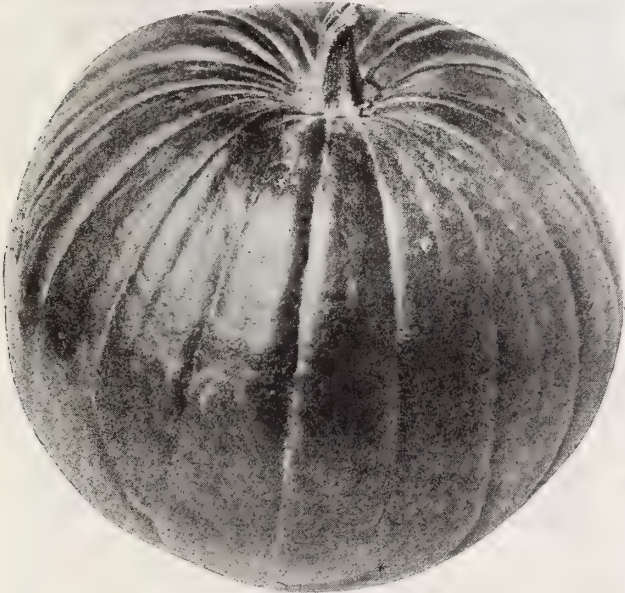

Kentucky Yellow Field Pumpkin

Japanese Pie Shaped somewhat like the Cushaws and grows to a large size; skin deep green with dark stripes and rough ridges on the neck; flesh deep yellow and of the highest quality; seeds sculptured like Chinese letters. This is one of the best varieties to plant for home use. Pkt. 5c; 1 oz. 15c; 2 oz. 25c; ¼ lb. 40c; 1 lb. \$1.25, parcel post paid.

Tennessee Sweet Potato Of medium size and nearly bell-shaped, with neck slightly crooked; skin creamy white, sometimes slightly striped with green; flesh creamy white, deep, fine-

grained, and of excellent quality. One of the favorite old Southern sorts. Pkt. 5c; 1 oz. 20c; 2 oz. 35c; ¼ lb. 50c; 1 lb. \$1.50, parcel post paid.

Striped Cushaw This pumpkin is of the crookneck type with mottled green and white stripes. The neck is rather small. Fruit often attains a weight of 15 pounds; flesh is yellow, very solid and fine-grained. An excellent variety for culinary purposes. Pkt. 5c; 1 oz. 20c; 2 oz. 35c; ¼ lb. 50c; 1 lb. \$2.00, parcel post paid.

PARSNIPS

CULTURE.—One ounce will sow 200 feet of drill; 5 pounds required for 1 acre. Like all root crops, they do best on a deep, rich, sandy soil, but will make good roots on any soil that is deep and mellow. As the seed is sometimes slow to germinate, it should be sown as early as possible in spring, in drills 2 to 2½ feet apart; cover with ½ inch soil and press the seed down firmly. Thin the plants to 5 or 6 to the foot; cultivate frequently during the summer to insure rapid growth. In fall the roots may be taken up and stored in root cellars or pits for winter use.

Sugar, or Hollow Crown As the name indicates, the tops grow out of a hollow in the crown. The roots are very long, white, tender and sweet. A very popular variety. Pkt. 5c; 1 oz. 20c; 2 oz. 35c; ¼ lb. 50c; 1 lb. \$1.75, parcel post paid.

Long Smooth Roots are very long, sugary, and of most excellent flavor. This variety is very hardy, making good crops where others fail. Pkt. 5c; 1 oz. 20c; 2 oz. 35c; ¼ lb. 50c; 1 lb. \$1.85, parcel post paid.

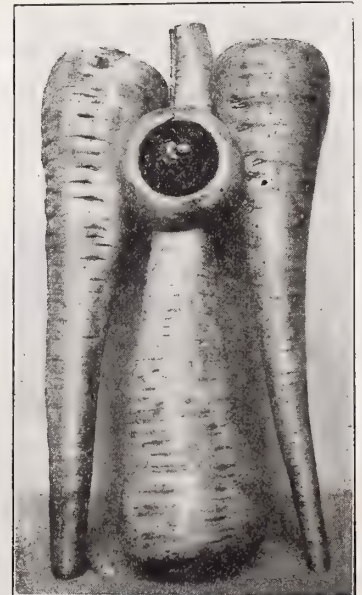

Sugar or Hollow Crown Parsnip

SCHWILL'S RADISHES



Schwill's Perfection Scarlet Turnip White Tip Radish

CULTURE.—Sow in open ground, in spring, as soon as the soil can be worked. Sow in rich, sandy loam, in drills 18 inches apart; thin plants to prevent crowding. Keep the soil loose and apply a little nitrate of soda—this will cause rapid growth, which is essential to secure tender roots. Sow every ten days for succession. After May it is best to plant the summer and winter varieties.

FORCING.—Sow in hotbed or under glass in rich, well pulverized soil; scatter seed over the surface, about 100 to the square foot, and cover lightly with sifted soil. Water carefully to keep the soil moist. For rapid root development, the temperature must be moderate and even. Good ventilation is necessary. The crop should be off in 25 to 40 days.

ROUND AND OLIVE-SHAPED VARIETIES

Schwill's Early Bird This is a splendid strain of small, extra early, round, bright red radish. We have frequently had them ready for use in 18 to 20 days after sowing the seed. Skin is bright scarlet; flesh pure white, crisp, tender, and mild in flavor. Pkt. 5c; 1 oz. 15c; 2 oz. 25c; ¼ lb. 45c; 1 lb. \$1.50, parcel post paid.

Schwill's Perfection Scarlet Turnip, White Tipped A special stock White Tipped radish, bright rose above with a large white tip; very showy and distinct; of excellent quality. Matures in 24 days and is very crisp, tender and mild; can be used outdoors or in frames. Pkt. 5c; 1 oz. 20c; 2 oz. 30c; ¼ lb. 50c; 1 lb. \$1.75, parcel post paid.

Early Scarlet Turnip A well known and highly esteemed variety; extensively grown for market. A turnip-shaped sort; skin bright scarlet, flesh white; a very quick grower. Pkt. 5c; 1 oz. 15c; 2 oz. 25c; ¼ lb. 40c; 1 lb. \$1.50, parcel post paid.

Crimson Giant Suitable both for forcing or early planting out of doors. A remarkable feature is that it will grow double the size of other round red forcing Radishes and still remain solid, not showing the least sign of becoming hollow. In shape it is round to oval and very attractive. The flesh is mild and tender. Pkt. 5c; 1 oz. 15c; 2 oz. 25c; ¼ lb. 45c; 1 lb. \$1.50, parcel post paid.

Cooper's Sparkler, White Tipped A comparatively new variety. Globular in shape, rosy carmine, with white tip. Solid and crisp; very short top. This is a splendid variety and very popular on many markets. Pkt. 5c; 1 oz. 20c; 2 oz. 30c; ¼ lb. 50c; 1 lb. \$1.75, parcel post paid.

Vick's Scarlet Globe One of the earliest and best for forcing; color a very handsome shade of scarlet; mild flavor, crisp and juicy; stands a great amount of heat without becoming pithy. This variety does equally well for forcing and outdoor planting. Pkt. 5c; 1 oz. 20c; 2 oz. 30c; ¼ lb. 50c; 1 lb. \$1.75, parcel post paid.

Early White Turnip This is a very desirable white summer radish; grows a round, smooth root. Very crisp and firm. Pkt. 5c; 1 oz. 15c; 2 oz. 25c; ¼ lb. 40c; 1 lb. \$1.50, parcel post paid.

Scarlet Turnip White Tip Forcing The best for forcing under glass; has short tops, roots bright red with large white tip; one of the earliest for forcing and a favorite with market gardeners. Pkt. 5c; 1 oz. 20c; 2 oz. 30c; ¼ lb. 50c; 1 lb. \$1.75, parcel post paid.



French Breakfast Radish



Schwill's Early Bird Radish

Early Scarlet Turnip, White Tipped One of the handsomest of the turnip radishes, and a great favorite. Color very deep scarlet with a distinct white tip; flesh white and of the very best quality. Extensively grown for market. Pkt. 5c; 1 oz. 15c; 2 oz. 25c; ¼ lb. 45c; 1 lb. \$1.50, parcel post paid.

French Breakfast Of oblong form, color bright carmine with clear white in the lower portion. Very tender and mild. Good outdoors or under glass. Pkt. 5c; 1 oz. 15c; 2 oz. 25c; ¼ lb. 45c; 1 lb. \$1.50, parcel post paid.

Yellow Summer A yellow turnip-rooted sort, which stands the hot weather better than any of the yellow varieties. Of good flavor and excellent quality. Pkt. 5c; 1 oz. 15c; 2 oz. 25c; ¼ lb. 45c; 1 lb. \$1.50, parcel post paid.

Round Black Spanish This splendid winter variety should be better known; roots are round and sometimes top shaded. Grows to large size and is an excellent keeper. Flesh is white, firm and of good quality. Pkt. 5c; 1 oz. 15c; 2 oz. 25c; ¼ lb. 45c; 1 lb. \$1.50, parcel post paid.



SCHWILL'S RADISHES



Chartier or Sheperd Radish

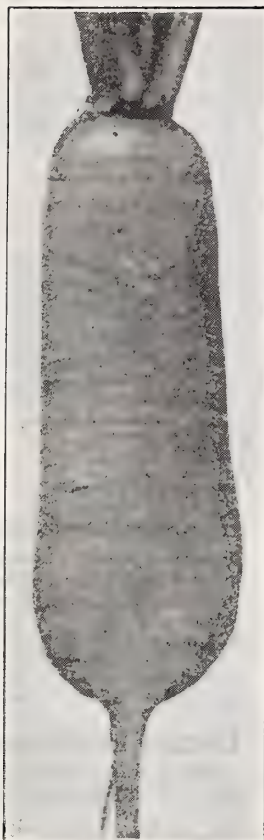

China Rose Winter Radish



White Icicle Radish

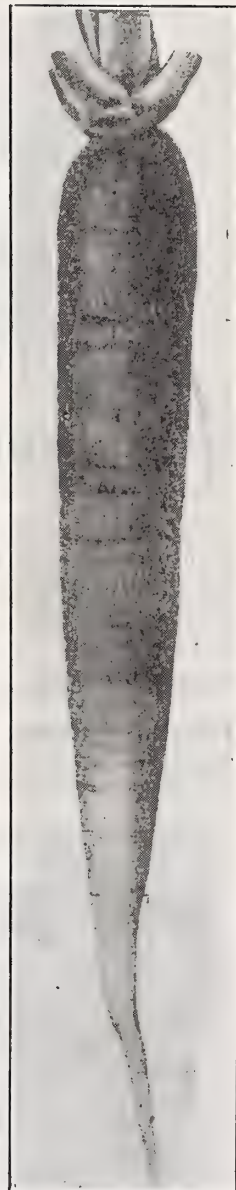

Long Scarlet Short Top Radish

LONG SHAPED VARIETIES

Long Black Spanish One of the latest and hardiest varieties for winter use; grows to large size; roots 8 to 9 inches long and 2 to 3 inches in diameter, nearly black in color. The flesh is white, very firm and of good quality; a very popular market variety. Pkt. 5c; 1 oz. 15c; 2 oz. 25c; ¼ lb. 40c; 1 lb. \$1.50, parcel post paid.

Schwill's Superb Radish Mixture A superb mixture of all kinds of radishes, early, medium, fall, winter, etc. Sow a row of it and it will furnish you delicious radishes throughout the year. Pkt. 5c; 1 oz. 15c; 2 oz. 25c; ¼ lb. 40c; 1 lb. \$1.50, parcel post paid.

White Icicle One of the best early long, white sorts, suitable either for forcing or growing outside. Roots some-

what shorter and tops smaller than White Vienna. Very crisp and tender and of a beautiful waxy white color. Pkt. 5c; 1 oz. 20c; 2 oz. 30c; ¼ lb. 50c; 1 lb. \$1.75, parcel post paid.

Long Scarlet Short Top The best of the long red radishes. It is very early, of good size, fine quality; most largely planted of all long red radishes. Pkt. 5c; 1 oz. 15c; 2 oz. 25c; ¼ lb. 40c; 1 lb. \$1.50, parcel post paid.

Half Long Deep Scarlet The roots of this hardy and desirable sort are of a very brilliant, deep, rich red color and half long, with a somewhat tapering point; the flesh is very white, crisp and tender; of quick growth and seldom pithy. Pkt. 5c; 1 oz. 15c; 2 oz. 25c; ¼ lb. 40c; 1 lb. \$1.50, parcel post paid.

White Vienna, or Lady Finger A medium early maturing, long white summer radish; roots are 6 to 7 inches long, white, slender and smooth. This variety grows more above the ground than the Icicle and consequently is more or less tinged with green at the top of the root. Pkt. 5c; 1 oz. 15c; 2 oz. 25c; ¼ lb. 40c; 1 lb. \$1.50, parcel post paid.

China Rose, Winter One of the very best winter sorts, roots are cylindrical, or largest near the bottom, stump-rooted, or blunt at both ends; skin smooth and bright, deep rose color; flesh white, crisp and pungent; the roots are 4 to 5 inches long and 2 inches thick. Pkt. 5c; 1 oz. 10c; 2 oz. 20c; ¼ lb. 35c; 1 lb. \$1.25, parcel post paid.

Chartier, or Sheperd A very good, long summer sort; roots are 7 to 8 inches long and rather thick, deep scarlet at the top, shading to white at the tip. Pkt. 5c; 1 oz. 15c; 2 oz. 25c; ¼ lb. 40c; 1 lb. \$1.50, parcel post paid.

California Mammoth, Winter A large late or winter variety. The large, white roots grow 10 to 12 inches long and 3 to 4 inches in diameter at the shoulder, tapering regularly to the tip; flesh crisp, firm and decidedly pungent. Pkt. 5c; 1 oz. 20c; 2 oz. 30c; ¼ lb. 45c; 1 lb. \$1.50, parcel post paid.



RHUBARB

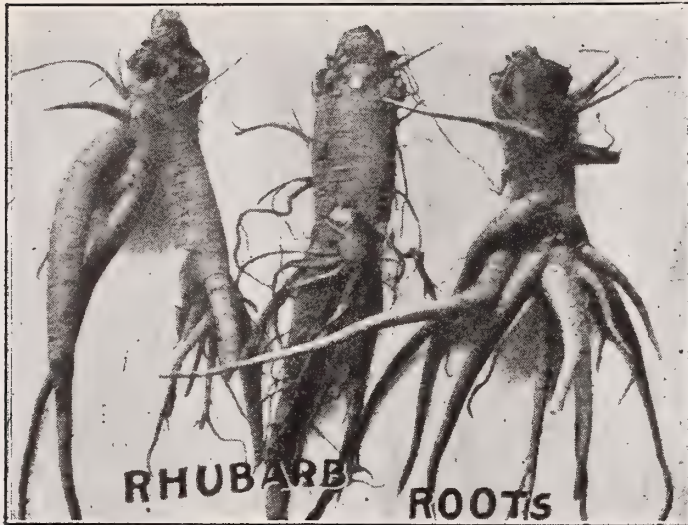

CULTURE.—Rhubarb roots for setting out can be easily grown from seed in a single season. The seed should be sown in shallow drill or seed bed in the spring, using 1 ounce to 125 feet of drill. When well started, thin to stand 10 to 12 inches apart. Cultivate well. The stalks should not be cut before the third year. For immediate use, order roots, which come into use at once.

Victoria Seed The most popular variety. Pkt. 5c; 1 oz. 30c, parcel post paid.

Rhubarb Roots We can supply fine roots of above variety. 1-yr. roots each 15c; doz. \$1.25. 2-yr. roots each 35c; doz. \$2.50, parcel post paid. Not prepaid, 1-yr. roots each 10c; doz. \$1.00. 2-yr. roots each 25c; doz. \$2.00.



Salsify,
Mammoth Sandwich Island

SALSIFY

CULTURE—One ounce will plant 100 feet of drill; about 8 pounds to the acre, in rows. This plant is grown largely for winter market. Seed should be sown thinly in shallow drills about 18 inches apart, and when well started, should be thinned to stand 3 or 4 inches apart in the row. Cultivate frequently to keep the soil loose and fine. Very large, fine roots can be grown in deep rich soil. The roots are hardy, and can be left in the ground during the winter, but it is best to dig them carefully, cut off the leaves and store in a root cellar or moist earth.

Mammoth Sandwich

Island This variety is large, strong growing, and less liable to branch than the other sorts. Pkt. 5c; 1 oz. 25c; 2 oz. 40c; ¼ lb. 75c; 1 lb. \$2.50, parcel post paid.

SORREL

A hardy plant—grown for its leaves, which are used as boiling "greens" or salad, also for making soup. Seed should be sown thinly, in drills, early in spring. When well started, thin to stand 4 to 6 inches apart in the row. The leaves can be gathered for use at any time after the plants are well started in growth, and the roots will continue to produce a further supply.

Large-Leaved French Pkt. 10c; 1 oz. 35c; 2 oz. 60c;

SPINACH

CULTURE—One ounce will sow 60 feet of drill; 8 to 10 pounds to the acre. For an early summer crop, sow early in spring, in drills 1 foot apart, and thin to 2 inches in the row. For winter or spring crop, sow either broadcast or in drills about the 1st of September, or later. The soil should always be rich and well pulverized.



Spinach, Broad Leaf Flanders

Bloomsdale Savoy Leaved A valuable variety with wrinkled leaves, resembling the Savoy Cabbage. It is very hardy and prolific. The most popular sort. Pkt. 5c; 1 oz. 15c; 2 oz. 25c; ¼ lb. 40c; 1 lb. \$1.25, parcel post paid.

Victoria One of the best varieties for spring growing, as it stands fully two weeks longer than any other sort before running to seed. Pkt. 5c; 1 oz. 15c; 2 oz. 25c; ¼ lb. 40c; 1 lb. \$1.75, parcel post paid.

Round Leaf Summer A desirable sort for early spring sowing; leaves large, bright green and of good quality. Pkt. 5c; 1 oz. 15c; 2 oz. 25c; ¼ lb. 40c; 1 lb. \$1.25, parcel post paid.

New Zealand Grows 1½ feet high and, if transplanted two or three feet will produce an abundant crop in the hot weather when the ordinary spinach cannot be had. Pkt. 10c; 1 oz. 20c; 2 oz. 35c; ¼ lb. 60c; 1 lb. \$2.00, parcel post paid.

Broad-Leaved Flanders One of the most vigorous and strong-growing varieties. The leaves are nearly round, uniformly deep green, quite thick and slightly crimped in the center. Pkt. 5c; 1 oz. 15c; 2 oz. 25c; ¼ lb. 40c; 1 lb. \$1.25, parcel post paid.

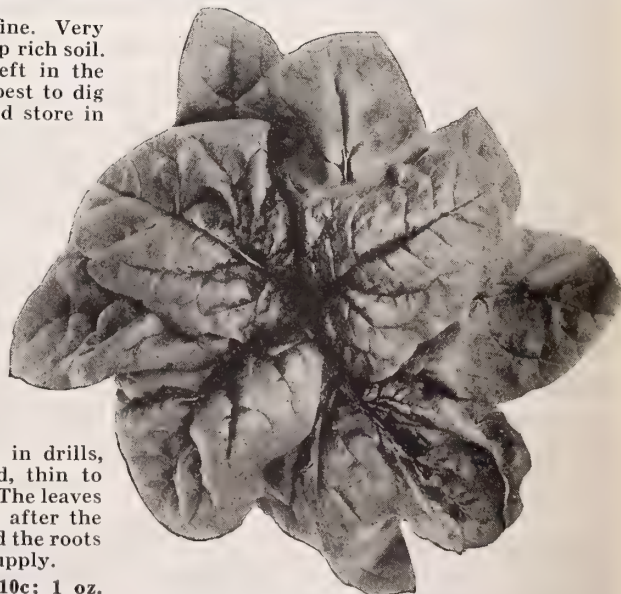

Spinach, Bloomsdale Curled Savoy

SCHWILL'S SQUASH SEED

CULTURE.—One ounce will plant about 40 or 50 hills; 3 or 4 pounds to the acre. Sow as soon as the weather becomes warm and settled, in hills, about 4 feet apart. Cultivate often to keep the weeds down, and the soil loose. The late varieties should be planted about 6 feet apart.

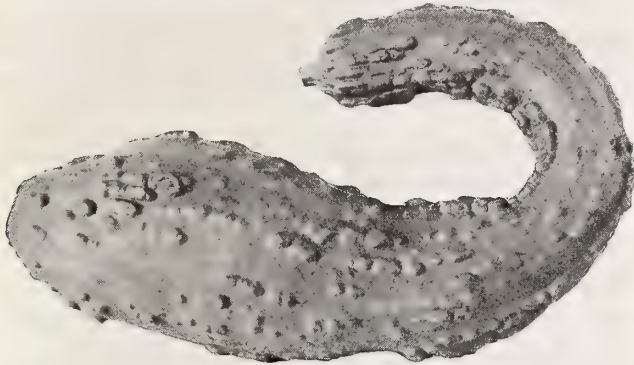

Yellow Summer Crookneck Squash

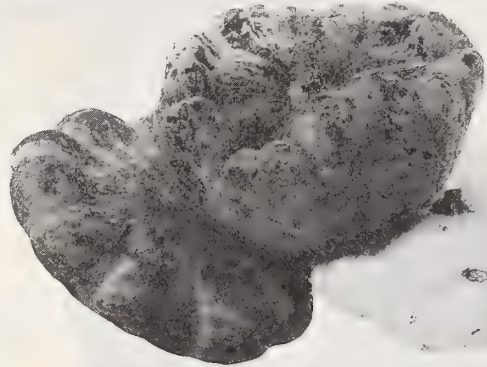

Golden Custard Squash—Early White Bush Squash

Early White Bush Extremely early; one of the best for summer use. Fruit white, with scalloped edges. Grown extensively by market gardeners. Pkt. 5c; 1 oz. 15c; 2 oz. 25c; ¼ lb. 35c; 1 lb. \$1.25, parcel post paid.

Mammoth White Bush An improved variety of the well known White Bush Squash, growing 12 to 25 inches across; of uniform shape, of a beautiful white color, very early and prolific. Pkt. 5c; 1 oz. 15c; 2 oz. 25c; ¼ lb. 35c; 1 lb. \$1.25, parcel post paid.

Hubbard One of the best winter squashes; flesh bright orange yellow, fine-grained, very dry, sweet and richly flavored. Pkt. 5c; 1 oz. 15c; 2 oz. 25c; ¼ lb. 35c; 1 lb. \$1.25, parcel post paid.

Delicious A fall or winter sort, of medium size; top-shaped in form, dark green in color. The flesh is dark orange, very sweet, dry and delicious. An excellent keeper. Pkt. 5c; 1 oz. 15c; 2 oz. 25c; ¼ lb. 35c; 1 lb. \$1.25, parcel post paid.

Golden Custard This is a flattened, scalloped bush squash of the largest size. Flesh is pale yellow and of very fine flavor. Except for color, this squash is identical with the Mammoth White Bush. This is a splendid yellow variety to plant. Pkt. 5c; 1 oz. 15c; 2 oz. 25c; ¼ lb. 35c; 1 lb. \$1.25, parcel post paid.



Fordhook Squash

Yellow Summer Crookneck A standard, early and productive summer sort; skin bright yellow, much wanted; fruit about 1 foot long. Pkt. 5c; 1 oz. 15c; 2 oz. 25c; ¼ lb. 40c; 1 lb. \$1.50, parcel post paid.

Giant Yellow Summer Crookneck The largest and one of the earliest summer varieties, being twice as large as the ordinary Crooknecks. The fruit is often two feet long, very warty, and of excellent quality. Pkt. 5c; 1 oz. 20c; 2 oz. 35c; ¼ lb. 50c; 1 lb. \$1.75, parcel post paid.

Fordhook A small, oblong variety, excellent for summer or winter; fruits 8 to 10 inches long, slightly ridged; skin smooth, thin and yellow; flesh very thick, creamy yellow, extremely dry and sweet. Pkt. 5c; 1 oz. 15c; 2 oz. 25c; ¼ lb. 35c; 1 lb. \$1.25, parcel post paid.

Vegetable Marrow An English variety for summer and fall use. Produces large oblong fruit, dark green at first, but becomes marbled with yellow as it matures. Grows about 9 inches long; the flesh is white and the shell pale yellow. Pkt. 5c; 1 oz. 15c; 2 oz. 25c; ¼ lb. 40c; 1 lb. \$1.35, parcel post paid.

Golden Hubbard Quite like the old Hubbard in form and habit, but decidedly earlier; the shell is moderately warty, hard, strong and of a rich orange red color; flesh deep orange, dry and of best quality. Pkt. 5c; 1 oz. 15c; 2 oz. 25c; ¼ lb. 35c; 1 lb. \$1.25, parcel post paid.

Boston Marrow Large-fruited, hard shell sort, for winter use. In form and size similar to Hubbard; shell bright orange, flesh yellow and firm; the best for pies and canning. Vines running, very productive. Pkt. 5c; 1 oz. 15c; 2 oz. 25c; ¼ lb. 35c; 1 lb. \$1.25, parcel post paid.



Swiss Chard

SWISS CHARD

Silver Beet, or Cut and Come Again Spinach.

This vegetable is grown for its leaves and stalks, which make excellent greens. Sow the seed early in spring, in rich, well-drained soil, in drills 1½ feet apart. Thin to 6 or 8 inches, and cultivate like spinach. The leaves can be used as soon as they are large enough to cut without destroying the plant. It is also a good green feed for chickens. Good cultivation increases the tenderness of the leaves. Pkt. 5c; 1 oz. 20c; 2 oz. 35c; ¼ lb. 60c; 1 lb. \$2.00, parcel post paid.



SCHWILL'S SELECT TOMATOES

CULTURE.—One ounce of seed will produce from 2,000 to 3,000 plants. Sow the seed in hotbeds during March. When the plants are 2 inches high transplant into cold frames, plan boxes, paper pots or earth bands. After all danger of frost is over, set these plants into the open ground. The soil should be warm, mellow and fertile. Set plants 4 feet apart each way. To insure best results, it is advisable to train tomato vines to stakes or trellises. Cultivate often, and as long as the plants permit.



Earliana Tomato

Schwill's Premier The largest and smoothest of the extra early red tomatoes. Ripens a few days ahead of Earliana; the fruits are larger and smoother. The vines grow very compactly, are immensely productive, better still, bear continuously throughout the season, in which respect it far surpasses the Earliana. Pkt. 5c; 1 oz. 50c; 2 oz. 90c; ¼ lb. \$1.50; 1 lb. \$4.50, parcel post paid.

Earliana The earliest and best of the very early tomatoes, very productive for an early sort; fruit of fair size, round, very smooth and solid, and produced in clusters in center of the plant; color bright scarlet. Pkt. 5c; 1 oz. 35c; 2 oz. 60c; ¼ lb. \$1.00; 1 lb. \$3.25, parcel post paid.

June Pink In habit of growth, productiveness and size of fruit, identical with Earliana, differing only in having purple fruit; the best extra early purple or pink fruited variety. Pkt. 5c; 1 oz. 35c; 2 oz. 60c; ¼ lb. \$1.00; 1 lb. \$3.25, parcel post paid.



Livingston's Globe Tomato

John Bear This variety produces the largest fruit of the extra early sorts. The fruits are large, nearly round, smooth, firm, of excellent quality; color bright red. Pkt. 5c; 1 oz. 50c; 2 oz. 75c; ¼ lb. \$1.25; 1 lb. \$4.00, parcel post paid.

Bonny Best A prolific early sort, being only a few days later than Earliana. The fruits are very smooth, solid and uniform, and produce in clusters in center of the plant and ripens more uniformly than any other early scarlet fruited sort; color bright red. Pkt. 5c; 1 oz. 35c; 2 oz. 60c; ¼ lb. \$1.00; 1 lb. \$3.50, parcel post paid.

Early Detroit This splendid variety is the largest and best of the early purplish pink tomatoes. The fruits are very smooth, uniform in size, nearly globe-shaped, firm and of excellent quality. Early Detroit is most valuable as a shipping variety as well as for home or market use. Pkt. 5c; 1 oz. 50c; 2 oz. 85c; ¼ lb. \$1.50; 1 lb. \$4.50, parcel post paid.

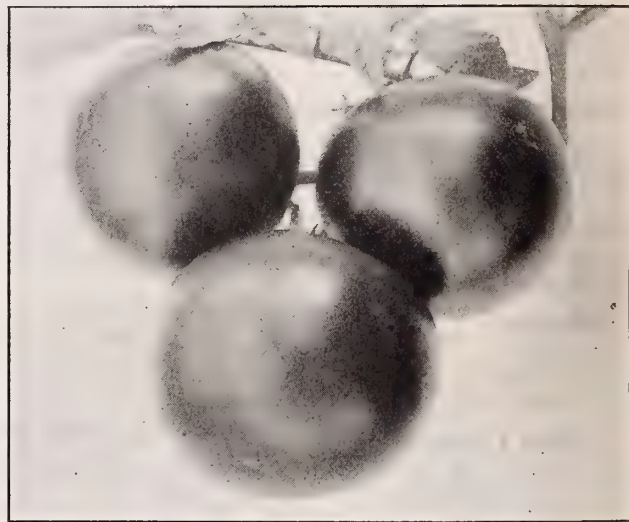

Early Detroit Tomato

Acme A well known, hardy, early and productive sort; fruit of fair size, round and smooth; color purplish pink. Acme is solid and of excellent flavor. Pkt. 5c; 1 oz. 35c; 2 oz. 60c; ¼ lb. 95c; 1 lb. \$3.50, parcel post paid.

Livingston's Globe A very vigorous, productive, medium early tomato, much in favor with Southern truckers as a shipping sort. Fruit globe shape, smooth and solid; color purplish pink. Pkt. 5c; 1 oz. 40c; 2 oz. 70c; ¼ lb. \$1.25; 1 lb. \$4.00, parcel post paid.

Large Trophy A very large, mid-season or main crop tomato, of a beautiful rich deep crimson-scarlet color, of excellent quality. The fruits are very solid, smooth and of uniform size. Pkt. 5c; 1 oz. 40c; 2 oz. 70c; ¼ lb. \$1.25; 1 lb. \$4.00, parcel post paid.

Beauty A productive main crop variety; fruits large and exceptionally smooth, solid and of excellent quality; color purplish-pink. This is one of the best mid-season or main crop varieties for table use. Pkt. 5c; 1 oz. 35c; 2 oz. 60c; ¼ lb. 95c; 1 lb. \$3.25, parcel post paid.

Red Rock A very fine selection of the Matchless type; medium early, round, smooth and bright red, makes a good canning variety. Pkt. 5c; 1 oz. 35c; 2 oz. 60c; ¼ lb. 95c; 1 lb. \$3.25, parcel post paid.

Truckers' Favorite A popular purple-fruited, on the order of the Beauty, and of the same general habit of growth; the fruit is, however, more flat. It is a main crop variety, maturing the same season as Schwill's Red Majestic, and equally as productive. Pkt. 5c; 1 oz. 40c; 2 oz. 70c; ¼ lb. \$1.00; 1 lb. \$3.75, parcel post paid.

SCHWILL'S SELECT TOMATOES

Perfection A medium to large main crop tomato, of deep crimson-scarlet color. The fruits are nearly round, uniformly smooth and even in size. Vines very vigorous and productive. Pkt. 5c; 1 oz. 35c; 2 oz. 60c; ¼ lb. 90c; 1 lb. \$3.25, parcel post paid.

Favorite Very prolific, solid, and ripens early and evenly; smooth, free from cracks, holds its size till end of season and of first class quality. Fine canner; color dark red. Pkt. 5c; 1 oz. 35c; 2 oz. 60c; ¼ lb. 90c; 1 lb. \$3.25, parcel post paid.

Colossal So named on account of its size. Deep red in color, smooth and solid. Ripens mid-season; a profitable variety. Pkt. 10c; 1 oz. 60c; 2 oz. \$1.00; ¼ lb. \$1.50, parcel post paid.

Schwill's Red Majestic A main crop sort of superior merit. The fruits are very large, smooth and symmetrical, ripening well to the stem. The flesh is rich, bright red in color, and of fine quality. Pkt. 5c; 1 oz. 40c; 2 oz. 75c; ¼ lb. \$1.25; 1 lb. \$4.00, parcel post paid.

Stone The standard and general favorite with truckers and canners; always dependable, very vigorous and productive; fruits round, large, solid, smooth and deep red in color. The most popular of the late or main crop sorts. Pkt. 5c; 1 oz. 35c; 2 oz. 60c; ¼ lb. \$1.00; 1 lb. \$3.25, parcel post paid.



Stone Tomato

Ponderosa An exceptionally large, purple-fruited tomato, and for home use one of the best, fruits very solid, with few seeds. We have a very much improved stock of this variety which lacks considerable of the roughness and tendency to split which it formerly possessed. Pkt. 5c; 1 oz. 60c; 2 oz. 90c; ¼ lb. \$1.60; 1 lb. \$5.50, parcel post paid.

Red Pear Used for preserving and to make "tomato figs." Fruits bright, distinctly pear-shaped and of excellent flavor. Our stock is the true pear-shaped. Pkt. 10c; 1 oz. 60c, parcel post paid.

Peach Desirable for preserving or for table decoration. The fruit resembles a peach in shape and size and the color is a light terra cotta red with a delicate bloom. The flesh is of good flavor. Pkt. 10c; 1 oz. 60c, parcel post paid.

Yellow Pear Fruits similar to the Red Pear, but of rich, clear, yellow color, and quite distinct from the variety sometimes sold under this name. Pkt. 10c; 1 oz. 60c, parcel post paid.

Strawberry, or Husk Very sweet, mild flavor; used for preserves. Vines low and spreading. Fruits small, about ½-inch in diameter, enclosed in a loose husk. The seed we offer is that of the true Strawberry or Husk. Pkt. 10c; 1 oz. 60c, parcel post paid.

Golden Queen Large, smooth fruits, of a beautiful golden color; quality excellent; attractive for slicing and mixing with sliced red sorts. Pkt. 10c; 1 oz. 50c; 2 oz. 90c; ¼ lb. \$1.50, parcel post paid.

Dwarf Champion Sometimes called Tree Tomato. It is a medium early, purplish-pink variety. The vines are about 2 feet high, vigorous, upright and compact. The fruits are medium size, smooth and of good quality. Very desirable where garden space is limited. Pkt. 5c; 1 oz. 35c; 2 oz. 60c; ¼ lb. 90c; 1 lb. \$3.00, parcel post paid.

Schwill's Red Majestic Tomato

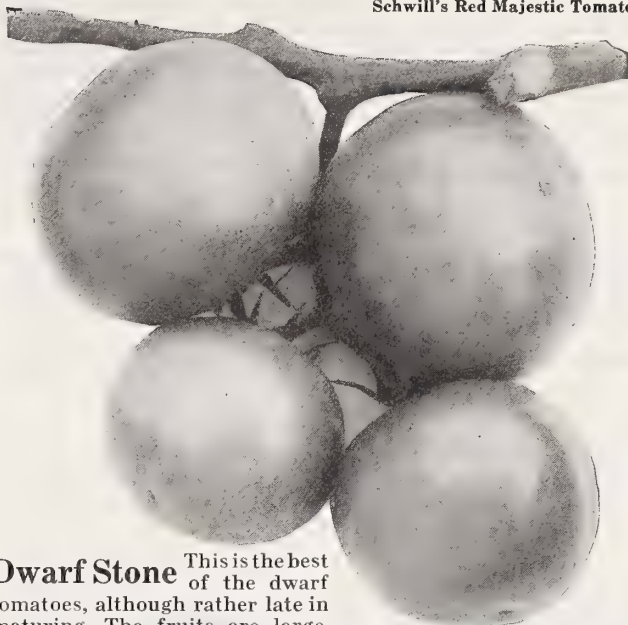

Dwarf Stone This is the best of the dwarf tomatoes, although rather late in maturing. The fruits are large, smooth, round, very solid, and of a deep scarlet color. Pkt. 10c; 1 oz. 60c; 2 oz. \$1.00; ¼ lb. \$1.50; 1 lb. \$5.25, parcel post paid.

Dwarf Ponderosa Compact, bushy habit; fruit immense in size, of a rich purple-crimson color, and as solid as a rock, perfectly smooth; like all dwarf tomatoes, the plants are vigorous and do not blight as easy as the running or vine varieties. Pkt. 10c; 1 oz. 60c; 2 oz. \$1.00; ¼ lb. \$1.50, parcel post paid.

TOMATO PLANTS—See Page 37.

TOBACCO

CULTURE.—One ounce of good seed is sufficient for an acre. Sow seed for plants early in spring in frames or seedbed, using soil well enriched with wood ashes, etc. Transplant to open ground when weather has become warm and settled, in rows 4 feet apart, and give cultivation as for corn.

Havana The leaf is very thin and is of fine texture. The variety is much used for cigar wrappers. Pkt. 10c; 1 oz. 50c, parcel post paid.

White Burley A favorite for plug fillers and wrappers. Pkt. 10c; 1 oz. 40c, parcel post paid.

Connecticut Seed Leaf A hardy cigar variety, well adapted to growing in the middle and northern states. Pkt. 10c; 1 oz. 40c, parcel post paid.

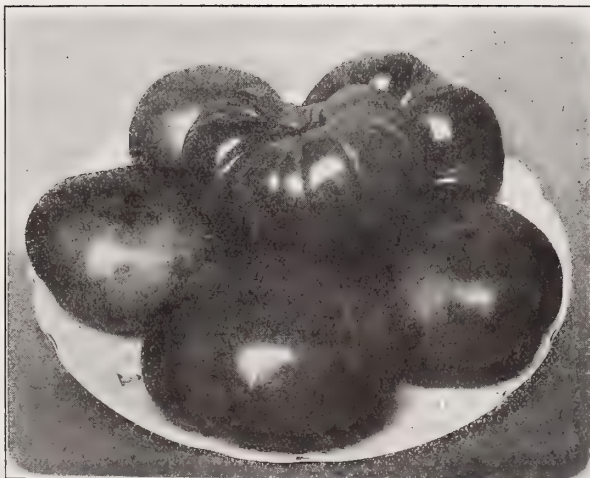

Dwarf Ponderosa Tomato

TURNIPS AND RUTABAGAS

CULTURE.—One ounce will sow 200 feet of drill; 1 to 2 lbs. for an acre. For early use, sow seed of flat varieties in open ground in spring, in drills 1 foot or more apart, using seed sparingly. Thin to 3 or 4 inches apart. For succession sow every two weeks until May. For fall and winter sow in August and September. A good crop may often be grown by scattering seed thinly in the cornfield at the last cultivation.

Large White Globe Of perfect globe shape; skin white and smooth; leaves large and dark green. Pkt. 5c; 1 oz. 15c; 2 oz. 25c; ¼ lb. 40c; 1 lb. \$1.50, parcel post paid.

Extra Early White Egg Is very early, tender and crisp; the shape is oblong, resembling an egg. Pkt. 5c; 1 oz. 15c; 2 oz. 25c; ¼ lb. 35c; 1 lb. \$1.25, parcel post paid.

Early White Flat Dutch S. L. A very quick-growing white variety, adapted for spring sowing. Pkt. 5c; 1 oz. 15c; 2 oz. 25c; ¼ lb. 40c; 1 lb. \$1.50, parcel post paid.

Red or Purple Top Flat Strap Leaf An early flat sort; crown purplish-red, white below, flesh white. Will make a crop sown among corn. Pkt. 5c; 1 oz. 15c; 2 oz. 25c; ¼ lb. 40c; 1 lb. \$1.50, parcel post paid.



Large White Globe



American Red Top Globe

Extra Early Purple Top Milan Similar to White Milan, except roots are a little flatter and purple-red on upper portion. All in all, the Milan turnips leave nothing more to be desired in the way of an extra early garden turnip. Pkt. 5c; 1 oz. 25c; 2 oz. 40c; ¼ lb. 75c; 1 lb. \$2.50, parcel post paid.

Mammoth Purple Top White Globe Flesh white and of excellent quality; shape is nearly a globe; skin white at bottom, purple at top. Pkt. 5c; 1 oz. 20c; 2 oz. 35c; ¼ lb. 60c; 1 lb. \$2.00, parcel post paid.

American Red Top White Globe A large globular variety, very even in shape and of handsome appearance. The crown is purplish red and the remaining portion clear white. The flesh is white, of excellent quality and desirable for table use. The variety is a good keeper and a fine market sort. Pkt. 5c; 1 oz. 20c; 2 oz. 35c; ¼ lb. 60c; 1 lb. \$2.00, parcel post paid.

Long White Cowhorn A very productive, quick-growing turnip, of excellent quality, fine-grained and very sweet. Often used as a soil improver. Pkt. 5c; 1 oz. 15c; 2 oz. 25c; ¼ lb. 40c; 1 lb. \$1.50, parcel post paid.

Purple Top Yellow Aberdeen A medium-sized, round, late-maturing yellow turnip. Roots yellow with purple crown; flesh pale yellow. Pkt. 5c; 1 oz. 20c; 2 oz. 35c; ¼ lb. 50c; 1 lb. \$1.75, parcel post paid.

Large Amber Globe Grows to a large size, skin yellow, with green crown. Flesh yellow. Pkt. 5c; 1 oz. 20c; 2 oz. 35c; ¼ lb. 50c; 1 lb. \$1.75, parcel post paid.

Superb Mixed Turnip A mixture of all varieties, lasting from early fall to the following spring. Pkt. 5c; 1 oz. 15c; 2 oz. 25c; ¼ lb. 40c; 1 lb. \$1.25, parcel post paid.

Seven Top Cultivated extensively in the South for tops, which are used for greens. It is very hardy and will grow all winter. Pkt. 5c; 1 oz. 15c; 2 oz. 25c; ¼ lb. 40c; 1 lb. \$1.25, parcel post paid.

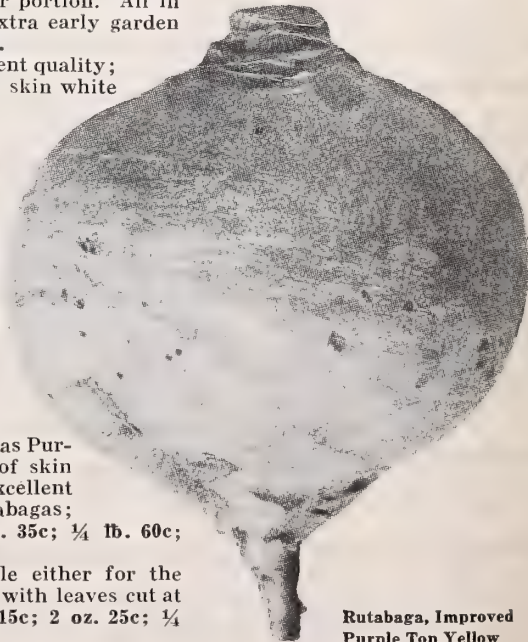

Rutabaga, Improved Purple Top Yellow

RUTABAGA

Swedish or Russian Turnips.

Improved Purple Top Yellow Grows the same shape and size as Purple Top Globe Turnips. Color of skin yellow with purple crown. Flesh deep yellow, fine grained and of excellent quality. It is an excellent keeper. The top is much shorter than most Rutabagas; it has absolutely no neck and is a rapid grower. Pkt. 5c; 1 oz. 20c; 2 oz. 35c; ¼ lb. 60c; 1 lb. \$2.00, parcel post paid.

White, or Sweet Russian An excellent keeper and very desirable either for the table or for stock. The tops are small, with leaves cut at the edges. The roots are very large, nearly globe-shaped. Pkt. 5c; 1 oz. 15c; 2 oz. 25c; ¼ lb. 45c; 1 lb. \$1.50, parcel post paid.



SCHWILL'S VEGETABLE PLANTS

All orders for vegetable plants will be filled in season when plants are in right condition, and at the right time. See dates below when different varieties are ready for shipment.

We can supply in any quantity, in their proper season, all vegetable plants, here mentioned, and ship directly from beds, well packed, on the shortest notice. NOTICE—If we should for any reason be out of any variety ordered, we will send some other similar variety in place of it, unless requested to the contrary.

At prices quoted, they are sent by express at purchaser's expense, excepting where noted by mail. As plants are perishable, we advise all large lots to be forwarded by express.

Brussels Sprouts Plants

Ready March 10th to May 1st.

Prices, Strong Hotbed Stock, doz. 30c; 50 for 65c; 100 for \$1.10, parcel post paid. By express, not prepaid, doz. 20c; 50 for 50c; 100 for 85c.

Beet Plants

Ready March 10th to May 1st.

Eclipse Early Detroit Crosby Egyptian

Prices, Hotbed Stock, 50 for 35c; 100 for 60c, parcel post paid. By express, not prepaid, 50 for 25c; 100 for 45c; 500 for \$2.00.

Cauliflower Plants

Ready March 10th, and up to May 1st.

Early Snowball Dry Weather

Prices, Strong Hotbed Stock, doz. 35c; 50 for \$1.15; 100 for \$1.75, parcel post paid. By express, not prepaid, doz. 25c; 50 for \$1.00; 100 for \$1.50.

Celery Plants

Ready April 15th, and up to June 1st.

Hend White Plume Golden Self-Blanching

Prices, Hotbed Stock, doz. 25c; 50 for 50c; 100 for 75c; 500 for \$2.50, parcel post paid. By express, not prepaid, doz. 15c; 50 for 40c; 100 for 65c; 500 for \$2.25.

Frost-Proof Cabbage Plants

Ready January 1st.

These are hardy outdoor-grown plants that will stand any kind of weather. The seed is planted in October and November, in a section in the South especially suited for this purpose. We are growing several million of plants this year, and will be able to supply all orders. By recent experiments, we have located a desirable climatic condition near the Gulf, and the plants will be satisfactory in every way.

The use of open air, practically frost-proof, cabbage plants often enables the truck gardener to put full-grown heads of cabbage on the market two to three weeks ahead of the ordinary home-grown plants, and, of course, he gets the top price for his crop.

The Frost-Proof Plants may not look a bright green color, like the tender hotbed seedlings, as naturally their outdoor winter growth, standing through frosts, light freezes, discolors them and gives them a stunted appearance. Set them out, and their excellent growth, as soon as the weather warms up, will make you forget how they looked.

These plants are from the very best grown seed, and will be sent both from Memphis and from our grower at purchaser's option at prices below.

Will have the following varieties:

Early Jersey Wakefield Early Flat Dutch and
Charleston or Large Wakefield Succession

Prices, by parcel post, 100 for 45c; 500 for \$2.00; 1000 for \$3.35. No orders filled for less than 100 plants of a variety.

By express, not prepaid, 100 for 35c; 500 for \$1.75; 1000 for \$3.00.

Hotbed Cabbage Plants

These are grown in hotbeds and are, of course, a bright green looking plant, but they should not be planted out until the 10th or 15th of March.

Early Flat Dutch Early Jersey Wakefield
Large Late Drumhead Early Summer
Succession Charleston Wakefield

Prices, 100 for 60c; 500 for \$2.50, parcel post paid. By express, not prepaid, 100 for 50c; 1000 for \$4.00.

Egg Plants

Ready April 20th, and up to June 1st.

Black Beauty New York Improved Purple

Prices, Hotbed Stock, doz. 40c; 100 for \$1.85, parcel post paid. By express, not prepaid, doz. 30c; 100 for \$1.50.

Prices, Transplanted Stock, doz. 85c; parcel post paid. By express, not prepaid, doz. 60c; 100 for \$4.50.

Lettuce Plants

Ready March 1st, and up to May 1st.

Big Boston Large White Cabbage Head

Prices, Hotbed Stock, 50 for 35c; 100 for 60c, parcel post paid. By express, not prepaid, 50 for 25c; 100 for 45c; 1000 for \$4.00.

Pepper Plants

Ready April 20th, and up to June 1st.

Chinese Giant Long Red Grimson Giant

Prices, Hotbed Plants, doz. 40c; 100 for \$1.85, parcel post paid. By express, not prepaid, doz. 30c; 100 for \$1.50.

Prices, Transplanted Stock, doz. 85c, parcel post paid. By express, not prepaid, doz. 60c; 100 for \$4.50.

Sweet Potato Plants

Ready April 25th, and up to July 1st.

Florida Yam Porto Rica Yam Slips
Gold Coin Bunch Yam Nancy Hall
Bunch Yellow Yam Southern Queen
Early Triumph Yellow Yam

Prices, 100 for 60c; 500 for \$2.25; 1000 for \$4.35, parcel post paid. By express, not prepaid, per 100 50c; 1000 \$4.00.

Tomato Plants

Ready March 25th, and up to June 1st.

Our own growing; all first-class stock; varieties as follows:

Acme Livingston's Globe Ponderosa
Early Detroit Beauty Stone

Prices, Hotbed Stock, or Seedling Plants, doz. 25c; 100 \$1.00, parcel post paid. By express, not prepaid, doz. 15c; 100 for 75c; 1000 for \$4.50.

Prices, Transplanted Stock, doz. 35c; 100 \$1.85, parcel post paid. By express, not prepaid, doz. 25c; 100 for \$1.50; 1000 for \$10.00.

Prices, Potted Plants, doz. \$1.00, parcel post paid. By express, not prepaid, doz. 75c; 100 for \$5.00.



SCHWILL'S SEED CORN



Paymaster Corn

Paymaster Corn Similar in type to the well known Tennessee White Red Cob Corn, however, the ears are not quite so large, but it produces two ears to the stalk and the cob is much smaller, with well filled butts and tips, and will shell more corn. Paymaster Corn was originated in Tennessee, which makes it a truly Southern variety, and has been proven that Southern corns are the best. While Paymaster Corn is not offered as a prize winning corn, it has won several first prizes, but we are offering a variety that will produce more corn to the acre than any variety that has only one large ear. The seed stock we are offering was grown by us on both our Mississippi and Tennessee farms. Qt. (28 ozs.) 40c; 4 qts. (7 lbs.) 90c, parcel post paid.

Mosby's Prolific This is a Southern corn, and is recommended for general crop. It is purely white, small cob, deep full grain, neither too hard nor too soft, and stands crowding in the drill as close again as any other kind. Ears of medium size, but long. Our stock is extra select and pure this season. Qt. (28 ozs.) 35c; 4 qts. (7 lbs.) 85c, parcel post paid.

Schwill's Prize Medal The largest white corn grown; matures in 120 days. It is vigorous, healthy, a rank grower and an enormous yielder. A deep, near gourd seed grain, sound as a dollar, ears a full foot long. On good ground will make 60 to 75 bushels to the acre. A whacking big ear with a big stalk. Truly a Southern favorite. It is also a fine ensilage variety on account of its heavy foliage and stalk. Qt. (28 ozs.) 40c; 4 qts. (7 lbs.) 90c, parcel post paid.

Big Rockdale Ears large, 10 to 13 inches, weigh 1 to 1 1/4 pounds. Medium early, cob small with deep white grains. It is one of the best big-eared Southern field corns for main crop, either for rich bottom or fertile uplands. Qt. (28 ozs.) 40c; 4 qts. (7 lbs.) 90c, parcel post paid.

North Carolina White Prolific A fine variety of white field corn. It is very hardy and can be planted very early, as well as late. Qt. (28 ozs.) 35c; 4 qts. (7 lbs.) 85c, parcel post paid.

Schwill's Ninety-Day Early White One of the earliest. Planted on or about March 20, it will be ready to gather July 1. Qt. (28 ozs.) 35c; 4 qts. (7 lbs.) 75c, parcel post paid.

St. Charles White, Red Cob Makes good stout stalks, medium height, ears 8 inches, pure white grain on medium red cob, a desirable corn for the South. Qt. (28 ozs.) 30c; 4 qts. (7 lbs.) 75c, parcel post paid.

Snowflake Ears 9 to 12 inches in length; matures in 90 to 100 days. Grain pure white; a sure cropper. Qt. (28 ozs.) 35c; 4 qts. (7 lbs.) 85c, parcel post paid.

Mexican June This is a valuable addition to our large and selected list of field corn, best adapted for the South, has been thoroughly tested in the past and has proven all that was claimed for it. It is a strong, robust grower, sending the roots deep into the soil. Stands heat and drouth well. Ears large, small grain and well covered with shucks. Should be planted in succession from middle of April to end of July. Qt. (28 ozs.) 40c; 4 qts. (7 lbs.) 85c, parcel post paid.

Tait's White Dent A pure white early corn, bearing two good ears to the stalk, maturing in 90 to 100 days. The cobs are unusually small for the size of the corn. The ears are medium-sized, 14-rowed. Plant it for early crop, as it makes before summer drouths. Qt. (28 ozs.) 40c; 4 qts. (7 lbs.) 85c, parcel post paid.

Champion White Pearl A highly bred, pure white 90-day corn, large ear and a heavy yielder. Ears about 12 inches long and average 1 pound in weight. Uniform in weight, size and color. Qt. (28 ozs.) 40c; 4 qts. (7 lbs.) 85c, parcel post paid.



Schwill's 90-day White Corn

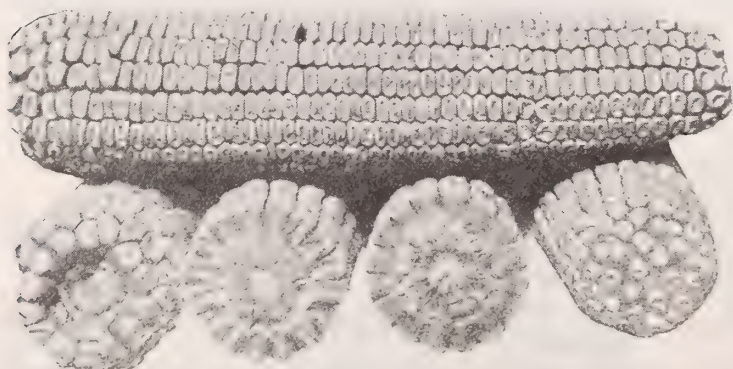

Mosby Prolific Corn

Iowa Silver Mine A fine white corn, growing about 7 to 8 feet high. Every stalk bears a good ear—sometimes two and three. The ears are long and uniform, with usually 18 rows of deep, pure white grain. Cobs well filled; remarkably heavy cropper. Qt. (28 ozs.) 40c; 4 qts. (7 lbs.) 85c, parcel post paid.

Tennessee Red Cob, White A large, white, red cob corn. Ears are medium size, 16 to 18-rowed; grains are very large, deep, wide and thick. Matures in 100 to 110 days. This corn makes fine roasting ears and meal. Qt. (28 ozs.) 40c; 4 qts. (7 lbs.) 85c, parcel post paid.

FOR PRICES ON LARGER QUANTITIES, SEE PINK PRICE LIST, PAGES 97-98.



FOR SOUTHERN PLANTERS

New Brazilian, or Stooling Flour Corn This corn, as the name indicates, is inclined to stool, and one grain will produce, in many instances, more than one stalk. Each stalk bears 2 to 3 ears, 5 to 7 inches in circumference, 9 to 12 inches in length, and beautifully white. It produces an abundance of fodder, and is the best variety for ensilage. It yields 30 to 50 bushels of corn per acre, and the ears are fine for roasting although not sweet. It does not require a very rich soil and, therefore, the best variety for poor soils. The kernel contains more starch than any other corn, and ground and bolted by the same process as wheat, gives a fine flour that will make bread, biscuits, etc., the same as the wheat flour. Qt. (28 ozs.) 50c; 4 qts. (7 lbs.) \$1.25, parcel post paid.

Hickory King 100 days. The cob is so small and the grain is so large that when an ear is broken in half one grain will cover the entire end of the cob. Nearly all of the stalks bear two ears, and we consider it one of the best white corns grown. Does well on thin land. Qt. (28 ozs.) 40c; 4 qts. (7 lbs.) 85c, parcel post paid.

Vardaman's Stooling Corn Vardaman's Stooling Corn is a cross of Mosby's and North Carolina Prolific, and resembles the former variety; a pure white corn with good size ears that will produce from 2 to 10 ears on every hill, depending on the land. The average yield of this splendid corn for the last three years was 94 bushels per acre. Plant in rows 3 feet apart and 18 inches apart in the row, leaving two stalks to each hill. Qt. (28 ozs.) 40c; 4 qts. (7 lbs.) 90c, parcel post paid.

YELLOW VARIETIES

Iowa Gold Mine This is a very early variety, ripening in 90 days. The ears are large and the cob small; the grain is deep and a bright golden yellow. Qt. (28 ozs.) 35c; 4 qts. (7 lbs.) 75c, parcel post paid.



Golden Surprise Corn

Schwill's Ninety-Day Early Yellow This is a standard variety; matures quick and yields good crops. Is used extensively by truckers and market gardeners. Qt. (28 ozs.) 35c; 4 qts. (7 lbs.) 75c, parcel post paid.

Golden Surprise One of the finest varieties of yellow corn. Ears are large, grain very solid and exceedingly long, of attractive yellow color. The ears have 16 to 18 rows of solid grain on the cob. Matures in 100 days. Qt. (28 ozs.) 40c; 4 qts. (7 lbs.) 85c, parcel post paid.

Reid's Yellow Dent One of the oldest varieties of corn; breeds very true to type. Well adapted to rich, strong land. Ears are medium size, light yellow and deep grained, on a small red cob. Medium early. Matures in about 95 days. Qt. (28 ozs.) 35c; 4 qts. (7 lbs.) 75c, parcel post paid.

Improved Yellow Loaming A very popular and extremely productive variety. The ears are long, cob small, well filled with small, deep, orange-yellow grains. Matures in 100 to 110 days. Qt. (28 ozs.) 35c; 4 qts. (7 lbs.) 75c, parcel post paid.

Mortgage Lifter A large-eared variety of yellow corn. Matures medium early, about 95 days; a big yielder. The ears are well filled with bright yellow grains of fair size. Qt. (28 ozs.) 40c; 4 qts. (7 lbs.) 85c, parcel post paid.

Tennessee Mammoth Yellow A Southern-grown, large-eared yellow corn. The ears are of perfect shape, long, and filled to the end of cob. The grains are not of a flinty type, neither are they soft. Qt. (28 ozs.) 40c; 4 qts. (7 lbs.) 85c, parcel post paid.

Early Yellow Canada A long, 8-rowed, flint variety of yellow corn. It is very early, and is planted in both field and garden. Grows and produces well, and makes excellent roasting ears. Qt. (28 ozs.) 50c; 4 qts. (7 lbs.) \$1.00, parcel post paid.

ENSILAGE AND FODDER CORN

Red Cob White Ensilage Heavy, tall stalks, for ensilage; the very best sort.

Eureka White Ensilage Grows tall and leafy and gives fine results for an ensilage crop.

Price of the foregoing two varieties, uniform, as follows: By parcel post, qt. (28 ozs.) 40c; 4 qts. (7 lbs.) 90c, parcel post paid.

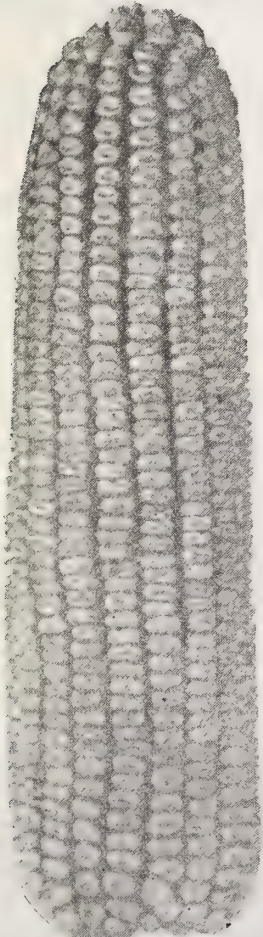

Tennessee Mammoth Yellow

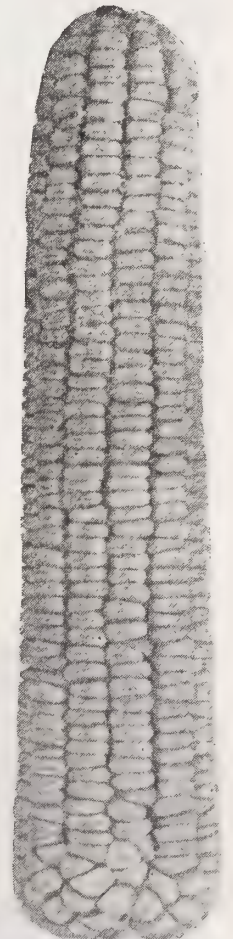

Schwill's Yellow—90-day

ALFALFA, QUEEN OF AMERICAN CROPS



Second Cutting of Alfalfa

The Kind of Land For Alfalfa.

Specialists claim that Alfalfa can be grown on any good land, providing it is properly drained and, if carbonate of lime is added, using 1 to 2 tons of lime dust, 400 pounds of acid phosphate, 16 per cent, or like amount, of bone meal, which is 24 per cent acid phosphate, to each acre, and the seed should be previously inoculated with Mulford Culture. The essential point is liming the land and furnishing the proper bacteria. The lime keeps down crab grass, which is and has been, the trouble in making Alfalfa live. Old fields of Alfalfa should be disc-harrowed and fertilized with 400 or 500 pounds of bone meal or acid phosphate to stimulate the old plant, thereby keeping down crab grass and weeds. There is one exception where Alfalfa cannot be grown—it is impossible to grow Alfalfa on wet or swampy land.

Preparation of Seed Bed For Alfalfa.

One of the most important factors necessary to guarantee success with Alfalfa is the preparation of the seed bed. Alfalfa, being a field crop, most farmers think a rough-and-tumble preparation is sufficient, and the result in most cases, is a bed totally unfit for the requirements of Alfalfa. The ground cannot be worked too thoroughly and too fine. The surface of the ground should be in as fine condition as a garden. The better the ground is worked the easier it will be to get a good and perfect stand.

Time For Sowing Alfalfa.

As to the time of seeding, this varies in different parts of the country. Thus it is impossible to set a time or a month in the year for every section or locality. There is one great principle, however, which governs the time of sowing, and if the sowing can be done in harmony with this principle, you are reasonably sure of success. Alfalfa should be sown at such times as would give the seed such amount of growth as will stand unfavorable conditions, such as cold weather, wet spells, prolonged drouth or excess of weeds.

Alfalfa may be sown in September, October or November, or during February, March and April, using 20 to 25 pounds of seed to the acre. Fall sowing should prove more profitable, although such is not always the case.

The danger of early spring planting is frost; the danger of early fall planting is drouth; the danger of late spring planting is being choked out with grass and fowl weeds; the danger of late fall planting is frost. The danger from weeds is not so great as from crab grass and foxtail. The greatest dangers are: first, dodder; second, crab grass, and, third, foxtail. Therefore, if there be no danger from crab grass or foxtail, later spring plantings might be safer. Sow Alfalfa without a nurse crop, it succeeds best when sown alone.

Bacteria For Alfalfa Seed.

The proper bacteria in soil is very necessary for growing Alfalfa successfully. In our experience Mulford's Culture is the most satisfactory to inoculate the seed, the method being very simple. We carry a supply in stock and can furnish it at all times. Full directions come with every package. Soil inoculation is also good if you have it close at hand, so the bacteria will not perish by drying out.

Pure Alfalfa Seed.

The first requisite for a successful Alfalfa meadow is good seed. There are low-priced, low-grade seeds offered in abundance, but, crop considered, they are the most expensive you can buy. The best is the cheapest in the end. If you use our seed, you are sure of the best that can be produced.

Schwill's High Grade Alfalfa, 1 lb. 50c, parcel post paid.

Baling Alfalfa Hay



FOR PRICES ON LAGER QUANTITIES,
SEE PINK PRICE LIST, PAGE 98.



SCHWILL'S HIGH-GRADE CLOVERS



Red Clover

Red Clover A valuable farm crop, largely used for pasturage and soil improvement. Yields two to three cuttings per year. First crop makes rich feed and is most valuable for hay. Clover draws nitrogen from the air largely and is one of the best soil renovating crops. Clover, intelligently used, is the farmer's best friend. Should be used as a rotation crop. Sow either in the fall or spring. September and March are the best months. Sow 10 to 12 pounds to the acre. 1 lb. 60c, parcel post paid.

Mammoth or Sapling Clover Being a rank grower, makes it most valuable for fertilizing purposes. Succeeds better on thin land than the ordinary Red Clover and also makes better hay. Sow March to April, or in the fall 10 to 12 pounds to the acre. 1 lb. 65c, parcel post paid.

Alsike Clover Thrives well on damp soils or in situations where it is impossible to secure a catch of Red Clover. Because seed goes so much further than Red Clover, and because of its comparative reasonable price this year, many farmers are giving Alsike the preference. It is also largely sown with Timothy. Sow 6 to 8 pounds to the acre in the spring. 1 lb. 50c, parcel post paid.

White Clover This variety is extremely valuable for permanent



Melilotus Clover

grass mixtures or those prepared for grazing land. It will stand more grazing than any other clover. As the growth is short it has no value in a hay crop. Much is used in lawns. Sow in spring, 4 to 6 pounds per acre. 1 lb. 75c, parcel post paid.

Crimson Clover Succeeds on most any grade of soil. Sown at the rate of 15 pounds per acre, any time after August 15th, and up to November 1st, or can be sown between cotton or corn during August, using 6 to 10 pounds to the acre. Crimson Clover furnishes good hay and adds fertility to the soil. For best results, inoculate seed with Mulford Culture. 1 lb. 35c, parcel post paid.

Japan Clover (Lespedeza Striata) To obtain a good stand, disc-harrow your land, then scatter the seed on top, roll the field; this will cover them enough. Sow in March or April. Seeds weigh 25 pounds per bushel. Sow 20 to 25 pounds per acre. Grows anywhere; is tenacious in any soil; lasts always; well known in the South. It may be classed among the most

valuable hay and pasture plants in the Southern States. 1 lb. 50c, parcel post paid.



Alsike Clover

Melilotus or Sweet Clover A variety of clover which, when young, resembles alfalfa, but on mature development grows from 4 to 6 feet in height. It is extremely vigorous and especially adapted to waste lands, though by many prominent farmers and stock raisers, is used on good land for a crop forage. It is very vigorous in growth, standing frost and drouth remarkably well, the tap root penetrating the soil very deeply, and occasionally used as a drainage plant for wet soils. It will grow on almost any barren hillside, in bottoms, and is equally adapted to all good farming lands. Sweet Clover is one of the most valuable crops for bees, being the main honey plant in many sections. We handle only the white blossom variety, which we consider the best. Seed are unhulled and require 12 to 15 pounds per acre. Can be sown either in spring or fall, preparing and sowing as you would for red clover. 1 lb. 40c, parcel post paid.

Burr Clover An annual variety which is sown in August and September. Makes superior pasturage, fair hay, and if turned under the following spring, acts as a splendid fertilizer. Grows on any thin land. Sow 10 pounds fancy hulled seed or 20 pounds in the burr, to the acre. In burr, 1 lb. 35c; hulled or cleaned seed 1 lb. 45c, parcel post paid.

GRASSES FOR LAWN,



A Beautiful Lawn

HOW TO MAKE A LAWN

The ground should be spaded deeply and thoroughly, and a good compost of decomposed and finely pulverized manure or rich loam spread over the ground. It would be well also to give a sprinkling of bone dust. Then use a slanted tooth harrow and a light or medium roller until the soil is smooth, even and firm. Then sow the seed and harrow again and smooth off with a common garden rake. When the grass has grown 2 or 3 ins. in height, use the lawn mower, gauged to cut full 1 inch above the ground, repeat the same as often as it grows to that height. The weeds and fowl grass can be kept down and destroyed by repeated mowing.

As a guide for the proper quantity to order, we may state that 1 pound of Emerald Mixed Lawn Grass Seed is sufficient to thoroughly sow an area of 15 by 15 feet—225 square feet. It should be borne in mind that in order to produce the best results, grass seeds for lawns should be sown about thrice as thick as if sown for hay.

Schwill's Emerald Lawn Grass

This is by far the best mixture of grasses offered for the purpose of quickly producing a permanent lawn. It is prepared from our own formula and is a careful blending of varieties adapted to producing the thick growth and velvety appearance so much sought after. Each variety of grass in its composition is there for

a special purpose—some for making strong, fibrous roots, which take hold upon the soil and keep the turf in place; others of a creeping nature quickly fill up any bare spots which may be caused by the taller sorts dying down; varieties which are useful for their color value, and also kinds that are able to withstand the beating down of excessive rains. Whether you want to seed a small grass plot in your yard, or a lawn of more pretentious size, you should use Emerald Lawn Grass Mixture and produce the results as shown in the picture above, which is a sight that will gladden any heart. 1 lb. 50c, parcel post paid.

Shady Spot Lawn Grass Usually it is quite difficult to obtain a satisfactory growth of grass under trees and in shady places. For sowing such places we recommend the use of our Shady Spot Mixture. It will quickly produce an abundant and even growth of beautiful green grass. The grasses used in making this special mixture are only those that are well adapted for growing in the shade, and it blends well with our Emerald Lawn Mixture. It may be used on those portions of the lawn which are shaded by trees, buildings, etc., thus covering the whole area with rich, green sward. 1 lb. 50c, parcel post paid.

Schwill's Terrace Grass Ordinary lawn grass will not hold the soil on terraces and embankments, which require a thick turf composed of varieties which make strong roots to take hold of the soil and prevent washing by heavy rains. Our Terrace Mixture is carefully prepared with a combination of such grasses as will fill the requirements by making a quick growth of grass which will form a strong mat and present a good appearance. It will grow well anywhere, but it is best to enrich the soil, in order to provide nourishment to the young roots, and give a vigorous start to their growth. 1 lb. 60c, parcel post paid.



Red Top Grass

Permanent Pasture Grass Mixture

Furnishes pasture from early spring through the winter. Suitable for most all soils. Sow in early spring or fall, using 1½ bu. to the acre. 1 lb. 40c, parcel post paid.

Permanent Meadow Grass Mixture

A special mixture for a lasting hay crop. A combination of all the best cultivated grasses that will furnish hay all during the spring and summer months. Sow in spring or fall, using 1½ bushels to the acre. 1 lb. 40c, parcel post paid.

Permanent Hog Pasture Mixture

A combination of mixed clover and best grass suitable for hog pasturage, and if taken care of will last a number of years. Composed largely of red clover and orchard grass. Sow in early spring or fall, at rate of 1 bushel to the acre. 1 lb. 40c, parcel post paid.

Chicken Pasture Mixture

A splendid mixture of grains, clover and grasses for green feed for chicken runs. Sow in February, March and September, at the rate of 30 lbs. to the acre. 1 lb. 40c, parcel post paid.

Timothy and Alsike Mixture

Suitable mixture for low, wet lands, furnishing good pasture and hay. Sow in early spring and fall, using 15 lbs. of the mixed seed per acre. 1 lb. 50c, parcel post paid.



Orchard Grass

FOR PRICES ON LARGER QUANTITIES, SEE PINK PRICE LIST, PAGE 98.



PASTURE AND HAY



Kentucky Blue Grass

Kentucky Blue Grass This famous grass is well known in all sections and, where the land is suitable, is one of the most profitable of all for pasture. It generally grows well on any stiff or loamy soils in central and northern states where rich, moist, though moderately well drained, and succeeds fairly well in some sections of the South, where lime is present in the soil, being largely used with Bermuda Grass. Kentucky Blue Grass is at its best in the spring and fall months, but being rather sensitive to heat, does not grow luxuriantly during the summer months. It takes a considerable time to get a good stand of this, as it grows very slowly at the start, but when once established, forms a close, compact turf, making a fine pasture, and is most excellent for lawns. 1 lb. 50c, parcel post paid.

English Blue Grass A splendid grass for permanent pastures, starting early and also making excellent pastures very late in the season. It makes good hay, growing on almost any soil, thriving best in that which is moist. 1 lb. 50c, parcel post paid.

Italian Rye Grass A valuable grass for moist soils, making a rapid growth used either alone or in mixture with other grasses for hay. If sown alone use 2 to 3 bushels per acre; if with red clover, ½ to 1 bushel per acre. 1 lb. 35c, parcel post paid.

Perennial Rye Grass Used very largely in Europe for both hay and pasture, and well adapted to this section also, for both. It is a strong grower, starting very early in the spring and can be used to great advantage in mixtures. 1 lb. 35c, parcel post paid.

Johnson Grass A most prolific perennial hay and pasture grass, eminently suitable to hot, dry climate and soils. It makes excellent hay and furnishes an enormous amount of grazing. No drouths, methods of culture or application of chemicals to eradicate it will destroy it when once sown, therefore, we do not recommend it to be sown on any land which is intended in future years for other crops. The best time for cutting is before the heads appear, as, if allowed to ripen, it becomes unfit for stock. Sow in the spring—March or April, at the rate of 1 to 1½ bushels per acre. 1 lb. 50c, parcel post paid.

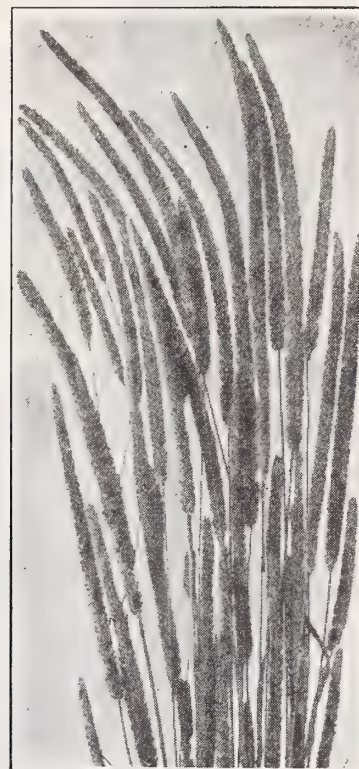

Timothy

FOR PRICES
ON LARGER QUANTITIES,
SEE PINK PRICE LIST,
PAGE 98.

Orchard Grass This is one of the very best grasses for upland, loamy or moderately stiff soils, affording a large amount of pasturage as well as making excellent hay if cut when in bloom. It grows about 3 feet high and matures much earlier than Timothy, does not exhaust the soil and will produce 2 to 3 tons per acre of fine hay. Having a tendency to grow in clumps, it does better if sown thickly, 1½ to 2 bushels being the amount usually sown. It does especially well if used with other grasses. 1 lb. 50c, parcel post paid.

Bermuda Grass Very popular and a great boon in the South for pasture; when once established no amount of drouth or hot weather will kill it out. It succeeds on nearly all soils, furnishing a constant growth of grass during the summer, but becomes brown and bare in the fall and winter. It cannot be recommended too highly for pasture and general culture in the South, and it is also excellent for summer lawns. Its strong, creeping roots will absolutely prevent wash. 1 lb. 65c, parcel post paid.

Red Top or Herds Grass Succeeds better on more soils than any other grass and in all sections of the United States. Grows slowly but becomes very vigorous later and spreads rapidly into a compact sod. Suitable to stiff soils and in low situations subject to overflow, producing luxuriant growth, attaining a height of 3 to 3½ feet. For the best quality hay it should be cut when in bloom; ripens about the same as Timothy. 1 lb. 35c, parcel post paid.

Canadian Blue Grass A flat-stalked meadow grass. Grows a foot or more high. Recommended for horses, cows and sheep. Thrives well on clay; sow 30 pounds per acre. 1 lb. 35c, parcel post paid.

Tall Meadow Oat Grass Very desirable for permanent pasture and meadows, because of its early growth, also from the fact that it produces a heavy growth after being mown, and lasts several years. It grows wherever Orchard Grass will. 1 lb. 50c, parcel post paid.

Timothy No grass is better known than this, nor more generally grown, as it produces the best hay of all grasses, but is of little value for pasture. It produces good hay on almost any class of land, but in this section is best suited to bottom lands or good, well-drained soil. It yields about 1½ to 2 tons of hay to the acre, which is always in demand. 1 lb. 30c, parcel post paid.

Sudan Grass A new forage crop of immense value. Sudan Grass is an annual, therefore it is necessary to sow every year. Plant grows tall, 7 to 8 feet, stems very small and tender, stools wonderfully, makes fine hay and much relished by stock. Yields from 2 to 4 tons per acre. Sow in April, in drills or broadcast, using 3 pounds of seed to the acre, having drills 3 feet apart, and cultivate. If sown broadcast, 14 to 20 pounds of seed will plant an acre. Soudan Grass can be cut two or three times during the season. 1 lb. 50c, parcel post paid.



VELVET BEANS

A GREAT FORAGE AND SOIL IMPROVING CROP.

Velvet Beans make an enormous growth of vines; greater, in fact, than any other known forage plant, in the same length of time, far surpassing the cow pea in growth. Velvet Beans are usually planted in rows 4 to 5 feet apart, at the rate of about half a bushel per acre. As a soil improver they are considered superior to cow peas, as they make so much larger growth and so much heavier amount of foliage.

In the South these beans are very generally grown in with the corn. The corn is planted in rows five feet apart, and the corn about three feet apart in the row, and the beans planted in the drill between the corn. At the last working of the corn beans are planted again in the middles between the rows of corn. When the corn is dry, it is pulled from the stalk and the cattle afterwards turned in to graze in the Velvet Bean and corn field. It furnishes most nutritious and fattening food for cattle, and is considered the cheapest method of fattening cattle known, and at the same time the roots and what is left of the vines after the cattle are taken off when turned under, make a good soil-improver.

Early Bird Speckled This early speckled Velvet Bean is a variety that matures in 90 to 100 days, and can be grown in almost any part of the South. The Early Bird Bean may be planted in April or May, in the drill with corn, or in rows close to the corn, preferably after a rain, and cover shallow. The cultivation of the corn does the rest. The beans will begin to mature in July and will about have finished maturing October 1st, or before frost in any section of the Southern States. 1 qt. (30 ozs.) 35c, parcel post paid.

Chinese This new velvet bean is rapidly coming into great popularity wherever it is grown, on account of its earlier maturity than the regular velvet bean. It makes even a ranker and larger growth of vines and leaves than the regular Speckled Velvet Bean, and is of more value for soil improvement. 1 qt. (30 ozs.) 40c, parcel post paid.

Osceola This new velvet bean has several advantages over the early speckled varieties. It is free from the stinging fuzz or velvet on the pods, which makes the other varieties very unpleasant to handle. It has larger beans and pods, making them less expensive to gather, and is also much earlier than most of the other beans. It is two weeks earlier than the 100-day. Commences to get ripe about September 1st, and largely ripened by September 15th; all ripe last September. Will make 25 per cent more beans than the 100-day. Blooms mostly purple. 1 qt. (30 ozs.) 40c, parcel post paid.

SOJA, OR SOY BEANS

ONE OF THE BEST SUMMER FORAGE CROPS.

In addition to the fact that Soja Beans make one of the best of summer forage crops, and are splendid soil improvers, they are coming rapidly into use and popularity for use as table beans, and also for canning, the same as navy beans for "pork and beans." They are also being very largely used for the extraction of oil for commercial purposes. Their uses for these purposes have increased their popularity to a wonderful extent.

To grow for a crop of beans, they should be planted in drills 3 feet apart, at the rate of about ½-bushel to the acre, and cultivated the same as for corn.

For a forage and soil improving crop, they are best sown broadcast at the rate of about a bushel to the acre.

For forage and soil improving purposes, however, they give, in our opinion, best results when sown in connection with cow peas, and half a bushel of Soja Beans with 3 pecks of cow peas to the acre will give excellent results.

Mammoth Yellow The largest growing and the most popular of Soja Bean for forage

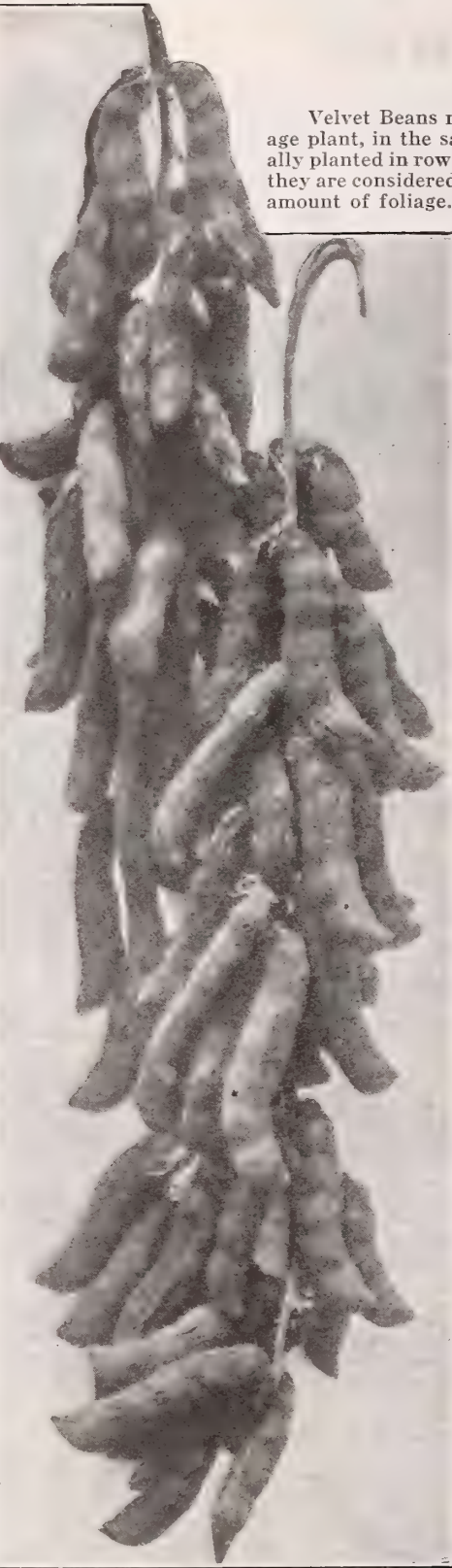

Early Bird Velvet Bean

purposes. A little later in maturing than other kinds, but makes larger yields, both of forage and seeds. 1 qt. (30 ozs.) 40c, parcel post paid.

Ito San A very satisfactory variety to grow in a short season. Produces seed fairly well, and matures in 95 to 100 days. The plants are of medium size, averaging 25 to 30 inches in height. 1 qt. (30 ozs.) 45c, parcel post paid.



FOR PRICES ON LARGER QUANTITIES, SEE PINK PRICE LIST, PAGE 98.



FIELD BEANS, COW PEAS AND PEANUTS

FIELD, OR COW PEAS



Cow Peas, Grown in Corn

Cow Peas make one of the largest yielding and most nutritious forage crops grown. There is also no surer or cheaper means of improving and increasing the productiveness of our soils than by sowing the Cow Peas. It is not necessary to turn under the crop of vines to improve the soil, and it is really considered more economical and the best way to cut off the crop of vines and cure them as a forage or hay crop, and then turn under the stubble and roots. Even when the crop is cut off, the land is left in very much better mechanical condition, and the productiveness very much increased over what it was before the crop was grown. The Cow Peas, to a greater extent than any other leguminous crop, has the power to extract nitrogen and ammonia from the atmosphere and to store same in the vines and roots, so that, even if the crop is cut off, the land is enriched and its condition improved.

We can supply, in season, any of the following varieties:

Whippoorwill or Speckled	Black	Clay
Unknown or Wonderful	Red Ripper	Mixed
Qt. (30 ozs.) 30c, parcel post paid.		

FIELD BEANS

White Marrow Plant in June or July, usually makes a very profitable crop to grow as shelled white beans for market. Planted in rows 3 feet apart, dropping 2 to 3 together, a foot apart in rows. Cultivate early, as they grow rapidly, but do not work them while the dew is on the foliage. Do not cultivate after they begin to bloom. Qt. (30 ozs.) 70c, parcel post paid.

White Kidney Easily grown. Plant and cultivate same as White Marrow Beans. A good, strong growing variety. It is much used for shelling when the pods turn yellow so the beans are well developed. Qt. (30 ozs.) 70c, parcel post paid.

White Navy Largely grown in many sections as a commercial bean. Vines are very prolific, producing a large quantity of shelled beans per acre. Cultivate the same as Marrow Beans. Qt. (30 ozs.) 70c, parcel post paid.

Tepary One of the most wonderful plants ever presented to the dry farming public. It will make a fair crop in 75 days, and a good crop if they have 90 days. If struck by drouth it will ripen the pods already set and when the drouth breaks it will set and ripen a new crop. Under ordinary conditions they yield from 400 to 700 lbs. per acre. The beans are white, cook well, have a delicious flavor. Qt. (30 ozs.) 70c, parcel post paid.

Castor Beans (Ricinus or Castor Oil Bean). Plant like corn, in March and April; use ½ peck of seed to the acre in rows 4 feet apart; thin plants to 24 inches. The plant prefers a rich, well drained sandy or clay loam. Qt. (30 ozs.) 60c, parcel post paid.

Mexican Pinto This is a popular bean in Mexico, and should be grown more largely here. As a table bean it is excellent, both as a dry and green shelled bean. This bean has found great favor wherever tried, especially in Texas. Qt. (30 ozs.) 70c, parcel post paid.

CHUFAS (EARTH ALMONDS)

Used to fatten hogs. Plant in April and May, in rows 3 feet apart, and 8 to 10 inches apart in the row. Soak seed in warm water before planting; 1 peck is sufficient for 1 acre. 1 lb. 35c, parcel post paid.

PEANUTS

Plant in May and June, in 3-foot rows, dropping seed 12 inches apart; 1½ bushels of unhulled nuts will plant 1 acre. Merely break hulls in half, they do not need to be shelled before planting.

Spanish Peanuts Nuts small, very productive, fine for hogs. 1 lb. 30c, parcel post paid.

Tennessee Mammoth Long Red Easily cultivated; erect, bushy habit; productive. 1 lb. 35c, parcel post paid.

Mammoth White Virginia Large size pods; best variety for commercial use. 1 lb. 35c, parcel post paid.

Mammoth Bush Peanuts Extra large jumbo pods and nuts; 1 dozen nuts will produce 1 bushel; quite a novel variety. ¼ lb. 25c; 1 lb. 60c; 3 lb. \$1.50, parcel post paid. By exp., not prepaid, 1 lb. 50c; 3 lb. \$1.25; 5 lb. \$2.00

Valencia Peanuts Also known as the Red Spanish. It is a trifle longer and larger than the White Spanish, similar otherwise. Skin dark red, and on account of having 3 and 4 to the pod, and being prolific, is highly prized. 1 lb. 40c, parcel post paid.

WHITE TABLE PEAS

California Large White Blackeye Very large, kidney-shaped peas, maturing the earliest of all; fine for early market. Qt. (30 ozs.) 50c, parcel post paid.

White Brown-Eyed A desirable table pea. Prolific. Qt. (30 ozs.) 50c, parcel post paid.

White Lady Peas Very small seeded but strong growing and prolific pea for table use. Peas are creamy white and of the finest quality. Qt. (30 ozs.) 50c, parcel post paid.

Crowder Peas Exceptionally fine for table use. Prolific and very sweet. Qt. (30 ozs.) 75c, parcel post paid.

Canada Field Peas Every year there is more inquiry for field peas. As a fertilizer they come next to clover, to be plowed under when they commence to blossom. They will grow on land that will not produce clover. Sow 1½ to 2 bushels to the acre; or, if with oats, sow 1 bushel of each. Qt. (30 ozs.) 50c, parcel post paid.



Spanish Peanuts

FOR PRICES ON LARGER QUANTITIES, SEE PINK PRICE LIST, PAGE 98.

SORGHUMS AND MILLET

MILLET

Millet makes a large-yielding and most nutritious hay crop, quick growing and easily cured. It, however, requires to be seeded thickly—not less than 1 bushel per acre, and the crop should always be cut while in bloom, before seed hardens in the head. If the seed is allowed to form the stalks get hard and it does not make nearly as good hay, and at the same time is more exhaustive to the land. Can be sown any time from the middle of April to the end of July. Do not sow too early.

Tennessee Golden Millet This true Tennessee cultivated Golden Millet is sown more largely in the South in preference to any other variety, as it is true stock and produces more abundantly nutritious hay than the others. 1 lb. 25c, parcel post paid.

Western Golden Millet This variety is very similar to the Tennessee Golden, however, it does not produce quite as much hay, and the heads are not quite so large. 1 lb. 20c, parcel post paid.

Hungarian Millet For good, low grounds; on rich soils this makes even a more valuable crop than the Golden Millet. It is of fine growth and makes excellent hay. It has numerous succulent leaves which furnish an abundance of green fodder. 1 lb. 25c, parcel post paid.

Japanese or Barnyard Millet This is a forage plant of great value, growing in most any soil. It has been known to produce 3 to 5 tons of fodder if planted early. After second cutting it will afford a pasture all the fall. It is relished by all stock, and is sometimes called the Billion Dollar Grass. 1 lb. 30c, parcel post paid.

Pearl or Cat Tail Millet Makes a splendid quick-growing, continuous-cutting forage crop, either for green food or hay, and is fine for dairy cows. If sown broadcast, use 20 to 30 pounds to the acre, but quicker and more frequent cutting will be obtained if sown in drills 3 feet apart and cultivated occasionally, using 5 pounds of seed per acre. 1 lb. 60c; 5 lb. \$2.40, parcel post paid. Not prepaid, 1 lb. 50c; 5 lb. \$2.25; 10 lb. \$4.25.



Tennessee Golden Millet

SORGHUM, OR SUGAR CANE

Sow broadcast for hay or roughness 1 bushel or 50 pounds per acre; for sorghum or grain, ½ peck per acre, any time from April to August.

Texas Seeded Ribbon Cane This cane gets its name from being a variety that closely resembles the true Ribbon Cane raised from cuttings. It makes the finest kind of syrup. 1 lb. 40c, parcel post paid.

Japanese Honey Syrup Cane The best of the canes for making syrup ever introduced. It is a big yielder and has found great favor with everyone who has tried it. 1 lb. 40c, parcel post paid.

Early Orange Sorghum Largely used for hay and fodder. It is taller and has heavier stalks than the Early Amber, and is excellent for making syrup. 1 lb. 25c, parcel post paid.

Early Amber Sorghum The earliest type in cultivation. Stalks tall and slim. Most suitable for hay, as it matures very quickly. 1 lb. 25c, parcel post paid.

Red Top Sorghum Grown extensively in Middle Tennessee. Very sweet and one of the best for hay. 1 lb. 30c, parcel post paid.

NON-SACCHARINE SORGHUMS

Sow all of these from April and May, 10 pounds of seed to the acre, in drills, and 1 bushel to the acre broadcast, excepting where stated otherwise.

Red Kaffir Corn 1 lb. 25c, parcel post paid. **Yellow Milo Maize** 1 lb. 25c, parcel post paid.

Dwarf Straight Neck Milo Maize 1 lb. 25c, parcel post paid.

White Kaffir Corn 1 lb. 25c, parcel post paid.

Feterita A non-saccharine cane, a new forage crop for the South. Similar to Kaffir Corn in general habit, but, grows a little taller and produces larger heads, standing erect, white seed and early maturity. Its greatest value, however, is its great ability to resist drought. Feterita should be planted any time from April to June, in rows about 4 feet apart when it will take about 3 pounds of seed per acre. 1 lb. 25c, parcel post paid.

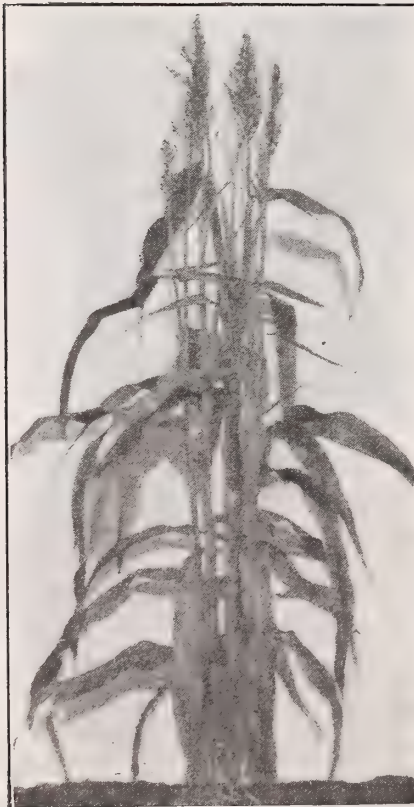

Japanese Honey Syrup Cane

FOR PRICES ON LARGER QUANTITIES, SEE PINK PRICE LIST, PAGE 98.



MISCELLANEOUS FARM SEEDS

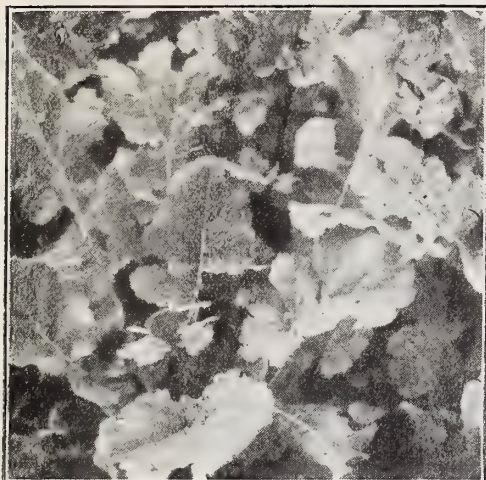

Rape, Dwarf Essex

SEED OATS

Sow 2 bushels of any following varieties to the acre. Plant in February or March. Applying nitrate of soda, 100 pounds to the acre, early in April. It will increase your crop.

Early Burt The quickest growing, most prolific and surest cropping of the Spring Oats. Good for thin land.

Red Rust Proof These oats are very popular throughout the South. They do well on any good land and are very productive. They are sown both in the spring and fall.

Appler A very hardy variety, rust proof and a heavy yielder. Matures ten days earlier than native rust proof and about a week later than Burt.

BUCKWHEAT

Japanese Buckwheat Sow in April, May or June, 1 bushel broadcast to the acre. 1 lb. 25c, parcel post paid.

Silver Hull Buckwheat

Splendid for bees, also makes best grain. Sow in June, 1 bushel, broadcast, to the acre. 1 lb. 25c, parcel post paid.



Teosinte

BROOM CORN

Broom Corn will succeed in any good corn soil and will make a crop with little rain. Besides the brush, it will produce a large yield of grain equal in feeding value to oats. Six pounds of seed are required for an acre when drilled in rows 3 feet apart.

Improved Evergreen A favorite in all sections. Grows to a good length and, if cut at the proper time, retains a good color. 1 lb. 30c, parcel post paid.

Dwarf Oklahoma This variety grows only 3 or 4 feet high, and is much easier handled than the tall growing sorts. The brush is straight, smooth and of good quality. 1 lb. 30c, parcel post paid.

VETCH

Spring Vetch Better for spring sowing than the Winter Vetch. A nutritious and valuable forage and soil-improving crop. Large and quick growth. Sow 50 lbs. to the acre. 1 lb. 45c, parcel post paid.

Sand or Hairy Vetch Sow from July to November, preferably with grain, which will hold vetch off the ground. Sow 50 lbs. to the acre. With grain, 1 peck to the acre. 1 lb. 40c, parcel post paid.



Broom Corn, Improved Evergreen

Upland Rice An early variety which can be grown on any ordinary land without irrigation, although it prefers a moist situation. Sow 1 peck per acre. 1 lb. 40c, parcel post paid.

Speltz or Emmer Matures as early as Barley and grows as tall as Rye, but is of better feeding value than either. It is tough and hardy and stands drouth better than any other grain. Sow in March, 1 bushel to the acre, broadcast. 1 lb. 25c, parcel post paid.

Early Wonder Spring Wheat Sow for hay or grain in February and March, 1 bushel to the acre. 1 lb. 25c, par. post paid.

Beardless Spring Barley It makes a quick growing crop of most excellent and nutritious feed, either to use green or to cure as hay. Sow 1½ to 2 bushels per acre. 1 lb. 25c, parcel post paid.

Russian Sunflower Plant in March, April and May, 6 pounds of seed to the acre, making rows 3½ feet apart, dropping 2 seeds every 18 inches; cultivate like corn. 1 lb. 35c, parcel post paid.

Rape, Dwarf Essex This is an ideal sheep feed, easily grown; perfectly hardy and possesses remarkable fattening properties. Any corn soil will grow Rape. Sow the seed any time in March and by the end of June, and the crop can be ready to feed at a season when it is most needed. It does well sown with oats. After oats are cut the Rape grows rapidly. If the soil is rich and clean, sow broadcast; if not so clean, sow in drills and cultivate as for corn. When sown broadcast use 6 lbs., and if in drills, 2 lbs. to the acre. 1 lb. 30c, parcel post paid.

Teosinte A valuable continuous cutting forage plant for Southern and Southwestern States, furnishing a most nutritious food, green or dry, for horses and cattle. It resembles Indian Corn, the leaves being larger and the sap sweeter. Sow in May or June, in drills, 3½ to 4 feet; 2 to 3 lbs. per acre. ¼ lb. 35c; 1 lb. 85c; 5 lb. \$3.70, parcel post paid. By express, not prepaid, 1 lb. 75c; 5 lb. \$3.50.

FOR PRICES ON LARGER QUANTITIES, SEE PINK PRICE LIST, PAGE 98.



HIGH BRED COTTON SEED

We have listed only the most popular and new varieties, and all are stocks that have been grown for us on contract. Any one wanting other cottons not shown here, write us for prices on same, as we are always in position to obtain pure seed of most all kinds. Prices subject to market changes. Write for special quotations on large amounts. All Cotton Seed sold at the rate of 30 pounds to the bushel.



King's Improved Early Cotton

Half and Half We recommend Half and Half as the most valuable short staple cotton ever developed, to planters who prefer a short staple, or have the boll weevil to contend with. It is earlier than King's, and stands drouths better than the average varieties. On fertile land, with good seasons, its lint will run as high as 50 per cent. The staple is about 1 inch. We feel sure that anyone who plants Half and Half the coming season will be more than pleased. 1 lb. 30c, parcel post paid.

Wannamaker Cleveland Especially recommended for sections where the boll weevil is present. Plant is vigorous, thrifty, with low close-jointed basal fruit limbs; large bolls, easily picked, medium-sized seeds, grayish to greenish. The lint runs 34 to 38 per cent, is fine and strong, 1 1/8 to 1 1/4 inches long. Earliest and most prolific at experiment stations. 1 lb. 30c, parcel post paid.

Early Triumph Big Boll This is the earliest of all big boll varieties. The bolls are usually 5-locked, very large and solid, therefore making more cotton than the other spongy, large bolls. Lint of Triumph Cotton is silky, 1 1/16 to 1 1/8 inches in length. It makes 36 to 41 per cent of lint, 36 to 41 pounds of lint to the 100 pounds of seed cotton. 1 lb. 30c, parcel post paid.

Columbia Big Boll This is one of the best varieties, adapted to all sections; big bolls, does not blow or drop out easily. Plant grows large and strong, resists dry weather; will turn out 37 to 40 per cent lint. Matures early, staple 1 1/4 to 1 3/8 inches. 1 lb. 30c, parcel post paid.

Polk's Early Maturing Long Staple The earliest staple cotton on the market, also the most productive. Polk Cotton was started from one plant by the originator some years ago, and by careful work he has developed a superior cotton that is earlier than most of the other varieties. Planters who paid fancy prices for this seed last spring declare that it did extremely well. Bolls are medium to large, 5-locked; fibre is of excellent quality and staple 1 4/16 to 1 5/16. Will produce a bale to the acre on good land if the season is favorable. Yields 31 to 32 per cent fiber. We feel sure that anyone who gives this variety a trial, will be highly pleased. 1 lb. 30c, parcel post paid.

Express A well established variety. Many large farmers use Express Cotton entirely. It is a very early type, productive, and makes staple 1 1/8 to 1 3/16, depending on the fertility of the land. The Delta Branch Experimental Station tests show Express stands first, out of twenty-eight varieties, on their trial ground. 1 lb. 30c, parcel post paid.

King's Early Improved A very early, small boll, small seeded variety, matures two weeks earlier than any other sort and nearly always thirds itself. On account of its extreme earliness, it is largely planted in the boll weevil infected sections, as it matures most of its crop before the weevil makes its appearance. 1 lb. 30c, parcel post paid.

Webber This we consider one of the very best long staple cottons, as it is a heavy fruiting variety, making quality lint 1 1/4 to 1 3/8 inches in length. It matures early and is extensively grown by many planters. 1 lb. 30c, parcel post paid.

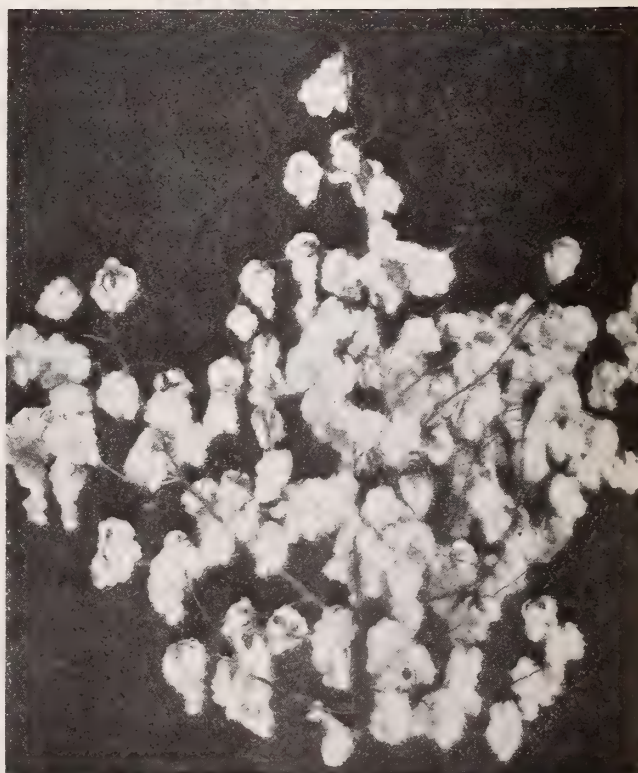

Wannamaker's Cleveland Cotton

FOR PRICES ON LARGER QUANTITIES, SEE PINK PRICE LIST, PAGE 98.

GRANDIFLORA AND SPENCER SWEET PEAS

CULTURAL DIRECTIONS.—Sow in the spring as soon as the ground can be prepared, in a deep, rich soil, and for succession until the middle of April. Open a drill 4 to 5 inches deep and cover the seed from 2 to 3 inches. As the vines grow up, draw the soil up against them for support. A row of brush or wire netting should be placed between them for the vines to trail on. Pick flowers closely and do not allow to go to seed.

Sheep manure and Nitrate of Soda are the best fertilizers for Sweet Peas; apply lightly alongside of plant not too close. Bone Meal is also fine, and should be used if your soil is poor.



Superb Spencer Sweet Peas

Re-Selected Superb Spencer Sweet Peas

Price, any of the following varieties: Pkt. 10c; oz. 30c; 2 oz. 55c; ¼ lb. \$1.00; 1 lb. \$3.50, parcel post paid.

- Apple Blossom Spencer—Brightest pink rose shade.
- Asta Ohn Spencer—Soft lavender, suffused mauve.
- Countess Spencer—Soft rose pink, large and wavy.
- Dobbie's Cream Spencer—Cream or yellow, very showy.
- Helen Lewis Spencer—Orange pink, with bright orange standard.
- Illuminator Spencer—A most intense glowing orange scarlet.
- King Edward Spencer—The best pure red Spencer.
- King White Spencer—A giant free-flowering white Spencer.
- Margaret Atlee Spencer—The best cream pink.
- Maud Holmes Spencer—Mammoth wavy petals of brilliant red.
- Mrs. Routzhan Spencer—Apricot, pink and straw color.
- Masterpiece Spencer—A very beautiful shade of lavender.
- Othello Spencer—Deep rich maroon purple, very dark.
- Primrose Spencer—Clear primrose, very large and wavy.
- Roosevelt Spencer—A giant rose-colored, extra large and wavy.
- Thos. Stevenson Spencer—Giant flame-colored Spencer.
- Vermilion Spencer—A bright, pure scarlet color, large flowers.
- Wedgewood Spencer—Silvery blue, large and wavy.
- White Spencer—A superb purest white with large blossoms.

New Spencer Sweet Peas

- Royal Purple—A rich, warm rosy purple color. Flowers are of immense size while the stems are of great length. Pkt. 10c; 3 pkts. 25c.
- Fiery Cross—A glittering, fiery scarlet, without any shading. The flowers are extra large and wavy. Pkt. 10c; 3 pkts. 25c.

Perennial Mixed Sweet Peas

Perfectly hardy, and very handsome free-blooming climbers. They come up year after year. Pkt. 10c; oz. 35c.

Named Standard Grandiflora Sweet Peas

Prices for any of the following named sorts: Pkt. 5c; oz. 15c; 2 oz. 25c; ¼ lb. 50c; 1 lb. \$1.75, parcel post paid.

- Countess of Radnor—Delicate lavender, mauve wings.
- Dorothy Eckford—Purest white, very large flower.
- Duke of Westminster—Dark purple, flowers very large.
- Janet Scott—Finest bright pink and buff.
- King Edward 7th—Bright red, flowers large and showy.
- Lady Grisel Hamilton—Light lavender, very beautiful.
- Lord Nelson—Brilliant blue or deep navy blue.
- Miss Wilmott—Orange pink, a beautiful shade.
- Othello—Deep maroon, a very beautiful color.
- Prima Donna—A beautiful shade of pink.
- Prince of Wales—Bright deep rose, very large.

Schwill's Superb Large Flowering Mixed

This mixture is composed of all of the largest flowering varieties of Grandiflora Peas, in even quantities of colors. Pkt. 5c; oz. 10c; 2 oz. 15c; ¼ lb. 30c; 1 lb. \$1.00, parcel post paid.

Schwill's Gilt Edge Mixed

In this mixture we have used only the choicest and best of Waved Spencer and Grandiflora Sweet Peas, and have taken every care to produce in the mixture a proper balance of colors. Pkt. 5c; oz. 15c; 2 oz. 25c; ¼ lb. 50c; 1 lb. \$1.50, parcel post paid.

Spencer Mixed Sweet Peas

These are larger and more graceful in every way than the ordinary varieties, absolutely unequaled, a matchless combination of giant flowers. Pkt. 5c; oz. 20c; 2 oz. 35c; ¼ lb. 60c; 1 lb. \$2.00, parcel post paid.

Cupid, Dwarf or Bedding Mixed

These form a line of emerald-green foliage, a little over a foot wide and 6 inches high, and from June until late summer are literally a sheet of blooms; the mixture contains all the colors. Pkt. 5c; oz. 20c; 2 oz. 35c; ¼ lb. 60c, parcel post paid.



SCHWILL'S FLOWER SEEDS

RAISING FLOWERS FROM SEEDS

Success in the cultivation of flowers from seeds depends to a great extent on the earlier operations. Much of the disappointment and failure that attends this pursuit may be avoided by carefully noting the class to which each belongs and then following the appropriate culture. Generally speaking, brief culture directions are printed on every packet of seed sold, and in some instances they prove sufficient, but we here offer a few suggestions which may be helpful to beginners.

The first and most essential requisite is **Reliable Seeds**. Next a suitable soil. That best suited for flower culture is a rich loam containing enough sand to make it porous. A large portion of the summer flowers are **Annuals**. As they do not take kindly to transplanting, it is best to sow seed where the plants are to bloom. Sow from March until June in dry soil previously fertilized by bone meal, sheep manure, or similar stimulants. Make a broad but shallow depression in which to sow the seeds as thinly and evenly as possible and cover in proportion to the size of the seed. Very small seeds should not be covered. Press them into the soil with a flat board. The seedlings should be thinned out during moist or dull weather.

Half Hardy Annuals—Towards the end of March seeds of this class may be sown in the place where they are to bloom. It is advisable, however, to sow the seeds in February and March indoors, either in pans, shallow boxes or pots. When the little plants have made three or four leaves, reset them into another box so they may be strong and sturdy to set in the garden at planting time. Occasional watering with weak liquid sheep manure is beneficial.

Hardy Perennials—These may be sown in open borders any time from April to October. **Biennials** require similar treatment to Hardy Perennials. By sowing seeds in boxes or pots in cold frames in February and March and transplanting the seedlings to a north border, a much earlier bloom will be secured. The seeds of perennials usually germinate slowly.

Asters

This has become one of the most popular beautiful and effective garden plants, growing from 10 to 24 inches high. Sow the seed early in the spring, under glass or in pots, in the house, and transplant into rich soil. Half hardy annual.

Giant Comet Aster—Flowers of immense size, often 6 inches across. Long, wavy, twisted petals, gracefully formed into loose yet dense globe, resembling Chrysanthemums, 12 to 16 inches in height. Price, any of the following varieties, packet 10:

- | | |
|----------------------------------|------------|
| Pure White | Light Blue |
| Clear Rose | Scarlet |
| Comet Asters, all colors, mixed. | |



Carnation Marguerite



Aster, Giant Comet



Antirrhinum (Snapdragon)

Aster, Paeony Flowered—Large and double mixed. Pkt. 10c.

Aster, Victoria—Imbricated petals; large flowers. Pkt. 10c.

Aster, China, Mixed—Well known, hardy variety. Pkt. 5c.

Alyssum, Sweet—One of the sweetest and most useful of summer flowers for edging, borders, rock work, etc., continuous in bloom the entire season. Flowers white, 1 foot; hardy annual. Pkt. 5c; oz. 40c.

Alyssum, Little Gem—A Sweet Alyssum with pure white blossoms, very dwarf and dense growth. It is, perhaps, the finest sort for geometrical flower beds and borders; hardy annual. Pkt. 5c; oz. 50c.

Antirrhinum (Snapdragon)—Showy and useful border plants, producing a great variety of brilliant flowers. Very effective in beds, succeeding in any good soil. Blooms the first season. Biennial. Pkt. 5c.

Amaranthus, Princess Feathers—Highly ornamental. We offer a splendid mixture of all varieties; have handsome foliage; hardy annual. Pkt. 5c.

Ageratum (Imperial Blue)—A Mexican flower of bush-like appearance, suitable for bedding or pot culture. Blooms continually; hardy annual. Pkt. 5c.

Bachelor's Button—It has been so perfected that fully 80 per cent of the flowers are double and semi-double; are also increased in size and present many colors and distinct markings; mixed; hardy annual. Pkt. 5c.

Browallia—Profuse blooming plants, continuing throughout the summer, studded with blue and white flowers; half hardy annual; mixed. Pkt. 5c.

Brachycome (Swan River Daisy)—A delicate dwarf, half hardy annual; effective for edging, beds or rustic baskets. Produces an abundance of daisy-like flowers in shades from dark blue to nearly white; mixed colors. Pkt. 5c.

Balsam, Double Mixed—Magnificent for outdoor planting, producing in gorgeous profusion flowers of the most beautiful and varied colors; tender annual. Pkt. 5c.

Balsam Apple Vine (Balsamina)—Curious fruits, fine climber; annual. Pkt. 5c.

Balloon Vine—Quick growing climber; 15 feet; annual. Pkt. 5c.

Calliopsis—Large, bright yellow flowers; very effective for cutting and decorations; mixed varieties; hardy annual. Pkt. 5c.

Carnation, Marguerite—Exceedingly fragrant double flowers, very beautiful. Half hardy perennial. Pkt. 10c.

Candytuft, Finest Mixed—All varieties and colors in one packet; hardy annual. Pkt. 5c.

Canary Bird Vine—A beautiful, rapid climber; annual. Pkt. 5c.



Cobea Scandens—Cup and Saucers Vine; a climber of rapid growth; valuable for covering trellises, arbors, trunks of trees, etc.; large, bell-shaped purple flowers; half hardy perennial. Pkt. 5c.

Cypress Vine—For a neat trellis or ornamenting the trunks of young trees it is hardly excelled. Mixed colors; tender annual. Pkt. 5c.

Canterbury Bells (Campanula)—Bell shaped flowers, mixed; hardy biennial. Pkt. 5c.

Coreopsis—Fine for cutting; graceful flowers; hardy perennial. Pkt. 5c.

Columbine—Flowers showy and luxuriant; hardy perennial. Pkt. 5c.

Cardinal Climber—A new and brilliant colored annual climber. Flowers glowing scarlet, 1½ inches in diameter, the tube being 1¼ inches in length. Vines branch freely, attaining a height of from 20 to 30 feet. Start seed indoors in March and transplant. Pkt. 10c.

Cosmos, Giant—Flowers measure from 4½ to 5 inches across, petals fringed, pinked, toothed and plain, and in colors from pure white through shades of pink and red to rich dark red. Hardy Annual.

Giant Crimsonpkt. 10c

Giant Pinkpkt. 10c

Giant Whitepkt. 10c

Giant Mixedpkt. 10c

Cosmos, Dwarf, Early-Flowering—Of compact, bushy growth (about 4 feet), with flowers as large as the older sorts. This has proved to be a most popular variety. Pkt. 5c.

Cosmos, Lady Lenox—The most beautiful of all the Cosmos. The blooms measuring 4 to 5 inches. A very vigorous and free-blooming variety.

Lady Lenox, Pink.....pkt. 10c

Lady Lenox, Whitepkt. 10c

Corn Flower—The well known hardy annual, noted for its old-fashioned flowers. Mixed, all colors; hardy annual. Pkt. 5c.

Coleus—The most popular of all foliage plants. Easily grown from seed, but must be started in a box in the house or hotbed, as the seed is very fine and when sown is scarcely covered, yet must be kept moist. Tender perennial. Mixed colors. Pkt. 15c.

Canna, Mixed—Flowers of large size and brilliant colors. Our mixture contains all the tall varieties and all colors. Pkt. 5c.

Cockscomb, Mixed—Choice mixed, of all sorts and colors. Half hardy annual. Pkt. 5c.

Dahlias—Dahlias are easily grown from seed and bloom the first season as well as if grown from roots. Start seed early. Perennial. **Dahlia, double, mixed colors, Pkt. 10c.** **Dahlia, single, mixed colors, Pkt. 5c.**



Cosmos, Giant Flowering, Mixed



Gaillardia

Daisy Shasta—Flowers snowy white with yellow center; freely produced on strong, wiry stems, about 2 feet in length. Perennial. Pkt. 10c.

Daisy, Double—An old favorite; hardy perennial, mixed. Pkt. 10c.

Eschscholtzia—Hardy annual, 1 foot. Especially valuable for growing in flower beds and masses. Sow where plants are to bloom. Bright, showy flowers and feathery foliage. Pkt. 5c.

Forget-Me-Not—A modest little flower; to friendship ever dear; color blue. Tender annual. Pkt. 5c.

Four O'Clock—A handsome, free-flowering plant. They open their blossoms about 4 o'clock in the afternoon, hence their name. Hardy annual; mixed varieties. Pkt. 5c.

Foxglove (Digitalis)—One of the most striking flowers; tall, stately and handsome; of easy culture. Hardy perennial. Pkt. 5c.

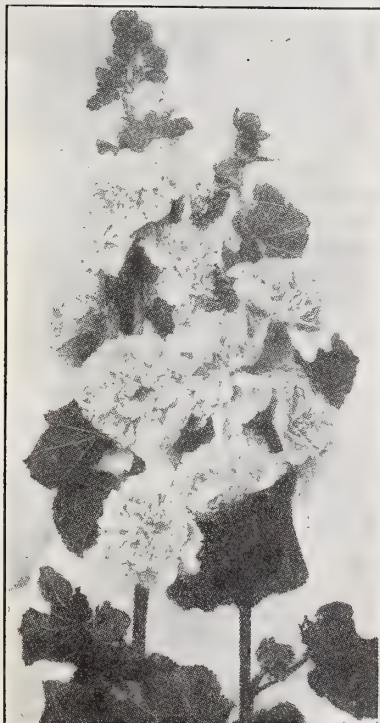

Hollyhock

Gourds

Dipper Gourd—Pkt. 5c.

Nest Egg Gourd—Pkt. 5c.

Ornamental Gourd—Pkt. 5c.

Dish Rag or Luffa—Pkt. 5c.

Orange Gourd—Pkt. 5c.

Sugar Trough—Pkt. 5c.

Calabash Pipe Gourd—Pkt. 10c.

Gourds—Small, ornamental sorts; mixed. Pkt. 5c.

Gaillardia—Blanket flower; fine for bouquets; mixed. Perennial. Pkt. 5c.

Gomphrena (Globe Amaranth)—Hardy annual; 2 feet. Red, clover-shaped flowers. Cut when in full bloom and dried, they retain their color. Mixed. Pkt. 5c.

Helichrysum (Straw Flower)—Bright, attractive summer blooming annual, of free growth, producing in abundance large double red, white, yellow flowers. Mammoth mix. Pkt. 5c.

Heliotrope—These well-known greenhouse and bedding favorites are highly esteemed for their fragrant flowers. Fine mixed. Half hardy perennial. Pkt. 10c.

Hollyhock, Double, Mixed—Fine, showy, double blooms. Hardy perennial. Pkt. 5c.

Hollyhock, Double, White—Purest white; double flowers. Hardy perennial. Pkt. 10c.

Hollyhock, Double, Red—Finest scarlet and red. Hardy perennial. Pkt. 10c.

Humulus Japonicus (Japanese Hop)—Ornamental and rapid climber. The foliage is lovely green; splendid for covering verandas, trellises, etc. Tender annual. Pkt. 5c.

Hyacinth, or Jack Bean—A rapid-growing annual climber; mixed; all colors. Pkt. 5c.

Ice Plant—A low-growing, trailing, tender perennial. The thick leaves seem to be covered with crystals. Used for edging embankments and box work; thrives in bright sunlight and dry situations. Flowers, cerise purple and small, completely covering plant. Pkt. 10c.



Larkspur, Double, Mixed

Kudzu Vine (Jack-and-the-Beanstalk)—For rapidity of growth this hardy vine has no equal. It will grow 8 to 10 feet from seed the first year. The leaves are large and abundant. It bears racemes of pea-shaped rosy purple flowers. Hardy perennial. Pkt. 10c.

Kochia (Summer Cypress)—An easily grown annual with perfect symmetry. It is a lively green, but on approach of autumn the whole plant becomes bright scarlet, making in all a very desirable plant. During the summer it obtains a height of about 3 feet. Pkt. 10c.

Larkspur—Hardy annual. These Larkspurs grow about 1½ to 2 feet high. A great variety of bright colors; of easiest culture, doing well in any soil; all colors, mixed. Pkt. 5c.

Larkspur (Delphiniums)—Hardy Perennial. These are taller than the annual sorts and their brilliant flower spikes arrest your attention even at a distance. The foliage is attractive and the plants strong and neat in habit. By keeping the plants well watered and the flowers cut, a second crop of bloom may be had, and from some a third. Seed is a little difficult to start, so advise sowing in a box in prepared soil, under glass. All colors, mixed. Pkt. 15c.

Lobelia—Neat, graceful trailing plant. Hardy annual. Pkt. 5c.

Marigold—Old favorites, of easy culture. Effective when planted in groups or in garden borders. Hardy annual.

Marigold, Tall, Mixed—Flowers golden yellow. Pkt. 5c.

Marigold, Eldorado—Double flowers, of immense size. Pkt. 5c.

Mignonette—Seed of this popular annual can be sown at any time. If successions are made, these modest-colored, fragrant plants blossom outdoors until November. Sweet Mignonettes, Pkt. 5c.

Morning Glories, Japanese Imperial—A revelation in the size and beauty of their flowers. Pkt. 5c; oz. 15c.

Morning Glories—Undoubtedly one of the most profuse flowering vines in cultivation; choice mixed varieties. Pkt. 5c; oz. 10c.

Nigella—A hardy annual, 1 foot high, with finely cut foliage; oddly shaped blossoms in blue and white. Pkt. 5c.

Nasturtiums

Few flowers compare with Nasturtiums in richness and variety of colors, freedom of bloom, ease of culture and general usefulness. Sow the seed an inch deep and then thin seedlings to 10 or 12 inches apart.

Nasturtiums, Dwarf Mixed—In this will be found varieties of both light and dark color foliage. Pkt. 5c; oz. 20c; 2 oz. 35c; ¼ lb. 60c; 1 lb. \$2.00 parcel post paid.

Nasturtiums, Exquisite Dwarf Mixed—A magnificent strain, containing countless shades, colors, stripes, blotches and veinings. Pkt. 5c; oz. 25c; 2 oz. 40c; ¼ lb. 75c, parcel post paid.

Nasturtiums, Tall Mixed—A brilliant, effective mixture. Pkt. 5c; oz. 15c; 2 oz. 25c; ¼ lb. 50c; 1 lb. \$1.50, parcel post paid.



Nasturtiums, Exquisite Dwarf, Mixed

Nasturtiums, New Giant Flowered—These superb Nasturtiums attract instant attention by the great size, exquisite form and rich color of the flowers. Mixed colors. Pkt. 5c; oz. 20c; 2 oz. 35c; ¼ lb. 60c, parcel post paid.

Moon Flower, White—Its large white flowers expand in the evening and remain open till the following day. Pkt. 10.

Moon Flower, Heavenly Blue—This variety blooms in forenoon. The flowers are azure blue with a yellow throat. Pkt. 10c.

Petunias

Petunias grow with little attention or care, and in any soil, and bloom profusely all spring and summer. The large, double varieties do not produce seed, but the pollen from them is artificially crossed on the large, single and fringed plants, and the seed so produced will make a percentage of double blossoms. The Giant Flowered types are in large, single, plain edged or fringed edged blossoms, or in very thickly double flowers. As Petunia seed is exceedingly fine, merely press it into the soil after sowing, cover with chopped moss or sift a little sand over to cover, and, if possible, allow the water to soak up from beneath. The weakest-looking plants will develop into the handsomest flowers, so save all plants carefully.

Petunia, Single—A splendid mixture of varietiesPkt. 5c

Petunia, Large Flowering—MixedPkt. 15c

Petunia—Finest double mixedPkt. 25c



Petunia, Large Flowering, Mixed

Pinks

- Pink, China, Double**—Deeply fringed petals; mixed colors; hardy annual. Pkt. 5c.
- Pink, Double Diadem**—Superb large double flowers, magnificent in color and variety; hardy annual. Pkt. 5c.
- Pink, Double Imperial**—Brilliant colors; mixed; hardy annual. Pkt. 5c.
- Pink, Crimson Bell**—Double; brightest scarlet; hardy annual. Pkt. 10c.
- Pink, Heddewigii**—Double Japan Pink; mixed colors. Pkt. 10c.
- Pinks, Double Clove or Grass**—Seed sown in March will bloom the first year, and will come next season again. The flowers are delicately fringed, variously colored and delightfully fragrant; perennial. Pkt. 15c.

Pansy

- Pansy, Choice Mixed**—Our own mixture. This contains a wide range of colors and markings. Pkt. 5c.
- Pansy, Extra Large Flowering, Mixed**—Our mixture of the best English varieties of Pansies. Pkt. 10c.
- Pansy, Schwill's Superb Mixed**—This includes not only seeds of Giant Pansies, but also those of several new large-flowered sorts, with highly colored blooms. Pkt. 15c.
- Pansy, Giant Trimardeau**—A beautiful class; compact growers, with enormous flowers; finest mixed. Pkt. 15c.
- Pansy, Prize Medal Mixture**—Unrivalled for diversity of coloring and markings, beauty of form and large size. Selected separate colors from best French, English and American growers; mixed and blended. Pkt. 15c.

Phlox

- Phlox Drummondii, Mixed**—A splendid mixture of all colors; hardy annual. Pkt. 5c.
- Phlox, Mammoth Large Flowering, Mixed**—The largest flowering kinds are a decided improvement on the Drummondii, producing large flowers twice the size of the latter; mixed; hardy annual. Pkt. 10c.
- Phlox, Fireball**—Scarlet, superb when in full bloom; hardy annual. Pkt. 10c.
- Phlox, Snowball**—Purest white flowers; hardy annual. Pkt. 10c.
- Phlox, Hardy Perennial**—Large and showy; mixed colors; 3 feet. Pkt. 15c.

Phlox, Mammoth Flowering, Mixed

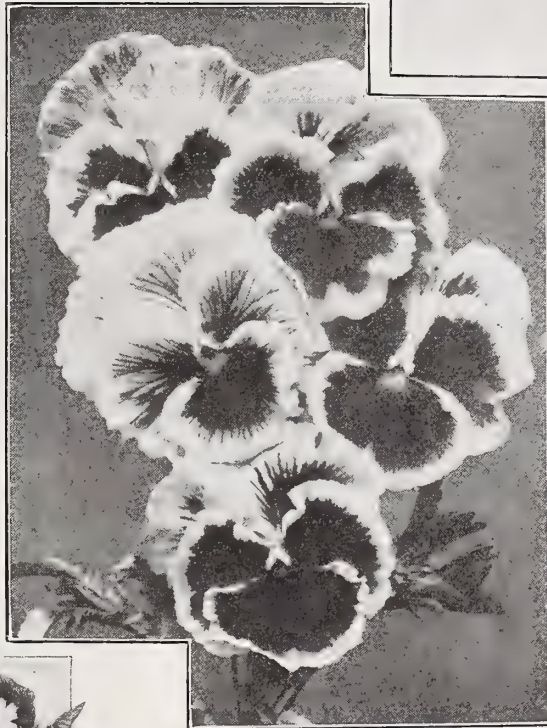

Schwill's Superb Mixed Pansy



China Double Mixed Pinks

Poppy

- Poppy, Carnation**—Double; mixed; superb; from many varieties; 2 feet; annual. Pkt. 5c.
- Poppy, Schwill's Superb**—Grand, large double flowers in every color; magnificent in form; annual. Pkt. 5c.
- Poppy, Shirley**—The handsome flowers are single, beautiful in color, from pure white to deep crimson; annual. Pkt. 5c.
- Poppy, Peony Flowered**—Enormous size; perfectly double; always admired; mixed; annual. Pkt. 5c.
- Poppy, Perennial**—Hardy; coming up year after year; very effective among shrubbery; mixed hybrids. Pkt. 10c.

Portulaca

- Portulaca, Fine Single, Mixed**—A great variety, mixed; tender annual. Pkt. 5c.
- Portulaca, Double, Mixed**—A large proportion will come very double; tender annual. Pkt. 10c.
- Rudbeckia (Cone Flower—Bicolor Superba)**—Grows about 2 feet high, forming a many-branched dense bush, and producing its long-stemmed flowers in greatest abundance. Disk brown; florets yellow with brown spots at the base; 2 feet; annual. Pkt. 10c.
- Ricinus (Castor Oil Plant)**—Rapid growing plants with palm-like foliage and showy fruits. Used with decorative effect, planted singly on the lawn or in the center of a Canna or Caladium bed, 6 to 15 feet. Mixed; all the plain and fancy sorts; tender annual. Pkt. 5c.
- Salpiglossis**—Annual, about 18 inches high, bearing throughout the season large flowers of many beautiful colors, all exquisitely veined and laced; mixed. Pkt. 5c.
- Sweet William, Single**—Handsome colored flowers; mixed; hardy perennial. Pkt. 5c.
- Sweet William, Double**—Finest double flowers; hardy perennial. Pkt. 10c.



Salvia, Scarlet Sage

Scarlet Runner Beans—A great favorite as an ornamental climber. bright scarlet sprays of pea-shaped blossoms. Pkt. 5c.

Salvia—Scarlet Sage; gorgeous plants with numerous spikes of intensely vivid scarlet flowers 10 to 12 inches in length. Pkt. 10c; oz. \$2.00

Salvia, Bonfire—Plants form handsome bushes about 2 feet high by 2 feet across. Flowers of a most brilliant, dazzling scarlet; one of the finest. Pkt. 15c; oz. \$3.00.

Schizanthus—Few annuals can surpass in beauty the Schizanthus, so much so that it has been aptly called "The Poor Man's Orchid." Large flowered hybrids. Pkt. 5c.

Sensitive Plant—One of the most remarkable and interesting plants in cultivation; the leaves, when touched, instantly fold up. Pkt. 5c.

Sweet Rocket—Grows 2 to 3 feet high, bears spikes of showy fragrant flowers, all colors, mixed; hardy perennial. Pkt. 5c.

Stocks (Gilliflower)—The free-blooming, fragrant and charming colors of the Stock have brought it into great popularity for both summer and winter flowering. For beds and borders they are very effective. Annual. Pkt. 10c.

Sunflower—Tall growing plants, with large and showy yellow flowers. Hardy annuals.

Double Dwarf Sunflower—Four feet. Pkt. 5c; oz. 40c.

Globe of Gold Sunflower—Four and one-half feet. Pkt. 5c; oz. 50c.

Double Tall Sunflower—Seven feet. Pkt. 5c; oz. 30c.

Stella or Star Single Sunflower—Three feet. Pkt. 5c; oz. 75c.

Mammoth Russian Sunflower—Eight feet. Pkt. 5c; oz. 10c.

Thunbergia (Sometimes called Blackeyed Susan)—An excellent trailing or bedding plant; very popular. Hardy annual. Pkt. 5c.

Vinca (Periwinkle)—Dark green foliage, handsome rose and white single flowers; very effective for beds and borders. Blooms continuously all summer from seed sown early in March; half hardy perennial.

Vinca, Alba—Pure white. Pkt. 10c; oz. \$1.00.

Vinca, Rosea—Bright rose. Pkt. 10c; oz. \$1.00.

Vinca, Mixed—Several colors, mixed. Pkt. 10c; oz. 75c.

Verbena—A low-growing annual, profuse in its blooms, ranging from brilliant and startling colors to soft and delicate tints. Our mammoth strain produces large trusses of brilliant, beautiful flowers.

Verbena, Choice Mixed—All shades. Pkt. 5c; oz. 40c.

Verbena, Mammoth Mixed—Large flowering. Pkt. 10c; oz. 75c.

Verbena, Scarlet Defiance—Large flowering. Pkt. 10c; oz. 75c.

Verbena, Mammoth Pink—Large flowering. Pkt. 10c; oz. 75c.

Verbena, Mammoth White—Large flowering. Pkt. 10c; oz. 75c.

Verbena, Mammoth Purple—Large flowering. Pkt. 10c; oz. 75c.

Violet—Favorite little plants, producing delightfully fragrant flowers; popular with every one. Pkt. 10c.

Wallflower—Very conspicuous in beds or borders, and are very useful in making bouquets. They are deliciously fragrant; single, mixed; half hardy perennial. Pkt. 5c.

Wild Garden Flower Seeds—Under this heading we offer a mixture of the easiest and surest growing kinds that can be sown broadcast, and with little or no care will produce a bright effect in places that would otherwise be nothing but a collection of unsightly weeds, and furnishing an abundance of flowers for cutting. Pkt. 5c; oz. 25c.

Wild Cucumber—This is the most rapid growing vine we know of. It will reach a height of 30 feet in one season. It is thickly dotted over with pretty, white flowers, followed by quantities of ornamental and prickly seed pods. Pkt. 5c.

Zinnia—Annual, of great beauty and brilliancy; of branching habit and superb colors; continuous in bloom a long time; very effective in beds, groups or mixed borders; half hardy annual.

Double White—Large flowering. Pkt. 10c; oz. 75c.

Double Orange—Large flowering. Pkt. 10c; oz. 75c.

Double Pink—Large flowering. Pkt. 10c; oz. 75c.

Double Crimson—Large flowering. Pkt. 10c; oz. 75c.

Double Purple—Large flowering. Pkt. 10c; oz. 75c.

Double Yellow—Large flowering. Pkt. 10c; oz. 75c.

Double Striped—Large flowering. Pkt. 10c; oz. 75c.

Mammoth Mixed—Large flowering. Pkt. 10c; oz. 75c.

Double Mixed—... Pkt. 5c; oz. 60c.



Zinnia, Mammoth Large Flowering



Mammoth Mixed Verbena

SUMMER FLOWERING BULBS

Dahlias

The Dahlia is one of the showiest of all autumn flowers. Commencing to flower in July, they are a perfect blaze of bloom until stopped by frost.

Double Pink Double White
 Double Yellow Double Scarlet
 Double Purple Double Striped

Price, any shade, each 25c; doz. \$2.00, parcel post paid. By express, each 20c; doz. \$1.50.

Caladium Bulbs

Caladium Esculentum (Elephant's Ears)
 —Effective as a single plant on a lawn or in groups; also useful for decorative effect near streams or pond.

Small Bulbs—By parcel post, each 15c; doz. \$1.25. By express, not prepaid, each 10c; doz. \$1.00.

Large Bulbs, by parcel post, each 25c; doz. \$2.50. By express, not prepaid, each 20c; doz. \$2.00.

Extra Large Bulbs—By parcel post, each 45c; 3 for \$1.25. By express, not prepaid, each 35c; 3 for \$1.00.

Fancy Leaf Caladiums—Finest mixed varieties. By parcel post, each 35c; doz. \$3.25. By express, not prepaid, each 25c; doz. \$2.75.

Tuberose, Double Pearl—Doz. 50c, parcel post paid. By express, doz. 40c; 100 \$2.75.

Tuberose, Single Albino—Doz. 60c, parcel post paid. By express, doz. 50c; 100 \$3.00.

Maderia Vine—A beautiful, rapid growing climber, bearing fragrant white flowers. Each, 10c; doz. 60c, parcel post paid.

Cinnamon Vine—Hardy climber, of a delicious cinnamon fragrance. Each 10c; doz. \$1.00, parcel post paid.

Peonies

They have become indispensable in every garden. They are all hardy and admirably suited to our Southern climate, growing in almost all situations, and even flourishing under shade trees.

Red, Pink, White—Each 35c, parcel post paid. By express, each 25c; doz. \$2.50.

Gladiolus

Planted during the very early spring they will produce handsome cut flowers that will last for a week or more.

Hybrid Fine Mixed—By parcel post, doz. 45c; by express, not prepaid, doz. 35c.

Childsii Mixed—By parcel post, doz. 60c; by express, not prepaid, doz. 50c.

Named Gladiolus Bulbs

America—Beautiful soft flesh pink. By parcel post, doz. 75c; by express, not prepaid, doz. 65c.

Augusta—Lovely white, with blue anthers. By parcel post, doz. 75c; by express, not prepaid, doz. 65c.

Mrs. Frances King—Striking shade of light scarlet or flame color. By parcel post, doz. 75c; by express, not prepaid, doz. 65c.

Niagara—Delicate cream yellow, lightly marked with rosy carmine in the throat. By parcel post, doz. \$1.10; by express, not prepaid, doz. \$1.00.

Schwaben—A fine strong growing variety, with massive spikes of clear canary yellow; a small garnet blotch in throat. By parcel post, doz. \$1.40; by express, not prepaid, doz. \$1.25.

Baron Hulot—Rich deep violet blue. By parcel post, doz. \$1.40; by express, not prepaid, doz. \$1.25.

Write for Special Prices on Gladiolus in lots of 100.

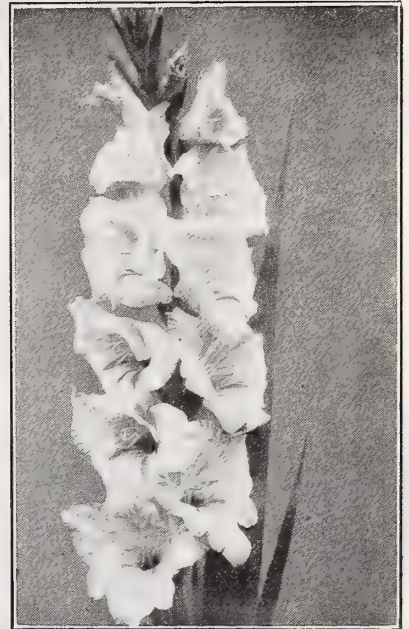

Gladiolus

Cannas

A fine foliage plant; a rapid grower, producing large trusses of beautiful flowers from early summer to late in the autumn. Price, Bulbs, each 15c; 12 for \$1.25, parcel post paid. By express, not prepaid, each 10c; 12 for \$1.00.

Eureka—Pure White. The best white Canna; 4½ feet.

Fanal—Intense fiery red; 4 feet.

Beacon—Rich cardinal red; 3 feet.

Gladiator—Deep yellow, dotted with red; 4½ feet.

Gustav Gumper—Splendid rich golden yellow; 4 feet.

Madam Crozy—Red, with golden border; 4 feet.

The following three varieties of Cannas, price, each 20c; 12 for \$1.75, parcel post paid. By express, not prepaid, each 15c; doz. \$1.50:

Hungarian—Beautiful rose pink; 3½ feet.

Mrs. Alfred Conard—Lovely shade of salmon pink; 4 feet.

King Humbert—Orange scarlet, with bronze leaf; 4 feet.



Peony



Double Dahlia



Canna



NURSERY DEPARTMENT

FRUIT TREES, GRAPE VINES, STRAWBERRY PLANTS, ETC.

Especial attention is called to the very superior quality of the Nursery Stock we supply. It is first class in every respect, smooth, straight, handsome. No orders filled after April 1st, trees being mostly leaved at that time, and will seldom prove satisfactory.

Terms are strictly cash. We do not send out Trees or Plants C. O. D. under any conditions.

All prices are f.o.b. Memphis.

EXTRA DISCOUNT—Notwithstanding the low prices we have put on all Fruit Trees, we make the following liberal offer when cash accompanies the order:

On orders amounting to \$2.50 or over, at Catalogue prices only, the purchaser may select free one tree valued at 25c.

On orders amounting to \$5.00 or over, at Catalogue prices only, the purchaser may select free trees to value of 75c.

On orders amounting to \$10.00 or over, at Catalogue prices only, the purchaser may select trees to value of \$2.00.

Bear in mind, this discount applies only on trees in this department at regular prices, and you must select your discount from this department when you order Nursery Stock.

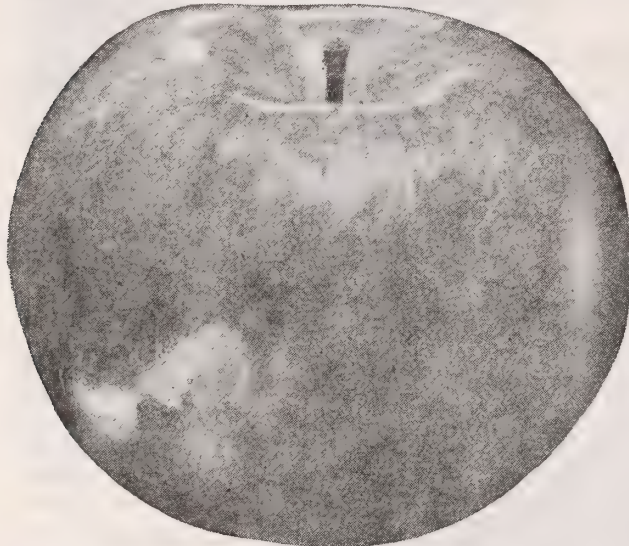

Wine Sap Apple

APPLES

- 2-year-old Trees each 40c; 12 for \$4.00
- 3-year-old Trees each 50c; 12 for 5.00
- Extra Heavy, large size, 8 ft. high each \$1.00; 6 for 5.00

SUMMER VARIETIES

- Early Colton—Yellowish white; ripens in July.
- Duchess of Oldenburg—Yellow, striped red; ripens in July.
- Early Harvest—Fine yellow; ripens in June.
- Family—Yellowish, with crimson; ripens in July.
- Horse—Large, yellow, fine for cooking; ripens in August.
- May Pippin—Greenish yellow; ripens in May and June.
- Red Astrachan—Greenish, covered crimson; ripens in June.
- Red June—Dark crimson, fine grain, moderately juicy.
- Summer Queen—Flesh yellow, firm, rich; ripens in May.
- Yellow Transparent—Large, clear, yellow, juicy.

FALL VARIETIES

- Bachelor—Large, agreeable flavor; ripens in November.
- Bell Flower—Oblong, fine rich yellow, juicy, acid.
- Fall Pippin—Large, yellow; ripens in September.
- Gloria Mundi—One of the largest apples; ripens in September.
- Maiden's Blush—Large, pale yellow; ripens in September.
- Rome Beauty—Large, red, white flesh.
- Yates' Mammoth—Richly striped; ripens in November.

WINTER VARIETIES

- Arkansas Beauty—Large, bright red; succeeds well.
- Arkansas Black—Large, dark crimson, flesh yellow.
- Ben Davis—Large, greenish yellow, striped with red.
- Black Twig—Resembles the Wine Sap, except that it is from one-third to one-half larger.
- Grimes' Golden—Golden yellow, crisp, tender, juicy.
- Jonathan—Large size; rich color, handsome variety.
- Kentucky Streak—Large, handsome, flesh white.
- Kinnard's Choice—Medium, flesh crisp, highly flavored.
- Shockley—Waxen yellow, with crimson cheek.
- Wine Sap—Rich, dark red, flesh fine, creamy yellow.

CRAB APPLES

- Each.....\$.40 Dozen.....\$4.00
- Golden Beauty Red Siberian Yellow Siberian

APRICOTS

- Strong 2-year-old Trees each 40c; doz. \$3.50
- Early Golden—Small, pale orange, juicy and sweet.
- Moorepark—Medium size, good keeper.
- Russian—Of best quality, ripens early; very productive.

FIG BUSHES

- Price, either variety, 1-year trees each 50c; doz. \$5.00
- Brown Turkey—Medium size, very sweet, prolific, hardy.
- Celestial—Very large, violet, good and productive.
- Lemon—A beautiful lemon-colored fig, very sweet.

JAPAN PERSIMMONS

The Japan Persimmon is thoroughly adapted to the Cotton Belt. The fruit varies in color and shape. We offer two of the best kinds, well adapted to this latitude, in four distinct sorts. Price, 2 to 4 feet, each 50c.

NECTARINES

- Strong 2-year-old trees each 35c; doz. \$3.00



May Duke Cherry

CHERRIES

- 2-year-old Trees each \$.50; 12 for \$5.00
- 3-year-old Trees each 1.00; 12 for 10.00
- Black Tartarian—Black, juicy; ripens last of June.
- Early Richmond—Fine, very early; ripens in May.
- Governor Wood—Very large; ripens last of May.
- Late Duke—Light red; ripens last of June.
- May Duke—Large, dark red; ripens in May.
- Wright's Early—A native variety; ripens early.
- Wright's Mammoth—Vigorous grower, fruit large.

ROCKY MOUNTAIN CHERRY

Rocky Mountain Cherry—A fruit for all people and all sections. One of the greatest novelties in the fruit line ever introduced. It bears every year and is as prolific as a currant bush. Sixteen quarts have been picked from a 3-year-old tree. Grows to a height of 4 feet and has never been affected by insects, black knot or other disease. The fruit is a rich red and changes to almost black when ripe, of good size, fine flavor and unsurpassed for preserves or eating. Price, trees 18 inches high, each 50c; 6 for \$2.50; by parcel post, each 70c.

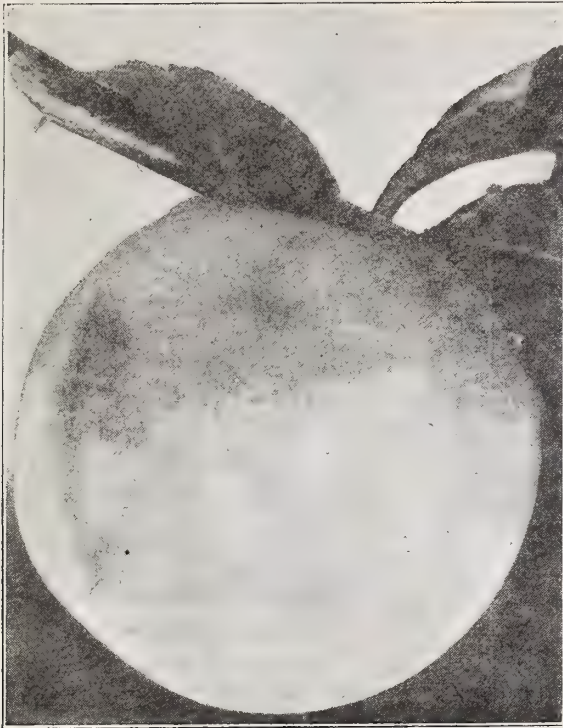

Elberta Peach
PEACHES

2-year-old Trees each \$.35; 12 for \$3.00
3-year-old Trees each .50; 12 for 5.00

CLINGSTONES

Chinese Cling—Creamy white; ripens July 15.
Fitzhugh Lee—Creamy white, crimson blush; July.
Heath Cling—Pale yellow, fine; ripens September.
Indian Blood—Large, dark crimson; ripens August.
Lemon Cling—Deep yellow; ripens end of July.
Levy's Late—A fine, large late variety; ripens October.
Morris October—One of the best; ripens October 1.
Nix Late—A large, late clingstone from Georgia.
Old Mixon Cling—Yellowish white; ripens August.
Sneed, or Peeble's—Creamy white, half cling; ripens June.
Stonewall Jackson—Very fine; ripens July 15.
White English Cling—Very large, creamy white, with blush on sunny side, flesh very juicy; ripens August.

FREESTONES

Admiral Dewey—Orange yellow, crimson cheek; June 15.
Belle of Georgia—Large white; ripens July 20.
Carmen—Freestone; ripens in June; large.
Champion—Immense size, white, red cheek; August.
Coleman's Choice—Freestone, large yellow; ripens July.
Crawford's Early—Yellow, juicy; ripens August.
Crawford's Late—Finest quality; ripens August 20.
Early Rivers—White, pink cheek; ripens July.
Ensley—Crimson yellow; ripens August 15.
Early Tillotson—White covered, red cheek; July 25.
Elberta—Flesh yellow, juicy and sweet; ripens August 1.
Greensboro—An early variety, large white; ripens June 15.
Globe—Fine yellow; ripens October.
Heath Free—Very tender, juicy and melting; September.
Matthews' Beauty—Large yellow peach; August.
Mountain Rose—White, splashed carmine; ripens July 1.
Old Mixon Free—Yellowish white; ripens August 15.
Piquet's Late—Flesh yellow, sweet; ripens September.
Stump the World—Large, white, fine; ripens August 15.
Susquehanna—Fine canner; ripens July 30.
Triumph—Yellow; ripens June 1 to 15.
Wonderful—Handsome, productive; ripens October 10.
Yellow St. John—Golden yellow; ripens June 20.

QUINCES

Strong 2-year-old Trees each \$.40; doz. \$3.50
Champion—Large and handsome; tender and rich in flavor.
Orange—Large, round, golden yellow; very fine.
Rea's Mammoth—An improvement upon the Orange; much larger.

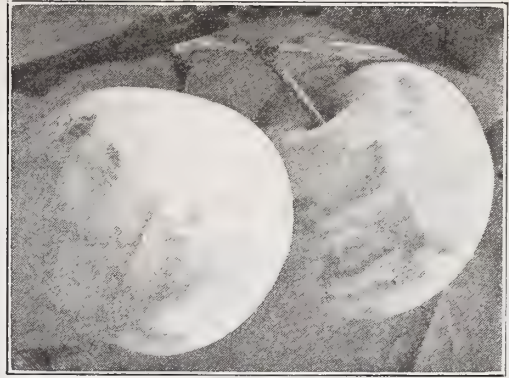

Abundance Plum

PLUMS

2-year-old Trees each \$.40; 12 for \$4.00
3-year-old Trees each 1.00; 12 for 10.00
Abundance—Large, sweet, juicy; very early, bright red.
Burbank—Large, clear, cherry red, very sweet.
Damson—Bluish purple, fine for cooking; ripens in August.
Red June—Purplish red, flesh yellow, solid, juicy.
Wild Goose—Very large and fine; ripens in June.
Wickson—Purple red, firm, sweet and juicy.

GRAFTED OR BUDEDDED PECANS

The budded or grafted pecans will bear at six years of age, while the seedlings seldom commence to give fruit under ten years after planting. Price 2 to 3 feet \$1.00 each; 3 to 4 feet \$1.50 each.

Bradley Pecans—Its good points are large size, thin shell, well filled and very prolific.
Frotscher Paper Shell Pecan—One of the best; large, thin shells; prolific bearing.
Pride of the Coast—Nuts frequently 2 inches in length; shell moderately thin; nuts will run from 24 to 32 to the pound.

SEEDLING PECANS

These are raised from the large thin shelled nuts.
Paper Shelled Seedling Pecans—The nuts are large and very thin shelled. 2 to 3 feet, each 50c; doz. \$5.00.

STANDARD PEARS

2-year-old Trees each \$.40; 6 for \$ 2.00; 12 for \$ 3.50
3-year-old Trees each 1.00; 6 for 5.00; 12 for 10.00
4-year-old Trees each 2.00; 6 for 10.00; 12 for 15.00

Bartlett—Yellow, faint blush; ripens in August.
Clapp's Favorite—Resembles Bartlett; ripens in August.
Duchess D'Angouleme—Very large; ripens in October.
Flemish Beauty—Large, sweet; ripens in August.
Garber—Larger than Keiffer; beautiful yellow.
Koonce—Of large size and of good form and color.
Keiffer—Golden yellow, tinged with red on one side, remarkably free from blight; ripens in September.
LeConte—Large, of fair quality; ripens in August.

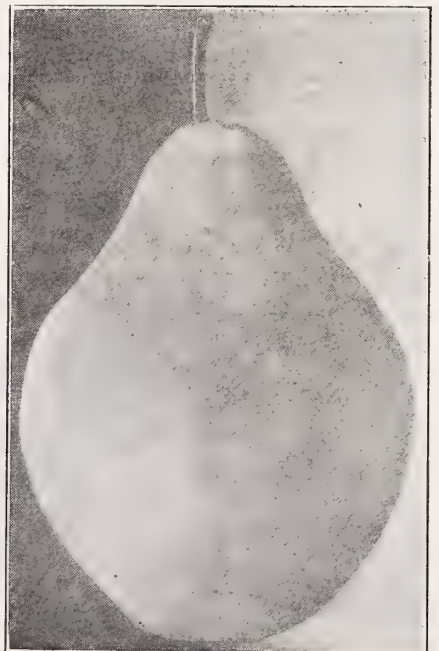

Keiffer Pear

STRAWBERRIES

Plant in February, March, April and November, on good ground, deeply worked and well manured. Set in rows 3½ feet apart, 15 inches in rows, for field culture; 15 inches each way for garden. Cultivate clean, mulch late in the fall and uncover early in the spring. Remove mulch after fruiting and spade in a light dressing of manure.



Klondyke Strawberry



Lady Corneille Strawberry



Superb Everbearing Strawberry

Brandywine—Largest, most brilliantly colored and most strikingly beautiful of all berries. It is truly glorious. Very early, right on the heels of Excelsior. King of markets wherever it shows itself. Price, by express, 25 for 30c; 100 for \$1.00; 500 for \$4.00; 1000 for \$7.00. By parcel post, 25 for 45c; 100 for \$1.20; 500 for \$4.50.

Gandy Strawberry—The best late variety; produces large even dark crimson fruit; a splendid shipper. Price, by express, 25 for 25c; 100 for \$1.00; 500 for \$4.00; 1000 for \$7.00. By parcel post, 25 for 40c; 100 for \$1.20; 500 for \$4.50.

Aroma Strawberry—Very large, late maturing, berries solid, deep red, uniform in size; does well in this section. Perfect blooming. Price, by express, 25 for 30c; 100 for \$1.00; 500 for \$4.00; 1000 for \$7.00. By parcel post, 25 for 40c; 100 for \$1.20; 500 for \$4.50.

Lady Thompson Strawberry—Well known standard variety for home use; fruits large, slightly pointed, light red, but very sweet; perfect blooming. Price, by express, 25 for 30c; 100 for \$1.00; 500 for \$4.00; 1000 for \$7.00. By parcel post, 25 for 40c; 100 for \$1.20; 500 for \$4.50.

Excelsior—A standard extra early variety that succeeds everywhere. Firm, brilliantly colored. Fine table berry when perfectly ripe. Price, by express, 25 for 30c; 100 for \$1.00; 500 for \$4.00; 1000 for \$7.00. By parcel post, 25 for 40c; 100 for \$1.20; 500 for \$4.50.

Superb Everbearing—A new species, different from the ordinary strawberry, in that they bear in the fall. Many persons have the impression that the fall, or Everbearing strawberries are difficult to grow successfully. This is an error; their culture is almost as simple as the ordinary kinds. For full crops in autumn it is best to remove all blossoms until about the first or middle of July. In all other respects they should be given the same treatment as other varieties of strawberries. Price, Superb Everbearing, as follows: By express, 25 for 75c; 50 for \$1.25; 100 for \$2.25; 500 for \$10.00. By parcel post, 25 for 85c; 50 for \$1.40; 100 for \$2.45; 500 for \$10.50.

New Strawberry, Lady Corneille—A wonderful new strawberry from Louisiana, ripens with Klondyke, but continues in bearing longer; berries large, rich, glossy red, slightly long, uniform in size and shape; rich, juicy, sweet and delicious. The plant is vigorous, with dark green glossy leaves, and stands drouth better than any other variety. Lady Corneille is a better berry than Klondyke for shipping, being larger, darker in color, and carries well in transit. Flowers perfect, therefore will produce crop when planted alone. Price, by express, 25 for 50c; 100 for \$1.25; 500 for \$4.00; 1000 for \$7.00. By parcel post, 25 for 70c; 100 for \$1.40; 500 for \$4.50.

Klondyke Strawberry—A Southern berry, one of the best; color dark red, and good size. Flowers perfect. Price, by express, 25 for 30c; 100 for \$1.00; 500 for \$4.00; 1000 for \$7.00. By parcel post, 25 for 40c; 100 for \$1.20; 500 for \$4.50.

RASPBERRIES

Plant in rows 5 to 6 feet apart, 2 to 4 feet in the row. Cut the tops off within a few inches of the ground when planted. After the fruit season, cut out all the old wood which bore the last crop of fruit. Pinch the vigorous young shoots several times during the summer. They will then grow stout enough to stand without staking.

Cumberland—The largest black raspberry grown; immensely productive; quality fine; ripens very early. Price, by express, each 15c; 6 for 50c; 12 for 85c; 100 for \$5.00. By parcel post, each 25c; 6 for 70c; 12 for \$1.10.

St. Regis Everbearing Raspberry—One of the greatest raspberries ever introduced. Plants of the St. Regis put out in the fall or early April gave ripe berries on the 20th of June. For four weeks thereafter the yield was heavy and the canes continued to produce ripe fruit without intermission until late October. The berries were large and beautiful, firm and full flavored, to the very last. The St. Regis is the only raspberry, as far as known, that is practically sure to produce a crop of fruit the season planted. Price, by express, each 15c; 6 for 75c; 12 for \$1.25; 25 for \$1.75; 100 for \$6.00. By parcel post, each 25c; 6 for \$1.00; 12 for \$1.50.

Cuthbert—Fruit large, red, of excellent quality, yield very prolific; ripens middle of May, and continues for several weeks. Price, by express, each 15c; 6 for 50c; 12 for 85c; 100 for \$5.00. By parcel post, each 25c; 6 for 70c; 12 for \$1.10.

Gregg—Blackcap; very productive, large size, firm, black. Price by express, each 15c; 6 for 50c; 12 for 85c; 100 for \$5.00. Parcel post paid, each 20c; 6 for 70c; 12 for \$1.10.

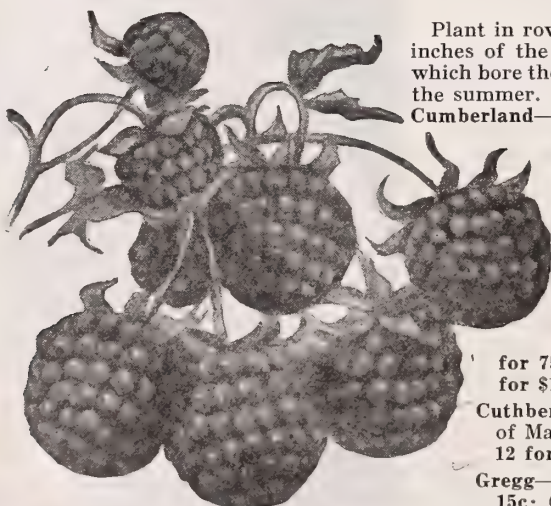

St. Regis Everbearing Raspberry

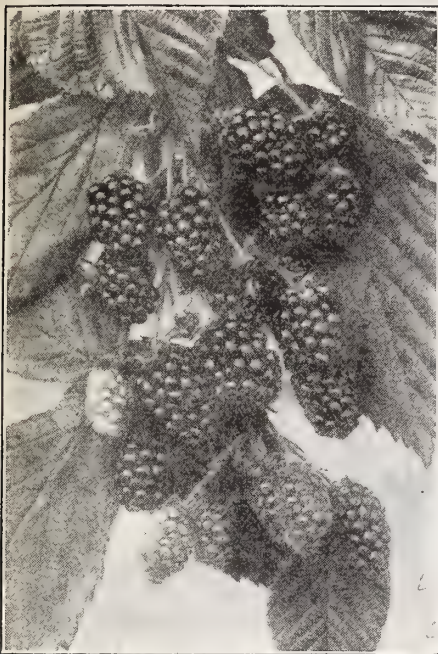

Himalaya Giant Blackberry

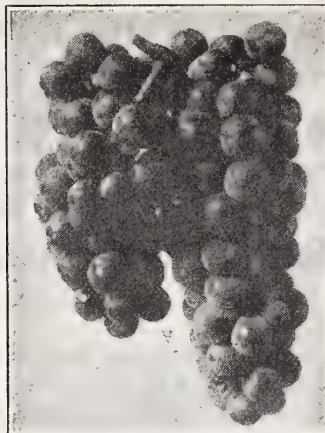

Concord Grape



Campbell's Early Grape

GRAPES

Strong 2-year-old vines each 35c; doz. \$3.00; 100 \$15.00
 By parcel post each 50c; 6 for 2.00
Brighton—Large, coppery red; best quality.
Campbell's Early—Large, compact, black berry.
Concord—Large, black, juicy; sweet when ripe.
Delaware—Bunches small and compact; light red.
Early Ohio—The earliest black grape; bunches large.
Lutie—Very early, large red; free from rot.

Moore's Early—Large, black, earlier than Concord; fine.
Niagara—Berries large, sweet, greenish white.
Worden—Concord type, large in bunch and berry.

BLACKBERRIES

Plant in good soil, in rows 5 to 6 feet apart, and 3 to 4 feet apart in the row. After the fruiting season, or in early spring, cut out all the dead wood. Blackberries should be planted early, before the buds start. A good top dressing of stable manure, applied annually, will be conducive to large crops. Keep the ground clean.

Himalaya Giant—A mammoth late blackberry, coming after the other berries are gone, ripens over a period of several weeks, making it especially desirable for family use. Fruit large, fine quality. Price by express, each 15c; 6 for 85c; 12 for \$1.00; 100 for \$5.00. By parcel post, each 25c; 6 for 90c; 12 for \$1.25.

Eldorado—Fruit large, roundish conical, rich glossy black; firm, juicy, sweet and excellent. Price, by express, each 15c; 6 for 65c; 12 for \$1.00; 100 for \$5.00. By parcel post, each 25c; 6 for 90c; 12 for \$1.15.

Early Harvest—The earliest good blackberry, fruits well, of excellent quality. Price, by express, each 10c; 6 for 60c; 12 for \$1.00; 100 for \$5.00. By parcel post, each 15c; 6 for 75c; 12 for \$1.15.

CURRANTS

Fay's Prolific—One of the most prolific, of excellent quality. Price, by express, each 15c; 6 for 75c; 12 for \$1.25; 100 for \$7.50. By parcel post, each 25c; 6 for 90c; 12 for \$1.50.

DEWBERRIES

Lucretia Dewberry—The berries are far larger and incomparably better than any blackberry, and of unequalled excellence; soft, sweet and luscious throughout; of brightest glossy black color. Price, by express, each 15c; 6 for 75c; 12 for \$1.00; 100 for \$5.00. By parcel post, each 25c; 6 for 90c; 12 for \$1.15.

GOOSEBERRIES

Downing—Large, pale green berries. Price, by express, each 20c; 6 for \$1.00; 12 for \$1.75; 100 for \$12.00. By parcel post, each 30c; 6 for \$1.15; 12 for \$2.00.

MULBERRIES

Price each 50c; doz. \$5.00
Hick's Everbearing—Produces immense crops; splendid for poultry and hogs.

HAWKEYE TREE PROTECTOR

A sure protection against sun scald, rabbits, mice and other vermin. Keeps them from eating the bark on young trees. 100 for \$2.00; 50 for \$1.35; 12 for 35c. By parcel post, 100 for \$2.40; 50 for \$1.50.

SCUPPERNONG GRAPES

Scuppernong Grapes—Bunches seldom ever composed of more than 8 or 10 berries; berries round, of a bronze color, when full ripe; vine is free from all disease and attacks of insects. 1-year, each 50c; doz. \$4.00; 2-year, each 75c; doz. \$7.50. By parcel post, 1-year, each 65c; 2-year, each 90c.

PRIVET HEDGE PLANTS

California Privet—The great hedging plant. Remarkable for the beauty of its evergreen foliage and strong, regular, symmetrical growth. The foliage is dark green, very glossy and wax-like; hardy everywhere. Remove the unsightly fence and increase the value of your property by planting a California Privet Hedge. Does well in all situations and under all conditions.

Price, by express only—

1-year plants, 12 to 15 inches..... 25 \$1.00; 100 \$3.00
 1-year plants, 18 to 24 inches..... 25 1.25; 100 4.00
 2-year plants, 30 to 36 inches..... 25 2.00; 100 5.00

Amor Privet—Retains its color remarkably well in the winter. Is quite hardy and makes a fine hedge.

Price, by express only—

1-year plants, 12 to 15 inches..... 25 \$1.25; 100 \$4.00
 1-year plants, 18 to 24-25 inches..... 25 1.50; 100 5.00
 2-year plants, 30 to 36 inches..... 25 2.00; 100 6.00

SHADE TREES

Price, trees 5 to 6 feet 75c; 8 to 10 feet \$1.00 each.

Silver Leaf Maple Red Elm Weeping Willow
 Lombardy Poplar Judas or Red Bud Norway Maple
 Carolina Poplar Catalpa Speciosa Sugar or Rock Maple

HARDY SHRUBS

	2-yr. plants.	Doz.
Althea, in 10 colors, each, Rose or Sharon.....	.30	\$3.00
Calycanthus, sweet shrub, clove or allspice.....	.35	3.50
Crepe Myrtle, crimson35	3.00
Deutzia, assorted colors30	3.00
Forsythia, Golden Bell35	3.50
Japan Quince, per 100, \$15.0035	3.50
Lilac, purple35	3.50
Philadelphus, Syringa30	3.00
Snowball Shrub35	3.50
Spirea, assorted30	3.00
Weigela, assorted35	3.50
Hydrangea, hardy50	5.00

Shrubs at Wholesale—Parties wanting any of the above varieties in lots of 50 or 100, will quote special prices.

INOCULATE YOUR ALFALFA, CLOVERS, COW PEAS, SOY BEANS, VETCHES,
and All Other Legume Crops, with

Mulford Cultures

FOR LEGUMES

Small Cost

Large Returns

Easy to Use

No Labor Expense



Alfalfa plant on left not inoculated. Plant on right inoculated with Mulford Culture for Alfalfa. All other conditions identical. This contrast speaks for itself.

Mulford Cultures contain pure, tested strains of active, vigorous nitrogen-fixing bacteria, for inoculating seeds of legumes or soil. Enormous numbers of these very valuable and desirable bacteria are thus available to you in every package of Mulford Culture and may readily be applied to your seed. The sealed bottle insures purity.

Increase Your Crops Improve Your Soil

Legumes Offer the Best Known Means of maintaining soil fertility and rejuvenating over-cropped and worn-out fields. They add both humus and nitrogen to your soil and thus increase your yield of wheat, cotton, corn, and other non-legume crops.

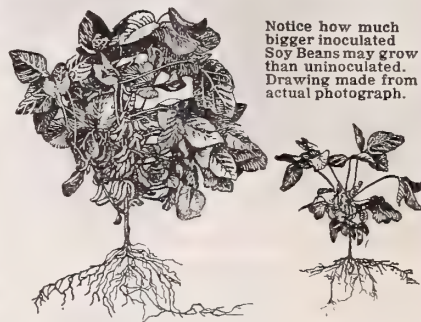

Notice how much bigger inoculated Soy Beans may grow than uninoculated. Drawing made from actual photograph.

Mulford Cultures are Scientifically Prepared and tested by experts, in the biological laboratories of H. K. Mulford & Co., Philadelphia, U. S. A., with the same degree of care as Mulford Antitoxins, Serums, Vaccines, etc., which are standard all over the world.

Always specify on your order what crop you want to inoculate, as there is a different strain of bacteria for each legume.

ALFALFA
CRIMSON CLOVER
SWEET CLOVER
WHITE CLOVER

RED CLOVER
ALSIKE CLOVER
BURR CLOVER
COW PEAS

SOY BEANS
PEANUTS
VETCH
VELVET BEANS

SWEET PEAS
GARDEN PEAS
GARDEN BEANS
LIMA BEANS

MULFORD CULTURES are supplied for the varieties of legumes listed, at the following prices:

5-Acre Size	\$5.00; By parcel post, \$5.15
1-Acre Size	1.50; By parcel post, 1.60
1/2-Acre Size50; By parcel post, .55
Small Size, (Supplied only in 4 varieties, for Garden Peas, Garden Beans, Lima Beans and Sweet Peas)25; By parcel post, .30

Why buy expensive commercial nitrates when you can grow Legume crops and thus increase your yield and at the same time increase the nitrates and enrich and renovate your soil, by Nature's own method?

FREE DESCRIPTIVE FOLDER SENT UPON REQUEST

The Kirke Automatic Lawn Feeder and Fertilizer and Insecticide Dispenser

The Kirke System of fertilizing, etc., means the attachment to your garden or greenhouse hose a cylinder containing a readily soluble solution high grade fertilizer or insecticide cartridge. You water the lawn or your plants and the Kirke System does the rest. The flow of water through the feeder and hose gradually dissolves the cartridge and insures an even and positive distribution of fertilizer or insecticide over lawn or plants. Clean, odorless, efficient, economical; easily attached and convenient.



Showing Kirke System of Lawn Fertilizing

Kirke Feeder—(Distributing Container). Nickel plated; holds 1 cartridge, no complicated parts. Each.....\$3.00

The following Cartridges—

		By parcel post
Kirke Fertilizer Cartridge	\$.20	\$.30
Kirke Tobacco Insecticide30	.40
Kirke Arsenate of Lead40	.50
Kirke Bordeaux Fungicide25	.35
Kirke Angle Worm Destroyer	1.00	1.10
Kirke Fly Maggot Destroyer30	.40
Kirke Sulphur Cartridge30	.40
Kirke Salt Cartridge10	.20
Kirke Sprinkling-Can Plant Food—30c per box (12 tablets).		

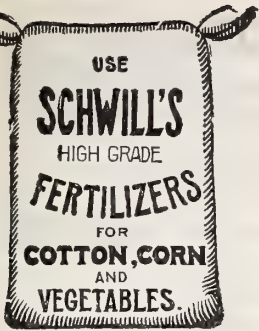

HIGH-GRADE FERTILIZERS

BEST RESULTS FROM THE SOIL.—If you want to obtain the best results from the soil, we are compelled, by sheer necessity, to use commercial fertilizers. The prices given below are net cash and f.o.b. Memphis. Special prices on car lots and larger quantities delivered at your depot will be given on application.



Schwill's Special Brands

- Schwill's Truck Grower**—Made especially for vegetables and garden crops. Analysis: 10 per cent phosphoric acid, 4 per cent potash, 4 per cent nitrogen. 3 lb. 25c; 25 lb. \$1.50; 100 lb. \$4.50; ton \$80.00.
- Schwill's Corn Grower**—Prepared to give increased yield on corn crop. Analysis: 12 per cent phosphoric acid, 1 per cent potash, 1 per cent nitrogen. Price, 100 lb. \$2.75; ton \$46.00.
- Schwill's Cotton Grower**—Especially recommended for cotton, which needs plenty of potash. Analysis: 10 per cent phosphoric acid, 2 per cent potash, 1 per cent nitrogen. 100 lb. \$3.00; ton \$52.00.
- Schwill's Acid Phosphate**—Splendid for making compost or mixtures; 16 per cent analysis. 100 lb. \$1.90; ton \$31.50.
- Schwill's Lawn Fertilizer**—A very rich, pure, natural manure, especially prepared for lawns. 10 lb. 50c; 100 lb. \$4.00.

Sterlingworth Lawn Compound

Kills the weeds but not the grass. Makes lawns green and velvety. Price, 5 lb. 40c; 10 lb. 75c. By parcel post, 5 lb. 60c; 10 lb. \$1.00.

Walker's Excelsior Plant Food

Produces rich, green growth and profusion of flowers. Small size 25c; large size 50c, parcel post paid.

Japanese Palm Food

Manufactured Expressly for Palms, Rubber Plants and Ferns.

When Applied as a Top Dressing—Sprinkle about ¼ teaspoonful over the surface for plant in a 6-inch pot; larger or smaller pots in proportion. Be sure and stir the surface of the soil, and water as usual.

In Re-Potting Plants—Add about ½ teaspoonful to a 6-inch pot—be sure and mix with soil; larger or smaller pots in proportion.

How Often to Use It—Use the food about once a week for two or three weeks, or until you notice a greener growth. Then do not use the food oftener than once in six weeks. Do not use more than directions call for. 5 oz. can 30c, parcel post paid.

Nitro-Fertile

Nitro-Fertile—An odorless liquid fertilizer for house plants, flowers, lawns, vegetable garden, shrubbery, and fruit trees, containing all the necessary food for plant life in correct proportions. Being in liquid form it is easily applied throughout the plant life with unusual and prompt results. Improves the growth, bloom and foliage.

Nitro-Fertile is put up in glass containers and sold at the following prices. Directions on every package:

Pints	\$.40
Half-Gallons	1.10
Gallons	2.00

One gallon of Nitro-Fertile makes 120 to 240 gallons of commercial fertilizer. Cannot be mailed.



Raw Chemical Material

- Pure Bone Meal**—Invaluable for top dressing lawns. Nothing is better for fertilizing young fruit trees, grape vines, roses, etc. 3 lb. 25c; 25 lb. \$1.50; 50 lb. \$2.00; 100 lb. \$3.75.
- Wizard Brand Sheep Manure**—Nature's own fertilizer, absolutely pure and best to use on lawns and flowers. 5 lb. 30c; 25 lb. \$1.00; 100 lb. \$3.00.
- Land Plaster or Gypsum**—Is largely used as a fertilizer for clover, corn and other crops. Excellent to mix with paris green at the rate of 100 lbs. of plaster to 1 lb. of paris green to kill bugs, worms, etc. 50 lb. \$1.00; 100 lb. \$1.50; 200-lb. sack \$2.25; per ton \$18.00.
- Nitrate of Soda**—This is the most soluble and quickly available form of Nitrogen or "Ammonia." It is of great benefit in forcing a strong, luxuriant growth in plants. It is especially valuable for cabbage, cauliflower, beets, carrots, onions, potatoes, and similar crops, as well as for grass, grain, fruit and flowers. Use 100 lb. to an acre. 2 lb. 25c; 25 lb. \$2.00; 100 lb. \$7.50.

Ground Limestone

Use ground limestone on your alfalfa, red clover and grasses and you will get results. Sow broadcast, then plow or disc harrow in 2,000 to 4,000 pounds of it on an acre of land about two weeks before sowing seed. Price, 100 lb. \$1.25; per ton \$15.00, f.o.b. Memphis.

Sterlingworth Plant Tablets



A new odorless invigorator for house plants; increases growth of plant and doubles the bloom. Two sizes—10c and 25c per box. By parcel post, 15c and 30c.



Daisy Fertilizer Distributer

Is a strong, accurate and trustworthy tool, handsomely finished and the material and workmanship throughout is the very best. The hopper has tongue and grooved joints, securely held together by cement nails and two bolts; is well braced to the stock. The gauge is positive and is easy to set so as to distribute any amount to the acre. Price \$10.00, f.o.b. Memphis.



INSECTICIDES AND FUNGICIDES



Order Early. Fruit Trees should be sprayed late in winter or very early in spring. Have the material on hand and do the work at the right time. You can raise good fruit by a systematic spraying.

Try spraying this spring. You will be well repaid for your expense and trouble. Directions for applying the different preparations are printed on the packages. Prices are f.o.b. Memphis, purchaser paying carrying charges, unless stated otherwise.

Poisonous insecticides and liquids of any kind are not permitted in the mails, so all packages of poisons, no matter how small, must be sent by express or freight.

For fungus diseases, use at all times Bordeaux Mixture, or Pyrox. For lice and chewing insects and aphids, use Kerosene Emulsion. On roses, use Fir Tree Oil Soap solution for green fly. For caterpillars, use Arsenate of Lead. For mildew, use Lime Sulphur, Hammond's Grape Dust. For cut worms, Cut Worm Food. For tomato worms, apply Slug Shot; cabbage worms, Pyrox. For potato bugs, use Bug Death and Arsenate of Lead or Tuber Tonic.

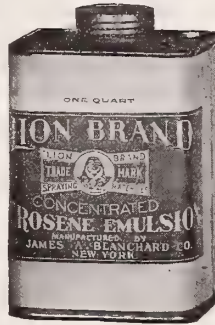

Bug Death—An effective non-poisonous powder for potato bugs and other insects in the garden. 1 lb. 20c; 3 lb. 40c; 5 lb. 60c; 12½ lb. \$1.25; 100-lb. keg \$8.50. By parcel post, 1 lb. 30c; 3 lb. 55c; 5 lb. 80c; 12½ lb. \$1.80.

Slug Shot, Hammond's—Non-poisonous; a splendid powder for general use. 1 lb. 20c; 5 lb. 60c; 10 lb. \$1.00; 25 lb. \$2.25; 100 lb. \$8.00. By parcel post, 1 lb. 30c; 5 lb. 75c; 10 lb. \$1.25.

Hammond's Grape Dust—Keep off blight and other fungus diseases. 1 lb. carton 25c; 5 lb. 75c. By parcel post, 1 lb. 30c; 5 lb. 90c.

Sulphur Powder—Very effective against mildew. 1 lb. 15c; by parcel post 25c.

Dry Powdered Arsenate of Calcium—Contains the maximum amount of arsenic oxide which can safely be combined with calcium so as to produce a quick acting, adhesive and economical insecticide. It has relatively the quick killing action of Paris Green, but adheres to the leaf for a longer time than does Paris Green. It is white in color and therefore it is easier to insure proper and uniform distribution. Due to the thorough chemical combination of the elements entering into the manufacture of Arsenate of Calcium, we produce a powder which insures maximum results at a minimum cost. Arsenate of Calcium is lower in cost than Arsenate of Lead, and very much less expensive than Paris Green. 1 lb. 55c; 5 lb. \$2.25; 10 lb. \$4.50; 25 lb. \$10.50; 50 lb. \$19.50; 100 lb. \$38.00; cannot be mailed.

Dry Arsenate of Lead—Does not burn the foliage, absolutely safe to use, kills every insect that eats it, superior in every way to Paris Green, as it does not burn or scald the foliage, can be used dry as a powder or as a solution in water. Corona Dry Arsenate of Lead is one of the best preparations on the market. ½ lb. 35c; 1 lb. 65c; 5 lb. \$2.75; 10 lb. \$5.00; 25 lb. \$12.00; 50 lb. \$22.00; 100 lb. \$42.00. Cannot be mailed.

Paste Arsenate of Lead—It is simple to dilute; always effective. 1 lb. 40c; 5 lb. \$1.50; 10 lb. \$2.75; 20 lb. \$5.00; 25 lb. \$6.00; 50 lb. \$11.50; 100 lb. \$21.00. Cannot be mailed.

Lemon Oil Insecticide—Safe to use; leaves no odor; will destroy all lice, scale, worms, spiders, aphids, etc., on all plants. Mixes with water and easily applied. ½ pt. 35c; 1 pt. 60c. Cannot be mailed.

Pruning Compound—For use on trees after pruning, keeps limbs from bleeding. 1 qt. 60c; not mailable.

Tuber Tonic—A new preparation from Sherwin-Williams Co., especially made to kill potato beetle and at the same time acts as a tonic to the plant. 1 lb. 60c; 5 lb. \$2.75; 10 lb. \$5.00; 25 lb. \$11.00. Cannot be mailed.

Powdered or Dry Bordo—The perfect dry Bordeaux mixture, all ready to be mixed, as you need it, with water; kept dry will last for years; full directions on every package how to use it. 1 lb. 45c; 5 lb. \$2.00; 10 lb. \$3.50; 25 lb. \$7.50; 50 lb. \$11.50. Cannot be mailed.

Bordeaux Mixture—We carry the best brands of this standard formula. Price, Bordeaux Liquid, 1 qt. 60c; 1 gal. \$1.85.

Bordeaux and Arsenate of Lead Mixture—A combination fungicide and insecticide. Liquid, 1 qt. 85c; 1 gal. \$2.75. Dry Powder, 1 lb. 60c; 5 lb. \$2.50; 10 lb. \$4.75. Cannot be mailed.

Kerosene Emulsion—Lion Brand, full directions on can. 1 pt. 35c; 1 qt. 60c; 1 gal. \$1.75. Cannot be mailed.

Sulpho Tobacco Soap—Will keep off and kill all insects on plants and trees. 3 oz. cake 15c; 8 oz. 35c. By parcel post 10c extra.

Hammond's Thrip Juice—For sucking insects. Non-poisonous. Dilute one to fifty. Absolutely sure shot against aphids, lice, mealy bugs, etc. ½ pt. 40c; pt. 65c. Cannot be mailed.

Paris Green—¼ lb. 25c; ½ lb. 40c; 1 lb. 70c; 5 lb. \$3.00. Cannot be mailed.

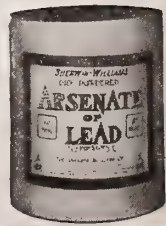
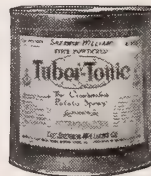

OTTO SCHWILL & CO., MEMPHIS 50th YEAR SCHWILL'S SURE SEEDS

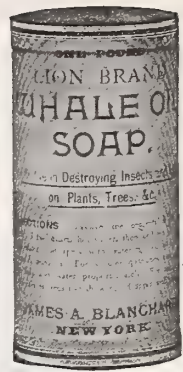
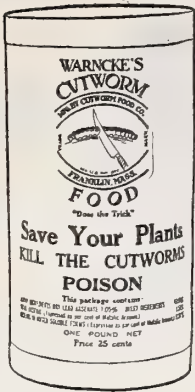

Tree Tanglefoot—Applied to trees keeps ants and caterpillars from crawling up; a sure cure for most insect trouble on all kinds of trees. 1 lb. can 45c; 3 lb. can \$1.30; 10 lb. can \$4.00. By parcel post, 1 lb. 60c; 3 lb. \$1.40; 10 lb. \$4.25.

Cut Worm Food—Simple, easy to use; a sure dose for eradication of all cut worms. 1 lb. 30c; 5 lb. \$1.25; not mailable.

Pratt's Sulfoicide—The very best and safest preparation to use on peach trees. A spraying with Sulphocide, one part to ten parts of water, just as the dried blossoms are coming off of the newly-formed fruit, will insure fruit free from worms or brown rot. This is a very important spray for peaches, and should not be omitted. A second spraying should be done when fruit is about the size of a hickory nut. Further instructions on request. 1 pt. 50c; 1 qt. 75c; 1 gal. \$2.25. Not mailable.

Pratt's Scalecide—One of the very best preparations for controlling San Jose Scale. Scalecide will also destroy the eggs and larvae of many insects wintering on trees, as well as fungus troubles, by a dormant spray. This cannot be said of any other spray on the market, like oil or Lime Sulphur. The manufacturer claims that it will do all Lime Sulphur can do, and some things that Lime Sulphur cannot do. The longer the trees are sprayed with Scalecide the more beautiful and healthful and fruitful they become. Scalecide is easier applied than Lime Sulphur. It is non-corrosive and non-poisonous. One gallon of Scalecide diluted for use will spray twice as many trees as two gallons of diluted Lime Sulphur. This is due to its spreading properties. Ask for Pratt's booklet on Scalecide. 1 qt. can 60c; 1 gal. can \$1.45; 5 gal. can \$5.75. Not mailable.

Copper Sulphate Solution—For any kind cabbage worm, scale insects on apple, pear and other trees. 1 qt. \$1.00.

Lime Sulphur Solution—We handle the Sherwin-Williams brand, the best on the market. 1 qt. 40c; 2 qts. 60c; 1 gal. \$1.00; 5 gal. \$3.50; ½ bbl., 30 gals., at 32c gal. Not mailable.

Dry or Powdered Lime Sulphur—This new preparation is even better and more effective than the liquid formula. Besides, it don't spoil. You can use as you want same, and then you also don't have to pay freight on water. Five pounds Powdered Lime Sulphur will make 50 gallons of spray material. Full directions come with every package. 1 lb. pkg. 35c; 5 lb. pkg. \$1.50; 10 lb. \$2.50; 25 lb. \$5.00. By parcel post, 1 lb. 50c; 5 lb. \$1.75.

Aphis Punk—Tobacco paper, the original and genuine nicotine fumigant. Price, can of 1 doz. sheets, 60. By parcel post 70c.

Hydrometer—For testing accurately the strength of your Lime Sulphur and other spray materials. Set complete, one Hydrometer tube, one 12-in. glass test jar with foot and pour-out, packed in a wooden case with full directions. Price, \$2.00. By parcel post, \$2.15.

Fish or Whale Oil Soap—Effective against scale, ants, aphids, etc., on trees and plants. ¼ lb. 10c; 1 lb. 30c. By parcel post, ¼ lb. 15c; 1 lb. 40c.

Fir Tree Oil Soap—Excellent remedy for all house plants, trees or shrubs. ½ lb. can 30c. By parcel post, 35c.

Weedicide—Kills and eradicates weeds of all sorts by simply sprinkling the liquid on them. For yards and lawns, walks, drives. 1 gal. jug 50c.

Sterlingworth Lawn Compound—A fine preparation for killing weeds where there is grass, at the same time benefiting the lawn. 5 lb. 60c; 10 lb. \$1.00. By parcel post, 5 lb. 75c; 10 lb. \$1.25.

Sterlingworth Borer Oil—Useful against flat and round-headed borers, also peach borers. 1 pt. 25c. By parcel post 35c.

Sterlingworth Weed Killer—For killing weeds in walks, drives, courts, etc. One pound makes 10 gallons. 1 lb. 50c; 5 lb. \$2.00. Not mailable.

Nicoteen Liquid—A very strong solution of Nicotine, which is sure death to all insect life, does not injure the most tender foliage, if directions are followed. 1 oz. bottle 25c; 1 ¼ oz. 40c; ½ lb. 85c; 1 lb. \$1.50. Not mailable.

Sterlingworth Plant Lice Killer—For use against most sucking insects, and many spiders which infest house plants and greenhouse flowers. 1 pt. 25c; by parcel post 35c.

Sterlingworth Ar-Bo—A combined insecticide and fungicide. Kills most leaf-eating insects, also prevents certain fungus diseases. 1 lb. 25c. Cannot be mailed.

Tobacco Dust—For lice and other insects on all vegetable and flower plants. 1 lb. 15c; 5 lb. 40c; 25 lb. \$1.25; 100 lb. \$4.00. By parcel post, 1 lb. 25c; 5 lb. 60c.

Grafting Wax—Prepared especially for all grafting on trees, etc. ¼ lb. 20c; ½ lb. 30c; 1 lb. 50c. By parcel post, ¼ lb. 25c; ½ lb. 40c; 1 lb. 60c.

Pyrox—Is easy to use; simply mix with water and spray; sticks like paint to the leaves and is not washed off by even heavy rains. Saves time, labor and trouble. Pyrox is a double-header spray—it kills leaf-eating worms and bugs; prevents blight, rot, rust and fungus in one operation. It stimulates growth, increases yield and quality, keeps the tree or plant healthy and vigorous throughout the growing season. 1 lb. 40c; 5 lb. \$1.50; 10 lb. \$2.75; 25 lb. \$6.25. Not mailable.

White Hellebore—Effective on all lice and other insects on vegetable plants; poisonous but safe to use. ½ lb. 35c; 1 lb. 65c. Cannot be mailed.





SPRAY PUMPS

The Auto Spray Pump—The "Auto Spray" works automatically for 6 to 15 minutes, according to the nozzle opening. Diameter, 7 inches; height, 2 feet; capacity, 4 gallons.

- A—Brass Tank with stop cock \$11.50
- B—Brass Tank with Auto Pop No. 1 12.00
- C—Galvanized Tank with stop cock 7.50
- D—Galvanized Tank with Auto Pop No. 1 8.00
- Auto Pop Attachment with Hose 2.50
- Auto Pop Attachment without Hose 2.00
- Brass 2-ft. Extension, per Length70
- Brass Elbow Extension75

By parcel post, Auto Pumps, 50c each extra.

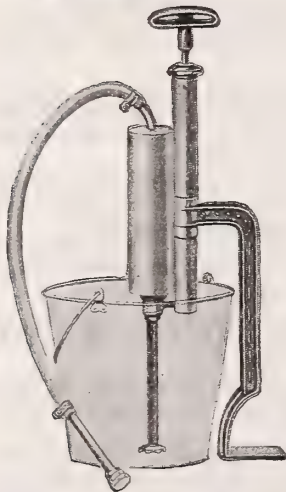
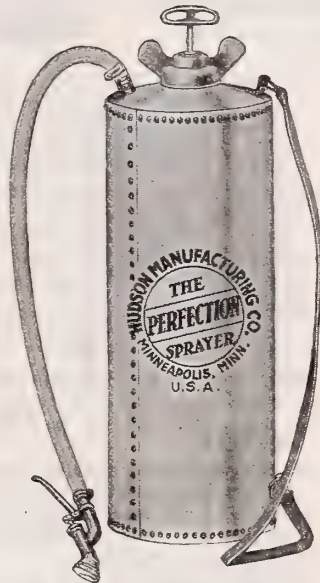

Magic Bucket Pump

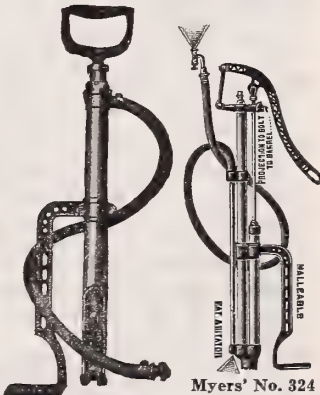

Modoc Bucket Pump

Myers' No. 324 Bucket Pump

Perfection Compressed Air Sprayer—A light, compact compressed air sprayer. Will spray whitewash. Galvanized iron, \$7.00; brass \$10.00. 2½ ft. Extension Pipe, 50c each extra; whitewash caps 50c each extra. By parcel post, add 50c extra.

Baby Lowell Compressed Air Sprayer—The air enters the sprayer through the valve at bottom of pump, thoroughly agitating and mixing the contents of sprayer. Holds one gallon. Price, galvanized iron \$4.50; by parcel post, \$4.75.

Myers' Knapsack Sprayer—The best knapsack sprayer. Price, with galvanized iron tank, \$15.00; by parcel post, \$15.75; with copper tank, \$24.00; by parcel post, \$24.75.

Magic Bucket Pump—A new departure in bucket pump design. The only bucket pump in which both intake and outlet valves are mounted in one cage and easily removable. This pump has a very large capacity. All work being done on the down stroke. Makes a very easy operating pump. The large air chamber enables the operator to maintain a high pressure and a steady discharge. Pump can be mounted in an 8-gallon tank, making a very portable and convenient spray outfit. All parts, except handle and foot rest, are of brass. Price, \$5.25; by parcel post, \$5.75.

"Modoc" Bucket Pump—This pump is used for a bucket spray and force pump, as well as for whitewashing. It will throw a stream 35 feet high. All solid brass, double action, bronze ball valves. Will whitewash and spray with same nozzle by simply turning the disc. Equipped with 5-ply pressure hose. Price, \$4.75. By parcel post, \$5.00.

Myers' No. 324 Bucket Pump—Furnished with lever handle, which gives additional force to the stream. This is a perfect double-acting pump, easy to operate. Complete with hose and graduating vermored nozzle. Price, \$9.00. By parcel post, \$9.50. Eight-foot extension pipe, \$1.25 extra, f.o.b. Memphis.

The Binks No. 21 Whitewash and Spraying Machine—Something entirely new. A small portable hand-power sprayer, easily moved, having two large wheels, well balanced, strong in construction; will spray whitewash in a thorough manner without clogging; can also be used for all tree spraying. Tank holds 12 gallons, equipped with patent agitator and wont clog. Price, with 10 feet ½-inch hose and couplings, spray pipe, complete with ¼-inch cock and nozzle, \$20.00.

Ideal Portable Sprayer—Equipment: tank 15 gallons, portable, attached to an iron wheelbarrow frame with wheel; 10 feet ¾-inch pressure hose; 10 feet 2-piece pipe extension; 1 T shut-off cock; 1 Brandt nozzle. Weight, 65 lbs. Price, \$22.00, with air tank as shown in cut, \$32.00.

Auto Spray No. 40—A complete 12-gallon galvanized tank sprayer on truck for whitewash, or insecticides, one 8-ft. iron extension pipe, 8 feet of ¾-inch hose, shut-off and latest vermored nozzle. Price, \$26.50.

Utility Barrel Pump No. 50A—This pump has a 2½ in. heavy brass cylinder, also extra large water-way permitting a high pressure with little effort. This pump is complete with barrel and ten feet of ½-inch, also 4-foot extension pipe and adjustable nozzle. Price, \$25.00.



Auto No. 40, Portable Sprayer

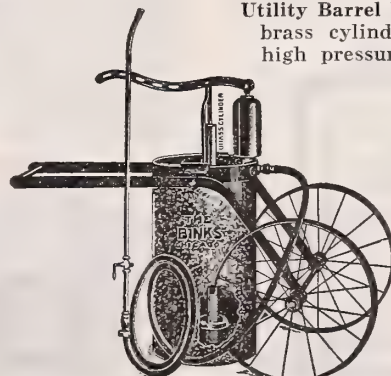

Binks' No. 1 Whitewash Spraying Machine



Ideal Portable Sprayer with Air Tank



SPRAY PUMPS

CONTINUED



Myers' No. 318 Barrel Spray Pump Auto No. 240 Barrel Spray Pump

Auto No. 240 Barrel Sprayer—This pump is most powerful. Develops great pressure with but little exertion. A solid piece pump cylinder, base and air chamber, giving perfect alignments. Simple in construction, yet very strong and durable. The agitator is mechanical and very effective. We consider this outfit one of the best on the market. Guaranteed to give perfect satisfaction. Price of pump, barrel, 15 feet of ½-inch 5-ply hose and automatic spray nozzle, each \$40.00. Mounted on steel cart, each \$50.00. Nine-foot Bamboo Extension Rod, extra, \$4.20.

Myers' Cog Gear Barrel Spray Pump No. 318B—Has malleable iron base, fits any regular size barrel. Cylinder valves and valve seats all brass; has 15 ft. of ½-inch 5-ply discharge hose; mechanical agitator, and Vermorel nozzle. This is a splendid outfit. Price, complete, excepting barrel, \$21.00; with barrel, complete, \$28.50. Eight-foot Bamboo Extension Rod, extra, \$4.00.



Auto No. 5, with Knapsack

Auto Spray No. 5—This pump is the ideal all-purpose hand sprayer. Its field is practically unlimited as it may be used for spraying tree, vines, garden truck, potatoes and any field crops, and for handling whitewash and disinfectants. It is made entirely of brass, doing away with all danger of corrosion. The pump is double-acting. This feature makes the spray continuous. Price, Auto No. 5 Pump without knapsack \$5.50; by parcel post, \$6.00. Price, Auto No. 5 with knapsack, \$9.50; by parcel post, \$10.00. Extension 60c; parcel post, 70c.



The Standard Sprayer—A general purpose sprayer, suitable for every spraying need. Made entirely of brass, with two solid brass ball valves. No leather suckers or washers, no castings to rust, no leaking joints, nothing to get out of order. Sprays orchards, large or small, potatoes or truck crops. Sprays whitewash, any cattle dip or disinfectants. Write for circulars. Price, Standard Sprayer, \$5.00; by parcel post, \$5.50. Price, Standard Sprayer with Knapsack Tank, \$8.00; by parcel post, \$8.50.

Hose, Nozzles and Extension Pipes

Spray Hose, ¾-inch, ½-inch, ¼-inch.....	per ft.	\$0.25
Vermorel Nozzles, ½-inch thread	each	1.25
Bordeaux Nozzles, ½-inch thread	each	1.50
Misty Spray Nozzles, ½-inch thread	each	1.25
Auto No. 434 Nozzles, ½-inch thread	each	.75
Iron Extension Pipe, 8 feet	each	1.00
Bamboo Extension Pipe, 8 feet.....	each	4.00
Bamboo Extension Pipe, 10 feet.....	each	4.40

Hand Atomizer

These are very useful in the poultry house for applying liquids, also fine for spraying the small plants, roses, shrubs, etc. Our line is the most complete in the city.

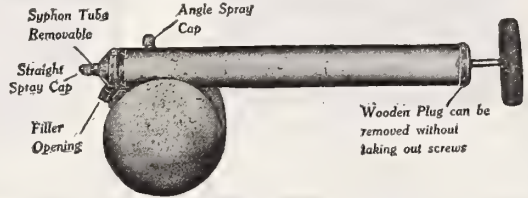

Auto No. 25, Continuous Sprayer

The Auto No. 25 Continuous Sprayer—Throws a continuous fine misty stream, easy and simple to operate, a new style sprayer and one of the best.

Tin Tank, quart size\$1.00; by parcel post, \$1.15
Galvanized Tank, quart size 1.25; by parcel post, 1.45
Brass Tank, quart size 1.50; by parcel post, 1.70

Rapid Double Tube Sprayer—Throws a wide double V-shaped spray; strong galvanized tank, double seamed; well braced; holds one quart. Price, 85c. By parcel post 95c.

Crescent Glass Tank Sprayer—Any Mason quart jar fits this pump. Six, seven or more different kinds of insecticide can be used with this same sprayer, by simply changing the glass jars. Will make a double spray that spreads over a wide area. Price, 85c. Cannot be mailed.

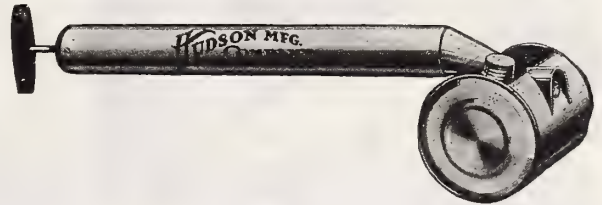

Schwill's Hand Atomizer

Schwill's Hand Atomizer—Capacity 1 qt. One of the best sprayers made. Throws a spray as fine as mist, rendering the use of strong solutions safe on tender foliage plants, or in poultry houses. Tin 60c; by parcel post, 20c each extra.

Schwill's Midget Sprayer—Small size sprayer for ladies' use. Splendid for house use or in the garden; holds 1 pint. Price, 40c. By parcel post 55c.

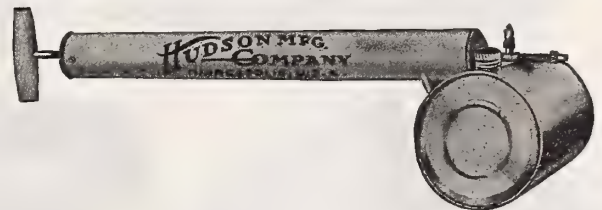

Continuous Sprayer

Continuous Atomizer—Makes a continuous spray; easier to operate and much superior to the ordinary kinds of sprayers. Tin 85c; Galvanized \$1.00; Brass \$1.25. By parcel post, 20c each extra.

Utility Three-Quart Sprayer No. 35—Tank made of heavy galvanized iron, 3-quart capacity, and has extra heavy tin cylinder. Price, \$1.25. By parcel post, \$1.50.

Dry Powder Sprayers and Dusters

Acme Hand Bellows	each	\$1.50; by parcel post \$1.75
Lowell Dry Powder Sprayer	each	1.25; by parcel post 1.50
Dickey Bug Death Duster	each	.35; by parcel post .50
Acre-an-Hour Sifter	each	1.00; by parcel post 1.15
Scollay's Rubber Sprayer	each	1.25; by parcel post 1.35
Scollay's Putty Bulbs	each	1.50; by parcel post 1.60

We carry a full stock of all parts, washers, etc., of most all sprayers listed. Write us for what you may need.

BOXES, STANDS, BASKETS, ETC., FOR PLANTS

Wire Plant Stands

These are convenient and make a handsome effect when filled with plants.

No. 4, Half Round—This is one of our most attractive stands; holds about 30 pots; is 48 inches wide; 31 inches deep. Each \$8.50, f.o.b. Memphis.

No. F-6—Square stand with 3 shelves, 3-ft. 3 ins. long. Each \$7.50, f.o.b. Memphis.

Single Plant Stands

Especially for specimen plants. Very strong; 12 inches in diameter; 19 inches high to shelf. Each \$2.00. By parcel post, each \$2.50.

Wire Flower Pot Bracket

Very neat and attractive in appearance. Made of steel wire and tinned after being made. Very strong. Easily put up and instantly removed. Made in two sizes; 6 inches in diameter, each 25c; doz. \$2.50; by parcel post, each 30c.

Cemetery Vase

Unglazed, 4-inch Cemetery Vase, each 25c; by parcel post 30c.

Wire Window Shelf

A serviceable shelf for little money. Easily attached to a window frame with two screw eyes; 33 inches long. Each \$1.25; 36-inch, each \$1.50; by parcel post, 25c each extra.

Wire Hanging Baskets

8-inch, each\$0.25 14-inch, each70
 10-inch, each40 15-inch, each75
 12-inch, each60 By parcel post, 20c each extra.

Ideal Plant Protector

Protects plants from frost and cold. Most exhaustive tests have proven that the "Ideal Plant Protector" will protect a plant against injury from frost, from rain, from hail and from wind. The protector being made of dry, water and frost-proof cardboard, which protects the plant from rain or cold. The gardener who uses Ideal Plant Protectors can safely sow seed two weeks earlier than usual, as they protect all tender plants, such as Tomato, Pepper, Cucumber, Egg Plant, Squash, etc., from frost. Made in two sizes—No. 10, 10 inches high and 10 inches in diameter, and No. 12, 12 inches high and 12 inches in diameter. Price, No. 10, 40c per doz.; \$3.00 per 100. Price, No. 12, 50c per doz.; \$4.00 per 100. By parcel post, No. 10, 60c per doz.; \$3.50 per 100; No. 12, 70c per doz.; \$4.60 per 100.

Hawkeye Tree Protector

A sure protection against sun scald, rabbits, mice and other vermin. Keeps them from eating the bark on young trees. 100 \$2.00; 50 \$1.35; 12 35c; by parcel post, 100 for \$2.40; 50 for \$1.50.

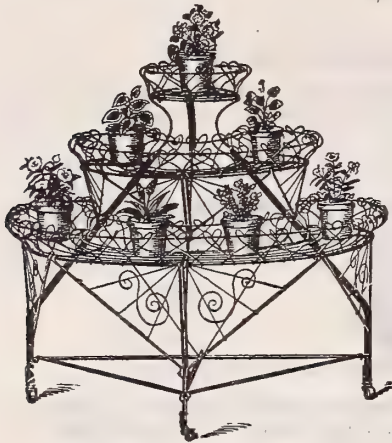

No. 4, Half-Round Plant Stand

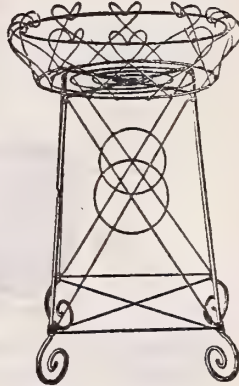

Wire Single Pot Stand



Wire Hanging Baskets

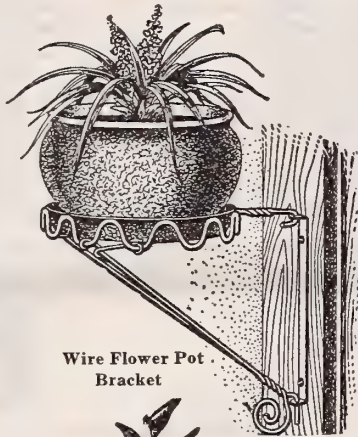

Wire Flower Pot Bracket



Wire Window Shelf

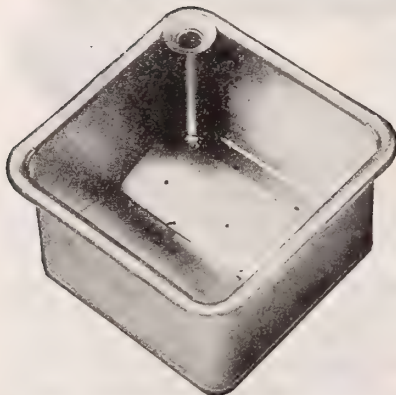

Model E or F Savo Box or Hanging Basket

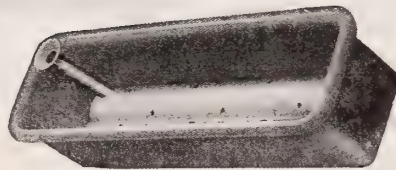

Model A to D Savo Plant Box

SAVO

ALL-YEAR-ROUND FLOWER AND PLANT BOX

The Savo Flower and Plant Boxes are made of the best grade of galvanized steel, with neat round corners and a full roll rim, watering is easy, drainage ample and air circulation perfect. The enamel finish prevents rust and leakage. The two perforated arches running the full length of the box not only hold and distribute water evenly, but supply air to the roots constantly. This keeps the plants healthy and fresh the year round, as they absorb the exact amount of moisture needed from below. The circulation of air keeps the soil loose and mellow, making the life and growth of plants a certainty. They are beautifully finished in Aluminum or Dark Green.



Model A to D Savo Plant Box

Prices as follows, f.o.b. Memphis:
 Model A, 6 1/2 in. high, 6 1/2 in. wide, 23 in. long, each.....\$3.00
 Model B, 8 in. high, 9 1/2 in. wide, 29 in. long, each..... 3.50
 Model C, 8 in. high, 9 in. wide, 35 in. long, each..... 4.00
 Model D, 8 in. high, 9 1/2 in. wide, 41 in. long, each.....\$4.50
 Model E, 8 in. high, 12 in. wide, 12 in. long, each..... 3.00
 Model F, 12 in. high, 12 in. wide, 12 in. long, each..... 4.50



FLOWER POTS, PLANT TUBS, ETC.



Standard Flower Pots

(Without Saucers)

2 inch, doz., \$.20	100	\$1.00
2½ inch, doz., .25	100	1.50
3 inch, doz., .30	100	1.75
4 inch, doz., .40	100	2.00
5 inch, doz., .50	100	3.75
6 inch, doz., .75	100	5.50
7 inch, each .15	doz.	1.25
8 inch, each .20	doz.	2.00
9 inch, each .30	doz.	2.50
10 inch, each .40	doz.	3.75
12 inch, each .65		
13 inch, each 1.00		
14 inch, each 1.50		
16 inch, each 2.00		
18 inch, each 2.25		

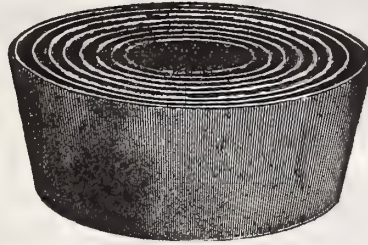

Fern Pans

4¾-inch, each	\$.20
5½-inch, each25
6¼-inch, each30
8 -inch, each35
10 -inch, each40



Flower Pot Saucers

3-inch, doz.	\$.25
4-inch, doz.35
5-inch, doz.40
6-inch, doz.50
7-inch, doz.85
8-inch, doz.	1.25
9-inch, each15
10-inch, each20
12-inch, each25
14-inch, each35



Fancy Jardiniere and Pots

A new line of extra quality; every one a handsome ornament. Can be used either indoors or outside.

No. 7—15-inch Terra Cotta Jardiniere, each	\$ 3.50
No. 10—11½-inch Terra Cotta Jardiniere, each	2.00
No. 6—14½-inch Terra Cotta Jardiniere, each	3.00
No. 11—9½-inch Terra Cotta Jardiniere, each	2.00
No. 6—11½-inch Gray Stone Jardiniere, each	4.00
No. 2—19-inch Gray Stone Jardiniere, each	9.00
No. 16—11½-inch Gray Stone Jardiniere, each	4.00
No. 18—19-inch Gray Stone Jardiniere, each	8.50
No. 7P—17-inch Terra Cotta Jardiniere, with pedestal, each	9.00
No. 2P—19-inch Gray Stone Jardiniere, with pedestal, each	17.00
No. 14—15-inch Gray Stone Window box, with linings, each	5.00

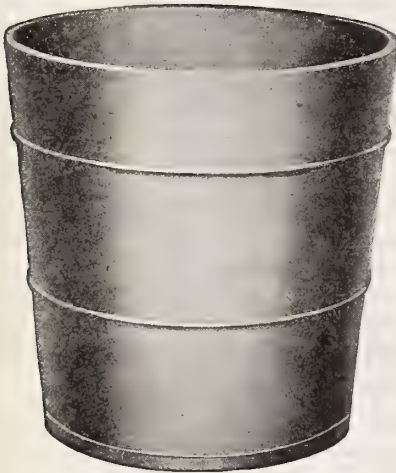

Richmond Cedar Plant Tub

Made of selected White Cedar and are bound with electric welded hoops, strong, and durable, at a moderate price. Prices as follows f.o.b. Memphis:

No. 3, Diameter 8 inches, each	... \$.60
No. 5, Diameter 10 inches, each	... 1.00
No. 7, Diameter 12 inches, each	... 1.25
No. 9, Diameter 14 inches, each	... 1.75
No. 10, Diameter 15 inches, each	... 1.80
No. 11, Diameter 16 inches, each	... 2.25
No. 13, Diameter 18 inches, each	... 2.50

Oasis or Self-Watering Pots

6-inch, each	\$.40	8-inch, each	\$.90
7-inch, each	.60	10-inch, each	1.50

Neponset Paper Flower Pots

2½-inch, per 100	\$.60; per 1000	\$4.50
3 -inch, per 100	.80; per 1000	6.00
3½-inch, per 100	.90; per 1000	8.00
4 -inch, per 100	1.00; per 1000	9.00

By parcel post, add 10 cents per 100 to above prices.



Fancy Fluted Flower Pots

No. 88—8-inch Fancy Pot, with saucer, each	\$.50
No. 89—10-inch Fancy Pot, with saucer, each65
No. 90—12-inch Fancy Pot, with saucer, each	1.00



Terra Cotta Hanging Baskets

7-inch Terra Cotta Basket	\$.25
8-inch Terra Cotta Basket35
9-inch Terra Cotta Basket45
Brass Chains, for hanging, 5c per running foot.		
No. 17—7-inch Terra Cotta Basket with lining and chain, each	\$.75
No. 18—8-inch Terra Cotta Basket with lining and chain, each	1.00



Azalea or 3/4 Size Pots

5-inch, each	\$0.05; doz	\$ 1.60
6-inch, each	.10; doz	1.00
7-inch, each	.15; doz	1.25
8-inch, each	.20; doz	2.00
10-inch, each	.40; doz	3.75
12-inch, each	.60; doz	7.00



Bulb or 1/2 Size Pots

6-inch, each	\$.15
7-inch, each20
8-inch, each25
10-inch, each35
12-inch, each50

Prices on Flower Pots are packed f.o.b Memphis. We cannot send them by parcel post, excepting where noted.

MISCELLANEOUS GARDEN TOOLS

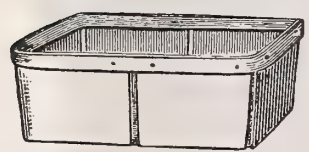

4-qt. Tomato or Peach Basket

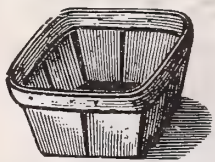

American Style Qt. Straw'b'y Box



5-Prong Garden Cultivator



Shaw's Calf Weaner

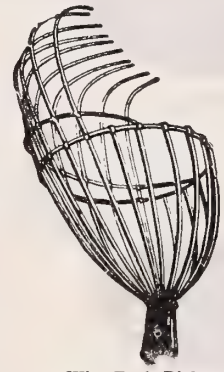

Wire Fruit Picker

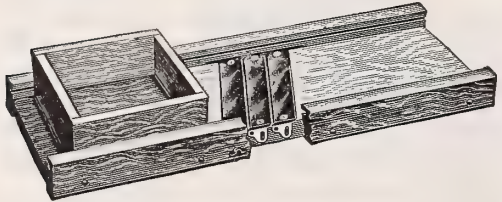

Three-Knife Cabbage Cutter

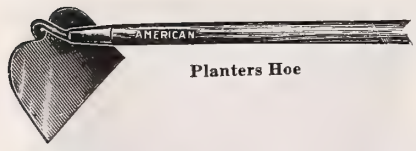

Planters Hoe

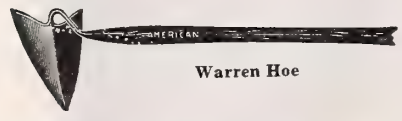

Warren Hoe



Spading Fork



Transplanting Fork

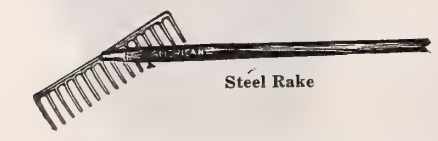

Steel Rake



Wire Lawn Rake



1-Hand Seg. Corn Planter



2-Hand Corn Planter

Asparagus Bunchers, each	\$ 2.75
Asparagus Knife, Goodell, each	.75
Baskets, 1 bushel, round, stave, doz.	2.50
Baskets, 1/2 bushel, round, stave, doz.	2.50
Baskets, Peach, 4-quart size, per 100	2.00
Crates, for Peach Baskets, hold 6 baskets, per 10	2.25
Baskets, Tomato, 4-quart size, per 100	2.00
Crates, for Tomato Baskets, hold 6 baskets, per 10	2.25
Strawberry Boxes, American style, quart, per 1000	7.00
Strawberry Crates, American, hold 24 boxes, per 100	22.00
Bush Hooks, each	1.00
Corn Planters, 2-hand, No. 306	1.50
Corn Planters, 2-hand, rotary, No. 309	2.50
Corn Planters, 1-hand, Segment, No. 311	2.00
Corn Huskers, hand, each, 25c and	.35
Calf Weaners, Shaw's Basket, small, each	.70
Calf Weaners, Shaw's Basket, medium, each	.80
Calf Weaners, Shaw's Basket, large, each	.90
Dibbers, Iron, for transplanting, each	.75
Cultivators, Norcross, Midget, each	.50
Cultivator, Norcross, 3-prong, each	.85
Cultivator, Norcross, 5-prong, each	1.25
Cabbage Cutter, hand, 1-knife, each	.75
Cabbage Cutter, hand, 2-knife, each	3.00
Cabbage Cutter, hand, 3-knife, each	5.50
Garden Drill, Eureka, each	.75
Fork, Transplanting, English Steel, No. 300, each	.50
Forks, Transplanting, Cast Steel, No. 400, each	.25
Forks, Spading, 4-prong, each	1.35
Forks, Spading, 5-prong, each	2.25
Forks, Hay, 3-prong, each	1.00
Forks, Manure, each	1.00
Fruit Picker, galvanized wire, each	.75
Fruit Picker, with 10-foot pole, each	1.10
Grass Hooks, Best Steel, each	.60

Hoes, Garden

Hoe, Cast Steel, 6-inch, each	.80
Hoe, Cast Steel, 7-inch, each	.90
Hoe, Planters, 6-inch, each	1.00
Hoe, Planters, 7-inch, each	1.10
Hoe, Planters, 8-inch, each	1.20
Hoe, Onion, 1-prong, each	.50
Hoe, Onion, 2-prong, each	.60
Hoe, Onion, Southern Queen, each	1.10
Hoe, Warren, 6-inch, each	1.25
Hoe, Ladies' Steel, 5-inch, each	.60
Hoe, Detachable Triangle, each	.70
Hoe and Cultivator combined, No. 6, each	.85

Measures, Wooden

Measures, 1-quart, each	\$.20
Measures, 2-quart, each	.25
Measures, 4-quart, each	.30
Measures, 1-peck, each	.35
Measures, 1/2-bushel, each	.50
Mole Trap, Riddick, each	1.00
Mole Trap, Rittenhouse, each	1.00
Sparrow Trap, Dodson, each	7.00

Rakes, Garden

Rake, 10 teeth, steel, each	\$.70
Rake, 12 teeth, steel, each	.75
Rake, 14 teeth, steel, each	.85
Rake, Lawn Wire, double edge, each	.75
Rake, Lawn Wood, Ole Olson, each	.75

Shears

Hedge Shears, 8-inch, each	\$ 1.75
Hedge Shears, 9-inch, each	2.00
Hedge Shears, 10-inch, each	2.25
Grass or Sheep Shears, each	1.00
Garden Reel, galvanized, each	1.50



MISCELLANEOUS GARDEN TOOLS — CONTINUED

Pull-Easy Cultivator

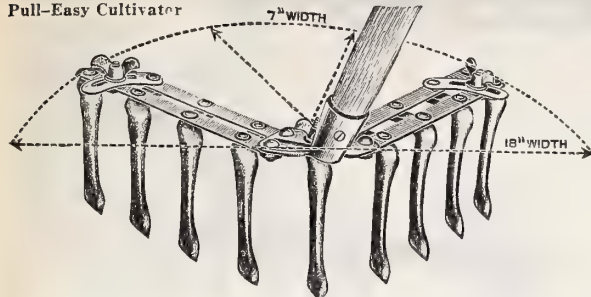

The Pull-Easy Adjustable Cultivator

When the arms are spread out to full width of 18 inches this cultivator is like a rake.

For narrower rows the outer ends of the arms can be closed to any width down to 7 inches.

The shape of the teeth and the way in which they are attached to the steel side bars makes the cultivator entirely different from any ordinary rake because the teeth penetrate the ground, stir it up and pulverize it thoroughly without the operator being obliged to exert any downward pressure on the handle.

The middle tooth can be instantly removed permitting narrow rows of small plants to be cultivated two at a time. Price, each \$1.50.

Potato Planter, Acme, hand, each	\$1.00
Potato Hook, 4-prong, each	1.25
Potato Picking Bags, each60
Plant Setter, Masters, each	5.00
Putty, English Glazing, 10-lb. can, each	2.00
Pruning Shears, Ladies', rickeled, each	1.50
Pruning Shears, R 50, each	1.00
Pruning Shears, R 65, each	1.75
Pruning Shears, R 165, each	2.00
Pruning Shears, R 170, each	2.25
Pruning Saw, 16-inch, each	1.25
Pruning Saw, 18-inch, each	1.40
Pruning Saw, 20-inch, each	1.60
Pruners, Waters Tree, 8-foot, each	1.50
Pruners, Waters Tree, 10-foot, each	1.75
Spades, Ames Best, each	2.25
Spades, Pony, Nos. 7 and 8, for ladies, each60
Scythe Blades, each	1.25
Scythe Handles, each	1.25
Twine, 2-ply jute, per lb.35
Thermometers, Standard Weather, each50c, 75c & 1.00

Trowels, Garden

Trowel, No. 211—6 -inch, English steel, each	\$.50
Trowel, No. 211—4½-inch, Berry Trowel, each50
Trowel, No. 212—6 -inch, steel, each25
Trowel, No. 213—6 -inch, forged, each15
Trowel, No. 216—6 -inch, Ladies' Floral, each25
Trowel, No. 217A—Transplanting Hoe, each50
Trowel, No. 215—6 -inch, Garden, each25
Trowel, No. 2120—Long Handle, each50
Trowel, Hall, No. 2, each15
Trowel, Hall, No. 3, each20
Trowel, Hall, No. 4, each25

Weeders

Excelsior Hand Weeder, each	\$.25
Eureka Hand Weeder, each50
Lang's Hand Weeder, each30
Magic Hand Weeder, each25
Hall No. 1 Hand Beet Weeder, each15
Cleveland Lawn Weeder, each75
Finch's Lawn Edger, each75
Dandelion Killer, each	1.00
Dandelion Puller, each75
Plant Stakes, 4-foot, each10
Plant Stakes, 5-foot, each10
Shovels, Potato, wire scoop, each	2.00
Shovels, Wire Furnace, each	1.00
Wire Horse Muzzles, each 20c; doz.	2.00
Wood Pot Labels, 6-inch, per 10050
Wood Pot Labels, 8-inch, per 10075
Wood Pot Labels, 10-inch, per 100	1.00
Wood Pot Labels, 12-inch, per 100	1.50
Wood Tree Labels, wired, per 10050

Pruning Saw

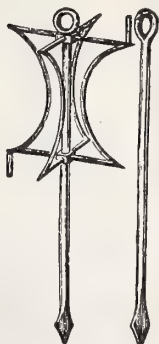
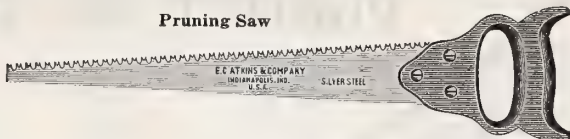

Garden Reel Thermometer



Scythe Blades



Eureka Weeder



Pruning Shears



Iron Dibber



Excelsior Weeder



Wire Horse Muzzle



Hoe Transplanting Trowel



WATERS IMPROVED TREE PRUNER.



Acme Potato Planter

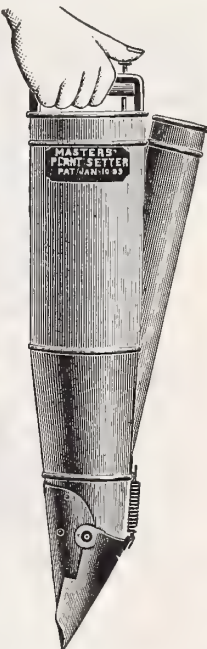

Master's Plant Setters



Hedge Shears



Steel Garden Trowel

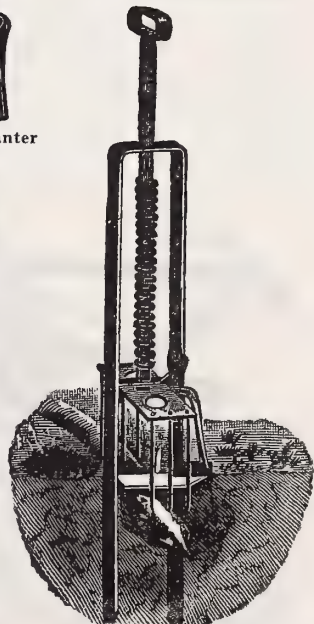

Reddick Mole Trap



PLANET, JR., GARDEN TOOLS

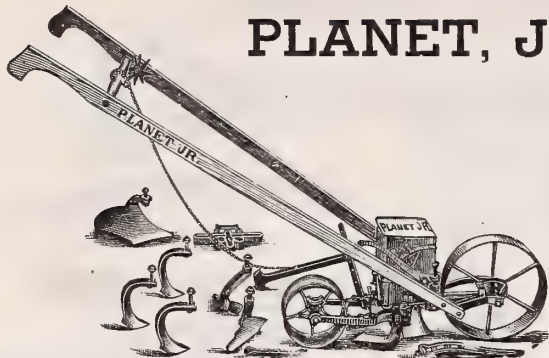

Planet, Jr., Hill and Drill Seeder and Cultivator

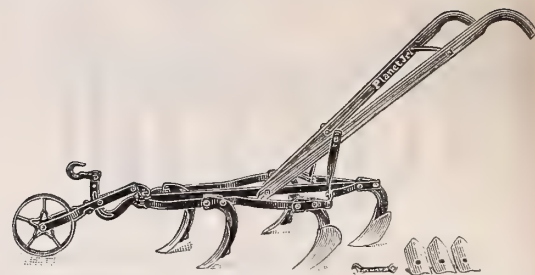

Planet, Jr., Horse Hoe Cultivator

Garden Drill and Hill Seeders

Planet, Jr. No. 2—The best drill	\$12.75
Planet, Jr. No. 3—Hill seeder	18.50
Planet, Jr. No. 4—Hill and drill seeder	19.50
Planet, Jr. No. 5—Large size seeder	21.00
Planet, Jr. No. 25—Hill and drill seeder	23.00
Planet, Jr. No. 28—Hill and drill seeder and cultivator	26.00
Planet, Jr. No. 29—Hill and drill seeder	21.00
Planet, Jr. No. 31—Combined drill and wheel hoe	13.00
Planet, Jr. No. 32—Drill	11.50

Horse Hoers and Cultivators

Planet, Jr. No. 4—Horse Hoe, less wheel	\$12.75
Planet, Jr. No. 8—Horse Hoe and Cultivator, with wheel	20.00
Planet, Jr. No. 9—Horse Hoe, less wheels	15.00
Planet, Jr. No. 4—Plain Cultivator, less wheel	10.25
Planet, Jr. No. 9—Plain Cultivator, less wheel	12.75
Planet, Jr. No. 90—Twelve-tooth Harrow, plain	16.75
Planet, Jr. No. 12—Twelve-tooth Harrow, complete	11.00

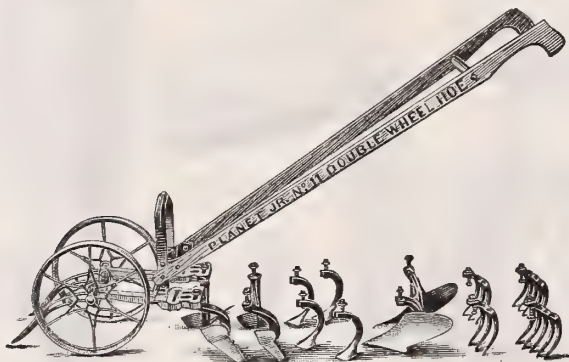

Planet, Jr., Double Wheel Hoe

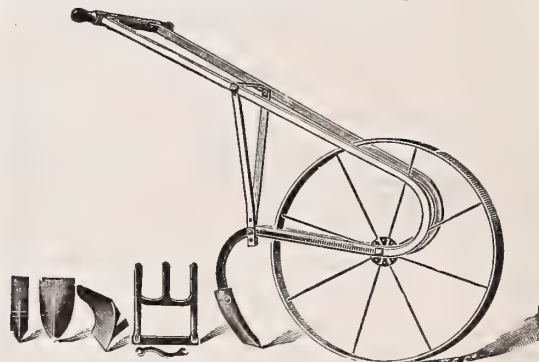

The Leader No. 3 Garden Plow

Garden Wheel Hoers

Planet, Jr. No. 11—Double wheel hoe	\$16.00
Planet, Jr. No. 12—Double wheel hoe	12.50
Planet, Jr. No. 13—Double wheel hoe	9.00
Planet, Jr. No. 16—Single wheel hoe	10.50
Planet, Jr. No. 17—Single wheel hoe	8.75
Planet, Jr. No. 18—Single wheel hoe	6.25
Planet, Jr. No. 19—Garden plow	6.25
Planet, Jr. —Firefly hand plow	4.00
Planet, Jr. No. 3—Grass edger	9.00
Planet, Jr. No. 33—Single wheel hoe	6.50

Hand Garden Plows

The Leader No. 3—The most inexperienced and ignorant laborer on earth can handle this tool with entire success. All kinds of work can be done with this plow and combination of tools; plowing and breaking of the ground in spring and harrowing, cultivating, hilling and weeding. Price, each \$4.50.

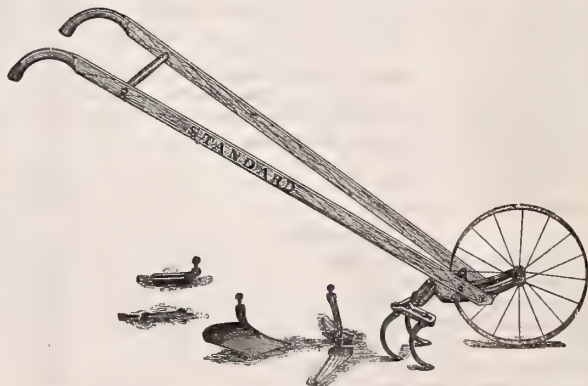

No. 22 Standard Single Wheel Hoe

Standard Line of Garden Tools

No. 22, Standard Single Wheel Hoe and Cultivator and Plow. Price, \$6.00.

Hall Cultivator Attachment for Garden Plows

This prong cultivator can be attached to any make of garden cultivator. It has all features of a hoe cultivator with the labor and time-saving advantages of a wheel cultivator. Price, each 75c; by parcel post, \$1.00.

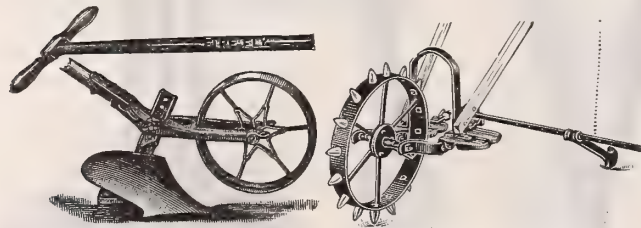

Planet, Jr., Firefly Handy Plow

Planet, Jr., Spot Marker

Planet, Jr., Spot Marker

A great labor-saving device. To be attached to any Single or Double Planet, Jr. Wheel Hoe.

1-Row Spot Marker Attachment, each	\$4.00
2-Row Spot Marker Attachment, each	7.00



SEED SOWERS, HOTBED SASH, HOG OILERS

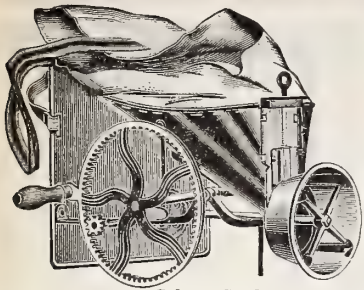

Cahoon Seeder



Lightning Horn Seeder

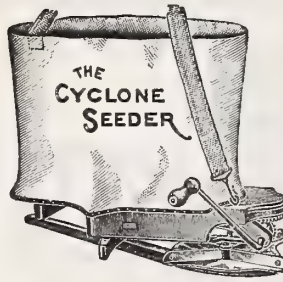

Cahoon Broadcast Seeder—One of the best seeders manufactured, and sows all kinds of grain, clover seeds, etc., rapidly and evenly. Price, each \$4.75; by parcel post, \$5.00.

The Lightning Horn Seeder—A splendid little tool, simple and easy to operate. Will sow any fine seed like clover, lespezeza, timothy, alfalfa and grasses. Holding the tube downward wind won't blow seed away. We know this seeder to be good. Price, 75c; by parcel post, 85c.

The Rittenhouse Seeder—A hand broadcaster that sows accurately. Has an agitator or stirrer which revolves over the feed opening and keeps it clear so that the seeds run out evenly. Price, each \$2.00; by parcel post, each \$2.20.

Cyclone Seed Sower—Will sow timothy, clover, oats, rye, wheat, millet, grass seeds, peas, sorghum, etc. Distributes evenly, works perfectly; has an agitator feed plate, which insures a uniform flow of seed. Price, each \$2.00; by parcel post, \$2.20.



Thompson's Wheelbarrow Seeder

Thompson's Wheelbarrow Seeders—These are the most valuable implements for sowing all grass seeds broadcast. The quantity of seed sown per acre is accurately governed by the wheel, which moves correspondingly slow or fast as the machine is run over the ground. For all sections where winds prevail, there is no machine made that will equal this implement for an even, accurate job of seeding. The quantity required per acre can be instantly changed by slipping a pin from one hole to another. The seeders run light, are not complicated, and complete, ready for work, weigh from 40 to 50 pounds. Seeds can be sown mixed or separate, any quantity desired, 30 to 50 acres per day, and give an absolute evenness of seeding.

Seeder No. 1—Sows Clover, Timothy, Alfalfa and other seeds of same nature, any quantity from 2 to 12 quarts per acre. Hopper 14 feet. Price, \$11.00. Hopper 16 feet, \$11.50, f.o.b. Memphis.

Seeder No. 2—Sows same as No. 1, and in addition, any quantity required per acre, Red Top, Orchard Grass, Clean Blue Grass. Hopper 14 feet. Price, \$12.50, f.o.b. Memphis.

Thompson's Grain Hopper

Thompson's No. 4 Hopper—This is a hopper about 6 inches square and 10 feet long that fits on the wheelbarrow or gearing, and sows Wheat, Rye, Oats, Barley, Buckwheat and Field Peas broadcast. Price, \$6.00, f.o.b. Memphis.

The Lee Seed Corn Tester

No artificial heat needed. Easy and simple to operate. It pays to test your seed corn. Directions come with every machine. Price, 500 compartment Tester, \$6.00; 1000 compartment Tester, \$8.00, f.o.b. Memphis.

Sharple's Cream Separator

This is a suction-feed, tubular separator, easy to operate and clean, and one of the best offered today. Complete instructions furnished with each machine.

No. 2S—300 pounds capacity, each \$60.00
 No. 4S—500 pounds capacity, each \$85.00

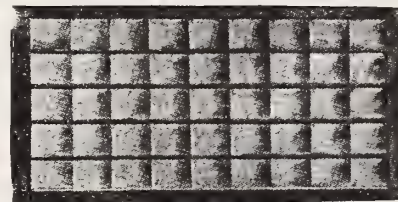

Schwill's Hotbed Sash

Genuine Cypress, size 3x6 feet, 1 3/8 inches thick, bars firmly fastened on bottom rail ready for immediate use.

Our Hotbed Sash are the best made. Material and workmanship guaranteed. Glass laps over to prevent leaks. Higher grade in every way than dealers sell for double our price. Truck farmers, market gardeners and everybody who has a garden, large or small, should Buy a Hotbed Sash Now.

No. E440, Hotbed Sash—Glazed 5 rows 6-inch glass, clear cypress frames 3x6 feet, 1 3/8 inches thick. Price, each \$4.00; in lots of 5 at \$3.75 each, f.o.b. Memphis.

No. E546, Melon Sash No. 0—Glazed 1 light 12x12 inches, 1 1/2 inches thick, clear white pine. Price, each \$1.00; 5 for \$3.00.

No. 00, 20x24 inches, each \$1.25; 5 for \$5.00, f.o.b. Memphis.

The Rowe 'New Idea' Hog Oiler

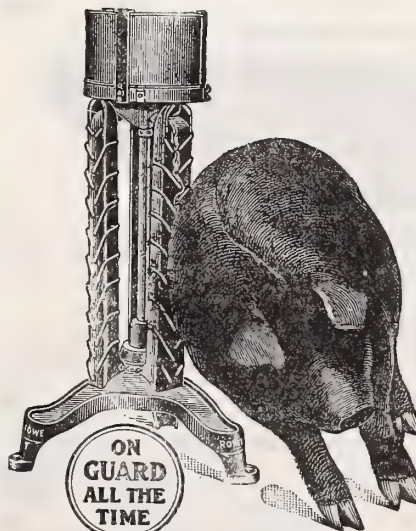

Rowe New Idea Hog Oiler

Will kill the lice on your hogs. Lice sap the hog's vitality—weaken it, prevents its putting on fat and weight, makes the hog susceptible to disease germs. The "New Idea" Hog Oiler will destroy these blood-sucking parasites. It is simple in construction, no complicated parts, nothing to get out of order, no valves, springs, wheels, chains or cylinders. Strongest construction. Guaranteed. Price, Rowe New Idea Hog Oiler, each \$8.50. Medicated Oil, 5 gal. can for \$3.50, f.o.b. Memphis.

LEWIS BEE HIVES AND SUPPLIES

We carry a full line of the celebrated Lewis Bee Ware, manufactured by the G. B. Lewis Company, Watertown, Wisconsin, and furnish everything at factory prices, saving you freight and time. The following prices are f.o.b. Memphis:

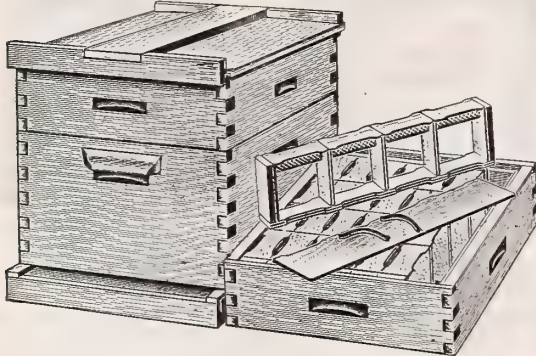

1 1/2-Story Hive Complete, Showing No. 1 Regular Super

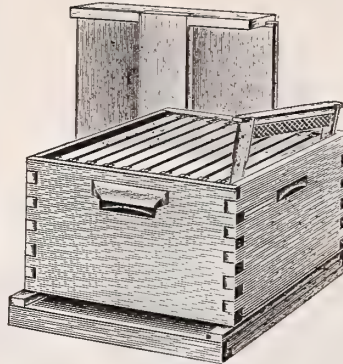

1-Story Hive Complete

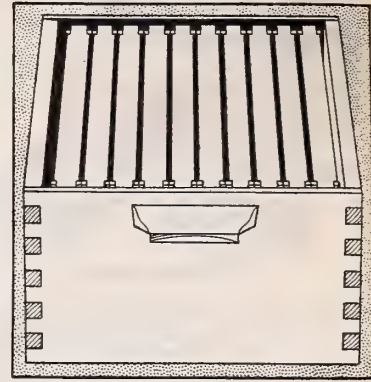

Hive Body with Frames

One and One-Half and Two-Story Hives

For Comb Honey, with 4 1/4 x 1 7/8" Beeway Sections. Including Section Boxes and Foundation Starters.

In Flat, including Nails.	1 Hive	5 Hives
1 1/2-Story, 8-Frame	\$4.96	\$22.45
1 1/2-Story, 10-Frame	5.06	22.80
2 -Story, 8-Frame	6.52	29.55
2 -Story, 10-Frame	6.68	30.15

Not Including Section Boxes or Foundation Starters.

In Flat, including Nails.	1 Hive	5 Hives
1 1/2-Story, 8-Frame	\$4.36	\$19.45
1 1/2-Story, 10-Frame	4.46	19.80
2 -Story, 8-Frame	5.42	24.05
2 -Story, 10-Frame	5.58	25.65

NOTE—Hives for Comb Honey are always sent unless otherwise specified.

Dovetailed Hives for Extracted Honey

In Flat, including Nails.	1 Hive	5 Hives
1 1/2-Story, 8-Frame	\$4.45	\$19.85
1 1/2-Story, 10-Frame	4.55	20.25
2 -Story, 8-Frame	5.60	24.95
2 -Story, 10-Frame	5.76	25.25

Foundation for 1-inch starter, 20c per hive extra.

One-Story Hives

Not Including Foundation Starter.

In Flat, including Nails.	1 Hive	5 Hives
1-Story, 8-Frame	\$3.30	\$14.85
1-Story, 10-Frame	3.34	14.95

With Foundation, 20c per hive extra.

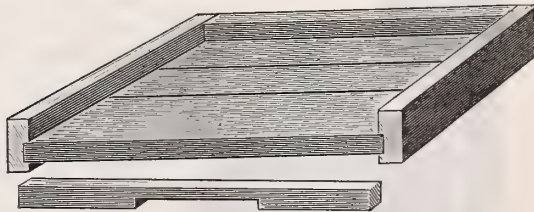

The Reversible Bottom

Bottoms for Dovetailed Hives

In Flat, including Nails.	1 Bottom	5 Bottoms
8-Frame	\$0.76	\$3.35
10-Frame	.80	3.50

Hive Stands

In Flat, including Nails.	1 Stand	5 Stands
8-Frame	\$0.38	\$1.43
10-Frame	.40	1.50

Dovetailed Bodies

When extra Bodies are wanted, the prices are as follows, including Brood Frames and Division Board and Metal Rabbits, except 10-Frame do not have Division Boards.

In Flat, including Nails.	1 Body	5 Bodies
8-Frame	\$1.82	\$7.95
10-Frame	1.77	7.65
8-Frame, without inside fixtures	.99	4.45
10 Frame, without inside fixtures	1.04	4.70

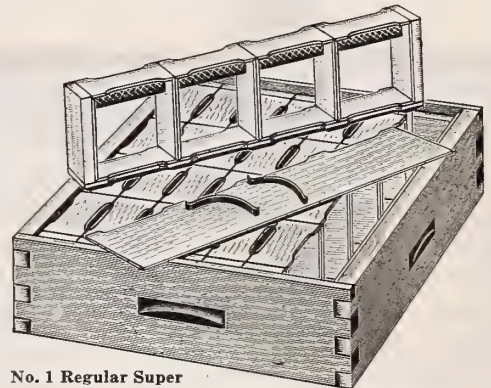

No. 1 Regular Super

Dovetailed Comb Honey Supers

The following prices are in flat, without sections or starter, and if same are wanted, add 50c per Super extra.

No. 1, or Regular, taking 4 1/4 x 1 7/8" Beeway Sections.

	1 Super	5 Supers
8-Frame	\$1.06	\$4.60
10-Frame	1.12	4.85

No. 2, or Plain, taking 4 1/4 x 1 1/2" Sections.

	1 Super	5 Supers
8-Frame	\$1.25	\$5.50
10-Frame	1.31	5.80

No. 4, or 4x5" taking 4x5x1 3/8" Plain Sections.

	1 Super	5 Supers
8-Frame	\$1.47	\$6.65
10-Frame	1.55	7.00

Shallow Extracting Super, 5 11/16" Deep

In Flat, including Nails.	1 Super	5 Supers
8-Frame, size 5 3/8-in. deep	\$1.15	\$5.05
10-Frame, size 5 3/8-in. deep	1.20	5.30

Foundation for 1-inch Starter, 20c per Super extra.

Empty Supers

Always state which style Super Shell is wanted, whether the No. 1, No. 2 and No. 4, or for Shallow Extracting Frames.

In Flat, including Nails.	1 Super	5 Supers
8-Frame Size, for Section Holders	\$0.55	\$2.30
10-Frame Size, for Section Holders	.58	2.40
8-Frame Size, for Shallow Extract'g frames	.66	2.80
10-Frame Size, for Shallow Extract'g frames	.69	2.95

COMPLETE BEE SUPPLY CATALOG FREE ON REQUEST.

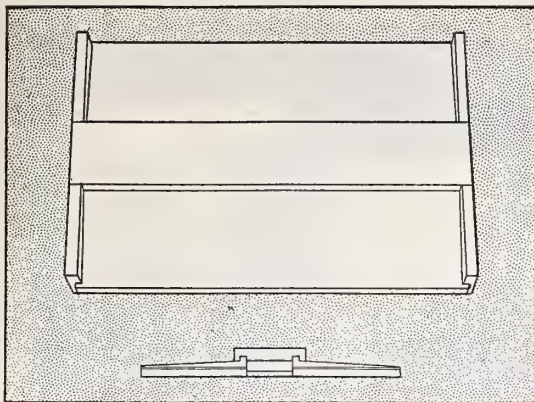

Excelsior Cover

Covers for Hives

In Flat, including Nails.

1 Cover 5 Covers

8-Frame, Excelsior	\$0.89	\$4.00
10-Frame, Excelsior	.94	4.20
8-Frame, Metal Roof, Inner Cover	1.30	6.05
10-Frame, Metal Roof, Inner Cover	1.37	6.35

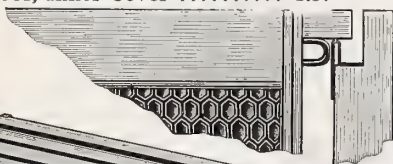

Hoffman Self-Spacing Frame

Hoffman Self-Spacing Frame

Prices in Flat, including Nails, 10 Frames, 72c; 100 Frames, \$6.66.

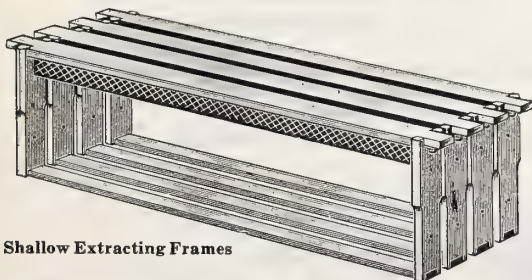

Shallow Extracting Frames

Shallow Extracting Frames

Prices, in Flat, including Nails, 10 Frames, 59c; 100 Frames, \$5.32.

Section Holders



Slotted Section Holder

Slotted Section Holders, per 100	\$5.08
Plain Section Holders, per 100	4.45
Plain Section Holders for 4x5-in., per 100	5.25

COMPLETE BEE SUPPLY CATALOG FREE ON REQUEST.

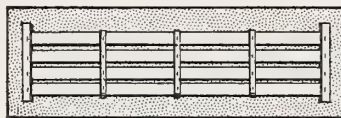

Fence Separator

Fence Separators

Prices, any Style, 10, 60c; 100, \$5.08

No. 2 or P Fence—Used in No. 2 or Plain Super, with Plain section holders and plain 4¼x4¼x1½ Sections.

No. 4 or 4x5 Fence—Used in No. 4 Supers, with Plain Section Holders for 4x5x1½ Sections.

Wood Separators

Slotted Wood Separators	10, 25c; 100, \$1.90
Plain Wood Separators	10, 20c; 100, 1.60

Section Boxes

We carry following sizes in stock, all No. 1 grade. 4¼x1½, 2-Bee-way; 4¼x1½, plain; 4x5x1½, plain; 3½x5x1½, plain.

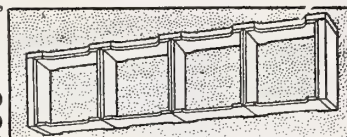

Regular Two Beeway Section Boxes

Prices as follows:

100	\$1.10
250	2.60
500	5.00
1000	10.00

Plain Sections, 40c per 1000 less.
By parcel post, add 25c per 100 for postage.
Write for prices on more than 1000 lots.

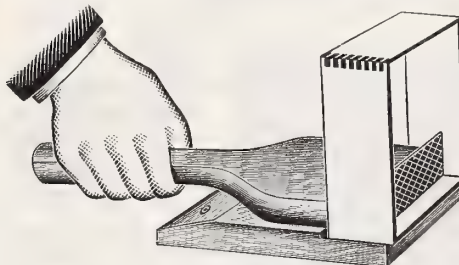

Parker Foundation Fastener

Parker Foundation Fastener

Price, each, 35c by mail, 45c

Lewis Foundation Fastener

Price, each \$2.00; by parcel post, \$2.40.

Without doubt the simplest and best device for the purpose ever offered to the bee keeper.

Daisy Foundation Fastener

Price, with lamp	\$2.00; by parcel post, \$2.50
Price, without lamp	1.75; by parcel post, 2.25
Weight, without lamp,	5 pounds.

Lewis Section Former

Price, each \$2.40.

For 4¼x4¼ sections only. This is a simple device for folding together sections. If you do not use a larger quantity of sections, this is the best former on the market and the price is low.



Wax Tube Fastener

Wax Tube Fastener	each 30c; by parcel post, \$0.40
Wire Imbedder	each 30c; by parcel post, .40



Bristle Brush

Bee Brushes

Bristle Brush, black bristle	each, \$0.30
Bristle Brush, white bristle	each, .40
Dixie Brush	each, .25
Cogshall Brush	each, .30
By parcel post,	10c each extra.

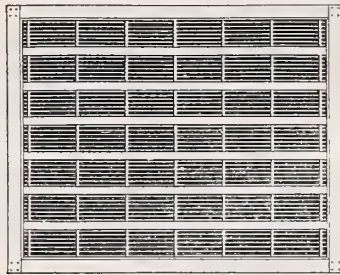

Wood and Wire Excluders

Queen Excluding Honey Boards

Wood Bound Zinc Board.

Prices as follows:	One	Ten
For 8-Frame Hive\$.52	\$4.70
For 10-Frame Hive57 5.20

Unbound Zinc Board.

Prices as follows:	One	Ten
8-Frame, 12x19 1/2\$.44	\$3.90
10-Frame, 14x19 1/249 4.40

Wood and Wire Boards.

Prices as follows:	One	Ten
8-Frame, 13 3/8 x 20\$.75	\$7.00
10-Frame, 16 x 2082 7.70

By parcel post, add 15c each for postage.

Bee Escape With Board

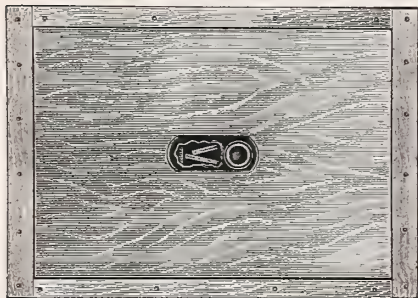

Price, with single exit escape, each 52c; 10 for \$4.70. With double exit escape, each 54c; 10 for \$4.90. Weight each 2 lbs.

Always state whether for 8 or 10-frame hive.



Porter Bee Escape

Porter Bee Escape

Price, each, Single Exit17c; by parcel post, \$.22
Price, each, Double Exit19c; by parcel post, .24

Porter Escapes for Honey Houses

Price, each22c; by parcel post, \$.27
-------------	----------------------------------



Nicked Hive Tool—A handy tool to use as a scraper or pry. Price, 60c; by parcel post, 70c.



Honey Knives

Bingham's Uncapping Knife—Standard length, Each, \$1.20; by parcel post, \$1.30. Extra long, each \$1.35; by parcel post, \$1.50.

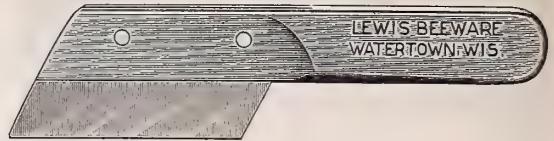

Section Scraping Knife

Priceeach 36c; by parcel post, \$.45

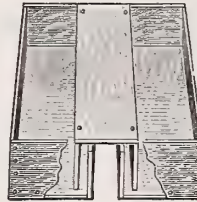

Miller Feeder

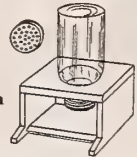

Boardman Feeder

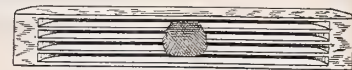

Simplicity Feeder

PRICE LIST OF FEEDERS

Alexander, completeeach	\$.35
Doolittle, nailedeach	.50
Doolittle, in flateach	.35
Miller, nailedeach	.75
Miller, in flateach	.50
Boardman, nailedeach	.25
Boardman, in flateach	.20
Simplicityeach	.15

By parcel post, add 15c each extra.

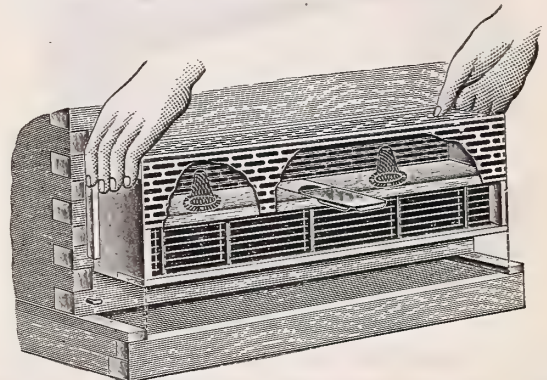

Alley's Queen and Drone Traps

Woven Wire Style.

Priceeach 75c; by parcel post, \$.90
State if wanted for 8 or 10-frame hives.	

Entrance Guards

Priceeach 25c; by parcel post, \$.35
State if wanted for 8 or 10-frame hives.	



The Carlin Foundation Cutter

Priceeach 30c; by parcel post, \$.40

The Carlin Foundation Cutter

Price List of Tinned Wire

3/4-oz. Spoolseach	\$.07; by parcel post, \$.12
1/4-lb. Spoolseach	.16; by parcel post, .21
1/2-lb. Spoolseach	.27; by parcel post, .32
1-lb. Spoolseach	.48; by parcel post, .58
5-lb. Coilseach	2.00; by parcel post, 2.20

COMPLETE BEE SUPPLY CATALOG FREE ON REQUEST.



NEW BINGHAM BEE SMOKER
Patented

Bee Smokers

Clark Smokers.

Price each 80c; by parcel post, \$.95

Bingham Smokers

Name.	Size of Barrel	Each	By mail
Doctor	3½-in.	\$1.20	\$1.35
Conqueror	3 -in.	1.10	1.25
Little Wonder	2½-in.	.80	.95
Smoke Engine	4 -in.	1.50	1.65

The Corneil Smoker

Name.	Each	By mail
Jumbo Corneil	\$1.50	\$1.65
Standard Corneil	1.15	1.30
Junior Corneil80	.95

Price List Metal Parts for Hives

- T Tins, 14 in. long or under per 100, \$2.00
- T Tins, over 14 in. and to 16 in. per 100, 2.00
- Flat Tins, 14 in. long or under per 100, 1.25
- Tin Rabbits same price as T Tins.
- Super Springs—Price of extra springs, each 2c; per 100, 90c; by parcel post, 100 for \$1.15.
- Frame Spacing Staples—Per lb. 30c; by parcel post, add 10c per pound.
- Hive Hooks—With screws, per pair, 5c; 10 pairs, 30c. No screws, 10 pairs, 25. By mail, 2c per pair extra.

Hive Scrapers

Price, each 35c; by parcel post, \$.45

Manum's Swarm Catcher

Price, each, with Pole,\$2.75; Without Pole, \$2.00

Swarming Box

Price, each, with Pole\$1.75; Without Pole, \$1.00

Comb Honey Shipping Cases

Regular Style

In ordering, give full description as below.

In Flat, with Nails, with 2-inch Glass.	10	100
24-lb., for 4¼x1¾ sections	\$4.60	\$44.00
24-lb., for 4¼x1½ sections	4.20	40.00
24-lb., for 4x5x1¾ sections	4.20	40.00
24-lb., for 3⅝x5x1½ sections	4.20	40.00

Comb Honey Shipping Cases

New Safety Style

Complete in the flat, including nails, 2-inch glass, Safety Cartons, corrugated paper lining and paper for bottom.

Size—Sections.	10	100
24-lb., for 4¼x1¾	\$7.28	\$70.80
24-lb., for 4¼x1½	6.88	66.80
24-lb., for 4x5x1¾	6.80	66.80

Safety Cartons

Safety Cartons, same as furnished with above Safety Cases, 100, \$11.20; 1000, \$111.10.

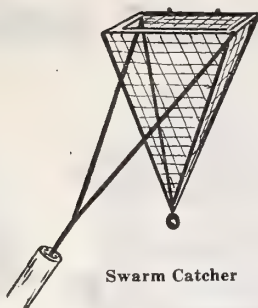

Swarm Catcher



Bee Veils

Muthveil, each	\$1.60
Mosquito Bar, each60
Cotton, with Silk Face, each	1.30
All Cotton, each	1.20
All Silk, each	1.60

By mail, 10c extra.

Globe Bee Veil—Sent by mail for \$1.60. Extra Nets, \$1.30 each

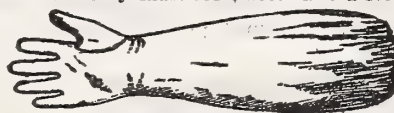

Bee Gloves

Bee Gloves—Canvas, large, medium or small. Per pair \$1.00; By parcel post, \$1.10.

Queen Rearing Outfit

Frames for Rauchfuss Cages, S. U.....	each, \$.25
K. D.....	each, .20
Nuclei Boxes, with Sections, S. U.....	each, .60
No Sections, K. D.....	each, .50
Rauchfuss Cages, each 6c	100, 4.00
Artificial Wax Cell Cups	100, .40

Price List of Comb Foundation

	In Lots of		
	1-lb., per lb.	2-lb., per lb.	5-lb., per lb.
Medium Brood	\$.85	\$.84	\$.82
Light Brood88	.87	.85
Thin Surplus93	.92	.90
Extra Thin Surplus96	.95	.93

Foundations by mail, 10c per lb. additional for postage.

Size and Sheets per Pound

Medium Brood	size 16½x7¾, Sheets 7 to 8
Light Brood	size 16½x7¾, Sheets 9 to 10
Thin Surplus	size 16½x3¾, Sheets 28
Extra Thin Surplus	size 16½x3¾, Sheets 32

Section Holder Nailing Form

Price each 90c; by parcel post, \$1.10

West's Queen Cell Protector

Price, each 6c; 10, 50c; 100, \$4.50. Postage 1c each extra. Spiral Cages, each 10c; 10 80c; 100, \$7.00. Postage 1c each extra.

Handy Section Press

Price each 95c; by parcel post, \$1.10

Rauchfuss Foundation Cutting Box

This box will hold about forty sheets of surplus Foundation and, with use of corrugated edge knife, which is included, the whole lot may be perfectly cut at one time. Price, each complete \$1.50; by parcel post, \$1.75.

Honey Extractors

No. 5, Novice, two frames	each \$24.00
No. 15, Cowan, two frames	each 33.00

COMPLETE BEE SUPPLY CATALOG FREE ON REQUEST.

CANARY BIRDS, CAGES AND BIRD SUPPLIES



Hartz Mountain Canary Birds

This is the most popular of all birds, as well as the most satisfactory songster. Each bird is tested and known to be in full song before leaving the store. Price, each \$7.50 to \$10.00. Females, each \$2.00 to \$4.00, f.o.b. Memphis, at owner's risk. Canaries cannot be shipped in cold weather.

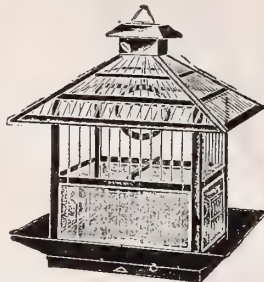

No. 8050 Brass Bungalow Cage



No. 275 Round Brass Cage

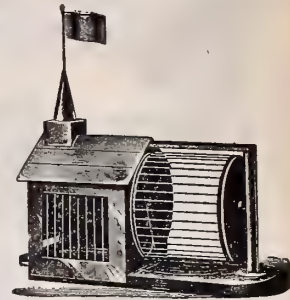

Gray Squirrel Cage

Fancy Brass Cages

- These are all handsome fancy styles, every one an ornament.
- No. 8000 Brass Bungalow Square Cage, each \$10.10
 - No. 8020 Brass Bungalow Square Cage, each 10.50
 - No. 6020G Brass Round or Globe Cage, each 11.10
 - No. 274 Brass Round Cage, each 6.25
 - No. 275 Brass Round Cage, each 6.75
 - No. 276 Brass Round Cage, each 7.25

If wanted by parcel post, add 35c each for packing and postage.

Metal Parrot Cages

- Round, Metal Cages, each \$ 6.10
- Square, Metal Cages, each 12.95
- Cups, Metal, for Parrot Cages, each60

Gray Squirrel Cage

- Body 13 1/8 x 10 3/8 -in., wheel 10x9-in., height 14 1/2 -in., each.. \$8.65

White Enamelled Gold-Trimmed Cages

- No. 231— 9 3/4 x 6 3/4 x 15 1/4 ins., each \$2.15
- No. 232—10 1/2 x 7 x 16 ins., each 2.75
- No. 233—11 x 7 1/2 x 16 3/4 ins., each 3.10
- No. 234—12 x 8 x 17 1/2 ins., each 3.45
- No. 235—13 x 9 x 18 ins., each 3.65

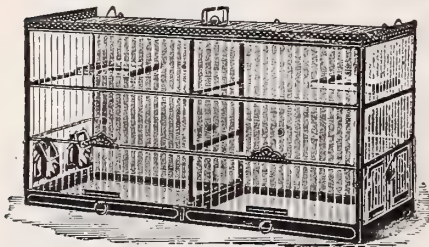

Breeding Cage



No. 5004 Brass Cage

Brass Canary Bird Cages

- No. 5000 Brass Cage, 8 1/4 x 5 1/2 -in., each..... \$2.10
- No. 5000 DB Brass Cage, 8 1/4 x 5 1/2 -in., each..... 2.75
- No. 5004 Brass Cage, 9 5/8 x 6 1/2 -in., each..... 2.70
- No. 5004 DB Brass Cage, 9 5/8 x 6 1/2 -in., each..... 3.40
- No. 5006 Brass Cage, 10 3/8 x 7 1/8 -in., each..... 3.00
- No. 5006 DB Brass Cage, 10 3/8 x 7 1/8 -in., each..... 3.90
- No. 5008 Brass Cage, 10 3/4 x 7 3/4 -in., each..... 3.85
- No. 5008 DB Brass Cage, 10 3/4 x 7 3/4 -in., each..... 4.55
- No. 5010 Brass Cage, 13 x 8 1/2 -in., each..... 4.65
- No. 5010 DB Brass Cage, 13 x 8 1/2 -in., each..... 5.50

All cages marked DB have removable bottom for cleaning.

Breeding Cages

- No. 86S—Metal Breeding Cage, 17x 8x13 ins..... \$3.50
- No. 86 —Metal Breeding Cage, 20x10x14 ins..... 5.10
- No. 87 —Metal Breeding Cage, 22x11x15 ins..... 5.80
- No. 88 —Metal Breeding Cage, 24x12x16 ins..... 7.15

If wanted by parcel post, add 35c for packing and postage.

Japanned Canary Bird Cages

- No. 165 New Style Japanned Cage, 9 1/2 x 6 1/2 -in., each... \$1.75
- No. 165 DB New Style Japanned Cage, 9 1/2 x 6 1/2 -in., each... 2.15
- No. 166 New Style Japanned Cage, 10 x 7 -in., each... 2.15
- No. 166 DB New Style Japanned Cage, 10 x 7 -in., each... 2.85
- No. 167 New Style Japanned Cage, 11 x 7 1/2 -in., each... 2.40
- No. 167 DB New Style Japanned Cage, 11 x 7 1/2 -in., each... 2.95
- No. 168 New Style Japanned Cage, 12 x 8 -in., each... 2.60
- No. 168 DB New Style Japanned Cage, 12 x 8 -in., each... 3.10
- No. 6 1/2 Fancy Round Cage, with seed guard 3.90

If Cages are wanted by parcel post, add 35c each for packing and postage.

Miscellaneous Bird Supplies

- Bird Cage Seed Cups, Opal or Glass each 15c; parcel post \$.20
- Bird Cage Bath Cups each 20c; parcel post .30
- Bird Cage Brackets, brass, 12-in..... each 35c; parcel post .40
- Bird Cage Brass Springs each 15c; parcel post .20
- Bird Cage Brass Chain with springs each 35c; parcel post .40
- Bird Cage Nests, Wire each 10c; parcel post .15



Philadelphia Bird Food

These are all especially prepared for birds, and are of the very best quality. Our stocks are complete at all times, so your order can be filled promptly.

- Phil. Bird Manna—The best tonic for Canaries; keeps them in good condition; helps moulting. Each, 15c; by parcel post 20c.
- Phil. Mixed Canary Seed pt. box 30c; parcel post \$.40
- Phil. Silver Gravel pt. box 10c; parcel post .20
- Phil. Red Gravel pt. box 10c; parcel post .20
- Phil. Bird Bitters bottle 25c; parcel post .30
- Phil. Bird Mite Exterminator box 25c; parcel post .30
- Phil. Bird Moulting Pepper box 25c; parcel post .30
- Phil. Bird Nestling Food box 25c; parcel post .30
- Phil. Bird Nestling Hair box 10c; parcel post .15
- Canary Seed, plain 1 lb. 35c; parcel post .45
- Canary Seed, mixed 1 lb. 30c; parcel post .35
- Hemp Seed 1 lb. 20c; parcel post .30
- Millet Seed 1 lb. 10c; parcel post .20
- Rape Seed 1 lb. 20c; parcel post .30
- Sunflower Seed 1 lb. 15c; parcel post .25
- Spratt's Parrot Food pkg. 20c; parcel post .30
- Mocking Bird Food, Defiance box 50c; parcel post .60
- Cuttle Fish Bone each 10c; parcel post .15
- Cuttle Fish Bone, with holder..... each 15c; parcel post .20

Gravel Paper

For the bottoms of Bird Cages; 7 1/2 x 10 inches. Will fit any oblong Canary Cages. Per box, 12 sheets, 15c.



AQUARIUMS AND GOLD FISH SUPPLIES

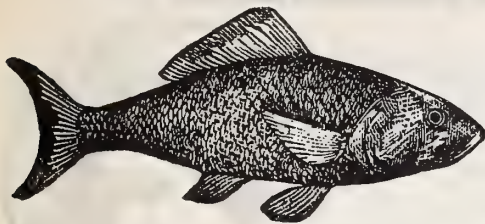

Gold Fish

American Gold Fish—The well known bright scarlet and gold color. Small, each 15c; medium, each 25c; large, each 50c; tadpoles, each 10c. Tin bucket for shipping, extra, 15c each. All Gold Fish shipped at buyer's risk.

Aquarium Castles

- No. 612—Square Castle, each\$.50
 - No. 631—Round Grotto, each50
 - No. 571—Castle, each35
 - No. 467—Plain Grotto, each35
 - No. 618—Arch Castle, each30
- Other small Ornaments at 25c and 35c each.

Aquariums

Neat and well made, with steel frame.

- Ideal Slate Bottom Aquariums, 3-gallon.....\$4.50
- Ideal Slate Bottom Aquariums, 9-gallon..... 6.50
- Ideal Slate Bottom Aquariums, 12-gallon..... 7.50

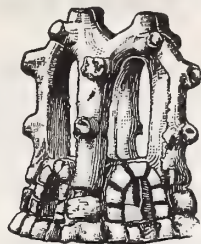

Gold Fish Bowls

- Glass Bowls—Made of clear glass, in following sizes:
- 2-Quart, each40
 - 4-Quart, each70
 - 2-Gallon, each 1.25
 - 3-Gallon, each 2.00

These are raised up on a glass base and are handsomer than freight or express, at buyer's expense.

Footed or Standing Fish Globes

These are raised up on a glass base and are handsomer than the ordinary fish globes.

- 1-Gallon size, each\$1.50
- 2-Gallon size, each 2.50
- 3-Gallon size, each 3.50

Prices are packed, f.o.b. Memphis.

Fish Food, Etc.

- Natural Fish Food, pkg.\$.15
- Wafer Fish Food, pkg.10



Spratt's Dog Cakes

- Spratt's Dog Cakes, 2-lb. box\$.40 By parcel post \$.50
- Spratt's Dog Cakes, 4-lb. box80 By parcel post 1.00
- Spratt's Dog Cakes, 10-lb. bag 1.75 By parcel post 2.00
- Spratt's Dog Cakes, 50-lb. box 7.75 Cannot be mailed
- Spratt's Dog Cakes, 100-lb. box 15.00 Cannot be mailed
- Spratt's Puppy Cakes, box40 By parcel post .50

Bennett's Milk Bone Dog Biscuit

A superior preparation. Keeps dogs in good condition. Ask for circulars. Per box 40c; by parcel post, 50c.

Bennett's Milk Bone Puppy Biscuit

Especially prepared for puppies. They thrive and grow fat on M. B. Biscuits. Per box 40c; by parcel post, 50c.



RAT CORN



Kills Rats and Mice. No odor or smell. It mummifies them. No matter where they die, they simply dry up; positively do not smell. Rat Corn is a new and scientific discovery and without a doubt the greatest rat destroyer in the world. The only one that kills rats without any dangerous or disagreeable effects. A trial will convince you. Small can 25c; medium can 50c; large can \$1.00. By parcel post, small 30c; medium 55c; large \$1.10.

Devil's Paste

Kills rats, mice and roaches on the spot. Their appetites crave it. They will leave grain or food of every description to eat Devil's Paste. We have given it severe trials in our warehouse, and it surely does the work. Price, 15c, 25c and 50c jars, f.o.b. Memphis. Being poison, it cannot be mailed.



Rat Annihilator

The modern rat destroyer. Kills and completely consumes the body of the rodent, leaving no bad odor. Simple to use, safe, sure and sanitary. Price 15c a box; 12 boxes \$1.50. Cannot be mailed.



Vermilax Supreme Dog Remedies

Owners of pets and valuable dogs can rely on purity, safety and sterling usefulness of Vermilax Remedies. Any of the following preparations sent parcel post paid on receipt of price—

- Blood Purifying Tablets. \$.50
- Cankered Ear Lotion. .50
- Chorea Tablets. .50
- Condition Tablets. .50
- Cough Syrup. .50
- Diarrhea Tablets. .50
- Distemper Remedy. 1.00
- Eye Lotion. .50
- Fever Tablets. .50
- Germicide and Disinft. .50
- Gum Set. .50
- Kidney Tablets. \$.50
- Liniment. .50
- Mange Remedy, 50c and 1.00
- Mouth Wash. 1.00
- Rheumatic Tablets. .50
- Shampoo. .50
- Skin Cleanser. .50
- Soap, Animal. .50
- Soap, for Puppies. .50
- Tonic Tablets. .50
- Vermilax Worm Remedy. .50

Be sure to send for Dr. Delaney's book on Dogs. It's Free.

POULTRY SUPPLY DEPARTMENT



Our stocks in this department are complete and we handle only the very best in both APPLIANCES and FEEDS, and at reasonable prices. The FEEDS and APPLIANCES offered are of known merit and have been thoroughly tested and proven, and if you have never tried them and you want QUALITY, it will pay you to give them a trial. All prices quoted are subject to market changes and are those ruling at this time, but we will endeavor to fill all orders for APPLIANCES at prices quoted, except FEEDS, which will be filled at prices ruling day order is sent.

All prices quoted are f.o.b. Memphis, except where marked postpaid.

RED COMB QUALITY FEEDS



Red Comb Poultry Feed—The extra quality feed contains no shell or grit to make weight; try it, and you will use no other. Composed of choice grains, seeds and charcoal. A clean, bright, balanced ration for general use. As a scratch feed it is unequalled. Made without grit or shells. 5 lb. 25c. By parcel post, 5 lb. 40c.



Red Comb Mash, with Dried Buttermilk—This is the great egg producer. A mash feed prepared expressly for egg production, being very rich in egg-making elements. This mash is unsurpassed as a winter egg maker. It is the most wonderful feed in the world for making hens lay in cold weather. 5 lb. 25c. By parcel post, 5 lb. 40c.

Red Comb Coarse Chick Feed—A developing food, composed of cracked grains and seed of the highest quality and especially adapted to the growing period, and when used insures a strong and rapid growth. This feed also contains charcoal. 4 lb. 25c. By parcel post, 4 lb. 40c.

Red Comb Fine Chick Feed—Composed of cracked grains, seeds and charcoal. Highly nutritious, easily digested and especially suited to the tender digestive organs of the little chicks. Made without grit. 4 lb. 25c. By parcel post, 4 lb. 40c.



Red Comb Baby Chick Milk Mash—A milk substitute. Made with the utmost care from dried milk, barley meal, locust bean meal, bone meal, rice polish, flax seed meal, and a dozen other needful grains and herbs ground to the proper consistency. Red Comb brand Poultry and Chick Feeds are always dependable. Don't fail to use the new Milk Mash on your chicks this spring. 1 lb. 10c; 3 lb. 25c. By parcel post, 1 lb. 20c; 3 lb. 40c.



Pound Squab Pigeon Feed—Composed of the very best hard, red winter wheat, hemp, Canadian peas and other grains and seeds of equal quality. It is very strong in muscle and bone-making elements and is so perfectly balanced that no organism is neglected. Contains no corn whatever. 4 lb. 25c. By parcel post, 4 lb. 40c.

Red Horn Calf and Pig Meal—You can raise calves and pigs easily and economically by using Red Horn Calf and Pig Meal. Raising calves and pigs by hand is a good deal like raising a baby on a bottle. One person should attend to the calf or calves and pig or pigs to be so raised—some one who likes to feed and who takes real interest in their welfare. In each bag of Red Horn Calf and Pig Meal we put a sheet of feeding directions and, as far as possible, it is a dependable rule and guide. It is, however, based on the fact that the Red Horn Calf and Pig Meal is always the same, while the calf and pig are not. They vary in size, vigor, capacity and ability, to assimilate food; a set rule cannot always be rigidly adhered to. See Pink Price List, Page 98, for Price.



Red Horn Dairy Feed—For more milk and cream, don't fail to use this feed. It contains 25 per cent protein, composed of cotton seed meal, corn gluten feed, wheat bran, linseed oil, malt sprouts, corn feed meal and brewers' dried grains, all of these are the greatest of milk producers. See Pink Price List, Page 98, for Price.

Pioneer Hog Feed, with Dried Buttermilk—The first "important step" in raising hogs for profit is to properly feed a balanced ration that will supply every demand of the growing hog. This Hog Feed is a perfectly balanced ration, made from wheat middlings, corn feed meal, linseed oil meal, ground and bolted wheat, barley & kaffir screenings and dried buttermilk. You cannot afford to feed hogs corn without buttermilk, so give Pioneer a trial. See Pink Price List, Page 98, for Price.



FOR PRICES ON LARGER QUANTITIES, SEE PINK PRICE LIST, PAGE 98.



MISCELLANEOUS POULTRY FEEDS



Blatchford's Milk Mash For Chicks—Made of milk and milk substitute; makes mammoth chicks, healthy and strong. A positive preventive against bowel trouble in chicks, which is one of the worst causes of loss in chick raising. A perfect milk substitute with a combination of barley meal, corn meal, oat meal, beef scraps and fish for feeding chicks from the start. For Price, See Pink Price List, page 98.



Blatchford's Fill the Basket Egg Mash Feed—A combination of dry milk, bran, alfalfa, corn meal, barley meal, oat meal, oil meal, beef scraps and pepper, and will simply force hens to lay. Must be used dry, just as it comes from the bag. Keep before the birds at all times, in connection giving them a good scratch feed, and it will make your hens shell out the eggs. For Price, See Pink Price List, Page 98.



Blatchford's Calf Meal—The perfect milk substitute; contains all the elements for pushing calves to maturity; easily digested, prevents scouring. Full directions with every bag. For Price, See Pink Price List, Page 98.

Blatchford's Pig Meal—Your little pigs will wean easily, quickly and safely on Blatchford's Perfect Milk Meal. It will also keep them growing steadily and rapidly, developing bone and muscle. You will seldom find a runt in a litter of Blatchford's Pig Meal weaned pigs. For price, see Pink Price List, page 98.



Chamberlain's Perfect Chick Feed—The original dry feed for baby chicks, made without any corn, avoids bowel trouble and many other diseases caused by improper feed. Contains all the meat, bone, charcoal, grit, oat meal, etc., necessary for the successful raising of baby chicks, thus making it unnecessary to feed them anything else. 4 lb. 25c. By parcel post, 4 lb. 40c. Price on larger quantities, see Pink Price List, page 98.



Pratt's Baby Chick Feed—A superlative mixed feed for Baby Chicks. Contains only such grains that are easily digested. This is one of the most scientifically mixed baby chick feeds on the market. 2½ lb. pkg. 30c; 5¼ lb. pkg. 60c; 14 lb. bag \$1.35. By parcel post, 2½ lb. pkg. 45c; 5¼ lb. pkg. 80c; 14 lb. bag \$1.70, parcel post paid, not past 3rd zone.

F. P. C. Chick Manna—A food that has merited the praise and admiration of poultry keepers, comprising a variety of nutritious food and health preserving properties so proportioned and combined as to be peculiarly adapted to promote health, quick growth and strong development. Chicks when first hatched need no food for at least from twelve to twenty-four hours. Chick Manna should be the first food and exclusively fed for ten days. Packed in 1-lb., 5-lb. and 15-lb. packages. Prices on Application.



Conkey's Buttermilk Starting Food for Chicks—A ready-prepared food for Baby Chicks, Turkeys, Ducks, Guineas, etc. Feed according to directions. You will raise 90 per cent of those hatched. It is a special starting feed and will avoid much trouble in raising the flock. 1 lb. 10c; 3 lb. 25c. By parcel post, 1 lb. 20c; 3 lb. 35c. For price on larger quantities, see Pink Price List, page 98.



Hen-O-Lay Dry Mash—A complete balanced ration, especially fine for feeding baby chicks. Hen-O-Lay beats all mashes for chicks, because it's ground fine and prevents them from getting crop-bound and other diseases. The five nutrients are protein, fat, carbohydrates, phosphorous and lime, and these you get in the celebrated Hen-O-Lay Mash. Feed it dry, no beef crap, or charcoal needed—our experiments the past season with Hen-O-Lay were more than satisfactory. Many customers' reports were fine. Take our word for it, use Hen-O-Lay Mash, both for baby chicks and grown fowls, feed it dry from any good hopper, one quart to twelve hens, one-half pint to twelve chicks, twice a day. 4 lb. 25c. By parcel post, 4 lb. 40c. For price on larger quantities, see Pink Price List, page 98.



Miscellaneous Poultry Grains

- Buckwheat For Price, see Pink Price List, page 98
- Corn Chops, sifted For Price, see Pink Price List, page 98
- Hemp Seed For Price, see Pink Price List, page 98
- Millet Seed For Price, see Pink Price List, page 98
- Wheat, Red For Price, see Pink Price List, page 98
- Sunflower Seed For Price, see Pink Price List, page 98
- Kaffir Corn For Price, see Pink Price List, page 98
- Canada Peas For Price, see Pink Price List, page 98
- Steel Cut Oats For Price, see Pink Price List, page 98

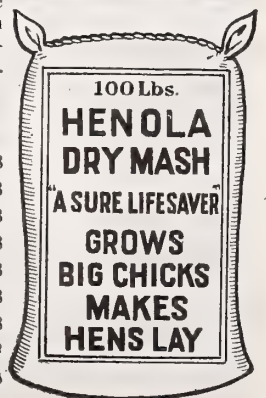

FOR PRICES ON LARGER QUANTITIES, SEE PINK PRICE LIST, PAGE 98.

BEEF SCRAP, BONE, OYSTER SHELL, GRIT, ETC.

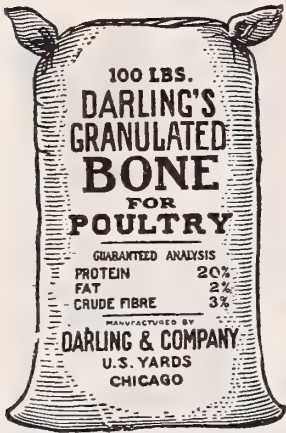

Granulated Bone

Granulated Bone—Granulated Bone is made from fresh, green bone, from which the moisture and grease have been taken leaving nothing but the phosphates, lime and nitrogenous matter. These are the only food properties of bone, green or dry, so when you buy granulated bone you will get it without paying freight on moisture or grease. This preparation will keep in any climate, in any kind of weather, if kept in a dry place. It is especially valuable as an egg-shell producer. Promotes strong, healthy growth of the bones in young chickens. Prevents leg weakness. Mix a little in soft feed. Coarse, for hens, 3 lb. 25c; 25 lb. \$1.50; 100 lb. \$5.50. Fine for chicks, 3 lb. 25c; 25 lb. \$1.50; 100 lb. \$5.50. By parcel post, 3 lb. 35c.

Alfalfa Clover Meal

It is an acknowledged fact that green food is one of the most important foods necessary to heavy egg production. Among those who are unable to obtain a plentiful supply of green stuff, Alfalfa Meal should fill a long-felt-want, it being an excellent substitution and a very nutritious food, which, when mixed with the mash, also affords bulk to concentrated foods.

Directions—Place in a water-tight vessel, pour boiling water over it, cover with a tight lid, and let it steam and soften for about twelve hours. Mix with the soft food, allowing the meal to compose one-tenth part of the mash. Price, 5 lb. 25c; 50 lb. \$2.00; 100 lb. \$3.50. By parcel post, 5 lb. 40c.

Ground Oyster Shells

Every poultryman realizes the importance of crushed oyster shells as an egg-shell maker and promoter of good health. Every pound of oyster shells offered by us is especially prepared for feeding poultry. They are crushed and ground to the size which expert poultrymen agree to be the best. Use oyster shell freely. It is good for chickens, old or young. Coarse, for hens, 10 lb. 25c; 50 lb. 90c; 100 lb. \$1.50. Fine, for chicks, 10 lb. 25c; 50 lb. 90c; 100 lb. \$1.50. By parcel post, 10 lb. carton 50c, not past 3rd zone.

Peerless Brand, Extra Quality, hen size, 100 lbs. \$2.00
Charcoal

If you want healthy chickens, rugged-growing stock with bright, healthy plumage, birds that will fatten easily and well, and entire freedom from sour crops and indigestion with laying stock, feed Charcoal. This is an easy hint to take, and the coal is low in price. The per hen cost is so low as to be almost ridiculous, and yet it is one of the simplest and best helps to success. Keep it before them all the time, and also feed in the mixed grain. Nothing equals it as a disease preventative. Made in 3 sizes—coarse for hens; medium for pigeons; fine for baby chicks. Price, 2 lb. carton 15c; 25 lb. \$1.50; 50 lb. \$2.50; 100 lb. \$4.50. By parcel post, 2 lb. carton 25c.

Hog Charcoal

Small pieces of Charcoal, especially made for hogs. Simply put some in their troughs and watch them get away with it. Charcoal aids digestion, purifies the blood and keeps hogs from dreaded Cholera. Try a bag and watch the benefits. Price, 50 lb. bag \$2.50, f.o.b. Memphis.

Darling's Meat Scraps

Darling's Meat Scraps—For success with poultry it is absolutely necessary to give them plenty of animal food in the winter, to take the place of insects, etc., which they get during the summer. Feed mixed with meal or bran, at the rate of 1/4 lb. of beef scraps per day to a dozen hens. 3 lb. 25c; 25 lb. \$1.90; 50 lb. \$3.50; 100 lb. \$6.50. By parcel post, 3 lb. 35c.

Darling's Blood Meal

Darling's Blood Meal—2 lb. 25c; 25 lb. \$2.50; 100 lb. \$8.00. By parcel post, 2 lb. 35c.

Armour's Meat Meal

Armour's Meat Meal (known also as Digester Tankage)—Especially prepared for feeding hogs and animals. High in protein, producing muscle and sturdy growth. Price on application.

Gluten Meal

Gluten Meal—For making poultry food mash. Nothing superior to Gluten Meal for this purpose, supplying the necessary element in making mixture. Recommended by the Maine Experiment Station. We have it pure. 4 lb. 25c; 25 lb. \$1.25; 100 lb. \$4.00. By parcel post, 4 lb. 40c.

Linseed Meal

Linseed Meal—A little of this occasionally mixed with soft feed will prove of great benefit, especially if a rich, glossy plumage is desired. 5 lb. 25c; 25 lb. \$1.25; 100 lb. \$4.00. By parcel post, 5 lb. 40c.

Grit For Poultry

Poultry Grit—Grit is as essential for poultry as food, as without it they cannot digest the food. Poultry will starve to death with full crop for no other reason than they have no teeth with which to grind the food into proper consistency. Grit should be fed in hoppers or boxes. Hen size, 10 lb. 25c; 50 lb. 75c; 100 lb. \$1.25. Chick size, 10 lb. 25c; 50 lb. 75c; 100 lb. \$1.25. By parcel post, 10 lb. carton 50c, not past 3rd zone.

Crys-Co Grit and Shell Producer—In buying Crys-Co you get a shell producer and grit combined. 6 lb. 25c; 50 lb. \$1.25; 100 lb. \$2.00. By parcel post, 6 lb. 45c, not past 3rd zone.

Hen-E-Ta Bone Grits—Will make hens lay, just right for chicks; no other bone or grits needed. 100 lb. bag \$3.00; 50 lb. bag \$1.75; 5 lb. 25c. By parcel post, 5 lb. 40c, not past 3rd zone.

Red Cross Baby Chick Grit—Nothing is more essential in rearing baby chicks. Don't fail to have it on hand, and see that it is kept before them regularly. Price, 4 lb. 25c; 50 lb. \$1.75; 100 lb. \$3.00. By parcel post, 4 lb. 40c, not past 3rd zone.

Red Cross Pigeon Grit—Especially for pigeons. A tonic and grit combined. Pigeon fanciers say it's the best preparation of its kind. 5 lb. 25c; 50 lb. \$1.75; 100 lb. \$3.00. By parcel post, 5 lb. 40c, not past 3rd zone.

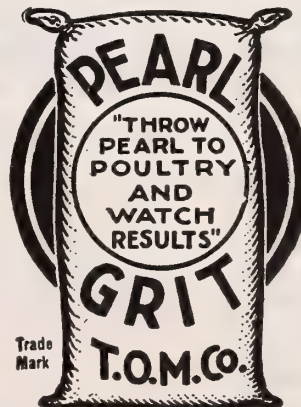

ALL PRICES SUBJECT TO CHANGE WITHOUT NOTICE



POULTRY AND STOCK REMEDIES

We carry a complete stock of all the best preparations. These prices are f.o.b. Memphis, except where priced by parcel post; also please note liquids cannot be mailed.

Lee's Poultry Food and Remedies

	Not past 3rd zone.
Lee's Egg Maker, 2-lb. box	\$.35; by parcel post \$.50
Lee's Egg Maker, 5-lb. box75; by parcel post .90
Lee's Lice Powder, small size25; by parcel post .35
Lee's Lice Powder, large size50; by parcel post .65
Lee's Hog Remedy, 7-lb. box	1.00; by parcel post 1.20
Lee's Hog Remedy, 25-lb. pail	3.00; Cannot be mailed
Lee's Liquid Lice Killer, 1-qt.50; Cannot be mailed
Lee's Liquid Lice Killer, 2-qt.75; Cannot be mailed
Lee's Liquid Lice Killer, 1-gal.	1.25; Cannot be mailed
Lee's White Diarrhea Cure, bottle, large50; Cannot be mailed
Lee's Smoke Flavor, small50; Cannot be mailed
Lee's Smoke Flavor, large	1.00; Cannot be mailed
Lee's Egg-O-Hatch50; By parcel post .55
Lee's Egg-O-Latum50; By parcel post .55
Lee's Head Lice Ointment15; By parcel post .20



Lee's Germozone

Is undoubtedly the most popular poultry medicine on the market. It is practically infallible as a cure for bowel trouble, that disease from which more chickens die annually than from all other diseases combined. It is also of great value for Roup, Colds, Chicken Cholera and other diseases which are so prevalent among poultry. A little of it in drinking water twice a week will keep your fowls healthy and in good condition all the time. Liquid—Price, 4-oz. bottle 40c; 12-oz. bottle 75c; cannot be mailed. Tablets—Price, 65c per box. By parcel post, 70c.



Pratt's Poultry and Stock Food

	Not past 3rd zone.
Pratt's Poultry Regulator	\$.30; by parcel post \$.40
Pratt's Poultry Regulator60; by parcel post .75
Pratt's Poultry Regulator	1.20; by parcel post 1.45
Pratt's Poultry Regulator, 12-lb. pails	1.75; by parcel post 2.10
Pratt's Roup Remedy25; by parcel post .30
Pratt's Poultry Condition Tablet25; by parcel post .30
Pratt's Cholera Remedy25; by parcel post .30
Pratt's Gape Remedy30; by parcel post .35
Pratt's Sorehead Remedy25; by parcel post .30
Pratt's Bronchitis Remedy25; by parcel post .30
Pratt's White Diarrhea Cure25; by parcel post .30
Pratt's Lice Powder10; by parcel post .15
Pratt's Lice Powder30; by parcel post .40
Pratt's Animal Regulator30; by parcel post .40
Pratt's Animal Regulator60; by parcel post .70
Pratt's Animal Regulator	1.20; by parcel post 1.45
Pratt's Calf Tonic60; by parcel post .70
Pratt's Cow Tonic60; by parcel post .70
Pratt's Worm Powder50; by parcel post .60
Pratt's Hog Cholera Specific50; by parcel post .60
Pratt's Heave Cure50; by parcel post .60
Pratt's Hog Worm Powder50; by parcel post .60
Pratt's Spavin Paste50; by parcel post .60
Pratt's Distemper Cure60; Cannot be mailed
Pratt's Bag Ointment35; by parcel post .40
Pratt's Colic Cure75; Cannot be mailed
Pratt's Liquid Spavin Cure	50c and 1.00; Cannot be mailed
Pratt's Animal Liniment	30c and .60; Cannot be mailed
Pratt's Animal Regulator, 25-lb. pail	3.75; Cannot be mailed
Pratt's Lice Liquid, 1-qt.40; Cannot be mailed
Pratt's Lice Liquid, 1-gal.	1.25; Cannot be mailed
Pratt's Disinfectant, 1-qt.50; Cannot be mailed
Pratt's Disinfectant, 2-qt.90; Cannot be mailed



Schwill's Poultry Remedies

	Not past 3rd zone.
Schwill's Egg Producer, 2½-lb. box	\$.30; by parcel post \$.40
Schwill's Lice Powder, 15-oz. box30; by parcel post .40
Schwill's Lice Powder, 48-oz. box60; by parcel post .75
Schwill's Roup Powder, small25; by parcel post .30
Schwill's Roup Powder, large50; by parcel post .55
Schwill's Liquid Lice Paint, quart40; Cannot be mailed
Schwill's Liquid Lice Paint, gallon	1.25; Cannot be mailed
Schwill's Poultry Dip, quarts50; Cannot be mailed





Conkey's Poultry Remedies

Conkey's Gape Remedy\$.30;	by parcel post	\$.35
Conkey's Gape Remedy	by parcel post	.70
Conkey's Head Lice Ointment	by parcel post	.20
Conkey's Head Lice Ointment	by parcel post	.35
Conkey's Scaly Leg Remedy	by parcel post	.35
Conkey's Limber Neck Remedy	by parcel post	.70
Conkey's Healing Gall Salve	by parcel post	.35
Conkey's Bronchitis Remedy	by parcel post	.70
Conkey's Poultry Worm Powder	by parcel post	.70
Conkey's Poultry Laxative	by parcel post	.35
Conkey's Poultry Tonic	by parcel post	.40
Conkey's Lice Fix Salve	by parcel post	.65
Conkey's Laying Tonic, small	by parcel post	.40
Conkey's Laying Tonic, large	by parcel post	.75
Conkey's Lice Powder	by parcel post	.20
Conkey's Lice Powder	by parcel post	.40
Conkey's Lice Powder	by parcel post	.80
Conkey's Lice Powder	by parcel post	1.65
Conkey's Mange Remedy	by parcel post	.70
Conkey's Rheumatic Cure	by parcel post	.70
Conkey's Stock Vigor, pkg.	by parcel post	.40
Conkey's Cow Special	by parcel post	.70
Conkey's Canker Special	by parcel post	.70
Conkey's Healing Salve	by parcel post	.35
Conkey's Liquid Lice Killer, 1-qt.	cannot be mailed	.50
Conkey's Liquid Lice Killer, 2-qt.	cannot be mailed	.75
Conkey's Liquid Lice Killer, 4-qt.	cannot be mailed	1.25
Conkey's Noxicide, 1-pt.	cannot be mailed	.40
Conkey's Noxicide, 1-qt.	cannot be mailed	.70
Conkey's Noxicide, 2-qt.	cannot be mailed	1.00
Conkey's Noxicide, 1-gal.	cannot be mailed	1.75
Conkey's Fly Knocker, 1-qt.	cannot be mailed	.50
Conkey's Fly Knocker, 1/2-gal.	cannot be mailed	.75
Conkey's Fly Knocker, 1-gal.	cannot be mailed	1.25
Conkey's Laying Tonic, 25-lb. pail	cannot be mailed	2.75
Conkey's Roup Powder, small	by parcel post	.35
Conkey's Roup Powder, medium	by parcel post	.65
Conkey's Roup Powder, large	by parcel post	1.30
Conkey's Roup Pills	by parcel post	.35
Conkey's Condition Powder	by parcel post	.35
Conkey's Cholera Cure, small	by parcel post	.35
Conkey's Cholera Cure, large	by parcel post	.65
Conkey's White Diarrhea Cure, small	by parcel post	.35
Conkey's White Diarrhea Cure, large	by parcel post	.65
Conkey's Chicken Pox Remedy, small	by parcel post	.35
Conkey's Chicken Pox Remedy, large	by parcel post	.65

Rust's Poultry Powders

We have been selling these preparations for 30 years. Customers say they want no better.

Rust's Climax Condit. Powder, 13-oz.\$.25;	by parcel post	\$.35
Rust's Climax Condit. Powder, 32-oz.	by parcel post	.65
Rust's Climax Condit. Powder, 5-lb.	by parcel post	1.00
Rust's Climax Condit. Powder, 8-lb.	by parcel post	1.75
Rust's Egg Producer, 1 -lb.	by parcel post	.35
Rust's Egg Producer, 2 1/2-lb.	by parcel post	.65
Rust's Egg Producer, 6 -lb.	by parcel post	1.20
Rust's Lice Powder, box	by parcel post	.35
Rust's Roup Powder, 3-lb. box	by parcel post	.60
Rust's Roup Powder, small	by parcel post	.30
Rust's Roup Powder, large	by parcel post	.60
Rust's Roup Pills, small	by parcel post	.30
Rust's Roup Pills, medium	by parcel post	.55
Rust's Roup Pills, large	by parcel post	1.10
Rust's Lice Liquid, 1-quart	cannot be mailed	.35
Rust's Lice Liquid, 1/2-gallon	cannot be mailed	.60
Rust's Lice Liquid, 1-gallon	cannot be mailed	1.00

Cyphers Poultry Remedies

Cyphers Roup Cure, small size box\$.25;	by parcel post	\$.25
Cyphers Roup Cure, large size box	by parcel post	.50
Cyphers Remedial Ointment, per tube	by parcel post	.25
Cyphers Lice Powder, 15-oz. box	by parcel post	.35
Cyphers Lice Powder, 48-oz. box	by parcel post	.65
Cyphers Lice Powder, 100-oz. box	by parcel post	1.20
Cyphers Remedy No. 6, for Liv. Troub.	by parcel post	.25
Cyphers Remedy No. 3, for Chick. Pox	by parcel post	.25
Cyphers Full Nest Egg Food	by parcel post	.35
Cyphers Disinfectant Tablets	by parcel post	.25
Cyphers Salt Cat for Pigeons	by parcel post	.35
Cyphers Napcreol, 1-quart	cannot be mailed	.50
Cyphers Napcreol, 2-quart	cannot be mailed	.85
Cyphers Napcreol, 1-gallon	cannot be mailed	1.50

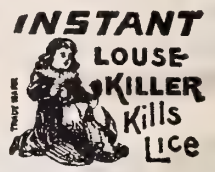

Dr. Hess' Poultry and Stock Food

Dr. Hess' Poultry Panacea, small\$.30;	by parcel post	\$.40
Dr. Hess' Poultry Panacea, medium	by parcel post	.90
Dr. Hess' Poultry Panacea, large	by parcel post	1.80
Dr. Hess' Instant Louse Powder	by parcel post	.40
Dr. Hess' Stock Food	by parcel post	.40
Dr. Hess' Stock Food	by parcel post	.75
Dr. Hess' Worm Powder	by parcel post	.60
Dr. Hess' Distemper Remedy	by parcel post	.60
Dr. Hess' Healing Powder	by parcel post	.30
Dr. Hess' Heave Powder	by parcel post	.60
Dr. Hess' Colic Cure	cannot be mailed	1.00
Dr. Hess' Stock Food, 25-lb. pail	cannot be mailed	2.25
Dr. Hess' Poultry Panacea, 25-lb. pail	cannot be mailed	3.00
Dr. Hess' Animal Dip, 1-qt.	cannot be mailed	.50
Dr. Hess' Animal Dip, 2-qt.	cannot be mailed	.90

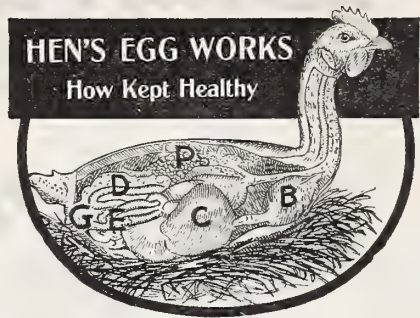
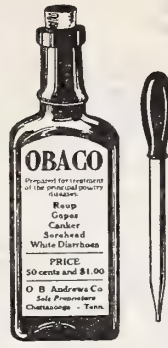
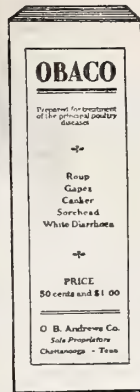
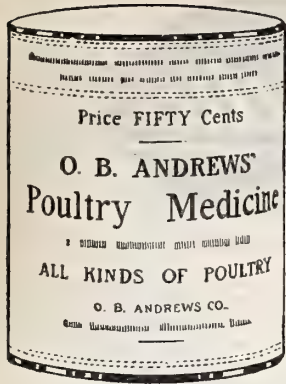

Andrews' Poultry Remedies

A new line. Every preparation has been tried out and will do all the manufacturer claims.
 Andrews' Deathmite, box \$.50; by parcel post \$.55
 Andrews' Deathmite, box 1.00; by parcel post 1.10
 Andrews' Disinfectant, bottle 1.00; cannot be mailed
 Andrews' Liniment, bottle 1.00; cannot be mailed

Andrews' Dip and Disinfectant

When diluted, makes one of the best poultry dips on the market. Sure to kill lice and mites. Also fine for household use. Price, \$1.00 per bottle. Cannot be mailed.

Andrews' Obaco

A valuable and sure preventative of White Diarrhea in chicks. Also cures Roup, Cholera, Gapes and Sore Head. Obaco kills the germ. Write for the Poultryman's Text Book; it's free, and tells you all about this excellent germicide. Bottle, 50c and \$1.00. Cannot be mailed.

Andrews' Poultry Medicine

A tonic and cure for liver and indigestional troubles. Hastens the moult and keeps the fowl in good condition. Price, 50c and \$1.00 a box. By parcel post, 55c and \$1.10.

International Poultry and Stock Remedies

- International Poultry Food \$.30; by parcel post \$.35
- International Poultry Food60; by parcel post .65
- International Poultry Food 1.20; by parcel post 1.25
- International Louse Powder30; by parcel post .35
- International Bowel Remedy25; by parcel post .30
- International Gape Remedy60; by parcel post .70
- International Stock Food30; by parcel post .35
- International Stock Food60; by parcel post .65
- International Stock Food 1.20; by parcel post 1.25
- International Heave Cure60; by parcel post .60
- International Worm Powder50; by parcel post .60
- International Gall Cure30; by parcel post .30
- International Distemper Cure60; by parcel post .65
- International Tarfoot Remedy60; cannot be mailed
- International Colic Cure60; cannot be mailed
- International Healing Oil 60c and 1.20; cannot be mailed
- International Pheno-Chloro, 30c and .60; cannot be mailed
- International Stock Food, 25 lbs. 4.00; cannot be mailed

Austin's Pyrotone

Sure death to lice and mites. Acts as a preventative as well as a cure. Price, large bottle, 75c, by express only. Cannot be mailed.

Sulphur Fumigating Candles

Sulphur Fumigating Candles—A safe and effective fumigator. Moisture is given off with the gas, producing sulphurous acid gas, which is essential to thorough fumigation. Easily lighted and a sure burner. Each, 15c; by mail 20c.

Blackman's Medicated Salt Brick

As its name implies, it is in brick shape, made of purest salt and medicine necessary for treatment of diseases for which it is intended. By this simple plan they take their medicine. Price, per brick 25c; by parcel post, per brick 40c.

Oculum

A scientific remedy and preservative for all poultry diseases. It is especially valuable for preventing and curing White Diarrhea in baby chicks. Be sure to inoculate your chicks this season with Oculum and you will raise 95 per cent. Oculum is also used as an egg-producer; increases both fertility and vigor. Ask for descriptive circular. Price, 50c and \$1.00 bottles; cannot be mailed.

Bee Dee Powders

A poultry and stock medicine, formerly called Black Draught. Highly recommended for all stock and poultry troubles, hof cholera, etc. 25c and 50c a can. By parcel post, 30c and 60c.

A certain and positive cure and preventative for Roup in all fowls. Not necessary to separate the sick birds from the well ones when using Roupene; this saves much trouble in handling. Roupene is fully guaranteed to do all it claims. Price, 50c per bottle. By parcel post, 60c.



Whiting's White Diarrhea Remedy—Price, 50c per bottle. By parcel post, 60c.



Germo Magic Cholérine

Germo Magic Cholérine—A vegetable compound for poultry; put in drinking water, will cure and prevent chicken pox and keep poultry in good condition. Price, 65c bottle; gallon jug \$2.25; cannot be mailed. Tablets, 65; by parcel post 70c.

Magic Poultry and Stock Powders

- Magic Poultry Food \$.25; by parcel post \$.35
- Magic Poultry Food50; by parcel post .60
- Magic Lice Powder10; by parcel post .15
- Magic Lice Powder25; by parcel post .35
- Magic Roup Powder35; by parcel post .40
- Magic Stock Food50; by parcel post .65
- Magic Death Powder10; by parcel post .15
- Magic Death Powder25; by parcel post .30
- Magic Hoof Ointment25; by parcel post .35
- Magic Worm Powder50; by parcel post .60
- Magic Heave Cure50; by parcel post .60
- Magic Distemper Cure50; by parcel post .60
- Magic Hog Medicine50; by parcel post .60
- Magic All-Heal Liniment50; cannot be mailed
- Magic Colic Cure 1.00; cannot be mailed
- Magic Disinfectant25; cannot be mailed



Diarrhene

Prevents and cures White Diarrhea in baby chicks. Reaches the very seat of this dreaded trouble, and is absolutely a sure and safe remedy. Price, 60c; by parcel post, 65c.

Coldene

Used for ordinary colds, for Bronchitis, Pneumonia, and for extreme cases of Roup. Coldene is used in connection with Pipene. Price, 60c; parcel post paid, 65c.

Pipene

One application cures the worst case of Roup. It is safer than all the other Roup powders, which are given in the water, as Pipene is injected in the nostrils from inside the mouth and one treatment effects a sure cure. Price, 60; parcel post paid, 65c.

Licene

Licene will destroy every louse and "nit" on your chickens, usually keeping them free from lice for six months. Per tube, 60c; parcel post paid, 65c.



Sal Vet—Destroys worms in Hogs, Sheep, Horses and Cattle. Simply put Sal Vet in the animals' troughs, or give it to them in their feed. Send for circulars.

- 15-lb. package\$1.50; by parcel post \$1.85
 - 40-lb. package 3.00; cannot be mailed
 - 100-lb. package 6.75; cannot be mailed
- Gall-Vet—The liquid gall remedy. Price, 30c; cannot be mailed.



Zenoleum Preparations

- Zenoleum Lice Powder, box\$.30; by parcel post \$.40
- Zenoleum Hog Worm Powder 1.00; by parcel post 1.05
- Zenoleum Lice Liquid, 1-qt.50; cannot be mailed
- Zenoleum Lice Liquid, 2-qt.90; cannot be mailed
- Zenoleum Lice Liquid, 1-gal. 1.25; cannot be mailed
- Zenoleum Dip, 8-oz. can30; cannot be mailed
- Zenoleum Dip, 1-qt. can60; cannot be mailed
- Zenoleum Dip, 2-qt. can 1.00; cannot be mailed
- Zenoleum Dip, 1-gal. can 1.75; cannot be mailed
- Zenoleum Dip, 5-gal. can 7.50; cannot be mailed



Cooper's Medico

Cheapest and most concentrated worm destroyer and tonic on world's market. A \$1.00 package will make 75 pounds and only costs \$1.00. Will last 75 sheep or 75 hogs for 60 days. Stop paying fancy prices for worm destroyer, make it yourself at home with Medico and pocket the difference. Price of Medico, per 5-lb. pkg., \$1.00; by parcel post, \$1.20.

MUSTARD == FOR == POULTRY

French's Poultry Mustard is different from the ordinary table mustard in its manufacture and constituents. The great Corn-ing Egg Farms has used it over two years with excellent results. Can be used at any season, being an excellent tonic; increases egg production, adds to the fertility and keeps the birds in excellent health and condition. It is not in any way injurious, like other condiments. If you want plenty of eggs in the winter and if you want fertile eggs in the spring, try French's Mustard for Poultry.

- 1½-lb. box\$.55; by parcel post \$.70
- 3 -lb. box95; by parcel post 1.10
- 5 -lb. box 1.60; by parcel post 1.75
- 10 -lb. box 3.10; by parcel post 3.35



O. K. Poultry Litter

A perfect scratching material. Superior to straw, alfalfa meal, etc. A deodorizer, absorbent, disinfectant and labor-saving litter. It absorbs all the moisture from droppings. Will last for several months, in your brooder or poultry house. Lice will not live in it, and therefore makes a splendid material for nests, being soft and pliable and keeps out all insects. Try O. K. Poultry Litter once and you will never be without it. Price, 4 lb. 25c; 25 lb. \$1.25; 100 lb. \$4.50, f.o.b. Memphis.

Milkoline

Milkoline is pure condensed Buttermilk medicated and modified; a tonic for poultry and hogs. Administered either in drinking water or wet feeds, at the ratio of one part Milkoline to fifty parts of water. 1 qt. 50c; 1 gal. \$1.50; cannot be mailed.

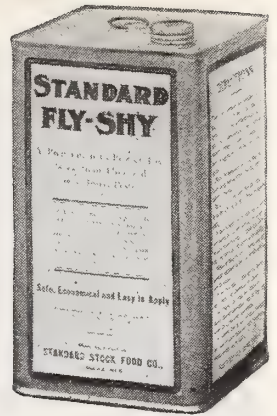
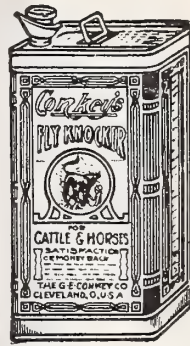

Cooper's Fluid Dip and Disinfectant

Cooper's Fluid Dip and Disinfectant—A perfect sheep and hog dip, cattle wash, etc. Officially approved by the United States Government. It is of higher concentration and goes further than any other dip in dilution, therefore making it cheaper. 1 gallon of Cooper's Dip will make 100 gallons of effective solution. Be sure it is Cooper's, then dip. Price, 4-oz. bot. 25c; qt. can 75c; ½ gal. \$1.25; gal. \$2.00, f.o.b. Memphis.

Cow Ease

Cow Ease—Keeps off flies. Gives cows a chance to feed in peace. Repellant to lice, good for barn or cattle itch. Does not gum the hair; increases the flow of milk; good for spraying hogs. In fact, Cow Ease is one of the best preparations of its kind on the market. Qt. 50c; gal. \$1.50, f.o.b. Memphis.

Bee Brand Insect Powder

The kind that kills the bugs. Harmless to mankind or domestic animals. Bee Brand Insect Powder is the true Persian powder. Absolutely effective and safe. Cans, 25c and 50c; by parcel post, 30c and 55c.

Red Wing Insect Powder



For the destruction of chicken lice, roaches, bed bugs, fleas, ants, cock-roaches, flies, etc. As a matter of fact, it will destroy all leaf-eating insects that infect the garden and house plant. Harmless to man and all animals. Red Wing Insect Powder is put up in two sizes: 10-cent size, 25-cent size, each, postpaid.

Sterlingworth Roach Killer

Fatal to roaches and at the same time non-poisonous to human beings or animals. Easy and safe to use. ¼ lb. patent bellows box 25c; by parcel post 30c; 1 lb. box 80c; 5 lb. box \$3.50.

Sterlingworth Ant Driver

Sure death and preventative of these little pests. 1 lb. 25c; by mail 35c.

Sterlingworth Bed Bug Killer

Non-poisonous to man, but sure death to bed bugs. A splendid preparation. Box, 25c; parcel post, 35c.

Sterlingworth Flea Powder

Does away with washing dogs or cats for fleas. Box, 25c; parcel post, 35c.

Fly Knocker, Conkey's—Keeps flies off cattle, etc., in the summer time. Applied with sprayer or sponge. Price, qt. 50c; ½ gal. 85c; gal. \$1.50, f.o.b. Memphis.

Standard Fly Shy—Absolutely one of the very best fly chasers on the market. Lasts longer, therefore, more effective. It can be used as a deodorizer and disinfectant. Price, qt. 50c; ½ gal. 85c; 1 gal. \$1.50, f.o.b. Memphis.



Red Star Disinfectant

Will positively kill all kinds of bugs, insects, their nits and eggs, such as ants, roaches, mosquitoes, bed bugs, etc. It will not injure furniture or the most delicate fabric. It is perfectly safe to use in every way, and the most effective article of its kind. Pt. 40c; qt. 75, f.o.b. Memphis. Not mailable.



CARBOLA

A PAINT THAT DISINFECTS, or
A DISINFECTANT THAT PAINTS.

Carbola is a snow-white paint, in powder form, combined with a germicide, or disinfectant, that is many times stronger than pure carbolic acid. It is neither poisonous nor caustic. Carbola kills lice, mites, fly eggs, etc., and helps prevent the germs of contagious diseases that effect poultry and livestock from getting a start and spreading through flocks and herds. It will not harm the smallest chick or stock that licks a treated surface. Carbola is ready to use as soon as it is mixed with cold water—no straining or waiting—and can be applied to wood, brick, stone or cement surfaces or over whitewash, with a brush or spray pump. One gallon covers about 200 square feet. It will not blister, flake or peel off. It has no disagreeable odor to taint milk or other food products. It does not spoil by standing, so can be kept on hand ready to use for a rainy day job. The dry Carbola powder is unexcelled as a lice powder. Price, trial package, 25c; 10 lb. pkg. \$1.00; 50 lb. bag \$4.00. By parcel post, trial pkg. 40c; 10 lb. pkg. \$1.30, not past 3rd zone.

POULTRY DRINKING FOUNTAINS



Moe's Sanitary Top-Fill Fountain

Moe's Sanitary Poultry Drinking Fountain

Fills from the top. Dead air space keeps water cool in summer and from freezing in winter. Now made with square pan, which does away with spilling when hung up. Can be used for two pens at the same time. Manufactured in 3 sizes.

No. 1, 1-gallon capacity\$2.00
No. 2, 2-gallon capacity 2.75
No. 4, 4-gallon capacity 3.50

By parcel post, 25c each extra.

Moe's Heater For Top-Fill Fountains

Makes our top-fill fountains absolutely non-freezing, no matter what the weather. Simple and safe to operate; 3 sizes.

To fit our No. 1 Fountain\$1.00
To fit our No. 2 Fountain 1.25
To fit our No. 4 Fountain 1.50

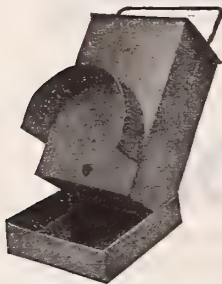

Square Drop-Bottom Fountain



Wall or Hub Fountain

Wall or Hub Fountain

A galvanized iron hood projects over the water trough and protects the water from becoming soiled. These fountains are equally serviceable for young chickens or adult fowls, and are especially useful for pigeons.

Price, 1-quart\$.60; by parcel post \$.75
Price, 1-gallon 1.00; by parcel post 1.15
Price, 2-gallon 1.25; by parcel post 1.40

Square Drop Bottom Drinking Fountain

The bottom can be swung open with one hand, as it is secured by one spring in the front. Price, 2 qts. 75c; 1 gal. \$1.00. By parcel post, 2 qts. 90c; 1 gal. \$1.15.

Two-Piece Galvanized Iron Drinking Fountain

Made of heavy galvanized iron, all seams being carefully turned and soldered. Easily cleaned. Price, 1 qt. 35c; 2 qt. 45c; 3½ qt. 95c; 6 qt. \$1.25. By parcel post, 1 qt. 45c; 2 qt. 55c; 3½ qt. \$1.05; 6 qt. \$1.50.

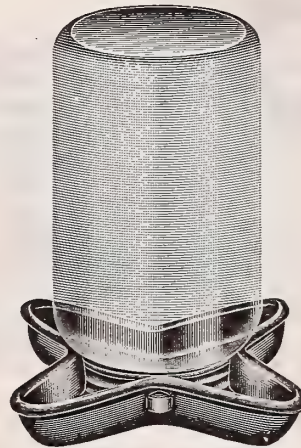

Star Fountain Holder

Star Jar Fountain and Feeder

No parts to some unsoldered. Leaking impossible. Will fit pint, quart or half-gallon Mason jar. Convenient, cheap and sanitary. One size only. No. 32, each 20c; 6 for \$1.00. By parcel post, each 25c; 6 for \$1.15.

All Right Fountain Holder

Can be used with any size bottle, or with pint, quart, or two-quart glass jar. Each 15c; 2 for 25c; bottle not included. By parcel post, each 20c; 2 for 40c.

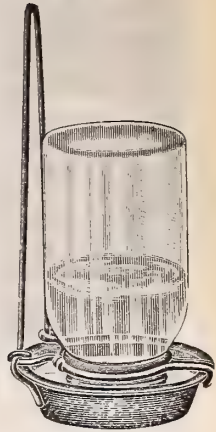

All Right Fountain Holder

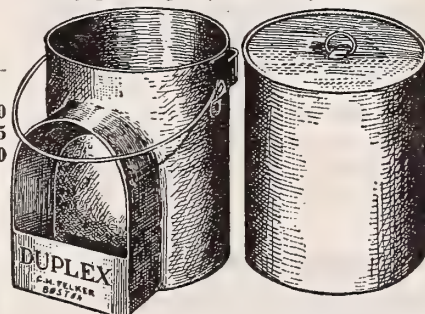

The Duplex Fountain



Stoneware Jug-Shape Fountain

The Duplex Fountain

The latest and most practical sanitary fountain on the market. This is a double fount, keeps the water clean and pure. Easy to fill, easy to care for. Made in two sizes. Try a Duplex. 4 qt. \$1.50; 8 qt. \$2.00. By parcel post, 4 qt. \$1.75; 8 qt. \$2.50.

Stoneware Jug-Shaped Poultry Fountain

It is made in two parts, the saucer being separated from the upper portion, so it can be easily separated and thoroughly cleaned. You will not miss it if you include the Sanitary Fount in your order of Poultry Supplies. ½ gal. 40c; 1 gal. 60c; 2 gal. 85c; f.o.b. Memphis. Cannot be mailed.



Two-Piece Galvanized Iron Drinking Fountain



POULTRY DRINKING FOUNTAINS



Schwill's Fountain Holder, Ready to Fill

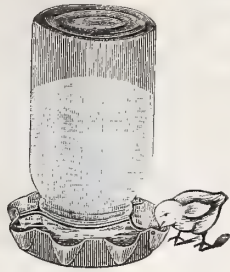

Schwill's Fountain Holder Filled, Ready for Use

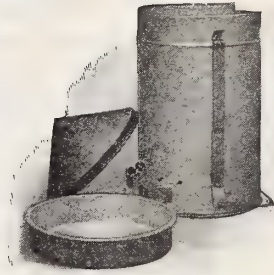

Improved O. K. Sanitary Fountain

Schwill's Fountain Holder

It is easy to fill and operate. Just lift trigger as shown above, fill jar with water, snap on pan and reverse as above, and you have a fountain that affords water to many chicks at the same time, while there is no danger of wet feet or from drowning. Fits any Mason jar. Each 20c; by parcel post 25c.

Improved O. K. Sanitary Fountain

In the Improved O. K. Poultry Fountain we have combined all the best features of other fountains with the new and important feature of the double wall with dead air space. In the old style double wall fountains, the two cylinders are entirely separate so that the water rises between them to the same height that it stands in the fountain; and as water is one of the best conductors of heat, the two walls are no better than one so long as there is water between them. In our improved O. K. Fountains the two cylinders are connected and sealed water-tight, making a dead air space of 1/4-inch between them. This construction is similar to the thermos bottle, and gives the very best protection from both heat and cold. This fountain therefore keeps the water cool and fresh in summer, and prevents freezing for a considerable time in winter. Fowls, like people, prefer a hot drink on a cold morning, and so in severe weather we fill the O. K. Fountains with hot water, and they never freeze up on us if emptied at night. No. 2, holds 2 gals., \$2.75.



Lathrop Chick Server



Atsatt Chick Fountain

Atsatt's Sanitary Chick Fountain

The Atsatt, specially illustrated above, is one that every poultryman needs. It is designed for chicks in brooders or in the open. The bottom snaps on but is easily removable. All danger of drowning is eliminated and the fountain cannot be tipped over like the kind commonly used, consisting of a can in a dish. A very small amount of water is exposed at one time, but there are four different places, or corners, for the chicks to drink. This fountain is sanitary in every respect and is a preventative of disease. The chicks cannot contaminate the water in the pan, and that in the reservoir is protected from dirt, dust, etc. 1 qt. 40c; by parcel post, 50c.

Lathrop Sanitary Chick Server

For supplying water and feed to little chicks. Nothing better made. Each 30c; 5, \$1.30. By parcel post, each 40c; 5, \$1.60.

Iron Poultry Drinking Trough

An indispensable article in the poultry yard; heavy, does not turn over; readily cleaned. Each, No. 1, 7 1/2 ins. long, 25c; No. 5, 19 ins. long, 50c. By parcel post, No. 1, 45c; No. 5, 80c.

Victor Automatic Fountain

Made to attach to any wooden tub or barrel; works automatic, as the fowls or stock empty the pan it fills itself and shuts off when pan is full. Very durable, being made of cast iron. Price, each \$1.00. By parcel post, \$1.25.

Oakes' Chick Fountain

This is a small fountain shaped similar to the Improved Nesco. Price, 1 pt. 20c; 2 pt. 30c. By parcel post, 1 pt. 35c; 2 pt. 40c.

Successful Non-Freezing Fountain

Galvanized iron; durable and convenient. Price, Fountain, Lamp Base and Lamp, 2 gal. each \$2.25. By parcel post, \$2.60.



Weldon Non-Freezing Fountain

Weldon Non-Freezing Poultry Fountain

With this fountain you pour in hot water and it stays hot; pour in cold and it stays cold. It has been proved beyond a question that cold water in summer acts as a tonic, the fowls keep busy and the egg box is full. Warm water in summer enervates the fowl just as well as the intensely hot days make a man listless and not inclined to work. The hot water in winter seems to act as an invigorator, and keeps the fowls warm. This means a great deal to you when food is at the highest notch and eggs bringing 50c a dozen. Price, 2 gal. size, each \$4.00.

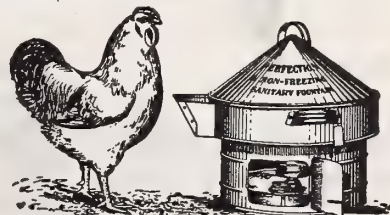

Perfection Non-Freezing Fountain

Perfection Non-Freezing Fountain

Easy to fill and clean. The heater keeps the water from freezing by the use of a small lamp that is perfectly safe and requires but very little oil. Fountain with heater and lamp, complete, 2 gal. size \$3.00. By parcel post, \$3.50.

FEEDERS, HOPPERS AND GRIT BOXES



The Apaco Poultry Hopper

The Apaco Poultry Hopper

Here we have an automatic feeder at a reasonable price, only \$1.75. Think of it; now every one can afford one of these splendid devices. Constructed to fill a long-felt want for a good feeder at a small price. The Apaco Feeder will save work and worry; insures proper feeding, increases egg production, decreases feed bills, scatters the feed thoroughly; it wont clog. Made in one size only, 12-qt. capacity, \$1.75. By parcel post, \$2.00.

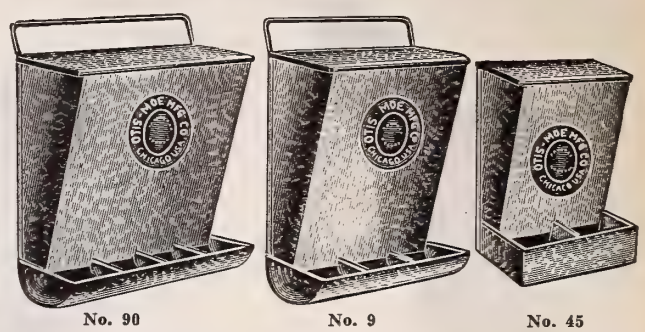

No. 90 No. 9 No. 45

Grit and Shell Boxes

Grit, shell and charcoal have now become a recognized essential part of the diet, insuring healthy fowls, and it cannot be more economically supplied than in one of these triple compartment boxes.

No. 45, 2 Compartments, for chicks \$.50; by parcel post \$.60
 No. 9, 3 Compartments, for hens.. 1.20; by parcel post 1.40
 No. 90, 4 Compartments 1.50; by parcel post 1.75

Ideal Dry Mash Feeder

We guarantee these feeders not to clog, also that the fowls cannot waste the Dry Mash, and are rat proof if our directions are followed. The screen shown in the above cut rests on the top of the Dry Mash and as the fowls eat the mash the screen settles. This screen is to keep the fowls from "hooking" the Dry Mash out over the sides of the hopper, and also to keep them from eating the Dry Mash too fast; 15 or 20 fowls can eat out of this hopper at the same time. Price, 12 qt. \$1.50. By parcel post, \$1.75.

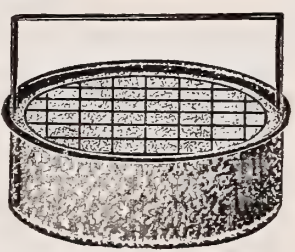

Ideal Dry Mash Feeder



Moe's Round Baby Chick Feeder

Moe's Round Baby Chick Feeder

The most convenient and commodious feeder on the market. Can also be used for water. Manufactured in two sizes.
 No. 11, Small size \$.25; by parcel post \$.35
 No. 12, Large size30; by parcel post .40



Norwich Exerciser and Feeder

Improved Norwich Automatic Exerciser and Feeder

The new style has adjustable legs adapted for feeding large poultry or baby chicks. Fill the hopper with any dry grain feed, or any mixture of dry grain feed, and the revolving feed bar with wheat or cracked corn. Stand the Norwich Automatic Exerciser and Feeder anywhere in the yard, pen or house, and put any kind of litter under machine. Adjust valve to feed desired quantity.
 No. 1, 8 qt., each \$3.25; No. 2, 14 qt., each \$4.25; 20 qt. \$5.25. All f.o.b. Memphis.

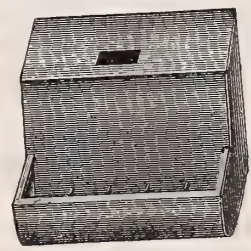

Front View Handy Hopper

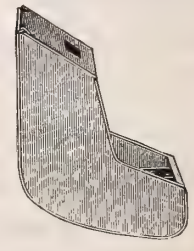

Side View Handy Hopper

The Handy Dry Mash Hopper

The Handy Hopper is made considerably wider at the bottom than at the top, so that it is impossible for any sort of dry mash to clog in it. Feed put in this hopper cannot be wasted for the trough is deep, has a wide flange all around it, and solid partitions, making it impossible for the fowls to pile up the feed and throw it out with their bills. We consider this one of the best hoppers made, and it is suitable for any kind of dry mash. The cuts do not show any lid over the trough; but we make them with a rat proof and dust proof lid over both hopper and trough.

No. 1, Handy Hopper, 9 ins. long,
 one compartment \$1.50; by parcel post \$1.75
 No. 2, Handy Hopper, 15 ins. long,
 one compartment 2.25; by parcel post 2.50

Round Pigeon and Chick Hoppers

Made of galvanized steel and the galvanized wire grating is adjustable, up and down, to regulate the feed, which is automatic.

A neat, practical, and durable hopper. Height, 13 1/2 inches; diameter of hopper, 7 1/2 inches; diameter of pan, 10 1/2 inches. Price, each \$2.25; by parcel post, \$2.60.



Pigeon and Chick Hopper

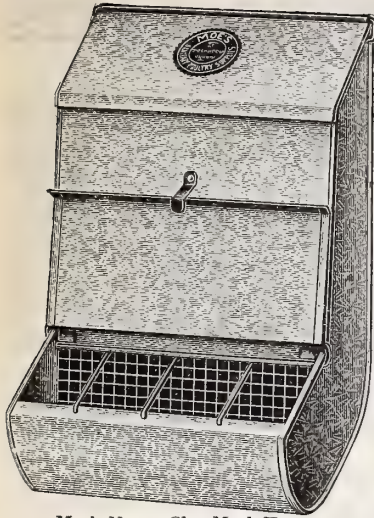

Moe's Never-Clog Mash Hopper

Moe's Never-Clog Mash Hopper

This is the best mash feeder ever put on the market and does away with all trouble of feed clogging, no matter how coarse. It is made with netting so the poultry can see the food and has cover that can be lowered at any time and is made in three sizes.

- No. 35, 12-quart capacity \$1.50; by parcel post \$1.75
- No. 36, 18-quart capacity 2.00; by parcel post 2.25
- No. 37, 36-quart capacity 2.60; by parcel post 2.90

The Boston Dry Feed Hopper—Rat Proof

These hoppers are absolutely automatic and positive in their action. They cannot clog; they do not waste. They are made of galvanized iron with swinging grid (mesh) and hold from ½-peck to ½-bushel, respectively, and will last a lifetime.

- Short Chicken Hopper**—Small, for small brooders. Each \$1.00; by parcel post, \$1.20.
- Long Chicken Hopper**—Holds 1 peck. Excellent for small chicks. Each \$1.50; by parcel post, \$1.75.
- Large Hopper**—Holds 16 quarts, for dry mash feed for hens. Each \$1.50; by parcel post, \$1.80.

Oakes' Chick Grit and Shell Box

Growing chicks should have grit, oyster shell and charcoal always before them; and for this purpose our Chick Grit and Shell Box is indispensable. It is made of galvanized steel with three compartments. Height, 7½ ins., width, 6 ins.; depth (front to back), 4 ins. at bottom, and 2 ins. at top. Price, chick size, 40c; by parcel post, 50c. Large size, for grown fowls, 80c; by parcel post, 95c.

Wooden Feeding Troughs

Long and convenient. A handy arrangement for feeding all kinds of mash or grain. Two sizes, 20c and 30c each. By parcel post 30c and 40c each.

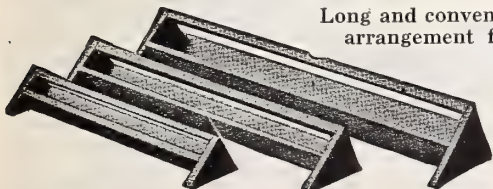

Mann's Swinging Feed Tray for Poultry

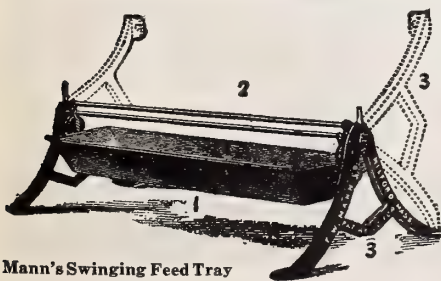

Mann's Swinging Feed Tray

Saves all waste of food. Hens cannot scratch the food out or the dirt in. 18-in. trays \$1.00; 27-in. trays \$1.25; 36-in. trays \$1.50. By parcel post 25c each extra.



Oakes' Chick Grit Box

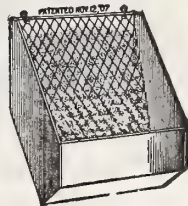

Large Boston Hopper



Oakes' 10-inch Feed Trough



Oakes' 20-inch Feed Trough

Oakes' Feed Trough

Over the trough is a gable-shaped grate which prevents the chicks from getting into it and wasting or fouling the feed. This grating is a separate piece and slides on and off easily. It is stamped into shape with dies, and is ribbed as shown in the cut, making it strong and substantial. Made in two sizes—10-inch and 20-inch.

- 10-inch Trough with Grate \$.40; by parcel post \$.50
- 20-inch Trough with Grate60; by parcel post .75



Feed Pan

Size, 2¾ inches deep, 6 inches wide, 18 inches long. A flat pan made of heavy galvanized iron. Price, 40c; by parcel post, 50c.



Atsatt Wall Feed Pan

For feeds, grit, shell, bone, charcoal, water, etc. Hangs on two nails. Easy to clean. Saves waste. Always out of the way. Wet or dry feeds. Chicks cannot roost on it. Hangs high or low. Made of galvanized iron; 23 inches long, holds three quarts. Practical and cheap. Each 60c; by parcel post, 70c.



Atsatt Chick Feeder

"They cannot get into it." Therefore, clean food. The top removes easily for cleaning. Springs back into place. Can be used for either wet or dry feed or for water. Cannot rust. Made for any brooder, but does not take up much space. Size, 10 inches long, 4 inches wide. Just the thing for your brooder. Each 40c; by parcel post, 50c.



Atsatt Galvanized Poultry Feeder

Made with hinged guard to keep fowls from wasting the feed; can be used for mash or any dry grain feed. The tapering guard keeps birds from roosting or setting on top of the feeder. The pan is 18 inches long, 6 inches wide and 3 inches deep, and holds 4 quarts. It is well made, strong and durable. Price, each 90c; by parcel post, \$1.15.

BUTTER, EGG AND CHICK SHIPPING BOXES

Crosby's Parcel Post Egg Carrier

Made of galvanized steel with patent lock top, which is operated by simply pressing a button and turning the handle. Case is lined with double corrugated paper; egg cells made of same material, making an egg carrier which is practically breakproof.

6 doz. size, wt. 6 lbs. . . . \$3.00; par. post, not past 3rd zone, \$3.20
9 doz. size, wt. 8 lbs. . . . 3.50; par. post, not past 3rd zone, 3.70

12 doz. size, wt. 10 lbs. . . . \$3.75; par. post, not past 3rd zone, \$4.00
15 doz. size, wt. 13 lbs. . . . 4.00; par. post, not past 3rd zone, 4.30

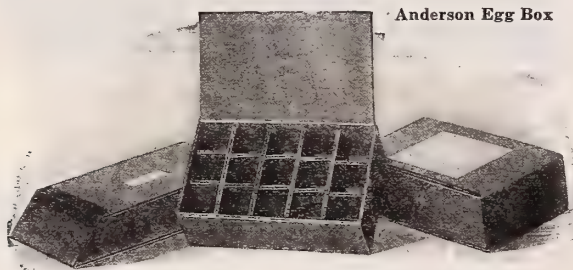

Anderson Egg Box

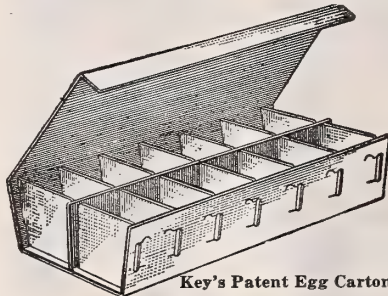

Key's Patent Egg Carton

Key's Patent Egg Carton

A moderate price box. It is well made, compact, strong and safe, the outside being made of one piece heavy cardboard, therefore holds its shape and holds the eggs firmly. Dozen 25c; 100 \$1.50, f.o.b. Memphis.

Anderson Parcel Post Egg Boxes

Similar to the Eyrie, made without a handle, shipped in flat, saving freight or express charges. For hatching eggs.

Not past 3rd zone

15-egg size \$.25; 12 for \$2.50. By par. post \$.30; 12 for \$2.75
30-egg size .40; 12 for 3.25. By par. post .50; 12 for 3.60
50-egg size .50; 6 for 2.50. By par. post .60; 6 for 2.80
100-egg size .85; 6 for 4.00. By par. post 1.00; 6 for 4.50

Anderson Box for Commercial Eggs

Anderson Boxes for shipping commercial eggs by parcel post or express.

Not past 3rd zone

12-egg size \$.20; 12 for \$1.75. By par. post \$.25; 12 for \$1.90
24-egg size .25; 12 for 2.25. By par. post .30; 12 for 2.50
36-egg size .35; 12 for 2.75. By par. post .45; 12 for 3.05
48-egg size .40; 12 for 3.50. By par. post .50; 12 for 3.90
60-egg size .45; 12 for 4.25. By par. post .55; 12 for 4.75
72-egg size .50; 12 for 4.65. By par. post .60; 12 for 5.25
120-egg size .75; 12 for 7.50. By par. post .90; 12 for 8.20



Self-Locking Carton

Self-Locking Quality Egg Carton

For delivering eggs to customers. Cannot be used for shipping. Shaped long, two rows, holding six eggs each; strong, well locked. Price, doz. 25c; 100 \$1.75, f.o.b. Memphis.

Live Chick Shipping Box

How have you been shipping your little chicks? Why not use an up-to-date box, made especially for them? For shipment is folded flat, but can be easily set up and made ready for use.

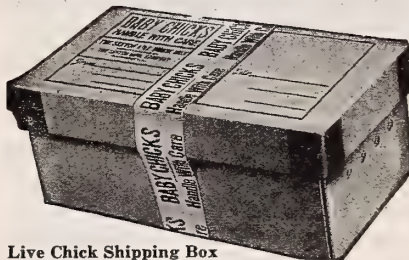

Live Chick Shipping Box

Not past 3rd zone

25-Chick size, each \$.30; by parcel post \$.45
50-Chick size, each45; by parcel post .60
100-Chick size, each75; by parcel post .90

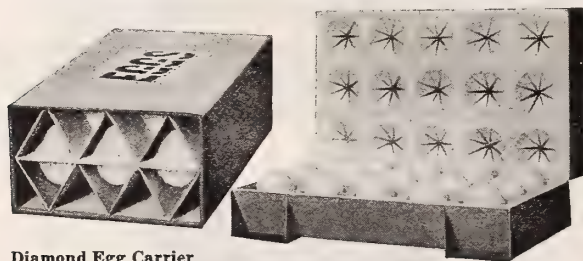

Diamond Egg Carrier

Diamond Egg Carrier

Something new, in a class by itself; box has cushions on all sides, impossible to break eggs. This is the strongest and safest egg shipping box on the market.

15-egg size \$.40; 12 for \$3.25. By parcel post, each \$.50
30-egg size .50; 12 for 5.00. By parcel post, each60
50-egg size .75; 12 for 8.00. By parcel post, each85
100-egg size 1.50; 12 for 15.50. By parcel post, each 1.65
12-egg size .30; 12 for 3.00. By parcel post, each40
24-egg size .45; 12 for 4.50. By parcel post, each55
48-egg size .70; 12 for 7.00. By parcel post, each85
60-egg size .90; 12 for 9.00. By parcel post, each 1.05

The Eyrie Egg Shipping Box

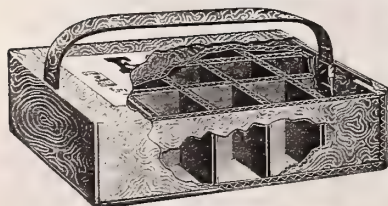

Eyrie Egg Shipping Box

For shipping settings of eggs by express only. Made from jute board and partitioned off with double-faced corrugated paper.

15-egg size \$.30; 12, \$2.75
par. post \$.40; 12, \$3.00
30-egg size \$.45; 12, \$4.00
par. post \$.55; 12, \$4.50
Not past 3rd zone

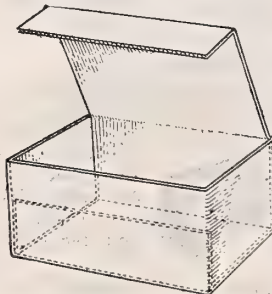

Butter Boxes for Parcel Post

Butter Boxes for Parcel Post

This two-piece corrugated box is designed to hold 2, 3, 5, 10 lbs. of butter when packed in Tuck End Cartons, described below, for shipment in Local Delivery and First Zone. The air cells in the corrugated board assist in preserving a uniform interior temperature, making possible the delivery of the butter in a cool, sweet and sanitary condition. Folds flat for shipment.

2-lb., each \$.10; doz. \$1.00. By parcel post \$.15; doz. \$1.10
3-lb., each .15; doz. 1.25. By parcel post .20; doz. 1.40
5-lb., each .20; doz. 1.50. By parcel post .25; doz. 1.70
10-lb., each .25; doz. 2.00. By parcel post .35; doz. 2.25

Tuck End Butter Cartons

(Not corrugated). For 1-lb. Square Prints. For butter, our Tuck End Butter Cartons (to be used in combination with Corrugated Boxes, described above, for parcel post shipping) furnish a sanitary and convenient method of packing. These cartons are made of the finest grade of manila paper, paraffined both sides. Doz. 15c; 100 75c. By parcel post, doz. 20c; 100 90c.



NESTS AND NEST EGGS

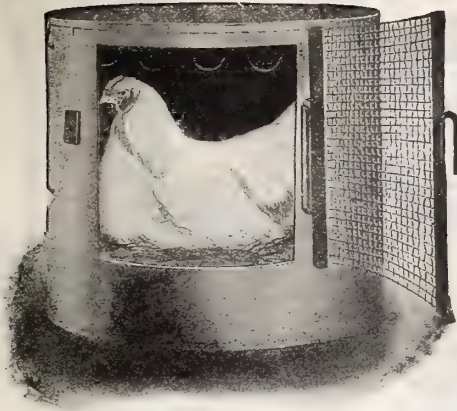

Successful Combination Nest

Successful Combination Metal Nest, Vermin Proof

A hen in this nest will hatch better and stronger chicks than in a wooden nest, from the fact that eggs require moisture to hatch well, and this nest retains the moisture from the hen's body, while the wooden nest absorbs it. Size, 14 inches high; 14 inches wide. Each \$1.75; by parcel post, each \$2.10, not past 3rd zone.

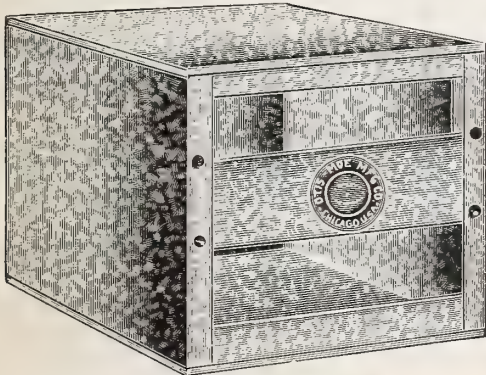

Moe's Never Fail Trap Nest

Moe's Never Fail Trap Nest

As the name implies, it never fails. Every nest set up and ready for use when shipped. Manufactured in two sizes.
 No. 33, 12x12x12 ins., complete, each \$1.50
 No. 34, for larger fowls, 12x12x14½ ins., complete, each . . . 1.90
 By parcel post, No. 33, \$1.75; No. 34, \$2.30, not past 3rd zone.

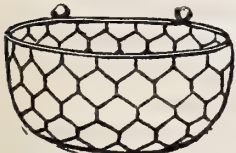

Wire Hen Nest



Pigeon Nest

Wire Hen's Nest

These nests are intended to be fastened with screws or screw hooks—if wanted removable. They afford no place for vermin and allow the air to circulate freely, advantages not obtained when wooden boxes are used. They are intended to be filled with straw, which can be readily removed. Each 20c; doz. \$2. By parcel post, each 35c; 6 for \$1.50, not past 3rd zone.

Clay Pigeon Nests

Made of high grade and valuable clay, terra cotta in color. Diameter 8 inches. Each 15c; 2, 25c; doz. \$1.20; 100, \$9.00, f.o.b. Memphis.

Fibre Ware Pigeon Nests

Made of fibre. Very light and durable. Pigeon fanciers prefer them to any other kind. Each 25c; 6 for \$1.35; 12 for \$2.50. By parcel post, each 30c; 6 for \$1.60.

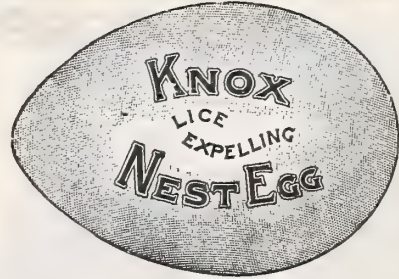

Nest Eggs

Knox Lice Medicated Nest Eggs—These eggs are a perfect imitation of the hen's egg, containing a powerful disinfectant, which keeps all lice, mites, etc., out of nest and off the hens. Each 10c; doz. 75c. By parcel post, each 15c; doz. 95c.

Lime Nest Eggs—Non-breakable. Antiseptic. A perfect shape making it a splendid and lasting accessory. Doz. 35c. By parcel post, doz. 50c.

Porcelain—These are made of first-class glass. They will not break easily and will last a lifetime. Doz. 35c. By parcel post, doz. 50c.

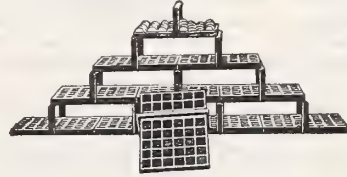

Andrews' Egg Gathering Tray

Andrews' Egg Gathering Tray

Use these trays in gathering eggs. They save loss. Light and easy to handle. Price, each 50c. By parcel post, 70c.

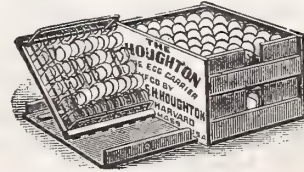

Houghton's Wire Egg Carriers

Houghton's Wire Egg Carriers

No. 1—Holds 6 dozen eggs...each \$1.35. By parcel post \$1.50
 No. 2—Holds 9 dozen eggs...each 1.50. By parcel post 1.75
 No. 3—Holds 15 dozen eggs...each 2.00. By parcel post 2.75

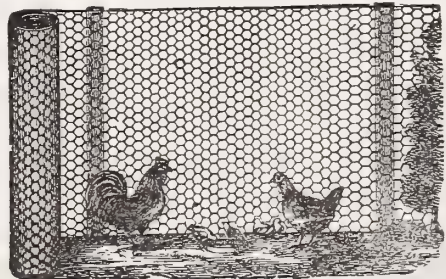

Galvanized Wire Poultry Netting

We furnish Poultry Netting in large and small meshes; 150 feet in a roll. We do not break rolls or sell less than original package. The following prices are f.o.b. Memphis:

Height. 2-inch Mesh	Height. 1-inch Mesh
2 ft., per roll, 150 ft. . . . \$4.75	1½ ft., per roll, 150 ft. . . \$4.50
3 ft., per roll, 150 ft. . . . 6.25	2 ft., per roll, 150 ft. . . 5.50
4 ft., per roll, 150 ft. . . . 8.50	3 ft., per roll, 150 ft. . . 7.50
5 ft., per roll, 150 ft. . . . 10.50	
6 ft., per roll, 150 ft. . . . 12.50	

GRINDING MILLS, OAT SPROUTERS AND COOPS

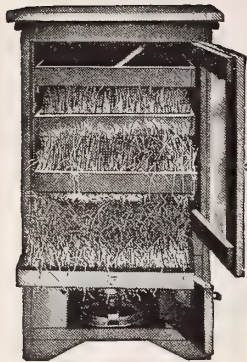

Successful Grain Sprouter

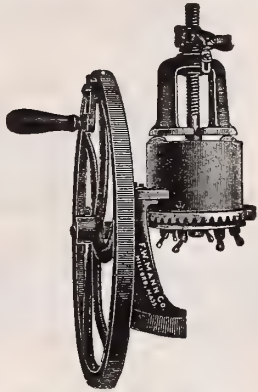

Mann's No. 5 Green Bone Cutter

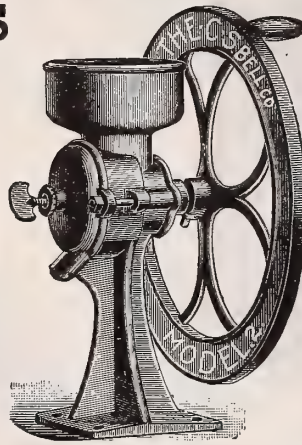

Model Mill



Banner Root Cutter

Banner Root Cutter No. 7

Exclusively for poultry. It cuts fast and is easy running. Leaves the feed in fine, brittle, ribbon-like strips that make choking impossible. Fowls, large or small, can safely eat the feed. The knives are adjustable and made of the very best of steel. An iron grate in bottom of hopper lets dirt and gravel escape before reaching the knives. In this cutter we offer the poultrymen a low-priced, high-grade, nicely-finished and mechanically constructed machine, and feel that anyone who desires to feed Roots and Vegetables to their flocks can well afford to own one. Two to five minutes will cut enough feed for a large flock of birds. Price, \$5.50, f.o.b. Memphis.

Model Grinding Mill

One of the best all-round mills yet produced. They are designed for grinding wheat, making graham flour and corn meal for family use. Grinds feed, either fine or coarse, for chickens; also shells, roots, salt, charcoal, etc. Capacity about as follows, depending on the condition of grain and fineness: No. 1, 1/2 to 1 bushel per hour; No. 2, 3/4 to 1 1/2 bushels per hour; No. 3, 1 to 2 bushels per hour.

Prices and Sizes.

- No. 1—Height, 13 ins., weight, 20 lbs., price \$3.75
- No. 2—Height, 16 ins., weight, 35 lbs., price 7.00
- No. 3—Height, 18 1/2 ins., weight, 63 lbs., price 9.00

Mann's Green Bone Cutters

No. 5 B. M.—Intended for flocks of 15 to 25 hens. Can be used for flocks of 100 hens, but larger size is more economical in the end for such a large flock. Mounted on iron stand, no expense to set it up. Place for pan to catch the bone. Patented automatic governing spring feed. Cylinder, 6 inches diameter, 4 inches deep. Cutter plate has 4 knives instead of 3. Will cut faster and easier than other types costing twice as much. Price, \$17.00, f.o.b. Memphis.

No. 5 B.—This machine is exactly the same as the No. 5 B. M., except that it has not the iron stand. The capacity is the same. Price, \$13.00, f.o.b. Memphis.

No. 7, New Model—Intended for flocks of 40 to 100 hens. Can be profitably used for 200 hens or more, but we recommend No. 9 for flocks of more than 100. Mounted on strong iron stand with large table for box or pan to receive cut bone. Patented New Model automatic governing spring feed. Large open-hinged cylinder, giving instant access to all working parts. Six special knives; gear guard; anti-clog device; heavy balance wheel, with adjustable handle, besides all the best features of our old style machines. Price, \$19.50, f.o.b. Memphis.

No. 7 1/2, Semi-Power—A combination hand or power Bone Cutter. Adapted to run either way without changing any part. It is always ready for use. Intended to meet the demand for a small power cutter. Cylinder the same size as No. 7. Capacity, 50 to 100 pounds per hour. The No. 7 1/2 has all the latest improvements, special feed, anti-clog, open cylinder, tight and loose pulley, etc. Horse power required, 1/2 to 1. Price, \$27.00, f.o.b. Memphis.

Successful Grain Sprouter

Made in sections, double galvanized steel wall construction, will sprout oats, barley, etc., safely and quickly. Prices as follows:
 No. 1—Base and 1 section, 2 trays, cap. 30 to 60 hens, \$10.50
 No. 2—Base and 2 sections, 4 trays, cap. 75 to 100 hens, 12.50
 No. 3—Base and 3 sections, 6 trays, cap. 130 to 200 hens, 15.00

Black Hawk Corn Sheller

This sheller, although low in price, is guaranteed to do as good work as any sheller on the market. Clamps to barrel or box; adjusts itself to any size ear. Price, \$2.50.

Red Chief Grist Mill

A good strong, reasonable price mill; easily adjusted for grinding coarse or fine. Price, \$2.50 each. By parcel post, \$3.00.

Humphrey's Green Bone Cutter

This is one of the leading bone cutters on the market. Ask for catalogue fully describing Humphrey's Bone Mill. No. 1, hand power Cutter, \$15.00.

Mann's Clover Cutter

This is the best Clover Cutter on the market for the poultry raiser, and is strongly built. Price of Clover Cutter with wheel and stand, \$16.50, f.o.b. Memphis.

The Lawn Park Coop

Gives the chicks sunshine, fresh air, grass and protection from all enemies. This coop is made to telescope, therefore affords chicks roving space, yet they are safe. Has removable bottom, makes cleaning easy; sanitary; keeps out lice and mites, and gives ample ventilation. Size coop, closed 18x24"; when open, with park extended, 18x48". Price, each \$4.00, f.o.b. Memphis.

The Eyrie Shipping Coop

Shipped flat; simple in construction—a child can set them up. Prices, f.o.b. Memphis:
 No. B—12x18x22, holds 3 fowls, each.. \$.75
 No. C—12x22x22, holds 4 fowls, each.. .85
 No. D—20x22x22, holds 5 fowls, each.. 1.10
 No. E—20x24x22, holds 6 fowls, each.. 1.25

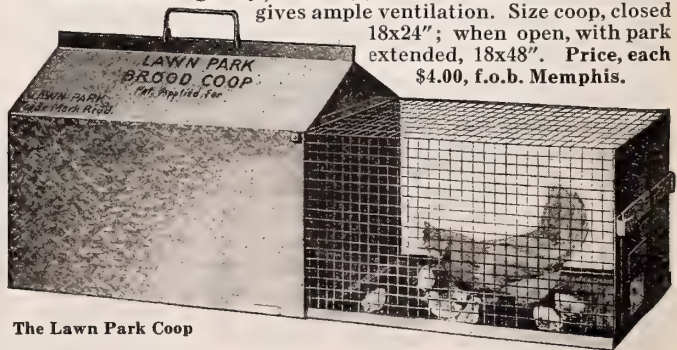

The Lawn Park Coop



MISCELLANEOUS POULTRY REQUISITES

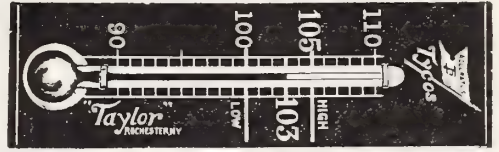

Colored Celluloid Spiral Leg Bands

Incubator Lamp with Chimney

Schwill's 5774 Incubator Thermometer

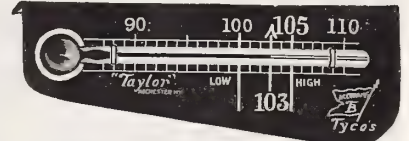
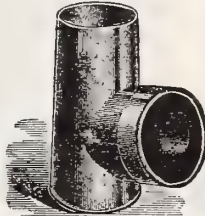

Automatic Chick Greaser

Champion Leg Bands

X-Ray Egg Tester

Schwill's 5770 Incubator Thermometer

Leg Bands

Champion Leg Bands—This aluminum band is made in one piece, adjustable to fit any fowl. Held by double lock; it is impossible for them to lose off. Numbered from 1 to 400. Price, doz. 15c; 25 for 25c; 100 for 75c, parcel post paid.

Colored Spiral Leg Bands—Made in many different colors—red, green, blue, yellow, pink, white, etc. Slip on just like a key ring; no tools required. Will not come off; fowls cannot lose or remove them. Made in all sizes. State for what breed you want the bands. 12 for \$.20; parcel post \$.25 50 for \$.60; parcel post \$.65 25 for .35; parcel post .40 100 for 1.00; parcel post 1.10

Smith Sealed Leg Bands—Doz. 25c; 25, 40c; 100, \$1.50, parcel post paid.

Smith Sealers—Made especially for using on Smith Leg Bands. Each 75c, parcel post paid.

Moe's Self-Locking Leg Band—The simplest and most durable metal leg band on the market. Every band its own raised number. Manufactured in sizes for Mediterranean, American and Asiatic birds, also turkeys. 12 bands, any size, 15c; 100, \$1.00, parcel post paid. In ordering, be sure to state for what breed you want bands.

Burrill Pigeon Bands

This band, for pigeons, is made in twelve colors, each color having the numbers from 1 to 72. In banding mated pairs, the usual rule of cock on right leg with one number, and his hen on left leg with the same number should be followed.

Prices, Postage Paid

6 Pairs	\$.20
12 Pairs35
25 Pairs70
50 Pairs	1.25

Poultry Punches

Petty Poultry Punch—Cuts clean hole with ease. Price, 25c, parcel post paid.

Schwill's Poultry Punch—A strong, well made, durable punch. Price, each 25c, parcel post paid.

X-Ray Egg Tester

Designed for use on an ordinary hand lamp and fits over any style burner with a diameter approximately that of the tester. Each 35c; by parcel post, 45c.

Magic Egg Tester

Designed especially to show before incubation which eggs will give to the germ the greatest strength and most complete nourishment, so that eggs having weak germs may be rejected. Get a Magic Tester in time, so as to be able to tell when hens lay fertile or infertile eggs. Complete circulars on request. Price, each \$2.00, parcel post paid.

No. 5792 Thermometer

Incubator and Brooder Thermometers

	Each.	Par.	Po.
Buckeye Incubator Thermometer	\$1.00		\$1.10
Cycle Hatcher Incubator Thermometer	1.00		1.10
Cyphers Incubator Thermometer	1.00		1.10
Mandy Lee Incubator Thermometer	1.00		1.10
Prairie State Incubator Thermometer	1.00		1.10
Schwill's Tycos Thermometer, No. 5770	1.00		1.10
Schwill's Tycos Therm., No. 5774 (without wire) ..	1.00		1.10
Schwill's Tycos Brooder Thermometer, No. 5792..	.50		.60
Wires for Hanging Thermometers10		.15

Mandy Lee Hygrometer

Registers accurately the percentage of moisture in the egg chamber, and directions that go with it show absolutely what percentage of moisture is needed during each day of incubation and how the desired amount may be maintained, regardless of the humidity of the outer air. Can be used in any incubator. Price of the Mandy Lee Hygrometer, \$2.00 each, parcel post paid. Extra wicks, 10c each, 3 for 25c.

Improved Automatic Chick Greaser

Saves the chicks from vermin. The chicken its own doctor. Will grease 100 chickens in a few minutes. Kills mites, fleas, lice and red bugs. The chicken, while eating out of the pan, rubs against the wick, greasing itself; you don't catch them. Put melted lard in the tank and feed in the pan, set pan in the yard among the chicks and see how quick it works; the chicken and wick come together and the vermin are killed. No. 1 Machine, for 50 chicks, \$1.25. By parcel post, \$1.40.

Buckeye Incubator Extras

Buckeye Inc. Thermometers, each	\$1.00; parcel post \$1.10
Buckeye Inc. Thermom. holders, each15; parcel post .15
Buckeye Inc. Lamp Bowls, each75; parcel post .85
Buckeye Inc. Lamp Burn'rs, each 50c, 75c, 1.00; parcel pos. extra	
Buckeye Inc. Lamp Chimneys, each35; parcel post .45
Buckeye Inc. Ad. Rod & Set Screw, each ..	.30; parcel post .35
Buckeye Egg Testers, each30; parcel post .35

Other parts quoted on request. When ordering lamp bowls always give height and width of the old lamp.

Incubator and Brooder Lamps

	Par.	Po.		Par.	Po.
No. 1 Lamp Bowls	\$.60	\$.75	No. 1 Lamp Burners	\$.50	\$.60
No. 2 Lamp Bowls65	.80	No. 2 Lamp Burners60	.70
No. 3 Lamp Bowls75	.90	No. 3 Lamp Burners75	.85

Lamp Wicks

Cotton Wicks, all sizes, each 5c; dozen, 50c, parcel post paid. Red Felt Wicks, all sizes, each 10c; 3 for 25c, parcel post paid. We also have Extras for Mandy Lee, Cyphers and Cycle Hatcher Incubators in stock. Prices quoted on request.

BUCKEYE INCUBATORS AND BROODERS

We are Authorized Agents for the celebrated Buckeye Incubators. These are hot water machines, well made and easy to operate. The Buckeye Incubator is built up to a standard and not down to a price, and still the price is very reasonable. These machines are sold under an absolute factory guarantee and, with the proper care, should give perfect satisfaction for years. There are more Buckeye Incubators sold today than any other machine, owing to their satisfactory operation, and it is endorsed by many of the Agricultural and Experiment Stations. If you want an Incubator it will pay you to buy a Buckeye.

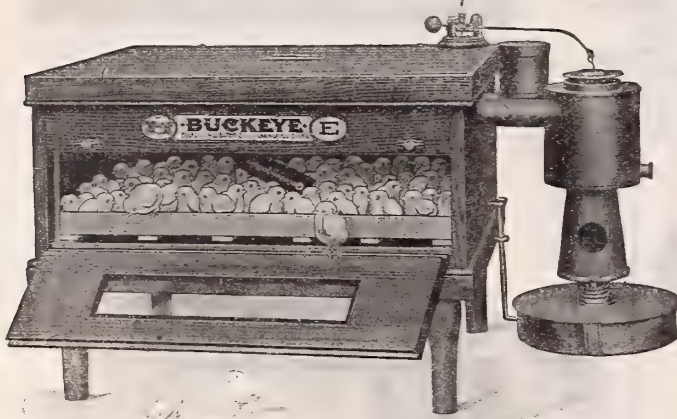

Buckeye No. 14, Style E, 65-Egg Incubator

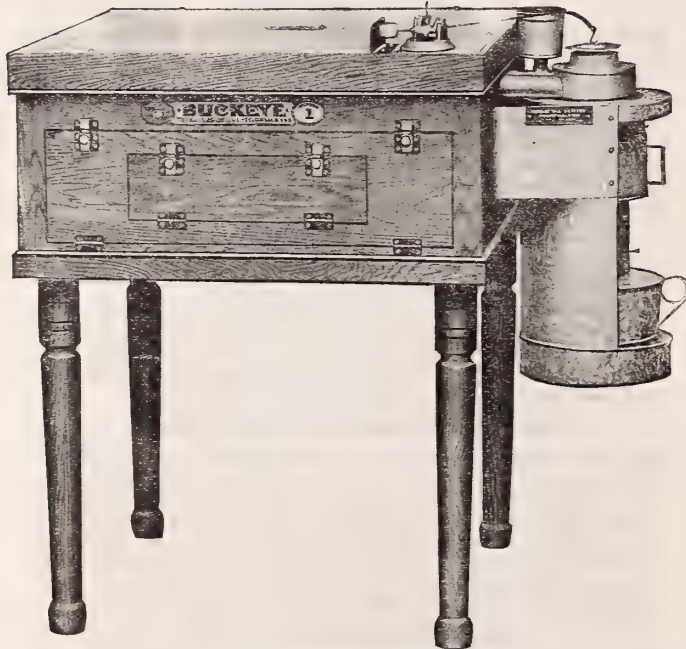

Buckeye No. 1, Standard 120-Egg Incubator

Buckeye Incubators

These machines are made in seven sizes, as follows:

Buckeye No. 14, Style E, 65-egg Incubator, price	\$12.00
Buckeye No. 16, Style E, 120-egg Incubator, price	20.50
Buckeye No. 17, Style E, 210-egg Incubator, price	27.50
Buckeye No. 60, Standard 65-egg Incubator, price	19.50
Buckeye No. 1, Standard 120-egg Incubator, price	27.50
Buckeye No. 2, Standard 175-egg Incubator, price	32.50
Buckeye No. 3, Standard 250-egg Incubator, price	42.50
Buckeye No. 4, Standard 350-egg Incubator, price	52.50
Buckeye No. 5, Standard 600-egg Incubator, price	75.00

Buckeye Portable Brooders

These oil-burning brooders are similar in construction to the Security Portable Brooders. They were especially designed for those who want a good brooder to raise only a few chicks. These brooders are made in three sizes and will accommodate from 60 to 150 chicks, according to size, as follows:

No. 20—19 ins. in diameter, capacity 60 chicks	\$ 8.50
No. 21—22 ins. in diameter, capacity 100 chicks	10.50
No. 22—30 ins. in diameter, capacity 150 chicks	13.50

Buckeye Security Portable Brooder

The greatest oil-burning brooder ever invented. Operates on the same plan as the unmatched Standard Coal Burner. Perfect in ventilation, with free even temperature. Guaranteed to be absolutely free from all gases and odors whatsoever, and to provide a circulation of pure, fresh air every minute in the day or night. It is a combination of security and simplicity. Fully guaranteed. Capacity 100 to 150 chicks, weight 60 lbs. Price, \$15.00.

Buckeye Standard Colony Stove Brooder

The most remarkable coal-burning brooder ever invented. It is self-feeding, self-regulating, simple, safe and everlasting. Cuts the cost of equipment and cost of operation to less than half. Reduces the time and labor to less than a fourth. Simple as a kitchen range. Broods from 100 to 1000 chicks. Write us for special circulars.

No. 18—Capacity 500 chicks, price	\$19.00
No. 19—Capacity 1000 chicks, price	23.50



Buckeye Portable Brooder

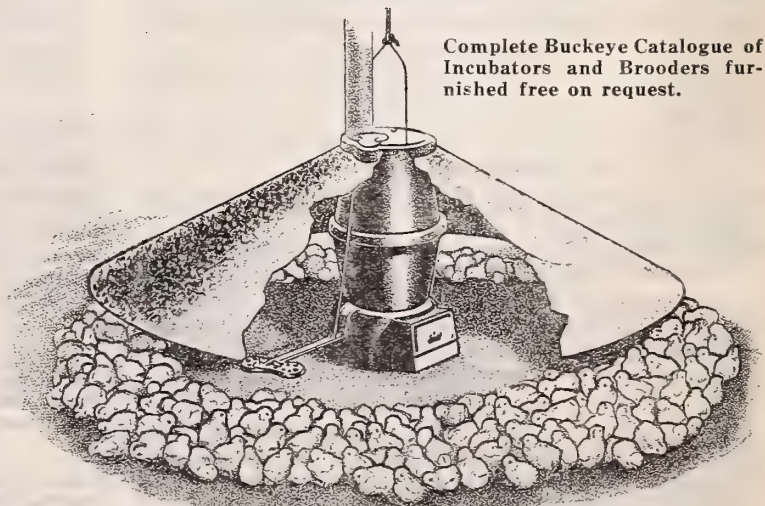

Buckeye Standard Colony Stove Brooder

Complete Buckeye Catalogue of Incubators and Brooders furnished free on request.



PRAIRIE STATE INCUBATORS AND BROODERS



Prairie State Sand Tray Incubator

Prairie State Incubators

The Prairie State Incubators and Brooders have been on the market 39 years. These machines have been constantly improved until today they will hatch a greater number of livable chicks than any other. By "livable" chicks we mean chicks that will live and grow to maturity. No matter how many chicks you hatch, if they don't live it is a dead loss. The Prairie State Incubators copy Nature. Did you ever notice the hen that steals her nest on the ground? That is natural incubation. And she usually hatches every egg, doesn't she? A wet sand tray, covering the entire bottom of the machine in close proximity to the eggs, furnishes the proper amount of moisture and reduces the evaporation from the eggs to the same per cent (9 to 11 per cent) as under a hen. This insures chicks of full vitality—chicks that will live—just like the hen-hatched chicks. Complete Prairie State Catalogue free on request.

- No. 0—Prairie State 100-egg Incubator \$27.00
- No. 1—Prairie State 150-egg Incubator 35.00
- No. 3—Prairie State 240-egg Incubator 50.00

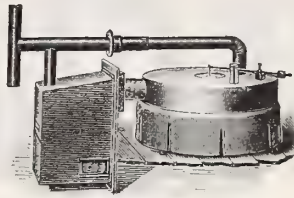

Prairie State Universal Hover

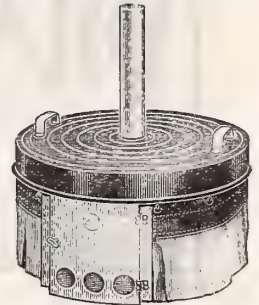

Oakes Economy Hover

The Prairie State Universal Hover

Has completely revolutionized the rearing of chicks. No device ever offered to the poultry raiser has received such endorsement. It may be attached to any form of colony house, shed, coop, piano, dry goods or organ box. It also enables those who wish to build their own brooders to get the best brooding device possible in an economical manner. Complete with Lamp Case and Regulator, \$10.00; no Regulator, \$9.00.

Prairie State Portable Hover

Made of galvanized iron, fireproof, portable, ventilated and easy to heat. Can be used indoors or outdoors; can be easily cleaned, as it sits directly on the floor. Supplied with a powerful wafel regulator which controls the temperature. This is the latest brooding device put out by the Prairie Incubator Co. Price, complete, Small Hover, \$11.00; Large Hover, \$18.00.

Prairie State Colony Outdoor Brooders

The proper device for rearing is just as necessary as a good machine for hatching. For outdoor use, the Combination Colony House Brooders have no equal. Zero Weather has no ill effects and you can rest assured that your chicks are safe and comfortable either with a rain, hail or snow storm raging outdoors. Large and convenient, they are all one could desire; the sanitary conditions are easily maintained because of the plan of construction.

- Prairie State Colony Brooder No. 2 \$27.50
- Prairie State Colony Brooder No. 3 22.00



Economy Incubator

Oake's Economy Incubator

This is a light and compact incubator that holds fifty eggs and hatches good, strong chicks. Sold at a price most any one can afford, and the very machine for one who wants to hatch a few chicks at a time. Price, \$7.50; by parcel post, not past the third zone, \$8.00.

Oake's Economy Brooder Hover

All galvanized steel, light, strong and durable. Can be used anywhere, as it stands on level floor, in a box or brooder house. The very brooder to use with the above incubator. Price, \$6.00; by parcel post, not past the third zone, \$6.50.

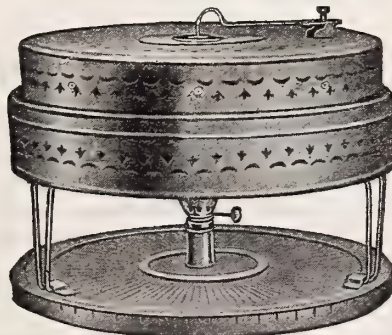

Cycle Hatcher



Cycle Hatcher Incubator Brooder Combined

Cycle Hatchers or Metal Mother Incubators

The Cycle Hatcher is designed to take the place of the hen and the large, clumsy incubators, and to carry out the development of the embryo chick in the egg to a living, healthy bird by a device approaching nearer to the stage of perfection in construction, operation and control of the moisture than anything on the market to date. 50-egg Cycle Incubator each \$7.50 f.o.b. Memphis. Cycle Brooder Hatchers, each \$10.00, f.o.b. Memphis. By parcel post, not past 3rd zone, 60c each extra.



Alfalfa—By F. D. Coburn	\$.50	Peach Culture—J. Alexander Fulton	\$1.50
Asparagus Culture—By F. M. Hexemer50	Play and Profit In My Garden—E. P. Roe	1.50
Bean Culture—By G. C. Sevey50	Practical Floriculture—Henderson	1.50
Broom Corn and Brooms50	Soiling Crops and Silos—Shaw	1.50
Barn Plans and Outbuildings	1.00	Soils and Crops—T. F. Hunt	1.50
Celery Culture50	Spraying of Plants50
Clovers and How to Grow Them—Shaw	1.00	Study of Corn50
Farm Drainage—French	1.00	Tomato Culture—W. W. Tracy50
Feeding Farm Animals	2.00	The Peanut Plant, Its Cultivation and Uses50
Fertilizers, Rural Science Series	1.50	The Principles of Fruit Growing—L. H. Bailey	2.00
Gardening For Profit—Henderson	1.50	Truck Farming at the South—A. Oemler	1.00
Insects and Insecticides—C. M. Reed	1.50	The Young Farmer, Things He Should Know—Hunt	1.50
Mushrooms, How to Grow Them	1.00	The Home Vegetable Garden	1.00
Onion Culture, New—T. Greiner50	Vegetable Gardening—By R. L. Watts	1.75
Potato, The—Samuel Fraser75		

BOOKS FOR THE POULTRYMAN

American Standard of Perfection	\$2.00	Reliable Poultry Remedies	\$.25
Artificial Incubating and Brooding50	Successful Poultry Keeping	1.00
All About Broilers50	Turkeys, Their Care and Management75
The Chick Book50	Rabbit Culture and Standard50
Ducks and Geese75	A to Z of Pigeons and Bantams50
Eggs and Egg Farms50	Pigeon Diseases50
Poultry Houses and Fixtures75	Poultry Diseases75

BOOKS FOR THE BEE KEEPER

Bee Primer, For the Prospective Bee Keeper	\$.15	ABC and XYZ of Bee Culture	\$2.65
Thousand Answers to Bee Keeping Questions	1.20	Fifty Years Among the Bees—By C. C. Miller	1.00
Bee Keeping—By E. F. Phillips	2.15	How to Keep Bees—By A. B. Comstock	1.30
Productive Bee Keeping—By Frank C. Pellet	2.15	Scientific Queen Rearing—By Doolittle80
Advanced Bee Culture	1.00	First Lessons in Bee Keeping—By Dadant	1.00
The Honey Bee—By Langstroth and Dadant	1.65		

LIPPINCOTT'S FARM MANUALS

Productive Bee Keeping—By Frank C. Pellet; 320 pages and 134 illustrations. A most complete book on apiculture. Price, parcel post paid	\$2.00	Productive Vegetable Growing—By John W. Lloyd; 320 pages, 102 illustrations. A very complete works. Price, parcel post paid	\$2.00
Productive Poultry Husbandry—By Harry B. Lewis; with 329 illustrations and 536 pages. Handsome cloth binding. Price, parcel post paid	2.00	Productive Orchardng—By Fred C. Sears; with 157 illustrations and 316 pages, on the modern methods of growing and marketing fruits. Price, parcel post paid	2.00

ALL ABOVE BOOKS WILL BE SENT BY PARCEL POST PAID ON RECEIPT OF PRICES QUOTED.

SCHWILL'S PINK PRICE LIST

MEMPHIS, TENN., JANUARY 1, 1919

United States Food Administration License No. G-29575.

NET CASH GOODS.—All prices quoted in this list are present values and subject to change without notice, and provided our stock is unsold. We do not, however, expect many changes, and our customers may rely upon receiving the very lowest prices current at the time their orders are received.

TERMS.—As the prices are NET CASH, a remittance must accompany all orders. These prices are F.O.B. Memphis, sacks included. Freight or express charges to be paid by the purchaser.

PARCEL POST.—When Clover, Grass Seed, Seed Grains, etc., are to be sent by mail, sufficient must be added to the following prices to pay postage.

ARTICHOKEs.	(Page 3)	1 lb.	Pk.	Bu.
Jerusalem, (bu. 50 lbs.)		\$.15	\$.90	\$ 2.75

BEANS, BUSH—Green Pod.—Bu. 60 lbs.	(Page 4)	4 Qt.	Pk.	Bu.
Black Valentine		\$2.25	\$4.00	\$15.00
Burpee's Stringless Green Pod		2.50	4.50	16.50
Early Mohawk		2.35	4.25	15.50
Full Measure		2.50	4.50	16.50
Giant Stringless Green Pod		2.50	4.50	16.50
Hopkins Improved Red Valentine		2.60	4.60	16.50
Improved Extra Early Red Valentine		2.50	4.50	16.00
Refugee Extra Early		2.35	4.25	15.50
Round Yellow Six Weeks		2.35	4.25	15.00
Tennessee Green Pod		2.50	4.50	17.00

BEANS, BUSH—Wax Pod—Bu. 60 lbs.	(Page 5)	4 Qt.	Pk.	Bu.
Prolific Black Wax		\$2.50	\$4.50	\$16.50
Currie Rust Proof Wax		2.50	4.50	16.50
Davis White Kidney Wax		2.90	5.50	20.00
Flageolet Violet Wax		2.90	5.50	20.00
Improved Golden Wax		2.50	4.50	16.50
Burpee's New Kidney Wax		2.75	5.00	18.00
Round Pod Kidney Wax		2.75	5.00	18.00
Sure Crop Wax		2.75	5.00	18.00
Webber Wax		2.75	5.00	18.00
Wardwell's Kidney Wax		2.75	5.00	18.00

BEANS, POLE OR RUNNING—Bu. 60 lbs.	(Page 6)	4 Qt.	Pk.	Bu.
Kentucky Wonder		\$2.75	\$5.00	\$18.00
White Creaseback		2.80	5.25	18.50
Red Speckled Cut Short		2.90	5.50	20.00
Scotia or Cornfield		2.90	5.50	20.00
Southern Prolific		2.80	5.25	19.00
Lazy Wife		3.15	5.90	22.00
Horticultural Pole		3.15	5.90	22.00
Golden Cluster Wax		3.15	5.90	22.00

BEANS, POLE LIMA—Bu. 60 lbs.	(Page 7)	4 Qt.	Pk.	Bu.
Carolina Sieva or Small Lima		\$2.75	\$4.90	\$18.00
King of Garden		2.75	4.90	18.00
Large White Lima		2.75	4.90	18.00
Schwill's Monstrous Lima		2.75	4.90	18.00
Calico or Irish		3.00	4.90	18.50
Schwill's Ideal Butter Bean		3.00		

BEANS, BUSH LIMA—Bu. 60 lbs.	(Page 7)	4 Qt.	Pk.	Bu.
Henderson's Bush		\$2.75	\$4.90	\$18.00
Burpee's Improved Bush		2.90	5.50	20.00
Fordhook Bush		2.90	5.50	20.00
Wood's Prolific		2.80	5.25	19.00

CORN, GARDEN.	(Pages 14 and 15)	4 Qt.	Pk.	Bu.
Extra Early Adams	(bu. 56 lb.)	\$1.25	\$2.25	\$ 7.00
Golden Bantam	(bu. 45 lb.)	2.35	4.25	15.00
Early Fordhook	(bu. 45 lb.)	2.35	4.25	15.00
Golden Cream	(bu. 45 lb.)	2.35	4.25	15.00
Kendall's Early Giant	(bu. 45 lb.)	2.35	4.25	14.50
Early Minnesota	(bu. 45 lb.)	2.35	4.25	14.50
Adams Large Early	(bu. 56 lb.)	1.25	2.25	7.00
Schwill's Improved Large Adams.	(56 lb.)	1.25	2.25	7.00
Schwill's Delicious	(bu. 45 lb.)	2.35	4.25	15.00
Schwill's Early Surprise	(bu. 56 lb.)	1.25	2.25	7.00
Country Gentleman	(bu. 45 lb.)	2.35	4.25	15.00
Mammoth or Large Sugar	(bu. 45 lb.)	2.35	4.25	15.00
Stowell's Evergreen	(bu. 45 lb.)	2.35	4.25	14.50
White Evergreen	(bu. 45 lb.)	2.35	4.25	14.50

ONION SETS—Bu. 32 lbs.	(Page 24)	4 Qt.	Pk.	Bu.
Yellow Danvers		\$.60	\$1.00	\$ 3.50
Dark Red Wethersfield		.60	1.00	3.50
White Silver Skin		.75	1.20	4.00

ONION SETS—Continued.	Bu. 32 lbs.	4 Qt.	Pk.	Bu.
(Page 24)				
Yellow Potato		\$.90	\$1.60	\$ 5.50
White Multipliers		.90	1.50	5.00

SEED POTATOES—Bu. 60 lbs.	(Page 25)	4 Qt.	Pk.	Bu.
Red Triumph, Northern Grown		\$.45	\$.75	\$ 2.50
Red Triumph, Tenn. 2nd Crop		.50	.90	2.75
Irish Cobbler		.45	.75	2.50
Early Ohio		.45	.75	2.50
Early Rose		.45	.75	2.50
Peerless		.45	.75	2.50
Burbank		.45	.75	2.50
Lookout Mountain		.50	.90	2.75

SEED SWEET POTATOES—Bu. 45 lbs.	(Page 25)	4 Qt.	Pk.	Bu.
Nancy Hall		\$.50	\$.85	\$ 2.50
Bunch Yellow Yam		.50	.85	2.50
Early Triumph Sweet Potato		.45	.75	2.25
Gold Coin Bunch Yam		.45	.75	2.25
Genuine Yellow Yam		.50	.85	2.50
Southern Queen		.45	.75	2.25
Porto Rica Yam		.50	.85	2.50
Florida Yam Sweet Potato		.50	.85	2.50

PEAS, GARDEN.	(Pages 26-27)	4 Qt.	Pk.	Bu.
American Wonder	(bu. 56 lb.)	\$2.50	\$4.50	\$16.00
Alaska	(bu. 60 lb.)	2.00	3.75	13.00
Ameer, or Large Alaska	(bu. 60 lb.)	2.25	4.00	14.00
First and Best	(bu. 60 lb.)	2.00	3.75	13.00
Gradus, or Prosperity	(bu. 56 lb.)	2.50	4.50	16.00
Improved Pilot	(bu. 60 lb.)	2.50	4.50	16.00
Prolific Early Market	(bu. 60 lb.)	2.25	4.00	14.00
World's Record	(bu. 56 lb.)	3.00		
New Saxonia	(bu. 56 lb.)	2.35	4.25	15.00
Schwill's Leader	(bu. 60 lb.)	2.35	4.25	15.00
McLean's Little Gem	(bu. 56 lb.)	2.50	4.50	16.00
Nott's Excelsior	(bu. 56 lb.)	2.50	4.50	16.00
Champion of England	(bu. 56 lb.)	2.60	4.75	17.00
Large White Marrowfat	(bu. 60 lb.)	1.75	3.25	10.50
Pride of Market	(bu. 60 lb.)	2.00	3.75	13.00
Telephone	(bu. 56 lb.)	2.35	4.25	15.00
Potlatch	(bu. 56 lb.)	2.50	4.50	16.00

SEED CORN—White—Bu. 56 lbs.	(Pages 38-39)	4 Qt.	Pk.	Bu.
Paymaster		\$.70	\$1.15	\$ 3.75
Mosby's Prolific		.70	1.15	3.75
Schwill's Prize Medal		.75	1.25	4.00
Big Rockdale		.70	1.15	3.75
North Carolina White Prolific		.70	1.15	3.75
Schwill's Ninety-Day Early White		.60	1.00	3.25
St. Charles White, Red Cob		.60	1.00	3.25
Snowflake		.75	1.25	4.00
Mexican June		.75	1.35	4.25
Tait's White Dent		.75	1.35	4.25
Champion White Pearl		.60	1.00	3.25
Iowa Silver Mine		.60	1.00	3.25
Tennessee Red Cob, White		.70	1.15	3.75
New Brazilian, or Stooling Flour Corn		1.00	1.75	6.00
Hickory King		.75	1.25	3.75
Vardaman's Stooling Corn		.85	1.40	4.50

SEED CORN—Yellow—Bu. 56 lbs.	(Page 39)	4 Qt.	Pk.	Bu.
Iowa Gold Mine		\$.60	\$1.00	\$ 3.25
Schwill's Ninety-Day Early Yellow		.60	1.00	3.25
Golden Surprise		.75	1.25	4.00
Reid's Yellow Dent		.60	1.00	3.25
Improved Yellow Leaming		.60	1.00	3.25
Mortgage Lifter		.75	1.35	4.25
Tennessee Mammoth Yellow		.70	1.15	3.75
Early Yellow Canada		1.00	1.75	6.00

OTTO SCHWILL & CO., MEMPHIS SCHWILL'S SURE SEEDS

ENSILAGE AND FODDER CORN—

Bu. 45 lbs. (Page 39)	4 Qt.	Pk.	Bu.
Red Cob White Ensilage	\$1.00	\$1.75	\$ 5.50
Eureka White Ensilage	1.00	1.75	5.50

CLOVER SEED. (Pages 40-41)

	1 lb.	Pk.	Bu.
Alfalfa (bu. 60 lb.)	\$.35	\$4.25	\$16.50
Red Clover (bu. 60 lb.)	.60	8.00	30.00
Mammoth or Sapling Clover (bu. 60 lb.)	.60	8.00	30.00
Alsike Clover (bu. 60 lb.)	.50	7.00	25.00
White Clover (bu. 60 lb.)	.65	9.00	33.00
Crimson Clover (bu. 60 lb.)	.30	3.50	12.50
Japan Clover (Lespedeza Striata) (25 lb.)	.50	2.75	10.00
Melilotus or Sweet Clover (bu. 25 lb.)	.30	1.50	5.00
Burr Clover (hulled, bu. 60 lb.)	.30	4.00	15.00
Burr Clover (burr, bu. 10 lb.)	.25	.75	2.00

GRASS SEEDS. (Pages 42-43)

	1 lb.	10 lb.	50 lb.
Schwill's Emerald Lawn Grass	\$.50	\$4.50	\$20.00
Shady Spot Lawn Grass	.50	4.50	20.00
Schwill's Terrace Grass	.50	4.50	20.00
Permanent Pasture Grass Mixture (14 lb.)	.35	3.00	14.00
Permanent Meadow Grass Mixture (14 lb.)	.35	3.00	14.00
Permanent Hog Pasture Mixt. (bu. 14 lb.)	.35	3.00	14.00
Chicken Pasture Mixture	.25	1.75	7.50
Timothy and Alsike Mixture	.35	3.00	14.50
Kentucky Blue Grass (bu. 14 lb.)	.40	3.50	15.00
English Blue or Meadow Fescue (bu. 24 lb.)	.40	3.50	15.00
Italian Rye Grass (bu. 24 lb.)	.25	2.00	9.00
Perennial Rye Grass (bu. 24 lb.)	.25	2.00	9.00
Johnson Grass (bu. 28 lb.)	.50	4.00	17.50
Orchard Grass (bu. 14 lb.)	.35	3.00	14.00
Bermuda Grass	.60	5.00	23.00
Red Top or Herds Grass	.30	2.50	11.00
Canadian Blue Grass (bu. 14 lb.)	.40	3.50	15.00
Tall Meadow Oat Grass (bu. 14 lb.)	.50	4.75	17.50
Timothy (bu. 45 lb.)	.20	1.75	7.50
Sudan Grass	.30	2.75	12.50

FIELD BEANS—Bu. 60 lbs. (Pages 44-45)

	4 Qt.	Pk.	Bu.
Velvet Beans, Early Bird Speckled	\$.60	\$1.00	\$ 3.00
Velvet Beans, Chinese	.75	1.25	4.00
Velvet Beans, Osceola	.75	1.25	4.00
Soy Beans, Mammoth Yellow	.75	1.25	4.00
Soy Beans, Ito San	.90	1.50	5.00
White Marrow	2.25	4.00	14.00
White Kidney	2.25	4.00	14.00
White Navy	2.25	4.00	14.00
Tepary	2.25	4.00	14.00
Mexican Pinto	2.25	4.00	14.00
Castor Beans (bu. 46 lb.)	1.75	3.00	9.75

COW PEAS—Bu. 60 lbs. (Page 45)

	4 Qt.	Pk.	Bu.
Whippoorwill or Speckled			
Unknown or Wonderful			
Black			
Red Ripper			
Clay			
Mixed			
Canada Field Peas			

**Crop Short
Write for Prices**

WHITE TABLE PEAS.—Bu. 60 lbs.

(Page 45)	4 Qt.	Pk.	Bu.
California Large White Black-eyed	\$1.25	\$2.25	\$ 7.50
White Brown-eyed	.90	1.50	5.00
White Lady Peas (bu. 22 lb.)	1.25	2.25	7.50
Crowder Peas	1.50		

PEANUTS AND CHUFAS. (Page 45)

	1-lb.	Pk.	Bu.
Spanish Peanuts (bu. 22 lb.)	\$.15	\$.75	\$ 2.25
Tennessee Mammoth Long Red (bu. 22 lb.)	.25	1.10	4.00
Mammoth White Virginia (bu. 22 lb.)	.25	1.10	4.00
Valencia Peanuts (bu. 22 lb.)	.30	1.10	4.00
Chufas (Earth Almonds) (bu. 44 lb.)	.25	1.75	6.00

MILLET SEED. (Page 46)

	1 lb.	10 lb.	50 lb.
Tennessee Golden Millet (bu. 50 lb.)	\$.15	\$1.00	\$ 4.50
Western Golden Millet (bu. 50 lb.)	.15	1.00	4.25
Hungarian Millet (bu. 48 lb.)			Write for Price
Japanese or Barnyard Millet	.20	1.25	5.00
Pearl or Cat Tail Millet	.30	2.50	10.00

SORGHUM OR SUGAR CANE.—Bu. 50 lbs.

(Page 46)	1 lb.	10 lb.	50 lb.
Texas Seeded Ribbon Cane	\$.30	\$1.75	\$ 6.00
Japanese Honey Syrup Cane	.30	1.75	6.00
Early Orange Sorghum	.15	1.00	3.25
Early Amber Sorghum	.15	1.00	3.25
Red Top Sorghum	.20	1.25	4.00
White Kaffir Corn	.15	1.00	3.25
Red Kaffir Corn	.15	1.00	3.50
Yellow Milo Maize	.15	1.00	3.50
Dwarf Straight Neck Milo Maize	.20	1.25	4.00
Feterita	.20	1.25	4.00

SEED OATS.—Bu. 32 lbs. (Page 47)

	1 Bu.	5 Bu.	10 Bu.
Early Burt	\$1.50	\$7.00	\$13.50
Red Rust Proof	1.35	6.50	12.50
Appler	1.75	8.25	16.00
Fulgham	1.75	8.25	16.00

MISCELLANEOUS FARM SEEDS.

(Page 47)	1 lb.	Pk.	Bu.
Upland Rice (bu. 44 lb.)	\$.20	\$1.50	\$ 5.00
Speltz or Emmer (bu. 40 lb.)	.15	1.00	3.50
Early Wonder Spring Wheat (bu. 60 lb.)	.15	1.25	4.00
Beardless Spring Barley (bu. 48 lb.)	.15	.90	3.00
Japanese Buckwheat (bu. 50 lb.)	.15	1.25	4.50
Silver Hull Buckwheat (bu. 50 lb.)	.15	1.25	4.50
Broom Corn, Improved Evergreen (46 lb.)	.15	1.25	4.50
Broom Corn, Dwarf Oklahama (bu. 46 lb.)	.15	1.25	4.50

	1 lb.	10 lb.	50 lb.
Rape, Dwarf Essex	\$.20	\$1.75	\$ 8.00
Teosinte	.75	7.00	
Spring Vetch	.25	2.00	9.50
Sand or Hairy Vetch	.30	2.50	11.50
Sunflower, Russian	.20	1.75	7.50

COTTON SEED.—Bu. 30 lbs. (Page 48)

	1 Bu.	5 Bu.	10 Bu.
Half and Half	\$3.25	\$15.50	\$30.00
Wannamaker Cleveland	3.25	15.50	30.00
Early Triumph Big Boll	3.00	14.25	27.50
Columbia Big Boll	3.00	14.25	27.50
Polk's Early Maturing Long Staple	3.00	14.25	27.50
Express	3.00	14.25	27.50
King's Early Improved	3.00	14.25	27.50
Webber	3.00	14.25	27.50

POULTRY FEED, Etc. (Pages 78-79)

	25 lb.	50 lb.	100 lb.
Red Comb Poultry Feed	\$1.15	\$2.15	\$ 4.10
Red Comb Meat Mash	1.20	2.25	4.25
Red Comb Coarse Chick	1.35	2.35	4.35
Red Comb Fine Chick	1.40	2.50	4.50
Red Comb Baby Chick Milk Mash	1.50	2.75	5.00
Pound Squab Pigeon Feed	1.50	2.75	5.00
Red Horn Pig Meal	1.65	2.85	5.35
Red Horn Calf Meal	1.65	2.85	5.35
Red Horn Dairy Feed	1.25	2.25	4.00
Pioneer Hog Feed	1.25	2.25	4.00
Conkey's Buttermilk Starter			Write for Price
Blatchford's Milk Mash for Chicks			Write for Price
Blatchford's Egg Mash Feed			Write for Price
Blatchford's Calf Meal			Write for Price
Blatchford's Pig Meal			Write for Price
Hen-O-Lay Mash	1.40	2.50	4.50
Chamberlain's Perfect Chick Feed	1.65	3.00	5.50

MISCELLANEOUS POULTRY GRAINS.

(Pages 78-79)	10 lb.	25 lb.	100 lb.
Buckwheat	\$.80	\$1.75	\$ 6.00
Corn Chops, Sifted	.50	1.20	4.00
Hemp Seed	2.00	3.75	14.00
Millet Seed	.80	1.75	6.00
Sunflower Seed	1.50	3.65	14.00
Kaffir Corn	.50	1.20	4.00
Canada Peas	1.20	2.50	10.00
Steel Cut Oats	.80	1.85	6.50
Red Wheat	.55	1.35	4.75

SCHWILL'S POPULAR COLLECTIONS

For the convenience of our customers we have prepared in advance the following collections which we can sell at the low prices quoted, only when ordered as listed. All seeds in these collections are of the most popular varieties and of high quality. No changes allowed, as same are packed in advance.

SCHWILL'S ANNIVERSARY COLLECTION

Twenty-four packages of Assorted Seeds for only \$1.00. At regular prices they would cost you \$1.50. A complete Garden for only \$1.00, parcel post paid. One packet each of the following seeds:

Bush Beans, Early Valentine	Cantaloupe, Rocky Ford	Parsley, Double Curled
Pole Beans, Kentucky Wonder	Egg Plant, New York Purple	Radish, Scarlet Turnip White Tip
English Peas, Large Alaska	Lettuce, Big Boston	Radish, Long Scarlet
Beet, Crosby's Egyptian	Mustard, Giant Curled	Spinach, Curled Savoy
Cabbage, Early Flat Dutch	Okra, White Velvet	Squash, Early White Bush
Collard, Georgia White Cabbage	Onion, Red Wethersfield	Tomato, Acme
Carrot, Improved Long Orange	Pepper, Bell or Bull Nose	Turnip, Purple Top Globe
Cucumber, Improved Long Green	Parsnip, Sugar Hollow Crown	Watermelon, Halbert Honey

SCHWILL'S BARGAIN COLLECTION

Thirty-five packages of Assorted Seeds for only \$1.50. At regular prices they would cost you \$2.20. A complete Garden for only \$1.50, parcel post paid. One packet each of the following seeds:

Bush Beans, Early Valentine	Cantaloupe, Rocky Ford	Parsley, Double Curled
Pole Beans, Kentucky Wonder	Egg Plant, New York Purple	Radish, Scarlet Turnip White Tip
English Peas, Large Alaska	Lettuce, Big Boston	Radish, Long Scarlet
Corn, Garden, Schwill's Surprise	Lettuce, White Cabbagehead	Radish, French Breakfast
Beet, Crosby's Egyptian	Mustard, Chinese Mammoth	Spinach, Curled Savoy
Beet, Early Blood Turnip	Mustard, Giant Curled	Squash, Early White Bush
Cabbage, Early Flat Dutch	Okra, White Velvet	Swiss Chard, For Greens
Cabbage, Large Late Drumhead	Onion, Red Wethersfield	Tomato, Acme
Collard, Georgia White Cabbage	Pepper, Bell or Bull Nose	Tomato, Stone
Carrot, Improved Long Orange	Pepper, Long Red Cayenne	Turnip, Red or Purple Top
Cucumber, Improved Long Green	Parsnip, Sugar Hollow Crown	Turnip, White Flat Dutch
Cucumber, Improved White Spine		Watermelon, Halbert Honey

SCHWILL'S KITCHEN GARDEN COLLECTION

Sent post paid to any address for \$2.00, one packet each of the following Seeds, which would cost at regular prices \$2.65:

$\frac{1}{2}$ pt. English Peas, Early	$\frac{1}{2}$ pt. Pole Snap Beans	$\frac{1}{2}$ pt. Garden Corn
$\frac{1}{2}$ pt. English Peas, Late	$\frac{1}{2}$ pt. Pole Butter Beans	$\frac{1}{2}$ pt. Bush Snap Beans
1 packet Cabbage, Early	1 packet Cucumber	1 packet Parsnips
1 packet Cabbage, Late	1 packet Collard	1 packet Squash
1 packet Carrot	1 packet Mustard	1 packet Turnips
1 packet Lettuce	1 packet Radish, Round	1 packet Turnip Beets
1 packet Okra	1 packet Radish, Long	1 packet Cantaloupe
1 packet Tomato	1 packet Sweet Pepper	1 packet Egg Plant
1 packet Onions	1 packet Hot Pepper	1 packet Watermelon

SCHWILL'S BANNER COLLECTION

Twelve packets of best Garden Seed for only 35c, postage paid. One package each of the following varieties:

Beet, Blood Turnip	Cucumber, Long Green	Mustard, Giant Curled
Cabbage, Early Drumhead	Watermelon, Rattlesnake	Radish, Scarlet Turnip
Lettuce, Hubbard Market	Carrot, Danvers	Squash, Early White Bush
Collard, True Southern	Onion, Wethersfield	Tomato, Early Detroit

SCHWILL'S STAR COLLECTION OF FLOWER SEEDS

Twelve papers Assorted Flower Seeds for only 35c, postage paid. One packet each of the following varieties:

Aster, China Mixed	Mignonette, Sweet	Morning Glory	Phlox, Mixed
Sweet Alyssum	Verbena, Mixed	Zinnia, Mixed	Petunia, Single Mixed
Pink, China Mixed	Pansy, Choice Mixed	Poppy, Mixed	Sweet Peas, Mixed

GRANDIFLORA SWEET PEA COLLECTION

One pkt. each of the 12 following varieties of Grandiflora Sweet Peas mailed to any address for only 35c.

Countess of Radnor	Miss Wilmott	Duke of Westminster	Lord Nelson
Janet Scott	Prince of Wales	Superb Mixed	Prima Donna
Lady Grisel Hamilton	Dorothy Eckford	King Edward VII	Othello

SUPERB SPENCER SWEET PEA COLLECTION

One pkt. each of the following Spencer or Orchid Flowering Sweet Peas mailed to any address for only \$1.00.

Apple Blossom Spencer	Rosabella Spencer	Aster Ohn Spencer	Primrose Spencer
Countess Spencer	White Spencer	King Edward Spencer	Thomas Stevenson Spencer
King White Spencer	Dobbies Cream Spencer	Maude Holmes Spencer	Royal Purple Spencer
Mrs. Routzahn Spencer			Helena Lewis Spencer

SCHWILL'S FRUIT TREES



SCHWILL'S FARM SEEDS