



505,73

SCIENCE

AN ILLUSTRATED JOURNAL

PUBLISHED WEEKLY

VOLUME X

JULY—DECEMBER 1887



NEW YORK

THE SCIENCE COMPANY

1887

REVISED

1917

THE

AMERICAN

PHYSICAL

SCIENCE

TEACHERS

ASSOCIATION

OF

THE

UNITED STATES



INDEX TO VOLUME X.

A.

- Abbott, C. C. American caves, 180.
 Academy of Sciences, National, 224; list of papers read at, 249; meeting, 241.
 Act of God, 241, 264, 276, 299.
 Adams, H. C. Dodd's Republic of the Future, 92.
 Adams's Public Debts, 164; Study of History in American Colleges, 282.
 Afghan life in Afghan songs, 195.
 Africa, Central, 42; Junker's travels in, 54; Kerr's journey across, 321; map of, 51, 306; travels in, 221; Wissmann's expedition across, 270.
 Agricultural chemists, 112; experiment station, Pennsylvania, 307; Science Society, 21.
 Alaska boundary-line, survey of, 191; letter, 114; natural history notes on, 264.
 Alaskan Society of Sitka, 260.
 Allen's Common Sense Science, 20.
 Alsace-Lorraine, population of, 9.
 Alvord, H. E. Economy in management of soil, 77.
 Andrews's Brief Institutes of General History, 4; Section A, 85; Section B, 86; Section C, 98; Section D, 87; Section E, 87; Section F, 88; Section H, 88; Section I, 99.
 Amercy, C. F. Nitrogen in manures, 34.
 Anderson, W. Some Western mummies, 146.
 Anderson, W. W. Tornado force, 223.
 Anderson's Conversion of Heat into Work, 190.
 Andrews's Brief Institutes of General History, 190.
 Animals, ideas of number in, 316.
 Antarctic region exploration, 181.
 Anthony and Brackett's Physics, 236.
 Anthropological treatises, 57.
 Anthropology in the American and British Associations, 231.
 Ants, bees, and wasps, habits of, 320.
 Apparitions and haunted houses, 259.
 Arctic, notes from the, 233.
 Arctic America, 3.
 Aristotelian Society of London, 272.
 Arkansas, pronunciation of, 107, 120.
 Armor for land-defences, 124.
 Ashe, W. A. Freezing-point of sea-water, 36; glacier-like movement in snow, 180; height and temperature of Eskimo, 37; Hudson Bay route, 47; ice and sea-water volumes, 24; sea-water ice, 95.
 Asia, Prejevalsky's journeys in, 62.
 Atkinson, E. The American physique, 239, 276.
 Atkinson's Margin of Profits, 127.
 Attention, mechanism of, 269, 283.
 Audubon's grave, 68, 108, 305, 277.
 Ayres, W. O., death of, 24.

B.

- Baird, Spencer F., 97.
 Baldwin's Psychology and Education, 263.
 Ballet, T. M. Examinations, 113.
 Ballooning, 45.
 Banana, coconut, and India-rubber, 36.
 Barrows's Facts and Fictions of Mental Healing, 93.
 Bartley, E. H. Distillery-milk, 59.
 Base-ball players, 65.
 Basques, the, 246.
 Bastian's Die Welt in ihren Spiegelungen unter dem Wandel des Völkergedankens, 284.
 Bastian's Elements of Botany, 140.
 Bauch, E. Microscopes, 310.
 Beauchamp, W. M. Changes in Indian languages, 251, 264.
 Beer-trade statistics, 182.
 Bell, R. Rock specimens from Cumberland Sound, 287.
 Bell's Principles of Elocution, 223.
 Bell's Selkirk Settlement, 320.
 Bell, H. B. Birds and universities, 210.
 Bitumen in coal, 228.
 Boas, F. Eskimo and Indian, 273; Nicaragua Canal, 182; sea-water ice, 118.
 Boll, R. Untersuchungen des Gehirns, 223.
 Bones, ash in human, 179.
 Botanical Club, 21.
 Botany, Annals of, 238.
 Bowl, 116.
 Bottomley's Mathematical Tables, 129.
 Bowditch, statue of, 32.
 Bowditch, H. I. Cause of consumption, 71.
 Bowen, H. B. Birds and universities, 210.
 Bower and Vines's Instruction in Botany, 175.
 Bowne's Philosophy of Theism, 215.

- Boyhood, savagery of, 173, 203.
 Bradwin, G. Act of God, 239.
 Brain-growth and body-growth, 172.
 Brain-wounds, 30.
 Brashear, J. A., exhibition by, 319.
 Brazil, 213.
 Breathing, types of, 65.
 Brewer, W. H. Distillery-milk, 60.
 Bridgeman, Laura, 319.
 Brigham's Guatemala, 223.
 Brinton, D. G. Chronology of America, 76; Eskimo and Iroquois, 300; rate of change in American languages, 374.
 Britton's Ancient Nahuatl Poetry, 222.
 British Columbia, 221, 234.
 Browning, O. Aspects of education, 206, 253.
 Bruehl's Culturvölker Alt-Amerika's, 174.
 Bryozoa, study of, 225.
 Buel, R. H. Conspiracy of silence, 298.
 Bumstead, S. J. Study of logic, 256.
 Butler, N. M. Manual training in Norway, 255.
 Butler's Effect of the War of 1812, 30.
 Buzzards, sense of smell in, 319.

C.

- Cabaane, C. Distillery-milk, 72.
 Canal between Bordeaux and Narbonne, 224.
 Carnesley's Melting and Boiling Point Tables, 103.
 Carpenter, W. L. University of New Zealand, 12.
 Caspian Sea, elevation of, 32.
 Catalogues, 104.
 Catamaran, a steam, 273.
 Caterpillar-cocoons, 32.
 Cato Major et Lelius, 285.
 Cattle-plague, 221.
 Caves, American, 180.
 Cetti's nest, 100.
 Challenge Report, 44.
 Chamberlain, A. F. Eskimo and the Indian, 120, 273, 322; Volapük, 24.
 Chamberlin and Salisbury's Driftless Area of the Upper Mississippi, 305.
 Charney's Ancient Cities of the New World, 200.
 Chemistry, University Press publications in, 191.
 Chey-nee, 229, 284.
 Children, false testimony of, 215; of New York, 197.
 Children's minds, contents of, 204.
 Chinese folk-lore, 302; wall, 287, 323.
 Chloroforming while asleep, 114, 214.
 Cholera and cold weather, 246; and yellow-fever, 181; at quarantine, 220, 230; bacillus, test for, 196; Calcutta outbreaks of, 202; precautions against, 188.
 Chrome as a poison, 58, 104.
 Chronology of America, 76.
 Clark, Alvan, 97.
 Classen's Analysis by Electrolysis, 191.
 Climatologist, The, 129.
 Cloud-heights, 46.
 Coal-mines, statistics of, 45.
 Coast Survey vessels, 57, 68.
 Cohen's Practical Organic Chemistry, 128.
 Coin-sales, 186.
 College, original research in, 109.
 Colleges and schools, New England association of, 202; of Ohio, Association of, 298.
 Color-blindness, 157.
 Color-blindness, 121, 179.
 Columbia College, progress of, 253; report, 169.
 Conn, H. V. Original research in college, 109; Robotic Love, 143.
 Conspiracy of silence, 265, 298, 308.
 Constance, Lake of, soundings in, 320.
 Consumption, 30; and chest-expansion, 173; and overgreens, 22; cause of, 24, 71; cure of, 38, 99; grinders, 197; treatment of, 114.
 Contagion, flies as carriers of, 314.
 Cook's voyages, relics of, 176.
 Coops's Animal Life, 188.
 Co-operation in England, 1; in Europe, 121, 161.
 Copyright with England, 25.
 Corals, sections of, 252.
 Corfield's Treatment of Sewage, 116.
 Cornell, electrical engineering at, 208.
 Corset, the, 281.
 Coues, E. Flight of birds, 321.
 Craig's Animal Life, 201.
 Crampton, C. A. Sorghum-sugar, 227.
 Cumming's Electricity treated Experimentally, 93.

D.

- Darby's Nineteenth-Century Sense, 31.
 Davis, W. M. Classification of lakes, 142; study of geography, 131.
 Deaths and the tide, 24.
 De Bary's Comparative Morphology and Biology of Fungi, 175.
 Declinal system in England, 13.
 DeGarmo, C. German normal schools, 302.
 Delagoa Bay, 189.
 Density of the earth, 104.
 Dentition, mammalian, 300.
 Derriset vessels, danger to commerce from, 265.
 Dialects, Romican, 174.
 Diamond, a North Carolina, 168.
 Diamond-field in Kentucky, 149.
 Diamonds, four large South African, 69.
 Diller, J. S. Diamond-field in Kentucky, 140.
 Diphtheria carried by the cook, 65.
 Disinfectants, Report on, 55.
 Dodd's Republic of the Future, 92.
 Dolbear, A. E. Tornado force, 60.
 Donaldson, F. Cause of consumption, 24.
 Drake's Making of the Great West, 175.
 Dreams, investigation of, 223.
 Drought of 1887, 321.
 Duck's brain, 126.
 Dutch Literature, Review, 293.
 Dutton, C. E. Charleston earthquake, 10, 35.
 Dutton's Mount Taylor and the Zuñi Plateau, 317.
 Dynamite races, 173, 232.
 Dynamism, gun, 151.

E.

- Ear-boxing, 25.
 Earthquake of Central Asia, 140; Charleston, 10, 35; Sonora, 81; submarine, 177.
 Earthquakes, depth of, 232.
 Eclipse, total solar, of 1893, 9.
 Education, a rational, 13; aspects of, 206, 253; method applied to, 18; scientific, in England, 250; technical, 72.
 Educational Association, National, 37; indorsement of Blair bill, 161, 182; council, a novel, 313.
 Edwards's Butterflies, 165.
 Electric light in mines, 217.
 Electrical exhibition in New York, 8.
 Electricity in the earth, 72, 96; loss of, 151, 208.
 Electroplating natural objects, 203.
 Ely, R. T. Adams's Public Debts, 164.
 Emlin Paeha, 68.
 Emminghaus's Die psychischen Störungen des Kindesalters, 199.
 English science, 193.
 Entomological Club, 20.
 Error, natural history of, 41.
 Eskimo, 150; and Indian, 120, 273, 287, 322; and Iroquois, 300; height and temperature of, 37; origin of, 116; tribes, 271, 288.
 Ethnographical museums, 245.
 Ethnographie, Internationales Archiv für, 229.
 European literature in America, 209.
 Evolution, what American zoologists have done for, 23.
 Examinations, school, 109, 112.
 Explosion record, 320.
 Explosives, modern, 205.
 Eyesight of children, testing of, 264.

F.

- Factory, German, statistics, 320.
 Fechner, Gustav Theodor, death of, 301.
 Ferrel, W. Theoretical meteorology, 48.
 Fibre industry of Burma, 202.
 Filth-diseases, 36.
 Finck's Romantic Love, 100.
 Fish, distribution of, 36; frozen, 208; propagation, 177.
 Fish Commission steamer Albatross, movements of, 264.
 Foerste, A. F. Bryozoa, 225.
 Folk-Lore Society, 319.
 Foods and Food Alternatives, 128; in winter, 173.
 Fossils, chondrocodized, 155; sections of, 180.
 Fourth of July casualties, 25.
 Fowler and Wilson's Principles of Morals, 31.
 Frazer, P. Geological questions, 35; Geologists' Congress, 113.

Frederick's Study of History in England and Scotland, 282.
 Freezing-point of sea-water, 36.
 Froebel's Education of Man, 263.

G.

Galliard's French for Young Folks, 264.
 Gallaudet's hundredth birthday, 301.
 Gannett, H. Survey of the United States, 49.
 Gannett, E. B. Cavalry notes, 48.
 Gaster's Greco-Slavonic Literature, 249.
 Geikie's Teaching of Geography, 139.
 Gems, American, 264; and precious stones, 184, 226.
 Gems, universal, 65.
 Geographical methods, lec. ures on, 238; names, 143; Society, debating club in American, 330.
 Geography in England, 89; study of, 91, 131; teaching of, 177.
 Geological Congress meeting next year, 308; questions, 35; survey in Arkansas, 57; Survey maps, 37.
 Geologist, the American, 307, 321.
 Geologists, congress of, 30, 119.
 German normal schools, 302.
 German Historical Readers, 103.
 Gierster in Colorado, 152.
 Glaciers, flora following retreating, 45.
 Glenn, W. Chrome as a poison, 53; fifth-diseases, 36.
 Goodce, artificial preparation of, 263.
 Gouff, G. B. As fish commissioner, 109.
 Goodfellow, G. E. The Sonora earthquake, 81.
 Gore's Elements of Geodesy, 80.
 Grandgren's Italian Grammar, 238.
 Gracnap, L. P. Science at the American Association, 166.
 Greenland, 221.
 Grindelia glutinosa, 180; squarrosa, 152.
 Groff, G. G. Blue educational bill, 132.
 Gulf Stream investigations, 308.

H.

Hague, A. Map of the Far West, 317.
 Hall, A. Act of God, 264; applied optics, 108.
 Hall, E. H. Physics for schools, 129.
 Hall, J. Faulty memory, 350.
 Hall and Knight's Higher Algebra, 128.
 Harger, Oscar, death of, 268.
 Harrington, C. Chrome as a poison, 104.
 Hartleben's Die Erde in Karten und Bildern, 175.
 Harvard Observatory bulletins, 129.
 Harvey, F. L. Faulty memory, 374.
 Hawaiian Islands, 115.
 Hazen, H. A. Ballooning, 45; theoretical meteorology, 31; weather-predictions, 332; wind-pressure, 116.
 Health, a national board of, 313.
 Health Association, the American, 189, 258, 288, 278, 330.
 Healy's The Mark of the Beast, 102.
 Hegel's Philosophy of the State and of History, 307.
 Heimboltz, 68.
 Heredity of mental traits, 123.
 Heron, Florida, 36.
 Heronries, destruction of Florida, 47.
 Herrmann's Graphical Statics of Mechanism, 140.
 Hewitt, W. T. Study of modern European literature in America, 209.
 Hilgard, E. W. Cyanhydric gas as an insecticide, 11.
 Hill, R. T. Corruption of geographic names, 143; pronunciation of Arkansas, 107.
 Hinsdale, B. A. Examinations, 112; over-pressure in schools, 177.
 Höfding's Psychologie im Umrissen auf Grundlage der Erfahrung, 222.
 Holder's Living Lights, 200, 226.
 Home Sanitation, 66.
 Hop-louse, 21.
 Horsford, E. N. Volapük, 10.
 Howard, M., and Schuyler, E. Waterspouts, 32.
 Howell, E. E. Rockwood meteorite, 107.
 Hubbard, G. G. Transcontinental railroads, 133.
 Hudson Bay expedition of 1886, 270; route, 47.
 Huxley's Royal Academy address, 31.
 Hyatt, A. Scientific swindler, 303.
 Hydrophobia, 214; in New York, 100; old observations on, 247.
 Hypnotism, recent observations in, 187.
 Hyslop, J. H. Temperature sense, 252.

I.

Ice and sea-water volumes, 24.
 Indian basketry, 150; names, 252.
 Industrial Education Association, 250.
 Infants, progress of, 138.
 Insanity, scientific study of, 176.
 Insect-light, 94.
 Insecticide, cyanhydric gas as an, 11.
 Insects, maxillary palpi of mandibulate, 176.
 Iron carburets, 191.
 Itaska, Lake, 48, 72, 84.

J.

Jacobson's Higher Grounds, 266.
 Jahn's Ethik als Grundwissenschaft der Pädagogik, 46.
 James, J. F. Chalcedonized fossils, 156; Chinese wall, 232; sections of corals, 252; sections of fossils, 180.
 Janney, J. J. Distillery-milk, 107.
 Jastrow, J. Secret Commission report, 7.
 Jerram's Anglie Reddena, 19.
 Johnson, N. N. Grindelia squarrosa, 152.
 Johnson, W. D. Topography, 152.

K.

Kansas Academy of Science, twelfth meeting of, 286; Historical Society, 238.
 Kapp's Electric Transmission of Energy, 92.
 Keith, J. S. Geography in England, 89.
 Keweenaw system, 166.
 Kidder, J. H., appointment of, 273.
 Kilpatrick, J. W. Stone daggers from Missouri, 192.
 King, E. L. Over-pressure in schools, 192.
 Kirshoff, G. R., death of, 216.
 Kuango, the, 221.
 Kunz, G. F. A North Carolina diamond, 163; diamonds in Kentucky, 140; four large South African diamonds, 93; gems and precious stones, 226.

L.

Lake classification, 142.
 Landolt's Uebersichtliche Zusammenstellung der Augenbewegungen, 223.
 Lang, H. Silver in Oregon, 192.
 Langley's address to the American Association, 80.
 Language, articulated and sign, 15.
 Languages, American, 245; changes in, 374; Indian, bibliography of, 307; changes in, 251, 264; school of Oriental, at Berlin, 224; study of, 324.
 Larden's Electricity, 237.
 Laughlin's Political Economy, 198.
 Law, international, 101.
 LeConte, Joseph. Depth of earthquakes, 22; sound-blindness, 312.
 Leprosy, a case of, 202; in Louisiana, 43; in South Africa, 32.
 Lesley, J. P. Conspiracy of silence, 308.
 Levy's Electric Light Primer, 93.
 Lightning, global, 324.
 Lindsay, P. Capt. Hauti Captivi, 19.
 Logic, study of, 256.
 Longevity of English scientists, 238.
 Lotze's Metaphysics, 250.
 Love's Industrial Education, 215.
 Lubbock's Pleasures of Life, 66.
 Lucas, F. A. Maxillo-palatines of Tachycyeta, 12.
 Lucas's Historical Geography of the British Colonies, 287.

M.

McCosh, Dr., resignation of, 241.
 Macloskie, G. Mosquito poison, 106; pineal eye of lizard, 10.
 Magnetism, terrestrial, 81.
 Mahady's Creek Life and Thought, 317.
 Manchuria, 189.
 Mantegazza's Die Kunst Glücklich zu Sein, 255.
 Manual training at the New York school superintendents' meeting, 305; in England, 327; in Norway, 255; in St. Louis, 1; in Sweden, 305.
 Manures, nitrogen in, 34.
 Map of the Far West, 217.
 Marks's Engineering Pocket-Book, 190; Proportions of the Steam-Engine, 199.
 Martin, D. S. Audubon's grave, 68.
 Martin and Wetzi's Electric Motor, 93.
 Marwede's Conscious Motherhood, 284.
 Mason, O. T. Ascian scrapers, 10.
 Masou, W. P. Ash in human bones, 179.
 Matthews, W. The Sioux, 300.
 Measles, 43.
 Medical congress, 145; legislation, 85.
 Medicine, practice of, in New York, 1; preventive, 29.
 Mileney, C. E. New Jersey reading-circle, 62.
 Memory, faulty, 177, 223, 250, 374.
 Meteor-fall, 276, 258.
 Meteoric stone of Krasnoslobodsk, 308.
 Meteorite, Rockwood, 107.
 Meteorological observations above the earth's surface, 33; international, 181; summarizing, 302; service in Argentine Republic, 45.
 Meteorology, revision of Loomis's contributions to, 201; theoretical, 31, 49.
 Metlakahla, 174, 191.
 Michie's Analytical Mechanics, 190.
 Microscopes, 275, 310.
 Microscopical society of, 94.
 Middleton, J. D. Ohio mounds, 32.
 Milk, condensed, 154; distillery, 4, 46, 59, 72, 107, 157, 251.
 Mills, T. W. Romantic Love, 130.
 Mills's Science of Politics, 237.
 Milton's Paradise Lost, 128.
 Minchin's Natura Veritas, 128.
 Mind, can the attend to two things at once? 17; primitive, 270.
 Minot, C. S. Microscopes, 275.
 Morey, J. T. Objects in teaching, 179.
 Morgan, A. Act of God, 141; international copyright, 25.
 Morgan, T. J. Examinations, 112; sense of smell, 340.
 Morgan's Educational Mosaics, 103.
 Morphology, Journal of, 234, 272.
 Morrison's Ventilation and Warming of School-Buildings, 200.
 Morse, E. S. What American zoölogists have done for evolution, 73.
 Mosquito poison, 106.
 Mosquitoes, 72, 86.
 Motion, anatomy of, 214.
 Mound-exploration, 148.
 Mounts, Ohio, 32.
 Mummies, some Western, 146.
 Murdoch, J. Eskimo and Indian, 287; pronunciation of Arkansas, 130.
 Muscle, dermo-tensor patagii, 57.

N.

Nebraska Chemical Laboratory, 82.
 Nipples in the body, 231.
 Neurological Association, 53.
 Nevins, W. M. Act of God, 276.
 Newberry, J. S. Flight of birds, 299.
 New Guinea, 148, 213.
 Newton, W. K. Condensed milk, 154.
 New Zealand, acclimatization in, 170.
 Nicaragua Canal, 182, 238; canoes, 273; expedition, 286.
 Nicholson, H. H. Nebraska Chemical Laboratory, 82.
 Noyes's Qualitative Analysis, 191.

O.

Ocean tracks, 312.
 Oerter's Social Question, 189.
 Oil on troubled waters, 61, 145, 191.
 Okinagan Indians, myth of, 150.
 Oliver, J. E. Faculty memory, 374.
 Opium, effect of, on higher animals, 138; in Tonquin, 202; use of, 100.
 Optics, applied, 108.
 Pars propatialis, 70.
 Pasture's methods, 42.
 Payne, F. F. Sea-water ice, 120.
 Payne, W. H. Examinations, 113.
 Peck's Anatomy of the Human Eye, 150.
 Peet, L. R. The Florida heron, 96.
 Pennsylvania, archaeology at University of, 202.
 Petroleum, origin of, 308; transportation in bulk, 273.
 Philological Association, 37.
 Photograph, Edison's, 229.
 Photographs by the light of fire-files, 129.
 Physical Education Association, 231; training, 278.
 Physics for schools, 129; summer school of, 21.
 Physiology in schools, 224.
 Physique, the American, 239, 276.
 Pickering, W. H. Total solar eclipse of 1886, 9.
 Pigweed-leaves, coloring of, 168.
 Pilling's Bibliography of the Eskimo language, 68.
 Pineal eye of lizard, 10.
 Plant's Storage of Electrical Energy, 93.
 Political Science Quarterly, 8.
 Pot-holes, Pennsylvania, 203, 228, 240, 252.
 Powell's Our Heredity from God, 234; Sixth Annual Report, 235.
 Preyer's Naturforschung und Schule, 284.
 Price's Industrial Peace, 236.
 Prisoners, health of, 221.
 Price, Erminie A. Smith memorial, 238.
 Proctor's Chance and Luck, 43.
 Prudden, T. M. Microscopes, 310.
 Psychological Research, American Society for, 287.
 Psychological medicine at the medical congress, 137.
 Psychology, American Journal of, 45, 248.
 Purlane-worm, 204, 228.
 Putnam, C. E., death of, 81.

Q.

Quarantine systems, 315.

R.

Railroads, transcontinental, 133.
 Railway in the Arctic, 319.
 Ray, Charles, death of, 57.
 Re-action time, 232.
 Reade's Origin of Mountain Ranges, 139.
 Reading-circle of New Jersey, 62.
 Reynolds, T. Seasickness, 34.
 Richer's Essai de Psychologie Generale, 222.
 Rifle-ball, energy of, 272.
 Roach's Trigonometry, 191.
 Roads, making of good, 109.
 Robin's nest, 48, 60, 72.
 Robins's Technical School and College Buildings, 163.
 Rock specimens from Cumberland Sound, 287.
 Rockwood, C. G., jun. An insect light, 94.
 Rohé, G. H. Distillery-milk, 46.
 Romantic Love and Personal Beauty, 100, 130, 143, 152, 216.
 Rosmini Serbati's Method applied to Education, 15.
 Route from England to Asia, 15.
 Run and civilization, 301.
 Russell's Geological History of Lake Lahontan, 79.
 Ryder, J. A. Microscopes, 311.

S.

Saintsbury's History of Elizabethan Literature, 307.
 Samoa Islands, 189.
 Sanitary convention in Michigan, 117, 214; science and education, 218.
 Scarlet-fever, 109; in London, 221; report, 294.
 Schiller's Wallenstein, 128; Wilhelm Tell, 128.
 School attendance in Prussia, 212; for Indians, 61.
 Schools, health in, 64, 247; Norway, 168; over-pressure in, 177, 182; reform of German, 250.
 Schurman's Ethical Import of Darwinism, 201.
 Science at the American Association, 166.
 Scrapers, ancient, 10.
 Seasickness, 34, 100, 214.
 Sea-water ice, 95, 118, 120.

Seals's Children of Silence, 271.
 Sensations, the influence of, on one another,
 37.
 Sewer-air, 49.
 Sewer-gas, 247.
 Snad, distribution of, 31.
 Shorthand congress, 194.
 Shufeldt, R. W. Audubon's grave, 108; dermo-ten-
 sor patagii muscle, 57; destruction of Florida her-
 onies, 47.
 Sibley College extension, 158.
 Sidgwick's Political Economy, 250.
 Signal Service stations, 140.
 Silver in Oregon, 192.
 Sioux, the, 300.
 Sleep, why do we? 115.
 Smell, sense of, 240; in dogs, 78; and touch *versus*
 sight, 215.
 Smyth, H. L. Cloud-heights, 46.
 Snow, F. H. Purslane-worm, 204.
 Snow, glacier-like movement in, 180.
 Snow Hall at Lawrence, Kan., 314.
 Soil, management of, 77.
 Sorghum-sugar, 181, 227.
 Sound-blindness, 244, 312.
 Sparrows, expulsion of, 108, 120.
 Spiritualism, exposure of, 81; Seybert report
 on, 7.
 Stanley Falls, 213.
 Stanley's movements, 97, 133, 169.
 Star of Bethlehem, 324.
 State interference, 2, 13, 28, 60.
 Steamers, tonnage of, 191.
 Stejneger, L. New species of thrush, 108; pars pro-
 patagialis, 70.
 Stewart and Gee's Physics, 236.
 Stewart's Our Temperaments, 44.
 Stone daggers from Missouri, 192.
 Stone, G. H. Glacier in Colorado, 153.
 Streets' The Hidden Way across the Thresh-
 old, 102.
 Strode, W. S. Flight of birds, 322.
 Sun, diameter of the, 129.
 Survey of Florida Keys, 129; of India, 68; of the
 United States, 49.
 Swindler, scientific, 203.
 Swiss Alps accidents, 176.

T.
 Tachycinetæ, maxillo-palatines of, 12.
 Tape-worm, 108.
 Tea and coffee, what to eat with, 30; and chicory,
 consumption of, 224.
 Teachers' Association, 350.
 Teaching, objects in, 179; pictorial, 17.
 Teas from India and China, 250.
 Telegraphy, automatic, 176; from a train, 238.
 Temper, types of, 65.
 Temperance-teaching, 68; gone mad, 49.
 Temperature sense, 252.
 Temperatures of the ocean, 291.
 Tertuue, J. Temperance-teaching, 68.
 Thackeray's Letters, 175.
 Theosophical movement in India, 261.
 Thomson, G. M. Acclimatization in New Zealand,
 170.
 Thoreau's Journal, 286.
 Thought-phantasms, 138.
 Thought-transference fraud, 229.
 Thring, Edward, death of, 253.
 Thrush, new species of, 108.
 Thurston, R. H. Armor for land defences, 124; tech-
 nical education, 73.
 Thwing's The Family, 293.
 Tidy's Treatment of Sewage, 117.
 Timbuktu, 213.
 Time necessary to perceive cold and heat, 79.
 Tolens an historical nationality, 231.
 Topography, 152.
 Tornado power, 48, 60, 323.
 Townsend, C. H. Natural history notes on Alaska,
 170.
 Trumpet-creepers, 204, 216, 240.
 Tunis, stone age in, 133.
 Typhoid-fever, cause of, 198; contagion, 221; epi-
 demic at Plymouth, 314.
 U.
 Universities, British, 210.
 University of New Zealand, 12.
 Upcott's Greek Sculpture, 140.
 Upham's Upper Beaches of the Glacial Lake Agas-
 sis, 103.

V.
 Vessels, speed of, 249.
 Vital statistics in Massachusetts, 213.
 Volapük, 10, 24, 140.
 W.
 Wadsworth, M. E. Keweenaw system, 166.
 Waldo, F. Meteorological observations above the
 earth's surface, 33; Wind-register, 309.
 Wall's Natural History of Thought, 163.
 Ward's Flora of the Laramie Group, 150.
 Waters, G. F. Color-blindness, 179.
 Waterspouts, 32.
 Wave, the Umbria's, 193.
 Weather-predictions, 322.
 Wells, The, 189.
 Wheat, Indian, 314.
 Wheat-crop of India, 253.
 Wheeler, W. M. *Grindelia glutinosa*, 180.
 Whitcher, G. M. Purslane-worm, 225.
 White's Laramie Molluscan Fauna, 126.
 Whooping-cough in the cat, 35.
 Wilson, C. Cheyenne, 239, 264.
 Wilson, J. D. Indian names, 252.
 Wilson's Studies in Life and Sense, 20.
 Wind-pressure, 118, 132.
 Wind-register, 309.
 Wood's Die Klimate der Erde, 127.
 Wolff, A. R. Wind-pressure, 132.
 Wollny's Grundriss der Psychologie, 238.
 Women, 10.
 Wood's Natural Law in the Business World, 286.
 Wounds healed by mental impressions, 163.
 Wurtz's Psychologie, 305.
 Wurtz's Elements of Modern Chemistry, 191.
 Y.
 Yellow-fever at Tampa, 214, 221, 247.
 Yemen, explorations in, 203.
 Yukon, survey of, 163.
 Z.
 Zoologischer Jahresbericht, 151.

LIST OF ILLUSTRATIONS.

	PAGE		PAGE
Africa, Central, Junker's explorations in	54	Salt marshes in Tssaidam	64
Asia, sketch-map showing shortest routes from the United States to	16	Sand-hills	63
Eastern	97	Science at the American Association (7 figs.)	167, 168
Baird, Spencer F.	97	Sibley College extension (5 figs.)	158, 159, 160
Clark, Alvan	233	Stone dagger from Missouri	192
Cumberland Sound, ice-chart of	168	Tachycinetæ, maxillo-palatines of	232
Diamond, North Carolina	141	Temperatures of the Pacific Ocean	252
Diamond-field in Kentucky	69, 70	Theosophical brothers, annual congress of, in India	51, 52
Diamonds, four large South African (41 figs.)	24	Topographical survey of the United States (3 figs.)	82, 83, 84
Earthquake, Sonora	23, 24	University of Nebraska, chemical laboratory of (5 figs.)	309
Earthquakes, depth of (3 figs.)	156	Wind-register	309
Fossils, chalcedonized (2 figs.)	42		
Kongo Basin, map of	33, 34	Arctic America, map of north-eastern	opposite 3
Meteorological observations above the earth's surface (2 figs.)	33	Asia, Central	opposite 62
Mounds, Ohio	146, 147	Far West, early map of	opposite 217
Mummies, Western (4 figs.)	57	Nicaragua Ship-Canal	opposite 182
Muscle, dermo-tensor patagii	149	Snow Hall of Natural History, Lawrence, Kan	opposite 314
New Guinea, explorations in	71	Temperatures of the Atlantic Ocean	opposite 289
Pars proptagialis musculi oculi			

SCIENCE

AN ILLUSTRATED JOURNAL PUBLISHED WEEKLY.

Vérité sans peur.

NEW YORK: THE SCIENCE COMPANY.

FRIDAY, JULY 1, 1887.

WE HAVE THE PLEASURE of informing our readers that a step long considered desirable has been taken. The price of *Science* has been reduced to \$3.50. This has been rendered possible by the improving position of the paper financially, and by taking a form which saves largely in the items which make up the cost of manufacture. The saving in paper by making the page nearly double the size of the old *Science* page allows a saving of many hundred dollars each year, which would otherwise be spent on white paper for extra margins. We mention this as an item little suspected by most people. Each subscriber will find that his subscription has been extended *pro rata*.

THE ACT TO REGULATE the licensing and registration of physicians and surgeons, and to codify the medical laws of the State of New York, has been signed by the governor, and is now a law. By Section 9 of the act, all pre-existing laws relating to these subjects are repealed; so that to this single act physicians, attorneys, and courts must hereafter look for the regulation of the practice of medicine in this State. It is gratifying to find that this act is indorsed by all the different schools of medicine, and that the only opposition made to it has come from those who believe that the power of healing by the laying-on of hands is likely to be diminished or impaired by the course of study required by the medical colleges. We are glad to see that the objection which we had to make to one of the sections in the act of 1880 is thoroughly and satisfactorily met in the present law. Physicians may hereafter practise in other counties than that in which they first registered, by simply mailing to the county clerk their certificates of registration. Upon this an indorsement will be made which will render practice in the new county legal. Provision is also made by which registered physicians can attend isolated cases in other counties without re-registration, provided they do not intend to habitually practise in such counties. By another section of the act, no person can be licensed or permitted to practise who has been convicted of a felony by any court of competent jurisdiction; and conviction of a felony cancels the license, if one has been granted. We are informed that there is now practising in New York one who has served three terms of imprisonment for criminal practice. The following offences are also punishable under this law: perjury, in false affidavit of registry; counterfeiting, buying, selling, and altering diplomas, or practising under counterfeited diplomas; or falsely personating another practitioner. It is not improbable that this act may in the future require some modification; indeed, it would be strange if it did not; but the medical profession is to be congratulated on having all the laws pertaining to it codified, and thus enabling its members to ascertain their privileges and responsibilities without searching through the session-laws of many years. To Mr. W. A. Purrington, counsel for the medical societies of the State and county of New York, much credit is due for the skill with which this act is drawn, and for his persistence in urging the measure upon the legislative and executive branches of the State government.

THE NINETEENTH ANNUAL co-operative congress of delegates from co-operative societies in Great Britain and Ireland has closed its session at Carlisle. An exhibition was held in connection with the meeting, which included products purchased or imported by the wholesale for distribution to the retail societies. The exhibits indicated the strength of distributive co-operation in the power to purchase on the largest scale from producers or importers. There were also fabrics and manufactured articles which indicated the advance of co-operative production. It is in this sphere of production that the question is raised whether the benefit of co-operation embraces the working producers as well as the consumers; whether spinners, weavers, and dyers, tailors, needlewomen, and shoemakers, are really co-operative producers, or wage-earners having no interest in the sale of that which they produce. The voluminous returns made to the congress throw much light on the present position of co-operative production. There are in England fifty-eight productive societies, and they make cotton-cloth, elastic web, flannel, hosiery, quilts, table-covers, worsted, boots and shoes, galvanized ware, nails, watches, cutlery, locks, baking-powder, portmanteaus, trunks, and biscuits. Scotland has eight such societies. Last year these sixty-six societies sold goods to the amount of £1,817,000, and the net profit was £74,000. Of this profit, £24,871 was paid on share capital, over £1,913 was paid to labor by seventeen societies, and £33,733 to purchasers. Mr. Thomas Hughes delivered an admirable address at the opening of the congress, summing up the past, and pointing out the future problems for co-operation to deal with. He said that the problem of distribution was already fairly solved, and that there is hardly any neighborhood, from John O'Groat to Land's End, to which co-operation has not penetrated. "Our membership," the speaker continued, "is numbered by millions, and the poorest member of the smallest society can now be sure that he gets as full value for every shilling he has to lay out as the richest. Co-operation has taught English working-men how to get full and fair value for the wages of their work: can it help them in like manner to get full and fair value for the work itself? This, Mr. Hughes asserts, is the pressing question, and it must be faced at once. He deprecates the solution of it in accordance with those who favor centralization rather than federation. He pressed this point very earnestly, and apparently with the approbation of a majority of the delegates to the congress. Lord Ripon, speaking in London just before the congress met, also urged the necessity of settling the question of co-operative production without having recourse to centralization.

AT THE RECENT graduation exercises of the St. Louis Manual-Training School, Professor Woodward pointed out the fact that the number of graduates was increasing each year. The first class numbered twenty-nine; the second, twenty-nine; the third, thirty-nine; the fourth, forty-five; and the fifth, fifty-two. Professor Woodward also enlarged upon the way in which the course of instruction at the school is organized. He showed that but one-third of the time is given to shop-work, and that it is distributed in such a way that the students acquire not so much dexterity in a single direction or in a few directions, as a knowledge of principles and methods in many directions. He protested against the assumption that the graduates of the school are skilled workmen in several crafts. They are simply better educated than their fellows who

have had no manual training. The St. Louis school has never received a dollar from either the city or the State, and, as Professor Woodward phrased it, "the director is gratified by the thought, that, in spite of its many shortcomings, the school has served to demonstrate the entire feasibility of incorporating intellectual and manual training in such a way that each is the gainer thereby, and that it has correctly read the public demand for a valuable mental discipline which shall at the same time insure the acquirement of knowledge and skill of intrinsic worth."

THE INCREASE OF STATE INTERFERENCE IN THE UNITED STATES. — I.

THE most casual newspaper-reader and observer of legislation must have had his attention attracted to a growing tendency in our legislation toward the regulation of private and personal concerns. We are aware, of course, that the term 'private and personal concerns' may be said to be more or less indefinite; but it is nevertheless true, that, as used by the majority of intelligent people, its content is, in a general way, understood and agreed to. It is in this generally accepted sense that we use it here.

A few weeks ago we editorially called the attention of the readers of *Science* to an article in which Dr. Albert Shaw of Minneapolis illustrated the tendency of which we speak, from recent legislation in Minnesota. Dr. Shaw gave a digest or summary of the session-laws of 1885 in his State, and pointed out not only the relatively large number of laws that may be put under the head of 'State interference,' but the great variety of subjects with which they attempted to deal.

It is our opinion that the majority of the American people are not aware of this tendency in legislation, and that many of those who are informed about it do not appreciate its real character, nor the result to which it logically leads. To arouse discussion on these points, as well as to secure more accurate data than have yet been laid before the general public, we have addressed letters to various students of legislation and political science in all parts of the country. In our correspondence we have presented four questions, as follows: 1. How far does the legislation in your State show a tendency similar to that observed in Minnesota? 2. In what new particulars is State interference being manifested? 3. Do you believe such interference to be advisable? 4. If not, what measures would you adopt to check it? It is the answers to these questions which we now desire to lay before our readers. As was to be expected, the different correspondents differ widely, both in standpoint and in method. In a few cases correspondents from the same State interpret the tendency of legislation in that State differently. The one considers it in the line of State interference, the other does not so view it. In a small number of cases the writers have considered the questions as affording them an opportunity to make an attack on protection, prohibition, or some similar question. These answers, involving as they do a begging of the question, are of no value for our discussion. But, setting aside a few such instances as these, the replies are of very great interest and value, and are of practical unanimity in stating that State interference is becoming more general in all parts of the country, and along pretty much the same lines. Granger legislation pure and simple, anti-co-operation legislation in general, and labor legislation, are the classes under which the vast majority of the laws indicating State interference may be brought. The question at issue is, we take it, twofold, involving, first, the conception of the powers and duties of the State; and, second, the application and use of these powers and duties. This has not always been comprehended by our correspondents. And, furthermore, for others than professed students of economics, it will require some thinking and investigation in order to take a position on the questions involved which shall be worth any thing. As Pres. Francis A. Walker writes, "For an out-and-out *laissez-faire* it is easy to dash off some highly obnoxious remarks on the subject of State interference; but for one who believes that the State has important functions, social and industrial, as well as political, it would require much time and thought to give a proper expression of one's views as to where State interference should begin, and where it should end."

Although the expressions of opinion which we have received come from all parts of the country, it will conduce to clearness if we discuss them by locality. For that reason we begin with the New England States.

In Maine it seems that the tendency referred to is quite noticeable, though it has only become so recently. Mr. F. E. Manson of the *Kennebec Journal*, Augusta, writes, that, until the Legislature of 1886 passed slight restrictive measures, there were no laws which regulated the formation of private and corporate concerns. Prof. A. E. Rogers of the State College at Orono designates three particular directions in which State interference is being manifested: (a) the increasing stringency of sumptuary laws, (b) the tendency to diffuse education among the masses, and (c) the increasing tendency to protect individual interests against corporate power. Professor Rogers is emphatically in favor of this development of State interference. He writes, "The government exists for the benefit of the people, and whatever, *all things considered*, conduces to their benefit, is in the province of the government. In the proposing and determining of legislation is the test of statesmanship. No fixed rule can be laid down as to what measures may or may not be undertaken." And then, with a bluntness that sounds like Patrick Henry, the professor defiantly adds, "If this smacks of socialism, so does the very organization of man into society, so does government itself."

From Massachusetts we have received a large number of replies; and it is extremely interesting to compare the views they take as to whether legislative interference is extending or not. Mr. Thomas Wentworth Higginson, himself a legislator as recently as 1881, does not believe that the tendency, while observable, has reached a dangerous point. He believes that the town organizations, with their jealousy of all centralization which curtails their powers, will effectually check State interference in Massachusetts. Mr. Higginson instances educational supervision in support of this position, and states that the strong feeling in the towns against State interference has thus far defeated all attempts to secure a more efficient supervision of the schools. Mr. Higginson believes that this local feeling is similar in force and character throughout New England, and attributes the increase of legislative interference in the Western States to the absence of the town organization, with its attendant local feeling.

Prof. John B. Clark of Smith College finds the tendency to have been stronger last year than this, and attributes the re-action to an effort on the part of conservative men to keep the growth of State interference within bounds. Professor Clark instances an arbitration bill (by which either party in a labor-dispute may secure a decision), an employers' liability bill (which makes employers responsible for the acts of their employees resulting in injury to other employees, in cases in which the common law would exempt them on the 'fellow-servant' principle), and a bill fixing uniform times for meal-hours in the case of factory-employees, as examples of the most recent manifestations of State interference. Professor Taussig of Harvard adds to this list certain legislation regarding food-adulteration, but fails to find any distinct tendency toward an increase of legislative interference, save in the case of labor-troubles. Professor Perry of Williams College is of the opinion that Massachusetts is, on the whole, true to "that sound political maxim, 'That government is best which governs least.'" He is inclined to believe that the tendency toward interference is for the most part exhausted in the introduction and push of bills of that general character, and exercises but slight influence on the positive enactments. Professor Perry defines State interference as "nothing but the interference of certain individuals for their own profit with the rights and property of their fellow-citizens in the alleged *name* of the State." We shall refer again to this definition, which seems to us to reach the kernel of the whole matter.

Another correspondent, Mr. Joshua H. Millett of Boston, finds that Massachusetts legislation shows a very great increase in the number and variety of measures that may be styled 'interfering.' On the statute-book he finds laws very similar to those cited from Minnesota. "A *Wass* treat of almost every article of consumption and use," writes Mr. Millett. Among the articles legislated about are butter, cheese, fish, bread, vinegar, hops, leather, ashes, milk, oil, gas, lumber, fertilizers, fruit, hay, marble, nails, and sewing-

80

Wood Is.
Humboldt
Glacier

G F



ARCTIC AMERICA

ON A SCALE OF 1:10,000,000

By DR. F. BRAS

EASTERN SHEET

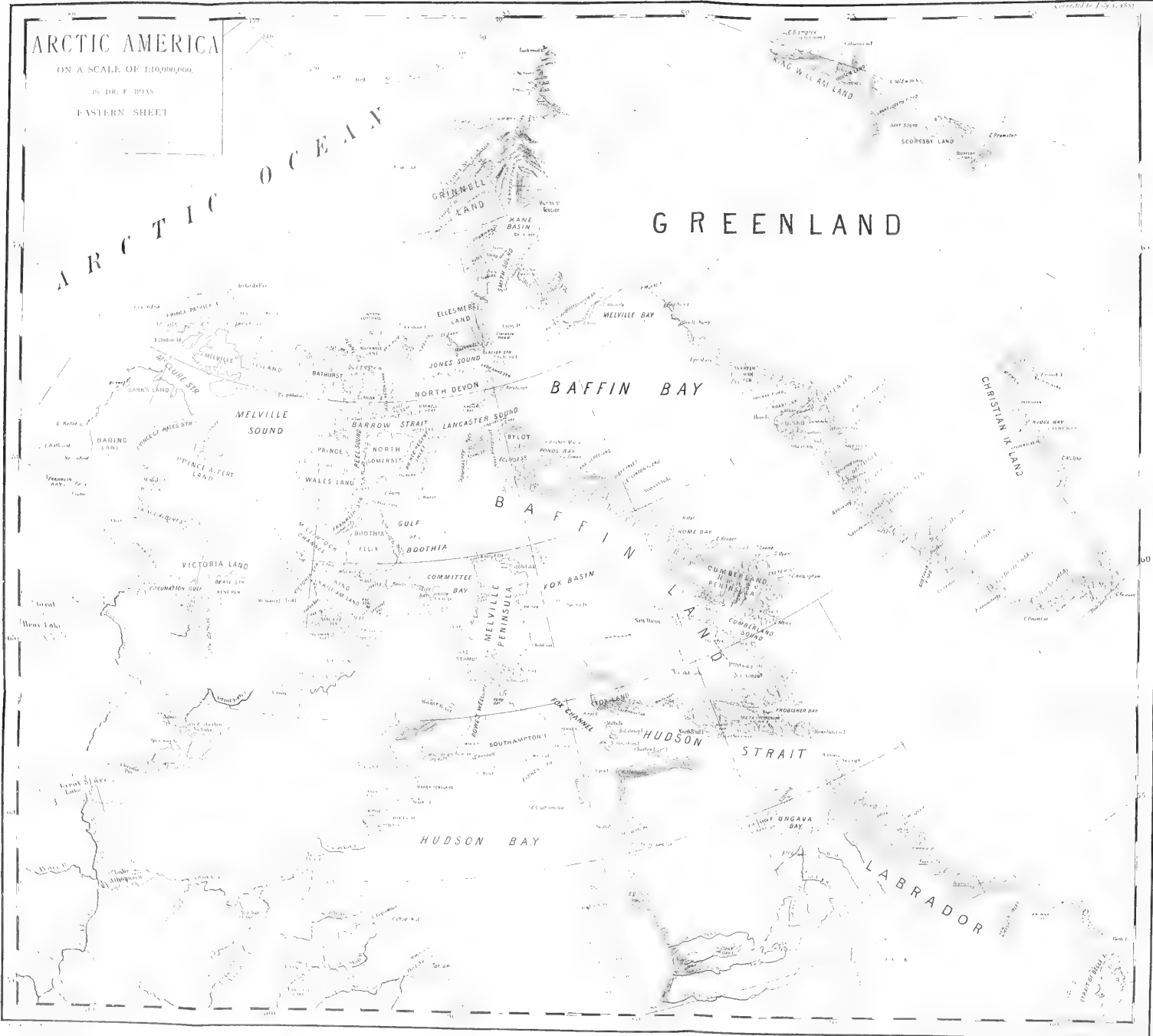

Corrected to July 1, 1887.

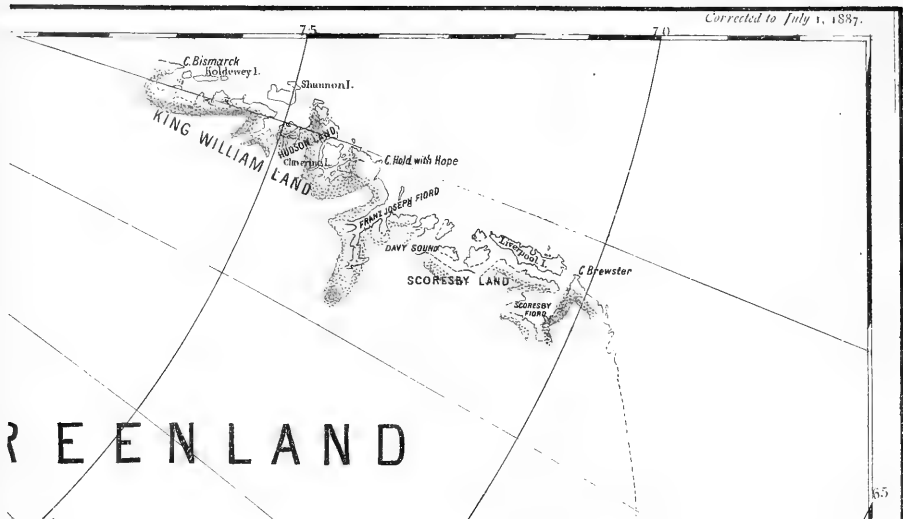

GREENLAND

65

thread. The State gives bounties to agricultural societies. The practice is extending of bringing all places of resort and amusement under the control of the State. In 1885 an act was passed, permitting municipalities to control skating-rinks, in order that the attendance might be regulated irrespective of sex and age. A recent law prohibits minors under the age of eighteen from working more than sixty hours a week in mercantile establishments. A weekly-payment law was passed in 1886.

Dr. Davis R. Dewey of the Massachusetts Institute of Technology finds that "the tendency of the statutes toward State interference is not so marked in Massachusetts as in Minnesota." From 1866 on, each year has seen an extension of legislation in the direction of control over employers.

Dr. E. W. Bemis of Springfield writes that "there has been a steady increase of State action during the past ten years in Massachusetts. This increase has been chiefly in matters of monopoly regulation, sanitation, education, and labor legislation. There has been no marked interference with the ordinary business or domestic life of the people, but the State has been called upon to control for the public good, large and otherwise irresponsible corporate bodies, and to protect the weak and ignorant." Dr. Bemis relates a case in which the New Haven and Northampton Railroad objected to the advice of the railroad commission to establish a depot in the town of Whately, Mass., through which the road ran. The commission thereupon ordered the depot built, and said, "The mistake of the railroad-managers in such cases is in supposing that the interests of the stockholders are paramount, and that the earning of dividends is the sole object to be sought in operating a road. Our supreme court has said more than once that a railroad-corporation is erected mainly for the public benefit, and only incidentally for its own profit. And because directors are liable to take a wrong view of their duties, the State reserves full control, and delegates to its agents the power of supervising the operation of these corporations." The State has a savings-bank commission with similar powers and duties. In 1885 a gas commission was organized, the function of which is, upon the complaint of the mayor of a city or the selectmen of a town in which a gas company is located, or of twenty customers of such a company, relative to the quality or price of the gas, to give a public hearing, and order such reduction in price or improvement in quality as seems best. And in Worcester this provision has been applied, and a reduction in price from two dollars and a quarter to a dollar and a half a thousand cubic feet was ordered by the commission. Thus, at one blow, the gas company's income was reduced by more than fifty-six thousand dollars per year. Dr. Bemis further states that more than four-fifths of the area, and probably two-thirds of the population, of the State, are under local prohibition.

Dr. Bemis sees no occasion for alarm in the progress of this tendency, because it has only passed into practice in "such cases as the condition of the times seems to demand."

[To be continued.]

THE EXPLORATION OF ARCTIC AMERICA.

The map accompanying the present number of *Science* shows the present state of our knowledge of north-eastern Arctic America. During the last ten years very little has been added to our knowledge of this vast territory as compared to the period from 1845 to 1870. It was during that time that the search for Franklin resulted in the thorough exploration of the Arctic American Archipelago, in the discovery of the waters north of Smith Sound, and the discovery of the unknown parts of the coast of the continent. Though English expeditions did the greatest part of this work, we Americans may boast of names and discoveries not inferior to theirs: de Haven, Kane, Hayes, Hall, are names that will always be remembered in the history of arctic exploration. The names of American patrons of science, such as Grinnell's, are justly given to lands and seas discovered by the expeditions they had sent out.

After the period of lively activity in the Arctic regions, a relapse ensued, and the noteworthy expeditions since 1870 are, very few. The German expedition to East Greenland explored part of north-eastern Greenland, and discovered the large fiords of that coast. It is only since last year that the important results of

Holm's expedition in 1884-85, on the east coast of Greenland, are known. He discovered the ragged coast of Christian IX. Land. Danish explorers are continually adding to our knowledge of West Greenland. Nordenskiöld's remarkable journey into the interior of Greenland was made in 1883. However, it is in the Smith Sound region that the most important additions to our knowledge have been made. Every new expedition pushed the limit of the unknown area farther north. Bessels' tide-observations made on the 'Polaris' expedition first established the insularity of Greenland by showing that the Atlantic tide enters Robeson Channel from the north. The important explorations of the expeditions of Nares and Greely need hardly be mentioned. The explorations in the other parts of Arctic America are of no great importance. Hall's observations from 1864 to 1869, which were published only lately, gave corrections for several parts of the American coast; Schwatka's bold march to King William Land added a few details to that part of the map. A few scattered surveys by whalers, principally those of the enterprising Captain Spicer of New London in Fox Basin and Hudson Strait, are embodied in our map. Last we have to mention the German surveys on the east coast of Baffin Land.

How little is this as compared to the results of former years! And how much is still to be done! On looking at our map, it might seem as though the coasts and part of the interior were well known, but all maps are deceptive in this respect. In many instances we do not know the sources from which the information contained in the map was derived, and consequently are unable to test their accuracy; but wherever this was done, the maps proved to be utterly unreliable. A few weeks ago we mentioned the journey of Missionary Peck from Richmond Gulf on the west coast of Labrador, to Ungava Bay, by way of Seal Lake and Freshwater Lake. He reported that no such rivers and lakes exist as shown on our maps; yet we have to do the best we can, and reproduce what former maps contain, as it comes nearest to the real configuration of the land. Colonel Gilder informs us that the coast near Chesterfield Inlet is not at all similar to the map, but we have no means of correcting it. Is it necessary to point out a few other inaccuracies of the map? We do not know the configuration of Ungava Bay and the north-western half of Labrador; Wager River, on the west coast of Hudson Bay, and the north coast of Hudson Strait, are practically unknown; Eclipse Sound, on the west coast of Baffin Bay, is drawn from a rough sketch, without any actual survey, and so is Admiralty Inlet; and the vast territories in the interior of the islands and continent have not yet been visited by any scientific man. In short, there is not a square inch on this map on which important discoveries might not be made.

However, these are 'polar regions;' and it seems that, after the sad experiences of de Long's and Greely's expeditions, the mere word 'polar' is sufficient to suppress all interest in such explorations. The ideas conveyed by the word are of ships crushed by ice, and a party starving on an ice-field or devoured by ferocious polar bears. But this is a gross misconception of what polar exploration is and ought to be. Its object is the thorough exploration of the Arctic region and of all its phenomena. In order to attain this object, it is not necessary to organize adventurous expeditions the sole object of which is to push north and gain a few miles upon predecessors. The exploration of the polar regions is not a work for the bold and daring adventurer: it is the task of the careful scientist, who knows thoroughly what science will profit by every mile gained and by the study of all the phenomena of regions often passed by ships or never visited by man.

We will draw attention to some geographical problems which offer themselves in the vast area shown in our map, and which can be solved without incurring great expense or great danger. The problem which is of greatest importance is the exploration of the islands west of Smith Sound. There are two starting-points for such expeditions,—Hayes Sound and Jones Sound. Eskimo reports lead us to suppose that Hayes Sound forms a strait leading to the western ocean; but, even if this be not the case, Greely's expedition across the isthmus between Archer Fiord and Greely Fiord shows that it would not be difficult to reach the west coast. Jones Sound is easier of access. It has only been visited twice,—by Belcher and Ingfield on a short trip,—and no serious attempt has been made to explore its western continuation. From Eskimo

reports it would seem that it is closed, as indicated on our map; and seal and walrus are said to abound in its western part, which is formed by low land. If this information is correct, this would be an excellent starting-point for the exploration of the archipelago west of Ellesmere Land and the west coast of this large island. Such an expedition would not be very expensive, and almost without danger. The American expeditions of Schwatka and Hall show that sledging in the Arctic is the most successful and least dangerous way of making explorations. This district is of the greatest importance from a geographical point of view, forming the northern limit of the American continent. It will be very interesting to know the configuration of this district and its extent towards the north-west. The study of this region will show how far the heavy ice met with at the outskirts of the Arctic islands extends south-eastward.

Another exploration which might be easily accomplished is that of Fox Basin and Hudson Strait. A ship stationed in these waters for two years might solve all important questions of that country. Ethnologists wish for an exploration of the central parts of the Arctic coast, particularly between King William Land and the Mackenzie, where the Eskimos may be studied uninfluenced by Europeans. These are tasks for American travellers. But where is the patron to-day who would encourage and support such enterprises? Who will be the next to carry north the little Henry Grinnell flag, which waved in so many parts of Arctic America? The means which are required to carry on such researches are so small that they will not hinder the resuming of the work as soon as it may be considered desirable.

Such work is not the adventurous 'polar expedition,' the only aim of which is to push north; but these explorations will enable us to go on step by step, and to reach the unknown regions of the Arctic Basin without running great risks. Explorations in Jones Sound will show how far we can go. East Greenland offers a safe basis for expeditions towards the north, and so does Franz Joseph Land. Hazardous expeditions into the open ocean without the shelter of land and without any line of retreat, such as de Long's expedition, must be abandoned, as they will almost always end in disaster. The exploration of the pole is not a work for a single adventurous expedition, however lucky and successful it may be, for the risk such travellers run is not adequate to the probable results. Progress must be made cautiously, and founded on the discoveries and experiences of past expeditions: therefore we believe that spasmodical efforts now in East Greenland, now in Smith Sound, now in Franz Joseph Land, are not desirable, but that one plan ought to be pursued by Arctic explorers. It is only thus that scientific results can be obtained.

The problems which must be solved in the Arctic regions are numerous and important. It is more than curiosity if we desire to know the outlines and the interior of the Arctic and Antarctic islands and continents; for without this knowledge geographical science is imperfect. We must know it, if we want to understand the circulation of the oceans and of the air; and researches in the Arctic are indispensable for the study of terrestrial magnetism. It is sufficient to mention these facts. Even commerce will profit by such expeditions. The produce of whale-fishery adds yearly considerably to our national wealth, and by new expeditions new hunting-grounds have always been opened. Many other resources of the Arctic Ocean are not yet made use of. There are enormous herds of walrus in regions easy of access, there are the lakes and rivers abounding in salmon, there is the valuable fur of the black fox and polar bear, and, though the commercial interest will always be of secondary importance in such enterprises, we must not overlook it.

Our map teaches that the problems of arctic exploration must not be looked for in the extreme north alone. The coasts of Arctic America and its numerous islands are a field for travellers which will yield important results for years to come. The explorer of these regions will contribute not less to science than the adventurous traveller who seeks to reach the pole, and his work will be surer of success, and accomplished with less danger and at smaller expense. We hope that researches in these regions will soon be taken up again, and that we may soon see American explorers again at work in this field.

DISTILLERY-MILK REPORT.—IV.

Bibliography.

IN the replies received from our correspondents in answer to the circular letter, references are made to the following authorities, from which we make liberal quotations:—

Manual of Cattle-Feeding. By HENRY P. ARMSBY, Ph.D. New York, Wiley, 1887.

In the manufacture of distilled liquors, the first stages of the process are essentially the same as in the preparation of malt liquors, but after the fermentation the mash is subjected to distillation to separate the alcohol. The residue remaining in the still constitutes distillers' grains, or 'slump.' This has much the same composition as brewers' grains, except that it is more watery, containing only about eight or nine per cent of dry matter. Like brewers' grains, it has lost chiefly non-nitrogenous matters: it consequently has a narrow nutritive ratio, and is a valuable addition to fodder poor in proteine. Moreover, it contains a considerable proportion of mineral matters, which may be of advantage under some circumstances. Distillers' grains are best adapted for cattle, and yield excellent results in fattening or feeding for milk when rightly used. For sheep, hogs, and horses, they are not well suited. In using this feeding-stuff, its watery nature should not be forgotten. Its relatively large proportion of proteine renders it a suitable addition to a fodder deficient in this nutrient; while, on the other hand, the health of the animals requires the addition to the 'slump' of some dry, coarse fodder, like hay or straw. A poor quality of coarse fodder may be rendered more palatable to cattle by saturating it with distillers' grains, and thus the watriness of the one fodder, and the poverty of the other as regards proteine, can be simultaneously corrected. Used in this way, distillers' grains constitute a perfectly healthy fodder. Much of the common prejudice against the use of distillery slops appears to be occasioned by their irrational application, and frequently by the filthy surroundings of the animals, rather than by any thing injurious in the feeding-stuff itself.

'Milk: its Adulterations, Analysis, etc.' By JOHN MORRIS, M.D. (*Maryland Medical Journal*, June 15, 1882.)

Of all the nutrients employed to rear children deprived of natural food (the mother's breast), I know no one more pernicious than the swill-milk sold in all large cities. Children fed with it appear to thrive and fatten, but their real vitality is much less than that found in those properly nourished. What seems to be fat is merely adipose tissue, just as is seen in chronic ale and beer drinkers, who are also deficient in vitality, and unable to withstand attacks of disease, endure privation or great suffering. During the summer months, cholera-infantum plays sad havoc among swill-fed children. Frequently after a few hours' illness they fall into a state of extreme prostration, collapse and death following rapidly. From the want of tissue-making food, they lack the vital force already alluded to, and all the efforts of the physician to arrest the disease and restore their impaired strength prove unavailing. The infant mortality in our large cities may be attributed in a great measure, I am convinced, to the employment of milk from cows improperly fed.

The draymen connected with the breweries of London are the most unhealthy body of men to be found anywhere. These men have the unlimited privilege of the brewery cellar. Though apparently models of health and strength, the slightest accident that befalls them generally proves fatal. Sir Astley Cooper mentions a case of a drayman, a powerful, flesh-colored, healthy-looking man, who received a slight injury from the splinter of a stave. The wound was trifling, but it suppurated. Sir Astley opened the abscess, but in going away forgot his lancet. On returning to get it, he found the man dying. Beer-drinkers, when attacked by any acute disease, are unable to bear the proper treatment necessary, and consequently die. They cannot undergo the slightest surgical operation with safety. Dr. Buchan says, "Malt liquors render the blood sily and unfit for the circulation: hence proceeds obstruction and inflammation of the lungs. There are few great beer-drinkers who are not phthisical, brought on by the glutinous and indigestible nature of ale and porter."

¹ Continued from Vol. IX., p. 604.

So it is with cattle fed with slops from distilleries: though, like Sir Astley Cooper's drayman, they look powerful and flesh-colored and healthy, and increase in size and weight, they are not truly healthy, and the increase in weight is not due to additional muscle or genuine fat. What appears to be fat is a soft, flabby degeneration of tissue, and, if they are exposed to hardship or attacked by disease, will at once succumb.

In conversation with Mr. Outerbridge Horsey of Frederick County, a well-known farmer and distiller, I gleaned some practical hints in regard to the use of swill in feeding cows. Mr. H. does not believe that it is injurious if given in proper quantities and in combination with grasses or other food. He has abandoned feeding his own cows with it, however, for the reason that it imparts a peculiar odor to the milk, and notably to the butter. This is no doubt the case, for there is a particular pungency in this character of food. Therefore milk from cows fed on swill cannot be made into condensed milk, for such milk when condensed has a rank smell and a bitter taste. The swill, if given in large quantities and for a length of time, exercises a very pernicious influence on some of the organs of the body. The teeth fall out, and it is said that the tails atrophy and loosen. If this be the case, I cannot explain the exact cause. It is a necrosis, and must be due to some poisonous element in the food. Nearly fifty per cent of the inorganic elements in swill is composed of phosphoric acid; but, as the inorganic elements are scarcely five per cent of the whole, I can hardly ascribe the degeneration which takes place to the excess of phosphoric acid. According to Fownes, the inorganic elements of milk are 4.91 parts in the 1,000, as follows:—

- 2.31 Phos. calcium.
- .42 Phos. magnesium.
- .07 Phos. iron.
- 1.44 Chlor. potassium.
- .24 Chlor. sodium.
- .42 Sodium and caseine.

4.91

This gives a little more than one part in a thousand of phosphoric acid,—in normal milk a very small quantity indeed. It may be possible that the necrosis is due to the heat of the swill, for the teeth of pigs become decayed from this cause. Cows do not like the hot food at first, but after a time become exceedingly fond of it,—so fond that they do not care to partake of cold food. Mr. Peter G. Sauerwein relates to me a very singular circumstance in regard to this point. Whilst acting as revenue collector, the machinery of one of the distilleries in his district which supplied slop to the milkmen became deranged for several weeks. During this time the milkmen came daily to the distillery and filled their hogsheads with the boiling water, paying the same price for it that they usually paid for the same quantity of swill. They gave as a reason for this that their cattle were so used to hot food that they cared for nothing else.

Swill, if used judiciously, that is, in combination with good grasses or cereals, is not injurious or objectionable. It serves the purpose of the glass of ale or porter to the nursing mother; that is, it increases the quantity of milk, but I do not believe it improves the quality. There is another form of food given to cattle still more deleterious than swill; viz., the *débris* or refuse left after the extraction of glucose from corn. This is highly injurious, if not poisonous. Fortunately there is not much of this to be procured in Baltimore, as we have but one glucose-factory in our midst; but it is given very freely to cattle in Buffalo and Chicago, where immense quantities of glucose are manufactured.

Inasmuch as the analyses of swill made by different chemists show it to be rich in certain forms of food-elements, it may be asked, why is it so injurious to cows? This is a question more easily asked than answered. The alcohol and fusel-oil which ordinary swill contains are not sufficient to produce the bad results which it is asserted follows its liberal use. Can it be that the excess of nitrogenous and albuminoid substances in this form of food lead to non-assimilation, or other functional disturbances, thus proving its unfitness for the animal economy? Experience is certainly more important than mere chemistry, and therefore the judgment of those feeding cows as well as those consuming the milk must determine

the whole question. Popular prejudice, which in many cases is founded on ignorance, or mere science independent of experience, should not be allowed to determine a matter of this character. Whilst I myself do not think swill proper food for cows, except, as I have before stated, in small quantities and in judicious combination with grasses, and whilst I think that swill-milk is equally unfit for children, I am willing to give those entertaining different views a candid hearing.

Analyses have been recently made, at the instance of those largely interested in this matter, of the swill fed to cows, and also of the milk resulting from its use. These analyses are by two well-known chemists,—Professor Simon of this city, and Mr. Peter Collier of the Department of Agriculture, Washington. Professor Simon furnishes the results of the analyses of three samples of milk,—the first drawn by himself at the stables of Messrs. M. Crichton & Co., from different cows, on April 7, 1882; No. 2 sample bought from Pikesville Dairy Company; No. 3 sample bought from a store in the south-eastern section of Baltimore.

Specific Gravity. 100 Parts Milk contain	No. 1. 1.029	No. 2. 1.031	No. 3. 1.026
Water.....	86.47	87.12	89.93
Fat.....	3.77	3.40	1.45
Caseine.....	4.44	4.23	3.83
Milk-sugar.....	4.56	4.51	4.16
Ash.....	0.76	0.74	0.63
	100.00	100.00	100.00

Mr. Simon says, "In looking over the results of my analyses, you will see at once that the sample drawn by myself from your 'swilled' cows compares most favorably with sample No. 2, produced by cows receiving no distillery refuse. Both these samples represent very good milk; and especially No. 1 is, in the amount of cream and total solids, far above the average milk.

"No. 3 sample represents an adulterated article, from which no doubt not only cream had been removed, but to which also some water had been added. I selected this sample out of about two dozen samples, brought from different dealers, as the worst milk which has come under my notice."

Professor Simon furnishes the result of an analysis of swill drawn by himself from about 1,000 gallons at the Melrose distillery on March 6, 1882.

One hundred parts of sample contain of—

A. Volatile products (expelled at 212° F.).....	94.63
B. Organic matter.....	4.83
C. Inorganic matter (ashes).....	0.54
	100.00

ANALYSIS OF PORTION A.

Volatile Products.

Water.....	99.74
Alcohol.....	0.08
Fusel-oil (chiefly amylic alcohol).....	0.12
Loss.....	0.06
	100.00

ANALYSIS OF PORTION B.

Organic Matter.

Starch isomers.....	26.68
Cellulose.....	23.83
Albuminoids.....	25.30
Gum.....	6.73
Sugar.....	5.44
Fats.....	7.37
Glycerine.....	1.20
Organic acids.....	1.46
Extractive and coloring matter.....	1.14
Loss and not determined.....	0.35
	100.00

51.98 flesh-producing food.

20.68 fat-producing food.

ANALYSIS OF PORTION C.

Inorganic Matter.

Phosphoric acid.....	48.63
Sulphuric acid.....	1.80
Silicic acid.....	2.22
Chlorine.....	0.20
Carbonic acid.....	5.06
Potash.....	20.14
Soda.....	8.47
Lime.....	6.12
Magnesia.....	7.10
Oxide of iron.....	Traces
Loss.....	.26
	100.00

Mr. Simon says, in his note appended to the analysis, that "swill is a highly nutritious form of food, and that he sees nothing in its composition that could possibly work injury to cattle feeding on it."

The results obtained by Mr. Collier are very similar to those furnished by Professor Simon, but are even a little stronger in statement. He compares swill with corn and rye and other products, and shows that it is richer in food-elements, and decidedly richer than ensilage, which is so highly prized by certain cattle-feeders. In reply to interrogatories, Mr. Collier expresses the belief that swill is a wholesome and highly nutritious form of food, and can be given to cows with great advantage. He, however, adds that much will depend upon the amount given, the circumstances and surroundings, and the proper combination with other aliments.

The truth is, the whole matter in discussion hinges upon this last point, and Mr. Collier has not made it any clearer by his statements, however honestly made. It is to the physiologist, in my judgment, and not to the analytical chemist, that we must look for a scientific solution of the problem. Analytical chemistry serves but a feeble purpose in solving many important questions. By it butter and oleomargarine appear equally wholesome and nutritious; and it can detect but little difference in impurity between water-closet matter, and sewage from which excrement is excluded.

'Milk for Babes.' By E. M. NELSON, M.D. (*St. Louis Courier of Medicine*, May, 1883.)

In regard to the feeding of the cows, there is almost as much variation between different dairies as there is in regard to cleanliness. Nearly all the city dairies make use of the products of the breweries and distilleries as a considerable part of the feed of their cows. So far as the malted grain is concerned, perhaps nothing can be said in objection to its use as a part of the food. It is recommended by the best writers as a valuable and economical constituent of the food of milch-cows. The same cannot be said of the hot distillery swill. The effect of this food has been found by the best and most careful observers to be prejudicial to the health of cows, and to produce a milk that is lacking in nutritive quality as well as being specially liable to speedy change and fermentation. Mr. Lake, who was for many years the largest feeder of distillery swill in the city, asserted that cows fed on this article invariably become diseased within a period of six months, and the lungs show constantly the evidences of tubercular infiltration. Mr. Cabanne states, that, when he formerly fed swill in his own dairy, he butchered over one hundred and fifty cows, and never found one in which there was not tuberculous disease of the lungs.

'Our Milk-Supply.' By W. K. NEWTON, M.D. (*Fourth Annual Report of New Jersey State Board of Health*.)

Swill-milk is rarely heard of now, but not many years ago it was a fruitful cause of disease and death in children. Fearing that the lessons of the past may be forgotten, we are constrained to mention it as a possible cause of disease. Distillery swill, "if properly fed in limited quantities, in combination with other and more bulky food, may be a valuable article for the dairyman; but if given, as it too often is, without the addition of other kinds of food, it soon affects the health and constitution of the animals fed on it. Where this forms the principal food of milch-cows, the milk is of a poor quality: it contains often less than one per cent of butter, and seldom over one and three-tenths or one and one-half per cent. 15

effect on the system of young children is therefore very destructive, causing diseases of various kinds, and, if long continued, certain death. The adulteration of pure milk from the healthy cow by water, though dishonest and objectionable in the highest degree, is far less iniquitous in its consequences than the nefarious traffic in swill-milk, or milk produced from cows fed entirely on still-slops, from which they so become diseased, after which the milk contains a subtle poison, which is as difficult of detection, by any known process of chemistry, as the miasma of an atmosphere tainted with yellow-fever or cholera. The fact is sufficiently palpable, that no pure and healthy milk can be produced by an unhealthy and diseased animal, and that no animal can long remain healthy that is fed on an unnatural food, and treated in the manner too common around the distilleries of many large cities." (*C. L. Flint*, pp. 144, 208, 216.)

Where swill-milk was sold in New York a few years ago, "it was found different in alimentary character from that produced by cows that were fed on grass, hay, or grain. It was not so well digested in the stomach, nor had it the nutritive power to create flesh and sustain strength. The children lost flesh, and failed to gain it. Their skins were pallid, sometimes discolored and corrugated. Their countenances had the appearance of old age, rather than the bright and lively bloom of childhood. They suffered from diarrhoea and dysentery and great debility, and many died." (*Jarvis*.)

Fortunately, no swill-milk is sold in this State at the present time, but it is well for health officers to be on the lookout for it. The sale of it is, in this State, considered a misdemeanor, punishable by a fine of fifty dollars and imprisonment for thirty days. The laws of Massachusetts, New York, Michigan, and other States also forbid its sale.

'Report of Committee on City Milk.' By S. R. PERCY, M.D. (*Transactions New York Academy of Medicine*, Vol. II. Part IV., 1859.)

This report, which occupies fifty-three pages of the transactions, is the fullest statement of facts in connection with distillery swill and milk which we have seen. In June, 1858, the New York board of health adopted a resolution that the Academy of Medicine be requested to lay before the board such facts and evidence as they may have in relation to the milk furnished to the citizens of New York. The academy appointed a committee of five of its members, including Drs. B. Fordyce Barker and S. Raton Percy, and in March of the following year presented its report. The greater part of the labors of the committee was performed by Dr. Percy, and his report is the most valuable. It includes chemical analyses, which we have already given under that head, microscopic examinations and drawings, and cases of disease resulting from the use of distillery milk. Associated with Dr. Percy in his investigations was Mr. Solon Robinson, who had been long conversant with the raising and fattening of cattle, and Mr. Thomas Devoe, who had been long and extensively engaged in the slaughtering of cattle, and in supplying the markets with wholesome beef. Mr. Robinson accompanied the committee to the distillery stables, and, as the result of his observations, said, "From my personal experience in feeding cows with various agricultural products, and in producing milk and butter, I am well satisfied that cows fed as described, and kept in such an atmosphere as I could not remain in ten minutes without feeling severe sickness, must produce poisoned milk. And I do not consider the beef any more fit for human food than the milk; not so much on account of the bad food, as the poisonous atmosphere in which the poor brutes are confined. I would no sooner touch this swill-milk than I would use milk from the most 'milk-sick' region of Illinois." Mr. Devoe, in speaking of the quality of beef furnished by animals fed on distillery swill, says, "I have slaughtered, and seen slaughtered, the various kinds of animals that have been fed, wholly or partially, on this swill, which appears to have produced almost as many varieties of beef, and I think I may be better understood by placing them under three general heads; viz., first-class, second-class, and third-class. The first-class beef, no doubt, is produced from thrifty steers, fed in some of the distilleries in the northern counties of New York, where only a small portion, or the liquid portion, of the food, is swill; the rest being of meal, roots, hay, and grass; and, when brought to our markets in a fat,

healthy condition, their flesh proves to be tender, juicy beef, but not so firm or so sweet and well flavored as if wholly fed on grain, or even grass. The second-class beef is from animals wholly confined in these large distilleries, fed the greater portion on swill, with plenty of hay, and occasionally a little grain. I might add, that the Northern distillery swill is of a superior quality to that which is run into troughs at the various distilleries where it is sold by the hogshead or other particular quantities. These Northern distilleries own both the swill and the cattle, and the quantity of swill made by them is fed up clean. This second class of animals, although they may be fat, produce a softer quality of beef, not so well flavored, but juicy and tender. When they are slaughtered, the flesh will show or produce the peculiar smell attached to this beef. The third class is to be found in some of your neighboring distilleries, where the visitor could almost swear (unless he could see the hay given to the animals) that they had little else to eat than the thin, poor, and sometimes spoiled swill. The beef from the general run of the third class has a very peculiar, unpleasant smell, especially when slaughtered. I have known it so disagreeable as to create nausea, especially on opening the animal to take away the paunch or belly: this and some other parts I have sometimes opened to discover some signs of hay, and in some instances found none. This class of beef retains that smell, especially when cutting it up fresh into pieces, and also when cooking it. It is usually flabby or soft, and often appears adhesive or sticky, like very young veal that had not yet lost nature's first flesh. My conclusions and convictions were made up long before this subject was so strongly agitated, both as to the meat and milk of the distillery-fed cow, which I have considered under the third class; and these conclusions are that neither the milk nor the flesh of these animals can furnish healthy human food." The committee, in summarizing its labors, says that the beef produced from the animals fed in the distillery stables is unsavory, and easily recognized by its offensive odor; that the odor is not dissipated even by the process of cooking; and that the fibre is flaccid, and its cellular tissue is infiltrated with watery fluids instead of solid fat. The milk of these cows does not exhibit the characteristics of wholesome milk: it presents almost invariably an acid re-action. The cases collected by Dr. Percy demonstrate the fact, independent of any chemical examination or any *a priori* reasoning, that the milk procured from these swill-fed animals is injurious to those who use it. In view of the disclosures made, the committee states that it is evident that the traffic in the milk of swill-fed cows is one which is detrimental to the health of the community, and should be discontinued.

'Sanitary Control of the Food-Supply.' By W. K. NEWTON, M.D., health officer of Paterson, N.J. (*Third Annual Report of the State Board of Health of New Hampshire.*)

Distillery waste, and sometimes beer-grains, produce a quality of milk of low nutritive powers, and dangerous to infants.

References are also made to the following authorities: 'Milk-Cows and Dairy-Farming,' by C. L. Flint (Boston, 1874 and 1887); 'Infant Mortality,' by E. Jarvis (*Fourth Annual Report of State Board of Health of Massachusetts*); and 'Milk,' by C. F. Chandler (*Johnson's Cyclopaedia*).

[To be continued.]

BOOK—REVIEWS.

Preliminary Report of the Commission appointed by the University of Pennsylvania to investigate Modern Spiritualism in accordance with the Request of the late Henry Seybert. Philadelphia, Lippincott. 12°.

THAT peculiar medley of alleged fact and fanciful theory, of Occidental pseudo-science and Oriental mysticism, which goes by the name of 'Modern Spiritualism,' has been examined more or less frequently, publicly and ably. The advocates of the tenets which this belief imposes have given little attention to the adverse opinions, explaining them away by a piece of logic which would be admirable did it not need such frequent modification, and were it not so evidently manufactured for the purpose, and have vaunted and gloried over all their successful efforts, large and small, in securing proselytes. The commission, whose long-expected report

is now before the public, is most favorably constituted for receiving a hearing destined to be called authoritative, and for registering an important turning-point in the rather sad history of the modern movement. The commission takes its name and its resources from the fund intrusted to the University of Pennsylvania by the will of Henry Seybert, a strong believer in Spiritualism and its physical manifestations. The *personnelle* of the commission leaves nothing to be desired. Its members originally appointed were Dr. William Pepper, provost of the University of Pennsylvania, Profs. Joseph Leidy, George A. Koenig, Robert Ellis Thompson, and George S. Fullerton, all of the same university, and the eminent Shakspearian Dr. Horace Howard Furness. To these were afterward added Mr. Coleman Sellers, Drs. J. W. White, C. B. Knerr, and S. Weir Mitchell. The members individually expressed entire freedom from all prejudices against the subject, and readiness to accept any conclusion warranted by facts; Dr. Furness, moreover, confessed to a leaning in favor of the doctrine.

The method of work of the commission was to take a definite subject for investigation, invite both professional and non-professional mediums (had they been able to procure them) claiming the power of presenting the desired manifestations, and to meet them under fair conditions. The mediums were often exorbitant in their charges (asking a hundred dollars from the commission for what they would do for five for a private citizen), and arbitrary in their conditions. Nevertheless the commission has seen enough to tell a very important and a very interesting story.

They first looked out for a 'professional independent slate-writing medium.' This medium was to take a double slate firmly fastened together, with a bit of slate-pencil placed between, and produce writing on the previously blank slate, professedly the work of spirits in answer to questions addressed to them. Their first medium (a Mrs. Patterson) kept them waiting one hour and a half, and on another occasion one hour and twenty minutes; but the slates remained as clean as at first. Their next medium was the famous Dr. Henry Slade, with whom they had several sessions, all with the object of obtaining the slate-writing under conditions varying in detail, but not in principle, from that above described. Dr. Slade has two methods: for the long, clearly written messages, he substitutes at a favorable moment a prepared slate for the one given him; for the short, hardly legible messages, he in one way or another writes on the slate while hidden from view of the two or three observers (he allows no more) seated with him. Every particular of the process has at one time or another been seen by the committee. In fact, on the day when Dr. Slade received three hundred dollars in payment for his services, he was so excited that he could hardly sign the receipt; and the cause of this excitement was simply that shortly before, Dr. Furness had kicked over a slate placed at the foot of the table, and thus exposed the prepared writing upon it. In short, their verdict with regard to the doings of this their most famous medium is, "that the character of those which passed under our observation was fraudulent throughout. There was really no need of any elaborate method of investigation: close observation was all that was required."

Next with regard to rappings. Their preliminary conclusion reads that "the theory of the purely physiological origin of the sounds has been sustained by the fact that the mediums were invariably and confessedly cognizant of the rappings whenever they occurred, and could at once detect any spurious rappings, however exact and indistinguishable to all other ears might be the imitation."

The commission attempted to procure some 'spirit photographs,' but were asked three hundred dollars for this luxury, and were to be excluded from the room at the critical moment. They very properly refused any such terms.

The brother of the would-be photographer (Keeler is the family name) is also a medium. His specialty is to 'materialize' a right hand when apparently holding his neighbor's wrist with both his hands, and have this hand perform the usual simple tricks with the musical instruments, etc. The trick was afterwards repeated by one of the commission, and consists in really holding the wrist with one hand only, but producing the feeling in the owner of the wrist of its being clasped by both. The right hand is then free to do all the hocus-pocus.

Another medium did about the same thing with his hands apparently tied. That his hands were loose enough for all that was done, was glaringly evident.

Thus far the commission as a whole. Their verdict is everywhere the same: "No new facts and many, old frauds." Individually the members have seen much, in fact, more than the mediums intended. The experiences of Dr. Furness, the acting chairman, are especially interesting, and recorded with a humor that does much to relieve the monotony of this record of constant fraud and deceit. Dr. Furness was repeatedly assured by several Spiritualists that there was in him the making of a magnificent medium; and so he sacrificed himself for the cause, and 'sat for development.' Every day for six months Dr. Furness sat with a slate for half or three-quarters of an hour, and, in addition, constantly wore a bit of magnetized (!) blotting-paper on the top of his head, until he was allowed, by the dispensation of the medium under whose direction he was studying, to wear it around his neck. The paper had to be changed every twelve hours, and the medium received a dollar for each sheet. Although he was promised writing, or at least some zigzag lines, in three weeks at the utmost, at the end of six months 'not a zig nor a zag.' "Let spiritualistic reproaches of investigators, for lack of zeal and patience, be heaped up hereafter until 'ossa becomes a wart.' I care not: my withers are unwrung."

Dr. Furness next experimented with sealed letters. A question carefully sealed was sent to the medium, and the answer to the unopened letter returned. Many mediums were written to. They gave contradictory answers when asked the same question, and in every case the letter had been opened, and mutilage and skill been used to cover up the deception.

Dr. Furness's description of the materializing seances can only be appreciated when read in full. Everywhere he found fraud where he looked for honesty. The fraud is so gross, so easily made to leave its hiding-place and snatch the bait offered by an ingenious question, that it becomes ridiculous.

Professor Fullerton's account of the famous Zoellner investigations with Dr. Slade is a highly valuable contribution. He has personally examined Zoellner's confrères in the investigation, and finds that Zoellner was of unsound mind at the time; that Fechner was partially blind, and relied on Zoellner; that Scheibner was too myopic to see any thing, and was not quite satisfied with the seances; that Weber was old, and did not recognize the disabilities of his associates. On the evidence of these men, — deservedly honored in their own specialties, as they are, — without knowledge of the arts of a conjuror, has rested one of the most famous proofs of the truth of Spiritualism and its connection with the fourth dimension of space.

A device by which Dr. Knerr detected a fraud is too ingenious to be left unnoticed. He arranged a mirror about his person so that it reflected the hands of the medium at work on a slate under the table. He plainly saw the hand open the slate, read the question, and noiselessly write the answer, which the fair medium had the impudence to present to him the next minute as the work of departed spirits.

The mysteries and miracles that shape people's beliefs upon that which is most sacred to the human heart, thus resolve themselves, under the scrutiny of careful scientific observers, into a mass of vulgar frauds and low deceptions. The mystic theories and spiritual messages are 'disgusting cant;' the medium, a criminal.

The psychological process by which believers are convinced is the key to the secret of the success of Spiritualism: this is the problem that lies closest to the securing of that mental health with which such practices and beliefs are incompatible. If any one will recall the feelings of utter bewilderment on leaving for the first time a good performance of a professional trickster, and will imagine in addition that the things he holds dearest were at stake in the explanation of what he saw, he will easily understand the excited state of mind of a susceptible person on leaving a spiritualistic seance at which he has seen but not understood. If your friend is a believer, and urges your ignorance on to belief, you are apt to yield, and assume that credulous state of mind which accepts all and examines nothing. It is this state of mind that is to be prevented; it is this state of mind that is dangerous to mental sanity, that becomes morbidly hungry for something unusual, something mystic, something

occult. There can be no better check to the spread of this mental temperament (except, of course, a sound training in scientific reasoning) than such a report as this, of sincere, able, scholarly men, anxious to learn, and meeting only with practices for which the law provides the jail.

That these men have not yet exhausted the art of detecting deception is shown by the fact that they are confessedly unable to discover the methods by which a prestidigitateur performed slate-writing tricks in their presence: this needed more training than they as yet possess. But the magician confided his methods to one of the commission, and showed that they were simply tricks. This suggests the final point to be here noticed: this is, that the Spiritualists will have a roundabout way of explaining these frauds. They will say, "That does not prove that real manifestations do not exist." This the commission admit, but it makes it improbable in more ways than one. They claim that their explanations of how the things are done are rational from their point of view. They need the dark because darkness is negative; if the spirit takes on the peculiarities of the medium, that is a habit of the spirits; if the writing does not occur when the slate is looked at, it is because the magnetism of the eye is unfavorable; and so on, and so on. This is perfectly true. There is no proposition so absurd, no fancy so insane, as not to be capable of some kind of support, on the basis of some kind of a theory. But the logic upon which civilization is built is a marvellous network of mutually corroborating laws and observations, multiplying the probabilities of the truth of its conceptions in a geometrical ratio, and similarly dwindling into insignificance the possibility of theories opposed to its fundamental tenets. Of such a character are the explanations offered by the Spiritualists. They are not impossible in an extremely exact, ultimate sense. From a practical point of view, they are utterly impossible. But, after all, it is not the logic that convinces. It is because this system goes deeper, and appeals to the feelings, that it blinds its adherents to sense and reasoning.

The commission has done its work well, has set an excellent example in recording what they saw *accurately* (for all turns here, as in jugglers' tricks, upon the apparently most insignificant detail), in subjecting mediums to ingenious tests, in treating them courteously and sympathetically, as well as in exposing them plainly and mercilessly. The present report, though only a preliminary one, should do much to hasten that day, which Dr. Furness thinks not far distant, "when the more elevated class of Spiritualists will cast loose from all these physical manifestations, which, even if they be proved genuine, are but little removed from materialism; and eventually materializing seances, held on recurrent days and at fixed hours, will become unknown. JOSEPH JASTROW.

NOTES AND NEWS.

THE New York Electrical Society has decided to give an electrical exhibition in this city during the coming fall in the large exhibition-building of the American Institute. The exhibition will open Sept. 28, and continue to Dec. 3, 1887, and is intended to include all that relates to the science and application of electricity in its broadest sense. No electrical exhibition has ever been held in New York, and it is confidently believed that the one now to be given will attract a large number of visitors, both residents and from other cities. The American Institute has provided ample means to carry out the designs of the society, which is also assured of the co-operation of the American Institute of Electrical Engineers.

— The *Political Science Quarterly* for June is a splendid number, the articles covering important topics in economics, history, and administrative science. Dr. Seligman's masterly article on the interstate commerce law, an abstract of which was read before the American Economic Association, is the leading article in the number. It is sufficient to say that the paper amply sustains Dr. Seligman's reputation as a master of the railway question in all its phases. Prof. Woodrow Wilson writes on the study of administration; and William M. Sims, chamberlain of New York City, discusses municipal government, making generous use of his knowledge of the details of the municipal machinery of the metropolis. Professor Burgess's paper on the Culturconflict in

Prussia — by the way, why is not the perfectly familiar *Culturkampf* used in the title, instead of a word which is partly foreign in form, and wholly so in sound? — is the first clear and adequate description in English of that very significant and important movement in Prussia's political history. The book-reviews are as numerous and as well done as usual. We observe that a very severe criticism is passed on the volume on New York in the 'American Commonwealth' series. Prof. Richmond Smith reviews Prof. H. C. Adams's 'Public Debts' in a very appreciative manner, describing the book as "careful, scholarly, and extremely suggestive." We observe this sentence, which Professor Smith uses in speaking of the industrial effects of public debts: "Professor Adams's discussion is acute and logical, and, in my opinion, a distinct advance upon the treatment of the same question by Leroy-Beaulieu, the distinguished French financier."

— Some remarkable facts as to the change in the population of Alsace-Lorraine are brought out by the recent publication of the results of the census taken in those provinces in December, 1885. The statistics are published in the *Landes Zeitung*, the official journal in the provinces. It appears that in December, 1885, the total population was only 1,564,355 as compared with 1,566,670 five years before, — a decrease of 2,315 in five years. Classified according to nationality, there were in December, 1885, 1,368,711 natives of Alsace-Lorraine, 151,755 Germans from other parts of the empire, and 43,829 foreigners; whereas in December, 1880, the natives of Alsace-Lorraine numbered 1,418,025, and the immigrants from Germany only 114,797. So in five years the native population has decreased by 49,254, while the immigrants have increased by 36,958. The increasing emigration of the native population explains their falling-off; and the *Landes Zeitung* estimates, that, if the present rate of diminution continues, the native population will have disappeared entirely in less than thirty years.

LETTERS TO THE EDITOR.

. The attention of scientific men is called to the advantages of the correspondence columns of SCIENCE for placing promptly on record brief preliminary notices of their investigations. Twenty copies of the number containing his communication will be furnished free to any correspondent on request.

The editor will be glad to publish any queries consonant with the character of the journal.

Correspondents are requested to be as brief as possible. The writer's name is in all cases required as proof of good faith.

The Total Solar Eclipse of 1886.

THE following brief account is penned in order that it may be published in time to be of service to the observers of the eclipse of 1887.

It was found that by using rapid gelatine plates an exposure of one or two seconds was sufficient to show the details of the inner corona satisfactorily with an ordinary telescope-lens. With a portrait-lens the ratio of whose aperture to its focus was as one to five, one or two seconds' exposure showed the outer corona satisfactorily, as far as a distinct falling-off place in the light. This was at a distance of from 15' to 30' from the limb of the moon. Beyond that the light was very decidedly fainter, and was shown best by exposures with lenses of the same ratio, of from eight to forty seconds. This light extended to from one to two degrees from the moon's limb, was very faint, and seemed analogous in character to the zodiacal light. It was clearly not a mere reflection of the corona in the camera-lenses, as it did not extend over the moon's image, where it would, in that case, have been brightest. Measurements of the actinic brightness of different portions of the corona were made, which will appear in a subsequent paper.

The corona showed the usual short rays of light proceeding from the sun's poles, and from the south-western quadrant a very conspicuous ray, appearing like a hollow cone projected to a distance of some twenty minutes of arc. On one of the long-exposure plates it was noticed that this was crowned by a curious fountain-like structure, — three fine jets, about a minute in diameter, shooting up 35' to 40' from the moon's limb, curving round, and falling back towards the sun. On closer inspection, seven other jets were counted, all more or less well marked, and all proceeding from the summits of bright rays of the corona. Some of these returned towards the sun, but the majority faded away at about 30' distance from the limb. Unfortunately, only one of the plates was taken on

a sufficiently large scale, and with sufficient exposure, to show this phenomenon, and the whole appearance may therefore be due to defects in the gelatine film of that plate. But, as the markings are certainly on the plate, I have ventured to describe them; the more readily, as a somewhat analogous appearance, though on a smaller scale, is represented in Mr. Ranyard's 'Observations made during Total Solar Eclipses' (Memoirs of the Royal Astronomical Society, xli., Plate x.)

Passing from the corona to the prominences, a number of them were seen near the equator, on both sides of the moon; but the most conspicuous one of all was situated in the north-western quadrant. It extended to a height of about one hundred thousand miles, and had apparently a somewhat spiral structure. The spectra of the various prominences were shown very clearly by the prismatic camera. In the equatorial ones the hydrogen and H and K lines were prominent, superposed on a background of continuous spectrum; but in the large prominence the hydrogen lines were all absent, confirming Professor Tacchini's observation of its invisibility both before and after totality.

The H and K lines, however, were strongly marked; and it seems quite probable that numbers of prominences may escape ordinary observation by the spectroscopic method, merely because they shine only by the actinic radiations, and are hence invisible to the eye. The remedy for this difficulty would be, either to use a fluorescent eyepiece, or, better, to photograph them, instead of trusting merely to eye-observations. The position of the maximum density in the continuous spectrum of the prominences was found to be quite different from that of the corona. In the prominences and in the sun it is found to be not far from the G line, while in the corona it lies between G and F. This may indicate, that, besides the gaseous constituent, the corona is composed also of incandescent solid or liquid matter, which, while cooler than the sun, still shines by its own light. In this case, the position of the maximum might give us a hint as to the temperature of the corona.

Photometric measurements of the general light during totality were made, which, roughly stated, indicate a brightness equal to one candle at about 29 inches or 73.5 centimetres distance. Previous observations by Mr. W. O. Ross in 1870 had given 18.5 inches; and by Dr. J. C. Smith in 1878, 51.25 inches. It had been intended to make some observations on the actinic power of the sky during the eclipse, but unfortunately the plates reserved for this purpose were found to have been spoiled by the excessive moisture of the Grenada climate; so that no result was obtained. In some of the longer exposures, however, where a large field was used, portions of the landscape appeared upon the plates, showing that considerable actinic radiation was given out even during the total phase.

A large number of persons observed the shadow-bands, which appeared before and after totality. The general result of their observations indicated that the bands were about five inches wide and eight inches apart, that they were colored like the spectrum, and that they moved with a velocity comparable with that of an express-train; at all events, much faster than a man could run. Before totality the bands lay N. 12° W. and S. 12° E., and travelled west: after totality they lay N. 60° E. and S. 60° W., and travelled north-west. The wind during totality blew from the point S. 35° E.: during the partial phases it was blowing from six to nine miles an hour, but fell during the three minutes of totality to between two and four miles. The thermometer ceased rising as totality approached, but afterwards rose more rapidly. The extent of the effect produced on it amounted to .4° C. This figure may seem small, but it must be remembered that the fluctuation between sunrise and noon in these tropical islands in the summer season seldom exceeds two or three degrees.

In general results, the expedition may be said to have proved successful, although one of the most important instruments, the forty-foot photo-heliograph, failed to work, through lack of sunlight previous to totality, which prevented the application of the necessary adjustments to the mirror. It is hoped, however, that this omission will be in part rectified at the present eclipse, as a similar instrument, even better equipped, has been sent in charge of Professor Todd to Japan; and, if the weather favors, some excellent pictures should be the result.

W. H. PICKERING.

Harvard Observatory, Cambridge, June 23.

Women.

A LATE correspondent of yours is guilty of a species of bad taste, which happily is rapidly becoming extinct. It was once considered both clever and gentlemanly to speak of women as if they belonged to one of the lower orders of animals, but that period has now quite passed by. Remarks of such a kind are hardly ever met with in English publications, and seldom in those of this country within a certain range of longitude. I happened to see it stated lately in a book on etiquette that it was no longer considered good form to make insulting remarks about women, and, when a principle has reached that organ of distribution, it may be considered that it has already become pretty widely disseminated. The change is an agreeable one, not only to women, but also to the rather numerous class of chivalrous-minded men.

If women are not capable of a very high degree of intelligence, it can at least be maintained that they are capable of a higher degree than Americans. An English woman has written greater novels, and a Russian woman has made more important contributions to pure mathematics, than any American man. Neither women nor Americans have had very great incentives to intellectual work hitherto, but it is quite possible to hope that they will both play a more important rôle in the future than they have done in the past.

If women are more easily frightened than men, it is as easy to attribute it to a more sensitive organization as to any other cause. Poets and musicians are not as cool and collected in the presence of danger as firemen, nor white men as the American Indians. Many people consider that the delicately balanced nervous organization of the horse indicates as high a degree of development as is to be found in more phlegmatic and thick-skinned varieties of animals.

It is not surprising to find that your correspondent's bad taste is equalled by his bad logic. It is seldom that one finds in so short a space so many pretty specimens of unreason:—

1. The cockroach, when caught between two hot portions of metal, chose to jump down instead of walking over them. If it had broken its neck, and if the metal had not been so hot as to injure it, this conduct would have turned out to be very foolish; but, in fact, the cockroach ran away unhurt. The highest wisdom could not have dictated a more prudent course of conduct, and there is hence no analogy to a case of jumping from a window in unreasoned terror when there are other and better modes of escape.

2. Because an organized being has reached a stage of development where reasonable conduct may be looked for, it does not follow that none of its actions will be instinctive. Both men and women perform many instinctive actions,—a drowning man will instinctively catch at straws,—but that does not prove that they are not endowed with reason in addition to instinct.

3. Your correspondent maintains that what would be instinct in women, and hence proof of a low grade of intelligence, is, in the cockroach, "singularly like the operation of reason." But it is no mark of reason having come into play, that conduct looks intelligent to the outsider. If it were, we should have to attribute reason to the Amoeba, which encloses food and not grains of sand, and to the Drosera, which shuts up on bits of meat and not on bits of chalk. The one sure objective test of the action of reason is that different individuals behave differently under the same circumstances, and that test is wanting here. We are expressly told that every one of more than a dozen cockroaches did exactly the same thing. Cockroaches make their constant home by the kitchen range, and there is hardly any source of danger which ancestral experience is more likely to have warned them of than hot metal.

L.

Ancient Scrapers.

A FACT has lately come to my knowledge which may be of interest to archaeological students of the ancient stone age, who have frequently expressed surprise that so few of the ancient scrapers, blades, chipped axes, and other cutting implements, show signs of use.

Lieutenant Stoney, Lieutenant Ray, Nelson, Turner, and others

have sent to the National Museum a large number of modern Eskimo scrapers, and also many specimens of the implements used in chipping and sharpening their scrapers. The latter are of two kinds: 1. A curved handle of walrus ivory, with short pieces of antler lashed in a groove cut in the front of the handle (this form has frequently been figured); 2. A single cylindrical handle of wood, into one end of which an incisor tooth of a beaver has been firmly fixed. Indeed, one or two specimens consist of a portion of the upper jaw with the teeth in place. This tool is called by all collectors a knife-sharpener. Lieutenant Stoney informs me that during his late exploration in Kotzchue Sound he saw the natives using these implements, and says that they keep them always at hand, and spend much time in touching up the edges of these scrapers and other stone cutting-tools, and that the beaver-tooth sharpener is also employed by the ivory-carvers to keep a fresh edge on their metal knives. The variation in the length of scraper-blades is due partly to the fact that some of them, when new, are over two inches long, and become worn down by constant sharpening until they are reduced to a mere stub. It will be seen from Lieutenant Stoney's observation that it will be difficult to find in Alaska a scraper-blade showing signs of use, the interest of the artisan depending upon his keeping his edge constantly sharp.

O. T. MASON,

Washington, June 25.

Volapük.

I COPY the titlepage of one and a part of another grammar of Volapük, before me. Hachette & Co. is a London house, as you will see. The Paris house is Le Soudier. "Grammar of Volapük: The Language of the World. For all Speakers of the English Language. Translated and published with the consent of the inventor, Johann Martin Schleyer, by W. A. Seret. Glasgow, Thomas Murray & Sons; London, Whittaker & Co." "International Commercial Language. Abridged Grammar. . . . By Karl Dornbusch. London, Hachette & Co.; Paris, H. Le Soudier."

E. A. HORSFORD.

Cambridge, June 25.

Pineal Eye of Lizard.

THE pineal eye is so well developed in the common pine-tree lizard (*Sceleporus undulatus*) that it may probably seem to warn its owner of the advent of daylight. It is a lenticular, glassy area of the skin of the vertex (about a millimetre in sagittal diameter), surrounded by a yellow border, and having a dark spot in its centre. The dark spot is opaque, caused by a mass of pigment internal to the dermis, set on the extremity of a pineal outgrowth from the brain. The clear area around it is caused by the dermis, which is transparent and free from the pigment which covers it internally in other parts. The eye is covered by an escutcheon-shaped epidermal shield, more transparent in the centre and larger (3 × 3 millimetres) than the normal epidermal scales. The only sign of degeneracy is the central cloudy mass of pigment, like a big cataract.

G. MACLOSIE.

Princeton, June 25.

The Charleston Earthquake.

I FEEL thankful to Professor Mendenhall for his forcible criticism of the paper relating to the Charleston earthquake, and fully concur with him in his remarks concerning the uncertainty of the data upon which the inoseismals were drawn. This was commented upon in similar vein in the paper under discussion. He cannot complain of them more loudly than we did. The features to which he calls attention (viz., that the curves of high intensity are less sinuous than those of low intensity) had not escaped our attention, and the results of our reflections were these: 1st, The data indicated that the amount of variation of intensity within any zone or annulus generally bears a smaller ratio to the mean intensity of that zone when the mean intensity is high than when it is low (I think this was to be expected, and is intelligible from the nature of the case), hence there ought to be less sinuosity in the inner than in the outer curves; 2d, In order that the amount of sinuosity may be in due proportion in all curves, the density of observation (i.e., number of observations per unit area) should be inversely pro-

portional to the square of the distance from the origin. Perhaps it is needless to say that the observations had no such distribution. But, after all is said, it must be admitted that there is much justice in Professor Mendenhall's criticism of the isoseismals, and he certainly scores an important point. An earnest and conscientious effort will be made to remedy the defect he has undoubtedly proven.

As regards the 'areas of comparative silence,' I think they have been too well established by the data in hand to be explained away on the ground of defective testimony. They attracted attention at an early stage of the investigation, and were at first thought to be due to defective testimony; but as the information increased, it was seen that they were not so easily disposed of. Special inquiry was then made, and the result was, to our thinking, a full confirmation of their reality.

In his criticism upon the method of computing the depth of the focus, he proposes an argument which we anticipated would be raised against it. He says, "As far as can be seen from the contents of the paper, the result depends upon the unjustifiable assumption that surface destruction is proportional to" the energy per unit area of wave-front. I cannot admit that the paper implies that assumption. But if he will permit me to substitute the word 'effects' for the word 'destruction,' then I will say that the result does depend upon the assumption so modified, and stands or falls with it. And, moreover, I hold that assumption to be not only justifiable, but next door to an axiom. If our estimate of relative intensities were to be derived solely from the destruction of buildings and chimneys by a force which in turn must be measured by the maximum acceleration of the earth-particle in a horizontal plane, our argument would indeed be in a piteable plight. But we ought not to be, and certainly are not, so limited. Other means of forming an approximate estimate of relative intensity are abundant, even where the destruction is little or nothing. Subject to local modifications, a great earthquake is bound to make itself felt somehow, and in due proportion to its energy, whichever component, vertical or horizontal, predominates. In the epicentral tract, brick buildings were few; but there were plenty of wooden ones, and plenty of intelligent men to tell what had happened. The best but by no means the only inanimate testimony was furnished by the railroads which cross this tract. They were like continuous lines of seismometers; and the men who repaired them had no difficulty in stating where the road-beds were shaken up most, and where least, and how the effects varied from mile to mile.

What Professor Mendenhall really challenges, I infer to be, not the theory, but the competency of the data through which the theory must be applied, if it can be applied. He appears to doubt the possibility of procuring such data; but it seems to me that he overestimates the exactions. He sees, indeed, that the vanishing of the constant α dispenses with the necessity of making any absolute evaluation of a single intensity, or even of the successive ratios between intensities. All that we require is to find, if possible, where these intensities vary most rapidly along a line. It is analogous to trying to locate, without the use of a level, the steepest point of a hill whose profile is similar to our intensity curves. It cannot be done exactly, but it can be done within moderate limits of error; and I have not much doubt, that, when Professor Mendenhall sees the data, he will concede as much. It was distinctly stated in the paper that the method was believed to be incapable alike of great precision and of great errors.

But, though I cannot yield to his criticism on this point, I am still greatly indebted to him for it. It is instructive in pointing out sharply what treatment must be given to the data to enable readers and investigators to judge of the validity of the method, and how the facts must be marshalled.

He also dissents from our inference that there were some facts in Charleston which seemed hard to explain upon the assumption of amplitudes of the earth-particle less than ten inches to a foot. This was suggested as a maximum confined to a few spots, while the mean amplitude was presumed to be considerably less. Let us examine this point.

In all great earthquakes, those who have felt their violence near the epicentrum have been impressed with, and testified to, an apparently large amount of movement in the soil,—an amount to be measured, so far as they could estimate, not by millimetres, but by

inches, and sometimes even by feet. To verify these purely sensory estimates was, of course, impossible; but the circumstantial character of the testimony seemed, in the absence of precise measurement, to warrant the belief that the movements probably had about that order of magnitude. When the seismograph was applied in Japan to the measurement of the frequent but moderate shocks, and it was found that an amplitude of a few millimetres would sometimes crack walls and throw down chimneys, it was at once inferred that the unmeasured estimates or guesses of the amplitude in the grander shocks had been greatly exaggerated: for, the energy being proportional to the square of the amplitude, it seemed needful to multiply those already measured only a few times to obtain a destructiveness commensurate with that exhibited in the worst catastrophes. There has been, therefore, a great change of opinion about these large estimates among seismologists; but I think it can be shown that such estimates are not necessarily invalidated by the seismograph.

The intensity of a shock is not alone proportional to the square of the amplitude, but also to the wave-velocity divided by the wave-length. It is, I believe, a general fact that great amplitudes of earthquake-waves are accompanied with great wave-lengths. This does not follow from the accepted laws of wave-motion in elastic solids, but is an independent fact, whose explanation must go back to the nature of the originating impulses. Thus increasing amplitude does not carry with it an increasing destructiveness in so rapid a ratio as might at first be supposed. The displacement is greater, but the time of displacement is longer. Again, the amplitude diminishes as the wave moves on; at least as fast as, and probably faster than, the distance from the origin increases. Let us, then, endeavor to make a comparison, rough though it must necessarily be, between the larger amplitudes measured by the seismograph, and those which may be inferred in localities shaken by the Charleston earthquake with equal energy. I regard it as improbable that the intensity of the most vigorous shocks measured by the seismograph in Japan (so far as published) exceeded that at Atlanta, Asheville, and Raleigh, all of which have been estimated to exceed No. 7 in the Rossi Forel scale. If we take ten millimetres as the average amplitude of those places, we shall not exceed the higher ones recorded by the seismograph for shocks of probably not greater intensity. The mean distance of these places from the centrum is eleven and a half times as great as that of Charleston. This would give an amplitude of about three inches at the latter place, on the assumption that the wave-lengths were equal to the Japanese, and that no energy was dissipated as the waves moved on. The last assumption is certainly untrue, and, whatever allowance may be made for it, must lead to a greater inferred amplitude at Charleston. It does not seem to me that a mean amplitude for the greater waves in that city, of three to four inches, is too much, while local maxima may have been considerably greater. The seismograph has not as yet tackled a first-class earthquake in the vicinity of the central tract.

Although I am still disposed to adhere, either wholly or in part, to most of the propositions advanced in the paper referred to, I must still acknowledge the high value of Professor Mendenhall's criticism. It defines much more sharply the issues involved, and is full of most useful suggestion.

C. E. DUTTON.

Washington, June 23.

Cyanhydric Gas as an Insecticide.

AMONG the insect-enemies to plant-life, of which California has received and is still receiving a full assortment from all parts of the globe, the most formidable is the *Tecrya purchasi*, a coccid which, instead of the hard shield that protects most of its congeners the scale-lice, surrounds its egg-masses with a woolly fur that in many respects serves even as a more efficacious protection. It has until recently been supposed to have come from Australia; but, according to late researches of Professor Riley, it is to the Island of Martinique that we are indebted for this most pernicious insect. It there infests the sugar-cane, and may readily have come in with the canes often placed for drainage within the hogsheds of raw sugar. Being apparently omnivorous, it has not been dismayed by the absence or scarcity of its original plant-food. Pine and cypress appear to be nearly as much to its taste as the

pungent *Eucalyptus* and the highly tannic acacias, the black locust, and all kinds of fruit-trees and shrubs, including the *Citrus* tribe: when hard-pushed, it will even be content with grass and weeds for a while. Being enormously prolific, and thus far apparently free from any effective enemy but man, its spread is very rapid, and its attack most formidable and quickly fatal, even to large trees. It is very tenacious of life in all its stages of development. Its eggs, stowed away in thick masses of white wool, are very difficult to kill, as most insecticide-washes will rebound harmlessly by capillary repulsion.

The most fatal work of the *Icerya* has been done in the orange-groves of Southern California, where even the most persistent fight against it, with every variety of insecticide-washes, has only partially checked its ravages, and has nowhere succeeded in extirpating it entirely from an orchard, in consequence of the difficulty of reaching effectively both surfaces of every leaf in the dense-topped evergreen-trees. Even when the foliage, and therefore at least one crop of fruit, has been sacrificed by the use of caustic alkaline washes, success has not been complete.

The use of gaseous insecticides within a gas-tight tent lowered over the trees, has long been suggested against this, as well as other insects infesting evergreen-trees; but experiments made, e.g., with vaporized carbon bisulphide, have not given satisfactory results in practice. Either the insects were not completely destroyed, or the foliage was seriously harmed when the treatment was long continued.

The repression of the *Icerya* having at last become a life-and-death question for some of the older citrus-orchards, it was determined by some orchardists in the neighborhood of San Gabriel to have the feasibility of gaseous insecticides thoroughly tested. At their request, Mr. F. W. Morse, assistant in charge of the agricultural laboratory at the University of California, was detailed for this purpose; and the experiments made by him during nearly two months have furnished some scientifically interesting results, while demonstrating that cyanhydric gas can be made fully effective without harm to the foliage, and that seven other gases tried were either too slow in their action on the insect, or caused severe injury to the foliage. These other gases were chlorine, sulphuretted hydrogen, ammonia, carbon monoxide, oxalic and formic acids, and carbolic acid. A summary statement of these experiments is given in Bulletin No. 71 of the California Experiment-Station, just published.

Several interesting facts are thus brought out. One is, that apparently no practically adequate insecticide effects are produced when these effects depend upon the respiration of the gas by the insect; the respiratory action being so very slow, as compared with that of the higher animals, that anæsthetic rather than toxic effects are produced within the practically admissible limits of time: while within these limits the foliage also suffers, as a rule.

Cyanhydric gas, acting directly upon the nervous system through the nerve-ends, is quickly fatal, independently of respiration, and even in very small amounts. It is slow in affecting the insects' eggs inside of their woolly casings; but an effective insecticide dose also acts very injuriously on the leaves of the trees.

To prevent the latter effect, intermixture with some other gas beside air suggested itself. Experiments with sulphuretted hydrogen gave unfavorable results. This gas seemed to mitigate only the action on the insects (by anæsthesia). Complete success was, however, attained by the use of carbonic gas, evolved from sodic bicarbonate at the same time that the cyanhydric gas was evolved from potassic cyanide. The insects were killed as promptly as when air alone was present, but even a lengthy application did not affect the foliage in the least. The minimum proportion of the bicarbonate required for full protection was, for the case of a tree having a top twelve feet in diameter covered by an air-tight tent, a pound and a half, ten ounces of the cyanide being used at the same time.

It is not easy to conceive the exact cause of the protective action of the carbonic-dioxide gas upon the leaves; but there can be no question as to the fact, and it is hoped that further investigation will throw light upon the problem. The board of supervisors of Los Angeles County having requested a further elaboration of the details of the process by Mr. Morse, the latter will have full opportunity for testing the conditions and limits of the action of both gases, and upon deciduous as well as citrus trees. The high value

of the latter renders the process perfectly available for them, even if, on account of the later hatching of unscathed eggs, the operation should have to be repeated. Whether the same will hold good of other orchard-trees, and whether their leaves will experience the same adequate protection from the presence of carbonic gas, remain to be seen.

University of California, June 13.

E. W. HILGARD.

University of New Zealand.

I HAVE just received your issue for June 3, with the 'New Zealand Letter' therein, dated Dunedin, April 20. As the agent in London of the University of New Zealand, permit me to supplement the exceedingly inadequate account of that body given by your correspondent. He states correctly that the university, like its prototype in London, does not teach; but he only hints at powers to confer degrees, and says not a word about any examinations. As a matter of fact, so anxious is its senate to make its degrees worth having, that the whole of its degree-examinations are conducted by English examiners, who are instructed that their standard of examination is to be at least as high as that of the University of London, for corresponding degrees. At the present moment I am seeing through the press no fewer than eighty-six degree-examination papers, set by fourteen examiners, all men of the highest standing, and present or past examiners in either Oxford, Cambridge, or London Universities. These papers will be worked in New Zealand in November, and the answers transmitted to me. After their revision by the examiners, a meeting of these gentlemen will be held in London, and the results will be transmitted to Wellington by cable. This has been going regularly on for more than seven years, and there are now nearly one hundred candidates for degrees every year of both sexes. This, from a total population of not exceeding half a million, speaks well for the colony. The degrees conferred as yet are in arts, laws, and science, but provision is made for degrees in medicine and in music.

The examinations are, I believe, held in different towns in the colony simultaneously. The 'peripatetic annual session' of which your correspondent speaks, is simply the annual meeting of the university senate. Its members are scattered over a very large area (travelling-facilities are not great), and hence the senate usually does all its work for the year at one sitting, which lasts for several days.

WM. LANT CARPENTER.

London, June 13.

The Maxillo-Palatines of *Tachycineta*.

If Dr. Shufeldt will consult my note in *Science* for May 13, he will find that neither the accuracy of his figure, nor the entirety of the specimen from which it was drawn, is there called in question. It is evident, to one acquainted with the palatal region as it is found in the swallows, that Dr. Shufeldt's figure represents a skull with mutilated or abnormal maxillo-palatines, in either case not perfect.

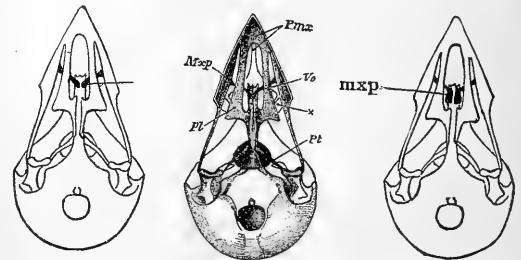

Since Dr. Shufeldt says his specimen is not broken, it must be abnormal. The extent and importance of the alterations Dr. Shufeldt charges me with having made in hastily tracing this figure, can best be understood by comparing the tracing (Fig. 1) with a reproduction of the original (Fig. 2). Fig. 3 shows the maxillo-palatines approximately correct.

FREDERIC A. LUCAS.

Washington, D.C., June 15.

SCIENCE

FRIDAY, JULY 8, 1887.

IN THE LEADING civilized countries in which a decimal system of weights and measures is not in vogue, there are considerable bodies of men urging the adoption of at least a decimal coinage. From time to time attacks are made on the time-honored and inconvenient pounds-shillings-and-pence system in which English trade is carried on, but thus far conservatism has proven too mighty even for convenience. It is nevertheless true, that, each time the agitation for a decimal system is begun in Great Britain, it obtains larger support than before, though the opposition to it loses nothing in vehemence. Within a few weeks an influential deputation has waited on the chancellor of the exchequer to urge his advocacy of a decimal coinage. The deputation represented sixty-eight provincial chambers of commerce, all of which, out of a total of sixty-nine, have passed resolutions in favor of a change to a decimal system. The deputation urged the change on five grounds: first, because every foreign country in the world possessed a decimal currency, and some of the British possessions (Canada, Ceylon, and Mauritius); second, because no country which had once adopted the decimal system of currency had retraced its step; third, because the mathematical education in the schools would be simplified by the use of the decimal system for measuring values, and consequently the period necessary for education in the elementary schools would be shortened; fourth, because experience proved that in business-houses in decimal-using countries considerable time was saved in calculations both for home and foreign business, while transactions between countries using the decimal system were rendered uniform, and an economy of labor therefore resulted; and, fifth, because the British currency might be placed upon a decimal basis with a minimum of change by decimalizing the pound sterling. It is proposed to decimalize the pound sterling by making it equal to 1,000 mills, the mill to be the unit of the system. Then the half-sovereign would equal 500 mills; the crown, 250 mills; the double florin, 200 mills; the half-crown, 125 mills; the florin, 100 mills; the shilling, 50 mills; and the sixpence, 25 mills. Three new coins would be necessary,—a dime, equal to ten mills; a half-dime; and a new farthing, equal to one mill. Various speakers enlarged on these arguments. Mr. Goschen, in reply, acknowledged the importance of the subject and the authority of the delegation, but he could give no promise of government action, because a reform of so far-reaching a nature depends for its success on a practical unanimity of popular sentiment; and that, Mr. Goschen thought, is far from having been reached at present. He closed by encouraging the deputation to go on with their propaganda, and endeavor to unite public sentiment in favor of the change. If that were done, he felt sure the necessary legislation would follow.

IT IS THE PRIVILEGE of the philosopher, at least of such a one as bases his right to that title on the practical comprehensiveness of the study of his choice, to have an important word on those general problems of civilization most intimately connected with human development. And it is the privilege of our age to emphasize the truth that every intellectual worker is to a greater or less extent a philosopher in his own domain. It is not a coincidence, but a deeply significant fact, that the 'new education,' the 'new political economy,' the 'new psychology,' the 'new biology,' and the rest, are all claiming attention at the same time. It is the expression of the consciousness of the changed conditions of modern life. A most

alarming symptom of this change is the increasing frequency of mental 'breakdown,' caused by a failure to adapt one's self to the changed environment. For the use of the mental powers, we now substitute their abuse. The business-man is worried into insanity, the student hurried into unhealthy precocity, and the woman forced into an imprudent competition with man. One of the earliest cries of warning to the most restless of all nations, the Americans, was raised by Dr. S. Weir Mitchell, in a paper entitled 'Wear and Tear,' which has just reached a fifth edition as a separate publication. In the period since its first appearance, this sermon has been preached by educators, political economists, and psychologists, as well as by the family physician, and to some extent has been listened to. Practical men are so apt to think that the studies of the theoretical scientists are more or less the pursuit of useless hobbies, that the opportunity of so glaringly showing the essential importance to them of theoretical science should not be neglected. To be able to express physiologically and psychologically such doctrines as are suggested by the practical experience of thoughtful men, endows these principles with the authority of natural laws, and sanctions their introduction into the elementary education of the next generation. It makes science out of opinion. The cause which Dr. Mitchell pleads under the above terse heading is well known to-day. It is simply the problem of obtaining a maximum of work with a minimum of overwork; a brisk and healthy wear without a rushing and wasteful tear. And it is because this problem is so largely the problem of a rational education founded upon a scientific psychology, that it merits notice in this column. With the successful solution of this problem,—and all this applies with increased force to our country,—the new education, the new political economy, the new psychology, and the new biology will all have succeeded together.

THE INCREASE OF STATE INTERFERENCE IN THE UNITED STATES.—II.

AS to the States of Rhode Island and Connecticut, our information is fairly full and accurate, though showing a curiously divergent condition of things in two adjoining States. The secretary of state for Rhode Island finds, as the result of nearly twenty years' experience in connection with the legislation of the State, the tendency has rather been away from than toward interference with personal concerns. Numerous matters of that nature which formerly occupied the attention of the Assembly have now ceased to have attention, the jurisdiction of the courts having been enlarged so as to cover such matters. The Legislature has further established a joint rule to the effect that "neither House shall entertain any petition the subject of which is within the jurisdiction of any court in the State." Rhode Island, owing to a peculiar constitutional provision, has no general act of incorporation, and every charter is a special act of the Legislature. In granting these charters, much of the time of the Assembly is occupied.

From Connecticut Professors Hadley and Farnam of Yale agree in pointing out the Sunday traffic (railroad) law, the law limiting the hours of employment for women in stores and factories, the law prohibiting child-labor under thirteen years of age, the law making weekly payments compulsory, and the laws providing for the inspection of certain classes of business, as the latest particulars in which State interference is being manifested. Mr. A. Hills of Bridgeport finds that Connecticut legislation is showing "an increasing tendency to interfere between employers and employed, and generally to regulate matters which individuals ought to be left to arrange between themselves." Mr. Morris F. Tyler is of similar opinion. He writes, "It may be said that legislation in Connecticut shows that in almost all the relations of life the meddle-

some legislator has thought of touching. We do not regulate the price that a man shall pay for his food and clothing, but we do say what kind of food and clothing can be sold to him, and under what conditions. In looking over the statutes of the session just closed, I see that it will no longer be safe for a man to send his children to a private school unless that school complies with some of the technical regulations of the State Board of Education in the matter of returns to their secretary; that a man cannot sell the securities of foreign trust and investment companies in this State unless those companies have submitted to certain examinations by our bank commissioners. Butter and molasses are under the protecting care of the dairy commissioner. Nobody can negotiate the insurance of his neighbor without a license to do so from the insurance commissioner. A man cannot travel on a railroad-train on Sunday, and have the benefit of his commutation or mileage ticket. If, in case of illness in my family, I find there is no brandy in the house, and it is wanted at once, it is illegal for my grocer to give it to my boy if I send him for it in a hurry. If I run a factory, it must be run as the newly appointed inspector of factories says is right, and not as the business may compel me."

The data from New York State which has reached us, while plentiful, is not very specific. The large majority of our correspondents in that State coincide in stating that State interference is on the increase. Assemblyman Ernest H. Crosby of New York City writes that interference has lately been shown in the appointment of such officials as railroad commissioners, factory inspectors, commissioners of arbitration, and so forth, and in acts regulating the price of gas, limiting the hours of labor on street-railways, etc. Mr. Herbert L. Osgood of Brooklyn refers to the Mechanics' Lien Act of 1885 as an interference with the freedom of contract. He mentions also an act compelling employers to erect proper scaffolds for those at work upon buildings, an act regulating the height of dwellings in New York City, acts relating to the manufacture and sale of oleomargarine, the sale of butter, the slaughter of cattle, etc. The State expends about twenty-eight thousand dollars a year in subsidizing agricultural societies.

With respect to State interference in New Jersey, we are in possession of extremely full returns, for the most valuable portions of which we are under obligations to Mr. William I. Lewis of Paterson. Mr. Lewis finds as the result of a careful examination of the legislation since 1878, — to and including the session of 1886, — that about two-sevenths of the laws show a marked tendency toward interference with personal affairs, and about one-seventh additional show a slight tendency in that direction. In the period mentioned above, 2,016 laws have been enacted, and 414 of them are for the purpose of controlling or regulating private and personal affairs or business. Of these 414 laws, seven provide for agricultural experiments; two protect bottlers of beer by establishing a peculiar procedure, and inflicting peculiar penalties on persons who steal bottles or unlawfully have them in their possession; fourteen regulate the sale of butter and milk; one directs how cows shall not be fed; eight are designed to protect children by regulating their employment and education; two to encourage organizations of workingmen; one establishes standard packages for cranberries; one provides for the construction of proper waste-gates in dams; four are in aid of deaf-mutes; three regulate the manufacture and sale of fertilizers; two offer bounties for the production of jute, flax, and hemp; fifty-seven are for the protection of game and fish; thirty-six are for the protection of health; two deal with the cutting and sale of ice; twenty-seven regulate the business of insurance; ten establish and encourage a bureau of labor statistics; seven aim to improve meadow and swamp lands; three deal with pilots and their apprentices; six incorporate rifle societies, and encourage marksmanship; seventy-seven concern education; twelve provide for the maintenance of an industrial school for girls; four are for the better securing of wages to workingmen; and six concern the relief, protection, etc., of workingmen.

This exhibit of Mr. Lewis's exemplifies excellently the tenor of legislation in New Jersey. We could wish that we had as accurate an analysis of the laws elsewhere; but it will be seen that there is general consensus of opinion among our correspondents to the effect that the tendency toward State interference is not confined to any one State or group of States.

Prof. E. J. James of Philadelphia writes that "the course of legislation in Pennsylvania is very similar to that in Minnesota;" and Professor Holmes of the University of Virginia mentions local opinion, railroad supervision, the multiplicity and inquisitorial character of the taxes, civil marriages, and the drummers' tax law (recently declared unconstitutional) as recent evidences of a similar development of legislative activity.

Our most definite reply from the south-western States comes from Hon. Logan H. Roots, president of the board of trustees of St. John's College, Little Rock, Ark. Mr. Roots says that "a tendency upon the part of the indolent to ascribe their poverty to honesty, and the prosperity of the industrious to dishonesty, seems to have seized the ignorant; and the legislators pandering to that tendency have many of them acted on the theory that any thing or person that prospered was *per se* a 'fraud' which must be regulated. The special 'frauds to be regulated' in the eyes of our recent Legislature were money-lenders, telephones, railroads, and cottonseed-oil mills, with some attention given to prices at which merchants might transact business."

Of the central-western States, Ohio, Indiana, and Illinois are following the same road that we find to be so popular elsewhere. Ohio has a board of stock commissioners with absolute power to regulate the trade in live-stock and all importations, dairy commissioners, and special laws to govern the sale of farm-products, laws prohibiting the sale of liquor in certain places, and so on through a long list.

Illinois is overrun with such laws, and Mr. Edward J. Cahill of Chicago sends us a long list of them. Since 1871, Illinois has been in the grain-weighting business: it designates elevators for the storage of grain, and regulates its transportation by railroad. Mills and millers are carefully looked after, including the manner of grinding, the character of the buildings and tools used, etc. A bounty of ten dollars an acre is at the disposal of those who will plant forest-trees. Fence-laws appoint fence-viewers, who see that all fences are four and a half feet high, and that proper materials are used. A State board of agriculture, with a corps of salaried officials, promotes agriculture and horticulture. This board spent thirty-six thousand dollars in 1885, and is authorized to bestow five thousand dollars annually in premiums at fairs and stock-shows. The Bureau of Statistics, organized in 1879, has become a department of state, and presents annual reports on the social, educational, and sanitary condition of the laboring-classes. Game-laws are numerous. The manufacture of butter and cheese is regulated: five hundred dollars goes every year to assist dairymen in making reports. Illinois offered ten thousand dollars to the citizens who had exhibits at the New Orleans exhibition; it also pays from fifty thousand to one hundred thousand dollars to assist cities which, through the negligence of their officials, fail to take proper precautions against damage and loss by fire and water. Mr. Cahill also points out what the effect of the passage of such bills has been on subsequent Legislatures. In the session of 1887, for instance, about eight hundred bills were presented to the Legislature, and fully three-fourths of them had a tendency toward State interference. "We have bills seeking to regulate contracts between employer and employee, providing for the giving to each party a given number of days' notice to quit or intention to quit, calling for mutual co-operative associations for pecuniary profit, to increase the power of the department of labor, to provide for arbitration of labor-troubles, to grant additional labor-liens, to enforce the eight-hour movement, and to encourage mutual loan associations on the co-operative plan. The effect of State interference with professions and other business interests has created new demands: the architect petitions for a special board; the stenographer demands recognition; and in due course we shall have the merchant-tailor and the corner grocer, for already we have the liquor interest asking for a State board to pass on 'good whiskey;' and the prohibitionist asks for a bureau for the study of the nature and effect of alcoholic beverages, etc.; while the 'mugwump' of religion is on hand, seeking recognition by way of 'ethical instruction' in our public schools; and, to crown the ridiculous, we have the Live-Stock Board, just created, asking 'that companies be formed for the detection and apprehension of horse-thieves;' thus making a farce of our criminal procedure."

Prof. Henry C. Adams writes that in Michigan the tendency is in harmony with that observed by Dr. Shaw in Minnesota.

President Pickard of Iowa State University finds the most striking feature in the recent legislation of Iowa to be the number of legalizing acts passed. He says that twenty-five per cent of all acts passed were designed to correct carelessness or ignorance of officers and municipal corporations; but Prof. Jesse Macy of Iowa College says that Iowa is side by side with Minnesota, and cites in evidence a number of acts passed at the last session of the Legislature. The Legislature passed laws strengthening the prohibitory liquor legislation, it made elaborate statutes regulating the practice of pharmacy and medicine, it looked after the miners' interests through a commission, it provided an arbitration board for the settlement of labor-difficulties, it laid new duties on the board of health concerning canned goods and inflammable oils, and passed a large number of laws of the same general tenor.

Ex.-Pres. A. L. Chapin of Beloit College, Wisconsin, thinks that State interference has not gone so far in that State as in Minnesota, though it is plainly seen in numerous enactments.

Mr. Frank R. Morrissey of the Omaha *Herald* represents Nebraska in our correspondence, and finds a marked tendency to sumptuary legislation in his State.

From the Pacific coast we hear of this tendency, though in California the new State constitution seems to have repressed it to a great extent. Mr. A. H. Agard of Oakland writes that proposed legislation in California manifests the tendency in question; but little progress is made, because the Legislature is restrained by the provisions of the State constitution, which forbids the enactment of laws termed 'special.' The effort on the part of the Legislature is to frame laws of such a character that they will operate restrictively, and yet not be declared unconstitutional by the Supreme Court. It might be termed 'forbidden legislation by adroit evasion.' The particular manifestations of interference just now are against the Chinese, against 'monopolies,' hydraulic mining, and the retail liquor-trade.

It will thus be seen, from this brief summary of the evidence we have gathered, that State interference has a tendency in general throughout the United States. It is more extreme in some States than others; and our analysis of the laws of Massachusetts, New Jersey, and Illinois, shows it to be particularly progressive in those States. It remains to present the various opinions entertained toward State interference by our representative correspondents.

[To be continued.]

THE NEW ROUTE FROM ENGLAND TO EASTERN ASIA, AND THE HUDSON BAY ROUTE.

A FEW weeks ago the first steamer coming from Yokohama arrived at Vancouver. Thus the new line from England to eastern Asia by way of the Canadian Pacific Railroad has been opened. In order to show the merits of this route as compared to the American Pacific railroads, we have drawn up the accompanying sketch-map. We have chosen the gnomonic projection, as it is the best means to show the shortest route between two points. The earth's surface is projected from the centre of the globe upon a tangential plain touching it in latitude 60° north and longitude 120° west. In this projection all great circles, i.e., the shortest lines between two points, are represented by straight lines. The map extends from England in the east to Yokohama in the west. It makes it clear why the North-west and North-east Passages were so eagerly sought for. They are the nearest to the great circle between England and China, which runs right through the Polar Basin. The nearer a route approaches this great circle, the shorter it is. Therefore it will be seen that the distance from London to Yokohama, *via* the Canadian Pacific Railroad, would be by far the shortest. There are several facts, however, which detract from the value of this route. We have drawn out the great circle between London and New York. It will be seen that it crosses Newfoundland. Yet ships do not keep close to the southern point of that island, on account of the numerous dangers obstructing their passage, but prefer to go a round-about way, keeping far south. The same difficulty is encountered in approaching Halifax; and therefore the longer route to New York is by far to be preferred to the shorter one to Nova

Scotia, particularly in the latter part of the winter and in spring, when ice is met with in the Atlantic Ocean. The Gulf of St. Lawrence is not navigable during part of the year on account of the heavy masses of ice. Thus the shortness of the route from England to Nova Scotia is more than counterbalanced by the dangers of navigation.

But even from New York the Canada route to Japan is far shorter than that by way of San Francisco. The difference in length between the great circle San Francisco-Yokohama and Vancouver-Yokohama may be seen on the sketch-map. It must be considered, however, that the latter cannot be made use of, as it crosses Alaska and the Aleutian Islands. Steamers must keep farther south, and must strike the San Francisco route near the longitude of the west point of Alaska Peninsula. This makes the distance from Vancouver to Yokohama somewhat longer than it would be without this chain of islands intervening. The distance from New York to Puget Sound by way of the Northern Pacific Railroad is longer than by the Canadian Road, as Lake Michigan extends so far south; but when the road from Umatilla Junction to Tacoma is finished, the difference in the two distances will not be very great. The sea-route from Tacoma to Yokohama is of course essentially the same as that from Vancouver. The great circle between these places and the ports of China runs nearly through the Tsugaru Strait, passing Hakodadi.

When the work on the Canadian Road is completed, it will probably be not more frequently obstructed by snow-drifts than the Northern Pacific, but the difference in distance between these two lines is not so great as to exclude a successful competition.

The harbor of Vancouver is Burrard Inlet. It is sheltered from the sea, but the entrance is somewhat difficult, being very narrow and occupied by tide-races. The shortest route from the port would lead through the narrow channels between Vancouver Island and the mainland, in which navigation is difficult on account of the strong tides and numerous rocks.

The shortest route from the ports of the Atlantic coast to Japan and China would lie even farther north than the Canadian Pacific Railroad; and if the Saskatchewan branch should be built, and continued to the northern part of the coast of British Columbia, the distance would be still more diminished. We do not believe that the climate would offer insurmountable difficulties, but the settlement of these countries will not be so rapid as to justify the construction of a new Pacific railroad.

The railroad question is of the greatest importance for the development of the North-west Territories, — Athabasca, Alberta, Saskatchewan, Assiniboia, and Manitoba. The distance to the nearest ports is so long that export is very difficult: therefore endeavors have been made to open a new route by making use of Hudson Bay. It will be seen on our map that the proposed Hudson Bay route from Liverpool to Port Nelson is very short and straight, and that it would offer a splendid opportunity for the export of the North-west Territories. We believe, however, that the character of the seas will prevent the plan being carried out. The railroad-route from Winnipeg to Port Nelson has been surveyed, and no serious obstacles are said to exist; but the railroad must be continued farther north to Fort Churchill, as Port Nelson is not a safe harbor. The navigation of the west coast of Hudson Bay, particularly for large vessels, is very difficult on account of its shallowness, and the construction of piers in Fort Churchill will be expensive and difficult on account of the ice.

The principal difficulty is the navigation of Hudson Strait. Its eastern entrance is blocked by pack-ice until the middle of July. A passage may sometimes be forced early in June by a ship well strengthened against the pressure of the ice, but navigation cannot be opened until about the 10th of July. About this time, ice is still whirling around in Ungava Bay, patches are found near Charles Island, and Fox Basin is filled with very heavy and dangerous masses of ice. We believe that these form the principal obstacles to navigation. The light ice of Hudson Bay and Hudson Strait will not form serious obstacles late in the season; but a spell of northerly winds will invariably drive the heavy masses of Fox Basin into the Strait, and a ship caught in this ice will be in an extremely dangerous position. The floes are small, and attain a thickness of from twenty to thirty feet. This ice frequently blocks

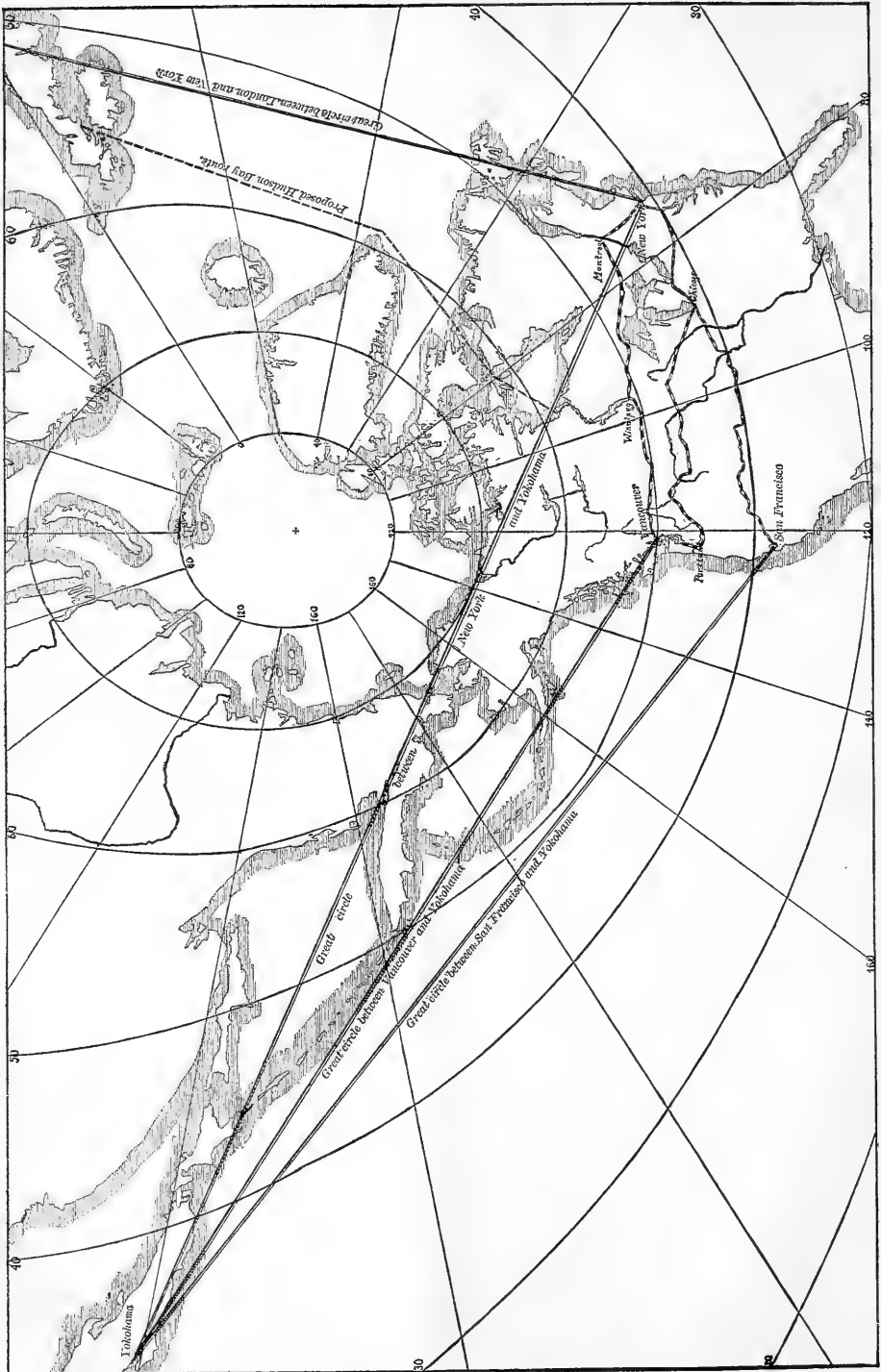

SKETCH-MAP SHOWING SHORTEST ROUTES FROM THE UNITED STATES TO EASTERN ASIA.
(This map is so projected that a straight line shows the shortest distance between two points.)

up the passages between the islands at the western entrance of Hudson Strait, where it is kept in rapid motion by strong currents. Log-books kept by whalers show that it is frequently found in Hudson Strait in September. We should say that the passage will never be safe, and that large freight-steamers, such as would be required for this trade, cannot be run longer than from the middle of July to the first days of October. It is improbable that under such circumstances a railroad to Fort Churchill and a line to Hudson Bay would pay. The shortness of the season and the dangers of the ice are so great, that this line cannot attain a great commercial value.

THINKING IN SHAPE AND PICTORIAL TEACHING.

THE Rev. Edward Thring of Uppingham, the well-known author of 'Theory and Practice of Teaching,' spoke before the teachers' guild in London recently on thinking in shape and pictorial teaching. Mr. Thring began by drawing attention to the vital distinction which divides mankind, consciously or unconsciously, into two classes,—those who value knowledge, and those who value the seeing heart and the seeing eye. The pursuit of knowledge is the creed of the first. Knowledge he defined to be for the multitude second-hand information, which, however valuable, may, like gold in the desert, be utterly useless. He then showed, that, precious or not, few get it, and that the unsuccessful attempt to get it is deadly to living power. Living power is required, and can only be given by teaching pupils to think in shape; that is, to train the mind, whenever it sees any thing, to find out at once what thought made the shape it sees; and, on the other hand, to take every word used and put it at once into some definite shape, example, or reality. Examples of this were given, showing the difference between an arithmetical fact and living feeling, between words and memory and a vivid mental picture. Then the lecturer proceeded to show that every word not vividly understood is a cipher, and that words are not vividly known, and never can be vividly known, unless thinking in shape is taught and practised. After showing the failure of memory-work, the lecturer pointed out that the commonest objects cannot be described correctly, because no one has been taught to see what they really are. A common chair can be made to give a history of thought and life and experience taking shape, and to lead up to the great fact that every shape is such a history, a living narrative, and the whole world a great illuminated volume of thought, speaking through shape which can be read by those who have learned to read thought in shape. But if this is so, then all shape is a language speaking truth or falsehood, giving honor or dishonor. And it does matter whether rooms and appliances are worthy or unworthy. How, then, has England treated lessons? Let the class-rooms in all their meanness answer. Then what class-rooms ought to be was shown, and examples brought forward of pictorial teaching. The way in which walls can be decorated without the painter going near the wall was explained, and designs for wall-decoration given. The treatment of books, and what is needed for books, next claimed attention. Then the effect on language of thinking in shape was dealt with, and the true progress of art by expression ever becoming more vivid in word and painting.

"Thinking in shape and pictorial teaching at once turn all created things into new language for thought. Every created thing becomes, on the spot, a possible new bit of thought, a possible new word born into the world of speech. I throw out, as a suggestion for any master of language, as distinct from a doctor of words, to examine into the curious fact, that in the last eighty years the English language has in this way doubled itself, by flashing new light into old words, by new combinations of words, by freer use of allusions and metaphors, and by pictorial handling of its material; and that it is practically a new language, in its wonderful increase in power of expression, and the breathing of new life into its shape. For expression goes on forever, as higher life produces higher manifestation of life, feelings, and thought, in human face and form, and again becomes able, by being higher, more sensitive, more sympathizing, not only to see and interpret the new shapes, but to find endless riches of unknown stores of precious discoveries in the old. This is the only true path of progress.

"The pictorial mind first pictures to itself all its own ideas, and

thinks in shape; and, secondly, is ever extracting ideas, new and old, out of the things it sees, picturing to itself all the words it uses, translating and retranslating thought into shape and shape into thought, till all things live and move for it in a universe that is living thought incarnate. The lesson-book is always before it. In city or desert, church or hovel, street or field, with flower, or tree, or cloud, or sun, or animal, or bird, or insect, from end to end of all things, there is the everlasting voice crying, 'He that hath ears to hear let him hear, he that hath eyes to see let him see, for life infinite, language universal, lies at your feet for pleasure and use always.' The pictorial mind is the only power man has that is capable of infinite progress. It is the only power that belongs to all men. It is the only power that is within reach of the poor. It can be taught. It can almost be created.

"As the world goes on and knowledge increases, it will be more and more impossible to know it all, a thing which was once quite within reach. Every man, however learned, will be narrowed by degrees down to a single subject. But subjects are many. There are a thousand languages, for instance; to know how to speak even half a dozen really well is an achievement; and so on, through the whole range of knowledge. How can any one man cope with this accumulation of facts? Boasts of knowledge, therefore, belong to the nursery level, betokening stupendous ignorance of man's capacity for knowing, and of what there is to know. Let us get out of the nursery and betake ourselves to true progress, and men as they are."

But "as long as examinations reign, there can be no true teaching," said Mr. Thring, "and thinking in shape and pictorial teaching find no place."

MENTAL SCIENCE.

Can the Mind attend to Two Things at Once?

THIS question has been frequently asked, and variously answered, according to the conception of 'attention' and of the objects to be attended to. Those who lay stress on the unity of mind regard it as almost evident *a priori*, that but one concept can occupy the focus of attention at a time, and that, if apparently many are entertained by consciousness at the same moment, it is simply because of the rapidity with which the attention can flit from one to the other. The holders of the opposite view call attention to the fact that in the quickest possible glance, in the flash of an electric spark, we get a view of an object, capable of being analyzed into a series of concepts, and that we saw every one of these as well as any other. A French psychologist, M. Paulhan, has recently stated the problem in its proper aspect, and illustrated the position he takes by some very interesting experiments. What is at one time the sole object of attention, completely filling the field of consciousness, may at another be only a small part of that field. Attention, like the lens of the eye, is now accommodated to act as an instrument of near focus, high magnification, but limited aperture, and again as one of distant focus, small magnifying-power, but wide range. At one time we see the rider and the horse as a single object; at another they are two. Admitting, then, that the object of attention is determined by a subjective element, by interest, by importance, by attractiveness, or what not, it remains to similarly determine the meaning of 'attention.' Just as memory is, from one point of view, not a single faculty, but a co-ordinated set of separate, individual memories, so attention is capable of various degrees of intensity, of various subdivisions of function. There are currents and undercurrents of attention. The eye may be intently engaged in looking for a friend, while the ear is drinking in the notes of a symphony, and we are suddenly conscious of a draught in the room. Whether or not there is a loss of energy between these occupations is to be determined by experiment.

M. Paulhan wrote the lines of one poem while reciting the words of another. The two series would sometimes get confused, a word, syllable, or prominent letter of the recited verse creeping into the written; but such mistakes soon became rare. The two series are largely strung on separate strings, and proceed in parallel directions. To repeat one poem aloud, and mentally go over the words of another, caused greater confusion.

If we compare the sum of the times necessary to perform each act separately with the time necessary to perform the two together,

we arrive at the law that the simpler the operations (especially in widely disparate senses), the more time is gained in performing them simultaneously, there being a loss of time in doing complex acts at the same moment.

To multiply on paper 7,897,654,987,896,687,786 by 7 took M. Paulhan 62 seconds; to recite 25 lines of 12 feet each, 38 seconds; the sum of which is 100 seconds. To do both together required 98 seconds, so that this is about the complexity at which there is neither gain nor loss. Here is a simpler pair of processes: to write out the product of 1,321,242,131,221,241,211 by 2 required but 11 seconds; to recite a certain couplet, 7 seconds; to do both at once, only 12 seconds,—a saving of 6 seconds in 18. The maximum of saving occurs when it takes no longer to do two acts than one; then certainly the two are done at once. This occurred when 421,312,217 was multiplied by 2 while 4 lines of 12 feet each were spoken; each of the processes consuming 6 seconds separately, and no more when performed together.

If the two processes are closely similar, and probably calling into action intimately connected brain-centres, there is a more decided loss. To write out the product of 33,213,442,124,343 by 2 with the left hand while the right does the same for 12,321,443-432,123 by 2, showed a loss of 15 seconds in 38. The right did the multiplication almost twice as rapidly as the left hand.

The following times illustrate the same principle: to write four verses of 'Alholic' required 22 seconds; to recite eleven verses from de Musset required 31 seconds; to do both at once, only 40 seconds.

The sum of the times necessary to read a selection aloud and to mentally repeat another selection was 33 seconds, while to do both simultaneously required as much as 38 seconds.

An attempt was made to have three series of mental operations go on side by side; to have the left hand writing the numbers 1, 2, 3, 4, 5, 6, 7, 8, 9, while the right wrote a verse, and the vocal apparatus recited some lines of poetry. This is a very difficult matter: the two hands tended to work intermittently, and there was much evident hesitation, friction, and loss of time.

We see, then, that the brain-centres, though closely co-ordinated, can so thoroughly acquire the habit of doing their more simple functions that it requires but a small portion of the attention to guide their action, while the rest can be given to the activities of another centre. The more unlike in function the other centre, the better can this subdivision take place. But when the act is complex, it soon requires the total amount of attention at command; and to attempt to do any thing else is a loss of energy. That individuals differ largely in their powers to perform such 'double acts' goes almost without saying.

ARTICULATED AND SIGN LANGUAGE.—When we wonder at the rapidity with which deaf-mutes spell out their words on their fingers, we are apt to feel that this invention has really diminished the disadvantages of this class of persons almost to a minimum. That such is not the case is vividly suggested by the statistics which a teacher of the deaf-mute has had the patience to gather. He has counted the average number of words which a pupil in his school wrote or spelled on the fingers per day, and finds it to be 1,118: the teacher similarly employs 216, but uses signs equivalent to 861 words daily. It has been estimated that a mother talks 27,000 words to her child in a day. Making due allowance for the habit of forming only parts of sentences which the deaf-mutes cultivate, and also for the suggestiveness of the sign-language (which hearing people really also use in the form of an expressional accompaniment), the comparative meagreness of the deaf-mute's conversation, and slowness with which his mental food can be brought to him, are plainly evident.

BOOK—REVIEWS.

The Ruling Principle of Method applied to Education. By ANTONIO ROSMINI SERBATI. Tr. by Mrs. WILLIAM GREY. Boston, Heath. 8°.

OUR English educational literature has had no richer contribution than this translation of Rosmini by Mrs. Grey. It is at once philosophical, scientific, and practical. Rosmini himself is too little

known in this country; and it was our intention, in noticing this book, to give some slight idea of his life and thought in so far as they moulded educational doctrine. But in this we have been anticipated by Mr. H. C. Bowen, late principal of Finsbury Training-College. As Mr. Bowen's sketch is inaccessible to American readers, we feel that we are doing them a service in reproducing most of it. Mr. Bowen calls Rosmini 'the Italian Froebel.'

Antonio Rosmini Serbati was born at Rovereto, in the Italian Tyrol, in 1797. He died at Stresa in 1855. When it is added that he keenly felt and took an active part in the events of his time, these dates above will suffice to show us that his life is worthy of attention, and was not without its trials and exciting episodes.

It was towards the close of 1839 that Rosmini, who had already more than once published the results of his study of psychology, undertook his work on pedagogy. It appears that a pious and generous lady of Stresa, Anna Maria Bolongaro, had offered to intrust to the Institute of the Brethren of Charity (the order founded by Rosmini) the management of an elementary school which her grandfather had founded in that place. The offer was accepted, and Rosmini set to work to compose a complete treatise on pedagogy. 'The Ruling Principle of Method applied to Education' is that part of it which he accomplished, and it carries us very nearly to the end of the kindergarten age. To quote from Francesco Paoli's preface to the original edition, "Rosmini based his treatise directly upon anthropology and psychology, which give us the knowledge of the human faculties which we are to educate, and their modes of action; on idealogy and ethics, which point out the objects, both proximate and ideal, by which the human faculties must be stimulated in order to be properly educated; and on ontology and theology, which provide the knowledge of the ends towards which the human faculties should harmoniously develop, to find in them rest and full satisfaction, which is the ultimate goal of human education." Rosmini divides life, not into periods of years, but into stages or degrees of cognition,—the successive acts of the understanding (*intellezioni*) through which the human mind advances in the development of its powers. The first period extends up to the first smile (roughly, a period of about six weeks), and possesses no definite cognitions, except the primary and fundamental cognition or intuition of being (the innate assurance that something is). It possesses also what Rosmini calls the 'fundamental feeling,' or that generally diffused feeling of our own bodies which, though it is not as yet attended to, constitutes us sentient beings. The cognitions of the second period, which extends up to the first articulate word (roughly, till the end of the first year), consist of the simple perception of things as subsisting, with corresponding volitions, termed by Rosmini 'affective' or 'instinctive,' which have these things for their object. Speech is the sign that the child has entered upon the third period of life, or the second order of cognitions, this order being formed by the child's analyzing the cognitions of the first order, and by his abstracting the more interesting, sensible qualities of things from the ideas of these things in his mind (imaginal ideas); and to these correspond the affective volitions, which have for their object these more interesting qualities abstracted from the actual things, and marked off from the things' other qualities, to which the appetitive faculty is at present indifferent. The third order of cognitions shows itself when the child begins to learn to read, say, at the end of the third year. We have now the exercise of the judging faculty, which has become able to connect by synthesis the elements of the previous analysis, and to affirm the existence in a subject of the qualities before abstracted. The corresponding volitions are the estimative or prizing volitions, by which the mind recognizes in a thing its interesting qualities, and thus estimates them. This is soon followed by the cognitions of the fourth order, which introduce analysis once more, as far as is necessary for forming comparisons between two objects judged of, and giving the preference to one over the other. The volitions belonging to this order are the appreciative, or the volitions of choice. The moral sense, which existed in germ in the preceding periods, now takes a larger development. The cognitions of the fifth order consist in a synthesis by which are determined the relations existing between two things combined into one, and conceived as one, of which conceptions the most important is that of the 'I' and of self-identity. About this

time appears the first dawn of conscience. And so, with their regularly alternating analysis and synthesis, Rosmini would have gone on sketching for us the characteristics of the succeeding orders. But here, to our misfortune, the treatise terminates, and we have nothing but rough notes and hints as to what would have followed. We must not, however, forget the warning which Rosmini gives us, more than once, concerning his stages of cognition. He only gives us the order in which they commence; but, when once commenced, they go on through all the other periods, increasing in power and widening in application. Moreover, the acts of the understanding are always excited by some stimulus external to themselves, and depend on this stimulus; and hence, when particular stimuli come late, we shall find the corresponding cognitions belonging to earlier orders coming into being alongside of cognitions belonging to the later orders.

But what of the practical application of all this? some of our readers may ask. Well, Rosmini himself answers, "I am a thinker, a psychologist. You good people of practice and experience must make the practical application of my principles for yourselves." But being human, as well as a psychologist, he cannot altogether refrain: he gives us some of his own 'practical applications;' and of these, some are very striking and suggestive, and some of—well, very moderate utility. "The object of instruction," Rosmini tells us, "is to bring the young to know, and it may therefore be called the art of properly directing the attention of the youthful mind." "There are always three distinct parts of instruction," he tells us elsewhere: "(a) that which serves to increase in the mind of the pupil the number of cognitions he has gained in the preceding order, and to make them more perfect; (b) that which enables the pupil to pass from the order of cognition in which he is, to the next higher order; and (c) that which serves to exercise and perfect the pupil in the knowledge belonging to the order he has just reached." He adds that it is evident that the language and style of the teacher should vary according to the order of cognition attained by the child. All language that goes beyond that order is wasted; or, worse still, it will produce confusion. In treating of the first order of cognition, he points out that nature has placed perception as the foundation of the whole immense pyramid of human knowledge, and that perception therefore should be the foundation of all human education. "Nature herself leads the child to observe every thing, and to experiment on every thing; but all these experiments and perceptions are unconnected and desultory. The earliest office of the educator, therefore, consists in regulating the child's observations and experiments, so as to lead him to perceive and to perfect his perceptions." The application of this is little more than hinted at, but enough is given to show how strikingly alike Rosmini and Froebel were with regard to the earliest childhood, though each worked independently and in complete ignorance of the views of the other. Indeed, one of the chief advantages of studying Rosmini's system is the added strength and clearness and meaning which it so frequently gives to the plans of Froebel, who, as a practical teacher, stands a head and shoulders taller than his Italian contemporary. Nor is Rosmini's psychology always equal to Froebel's. He has, for instance, some strange views on language, which, but for Prof. Max Müller's championship of very similar ones, would come upon us not only as novel, but also as startling. Rosmini holds that "by language we form our ideas," and that "man could not have invented that part of language which expresses abstractions." But, what is far more disconcerting to a teacher, is to find him stating that "one of the fundamental principles which should govern the instruction given, from first to last, is to consider language as the universal instrument provided by nature for the intellectual development of man," and to see, in the application, that this means that education is to be mainly a training in the use of words. Still, undoubtedly many of the practical hints he gives for the teaching of reading and writing will be found valuable, though they are applied somewhat prematurely; and much that he says on the use of music, and on picture-teaching, is highly suggestive. On the whole, however, we are inclined to think that teachers will be most struck with, and set most value on, the exposition given of the gradual development of the moral sentiment,—"based as upon a rock, on the great fact, that, rooted in the depths of the child's nature, there is a primary

necessity of growing respect and love to whatsoever intelligent being he comes to know,"—and with this, step by step, the corresponding gradual training. We have met with nothing elsewhere so soundly reasoned, so clearly expressed, and so practically suggestive; though here, again, the general line pursued is the same as that pursued by Froebel.

For the present we will say no more. But we hope we have said enough to prove to teachers that 'The Ruling Principle of Method' is a book to be studied with pleasure and profit. And, though some of us may be inclined to pronounce the system as rather logical than psychological, we shall all of us gain by coming in contact with a mind so eminently clear and reasonable, and so full of human kindness.

T. Macci Plauti Captivi. With Introduction and Notes. By W. M. LINDSAY, M.A. Oxford, Clarendon Pr. 16°.

Anglice Reddenda; or, Extracts for Unseen Translation. (Second Series.) Selected by C. S. JERRAM, M.A. Oxford, Clarendon Pr. 16°.

FROM the Clarendon Press comes a very neat little edition of the 'Captivi' of Plautus, by Mr. W. M. Lindsay, intended as a companion to the 'Trinummi' of Messrs. Freeman & Sloman of the Westminster School, where the plays of Plautus have been frequently exhibited by the scholars with much dramatic and archaeological success. The only fault to be found with those exhibitions, however, is their practice of ignoring the musical element, that must undoubtedly have been an important feature in the original production of the Plautine plays. In fact, the ancient divisions of the comedies were effected solely by the musical passages, or 'Cantica;' and in the manuscript the name of the musical performer at the first exhibition of the play is often given in the title, or, rather, after it. In the present edition of the 'Captivi,' Mr. Lindsay has very properly called attention to this fact, which even careful students of the Roman drama are too apt to overlook; and his remarks, although unduly brief, will be instructive to the young student, for whom this little book is intended. Within the limits which the editor has marked for himself in the preface, he has done very excellent work, availing himself of the most recent German research, and giving notes, that, while useful to the school-boy, are often very suggestive to the more mature scholar. Mr. Lindsay properly regards the Plautus lecture as affording "the best opportunity for teaching the etymology and structure of Latin words," and he has therefore given this side of the subject particular attention in the notes. The book may be unreservedly commended as being precisely what it professes to be,—an edition of the 'Captivi' that will "enable boys of the higher forms to read with intelligence and interest a play which, more than any other of Plautus, may suitably be put into a school-boy's hands."

The reading of Greek and Latin at sight is deservedly becoming an important part of the preparatory training for college, both in England and our own country. The advantages of an ability to read an ordinary classical author without the aid of a dictionary are so obvious as to need no comment, and, as they impress themselves more and more upon our instructors, a much-needed reform will gradually come about. One may hope to see the day when college-examinations will test not only the memory, but the genuine knowledge, of the student, and when the object will be to discover not merely how much he knows of some particular author, or portion of an author, but of the language as a whole. Already sight-reading of easy Greek and Latin has become a part of the required entrance-examinations at Yale and Harvard, it has for some time held a prominent place in the classical instruction at Columbia, and the time is not far distant when it will form one of the important tests of all our leading colleges. Mr. C. S. Jerram of Trinity College, Oxford, already well known as the author of several useful publications, has just sent forth a volume of extracts for sight-reading, bearing the imprint of the Clarendon Press, and entitled 'Anglice Reddenda.' It supplements a much simpler work issued some years ago, and is intended for students who may reasonably be supposed to have acquired a somewhat extensive vocabulary. The extracts are about equally divided between Greek and Roman authors, and are admirably selected so as to interest and entertain as well as to instruct. It may be doubted, however, whether such excerpts as odes from

the first book of Horace, fragments of the fourth Æneid, passages from the *Metamorphoses* and *Fasts* of Ovid, and the first eclogue of Vergil, will possess the requisite novelty to the class of students for whom this book is professedly intended.

Common Sense Science. By GRANT ALLEN. Boston, Lothrop, 12^o.

Studies in Life and Sense. By ANDREW WILSON. London.

If the question, 'What is the ideal method of popularizing science?' were raised at any of our large scientific meetings, about as many minds as men would probably be heard. Everybody admits the importance of the topic; everybody recognizes that science is all along getting popularized and gradually rendered digestible by the average man: but there is much difference as to the relative value of the several agencies by which this result is being produced, and the direction which these efforts should take in the future. There is a great deal of false popular science, — a class of writing in which the difficult points are always skipped, and the light and temporarily interesting ones unduly magnified; in which the interest is attracted towards certain minor points, and the whole doctrine set forth in a perverted perspective. One can dress up the facts of science in as attractive a garb as one likes; but the aim must be to bring home the fact, and not the study of the costume. The spirit of accuracy by which science is differentiated from un-critical knowing is the *sine qua non* of a real interest in scientific work.

Into what category of 'popular-science' writing one will put this work of Grant Allen's will depend largely on one's conception of the purposes of such literature. The geniality and attractiveness of his style are well known. They are important factors in the success of his works. The present series of essays exhibit the strength and the weakness of this class of writing. Its strength consists in its power to bring home simple truths in a way that suggests their real significance to the average mind; its weakness, in the fact that so much of it is not 'common-sense' science, but 'common-place' science: it says very little for the amount of words.

A striking feature of this and other recent general works is the great rôle which psychological subjects are now playing in science. Of the twenty-eight essays here printed, ten are distinctly psychological, and many others partly so. The main reason of this increased interest in the scientific study of mental phenomena is the recognition of their intimate relation with education. We are beginning to appreciate that the requisite for rationally educating the mind is to accurately know it.

It is only just to Mr. Allen to give a sample of some of the essays. A very typical one is that on self-consciousness, the tone of which will be readily gathered from the following sentences: "A philanthropist who had it in his power to abolish, if he chose, with a single wave of his hand, either small-pox or self-consciousness, would probably do more in the end to diminish human suffering and to increase human happiness if he elected to get rid, by an heroic choice, of the less obtrusive but more insidious and all-pervading disease; for small-pox, at the worst, attacks only a very insignificant fraction of the whole community; while every second person that one meets in society, especially below the age of fifty years, is a confirmed sufferer from the pangs of self-consciousness." The essay on memory sets forth in apt illustrations the complexity of human knowledge; that on the balance of nature, the inter-relation between the various classes of organic life. Under the title 'Big and Little,' is a lesson on the relativity of knowledge. The 'Origin of Bowing' traces the gradual refinement of a savage's slavish obeisance into the modern gentlemanly courtesy. 'The Pride of Ignorance' teaches an admirable lesson, as also does the essay on home-life. Other sufficiently suggestive titles are 'Holly and Mistletoe,' 'Sleep,' 'Amusements,' 'Evening Flowers,' 'Genius and Talent,' and so on.

Like all his works, this collection of papers will doubtless find a large and appreciative public. To those who do not already know the facts which it contains, it will offer an attractive method of acquiring them.

The spirit of Dr. Wilson's book is quite a different one. There are many who will listen to Mr. Allen who would not listen to Dr. Wilson; but those who choose the latter will not be sorry for their

choice. There is in these essays an unusual amount of information, well and attractively put together. It needs to be read attentively, but leaves the reader with the same feeling of satisfaction that one experiences when rising from a good and substantial meal. There will follow a process of healthy digestion, and the food will contribute some little to the making of its partaker.

Dr. Wilson is a biologist, and the sixteen careful studies contained in this volume touch portions of the entire field, from the 'Inner Life of Plants' and 'The Past and Present of the Cuttlefishes,' to the 'Body and Mind.' In each topic the author writes as one perfectly at home; avoiding the fault of attempting to tell too much, as well as of having too little to tell. It is popular-science writing, a very good type indeed.

Like the former book, this, too, is characterized by a preponderance of psychological subjects. Seven of the essays treat entirely or mainly of mental phenomena, while several others touch upon such topics. 'The Old Phrenology and the New' is an unnecessarily painstaking refutation of the claims of the 'cranial-bump examiners,' with a brief account of the evidence for the modern doctrine of the localization of function in the cortex of the brain. The old phrenology serves as an excellent type of the shoals, on which the hasty wanderer, leaving the straight but slow path of scientific advance, is likely to be wrecked. The nature of the relation between nerve-tissue and mental phenomena is outlined in the paper on body and mind; the main point being to show by striking examples the strange effects produced by intense expectation and concentration, which furnishes the kernel of truth in the claims of the mind-cure. 'The Mind's Mirror' explains the development of the expression of the emotions in animals and men, while 'The Coincages of the Brain' is a timely account of the part played by hallucinations in such happenings as our psychic-research societies are likely to record.

The more strictly biological essays treat of the economies of nature, showing, that, as conditions vary, nature utilizes every trifle, and avoids waste, or scatters tons of pollen over a barren soil. There are two excellent chapters on the zoölogical position of monkeys and elephants; while the volume closes with 'An Invitation to Dinner,' which gives occasion to a lesson on the physiology of digestion.

In the present case the proverbially odious comparison can hardly be avoided. Dr. Wilson's is in every way the better book; but Mr. Allen's will have the wider public, and, it is to be hoped, will excite an appetite that will lead to the searching for the more substantial food.

NOTES AND NEWS.

THE American committee of the International Congress of Geologists — a committee appointed by the American Association — will present a report at the meeting of the American Association in August concerning the positions to be taken by the representatives of American geologists at the next session of the congress in London (1883), upon the more important questions of nomenclature, classification, and coloring, which will there be discussed. It requests that Section E set apart a day for the purpose of considering these questions to be submitted by the committee, and of aiding that body to ascertain the direction of American opinion thereon. In order the better to accomplish this object, it requests Section E to issue an invitation to all American geologists (whether members of the American Association or not) to attend this session and participate in the work. The American committee also request that members of the association be informed of the opportunity offered for obtaining the great geological map of Europe, now preparing by a special committee of the International Congress. This map will be issued in 49 sheets, which, combined, will cover a space about 11 by 12 feet. The price is \$20 a copy, with additional charges of duty and expenses amounting to about \$6. Incorporated scientific institutions are of course exempt from duty-charges. For further information address Dr. Persifer Frazer, secretary of the American Committee, 201 South Fifth Street, Philadelphia, Penn.

— The Entomological Club of the American Association will meet on the day prior to the meeting of the association, at 2 P.M. The

Brooklyn Entomological Society has appointed a committee to welcome the members of the club, and to assist in making the meetings interesting, as well as to give such information regarding matters of special interest to entomologists as may be desired. The same society will arrange for one or more field-excursions in the vicinity of New York, and a reception will be arranged for. Members of the club intending to contribute papers will please communicate the same to the president, Prof. J. H. Constock, Ithaca, N.Y., or to the secretary, Mr. E. Baynes Reed, London, Ontario.

— The Botanical Club of the American Association will hold its meetings, as usual, during the week of the association. For particulars address Mrs. E. L. Britton, secretary of the club, Columbia College, New York.

— The Society for the Promotion of Agricultural Science will hold its eighth annual meeting in New York, beginning on Monday evening, Aug. 8, at Columbia College, and continuing on Tuesday. For further information address Prof. W. R. Lazenby, secretary, Ohio State University, Columbus, O.

— The aggregate production of shad for distribution the present season by the United States Fish Commission has been enormous. The number produced has been increasing from season to season, owing to the perfection of the methods in use. A summary of the distribution for the present season, arranged by river-basins, is as follows:—

Penobscot River.....	1,169,000
Kennebec River.....	800,000
Tributaries of Narragansett Bay.....	1,275,000
Hudson River and tributaries.....	1,979,000
Tributaries of Delaware Bay.....	5,099,000
Tributaries of Chesapeake Bay.....	68,149,000
Tributaries of Albemarle Sound.....	5,332,000
Tributaries of South Atlantic coast.....	3,566,000
Tributaries of Gulf of Mexico.....	7,048,000
Inland waters.....	1,014,000
Total.....	95,421,000

It will thus be seen that over 68,000,000 young shad-fry have been returned to the waters of Chesapeake Bay. The entire production of the fisheries of the Chesapeake for the present season was about 2,000,000 young shad. It is therefore evident, that, for every mature shad taken from the waters of the Chesapeake, thirty-four young, healthy, and vigorous shad have been returned to those waters. Experiments already made by the commission indicate, that, up to the close of their river-life (the young shad migrating in October), twenty per cent of the fry placed in our rivers will survive, and attain a size of from two to three inches in length. Arrangements have been made by the commission to secure complete statistics of the shad-catch all along the entire coast for the present year, similar statistics having already been collected in 1885 and 1886. Information already in the hands of the commissioner makes it certain that the aggregate production of shad on the coast has been larger the present season than at any time in the last twenty years, but it will be impossible to give the measure of increase. For the Potomac River it is already assured that the increase of 1887 is fully 100,000 shad over that of 1886, and the increase of 1886 over that of 1885 exceeded 100,000. In the Potomac fisheries alone in the last two seasons the increase in shad has been over 250,000; the increase representing a much larger number than the entire catch of 1879, in which year the fisheries of the Potomac reached their lowest ebb.

— Professor Riley, the entomologist of the Department of Agriculture, has made public the result of an exhaustive personal investigation into the habits of the *Phorodon humili*, or hop-louse. His discoveries are expected to prove of great value to hop-growers, as he has succeeded in learning the habitation of this plant-pest during the winter months, and tracing it through the varying stages of insect-life. Before the investigation, it was not known how or where the insect survived the winter. As a result of his inquiries, Professor Riley has satisfied himself that the eggs laid by the female at the close of the summer are deposited in plum-trees, where the insect hatches in the spring, and resides until the third generation. This third brood, unlike its predecessors, is winged, and immediately after development abandons the plum-tree and attacks

the hop-vine. In the autumn a counter-migration from the hop-vine to the plum-tree occurs, the winter eggs are deposited, and the cycle of life goes on in the same way. It is a notable fact that in regions where the cultivation of hop-vines is a new industry, the growers have had complete immunity for a while from the pest. In California to-day they are not troubled by it. Professor Riley believes that the *Phorodon humili* has been brought to this country from Europe on plum-stock; and there is reason to believe that the *Phylloxera*, the dreaded grape-pest, was carried from this country to Europe on grape-vine cuttings. Therefore California hop-growers are warned to beware of importing plum-stock from eastern hop-regions. These discoveries render it possible to check the ravages of the hop-louse either by the use of insecticides in the springtime, before the insect has reached the winged state, or by the destruction of the sheltering plum-trees. The experiments will be continued with a view to protecting the hop-vines after they have become infected with the hop-louse.

— The project of holding a summer school of physics at Harvard College this season has been abandoned; but on July 19 and 20 apparatus designed for use in the 'forty-experiment course,' preparatory for admission to Harvard College, will be shown to teachers or others at the Jefferson Physical Laboratory, and questions relating to the experiments will be answered. The same thing will be done for the 'sixty-experiment course' on the second day, July 20.

LETTERS TO THE EDITOR.

* * * The attention of scientific men is called to the advantages of the correspondence columns of SCIENCE for placing promptly on record brief preliminary notices of their investigations. Twenty copies of the number containing his communication will be furnished free to any correspondent on request.

The editor will be glad to publish any queries consonant with the character of the journal.

Correspondents are requested to be as brief as possible. The writer's name is in all cases required as proof of good faith.

Theoretical Meteorology.

A REVIEW of Professor Ferrel's recent work on this subject in *Science* for June 3 furnishes an opportunity to present a few points on this subject. Professor Laughton, ex-president of the Royal Meteorological Society, once said that there was hardly a theory in meteorology that was well established. If this be so, it seems to me there is great danger of putting too much reliance upon mere theory, which does not have a sufficient groundwork of facts. There is special danger of this in meteorology, where the mathematical discussions of gaseous movements and vortices are hedged about with so much difficulty and complication. I am well aware that the views here advanced are opposed to those of many most advanced thinkers in this field, and I only ask an unbiased hearing.

To my mind there are at least two fundamental errors in this subject, but these are intimately interwoven throughout its warp and woof. These are, first, that there is friction only between the air and the earth, or at least that friction between contiguous air strata may be neglected; second, that conditions and changes of pressure, temperature, and moisture in the atmosphere, are the only causes acting in producing either its general motions or storms.

The objections to the first theory are briefly as follows. At a height of 100 feet, or at the most 200 feet, in a level country, there is no longer friction between the air and earth, but rather between air and air. This is especially the case on the ocean; and here, surely, we would have no waves, if it were not for the friction between air and air. If there were no friction, all storms would take place in a virtual vacuum, and into a vacuum air would tend to flow with about the velocity of sound. Professor Ferrel thinks, that, according to laws of gaseous motion, the earth's atmosphere would leave the poles and heap itself at the equator, but this is prevented by friction with the earth's surface; but, as we have just seen, we need consider only friction of air on air at 100 feet elevation.

The objections to the second theory cannot be set forth as easily as the above. When we are gravely told that the sun heats up a certain portion of the earth's surface, and that in consequence vertical currents are set up which finally bring about a wind of 100 miles an hour, we can but be credulous. As a matter

of fact, the sun does not heat up a limited portion of the earth. Its rays shine with equal intensity over 1,000 miles from east to west. It has also been shown that this heating of the surface does not ascend more than a few inches in the air. One of the strongholds of the theorists is unstable equilibrium; but right here we find two seemingly contradictory statements. On p. 51 of Professor Ferrel's book, 'Recent Advances in Meteorology,' there is a suggestion that this state (unstable equilibrium) is brought about whenever there is a less diminution of temperature with height in an ascending column than in neighboring portions of air. On p. 328 of the same volume, however, the idea is given that this same state may be produced if there is an abnormally great diminution of temperature with height. It would seem as if in both these instances, even if there were a tendency to this state, air would flow in at all times from surrounding regions, and instantly relieve the condition. This relief would be afforded the more rapidly, the less the friction. However, the error here is farther back. We cannot suppose that the atmosphere is either quiescent or flowing in a current having a uniform velocity in all its layers, to the height, say, of 15,000 feet. The fact is admitted that there is a uniform acceleration in the different strata as we arise; so that, even if an upward movement should begin, a few hundred feet would destroy all vertical tendency. As a matter of fact, when we consider the actual conditions under which solar radiation acts at a storm-centre, we see that this unstable state could not be formed. At a storm-centre clouds cover the earth's surface, and prevent all abnormal conditions from great heat. Balloon-ascents have shown uniform temperatures up to the top of the clouds.

The theoretical computations of the velocity of the upper air strata do not correspond with the actual movements recorded. On p. 259 Professor Ferrel gives the velocity of the current at the height of 16,000 feet as 26 miles per hour in the middle latitudes of the United States.

On Mount Washington, 6,300 feet in height, the velocity when a low area passes is 53 miles per hour, and when a high area passes it is 21. The velocity of the low areas near Mount Washington is 34 miles per hour. This would indicate that the 'power' of the storm must be below 6,300 feet, since it is admitted that its progressive motion is due to the movement of the strata where it exists. It may be safely said that a height of less than 6,000 feet for the centre of disturbance would be fatal to a great many of the present theories of storm-generation.

Formerly it was said, that, owing to friction with the earth's surface, the upper part of the storm must be in advance of the lower; but it is certain that such a state of things could continue only a few minutes, for the upper portion of the storm would be rapidly separated from the lower. Professor Ferrel, on p. 260 of the present volume, explains this difficulty by suggesting that the upper part of the storm is continually re-forming itself, and that there is no actual transference of air. I hardly think that this suggestion will be accepted. It seems to me our storms would behave differently if it were true, and certainly our synoptic charts do not give any clew to such re-formations of the upper part of the storm. It seems to me this later theory destroys the continuity of the ascending current and the essential features of unstable equilibrium. One of the most difficult phenomena to explain is the fall of rain at a distance of 300 and more miles from the storm-centre. If we suppose the ascending currents are at the centre of the storm, then rain should fall at that point. Professor Ferrel, at p. 266, advances the novel idea that the rain is formed in or carried to the upper currents, and, as these are more rapid than the storm, it must fall in advance of the storm. I do not think this theory takes sufficient account of the facts. Let us suppose the raindrop carried to a height of 7,200 feet: observations in balloons show that rain very rarely occurs above that height, and that the 'power' of the storm is at 5,000 feet. We may consider the velocity of the current at 7,200 feet 15 miles per hour greater than at 5,000 feet: the drop would fall at about 10 feet per second, or would reach the earth in 12 minutes; and hence, if it had been carried in the upper current during this time, it would have fallen 3 miles in front of the centre, instead of 300 or more. As a matter of fact, since the currents below 5,000 feet are very much slower than above that height, any acceleration would be entirely overcome, and from these principles the drop

would actually fall back of the centre. On the continent of Europe the bulk of the rain falls at the rear of the storm.

To my mind, however, theoretical meteorology most signally fails in its attempts to explain our more violent storms and tornadoes. That the sun's heat could start a vertical current which, with the condensation of moisture in the upper air, would give rise to winds of 200 or 300 miles per hour, seems incredible. The attempt to meet the difficulties by suggesting 'great contrasts of temperature,' 'meeting of warm southerly with cold northerly winds,' 'cool air overrunning warm,' 'warm air overrunning cool,' etc., does not seem at all satisfactory. As long as it was supposed that tornadoes occurred at the centre of a low area where it was thought there was an ascending current, the theory seemed plausible; but when it was clearly shown, in March, 1884, that tornadoes do not occur at a low centre, but 400 or 500 miles to the south-east, it became necessary to explain this. It seems to me that all attempts to elucidate this subject have merely served to lighten the darkness without removing it.

There is no space left for minutely examining the great superstructure built on what seem weak foundations. It seems as though the first and most important step is to remove the slur cast upon this science by those who are qualified to know its weakness. Let our theorists bend every energy to establish some fundamental proposition; either by actual experiment in the laboratory or by investigation in nature's laboratory at the spot where the 'power' of the storm manifests itself. It seems to me the recent attempts of Weyher in France to demonstrate the existence of this 'power,' by means of a rapidly revolving fan at some distance above water or grain, show the great need of further proof. These experiments show what might be if only there were an enormous fan in the upper air, but where is the fan? Must we not conclude that the true explanation is now farther off than before, and certainly much farther from the present theories. H. ALLEN HAZEN.

Washington, July 1.

Determination of the Depth of Earthquakes.

THE report of Captain Dutton and Everett Hayden on the Charleston earthquake (*Science*, ix. p. 489) is undoubtedly a very valuable addition to earthquake literature. There are two or three points, however, to which I wish to draw scientific attention, in the hope that investigation hereafter may clear them up.

Perhaps the most interesting and important point in the report is their method of determining the depth of earthquakes. The authors first review rapidly other methods. Mallet's method — by protracting the lines of emergence back to their meeting-point — they dismiss as too uncertain. Seebach's method — used in the earthquake of Central Germany in 1872, which depends on the law of decreasing velocity of the emergent wave — they also dismiss, because the times of arrival at different points cannot be determined with sufficient accuracy, on account of the different velocities of the two different kinds of waves, normal and transverse. In place of these methods they propose what they claim to be a wholly new one, founded on the law of decrease of intensity; i.e., of decrease of the shock-motion or motion of the earth-particle, or, in other words, the wave-height or amplitude.¹ They show by mathematical discussion that the place of the maximum rate of decrease of intensity bears a fixed relation to the depth of the focus; viz., as 1 to $\sqrt{3}$. Upon this basis they estimate the depth of the focus to be about twelve miles. In Fig. 1, which we reproduce from their report, the fall of the double-curved line represents the decreasing intensity. The place of most rapid fall, i.e., where the curve changes from convexity to concavity, is the place of most rapid decrease of intensity. This place was quite distinctly marked. It was about seven miles from the epicentrum.

We wish now to draw attention to the fact that this method does not differ very greatly from, and perhaps is not an improvement upon, another method suggested by Mallet in his 'Report to the British Association, 1853,' p. 102, though not used in his discussion of the Neapolitan earthquake of 1857; viz., by means of what may be called 'the circle of principal disturbance.' This method is mentioned and explained in my 'Elements of Geology,' p. 117. The authors seem to have overlooked it.

¹ With constant wave-length, intensity \propto amplitude.

The destruction about the epicentrum of an earthquake depends mainly, perhaps, upon the amount of motion, but partly also upon the direction of motion; horizontal motion being far more destructive than vertical. Now, the whole amount of motion is assumed to decrease as the square of the radius of the agitated sphere increases ($d \propto \frac{1}{r^2}$); but the horizontal element of the motion increases as the cosine of the angle of emergence. Under these two conditions, there will be a certain distance all about the epicentrum, bearing a fixed relation to the depth of the focus, where the horizontal element will be a maximum. This is at ad' (Fig. 2), where the angle of emergence is $54^\circ 44'$. In other words, the 'circle of principal disturbance' is the base of a cone whose apex is at the focus, and whose apical angle is $70^\circ 32'$. The distance ad of this circle from the epicentrum is to the depth of focus ax as 1 to $\sqrt{2}$.

Now, it is evident that in violent earthquakes the destruction over the whole area of this circle might be nearly the same; for in the central parts the whole motion would be greater, and on the margins the sideways motion would be greater. But beyond this circle the destructiveness would very rapidly decrease, because the whole motion and the sideways element are both decreasing: in other words, if we used the graphic method, the curve of destructiveness would be like the curve of intensity (Fig. 1), except

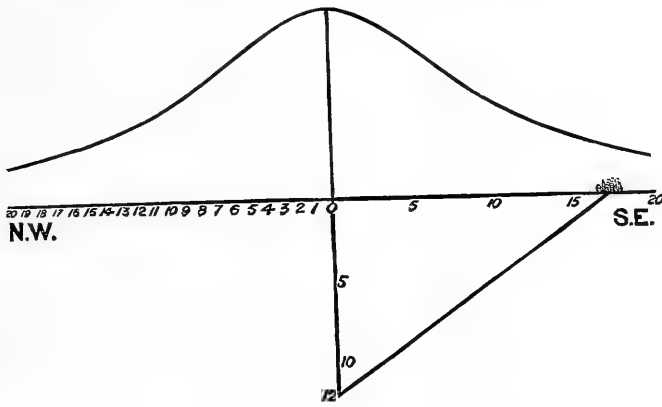

FIG. 1.

that it would be flatter on the top, and the descent more abrupt at a certain distance from the epicentrum. The decrease of destructiveness is more rapid at a certain point than is the decrease of intensity.

Now, since the intensity is estimated largely, if not wholly, by destructiveness, and since destructiveness depends largely upon the sideways motion, is it not possible, is it not even probable, that the supposed place of maximum decrease of intensity is really the place of maximum decrease of destructiveness; i.e., the circle of principal disturbance? If so, then the depth of the focus would be about ten miles instead of twelve miles.

We have assumed all along that the intensity or excursion of the earth-particle, or the height or amplitude of the wave, varies inversely as the square of the radius of the agitated sphere ($d \propto \frac{1}{r^2}$). The authors as well as all other writers assume this law. But is there not good reason to doubt its accuracy? The law is probably true so long as the wave is spherical; i.e., until it emerges on the surface. But when it emerges, what becomes of the energy which would have continued the wave if it had not been cut off by emergence? Some of it is doubtless consumed in more violent motion, and perhaps rupture, at the surface; but is not much of it reflected back into the earth to combine with the advancing waves? All other elastic waves, whether light-waves or sound-waves, coming out of a denser medium into a rarer (or *vice versa*), are largely reflected from the surface: why not earthquake-waves also? Sup-

pose the spherical wave were cut off, not on one side only, but on both sides; in other words, suppose a shock generating normal circular elastic waves of compression to occur in the centre of a thin plate: is it not evident that the intensity of these would vary simply inversely as the radius ($I \propto \frac{1}{r}$)? Or, if the plane be reduced to a bar, such waves would be substantially constant in intensity.

But we are not left to general reasonings on the subject. If the intensity or wave-height follow the law of inverse squares, it is impossible to understand how the waves should carry so far as we actually find. In the Charleston earthquake the motion at the distance of six hundred miles was still sufficient to create alarm and to produce seasickness. Now, the amount of motion at the epicentrum was not more than ten or twelve inches. Let us take twelve inches as the greatest motion, and the epicentrum as ten miles from the focus. At the distance of six hundred miles, according to the usually assumed law of decrease, the amount of motion or wave-height would be only a three-hundredth of an inch; but if the spherical wave is reflected back from the surface, and combines with the advancing wave, it is probable that its decrease is only as the increase of the radius. In that case, at six hundred miles the motion would still be a fifth of an inch, which is a very sensible motion.

It is very important that investigations should be undertaken to determine the law of decrease of wave-motion of earthquakes. This, however, cannot be done without seismographs.

While on this subject, it may be well to say something about Seebach's method of determining the depth of the focus. The method by the circle of principal disturbance, and that by maximum decrease of intensity, are based on the law of inverse squares, and

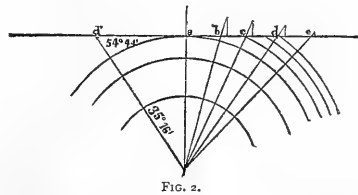

FIG. 2.

therefore fail if this law be untrue. Seebach's method, on the contrary, is based on the law of decrease of velocity of the surface wave; supposing, of course, a constant velocity of the spherical wave. I have been in the habit of representing Seebach's method as follows: on the co-ordinate axes A, B, C, D (cd being the earth surface), of the earth, let equal times be taken on AB , and spaces passed over in equal times on CD . The one represents the

constant velocity of the spherical wave, and the other the decreasing velocity of the surface or emergent wave. By connecting these points by rectangular co-ordinates, an equilateral hyperbola is developed, the centre of which is the focus x , and the character of which depends on the depth of the focus. The hyperbola becomes more and more triangular in form as the depth becomes less (as in taking the surface at $c'd'$, $c''d''$), until, if the focus is at the surface, the hyperbola becomes a right-angled triangle; i.e., the surface wave passes over equal spaces in equal times. If, therefore, we plot accurately the times on AB , and the corresponding places on CD , we may develop the hyperbola and calculate its centre; or else by accurate trial we may find a point which shall be the centre of circles passing through corresponding times and places. That point will be the focus. Such is a very general account of the method, given in my own way. For more accurate detail, Seebach's work must be consulted.

We believe that this method, in a thickly settled country dotted over with observatories on railroad-stations where accurate time is kept, will prove the most accurate. Dutton and Hayden object to this method that it is important to have the accurate time of arrival

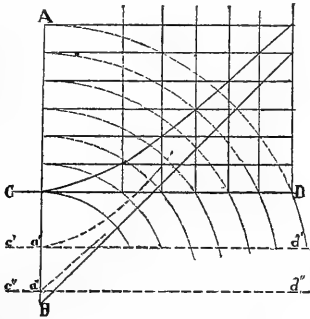

FIG. 3.

of the wave, because there are two kinds of waves, — the normal and transverse, — which run with different velocities. The answer to this is, that it is only over a comparatively small area that, on any method, observation can be relied on for estimating depth. Inspection of Fig. 3 shows that the arm of the hyperbola very soon becomes almost straight; the velocity of emergence at any considerable distance becomes sensibly the same as that of the spherical wave, and therefore can no longer indicate depth. But over the small area where the curve of the hyperbola, or change of velocity, is rapid, the time of arrival of the different waves would not greatly differ. At any rate, the use of seismographs which decompose the complex earth-motions will record these different waves separately, and thus enable us to determine the law of decrease of one of them — the normal — with accuracy.

In conclusion we would insist that we cannot any longer afford to study earthquakes without seismographs. The Geological Survey ought to have these in different parts of the country. The University of California has recently gotten three of these of the best character (Ewing's and Gray-Milne's), which will soon be set up in different parts of the State. JOSEPH LECONTE.
Berkeley, Cal., June 21.

The Corresponding Volumes, etc., of Ice and Sea-Water.

THESE determinations were made in Hudson Strait (latitude $62^{\circ} 33' 45''$ north, longitude $70^{\circ} 41' 15''$ west), in an inlet having a width of a little more than half a mile. I am thus particular in giving the width, because in a very narrow tidal harbor, with the ice fast on either shore, the line of flotation of the ice would sensibly alter with a rising or falling tide. In this instance I was particular in watching for such a difference, under these opposite conditions; but, if present, it was insensible.

The determination was made on Feb. 3, 1885, when the temperature of the air was -3° F.; for the water, $26^{\circ}.7$ F.

A hole having been cut through the ice, of such a size as to pre-

vent any sensible error owing to capillarity, its thickness was found to be 2 feet 9.6 inches from surface to surface; on top of the ice was an estimated average depth of snow of 3 inches, of such a density that by weight it was equal to 1.1 inches of the ice: the total thickness of ice, or its equivalent, would therefore be 2 feet 10.7 inches. Of this amount, 32.5 inches were submerged; leaving, therefore, 2.2 inches of ice, or its equivalent, above the water-line.

Therefore sea-water-ice floats with one part above the water-line and fourteen and eight-tenths below. Expressing the volume of a given quantity of sea-water by unity, its volume, when converted into ice, would be 1.0634; and their densities as 0.922 to 1.000.

W. A. ASHE.

The Observatory, Quebec, June 24.

Death of W. O. Ayres, M.D.

THE death of Dr. W. O. Ayres, one of the early members of the California Academy of Sciences, has recently been made known.

He was specially interested in the study of ichthyology, and for many years after his arrival in California, in the intervals of an extensive medical practice, contributed to this department of natural history by his investigations of and publications upon the fishes of California. At the first meeting of the academy of which there is any published record, Sept. 4, 1854, he presented descriptions of two new species, *Labrus pulcher* and *Hemitripterus marmoratus*, which still stand, though the generic status has been modified, — now *Harpe pulchra* and *Scoranicthys marmoratus*. His contributions to the ichthyological knowledge of the Pacific coast were frequent for many years, especially from 1854, as above, to the year 1863. His scientific inquiries sometimes extended, though rarely, towards other forms of animal life. He returned to his native State, Connecticut, about 1872 or 1873. His services to the cause of science on the Pacific coast in those early days entitle him to grateful remembrance. R. E. C. S.

U. S. Nat. Mus., June 28.

Cause of Consumption.

THE experimental together with the clinical study of tuberculosis has established the view that there are three factors in its causation: —

First, The presence of the parasite, the tubercle-bacillus, as a pathogenic element. This factor is necessary for the production of the disease.

Second, Heredity figures as a prominent element in about thirty per cent of the cases ordinarily met with.

Third, Mal-hygienic and debilitating agents, such as foul air, sedentary occupations, violations of the laws of health, and diseases, have a powerful effect, by impairing the nutrition, in developing the disease.

Heredity and lowered vitality cannot of themselves produce tuberculosis, but clinically they play an important rôle as factors by rendering the individual more vulnerable to bacillary influence.

FRANK DONALDSON, M.D.

Baltimore, Md., June 29.

Volapük.

YOUR correspondent, 'H. T. P.,' in your issue of the 24th of June, asks for information about Volapük. I can refer him to a most interesting article upon this subject, which appeared in the *Bulletins de la Société d'Anthropologie de Paris*, 1885, pp. 317-321. The article is by M. Kerckhoffs, who has published the following work, 'Cours Complet de Volapük,' par A. Kerckhoffs (Paris, 1886), and contains a sketch of the structure of the language and some interesting information about its prospects, progress, etc. A. F. CHAMBERLAIN.

Toronto, June 28.

Queries.

7. DEATHS AND THE TIDE. — A physician living near the sea states that during the past five years he has noted the hour and minute of death in ninety-three patients, and every one has gone out with the tide, save four who died suddenly by accident. Is there any other evidence to sustain this statement? — D.

SCIENCE

FRIDAY, JULY 15, 1887.

THE NUMBER OF ACCIDENTS which occurred on the 4th of July of the present year was very great. In Boston, twenty-seven individuals applied for surgical aid at the City Hospital, and nine beds are occupied by injured persons. At the Massachusetts General Hospital the number is nearly as great. In New York and in Brooklyn there were also very many casualties more. If a description could be given of all these injuries, the picture would be an appalling one. One of the saddest sights we have ever seen was that of a deaf-mute girl whose clothing took fire from a burning pack of fire-crackers which she carried in her pocket. Her back was so severely burned that she was compelled to lie upon her face in bed, and take her nourishment from a vessel while lying in this position. Three days after the receipt of the injury, she developed lockjaw, and died in twelve hours. It is to be hoped that the time is not far distant when the present barbarous method of celebrating Independence Day will be prohibited by law, and the prohibition enforced.

DR. SAMUEL SEXTON has contributed an article to the *Medical Record* on the subject of boxing the ears. He has upon his records fifty-one cases in which the ear has been injured by blows of the open hand or fist. Of these, thirty-one were males, and twenty females. Of the males, thirteen had been boxed upon the right ear, thirteen upon the left, and three upon both ears. One was kicked by a companion upon the left ear while bathing, and the right ear of another was injured by having the head violently squeezed between the hands of another person. Of the females, fourteen were struck upon the left ear, and six upon the right. Five of the women were assaulted by their husbands. Of the entire number, eight were boxed in play, four by school-teachers, two by parents, and one, a fervent lover, by his sweet-heart. Several cases occurred among pugilists, and others were due to assaults and brawls. The nature of the injuries varied to a considerable degree. One had inflammation of the ear, with suspicion of intracranial trouble. He had had a running of the ear for twelve years, following a blow upon that organ. This patient subsequently died of brain disease. In another case the ear became inflamed, and the hearing was very much impaired. In still another, the patient was slapped by his father upon the left ear. Immediate pain and deafness followed, with a bloody discharge from the ear. It was three months before this case recovered. The dangers to which Dr. Sexton calls attention are so grave, that parents, teachers, and others should never punish those committed to their charge by boxing the ear.

DO WE WANT AN INTERNATIONAL COPYRIGHT WITH ENGLAND?

THE agitation for an international copyright with England was at its topmost vigor just fifty years ago. It is going on to-day with precisely the same vigor, promoted by the same interest, but-tressed by the same arguments, as at its beginning. But meantime the situation has changed. In 1837, when Henry Clay championed a bill for an Anglo-American international copyright in the Senate, all our publishing-houses printed English books without going through the form of asking anybody's permission. All of our magazines were 'cruisers,' using the matter they found in the English monthlies and quarterlies with despotic freedom; and the question, 'Who reads an American book?' was answered with practical unanimity by our own countrymen, 'Nobody.'

To-day we are on the eve of another congressional effort for a bill providing for an Anglo-American international copyright. But what is now the situation? Our publishing-houses publish English books as fast as (and often earlier than) they appear in Great Britain, either by purchasing advance sheets of the British publisher, or reprinting by license. And our magazines find plenty of suitable material offered them at home not only, but quite too much, and so rather discourage voluntary contributions at all, preferring to invite contributions from parties chosen by their editors. The exceptions to these propositions are insignificant; and, even were they larger, they would still be exceptions, from which nothing but the rule can be argued. The only difference between the agitation of to-day and the agitation of 1837 is, that to-day we are told that the reform is desired because American authors are suffering for it, and because the absence of an Anglo-American copyright cheapens and discourages their work; and that it is therefore unpatriotic to further deny it.

Do we want any more books than we have already? What branch of science, or literature, or art, is suffering? From what quarter comes complaint of a dearth of books? Courts are established for the trial of controversies between man and man. Were there no litigation, there would be no courts. And yet one of the horn-book and capital maxims of court is, that 'it is to the interest of the public that there should be an end of litigation,'—a maxim which is interpreted to mean that compromises and quietings of actions between parties (statutes of limitation, or any discretion of a court tending to discontinuances of lawsuits) will always be encouraged. Are we not coming to the time when there will be some such a paraphrase of this maxim as that 'it is to the interest of literature that there shall be an end to books'? Certainly the groaning columns of our book-stores begin to bewilder us with their profusion of literary wares, and suggest a question as to how much of all this mass is, after all, literature. How much of it will be on these shelves a year, or even a month, from now, or will have been packed down in the cellars below, or turned over to the paper-stock men in the Ann Streets of our great centres?

If it should prove, for example, to be the fact that a couple of dozen men in the United States do all the writing for our American magazines, whose business would it be, except that of the public,—who buy those magazines or not, entirely as they please? Magazines are not edited, have not for the last ten years been edited, as of old, by voluntary contributions. The editor knows what his readers want, and writes to employ just what writers they want. He saves his reading of manuscripts, thus conserving his eyesight as well as his judgment. If some of our magazine-editors would just once print some of the manuscript they do receive from voluntary correspondents,—just as they receive them, with the orthography, etymology, syntax and prosody, punctuation, and so forth, precisely as their authors send them,—I think our public would be convinced that the editors are right in the policy they pursue. And I do not suppose the magazine-purchasing public would very largely clamor for a second effort, on the editors' part, to 'recognize voluntary contributors.' Add to this the fact that a large percentage of the voluntary contributors to our magazines,—convinced that a conspiracy exists among all magazine-editors to reject their manuscript,—'get their blood up,' so to speak, and print at their own expense in pamphlet or book form, and we derive some idea of the causes which are at work to load down our booksellers' counters. It seems to me that the world of readers will be more apt to ask for a law which will restrict, rather than for one which will increase, the publishing of books; and that they would look less askance at the proposal for an Anglo-American copyright law if assured that it would curtail, rather than exaggerate, the present deluge of printed and published matter.

Another change in the situation since the early agitation for English

international copyright lies in the fact that the daily newspaper, which sells for a couple of coppers, is no longer merely a bulletin of the telegraphic news and market reports, but furnishes daily a volume of reading-matter with which the bookseller must compete sooner or later. Add to this (we can go on adding here for a long time yet) that the articles in the newspapers and the periodicals of more lasting value will surely be printed in book form; and, if not of permanent value, a very large percentage of them will arrive at the same disposition by reason of the collective pride of the authors ("By request of numerous friends who desire to see them in more permanent form," is the stereotype here),—and the prospect for more books than we need soon becomes bewildering. And these books, too, are bound to be dilutions of other dilutions in combination; for the original atom which is to be added, at the best can be but small compared to the vast centuries of literature behind each successive book.

Now, in all this maze of things, the publisher is really in the same position as the editor of the magazine. He can bring out the untied manuscripts of his fellow-countrymen, and run the risk of selling enough copies of the venture to grow rich therefrom; or he can take the English books which he knows will sell, which the newspapers and periodicals of the world are advertising for him, and run no risk. He avoids the expenses of proof-reading and correction by buying advance sheets; and since he publishes for the same reason that authors write,—to accumulate a competency, and meanwhile to support himself until he does accumulate it,—we can hardly blame him, because, already once in print, the author or owner of the English book can deal with him on better terms than the American author.

In answering the question as to whether we really want an international copyright, I should like to consider it under two propositions; namely, (1) whether our own authors need it, and (2) whether the British authors need it (and, if yea to the latter, how we can give it to them at all). In answering these questions, I would like to premise, first, that personally I am in favor of an international copyright with England; that I am not only in favor of, but some years ago labored hard to secure, one (at my own expense), and contributed money to assist the labors of others in the same direction. Nay, further, I once devised a plan by which a case should be constructed, like the celebrated greenback case, wherein an English citizen should write and publish a book in this country, an American publisher pirate and print it, and the Englishman begin an action for the infringement and an accounting; and so go up to the Supreme Court of the United States on the question whether the Constitution of the United States by its exact words, or by any statute enacted by virtue of such exact words or grant of power therein clothed, did forbid, or deny in this single instance, the natural right which every man has to his own,—to his property. And I may add (in self-defence, lest what I am led to say in this paper may look as if I am of different mind now from what I was then) that I believe the abstract act of printing for gain, without license therefor, of literary matter one has not produced and which belongs to another, is larceny, pure and simple, and therefore without color of moral excuse.

Let us examine the second question, as to the British author, first. If an Englishman brings his horse to this country, it does not become the less his horse. If I break in upon that Englishman's stables and appropriate that horse, it is horse-stealing on my part; and if I use the horse so appropriated, and earn money by using it, and present the Englishman with a portion of my winnings, I am none the less a stealer of horses. Similarly, if a publisher takes an Englishman's book without the Englishman's consent, and publishes it, he has appropriated what does not belong to him; and if the book so republished sell, and the publisher presents the Englishman with a portion of the proceeds of the sales (or with the entire proceeds, for that matter), the fact that the publisher has appropriated what does not belong to him, and so committed an immoral act, is not affected in the least. But, unfortunately, it is one of the accompaniments of the curse of Adam that nations must legislate for their own people, and make treaties with each other on only the one principle, the selfish principle, of expediency,—of what is expedient to themselves and to their own people. Indeed, no attempt has ever been made, so far as I am aware, to maintain nations on

purely moral grounds. No nation that I am aware of, on being invaded by a foreign foe, has said, "You are right, we are morally wrong, therefore we will not fight you: take our nation, we have erred, and deserve to lose our homes." And, to go a little further, no nation that I am aware of has ever enacted laws for the benefit of citizens of another nation, or even for the benefit of a certain class or guild, or association of citizens of another nation, simply because it was morally right that such laws should be passed, or because the citizens of that country, or class, or guild, or association thereof, had really a moral right to something which the fact that they were not citizens of the nation enacting the laws had theretofore withheld from them. Could or would the British Parliament enact a law for the benefit of American statesmen, or American lawyers, or American physicians, without the comment that one man was as good as another, and that if Parliament proposed to give American statesmen, or lawyers, or physicians, equal rights with English subjects in England, the law should be for the benefit of all Americans, whatever the profession by which they earned their bread, not for a single class thereof, since the Law should be no respecter of persons? Clearly, the English author can only petition the American Congress for a statute of Anglo-American international copyright on the ground that he is a man, and that it is wrong to take his property without his consent; and the only answer to that statement will be, that the laws of national expediency do not, *prima facie*, permit a nation to pass statutes to secure special justice to a special class of aliens, although it is equally true that no civilized nation denies equal justice, under its general laws, to any man by reason of his alienage.

Second, so far as the American author is concerned, I apprehend that one reason why Congress cannot pass a statute of Anglo-American international copyright on the petition of American authors is because Americans can not (or at least because they do not) present a case, or at least a grievance, upon which Congress can act. Legislatures in constitutional countries can no more enact statutes than courts can find judgments or issue decrees, without a statement of facts, positive and special: neither the Legislature nor the court can act upon mere generalities. And generalities are all that our American authors can present (or at least have so far presented) to Congress. When any one, or one hundred, American authors can show to Congress that anybody is being specially damaged by the absence of such a statute as they pray for, then the time will come for the showing to be legislated upon. Let the petition recite that A is, and always has been, an American author; that he is dependent upon his trade or profession of authorship for his daily bread; that he cannot earn any money for his authorship unless he can secure a publisher; that he cannot secure a publisher, although he has made every effort in good faith; and that he is informed, and believes, that the reason why he cannot secure a publisher is because Congress has hitherto neglected or refused to pass a statute enacting an Anglo-American international copyright. On such a showing as that, Congress could act: could appoint a committee to inquire into the facts, and, if found as stated, report a bill for the relief of A. But is it not the fact, that, while any number of American authors are willing to sign a round-robin at any time for an Anglo-American international copyright, no single author has ever been known to come forward and make such a petition, or show such a loss or grievance, anywhere or to anybody?

Or if the round-robin of American authors could join in a petition of another sort: Let A, B, C, and D respectfully show that they are citizens of the United States; that, by reason of the neglect or failure of Congress to pass a statute enacting an Anglo-American international copyright, there is a dearth of books, or magazines, or other published matter in the United States; and that by reason of this dearth of books they cannot pursue their studies, or procure reading-matter for themselves or their families; that they are, by reason of this state of things, suffering great loss and hardship, etc.—there, again, would be a state of facts into which Congress could inquire, and, if found *bona fide*, could legislate. But I am afraid that this last round-robin would have hardly a leg to stand on, in the current year at least, from the fact that in the office of the Librarian of Congress, the legal depository for copyrights, the entries have footed up to 31,229, of which 4,676 were for bound volumes, being an increase of 588 over any previous year, as I learn

from the Librarian of Congress. If, therefore, Congress cannot find any individual to say that he is a sufferer by the present state of affairs, and cannot find anybody to depose that the country is suffering, where is the case to meet which, or the hardship to remove which, Congress can act?

As to the constitutional powers of Congress to pass laws resulting in an admission of Englishmen to full privileges of our laws so far as the protection of literary property is concerned, perhaps a word may be said; though, from the above considerations, it would hardly affect the fact, that, however constitutional the action to be taken, Congress must have some pretext upon which to base their action.

When the Constitution of the United States was framed, it gave Congress power to pass laws 'to promote the progress of science and the useful arts' by securing for limited times to authors and inventors the exclusive right to their respective writings and discoveries. It is argued, that, — since the words used are, 'to promote science and the useful arts,' — this clause must be construed to mean that the framers were not thinking particularly of the citizens of the Republic, but rather of the sciences and the useful arts, in their anxiety that the new commonwealth should grow in intelligence and intellectual strength. But, since the presumption is always that a State legislates for the benefit of its own citizens first, even before it legislates for the abstract benefit of arts and sciences; and for the practical worldly prosperity, safety, and peace and tranquility of its citizens, even before conservation of their intellectuality, — something more, I suppose, than abstract argument will be required by Congress before it will be satisfied that those presumptions have been disposed of, and the constitutional clause sufficiently widened for them to act upon a generality.

Commercially speaking, questions of copyright as a matter of fact are at present of very minor importance in the jurisprudence of the United States. As a matter of exact calculation, decisions upon questions of literary property do not occupy one sixty-fifth of one per cent of the time of our courts. It is impossible to deny that such a consideration as this may, in its turn, have some effect upon the indisposition of Congress to legislate upon questions of copyright; though that it can militate in the slightest against the right of every man to his own, of course nobody can pretend for a moment. The real value of the subject, being thus appraised by the despotic laws of trade and of supply and demand, need not be further assessed. But I have no doubt but that the great resources of the English language, and the perfect ease and impunity with which any literary work can be pirated by paraphrase, have something to do with this estimate. Eleven years ago I myself prepared a legal treatise on this very subject of copyright, and my publishers issued it in two octavo volumes of some fifteen hundred pages. Since copyright cases rarely appear in the digests, and only occasionally in the reports (being mostly settled, if they get into court at all, at special term), I was at the pains of considerable servile labor in collecting my cases at first-hand from counsel and the court records. But no sooner had my book appeared, than a general writer for the press, who, among other lucubrations, had been favoring a popular weekly with dissertations to the effect that copyright should not exist and be limited by statute at all, but by common law, and so be perpetual, — and that therefore the law was a robber and a villain, — gathered up these dissertations, and bound them, along with my cases, into a book; which, as it came later than mine, by the inexorable law-book rule, superseded it. To conceal the plagiarism, this last writer was at great pains to display in his volume a list of the authorities he had consulted, taking in authors a century or so back, but carefully omitting my work of the year before (which he, however, reviewed at great length in a daily newspaper), out of which he had nevertheless obtained all his recent, and the bulk of his valuable, material. Now, here was no apparent nor technical piracy, — nothing against which I could demur, or courts relieve. The example has survived its importance, and (since the last-coming volume is already effete) lawyers have so rarely occasion to open it, that I doubt if they have even discovered that its letter-press reads one way, and the cases it cites another. But I recall it here to show how small, at the most, is the real protection an author gets from the act of taking out a copyright; and how easily even technical matter can be pirated with impunity. But

when it comes to general propositions the protection vanishes altogether; for we can equally well say, 'the sun shines' or 'the orb of day illuminates,' 'the rain falls' or 'it rains,' 'gravity controls' or 'the attraction of gravitation governs,' 'the statute provides' or 'it is enacted by the statute,' etc.; and a very little ingenuity indeed will suffice to make a later book entirely entitled to copyright, while actually, consecutively, and unblushingly pirating the entire contents of its most recent predecessor by the simple and artless process of paraphrasing it. Certainly there is no law, rule, or custom of the copyright bureau to prevent; no oath of originality, novelty, or utility is required, as in the case of application for a patent. Anybody can mail a titlepage and fifty cents to the Librarian of Congress, and, on publication of his matter, two printed copies of something whose drift or contents corresponds to that titlepage; and this, — entirely irrespective of the source, authorship, proprietorship, or character of the matter forwarded, — gives a complete copyright under our statutes. Under such trivial, almost childish conditions, is it worth while to inquire exactly what franchises we are proposing to enlarge, or whether, on enforcing them, the constant and inevitable percentage of evasion will be increased or lessened? Our present statutes of copyright give the very minimum of protection, at the very maximum of expense; but the amendment they need is not just now, perhaps, in an international direction. For the American author, however, they do afford a certain amount of security, from the very fact of their being upon the statute-books; while, as to the English author, the purchase by our publishers of advance sheets — which, by the constantly decreasing time-distance between New York and London, is becoming much the cheapest thing our high-class publishing-houses can do — makes almost any piracy on this side labor under the great disadvantage of delay and a remainder-market already supplied. And as to the piracy of current standard works, we can, of course, pass no *ex post facto* laws.

Again: British authors have never ceased, I think, to press with whatever interest here they could muster, for international copyright between their own country and ours. But it is only since a remarkable series of letters by the late Charles Reade, addressed (about twelve years ago) to a New York City daily newspaper, — claiming that American authors suffered more than English ones by non-international copyright relations between the two countries, — that American authors have been found sending in their round-robins and petitions for a treaty or a statute securing such comity. Are our American authors quite sure that Mr. Charles Reade was entirely disinterested, or, as he claimed to be, entirely devoted to the interests of American authors, when he wrote? That it was not only a new tack, after all, from the English standpoint? Are American authors quite sure, if English authors could copyright over here, that American publishers would not still prefer the English to the home author; that he would not, perhaps, write quite as interesting novels and quite as competent text-books; that from King Log our American author would not find he had been appealing to King Stork?

As a matter of fact, there are numerically very few publishing-houses indeed at present engaged in reprinting English copyrighted books without English license. And by actual examination of the trade-lists of these, moreover, I find that they are publishing mostly such books as are called 'standard,' namely, the works of English anthology, letters, and science, from Shakspeare, Bacon, Locke, Newton, and the like, down to Tennyson, Browning, Darwin, Huxley, Tyndall; which latter (simply because they do not sell popularly, with the exception, perhaps, of Tennyson) they do not reprint at all. Now, although the descendants of William Shakspeare, could we find them, have a perfect copyright at common law in their ancestor's plays (for there were no statutes of copyright in William's day, and what is now American was English soil), there is no claim in that quarter for our publishers to sin against; and it is only the living English authors, mostly the novelists, who are moving for international comity. Now, the English novelists are a fraternity to which we owe a good deal in this country. For my own part, I would miss a large fraction of the amenities of existence without them. But the question is, are they a large enough body politically and economically, from an international point of view, to justify treaties or other international legislation

especially since no such legislation can be retroactive so as to compensate them for past losses?

As to American literature, I may repeat, that the constitutional right of Congress to provide an international copyright with England is based on the constitutional clause, when interpreted to mean that Congress has the right, not to encourage authors *quoad* authors, but to encourage the growth of literature and the arts *per se*; and this (though I have them not by me) I understood to be the gist of the arguments of my esteemed friend, E. L. Andrews, Esq., before a committee from one of the houses of Congress, and of Mr. Thorvald Solberg in a late letter to *Science*. I rather doubt, myself, if the framers of the Constitution were thinking, at that precise date, of future flights in literature and art, instead of the new born nation for which they were drafting organic laws, or if the presumption is not that they were thinking of the latter; but, at any rate, I am of opinion that the absence of an international copyright with England is rather more of an incentive to emulation on the part of our American authors than its presence could possibly be. Just as the highest standard produces the highest scholarship, so, it seems to me, the fact that, other things being equal, the American publisher prefers to print the Englishman's work rather than the American's, is a tremendous inducement to the American to make things unequal in his own favor. Said a writer of novels, an American, to me the other evening, "The public buy novels,—not your novels, nor my novels, but novels,—and I ought not to be obliged to compete with stolen goods.—But if that be the case," said I, "it appears that you are not competing with stolen goods necessarily, but with your brother novel-writers. Stolen goods are the accident, no doubt, of your trade, but not to a larger proportion than of any other trade. Your remedy, it seems to me, is not to petition for international copyright, but to give your goods such a character and reputation that consumers will take none but yours. If you assume a commercial standpoint, you must take the consequences of it."

However, in dealing with the guild of authorship, we must never forget that all the members, indiscriminately, of that guild, deserve our grateful recognition; and this is equally, I think, the public sentiment of this continent; and besides, as to any of the craft, alien or native, in these questions one should always remember that authors and dealers in literary property do not exactly stand upon a bread-and-butter basis. As to the author, he is a gentleman who has deliberately selected the worst-paid and least-thanked of the professions,—a profession which not only attracts the minimum of commercial attention, but practically unfits him for ever leaving its walks for any other,—and therefore he should be treated, if not with that benign munificence which the law extends to sailors and infants, at least with the consideration and self-abnegation of his fellow-men.

So far as the question of an international copyright with England goes, I personally have never abandoned my belief in its righteousness. However doubtful of the constitutional powers of Congress to enact one by special statute, I am able to see no reason why the present statute cannot be amended (say, by substitution of the word "person" for the words "citizen of the United States") so as to practically enact one: or treaty made with Great Britain, which, under the treaty-making power, might shield itself from any judicial question whatever. As to an international copyright with France, Germany, or other continental nation, it is needless to add, the considerations I have suggested above do not in any wise apply.

APPLETON MORGAN.

THE INCREASE OF STATE INTERFERENCE IN THE UNITED STATES.—III.

WE have now before us what is said in a general way by representative men among the economists and students of political science with respect to the character of recent legislation, so far as it bears upon the question as to the increase of State interference. We have sufficient data to justify the opinion that laws having a tendency to interference are on the increase, and that this increase is pretty general throughout the country. It remains to discuss the views entertained by our correspondents as to the advisability of such legislation. These views are extremely diverse, and show very

clearly the absence of any organized body of widely influential economic thought in this country. Sixteen per cent of our correspondents are unreservedly in favor of the unlimited extension of State control: they are therefore logically State socialists. We believe, however, that this proportion is far larger than that which obtains among either professed economists or the people at large. Twenty-seven per cent of our correspondents are in a general way favorable to the extension of State control, but would guard such extension carefully. Twenty-four per cent view State control with disfavor as a principle, but would admit it in certain cases. Thirty per cent are unreservedly, some of them violently, opposed to State control, and express themselves with much directness and force. A comparatively small number rest their opposition on *laissez-faire* as an economic doctrine, the larger number assigning other reasons. Three per cent express no opinion, and are therefore classed as non-committal.

In noticing the able pamphlet of Prof. Henry C. Adams, 'The Relation of the State to Industrial Action' (*Science*, ix, No. 222), we pointed out that he lays down three guiding principles for the regulation of State interference. It will be well to recall these principles, and keep them in mind for comparison with what is said on the subject by others. The principles referred to were, (1) the State may determine the plane of competitive action, (2) the State may realize for society the benefits of monopoly, (3) social harmony may be restored by extending the duties of the State.

Professor Cooper of Carleton College, Minnesota, says, "I believe the State should interfere to control powerful monopolies, but this power cannot be wisely used by such men as are chosen to our State Legislatures."

Frank R. Morrissy of the Omaha (Neb.) *Herald* strongly opposes State interference. He would check it by "the education of public sentiment to the fallibility of majorities through the columns of the press, the pulpit and the rostrum, infusing a broader knowledge of the privileges of personal liberty, and impressing upon the citizen the necessity for the consideration of every other citizen's opinions."

William Alvord of San Francisco believes in amendments to the State constitutions, forbidding the enactment of local or special laws. He says, that, since the adoption of the new California constitution, the bound volumes of session-laws have decreased from over 1,000 pages to 270 pages or thereabouts.

Prof. Jesse Macy despairs of any reform so long as thinkers and teachers beat the air, and keep out of speaking-distance with the people who are in governmental difficulties.

Prof. Henry C. Adams thinks that the increasing attention now being devoted to political science will in time produce less unsatisfactory legislation.

C. Caverno, Esq., of Lombard, Ill., is very optimistic. He finds in the increasing interference only renewed adaptation to the social environment. "In my judgment," he tells us, "our legislation is predominantly wholesome: the work of man rarely appears to so good advantage as therein."

Herbert L. Osgood of Brooklyn, N.Y., says, "Take the world over, political theories at the present time tend strongly toward the advocacy of more State interference. This is doubtless in response to a real need. The statutes of this nation, as well as those of Europe, will probably yield to this impulse to a certain extent; but theories always far outrun practice. The Republic does not necessarily lead toward individual freedom, but the spirit of private enterprise is too strongly developed in this country to yield to a paternal government. I believe the restrictions upon the freedom of the individual coming from public opinion and social custom are in this country more dangerous than those to be feared from the laws."

Assemblyman E. H. Crosby of New York City believes that the increase of legislative interference is the result of a popular demand for it. This demand, to be intelligent, must be directed by sound political science, and the dissemination of this is the need of the hour.

Morris F. Tyler of Connecticut is a representative of those who think that unlimited *laissez-faire* will work a cure in time. Prof. A. T. Hadley does not believe it worth while to try to check it, but would let extremists pass such laws as they please. These could not be enforced, and would either be repealed or become a

dead letter. Prof. John B. Clark of Smith College would trust to political education. "The specific point," he says, "in which intelligence can do the most immediate good, is in the labor-organizations from which the political pressure proceeds."

The Chicago *Tribune* sends us the following: "The *Tribune* holds that restrictive legislation is not only advisable, but necessary, though admitting it may be carried too far, and has often been overdone in the past. You have doubtless noticed that the relative breadth of restrictive legislation varies with the development of civilization in a community. At first all is arbitrary, each offence being treated on what the judge or judges (maybe dictator or plebiscite) regard as the merits of the individual case, without regard to precedent. As the community grows, the tendency is to swing towards the other extreme, and the resulting over-legislation is more slowly corrected. Bad laws are repealed, good ones consolidated, and special legislation forbidden for the future by constitutional enactment. These three phases may be said to be approximately represented by the mining-camp in this country, the frontier State, and the older State. Illinois is a senior of Minnesota in the family of States, and may therefore be expected to be less paternal in legislation. And there is reason to believe that a careful comparison of the two would show this to be the fact. Undoubtedly the best form of government, and we may even say the ideal one, is that in which an appeal to the common law would suffice as a rule of action in all courts, and its interpretation be found adequate to the punishment of wrong-doing by any member of the community, however prominent he may be. But no State in the Union has yet reached the stage where this could be depended upon; and, till this has been attained by a process of slow growth, it seems to be necessary to resort to some kind of special legislation to provide against new forms of wrong doing which every now and then crop out in the race between conscientiousness and rascality."

Prof. E. J. James prefers to secure better legislation by improving the grade of legislators. He would not "restrict the power to Legislatures to do much good, for fear they may do some harm," by constitutional amendments.

The replies mentioned above are fairly typical of the divergent views presented. Had space permitted, we should have been glad to produce more of our replies in full. But our end is gained if we shall have succeeded in directing thoughtful attention to the tendency developing among us. As Dr. Shaw says in his original article, we think we are proceeding on one economic theory, but our actual legislation is in direct opposition to that theory. We are not asking for a restoration of *laissez-faire*; but we should like to know whether this perpetual running to the Legislature for purely private enactments meets with the approval of the thinking men of the country. We do not believe that it does. We believe, with Professor Perry of Williams College, that interference results from the attempts, often successful, of individuals to accomplish, in the name of the State, their own personal ambitions and desires. We believe that when the people at large realize the extent to which paternalism in legislation has developed, they will declare themselves with no uncertain sound as in favor of the fundamental American principle of individual liberty and individual responsibility. They will just as emphatically refuse to permit the State's power to be prostituted to personal ends.

HEALTH MATTERS.

Preventive Medicine.

IN an address on the recent advances in preventive medicine, delivered at the thirty-eighth annual meeting of the American Medical Association, Dr. G. H. Rohé stated that the danger of an invasion of this country by cholera was greater than it had been at any time during the past three years. The United States are threatened from three sources: first, from Europe, by way of the Atlantic Ocean; second from Japan, by way of the Pacific; and, third, from the west coast of South America, by way of the Pacific, or by way of Mexico and our southern border. The Isthmus of Panama and the South Atlantic lines of transportation may also act as gateways to the infection.

In this address, Dr. Rohé refers to the researches of Shakspeare, Koch, and Pettenkofer into the relations between cholera and its

bacillus or spirillum. He also alludes to the claims of Freire of Brazil, and Carmona of Mexico, concerning protective inoculations against yellow-fever, and to the fact that these claims are now being investigated by Dr. Sternberg, under the authority of the president. A brief history is given of the cases of scarlet-fever which have occurred in England, apparently having their origin in milk from diseased cows. We have already mentioned these cases and the able investigation of them by Mr. W. H. Power of the English local government board. The subjects of tuberculosis and typhoid-fever also receive attention.

Decided advances have been made in the disposal of the refuse of cities. The cremation of garbage has been carried out at Montreal, Canada, and at Wheeling, W. Va. The irrigation system of sewage-disposal has been greatly extended in Germany. In Berlin it has given great satisfaction, the sewage of 900,000 people being carried to irrigation-fields, and the water which drains off being submitted to chemical examination for evidences of pollution, which were discovered but once during an entire year. The objection that this system of sewage-treatment is not applicable in cold climates is invalid, as is shown by the results in Pullman, Ill., and in Dantzig, Germany. Birmingham, England, with a population of 600,000, has adopted the irrigation system, and the income realized during 1885 from the sale of stock and produce from the sewage-farm amounted to over \$100,000.

During the past year the poisonous effects of tyrotoxicin, discovered by Professor Vaughan, have been witnessed repeatedly in persons who have taken milk and ice-cream. Professor Vaughan has made the suggestion that this ptomaine may be the active cause of cholera-infantum. The question of public baths is treated very fully in the address. Public, like private, bathing institutions must make provision for individual baths. Large pools, in which many persons bathe at once, fail to answer the requirements of sanitary science or of public decency. A French army surgeon, Duval, has overcome this difficulty, and now both the French and German soldiers have proper facilities for bathing. The latter are required to bathe every week, the government furnishing the bathroom, warm water, soap, and towels. In our army and navy no steps have been taken to introduce this reform, although Dr. Billings has shown its feasibility. Dr. Lassar of Berlin has demonstrated the practicability of separate bath-rooms in connection with public bathing, and has been urging the extension of the military system to the civil population, so that every German may have his weekly bath. He gives excellent illustrations of the practical benefits to be derived from the adoption of such a system. At the white-lead works in Ehrenfeld, the eighty employees are required to bathe weekly, the facilities being furnished by the proprietor. In the first year, 1884, the sickness was reduced twenty per cent, and in 1885 it was reduced still lower, fifty per cent. In certain dye-works in Berlin, ten rooms, containing shower-baths, have been provided for workmen and their families, and for all who desire to use them. In Göttingen, with a population of 21,000, of which number 3,000 are children who attend the public schools, baths are fitted up in the basement of one of the school-houses. A class of fifty can bathe in an hour. Each child has the opportunity of bathing once in two weeks, and seventy-five per cent of the children avail themselves of it. The authorities and teachers are unanimous upon the point that the system is of great benefit to the children, not only from its direct sanitary advantage, but from the habits of cleanliness formed, to which they are likely to adhere through life. The only cities in the United States having public baths are, Boston, with 17; New York, 15; Philadelphia, 5; Brooklyn, 3; Cleveland and Hartford, each 1; and Buffalo, the number not given. In New York, 3,431,086 persons bathed from June to October in 1883; during the same time in Boston, 959,765; and in Brooklyn, 225,885. In eighteen cities where there are no public baths, only about twenty-three per cent of the residences are supplied with bath-tubs.

Dr. Rohé concludes his address with a statement of some of the results of the application of sanitary measures, quoting the statistics of Dr. Baker in Michigan, and Dr. Ogle in Great Britain. The address is an admirable *résumé* of what has been done in the realm of preventive medicine, and no one can read it without being impressed with the great strides which have recently been made in this field of research.

WHAT TO EAT WITH TEA AND COFFEE.—In the *Journal of Anatomy and Physiology*, Dr. J. W. Fraser reports the results of his experiments on the action of tea, coffee, and cocoa on stomach and intestinal digestion. He summarizes his views by the following recommendations and deductions: 1. That it is better not to eat most albuminoid food-stuffs at the same time as infused beverages are taken; for it has been shown that their digestion will in most cases be retarded, though there are possibly exceptions. Absorption may be rendered more rapid, but there is a loss of nutritive substance. On the other hand, the digestion of starchy food appears to be assisted by tea and coffee; and gluten, the albuminoid of flour, has been seen to be the principle least retarded in digestion by tea, and it only comes third with cocoa, while coffee has apparently a much greater retarding action on it. From this it appears that bread is the natural accompaniment of tea and cocoa when used as the beverages at a meal. Perhaps the action of coffee is the reason why, in this country, it is usually drunk alone or at breakfast,—a meal which consists much of meat, and of meats (egg and salt meats) which are not much retarded in digestion by coffee. 2. That eggs are the best form of animal food to be taken along with infused beverages, and that apparently they are best lightly boiled if tea, hard boiled if coffee or cocoa, is the beverage. 3. That the caseine of the milk and cream taken with the beverages is probably absorbed in a large degree from the stomach, and that the butter used with bread undergoes digestion more slowly in the presence of tea, but more quickly in the presence of coffee or cocoa; that is, if the fats of butter are influenced in a way similar to oleine. 4. That the use of coffee or cocoa as excipients for cod-liver oil, etc., appears not only to depend on their pronounced tastes, but also on their action in assisting the digestion of fats.

CONSUMPTION.—At the recent meeting of the American Climatological Association held in Baltimore, the discussion of pulmonary consumption occupied an important position. The address of the president, Dr. F. Donaldson, sen., was on the prophylactic treatment of those who inherit a predisposition to phthisis. He thinks that we are justified in assuming from statistics that this disease is diminishing. In England there has been a gain in males of fourteen per cent, and in females of twenty-two per cent, while in Massachusetts there has been a gain of fifty-four lives in every hundred thousand. Thirty per cent of the cases have an inherited predisposition to the disease. This hereditary form, when developed, offers the least prospect of recovery. He regards the acceptance of Koch's bacillus as well-nigh universal. Its constant presence in phthisis must be accepted as the full explanation of the manifestation of tuberculosis. Persons who are predisposed to the disease may develop it by the inhalation of the dried bacillus from the expectoration of diseased persons. The prophylactic treatment embraces two elements: (1) the improvement of the general health of the subject, and (2) the protection from contagion. The tuberculous mother should not nurse her child, but, if possible, it should be given to a healthy wet-nurse. The hygiene of the nursery should be looked after carefully. The room should be well ventilated, and kept at a comparatively low temperature. The subject should live much out of doors, especially between the ages of fifteen and twenty years. The beneficial effect of sunlight should be borne in mind. The physical form of the chest should be enlarged by gymnastic movements. If possible, life should be passed in high altitudes. Oleaginous fluids are useful if they can be digested. The milk and flesh of tuberculous animals must be avoided, for cooking rarely destroys the bacilli of beef. If the prophylactic treatment is thoroughly carried out, the hereditary proclivity may remain latent, and the individual never contract the disease. In the discussion of the general subject, Dr. Bruen considered that in tubercular phthisis the influence of sea-air was disastrous. Those cases which are most benefited by prolonged sea-voyages are those in which there is no inherited tendency to tuberculosis. Dr. Bowditch thought that a great distinction should be made in speaking of the sea-coast-air and the pure sea-air. Cases which could not stand the harsh, cold, and changeable air of the sea-coast may be benefited by a sea-voyage, or residence on an island some distance from the shore, where the conditions are similar to those which are obtained in a sea-voyage. Dr. Knight remarked that he knew of

several patients who had improved and gained in weight during a stay at some of the coldest resorts on the New England coast. Dr. Wilson gave it as the result of his experience that there were three classes of consumptive patients who cannot go to the Atlantic sea-coast without risk: (1) those in whom there is active febrile disturbance, (2) those who have a highly excitable nervous organization, (3) those who suffer from repeated attacks of spitting of blood.

BRAIN-WOUNDS.—At a meeting of the American Surgical Association held in Washington, Dr. D. Hayes Agnew of Philadelphia discussed the medico-legal aspect of wounds of the brain and thorax. The study of the subject was suggested by a recent case which occurred in Newport, in which a colored man was found dead under the breakfast-table. He had food in his mouth, and a wound of the head and the heart. The question was as to the possibility of these wounds being self-inflicted. Dr. Agnew, after a thorough examination into the subject, states that injury to the brain is not necessarily followed by loss of consciousness or paralysis. Numerous instances have occurred in which, after injury to the heart, the individual had performed many acts. He concluded that it is possible for a ball to enter the brain without destroying consciousness, although for a moment it may cause mental confusion, and that a suicide may shoot himself in the head, and after a moment shoot himself in the heart. In the particular case which gave rise to the discussion, it was demonstrated that the deceased had been murdered, his son-in-law confessing the crime.

BOOK—REVIEWS.

The Effect of the War of 1812 upon the Consolidation of the Union. By NICHOLAS MURRAY BUTLER, Ph.D. Baltimore, Publication Agency of the Johns Hopkins University.

A VERY interesting subject is treated with tantalizing brevity in the monograph which forms the seventh number in the fifth series of the 'Johns Hopkins University Studies in Historical and Political Science.' Dr. Butler has confined himself wholly to one line of investigation, avoiding the many fascinating questions that are collateral to it, and freeing his own discussion of the main subject from all but the very briefest comment. He desires to show, first, that real peril to the perpetuity of the Union sprang from the anti-nationalistic theories broached in the first decade of the present century; and, second, that the immediate effect of the war of 1812 was so to stimulate national pride and strengthen the waning desire for national unity as to avert that peril until it confronted the State once more at a later day, allied with the political interests of slavery.

The term 'anti-nationalistic,' which Dr. Butler uses, serves a very convenient purpose; for it cannot be truly said, that, as a practical factor of national politics, the doctrine of State sovereignty was more the property of the Democratic than of the Federal party. It was really a question between the ins and the outs. Although the first clear statement of the principle of State sovereignty is found in the Virginia and Kentucky Resolutions, and hence must be regarded as Democratic, still, in the practical application of that principle, the Federalists of the Massachusetts and Connecticut Legislatures and of the unfortunate Hartford Convention were not a whit behind their old opponents; and Dr. Butler makes it very clear, that, until a foreign war had drawn the popular attention away from internal dissensions to the public peril, neither party was truly animated by a consistent and continuous desire for genuine union. That the war of 1812 was in its inception a party war, is, of course, quite true; yet in 1816 the people, as a whole, made it evident by their votes that they had united in approving it, and that they rejoiced, with a thrill of national pride that was wholly new, over the brilliant victories of the American navy, and of Jackson's army at New Orleans. Of this curious change in popular sentiment, Dr. Butler gives us much interesting corroborative testimony, and, strangely enough, from men of the same party that first paved the way for the later doctrines of Calhoun and Hayne.

"The war," says Dr. Butler, "had ruined the particularists: it had made all nationalists, if we may use the word. The bonds of the early days of the Revolution were forged anew, and the

nation's heart beat as one. Patriotism and national pride had conquered sectionalism and personal selfishness. The era of good feeling had dawned."

It may seem to the general reader that the author regards the beneficial effects of the war as wholly transient and temporary, — good while they lasted, but soon to be entirely obliterated: in other words, that the sentiment of nationalism which then made itself apparent was a thing of present interest rather than of permanent importance. "Although not *destined to be permanent*," says Dr. Butler on p. 26, "the national feeling it produced was something entirely novel." "The ebb was to be greater than the flow," is another expression that may mislead. But the author clearly does not mean to ignore the fact that the war of 1812 did, in truth, lay the foundation for that imposing constitutional structure which Webster and his followers were to build, and which fell not in the time of trial, being founded on a rock. In fact, from the year 1816 begins the true development of a party devoted to the preservation of the Union; and if Dr. Butler does not follow out this line of thought, it is because he has distinctly limited his discussion to the consideration of the immediate results, and declined to enter upon investigations too extensive for the pages of a monograph.

H. T. P.

The Principles of Morals. By Professors FOWLER and WILSON. Oxford, Clarendon Pr.

TREATISES in ethics seem more numerous in the last decade than in any other. The revival of interest in this subject reminds us of the emergencies that called forth the moral earnestness of Plato. Indeed, the revolution going on in present ethical speculations is a repetition of the sophistic movement in Greece, and seems to provoke similar reconstructive efforts. But the task this time is a greater one than that with which earlier moralists had to contend.

The successors of Professor Green follow that lamented author's 'Prolegomena' with a very different discussion of ethical problems. The work is the joint product of two authors, and consists of two parts. The introduction is mainly historical, but contains sufficient criticism to determine the position of the writers. It is admirably free from the long and labored discussions about pleasure which make so many systems of ethics tedious and useless. Only a few pages are devoted to methods of ethics, the authors not being willing to repeat the satisfactory work of Mr. Sidgwick, with whom they substantially agree. The second part is a pointed and direct discussion of those questions having an immediate interest for present speculative morals. Theories of ethics, that limbo of wasted energies, are entirely abandoned for the psychological examination of moral facts as they appear in the life of the individual and of society. A characteristic feature of the work is its unconscious betrayal of the immense influence exerted upon ethical conceptions by modern scientific thought, and especially by the doctrine of evolution.

The decline of theology, and of conceptions of life founded upon it, has disparaged the theonomic view of morals as advocated by men like Bishop Martensen; and a re-action against such ethics, led by the principle of evolution, has forced into great prominence the consideration of self-regarding impulses to action. The first chapter shows this very distinctly. The last completes the separation between theology and morals.

There is an important remark in the chapter on self-regarding feelings which is the keynote to all social and moral questions of the present time. It is this: "While man lives from hand to mouth, the want of the necessities of life, the hard struggle for existence, leaves neither leisure nor inclination for the development of the higher faculties." Professor Green makes a similar remark: "Until life has been so organized as to afford some regular relief from the pressure of animal wants, an interest in what Aristotle calls $\tau\acute{o}\ \epsilon\upsilon\ \zeta\eta\nu$, as distinct from $\tau\acute{o}\ \zeta\eta\nu$, cannot emerge." This means that moral life requires relaxation from perpetual and exhausting toil in order to be realized; and modern ethics have become conscious of the fact that large portions of the human race have not, and perhaps cannot expect, this exemption. What, then, about moral life where the industrial classes are condemned to employments that make it impossible? There is a tincture of pessimism latent here, and the unfortunates of modern social life

are learning the real causes of their deplorable condition: like Enceladus, they are trying to turn over, and to relieve themselves in their uneasy position. The inequalities of the present cannot be postponed to the future for adjustment, and egoistic instincts are likely to assume an arrogance which theological beliefs once effectually suppressed. Modern civilization is slumbering upon a volcano, and reminds us of Carlyle's allusion to Vesuvius: "The earth, green as she looks, rests everywhere on dread foundations were we further down; and Pan, to whose music the nymphs dance, has a cry in him that can drive all men distracted." Self-regarding impulses may become dangerous: still no progress is possible without them, and the marvellous recuperating forces of human nature will always bring up the unexpected and the impossible; so that, amid impending consequences of the most threatening kind, there may be the promise of escape and security.

The discussion of the sympathetic, the resentful, and the semi-social feelings is able and suggestive. The freedom of the will is dismissed in much the same way as it is disposed of by Bain and Sidgwick. There is an interesting chapter on the relation of the imagination to moral ideals. The style is like that of most English writers at present, except Mr. Martineau, heavy, and uninteresting, — a great fault in subjects which are fast acquiring such supreme importance.

NOTES AND NEWS.

AT the recent Royal Academy banquet, Professor Huxley concluded his speech thus: "Art and literature and science are one; and the foundation of every sound education, and preparation for active life in which a special education is necessary, should be some efficient training in all three. At the present time, those who look at our present systems of education, so far as they are within reach of any but the wealthiest and most leisured class of the community, will see that we ignore art altogether, that we substitute less profitable subjects for literature, and that the observation of inductive science is utterly ignored. I sincerely trust, that, pondering upon these matters, understanding that which you so freely recognize here, that the three branches of art and science and literature are essential to the making of a man, to the development of something better than the mere specialist in any one of these departments — I sincerely trust that that spirit may in course of time permeate the mass of the people; that we may at length have for our young people an education which will train them in all three branches, which will enable them to understand the beauties of art, to comprehend the literature, at any rate, of their own country, and to take such interest, not in the mere acquisition of science, but in the methods of inductive logic and scientific inquiry, as will make them equally fit, whatever specialized pursuit they may afterwards take up. I see great changes: I see science acquiring a position which it was almost hopeless to think she could acquire. I am perfectly easy as to the future fate of scientific knowledge and scientific training: what I do fear is, that it may be possible that we should neglect those other sides of the human mind, and that tendency to inroads which is already marked may become increased by the lack of the general training of early youth to which I have referred."

— Simultaneously with the appearance of the report of the Seybert Commission on Spiritualism, the J. B. Lippincott Company publish a volume by John Darby (Dr. Garretton) with the rather peculiar title, 'Nineteenth-Century Sense: the Paradox of Spiritualism.' The first fifty pages of the book are printed in small type, and describe a series of very wonderful experiments in 'transcendental physics,' the writing on slates by unseen hands, the slipping of iron rings upon firmly bound arms, the tying of knots in an endless rope, materializations and visions, and so on, all performed with the assistance of a member of the Seybert Commission. These are recorded with all the enthusiasm and interest of a believer, when suddenly we are told that his confrère confided to him how all had been done: it was sense-deception, trickery and nothing else. From this on, such manifestations have sought to do with Spiritualism. We now enter a higher sphere and a larger type. The author is a Rosacruzian (so he tells us), and uses the word as meaning an illuminatus. He has had revealed to him the inner meaning of things, and lives in a different world. He then ex-

pounds his theories in a language full of incomprehensible cant, glorying in paradoxes, flying from one topic to another at a most erratic gait, and beginning and ending nowhere. The whole is strongly suggestive of a semi-morbid condition of mind, and will probably have a charm for minds of neurotic temperament that delights in the apparent and exclusive possession of an un-understood mystery. The redeeming point of the volume is its refusal to ally itself with coarse, physical deceptions, and thus gives no opportunity for preying upon the liberality of the credulous.

— The changes in the elevation of the Caspian Sea and the Baltic have been discussed by Dr. Brückner in a lecture delivered at the meeting of the German Meteorological Society at Karlsruhe, and by W. Seibt ('Das Mittelwasser der Ostsee bei Travemünde'). Both authors show by their separate methods that the influence of the wind upon lakes has been overrated, and that the annual rainfall regulates the amount of water in lakes and seas communicating with the ocean through narrow channels. The amount of water carried by the Volga regulates the elevation of the surface of the Caspian Sea, and the same is the case with the Black Sea and its affluents. Brückner shows that the easterly winds of May and the westerly winds of July and August have an influence upon the Baltic, but the thorough discussion of the gauge observations at Travemünde by W. Seibt proves that only in April, May, and September the height of the water corresponds to the direction and pressure of the wind. It appears that the volume of water of the Baltic is subject to periodical changes. While Brückner believes that this is entirely due to the changes of the annual rainfall, Seibt concludes that a periodical annual tide exists in the ocean, which is observed only in seas in which the daily tide is insignificant.

— Over 60,000,000 caterpillar-cocoons were destroyed on the trees in Washington during the spring, so that the city will not suffer from this pest this year as badly as formerly.

— U. S. Consul Siler at Cape Town, Africa, has sent to the Department of State an interesting report on leprosy in South Africa. He says that he has recently read in American papers of the existence of leprosy on the Pacific coast, with expressions of fear that the disease may become general. The disease, he states, is not uncommon in South Africa.

— The sitting statue of Bowditch the navigator, executed in 1847 by Ball Hughes, and long one of the most celebrated monuments in Mount Auburn cemetery, Cambridge, has just been replaced by a new casting from the foundry of Gruet jeune of Paris, the old showing some signs of injury due to defective founding.

LETTERS TO THE EDITOR.

. The attention of scientific men is called to the advantages of the correspondence columns of SCIENCE for placing promptly on record brief preliminary notices of their investigations. Twenty copies of the number containing his communication will be furnished free to any correspondent on request.

The editor will be glad to publish any queries consonant with the character of the journal.

Correspondents are requested to be as brief as possible. The writer's name is in all cases required as proof of good faith.

Ohio Mounds.

HAVING recently made a survey on behalf of the Bureau of Ethnology, of some of the circles of the ancient works of Ohio, I wish to call attention, by permission, to one or two facts brought to light.

This can best be done by an illustration, for which purpose the 'Observatory Circle' of the works at Newark, Licking County, is selected (see 'Ancient Monuments,' by Squier and Davis, Plate xxv. F.).

Running this by means of short chords of seventy-five feet in length, taking the middle line of the top of the wall, I found the number to be 44, and twelve feet in addition, or the perimeter of the polygon 3,312 feet. The course of each chord was taken. While the variation from one to the other, if the figure were a true circle, should be about $8^{\circ} 9'$, it was found to vary from one to fifteen degrees. But, somewhat to my surprise, it was found that these variations compensated each other in short distances, so that in measuring the quarters they almost wholly disappear, the angle of the first quarter being $44^{\circ} 52'$, and its chord 747 feet; the angle of the second quarter 45° , and its chord 745 feet; of the third quarter, 44°

$52'$, and the chord 744 feet; the fourth quarter was not measured owing to obstructions. It is therefore apparent that the figure as a whole is very near a true circle.

But the most singular fact is presented by the diameters. These, as taken by careful measurements from the quarter-stations, are

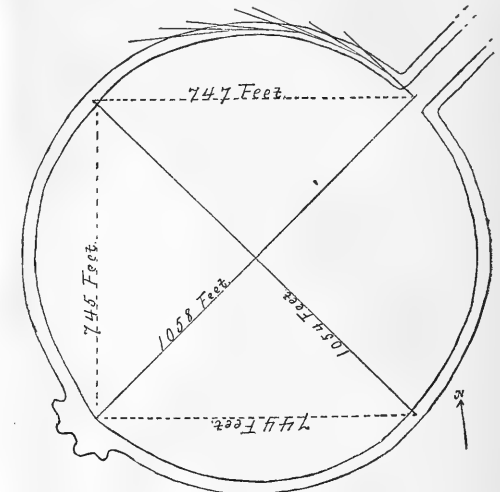

respectively 1,054 and 1,058 feet, the average of which is 1,056 feet, precisely sixty-four poles, or sixteen chains.

As there are several other circles of the size, this singular coincidence is, to say the least, interesting. JAMES D. MIDDLETON.

Youngsville, Penn., June 22.

Waterspouts.

BELIEVING that every natural phenomenon, especially when unusual or little studied, is worthy of record, we have put down a few notes about a series of waterspouts which passed here on Monday, May 23, shortly after noon. One of us saw at one time, from an elevation of about one hundred and fifty feet, as many as nine in various stages of their formation; the other, eight, at an elevation of fifty feet, we being about half a mile apart; and some persons claim to have seen twelve in all.

Allassio is situated on a bay, or rather roadstead, which is about five miles from headland to headland in a straight line: from that line to our villas is at least two miles.

On the 22d there was a severe storm throughout north Italy, extending from Padua to Turin, accompanied by hail and frost. The mountains behind Genoa, and all along the coast, were again covered with snow. This storm appeared to divide, and while going through the mountains to the north, not seen from here, passed us about three miles out at sea, at about 11 A.M. Then there was no wind; the sea was unusually smooth in the bay, but the line of the storm was strongly marked, and the roaring of the waves was distinctly heard. A little later we had a very slight shower.

The morning of the 23d was unusually electrical, so much so as to make every one feel uneasy and restless. The wind dropped, and there was a dead calm. At a little after twelve we were called out by our gardeners and servants, and, looking out at sea, saw a long black cloud lying in a straight line across the bay, from which long descending tubes—some straight, as if drawn with a rule, others twisted like snakes—were moving rapidly in procession in a south-westerly direction. The surface of the sea boiled, and the foam and spray rose many feet into the air with a loud roaring plainly heard on land. In some cases, as these tubes approached the sea with their dangling ends, the water seemed gradually to rise and meet them. In other cases the ends swayed to and fro above the waves, either forming no connection with them, or having already begun to break up. In nearly every case the

hollow tube was distinctly visible, the centre being clear like glass, while the outside was wrapped in a smoke-like mist. Even with the naked eye we could distinctly see a spiral motion on the inside of the tube, as if water were either ascending or descending, in which direction it was impossible to tell. Beyond the waterspouts, between the cloud and the sea, a blue sky with sunlit cumulus clouds was plainly seen. These tubes moved at the rate of more than thirty miles an hour, judging from the time ordinarily taken by steamers in crossing the same space. Estimates of the height of the cloud are difficult to make, but at least half the tubes were seen over the promontory of Capo delle Mele, which is about one thousand feet high, and distant about five miles, as the crow flies, from the point of observation.

The phenomenon caused a great panic among the inhabitants, owing to the prediction of Falb that there would be a violent earthquake on that day.

There was subsequently a slight storm of hail and rain; but farther westward, on the coast, the damage done was considerable, at San Remo secular olive trees being torn up by the roots and whirled away. No waterspout is, however, known to have burst on the land.

MAURICE HOWARD,
EUGENE SCHUYLER.

Alassio, Riviera, Italy, May 26.

How to make Meteorological Observations at a Distance above the Earth's Surface.

THE progress of meteorology in the beaten tracks of the usual observations is very satisfactory; but there are several new lines of work, that can be and ought to be carried out, that receive scarcely more than an occasional mention, or a regret that somebody does not do something in the matter. The observation of the conditions of the atmosphere above the earth's surface is perhaps the most important of these questions. I know of no meteorological data so much to be desired as that which is now obtained for short, irregular intervals, by the occasional ascent of a balloon. This, however, is a very expensive and risky method of observation, and has always been looked upon as a novelty rather than a regular method.

The few observations made in balloon-voyages, together with those obtained by means of an occasional captive-balloon ascent, are very valuable, and have been used over and over again in determining constants. The great expense of even a captive balloon, where the observer must go up, has prevented their general introduction into meteorological work.

It has often been proposed to send up self-registering instruments in smaller captive balloons; but, if this has been done, I have not seen accounts of it. The lighter forms (metal thermometer and aneroid barometer) could undoubtedly be used in this way; but the ordinary registering-apparatus is very delicate, and the swaying of the balloon might disturb the adjustments; besides, the original cost of the apparatus is considerable, and, moreover, any damage could not be easily repaired.

In place of a balloon, the kite has been suggested, and E. Douglass Archibald has made some interesting preliminary experiments with this method.

I have seen only the account of his experiments as given in the *Meteorologische Zeitschrift* for 1885 (p. 47); but in this paper there are references to *Nature* (Nov. 20, 1884) and *Quarterly Journal* (January, 1883).

Mr. Archibald flies two kites, the one to steady the other. He carried on systematic observations with an anemometer (six inches in diameter) for a year, and finally got results for a height of eleven hundred feet above the ground.

I saw this paper on Mr. Archibald's work a few days ago for the first time; but it interested me very much, as I had been considering the same problem. A year and a half ago I devised a form of apparatus that would seem to promise good results; but it was only some months ago that I suggested the following detailed construction, which is given here for the benefit of any who might wish to carry on any such experiments.

The general form is seen in Fig. 1, and consists of a balloon (5) which carries a basket (4) suspended from beneath, and the basket carrying an anemometer (6) with a weight below it.

The balloon is held captive by a three-strand (insulated) wire, which is wound around a reel (2), and passes to a table (1), where the battery and keys are mounted.

The reel (2) must be firmly anchored, and the wires arranged so there will be no danger from electric currents. A cloth ring, with the length of rope (from the balloon) written on it, can be glued to the rope at every hundred feet, so that the observer can see just how much rope is out; and, by means of some instrument for measuring vertical angles, the altitude of the balloon can be measured and the height of the balloon computed.

The apparatus as shown in Fig. 2 might also be sent up in a balloon held captive by an ordinary rope, if a small bichromate-of-potash battery, with closed hard-rubber cells and a clockwork to break the circuit every five or ten minutes, is also included. The whole apparatus might also be sent up on a kite, if one wished to risk the instruments, which would be destroyed by the sudden falling of the kite.

The method here given allows the observer to control the time of observation, and would seem best on that account. The registering apparatus as shown in Fig. 2 is practically Professor Wild's system, with some important differences, however. I was for a long

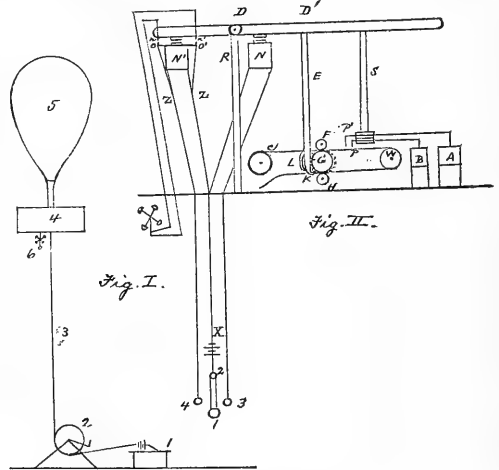

time troubled about the means of moving the registration-paper without clockwork, but Wild's method answers the purpose very well. It must be borne in mind that only a very general description of the apparatus is given here.

The following apparatus is to be placed in the basket suspended from the lower end of the balloon. The basket must be so arranged that the air will have free passage through it when the balloon is ascending or descending. The balloon need only be large enough to carry a few pounds (fifty) to the height of half a mile: it is impossible to foretell just how much the whole apparatus would weigh. A hair hygrometer could also be added to the instruments, but has not been put in the accompanying sketch.

The careening of the balloon would have no effect on the working of the apparatus as shown here, because nothing of the registration arrangement is free to move except the pointers. In making an apparatus, the best arrangement would be somewhat different from the sketch given here.

The main advantage of this apparatus is the cheapness with which an ordinary aneroid barometer and metal thermometer could be applied to the purpose.

In Fig. 2, R is a stand on which the long lever D rests, and turns in the vertical. N and N' are two electro-magnets which attract D. When the key 1 joins 2-3, then N acts, and draws D down on the right. When the key 1 joins 2-4, then N' acts, and pushes D up on the right. Self-registering paper is coiled on the wheel c, and one end of the paper passes between the rollers F and G, and then

over the roller W , and then between the rollers G and H . The rollers F and H are the same size; but G is larger, and has a ratchet-wheel at its end. E is a rod joining D at D' . At the lower end of E is a ratchet-catch K , pressed upon by the spring L , which is also fastened to E . S is a rod fastened to D , and has on

its lower end a wide framework  composed of horizon-

tal slats. Between these slats pass the indicator or pointer of an aneroid barometer B , and a metal thermometer A . These pointers are made longer than usual, and have attached a needle-point at right angles in the vertical, as shown by P' and P . This whole apparatus is mounted on a frame or board, and put into a basket suspended from the lower end of a balloon. The three wires below are fine wrapped wire, and serve to hold captive the balloon as well as to cause the self-registrations to be made, by aid of the battery X at the ground. Let the balloon ascend, say 100 feet; then put 1 on 2-3, and N draws D down. This pushes E down (and the ratchet-catch glides over the teeth on G), and pushes S down also. This last causes P' and P to puncture the paper. Now open 2-3 and close 2-4; then N' draws D up, S is pulled up, and the points P' and P are freed. Also K catches on G , and draws off some paper from c , the paper being drawn between F G , over W , and between G H . Then the holes pricked by P' P are out of the way, and other holes can be punctured at another elevation of 100 feet for the balloon. A fixed pencil is also pressed against the paper at each observation, as a reference-point for the puncture by the index-point.

For the hair hygrometer we should have another pointer, P'' . A small anemometer can be suspended from beneath the basket, and kept vertical by means of a weight. This anemometer causes a contact arrangement to close for an instant for every 100 feet of wind-motion. The two wires from the anemometer terminate at n and n' , and, when the magnet N' is not attracting the armature, the points n and n' are free. When the current is passed through N' , then n comes in contact with o , and n' in contact with o' ; o and o' being joined to the wires 4 and 2, which run to the reel at the ground. At the ground we insert a telephone or a galvanometer in the wire 4.

The normal condition of the apparatus will be with the current passing through N' , and the battery X will cause the galvanometer to give a constant reading; but, for every hundred feet of wind, the anemometer will close its circuit for an instant, and the dividing-up of the current at ZZ by including the anemometer in the circuit will cause a momentary deflection of the galvanometer (or will cause a slight sound in the telephone), and the observer can time these with a watch, and get the wind-velocities whenever he wishes them.

In place of N we could insert a spring, and do away with the wire 3, and probably various other changes would suggest themselves to any one actually constructing the apparatus.

FRANK WALDO.

Cincinnati, O., June 27.

Sea-sickness.

WITH regard to the subject of sea-sickness, treated of in an article in *Science*, June 3, I beg to offer a few remarks.

As to the causation of the affection, the process is a gradual one, affecting the balancing sense, which is not interfered with in the case of iron-plate workers. The sickness affecting these workers is caused by the successive shocks due to the hammering, and differs from sea-sickness in character and causation.

An article of mine in the *Lancet* of June 28, 1884, defines sea-sickness as follows: "The altered sensory impressions affecting those at sea interfere with the co-ordination of movements by which the body is adapted to its surroundings, and with the vomiting and other centres in the *medulla oblongata*. This interference causes sea-sickness."

The balancing of the body depends on the ordinary sensory impressions, and also on what Foster calls 'the afferent impulses, as it were, of a new sense,' from the semicircular canals, arising from variations of pressure in their ampullæ. With reference to the recent paper of Dr. James, the following quotation from my article

above mentioned may be of interest: "In cases where the internal ear has been injured by otorrhœa following scarlatina or measles, we may suppose that the person learns to balance himself without the intervention of the new sense, the absence of which is compensated for in some way; and it is a curious fact, and one which throws considerable light on the etiology of sea-sickness, that such persons invariably escape this disease. . . . That deafness in itself does not prevent sea-sickness is in keeping with the fact that the afferent impulses from the semicircular canals do not give rise to auditory sensations" (*vide* Foster's 'Physiology,' 2d ed. p. 495).

It is reasonable to believe that no structural change takes place in the semicircular canals, due to the motion of the endolymph, else the longer the motions continued, the more marked would become the sickness. The altered impressions affect the brain directly, and sea-sickness is prevented by their action from being mollified or nullified by the educated conscious ego.

As to drugs, atropine has a sedative action on the *medulla*, etc., and renders the altered sensory impressions inoperative in producing sea-sickness. It should be given in drop doses of the liquor atropine, B.P., in a teaspoonful of water, every hour, till the physiological effect of the drug is produced.

The bromides have also a sedative action on the brain, but, to prevent sea-sickness, must be given in sufficient doses to produce bromism. As this is a serious condition, and one likely to affect the patient's reason and general health most injuriously, the bromides should be used with great caution, and only when prescribed and their action watched by a medical man.

T. T. REYNOLDS.

Steamship 'City of Chicago,' Jersey City, July 1.

The Function of Nitrogen in Manures.

IN works on agricultural chemistry it is usual to classify manures or plant-food substances as nitrogenous matter, phosphates, and potash; but, while the phosphates and potash enter into the substance of every part of the plant, the amount of nitrogen found in the cereals and food-plants generally is inconsiderable.

A few food-plants contain nitrogen as an essential element of their substance: thus pease contain from two and a half to three and a half per cent, and tea-leaves from five to eight per cent; but in the case of all these plants it is well known that they are capable of drawing the necessary supply of nitrogen from the atmosphere.

Without entering on the question of whether the small traces of nitrogen found in the substance of food-plants generally are essential or accidental, or that other question whether all plants requiring nitrogen are, like animals, capable of deriving it from the air, it is very safe to infer, from the slight trace of nitrogen found in the cereals and food-plants generally, that the ammonia, or nitrogenous substance convertible into ammonia, which is necessary to secure a good crop, has some other and more important function to perform than that of supplying nitrogen to the plant. It may be doubted, even, whether nitrogen is a plant-food for the cereals, or in any way essential to their proper development; but hydrogen, the other element of ammonia, is one of the prime constituents of all vegetable substances, and I infer that it is the easily liberated hydrogen in the ammonia that gives it its manurial value. The function of the nitrogen is simply that of a carrier of hydrogen.

Let me explain. The substance of all trees and plants, wood, stalk, bark, leaves, fruit, etc., is a chemical compound of the three elements, oxygen, hydrogen, carbon. The tree or plant absorbs carbonic acid from the air, which gives it two of the three essential elements, carbon and oxygen. It also takes up water, which is a compound of oxygen and hydrogen, by the roots; and by the mysterious chemistry of organic life, the water and carbonic acid being decomposed on contact, the liberated hydrogen and carbon unite with a portion of the oxygen into definite chemical combinations, the new substance arranging its atoms as cell-contents or cell-walls. All the oxygen of the water, with a portion of that from the carbonic acid, is liberated, and returned to the atmosphere. Given air, water, and potash, and a soil mechanically suitable, and we have all that is necessary to the full and healthy development of timber and fruit trees, flowering plants, and in fact almost every species of vegetation except the grasses, cereals, and principal food-

plants, which cannot be grown under similar conditions. The fact that they will grow freely in soil containing ammonia, or decomposing animal matter convertible into ammonia, led to the conclusion that they wanted nitrogenous food. The fact that the nitrogen is not an important element of their substance at any period leads me to infer that these plants are incapable of decomposing water, and consequently dependent for their necessary supply of hydrogen upon ammonia or some other compound of hydrogen more readily decomposed than water. It is well known that while the nitrates of potash, soda, lime, etc., are all valuable auxiliaries to farmyard manures, they are of no value as a substitute for it. Very eminent chemists have been somewhat staggered at the results of their experiments in this direction; but precisely as the function of nitrogen in ammonia is to carry hydrogen, so the function of the nitrogen in the nitrates is to carry potash. Whether we dress the soil with nitrate of soda, lime, or potash, the result is the same. With potash salts in the soil, the addition of the nitrates of soda or lime leads to a double decomposition, and the conversion of the potash into nitrate. Sulphates and chlorides of these bases appear to have some small value as manure, although their composition remains unchanged; but in the mysterious laboratory of the growing plant the nitrate of potash is resolved into its elements. The potash allies itself with carbonic acid to form carbonate, or with carbon, oxygen, and hydrogen in various proportions to form the organates of potash (the citrates, tartrates, oxalates, etc.), so important to the development of fruits.

Whether we employ ammonia or the nitrates as manure, the nitrogen is liberated in the plant to unite with oxygen, and be radiated as common air. In the one case, hydrogen remains; in the other, potash.

The current theory of nitrogenous manure appears to be based on a complete misconception as to the function of the nitrogen in its various compounds; and when it is once clearly realized that hydrogen is the important food-substance yielded by ammonia, it will be of practical interest to determine whether this substance cannot be supplied more economically by the decomposition of water *secundem artem*.

C. F. AMERY.

Geological Questions.

THE replies to the following questions by some of the most eminent American geologists have induced me to ask your assistance in getting a wider circle to consider them. They were framed for the purpose of enabling the writer to properly represent American thought on the subjects mentioned, in his report on the Archaean to the American Committee in August next. Those geologists who are willing to render the undersigned the valuable assistance of expressing their opinions on the matters involved, are requested to write the letter of the question, and give the answer as laconically as is consistent with a clear statement of their views. In alternative questions, like J or N, it will suffice to append the numbers of the clauses representing their opinions.

A. Do you agree to the suggestions contained in the report of the International Committee on Nomenclature ('Report of the American Committee on the Work of the Geological Congress,' pp. 49 to B, p. 57)? Please state explicitly if you are willing to accept the recommendations of the congress.

B. Do you favor the division of the Archaean Group into a definite number of systems? If so, give their names and the order of their succession.

C. Give the horizons of non-conformability in the Archaean.

D. Do you approve of the plan of subdividing the Archaean petrographically and of omitting corresponding chronological divisions and names?

E. Should the eruptives occurring in the Archaean rocks be classified with the latter, or separately?

F. Which, if any, of the following terms is applicable in American geology, and how applied? 'Hebridean,' 'Dimetian,' 'Arvonian,' 'Pebidian.'

G. Are there crystalline rocks in, and after, the Paleozoic lithologically indistinguishable from those of the Archaean?

H. Are there any crystalline rocks in the Archaean which do not occur later?

I. Is mineral constitution indicative of geological age?

J. Are the lower stratified crystallines: (1) of aqueous origin metamorphosed partly, or wholly, by igneous action; (2) of igneous origin metamorphosed in part, or in whole, by subsequent agencies; or (3) partly one and partly the other?

K. Are there evidences of organic life in the Archaean; if so, where, and what?

L. In your opinion, is Eozoon Canadense of organic origin?

LL. Do you approve the European map committee's (Professor Lossen's) system of coloring and classifying the eruptives?

M. Should Serpentine constitute one class of eruptives?

N. Is Serpentine, (1) sometimes, or (2) always an alteration product: (3) of eruptives, (4) of sedimentary rocks, or (5) of either?

O. What, in your judgment, is the proper disposition of the term 'Taconic?' If employed, what are its limits, and what terms should it replace?

P. How should the Cambrian be divided?

Q. Are 'Menevian,' 'Ordovician,' or any other more or less comprehensive foreign names, applicable in American geology? if so, how?

PERSIFOR FRAZER,
Reporter for Archaean.

Philadelphia, 201 South Fifth St., July 9.

The Charleston Earthquake.

IN reply to Prof. Joseph Le Conte's valued criticism (*Science*, x, p. 22), I would say that it seems to me that the method for estimating the depth of an earthquake-focus proposed by Mr. Hayden and myself differs radically from that proposed by Mallet in the 'British Association Report' of 1858. His inference that the horizontal motion has a maximum value where the 'angle of emergence' is 54° 44' could be true only of normal waves. It cannot be true of the transverse waves. He ignores the transverse waves entirely in his formula; and the omission, I maintain, is fatal to its applicability. He also ignores the vertical component of the normal wave, which at such an angle is much more energetic than the horizontal component. What proportion of the horizontal motion is due to the normal waves can generally be determined at considerable distances from the origin when the facts upon the ground are clearly manifested. But at the very localities where such a determination is necessary for the application of Mallet's method the difficulty is greatest. It is just here, too, that all the components, vertical and horizontal, normal and transverse, blend together with such effect that not one of them can be ignored without fatal error. We must consider their total effect. But these motions compounded represent the intensity, i.e., the amount of energy per unit-area of wave-front. Mallet's 'circle of greatest destructiveness' has no real existence. It is a purely mathematical abstraction obtained by postulating conditions which do not have any separate existence.

Since writing the above, I have recurred to Mallet's paper, and find the following: "It is certain that in all great earthquakes the real mischief and overthrow at places pretty far removed from above the centre of impulse are done by the blow from the normal wave, which appears to come first; hence, the main observable effects are those of the normal, and we are justified and enabled, *in such localities*, to neglect the transversal. But within a considerable circle of area, whose boundary is evanescent, and whose centre lies at the point right above the origin, the actual effects of the transversal wave are very formidable, and can never be neglected." [Then why should he have suggested doing so?] "The ground beneath an object so situated, such as a house or pillar (as the distance from the origin to the surface is the minimum range of emergence, or shortest possible, and its energy therefore the greatest), is almost at the same instant thrown nearly vertically upwards by the normal wave, and at the same moment rapidly forced forwards and backwards in two directions orthogonal to each other; and this combined movement, which is that called 'vorticoso' by the Italians and Spanish Mexicans, is one that nothing, however solid and substantial in masonry, etc., can long withstand."

It is certainly a pleasure to find Mr. Mallet reasoning so justly; but in the remarks quoted it is apparent that he is taking account of

all the components of motion; which must give us the true intensity in the just sense that this term is employed by Mr. Hayden and myself. Its graphic representation will be the curves we have given and no other.

Professor Le Conte remarks: "We have assumed all along that the intensity or excursion of the earth-particle, or the height or amplitude of the wave, varies inversely as the square of the radius of the agitated sphere. The authors as well as other writers assume this law." Here he evidently misapprehends. It is indeed assumed that the intensity varies inversely as the square of the distance, but the amplitude varies (subject to later qualification) in a simple (not duplicate) inverse ratio with the distance. The intensity for a given wave-length is proportional to the square of the amplitude; for, by Hooke's law (*ut tensio sic vis*), the time of vibration of a particle in an elastic wave of given wave-length is uniform whatever the amplitude. Hence the mean velocity of the particle is simply proportional to the length of its path, i.e., to the amplitude. But its energy is proportional to the square of its velocity, ergo, to the square of its amplitude. Hence, too, the amplitude must be inversely proportional to the radius of the spherical wave, provided no energy is dissipated in transmission. If, then, the amplitude at Charleston were four inches, at a distance of a thousand miles it would, without dissipation, amount to about two millimetres,—a well-marked tremor.

Professor Le Conte's suggestion that the law of variation of intensity with distance may be affected by reflection back into the earth from the surface is, so far as I am aware, a novel one. That there must be some energy so reflected seems undisputable. But the portion so reflected would constitute a new wave, or series of new waves, independent of those already in progress. It would thus add to the number of waves without affecting the energy of those already in progress, except at points of coincidence or interference.

Seebach's method of finding the depth was objected to, because it requires a degree of accuracy much beyond the highest we can hope to attain. The speed of an earthquake-wave is enormous (the time-observations obtained for the Sonora earthquake give a very high wave-speed; they are not as yet fully examined and discussed, but the preliminary examination indicates a speed about the same as that obtained in the Charleston earthquake), the space-intervals at which the time-records must be made must be short, and the time-intervals correspondingly so. The data really needed are differences in these time-intervals; and these differences would most certainly be much smaller than the probable errors of observation.

C. E. DUTTON.

Washington, July 4.

The Freezing-Point of Sea-Water, and the Melting-Point of Sea-Water Ice.

THE difference existing between the result from my determination of the freezing-point of sea-water (*Science*, ix. No. 228), and the accepted one as value for the same of 28°·8 F., seems to be inexplicable, unless we can assume that in the methods followed for its determination a wrong interpretation has been put on one of the results.

There can be no doubt, that, if the temperature of a body of sea-water is lowered till congelation takes places under slight agitation of the water, the temperature then existing at its surface will be that of its freezing-point.

On the other hand, it seems probable, that, when the determination of the freezing-point is made by means of an admixture of sea-water and its ice in thermic equilibrium, we have reached a condition that would be better described as the melting-point of sea-water ice.

Could we assume that in the change from the liquid to the solid form, in freezing, all the saline particles were taken up without chemical changes, it would be reasonable to suppose that the melting and freezing points would coincide; but if, on the other hand, we assume that in this conversion, the entire saline particles have been expelled from the solid, we must conclude that part of the heat was expended in expelling these particles, for we may not imagine any work performed without a corresponding absorption of energy. We will have, in this imaginary case, essentially fresh-water ice; and, if we were determining the freezing-point of sea-

water with ice so constituted, thermic equilibrium would be obtained at a temperature of 32°, which we should erroneously call the freezing-point of sea-water.

Granting the accuracy of these two suppositions, it seems certain that in the case when freezing takes place to the exclusion of four-fifths of the saline particles, as is the case with sea-water, thermic equilibrium will exist between sea-water and its ice at a temperature intermediate between its freezing-point (26°·7 F.) and that of melting ice (32°·0 F.), and experiment has proved this temperature to be 28°·8 F.

I would therefore predict, that, in the case where a liquid is converted into a solid by freezing, the temperature of the freezing-point of the liquid will be equal to that of the melting-point of the ice, only in the case or cases where each contains the constituents of the other in the same proportion.

W. A. ASHE.

The Quebec Observatory, July 4.

Concerning Filth-Diseases.

THROUGH the heart of the city of Baltimore, flowing southward, runs the bed of the sluggish stream Jones Falls. Eight miles northward, its waters are divided and turned into the city water-supply. Within the city, the stream is confined by handsome stone walls, which form a canal of dimensions twenty feet deep by a hundred feet wide and two and a half miles long—roughly. The canal empties into the Back Basin, a nearly stagnant pool two hundred yards wide by five hundred yards long,—which itself is connected by a short canal with the City Basin and tide water of slight activity.

In the northern suburbs, and within the city, the Falls and Back Basin receive the drainage from a territory in which dwell eighty thousand souls, roughly estimated, a considerably portion of whom is packed into a lower quarter of the city. They receive that from the Causeway and a part of Fell's Point,—quarters fairly designated slums.

The sediments in this drainage are precipitated in the lower half-mile of the Falls and in the Back Basin. Here they undergo fermentation and decay, at times giving off odors offensive indeed. It is a necessity of the situation that these sediments must be removed by dredging; and with the active officials of the dredging companies, and with their workmen, the writer has been in quite constant communication for nearly three years. These people pass their days stirring about and digging up this fermenting and decaying city garbage and mud and sewage. They live in an atmosphere loaded with offensive gases. And what of their health? With singular unanimity they declare that the occupation is a healthy one. Excepting in rare instances a case of nausea and vomiting, which quickly pass away, they have no more sickness than those in other occupations. As a matter of fact, the writer has not in nearly three years heard of any case of zymotic disease among about a hundred men engaged in this dredging.

The decaying refuse from the slums of a city, deposited in warm and nearly stagnant waters, ought to contain all manner of poisonous elements,—animal, vegetable, gaseous, or otherwise. Men stirring up and removing such material ought to sicken and die. Curiously enough, they do not—more than men in other occupations.

The writer has no knowledge as to what filth-diseases are, or are not, and has no suggestions to offer. The studies here indicated were made because the field seemed to promise a rich harvest of such diseases, but the promise has not been fulfilled so far.

WM. GLENN.

Baltimore, July 11.

Queries.

8. WHOOPING-COUGH IN THE CAT.—A Liverpool cat is reported to have contracted whooping-cough from a boy sick with that disease. For two weeks it had five or six attacks daily of the cough characteristic of that affection. Is this unusual? X.

9. BANANA, COCOANUT, AND INDIA-RUBBER.—Can any one send us lists of books on the cultivation of the banana, cocconut, and india-rubber? J. C. E.

SCIENCE

FRIDAY, JULY 22, 1887.

THE SESSION of the National Educational Association at Chicago last week was a notable occasion. It was estimated by a competent authority that sixteen thousand teachers were assembled in the Exposition building when the opening session was held. Coming as they did from all parts of the country, — several of the Southern States excepted, — they were representative of the American public school in all its grades and phases. They were assembled to listen to the discussion of important questions, to talk together informally of school matters, and to view the great exhibition of educational material that was prepared for them. Despite the fact that several of the prominent speakers were not able to be present, the discussions were well sustained and attentively followed. The majority of the teachers present took more interest in the meetings of the sections devoted to matters of special interest than in the general meetings. It was very satisfactory to notice the ground gained by the advocates of manual training during the past year. This was clearly evidenced by the approval accorded to all references to it, by the character of the address by the President of the Chicago Board of Education, and by the great interest displayed in the exhibits of the work done at Chicago, Toledo, Cook County Normal School, and elsewhere. The exhibition was very complete, and well worth going a long distance to see. The States of Illinois, Wisconsin, and Michigan were particularly well represented. One fact was thoroughly demonstrated by the convention; namely, that despite the excitement and enthusiasm attendant on a large assembly, the Association's annual meeting has grown so large as to be unwieldy. Very many cannot hear what is going on, and very many more are dissatisfied at being afforded no proper opportunity to participate in the proceedings, while a few others who have long ago said all that they had to say that was worth hearing, continued to read papers and lead the discussions. In consequence of these facts, as well as because many teachers are unable to afford the expense necessary to attend a national convention, the proposal has been made to divide the Association into several, say four or five, each of which shall have its annual meeting and elect a quota of representatives to a central body, which shall meet annually and be deliberative, instead of hortatory and polemic, as the Association's meeting now is. This seems to us a most excellent plan, and we trust it may be soon adopted. The new president of the Association is Superintendent Aaron Gove of Denver, Colorado.

THE ECONOMIC BENEFITS of the work performed by the U. S. Geological Survey are just beginning to be appreciated by railway men who are laying out new lines of railroad. The officials of the Survey are of the opinion that within the next ten years the centre of all the railroad-building in the country will be located in the Southern States. They base this opinion on the fact that the calls for maps of the southern mountain ranges is increasing very rapidly. The maps thus far prepared by the Geological Survey cover the eastern coast-line from the Maryland boundary to the Georgia coast, with the exception of a small section of Virginia. They are at present issued only to those directly interested in the topography of the Appalachian range, yet there have been issued already upwards of three thousand five hundred maps of the region. That is to say, about a hundred different sets. These maps have all been distributed to those directly interested in the building of new railroads. It is said that there are somewhere about twenty

different roads in course of construction between the coal-fields of the South and the seaboard or the Ohio River. One gentleman, who is interested in the construction of a road between Charleston, S.C., and the mouth of the Big Sandy on the Ohio, called at the office of the Survey a day or two ago and said that the maps which had been furnished to his company had saved the corporation at least ten thousand dollars in preliminary surveys. From all sections of the South, reports are constantly received of the enormous value of the maps furnished by the Survey to topographical and civil engineers. Besides the work which has been done in the Southern States, the survey has been extended well into many sections of the North and West. Massachusetts has been mapped on a scale of a square mile to the inch, through the joint work of the State and the general government. A field-party has just begun operations in south-eastern Iowa for the purpose of mapping that State on a similar scale. Illinois and Indiana will, in all probability, be the next States in which the surveys will be undertaken. There is a great difference in the cost of the work in the various States. In the South, where the country is broken by mountain ranges, the cost is about twelve dollars a square mile; while in the prairie States of the West, where the country is flat, the work can be performed at about five dollars a square mile. It is the ultimate intention of the bureau to prepare topographic maps of the entire country. Owing, however, to the necessary slowness of the operations, it will be many years before the entire scheme of operations is perfected. As fast as the field-operations in each case are perfected and verified, the original maps are sent to the engraver, and a few copies are made for immediate use. Eventually there will be prepared an atlas of each State. These atlases will be of enormous value, not only to railroad engineers but to all municipalities who have use for an accurate topographic map of the country surrounding them.

AMERICAN PHILOLOGICAL ASSOCIATION.

THE nineteenth annual session of the American Philological Association was held in the Marsh-Billings Library of the University of Vermont, at Burlington, on July 12-14. In the absence of President Merriam, who is on his way to Athens, to take charge of the American School there for the ensuing year, the Vice-President, I. H. Hall of New York, occupied the chair. The attendance was not as large as usual, but this did not hinder the meeting from being an exceedingly interesting one, marked by the animated discussions which some of the papers aroused.

The reading of papers was begun, after the transaction of routine business, by Dr. C. K. Nelson of Brookeville, Md., who presented some interesting facts gleaned from a study of 'Murray's New English Dictionary,' Part iii. This part embraces the letter B from *batter* to *bozzom*, and contains 8,765 words. If we add to this about 3,000 words under B in Part ii., and estimate the remaining words at the same figure, we have, for entire B, 14,765 words, or more than twice the number given by 'Webster's Unabridged,' which has only 6,750 words. Of the 8,765 words in Part iii., 5,323 are main words, 1,873 compound, and 1,569 subordinate words; and of these main words, again, 3,802 are in current use, while 1,379 are obsolete. A feature of this letter is the small proportion of Latin and Greek words found under it, aggregating not quite twenty-five per cent. In summing up, Dr. Nelson said that "this part of the great English Thesaurus impresses philologists more and more with the fact that the creative period of language is by no means arrested. Sanscrit, and Latin, and Greek have crystallized linguistic forms, which afford splendid specimens of immutable structure, but it is in the living language, where words are

created as they are needed, that we have the opportunity of witnessing the phenomena of perennial growth."

Tuesday evening, a well-attended public meeting was held in the chapel of the University, when Prof. J. H. Wright, the Secretary, read President Merriam's address on a 'Review of the Greek Inscriptions Published During the Past Year.' It is to the monuments, which the soil of Greece has preserved in such large numbers, that we have to look for an increase of our knowledge of Greek history and civilization, and for a solution of the many problems still unsolved. Already the results of the explorations, which have been going on busily for some time, are beginning to make themselves felt, and it is not too much to say that Greek history will yet have to be rewritten in the new light shed upon events by the testimony of the stones. The past year has been, on the whole, an important and fruitful one. Greek inscriptions of particular value have been found in Naukratis, under the auspices of the Egypt exploration fund, at Sigle in Crete, at Epidaurus, and near the Peiræus, the harbor of Athens. It is within the domain of the history of the Greek alphabet that the most valuable results of the last year's work are to be sought. The rest of the address was devoted to an elucidation of these results.

At the session on Wednesday morning, Prof. F. A. March read a paper—that may in many respects be called remarkable—on 'Standard English.' He claimed, in opposition to the 'new phonetists,' that there is such a thing as standard English, defining it as the 'heir of all ages recorded in grammars and dictionaries.' Standard English, meaning by that both the proper use of words and their proper pronunciation, is an authoritative institution,—a stronghold of the unity and power of the Anglo-Saxon race. While it is true that speech in its simplest form is without reflective purpose, yet, when a higher state of civilization is reached, its growth proceeds under the guidance of reason. The development which the English language has taken since the days of Milton and Shakspeare is a proof of this. We are, therefore, not only justified in guarding jealously our standard English from contamination through impure influences, but it becomes, also, the duty of scholars and cultured people in general to superintend its growth. Students of language have it as their speciality to preserve and perfect the records of the language. The paper, which was thoroughly suggestive throughout, gave rise to a long, and at times animated, discussion, in which a large number of the members participated.

Professor Seymour of Yale College gave a report of the doings and needs of the American School at Athens. It will be remembered that some months ago the permanent Directorship of the school was offered to Dr. Charles Waldstein, who accepted the same, subject to the condition that an endowment fund of \$100,000 be raised in order to place the institution on a sound financial basis. Up to date, \$70,000 of this sum have been subscribed,—which, it must be confessed, is not a very encouraging showing. Still, there is a fair prospect that before the expiration of the time assigned by Dr. Waldstein,—October, 1888,—the remaining ninety thousand will be forthcoming. With the aid and encouragement which the school has received from the Greek government, such as the recent gift of a suitable site for a building,—which, it is pleasant to record, is in process of erection,—it would be indeed lamentable to see so important and valuable an undertaking maimed by our own indifference to its fortunes.

Prof. W. F. Allen had an interesting paper on 'The Monetary Crisis at Rome in 33, A.D.' The crisis in this year, which was so severe that it required the intervention of the Emperor Tiberius to restore credit by advancing, from the Treasury, a sum equivalent to four million dollars, in the form of loans without interest, was the necessary outcome of the conditions prevailing in ancient Rome, which made money-lending a curse and the money-lender an evil. At the present time, the legitimate business of bankers consists in advancing funds to be employed for productive purposes: the banker is therefore a highly useful intermediary between those who have money which they do not understand how to use productively, and those who are engaged in industrial occupations in which they can use to advantage more capital than they themselves possess. But there was no such thing as productive industry, on a large scale, in Rome. When money was borrowed, it was merely for purposes of future consumption, or to pay for past consumption. Money

was borrowed in order to pay a debt incurred, and therefore carried with it the incurrence of a new debt. The consequence of this state of things was, that a large body was growing deeper and deeper into debt, while a few—the money-lenders—reaped benefits out of all proportion to the services rendered by them. Already in Cæsar's time the attempt was made to counteract this threatening evil by the passage of a law for the regulation of loans and of debts. It aimed, as far as we are able to trace it, on the one hand, to prevent a scarcity in the money-market, by limiting the amount of cash an individual could have on hand, and obliging him to invest what he had above this sum in real-estate; and, on the other hand, made provision for the payment of outstanding debts, by an extension of time and by compelling creditors to take real-estate as payment. The law, however, remained a dead-letter until the days of Tiberius, who made an attempt to revive it. The attempt failed, and the much-feared crisis broke out. But it is a testimony to the wisdom of Tiberius that he foresaw its coming, and endeavored to prevent it by all means in his power. In order to relieve the debtors of their embarrassment, he issued the loans as above set forth, which was of course only a temporary relief, not a remedy for the evil.

Professor Greenough of Harvard University had some suggestive Latin etymologies to offer, among others, that of *elementum*. He favored the explanation, common in former days, but latterly superseded by other views, according to which it was an artificially coined word composed of the three letters *l, m, n*. The *l* was due to the force of analogy, so as to make the word conform with such forms as *rudimentum, alimentum*. Dr. H. Weir Smyth of Johns Hopkins University had an elaborate treatise on the Arcado-Cyprian dialect, which endeavored to cover the entire field of the famous Cypriote inscriptions, of which the Metropolitan Museum in New York has such a rich collection, and, by a minute examination, to make clear the relation in which the Cyprian stood to the other Greek dialects. Professor Hale of Cornell had two papers, one proposing a new terminology for the Latin tenses, the other on the 'Cum-constructions in Latin; Their History and their Functions.' Dr. Cyrus Adler of Johns Hopkins, in a review of the article 'Semitic Languages,' in the 'Encyclopædia Britannica,' took grounds against the writer, Professor Nildeke of Strassburg, for the subordinate rank which he assigns to the Assyrian among the Semitic languages. Dr. Adler claimed, that, in consequence of this, the article was not up to the mark of our present science. Professors Jastrow and Hall made some remarks in reply. Other papers were as follows: 'Conditional Sentences in Æschylus,' by Professor Clapp of Illinois College; 'Long-Vowels in Old Germanic,' by Dr. Wells of Providence, R. I.; 'Delitzsch's Assyrian Dictionary, Part I,' by Prof. Morris Jastrow, Jun., of the University of Pennsylvania.

On Wednesday evening the Association was entertained by Dr. and Mrs. Sears, and on Thursday, after the closing meeting, an excursion was taken to the Au Sable Chasm.

Before adjourning, the following officers were elected: President, I. H. Hall of the Metropolitan Museum, N. Y.; Vice-Presidents, Professors Seymour of Yale and Lanman of Harvard; Secretary and Treasurer, Prof. J. H. Wright of Harvard; Executive Committee, Professors Whitney, Gildersleeve, Perrin, and March. The next meeting of the Association will take place at Amherst in the second week of July, 1888.

IS CONSUMPTION CURABLE?

THE discovery by Koch in 1882, of the tubercle bacillus, gave a new impetus to the treatment of consumption. The investigations of Toussaint and others had made it more than probable that tuberculosis was an infectious disease, but the discovery of the actual germ which caused the disease seemed to open up to the victims of phthisis a means of escape from a fate which up to that time had seemed inevitable. That the hope thus aroused has not yet been realized is not due to any lack of enthusiasm on the part of the medical profession; for, ever since the nature of tuberculosis was established, search has been made for some means by which its germs or their products might be destroyed, and thus the disease arrested.

We have recently had occasion to mention two methods of treat-

ment from which much advantage was promised and expected, — those of Kremianski and Bergeon. The former, which was based on the fatal effect of the most dilute solution of aniline on the bacillus, has had but a brief existence, and, so far as we can learn, has been abandoned as being not only of no practical benefit, but as being actually dangerous to life.

The Bergeon method, on the other hand, seems to promise very much, and, as it is now being extensively employed, its value will doubtless soon be determined. This consists in the introduction into the body of sulphuretted hydrogen and carbonic-acid gas. Lecturing on the subject of tuberculosis at the Hôpital de la Pitié, Paris, M. Debove, in 1883, said the ideal end toward which physicians should always strive when in the presence of a parasitic disease, such as phthisis, is to find a parasiticide acting in the interior in the same manner as external remedies act which are employed for the cure of itch. It is necessary to find a substance which, without injuring the system, will be destructive to the parasite. Dr. Bergeon, senior deputy-professor at the School of Medicine at Lyons, suggested the use of hydrogen sulphide, carbon disulphide, and other antiseptic substances, associated with pure carbonic-acid gas, — agents which comply with the requirements of Debove.

A pamphlet by Dr. V. Morel, published by James W. Queen & Co., Philadelphia, entitled 'New Treatment of the Affections of the Respiratory Organs and of Blood Poison by Rectal Injections of Gases after the Method of Dr. Bergeon,' contains the experimental evidence on which this method is based, together with a description of the apparatus by which it is to be applied.

The agents by which the bacilli were to be destroyed having been determined, the next step was to devise means for introducing them into the human body without injury. Two methods of introduction presented themselves: the one, by inhalation; and the other, by introduction into the digestive tube of the same substances in such manner as to be eliminated by the lungs. Dr. Morel states that many inconveniences, grave dangers even, oppose the adoption of the method by inhalation. These antiseptic substances are endowed with great toxic power when they penetrate the arterial system, either directly or by way of the lungs, and Claude Bernard has demonstrated that the agents introduced by this method act almost immediately. In addition, they possess a very great local irritation, and this action, exercised on an organ already diseased, cannot but augment the pre-existing lesions. This is, doubtless, the reason that there has been so little success gained in inhalations in the treatment of phthisis, and the disagreeable odor of these substances has contributed to their being refused by the sufferers.

The introduction of antiseptics by the digestive tube does not offer the same dangers. Bernard has demonstrated that when toxic matter is introduced into an organ removed from the arterial system, — in the digestive tube, for example, — it does not enter into the arterial system, as it is eliminated before penetrating so far. It has then to traverse the portal veins, the liver, the hepatic veins, and the pulmonary tissue. Now, in this course it can be eliminated in the liver by the bile, and in the lungs by exhalation if it is volatile. Claude Bernard, after experimentation, stated that hydrogen sulphide can be introduced with impunity into the digestive tube, or into the veins, if care be taken not to give too great quantities at a time.

The next question to be decided was whether the antiseptic substances should be introduced by the mouth or by the rectum. Inasmuch as they reach the lungs through the same channels by whichever way they are introduced, it would seem to be a matter of indifference which of these two entrances was selected. From a case in which a fatal result followed the introduction by the mouth, Morel thinks that this may indicate that the essential action of the medicament is not the same in both cases. In addition to this, it is important in the adoption of a method of treatment that preference should be given, other things being equal, to that one which is most agreeable to the patient; and, inasmuch as both the odor and the taste of these antiseptics is very disagreeable, the rectal method is to be selected. By introducing the remedies by the mouth and stomach, we are also in danger of interfering with digestion and alimentation, which are especially important in the class of invalids under consideration. For these reasons, Dr. Bergeon has abandoned the method of injection into the stomach.

Having adopted the method of rectal injection, it was next necessary to find a medicament which would be exhaled by the lungs, and which while in those organs would destroy the tubercles bacilli.

The first experiments of Dr. Bergeon were made on animals, with chlorine, turpentine, ether, ammonia, and bromine; but these substances provoked an immediate and violent inflammation of the rectum, and even caused mortification of parts of the mucous membrane, and were therefore abandoned. A mixture of carbonic acid and hydrogen sulphide was perfectly tolerable when the two gases were pure and completely deprived of atmospheric air. In their union the carbon dioxide plays in some degree the part of an inert body, attenuating in all cases the irritating properties of the sulphuretted hydrogen. We know that sulphur possesses germ-destroying properties, and nothing is more logical than to apply it to the treatment of pulmonary tuberculosis. The sulphuretted hydrogen is taken up by the venous system and eliminated by the lungs, — thus this gas seems to fulfil all the requirements.

The apparatus by means of which these gases are prepared and injected is the invention, or adaptation, of Dr. Morel. It is constructed on the principle that a current of carbon dioxide passing through, or over, certain gaseous, or volatile, substances will carry with it a certain quantity of these substances: it produces a disassociation of the gaseous elements which they hold, and these elements, being liberated, are carried with the current of carbonic-acid gas. It is necessary, first, to produce very pure carbonic-acid gas, and, second, to pass this gas through a liquid medicated with these volatile substances, and to cause it to penetrate the rectum, and to prevent its return to the receptacle for the carbonic acid. The carbonic acid is produced by the action of sulphuric acid on bicarbonate of soda. Hydrochloric acid has been used, but a little always escapes with the carbonic-acid gas, and produces an irritation of the intestine. The carbonic-acid gas as it escapes from the generative flask is collected in a rubber bag. In order to avoid colic, the gas must not contain any atmospheric air. The injection-apparatus consists of the rubber bag filled with carbonic-acid gas; of a rubber bulb with a valve at each end, to which are adapted rubber tubes, one of which is red and the other black, so as to distinguish the valves; a metallic T-tube, the vertical branch of which, with a valve at each end, is plunged in the bottle containing the medicated liquid; and, last, a rubber tube with a pipe on the end for insertion into the rectum. These parts are attached in such manner that the carbonic acid is drawn into the bulb, then forced into the medicated solution in the bottle, taking up the sulphuretted hydrogen, and together these gases are forced into the intestine.

After describing the apparatus and the method of its use, Dr. Morel calls attention to certain precautions which are to be taken in making the injection. These include the attitude of the patient, the necessity of proceeding with caution, and, at first, its administration by the physician himself, the time occupied in giving the injection, and the amount of gas injected.

The natural mineral-waters which contain natural sulphuretted hydrogen or sulphides of sodium or calcium have, as a usual thing, been employed by Drs. Bergeon and Morel, being preferred to the artificial waters. The principal springs which contain a sufficient quantity of sulphuretted hydrogen gas or of sulphides for rectal injection are Allevard, Aix en Savoie, Eaux-Bonnes, and some fifteen others. To obtain permanent results, the treatment must be continued for months, in order to place the bacilli in a local bath of antiseptic vapors, which at length will destroy their virulence and power of reproduction.

The results obtained by Dr. Bergeon in the treatment of consumption by his method of rectal injections were communicated to the French Academy of Science in July, 1886, and to the Congress of the French Association for the Advancement of Science, at Nancy, in August of the same year; and in October the distinguished Professor Cornil made a communication to the Academy of Medicine on the subject. These results of Dr. Bergeon have been confirmed by physicians of Lyons, Paris, Geneva, and Marseilles. These physicians have observed the rapid disappearance of the symptoms of pulmonary suppuration in consumptives, and a progress toward a state of health, which has all the characteristics of a complete cure. Dr. Bergeon says that those whom he considers cured do not ex-

pectorate, or offer to auscultation any stethoscopic signs but those of dryness due to the presence of cavities which have cicatrized, or are in process of cicatrization, or to cicatricial bands consecutive to old lesions. Some of these patients have been obliged to take up again a very laborious existence. Mounting a great many stairs many times in the course of the day, nevertheless, their respiratory organs have resisted all these fatigues, and the improvement gained has been steadily maintained. In most of the patients, in two or three days, there is a marked diminution of the cough, the expectoration, the night-sweats, and the difficulty in respiration, which accompany pulmonary phthisis; in time, the patients gain a feeling of health and an increase in strength. Little by little the favorable symptoms gain the advantage, and the patients cease to lose flesh, and commence to gain it.

Dr. Morel notes the remarkable fact, that, even in patients who are apparently restored to health, the tubercle bacilli are still present in the sputum, and says that it remains to be ascertained if the bacilli which persist in the sputum, notwithstanding the return of health, still possess their functional activity, that is, the property of developing to any great extent, to infiltrate anew the pulmonary tissue, and there produce lesions similar to those which have been cured by the administrations of medicated gaseous rectal-injections. The constant presence of the bacilli in the sputum, after health has been restored, indicates two things; first, that their hurtful action is neutralized for a long time by the medication, and, second, that as long as they remain in the sputum, a return of the malady is to be feared, and on this account the injections should not be abandoned, even though it appears that the cure is complete. Many persons who have been so improved after several weeks of treatment as to consider themselves cured, have discontinued the injections, and have suffered a relapse.

Dr. Morel states that it is not the bacilli which are to be feared in phthisis, but the septicæmia caused by their presence in the pulmonary cavities, this being due to the absorption of the infectious products of the bacilli. The elimination of the medical principle in the gaseous injections by the alveolar and bronchial surfaces of the lung combats victoriously this septicæmia. While this elimination is taking place, these infectious products are neutralized, or better, are not absorbed. When the pulmonary lesions are completely healed the injections must be discontinued, because, the bacilli being no longer in contact with a diseased surface, there is no fear of septicæmia. But if the injections are stopped before the walls of the cavities are entirely cicatrized, or if the cicatrization is not rendered permanent by prolonged treatment, the cicatrized part will ulcerate anew, and by the contact of the bacilli the septicæmia is renewed. It is then necessary, in order to prevent the return of the malady, to take the injection time after time, even when the state of the health is satisfactory, and, with still greater reason, if the old symptoms, cough, expectoration, fever, and emaciation reappear.

It has also been noted that the improvement is not confined to the lung-lesions. When tubercular ulcerations of the larynx and pharynx exist, these are also cured without any further applications, solely by the contact of the gases as they are exhaled from the lungs.

Dr. Chantemesse, chief of the laboratory of bacteriology of the faculty of medicine, Paris, and physician of the hospitals, reports nine patients in his practice who had presented both the local and general symptoms of pulmonary tuberculosis, with the presence of bacilli in the expectorations, as having undergone great improvement under Bergeon's treatment; the increase in weight was rapid, sometimes a kilogram a week, while the cough and the expectoration were considerably diminished. The bacilli remained constant in the sputum. Professor Cornil is now engaged in experimenting upon tuberculous animals. He says that the rectal injection of carbonic-acid gas and of sulphuretted hydrogen constitutes an excellent therapeutic method in phthisis, and should gain more favor, in view of the fact that therapeutics are powerless in the face of phthisis. In this disease the only agents which till now have been found useful are foods and those remedies which aid nutrition. Dr. Morel claims that this method of treatment is not confined to tuberculosis. He claims much benefit from it in whooping-cough, bronchitis, and in the infectious diseases, such as typhoid-fever, the

eruptive fevers, and septicæmia, in which blood poisoning results from the introduction into the blood of infectious products of microbes. The infectious elements, spread throughout the blood, come in contact with the medicated gas, not only in the lungs, as in tuberculosis, but also in the right heart at the moment when the blood of the two venæ cavæ is united, and in all its course through the branches of the pulmonary artery. The venous blood, thus purified, frees itself of the excremental products on its arrival at the pulmonary cells, and re-enters, disinfected, the branches of the pulmonary veins. Thus is explained the diminution of fever and the amelioration of the disease which occur in the cases where gaseous injections are employed.

Drs. Spillman and Parisat have made experiments to determine to what height intestinal distension reaches after injecting eight pints of gas, and find that in the cadaver the large intestines only are distended. They find it impracticable to use a larger amount in the living subject on account of cramps and the danger of producing paralysis of the intestines. They conclude, from their experiments, that the method of Dr. Bergeon is powerless in averting tuberculous exacerbations; much less is it capable of arresting the development of phthisis. The night-sweats do not seem to have been influenced by the medication, and the temperature was not permanently lowered. The appetite was not disturbed, but there was temporary intestinal uneasiness, with distension of the abdomen, rendering confinement to the bed necessary. The weight remained the same; sleep was quiet and restful, due solely to the carbonic-acid gas. According to these writers, rectal gaseous-medication is palliative, not curative.

In England, the method has been employed by Dr. Bennett, and by Dr. Heron at the Victoria Park Chest Hospital. The London *Lancet*, in commenting on the method, says that the evidence is forthcoming that the treatment has been followed by many signs of improvement in at least some of the patients, and urges a more extended trial. The writer in that journal does not think it necessary to suppose that the gas must act after the fashion of a true germicide or antiseptic, but it may be that the value of the treatment, supposing it to have any, consists in improving the nutritive powers of the tissues, in increasing their vitality, thereby rendering them more able to cope with deleterious influences, or with the germs, by affording an unsuitable soil for the activity of the latter.

In our own country, much has already been done in testing this new plan of treatment. Dr. Crane of Chicago has used it in four cases, two of phthisis, one of intussusception of the bowel, and one of spasmodic croup. With the latter cases it acted like a charm, overcoming both almost instantly. In the case of croup, carbon bisulphide was used instead of sulphuretted hydrogen. One of the phthisis cases was a man, aged twenty-six years, whose two sisters and brother had died from that disease, and who had been under treatment for three years, during which time he had been twice to Colorado. Under the sulphuretted hydrogen he improved very fast, in one week his temperature becoming normal, the night-sweats almost stopped, and the expectoration became less. In the latter part of the second week of treatment he ventured out on a rainy March day, took cold, and died in two days. The second case was that of a widow, aged twenty-four years, whose mother and sister died from phthisis. She was suffering from incipient phthisis. She made seven visits to Dr. Crane, and then pronounced herself cured. The doctor thinks that she will probably have a return of her symptoms upon the slightest provocation. He has tried the mineral waters of Lafayette, Ind., Blue Lick, Ky., and Ypsilanti, Mich., and considers the last best adapted for the purpose. It is so strongly impregnated with gas that he is able to use it a second time. He has devised an apparatus for the manufacture and injection of the gas, differing from Morel's in no important particular, save in the expense of manufacture, which is reduced about one-half.

Dr. M. M. Johnson, of Hartford, Conn., has been using Bergeon's method in the Hartford dispensary for two months. The patients are mostly those in advanced stages of phthisis. The night-sweats have ceased, the cough has become loose and expectoration easy, the patients sleep well and have increased in weight, the circulation is quickened, and the cold, clammy extremities have become warm.

The treatment has not been carried on long enough to enable an accurate estimate of its true value to be formed.

Dr. H. C. Wood states that the method has been used in the Philadelphia Hospital in a large number of cases, and that a personal inspection shows that the statements made by the French observer are correct, and that there seems to be no doubt that under the treatment there is rapid alteration of some cases of phthisis for the better. Dr. Wood thinks that Bergeon is wrong in supposing that the natural waters are superior to the artificial. In Philadelphia the bottle is charged with ten grains each of chloride of sodium and sulphide of sodium, and this answers for a number of patients. The amount of sulphuretted hydrogen received by each patient is unknown and very variable, and is very small. Dr. Wood thinks that the evidence is already sufficient to indicate that we are in the presence of a very important addition to medical therapeutics, and that it is of vital importance to decide the mode in which the treatment acts.

The experiments of Dujardin-Beaumez show that the sulphuretted hydrogen is the medicinal agent, and not the carbonic-acid gas. He thinks it improbable that the good achieved is the result of any parasitical influence. There is, at present, no proof that sulphuretted hydrogen, when it does good in phthisis, acts by killing the bacilli, and there is still less proof that in any way increases the direct resistive powers of the individual to the action of the bacilli. It is probable that Bergeon's plan is simply a means of making an application of sulphur to the pulmonary mucous membrane and tissue, and this view is confirmed by the benefit resulting from the treatment of asthma and pulmonary catarrh by the same method. Dr. Wood had under his care a patient who had met with a railway accident, followed by pleurisy and pneumonia, whose symptoms led him to believe she would die. He employed the gaseous injection, and at the time of his writing he considered her as convalescent. In this case, although rectal injections were at first employed, subsequently Dr. Wood gave by the mouth the sulphuretted hydrogen in saturated solution artificially prepared, and the effects were apparently the same.

In order that the solution may be uniform in strength, Dr. Marshall of the University of Pennsylvania has devised an apparatus by which it may be made by the patient at his own home. The liquid is sweetish, and not at all unpleasant to the taste.

From the foregoing *résumé* of what is being done abroad and in this country in testing the efficacy of Bergeon's method, it will be seen that the evidence is gradually accumulating to determine its efficacy. It is still too early to declare that tuberculosis is curable, and that the method by which the cure is to be effected has been discovered; at the same time much may be hoped for from a therapeutic agent which has the support of so many well-known authorities in medical science. We deem the matter of sufficient importance to bring it thus fully before our readers, and shall keep them informed on the subject from time to time.

MENTAL SCIENCE.

The Natural History of Error

THERE is always a strong psychological interest in the study of such phenomena as the English Psychic Research Society investigate, apart from all considerations of the ultimate bearing on the truth of any theory. No matter whether houses really are haunted, or the raps made by spirits, or thought transferred from mind to mind; it will be of great value to ascertain how belief in these unusual manifestations arises and progresses, to be on the alert for facts apparently favoring their genuineness but really pointing to obscure psychological processes which might otherwise be overlooked. These important side-issues and preliminary investigations have been much neglected by the English society, and it is an encouraging circumstance, that, in their most recent issue, they make an important step towards making good this neglect.

Messrs. Richard Hodgson (now secretary of the American Society) and S. J. Davey contribute a highly important paper on 'The Possibilities of Mal-Observation and Lapse of Memory from a Practical Point of View.' Mr. Davey became interested in spiritualistic phenomena several years ago, and was so deeply impressed with what he saw, as to be on the high-road to conversion, when

he gradually gained a truer insight, and through skill and practice can now perform many of the medium's favorite manifestations. His specialty is the slate-writing phenomena, — 'psychography' is the technical word, — and in these he has achieved great success, his performance having been declared superior to Englington's. Mr. Davey, under the assumed name of Clifford, gave sittings to friends of Mr. Hodgson and others: he did this, not as a medium, took no fee, but simply posed as a phenomenon, asking his spectators to watch him as they would a conjurer, and afterwards to send him a *detailed written account* of what they had seen. These accounts are all published, and are extremely instructive. What was really done is here accurately known, and a comparison of this with the accounts of the 'sitters' at once shows how reputed marvels come to being, simply by inaccurate description. One must remember, too, that Mr. Davey was decidedly in a less advantageous position for deceiving and exciting wonder than a professed medium; for the latter, at the worst, deals with a person who has a little belief in the possibility of some supernatural agency, and this remnant of belief induces a mental attitude that does not watch trifling movements, slight delays, and so on. The witness of a conjurer's performance has an interest in minimising the mystery of the tricks. Some of Mr. Davey's sitters had no notion that they were to witness mere slight of hand, others more or less strongly suspected it, and a few were as much as informed of it beforehand. It is extremely interesting to see how the report of each is modified by his previous knowledge. One gentleman, whom Mr. Davey met at a séance, spoke very disparagingly of the performances of an amateur conjurer known as Mr. A., and remarked that Mrs. Sedgwick's attempt to explain 'psychography' by such powers were totally inadequate; after the performance, he declared that what he had just seen through 'Mr. Clifford' was more conclusive of the existence of supernatural powers than the evidences furnished by a distinguished medium. The joke of the story is that the amateur conjurer Mr. A., 'Mr. Clifford,' and Mr. Davey are all one and the same person.

None of the 'sitters' were able to explain how the thing was done, though one gentleman ventured the information that he was sure it was *not* done in such and such a way. Had he omitted the 'not,' he would have been nearer right than any. Some observed a few points correctly, but most had simply to record what they saw. On reading these reports, many a reader will imagine that *he* would certainly not commit such an error in description; this is assuredly an illusion. Some of the reports are exceptionally good. To describe accurately is a rare gift. It means scientific success. It is possible only after repeatedly witnessing the same performance. This mal-observation is natural; its absence is the exception.

It is time to turn to Mr. Hodgson's analysis of the kinds of error which these reports show. There are four convenient groups of such errors. First, are errors of 'interpolation;' something is inserted as having happened which really did not happen: the subject declares he examined slates when really he did no such thing. Second, errors of 'substitution;' the subject declares he examined the slate in every detail, when really he only glanced at it. Third, errors of 'transposition,' in which the event is correctly described, but is described as happening later or earlier than it really did (many a reputation has been made by skillfully utilizing this tendency). Last, errors of 'omission,' in which events apparently trifling are not noticed at all. These it is the object of the medium to induce by distracting the attention in one way or another; and it is just through exaggerations and misrepresentations, which these erroneous tendencies bring about, that the simple doings of the mediums become marvels in the mouths of enthusiastic narrators. It is all a question of attitude: what is utterly unimportant to observe, if the medium is believed to be acting under the control of spirits, becomes the most important, if he is regarded as a trickster. It has been a stumbling-block to many minds to understand how mediums could acquire such great reputations as wonder-workers, if they really did nothing more than these simple tricks. The mystery of this falls away if we remember that the power of accurate description is a rarity, and that, as is here experimentally proven, the amount and kind of distortion which mal-observation and errors of memory produce is perfectly sufficient to make a spiritualistic marvel of a conjurer's trick.

EXPLORATION AND TRAVEL.

New Explorations in Central Africa.

THE progress of explorations in the Kongo Basin is so rapid that our map of May 27 does not fully correspond to the present state of our knowledge. Therefore we reproduce in the present number the part in which the most important discoveries have been made, corrected to date. The Mongala and the tributaries of the Obangi are drawn more accurately from new maps published by the *Mouvement géographique*, but the most remarkable features of the new map are the discoveries of Giacomo de Brazza in the region between the Obangi and Ogove, which were published in the Bulletin of the Italian Geographical Society. Though it is more than a year since this traveller returned from his journey, the map has been published only now, but as it is not based on the longitudes of Captain Rouvier, the positions had to be corrected accordingly. De Brazza started from the upper Ogove. First he made several short excursions in the region between the upper Ogove and the

Mouvement géographique that Captain van Gèle has ascended the Lopuri, the tributary of the Lulongo. The upper part of this river runs in a north-westerly direction, and approaches the Kongo closely in longitude $21^{\circ} 26'$. Then it takes a south-westerly course. The parallelism of these rivers with the Kongo explains the absence of tributaries in the central part of its upper course.

HEALTH MATTERS.

Pasteur's Methods.

RECENT criticisms of the inoculation-method of Pasteur for rabies have been very unfavorable; but the report of the English Committee will undoubtedly turn the tide again in the opposite direction. It will be remembered that this committee was appointed by the President of the Local Government Board, in April, 1886, to inquire into Pasteur's treatment of this disease. Its report has just been presented to Parliament. The value of such a report depends en-

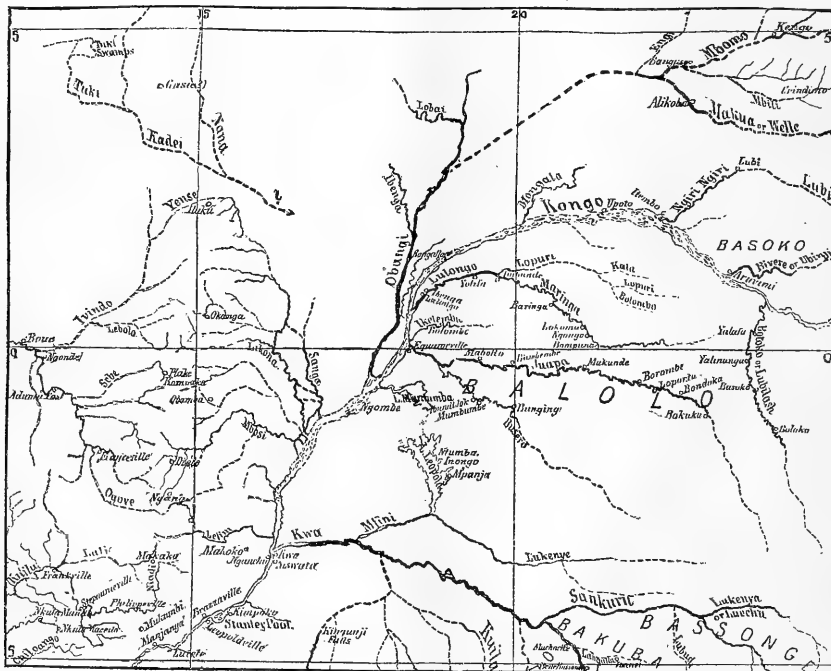

MAP SHOWING LATEST INFORMATION ON THE KONGO BASIN.

Alima, and then started on his important journey. He left Madi-ville on July 12, 1885, travelling in a north-easterly direction. He crossed the Sebe farther north than this river was supposed to run, and crossed the water-shed between the Likona and Ogove under the equator. The most northern point reached is Iluku, situated in a densely populated region. He indicates that this region belongs to the drainage area of the Ogove, the Ivindo rising near this place. This is an important discovery, as it considerably enlarges the drainage area of the Ogove. De Brazza returned to the Kongo by way of the Likuala. Close to the mouth of this river, a little farther east, the Sanga, which according to von François carries a great volume of water, empties. Therefore it must drain an extensive area. As the western tributaries of the Obangi are of no great importance, and the tributaries of the Ogove extend so far east, we must suppose that its sources lie far north, and it may be that the rivers Kadei and Nana, which have been described to Flegel by the natives, are its upper course.

Since the accompanying sketch-map was engraved, we learn from

tirely upon the qualifications of those who form the committee, and we presume, that, composed as it is of some of the most eminent of English investigators, its conclusion will receive the most respectful and careful consideration by the scientific world. The report is signed by James Paget, Chairman; T. Lauder Brunton, George Fleming, Joseph Lister, Richard Quain, Henry E. Roscoe, I. Burdon Sanderson, and Victor Horsley. We venture to say that no more eminent committee was ever appointed on such an investigation.

In the course of its inquiry the committee visited Paris to obtain information from Pasteur himself, and to observe his method of treatment. They investigated a considerable number of persons inoculated by him. Mr. Horsley conducted a careful series of experiments on the lower animals, and entirely confirms Pasteur's discovery of a method by which they may be protected from the infection of rabies. The committee states that "it may be deemed certain that M. Pasteur has discovered a method of protection from rabies comparable with that which vaccination affords against infection from small-pox. It would be difficult to over-estimate the im-

portance of the discovery, whether for its practical utility or for its application in general pathology." The committee investigated ninety cases treated by Pasteur. Of this number, twenty-four had been bitten on naked parts by undoubtedly rabid dogs, and the wounds were not cauterized, nor otherwise treated in any way likely to have prevented the action of the virus. Of thirty-one that were bitten, there was no clear evidence that the dogs were rabid, and in others the bites had been inflicted through the clothes. It is estimated, from experience of the results of bites in other cases, that had they not been inoculated, not less than eight among these ninety persons would have died. Not one of them has shown since the inoculation any signs of hydrophobia. The committee thinks it certain that the inoculations practised by M. Pasteur have prevented the occurrence of hydrophobia in a large proportion of those who, if they had not been so inoculated, would have died of that disease. And his discovery shows that it may become possible to arrest by inoculation, even after infection, other diseases besides hydrophobia.

If rabies be not reduced among the dogs of England, there will always be a large number of persons who will require treatment. The average annual number of deaths from hydrophobia during the ten years ending 1885, was, in all England, 43; in London alone, 8.5. These numbers may be taken as representing only five per cent of the persons bitten, so that the preventive treatment will be required for 860 persons in all England, and for 170 in London alone.

In commenting on this report of the committee, the London *Lancet* says that "their verdict is the most important yet pronounced upon the subject, and must go far to decide the question of the prophylactic value of the inoculation of Pasteur. The conclusion that the method has saved a considerable number of lives, and that it is at present, and probably will be for long, the only mode of saving from death those who have been bitten by a rabid dog, affords strong support to Pasteur's conclusions, and, we need hardly say, must have most important practical results."

MEASLES.—The prevalence of measles in some parts of the world, and its fatality, have aroused health-authorities to such an appreciation of the necessity for restricting the spread of this disease, that official steps are being taken for the attainment of this end. A recent occurrence at Portsmouth, England, makes the necessity for this work more emphatic. H. M. S. *Crocodile* arrived at that place with forty persons sick with measles on board, who were permitted to land. From these individuals the disease has spread to an epidemic, and at last reports the number of deaths was one hundred and ninety-seven.

LEPROSY IN LOUISIANA.—Considerable excitement has been occasioned in Louisiana by the report that leprosy existed at St. Martinsville in that State. The State Board of Health has made an examination, and finds that five persons are suffering from undoubted leprosy, while three others are as yet in doubt.

BOOK-REVIEWS.

Chance and Luck: a Discussion of the Laws of Luck, Coincidences, Wagers, Lotteries, and the Fallacies of Gambling; with Notes on Poker and Martingales. By RICHARD A. PROCTOR. London, Longmans, Green, & Co.

THE persistency of a superstition can generally be referred to the subtleness and persuasiveness of the logic upon which it is founded, or to the fact that it appeals to a strong instinct in human nature. Doubtless both these influences have been at work in keeping alive, among those in whom the hazarding instinct is at all strong, a fondness towards a belief in their own favoritism, in the obscure forces which control luck, and in the sundry other agencies which go to make of chance something which is more than chance. For the benefit of such,—and they form a respectable portion, both in size and ability, of mankind,—Mr. Proctor has written this book. He hopes to be able to convince a few of the errors of their ways, sadly recognizing "that the gambling fraternity will continue to proclaim their belief in luck, . . . and the community on whom they prey will, for the most part, continue to submit to the process of plucking, in full belief that they are on their way to fortune."

The wide-spread belief in luck is in many ways easy to account

for, and even to defend. There is an element of chance that enters in the lives of every one of us; and it is but natural that where this chance favors the success of our projects,—though not the least to our credit,—this should have a decided influence in the shaping of our character. Much that is attributed to good fortune is really good common sense and wise forethought; but, allowing for that, as long as there remains this element of uncertainty in our lives, it is evident that there must be certain individuals who are lucky, in the sense that they have been fortunate when they had no very good reason to expect success, and certain others who have been unlucky under the same circumstances. But this, Mr. Proctor well insists, is a very different thing from the common conception of a lucky individual, which regards such a man as more likely to be fortunate in success depending entirely on chance, in the future; as a chosen being for whose benefit the laws of probabilities will be suspended, and who can, even with considerable confidence, count upon such benign intervention. It is this conception that has the strongest hold upon gamblers, upon the wisest and sharpest of them, as well as upon the people at large, and is a very ridiculous and a very dangerous superstition. If some way could be devised by which the expectation, the subjective feeling of confidence, could be properly proportioned to the mathematical chance of securing the desired prize, lotteries could no longer exist, and the chance forms of gambling would appear as utter folly. The methods by which such occupations are carried on are devised to carefully prevent any such enlightenment, and they easily succeed in so doing.

The logic of the matter is very simple. Take lotteries as an example. If ten persons each deposit five dollars, and agree that the one throwing the highest number of points with a pair of dice shall receive the fifty dollars, that would be a fair lottery. To test its fairness, we have simply to consider, that, if one person bought all ten deposits, he would be sure to win, and would neither lose nor gain; in other words, mathematically the price to be paid for a share in a lottery is obtained by dividing the amount that can be gained by the number of shares. No lottery of this sort would pay: hence no paying lottery is fair, and every lottery that exists pays those who control it very well indeed. The Louisiana lottery, the peculiarity of which Mr. Proctor characterizes as 'the calm admission, in all advertisements, that it is a gross and unmitigated swindle,' sells monthly 100,000 tickets at five dollars each. Deducting from the \$500,000 thus received as much as \$10,000 for expenses, and a similar amount for 'the charitable and educational purposes' for which the State sanctions the lottery, there remain \$480,000. Instead of distributing all this in prizes, they distribute only \$265,000; and thus, when all the tickets are sold,—and few are ever left,—the managers have a clear profit of forty-five per cent per month. This is exactly the same kind of swindling as would be committed by the man who invited the ten persons to deposit their five dollars, were he to give the one who threw the highest number of points \$26.50, and quietly pocket the \$23.50 as a reward for his trouble. Lotteries exist and pay, because people are willing to give more for the chance of securing a prize than they ought to give. They dwell frequently and long on the immensity of the prize, entirely underestimating the slowness of the possibility of their securing it, and thus cherish a sort of optimism which overlooks barefaced robbery and tolerates the most glaring frauds. That such is the case was experimentally demonstrated by the English Government. Tickets for a lottery were offered for sale, not at a fixed price, but for what they would fetch. The contractors bought of the government tickets mathematically worth £10 at £16, and again sold the tickets at a large advance. The public was perfectly willing, and actually asked, to be plundered.

Gambling-banks and the superstitions of gamblers offer a still more interesting topic. Here there is often much ingenuity displayed in arranging plans by which apparently fortunes must be won, and in defending pet notions with an array of apparently sound argument. But the reason why a bank must win has often been exposed. It is simply that it reserves for itself, under certain conditions (apparently very unlikely), a certain sum, apparently small, or it stakes a larger sum at exaggerated odds for the great probability of winning a small fee. Thus the *refait en rouse et noir*, which apparently is a most improbable event, must, by the doctrine

of probabilities, occur sufficiently often to give the bank a sure profit of 1.1 per cent on every deposit. The fallacy of those who devise sure methods of defeating the bank ('martingales,' as they are termed, lies in the fact that they neglect to consider that the fortunes of any one gambler, compared to that of the bank, is small; they prove that in the long-run they must win, forgetting that they only have a short run. As a matter of fact, when their schemes require the risk of a very large sum, they generally are afraid to make the risk, and so leave the game with the firm conviction, that, had they but possessed a little more money, success would have been insured.

The gambling superstition that has probably worked more ruin than any other is what they term the 'maturity of chances.' The gambler says, to toss aces six times running is certainly a highly improbable event: if, therefore, aces have fallen five times, it is much more certain that the next throw will not fall an ace than if ace had not been thrown five times. The absurdity of this doctrine, apart from its being disproved by actual trial, can be easily shown. The chance of the occurrence of a certain event has no meaning after the event has occurred: it then has become a certainty. The chances of throwing an ace are as 1 to 6 on each throw, and entirely without reference to other throws. If I enter a room and pick up a die, the chances of my throwing an ace are as 1 to 6: to be told afterwards that five aces had just been thrown with that die, could evidently not influence the chances of my throwing an ace. Yet this doctrine is defended in the books on gambling, and is carried into practice at the gaming-table, to the ruin of many of its adherents.

Mr. Proctor gives very clear expositions of the fallacies underlying such beliefs; and makes a forcible statement of the swindling processes to which even the better class of gamblers, lottery-holders, and the like, must resort; and illustrates his arguments with facts derived from actual experience. The book is no theorist's exposition merely,—it really ought not to matter if it were, because here theory and practice have been found to agree,—and is thus excellently calculated to meet the purpose for which it was written. It is in every respect a commendable work. Men desirous of guiding their actions by reason will here find expressed the position they should take on matters of chance and luck.

Our Temperaments; their Study and their Teaching. By ALEXANDER STEWART. London, Crosby, Lockwood, & Co. 8°.

DR. STEWART gives in his preface a description of what this book is. "Impressed by the frequency with which the word 'temperament' is used to account for the action that is taken not only on the ordinary but on the eventful occurrences of life; while so little is known of the temperaments, that very few outside the medical profession can name off-hand the four principal ones,—the sanguine, the bilious, the lymphatic, and the nervous,—I have endeavored to construct, from scattered and scanty material and my own observation, a practical guide by which observers may know the temperament of any one by looking at him, and associate with it certain mental qualities and traits of character." The author points out the disparity between the part the temperaments play in medicine and in general literature. He accords them a more definite value than expression and physiognomy, and believes them more available than phrenology, for the reason that the physical characteristics of the temperaments are definite, few, and readily observed.

Dr. Stewart has collated an immense mass of observations on the temperaments from ancient, mediæval, and modern literature, and uses it to illustrate and expound his own argument. He first makes clear the ordinarily received medical doctrine of the temperaments, and then endeavors to give it added precision and scientific value. Dr. Stewart himself recognizes the just limitations of the doctrine which he develops. He sees, in the first place, that it applies only to civilized races; and, second, since the physical characteristics and the influences that modify the mental habit vary in different climates and countries, that it holds most forcibly with the British, since it is from that nation that the distinctions have been drawn.

Perhaps the greatest advance made by the present writer is the assignment of precise form-characteristics to the different temperaments. He gives a table, in which one column contains the physi-

cal, and the other the mental, characteristics of the four pure temperaments. These are very full and explicit. (The physical characteristics are seven,—three relating to color (of the hair, eyes, and complexion), and four to form (of the face, nose, neck, and body).)

The nervous temperament is accorded a special chapter, that the common error of confusing it with nervousness may be avoided. Nervousness, so far from being a normal characteristic, is described as "altogether a departure from the natural or healthy manifestations of the temperament." To the nervous temperament is ascribed the tempering, softening, and refining of the other three. "What literature would be without the grace, the tenderness, the sublimity of poetry, the other temperaments would be without the nervous" (p. 132). After a discussion of the compound temperaments, the practical applications of our knowledge of them are taken up. The aid they may render in education, in the choice of a congenial and fitting profession, and in the promotion of health, is developed in a most interesting way. By way of illustrating the form-characteristics mentioned, and to enable observers to classify faces by them, a number of engravings are given from Lodge's 'Historical Portraits.' Dr. Stewart has certainly given us a most entertaining and valuable study in anthropology, and the publishers have done their full share in making it attractive to the reader.

Report of the Scientific Results of the Exploring Voyage of the 'Challenger.' Zoölogy, vol. xix. London, Government. 4°.

In this volume, Hubrecht reports on the *Nemertea*, his contribution comprising one hundred and fifty pages and sixteen finely drawn plates. The 'Challenger' nemerteans were few in number, and only some twenty stations afforded specimens. Of these stations, only five were over one hundred fathoms, and only three of these exceeded one thousand fathoms. *Carinina grata* and *Cerebratulus angusticeps* were obtained from these three, but the last species was dredged elsewhere at a depth of only ten fathoms. The most aberrant types were the above-mentioned *Carinina* and the pelagic *Pelagoneurtes*. The section-cutter was the chief instrument of investigation, and the number of sections made exceeded 19,500. The report is divided into a systematic and an anatomical part, followed by a chapter on theoretical considerations. The latter will afford reading of much interest to those who are not engaged in the study of nemerteans. The conclusion reached by the author is, that "more than any other class of invertebrate animals, the *Nemertea* have preserved in their organization traces of such features as must have been characteristic of those animal forms by which a transition has been gradually brought about from the archicæloous diploblastic (coelenterate) type to those enterocœloous *Triploblastica* that have afterwards developed into the *Chordata* (*Urochorda*, *Hemichorda*, *Cephalochorda*, and *Vertebrata*)." This statement excludes the idea of any direct ancestral relations between *Nemertea* and *Chordata*, and fully recognizes the points of agreement between *Balanoglossus* and *Amphioxus*.

The clear and weighty arguments by which the author sustains this proposition do not admit of condensation.

The reports on the *Cumacea* and *Phyllocarida* are by Prof. G. O. Sars, where that distinguished naturalist finds himself on congenial ground. The number of species of the former group obtained by the 'Challenger' is fifteen, ranging, among them, from the surface to 2,050 fathoms in bathymetric distribution. In addition to the more purely systematic part, Professor Sars discusses the derivation of the group, and gives a summary of the characters of all the families, and enumerates the genera of which each is composed. The memoir is illustrated by eleven plates, distinguished by that accuracy and beauty which characterize all the work of Professor Sars' facile pencil.

To the single genus of recent *Phyllocarida* heretofore known (all the others being palæozoic fossils), the 'Challenger' expedition added two new generic types, which are naturally of great interest. The illustration and description of these take but three plates and some thirty odd pages of text, in which the author fully discusses the history, morphology, and development of the group, and the homologies of the several parts in the *Nebalida* with those of other recent *Crustacea*. As regards the phylogenetic relations, the

author is inclined to indorse the suggestions of Packard rather than the hypotheses of Metchnikoff and Boas.

The report on the *Pteropoda gymnosomata* is in some respects disappointing. It was hoped by those interested in these animals that the extraordinary opportunities offered by the 'Challenger' voyage would result in a monographic series of illustrations, giving us satisfactory artistic representations of these exquisite 'sea-butterflies' taken from life. Instead of this, we have a series of diagrammatic plates taken from pickled specimens, and in nearly every case grossly misrepresenting the form and proportions of the living animal. M. Paul Pelseneer, who reports on the group, is evidently quite unacquainted with these animals under their normal conditions of existence,—an ignorance which is not unpardonable, but which has led him into sundry observations which future experience, should he have it, will enable him to modify in the direction of accuracy.

For the rest, considering the chaos which preceded Dr. Boas's monograph, in the *Spolia Atlantica*, in regard to the species, sometimes well figured but poorly described, sometimes unfigured, and sometimes described from immature or mutilated specimens,—considering all this confusion, and finding the characters of form and color familiar to those who know these animals in life, gone irrevocably in pickled specimens, it is not surprising that the author should be disposed to criticize sharply, if not altogether justly, the work of a past epoch. He has brought a certain order out of the confusion, and his work will be helpful to the student of museum specimens. The ideal iconography, which we might have had, of the animals as they live and move, must, however, be looked for from some other direction.

NOTES AND NEWS.

The government of the province of Cordoba (Argentine Republic) has established a meteorological service, of which Prof. Oscar Doering will be in charge. The new institute will be independent of the national meteorological office which was founded by Mr. Gould. The officers of telegraph and telephone stations will be obliged to make observations in conformity with the instructions. The work will be begun next year on forty stations.

—The first number of the *American Journal of Psychology* will appear early in October. Among the articles which will probably appear in that or the succeeding numbers are the following: 'On Gradual Increments of Sensation,' 'New Methods and Further Results in the Study of the Knee-Jerk,' 'Psycho-Physic Methods and Star Magnitudes,' 'A Criticism of Psycho-Physic Methods and Results,' 'A New Binocular Phenomenon and its Use in Determining the Empirical Horopter,' 'A Review of Contemporary Methods and Results in the Histology of the Central Nervous System in Europe,' 'Paranoia.—A detailed study of a case extending over many years,' 'An Important Study of the Play-Instinct in Children,' 'A Further Study of Heracleitus,' 'An Extended Review of the Work of the English Society for Psychical Research.' The journal will also contain many digests and critiques of current psychological literature, both books and articles.

—The following statistics have been compiled, for the U. S. Geological Survey, by Charles A. Ashburner, principally from the direct returns of the operators of individual coal-mines, supplemented by valuable contributions from State officials. The total production of all kinds of coal in 1886, exclusive of that consumed at the mines, known as colliery consumption, was 107,682,209 short tons, valued at \$147,112,755 at the mines. This may be divided into Pennsylvania anthracite, 36,696,475 short or 32,764,710 long tons, valued at \$71,558,126; all other coals, including bituminous, brown coal, lignite, and small lots of anthracite produced in Arkansas and Colorado, 70,985,734 short tons, valued at \$75,554,629. The colliery consumption at the individual mines varies from nothing to 8 per cent of the total product, being greatest at special Pennsylvania anthracite mines, and lowest at those bituminous mines where the bed is nearly horizontal and where no steam-power or ventilating furnaces are employed. The averages for the different States vary from 3 to 6 per cent, the latter being the average in the Pennsylvania anthracite region. The total production, in-

cluding colliery consumption, was: Pennsylvania anthracite, 34,853,077 long or 39,035,446 short tons, all other coals, 73,707,957 short tons; making the total absolute production of all coals in the United States 112,743,403 short tons, valued as follows: anthracite, \$76,119,120; bituminous, \$78,481,056; total value, \$154,600,176. The total production of Pennsylvania anthracite, including colliery consumption, was 699,473 short tons in excess of that produced in 1885, but its value was \$552,828 less. The total production of bituminous coal was 1,086,408 short tons greater than in 1885, while its value was \$3,866,592 less. The total production of all kinds of coal shows a net gain of 1,785,881 short tons compared with 1885, but a loss in spot value of \$4,419,420.

—The *Naturwissenschaftliche Rundschau* gives an abstract of J. Coaz's observations on the planerogams first taking possession of the land at the end of retreating glaciers. The end of the Rhone glacier has been marked yearly since 1874, and therefore Coaz made his observations at this place. In the zone left by the ice in 1874, he found 39 species; in the zone following, 37: 23 species grew in the zone left by the ice in 1876, but then the figures fall off to 12. In the zone of 1881 only 7 are found, and in that of 1881 only a single species. This is *Saxifraga aizoides*. *Epilobium Fletscheri* and *Oxyria digyna* grow in all zones except the last. Willows do not occur except in the first two zones. The observations were made in 1883.

LETTERS TO THE EDITOR.

*. * The attention of scientific men is called to the advantages of the correspondence columns of SCIENCE for placing promptly on record brief preliminary notices of their investigations. Twenty copies of the number containing his communication will be furnished free to any correspondent on request.

The editor will be glad to publish any queries consonant with the character of the journal.

Correspondents are requested to be as brief as possible. The writer's name is in all cases required as proof of good faith.

Scientific Ballooning.

I AGREE most heartily with Professor Waldo, in *Science* for July 15, that "no meteorological data are so much to be desired as those which are now obtained for short, irregular intervals, by balloons." Six years ago, when there was talk of a balloon-voyage from Minneapolis to the Atlantic, I wrote a note regarding the relative importance of the free and captive balloon. I was not then aware that no balloon had ever been kept afloat at a half-mile height more than twenty hours, and then only by the use of about half a ton of ballast. Probably there are now several balloons, in this country, that can be floated more than twenty-four hours by using four hundred or five hundred pounds of ballast each day. The great desideratum in ballooning is a gas-tight envelope. The best record I know of is the suspension of a balloon at about one thousand feet, for thirteen hours, with a loss of about one hundred and sixty pounds of sand. I think an approximation to a tight balloon may be made by increasing the number of coats of varnish, but this would bring about an unwieldy envelope and one likely to crack when emptied of gas.

If we had such an envelope, however, it would be impossible to keep the balloon captive, at a half-mile height, in a wind much over five miles per hour. As the chief investigations we wish to make are during the progress of storms, when the velocity of the current rises to forty and fifty miles per hour, it can hardly be considered that a captive balloon is practicable.

A captive balloon, however, can never give us what we wish; namely, the distribution of temperature, moisture, etc., in a vertical direction, nor in a horizontal stratum. Just the height to which we must go is in some doubt, some authorities placing it at 20,000 feet and over. I think that at least nine-tenths of the disturbance is below 6000 feet, so that the exploration is by no means as formidable as it might seem at first. There is nothing the aeronaut, with a few hundred pounds of ballast, has so completely under his control as an up-and-down movement, and he can satisfy the most enthusiastic observer with all he may wish of such movement. The weight of an observer, perhaps, is the least objectionable point in ballooning. In most cases at least two men are taken, together

with a few hundred pounds of sand. If the envelope were absolutely tight, this would be ample for several ascents to 10,000 feet, or to keep the balloon in suspension many days. Nothing of scientific accuracy can be had at a high level without a practised hand on the spot. Questions of exposure of instruments, observations of clouds, etc., demand an immediate answer at each record, if we desire valuable observations. Glaisher made thousands of observations of the moisture-contents of the air in his memorable scientific ascents, but, though these have been utilized by others in doubtful computations, he himself does not summarize them in considering his results. All who have tried to make humidity-observations in a room, with no air stirring (which is precisely the condition in a balloon), know how exceedingly unsatisfactory they are.

I believe that the investigations needed may be made at an expense much less than is ordinarily supposed. There is needed a balloon of about 60,000 cubic feet capacity (a larger one would be too unwieldy, and is not necessary for ascents up to 20,000 feet). The gas for inflation should be the last that comes in the process of manufacture: this is poor in illuminating power, because it has less carbon, but it is nearly one-fourth more buoyant than ordinary coal-gas. This is not exactly a refuse product, yet it can be had very cheaply. It would be a most excellent plan to send up four balloons at once, about two hundred miles from the centre of a storm, in the north-east, north-west, south-west, and south-east quadrants. But, as this would be rather expensive, we must explore the most interesting point first. I would send up the balloon either to the south-west or west of a storm: at a height of 6,000 feet, it would, in all probability, outstrip the storm, and the descent could be made either in the centre or a little to the east of it. We could then either make another ascent immediately, or wait till the storm has passed overhead, and then make another trip just as at first. This will enable us to determine, not only the vertical distribution of temperature and moisture in the neighborhood of the storm, but also the action, whirling or otherwise, that takes place at the seat of the storm, or where the 'power' of the storm is developed. When the balloon is no longer able to rise, a fresh supply of gas may be carried to it in a small balloon, or in a long flexible cylinder (as suggested by Professor King). If near any gas-works, the balloon may be towed near enough to obtain a fresh supply. As about 30,000 feet of gas would be needed to float the balloon and all its appliances, it will be seen that this would effect a great saving. I understand perfectly that carrying out such suggestions as these may be a very difficult matter in practice, and often impossible in a high wind. For ten thousand dollars, I think, fifty or sixty ascents might be made, which would be of incalculable importance in the study of the origin, development, and progress of storms. Such investigation is absolutely necessary if we would advance our knowledge of the generation of storms. Any advance in this direction is of such moment to almost all classes of people, especially to farmers and mariners, that we may hope such a small sum will be volunteered, or obtained from government, ere long for this study.

H. ALLEN HAZEN.

Washington, D.C., July 19.

Cloud-Heights.

THE following method, which can often be used to determine the elevation of certain clouds, may interest some of your readers, particularly topographers and meteorologists.

I was watching to-day, from Little Monadnock, the shadow of a dense cumulus moving slowly along the southern slope of Monadnock, until finally the edge touched the hotel about half-way up the mountain. It occurred to me, that, if the point where I stood and the hotel were plotted on a plane-table sheet, and the sheet oriented, the elevation of the cloud could easily be found in this way. At the moment the shadow reaches the second plotted position, draw, through the station occupied by the observer, a line, and read a vertical angle to the edge of the cloud that casts the shadow. Then, through the second plotted position, draw a line in the direction of the sun. The point of intersection of these two lines is the horizontal projection of the position of a point on the edge of the cloud at the time the shadow has reached the second plotted position. The distance (to be scaled from the map) from this intersection to

the point occupied, is the base, and the vertical angle of elevation the adjacent angle of a right-triangle, of which the altitude is the height of the cloud above the observer. This may be corrected for curvature and refraction.

When a plane-table sheet is nearly complete, with many located points on it, the same cloud may be observed several times, and the determinations of altitude compared.

This method is extremely simple, and I am very anxious to have it tried. I shall not be able to do this myself for several weeks, but I hope some one who is working with a plane-table will, and let me know his results.

H. L. SMYTH.

Dublin, N.H., July 2.

The Wholesomeness of Swill-Milk.

THE discussion carried on in the pages of *Science* for some weeks past upon the healthfulness of milk from cows fed upon distillery-swill has, in my opinion, failed to definitely settle the question. There can be no doubt of the vital importance of the matter, and all physicians and sanitarians will agree that a solution of the problem is highly desirable.

1. I venture to say that no positive evidence has been submitted showing any ill effect of swill upon cows fed with it. The evils attributable to it are largely, if not entirely, to be ascribed to the unsanitary surroundings of the animals.

2. Whatever evidence has any positive value indicates that swill is equally as good and proper food (used with judgment) as hay, dried fodder, ensilage, or bulbous roots. These all differ widely in chemical composition from the green foods (grass, clover, green oats, and corn), which may be looked upon as the normal food of cows.

3. It may be worth while remembering that lactation in a dairy is not a normal process. Dairy-cows are 'milk-machines.' The dairy business would not be very profitable if lactation were not forced to some degree.

4. Experienced agriculturists, like Professor Armsby and Dr. Sturtevant (*Science*, ix, pp. 602-3), have failed to see any ill effects attributable entirely to swill, and such veterinarians of ability as Professor Law and Dr. Salmon (*Ibid.*, p. 552) corroborate this testimony.

5. The facts collated by Professor Brewer (*Ibid.*, p. 550), showing the ready absorption of germs and odors by milk, the transmission of the flavor of various odoriferous substances eaten by the animal to the secretion, the passage of certain drugs administered medicinally into the milk of nursing women, or the notorious fact that swill-milk stables are 'proverbially foul and stinking,' have no bearing upon the case. The evidence required to establish the unwholesomeness of swill as food for milk-giving animals must be of a different character.

6. While it may be conceded that 'chemical analyses will not settle the question' of the wholesomeness of swill-milk, the fact remains that we have at present no other way of determining the physical qualities of a specimen of milk. Bacteriological investigation may determine the presence of the germs of tuberculosis, typhoid, and, in view of recent discoveries, of scarlet-fever, but will not enable us to ascertain the relative proportions of saccharine, fatty, aqueous, or proteid matters present. Chemistry is here still our main-stay, and, other things being equal (more definitely, disease-germs being absent), a specimen of milk nearly approaching the chemical standard established by Kœnig may be looked upon as a wholesome food. Other factors besides the food of the animal enter into the production of milk. The age of the animal, period of lactation, time when the milk is drawn, and general sanitary condition, must not be ignored.

7. The asserted greater firmness, and consequent indigestibility, of the coagulum in swill-milk is not based upon a sufficient number of observations to admit of unquestioned acceptance. It should be easy to determine this in any chemical laboratory. No single series of observations would decide this, however. It would be necessary to test milk from cows fed upon swill but kept under good sanitary conditions, side by side with milk from animals kept under the ordinary conditions of city stable-life, and fed upon various foods.

8. A scientific solution of the question will not be furthered by

prejudiced appeals or unreasoning denunciation. Patient investigation, keeping in view all circumstances of the question, and avoiding all one-sidedness in considering the matter, will alone bring about the object desired. Personally I at present occupy the same stand-point as Professor Armsby (*Science*, x. p. 4), "Much of the common prejudice against the use of distillery-slops appears to be occasioned by their irrational application, and frequently by the filthy surroundings of the animals, rather than by any thing injurious in the feeding-stuff itself." GEORGE H. ROHE.

Baltimore, July 15.

The Hudson Bay Route.

In your article on 'The New Route from England to Eastern Asia, and the Hudson Bay Route' (Vol. x. No. 231), you show the advantages offered by the Hudson Bay route, as the most direct available line between Yokohama and Liverpool in connection with the Canadian Pacific Railway and their line of steamers between Yokohama and Vancouver. I should like to add a few remarks on that part of it known as the Hudson Bay route.

The Canadian Government decided, that, before any such line was encouraged by subsidy, it would be advisable to determine by actual observation what difficulties were likely to be met with; and, with this object in view, established several observing stations in the Strait and Bay, with men and material sufficient for continuous residence there during 1884-6. Complete details of these observations are published in the annual reports of the Marine Department.

A fact well established by these observations was that navigation was limited in these years to three months for the ordinary ocean-steamer; and that for a class of steamer specially constructed to withstand the lateral thrust of the ice, and to push her way amidst the outflowing arctic ice, four, or at most five months would be the limit, depending on whether the season was a late or early one. We must not forget, however, that in the earlier days at least of this route, before the telegraph and cable will have reached these waters, steamers will not attempt the passage at these earlier dates, fearing an arrival off the mouth of the Strait and an inactive wait for a late season's opening, so that practically such an advantage would be lost, and two months and a half become the period over which a steamer could be certain of making an uninterrupted passage during any season.

In considering the possibility of the route being equipped with a special class of steamer, we will have to remember that the required conditions will be strength and power rather than speed, and that therefore their field for employment outside of these few months' service would be of very limited extent.

The special objection I would point out as to this route, apart from the ice-question, is the difficulty of the passage itself: an unknown, an unlighted coast-line, with very few harbors of refuge, or none at all, and very little room to ride out a gale; extreme depths of water, one hundred fathoms being often found right up to the shore, with generally very foul holding-ground where the depths are more moderate. In foul weather, no sounding being possible that would be of value, a vessel would receive no warning of her proximity to the coast until the information would be of little or no avail.

Although fogs are of less frequent occurrence than off the Newfoundland coast, where the necessary conditions are most favorable, they are not infrequent during the season of navigation, Belle-Isle having an average of 1,600 hours fog during the year, as compared with 420 for the Strait during the same period. On the other hand, although the total amount of precipitation, in the Strait, was not great, rain or snow fell on an average of a little more than every other day, with its attendant thick weather.

In addition to and connection with these difficulties, we must not forget that the proximity of the Strait to the Magnetic Pole results in the horizontal, or directive, force of the magnetic-needle being so diminished that the common compass is perfectly useless; and even in the case of the Thomson compass, disturbing elements on ship-board have, in consequence, their values so increased (relatively) that sources of error might arise, the effects of which could not be counted on during thick weather.

That the people of Manitoba are seemingly satisfied with the feasibility of this route, there can be no doubt, if we may judge from the advance they have made with the construction of the railway from Winnipeg to Churchill; but, in face of the facts obtained from the observations made in the Strait, one must conclude that the resources of Hudson Bay itself and the country intervening are looked upon as reason sufficient for the construction, independently of the value of the road as a connecting link to the Hudson Bay route.

In conclusion, although it would be difficult to say that, with the appliances science is constantly developing to meet particular cases of difficulty, the navigation of Hudson Strait will not be possible for five or six months when the necessity arises, we cannot but conclude that, with the means at our disposal to-day, the navigation of Hudson Strait is possible for such a limited period, and under such serious disadvantages, that as a development of the 'New Route from England to Eastern Asia' we need not consider it as an immediate probability.

The Observatory, Quebec, July 16.

W. A. ASHE.

The Wanton Destruction of the Florida Heronies.

CANNOT general legislation, cannot State legislation, or cannot somebody raise a hand to stay the terrible, the shameless extermination of the herons at their breeding-grounds in the south-western parts of the State of Florida?

As I pen these lines this murderous work is being actively carried on, and apparently in the most lawless and reckless manner possible,—a disgrace to the entire country,—for one of America's grandest and most interesting natural features, her heronies, are simply, and without a check of any kind, being ruthlessly wiped out of existence. Prompted by an insatiable greed for gain, the 'plume-traders' of the markets are upon their grounds in numbers, and hundreds of these birds are now daily falling to their unceasing fire, simply that they may have their backs robbed of a few feathers to gratify a passing fashion. *The Auk* is now publishing an admirable series of articles on this subject from the able pen of Mr. W. E. D. Scott, at present on a scientific expedition in Florida, and I have just read his contribution to the July number of that journal. Mr. Scott has very recently made camp at a number of these heronies, and I quote a few of his words in order to show what work is going on there. At Matlacha Pass, near Charlotte Harbor, Pine Island has a herony, and here one Johnson was at work. "A few herons were to be seen from time to time flying to the island, and presently I took the small boat, and went ashore to reconnoitre. This had evidently been only a short time before a large rookery. The trees were full of nests, some of which still contained eggs, and hundreds of broken eggs strewed the ground everywhere. Fish-crows and both kinds of buzzards were present in great numbers, and were rapidly destroying the remaining eggs. I found a huge pile of dead, half-decayed birds, lying on the ground, which had apparently been killed for a day or two. All of them had the 'plumes' taken, with a patch of the skin from the back, and some had the wings cut off; otherwise they were uninjured. I counted over two hundred birds treated in this way." In some places, Mr. Scott found hundreds of the young herons just starling in their nests; in others, the gunners beneath the trees shooting down the magnificent birds in hundreds, stripping their backs, and leaving their carcases to rot upon the ground. Instances were noted without number where, during the breeding-season, the poor, affrighted survivors were driven to strange islands, dropping their eggs in quantities from the trees where they fearfully roosted for the night. A few more years, one or two at the most, and this disgraceful murder will cease, for the simple reason that there will no more victims for the murderers to prey upon,—and in the name of nature, and in the name of the shadows of the sweet old romances that have come down to us of the heronies of history, are these timid, and most engaging of all our larger water-fowl, our own American herons, to be destroyed in this manner!

Twenty years ago southern Florida was the site of the grandest heronies in all the world, and to-day this State is making enviable progress, and many cultured people are flocking to her for a permanent home: is she to stand idly by and watch what will surely

be one of her greatest natural attractions stamped out in a few months under her very eyes, — a work, that, when fully known, as it will surely be, will pass down as one of the blackest pages in her history? A quarter of a century ago the writer was at Charlotte Harbor himself, and well do I remember my unbounded enthusiasm as my eyes first feasted upon the sight of a Floridian heronry: many, many, species, represented by thousands upon thousands of individuals, were ranged along the beaches, or covered the cypress tops, where their nests were in hundreds. Never shall I forget their lovely uniforms as they glistened in the soft atmosphere of that sub-tropical land: some were snowy white, others a charming blue, or warm chestnut, while, more beautiful than all, the wondrous rosy tints of the spoonbills fairly shone in the bright sunlight.

Really I am sad as I see, only too vividly in my mind, the disgusting slaughter that is now being perpetrated in their very midst. Entire rookeries have been exterminated, and others reduced to a few, very few, pairs of birds, now so wild and suspicious that it requires the skill of the rifleman to capture them.

R. W. SHUFELDT.

Fort Wingate, N.Mex., July 14.

Tornado 'Power.'

REFERRING to a communication by H. Allen Hazen, in *Science* of July 8, entitled 'Theoretical Meteorology,' in which he states that "theoretical meteorology most signally fails in its attempts to explain our most violent storms and tornadoes," and, "that the theory that the sun's heat could start a vertical current, which, with the condensation of moisture in the upper atmosphere would give rise to winds of 200 to 300 miles per hour seems incredible," and "that the attempt to meet the difficulties by suggesting 'great contrasts in temperature,' 'meeting of warm southerly and cold northerly winds,' etc., does not seem at all satisfactory," I would say that there appears to be a disposition on the part of writers on scientific subjects, more particularly as relates to meteorology, to sacrifice common-sense reasoning and probable facts to profound but improbable theories, which, while they do, and are probably intended to, fill the common mind with wonder at such amazing displays of learning, are unsatisfactory and worthless from a practical scientific standpoint.

The attempt to prove that wind-velocity constitutes the 'power' of tornadoes always did and always will signally fail; nor will it be possible to convince any one who possesses a knowledge of meteorology, that air-currents can be made to attain the several-thousand-mile per hour velocity which would be required to effect the results of tornado action. It is evident to the practical mind that the suggestions referred to by Professor Hazen do not meet the difficulties involved in explaining the violent character of these phenomena, and it is equally evident that more satisfactory suggestions concerning them have not been brought to, or received, his intelligent attention.

It has been claimed and shown that the 'power' of tornadoes is electrical, and it has been demonstrated that trees and twigs which had been subjected to their action bore conclusive proof of this fact. It is not known, however, that theories have been advanced in explanation of the processes whereby the electric fluid is so largely collected within the tornado-funnel, and herein is embodied the object of this communication.

The meeting of warm southerly and cold northerly winds, in the southern quadrants of low-barometer areas, occasions great contrasts in humidity and temperature in a limited area, and it is well known that these conditions are essential to a storm's development and existence. Tornadoes and local storms are, in all instances, subsidiary to extensive storm-systems, and invariably occur at the point where, in accord with the laws governing the circulation of wind in low-barometer areas, the warm and cold currents are brought into opposition. A natural result of the meeting of warm and cold masses of air would be the elevating of the former to higher altitudes, if for no other reason than on account of their relative specific gravity: the ascending currents would, on attaining a proper elevation, precipitate their moisture, and the continual and large inpouring of these opposing currents, in any given locality, would intensify the elements of disturbance. It is conceded that

the angle of contact of air-currents, to the south-eastward of the centres of general storms, contributes to impart a rotary movement, and ascending warm-air currents would naturally assume that motion; and, in the case of tornadoes and local storms, this whirl is most marked at a distance from the earth's surface, or at the point where the moisture in the ascending air is precipitated. That this mass of revolving air is well charged with electricity is shown by the heavy electrical discharges which are commonly observed within its body and in its immediate vicinity. When, through its whirling motion, or the electrical attraction offered by the earth, the extremity of this generally low-lying cloud descends to the earth's surface, there is formed a column of very moist air extending from earth to cloud; and, as moist air is one of the best known conductors of electricity, and the earth is the great reservoir for the electric fluid, the tornado-funnel furnishes the medium of communication by means of which the fluid may leave the earth, and the collecting of vast quantities of both positive and negative electricity within such confined limits would naturally give rise to tremendous exhibitions of its power.

Every observable feature of tornadoes shows them to be electrical storms developed under unusually well-marked conditions. Their action and results are essentially electric, but until the true nature and composition of their mysterious element is known, the exact formula of its action as the destructive agent of local storms cannot be presented. We only know that under certain conditions it will produce certain results. Its presence in tornadoes, in enormous quantities, is shown, and its accountability for the destructiveness of these energetic phenomena is claimed, to the almost total exclusion of the wind-velocity theory, which is not only an improbable, but, it is perfectly safe to say, an impossible one. This is a fundamental proposition established by actual results on the spot where the 'power' of these storms has manifested itself, and is deserving of more consideration than has heretofore been accorded it.

E. B. GARRIATT.

Signal Office, Washington, July 15.

Theoretical Meteorology.

THERE is no contradiction whatever between page 51 and page 328 of 'Recent Advances in Meteorology.' My mind, also, remains entirely unchanged with regard to the other matters in the book referred to, by Mr. Hazen, in *Science* of July 8. There are, however, some other parts of the work, which, after a lapse of nearly three years since the first writing, I would be disposed to amend, and even in some cases correct, in a second writing. This it is proposed to do in a forthcoming more popular work, so far as it shall cover the same ground.

W. FERREL.

Kansas City, July 13.

Queries.

10. ROBIN'S NEST. — Is there any thing unusual in a robin's nest built inside of a last year's nest, which in turn was built inside of a nest now two years old, and that one inside of one three years old, and so on, like the house that Jack built, until you have a pile of nests fitting into one another and numbering ten? Such a ten-story affair was found in Potsdam, N.Y., lately, the top story being in use, while beside it on the same window-cap was another pile of three nests.

C. H. LEETE.

11. LAKE ITASCA. — There is one point in the controversy about the name of Lake Itasca, of which I have often thought, but to which I have not seen public attention directed. The priest who is said to have suggested the name is represented to have been a Latin scholar, and to have proposed a name which is intended to signify the 'true source,' *veritas caput*. Now, I have never been able to see how the words correspond to the idea. *Caput* will do for 'source;' but *veritas* is a noun and nothing else. The two nouns cannot, therefore, mean what they are represented to mean, or the Latin is not that of a classical scholar. *Verum caput* might mean the 'true source,' not, however, *veritas caput*. If there is any other explanation of the case than that the good priest was caught napping in his Latin, I should like to see it in print.

C. W. SUPER.

Athens, O., July 11.

SCIENCE

FRIDAY, JULY 29, 1887.

WILL THE READER please cast his eye upon the following questions: 1. How can it be proved that nicotine is a poison? 2. Why are cigarettes especially harmful? 3. Is alcohol a food? 4. What is the effect of disuse upon a muscle? 5. Under what names is opium sold? 6. Under what names is alcohol drunk? 7. What is the difference between a food and a poison? 8. Is any thing gained by changing from one narcotic to another? 9. What is the effect of beer as a drink? 10. How does cheerfulness help the muscle? These are the questions given as a test in physiology in the public schools of a prominent Eastern city. They are not addressed to young men about to leave school. No, they are asked of little boys and girls of from eight to ten years of age. This is the examination-paper at the end of the first year's elementary instruction in physiology. Of ten questions, eight relate to drinking and smoking: the physiology is a mere side issue. These children, who ought to have about as much knowledge of such matters as they should of the methods in vogue at the stock exchange, are actually forced to learn by rote the details of human vice; and that, too, under the name of 'physiology,' the only science which they learn. Unconsciousness, *naïveté*, is the symbol of childhood. The fact that physiology, even if well taught, tends to destroy this trait, is the chief objection to its early study. Instruction such as the above implies crushes the most valuable trait in the child, directs its curiosity to what is morbid, and forces into precocious development all its dangerous elements. Not enough that the newspaper and the dime novel proclaim in glaring colors the story of crime and sin: some notion of the perversity of human nature must be mixed with the food of babes. That the result of this teaching is to excite in the children a morbid curiosity to experiment for themselves in such matters; or (with the boys) to regard the whole thing as a lesson in 'goody-goodness,' to which they forthwith decide to show themselves superior; or to regard their father, who takes his glass of wine at dinner, as an incipient criminal,—this could easily have been foreseen, and goes without saying. If there is one method better than all others to produce a race of drunkards, this has good claims to that distinction. If there is a degree of wrong in such superlatively perverse methods, then it is still worse that the fair name of science should be outraged in this cause. Not only that this kind of teaching necessarily depends upon catechism methods (that the answer to the second question, for example, is to read that the especial perniciousness of cigarettes is due to the fact that they are usually made of decayed cigar-stumps), but that the entire idea of science thus implanted is as wrong as it well can be. Better far revert to the old days when there was no science on the curriculum than have science thus taught. The crowning educational virtue of science is that it leads to the use of scientific methods of teaching: this usurper chokes up all possibility of an interest in the scientific. The 'temperance' question is doubtless one of the most important with which our age has to deal; sufficiently important, perhaps, to make some consideration of it in the public schools a legitimate proceeding, but it must be done at the right time and in the proper way. Nothing can excuse the conversion of a text-book on physiology into a 'temperance' tract: nothing can excuse the sacrilege of presenting this story of disgusting vice under the name of 'science.'

THE STATEMENTS by Mr. W. Glenn in *Science* of July 15, as to the freedom from disease of men employed in the Baltimore sewers,

are of greater interest in view of the report of Professor Carnelley, D.Sc., and Mr. Haldane, of University College, Dundee, referred to in *Engineering* lately. These gentlemen have been investigating the impurities of sewer-air, and find that the organic acid in the sewers examined was about twice, and the organic matter three times, that of the outside air, whereas the number of micro-organisms was less. As regards the quantity of these three impurities, the air of the sewers was better than the air of naturally ventilated schools, while even mechanically ventilated schools were more polluted with organic matter. The sewer-air contained a much smaller number of micro-organisms than the air of any class of house, and the carbonic acid was rather greater than the air of houses of four rooms and upwards, but less than in two and one roomed houses. As regards organic matter, however, the sewer-air was only slightly better than the air of one-roomed houses, and much worse than that of other classes of houses. The amount of carbonic acid found by the observers shows that the sewers observed were better ventilated than those investigated by previous observers. They attribute the excess of carbonic acid over that of the outside air chiefly to oxidation of organic matter in the sewage and the air of the sewer. The excess of organic matter is probably chiefly gaseous, and derived from the sewage itself. The micro-organisms in sewer-air come entirely, or nearly so, from outside, and are not derived, or only so in relatively small numbers, from the sewer itself. This important conclusion is proved by the facts that the average number of micro-organisms in sewer-air was less than in the outside air, namely, as 9 to 16; that the number increased with the efficacy of the ventilation; that the average proportion of moulds to bacteria in sewer-air was almost exactly the same as in outside air at the same time, whereas one would expect the proportion to be very different were the outside air not the source from which they were derived, seeing that such a difference has been proved to exist in the air of houses and schools. Another consideration is that the filthiness of a sewer seems to have no influence on the number of micro-organisms. Further experiments in the laboratory showed that the number of micro-organisms in sewer-air is diminished nearly a half in passing along a moist tube 5 feet long and 1½ inches in diameter, at a rate of nearly 1 foot per second. There was, however, distinct evidence of the occasional dissemination of micro-organisms from the sewage itself; especially in splashing, owing to drains entering the sewers at points high up in the roofs. It is therefore important that drains should be arranged to avoid splashing.

TOPOGRAPHICAL SURVEY OF THE UNITED STATES.

It is some eight years since the passage of the law creating the U. S. Geological Survey. This survey is charged, among other things, with making a geological map of the United States. For this purpose, it is desirable to have good maps for the use of the geologist in the field, and for the exhibition of results. No map of the whole country, suitable for the purpose, exists, and, of many and extensive portions, rude and imperfect diagrams constitute the only maps. The Geological Survey, therefore, first sought to have inaugurated a general topographical survey of the whole country.

The superintendent of the Coast and Geodetic Survey was conferred with and solicited to undertake the work, and a little work was actually undertaken, but none upon a general or comprehensive plan. The Geological Survey, therefore, finding that no satisfactory progress in geological work was possible without suitable maps, set about organizing topographic work on a systematic and comprehensive plan.

The plan of work, the scale to be adopted, the methods to be used with a view to efficiency, rapidity, and economy, were carefully considered, and then a plan was adopted, subject to such modifications as experience should suggest. Although this plan, and the progress of the work, have been set forth in various official documents, nevertheless they seem to be very little known.

It therefore appears desirable to set forth in brief and simple form the plan which the Geological Survey has, after mature consideration, adopted for making a topographic map of the United States, and the progress which has been made in the prosecution of the adopted plan.

It was decided to make a map which, although primarily designed for the use of the geological corps, should be upon such scales and should represent such features as to make it subservient all purposes to which a general topographic map is applicable,—in short, that it should be *the topographic map of the United States*.

The question of the scale or scales of the map is one of the utmost importance, as upon this depends, on the one hand, the degree of accuracy and the amount of detail necessary to be obtained in the survey, and, upon the other, the value of the map. It was seen at once that it would be inadvisable to attempt to make the maps of all parts of the country upon the same scale. The differences in degree of settlement, in material wealth, in the character of the prevalent industries, in the complexity of geological phenomena, and in the amount and degree of detail of the relief, all emphasize the desirability of varying the scale in different parts of the country.

A scale of 1:62,500, or about one mile to an inch, was adopted for the most populous regions, after a careful consideration of the requirements which such a map should meet, and with full knowledge of the experience of European nations in this matter. In the southern and central States, the conditions of settlement, the character of the industries, and other conditions, appear to admit the use of a smaller scale, and accordingly for this area the scale was fixed at 1:125,000 or about two miles to an inch.

In the sparsely settled region of the Rocky Mountain plateau, a still further reduction appeared advisable; and for this region, with the exception of certain small areas which for special reasons appeared to require a larger scale, it was fixed at 1:250,000, or about four miles to an inch.

The maps represent all natural features of drainage and relief, in degree of detail proportioned to the scale. They represent all *public* culture, i. e., all such of the works of man as have relation to communities as distinguished from individuals. This excludes, it is true, a large part of the culture, but the portion excluded seems for various reasons to be out of place upon such a map. It is of little general interest; it is evanescent, much of it to such a degree that by the time the map is published it would be incorrect and misleading. Its adoption would require the use of a large number of arbitrary symbols, which would be unintelligible without an extensive legend upon each sheet; and, furthermore, the inclusion of so large an amount of cultural material would serve to confuse the map and render its more important parts illegible.

Relief is expressed by contours. The contour-interval, or, as it may be designated, the vertical scale, is adjusted to the horizontal scale, and to the degree of relief of the country. It ranges from 10 to 200 feet; the smallest contour-interval accompanying the largest scale, and *vice versa*.

The size of sheets is so arranged that each sheet upon the smallest scale comprises a square degree, i. e., a degree of latitude by a degree of longitude. Upon the scale of 1:125,000, each sheet is 30 minutes in each dimension, and upon the scale of 1:62,500, each sheet is 15 minutes in each dimension.

The field-work of the survey is carried on with direct reference to the scale of publication. The accuracy, the amount of geometric control, and the degree of detail of the sketching, are proportioned to this scale. A greater degree of accuracy than is required is undesirable, on account of the increased cost. A greater degree of detail in the sketching than is demanded by the scale is not only useless, but worse than useless, as it involves generalization in the office in order to adapt it to the scale, and such generalization cannot be as satisfactory as if made in the field.

For convenience, the original maps and the plane-table sheets are usually made upon scales larger than those of publication. The following table shows the scales in use for the original platting of the maps, the scales of publication, and the contour-intervals, together with the areas surveyed in 1886, in the several areas of work:—

	Field-Scale.	Publication-Scale.	Contour-Interval.	Area surveyed in 1886.
Massachusetts.....	1 : 30,000	1 : 62,500	20 and 40	3,359
New Jersey.....	1 : 20,000	1 : 62,500	10 and 20	1,400
District of Columbia.....	1 : 30,000	1 : 62,500	20	275
Appalachian.....	1 : 126,720	1 : 125,000	100	19,054
Kansas.....	1 : 63,360	1 : 125,000	50	6,000
Missouri.....	1 : 63,360	1 : 125,000	50	4,450
Texas.....	1 : 126,720	1 : 125,000	50	4,388
Arizona.....	1 : 126,720	1 : 250,000	100	7,800
California.....	1 : 63,360	1 : 125,000	200	3,025
Oregon.....	1 : 126,720	1 : 250,000	200	3,000
Montana.....	1 : 126,720	1 : 250,000	200	3,300
Total.....				56,951

At the close of the year 1886, areas amounting to 250,000 square miles, or about one-fourteenth of the area of the country, including Alaska, had been surveyed.

This work is carried on by a Division of Geography, having a *personnel* numbering about one hundred permanent employees besides the temporary aids and camp hands employed during the field-season. The organization of the division during the field-season of 1886 was as follows:—

Sections.	Sub-sections.	Parties.	No. men.
North-eastern.....	Massachusetts.....	4 topographic.....	37
	New Jersey.....	1 topographic.....	11
	Dist. of Columbia.....	1 topographic.....	2
Appalachian.....		{ 7 topographic } { triangulation }.....	58
Central.....	Kansas.....	{ 1 topographic } { triangulation }.....	10
	Missouri.....	{ 1 topographic }.....	5
	Texas.....	{ 1 triangulation } { 2 topographic }.....	11
Western.....	Arizona.....	{ 1 topographic and triangulation } { 1 triangulation }.....	5
	California.....	{ 2 topographic }.....	7
	Oregon.....	{ 2 topographic and triangulation } { 1 triangulation }.....	6
	Montana.....	{ 2 topographic }.....	8

The names given to the sub-sections indicate the fields of work, and the number of men includes permanent assistants and temporary aids, but not laboring force. The work is everywhere controlled by triangulation. Topographic work is prosecuted in part by plane-table, using it by the method of intersections and by traverse methods. Both these methods are in use in Massachusetts. The work in the western part of the State is done entirely by plane-table; that in the wooded, level country in the south-east, by traverse, using the compass for direction and the telemeter for distance, elevations being measured by the vertical circle and by the Y-level. In the north-east the two methods are combined to good advantage, the work of the plane-table being supplemented by telemeter traverses. In New Jersey the survey is made in plan by traverse, with the compass and odometer. The vertical element is subsequently added by Y-level. In the area adjacent to the District of Columbia, the survey is made by telemeter traverse. In the Appalachian Mountain region, south of Mason and Dixon's line, the triangulation rests upon the Appalachian belt of the U. S. Coast and Geodetic Survey. The topographic work is in part done by the plane-table, or the kindred method with the theodolite, but mainly by traverse with compass and odometer. Elevations are determined by barometer and the vertical circle.

In Missouri and Kansas the work is greatly expedited by the

use of the rectangular surveys of the General Land Office, which extend over this region. The township-plats supply more or less fully the drainage, and, in addition to this, they cover the ground with located points, the township, section, and quarter-section corners. Furthermore, throughout the settled portions of Kansas, and in the greater portion of Missouri, the roads, fences, hedges, etc., mark the lines of subdivision in such a manner that the country is graphically subdivided, and the location of features horizontally becomes simply a matter of sketching. In Kansas these lines of subdivision are controlled by belts of triangulation, which, starting from lines of the transcontinental belt of the Coast and Geodetic Survey, run westward, midway between parallels of latitude. In Missouri the work is controlled by the transcontinental belt of the Coast and Geodetic Survey. Each triangulation point is connected with the nearest township or section corner. The topographic work consists in the verification of the drainage of the Land Office plats, in supplementing it wherever necessary, and in adding the culture and relief. Heights are measured by barometer, and the profiles of railroads are utilized.

The work in the various fields of the Western section is carried on by methods quite similar to one another. The triangulation in Texas rests upon a base-line, measured near Austin, and the Coast and Geodetic Survey's determination of that city furnishes the initial astronomical location. The triangulation in Arizona, with that of a considerable area adjacent to it in New Mexico, Utah, and Nevada, starts from a base near Fort Wingate, N. Mex., and rests upon the astronomic determination of that place. The triangulation in Oregon and California rests upon lines furnished by the Coast and Geodetic Survey; while that in Montana rests upon a base measured near Bozeman, and upon the astronomic determination of that place made by the Wheeler Survey. The topographic work of this section is done by plane-table, supplemented in greater or less degree by traverses. The plane-table work is regarded, however, as a sketch, and, coincidentally with it, a secondary triangulation is carried on with theodolites, which, when plotted, serves to correct the plane-table sketch. Heights are measured with the barometer and the vertical circle.

The quality of the work is to be measured first by the accuracy of the geometric control; second, by its quantity, i.e., by the number of located points per square inch of map-surface; third, by the distribution of these points; and, fourth, by the quality of the sketching, by which the geometric skeleton is filled out into the proportions of the map. The angles in the primary triangulation are read by instruments having circles 6 to 11 inches in diameter, reading to 5 or 10 seconds. The mean closure errors in the various sections are as follows:—

Appalachian.....	16.00
Kansas.....	6.60
Texas.....	6.13
Arizona.....	9.05
California.....	20.39
Oregon.....	22.04
Montana.....	15.63

Within this primary work, a secondary system is usually carried on, with minute-reading theodolites; and, resting upon these locations, large numbers of minor points are determined by the plane-table, or by traverse, coincidentally with the sketching of topography. Thus as the lines to be determined become shorter, and the probability of an accumulation of error less, the means provided for their measurement are proportionately less accurate, until, in the ultimate work,—that of sketching,—the only means of measurement are the eye and hand of the topographer. It does not follow from this, however, that any part of the geometric work is in appreciable error. It is required that all location shall be sensibly accurate upon the map, and this condition is everywhere fulfilled.

Second, the number of located points, or the amount of geometric control, varies with the character of the country. The number of such points is necessarily greater in a country of high relief than in one of low, rolling hills; it is greater in a country of small, abrupt features than in one of large features; it is greater in a well-settled country, containing many cultural features, than in an unsettled one. Consequently, in this regard, the work done in different areas varies greatly, as will be seen by the following table,

relating to the work of 1886. This shows the number in each square inch of map of occupied points, of points located by angles, of inches of traverse line, and of traverse stations:—

	Triangulation Stations per sq. in.	Triang. Stations and Locations per sq. in.	Inches of Traverse per sq. in.	Traverse Stations per sq. in.
Massachusetts, Plane-table work.....	1	6.5	—	—
“ Traverse work.....	—	—	2.8	24
“ Mixed work.....	0.3	1.7	2.6	10
New Jersey.....	—	—	2.2	21
Dist. of Columbia, and vicinity.....	—	—	2.5	9
Appalachian region.....	0.1	0.3	1.4	30
Missouri.....	—	—	1.7	—
Kansas.....	—	—	0.7	—
Texas.....	0.1	0.35	0.9	9
Arizona.....	0.2	1.2	1.1	2
California.....	0.3	4	1.4	12
Oregon.....	0.3	4	1.3	5
Montana.....	0.25	3.2	—	—

In the above table the points located by the two methods of intersection and traverse are given separately. This has been done because they differ in value. Those made by intersection are

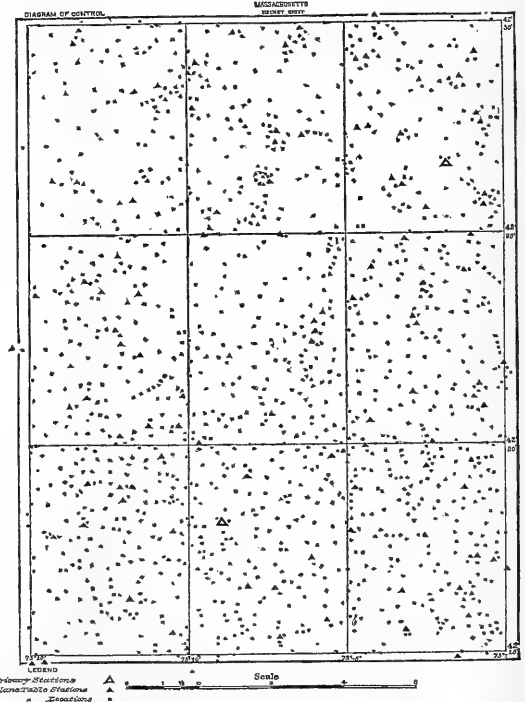

FIG. 1.

selected points, chosen because of their value in controlling area, while of the traverse locations a large proportion have no value whatever except for the purpose of carrying forward the line, and

comparatively few of them would be selected as key points for location purposes. Even with this qualification, caution is needful in making comparisons between different pieces of work. The undulating, sparsely settled Texas area, and the monotonous plateaus of Arizona, must not be contrasted with western Massachusetts, where abrupt hills and an abundance of cultural features require a large number of locations, and render it practicable to make them.

Third, the distribution of locations is a matter of no less importance than their number. To illustrate the degree of uniformity of their distribution, the following cuts are presented. Fig. 1 represents the geometric control of an atlas sheet, from the plane-table work of Massachusetts; and Fig. 2, a sheet from the traverse work in the same State; the lines representing the lines of traverse, and the triangles the triangulation points which serve to check the traverses. Fig. 3 represents the control of an Appalachian sheet, showing triangulation stations, locations by intersections, and traverse lines. It will be seen that the distribution is quite uniform. It will

or less idealized. No two men will generalize an area of country, to adapt it to the scale, in precisely the same way. Some will generalize more, others less; some will omit this feature, others that; and they will merge minor features in various ways. The smaller the scale, the greater is the generalization, and, consequently, the greater room for differences in the work of different topographers.

The cost of the work is influenced by a great variety of conditions, the principal of which are the following:—

a. The Scale. Other conditions being similar, the cost increases with the scale, at a rate somewhat less than a geometric ratio, i.e., if the scale be doubled, the cost is somewhat less than four times as great.

b. The character and amount of the relief, drainage, and culture. The greater the relief, and the greater its detail, the more the work will cost. Work in a thickly settled country, containing many settlements, roads, etc., necessarily costs more than that in one of sparse settlement.

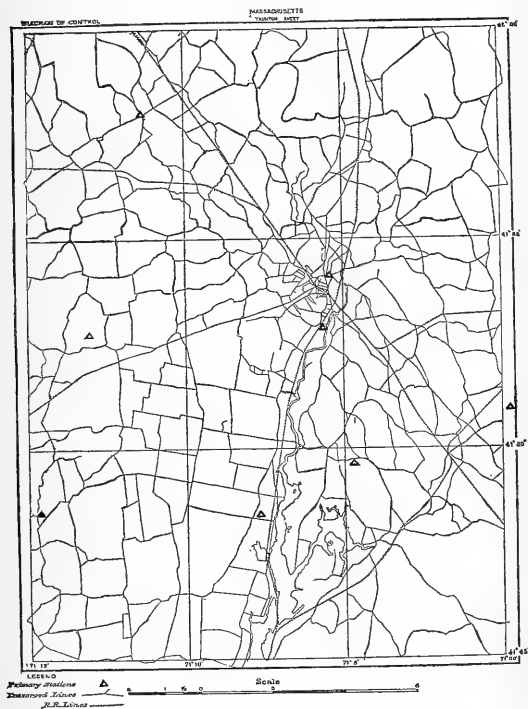

FIG. 2.

be noticed, further, that in a country composed of an alternation of mountain and valley, as the Appalachian region, most of the locations by intersections are upon the mountain ranges, while the traverse lines are mainly found in the valleys.

Fourth, concerning the quality of the sketching, little can be said. There are no means of verifying this work, except by an examination of it on the ground. It is in this part of the work more than any other that the personality of the topographer appears. It is here that his artistic sense, and his power of making his pencil record faithfully his conceptions, comes into play. It is scarcely necessary to add that no two topographers will sketch an area precisely the same. There will be differences in seeing, and differences in drawing, just as there are differences in handwriting. Every map, whatever its scale, is a reduction from nature. This reduction necessarily implies a certain amount of generalization. Certain features must be omitted, others merged into larger features, so that no map is or can be an exact miniature. Every map is more

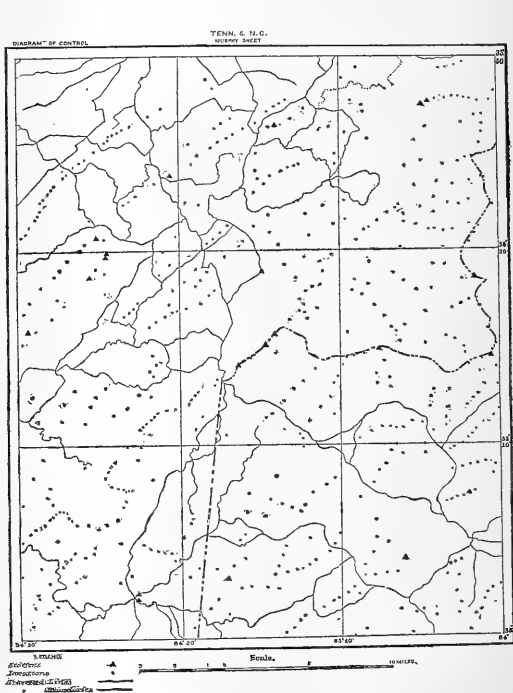

FIG. 3.

c. The degree in which a country is covered with forests. This element not only interposes obstacles and causes delays in the prosecution of work, but often necessitates the adoption of slower and more expensive methods of work.

d. Atmospheric conditions. This includes stormy weather, haze and smoke, which, being especially prevalent during the field-season in some localities, unduly increase the cost of the work.

e. Length of field-season. At the opening of each field-season, it is necessary to devote some time and money to outfitting the parties and starting field-work. This is in the nature of a plant or investment for the season. Once at work, the expense is not great. It costs little more to keep a party in the field for six months than for three months, while the amount of work done by the party is doubled. Therefore, long field-seasons are more economical than short ones.

The following table shows the cost of the work in the several areas under survey, including field and office expenses:—

Area.	Scale.	Cost per sq. mi.	Remarks.
Massachusetts.....	1:62500	12.00	Includes no primary triangulation.
New Jersey.....	1:62500	6.50	Includes some triangulation.
Dist. of Columbia.....	1:62500	7.30	Includes no primary triangulation.
Appalachian region.....	1:125000	3.00	
Missouri, Kansas.....	1:125000	.90	Aided greatly by land surveys.
Texas.....	1:125000	2.00	
Arizona.....	1:125000	1.00	
California.....	1:125000	3.00	
Oregon.....	1:250000	3.40	
Montana.....	1:250000	2.00	

The sheets, as completed, are engraved upon copper. For each sheet, three copper plates are used. Upon one is engraved all the drainage; upon another, the contours, expressing the relief; and upon the third, all culture and lettering. In printing, colors are used, — blue for drainage, brown for contours, and black for culture and lettering. At the present date, 120 sheets have been engraved, comprising an area of 250,000 square miles, parts of which were surveyed by the Powell Survey of the Rocky Mountain Region, by the Wheeler Survey, and by the Northern Transcontinental Survey.

HENRY GANNETT.

AMERICAN NEUROLOGICAL ASSOCIATION.

THE thirteenth annual meeting of the American Neurological Association was held at Long Branch on July 20-22. The president of the meeting, Dr. L. C. Gray of Brooklyn, in his opening address, reviewed the position of the study of neurology in this country as compared with European lands. America does not at all suffer by the comparison. In the movement which in the past twenty-five years has raised neurology to a science, the names of American workers are prominent, and the number of societies specially devoted to its interest is as large as in any other country.

The recent advance in our knowledge of the functions and diseases of the central nervous system is hardly appreciated, except by such as can remember how things stood twenty years ago. A medical student, who, in 1869, would have stated that the stimulation of the cortex of the brain would give rise to definite movements, would certainly not have received his degree; while the student of 1870, who would not have mentioned this fact, would have stood in equal danger. The amount of research, with a variety of ingeniously devised methods, that has been expended since then upon the localization of function in the cortex of the brain, is an excellent example of the great activity now current in neurological problems. In every direction—in the improvement of apparatus for diagnostic purposes, in the application of therapeutic agencies, in the rational care of the insane—have there been rapid strides, demonstrating beyond a doubt the important function of a neurological association.

The number and quality of the papers presented gave evidence of the increasing attention which the study of nervous diseases is here gaining. Dr. B. Sachs gave an interesting account of a case of arrested cerebral development. It was that of a child with hereditary predisposition to insanity, who lived for two years without exhibiting any but the most rudimentary signs of intelligence. It was listless, inactive, never learned to speak, and in its last period became blind. On examining the brain, the surface appearance was noteworthy. The left island of Reil—a group of cortical matter specially related to the faculty of speech—was exposed. In a normal child it would have been folded inwards, and an abnormal deviation accounts for the failure to develop speech. Many of the fissures flowed together which normally should be separate,—a mark of low-type and undeveloped brains. A microscopic examination showed that the pyramidal cells of the cortex, whose function (in parts of the cortex) is specially connected with motion, were abnormal; their positions were reversed, the nucleus faded, and the processes poorly developed. Outside the cells the appearance was normal. Dr. Sachs considered that the case was one of pure

arrested development, the brain having grown to a certain stage in the development, and then degenerative processes set in.

Dr. C. L. Dana recounted the remarkable history of a simple, chronic, neuroaesthetic tremor in a certain family. This tremor is present in three generations, and has attacked forty-four members of the family. The original member thus affected has had the tremor for seventy years: he can momentarily control it, and any excitement increases its intensity, as well as affects the clearness of his speech. He is a watchmaker by profession, and very skillfully controls the shaking at the instant when his hand must be steady. The tremor ceases in sleep, and his walk and posture are normal. The hereditary history is unusually interesting. His grandfather was intemperate, his father insane, his nine children all have the tremor to a greater or less degree, and some are mentally peculiar. Seven of these children married and produced thirty-four children, all of whom have the same tremor, and the other peculiarities still remain. There are evidences that the tremor, though present, is dying out in the third generation. It is noteworthy that an adherence to Spiritualism is hereditary in the same family.

Dr. Gray called attention to the serious aspects of chorea. This disease is often treated less seriously than it merits. The majority of cases occur in children between eight and twelve years of age, and frequently the attacks are slight and readily outgrown. The cases which the physician should regard with greatest anxiety are those in which convulsions occur, in which there occur spasms of the respiratory apparatus, in which there is hysteria or cardiac or pulmonary weakness. The essential part of the treatment is complete rest, the exercising of the muscles having a hurtful influence.

Dr. Spitzka called attention to the severe injuries which the brain of dogs could undergo with impunity, and to the obliteration in vigorous animals of the injury done by needles forced into the brain. There are great individual differences between dogs in this respect, and a dog once operated upon seemed better able to endure a second operation. These experiments seemed to justify the piercing of the brain in surgical operations.

Dr. J. H. Lloyd cited a typical case in the peculiar borderland of insanity known as the 'insanity of doubt.' The patient has a morbid impulse to do things over and over again, for fear they are not done exactly right. She gets in and out of bed twenty times, until she does it just so. She sends her husband down at night to light and extinguish a gas-burner in a definite way, and cannot rest until it is properly accomplished; otherwise she is perfectly rational, recognizes the nature of her weakness, but cannot resist it.

A very valuable contribution was that by Dr. C. L. Dana, describing a case of anencephalus. An apparently normal, healthy child lived for two and one-half days: it cried very little, at times opened its eyes, and re-acted to reflex stimulation. On opening the skull the cerebrum was seen to be entirely absent, there being nothing above the corpora quadrigemina except a not well-developed thalamus. Such cases are rare, and are valuable for the light they shed on the connections between the spinal cord and the brain. The cerebrum being absent, all such systems of fibres as connect it with lower centres are absent. Prominent amongst these is the pyramidal tract, which conducts voluntary movements, and these were entirely absent. The sensory columns of the cord were intact, as were also the cerebellum and the cranial nerves, except, of course, the olfactory nerves. The value of such a case is the independent testimony it affords to the correctness of the sensory and motor fibre-systems as deduced by other methods.

Amongst the other papers read was one by Dr. Ott, urging on experimental evidence the existence of heat-centres in the spinal cord; by Dr. Dercum, describing two cases of chorea limited to one-half the body and accompanied by Bright's disease; by Dr. Spitzka, carefully delineating the symptoms of acute delirium; by Dr. Mills, aiming to ascertain a distinctive symptom between polio-myelitis and multiple neuritis; by Dr. Putnam, on a case of overgrowth of the skull bones; by Dr. Hun, on the symptoms accompanying a tumor of the pons; by Dr. Jacoby, urging the treatment of neuralgia by sprays of extreme cold; and by Dr. Kellogg, on the effect of baths in mental disease.

The limit of membership was increased to one hundred, and Dr. W. A. Hammond was elected an honorary member. The president for next year will be Dr. J. J. Putnam of Boston.

EXPLORATION AND TRAVEL.

Junker's Travels in Central Africa.

JUNKER'S lectures delivered before the Berlin and London Geographical Societies have appeared almost simultaneously, and contain interesting details on the traveller's experience in Central Africa. Junker entered this region in 1879, travelling from Suez to Suakim, and thence to Berber. From Berber a steamer conveyed him to Khartum, where he arrived in the beginning of January, 1880. It was his intention to explore the regions on the Welle, and to follow that stream as far as possible to the west. His plan

the Egyptian Bar-el-Gasal Province. He had formerly prohibited the passage of the ivory-caravans through his country, and would suffer no station to be established in the districts under his sway. Adopting a plan followed in all subsequent journeys, Junker sent messengers forward to Nduruma to give him particulars about his intentions, and to announce that Junker travelled without military escort. This plan proved very successful, and enabled Junker to live generally on good terms with the rulers of the countries through which he travelled. His success shows that in Africa as well as in all other countries the traveller who is willing to adopt the mode of

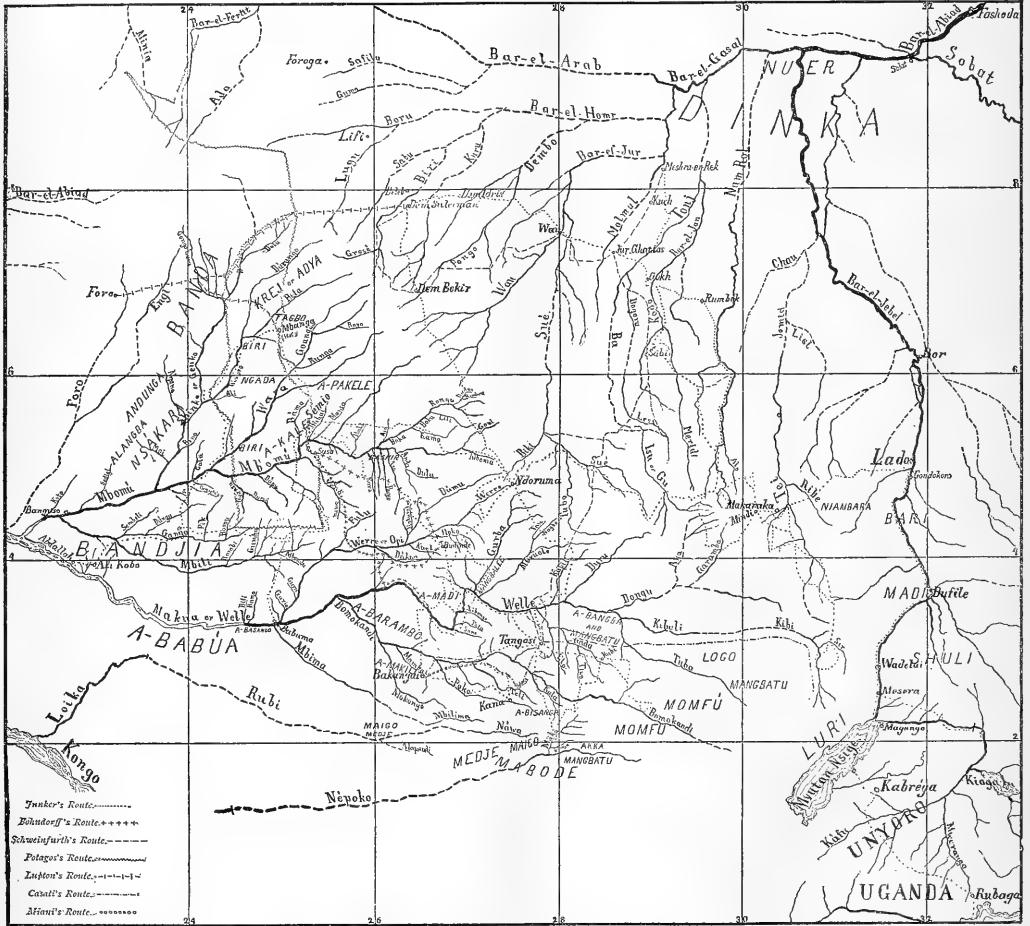

MAP SHOWING JUNKER'S EXPLORATIONS IN CENTRAL AFRICA.

was to start from Lado, but this was made impossible by the grass barriers which had closed the Nile for months. Therefore he took a steamer going up the Bar-el-Gasal, and arrived at Meshra-er-Rek in February. Here the land-journey began, and, in company with Gessi Pacha, he travelled by way of Jur Ghattas, Wau, and Dem Idris to Dem Suleiman, the head station of the Bar-el-Gasal Province. After a short stay at that place, he turned south to Dem Bekir, where his real work of exploration began. His first object was the exploration of Nduruma's territory, which is situated on the watershed between the Bar-el-Gasal and the Welle. Nduruma, a powerful Niam-Niam chief, had been at war with the troops of

life, and to accommodate himself to the way of thinking, of the natives, will accomplish his plans with comparative safety, and will glean ample results. Subsequently Junker made his headquarters in the village of a chief whose confidence he had gained, and made excursions from these stations. This makes his routes very trustworthy, most of them leading back to the starting-point. After having seen Nduruma and gained his confidence, Junker started from Dem Bekir in May, 1880, with two hundred and fifty bearers, and in a fortnight reached the huts of Nduruma. On his way he crossed many tributaries of the Mbomo, and found in their valleys a luxuriant vegetation which more to the east does not occur till

far south. Nduruma wished him to remain some time at his village, and therefore Junker resolved to set up a station there for the coming months. With the help of Nduruma's people, who were despatched to the work by hundreds, he was able to erect good substantial dwellings, which were surrounded by a high stockade to keep off the leopards which abound in this country. He staid here until August, when he left his companion, Bohndorff, in charge of the station, while he travelled south with only twenty bearers. He crossed the Welle and traversed the land of the Mangbatu, where he made friendship with the chief Mbango, and returned in December to Nduruma. But as the best season for travelling had approached, he did not rest, but started in January, 1881, by a new road to the south-west, the country of the A-Madi, crossed the Welle there again, and obtained, though with the greatest difficulty, the necessary number of bearers among the A-Barambo; these, however, robbed him of part of his goods; and it was only with the help of Sasa, a friendly Niam-Niam chief, that he safely returned to the A-Madi country north of the Welle. At the end of April he sent Bohndorff with the baggage, under the care of Sasa, into the latter's country south of the Mbomo, where he was to establish another permanent station. In the mean time war had broken out between the Mangbatu and Emin Bey, the governor of the Equatorial Province, but by Junker's mediation further hostilities were prevented. This, however, detained him until the end of November, 1881. Then he made another start, and was almost uninterruptedly on the way up to June, 1882, exploring the region south of the Welle and Bomokandi. He was kindly received by the Niam-Niam chiefs Bakangai and Kana, whose villages are situated south of the Bomokandi, whence he turned north and reached Semio, north of the Mbomo, where his station had been meanwhile established, in September, 1882. Here he had the misfortune to lose a great part of his valuable property by fire. Bohndorff, who had frequently been sick, wished to return to Europe, and therefore Junker packed his collections and sent him to the Bar-el-Gasal Province, where, in the mean while, Lupton Bey had become governor. But at this time the Dinka tribes revolted against the Egyptian Government; and thus Bohndorff, being unable to reach Meshra-er-Rek, was compelled to return to Semio. This was in October, 1882, the commencement of long and bloody wars in the Bar-el-Gasal territory, on which finally the invasion of the Mahdi's troops followed.

Before Bohndorff's return, Junker had started on an extensive journey west. He reached the Welle, near the mouth of the Werre and Mbima, and traversed the territory of the Bandjia, who, though speaking a dialect of the Niam-Niam language, pretend to be of an independent descent. The islands of the Welle are inhabited by the A-Basango, who speak a distinct language. After having reached Ali-Kobo, he turned north, crossed the Mbomo, ascended the Shinko, and returned to Semio by way of Mbanga. He arrived on May 1, 1883.

He now regarded his travels as finished, and intended to start for the Bar-el-Gasal, where Bohndorff had gone a short time before, as Lupton Bey hoped that the route to Meshra-er-Rek would be open. But, although Lupton called in all the outlying garrisons on the Welle, he did not succeed in putting down the Dinka, who afterwards were joined by the Nuer, Agar, and other tribes. This war lasted eighteen months, and was far more bloody and exhausting for both parties than the later engagements against the troops of the Mahdi in Emin Pacha's province. Finally the Dinka were supported by the Mahdi's forces; and Lupton, betrayed by those about him, was compelled to deliver his province without resistance to the emissary of the Mahdi, Emir Karm Allah. Junker says that the chief cause of this surrender is to be sought in the fact that Lupton had almost exclusively irregular troops at his disposal, consisting of Dongola people and Arabs of all kinds. In October, 1883, the state of Lupton's troops was very precarious, and he sent a letter to Junker entreating him to persuade the chief Semio to collect about a thousand of his people with spear and shield, as well as all those who had guns, and come to his help. He said, "I now see no other way of putting down the insurrection than by the help of the Niam-Niam chiefs. Do every thing in your power to persuade Semio to lose no time, and send him to meet me as soon as possible."

As Junker saw the routes north closed, he resolved to go east to Lado. He left Semio in November, 1883, and reached Emin at Lado in January, 1884, after fifty-five days' march. During this time Bohndorff was able to reach Khartum with the steamer, returning thither at the end of December, but all collections remained behind.

Emin Pacha's province had been quiet up to the first months of 1884; but the successes of the Dinka were too tempting for the other negro tribes, and so in the Equatorial Province the rebellion assumed more formidable proportions. Emin was compelled to give up all stations east of the Nile and to concentrate his troops. On the 27th of May he and Junker received letters from Lupton Bey and Emir Karm Allah, which contained the news that the province had fallen into the hands of the Mahdi, and the demand to surrender the Equatorial Province. Emin answered the Emir's letter, saying that he was ready to deliver the province into the hands of the representative of the Mahdi in order to prevent useless bloodshed, and till his arrival he would try to hold the province for the Mahdi. Meanwhile a defence was organized, and the outlying stations were called in. But it was not until January, 1885, that the troops of the Mahdi attacked Emin's province. After they had taken the station Amadi in April of the same year, they retreated, for unknown reasons, by forced marches, to the Bar-el-Gasal region. Since that time Emin's province has been unmolested by the troops of the Mahdi. On Jan. 2, 1886, Junker left Emin Pacha and Casati, going south. He crossed the Mvutan Nsige to Kibiro, and went to Kabrega, king of Unyoro. Here he learned by letters from Zanzibar of the events in the Sudan, of King Mwanga's hostility towards the Europeans, and of Dr. Fischer's unsuccessful expedition sent out by Junker's brother to seek him. In the mean time war had broken out between the Waganda and Wanyoro, and it was not until June that he received permission to enter Mwanga's capital. It took him a month and a half to cross the Victoria Nyanza; and at last Tabora was reached, whence he proceeded with one of Tippto-Tip's caravans to Zanzibar.

Thus his eventful wanderings in Central Africa were ended. It is hardly necessary to mention the importance of his explorations, which cover a large area, and of his interesting observations on the tribes with whom he lived for so long a time. The loss of his large collections will be regretted by naturalists and ethnologists, but nevertheless we should be glad that the enterprising traveller succeeded in extricating himself from the innumerable dangers and difficulties surrounding him.

BOOK-REVIEWS.

Report of the Committee on Disinfectants, of the American Public Health Association. Concord, N.H., Republ. Pr. Assoc. 8°.

THE REPORT of the committee on disinfectants, of the American Public Health Association, presented at the Toronto meeting in October last, has just been printed. It deals with the various apparatuses now in use in this country and Europe for disinfection by means of heat, and is abundantly illustrated. The experiments of this committee have demonstrated that the most efficient non-destructive disinfectants are, (1) steam under pressure at 110° C. (230° F.) for ten minutes, (2) dry heat at 110° C. (230° F.) for two hours (in the absence of spores), (3) boiling in water for one-half to one hour. It will be seen from this that the apparatus for disinfection by heat may be divided into three classes: (1) that in which dry hot air is employed, (2) that in which hot moist air is used, and (3) that in which steam is the disinfecting agent. In the disinfection of mattresses, feather beds, etc., where great penetrating power is required, dry hot air cannot be relied upon. In addition to this, there is another objection to the use of this agent,—that, when the temperature is sufficiently high to act as a disinfectant, certain articles are permanently injured by it. The committee expresses its conviction that the use of steam, and especially when superheated or under pressure, is the most efficient agent for the destruction of all sorts of infectious material. At the Boston quarantine station, Dr. S. H. Durgin, president of the Boston board of health, and a member of the committee, has been employing moist heat for disinfecting purposes since the spring of

1885. The disinfecting-chamber is a room ten by twelve feet, and seven feet high. It is made fairly tight, and has one window, on which is a thermometer so arranged as to be read from the outside. A hole two inches in diameter in the door admits a rubber hose, which discharges superheated steam from a boiler on a steamboat. The temperature of the room can by this means be raised in seven minutes to 230° F. It may easily be raised to 250° F. or more, but is generally brought to 230° F., and maintained at that point for twenty minutes. The articles to be disinfected are hung about the room loosely, and when removed, which is done as soon as the heat will permit, are found to be perfectly dry, not even the polish on freshly laundered shirts being damaged or changed. Boots, trunks, valises, and all other articles made of leather, are quickly destroyed by the high temperature, and should not be subjected to this process. Wood-work and paint are also damaged, and articles which are joined by cement fall apart. This process can be quickly applied, easily managed, and is without appreciable cost. Its trustworthiness as a disinfectant has already been established. Dr. Durgin describes the experience of the Boston board of health with the disinfection of rags in bales by means of superheated steam admitted to the interior of the bales through perforated hollow screws. In the first trial of this method a pyrometer indicated the temperature of the steam after it escaped from the bale to be 300° F. Bacteriologists had already shown that disease-germs of the greatest resisting power had been sterilized within the bale of rags which passed through this process. The evidence seemed sufficient to establish the claim that this process was effectual in its power to disinfect bales of rags. Subsequent tests showed that the rags might be intensely hot in one place, while in another they were perfectly cold. In one of these trials the moist heat used was at 300° F., and the time of exposure was four minutes. In some parts of the bales, after being removed from the steam-boxes, the intense heat could not be borne by the hand a moment, while at other points the rags were found to be cold. A still further test was made with steam at 500° F., and the time of exposure increased to eight minutes. Three bales were examined after being thus treated, and the cold places were found as before. Dr. Durgin was informed by the overseer of the process that a large number of bales had been set on fire by this intense heat, and that water had been required to extinguish them. The conclusions drawn by Dr. Durgin from these experiments are that the moist heat passing from the centre to the surface of a bale of rags must encounter knots or bunches of rags varying in degrees of density and of resistance to the penetration of heat; that while the temperature of the principal part of the bale is raised to a degree far above what is required for disinfection, other parts of the bale are found to be wholly unaffected by the heat. That anthrax bacilli have been killed and metals melted at 240° F. within bales of rags subjected to this process are facts not inconsistent with the experiences in Boston, and do not prove the disinfection of the whole bale. The degree of heat, the amount of pressure, and the time necessary for moist heat to penetrate and raise the temperature of all parts of a bale of rags to a degree necessary for disinfection without burning the rags, have not yet been declared.

Ethik als Grundwissenschaft der Pädagogik: ein Lehrbuch für Seminaristen, Studierende und Lehrer. Von Dr. MAX JAHN. Leipzig, 1887.

BOTH theoretically and practically the two foundation-stones of a system of education are psychology and ethics, — the one to set forth the nature of the mental activities, the other to expound the actual and ideal tendencies of human action. The systems of education that are prominent in its history derive an important characteristic from the kind and amount of attention they give to one or other of these underlying sciences. The history of educational methods similarly shows a recognition of this twofold origin in all stages: it may be as the education of the State or of the army, and that of the Church or the home. To-day our education has taken on a scientific tone: this advance was conditioned upon the scientific development of psychology and ethics. Any system of education that shall have the slightest chance of gaining a hearing in the future must take full account of the modern aspects of psychology

and ethics; and any teacher anxious to command success must have within himself the power to healthily unfold these two sides of human character.

Dr. Jahn's handbook is intended to present a convenient sketch of the natural basis of a moral education. It is an excellent example of the useful kind of a book which a German teacher can produce. It is admirable as much for what it does not do as for what it does. The danger in all such books is to deal in meaningless generalities, to drift into long casuistical discussions, to neglect the important moral aspect of little habits, and in general urging the teacher to present to the child an ideal from which its healthy instincts revolt as from something artificial and pitiable.

The first section treats of the self-regarding and the social instincts and feelings. These furnish the material upon which a moral education is to be built. They present themselves in the earliest days of life; they are the deepest elements in human nature; a child in whom they are weak is defective quite as much as one born without eyes. The development of these instincts is the beginning of a moral education. That is essentially a wrong method that allows the child to act as whim directs, excusing it on the ground of ignorance, and then suddenly deciding to begin its moral training, and subjecting it to an internal revolution, — quite as wrong as that other current method that begins at once to appeal to the child with high motives and far-reaching theoretical considerations, and is satisfied with the consciousness that the child is learning what is the *maximum bonum*, while constantly neglecting to exercise the little virtues. A moral training that keeps pace with the emotional susceptibilities as founded upon the growth of mind and body utilizes each element when it is at its best, and produces that firm tissue in which morality is embedded as a habit.

Passing from the consideration of morality as conditioned upon the psycho-physical organism, the main ethical conceptions and ideas that inspire the acts of mankind are described, ingenious distinctions are drawn, and suggestive hints are given, which any good teacher can illustrate and enlarge upon to himself.

It is not sufficient to feel what is right or to know what is good: the deep emotion and the high ideal find their true purpose in action. Weakness of will is a greater source of crime than lack of sympathy. That breach between knowing and doing — which Socrates could scarcely realize — is to-day a widely current source of break-down. The will needs to be trained by action: the daily occasions which call for the exercise of emotional kindness must find to hand a habit that does them without effort. Thus the will-power is left free for the larger occasions of life, on the same principle that allows us to walk and talk at once, because our automaton does the former, leaving the higher centres free for mental work.

The moral will realizes itself in the social government and customs of families, of tribes, of nations. The altruistic feelings here find an appropriate field of action, and the good man becomes a good father and a good citizen. The relations of life are diverse, but a common idea of final good runs through them all. Again: these relations are the result of a development; they are connected with a history which explains their defects, and shows the dear price paid for their virtues. It is in this way that Dr. Jahn understands the educational function of ethics. What is new about it is more in the spirit in which the position is upheld, and in the order and proportion in which the several points are emphasized. It is a book well adapted to present needs, and will doubtless find wide use in Germany. Would that we could substitute some such work as this for the dry compends of mental and moral science that we put in the hands of normal-school students.

NOTES AND NEWS.

At the last session of Congress a considerable sum was appropriated for the purpose of the establishment of several stations throughout the country for the distribution of fish by the United States Fish Commission, similar to the central station situated in Washington. The law provided that these stations should only be established in places where sufficient protection is afforded by law to the fisheries. For the purpose of investigating these conditions, and of making some observations relative to the propagation and distribution of young fish, Col. M. McDonald of the commission

will make an extended trip through the North-west. He will visit Denver, and will probably establish there a station for the breeding of trout, then proceeding to the Columbia River, where he will investigate the nature of the protection afforded by the State of Oregon and Washington Territory to its fisheries. If his investigations are satisfactory, he will take immediate steps toward the establishment of several propagating and distributing stations along this river.

— The following schedule shows the location of the vessels of the United States Coast Survey and the officers ordered to them: the 'Bache' and the 'Eagre' are continuing the hydrographic work on the approaches to Vineyard Sound, Mass.; naval cadets G. R. Evans and H. A. Bispham have been ordered to the 'Eagre'; naval cadet G. R. Slocum and ensign J. H. Oliver have been assigned to the 'McArthur,' now working off the coast of Washington Territory; naval cadets C. S. Stansworth and J. E. Shindel have been ordered to the 'Blake,' Long Island Sound; ensigns W. B. Fletcher and M. Johnson, and naval cadet Joseph Strauss, have been detached from the 'Endeavor,' and ordered to the 'Gedney' off the coast of Maine; naval cadet Robert L. Russell has been assigned to the 'Scorcesby' on the coast of North Carolina; Lieut.-Commander W. H. Brownson, United States hydrographic inspector, is now in Portsmouth, inspecting the new launch building at that place for the Coast Survey.

— The increasing interest which is felt in anthropological science is shown by the number of treatises now in course of preparation by eminent writers on different branches of this science. The Marquis of Nadaillac has in hand a work to be entitled 'Mœurs et Monuments des Temps Préhistoriques.' Professor de Quatrefages is busy with the second part of his 'Introduction to the Study of the Human Races.' This will be followed by a volume on the black

tions at Washington is due to the deceased, who devoted most of his time and work to their study. His numerous writings on American archæology, contained in the annual reports of the Smithsonian Institution and in foreign and American journals, and his recent work, 'Prehistoric Fishing in Europe and North America,' will always be appreciated by scientists, and secure him a prominent place among American archæologists.

LETTERS TO THE EDITOR.

"* The attention of scientific men is called to the advantages of the correspondence columns of SCIENCE for placing promptly on record brief preliminary notices of their investigations. Twenty copies of the number containing his communication will be furnished free to any correspondent on request.

The editor will be glad to publish any queries consonant with the character of the journal.

Correspondents are requested to be as brief as possible. The writer's name is in all cases required as proof of good faith.

The Dermo-Tensor Patagii Muscle.

CIRCUMSTANCES over which I had no control were responsible for my forwarding recently the wrong drawings which appeared in my letter to *Science* last month (No. 229). Although the essential part of my communication was perfectly correct, I did not intend to have the patagial muscles in the wing of a toucan stand for those structures in the wing of a passerine bird.

If you will kindly reproduce the three figures I here send you, the matter will be made quite clear.

The lettering of these figures remains the same as in those of my first communication upon this subject. In Fig. 1, we have Garrod's representation of the patagial muscles in the wing of a picarian bird (*Rhamphastos*), wherein the tensor patagii longus is found

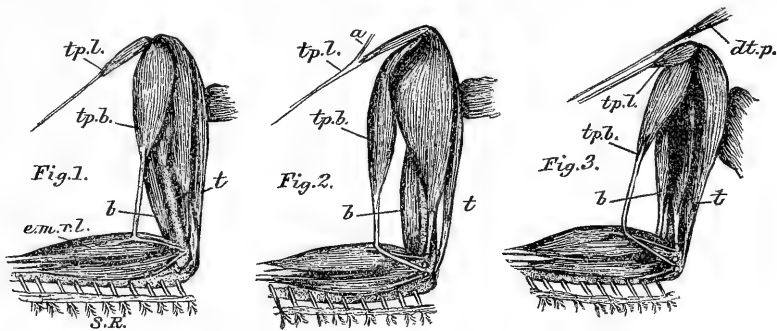

races, by Dr. Hamy; by one on the yellow races, by J. Montano; and by a third on the red races, by Luciep Biart. Prof. G. J. Romanes is engaged on a work on mental evolution in man, and Mr. C. Staniland Wake is preparing one on the law of marriage. Mr. Gladstone's forthcoming volume on the greater gods of Olympus is shown, by the portions already published, to have an important scientific as well as literary character.

— A geological survey has recently been established in the State of Arkansas, and Mr. John C. Branner has been appointed director. The prime object of the Legislature was to develop the economic resources of the State; and no provision has been made for work in botany or zoölogy. The annual appropriation is ten thousand dollars.

— Oliver P. Jenkins, M.A., M.S., professor of biology in De Pauw University, and Barton W. Evermann, M.S., professor of natural science in the Indiana State Normal School, have gone to Guaymas, Mex., on a zoölogical collecting-trip for the museums of De Pauw University, the Indiana State Normal School, and the Indiana University.

— Dr. Charles Rau, curator of the archæological department of the National Museum at Washington, died a few days ago at Philadelphia. The excellent arrangement of the large prehistoric collec-

pretty much the same as it occurs in the clamatorial birds (*tp. l.*). Fig. 2 is my copy of this anatomist's wing-muscles in a typical passerine bird (*Icterus vulgaris*), and *a* is the stump of the tendon I referred to in my letter in No. 229; it is just possible that it may be intended for the tendon of the dermo-tensor patagii. Lastly, in Fig. 3, I give my own dissection of the patagial muscles in the wing of a typical passerine bird, where *dt. p.* directs attention to the muscle in question. My original description of it in *Science* is correct in all particulars; and the points in regard to it to be briefly noted are, that Garrod apparently overlooked it, and failed to recognize its taxonomical value; that it is characteristic of the true *Passeres*; that it is absent in the *Passeres mesomyodi*, but present in such a form as *Amphelis*, and again absent in the *Caprimulgi*, *Trochili*, and *Cypseli*. To this extent it is an important morphological character.

R. W. SHUFELDT.

Fort Wingate, N. Mex., July 8.

Mean Heights and Body Temperatures of the Eskimo in Hudson Strait.

WITHIN forty miles of North Bluff, Hudson Strait, I should estimate there were sixty families. On such as visited our station, I carried out my determination of their heights; and, by several references to a family who resided alongside of us, I obtained the

temperatures. At first it had been my intention to have made this determination of temperature in the same general way as the other; but, with my indifferent command of the language, at the beginning of the investigation I had the greatest difficulty in making my subjects understand that the operation would result in no bodily harm, which I had no difficulty in understanding they anticipated, by the perspiration oozing from every pore, a look of piteous agony in their faces, and eyes fearfully watching for the first suspicious movement on my part. I naturally concluded that much misery would be saved, without in any way affecting the accuracy of the result, by determination from the individual rather than the mass. The determination was made by placing the bulb of a thermometer well underneath the tongue, and keeping the mouth closed till the mercury column reached its highest and stationary point.

Our mean temperatures were 98.1° F. for winter (December), and 97.7° for summer (July), whilst theirs were 100.2° and 98.4° respectively. I cannot help thinking that part of this large difference is owing to our Eskimo having changed his diet, by the rations we allowed him, towards the summer season.

In determining the mean heights, I considered it advisable to exclude palpable extremes, as my measurements were necessarily from a limited field. The result was a mean height for the men of 5 feet 3.9 inches; for the women, within a very small fraction of 5 feet.

W. A. ASHE.

The Observatory, Quebec, July 18.

Chrome considered as a Poison.

IN *Science* (viii. p. 178) is printed an extract from a paper written by Dr. Charles Harrington, and which appeared in the *Boston Medical and Surgical Journal* (cxv. No. 6). Dr. Harrington's paper was an original communication made to the Massachusetts Medical Society, and was read at the annual meeting of June, 1886. The society recommended the paper for publication. It thus appears with the indorsement of two journals and one medical society, all of the very first standing and ability.

This paper concerns itself with chromium considered as a poison to the animal body, and cites four cases, all of whom were Dr. Harrington's patients: 1st, A woman who made caps from blue cloth. She was attacked by ulceration over most of the body, with swellings, and with constitutional disturbances which had not subsided at the end of two years. The cloth proved to contain a "large amount of chromium." To dust arising from it the symptoms are assigned. 2d, The case of a clergyman whose hands ulcerated. His gloves proved to contain "a large amount of chromium," and to this the ulcers are attributed. 3d and 4th, Two young boys who were attacked with nausea, vomiting, fever, delirium, and convulsions. Their new suits of clothing were examined, and proved to contain "chromium in great abundance." The paper states that its compounds, when taken internally, produce symptoms similar to those described. One child sucked his fingers, and the other bit his nails. And thus the chrome-poison was introduced. The dejecta from the elder of the boys proved to contain "traces of chromium, and thus established the diagnosis of poisoning."

The well-written and highly indorsed paper, curiously enough, does not offer the slightest evidence that chromium or any of its compounds, in any quantity, however large or small, can injuriously affect the animal body. Furthermore, there is no reliable tradition or literature to that effect. And yet chrome-dyes have been in general use since 1828 at least, the American consumption alone being thousands of tons annually. In fact, so general is their use, that chromic oxide may be found in almost any piece of cloth which may happen to be at hand.

In the entire absence of any reliable literature pertinent, I was led to make studies as to the poisonous effects of chrome-salts. In the weaving of fabrics, the yarn suffers a constant succession of shocks and scrapings, which must detach any thing like dust which may adhere to it. If, then, dust from chrome-dyed yarn had any poisonous effects, weavers ought to have some knowledge of it. Inquiries were set afoot in three mills in Philadelphia, and from none was there reported any injurious effect from such dust. If any

existed, it was not known to the weavers. This seemed important.

Similarly, and in the same way, dyers were questioned, and none of them had any knowledge of injury from chrome. Such operatives have their hands and arms in chrome-dyes at almost any hour of the day, and therefore their replies seemed interesting.

Of even more importance are the workers in a chrome-factory, one which has been in operation over fifty years. Here are produced the alkali bichromates which dyers use. The operatives (some hundreds in number) live in an atmosphere quite heavily charged with alkali chromate dust, visibly charged. Yet these people are as healthy as those in other occupations. As a matter of fact, there may any day be seen at this factory several pensioners, worn out in the service, and now too old to do more than the semblance of labor.

But this is to be said, every man who works exclusively within the factory has the nasal septum partially destroyed in from eight to twenty weeks. The cautery then ceases, and there is no further inconvenience. And, further, if strong chrome-liquors, or much chrome-dust, be allowed to get upon any abrasion of the skin, they are apt to produce sores; and, if these sores be treated to more chrome, they will continue to suppurate, and will produce sores with vertical walls, having the appearance of syphilitic chancres; but if a sore be protected by salve, or otherwise, it heals like any other one would.

Through the courtesy of a practising physician, the health of these bichromate-makers was discussed at a meeting of a medical society whose members had the care of them. No chrome-disease or chrome-poisoning was known to those physicians.

To sum up so far: there is not known to exist, among the workers in any of the forms of chrome, any chrome-disease or chrome-poisoning from contact, from inhalation, or otherwise. This much established, there was no risk in the following experiments:—

1. Three healthy men were exposed for four hours to an atmosphere containing vapors from boiling sodium bichromate,—vapors visible in a beam of sunlight.

2. Two healthy men were exposed twenty minutes to an atmosphere containing visible clouds of dust of neutral sodium chromate.

3. The lower half of a shirt-sleeve was saturated with a ten-percent solution of potash bichromate, and then bound around the arm from wrist to elbow. It remained thus in contact with the skin three hours, and was kept moist.

4. A piece of white cotton cloth was dyed black in the ordinary way, by sumac, iron nitrate, chrome, and logwood. After washing in cold water alone, and passing through a clothes-wringer, a piece of it, eight inches wide and ten inches long, was pinned to the inner side of the undershirt, and worn in contact with the skin for four hours on a hot day.

No experiments were made to ascertain the effects of wearing chrome-dyed clothing, only because the writer was able to recall precisely the cases of so many men, women, and children who had done that without any deleterious results, so far as known. None of them, at least, were affected in any of the manners described as due to chrome-poisoning, in Dr. Harrington's communication. No unpleasant results followed any of the experiments mentioned. No one of the subjects has suffered in the slightest. The time elapsed is more than a month.

In the daily papers of July 12 of this year, appeared the report of a coroner's jury which considered the cases of several persons who died in Philadelphia during the years 1885, 1886, and 1887, from eating buns, it was supposed, made by Palmer, a baker, who had put into them chrome-yellow. The ages of the victims were from three years to twenty-four years, among them being seven of Palmer's own family. He did not deny having put lead chromate in the buns. It was, indeed, in evidence that eighty per cent of Philadelphia bakers so used it. The testimony of Dr. Stein, Dr. Stewart, and Dr. Stark, the attending physicians upon the particular subjects under consideration, was that the symptoms were those of lead-poisoning, and that they set about to search for the source. They found it in Palmer's bakery,—the lead chromate which he put in the buns. The viscera of victims, after death, were submitted to Dr. Leffman,

the chemist, who found lead in them, and testified that the subjects died of lead-poisoning. The newspaper reports say, "The evidence was conclusive that several members of the Diebel and Palmer families died of lead-poisoning." The verdict of the jury was, that "the deaths of the four persons were undoubtedly due to chronic lead-poisoning, and that the poisoning resulted from the use of chromate of lead as a coloring-matter in buns and other bread-stuffs." The only allusion to chrome-salts in the entire reports, as given in two newspapers, was made by Dr. Leffman, who said, "The traces of chromium had disappeared." We have here four cases well authenticated, in which lead chromate produced death,—produced it by chronic lead-poisoning, and not by any action of the chromium trioxide present.

The theory of antidotes, as understood by this writer, is that substances insoluble in any of the juices of the animal body are harmless as poisons. If we do not accept this as a fundamental proposition, it is difficult to see how we reasonably can employ any antidote supposed to act upon that principle. Chromic acid is a very active oxidizer. In contact with organic matter, it is quickly reduced to chromic oxide (a compound insoluble in any of the juices of the animal body). It is a destroyer of organic tissues, therefore. The action of both normal and acid alkali chromates is similar to chromic acid. They destroy organic matter by oxidizing it, chromic oxide being precipitated. Chromic acid and soluble chromates are then poisonous in the same sense as are sulphuric acid and nitric acid. Chromic oxide is harmless.

Concerning the Philadelphia cases mentioned, the writer cannot even pretend to speak with any authority. Any one, however, familiar with the oxidizing action of chromic-acid salts, and who is accustomed to making combustions with lead chromate, would not find much difficulty in believing that the small quantity of lead chromate taken by any one victim was reduced while in contact with organic matter in the stomach and intestines, chromic oxide passing out with the dejecta, and lead oxide being left to produce its cumulative poisonous effects.

When one states that the insoluble modifications of chromium are in any way poisonous to the animal body, the burden of proof rests upon him. The soluble salts (the alkali chromates) do, however, produce sores and sloughing under certain conditions: (1) if they fall in quantities upon an abrasion of the skin, or (2) upon the delicate mucous membrane. Speaking generally, a solution containing 150 grams of an alkali chromate in one litre of water is scarcely strong enough to produce sores upon the hands. Again, generally, alkali chromate dust which is just visible without direct sunlight is harmless, unless one should remain in it for some weeks. When such dust falls upon the mucous membrane, it is quickly reduced by the secretion it finds there, and chromic oxide is precipitated. The membrane is not attacked. There can be no doubt that Dr. Harrington found in the clothing he examined, the large quantities of chromium salts mentioned by him. It would have been rather strange if he had not, since most cloth is chrome-dyed, and contains about eight-tenths of one per cent chromic oxide in its fibre. Had he examined further, equally certain, he would have found iron, cellulose, keratin, and some other organic products. Why not assign to one or all of them the maladies of the patients mentioned? So far as his paper gives evidence, or so far as I know, cellulose is equally as poisonous as the insoluble chrome-dye on yarn. We should risk little in saying this is true so far as any one knows. Before we say otherwise, we should offer such proofs as would lead a cautious man to accept the statements.

To those who read the communication alluded to, it may be of interest to know that a suit of clothing for a small boy will lose in weight about three hundred and forty milligrams in a week. Of this, about eight-tenths of one per cent is chromic oxide, when the clothing is chrome-dyed. Such clothing then loses about two and seven-tenths milligrams of chromic oxide in one week. How much of this latter the boy would be likely to inhale as dust, and what injury it would do him, are matters about which I have no information to offer. If it were arsenic, and he inhaled the whole of it in one day, and twenty times as much more, it might possibly sicken him.

Five hundred milligrams of the chrome-dyed cotton cloth before mentioned was ground between the teeth of a healthy man, and

slowly swallowed. It produced no effect which could be detected. This cloth contained four milligrams of chromic oxide. Such a small quantity was taken only because of the desire to test the effects of minute quantities. The only inconvenience resulting from an attempt to eat a yard square of such cloth would be in masticating it. Even between strong molars, it is really difficult to grind.

To sum up, finally, the writer has not been able to show that chrome-dye, or indeed any modification of chromium, is in any way poisonous to the human body. The continuation of these studies is left to others 'better fitted to pursue them, and with the sincere hope that the subject will not be allowed to die of neglect. The matter intimately concerns the general welfare.

WM. GLENN.
Baltimore, July 22.

Distillery-Swill as a Food for Milch-Cows.

The interest in this subject, developed by the recent discussion in *Science*, prompts me to give its readers some additional points of interest. Until within the past four years, the practice of feeding distillery-waste on Long Island was very prevalent. Although the ordinances of the city of Brooklyn have for years forbidden the use of this food, no systematic effort was made to stamp it out previous to the year 1883. At that time it was used very generally in Brooklyn and its suburbs, especially during the winter months. Since then it has been almost entirely discontinued through the efforts of the Health Department.

It is the almost unanimous opinion of cow-keepers who have fed swill and dry feed, that the cows do better without swill; by which they mean that they are healthier and less subject to diseases. This statement is of value, as it is the result of a practical trial extending over several years of time, and under conditions otherwise the same. It is the verdict of a large number of stables where the experiment has been tried by different men. To me, this testimony is conclusive as to the question of this food upon the health of the cows fed upon it. Tuberculosis and pleuro-pneumonia are more prevalent in stables where swill is fed than where 'grains,' meal, and hay are fed. This statement is based upon personal observation, and the testimony of the dairymen themselves.

A word as to the manner of feeding swill. The cows do not take kindly to this food, and must be starved to it, as a rule. Consequently, when it is to be fed, it is necessary to withhold other food, for a time at least. I have rarely seen it mixed with other food, and, in fact, the testimony of milkmen in this vicinity is that it is next to impossible to get cows to eat a mixture of swill and other food, excepting hay. The digestion of cows fed upon swill soon suffers derangements that prevent their eating such other food. Whenever it is fed at all, it is claimed that it must constitute almost the only food,—and thus it was fed in this vicinity,—when fed at all. As all advocates of swill as food for milch-cows seem to make their advocacy rest upon a liberal supply of other food with it, it becomes an important point to determine whether cows will eat hot swill, and cold meal or grain, at the same time. The experience of Long Island dairymen seems to indicate that success in this direction is doubtful, and prejudicial to the supply of milk as well as to the health of cows.

Statements have been made from time to time that distillery-waste contains alcohol and fusel oil, and that these alcohols have a bad effect upon the animals. This is an error. Both alcohol and fusel oil are separated from the waste as completely as possible; and my analyses have failed to reveal more than mere traces of either.

Sensational statements have been made that the tails of cattle fed upon this food atrophy and fall off. This statement is based upon the results of anti-pleuropneumonic inoculation seen in such stables. From the prevalence of pleuro-pneumonia among cattle fed upon this hot feed, the owners have for years resorted to a clumsy method of inoculation, in the tail, with a slice of diseased lung. In a considerable number of cases, septicæmia results, necessitating an amputation of the tail. The loss of the tails has nothing to do with the food.

When cows are kept most of the time in stalls, and fed upon this hot food, they become feverish. The temperature usually ranges from 101.5° F. to 102.5° F. This must be regarded as an

unhealthy temperature, and no cow that has a persistent temperature of 102° F. can give a wholesome milk.

The conditions and methods here set forth are those that almost universally prevailed on Long Island when this food was used; and the milk, which I have analyzed, and which was referred to in previous numbers of this journal, was produced under these conditions.

The chemical features of the milk which are most marked, are, the strongly acid re-action, deficiency of fat and sugar, and great excess of casein or curd. So marked were these features, that I was able to identify swill-milk produced under these conditions.

That such milk is a dangerous food for young children, I have had abundant clinical evidence. The tough, hard curd produced in the stomach by this milk is entirely too much for the digestive powers of even healthy children, and passes undigested, irritating the intestinal mucous membrane throughout its entire length, giving rise to intestinal catarrh, inflammatory diarrhœa, or cholera-infantum. Occasionally the curd formed in the stomach is too large and firm to pass the pylorus, when the child passes into rapid collapse and death, unable to rid the stomach of the mass either by vomiting or purging. Remedies, under such circumstances, are of no avail. I have seen the same effects, in a somewhat less degree, produced in adults who were not disturbed by a pure, wholesome milk.

I think we may accept it as demonstrated, 1st, that fed as it has always been in this vicinity, distillery-swill is an unfit food for milk-cows, as it deteriorates the health of the cows, and produces unwholesome milk; 2d, from the difficulty of perfectly controlling the manner of feeding, it is not warrantable for any sanitary authority to recommend it as a food for milk-cows; 3d, it has not yet been proven that it can be successfully fed in conjunction with other wholesome food; 4th, the laws now in force in this and other States, forbidding the sale of swill-milk, are justifiable, and should be enforced.

E. H. BARTLEY, M.D.

Brooklyn, July 23.

In answer to yours of the 13th, I have read the papers and reports on distillery-swill milk published in *Science*, and, in my judgment, you have furnished reasonable evidence of the unwholesomeness of such milk as a general fact. I mean where distillery-swill constitutes the chief food of the animals.

From the very nature of the case, complete proof and absolute demonstration by direct, full, and conclusive experiments cannot be had: so we must rely on such evidence as is available, the same as in so many other sanitary questions where the deductions have to be derived from a great mass of cumulative evidence, each single fact in which is inconclusive. I have therefore only to suggest that you continue the recording of facts as the only available way either of arriving at just conclusions or of convincing the public of the truthfulness of the conclusions.

I know of no conclusion in sanitation so well established that men may not be found to deny it; and, so long as distillery-swill milk does not kill or sicken *all* who may use any of it, there will probably be persons who deny that it is harmful to any.

The correspondent in *Science* of July 22 (p. 46) fails to find "positive evidence" of "any ill effects of swill upon cows fed with it." On the other hand, he asserts, as if on "positive evidence," that "the evils attributable to it are largely, if not entirely, to be ascribed to the unsanitary surroundings of the animals." I hardly know how comprehensive and sweeping he intends this to apply. It would be unfair to charge him with asserting that the almost universal disease in distillery stables, the emaciation, the lax bowels, the loss of teeth, the short lives in such stables as distinguished from those where hay and grain are the chief food, and the "unsanitary surroundings of the animals" in these stables, as a rule, should be merely curious coincidences, and not due to the feeding of the swill itself. His language implies all this, but surely I can hardly believe that to be his meaning.

Some supplementary statements, however, are equally positive and equally striking, — the proposition "that lactation in a dairy is not a normal process," and that he regards the conclusions (if not, indeed, the facts) given by certain chemists and physicians, regarding the nature and digestibility of the curd of swill-milk, as on the whole unworthy of confidence.

If you can convince a few orphan-asylums and founding-hospitals

that it would be an innocent and harmless experiment to feed half of their children on distillery-swill milk, and the other on grass-and-grain milk, and continue this experiment for several years, on different races of children, in different localities, some of the swill-milk stables to be kept as clean as other stables may be, by some process not yet announced, and carefully record and collate all the results, the question would then be settled, in the usual acceptance of that term.

Until some such plan for "positive evidence" be secured, I suggest that you work at the method of cumulative evidence which has been so rich in conclusions and beneficent in its results in other departments of sanitary science.

WM. H. BREWER.

New Haven, Conn., July 25.

State Interference.

COPIES of *Science* containing two of the articles on State interference have been received; also your note asking opinions respecting them.

I am glad you undertook the investigation, and wish it might have called forth more elaborate replies. It is a subject which ought to be worked up carefully for all the States and for a period of years long enough to show the working of tendencies.

But, so far as the facts you have presented go, I see very little which will not be found upon the statute-books of England, which is generally known as the classic land of *laissez faire*. The protective system involves more serious interference with private concerns than almost any of the new laws. Our legislators, I admit, are ignorant, and moved largely by party or private interest; but that is the fault of our political system, and is connected with the essentially commercial character of the people. The social question is upon us: we must have laws regulating competition to a certain extent. The danger comes, not from the tendency toward such regulation, but from the character of the men to whom legislation is intrusted: hence the necessity of civil-service reform, of higher political education, and of a strengthening of the moral tone of the people.

H. L. OSGOOD.

Short Beach, Conn., July 23.

Tornado Force.

MR. E. B. GARRIATT has a communication on tornado power in your issue of July 22, in which he complains of the "disposition, on the part of writers on scientific subjects, . . . to sacrifice common-sense reasoning and probable facts to profound but improbable theories," and then proceeds to explain tornado energy as due to electricity, and not to wind. To support this view, he makes the statement, first, that "moist air is one of the best known conductors of electricity;" and, second, that the "earth is the great reservoir for the electric fluid." It might be worth the while for Mr. Garriatt to assure himself of the truth of his fundamental principles before he applies them on so large a scale. There is not the slightest experimental evidence that moist air is a conductor at all, much less "one of the best;" and as for the earth being a reservoir of electricity, every thing that is known about electricity negatives the idea.

Again: it is implied that electrical energy is more destructive than other kinds, as if a definite quantity of it could do more work than an equal quantity of other energy. He also speaks of "the electric fluid." These quotations show that he has no practical acquaintance with what physicists call 'electricity;' that he does not understand the laws of its generation, the conditions of its transference, nor its quantitative relation to other forms of energy; and therefore, to quote still further from his article, it is "unsatisfactory and worthless from a practical scientific standpoint."

A. E. DOLBEAR.

College Hill, Mass., July 23.

Answers.

10. ROBIN'S NEST. — The ten-storied robin's nest mentioned in *Science* of July 22 is indeed a remarkable affair. It is rather unusual for robins to build a new nest on an old one, although it sometimes happens. I have seen a number of two-storied nests, and one three-storied one, but such nests are rare.

J. A. ALLEN.

New York, July 26.

SCIENCE

FRIDAY, AUGUST 5, 1887.

IT IS GREATLY to be regretted that the National Educational Association, at its recent meeting, gave its indorsement to the so-called Blair bill, making provision for national aid to schools in the various States and Territories. This measure has been before the public long enough to obtain thorough discussion; and the opinion of the large majority of intelligent citizens is, that its effect, were it ever enacted into a statute, would be pernicious. The measure has been not unjustly styled a 'bill to promote mendicancy.' It is a bill to impair the self-reliance, and discourage the earnest efforts, of large portions of the community. We have lately taken occasion to call the attention of the readers of *Science* to the alarming increase of paternalism in legislation in the various States. The bill in question is in a direct line with the tendency toward paternalism. We are not among those who assert that the measure is advocated in a demagogic spirit. On the contrary, we believe it to be the outcome of a generous but mistaken intention to do good. We believe the premises on which its supporters base their arguments to be false, as well as that the effects they predict will follow its enactment to be very different from what will actually happen. A resolution indorsing this bill was brought before the teachers at their recent annual meeting, and referred to the appropriate committee. In course of time this resolution appeared, with a number of others, in the committee's report, and was adopted. We are informed that this was done as a mere form, and that the committee's report was adopted without any consideration, merely as a matter of courtesy. If this is so, it is no proper defence. If any teacher objected to that resolution, he should have made himself heard. But the record shows that no objection was made, and that the resolution passed. We repeat that it is very unfortunate that the association took such action. It will greatly lessen public confidence in its representative character.

DURING THE MONTHS in which the tropical tornadoes are most frequent, the pilot chart issued by the Hydrographic Office of the Navy Department will contain reports of experiments in the use of oil to lessen the force of waves during storms at sea. For several years it has been the custom of the office to print monthly on this chart a synopsis of the experience of vessel captains in the use of oil; and the results have in a great many instances been very successful. It has had another effect also. It has stimulated inventors to prepare devices for carrying the oil over the bows of vessels, and has induced a number of dealers in oleaginous fluids to prepare a special brand of oil for this purpose. The receptacle for the oil which seems to be the most useful yet offered to navigators is the design of a Swede. It is said that the British Channel fleet, while cruising in the vicinity of Copenhagen, were supplied with these funnel-shaped bags for distributing oil in storms. The authorities at the American Navy Department have not yet admitted the value of the experiments. A Chicago concern has succeeded in perfecting a combination of mineral and vegetable oils, which is said to be very effective for the purpose, and the Hydrographic Office is advised that it is being extensively carried by steamers on the Lakes during the present season. Thus far there have been very few reports of the effect of experiments on the inland lakes. A new apparatus has been described in the *Yacht*. It consists of a vertical cylinder with numerous small openings, which, by an automatic process, lets the oil flow out as soon as the bow of the ship to which the apparatus is fastened plunges into the water.

THE MONTANA INDUSTRIAL SCHOOL FOR INDIANS.

IN connection with the present movement to introduce manual training as a factor in the common-school education, it is valuable to make note of the testimony to its educational effectiveness derived from experiments in other fields. Its introduction into the colored schools of the South has been followed by most beneficial results, and we now learn of its success among the Indian tribes.

The American Unitarian Association is one of the religious bodies of the country which, since 1874, has had charge of the education of the Indians. This association has nominally been in charge of the Utes. The attempt to establish an industrial school for the Utes failed, however, because of the frequent removal of the tribe, its opposition to all forms of civilization, and the lack of sufficient government support. Mr. Henry F. Bond, the representative of the association, then turned his attention to the Crow reservation in Montana.

The Crow tribe, which numbers about thirty-five hundred, of whom about eight hundred are children of school age, have never had any settled missionary or educational work done among them, except a small government school at the agency. The tribe had been originally assigned to the Methodists; but no work has been done by them, though they, as well as the Catholics, have recently secured mission-sites on the reservation, which will soon be occupied.

The Crows have always been the firm friends and allies of the whites. They have resisted all overtures from other tribes to join them in hostilities, and have always been ready to take up arms against any tribe, even their own friends, who made war on the whites. It is perhaps for this very reason that they have been for so long neglected by missionary bodies, whose efforts have been directed to the Christianization and civilization of those tribes from whom most danger was to be apprehended. As a natural result of this neglect, the Crows are among the least civilized of all the tribes. They cling to their wild ways of life, and are reluctant to settle down to habits of industry. They are sensual and immoral in their practices. But the universal testimony of the twelve agents who have been appointed to the Crows, in the last eighteen years, is that they are docile, good-tempered, and not inclined to intemperance, as are most other tribes, and that they are faithfully endeavoring to adapt themselves to their changed condition. They have agreed to take up allotments, and to build houses on their homesteads, and cultivate the ground. The government has sent out farmers with their families to settle among them, and to instruct them in agriculture and the ways of civilized life; and the agents invariably speak well of their readiness to avail themselves of the facilities thus afforded. Nowhere would there seem to be greater need of missionary and educational work, and Mr. Bond decided that here was the best field of labor. His decision was approved, as were also the location selected and his plans for the erection of an industrial boarding-school building to accommodate from thirty to fifty pupils. The site chosen was on the Big Horn River, on the mail-stage route from Custer Station on the Northern Pacific Railroad, distant seven miles, to Fort Custer thirty, and the Crow agency, on the Custer battle-ground, forty, miles distant.

The commissioner of Indian affairs also approved the location, and promised a contract for Indian pupils. The government will pay \$108 annually for each Indian pupil taught and supported at the school. The annual cost of maintaining the school, with the full complement of fifty pupils, will be from \$8,000 to \$10,000, of which sum the government's payments will constitute one-half.

The building is substantial and commodious, made of hewn cottonwood logs, on a stone foundation, having eighty-six feet frontage, with wings running seventy feet to the rear, forming three sides of a hollow square. The gambrel roof gives a second story

for the dormitories, thus saving present expense for schoolrooms, which are placed in the lower story.

At the time of the last report to the association, April 30 of the present year, the school was in operation with eighteen pupils, with a prospect of having the full quota of fifty as soon as its equipment is complete.

Mr. Bond reports the Crow children at the school as docile, affectionate, intelligent, and happy under their new surroundings. They are quick to learn, and interested in their studies and in their occupations. They are to be taught, under the contract with the Indian Bureau, the various industries which will fit them for the duties of civilized life. One of three boys who had run away, and who, as the ringleader, was refused permission to return, offered to submit to punishment if only allowed to come back.

An interesting feature of the work at this school is, that, of the six teachers and officers in charge, three are Indians who have been students at Carlisle and Hampton.

It is intended to add a kitchen, blacksmith-shop, carpenter-shop, and slaughter-house. The slaughter-house is a necessary adjunct of an Indian school, in order that the Indian boys may be taught how to kill animals for food mercifully, and also how to cut them up scientifically instead of hewing and hacking them as they now do.

The curriculum is not yet completely systematized, but probably half the time will be given to industries, and half to the schoolroom exercises. The industrial training will include blacksmithing, carpentry, farming, and butchering for the boys, and house-work, sewing, and cooking for the girls. The outlook for the school seems excellent, and, if the hands of the teachers are upheld by sufficient funds, an excellent work will be accomplished.

THE NEW JERSEY TEACHERS' READING-CIRCLE.

THE results of the first year's work of the New Jersey teachers in the reading-circles call for the highest commendation, and indicate a thorough organization and faithfulness on the part of the members.

The plan of organization, and methods of work, should be known in every State: in fact, the Board of Control in New Jersey is glad to inform other reading-circles of its successes and methods in reciprocity for information kindly sent when their organization was in its incipency.

The committee on constitution sent to all the States in the Union having reading-circles, then numbering thirteen, and received much information which greatly aided them in formulating their report. The result was an organization differing materially in some essential points, and yet containing good ideas from many States. The features that have contributed to its success are the following:—

I. *The Board of Control.*—The election of this board was peculiarly fortunate. It consists of four officers, the State superintendent being president, and one director from each congressional district, thus affording complete representation. The work of the board is intrusted to the following committees: 1. Finance, 2. Course of Reading and Books, 3. Circulars and Printing, 4. Certificates and Diplomas, 5. Local Management. A great part of the success of the circle is due to the last-named committee. Its duties are to supervise the work throughout the State, appoint local managers, instruct them in the work, encourage the formation of local circles and the enrolment of members, hold meetings of managers and members, send speakers to county associations and institutes, and keep up the interest and enthusiasm in the State. Another very important part of the work of this committee, which has contributed very much to the success, is the intimate communication with the local managers in cities and counties, which is carried on by the secretary, Mr. B. C. Gregory of Newark, who has done more work than all the other members of the Board of Control put together. He is an indefatigable worker, an accurate statistician, a skilful organizer and administrator, and an enthusiast on reading-circles, being a Chautauquan, and the secretary also of the Chautauqua Teachers' Reading-Union. This tribute is due to Mr. Gregory, because the New Jersey circle could not have attained such success without him.

The committee on local management divided the State into dis-

tricts, to be supervised by the members of the board. By this means the work was easily pushed and encouraged. Where the best results have been attained, much credit is due to the county superintendents who have co-operated with the committee in spreading information and encouraging the local circles. Where work has been done, it was well done. Unfortunately there are a very few counties where the county superintendents are dead educationally, and the committee have not had time yet to push their work.

Another very important work of this committee has been the district meetings. Soon after the circle was organized, meetings of city and county managers were held in four central places for the purpose of giving instruction and for conference. During the last spring another series of meetings was held in six central places, when all members and friends of education were invited. At each meeting an address was given by some distinguished educator, in addition to the addresses of the chairman and secretary and the reports of local managers. These meetings resulted in much good in unifying the work and cementing the bond of common interest.

The duties of the other committees are essential, but do not come into relation with the organization.

II. *The County and City Boards of Managers.*—The duties and responsibilities of the local managers, city and county, are very important, and the success of the work depends very much upon them; in fact, no success can be looked for except through them. They must enrol members, encourage meetings, and keep the work moving. They must arrange programmes, direct the method of reading, and keep up the enthusiasm.

III. *The Local Circles.*—Experience shows that the work cannot be successfully carried on without meetings and local circles. It is impossible for the majority of teachers to pursue a course of reading alone. They need the inspiration of numbers, a proper comprehension of the matter; and the fullest appreciation of it depends upon discussion, analysis, and amplification. The cities and counties that show the best results have maintained regular meetings.

IV. *The Course of Reading.*—In making the courses of reading, the Board of Control, appreciating the needs of the teachers, provided professional works, embracing the history, principles, and methods of teaching, and reading of a general character, including history and literature. The books are arranged in groups, which enables members to select a purely professional course or one partly professional; but no selection can be made by the omission of a single educational work.

The object of the reading-circle is to induce teachers to continue systematic study in these lines, and it has put into their hands some of the best educational literature available. The course is attractive, entertaining, and inspiring.

The second year's course is now being read, and the third year's course has been arranged. Both provide for professional and general reading. The popularity of the course, and the success of the work, may be seen by the fact, that, out of about 3,250 teachers in the public schools of the State, the secretary reports 1,980 members of the reading-circle. The State superintendent says that its influence is being felt in the remotest districts, and that it has created a greater interest in education than has ever before been known in the State.

C. E. MELENEY.

EXPLORATION AND TRAVEL.

Prejevalsky's Journeys in Central Asia.

UP to the last few years, our knowledge of Central Asia was extremely deficient. Though in the middle ages many travellers crossed the arid highlands of Mongolia and Tibet, among them the famous Marco Polo, though numerous reports on the routes followed by the Chinese silk-caravans exist, the geography of that region was actually unknown. It is only of late years that scientific travellers succeeded in entering Central Asia; and among them Prejevalsky, the Russian general, is most prominent from the extent of his journeys and the valuable results of his expeditions. His most important discovery is that of the mountain-range connecting the Nan Shan system with the western Kwen Luen, which feeds the Khotan and Yarkand Rivers. He proved that the Kwen Luen

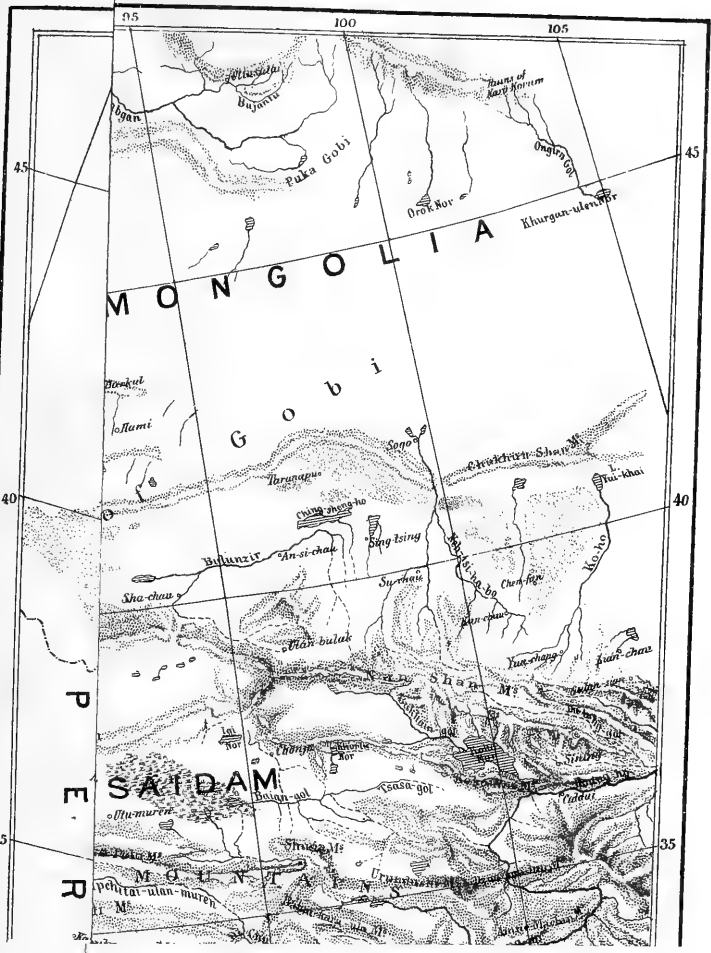

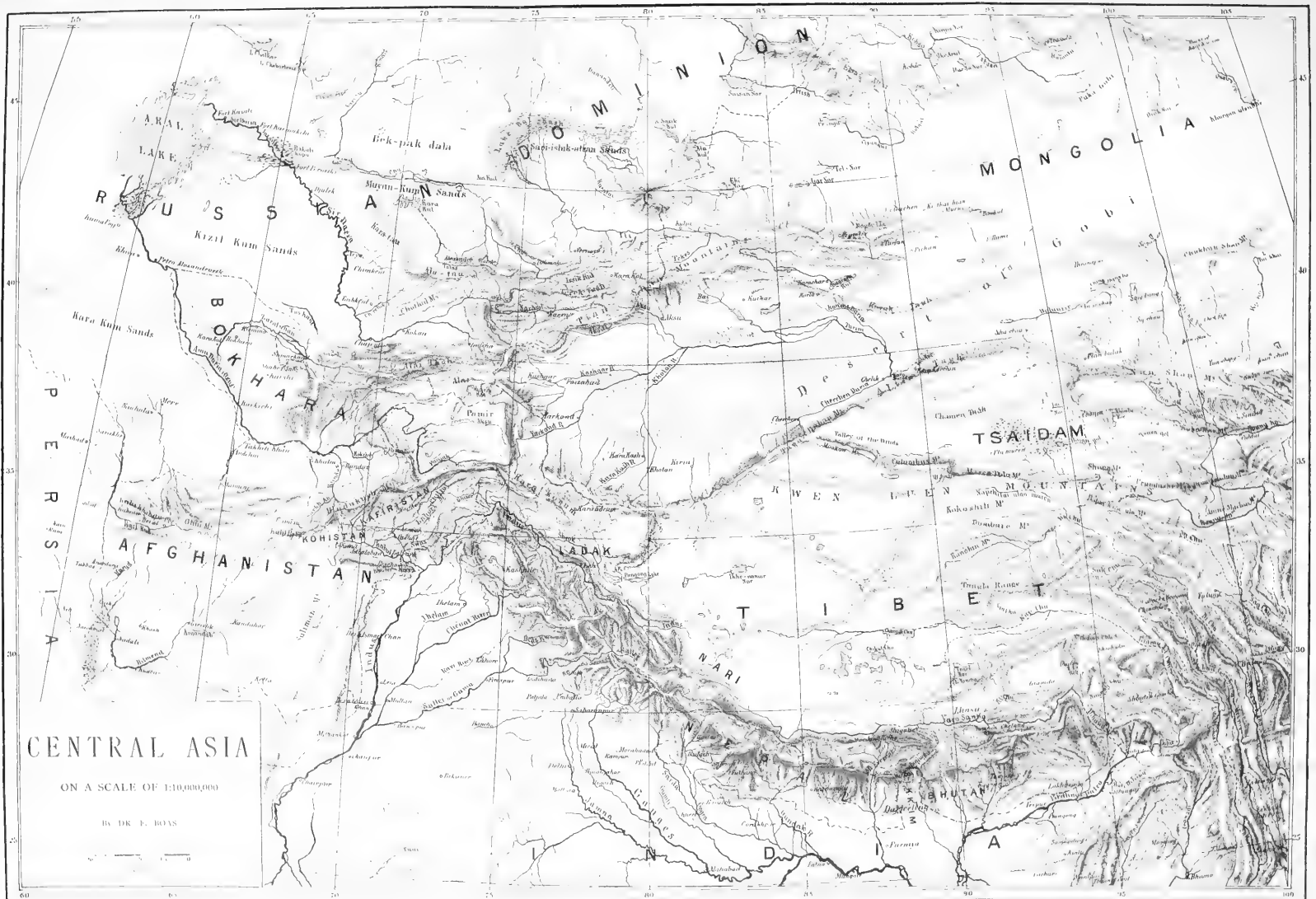

CENTRAL ASIA

ON A SCALE OF 1:10,000,000

By DR. E. BOAS



forms one enormous system stretching from the Pamir Plateau to western China. Its most northern range is formed by the Taguz Daban, the Altin Tagh, and Nan Shan. It was on his second journey, in 1876, that Prejevalsky explored this region. He advanced from Kulja on the Ili, which he describes as the most lovely district of Central Asia, crossed the Tian Shan, and descended to the oasis of Karashar, on the Bagrash Kul. Here he turned south, and, after having reached the Tarim, followed it until he reached the famous Lob Nor (Lake Lob). He stated the remarkable fact that the western part of this lake, which has no outlet, contains fresh water,—a fact which he verified on his fourth expedition. He concluded that Lob Nor is a reedy lake of no great depth, surrounded by flat shores, the haunt of prodigious numbers of water-fowl, and inhabited by a few hundred human beings, whose habits, tenements, and mode of life, resemble those of the primitive lake-dwellers. The eastern part of the lake must be salt, as it is an inland lake, and all the matter contained and dissolved in the waters of the Tarim is carried into it.

His most important discovery here was that a high chain of mountains, the Altin Tagh, rises almost precipitously from the southern shore of the lake to the limit of perpetual snow. On his fourth expedition he completed these discoveries by that of the high chains of mountains forming the western and southern boundaries of Tsaidam.

He had explored this saline marshy district on his first journey, 1871-73, and thence had visited northern Tibet, with the intention of visiting Lhasa; but when about five hundred miles from this place he was compelled to turn back.

The same region was the goal of his third expedition. Well supplied with funds, he started from Zaisan, in the government of Semipalatinsk. His party numbered thirteen all told, ten being Cosacks. They travelled along the south shore of Lake Urungu, and ascended the Ulyngur. The natives of this river and its chief tributary, the Bolgun, are Targute-Kalmuks, whose kinsmen, inhabiting north-western Dzungaria, are the descendants of those Kalmuks, who, driven out of their camping-grounds by the Dzungars, migrated to the banks of the Volga and Ural, and in 1770 suddenly departed, to the number of four hundred and sixty thousand families, and at last settled on the Ili.

Prejevalsky crossed from the Ulyngur to the eastern continuation of the Tian Shan, and, passing the plain of Barkul, he at last arrived at the oasis of Hami, which he describes as remarkably productive. Corn, vegetables, grapes, and melons are grown there, the last being of such exceptionally fine flavor as to be considered worthy of being sent to the Court of Peking. It is a place of the highest importance, as it commands the chief roads from China to eastern Turkestan and Dzungaria. From here, roads lead to the cities situated along the northern foot of the Tian Shan, and across the desert of Gobi to Sha-chau, on the upper Bulunzir. This oasis is situated at the foot of the Nan Shan, which is here a chain of mountains only twenty-seven miles in width; though farther east, near the Koko Nor, it attains far greater dimensions. Still farther east, in the province of Kansu, the mountains are covered with dense forests; but near Sha-chau it is a sterile, treeless range. Yet the highest parts possess a savage grandeur, with their summits towering above the main axis, their precipices, snow-covered peaks, and glaciers.

The expedition now entered the plateau of Tsaidam,—an expanse of salt marsh and clay flats dotted with lakes, and elevated about ten thousand feet above the sea. The level and desolate character of this country is shown in Fig. 2, which is reproduced from *Le Tour du Monde*.

Another characteristic feature of this region is shown in Fig. 1, which has been taken from the same journal. Around the shrubs and bushes masses of sand and dust are accumulated by the wind, and thus in course of time a small hill is formed, on the top of which a new shrub begins to grow. Von Richthofen's researches show that the masses deposited by the wind are distributed over a wide area in Central and Western Asia, and that the form of the surface of this region is principally due to the action of the wind.

Tsaidam forms the first terrace of the plateau of Tibet. On its northern and southern sides it is enclosed by the branches of the

Kwen Luen, while the spurs of the Nan Shan form its eastern limit. The southern part, which was formerly covered by an extensive salt lake, is extremely level, while the northern section is higher and hilly, and is composed of a barren, sandy ground and saline marshes. The inhabitants of this region are Mongols. Their principal occupation is stock-raising. In summer the herds are driven to the mountains, as the lower parts of the country swarm with insects. On account of the great distance of the agricultural districts of China, and the difficulty of obtaining grain, the inhabitants till the soil to a limited extent. As they are frequently attacked by the Chara Tanguts and the Golyks of the river Mur-usu, they fortify certain parts of their camps and villages, in which they defend themselves from their enemies, whose predatory excursions are said to be permitted and supported by the Chinese governor.

Though the inhabitants of Tsaidam received Prejevalsky well, the native princes, acting doubtless by orders from Peking, refused him both guides and provisions; but at length he succeeded in starting on his way south. After they had passed the Shuga and Baian-kara-ula Mountains, the difficulties of travelling increased greatly. Their guide, who had only once, fifteen years before Prejevalsky's journey, traversed that country on his way to Lhasa, did not



FIG. 1.—SAND-HILLS.

know the way, and the caravan had to select the way according to their own judgment. They succeeded in reaching the Napchitai-ulan-muren, where they found traces of caravan camps, which assured them that they were on the right road. Though it was only the middle of October, the weather turned cold, with continued snowfalls, and their camels and horses could find nothing to eat. Thus, under great difficulties, they succeeded in crossing the Koko-shili and Dumbure Mountains. Having reached the valley of the Mur-usu, they struck the track taken by the Lhasa pilgrims, and ascended the river. But soon the track was lost again; and, after having deposited part of the load in a *cache*, the caravan proceeded southward, and crossed the Tangla Range by a pass which, though 16,700 feet in height, is only 2,100 feet above the valley of the Mur-usu, and has a very gradual slope to the north and south. The eastern continuation of this mountain-range is probably the watershed between the Yang-tse-Kiang and the rivers of Farther India; but we are far from having a sufficient knowledge of the complicated river-systems of this region. It is even still doubtful whether the Nap Chu is the upper course of the Salween as represented on our map, or of the Irawadi, as some authorities on the geography of Farther India suppose. Prejevalsky now reached the valley of the San Chu; but here his further progress was stopped, as the Dalai-Lama did not permit him to enter his territories. So he was compelled to return, though only one hundred and fifty miles from Lhasa, the goal of his journey.

The results of this journey are confirmed and supplemented by the observations of the Pundit A-K, who visited Lhasa, and, continuing his journey farther north, reached Tsaidam.

In 1884 and 1885 Prejevalsky accomplished his fourth journey in Tibet. From Kiachta he went to the Chinese city of Sining, east of the Koko Nor. Having arrived in eastern Tsaidam, he left all his superfluous baggage under the charge of seven Cossacks, while he and his companions, a party of fourteen, started to explore the sources of the Hoang-Ho, which is situated in a plateau from 14,000 to 15,000 feet in height. Travelling south, Prejevalsky crossed the divide between the Hoang-Ho and Di Chu, the source of the Yangtse-Kiang, at a height of 14,500 feet, and, on entering the basin of the Di Chu, came to a country alpine in its character, but without forests, possessing, however, a rich and varied herbaceous flora. From here he returned to Tsaidam, and, turning west, made the important discovery of the 'Valley of the Winds,' which gradually rises to an easy pass across the Taguz Daban Mountains, leading to Cherchen. This pass, and the route from Sha-chau along the foot of the Altin Tagh, were the caravan routes used in former times in the trade between Turkestan and China. From here he paid



FIG. 2. — SALT MARSHES IN TSAIDAM.

another visit to the Lob Nor, and then returned to Russia by way of Cherchen, Kiria, and Khotan.

Our map shows the important results of these journeys; but besides this, other recent researches have been made use of in constructing the map. The sources of the Irawadi and the adjoining parts show Colonel Woodthorpe's explorations. The north-western part is from the Indian Trigonometrical Survey map of Turkestan, but corrected according to the recent Russian surveys on the Pamir and the adjoining regions, and to the surveys of the Afghanistan Boundary Commission, as far as they have been published.

HEALTH MATTERS.

Health in Schools.

THE Medical Society of the State of New York voted at its annual meeting to distribute fifteen hundred copies of the essay of Dr. A. N. Bell, on the physiological condition and sanitary requirements of school-life and school-houses, which received the Merritt H. Cash prize at the annual meeting held in February. These additional copies are intended for the school-officers of the State, and if read, and the advice therein given is put into practice, much good will result. The essayist opens by calling attention to the plasticity of every living organism during the early period of its existence, and to the liability of causing constitutional weakness, or even a diseased state, if a young person of originally healthy constitution be subjected for a considerable period to such injurious physical conditions as tend to produce a modification of type. All the phenomena of maintaining a living existence are accomplished by the process of nutrition. The parts played by respiration and the blood in this process receive due attention from the essayist; and the

nervous system, including the brain, is concisely described, both as to structure and function.

In speaking of the age at which children should be sent to school, Dr. Bell says children differ greatly in their powers of resistance to injurious influences, as do adults, though incomparably more susceptible to them: hence to fix upon the age at which school-life may be commenced involves the consideration of the kind of school-life as well as the adaptation of the child. The first and central fact to be constantly kept in view in conducting school-life is the plastic property of the child's mind. This fact being always uppermost, healthy children, at the age of about seven years, may safely begin to learn the alphabet, spelling, and figures, on the kindergarten system, giving them not more than two or three hours' application daily, with not less than half of the time, at equal intervals, for play; provided, always, the sanitary conditions of the school-room are duly regarded. At the age of about ten years, systematic education may be commenced; but up to the age of puberty, the school-time should not be more than six hours daily; and no child should be required to devote more than half of the time of school-hours to study, or more than forty minutes at a time to close application; and no recitation or blackboard exercise, which imposes the greatest exertion of the mind, should be longer than fifteen minutes. The education of the senses, and the best kinds of gymnastics for school, are considered quite at length.

There is one point upon which Dr. Bell lays great stress, and we are gratified that he does so; that is, the punishment of a refractory pupil by his detention from play, or keeping him in after school-hours. He says that teachers and others who favor the keeping-in system must be very superficial observers of children, not to have learned that to deprive a child of play is an exceedingly poignant punishment, — one that afflicts and grieves his mind not only, but frequently stirs up his worst passions. Besides, keeping-in is frequently coupled with an extra task, or 'till the lesson is got.' Surely, nothing could be better calculated to create a repugnance to study, and stimulate obstinacy. Moreover, it sometimes involves the loss of a meal, or, at least, a postponement of meal-time, to the derangement of digestion and injury of health. In every attitude of the case the system of keeping-in as a punishment is bad; worse, even than corporal punishment, and, like it, should never be practised except in extreme cases.

In the portion of the essay devoted to the school-house itself, the site first claims attention. In dealing with this subject, the essayist says that the ground air is liable to be impregnated with emanations from all decomposing material; and instances are by no means lacking to show that schools exposed to such dangers have frequently incurred severe epidemics of whooping-cough, measles, scarlet-fever, diphtheria, and typhoid-fever, and are constantly liable to pneumonia, catarrhal and diarrhoeal diseases. In speaking of the materials which should be selected to be used in building school-houses, Dr. Bell refers to the examination of various kinds of stone which was made with reference to the choice of building-stone for the British House of Parliament in 1839. It was then found that the absorption of water for one hundred volumes of rock was in the following proportions: in three specimens of siliceous limestones, 5.3, 8.5, and 10.9; three of nearly pure limestones from oolite, 18.0, 20.6, and 31.0. In all the experiments the air was removed by first placing the specimens in water under the vacuum of an air-pump. Brick, under the same process, will absorb from ten to thirty volumes of water. The ventilation, warming, and severage of school-houses are concisely and intelligently discussed.

In speaking of the sanitary surveillance which is so essential in every school-system, Dr. Bell's testimony is of great value. His experience as a member of the Board of Education in Brooklyn entitles him to speak *ex cathedra*. He says, that, constituted as our boards of education are, with few exceptions, though there may be some members who are physicians, it is impracticable to secure competent sanitary supervision under the direction of or subordinate to them. They are generally divided into committees with special charges, — on sites, construction, heating, ventilation, health, etc.; and on school-houses, with the special surveillance of particular schools, severally, to the different committees. All such committees are exceedingly jealous of their rights, and resist the interference of their fellows: hence even inquiries are commonly met

as if reflecting insinuations of shortcomings. It is manifest that no sanitary service under the direction of such a board can be efficient. Sanitary surveillance should therefore be exercised by the health department of every city, town, county, or district, as the case may be, with that special care which the nature of the service demands.

The essay, as we have already said, is one of great value, and we would recommend every teacher in the State to send to the secretary of the Medical Society, William Manlius Smith, M.D., for a copy.

BASE-BALL PLAYERS.—Dr. Leuf contributes an article to the *Medical and Surgical Reporter* on the injuries of base-ball players. The doctor is a player himself, and speaks from personal experience as well as from observation. He says that one of his fingers was injured by a ball five times in one week, and that all his fingers have been injured at least once. His treatment is to continue playing, and at every opportunity—either in the street, in the office, or upon the field—to firmly grasp the finger about the middle, and rub towards the tip. Under this treatment, the swelling, stiffness, and soreness diminish, and after some weeks are entirely gone. The most marked swelling of the hand, accompanied by great pain, can be best relieved by the application of water as hot as can be borne, the hand remaining in the water for an hour, the temperature being maintained during the whole time. Nothing will do so much harm to a player as to abstain altogether from playing because he has some trivial injury or sore muscles.

DIPHTHERIA CARRIED BY THE COOK.—Dr. Jacobi sends the following letter to the health board of New York: "Ann Donnelly is a cook. She was in the house of Lieutenant Reed of West Point. She went to New York to bury a child of hers, who died of diphtheria at the house of a Mrs. McKee, No. 327 West 43d Street, about May 20. About ten or twelve days ago she unpacked a trunk in Lieutenant Reed's house, in the presence of his children. The boy is recovering from diphtheria: the girl, of five years, died day before yesterday. The cook has disappeared from the house,—trunk and all,—ready to unpack again somewhere else, and go on murdering. If that woman cannot be sent to the State prison for sowing death wherever she goes, can she not be hunted up and stopped from doing mischief?"

TYPES OF BREATHING.—Dr. Mays of Philadelphia has been investigating the reasons for the abdominal or diaphragmatic type of breathing in the male, and the costal type in the female. That there is a fundamental difference in the two sexes was observed by Boerhaave as long ago as 1744. Hutchinson seemed to think that it might be a peculiar reservation against the period of gestation, when the abdomen cannot allow of so free a descent of the diaphragm; and to-day this is regarded as the reason for the difference. It occurred to Dr. Mays that an observation on the respiratory movements of females of a wild race, who had never been subjected to the constriction produced by civilized dress, would assist in solving the problem. With this object in view, he obtained permission to investigate the chest movements of the Indian girls of the Lincoln Institution. The instrument which he employed was a pneumograph of his own device, modelled somewhat after that of Paul Bert. It consists of a pair of calipers with two long and two short arms. The long arms are applied to the chest, and the short arms extend beyond the pinion which binds the instrument together. Between the two short arms, and by means of two small pinions, an air-drum is adjusted in such a way that the slightest motion produces either a rarefaction or a condensation of the air in the drum, which being connected by a column of air with a similar drum carrying a registering-lever, the movements of the chest are accurately marked on a revolving cylinder. In order to produce a slight and uniform pressure on the walls of the chest, the two long arms are connected near their union by a thin piece of elastic rubber. By means of this apparatus Dr. Mays examined the movements of eighty-two chests, and in each case took an abdominal and a costal tracing. The girls were partly pure, and partly mixed with white blood, and their ages ranged between ten and twenty years. There were thirty-three full-blooded Indians. Seventy-five of the entire number showed a decided abdominal type of breathing; three, a costal type; and in three

both types were about even. Those who showed the costal type, or a divergence from the abdominal type, came from the more civilized tribes, like the Mohawks and Chippewas, and were either one-half or three-fourths white; while in no single instance did a full-blooded Indian girl possess this type of breathing. From these observations Dr. Mays concludes, that, so far as the Indian is concerned, the abdominal is the original type of respiration in both male and female, and that the costal type in the civilized female is developed through the constricting influence of dress around the abdomen. It is very evident that the costal type of respiration in the civilized female is not due to the influence of gestation, as was believed by Boerhaave, Haller, and Hutchinson; for the influence of this process obtains as much among the uncivilized as it does among the civilized people. Dr. Mays directs attention to one result of his investigations which is well worthy of consideration. What is the influence of such abdominal constriction, as is practised by our civilized female, on the respiratory functions? he asks. Is it detrimental to health, or is it not? If, as is shown by these experiments, interference with the motion of the diaphragm produces a compensatory breathing in the costal portion of the chest, does not this tend to antagonize or counteract the sluggish respiratory movement of the lung apices? Is there any intimate relation between this induction and the fact that proportionally, and as a rule not without some exceptions, a less number of females than males die of pulmonary consumption?

MENTAL SCIENCE.

Good and Bad Temper.

MR. FRANCIS GALTON, whose researches on the hereditary and other characteristics of mental faculty have introduced science into subjects usually given over to opinion, publishes in the *Fortnightly Review* for July, an analysis of statistics on good and bad temper. Some time ago Mr. Galton drew up an extensive series of questions concerning the physical and mental traits of families, and offered prizes for the most complete set of answers embracing the record of several generations. Fully recognizing the sources of inaccuracy inherent in such reports, Mr. Galton has ingeniously tested their reliability, and is extremely careful not to treat them in a more accurate manner than they justify. The statistics, embracing descriptions of the tempers of 1,981 persons, are sufficiently extensive to warrant the general conclusions which they suggest.

'Temper' is a convenient word wherewith to describe that general complex of emotional traits which serves in common life to distinguish personal characteristics that lead to sociability from those that do not. Every one knows what it means, and, consciously or unconsciously, guides his social intercourse accordingly. It is this that is most tangibly referred to as the source of family feuds and social quarrels. Its variability and fundamental importance make it difficult to describe. It is curious to note that Mr. Galton has only fifteen epithets for good temper, and forty-six for bad.

These are again grouped into five main classes,—mild, docile, fretful, violent, masterful; the three former predominating in women, the two latter in men. The number of persons, however, in the two groups of good and bad temper, is about equal; one set of data making it 48 good to 52 bad, and another 47 to 53. There is likewise little difference between the sexes; but what there is, is in favor of the gentler sex, there being 45 per cent of bad tempers amongst them, and 55 per cent amongst men. Altogether 36 per cent were mild in temper, 15 per cent docile, 29 per cent fretful, 12 per cent violent, and 8 per cent masterful.

It is curious to note how well the number of persons recorded as good, bad, or neutral in temper coincides with what theoretical considerations demand. Of 1,361 persons, 321 are described as good, 342 as bad, and 705 as neutral (most of the last not being described at all); that is, these observers unconsciously divide persons into four equal classes,—good-tempered, bad-tempered, not decidedly either but with more of a tendency to good, and similarly towards the bad. This shows that the line of average temper was placed where it belongs, with equal deviations in either direction. Another mark of reliability is to be found in the fact that near relatives are spoken of as bad-tempered quite as unreservedly as more distant ones.

Whether temper is hereditary is a question not easily answered; but when asked of couples in which both parents are good-tempered, or both parents bad-tempered, the answer is emphatically in the affirmative. 30 per cent of the children of the former are spoken of as good-tempered, and only 10 per cent as bad; while, with regard to the children of the bad-tempered, only 4 per cent are good-tempered, and 52 per cent bad. Similarly, by a method necessarily somewhat arbitrary and not easily described, Mr. Galton concludes that in the ancestry of good-tempered persons, three persons of good temper will occur to two of bad temper, and *vice versa* in the ancestry of a bad-tempered person. Apart from direct heredity, education and circumstances evidently affect temper. A large class of such influences are about as favorable to good as to bad temper, and so tend to produce a variety of tempers. Another class of influences, typically illustrated in the case of a not unusually docile woman becoming very docile as the wife of a masterful husband, tends to divide persons (and this applies particularly to the offspring) into distinct groups; while the effect of a prepotent ancestor may be working to continue one kind of temper through many members of the family. Mr. Galton finds, that, in 14 cases of 49, these domestic and social influences are too weak to overcome the secondary influences in course of heredity, either by the prepotent temper of one member or the general concurrence of temper in several. Finally, it may be noted, that, though so important and readily observed a trait, temper is not a prime consideration in marriage, men of each kind of temper about as frequently choosing a wife of one temper as of another.

This research, though necessarily not very definite, is well calculated to bring out the great variety of this important trait, and to show, amidst this diversity, its tendency to continue its kind.

IS GENIUS UNIVERSAL?—The question, when asked with a due appreciation of the kind of evidence upon which it is to be answered, is by no means an idle one. To know whether the activity for which the world reserves its highest prizes is dependent upon an unusual strength of mental capacity in all directions, or upon the acute specialization of one faculty of mind to the exclusion of anything like equal development of other faculties, is certainly an important piece of knowledge. Carlyle had no respect for a genius that could not be any kind of genius, and his view is quite generally repeated with approval by persons with less right to an opinion. This is a mistake of all hero-worshippers. They exaggerate the abilities of their hero in all directions in which he had a somewhat more than average gift, and also exaggerate the share due to circumstances in his development. It is easy to cite quite a long list of men eminent in more than one direction; but, as Mr. Sully, whose train of thought (*Gentleman's Magazine*, July, 1887) we are now repeating, well points out, if we are careful to count only such kinds of eminence as imply markedly different modes of mental power, and demand first-rate ability in each, the number of 'double-firsts' is enormously diminished. We find that polynathy has been mistaken for universal genius; that the poet-scientist, for example, was a great poet, but only an average scientist; and that the few eminent names that shine in several departments are decidedly exceptional. "True genius very rarely shows itself in more than one well-defined region of human activity." That this is due to a more or less innate fitness for that kind of activity in which greatness is won, is shown not only by the fact that it is a marked characteristic of genius to show a decided bent that overcomes all obstacles in the direction of future greatness, but also that often tentative excursions in various directions result in failure, until the right activity is found, and success follows. This conception of genius is in harmony with the little we know of its physical substratum. "Universal genius is a biological absurdity," says Mr. Sully. Genius depends upon the abnormal development of a certain group of brain-centres. Widely versatile talent is the outcome of a splendid, generally excellent brain; and perhaps this is the clew to the tendency of genius to go over to abnormal one-sidedness, while talent keeps healthy as an "exalted common sense."

THE editor of *Petermann's Mittheilungen* is in receipt of a letter containing the news that Lupton Bey is safe in Khartum, although still a prisoner of Osman Digma.

BOOK-REVIEWS.

The Pleasures of Life. By Sir JOHN LUBBOCK. London and New York, Macmillan. 16^s.

THERE are in every age certain leaders of thought, who, by their successes already won, have gained for themselves the right to speak on topics important to the general culture of the age which they represent. In an age in whose culture science occupies a place exalted far beyond what was ever allotted it before, it is natural to find in the eminent scientist the spokesman of culture. Amongst those entitled to such a distinction, Sir John Lubbock stands amongst the first. The versatility of his talents, the success with which he has utilized them in so many directions, the practical interest he has always taken in the doings of the nation to which he belongs,—all have contributed to his well-merited fame. The author of the 'Origin of Civilization' and of 'Prehistoric Times' does not think it a whit less worthy to minutely record the doings of 'ants, bees, and wasps'; and that, too, in the leisure hours of a busy parliamentary career. In educational and all scientific movements his name has always been prominent. Such a man is naturally often called upon to make short addresses of welcome or of congratulation on the many occasions on which such are customary. These addresses are here collected, and make a very pleasing volume. "Being myself naturally rather prone to suffer from low spirits," says the author, "I have at several of these gatherings taken the opportunity of dwelling on the privileges and blessings we enjoy," etc.

The changed conditions of modern life form the subject of many an essay. That these changes cause a variation in the order and importance of the pleasures of life, goes without saying. This change Sir John Lubbock fully appreciates, and the liveliness of his little book is beyond question. That much of what he says is not new, will be foreseen: such a volume must be judged by lenient standards. If what is said is well and pleasantly said, if it appeals to the good sense of cultured people by the liberality and nobility of the thought, it answers its purpose. It must certainly have been a privilege to have heard these addresses: in the reading of them many will find a 'pleasure of life.'

Under the two titles 'The Duty of Happiness' and 'The Happiness of Duty' is advocated a scientifically justifiable optimism the practical realization of which will be a universal blessing. The importance of literature in the lives of the people at large is represented in 'A Song of Books,' and in the much-disputed 'The Choice of Books.' The social virtues find their praises recorded in 'The Blessings of Friends' and 'The Pleasures of Home.' The practical problems of modern life are touched upon in the essays on the value of time, on science, and on education. The plea for science is a just one: it aims to dispel the notion that science is all drudgery, or all grossly and immediately practical; the scientist a bug-hunter, and nothing more. The culture-worth of science, the educational value of its instructions, are amongst the most precious treasures of our civilization. The office of these in widening the mental horizon, in checking a narrowing dogmatism, in keeping alive a healthy communion with nature, can hardly be exaggerated. In the education of the future, science is destined to play a still more important part than it does now. One may well join the author in the wish for a glimpse of a science-primer of the twentieth century.

Home Sanitation: A Manual for Housekeepers. By the SANITARY SCIENCE CLUB of the Association of Collegiate Alumnae. Boston, Ticknor. 16^s.

THE Sanitary Science Club of the Association of Collegiate Alumnae was organized in 1883, for the study of home sanitation. Two years were devoted to general study and research before any attempt was made to extend the work beyond the limits of the club. Since that time the material presented in this little book of eighty pages has gradually taken form. It consists of a series of short essays on the different subjects connected with home sanitation, each of which is followed by a series of questions formulated with reference to the topics discussed, and so framed that an affirmative answer implies a satisfactory arrangement of that part of the home, while, if the answer is negative, a remedy for the defect is suggested. These questions have been practically tested by the

members of the club in their own homes, and by other housekeepers, and have also been adopted as the basis of a course in sanitary science offered by the Society to Encourage Studies at Home. The editors of the manual are Ellen H. Richards and Marion Talbot.

In the introductory chapter the editors call attention to the fact that the hygiene of the home is a subject of growing interest and importance. As one of the problems of social and economic science, it is beginning to receive the attention it may rightly claim. The women of our country are advised not only to follow the discussions which are carried on by sanitary congresses, boards of health, and other authorities, but by combining theory with practice, as few others can, to aid in solving the great questions which seriously affect the interests of the home and the family.

The object of this manual is to arouse the interest of housekeepers in the sanitary condition of their homes; not to alarm or discourage them, but to urge intelligent oversight, and to indicate the points requiring investigation, the methods of examination, and the practical remedies. One of the most dangerous qualities of the unsanitary house is that it does not always and at once produce a definite and virulent disease, such as typhoid-fever or diphtheria, but without doubt it slowly and insidiously causes ill health and general languor, which incapacitate for sustained effort, and to which women are especially subject from their greater confinement to the house.

Householders are reminded that it is not enough to secure right sanitary conditions: these must be maintained. This can best be done through the eternal vigilance of the housekeeper, who can thus, in a large measure, secure the two essentials of a happy home,—good health, and its attendant, good nature. The following motto should be the basis of her efforts: "Any invention intended to be a substitute for watchfulness will prove a delusion and a snare."

The following are the subjects discussed in the succeeding chapters: situation of the house, and care of the cellar; drainage and plumbing; ventilation; heating; lighting; furnishing; clothing; food and drink. The essays themselves are excellent, and the questions on them are very practical and suggestive. The manual also contains a paper read before the Association of Collegiate Alumnae, on sanitary work for women, by Annie E. Allen, in which some excellent advice is given to housekeepers on various subjects; such as their relations to their servants, the dangers connected with boarding-schools, and their duties to themselves.

The concluding paragraph of this paper is as follows: "The day is past when sickness was held to be a direct interference of Providence, as retributive punishment. Pestilence, fevers, and weakness are, indeed, penalties for sin, but it is the sin of ignorance. In this age of scientific enlightenment, and invention, and wide-spread information, ignorance of the primary conditions of health and vigor is unpardonable. A knowledge of sanitary principles should be regarded as an essential part of every woman's education, and obedience to sanitary laws should be ranked, as it was in the Mosaic code, as a religious duty."

We commend this little book to housekeepers, and hope that it will have wide circulation, and prove of as much benefit to those without the membership of the Sanitary Science Club as it evidently has to those upon its rolls.

The New Education. By GEORGE H. PALMER. Boston, Little, Brown, & Co. 16^c.

THOSE who are studying the many problems attending the development of our colleges and universities will be grateful to Professor Palmer of Harvard for preserving in permanent form the three articles which make up this book. On the appearance of the first of them in the *Andover Review*, some eighteen or twenty months ago, attention was directed to it as the strongest and fairest plea for the system of free electives in the college course, that had been published. It was immediately subjected to criticism and attack; and in the two other articles which form part of the volume before us, Professor Palmer replied to his critics.

Professor Palmer takes pains to keep one fact, fundamental to the fair discussion of the Harvard system, before his readers; namely, that the particular modes of choice now in use at Harvard are not finalities. They are a stage, merely, in the development,

and it is to be expected that other and better systems will eventually be found, both at Harvard and elsewhere. This consideration has been largely overlooked in the many discussions which have taken place, and omission to give it proper weight has prejudiced the Harvard case very much.

The peculiar strength of Professor Palmer's argument arises from the fact that it rests on a philosophical and ethical basis. It is not an appeal for conformity to a changing environment, although that feature is recognized; nor is it an *ex parte* argument for some preconceived system. It starts from the individuality of the pupil, and demands that his will and character be trained, and that by the exercise of his own free will,—the only character-building that amounts to any thing. Professor Palmer has no difficulty in making out a theoretical case from this standpoint, nor does he find any but cumulative evidence for his system in such facts as he cites from college-history. It must be admitted, too, that he has little trouble in offsetting the objections raised against his ideal plan by most of his critics. He does not allude, however, to Professor West's analysis of President Eliot's report for 1884-85, which many persons regard as the most damaging criticism on the Harvard system that has appeared. We regret this, for Professor West's paper has had a wide influence; and if Professor Palmer could successfully refute its conclusions, he should have done so.

We can heartily agree with the present author in holding that character-building is the main object of education, and that character-building is not mechanical, but organic. It depends, therefore, upon the pupil himself; and habitual wisdom of choice can only be attained through freedom of choice. We agree also in holding that the elective principle has come to stay, and that it will never again be wholly absent from any successful college. But we cannot conclude so rapidly as does Professor Palmer, that unlimited election is the wisest system. It may in time be proved to be so, but we cannot agree that it is proven to be so now. The danger of abuse and the tendency to over-specialization are so great, that we must ask for some provision to be made against them. Moreover, wiser heads than those of eighteen-year old boys know far better than the latter what sorts of knowledge are essential, and what non-essential. We would never urge a return to the old-fashioned inelastic course of study; but we do believe that the group system, modified in certain details, is superior to a system of unlimited election. We believe that under it there is found the freedom of choice which Professor Palmer insists on, as well as the necessary limitations to the abuse of that freedom by untrained minds. We would have it more elastic than it is found at present; we would have a greatly increased number of groups provided, but we would retain its fundamental principle. As the free man must exercise his freedom with due regard to the rights of his fellows, so the freedom of a student's choice must be limited by the teachings of experience. Professor Palmer himself seems to see the force of this position, for he says (p. 105), "Whenever I can hear of a group system, which like the old college has a place for the indistinct young man, and like the new elective college matures him annually by suggesting that he take part in shaping his own career, I will accept the group system." We have confidence that such a system of groups will be forthcoming in due season.

The remarks of the author toward the close of his volume (pp. 142-144, 149, 150, *et ff.*) as to the form of instruction and the character of the studies during the two final years of the college course, are intensely practical, and we trust that they will be heeded. As to methods of collegiate teaching, Professor Palmer says, "Recitations pure and simple have serious drawbacks. They presuppose a text-book, which, while it brings definiteness, brings also narrowness of view. The learner masters a book, not a subject. After-life possesses nothing analogous to the text-book. A struggling man wins what he wants from many books, from his own thoughts, from frequent consultations. Why should not a student be disciplined in the ways he must afterwards employ?" "A pure lecture system is a broad road to ignorance. Students are entertained or bored, but at the end of a month they know little more than at the beginning. . . . Personal sanction is wanted for every step. One who will grow wise must perform processes himself, not sit at ease and behold another's performance."

He again strikes a telling blow at the crude courses of study

in many colleges, when he says (p. 149), "Elementary studies are not maturing studies: they do not make the fibre of a student firm. To studies of a solidifying sort the last years should be devoted. I should like to forbid seniors to take any elementary study whatever, and to forbid juniors all except philosophy, political economy, history, fine arts, Sanscrit, Hebrew, and law. Under such a rule, we should graduate more men who would be first-rate at something; and a man who is first-rate at something is generally pretty good at any thing."

Professor Palmer's forceful thinking is interpreted by a lucid style, which adds greatly to its charm. No one interested in our American colleges can afford to leave the book unread.

N. M. B.

NOTES AND NEWS.

THE 'Bibliography of the Eskimo Language,' by James C. Pilling, is the first of a series of bibliographies of American languages which will be published as bulletins of the Bureau of Ethnology. A few years ago Mr. Pilling published a bibliography of North American languages, of which a limited number of copies were printed. The material has so rapidly increased in the hands of the author as to make a revised edition desirable. We consider the new form of the publication a great improvement, as the division of the material according to linguistic stocks makes the volumes handier. The arrangement of the material is alphabetic, both the names of the authors and the titles of the works being given. Thus the finding of any desired material is made very easy. Particularly valuable are the cross-references given under the heading of 'Greenland,' 'Aleut,' and other localities or tribes, and those under the heading of 'grammar' and 'vocabulary,' as they contain all material on these subjects. Mr. Pilling has comprised in his bibliography, books which contain only occasional remarks on Eskimo dialects in the text, though no connected accounts of the language are given. This made the compilation very difficult, as the material of this kind is scattered over an enormous literature. Notwithstanding this difficulty, Mr. Pilling has succeeded in bringing together an enormous amount of material. We do not think that many works of great importance are omitted, though the number of works containing remarks on Eskimo dialects might be considerably enlarged. We miss the important vocabulary of Rev. Gasté from Chesterfield Inlet, which was published by Petitot. Furthermore, the earliest records of the Eskimo language are older than Pilling states. In the description of the second voyage of Martin Frobisher, which was published in 1577, we find the name of a chief, 'Catchoe,' mentioned. In the 'Second Voyage attempted by Master John Davis, with others, for the Discovery of the North-west Passage, in anno 1586,' which was published in Hakluyt's, 'Principall Navigations,' 1589, a brief vocabulary is given. But these are slight defects which are unavoidable in a bibliography. The work will be indispensable for the student of Arctic ethnology and philology.

— The following is a list of the United States Coast and Geodetic Survey parties in the field, or assigned to field-duty, for the present season: Prof. George Davidson, primary triangulation in southern California, and in charge of work on Pacific coast; C. O. Boutelle, reconnaissance for triangulation to furnish points for State survey, Minnesota; H. L. Whiting, directing work of State survey, Massachusetts, and survey of Vineyard Sound, etc.; A. F. Rodgers, physical hydrography, San Diego Bay, and topography south coast of California; G. A. Fairfield, transcontinental triangulation in Indiana; J. S. Lawson, primary triangulation in California; C. Rockwell, topographical reconnaissance, coast of Oregon; W. H. Dennis, topographical reconnaissance, Long Island Sound; A. T. Mosman, transcontinental triangulation in Ohio; J. W. Donn, topography, District of Columbia; C. H. Boyd, triangulation, coast of Maine; Charles Hosmer, topography, coast of Maine; C. T. Iardella, topography, Long Island; R. E. Halter, in charge Magnetic Observatory, Los Angeles, Cal.; Gershom Bradford, triangulation in Massachusetts, furnishing points for State survey; H. L. Marinidin, physical hydrography, New York Bay; William Einebeck, transcontinental triangulation in Utah; F. W. Perkins, reconnaissance for triangulation in Indiana; J. J. Gilbert, triangula-

tion and topography, Washington Territory; Stehman Forney, topography, southern California; O. H. Tittmann, triangulation, coast of Maine; F. D. Granger, transcontinental triangulation, Kansas; Edwin Smith, telegraphic longitudes, Western States; Eugene Ellicott, topography, coast of Maine; E. F. Dickens, triangulation and topography, coast of Oregon; W. I. Vinal, survey Vineyard Sound, etc.; J. F. Pratt, triangulation and topography, Washington Territory; J. B. Baylor, magnetic work, Northern States; C. H. Sinclair, telegraphic longitudes, Western States; C. H. Van Orden, triangulation, Massachusetts; W. C. Hodgkins, topography, District of Columbia; R. A. Marr, re-survey Vineyard Sound; J. E. McGrath, levelling New York harbor; E. L. Taney, re-survey Vineyard Sound, etc.; J. H. Gray, topography, coast of Maine. Prof. George Davidson is just completing a new edition of the 'Pacific Coast Pilot' (to include the coasts of California, Oregon, and Washington Territory), about eight hundred pages of which have been received at the Coast Survey office, ready for the printer.

— The cable informs us that a letter from Emin Pacha dated Feb. 10, 1887, has been received. It seems that the attitude of King Mwanga towards Emin is far more friendly than some time ago, for Emin says that he hopes to make his retreat from his province by way of Unyoro. If he shall have succeeded in doing so, Stanley will be too late; but it is more probable that Emin, on hearing of Stanley's expedition in Unyoro or Uganda, will stay on the Mvutan Nsige, and await his arrival, or will try to meet him.

— We learn from *The Athenæum* that the government of India have undertaken a topographical survey of the native states of Travancore, Pudukota, and Cochin. The last survey was made seventy years ago. Some of the mountainous tracts of Travancore and Cochin are still absolutely blank, so that there will be much original work to be done.

— Professor Helmholtz, says *The Athenæum*, has been appointed president of the *Kuratorium* of the Physical and Technical Imperial Institute, which is to be opened at Berlin in 1888. Dr. Werner Siemens, who laid the foundation of the institute by his liberal gift, and Dr. Förster, the director of the Berlin Observatory, will also be curators.

LETTERS TO THE EDITOR.

* * * The attention of scientific men is called to the advantages of the correspondence columns of *Science* for placing promptly on record brief preliminary notices of their investigations. Twenty copies of the number containing his communication will be furnished free to any correspondent on request.

The editor will be glad to publish any queries consonant with the character of the journal.

Correspondents are requested to be as brief as possible. The writer's name is in all cases required as proof of good faith.

Temperance-Teaching.

MY attention has been called to the article on temperance, in *Science* of July 29. As evidence that I have given the subject some thought, I enclose you a copy of questions used last April in the schools of my county, in which no reference is made to stimulants or narcotics. I am inclined to think that constant reference to these subjects may tempt some of that age to a trial, in order to satisfy themselves if the sensation is as represented. General Grant says, "I know from my own experience, that when I was at West Point, the fact that tobacco in every form was prohibited, and the mere possession of the weed severely punished, made the majority of the cadets, myself included, try to acquire the habit of using it."

JNO. TERRUNE.

Hackensack, N. J., Aug. 1.

Audubon's Grave.

THE Audubon matter stands about thus: the great ornithologist is buried in an old family vault, not in the best order, at the extreme south-west corner of Trinity Cemetery. Only the name 'Audubon' under the door gives any indication.

Some street alterations are to be made ere long, which will cut close to this vault. An offer has been made by the trustees of the cemetery, and accepted by the Audubon family, to remove the remains, and place them in a plot (granted for the purpose) at the head of Audubon Avenue. The movement now proposed is to raise funds among the ornithologists for a worthy monument to mark the spot. The orphan grand-daughters are not able to do

much—perhaps any thing—towards it; nor should they be expected to. It is a matter in which American naturalists surely should be proud and glad to aid. It is intended to bring it before the American Association in some form, next week, and I should be very glad to have a notice in *Science* regarding it.

D. S. MARTIN.

New York, Aug. 1.

Four Large South African Diamonds.

A MODEL of the Victoria, the Great White Diamond, or the Imperial as it has been more recently called, having been sent to this city lately, and nothing having been published in any scientific periodical concerning this stone, it occurred to the writer that some illustrations showing it in its natural, uncut form, as well as after cutting, might be of interest. Concerning its early history very little is known: in fact, where the stone was found is only a matter of conjecture,—a remarkable circumstance when we consider that this is the largest brilliant in the world.

An explanation by a letter in the *London Times* was given, as follows: "that this stone was not found in English dominions at all, but in the neighboring Orange Free State; that it had been found by a boor on his farm, who, knowing it to be a diamond, but fearing being turned out of his farm by a mob, kept the secret a whole year, until a Mr. Allenberg of Porth-Elizabeth saw it, and forwarded it to London."

It is, however, believed that it was found by some one in one of the Kimberley mines, South Africa. The first intimation that any of the various mining companies had of its existence was when they heard of its safe arrival in London. It is generally supposed that in the month of June or July, 1884, the stone had been found by one of the surveillance officers of the Central Mining Company in the Kimberley mines. It being his duty to search others, he had the privilege of not being searched himself, and so the stone was passed through the searching-house, and he was afterwards supposed to have found means of communicating with four illicit diamond-buyers. Owing to the stringency of the diamond laws of Griqualand-West, the trading in rough diamonds is forbidden any one not owning one of the 'patents' or 'licenses,' as they are called, costing £200 and a guaranty of £500. All purchases made by them must also be entered in a special registry, and are duly signed every week by the police authorities. £3,000 was the price paid to obtain the stone from the first possessor. To prepare themselves for the ordeal of transporting the stone out of the district, they assembled at night, commenced drinking, then gambling, and after a night's debauch two of the party lost their share in the big stone. The other two reached Cape Town in safety, where the diamond laws are not in force, and from a dealer there received £19,000 cash for their stone. An outward duty of one-half per cent is collected on all shipments of diamonds from Cape Colony; but this diamond is said to have been carried by one of the passengers of a mail steamer, and was hence undeclared. We next hear from it in London, causing considerable sensation at Hatton Garden, the great diamond-market. After considerable time had been spent in trying to find a capitalist who could afford to buy such a gem, it was at last arranged by a former resident of the Cape mines to form a company of eight persons, who bought the stone together for £45,000 cash, on condition that if they should dispose of it each should receive a ninth share in the eventual profits.

Before cutting, it was estimated that the crystal would furnish either of the following gems; if cut as a briallette, 300 carats; as a drop, 230 to 240 carats; as a lozenge, 250 carats; and as a mathematically perfect brilliant, 150 carats. If cut in the latter form, it would have furnished cleavages that would cut into one 40-carat, one 20-carat stone, and 40 carats of smaller stones. It was finally decided to cut it into the largest possible brilliant, still preserving a good shape, and Amsterdam was selected as the place where the gem could best be cut.

It was accordingly sent to the polishing-mills of Jacques Metz, who erected a special workshop for the purpose. In order to better obtain the brilliant form of cutting, a piece was cleaved off which furnished a 19-carat diamond, and was sold to the King of Portugal for £4,000. The cutting of the large stone, which was commenced on the 9th of April, in the presence of the Queen of Hol-

land, took about twelve months, since, instead of being cut by abrasion with another diamond, as diamonds are usually cut, it was polished down on the scaif; and a great amount of time was consumed by the cooling of the stone, as it heated after an hour's running on the wheel. The cutter of the stone was M. B. Barends. The stone in its finished condition weighs 180 carats, and is a beautiful, perfect, steel-blue diamond, and is the largest brilliant in the world.

It is 39.5 mm. ($1\frac{5}{8}$ inches) long, 30 mm. ($1\frac{1}{4}$ inches) wide, and 23 mm. ($\frac{7}{8}$ of an inch) thick, being exceeded in size by one diamond only, the Orloff, belonging to the Russian crown, which weighs 194½

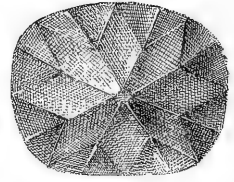
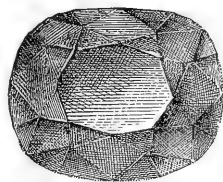
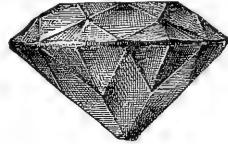

FIGS. 1, 2, 3.

carats, but is a large deep rose, and not a brilliant. The Victoria exceeds the Regent in weight by 44½ carats. The Kohinoor weighs only 106 $\frac{1}{10}$ carats.

The three figures (Figs. 1, 2, 3) give the front, back, and side features of the stone. It will be observed that the form is not entirely even, and that on one side of the girdle there is quite a flat place, a natural unpolished surface, necessary, in cutting, to preserve the large weight of the stone. It is, however, a perfect 58-facet brilliant.

The original weight of the stone was 457½ carats, 3 $\frac{3}{8}$ ounces



FIG. 4.

Troy. The figure (Fig. 4) is drawn from two photos, that, strange to say, had been taken by a Cape photographer, and fortunately passed through my hands; and the stone to-day is held by a London syndicate for £200,000.

The Tiffany Company large yellow diamond (Figs. 5, 6, 7) weighs 125½ carats, is absolutely perfect, is a 'double-deck' cut brilliant, as it is termed, and is undoubtedly the finest large yellow diamond known. It was found in the Kimberley mine about nine years ago, and was cut in Paris. One of the most pleasing features is that it not only retains its rich yellow color by artificial light, but is even more beautiful than by day. It has 40 facets on the crown, 44

facets on the pavilion or lower side of the stone, and 17 facets on the girdle: total number, 101. Because of its deep color, this is a finer stone than the historical Star of the South (125 carats), which was purchased by the Mahratta, ruler of Baroda, for \$400,000, at the French Exposition, 1867. It also rivals the Florentine, which, according to Schrauf's determination (*Sitzb. d. k. Akad. d. Wissensch.*, Band 54, Abtheil. i. Nov., 1866), weighed 133½ carats, and was sold for 2,000,000 florins, but is only a long double rose or drop, and not a brilliant.

The Tiffany Company No. 2 (see Figs. 8, 9) weighs 77 carats, is

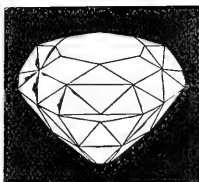
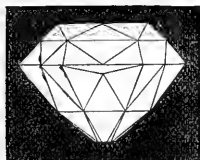
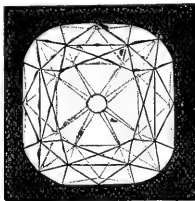

FIGS. 5, 6, 7.

of a light-yellowish color, is absolutely perfect, and is one of the few large stones that have been cut for beauty and not for weight. It is so evenly cut that it will stand on the culet, which is only of the regular size. This stone was exposed to a strong blazing sunlight for thirty minutes, two thermometers registering 110° to 120° F. during the whole time of exposure; and only a very faint, if any, phosphorescence was observed, although the stone was placed in a dark-room within thirty seconds after exposure. It had been laid on a black velvet case during the whole time of the experiment,

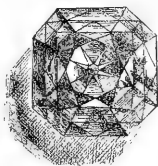
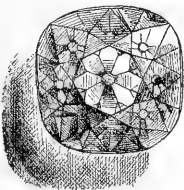

FIGS. 8, 9.

FIGS. 10, 11.

and nothing came in contact with it while it was being carried to a place of darkness. Its specific gravity is 3.523+ at 60° F.; it measures 26 mm. (1¼ inches) in length, 25 mm. (1 inch) in width, and 17 mm. (⅔ of an inch) in thickness; there are 33 facets on the crown or upper side of the stone, and 25 facets on the pavilion or back; and, in addition, there are 55 small facets evenly distributed around the girdle.

Figs. 10 and 11 show a fine yellow diamond, weighing 51½ carats, also from South Africa, and recently recut by Tiffany & Co. in New York City. It is absolutely perfect, and without flaws. It meas-

ures 22 mm. (⅔ of an inch) in length, 22 mm. in width, 23.75 mm. (⅔ of an inch) at the corners, and 15.75 mm. (⅔ of an inch) in thickness; there are 73 facets on the crown or upper side of the stone, and 49 facets on the pavilion or back; and the cutting, which is that of a double-deck brilliant with some of the lower crown-facets divided in two, is quite unique, forming a remarkably beautiful gem.

GEORGE F. KUNZ.

New York, Aug. 1.

Pars Propatagialis muscoli cucullaris.

In a previous number of *Science* (ix. p. 623) Dr. Shufeldt publishes an account of his discovery of "another muscle in birds of taxonomic value,"—a muscle which he thinks unnamed, proposing for it the name '*dermo-tensor patagii*,' and of which he says that "Garrod, even if he knew of its existence, certainly overlooked" it.

This muscle is by no means a new discovery, nor is it in want of names. In the first place, it is Fürbringer's and Gadow's "*pars propatagialis m. cucullaris*." Slightly modified, it is Viallane's "*temporo-alaris*." Gervais and Alix are said to have called this muscle "*tenseur de la membrane axillaire*," and other names might also be quoted. That this muscle has not been "pressed into service with telling effect in taxonomy of the class" is simply due to the fact that Dr. Shufeldt's predecessors found that it did not have the taxonomic value which he seems to attribute to it. He seems to suppose that it is peculiar to the "true passerine birds," by which term I suppose he means the "*Oscines*," since he excludes *Tyrannus* and the "typical *Passeres mesomyodi*." This is not the case, however, as the appended two figures demonstrate, which show that it is typically developed in at least some woodpeckers and parrots.

Dr. Shufeldt, in the paper alluded to, does Garrod great injustice. As I have already pointed out, the muscle is a well-known one, and it is quite unwarrantable to suppose for one moment that Garrod was ignorant of its existence ("even if he knew its existence"). When Garrod wrote his paper on the wing-muscles of birds, he had dissected about one hundred and fifty species of the most different groups of *Passeres* and picarions; and even if he was ignorant of the literature, which of course he was not, he could not possibly have overlooked so conspicuous a muscle. But the fact is, that in the paper in question he treats almost exclusively of the *tensor patagii brevis*, and *t. patagii longus* is only mentioned by the way. The muscular slip which inserts itself on the latter is therefore not at all mentioned, but that does not justify the conclusion that it was overlooked. On the contrary, in the numerous figures which accompany Garrod's paper, it is plainly shown in the only "true passerine bird" (*oscine*) figured by him; viz., *Icterus*. And here Dr. Shufeldt grossly misrepresents Garrod. He says, "Garrod chose the wing of *Ramphastos cucvieri* to illustrate the arrangement of the patagial muscles in the *Passeres*, but not a hint of this one is given" (Italics mine).² Of course, Garrod did nothing of the kind: he was too good an ornithologist to believe that *Ramphastos* is one of the *Passeres*. And in point of fact, Garrod expressly states that he presents the figure as representative of a typical picarian bird. That in this case "not a hint" of this muscle is given, should, then, no longer surprise Dr. Shufeldt.

The muscle in question is quite variable, but its true nature as a slip of the deeper portion of *m. cucullaris* (*panniculus carnosus*) may be plainly seen when dissecting such a bird as the English sparrow (*Passer domesticus*). In the free margin of the *parapatagium*, as I call the duplicature of the skin between the neck and the shoulder, which is only a continuation of the *propatagium*, you find a well-developed muscle, which, by means of a tendon at its distal end, inserts itself on the *tensor propatagii longus* at about the middle of the latter. The portion of *m. cucullaris* from which this slip is given off, in its upper extremity corresponds closely with Viallane's *temporo-alaris*, it being easily separated from the skin, and inserts itself on the head above the temporal muscle, while in its entire length it is separated from the dorso-medial line by a considerable space.

¹ See also where he speaks of the "passerine affinities" of *Ampelis* in contradiction to the "clamaratory ones."

² That this is not a *lagus calami* is evident both from the line italicized, and from the fact that in the explanation of Fig. 1 *Ramphastos cucvieri* is again referred to as "a passerine bird."

These parts are quite similar in the red-breasted grosbeak (*Habia ludoviciana*); but the upper portion of *cucullaris* is wider, apparently reaching the dorso-medial line, and is not so distinct from the skin. The propatagial slip is quite strong, and blends with the tendon of *t. propatagii longus* farther towards the metacarpus, although not distinct so far as in the swallow figured by Dr. Shufeldt.

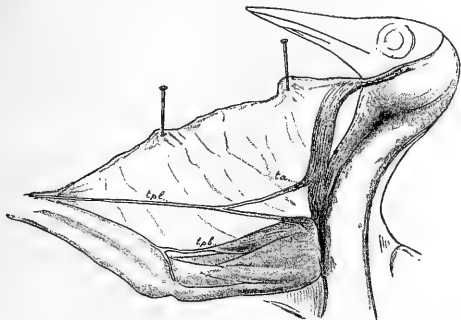

FIG. 1.—DORSAL VIEW OF THE PATAGIAL MUSCLES OF A WOODPECKER, *COLAPTES AURATUS* (DISSECTED AND DRAWN BY THE PRESENT WRITER).

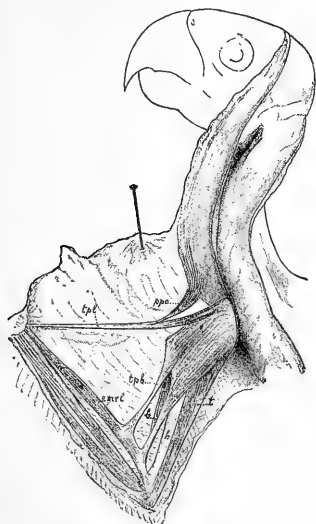

FIG. 2.—CORRESPONDING PARTS OF A PARROT, *AMAZONA LEUCOCEPHALA* (DISSECTED AND DRAWN BY THE PRESENT WRITER).

tpl, tensor propatagii longus; *tpb*, tensor propatagii brevis; *ta*, temporo-alaris, or *ppc*, pars propatagialis m. cucullaris; *b*, biceps; *t*, triceps; *h*, humerus; *emrl*, extensor metacarpi radialis longus. (Both figures one-third natural size.)

From the arrangement as I find it in a young flicker (*Colaptes auratus*), to that of the fully detached *temporo-alaris* of *Lophorina*, there is but a very short step, as will be seen from the accompanying figure (Fig. 1). The insertion on *t. propatagii longus* is more distal, however, than in *Lophorina*.

On the other hand, the case of *Amazona leucocephala* (Fig. 2) is more like that of *Habia*; but here again there is a difference in regard to the insertion of the tendon, it being more proximal in the parrot, though not so much so as in *Lophorina*.

From Dr. Shufeldt's description, it would seem as if, in the swallows at least, the temporal part of the muscle has become obsolete, — an arrangement corresponding exactly to that which Mr. Viallane found in the cockatoos.

In *Lophorina superba*, as shown by Mr. Viallane, the posterior

end of *cucullaris* is the portion that has become obsolete. The parapatagial slip is here strongly developed, and the junction with *propatagialis longus* takes place rather close to the shoulder.

Dr. Shufeldt claims that this muscle in question is 'wholly absent' in the kingbird (*Tyrannus tyrannus*). In this case, also, I am forced to disagree. Upon dissecting a bird of this kind, I find the propatagial slip of *cucullaris* present, but it does not insert itself on *propatagialis longus*, nor does it develop any tendon at its distal termination. It inserts itself, however, on the skin just where it overlies the fleshy portion of *propatagialis longus*. As in the other birds examined, it follows the free margin of the *parapatagium*.

In a young *Sayornis phoebe* the arrangement is essentially the same, though less distinctly developed, only a few muscular fibres being traceable.

A cuckoo (*Coccyzus erythrophthalmus*) gave a similar result. The whole *m. cucullaris* was exceedingly thin, with the fibres greatly disconnected.

Returning to those species in which the propatagial slip joins the *tensor propatagii longus*, I wish to record the fact, that both in *Passer* and *Habia* I found the propatagial portion of *m. cucullaris* to give off a slight muscular slip to the base of the humeral feather-tract, the feathers of which it probably helps to raise.

This leads to the question as to the function of the propatagial slip. In the first place, it acts as a *tensor parapatagii*. When particularly developed in its proximal portion, as in *Lophorina*, it also raises the elongated neck-feathers, while special development of its tendineal portion aids in strengthening the *tensor propatagii*.

The fact that it occurs similarly developed in so distantly related groups as the parrots, the woodpeckers, and the acromyodian *Passeres* (or *Oscines*) robs it, to a great extent, of its taxonomic value; even were it proven to be present in all the latter, and absent in all the *mesomyodi*, of which we are by no means sure. The example, however, which Dr. Shufeldt adduces to show its importance, is not a very fortunate one; for no ornithologist who knows that *Ampelis*, the waxwing, and the cedar-bird have laminiplatar tarsus, rudimentary tenth primary, and acromyodian (oscine) syrinx, has had any excuse for suspecting, during the last forty-five years, that its "clamatorial characters" are "predominating in its organization."

Since the above was placed in the hands of the publisher, Dr. Shufeldt has corrected (*Science*, July 29) the mistake in regard to *Rhamphastos* being a passerine bird, — a mistake which he said was caused by circumstances beyond his control. It is a matter of congratulation that he also presents a new drawing of the propatagial muscles of the swallows, in which he corrects the mistake of the former drawing, which represented the swallows as having a *tensor propatagii brevis* with an insertion similar to that of the picarian *Rhamphastos*.

LEONHARD STEJNEGER.

Smithsonian Inst., Washington, D.C., July 22.

Cause of Consumption.

IN the number of your journal for July 8 my respected friend, Dr. Donaldson, has a compact article on the cause of consumption. I agree to every word of it, but would suggest that he has not named one influence which for many years I have held to be a most potent one in New England, and also in Old England, in the development of that terrible disease; viz., residence upon a damp soil. This factor was first proved to be a powerful one in Massachusetts in 1862. Three years subsequently it was proved still more conclusively to exist in England by Dr. Buchanan, medical officer of the Local Government Board of that country. So far as I know, nothing has been done to prove or disprove whether it prevails over the whole world, or only on certain portions of it. I believe, from facts which I have already learned, that it is really a cosmic law. As it is desirable that it should be proved or disproved in this wide sense, I would respectfully suggest it as a subject worthy of the appointment of a world's commission, consisting of an able man from every country that may be represented in the International Medical Congress, which is to be held in Washington this autumn.

My professional experience since the law was first found to be

operative in New England has proved to my own satisfaction that it is vain to attempt to treat consumption while the patient is subjected to this deleterious influence; fatal, indeed, I might call it. My first prescription is to leave the damp locality. Why such a residence tends strongly to the production of consumption—whether as having something, as yet unknown in itself, or that it acts as the nursery of bacilli—I cannot say. But I feel in regard to the above practical rule, as the late Dr. John Ware said to me, that, “with the evidence which has been presented, I feel that I should be criminally in fault in regard to a patient if I did not enforce it.”

If any one wishes for further information, I refer him to Dr. Buchanan's reports to the Local Government Board (1866 and 1867),¹ my addresses before the Massachusetts Medical Society in 1862,² and before the International Congress which met at Washington in 1876.³

HENRY I. BOWDITCH.

Boston, July 23.

Technical Education.

I HAVE to-day received from Sir Henry Roscoe copies of two bills recently introduced into Parliament, through the action, I presume, of the National Association for the Promotion of Technical and Commercial Education, of which the Marquis of Hartington is president, providing for an extension of the technical branches of education in the general scheme. Accompanying these bills is a request for information in regard to what is being done in the United States. I take the liberty of suggesting that such among the readers of *Science* as may have any information of this nature which may be of service to the cause in Great Britain send any documents that may contain it, either directly to Sir Henry Roscoe, at 5 Palace Chambers, Bridge Street, Westminster, S. W., London, or, if preferred, to me. I will see that any thing so sent is forwarded, and should be particularly obliged if duplicates could be at the same time supplied for my own use.

The bills above referred to consist of provisions for the introduction of technical studies and the simpler forms of manual training into day and evening schools, and empower the school boards, local authorities, or managers of public elementary schools, to provide instruction in the use of ordinary tools, in commercial arithmetic, geography, book-keeping, modern languages, and freehand and machine drawing. The powers of the authorities are extended to these schools as in the common schools, defined in the Elementary Education Act of 1870, and they are given leave to apply for grants, and to raise funds, for these technical schools as for the older forms of elementary schools. The term ‘parliamentary grant’ is held to include any grant made by the Science and Art Department. This legislation is prepared and brought into Parliament by Sir Henry Roscoe, Sir Lyon Playfair, Mr. Dixon, Sir John Lubbock, and Sir Richard Temple (5o Vict.).

The evening schools thus provided for are also authorized to provide instruction in the ordinary school studies of the primary grades, and for the girls, sewing, cooking, domestic economy, and hygiene.

R. H. THURSTON.

Ithaca, N. Y., July 23.

Distillery-Swill as a Food for Milch-Cows.

PLEASE send me *Science*, commencing with June 10, containing the first article on distillery report; also your *Swiss Cross*. We are interested in the milk articles now coming out in *Science*.

Some eighteen years ago I owned a dairy, and run on one thousand acres of land eight hundred cows. I had one stable that held 672 cows; it was kept clean, and was well ventilated. For eighteen months I fed distillery-swill. From my experience in feeding swill to milch-cows, I should say that it produces tuberculosis. In ad-

¹ Reports of the Medical Officers of the Privy Council, 1866-67, proving that subdrained, sewered towns have less consumption than others not so subdrained; or, as Mr. Simon expresses himself, “*dampness of the soil is an important cause of consumption to the population living upon the soil*” [Mr. Simon's Italics].

² Consumption in New England, or Locality One of its Chief Causes: an Address delivered before the Massachusetts Medical Society. By Henry I. Bowditch, M.D. Boston. Ticknor & Field, 1862.

³ Public Hygiene in America; being the Centennial Discourse delivered before the International Medical Congress, Philadelphia, September, 1876. By Henry I. Bowditch, M.D. With extracts from Correspondence from the Various States, together with a Digest of American Sanitary Law, by Henry G. Rehering, Esq. Boston, Little, Brown, & Co.; London, Trubner & Co.; 1877.

dition to swill, I fed grass and hay, and during the summer months ‘soiled.’ At the expiration of eighteen months, I stopped feeding swill; and the number of cows that had to be disposed of because they had consumption was reduced to so few, that I do not now remember that there were any. It is my opinion that if cows are closely confined, and fed on swill and hay exclusively, tuberculosis will develop in nine cows out of every ten inside of a year. The nutritive quality of swill-food depends upon the amount of water put upon the grains after fermentation. I have never had any practical experience in feeding sweet distillery-swill; but if fed in moderate quantities, not too hot and sweet, and with hay and other dry and very nutritious food, I can see no reason why it should be harmful. Parties who produce swill-milk for sale in large cities find swill to be the cheapest food for the production of milk, and consequently use it to excess. I have never seen swill fed sweet in more than one city dairy, and I have been in fifty.

CHARLES CABANNE.

St. Louis, July 25.

Queries.

12. MOSQUITOES.—Is any one able to corroborate the following observation of an old resident of Staten Island? “I have lived on Staten Island twenty years,” said an old gentleman on the Staten Island ferryboat the other evening, “and I have noticed a remarkable thing about the mosquitoes. They always disappear after a storm, and it is invariably just seven days before they return.”

T. J. H.

13. ELECTRICITY AND THE EARTH.—Professor Dolbear, in *Science* for July 29, at p. 60, says, “As for the earth being a reservoir of electricity, every thing that is known about electricity negatives the idea.” On the other hand, at p. 507 of Deschanel's treatise on natural philosophy, translated by J. D. Everett, the statement appears, “On account of its practically inexhaustible capacity for furnishing or absorbing electricity, the earth is often called the *common reservoir*.” Upon the next page of the text-book named, the effect of moisture in the atmosphere upon the insulation of electrical machines is discussed in a manner that is misleading, if Professor Dolbear's statements in regard to the relative conductivity of dry and moist air are rightly understood. Has Deschanel been superseded?

M. A. VEEDER.

Lyons, N. Y., July 30.

Answers.

10. ROBIN'S NEST.—I have in my collection a three-story robin's nest taken from the sill of an unused window of the Watertown High School. I have often seen the old birds in the spring repairing the nest, and have photographed the bird and nest *in situ*.

H. M. HILL.

Watertown High School, N. Y., Aug. 7.

11. LAKE ITASCA.—A recent official bulletin of the Minnesota Historical Society, entitled ‘The Sources of the Mississippi,’ submits the following (p. 24) as one of the “results of their finding:” “That Henry Rowe Schoolcraft, accompanied by Lieut. James Allen, in a scientific expedition made by him, July, 1832, to the head waters of the Mississippi River, did discover, locate, delineate, and map the general basin, which is the first great gathering-place and reservoir of the head waters of that continental stream, and was by him named Lake Itasca, from the Latin words *veritas caput* (‘the true head’).” A more particular account of the occurrence is given, with other historical matter, in, I think, Andrea's or Andrea's large atlas of Minnesota, to which I have not present access. The statement is substantially this: Schoolcraft who was not a classical scholar, having arrived at the lake, asked of one of his party, perhaps Lieutenant Allen, the Latin equivalent for ‘true’ meaning ‘real,’ and was given *veritas*. He then desired the Latin for ‘head,’ and, being told it was *caput*, at once formed the combination Itasca, and applied it as a name to his new-found lake. It thus appears that the term *veritas* may either have been given Schoolcraft through mere inadvertence, or through misconception of his inquiry, as supposing him to wish an equivalent for ‘the true,’ ‘the real,’ in its substantive instead of its adjective form.

FRANC E. BABBITT.

Coldwater, Mich., July 22.

SCIENCE

FRIDAY, AUGUST 12, 1887.

WHAT AMERICAN ZOOLOGISTS HAVE DONE FOR EVOLUTION.¹

LADIES AND GENTLEMEN, — Eleven years ago I had the honor of reading before this association an address in which an attempt was made to show what American zoologists had done for evolution. My reasons for selecting this subject were, first, that no general review of this nature had been made; and, second, that many of the oft-repeated examples in support of the derivative theory were from European sources, and did not carry the weight of equally important facts the records of which were concealed in our own scientific journals. Darwin was pleased to write to me that most of the facts I had mentioned were familiar to him, but, to use his own words, he was amazed at their number and importance when brought together in this manner. The encouragement of his recognition has led me to select a continuation of this theme as a subject for the customary presidential address, — a task which is at best a thankless if not a profitless one. Had I faintly realized, however, the increasing number and importance of the contributions made by our students on this subject, I should certainly have chosen a different theme.

Incomplete as is this record of ten years' work, I am compelled to present it. In the Buffalo address two marked periods in the work of the zoologists in this country are recognized: the one period embracing the work of the topographers, the field-surveyors in the science; the other period dating from the advent of Agassiz, with the wonderful impulse he imparted to the study by his enthusiasm and devotion. A third period in American zoological science, and by far the most important awakening, dates from the publication of Darwin's 'Origin of Species.' Its effect on zoological literature was striking. The papers were first tinged with the new doctrine, then saturated, and now, without reference to the theory, derivation is taken for granted.

As zoologists, we are indebted to Darwin for the wide-spread public interest in our work. Before Darwin, the importance of our special studies was far outweighed by the practical value placed upon science, in the application of which an immediate material gain was assured. Chemistry, physics, geology, were important only because a practical application of these sciences was capable of showing an immediate material return.

Agassiz, in his appeal to the State for appropriations for the great museum at Cambridge, insisted that there were higher dividends than money ones to be looked for in endowments for zoological museums, and these were intellectual dividends. While the force of this appeal will always remain true, the transcendent importance of the naturalist's studies from the standpoint of Darwin is widely recognized. Man now becomes an object of rigid scientific scrutiny, from the new position which has shed such a flood of light upon the animals below him. His habits, behavior, the physical influences of his environment and their effects upon him, transmission of peculiarities, through the laws of heredity, — all these factors are directly implicated in the burning questions and problems which agitate him to-day. Questions of labor, temperance, prison-reform, distribution of charities, religious agitations, are questions immediately concerning the mammal man, and are now to be seriously studied from the solid standpoint of observation and experiment, and not from the emotional and often incongruous attitude of the Church. To a naturalist it may seem well-nigh profitless to discuss the question of evolution, since the battle has been won; and, if there be any discussion, it is as to the relative merits and force of

the various factors involved. The public, however, are greatly interested in the matter, as may be seen by a renewal of the fight in the English reviews; and the agitation is still kept up by well-meaning though ignorant advisers, who insist that science has not yet accepted the doctrine; and great church organizations meet to condemn and expel their teachers of science from certain schools of learning because their teachings are imbued with the heresy.

Dr. Asa Gray, in his discriminating biographical memoir of Darwin, says in regard to the 'doctrine of descent,' "It is an advance from which it is evidently impossible to recede: as has been said of the theory of the conservation of energy, so in this the proof of this great generalization, like that of all other great generalizations, lies mainly in the fact that the evidence in its favor is continually augmenting, while that against it is continually diminishing as the progress of science reveals to us more and more the workings of the universe." Let us examine, then, the evidences, trivial as well as important, that have been recorded by American zoologists within the past ten years in support of the derivative theory.

Without further apology for the very imperfect character of this survey, let me at once begin by calling attention first to the testimony regarding the variation in habits, and evidences of reasoning-power, in animals. The establishment of individual variation in mental powers, change in habits, etc., lies at the foundation of Darwinism as furnishing material for selective action. There is no group of animals which exceeds the birds in varied and suggestive material for the evolutionist. It is a significant fact that the birds, which appeared to Cuvier and his contemporaries a closed type, — a group that seemed to fulfil the ideal conception of a class archetype as compared to other groups which had their open as well as obscure relationships, — should be, of all groups, the one that first yielded its exclusive characteristics. In fact, there is no group in which the barriers have been so completely demolished as in this apparently distinct and isolated class. An attentive and patient study of the birds has established almost every point defined by Darwin in his theory of natural selection. One has only to recall the marked reptilian affinities as shown in their embryological and paleontological history. Besides all these structural relationships, the birds possess, as a group, remarkable and striking illustrations of variation in color, size, marking, nesting, albinism, melanism, moulting, migration, song, geographical variation, sexual selection, secondary sexual characters, protective coloring; and in their habits show surprising mechanical cunning and ingenuity, curious and inexplicable freaks, parental affection, hybridity: indeed, the student need go no further than the birds to establish every principle of the derivative theory.

The many observations on the nesting habits of birds would form a curious chapter as illustrating the individual peculiarities of these creatures.

Mr. J. A. Allen, in writing on the inadequate theory of bird's-nests, shows grave and important exceptions to Wallace's theory, though he subscribes heartily to his philosophy of bird's-nests. He expresses surprise that closely allied species of birds should oftentimes build divers kinds of nests, overlooking the fact that even closely allied varieties of man build entirely unlike houses.

The behavior of wild birds when kept in confinement, and the attempts made in domesticating them, has always furnished an interesting field for study. The curious freaks and impulses which they often betray, the changes they show under the new conditions, indicate in some measure the plasticity of their organization.

Hon. John D. Caton, in an interesting paper on unnatural attachments among animals, records a curious fondness shown by a crane for a number of pigs; and in another paper on the wild turkey and its domestication, this writer has made some valuable records

¹ Abridged from the address to the American Association for the Advancement of Science, at New York, Aug. 10, 1887, by Prof. E. W. Morse of Salem, Mass., the retiring president of the association.

of the successive changes which take place in the bird during this process, — changes in color, during which the more conspicuous features of protective coloring are lost; changes in habit, in which are seen the undoing or relaxing of those features which indicate constant vigilance, from carrying itself in a semi-erect attitude, perching on the tallest trees, covering up the eggs carefully with leaves when off the nest, etc., to moving in a horizontal attitude, perching near the ground, covering the eggs but slightly or carelessly, etc., and losing that wildness which characterizes the bird in its wild state. At the breeding-season, however, the females became wild again, but this was a feature too deeply implanted to show modification in the time allotted to Mr. Caton's experiment. The same writer has also observed in the Hawaiian Islands the effects of reversion to a wild state, of different kinds of domestic animals which have from time to time been carried there. Among other animals, he was fortunate enough to observe the undoing stages in the domestic turkey, and the assumption of those features which characterize the wild bird.

A great many facts illustrating the plainest features of natural selection, protective coloring, mimicry, etc., have been recorded in our journals from time to time. A brief allusion may be made to a few of these. . . . Dr. R. E. C. Stearns has made some interesting notes on protective coloring in *Phrynosoma*. Having collected these horned lizards (or toads, as they are commonly called) in central California, he has noticed, that, if the ground region they frequent is yellowish, the lizards are, without exception, of that color; if ashen gray, then that color is simulated; and this, without exception.

An unquestionable fact has been finally established by recent methods of observation on the habits of insects and other animals, and that is, that individuals of the same species vary in intelligence; that they are not automata; that they are not impelled by a blind instinct to perform certain acts with unerring accuracy, but, on the contrary, that they vary, and often greatly vary, in their ability to provide for their young, in their skill to secure sufficient food, in their wit to avoid danger; in other words, they make blunders and mistakes, and involve their progeny and even their colony in ruin. This individual variation in intelligence is brought out very clearly by a patient series of observations made by Drs. G. W. and E. G. Peckham on the special senses of wasps. They not only repeated many of the experiments of Sir John Lubbock, but many new and ingenious experiments were devised. Their studies were for the purpose of investigating the mental power, sense of hearing, color, direction, memory, emotion, power of communication, general intelligence, etc. An interesting result of their painstaking work was the determination of individual differences as to the faculty of memory and power of distinguishing color and direction. This kind of study of the habits of insects has brought to light features of the most surprising character. The remarkable studies of Sir John Lubbock, Dr. Moggridge, and others in Europe, have been paralleled in this country not only by the observations above quoted, but notably by the labors of Rev. H. C. McCook in his studies of the American ants and spiders.

Dr. Thomas Meehan describes a hornet that was gifted with great intelligence. He saw this insect struggling with a large locust in unsuccessful attempts to fly away with it. After several fruitless efforts to fly up from the ground with his victim, he finally dragged it fully thirty feet to a tree, to the top of which he laboriously ascended, still clinging to his burden, and, having attained this elevated position, he flew off in a horizontal direction with the locust. Dr. Meehan truly says, "There was more than instinct in this act: there was reasoning on certain facts, and judgment accordingly, and the insect's judgment had proved correct."

The delicate balance of conditions between organisms, whether it be between individuals of the same species or between widely separated groups, is an important feature in the question of survival. Prof. S. A. Forbes, in a thoughtful study of certain species of *Entomostraca* in Lake Michigan and the surrounding waters, calls attention to the important part played by these minute crus-

taceans, showing how they furnish almost the entire food for young fishes, larger crustaceans, and even insect larvæ. He writes, "*Mollusca*, one would say, could afford to be indifferent to them, since they neither eat them nor are eaten by them, nor seem to come in contact with them anywhere, through any of their habits or necessities. But for this very reason these two classes afford an excellent illustration of the stringent system of re-actions by which an assemblage of even the most diverse and seemingly independent organisms is held together. . . . If there were no *Entomostraca* for young fishes to eat, there would be very few fishes indeed to feed upon *Mollusca*, and that class would flourish almost without restraint; while, on the other hand, if there were no *Mollusca* for the support of adult fishes, *Entomostraca* would be relieved from a considerable part of the drain upon their numbers, and would multiply accordingly." He is much struck with the fact that in the larger bodies of water the species of *Entomostraca* show an inferior development in numbers, size, and robustness, and in reproductive power. Their smaller number and size are doubtless due to the relative scarcity of food.

The effect of mechanical strains as producing morphological effects has been treated in a masterly way by Dr. John A. Ryder. . . . Prof. A. Hyatt, in an exhaustive study, shows, among other things, the effect of gravitation as accounting for the form of the mollusk-shell, citing examples from all the classes, and even drawing examples from other sub-kingdoms, to support his views.

Prof. E. D. Cope, in a memoir on archæstheticism, considers the hypothesis of use and effort, the office of consciousness, etc. He attempts to show that consciousness is primitive, and a cause of evolution. He sustains his thesis by a series of arguments, which, if not beyond my grasp, would be too extensive to present here. I can only repeat the regret I expressed in the Buffalo address; namely, that neither Professor Cope nor Professor Hyatt have yet been induced to present to the public an illustrated and simple outline of their theories. Such a demonstration, I am sure, would be acceptable not only to the public, but to many scientific students as well. While these two eminent naturalists believe fully in the derivative theory, they insist that Darwin's theory is inadequate to explain many of the phenomena and facts which they encounter in their studies. Darwin has distinctly said in his first edition of the 'Origin of Species,' "I am convinced that natural selection has been the main but not the exclusive means of modification;" and in his sixth edition of the same work, in quoting these words, he laments that he is still misunderstood on this point. The theory of acceleration and retardation of these authors is, if I understand it rightly, a very plain case of natural selection. It was inevitable that those individuals that matured the quickest were better prepared to defend themselves, were quicker in the field, were able to give their offspring an earlier start in the season, were in every way more fitted to survive, than those which matured later. It is assumed that this is a law, when, to my mind, it seems the simplest result of natural selection. Instead of overriding it, it is only a conspicuous result and proof of it.

A parallel case may be seen in the increase in size of the brain in the vertebrates, and conspicuously in the higher vertebrates, since their first appearance in geological history. The individual brain clearly varies in size; and it does not require a great effort to perceive how, in the long-run, the greater brain survives in the complex struggle for existence. Associated with the greater development, parts that were freely used for locomotion before, now are compelled to perform additional service, and through the law of use and effort, which all admit as an important factor, organs are modified in structure, the anterior portion of the body assumes a new aspect; and it was on the character of these parts and aspects that Professor Dana was led to formulate his comprehensive and ingenious principle of cephalization. It is a result, and not a cause. And so I believe, though with great deference to Cope and Hyatt, that the laws of acceleration and retardation, exact parallelisms, inexact parallelisms and still more inexact parallelisms, and many other laws and theories advanced by these gentlemen, are not causes, but effects, to be explained by the doctrine of natural selection and 'survival of the fittest.'

The connecting links and intermediate forms which the sceptical

public so hungrily demand are continually being discovered. Great gaps are being closed up rapidly; but the records of this work, being published in the journals of our scientific societies, are hidden from the public eye as much as if they had been published in Coptic. So rapidly have these missing links been established, that the general zoologist finds it difficult to keep up with the progress made in this direction. He can hardly realize the completion of so many branches of the genealogical tree.

Professor Cope, who has accomplished so much in this direction, says, "Those who have, during the last ten years, devoted themselves to this study, have been rewarded by the discovery of the course of development of many lines of animals; so that it is now possible to show the kind of changes in structure which have resulted in the species of animals with which we are familiar as living on the surface of the earth at the present time. Not that this continent has given us the parentage of all forms of animal life, or all forms of animals with skeletons, or vertebræ, but it has given us many of them. To take the *Vertebrata*, we have obtained the long-since extinct ancestor of the very lowest vertebrates. Then we have discovered the ancestor of the true fishes. We have the ancestor of all the reptiles, of the birds, and of the mammals. If we consider the mammals, or milk-givers, separately, we have traced up a great many lines to their points of departure from very primitive things. Thus we have obtained the genealogical trees of the deer, the camels, the musk, the horse, the tapir, and the rhinoceros, of the cats and dogs, of the lemurs and monkeys, and have important evidence as to the origin of man."

The discovery in the western tertiaries of multitudes of huge and monstrous mammals, and, earlier still, of gigantic and equally monstrous reptiles, naturally led at once to an inquiry as to the cause of their extinction. . . . Among the most interesting discoveries connected with these creatures is the determination by Professor Marsh that these early mammals, birds, and reptiles had brains of diminutive proportions. . . . "The small brain, highly specialized characters, and huge bulk, rendered them incapable of adapting themselves to new conditions, and a change of surroundings brought extinction. The existing proboscidians must soon disappear for similar reasons. Smaller mammals, with larger brains, and more plastic structure, readily adapt themselves to their environment, and survive, or even send off new and vigorous lines. The *Dinocerata*, with their very diminutive brain, fixed characters, and massive frames, flourished as long as the conditions were especially favorable, but with the first geological change they perished and left no descendants."

Prof. A. E. Verrill, in a lecture at Yale College entitled 'Facts Illustrative of the Darwinian Theory,' shows what an important factor parental instinct is in the evolution of species. He regards the lack of parental care "as one of the probable causes, though usually overlooked, of the extinction of many of the large and powerful reptiles of the mesozoic age, and of the large mammals of the tertiary." He says, "The very small size of the brain, and its low organization, in these early animals, are now well known, and we are justified in believing that their intelligence or sagacity was correspondingly low. They were doubtless stupid and sluggish in their habits, but probably had great powers of active and passive resistance against correspondingly stupid carnivorous species. But, unless the helpless young were protected by their parents, they would quickly have been destroyed; and such species might, in this way, have been rapidly exterminated whenever they came in contact with new forms of carnivorous animals, having the instinct to destroy the new-born young of mammals, and the eggs and young of oviparous reptiles. Thus it would have come about, that the more intelligent forms, by the development of the parental instinct for the active protection of their young against their enemies, would have survived longest, and therefore would have transmitted this instinct, with other correlated cerebral developments, to their descendants."

Prof. John Fiske, in his 'Cosmic Philosophy,' arrived at a similar conclusion in regard to early man. He showed, that, when variations in intelligence became more important than variations in physi-

cal structure, then they were seized upon to the relative exclusion of the latter.

The wide-spread public interest in Darwinism arose from the fact that every theory and every fact advanced in proof of the derivative origin of species applied with equal force to the origin of man as one of the species. The public interest has been continually excited by the consistent energy with which the Church, Catholic and Protestant alike, has inveighed against the dangerous teachings of Darwin. Judging by centuries of experience, as attested by unimpeachable historical records, it is safe enough for an intelligent man, even if he knows nothing about the facts, to promptly accept as truth any generalization of science which the Church declares to be false, and, conversely, to repudiate with equal promptness, as false, any interpretation of the behavior of the universe which the Church adjudges to be true. In proof of this sweeping statement, one has only to read the imposing collection of facts brought together by Dr. White, the distinguished president of Cornell University, which are embodied in his work entitled 'The Warfare of Science,' as well as two additional chapters on the same subject which have lately appeared in the *Popular Science Monthly*.

Only the briefest reference can here be made to a few of the numerous contributions on the subject of man's relationship to the animals below him. The rapidly accumulating proofs of the close relation existing between man and the *Quadrumana* make interesting every fact, however trivial, in regard to the structure and habits of the higher apes.

Dr. Arthur E. Brown has made some interesting experiments with the monkeys at the Zoölogical Gardens in Philadelphia. He found that the monkeys showed great fear, as well as curiosity, when a snake was placed in their cage, though they were not affected by other animals, such as an alligator and turtle. On the other hand, mammals belonging to other orders showed no fear or curiosity at a snake. These experiments, repeated in various ways, lead him to only one logical conclusion,—"that the fear of the serpent became instinctive in some far-distant progenitor of man by reason of his long exposure to danger, and death in horrible form from the bite, and it has been handed down through the diverging lines of descent which find expression to-day in the genus *Homo* and *Pithecius*."

The same author, in an exceedingly interesting description of the higher apes, says, "Mr. A. R. Wallace once called attention to the similarity in color existing between the orang and chimpanzee and the human natives of their respective countries. It would, indeed, seem as if but half the truth had been told, and that the comparison might be carried also into the region of mind; the quick, vivacious chimpanzee partaking of the mercurial disposition of negro races, while the apathetic slow orang would pass for a disciple of the sullen fatalism of the Malay."

Dr. Brown has also given a description of the grief manifested by a chimpanzee on the death of its mate. His grief was shown by tearing his hair or snatching at the short hair on his head. The yell of rage was followed by a cry the keeper had never heard before,—a sound which might be represented by 'hah-ah-ah-ah' uttered somewhat under the breath,—and with a plaintive sound like a moan.

Mr. W. F. Hornaday read at the Saratoga meeting of this association an exceedingly interesting paper on the habits of the orang as observed by him in its native forests. He says, "Each individual of the Borneo orang differs from his fellows, and has as many facial peculiarities belonging to himself alone as can be found in the individuals of any unmixed race of human beings." After recounting the many traits of the orang, heretofore regarded as peculiar to man, he says, "Let any one who is prejudiced against Darwinian views go to the forests of Borneo; let him there watch from day to day this strangely human form in all its various phases of existence; let him see it climb, walk, build its nest, eat and drink, and fight like human 'roughs'; let him see the female suckle her young and carry it astride her hip precisely as do the coolly women of Hindostan; let him witness their human-like emotions of affection, satisfaction, pain, and childish rage,—let him see all this,

and then he may feel how much more potent has been the lesson than all he has read in pages of abstract ratiocination.

Prof. Alexander Graham Bell has presented a memoir to the National Academy on the formation of a deaf variety of the human race, in which he shows by tables a series of generations of certain families in which, the progenitors being deaf-mutes, this peculiarity becomes perpetuated in many of the descendants. Recognizing fully the laws of heredity, natural selection, etc., he shows that the establishment of deaf-mute schools, in which a visual language is taught which the pupils alone understand, tends to bring them into close association with each other; and that naturally, with this seclusion, acquaintance ripens into friendship and love, and that statistics show that there is now in process of being built up a deaf variety of man.

Dr. W. K. Brooks, animated by the cogency of Professor Bell's reasoning, is led to prepare an article entitled 'Can Man be Modified by Selection?' In this paper he discusses the startling proposition of Professor Bell, and recognizes the convincing proof which he furnishes to show that the law of selection does place within our reach a powerful influence for the improvement of our race. The striking character of the tables of facts presented by Professor Bell, and the significant suggestions of Dr. Brooks, lead one to consider how far the influence of selection has had to do with the character of great communities, as to their intelligence or ignorance. When we see nations of the same great race-stock, — one showing a high percentage of illiterates, a high death-rate, degradation and ignorance, while just across the borders another nation, apparently no better off so far as physical environments are concerned, with percentage of illiterates and death-rate low, intelligent and cleanly, — we are led to inquire if here a strict scientific scrutiny with careful historical investigation will not reveal the cause of these conditions. Can it be proved beyond question that the illiteracy and degradation of Italy and Spain, up to within recent years at least, is the result of centuries of Church oppression and the Inquisition, destroying at once, or driving out of the land, all independent thinkers, and at the same time forcing her priests to lead celibate lives, and inducing others of cultivated and gentle minds to lead cloister lives? Is it also a fact, as Alphonse de Candolle asserts, that by far the greater number of distinguished scientists have come from Protestant pastors? He gives a significant list of eminent men whose fathers were Protestant pastors, saying, that had they been priests of another religion, leading celibate lives, these men would not have been born.

It is considered an intrusion into matters which do not concern science when such inquiries are made, but the scientist has very deeply at heart the intellectual and moral welfare of the community. If the cause of degradation and ignorance, of poverty, of contagious disease, or of any of the miseries which make a nation wretched, can be pointed out by scientific methods, then it is the stern duty of science to step in and at least show the reasons, even if the remedy is not at once forthcoming. The men who would be reformers and agitators, and who by their earnestness and devotion get the attention of multitudes, are unfit for their work if they show their ignorance, as most of them do, of the doctrines of natural selection and derivation.

In drawing to a close this very imperfect summary of what American zoologists have accomplished for evolution, many other distinguished contributors might have been mentioned. The work of eminent physiologists and paleontologists has hardly been considered; nor has the long array of botanical facts for Darwin, as revealed in the fascinating study of the relations which exist between flowering plants and insects, contrivances for cross-fertilization, means of plant-dispersion, etc., and the distinguished botanists connected with this work, received attention here. Indeed, the proper limits for an address of this nature have been far exceeded.

Suffice it to say, that all these students have worked from the standpoint of derivative doctrines. A still greater triumph to Darwinism are the evidences of gradual conversion still going on among a few isolated workers who still remain stubborn, yet yielding to the pressure of these views by admitting features that ten years ago they repudiated.

There are two points to be emphasized here in closing: and one is, that American biological science stands as a unit for evolution; and the other is, the establishment of a great generalization which shows, that, when intelligence became a factor in animals, it was seized upon to the relative exclusion of other characteristics. This generalization offers an unassailable argument to-day for a wider, broader, and deeper education for the masses. The untold misery and suffering of the working-classes as witnessed in their struggles of the last two years would have been avoided had the rudiments of social science, even a knowledge of the value and significance of simple statistics, been appreciated by them.

The startling paper of Dr. Seaman (*Science*, viii. No. 190) on the social waste of a great city shows the blundering, criminal way in which municipalities are controlled by coteries ignorant alike of Science and the beneficent mission she stands waiting to enter upon.

PREHISTORIC CHRONOLOGY OF AMERICA.¹

THE prehistoric period of America dates back from the discovery of the several parts of the continent; and the problem is to reconstruct the history of the various nations who inhabited both Americas in this period. A review of the means at our command to accomplish this, divides them into six classes: —

I. *Legendary*. — This includes the legends or traditions of the native tribes. These often bear a strong resemblance to Semitic or other Oriental myths, but the similarity is a coincidence only, and those writers have been led astray who count it for more. The annals of the Mexicans, the Mayas of Yucatan, and the Quichuas of Peru, carry us scarcely five hundred years before the voyage of Columbus, although the contrary is often stated. The more savage tribes practically remembered nothing more remote than a couple of centuries.

II. *Monumental*. — The most famous monuments are the stone buildings of Mexico, Yucatan, and Peru. By many these are assigned an antiquity of thousands of years; but a calm weighing of the testimony places them all well within our era, and most of them within a few centuries of the discovery. The celebrated remains of Tiahuanuco in Peru are no exception. Much more ancient are some of the artificial shell-heaps along the coast. They contain bones and shells of extinct species, in intimate connection with stone implements and pottery. They furnish data to prove that the land was inhabited several thousand years ago.

III. *Industrial*. — The industrial activity of man in America may be traced by the remains of his weapons, ornaments, and tools made of stone, bone, and shell. In most of the deposits examined, specimens of polished stone and pottery testify to a reasonably developed skill; but in the Trenton gravels and a few other localities, genuine palæolithic remains have been found, putting man in America at a date coeval with the close of the glacial age, if not earlier. The vast antiquity of the American race is further proved by the extensive dissemination of maize and tobacco, — tropical plants of southern Mexico, which were cultivated from the latitude of Canada to that of Patagonia.

IV. *Linguistic*. — It is believed that there are about two hundred radically different languages in North and South America. Such a confusion of tongues could only have arisen in hundreds of centuries. The study of these languages, and of the gradual growth of their dialects, supplies valuable data for the ancient history of the continent.

V. *Physical*. — The American race is as distinctively a race by itself as is the African or white race. Although varying in many points, it has a marked fixedness of ethnic anatomy, and always has had. The oldest American crania, collected from the most ancient quaternary deposits, are thoroughly American in type.

VI. *Geologic*. — As the discovery of implements in glacial deposits locates man on this continent at least at the close of the glacial epoch, this carries his residence here to about thirty-five thousand years ago. But there is no likelihood that he came into being on this continent. He could not have developed from any of the known fossil mammalia which dwell here. More probably some colonies first migrated along the preglacial land-bridge which

¹ Abstract of an address before the Section of Anthropology of the American Association for the Advancement of Science, at New York, Aug. 10-17, 1887, by Dr. Daniel G. Brinton, vice-president and chairman of the section.

once connected northern America with western Europe. Later, others came from Asia. At that time the physical geography of the northern hemisphere was widely different from the present.

These various data have as yet been but imperfectly studied: when they shall have received the attention they merit, we may confidently calculate on a large increase in our knowledge of the course of events in ancient America.

ECONOMY IN MANAGEMENT OF SOIL.¹

IN this great metropolis, or wherever our association meets, we are shown with pride the abounding evidences of the progress of a great nation, and the material prosperity of its people.

Tracing this visible wealth to its source, we find that it has all, with insignificant exceptions, been produced from the soil. The American inheritance was a fertile soil. A policy perhaps warranted by the circumstances, but none the less improvident, has marked the growth of the nation. Generation after generation has recklessly drawn upon the stored fertility of the land, with no systematic effort at restitution, not only to supply the current support of people, but the surplus which has provided all our apparent wealth and private improvements.

The rapidly increasing demands of our own country are met, and more than met, so far as mere quantity is concerned, for a great surplus is annually sent abroad. For twenty years agricultural products have constituted three-fourths of the total exports from the United States, while in single recent years this proportion has reached eighty-three per cent, and amounted in value to nearly nine hundred million dollars. And it is manifest that this superabundance of soil-products will continue, despite any possible increase in population, at least well into the next century. We boast of our great exportation of soil-products, forgetting that this really means the sending to foreign lands great blocks of our store of natural fertility, thus disposing of the main source of our material wealth by the ton and by the million. The steady reduction in the fertility of the soil, which results from the annual draught by cropping and the absolute loss incident to ordinary disposition of the crops, is much greater than commonly understood, and a matter so important as to demand serious consideration.

For present purposes it is sufficient to refer to only three elements of plant-food, which are of vital importance, and in which the soil is most likely to be, or to become, deficient. A computation based upon the mean annual agricultural products of the United States at the present time, the average composition of these products as far as known to chemistry, and the cash value of the chief fertilizing-materials in domestic markets, gives the following stated quantities and values of the three elements named, which are taken from the land by the farming operations of every year:—

4,000,000 tons of nitrogen, worth \$360 per ton.....	\$1,440,000,000
3,000,000 " potash, 100 "	300,000,000
2,000,000 " phosphoric acid, 120 "	240,000,000
Total value.....	\$1,980,000,000

The effect upon the soil depends, of course, upon the disposition of the products embodying these enormous quantities and values. Fortunately, a very large part remain upon or are returned to the land, in the process of harvesting and preparing for market, and more in the form of water and residues incident to consumption.

On the other hand, there are vast absolute losses resulting from the well-known wastes of towns and cities, besides the portions actually sent to foreign countries. To exactly apportion the disposition made of these products, and hence of the fertilizing elements represented thereby, is impossible; but as to the latter, a rough approximation divides the total into three parts, respectively remaining on the land, returned to the soil, and wholly removed from it.

This country imports the agricultural products of other countries in considerable quantity, but in kind far less important to the question in hand than our exports.

The articles exported are largely of a character especially rich in plant-food. Making due allowances, therefore, I estimate the

¹ Abstract of an address before the Section of Economic Science and Statistics of the American Association for the Advancement of Science, at New York, Aug. 10-17, 1887, by Henry E. Alvord, C.E., of Amherst, Mass., vice-president of the section.

average exportations as representing thirteen per cent of the fertility value of our total products, and our absolute wastes at home at more than twenty per cent additional. Together these constitute a full third of the figures above given, or an annual removal from American soil, of nitrogen, potash, and phosphoric acid, worth, in the markets of this city to-day, more than six hundred million dollars. By our present system, or rather continued improvidence in the production of the necessaries of life, we are thus diminishing, at this alarming rate, the original capital of our foundation industry.

When products are exported, mainly food, which are worth seven hundred million dollars on our shores, there is included plant-food, all needed at home, which we cannot replace for one-third of that sum.

This fertility never comes back. It goes to enrich other lands, or is washed into seas from which we do not ever get the fish and the carp. Those of us who are contending with impoverished soils are well placed to appreciate the sober subject of agricultural exhaustion, and are in duty bound to send an earnest word of warning to those who labor on newer lands. The researches of modern times have done much in establishing truths of practical value regarding the effect upon the fertility of the land, of the removal of different crops and products, and hence teaching us what should be consumed at home, and what may be profitably sold.

Thus, if ton after ton of farm-produce be removed from a Western farm to an Eastern market, or from any American farm to a European market, it makes a great difference eventually, to the land where produced, and to its owner or user, whether these tons be cotton or corn, beef or butter.

The following table illustrates this point:—

Articles of Export.	Mean Annual Exports in Tons.	Approximate Value of 1 Ton at Place of Export.	Value of the Plant-Food in 1 Ton.	Percentage of Plant-Food Value on the Market-Value 1 Ton.
Cottonseed-meal...}	250,000	\$ 26.00	\$28.04	108.00%
All 'oil-cake' and 'oil-meals'...}		24.00	23.80	100.00
Tobacco.....	150,000	200.00	15.92	8.00
Beeves alive.....	100,000	100.00	13.98	14.00
Dressed beef.....	50,000	160.00	13.99	8.75
Pork products.....	500,000	200.00	13.43	6.25
Wheat.....	3,000,000	(34 bus.) 34.00	8.80	26.00
Wheat-flour.....	750,000	(10 bbls.) 50.00	7.08	14.00
Corn (maize).....	14,000,000	(56 bus.) 23.00	6.94	30.00
Cotton.....	1,000,000	(4 bales) 200.00	.60	—
Butter.....	15,000	(40 tubs) 400.00	.52	0.13

It merely mitigates the evil presented, to note that the soil holds large quantities of plant-food still in store; that nature has provided supplies of mineral manures in concentrated form, deposited in various places; and that some investigators yet believe they will prove conclusively the assimilation by plants of the free nitrogen of the atmosphere.

Should this much-disputed question of nitrogen-supply be so settled, it would certainly remove a vast deal of anxiety, trouble, and expense; for, as we have seen, nitrogen constitutes three-fourths in value of the plant-food annually used by crops. But the prevalence of the belief that the growing plant depends almost exclusively upon the nitrates of the soil, and has no power to assimilate the free nitrogen of the air, is amply shown by the market-prices of ammoniated manures and the extent of their sale and use.

The trade in commercial fertilizers has reached wonderful proportions, and agriculturists hail with joy the discovery of every new deposit like the potash-salts of Germany and the mineral phosphates of Canada and the Carolinas. But the expense incident to mining, manipulation, and transportation, greatly impedes the use of these natural stores, and makes the more important every means of husbanding the home resources of every acre of valuable land. If the

statement could be accepted without much qualification, we might derive great comfort from the assurance that chemical examination of soils shows the presence, within reach of the plough, of nine thousand pounds of potash, and half as much phosphoric acid, on every acre, or enough to furnish the average crop for from two hundred and twenty-five to two hundred and fifty years.

Now, in the first place, the average land in tillage at the present time by no means reaches such a standard; and, in the second place, it is well known that but a very small fraction of the plant-food actually present in soil is in an available form. Ordinarily more than ninety-nine per cent of the plant-food found in soil by the chemist the plant itself finds dormant or unavailable. Time and natural agencies gradually convert their inert elements; but, to keep pace with agricultural demands, the physical properties of soils must be closely studied, and knowledge obtained and applied regarding the proper mechanical treatment of land. Figures already sufficiently demonstrate the recognized condition and needs of the soil. So difficult is it to make the once fertile land take back into use the natural resources, and so active the demand for plant-food in every available form to return to the soil, that, incredible as it appears, commercial fertilizers are maintained at such selling rates as to make the entire annual farm-products of this country worth half as much for manure as they are in market.

With our rapidly increasing population, and a constantly lessening fertility of soil, we have presented to us questions of the gravest import. By the wasteful processes prevailing, we are expending our very substance, and daily adding to a burden under which generations to come will stagger.

The true economy of soil management, involving the production for our people of food and clothing, fuel and shelter, and the wise management and disposition of our surplus, are problems great enough to satisfy the ambition of both scientists and statesmen.

In all expositions of the condition and prospects of the agriculture of this country, Gen. Francis A. Walker claims that the American people have been fully justified, upon sound economical principles, in the past system of cultivation of the soil at the expense of future generations.

"Thirty-eight noble States, in an indissoluble union, are the justification of this policy. Their school-houses and factories, their roads and bridges, their railways and warehouses, are the fruits of the characteristic agriculture of the past."

But the reason for wasteful systems no longer exists. "The country in the arable parts is settled, and the line of population now rests near the base of the great sterile mountains which occupy so large a portion of the continent. . . . A continuance of this policy will be, not the improvement of our patrimony, but the impoverishment of our posterity. . . . Economical and political considerations alike demand that the soil bequeathed to this generation, or opened up by its own exertions, shall hereafter be deemed and held as a sacred trust for the American people through all time to come, not to be diminished or impaired for the selfish enjoyment of its immediate possessors."

These considerations should increase our regard for and interest in the business of farming. We should all rejoice at the revival of agricultural studies, and the increasing number of able men who are making them their life's work.

Let me cordially invite continued contributions to the proceedings of this section, upon foods, fabrics, forestry, industrial education, and other topics closely related to our material welfare. And I appeal for more encouragement and aid for the earnest workers in other sections,—in biology and chemistry, physics and mechanics,—who are laboring in the various branches of science, that its practical results may be applied to economizing the fertility of the soil, which is the basis of our material prosperity.

MENTAL SCIENCE.

The Sense of Smell in Dogs.

DR. G. J. ROMANES, by his careful observations and happy generalizations, has made himself the representative of the growing science of comparative psychology. His two books on animal intelligence and on mental evolution in animals (to which is to be added a third on the mental evolution of man), written under the

inspiration of Darwin, have done more, perhaps, than the works of any other writer, to introduce scientific order into a field formerly given over to poorly described, exaggerated stories, and hasty, unwarranted generalizations. With the downfall of the anthropomorphic theory of the universe, the importance of the mental phenomena observable in animals was more readily recognized and appreciated. Hundreds of observations drawn up with the requisite details and accuracy have been collected, and a number of reliable and suggestive generalizations have been recorded. To these Dr. Romanes has added an important study on the method by which his dog follows the scent of the master.

The observations were made on Dr. Romanes' setter-bitch, an animal very much attached to him. They were made on the grounds adjoining his house, and a number of precautions not easily described were taken. (1) When Dr. Romanes walks over the ground with his hunting-boots on, the dog follows the scent with the greatest readiness. (2) If she is put to the track of a stranger, she pays no attention to it. (3) The dog was led into the room when preparations were going on for an outing, but, instead of Dr. Romanes going out, the gamekeeper (whose scent he follows next after that of Dr. Romanes) went: when set free, the animal at first followed the track, but, finding that her master was not with the gamekeeper, returned. (4) The next experiment was a very ingenious one. Twelve men walked in Indian file, so that they all trod the same footsteps, thus producing a conglomerate of olfactory impressions. Dr. Romanes headed the company, so that the traces of his steps should be most obliterated; and, after walking thus two hundred yards, the first six men walked in one direction, the last six in another. The dog quickly ran along the route followed by the twelve, overshot the point of division, but soon returned and followed the direction taken by the six headed by Dr. Romanes. (5) A number of experiments were made to ascertain what part of Dr. Romanes' person or of his apparel gave the clew to the animal. It was suspected to be the hunting-boots, and this proved correct. A stranger put on these boots, and the dog eagerly followed the scent; and, contrariwise, when (6) Dr. Romanes put on the stranger's boots, the animal was indifferent to his track. (7) Further experiments were made to locate the source of the scent in the boots. The dog did not follow the scent of a stranger walking in bare feet. (8) When Dr. Romanes walked in bare feet, the dog followed the trace, but less eagerly than usual, and with much hesitation. (9) Again, the animal did not follow Dr. Romanes when he put on new shooting-boots. (10) Next a single sheet of brown paper was glued to the soles of his usual hunting-boots. The dog did not catch the trail until he came to a place where, as Dr. Romanes had previously noted, a few square millimetres of the paper had come off. (11) When her master walked in new cotton socks, the trail was lazily followed, and soon given up. With woollen socks worn all day the result was the same. (12) Dr. Romanes next walked fifty yards in shooting-boots; then three hundred yards in his stocking-soles, carrying his boots; then three hundred yards in his bare feet. The animal caught the scent, and followed it unhesitatingly through the whole distance, though the trace left by stockings or bare feet alone was not sufficient to guide the animal. (13) The next test was a modification of the last. Dr. Romanes and a stranger entered a carriage and drove for several hundred yards. The former, in his hunting-boots, then alighted and walked fifty yards, whereupon he re-entered the carriage, and the stranger walked the next two hundred yards: the dog, when shown the track, ran the whole two hundred and fifty yards without pausing. The experiment was repeated with another stranger, with the same result. (14) To test the power which the dog had of selecting the distinctive odor accompanying her master from other odors, Dr. Romanes soaked his hunting-boots in anise-seed-oil. The odor was so strong that a friend could follow the track an hour later by the odor of the oil; yet the dog was not confused except that she hesitated about the first few steps, but then pursued as usual.

The next test was directed towards ascertaining whether the animal could distinguish her master by odors emanating from other portions of his person. (15) Dr. Romanes, after pursuing a zig-zag course just trodden over by a number of footsteps, hid behind a wall, with his eyes just visible. The animal went at once to the hiding-place. (16) Again he hid in a ditch, with only the top of

his head visible. At two hundred yards the dog detected her master, and went to him directly.

From these tests, Dr. Romanes concludes that the dog distinguishes him from all others by the odor of his boots (1-6), and does not distinguish him in his naked feet (8-11). The odor is probably emitted by the feet, but must be mixed with that of shoe-leather to be of service to the dog. This is doubtless a matter of education: had the dog been used to following her master when without shoes, the animal would have learned to follow him thus. The characteristic odor cannot penetrate a sheet of brown paper, but a few square millimetres of surface is sufficient to give the dog the clew. The animal is ready to be guided by inference as well as by perception, but the inference is instantaneous (12 and 13 as compared with 2, 8, and 11). Lastly, not only the feet (through the boots) but the whole body emits an odor that the dog can distinguish in a mass of others (15). This order is recognized at great distances to windward (15), or in calm weather in any direction (16): it is not overpowered by anise-seed-oil (14) or by the footprints of another (4).

THE TIME NECESSARY TO PERCEIVE COLD AND HEAT.—It is well known that a cold sensation reaches consciousness more rapidly than a sensation of warmth. Dr. Goldscheider of Berlin, whose researches on the hot and cold points of the skin have gained him a well-deserved reputation, has recently accurately measured the length of the time necessary to perceive these sensations. The observations were made on parts equally sensitive to heat and cold, and with intensities of heat and cold equally different from the temperature of the part. The time of contact was recorded electrically by means of a metallic button fixed to the skin. Contact with a cold point was felt on the face after 13.5, on the arm after 18, on the abdomen after 22, on the knee after 25, hundredths of a second. The sensation of a hot point was felt on the same surfaces after 19, 27, 62, and 79 hundredths of a second respectively. This great difference in time has an important theoretical bearing on the physiology of dermal sensations.

BOOK—REVIEWS.

Geological History of Lake Lahontan, a Quaternary Lake of North-western Nevada. (U.S. Geol. Surv., Monogr. XI.) By I. C. RUSSELL. Washington, Government. 4°.

THIS volume, and the companion monograph by Gilbert on Lake Bonneville, are undoubtedly among the most interesting, if not the most important, contributions hitherto made to the ancient geography of this continent. It must be admitted, however, that the wonderful changes in the aspect of the Great Basin, of which we find here the most conclusive evidence, are scarcely ancient in the geological sense, having been accomplished almost wholly since the close of the glacial epoch, and largely since the advent of man.

Lake Lahontan, situated mostly within the area now forming the State of Nevada, filled a depression along the western border of the Great Basin, at the base of the Sierra Nevada; while Lake Bonneville, embraced almost entirely in the present Territory of Utah, occupied a corresponding position on the east side of the Great Basin, at the foot of the Wasatch Mountains.

The hydrographic basins of these two water-bodies embraced the entire width of the Great Basin in latitude 41°. Lake Bonneville was 19,750 square miles in area, and had a maximum depth of about 1,000 feet. Lake Lahontan covered 8,422 square miles of surface, and in the deepest part, the present site of Pyramid Lake, was 866 feet in depth. The ancient lake of Utah overflowed northward, and cut down its channel of discharge 370 feet. The ancient lake of Nevada did not overflow. Each of these lakes had two high-water stages, separated by a time of desiccation. In the Lahontan basin, as in the Bonneville, the first great rise was preceded by a long period of desiccation, and was followed by a second dry epoch, during which the valleys of Nevada were even more completely desert than at present. During the second flood-stage, the lake rose higher than at the time of the first high water, and then evaporated to complete desiccation; for the present lakes of the basin (Pyramid, Winnemucca, etc.) are of comparatively recent date, and are nearly fresh, for the reason that the salts deposited

when the quaternary lake evaporated were buried or absorbed by the clays and marls that occupy the bottom of the basin.

As Lake Lahontan did not overflow, it became the receptacle for all the mineral matter supplied by tributary streams and springs, both in suspension and in solution. The former was deposited as lacustral sediments, and the latter as calcareous tufa, or formed desiccation products when the lake evaporated.

The introductory chapter contains a sketch of the Great Basin as the explorer finds it to-day. It stands in marked contrast in nearly all its scenic features with the remaining portions of the United States. The traveller in this region is no longer surrounded by the open, grassy parks and heavily timbered mountains of the Pacific slope, or by the rounded and flowing outlines of the forest-crowned Appalachians; and the scenery suggests nought of the boundless plains east of the Rocky Mountains or of the rich savannas of the Gulf States. He must compare it, rather, to the parched and desert areas of Arabia and the shores of the Dead Sea or the Caspian.

To the geographer the most striking characteristic of the country stretching eastward from the base of the Sierra Nevada to the Rocky Mountain system is that it is a region of interior drainage. For this reason it is known as the 'Great Basin.' No streams that rise within it carry their contributions to the ocean; and the climate is dry in the extreme, the average yearly precipitation not exceeding twelve or fifteen inches.

The area thus isolated from oceanic water-systems is 800 miles in length from north to south, and nearly 500 miles broad, and contains about 208,500 square miles. At the south the valleys of the Great Basin are low-lying, Death Valley and the Colorado Desert being depressed below the level of the sea; but at the north the valleys have a general elevation of from 4,000 to 5,000 feet, while the intervening mountain-ranges rise from 5,000 to 7,000 feet above them.

The mountains exhibit a type of structure not described before this region was explored, but now recognized by geologists as the 'Basin Range structure.' They are long, narrow ridges, usually bearing nearly north and south, steep upon one side, where the broken edges of the strata are exposed, but sloping on the other with a gentle angle conformable to the dip of the beds. They have been formed by the orographic tilting of blocks of the earth's crust, that are separated by profound faults, and they do not exhibit the anticlinal and synclinal structures commonly observed in mountains, but are monoclinical instead. The mountains are rugged and angular, usually unclothed by vegetation, and owe their marvelously rich colors to the rocks of which they are composed, especially the purple trachytes, the deep-colored rhyolites, and the many-hued volcanic tuffs so common in western Nevada, often rivaling the brilliant tints of the New England hills in autumn.

The valleys or plains separating the mountain-ranges, far from being fruitful, shady vales, with life-giving streams, are often absolute deserts, totally destitute of water, and treeless for many days' journey, the gray-green sagebrush alone giving character to the landscape. Many of them have playans in their lowest depressions (simple mud-plains left by the evaporation of former lakes) that are sometimes of vast extent. In the desert bordering Great Salt Lake on the west, and in the Black Rock Desert of northern Nevada, are tracts hundreds of square miles in area showing scarcely a trace of vegetation. In winter, portions of these areas are occupied by shallow lakes, but during the summer months they become so baked and hardened as scarcely to receive an impression from a horse's hoof, and so sun-cracked as to resemble tessellated pavements of cream-colored marble. Other portions of the valleys become incrustated to the depth of several inches with alkaline salts, which rise to the surface as an efflorescence, and give the appearance of drifting snow. The dry surface material of the deserts is sometimes blown about by the wind, saturating the air with alkaline particles, or is caught up by whirlwinds and carried to a great height, forming hollow columns of dust. These swaying and bending columns, often two or three thousand feet high, rising from the plains like pillars of smoke, form a characteristic feature of the deserts.

Chapter II., on the genesis of Lake Lahontan, contains a summary of the facts which show that the lake filled a compound

ographic basin, resulting from the tilting of faulted beds. The question of outlet is discussed in detail, the conclusion being that the lake did not overflow.

Chapter III. discusses the physiography of the Lahontan basin, describing in detail the valleys and mountains, and its lakes, rivers, and springs, and including numerous analyses of the waters from these three sources. Attention is given to the peculiar playas or broad mud-plains of the arid region of the Far West, as well as to the temporary lakes, called 'playa-lakes,' which frequently flood them.

The physical history of the ancient lake is fully and ably discussed in Chapter IV. Under the head of 'Shore Phenomena' we find detailed descriptions and illustrations of the terraces, bars, embankments, etc., that were formed about its shores. The highest of the ancient water-lines is named the 'Lahontan Beach;' and the most conspicuous terraces below this are the 'lithoid,' 'dendritic,' and 'thinolitic.' Each of these marks the upper limit of a variety of tufa, from which it derives its name.

Numerous sections are introduced to show the structure and relations of the mechanical sediments, which consist of two deposits of lacustral marls, separated by a heavy layer of current-bedded gravels; thus recording two lake periods and an intermediate low-water stage.

Chapter V., on the chemical history of the lake, is especially important. It includes, first, a general account of the chemistry of natural waters as they occur in streams, springs, lakes, oceans, and enclosed lakes or seas, followed by descriptions of the tufas precipitated from the water of Lake Lahontan, the salts precipitated when complete evaporation took place, the efflorescences now forming on the desiccated floor of the lake, and the salt-works of the region. As already indicated, the tufas present three main divisions. The lithoid tufa is a compact, stony variety, and is the oldest of the principal calcareous deposits that sheathe the interior of the basin. Thinolitic tufa is composed of crystals, and was formed in the ancient lake when it was greatly reduced by evaporation. The dendritic tufa has a branching or dendritic structure, whence its name, and it is the newest of the tufa formations.

Chapter VI. presents the life-history of the ancient lake as determined by the abundant molluscan remains and other fossils that have been found. The shells show that the lake was fresh throughout its higher stages. During the period when thinolite was formed, it seems to have been too concentrated to admit of the existence of molluscan life, as no fossils have been found in that deposit. A chipped implement discovered in the upper lacustral beds indicates that man inhabited the Far West during the last rise of Lake Lahontan.

Chapter VII. is a brief *résumé* of the preceding chapters; while Chapter VIII. is devoted to a discussion of the quaternary climate of the Great Basin, the periods of greatest lake-expansion being correlated with the two glacial epochs of the Sierra Nevada, and believed to indicate cold and moderately humid periods.

In Chapter IX. we have a summary of the evidence bearing on the determination of the geological age of the lake. The conclusion reached is that it existed during the quaternary, but was more recent than the date usually assigned for the close of the glacial epoch.

The tenth and concluding chapter contains an account of the orographic movements that have affected the Lahontan basin since the last high-water period, including a map showing all the post-Lahontan faults, some of which are marked by exceedingly fresh escarpments, and are evidently still in process of formation.

The illustrations are profuse and admirably executed, and Mr. Russell's style is throughout clear and graphic. Details are mainly kept in the background, or presented in tabular form; and it is probable that both in general interest and educational value this monograph is excelled by none of the publications of the Geological Survey.

Elements of Geodesy. By J. H. GORE. New York, Wiley. 89.

THE present publication is a treatise on some geodetic operations, and intended to give the beginner a clear insight into the subject. It begins with a brief historical sketch of the various attempts to determine the figure of the earth. The former half of the book is

devoted to a description of the instruments and of the elementary operations and methods of plane geodesy, but the principal object of the author is to describe the methods of spheroidal and geoidic geodesy. The student who begins to study this important branch of geodesy will, or at least ought to, be conversant with the instruments applied by geodesists, with the theory of least squares, and with the calculation of triangulations, which are set forth at some length in the first part of the book. On the other hand, the beginner, who will find some valuable and practical hints in the chapters on base measurements and the field-work of triangulations, will miss a discussion of topographical methods and operations. The book would become far more useful for the beginner, who must study the simpler geodetic operations before beginning with the measurement of the figure of the earth, if a description of the methods and theories of topography were included in the plan. The development of each formula is very complete, and the results are given in the shape that the majority of writers have considered the best. Examples are given to illustrate the application of the formulae. The student will find at the end of each chapter a list of books referring to the subject under discussion. F. B.

NOTES AND NEWS.

AS we go to press we have obtained a copy of the opening remarks of Prof. S. P. Langley, president of the American Association. Professor Langley spoke as follows:—

MEMBERS OF THE ASSOCIATION,—While, for the main purpose of our coming here, we are all of one mind, some must remember a peculiar pleasure in their first attendance, when they came to these meetings as solitary workers in some subject for which they had met at home only indifference, and held themselves alone in, till here, with a glad surprise, they met others, too, caring for what they cared for, and found among strangers a truer fellowship of spirit than their own familiar friends had afforded. With such communities of purpose wherever two or three among us are gathered together, it is a happy thing that we cannot remain strangers; for doubtless, of the many here who have habitually breathed "the calm and still air of delightful studies," there are few but know by experience how hard it is for one coal to keep alight alone, and how especially good it is for the solitary workers to be brought at times into the warmth of companionship. To a great many of us, then, it may be counted as the very chiefest good of such an assembly as ours to-day, that here each meets some one with a kindred glow, and finds that interest and sympathy from his co-worker without which the scientific life would be but too cold. It is most fortunate, nevertheless, that our happy constitution as a body, not only of investigators in science, but of teachers and lovers of knowledge, brings those here in greatest numbers who disseminate as well as produce it, and who are skilled to recognize the value of the newly mined product when brought into this public exchange of ideas. We must admit here, that foolish ideas as well as wise ones are brought to this open mart, and that, in dealing with the variety of papers now presented for acceptance, it becomes almost as hard a task for us to shut out folly as to entertain wisdom; for, after all, who are we that judge, and how can we say "wisdom is in us to decide," when it is chiefly because we are ignorant that we are here? Probably the only rule is that taught by experience, that since art is long and life short, experience difficult and judgment uncertain, knowledge commonly advances best by such little steps, that one foot is not lifted till the other is securely planted on the solid ground of fact. On the whole, then, while we agree that some rare visitors have come to us over the "high *priori* road," do not let us welcome without scrutiny all those who would walk over it into this association's domain. At the same time, in view of our ignorance as to the real nature and causes of things, I would plead with those of you who are judges, for a large tolerance, even of what seem to be errors of speculation, when these are found in company with evidence of a faithful original study of facts; for we shall then have, at any rate, done our best not to turn away Truth, even if she has come to us in an unfamiliar dress. And now I can only congratulate this assembly of her followers on a meeting which opens so auspiciously, and express the hope, that whether in the new knowledge which we may take to the section-room or find there, or in the

social pleasures the gathering brings, this may fulfil its large opening promise of being a fruitful and happy season to us and to our association.

— Dr. E. Naumann, late director of the geological survey of Japan, has published an essay on the influence of the structure of the earth upon the phenomena of terrestrial magnetism. His researches in Japan show that the magnetical lines are to some extent influenced by the *fossa magna*, a great fault which crosses the islands in a direction south-east by north-west. By studying the direction of the magnetical lines in connection with the geological structure of other countries, the author comes to the conclusion, that, in the vicinity of faults and folds, the magnetical lines show remarkable irregularities, and that a connection exists between both phenomena. Recent researches by Ciro Christoni on the intensity of terrestrial magnetism in Italy (*Atti della R. Accademia dei Lincei*, 1887, p. 200) show irregularities of the magnetical elements in the eastern part of Venetia, on the western part of the coast of Liguria, and in Val Pelice. These places coincide with centres of seismic disturbances, and suggest a connection between geological and magnetical phenomena. It seems, however, that the available material is still too incomplete for a thorough study of the question at issue, the magnetical surveys not being of a sufficiently detailed character.

— Charles E. Putnam of Davenport, Io., died July 19.

— Those interested in Spiritualism will read with special interest Prof. Carvill Lewis's account of two sittings with the noted English medium, Englinton. This medium is such a tower of faith to believers, and has deceived so many, that so glaring an exposure of his methods as Professor Lewis gives is especially valuable. The article is published in the Proceedings of the English Society for Psychical Research, May, 1887.

— The readers of *Science* know from our notes on the exploration of Africa how rapidly one discovery follows another, and that it is difficult to keep a map up to date. This fact has induced J. Perthes to publish a second edition of his large map of Africa in ten sheets (1:4,000,000). The student of the geography of Africa will find this map, which contains an enormous amount of detail, and which is in every respect up to the date of publication, a valuable help in his researches. The routes of explorers, the tribes with whom they came into contact, and the character of the land they traversed, are shown in the map; deserts, steppes, and regions with tropical vegetation, including savannas and woods, being distinguished by different colors. An important feature of the map, and one necessary for the critical study of geography, is the distinction between countries which are really explored and those which are known by report only; the former being written with heavy letters, the latter with light ones. The new edition, of which two sheets—Kongo and Abyssinia—have been published, contains so much new material, that the section 'Kongo' is practically a new map. The results of the journeys of Kapello and Ivens, Reichard, von François, Kund and Tappenbeck, Wolf, Büttner, Grenfell, Junker, and the observations of Captain Rouvier, have been used in constructing this sheet. The important results of these journeys were published in our part of Central Africa some time ago. The observations of Chavanne and other visitors of the Lower Kongo induced the author, H. Habenicht, to include that region in the zone of steppes occupying south-west Africa. In Section 6, 'Abyssinia,' the routes of Cecchi and Chiarini have been made use of, and—what will be welcome to most readers—Emin Pacha's province, his stations, and those of the Kongo Free State, have been marked by separate colors. The political boundaries have been corrected according to recent treaties and annexations.

LETTERS TO THE EDITOR.

. The attention of scientific men is called to the advantages of the correspondence columns of SCIENCE for placing promptly on record brief preliminary notices of their investigations. Twenty copies of the number containing his communication will be furnished free to any correspondent on request.

The editor will be glad to publish any queries consonant with the character of the journal.

Correspondents are requested to be as brief as possible. The writer's name is in all cases required as proof of good faith.

The Sonora Earthquake.

THE past month has been spent by me in Sonora, U.S. Mexico, in examining the scene of the greatest disturbances during the re-

cent earthquake of May 3. This trip has required mountain-travel of about seven hundred miles, horseback and on foot; fully one-half, the latter. While it is impossible now to give the complete results of my explorations, a brief summary may prove interesting.

There is not now, nor has there been, lava eruption or crater volcano. I visited every locality in the Sierra Madres where such phenomena had been reported—fruitlessly. There is a grand fault extending along the eastern side of the San Bernardino and Yaqui River valleys for nearly one hundred miles. This fault has a general northerly and southerly strike, with a dip of from 45° to vertical; and the difference in level of the two sides is for fifty miles an average of eight feet. It lies close to the foot of the mountain-ranges, where the *mesa* drift joins the steeper part of the chain, until it crosses the Yaqui, where it goes directly into the mountains. There are numerous minor faults and fissures; and

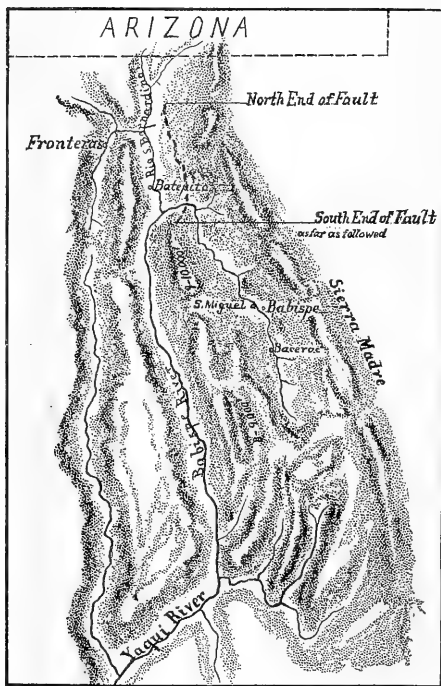

HEIGHT IN FEET.

Fronteras, 3,350.

Batispe, 2,990.

Batispe, 1,025.

Bacerac, 3,150.

the entire valley of the San Bernardino is apparently sunk from two to four feet. The relative level is changed that much. This condition exists also on the Batispe River above and for some distance below Batispe, and on the Yaqui at and below its junction with the San Bernardino. Almost every water-course in the disturbed area has changed in the same way.

The town of Batispe was totally destroyed, forty-two lives lost out of a population of seven hundred. No other town in Sonora suffered much. Extensive evidence exists of irruption of water, sand, and fiery gases. As stated in my first letter, mountain-fires succeeded the first shock. These were caused by the ignited gases and falling bowlders. Time data in Mexico, away from the railways, are unprocurable, none existing. The general fact that the first shock took place May 3, about 3 P.M., and that it came from a westerly direction, is all that can be obtained.

It is much to be lamented that the ground was not thoroughly explored before the beginning of the rainy season, which set in on the 14th of June with a violence unknown since 1881. This will

cause the obliteration not alone of the extensive and interesting minor details of the disturbance, but of many of the greater as well, particularly in the river-beds where the changes of level have occurred. The town of San Miguel, three miles north of Babispe, and Bacerac, nine miles south, were uninjured. This is, in view of the principal line of disturbance, particularly interesting.

I enclose a hasty tracing of the section, which may aid in showing the location of the fault. This does not show the length, for it is too tortuous. Scale of map is about 40 miles to the inch. The mountains as marked are the famed Sierra Madres.

G. E. GOODFELLOW.

Tombstone, Arizona, July 14.

Chemical Laboratory of the University of Nebraska.

So many requests for the plans and a description of the new chemical laboratory of the University of Nebraska have been re-

The entrances are in the south and north ends of the building; that in the south being the main one, while the north door is for the convenience of students coming to the laboratories from the other university buildings. Through this, access is had to every work-room in the laboratory, and to the main lecture-room on the second floor. This arrangement brings classes into the lecture-room from the rear, — an arrangement that will be appreciated by every lecturer on experimental science.

Entering at the south door, we find ourselves in the vestibule of the first floor. At our right and left, stairways lead to the basement floor, as shown in Fig. 3. Descending to the basement corridor (Fig. 2), at the front is a large vestibule opening by double side-doors into an area where heavy material is received. Under the stairway to our right is a small room containing the gas-meter. Under the left-hand stairway, and extending across the space occupied by the vestibule, is a ladies' toilet-room. Immediately in



FIG. 1.

ceived since its erection, as to warrant the belief that a brief description of its general features would be of interest to the readers of *Science*, and especially to those who are contemplating the erection of similar buildings, or who are interested in the educational growth of the West.

The building is situated on the south-east corner of the university campus, fronting south on R Street. A wide street bounds the east side, while on the north and west is the open campus: thus the building commands an abundance of light from all directions.

Fig. 1 shows the south front and east side. The building consists of a high basement of native limestone, and a two-story superstructure of the finest St. Louis pressed brick, laid in black mortar and relieved by belt courses of rough limestone. The style of architecture is Romanesque, the broad and heavy stone arches and pointed towers giving to the whole an appearance of massiveness and solidity in keeping with its construction.

In front of the stairway is the elevator shaft. The room at the right serves as a store-room for the basement laboratories, and as a balance-room for the assay and metallurgical laboratory. The corresponding room on the opposite side of the corridor contains a small upright boiler for furnishing distilled water, and large storage-tanks for hydrogen and oxygen gases. It serves also as a storage-room for acids and as a work-shop. The remaining portion of this floor is taken up by the general laboratory, where students beginning the study of chemistry do their work. This can be used as one large laboratory, accommodating seventy-five students at one time, or, by closing the communicating doors, be divided into two, A and B, A being used as an assay and metallurgical laboratory.

These rooms have high ceilings, and are well supplied with light. They are ventilated by means of the two large flues C and D, each of which is eight feet broad, and a series of smaller flues built into the side-walls, one between each pair of windows. The large

flues open directly into the air; the smaller ones, into the space under the roof, which communicates with the air by means of the small ventilating-tower on the rear part of the roof. On each floor, built into the space between the large flues, and opening into them, are large hoods accessible from both sides through sliding glass doors.

Extending along the side-walls—and this is the case in every laboratory-room in the building—is a table, furnished with gas and

for the use of those students who have had some preliminary training, and has accommodations for thirty-two workers. Opening from this laboratory at opposite corners are two rooms equal in size,—the one a balance and apparatus room; the other the private laboratory of the associate professor. Beyond these, on opposite sides of the south corridor, are a small lecture-room and a special laboratory. In this laboratory the chemical work of the investigations undertaken by the experiment-station will be carried on.

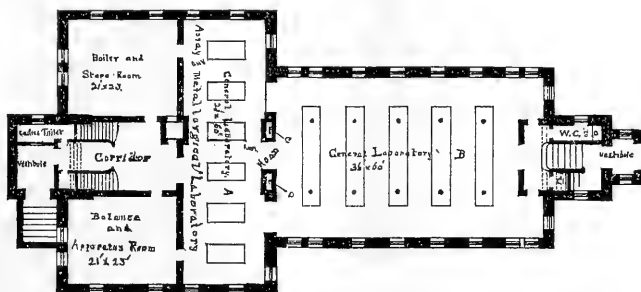

FIG 2

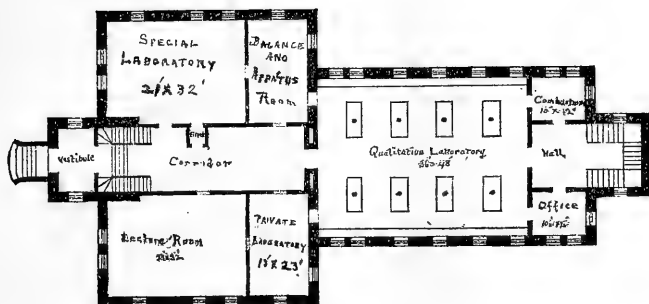

FIG 3.

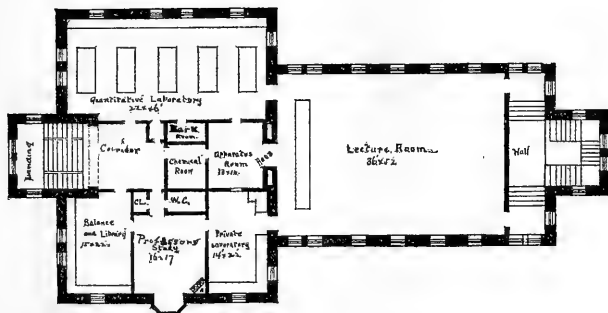

FIG. 4.

water, drawers and cupboards. These tables carry the smaller hoods, covering the sand and steam baths, and opening into the small flues. Space is also afforded here for such operations as require more room than the ordinary work-table gives.

Passing through the general laboratory, and ascending the stairway at the north end, we find ourselves in the north hall of the second floor (Fig. 3). On our right is a small room for blast-lamps and combustions. On the opposite side of the hall is the office and study of the associate professor of chemistry.

Passing on, we enter the qualitative laboratory. This is intended

Ascending the stairway at the end of the corridor, we reach the corridor of the second floor (Fig. 4). At our left is the quantitative laboratory, with accommodations for twenty students. Communicating with it is a small dark room for the storage of standard solutions.

Passing through the door in the north end of the room, we enter the main lecture-room. This room has a raised floor, placed at such a pitch that the top of the lecture-table can be seen from all parts of the room. It is furnished with Andrews's patent lecture-chair, and will comfortably seat two hundred people.

The lecture-table is large and roomy, and is abundantly supplied with water and gas. It is ventilated by powerful down draughts and movable box-hoods. Directly back of the table, and opening into the preparation-room, is one of the large hoods before mentioned. Connected with the preparation-room is a small dark room for the storage of chemicals. These rooms serve also as apparatus and store rooms for the laboratories on this floor.

Leaving the lecture-room from the opposite corner from which we entered, and passing through the laboratory and study of the professor of chemistry, we come to the balance-room and library. This room is very well supplied with books of reference and the current periodicals, having complete sets of the *Berichte*, *Fresenius Zeitschrift*, *Chemical News*, *American Chemical Journal*, *Centralblatt*, and others. No special room has been set apart for collections. It is the intention to utilize the corridors for this purpose.

The tables (Fig. 5) in each student work-room, except laboratory

accommodate ten students each. Besides table-supply, each laboratory has a large sink for use when large quantities of water are necessary. Distilled water is furnished on each floor. The building is heated throughout by steam from a central station in the main building. Fire-protection is afforded by sections of hose on each floor, connected with a standpipe which passes up through the centre of the building from basement to attic.

We have now been in occupancy about one year, and feel well satisfied with our arrangements, though some matters of detail await the necessary funds to carry them into effect.

H. H. NICHOLSON.

Answers.

11. LAKE ITASCA.—Rev. William T. Boutwell of Stillwater, Minn., several years ago, wrote for the Minnesota Historical Society the following account of the naming of Itasca Lake: "Coming to Mackinac in the summer of 1831, I received an invitation to spend the following



FIG. 5.

B, are ten feet long, four wide, and three feet and three inches high. Four students use one table; each having at his disposal, for storing his apparatus, two large drawers and two roomy cupboards, all secured by a single lock. Each student has two gas connections and an abundant supply of water.

The arrangement for water-supply is different from that usually employed. Instead of two basins placed at the ends, one large oval basin, twenty-one by sixteen inches, is sunk in the centre of the table, its long diameter across the table, and is supplied from two taps, one at each side. This arrangement has the advantages of being economical, convenient, and neat.

The work-places are numbered consecutively in each laboratory, and are supplied with sets of re-agent bottles, bearing, in enamelled letters, the name of the re-agent and the number of the desk. The stopper of the bottle bears a number corresponding to the one on its body. By this means a bottle out of place can be easily related, and the transposition of stoppers is inexcusable.

In laboratory B, tables are similarly equipped, and constructed on same general plan, except that they are twenty-six feet long and

winter at Sault Ste. Marie. There I made the acquaintance of Mr. Schoolcraft. Early in the spring of 1832, he received instructions from the government to visit the bands of Indians on the Upper Mississippi, and also to ascertain the true source of the river. He very kindly invited me to accompany him. Now for the origin or derivation of the name 'Itasca.' One morning we were coasting Lake Superior. Mr. S. said to me, 'I would like to give a name to Elk Lake that will be significant or expressive of the head, or true source, of the Mississippi. Can you give me any word in Latin or Greek that will convey the idea?' I replied, 'No one word will express the idea. The nearest I can come to it is *verum caput*, or, if you prefer the noun *veritas*, you may coin something that will meet your wishes.' In less than five minutes he replied, 'I have got the thing,' handing me a slip of paper on which was the word 'Itasca,' remarking, 'This is not poetic license, but you will find it, as you progress in the study of Ojibwa, to be Indian license. It was then and there, and in just this manner, that the name 'Itasca' was coined.'

J. FLETCHER WILLIAMS.

St. Paul, Minn., Aug. 3.

SCIENCE

FRIDAY, AUGUST 19, 1887.

THE MEETING JUST CLOSED in New York, of the American Association, has been generally voted a success. The attendance was not so large as had been hoped, but the character of the papers was satisfactory. Against the ordinarily large attendance at the meetings held in Eastern cities, there were this year registered not many over seven hundred. This may have been due partly to the late announcement of the place of meeting, and to a slight change from the usual date,—two circumstances which may have rendered it impossible for many to change their summer plans so as to allow of a week's visit to New York. The fear of hot weather in New York City has not been fulfilled. The next meeting of the association will be held at Cleveland, O. An invitation from Toronto unfortunately came just too late to allow of its being accepted. A list of the officers for the next meeting will be found in another column. In the general meeting of the association a few important resolutions were passed. The association expressed its opinion that the efficiency of the United States Geodetic Survey would be greatly increased if a superintendent were appointed who was thoroughly trained in the methods of geodesy; and it was resolved to ask the President of the United States to appoint a scientist to this position, instead of the present superintendent, who was only temporarily appointed. The second resolution which was passed by the association refers to the establishment of a bureau of standards, in which standard measures of electricity, heat, weight, length, etc., may be obtained. A motion of Prof. Cleveland Abbe was passed, requesting Congress to have an index of the publications of the Signal Service published. Scientists would be gratified if Congress should make a reduction in the tariff on scientific books and instruments.

THE SUBJECT OF MEDICAL LEGISLATION is attracting the attention of both the medical and legal profession throughout the country; and while it is generally conceded that the laws have in the past, either by reason of innate defects or their non-enforcement, permitted the practice of medicine by quacks and charlatans of the most pronounced type, still there is a sentiment, which is growing, that the State can go too far in its restrictions and exactions. This sentiment forms the basis of an address, entitled 'State Control of Medicine,' which was read before the Monroe County Medical Society by its president, Dr. Louis A. Weigel, the full text of which is published in the July number of the *Medical Press of Western New York*. In his opening remarks, Dr. Weigel says that it is usually considered absolutely necessary that there should be medical legislation to protect the public against quackery and imposture; that the lives of the people are directly endangered by incompetent and ignorant charlatans; and that it is the duty of the State to exercise a paternal control over its subjects, and dictate to them whom they shall employ when sickness invades their homes. He proposes in this address to investigate the practical results obtained by State interference in medical practice, and endeavors to show that no law has yet been passed which has had the slightest effect in suppressing quackery or protecting the community against imposture. The report of Drs. Dunglison and Marcy, a committee of the American Academy of Medicine appointed to ascertain the practical working of laws regulating the practice of medicine in the United States, is referred to at length by Dr. Weigel. The facts presented by this committee were obtained by correspondence with physicians in the various States and Terri-

ories. In New York the law has been inefficacious. From Michigan the answer came that the entire good of the law has been to give lots of quacks a legal standing. In Tennessee any and all may set up for physicians, and starve or make money, as the people decree. After referring to other States, the president says, "If any further proof of the inefficiency of legal enactment to suppress charlatanism is needed, I am at a loss to know what additional evidence I could present that would be more conclusive." He firmly believes, that, if no attempt at medical legislation had ever been made, the profession to-day would be held in higher estimation by the people, and occupy a still loftier position than now obtains. It is somewhat singular that the remedy for all this, in accordance with the view of Dr. Weigel, should be more legislation; and yet that is practically the outcome of what he proposes. He says that every year the multitude of medical colleges throughout the land send forth a large contingent of half-educated stupidity, endowed with the coveted half-yard of parchment, which a confiding public accepts as a guaranty of competency. It certainly has no standard to go by. The remedy for this suggests itself. The teaching and licensing bodies must be separated. The suggestion here made by the doctor is not a new one in this State, and is practically in operation in other States. It is more than probable that the next New York Legislature will be called upon to enact some such law as this. While theoretically it seems to be what is needed, we have never been able to see how it can be practically accomplished in this State without the danger of making it a political measure.

PROCEEDINGS OF THE AMERICAN ASSOCIATION.

Section A.

THE Mathematical Section was without a vice-president through the absence of Professor Ferrel of Washington, who had been elected to that office, but at the opening meeting of the association the vacancy was most satisfactorily filled by the election of Prof. J. R. Eastman of the Naval Observatory. A further consequence of this change of officers was that there was no vice-presidential address in Section A, which therefore held no meeting on Wednesday afternoon. On Thursday morning, however, the section convened with a fair attendance, including at times a number of ladies, who apparently did not find the abstruse subjects discussed at all beyond their comprehension or interest. Several papers were upon what is known as 'personal equation.' One by Professor Eastman called forth remarks by Professors Hough, Harkness, and others, from which it appeared that there is still considerable uncertainty in the matter; it being by no means sure that the results derived from the personal-equation machine are comparable with the personal error of actual observations, nor that the error is the same for light and dark illumination. Professor Eastman concluded that many of the Washington observations on record can only be made valuable after a further discussion of the personal equations involved. Mr. Farquhar criticised Mr. S. C. Chandler's conclusions in regard to the dependence of personal equation upon the stars' velocity. Mr. H. B. Fine gave a general proof that the singular solutions of differential equations of the second order have always a tangency of the second order with the consecutive curves in the system to which they belong.

Professor Harkness's interesting paper on the visibility of objects seen with a telescope was an account of the result of some experiments on the distance at which objects become invisible when viewed through small holes of different sizes. It incidentally brought out the fact, that, when the image of the object fills the pupil of the eye, further magnification is of no value, and led to the

speaker's giving a method by which any one can measure the size of the pupil of his own eye, all the apparatus needed being easily constructed from a half-sheet of writing-paper. Mr. Brashear exhibited a new form of comet-seeker, very conveniently arranged, consisting of a Newtonian reflector of six and one-half inches clear aperture, mounted with an altazimuth motion, the eye-piece being placed in the horizontal axis, so that the observer has no need to change his position while sweeping the sky. He also showed a modification of the Merz-Young polarizing helioscope, less liable to breakage than the old form; and in a third paper he advocated the adoption of standard sizes for screws and draw-tubes for astronomical instruments, so that the parts may be interchangeable, — an improvement whose utility seems self-evident, especially if combined with the adoption of metric units for the standards.

Professor Boss presented a list of over twelve hundred stars with large proper motions, whose data, collected from various sources, will, however, need to be verified before detailed publication.

The last paper of the day had been postponed from the first place on the list, and was by Prof. F. N. Willson. He presented a systematized nomenclature for the roulettes, or trochoidal curves, in which he recognizes the fact that the same curve may be generated in two ways by varying the relative size of the circles and the position of the tracing-point.

On Friday morning only seven papers were assigned to Section A, and two of these failed to appear. Mr. Woodward's paper on a method of computing the secular contraction of the earth, and Professor Stone's on the perturbations of the orbit of Hyperion, were of a technical character, consisting of a discussion of the differential equations involved in the problems. The interest of the morning, however, centred about the papers of Professors Mendenhall and Webb. The former was upon the eccentricities of guessing. The circumstances which gave rise to it were these: a number of persons having recorded their guess of the number of nails contained in a glass carboy, the nails being of various sizes, large and small, these guesses were given over to the professor for discussion. The results were plotted with amount of guess and number of guessers as abscissa and ordinate, and were found to agree pretty well with the probability curve; but the maximum of the curve did not coincide with the actual number of nails, showing that the average guess was considerably below the truth in this case, reasons for which were easily suggested. Mr. Farquhar suggested that the use of the logarithm of the number guessed for abscissa would bring the two curves into closer agreement. The author rather objected to his own title, and thought this was not really a case of guessing (which should be entirely without the bias of any reason), but rather a series of estimates. It is no doubt true, that, while some of the numbers were careful estimates, others were the most random guesses, made without ever seeing the carboy. The guesses numbered over seven thousand, and varied from forty-three to over three million, both extremes being seriously given. The true number was 2,551, as ascertained later by actual count. Professor Webb advocated the introduction of the idea of mass into the definition and formula for the moment of inertia, defining it as the summation of the mass into the square of the distance from the axis, or the mass which at unit's distance will have the same energy at the same speed of rotation. The discussion which followed, participated in by a number of those present, brought to light the fact that a good many persons object to the use of the term 'inertia' at all, some preferring 'moment of mass,' while others were content to retain the term because used in so many valuable memoirs already in print.

There was no session of Section A on Friday afternoon nor on Saturday; and on Monday, no papers being assigned to the section except the two which failed through absence on Friday, and their author still being absent, the section adjourned finally, so far as reading of papers is concerned.

Section B.

THE address of Vice-Pres. W. A. Anthony before the Physical Section, at its opening on Wednesday, was on the importance to the advancement of physical science of the teaching of physics in the public schools. Professor Anthony took the ground, that, since there is a strong re-action by which the applications of science

stimulated the development of the science itself by awaking more general interest and by bringing out phenomena that call for explanation, the cause of pure science will be advanced by giving inventors and all concerned with the application of physics a more thorough training in the principles of that science.

This training must be given by the public schools, and should begin early, and be prolonged over several years of the course, so that such a principle as the conservation of energy shall not be to the student something which he learned in cramming, during one year or a part of a year, a very difficult subject called physics, but it shall be as familiar and well understood a fact as that water will not flow up hill. When this is the case, the labors of inventors may be expected to be more fruitful, because more intelligently directed, and science itself will be advanced.

The most important paper of the session was presented by Professors Michaelson and Morley, and was on a method of making the wave-length of sodium light the actual and practical standard of length. The methods that have heretofore been advanced for this purpose all depend on the use of the diffraction grating, and do not afford a sufficient degree of accuracy in the comparison; for, as was remarked by Professor Rogers, before the wave-length of sodium light can be taken as the standard of length, it must be possible to lay off a distance on a scale which shall represent a given number of wave-lengths, at least as accurately as it is possible to compare two standard scales. Messrs. Michaelson and Morley allow sodium light to fall on a piece of plane parallel glass, where it is divided into two beams at right angles to each other, which are reflected back by two mirrors, and again brought together into one beam, which falls upon the observing telescope. Interference bands are seen, which depend on the difference between the distances which the two beams traverse. One of the two mirrors is provided with a screw motion, by which it can be moved back or forth in the direction of the beam of light which falls upon it. If, now, it is moved, the observer at the telescope, by counting the number of interference bands which cross the field of view, can determine the exact number of wave-lengths of sodium light corresponding to that distance. By this arrangement a distance of one decimetre can be directly determined; and by successively measuring off ten decimetres, and by having the marking diamond rigidly attached to the mirror which is moved, Professors Michaelson and Morley believe that they will be able to lay off a length of one metre, in terms of a given number of wave-lengths of sodium light, with an accuracy of about one part in a million, which is at least twice as accurately as two metres can be compared; but, in finding the number of wave-lengths that correspond to a metre, they will of course be limited by the accuracy with which the microscope can be set on the graduations of the standard.

A second paper of great interest was by these same investigators, and was an account of some experiments by which it was sought to measure the velocity of the luminiferous ether relative to the earth, by the interference between two beams of light, which were reflected back and forth a number of times, one being in the direction in which the ether was supposed to be moving, and the other at right angles to that direction. No effect was found, so that it was concluded that the ether must be very nearly at rest with respect to the earth; but this result leads to serious difficulty in explaining aberration, and should be carefully scrutinized.

Prof. William A. Rogers, to whose enthusiasm and skill in a very arduous field of research American investigators are so greatly indebted, presented a number of papers to the association, in one of which points of great importance in the exact measurement of lengths were brought out; in particular, that, in comparing standard scales, a time when the temperature is slowly changing is the worst possible, and that such comparisons should be made either with constant temperature, or at a certain critical time in the day when the temperature is changing quite rapidly, the time depending on the relative masses of the bars and on other circumstances. In the case cited this critical time was about 6 A.M., and measurements a half-hour before that time showed errors about equal in amount and opposite in direction to those made a half-hour after it.

Prof. W. F. Magie, in a study of capillarity, showed reasons for believing that the contact angle of water and glass is not zero.

It is striking evidence of the great velocity attained in tornadoes that straws and bits of hay are often driven like darts into pine boards, and even into the dense bark of hickory-trees. Professor Mees found, that, to obtain similar results by shooting straws from an air-gun, velocities of from one hundred and fifty to one hundred and seventy-five miles per hour were necessary.

Professor Mendenhall read a paper giving an account of the changes in the electrical condition of the atmosphere that are observed during thunder-storms, and referred to the excellent work done by the New England Meteorological Society in the study of these most interesting phenomena.

Prof. E. S. Nichols gave an account of a battery-cell on which he and Mr. W. S. Franklin had been experimenting, in which both electrodes were iron; but one was in a magnetic field, and the other not. The magnetized electrode was found to be sometimes electro-positive to the other, and sometimes electro-negative, depending on whether its magnetic poles were exposed to the liquid, or whether the neutral part alone was so exposed. A difference was also found between those liquids tending to produce ferric salts and those forming ferrous compounds.

Professor Barker presented two papers on behalf of Mr. Edison, in one of which a magnetic balance similar in principle to Wheatstone's bridge was described, by which the relative magnetic permeabilities of different samples of iron can be rapidly tested. In the other paper, Mr. Edison described an ingenious form of apparatus, which he calls a 'pyro-electric dynamo,' in which an electric current is obtained directly from heat-energy through the induction produced by alternately heating and cooling an iron core placed in a strong magnetic field and surrounded by an insulated coil.

Mr. C. E. Monroe presented to the section the results of some curious experiments in which blocks of gun-cotton, after having been stamped with certain letters, were exploded on flat plates of wrought iron. The gun-cotton blocks were placed with the lettered side down, and it was found, that, when the letters were stamped in relief, they appeared in relief on the iron after the explosion, and, on the other hand, when the letters were depressed in the gun-cotton, they were also depressed on the iron plate.

The session this year has been of considerable interest, and the number of communications presented to the section unusually large.

Section C.

[Report not received in time for this issue.]

Section D.

NINETEEN papers or subjects were presented during the sessions of this section by twelve gentlemen, as follows: on Nicaraguan woods, and friction of engines, by R. H. Thurston; on the American system of water-purification, by Albert R. Leeds; a new method of finding an equivalent uniform load, producing bending moments approximately equal to the maximum moments under a moving train, the deflection of girders and trusses, and re-action polygons and their properties (a new general class of graphical polygons suitable for the comparison of the bending moments and shearing stresses in simple girders and single intersection trusses, due to a moving train of wheel weights), by H. T. Eddy; on an improved method for testing metals, by Charles E. Monroe; on the effect upon the strength of iron by subjecting it to a pull while hot, Rankine's solution of the problem of turbines, and downward draught device for a furnace, by DeVolson Wood; on a new high-speed steam-engine indicator, by J. Burkit Webb; on errors of approximate calculations of the effect of the inertia of the moving parts of a steam-engine, by D. S. Jacobus; on the theoretical effect of errors of observation in calorimeter experiments for determining the latent heat of steam, and improved arrangement of Siemens's platinum electrical pyrometer, by J. E. Denton; on the uniformity of planimeter measurements, by T. C. Mendenhall and John Mack; on mechanical inspection of railway-tracks and results obtained, by P. H. Dudley; on the theories of the lateral pressure of sand against retaining walls, by Mansfield Meriman; on national armament, by J. R. Haskell.

A number of these papers were accompanied by illustrative

models or drawings, and some by both models and drawings. In some cases only a partial treatment of the subject was given, a complete consideration being reserved for another paper. In this way new lines of thought were suggested, and the authors thus indicated their intention of occupying the fields of thought which they thus partially opened up.

The section united with Section B (Physics) for an hour on Friday to hear two papers by J. Burkit Webb,—one on a new dynamometer, which was illustrated by a working model; and the other on the experimental determination of the re-action of a liquid jet.

On Monday afternoon Sections D and I combined to listen to four papers relating to different aspects of a plan for a Nicaragua ship-canal. The first of these was on the general subject of isthmian transit, by H. C. Taylor; the second, on the engineering features of the Nicaragua Canal, by K. E. Peavy; the third, climatic and sanitary notes on the Nicaragua Canal route, by John F. Bransford; and the fourth, historical and geographical notes concerning the Nicaragua Canal route, by J. W. Miller. The work of the section may be mainly classified under four heads:—

1. Papers recording actual practical work in new fields; as, for example, the paper on the mechanical inspection of railway-tracks, which was accompanied by rolls of diagrams taken upon different lines of railway, showing the condition of their tracks, and from which the interesting and valuable results set forth in the paper were obtained.

2. Papers illustrating new or improved special machines or devices for accomplishing difficult ends. The new high-speed steam-engine indicator, by Professor Webb, illustrates this class. A model and drawings of the instrument were shown, by means of which the theory and operation of the indicator were readily understood.

3. Papers based upon laboratory experiments, like Professor Denton's, on calorimeter experiments for determining the latent heat of steam, in which the results of experiments with two forms of calorimeter were recorded, and made the basis of valuable deductions in regard to the theory and operation of the calorimeters compared.

4. Discussions, suggestions, and criticisms relating to the application of laws and principles, and to methods of research and computation, of which Professor Eddy's paper, on re-action polygons and their properties, is an example.

The papers were generally fresh and stimulating, and clearly aimed to advance scientific thought and attainments, to secure the practical achievement of valuable work upon a scientific basis, and to perfect theories and harmonize them with actual facts and to secure their easy and correct applications in new fields of scientific work. The sessions of the section must have proved of value to all who followed the work done, and many regret that most of the papers must appear in abstract rather than in full in the Proceedings of the association.

Section E.

GEOGRAPHY is by title included with geology in Section E of the association; but geology takes all the attention, and, in the present vigorous condition of geological investigation, geography as a science is almost forgotten. Under geology itself, the work of the International Congress of Geologists and of its American committee received the greatest share of time, as the vice-presidential address of Mr. Gilbert considered the first, and the several reports read by Dr. Frazer introduced the second. There has been apprehension among some that more might be attempted by the congress in the way of authoritative dictation and majority rulings on matters of opinion than would be justifiable in our rapidly advancing science—or, indeed, in any science. The dangers of such a course were well pointed out by Mr. Gilbert: "The proper function of the congress is the establishment of common means of expressing the facts of geology. It should not meddle with the facts themselves. It may regulate the art of the geologist, but it must not regulate his science. Its proper field of work lies in the determination of questions of technology; it is a trespasser if it undertakes the determination of questions of science. It may decree terms, but it must not decree opinions. . . . For science it is not merely illogical, it is

suicidal, to establish facts in any other way than by observation. No vote of the most august scientific body can possibly establish a fact, and no vote can have any weight against a good observation." On these grounds, Mr. Gilbert said, "I am opposed to the classification by the congress of the sedimentary formations, and likewise to the classification of the volcanic rocks, and I also regard it as ill advised that the congress undertook the preparation of a map of Europe, for that — if more than a work of compilation — is a work of classification;" and "a classification, if it has any value whatever, is merely a generalized expression of the facts of observation, and is outside the domain of the voter."

The section was well prepared, after hearing this address, to listen on Friday to several abstracts of reports of semi-official character, by the various individual 'reporters' of the American committee, and submitted to it for approval at the recent meeting at Spring Lake. These were all read by Dr. Frazer, secretary of the committee, before discussion was opened, and their good judgment and conservatism excited general approval. The abstract presented by Dr. Frazer demands especial attention, both from the care in its preparation, and from its including at once a discussion of certain general principles, and of that most difficult of geological divisions, the Archæan; and it is to be hoped that these reports may be given to the association for publication, as expressing the matured opinions of many able workers on questions most frequently before American geologists. Among the paragraphs of Dr. Frazer's report, the following will doubtless be generally commended: "American geologists will acquiesce in the recommendations of the committee by sacrificing individual opinion to a reasonable degree, provided that these recommendations do not hamper the efforts of research by requiring more correlation of beds between the two continents than research can justify." "Until such time as the Archæan rocks can be correlated with each other in distant parts of the earth, it is best that geologists should distinguish them from each other petrographically, without attempting to ascribe more than local chronological value to such distinctions." On the other hand, the recommendation that all pre-Cambrian rocks should be called Archæan savors too much of pre-judgment, especially in view of the recent studies of Irving and Walcott. The possible metamorphism of eruptive rocks was properly emphasized; and, as they are thought to differ more as a result of such changes than by conditions characteristic of their eruption, their classification by composition as indicating age is not recommended.

The most animated discussion occurred over the recommendation that it should be "officially declared that neither the color-scheme for the proposed map of Europe, nor the classification of the eruptives of Professor Lossen, provisionally adopted by the map committee in order to bring out the map, are other than tentative schemes, subject to alteration when their application to the map shall have shown to what extent they are deficient." It was strongly objected by Major Powell that this implied the official adoption of the color-scheme alluded to, in case serious defects were not discovered in its test on the European map, and that it did not sufficiently dwell on the fact that the scheme of colors had been devised only by a committee of the congress, and not by the congress itself. A resolution approving the action of the committee, and hoping for its continuance, was adopted in the evening session; but it may be mentioned that it received only two or three affirmative votes, although the session was well attended at the time.

It is difficult to choose among the many papers read before the section, and we mention only the few that our space allows. Prof. H. S. Williams presented a model paper on the different types of Devonian in America; Mr. Hill gave the results of his recent studies in Texas; Professor Claypole described 'Lake Cuyahoga,' an extinct glacial lake in Ohio; Mr. Walcott contributed a paper on the so-called 'Taconic,' that promises, with his other studies, to bring about accord on this vexed problem; and Dr. G. H. Williams gave an excellent general account of petrographic methods and their application. These titles can only suggest others of like interest that are regrettably omitted from our report.

Section F.

THOSE who think that scientists are seriously divided on the question of evolution would have come to a different conclusion by

attendance' at the Biological Section during the meeting of the American Association, just closed. Reputable scientists no longer avoid the question as formerly, or mention it only in defence, but accept it as the basis for the discussion of questions of structure and classification. Dr. Farlow, vice-president of the section, following in harmony with the subject chosen by the president of the association, Professor Morse, chose for his subject 'Vegetable Parasites and Evolution.' Botanists have a smaller basis than zoologists for the study of development, owing to the incompleteness of the paleontological record, especially with reference to the lower plants, to which most parasites belong. The study of different degrees of parasitism has, however, rendered it probable that parasites may have originated at a remote period from non-parasitic plants, first as saprophytes, then as true parasites. The parallelism which exists between algæ and fungi seems also to indicate that the different groups of fungi have arisen from corresponding groups of algæ at different periods in the process of evolution.

The paper of Professor Cope, on the mechanical origin of the sutorial teeth of the *Carnivora*, showed in a striking manner the value which mechanical force may in some cases have as a factor in development. His statement, also, that a given structure may or may not be the best which could be devised for performing its particular function, but that it must be such as could be developed from a pre-existing form, is one which, if earlier understood, would have saved much misdirected effort.

Among the other papers presented, that of Professor Cook on the antennæ-cleaners of *Hymenoptera*, the series of structural papers by Dr. Beal, that of Dr. Schrenk on *Brasenia peltata*, and the papers on morphology by Professor Baur, were excellent examples of the present methods of study. The paper of perhaps the most practical importance was that of Dr. Rusby, on the cultivated cinchonas of Bolivia.

In the treatment of the topics relating to classification, there was manifested a tendency to restrict the number of species and increase the number of varieties. In regard to terminology, there was exhibited on one or two occasions a decided opposition to the introduction of comparatively unimportant new terms.

The proportion of botanical to zoological papers presented before the section was less than last year, although the attendance of botanists was greater. There is still a general desire, on the part of the botanists, to confine the discussions and short papers chiefly to the botanical club, and the necessity is felt of providing more time for that purpose. Among the work of the club was the appointment of a committee, consisting of Drs. Vasey, Britton, Watson, Morong, and Halstead, to devise a system for the exchange of specimens.

One of the most enjoyable features of the meetings was the excursions provided by the citizens of New York and the local societies. These gave an opportunity for the members to become acquainted, and to compare personal notes. Of especial interest was the excursion of the botanical and entomological clubs to Sandy Hook, which included an informal 'field-meeting' on board the boat during the return. Much is due from botanists to the Torrey Botanical Club, which, besides the delightful entertainments provided, furnished sets of the local plants to those in attendance.

Section H.

THE meetings of this section are always interesting on account of the great variety of papers read. At the present meeting the discussions were more lively than they used to be, and this is due to the skillful vice-president, Dr. D. G. Brinton, who encouraged discussion in every way, and, by giving summaries of the doubtful points, elicited remarks from all interested in the subject.

Among the different classes of papers, archæological ones take a prominent place. This is somewhat remarkable, when we consider that in many parts of America we have still the very best opportunities of studying the natives themselves; but the antiquity and doubtful origin of relics have always proved a stronger incentive for scientific remarks than the living neighbor, to whose customs and strange appearance we become accustomed. The most important one among this class of papers was Professor Putnam's report on the purchase of the serpent-mound of Adams County, O., by a number of ladies.

who presented the deed to the trustees of the Peabody Museum of Cambridge. Professor Putnam's report, in connection with a brief letter from Miss Alice Fletcher, led to an important discussion on the preservation of mounds and relics, and the opinion was expressed unanimously that some step must be taken in this direction. In order to impress the United States and the State governments and legislatures with the importance of this matter, it was moved that the association, in a general session, appoint a committee whose task it should be to take the necessary steps in this direction. Mrs. Stevenson, president of the Ladies' Anthropological Society of Washington, and Miss Fletcher, were elected members of the committee. Major Powell's remarks on the difficulties which would be encountered in carrying out the proposed scheme, and the fact that attempted 'preservations' had sometimes ended in actual destruction, led to the election of a second committee of five members, for impressing the State historical societies and legislatures with the importance of the matter, and inducing them to preserve the relics in their territories, while the former committee will draw the attention of Congress to those situated on public lands.

The desire to draw greater attention to archæology was also characteristic of Prof. Thomas Wilson's paper on the state of archæology in western Europe. He showed that in America, though the interest of the public is increasing, nothing equal to the work of European nations has been done. Scandinavian archæologists ought to be our teachers in this line of research: they were the first to work out scientific methods and to undertake researches on a great scale. Professor Wilson laid great stress on the influence of European societies and scientific institutions and of the support of the government upon the rapid development of prehistoric anthropology.

The papers and discussions on archæological subjects showed that a closer connection between geologists and archæologists is very desirable, or, rather, that the student of archæology ought to be conversant with dynamical geology, more particularly with the influence of water and wind upon the earth's surface. This is the only method to avoid serious errors and to reach satisfactory results. Prof. C. C. Abbott's method, which he explained during the sessions in numerous remarks and in his paper on evidences of pre-Indian occupation of New Jersey, makes it clear that this is the most satisfactory method of study. Of course, the form of the implements must also be considered. Dr. Brinton's suggestion, that the occurrence of simple implements and of compound implements (i.e., those in which the worked stones are attached to handles) should be made a principle of division of the paleolithic age, may be accepted in so far as we must suppose, *a priori*, that simple implements were the earliest inventions of developing mankind. It is, however, doubtful whether the finds really justify a separate consideration of both ages. The important question of the age of American antiquities, and whether they belonged to the Indians inhabiting the continent at the time of the discovery or to a pre-Indian race, received its proper share of attention. Besides Professor Abbott's paper, which was mentioned above, Mr. G. N. Perkins's remark, that in the Champlain valley a steady development of forms, from the most ancient to the recent ones, may be observed, deserves to be mentioned.

The desire of tracing the earliest history of man in America, which is the most vigorous inducement of American archæology, was also the basis of Horatio Hale's paper on the true basis of ethnology. A few weeks ago Major Powell had expressed, in a letter to *Science*, the opinion that there can be no ethnology, as all attempts to classify mankind have failed. This refers to ethnology, as defined by Powell, as the science treating of the classification of mankind. Professor Hale opposes this opinion, maintaining that the languages afford a sufficient basis for the classification of man into races. Major Powell, in defence of the position he had taken, said that languages, customs, and religions were only adhering to the individual, while the anthropological character was the only constant phenomenon. But here, as well as in the ethnological characteristics of races, admixtures of blood had made it impossible to reach satisfactory results. This elicited the important remark from Dr. Brinton, with which we heartily concur, that language and religion of the individual may be easily changed, but that tribes and races do not so readily adopt new social institutions and

new languages, and that not the individual, but the tribe, is the important object of study. His opinion is, that the psychology of nations is the true basis of ethnology, and we may add that the history of civilization is its ultimate aim.

Methods of ethnological researches are making steady progress. This is shown by the papers of Dr. Wesley Mills, on the study of a small and isolated community in the Bahama Islands; and by that of Mr. Steward Culin, 'China in America.' The former is a contribution to the solution of the problem of the influence of monotony in climate and social institutions upon man: the latter treats of another interesting question which is of the greatest importance in studying the history of mankind,—the constancy of ethnological peculiarities, and the influence of one people upon another. Papers treating of the ethnology of certain tribes were comparatively few. Great interest was excited by two specimens shown by Mr. G. F. Kunz, — a gigantic jadeite adze from Oaxaca, Mexico, which shows signs of being cut from a boulder by the use of a string, and is beautifully carved and polished; and a very remarkable human skull of rock crystal in natural size, probably of Mexican origin. On this occasion we had the pleasure of hearing the assumed similarity between the Mexican and Japanese arts thoroughly refuted by Mr. Tatui Baba. In fact, the task of proving the similarity rests on the shoulders of those maintaining its existence.

The last paper we have to mention is that by Mr. J. Jastrow, on sensory types of memory and apperception. He discussed apperception as brought about by visual and audital perceptions, and treated of the connection of both kinds of perceptions in many individuals. He referred to the important bearing of this question on education, as different methods must be applied for the two classes of individuals. He gave some methods for determining the prevailing faculty. His opinion is, that the visualists form the more numerous class, but we believe that the universal existence of language shows the importance of auditalism. Researches in experimental psychology, such as Mr. Jastrow undertakes, are not yet carried on to a great extent in America, but we may hope that in course of time they will become an important feature of the sessions of the Anthropological Section, as this branch of science is one of the foundations of the psychology of individuals and of nations.

Section I.

[Report not received in time for this issue.]

THE GEOGRAPHICAL MOVEMENT IN ENGLAND.

I WAS asked some time ago to furnish *Science* with an account of the results of the efforts of the Royal Geographical Society towards the improvement of geographical education in England, and to give some idea of the character of the collection of appliances exhibited in London and elsewhere in connection with this movement. I have waited till now in order that I might be able to state positively that so far the society's efforts have met with almost complete success. The University of Oxford has just appointed a reader in geography; not only so, but the appointment has been given, I believe I am safe in saying, to the only one among the numerous candidates likely to carry out the views of the Geographical Society as to what the geography of the future should be. Mr. Harford J. Mackinder, the new reader in geography, is a young graduate of Oxford, who has taken high honors both in science and in history, and thus is qualified to treat geography adequately on all its sides. As one of the lecturers in connection with the Oxford University extension scheme, he has attended large and enthusiastic audiences in various English provincial towns. What his conception of geography is may be seen from the paper which he read before the Geographical Society, and which is printed in the Proceedings of March, 1887. Cambridge University has decided to follow the example of Oxford in the beginning of next year, and meantime has requested the council of the Geographical Society to nominate one or more of its members to lecture on the subject in the autumn of the present year.

Thus it will be seen, that, so far as our two great universities are concerned, the recent efforts of the society have been completely successful: for it must be borne in mind that the council of the society have all along felt, that, unless geography were recognized

at our universities, it would be hopeless to attempt to make any impression, on our higher schools at least. Now, with two good men, working on right lines, and filled with contagious enthusiasm, at our two great universities, we may confidently expect that improvement will filter downwards.

It is nearly twenty years since the society felt compelled to raise geography from the low level it has occupied in English education. It memorialized both Oxford and Cambridge, but its memorials were scarcely even honored by a reply. Medals were offered for competition among certain (about fifty) selected schools of the higher grade; but after sixteen years these were dropped, from lack of competitors. Three years ago the council resolved to institute a thorough inquiry into the whole question of the position of geography at home and abroad, and did me the honor of appointing me to conduct the inquiry. The results of the inquiry have been published in the form of a report, which has been referred to at some length, on various occasions, in *Science*, so that I need not analyze it in detail here. The general conclusion was, that except in a few rare cases, depending mainly on the tastes of individual teachers, geography has no substantial place in English education. In many of our higher schools it is not taught at all. In most cases where it is taught, it is the barrenest of studies, consisting in the learning of long lists of names and figures. Rarely was any attempt made to show the intimate connection between physical and political geography, the latter being taken almost invariably in its narrowest and meagrest acceptance. In our elementary schools, on the other hand, some attempt is made, under the guidance of the Government Code, to make the subject a reality; but even here it is by no means compulsory. On the continent, again, especially in Germany, geography is everywhere taught, in every grade of school, and throughout nearly all classes in all schools. While the position is not the same throughout all the provinces of Germany, and while here also a good deal depends upon the teacher, still the subject holds a high position, and is taught after intelligent methods. It was everywhere admitted that improvement in Germany has been largely due to the establishment of chairs in the universities, of which there are now a dozen. In Austria, France, Italy, Holland, Belgium, Norway, Sweden, the position of the subject and the methods of teaching were far ahead of what we find in England. The Education Bureau of the United States very kindly instituted, on behalf of the society, an inquiry into the position of the subject in the schools there. Unfortunately the voluminous documents thus collected did not reach me until after my report was written; but, from what I gather from the documents, I fear American schools, so far at least as the methods and standard of the subject are concerned, are not very far ahead of those of the Old Country.

There can be little doubt that the society's recent action, apart from the results in the universities, has had considerable effect on the schools generally. It has drawn wide attention to the subject; not only laid bare its neglect and the poverty and wretched quality of the appliances used in teaching, but has set before the public a higher standard than was dreamt of before, and indicated how the despised and rejected subject might, with proper methods, become one of the most fruitful fields of scientific-historical research. It has been shown that geography has a field uncovered by any other department. Of what is known as physical geography, — the topographical surroundings of humanity, — there is not much to complain: its facts and principles are pretty well known, and fairly set forth in numerous text-books. It is when we come to apply these facts to humanity, to deal with their bearings on the development of man in communities, that we find so much to desire. Mr. Mackinder defines geography as the physical basis of history: may we not extend this, and say it is the physical basis of all the activities of collective humanity? At present 'political' geography consists mainly of a catalogue of States and their subdivisions, their routes, towns, and 'chief manufactures.' If 'political' were taken in its wider and more correct sense, and political geography treated as the department of knowledge that dealt with the development of States so far as that is influenced by geographical conditions, then it is evident that both as a branch of knowledge and as a discipline we might expect the most fruitful results. What are the lines on which this new geography should run may be learned from the lecture of Mr. Mackinder, referred to above; from the lecture de-

livered in connection with the society's exhibition, and presented in one large volume along with my report; and from an admirable paper by Dr. Boas in *Science* a few months ago. To attempt to develop the subject further here would take more space than can be allowed me. Suffice it to say that this aspect of it is rapidly gaining ground in England, both in our schools and among thoughtful men generally, and I am confident will make more rapid headway in the future.

It was part of my duty to collect specimens of the various appliances used in teaching geography at home and abroad. The collection thus formed so grew on our hands that it developed into a somewhat formidable space when displayed. This collection was on view in a large hall in London in the end of 1885 and beginning of 1886. During 1886 it was sent by request to Manchester, Edinburgh, and Bradford, and at each place attracted large numbers of visitors, chiefly teachers and those interested in education. The collection was not meant to be a model one, but only typical of the various appliances in use. It therefore contained good and bad; more of the latter, I fear, than of the former. The most prominent feature was the collection of wall-maps from the leading European countries. Besides these, there were relief-maps of all sizes, models, globes, telluria, text-books, atlases, and hand-maps, and a variety of other odds and ends. The principal result of this exhibition was to bring out in strong relief the poverty of English productions of this class, especially when compared with the variety and excellence of the appliances used in Germany. English wall-maps, for example, like English text-books and English geographical teaching generally, seem mainly intended to record names. Physical features are entirely subordinate, and special physical maps are rarely met with in our schools. High and aimless coloring is the most prominent feature of our maps and atlases; and these, with our text-books, reflect painfully the low standard of the subject which exists here. German maps, again, while capable enough of improvement, are in execution, instructiveness, intelligence, and accuracy, far above any thing we have here, except in one or two cases. In the best German schools we find wall-maps always in pairs; a physical map, with physical features simply, but permanently laid down, and no names; and a political map, with the physical features subordinate but clear, in which the political features and names are laid down. Some of the best wall-maps come from Winterthur, near Zürich, from the establishment of Randegger, and are almost perfect specimens of cartography. Even Italy, following close on the heels of Germany, furnishes its schools with better maps than does England; while France, though improving, is not often very far ahead of ourselves. To Italy we owe some of the best large relief-maps, — maps accurately executed from surveys, and with the minimum exaggeration of altitudes. At the same time Delagrange of Paris sent some beautiful specimens of large relief-maps by Mlle. Kleinhaus. The great model of the Monte Rosa group, executed by Imfeld and Heim of Zürich, was the gem of our exhibition, and has been secured for the science collection at South Kensington. Unfortunately its price places it beyond the reach of most schools. But reliefs of a glacier, of a volcanic island, and other subjects, by Professor Heim, are cheap enough, and of the greatest utility in teaching physical geography. I am glad to say that not a few teachers were induced to invest in copies. The globes were mostly too small. No globe under eighteen inches diameter is of much use for the purpose for which such an article is ordinarily used. The larger the better, but unfortunately large globes are too dear for ordinary schools. We had one or two relief-globes, but the exaggeration of altitudes is so great as to render such globes pernicious. We had some very large black slate globes of foreign make and wonderfully cheap, with only the lines of latitude and longitude marked. These globes, in the hands of good teachers, can be put to excellent use in a variety of ways. The ordinary planetaria and telluria are mere toys. Their mechanism is so coarse and elaborate as to convey the most erroneous conceptions to young pupils. The most useful thing of this kind was a simple terrestrial globe on a revolving arm, with a small glass globe in the centre to hold a candle, which represents the sun. But any teacher who knows his business, can, with a simple ball or an orange, and a lamp, show all that the most elaborate tellurium can illustrate, and with much less risk

of conveying misleading ideas. We had a simple and highly instructive arrangement devised by Mr. Francis Galton, to whose initiation I may say the whole of this geographical movement is due, to show the relative sizes of sun and earth and moon. We supposed the distance between sun and earth to be reduced to 56 feet. On a wall we fixed a disk of cardboard colored yellow, 6 inches in diameter, for the sun. On a table 56 feet away we had a pellet of wax, .056 of an inch in diameter, suspended by a hair to the end of a splinter of wood 1.68 inches in diameter, to represent the earth. At the other end was another pellet, .015 of an inch in diameter, to represent the moon. This arrangement costs nothing, and can be adapted to any building. In fact, there is ample room for a variety of demonstration of the kind in connection with geographical teaching, as well as of experiments to illustrate geographical facts. Thus the crumpling of the earth's crust might be illustrated by bringing lateral pressure to bear on a plastic material; and already in a few English schools sand and clay are used to build up the physical features of a country or region. The magic lantern also may be used with great effect to produce large-scale maps on the screen, to exhibit special features, and to bring pictures of typical landscapes before the eyes of the pupils. One of the most interesting and novel of our exhibits consisted of several series of geographical pictures from Germany; that is, pictures whose special object is to show the characteristic features of the various regions of the globe, and the typical forms assumed by the leading classes of phenomena with which geography deals. The best of these pictures is the series of about thirty oleographs published by Holzcl of Vienna, and which are now coming into use in this country. Above all things, such pictures must be accurate, and therefore good large-scale photographs are often to be preferred, — such photographs, for example, as are produced by the United States surveys and by private enterprise, — of some of the most striking features in American scenery. For teaching purposes, however, it should be remembered that it is not extraordinary features that are desired, but typical aspects of the earth's surface, — ordinary mountain forms, a prairie, a delta, a tundra, a steppe region, a coral island, a sandy desert, and so on.

The text-books and atlases which were exhibited were analogous to the wall-maps. The English text-books were mostly too large, and too crowded with names and tables, and made no attempt whatever to show the intimate relation between all sections of geography, and the influence which man's geographical surroundings has upon his social and political development. The German text-books are comparatively small; contain mostly heads of subjects, the filling-up being left to the teacher, who has generally had a thorough training in geography at the university or the normal school. I am sorry I cannot speak very highly of American text-books. As a rule, the American text-book is combined with an atlas and picture-book, — an arrangement which I do not consider a happy one. Neither text, nor maps, nor pictures, are any better shown than we have on this side; and even with Guyot's geographical manuals we were much disappointed.

Altogether the collection of geographical appliances has proved most suggestive and instructive. Reform has already begun. Many schools are now using Kiepert's wall-maps, and publishers are making haste here to supply the glaring want of good text-books, atlases, and wall-maps. Teachers have been stirred up to recognize existing deficiencies, as well as the undreamt of capabilities of geography when treated liberally and intelligently. They see that in geography, as in mathematics, a special training is required if it is to be taught effectually. The society appeals to the elementary teacher by offering a series of prizes on the basis of the examinations of the training-college students, and many of the school boards are instituting radical improvements in their geographical appliances. Out of the collection, which is once more in London, we are forming a small typical collection for exhibition to any who may wish to know what are the best things in any department. This collection is of course very small to begin with; but we hope, that, as improvements are introduced, we may be able to extend it.

Altogether I hope it may be seen from these notes that the Geographical Society has at last succeeded in raising geography from the slough in which it has lain so long in this country; has not

only initiated great improvements in the teaching of the subject, and obtained its recognition at our great universities, but has shown that it is eminently capable of becoming a fruitful and instructive medium of research, worthy of taking its place alongside of other departments of scientific investigation. J. SCOTT KELTIE.

THE STUDY OF GEOGRAPHY.

THE *Ausland* of May 9 contains an extract of A. Stauber's essay on the promotion of the study of geography, which carried the prize offered by the King of Belgium. The author discusses the methods which ought to be applied in primary teaching, in high-schools, and in colleges. In the primary grade, the method is that of object-teaching. First, the geography of the child's own country is taught, beginning with the nearest surroundings, the school-house or home, the village or city, the county, and so on. The close connection between natural history and geography must be kept in mind by the teacher, who is warned against overburdening the children's brains with names and dates. The drawing of maps and the use of charts are recommended; but Stauber remarks justly that not too much weight should be laid on the drawing of maps, which must only be practised as a means to impress the configuration of the earth's surface more effectively on the child's mind. In the upper classes, an atlas ought to be used, but it is important to select maps which contain the proper amount of material and show the geographical features of the country clearly and simply. After the native country has been thoroughly studied, the geography of the native continent, and later on that of the other continents, is taught.

In high-schools and colleges the analytic method gradually takes the place of the synthetic. The reading of travels is recommended as a means of making the study more attractive and of preventing its becoming a mere memorizing. The connection between natural history and geography must always be emphasized, and characteristic objects ought always to be shown. But, in order to be able to do this kind of work, teachers ought to be thoroughly conversant with the problems of geography. This can only be accomplished by the study of geography at a university. Therefore the establishment of professorships of geography is demanded. At the present time there are seventy-five such professorships at European universities. In Prussia, every university has its professor of geography; at other German universities there are lecturers. In England, geography will be taught in Oxford and Cambridge, as lecturers were appointed a short time ago. In Belgium, Greece, Portugal, Sweden, and in the United States, the science of geography is not taught by specialists, but, when it is taught at all, only incidentally.

Among the manuscripts which received honorable mention is an American one by Prof. Richard Owen of New Harmony, Ind. We are indebted to the author for a statement of his proposals.

The first principles of his method of teaching are, that he only makes one step at a time from the known to the unknown, and that the eye instructs more than the ear, and that consequently, whenever practicable, the object that is being described, or a good representation of it, should be shown. As a consequence of his first principle, he presents only one thing at a time. For instance, he uses a separate outline map, 1st, for the general outlines of the continents; 2d, for the same with mountains only; 3d, for the same with rivers added; 4th, for all these with political divisions. He depends chiefly upon numerous plastic relief-maps as a system of instruction, and shows that these can be made very economically, and that children of from ten to twelve years of age take great interest in their construction. He begins his course in the same way as Stauber, by having the student study the geography of his home, and by having him make the plan and model of the school-house, or of his own house and garden, by measurement and according to a definite scale. Then he proceeds to teaching the topography of his town, county, state, and finally of the United States.

Using the globe, he begins to give his pupils an idea of the earth being nearly a sphere, by various demonstrations, and by calling in a traveller who testifies that he returned to the place of beginning of his travels by steadily travelling west, and thus teaches the elements of mathematical geography. In teaching, he uses numerous maps and diagrams, showing the phenomena of physical geography, and models to explain the forms of the earth's surface.

HEALTH MATTERS.

Evergreens and Consumption.

AT a meeting of the American Climatological Association, held in Baltimore, Dr. Loomis of New York read a paper on evergreen-forests as a therapeutic agent in pulmonary phthisis, in which he said that it had long been known that similar climates, as determined by geographical and meteorological conditions, have different therapeutic effects. It is becoming more apparent that there is some relation between the development of organisms and atmospheric conditions. Cold and high altitudes render the air aseptic; but the degree of cold and the height required are so great, that clinically it is not possible to derive much benefit from this fact. The effect of a purely aseptic air upon ulcerative processes is not so great as the effect of an atmosphere which is aseptic on account of the presence of antiseptic agents. The belief in the good effects of pine-forests in cases of phthisis is quite unanimous, and the clinical evidence in favor of their beneficial influence is unquestioned. The atmosphere in such regions is not only aseptic, but also antiseptic. Such an atmosphere contains considerable turpentine-vapor, and we should therefore expect it to contain a certain amount of peroxide of hydrogen. The majority of cases of phthisis die, not directly from the lesions in the lung, but from the secondary septicæmia and pyæmia which are set up. It is impossible to apply to the ulcerations within the lung the antiseptic washing and dressing that is employed in external lesions; but, if an antiseptic atmosphere can be obtained, we may hope to counteract the secondary poisoning. Such an atmosphere will not destroy the bacilli, but it will accomplish much in the way of arresting the suppurative process. The atmosphere in the region of evergreen-forests acts in a manner similar to the antiseptic agents which are successfully used to arrest suppurative processes in other portions of the body; and, in all probability, the active agent is peroxide of hydrogen resulting from the oxidation of the turpentine-vapor. While it is not possible for every one suffering with pulmonary phthisis to go to an antiseptic atmosphere, yet it is possible to render the air of any particular locality antiseptic. In the course of the discussion of Professor Loomis's paper, Dr. Cohen reported excellent results in the way of alleviating the symptoms of phthisis by the inhalation of terebinthinate substances, especially when associated with the peroxide of hydrogen, or oxygen.

BOOK - REVIEWS.

The Republic of the Future; or, Socialism a Reality. By ANNA BOWMAN DODD. New York, Cassell & Co. 24°.

THIS is not a pretentious book, but a pleasantly written series of letters "from a Swedish nobleman living in the twenty-first century to a friend in Christiania." It appears from the letters that the American Republic has been dynamited, and upon its ruins a socialistic republic established. The year of the revolution is 1900, and, by placing the date of the letters late in the twenty-first century, the author assumes sufficient time to have elapsed to fully develop the characteristic society. The Swedish nobleman, recognizing the evils of society based upon the principle of competition, and learning that the Americans (that is to say, the Germans and Irish, who have exterminated the English stock) have succeeded in forming a socialistic society, pays a visit to this strange people for the purpose of studying their institutions. His letters are descriptive both of what he saw and of what he thought.

Such is the plot of the book, and it certainly is an attractive one; but, to be useful as an argument, the ideas from which it starts must properly represent the socialists, whom it undertakes to criticise. This, however, it fails to do. The author is either ignorant of the writings of the best socialists, or has deliberately chosen the views of inferior men in order the more easily to ridicule them.

It is right that such a charge as this should be sustained by specific statements, and we will call attention to three points in which these letters fail to appreciate or to understand the theory of socialism.

First, It is assumed that socialism demands absolute equality of

condition: for example, only homely women are permitted to become educated, lest the equality of attractiveness should be destroyed; and much more of the same sort. This is foreign to the spirit of socialism. "It is not equality of condition, but equality of opportunity, that is demanded. The rule of distribution is that each shall share in the good things of life according to his efficiency as a producer. It is communism which says, "To every man according to his needs:" socialism says, "To every man according to his ability."

Second, It is assumed that government directs methods of expenditure as well as methods of production. In this Republic the houses are built according to law. Dress, too, is prescribed. But all this is a mistaken notion. It is not found in the writings of representative socialists. Indeed, the opposite is expressed. A sharp line is drawn between wealth used as capital, and wealth used for giving enjoyment to the consumer; and there is no suggestion that law should prescribe how this second class of wealth may be used.

Third, The author of these letters says that 'Progress and Poverty' is the Bible of the new republic. It is read from the rostrum of the temple erected to ethical culture, — a temple, we are told, which stands without a steeple. Now, it seems hardly possible that our author could have read 'Progress and Poverty' with care, or the many contradictions which exist between the views of Mr. George and those realized in the socialistic society described, would have been recognized. For example, socialism charges upon commercial competition all the evils of modern society: it is therefore quite right to say, as our author says, that in a socialistic society competition in business-matters finds no place. But Mr. George does not desire to exclude competitive action: indeed, he is a firm believer in the doctrine of *laissez-faire*. He is a freetrader. He says, make one simple change in the system of taxation, and the natural laws of trade will insure justice. No socialist would recognize him as more than a temporary leader. He does not go far enough. He proposes only to nationalize land: the socialist would nationalize both capital and land.

This review has taken the book reviewed to be a serious argument against socialism. As such it is worthless, because it does not properly apprehend what socialism means. The reviewer does not call attention to this because he is a believer in the programme of social reform set down by Blanc and Lasalle, but because he feels that every witticism made at the expense of truth assists the cause which the writer of this book undertakes to oppose. It may be that this point of view is incorrect. Possibly the book was intended to be merely a bit of facetious writing. As such it is a success. It is bright, in good style, and full of pleasing imagination; but for an argument it is too full of imagination.

HENRY C. ADAMS.

The Electric Transmission of Energy. By GISEBERT KAPP, C.E. New York, Van Nostrand. 12°.

THIS book forms one of the 'Specialists' Series,' which is a series of handbooks for students and practical engineers. It begins with the customary *résumé* of the elements of electrodynamics, together with a brief study of the nomenclature of the science, and the units used in electrical measurements. While this part of the work is, on the whole, well done, it is evidently the product of the so-called 'practical' mind, rather than that of the educated or well-informed electrician.

A few curious statements occur, which illustrate the difficulty with which makers of handbooks contend in attempting to absorb, or at least to represent, purely scientific conceptions. As an instance the following may be quoted: "The potential of a body is its property of allowing energy stored up in it to become potent, that is, to do work." An investigation of the ideal motor and the ideal system of transmission is followed by an examination of the various types of armatures and the principles which govern their action. The field-magnet is then taken up, its many forms illustrated, and some attention is paid to magnetic resistance, self-induction, etc., use being made of 'characteristic curves' in the development of the principles involved. The subject of the efficiency of the motor is treated at some length, and various systems of transmission are described, including some of the applications of electricity to railway locomotive

tion. Tolerably complete discussions of some of the principal trials of long-distance transmission are also included, together with some of the numerical results of these trials. The volume contains much that is interesting and useful to students of electricity, and will be of undoubted value to those who are engaged in its practical application. The American reader will look in vain for any account of the more recent and highly important improvements in motors and systems of transmission which have originated in this country. This will not be a matter of regret to any one who has secured a copy of the next book under review.

The Electric Motor and its Applications. By MARTIN and WETZLER. New York, W. J. Johnston. 4°.

MADE up largely of articles contributed by its authors from time to time to the *Electrical World*, by far the greater portion of this volume is devoted to an exposition of the results of American activity in this field. Again is found on the first page the usual cut showing Oersted's experiment, and the usual brief and unsatisfactory presentation of elementary principles, without which it seems impossible for a book on electro-technics to make its appearance. Not much can be said in favor of this well-nigh universal introduction. The reader has but to turn over a single leaf to find himself involved in the use of such terms as 'counter-electromotive force,' 'Lenz's law,' 'the law of Jacobi,' and many others, for the proper understanding of which little assistance has been rendered in the short study of 'theoretical principles.' Books of this class are written for and read by those who already know more than the elements of the subject, and their presentation might safely be omitted.

Two chapters are devoted to an account of the earlier experiments with motors in Europe and America, and in the division of space Europe gets five pages to America's sixteen. A chapter is given to the theoretical consideration of the problem of the electrical transmission of power, followed by a very short one on the electric railway and tramway in Europe, and a very long one on the electric railway and street-car lines in America. The use of storage-batteries with electric motors on street-railway lines concludes the first half of the book, the remainder of which is devoted to a consideration of the industrial applications of electric motors in Europe and America. Much the largest share of space is given to American systems and inventions, and many of the most important 'plants' now in operation are described. The work is largely historical and descriptive in its character, a scientific treatment of the subject being only attempted in a single chapter.

As a *résumé* of what has been thus far accomplished, especially in this country, in the development of one of the most promising fields of applied electricity, it will be found to be very interesting and useful. Illustrations form a prominent feature of the work, there being as many as two hundred, many of which occupy an entire page. Several of the largest and most elaborate illustrations are intrinsically of very little value, being merely 'pictures' which are in no way especially related to the real object of the work, and convey no useful information. Of such may be mentioned a full-page 'winter view' of an electric street-railway, in which the only thing suggestive of electricity is a possible lightning-rod upon a building in the background.

Electric Light Primer. By CHARLES L. LEVÉY. New York, The Author. 8°.

THIS little primer consists of thirty-five octavo pages of good, bad, and indifferent matter relating to the management of dynamos and electric lights. The 'practical man' here has full sway, and he wisely declares in his preface that "it is not supposed that these pages will be of any value to the electrician."

They would have been of much greater value to the workmen and engineer in charge of electric machinery if they had been prepared by one who really understood what he was writing about. As it is, a good deal of knowledge of the subject is required to separate the good from the bad.

The Storage of Electrical Energy. By GASTON PLANTÉ. New York, Van Nostrand. 8°.

THE work before us includes the principal researches of Planté, contributed to the French Academy, and various scientific periodicals, from 1859 to 1879. The full history of the secondary battery, as it grew in his hands, will be found in the first two or three

chapters, and the construction of various forms is given with great exactness of detail. His use of the transforming rheostat for the purpose of obtaining electricity of 'high tension' is described at length, together with many practical applications of this device. The volume includes an account of Planté's experiments on the nature of the electric discharge under high tension, and also his application of these researches in the explanation of many natural phenomena.

While many electricians will be unable to agree with him in his conclusions, all will be glad to find the results of his labor in so compact and usable a form as that in which they are presented in this volume.

Electricity treated Experimentally. By LINNÆUS CUMMING. M.A. London, Rivingtons. 12°.

ALTHOUGH an excellent little book, it will be something of a disappointment to the many teachers and students who have for several years made good use of the 'Theory of Electricity,' by the same author. The disappointment will grow out of the fact that it is a less complete and comprehensive treatment of the subject than will be generally looked for. It contains the substance of a series of experimental lectures given to senior boys in Rugby School, and not much preliminary mathematical training is assumed. In a few of the discussions a knowledge of mathematical principles as developed in the author's 'Theory' is desirable, but in such cases the fundamental formulæ may be taken for granted or the articles may be omitted. Magnetism is first studied, and then a relatively large space is devoted to frictional electricity.

Book III. is devoted to voltaic electricity, and fills rather more than one-half of the entire volume. At the end of each general subject will be found an excellent list of problems and exercises; and, as the author says, the book is educational, and not technical, in its plan and character. There are doubtless many courses of study into which it will fit with extremely satisfactory results.

Facts and Fictions of Mental Healing. By C. M. BARROWS. Boston, Carter & Kerrick.

THE writer of this book states that he has not himself been engaged in mental healing, but has enjoyed exceptional facilities for studying its operations, and investigating a great number and variety of alleged cures. He is convinced by the results of many careful tests, that, if the mental treatment of disease be not all that its most sanguine advocates picture it, it is a powerful therapeutic agent when skillfully used, and based on a philosophy which has done the world incalculable good. In presenting the claims of this method of treatment, he has tried to make it apparent that there is a sound physical reason why well-directed thought should help the sick as much as medicine does; that a mental cure is nothing mysterious, but a natural event, which could not but take place under favorable circumstances. He disclaims any desire to compel the reader's assent, but his aim has been to awaken thought and deepen the reader's interest by fairly stating the evidence both for and against mental healing, and let him decide for himself. There are facts that prove the possibility of such cures beyond a peradventure. There are fictions, also, which must be abandoned if mental healing is to get and retain a hold upon the popular attention. It has a philosophy that will bear the intensest light that can be thrown upon it; and the subject needs only to be presented to educated, thoughtful persons in the right way, to appeal to their intelligence and convince their reason. Under the title 'Mental Healing' the author of this book includes 'spiritual healing,' 'prayer and faith-cure,' 'metaphysical healing,' 'Christian science,' and 'mind-cure.' In an introductory survey, the wonderful reputed cures are referred to of Dr. Newton, who, in Boston, in 1859, restored the sick to health by the laying-on of hands; of Elizabeth Mix, an ignorant colored woman of Connecticut, who performed many faith-cures; of Dorothea Trudel, who, in 1861, in Switzerland, worked remarkable cures of cases given over by physicians as utterly hopeless; and of others which want of space will not permit us to quote. The objection is often made to the various forms of mental healing, that there is no positive evidence that the cures are what they are claimed to be. Most of them, it is said, are performed by persons unskilled in the science of pathology, and not qualified to judge whether the subjects of their treatment really suffer from the

alleged disease, or, if actually sick, are fully cured. The best answer that mental healers can make to this charge is, that, whether right or wrong in their judgments of what ails their patients, they act precisely as any sensible physician would under like circumstances, and try to relieve the disease. In a chapter on the creeds of mental healers, we find that these differ to a considerable degree among the different schools or sects: for these points of difference we shall have to refer our readers to the book itself. Mr. Barrows states that it would not be putting the case too strongly to say that the theory of the mental healers, carried to the highest point, traces every form of disease, as well as sin, to mental causes, which may be removed and the effects destroyed. Even death itself they hold to be an illusion, that may be dispelled by a full reception of the truth and consequent right thinking. Thought creates a world for each one of us; thought makes the body; and all physical phenomena, whether of disease or health, are due to thought. In commenting on this view of the subject, the author says, that, if utterances like these seem extravagant, it should not be forgotten that a new truth—and every truth we grasp is new to us, though old to all the world beside—is apt to intoxicate its possessor, and become to his infatuated sense the universal solvent of the enigmas of life. Time and experience may safely be left to adjust the value of these claims; but meanwhile it is not the mark of wisdom to fear or ridicule them. We must confess, that, after a very careful reading of Mr. Barrows's book, we are as much in ignorance of just what is the basis of the mental healer's claim as we were before. They seem, indeed, to be divided into more sects or schools than those usually called physicians. Some of their claims, as quoted by Mr. Barrows, are simply absurd. Take this one, for example. It is an extract from one of the text-books of mental healing prepared for the guidance of students who intend to practise that method. If the case to be treated is a consumptive, begin your argument by taking up the leading points that this disease includes, according to belief, showing it is not inherited, that inflammation, tubercles, hemorrhage, and decomposition are but thoughts, beliefs, mental images before mortal mind, not the immortal Mind: hence they are not the truth of man, and should be treated as error, put out of mind, and then they will disappear from the body. That Mr. Barrows is a firm believer in mental healing is apparent from his writings; and that he himself believes that some of its teachers and practitioners make ridiculous claims for it, also seems to be clear. We are inclined to agree with some of the writers to whom he refers,—with Dr. Buckley, for instance, who acknowledges that most extraordinary recoveries have been produced, some of them instantaneously, from disease in some cases generally considered to be incurable by ordinary treatment, in others known to be curable in the ordinary process of medicine and in surgery only by slow degrees,—but can hardly be convinced that the case quoted from 'Nature and the Supernatural,' by Rev. Horace Bushnell, ever occurred, certainly not under just the circumstances as given, where a child ill with scarlet-fever was, immediately after a prayer made by his father, completely cured, so as to pronounce himself quite well and ask for his dinner. Mr. Barrows refers to the late Dr. Austin Flint with great respect for his opinions; and if mental healing, as he states, simply emphasizes the highest doctrines of the medical schools as announced by Dr. Flint, then we willingly acknowledge that there is much in it to demand consideration and recognition. Dr. Flint, in one of his addresses, said, "Let it be popularly known that most medicinal agents are curative, not directly but indirectly, by the removal of obstacles in the way of recovery; that Nature is always the efficient curative agent, and therefore that the physician is Nature's servant, not her master." We confess to a feeling of disappointment when we finished reading this book of Mr. Barrows. His preface seemed so fair and unprejudiced, that we expected to get a plain statement of the facts, particularly as he had stated that he had enjoyed exceptional facilities for study and investigation. If mental healing "is to get and retain a hold upon the popular attention," and if "the subject needs only to be presented to educated, thoughtful persons in the right way, to appeal to their intelligence and convince their reason," we fear it must be done in a much simpler, more matter-of-fact, and less metaphysical manner than has been done by the author of 'Facts and Fictions of Mental Healing.'

NOTES AND NEWS.

The officers for the next meeting of the American Association were nominated as follows: president, J. W. Powell of Washington; vice-presidents, Ormond Stone of the University of Virginia (Mathematics and Astronomy), A. A. Michelson of Cleveland (Physics), C. E. Munroe of Newport (Chemistry), Calvin M. Woodward of St. Louis (Mechanical Science), George H. Cook of New Brunswick (Geology and Geography), C. V. Riley of Washington (Biology), C. C. Abbott of Trenton (Anthropology), C. W. Smiley of Washington (Economic Science and Statistics); permanent secretary, F. W. Putnam of Cambridge (office Salem, Mass.); general secretary, J. C. Arthur of La Fayette; secretary of the council, C. Leo Mees of Athens; secretaries of the sections, C. L. Doolittle of Bethlehem (Mathematics and Astronomy), A. L. Kimball of Baltimore (Physics), William L. Dudley of Nashville (Chemistry), Arthur Beardsley of Swarthmore (Mechanical Science), George H. Williams of Baltimore (Geology and Geography), N. L. Britton of New York (Biology), Frank Baker of Washington (Anthropology), Charles S. Hill of Washington (Economic Science and Statistics).

—The arrangements for the tenth annual meeting of the American Society of Microscopists are now definitely made. The society convenes in Pittsburgh, Penn., Aug. 30, 1887, and will probably continue its sessions four or five days. There will be a field-excursion to Chartiers, and the society will be invited to visit the extensive steel-works of Carnegie, Phipps, & Co., at Braddock. The party will go by steamer up the historic Monongahela: a field-excursion has been planned in connection with this pleasure-trip. There will be collected a temporary library of rare books and manuals. A considerable number of volumes have been promised. These will be under the constant care of a librarian.

LETTERS TO THE EDITOR.

* * *The attention of scientific men is called to the advantages of the correspondence columns of SCIENCE, for eliciting promptly on record brief preliminary notices of their investigations. Twenty copies of the number containing his communication will be furnished free to any correspondent on request.*

The editor will be glad to publish any queries consonant with the character of the journal.

Correspondents are requested to be as brief as possible. The writer's name is in all cases required as proof of good faith.

An Insect-Fight.

An observation quoted by Professor Morse in his address before the American Association last night is so exactly confirmed by a recent observation of my own, that it seems worth while to put it on record.

While sitting in a hammock slung between two large maple-trees on the lawn, I heard a loud buzzing and fall of something behind me, and, looking around, I saw on the grass a locust (cicada) in the grasp of a large insect, evidently of the wasp family, but which I am not sufficiently well posted in entomology to name. It had brown wings, and large abdomen colored black or dark brown with white spots. The whole length of the insect was about thirty-five or forty millimetres. When first seen, the struggling locust was on its back; the wasp extended above it head to head, and industriously plying its sting between the abdominal wings of the locust. The locust quickly became quiet, and then the wasp, maintaining its former position, which it did not at any time abandon, grasped the head of the locust by the middle pair of legs, and, using the other four legs for locomotion, started to drag it through the short grass toward one of the trees. There was no hesitation or uncertainty, but the wasp started at once in a straight line for the foot of the tree. On reaching the tree, the wasp began without pause to carry its burden up the trunk, using its four legs for walking, as before, and assisting itself to sustain the weight of the locust by putting its wings in operation. In this way, with a few brief pauses as if to rest and get better hold, in one of which it hung for a moment apparently by one leg, the locust was carried up among the branches of the maple, some twenty feet or so, where it became difficult for me to follow its motions. After reaching such a height, the wasp flew off in a straight line through the branches, and went out of sight. I think it carried the locust with it, but the height was so great that I could not be positive. At any rate, the locust did not fall to the ground, although, as the

wasp's flight started from a crotch in a limb, it is possible that the locust was left in the crotch. The whole incident showed a perfect understanding, on the part of the wasp, of what he proposed to do, and the carrying-out of a preconceived plan of procedure without any stopping to think what he would do next. The only pauses were in going up the trunk of the tree.

C. G. ROCKWOOD, JR.

New York, Aug. 11.

A Good Word.

I SEE by your last issue that the Teachers' National Association indorsed the Blair bill. I am sorry to learn of this, as I think that bill is an imposition upon the intelligence of the people of this country.

In the first place, any State that cannot support schools in which to educate its children must be poor indeed; and, in the second place, any State that would accept national aid has not the spirit necessary to a sound government. We can plainly see where the most of that aid would go, and we do not feel like sending it into those States. I am aware that many will deem me unjust; but, be that as it may, I would never consent to the Blair bill, and I am sorry that my fellow-teachers ever gave their indorsement to such a bill, as by so doing it may have some weight in the future; but then teachers are only mortals, and many of them seem to have very poor judgment.

I am glad to see the position that *Science* takes in this matter, and you may rest assured that I shall be a life subscriber to that paper. I consider it the best paper published in this country for any advanced teacher or scientific man. I wish you the best of success.

JAMES LAWREY.

Fremont City, Io., Aug. 8.

The Formation and Dissipation of Sea-Water Ice.

SEA-WATER possesses several characteristics that make the operation of freezing different from that in the case of fresh water.

The density of sea-water increasing till the freezing-point is reached, it follows that its conversion into ice will take place beneath, instead of at the surface as in the case of fresh water. The freezing-point in most cases, then, should be situated near the bottom of the column of water, if not actually at it.

In equal thicknesses of fresh and sea water ice, two inches of the first will support a greater weight, without fracture, than an equal thickness of the latter; although it is quite possible, that, where greater thicknesses are concerned, the advantage may be in the opposite direction.

Sea-water ice is much less 'brittle' than that of fresh water; rising and falling under the influence of a heavy sea, and adapting itself to its undulations, in cases where fresh-water ice would be fractured: this is particularly noticeable in the earlier stages of its formation.

An inch of newly formed sea-water ice will not support a man's weight, and, in giving way beneath him, does so abruptly, without any warning preliminary fissures, leaving a cleanly cut hole of the same extent as the surface over which direct pressure was administered, and thus differs from fresh-water ice, which, on being fractured in this way, carries down a large portion of the surface beyond the area directly under pressure. We may therefore conclude that the cohesion amongst the particles in fresh-water ice is greater than in the case of sea-water, and possibly that the arrangement of the ice-crystals is different in each. Those in the case of fresh water, forming horizontally at the surface, overlap and bind each other together, whilst those from sea-water would seem to arrange themselves vertically, as a comparison of the fractures in each case will show.

The formation of a film of ice over a sheet of sea-water takes place indifferently, as to position, during calm weather; but, with a light breeze blowing, the permanent formation commences at the windward shore; narrow and rapidly lengthening 'streamers' form from the points of this shore; continuing, and growing very slowly narrower as it does so, it may reach a length of from four

hundred to five hundred yards; then parallel streamers combine, till at last the entire surface is covered. A great peculiarity of the preceding is the extreme narrowness of these streamers in comparison to their great length, and the consequently great cohesion that is capable of overcoming the strain that must be caused by even a light wind blowing over so lengthy a surface, whilst it is rising and falling to the pronounced ripple on the water's surface.

Recently formed sea-water ice is not of uniform texture throughout its depth. A section of four inches would be represented by a thin layer of partially decomposed ice, looking very much like thoroughly saturated snow; then about two inches of 'sodden' ice, occupying a condition intermediate between that of the surface film and fully formed ice, both in consistency and appearance; and, finally, the fully formed ice, having every appearance of fresh-water ice. These differences in the several strata of the ice do not continue, once the temperature of the air becomes very much lower than that of the water's freezing-point.

When the ice is first formed in tidal waters, that portion of it which is left aground above low-water mark freezes to the bottom (the temperature of the air being supposed to be below the water's freezing-point); so that, on the water rising again, it is left there, submerged. Over this, at the surface of the water, another ice-film is formed, which, on reaching the level of the submerged ice, is frozen to and remains with it in this position. This operation is repeated, till the result is, that a perpendicular wall of ice forms, whose outer limit is the low-water mark, terminated by a horizontal surface shorewards at the limit of high-water mark. The outcome of this peculiarity is, that the shore outline in winter undergoes a complete transformation, of more or less extent in accordance with the difference existing between high and low water mark. In the case of a mud or sand bottom, the ice, though freezing to it, possesses sufficient buoyancy to raise a film of mud or sand with it each time, till it is of sufficient thickness to counteract this tendency.

The explanation of this phenomenon seems to me to be as follows: in the first place, it is essential that the temperature of the air should be below the freezing-point of the water; and, in the next place, it is evident that the temperature of the earth forming the bottom must be above the freezing-point, else ice would form there; still, it need not be much above it, as the water, being very nearly at the temperature of its freezing-point, would reduce the surface of the bottom to that point, less the increase in temperature consequent on the convection of the earth's heat to that surface. The freezing-point of sea-water being $26^{\circ}.7$, the melting-point of sea-water ice $28^{\circ}.8$ (*Science*, ix. No. 228, x. No. 232), then, if the temperature of the bottom lies between these values, we can understand, that, when the formed ice is placed in contact with it by the falling tide, the temperature of the air reduces that of the water which is running off the ice as the tide leaves it, so that it freezes and cements the ice to the bottom. To free it again requires that the temperature of either the air or the water should rise above $28^{\circ}.8$, which, with the water at $26^{\circ}.7$ and the atmosphere below this point, is not possible: therefore our ice remains fast to the bottom.

Fresh water freezing, and its ice melting, at the same temperature, it cannot possibly freeze to the bottom; for, granting that the temperature of the water may be 32° , that of the bottom must be above, both on account of the water in contact with it being at a higher temperature than this, and because, even if we assume the temperature at 32° throughout, that of the bottom must be above this, owing to convection, as before stated. Anchor-ice does form in fresh water, but not on the bottom proper, as it attaches itself to boulders or pebbles which are not themselves in perfectly continuous connection with the bottom proper, and are therefore largely surrounded by the water, and correspondingly affected by its temperature, whilst insensibly affected by convection; so that, if we can assume conditions under which the water's temperature would be below the freezing-point, we have those cases in which anchor-ice will form.

On account of the position of the freezing-point in a column of sea-water, it is possible, under certain conditions, for two films of ice to form, one below the other. This was actually observed to have taken place under the following conditions: the temperature

of the water at its surface had been 29° for some days, when a very rapid and extensive fall in the temperature of the air took place; the following morning a film of ice half an inch thick had formed beneath the surface, and had become fixed in position at the under surface of the harbor-ice, whilst another film a quarter of an inch thick had formed at the surface of the water, leaving a space between them of about four and one-half feet.

The dissipation of sea-water ice by the approach of spring takes place at first much more rapidly from the upper than the under surface, the atmosphere reaching the required temperature so much sooner than the water. No sensible effect had been produced by the water till its temperature exceeded 29°, when a loss of transparency and vertical stratification of the ice became visible as the first signs of its dissipation from beneath. In the mean time, of a total thickness of four and one-half feet, eight inches of the upper surface had been dissipated.

W. A. ASHE.

The Observatory, Quebec, July 29.

The Florida Heron.

MR. SHUFELDT'S article on the wanton destruction of our heronries I found decidedly depressing reading. As an eye-witness, he was able to give graphic pictures of both life and death. There is perhaps no bird more beautiful, and at the same time more harmless to mankind. Indeed, it is its wonderful beauty that brings its cruel death; and the lack of fear and cunning, being never engaged in mean work, makes it all too easy for the barbarous murderer to approach. The heron is unfortunate. Nature has given it what human vanity makes valuable; and as only death can bring this beauty within reach of the hard-hearted wretches, whom money will induce to do many revolting things, the poor bird must die. If this were the only instance of the kind, it would be yet more painful to our better natures, and those who are guilty of the outrage would seem to us more blameworthy. In truth, it is the trivial use to which the heron's plumes are put that makes the act of getting them so detestable. The taste which calls for them is that of creatures not yet developed to the highest form. Would a bird's feather of any kind add to Venus de Medici? Yet feathers, even those of a buzzard's tail, would adorn an Indian female. When we contemplate any young lady of our age and generation, whose head is so covered with feathers that the only part of the impression the memory retains is that of the curiously combined mass of bird-plunder, we are apt to be led to reflections which it would be cruelty to the good-intentioned girl to make known to her. If the gentle creature is really beautiful, that beauty cannot be adorned, except from within. Any attempt to add to it externally by bright-colored ribbons, flashing jewelry, or plumage, is always shocking to refined minds. If beauty is lacking, the use of accessories to make up what nature has denied is quite certain to excite contempt or compassion.

The truly hideous practice, in vogue a few years ago, of wearing the bodies of birds on the head, seems to have been too much, even for the calloused sensibilities of people of fashion. To be attacked by hungry cats, or to see the famous myth of a spring chicken on Biddy's proudly erect head, was too unpleasant. That there was any sentiment about it is not easily conceivable. The silent woods and meadows did not trouble the dissipated young female of the city. She must be in the fashion, or she must die; and, if she reasoned at all, it was to the effect that it were better that birds should die than that she should give up her slavish ghost.

The fate of the heron is plain. After the slaughter has continued until only here and there a shy one can be found, they will probably assemble in convention, and migrate, to be seen by us no more.

It would be idle to legislate, for only hunters know the way to their resorts, and the former would hardly do for constables. The very habits of a hunter would make it impossible to catch him at it; and, as he likes the sport too well, it would not be practicable to try bribery. The horrible evil will have to be put up with until fashion shall dictate something to take the place of the matchlessly beautiful plumage, or until the frightfully persecuted bird takes itself to remote regions impossible of access to man.

This topic has occupied my mind at times for many years, and I have mourned over the fate of the harmless denizens of our glades;

but I have never been able to form a plan of hinderance that did not soon prove impracticable. I have submitted with a sigh which sometimes became almost a groan. My experience will, I fear, have to be that of all who become interested in the subject. The few words which I have brought together here may be of use in checking the abominable fashion; otherwise they are useless.

L. R. PEET.

Yalaha, Fla., Aug. 11.

Answers.

12. MOSQUITOES.—In *Science* for Aug. 5, 'T. J. H.' queries concerning the re-appearance of mosquitoes on Staten Island seven days after a storm. Though I have made some notes in reference to *Culex* from time to time, this fact has never been observed. Storms are always disastrous to insect-life, and will kill or blow away moths and butterflies, as well as mosquitoes; but that these latter insects should re-appear in numbers seven days after a storm, will depend entirely upon whether the majority of the pupæ have reached maturity or not at that time. Mosquitoes are present in numbers all summer on the salt meadows,—indeed, I have scooped with my two hands together hundreds of their larvæ from the little pools,—but it is only at intervals of about a month that they swarm on the upland. During the latter week in May or first week in June, and the first days of July and August, I have noted swarms of mosquitoes in past years. The worst visitation of all is likely to be the July one, or at least it has been generally so. On low ground and near the meadows I have seen horses in July dressed in garments made for the occasion, and others decked with a profusion of wild indigo, that shook violently as they trotted along. The older residents remember well the mosquito visitation of July 3, 1862, when the vegetables were left unpicked in the garden for a week, and people wore mosquito-net over their hats.

WM. T. DAVIS.

Tompkinsville, Staten Island, Aug. 9.

13. ELECTRICITY AND THE EARTH.—In your issue of Aug. 5, Mr. M. A. Veeder points out some passages in Deschanel's text-book of physics, which he takes to imply that moist air is a good conductor of electricity, and that the earth is a reservoir of electricity; and then he asks, "Has Deschanel been superseded?" I do not happen to have the book referred to at hand, but it does not matter. It is true enough that one may complete an electric circuit through the earth, or through any part of it, when there is proper conducting-material at the wire terminals, not otherwise. The earth, in such case, acts solely like a return wire to complete the electric circuit, and its sole function is conductivity between points that differ in electric potential. As most of the earth's surface is made of conducting-materials, one may make connections for conduction almost anywhere, and it is a great convenience to be able to do so; but it does not follow that the earth stores up any electricity at all, so that it might be called a 'reservoir.' Electricity is but a transient phenomenon, and, when it does work in no other way, is changed at once into heat, in the earth as well as anywhere else. It is therefore improper and misleading to speak of the earth as a reservoir of electricity. As to the effect of a damp atmosphere upon electrical machines, it is well enough known that if means be provided for preventing the deposition of moisture upon the surface of such machines, by heating or otherwise, the machines may be kept electrified for an indefinite time. The electricity generated creeps over the damp surfaces of wood or wax or varnish to the earth, not through the air, whether moist or not. If moist air were a good conductor of electricity, or if it were one of the best conductors, as was stated by Mr. Garriott, it is highly probable that telegraph companies would have found it out long ago, and have had to insulate the wire from the air, instead of which they find it only necessary to insulate from the posts upon which the wires are hung. There is nothing new or strange about these things, except it be, that, having been patent to all for so long a time, they should be unknown to any who are pretentious enough to criticise the labors of those who work according to knowledge, and at the same time evolve out of their consciousness a theory unsupported by a single experiment, and directly contradicted by all we do know.

A. E. DOLBEAR.

New York, Aug. 22.

SCIENCE

FRIDAY, AUGUST 26, 1887.

A FEW WEEKS AGO Stanley's death was announced by a cable despatch from St. Thomé. A missionary at Matadi was said to have received the news from a negro who had come from the upper Kongo. A few days ago the French government received a telegram to the same effect from Zanzibar. Both these reports are utterly unreliable. The last letters from Stanley were dated from Aruwimi Falls, June 18. He informed his friends of his safe arrival there, and says that the natives report numerous falls and rapids farther up the river. Therefore he was about to begin his land journey to the Mvutan Nsige. No later news has been received at



ALVAN CLARK.

the mouth of the Kongo, and the arrival at Zanzibar of letters or news from his expedition at this date is out of the question, as the distance is very great and part of the route difficult. It is probable that at the present time Stanley is very near Emin Pacha, or has met him. The messengers who were sent from Zanzibar to inform Emin of Stanley's expedition were detained some time by Mwanga, and only recently reached Unyoro. Here they learned that Emin had crossed the Mvutan Nsige, and gone up the river which probably connects the Muta and Mvutan Nsige. They were unable to see him, and therefore were expecting his return. From these reports it appears that Emin never intended to make his way through Uganda, as was said some time ago. News from Central Africa reaches us now with such wonderful speed that we may expect to hear soon of the meeting of Emin and Stanley on the shore of the Mvutan Nsige. Emin's latest letters show that the condition of his province has greatly improved, and that at the present time peace prevails on the banks of the upper Nile; but he says that the negro tribes are at the present time much more powerful than they were before the war, as they have obtained numerous guns. Therefore Stanley's help will be very welcome, and probably enable him to carry on the work of civilization which he has so successfully begun.

TWO LOSSES TO SCIENCE.

THIS week we have to chronicle the deaths of two leading American scientific men. Spencer F. Baird, born at Reading, Penn., Feb. 3, 1823, died at Wood's Holl on Aug. 22. Alvan Clark died the same day at his home in Cambridge, at the age of eighty-three, having been born, at Ashfield, Mass., March 8, 1804. We have already told, in *Science*, of Baird's life. He was from youth interested in natural history, and so devoted his time and energies that he was early an honored companion of the best. His executive powers finally led to his being singled out as a fit head for first one and then another of the rapidly growing government scientific organizations, and it is for his good conduct of these affairs that we now best know him, and for which he received the sincere respect of the public. Of Clark it might be said that we came near losing him. He was forty before he began his life-work which made him famous. His oldest son, as many a boy has before and since, wished a telescope, and, per force of circumstances, must make it.



SPENCER F. BAIRD.

He asked his father's help in grinding and polishing the piece of speculum metal he had obtained for his reflector. The father had never seen a mirror or lens ground and polished. But, as he once said, "a father tries pretty hard when a child asks for help;" and this father did try, so that now the renown of his achievements as a maker of lenses is world-wide.

Mr. Clark had been in his usual good health up to a fortnight ago, when he complained of illness, and though no disease of an organic nature appeared, he gradually failed, and death resulted from old age. He was essentially a New England man. He labored on the farm until he reached his twenty-second year, and then, having by

his own endeavors acquired considerable skill at painting, secured a position as a calico engraver at Lowell. Here he married Miss Maria Pease, and last year they celebrated the sixtieth anniversary of their wedding. From 1826 to 1835 he was employed at the Merrimac works at Lowell, designing patterns, a part of that time being employed at other establishments of a similar character.

During all that period he kept up his practice as a painter, he being an enthusiast in that direction. In 1835 he discontinued his business as a calico designer and engraver, and moved to Boston and established a studio on Tremont Street, selecting Cambridge as a place of residence, his home being on Prospect Street. His pictures of the late Dr. Hare of Philadelphia and that of Dr. Hill of Cambridge are specimens of his skill and taste. At the house on Brookline Street there are a number of specimens of his art, among which are the faces of Daniel Webster, Constable Clapp, renowned in his day as a skilful detector of crimes, and of a son who died when a youth, painted from memory. During this time sons and daughters were born to him, George B. in 1827 and Alvan G. in 1832, both of whom are living.

He began with his sons in 1846 the manufacture of telescopes. The younger son, Alvan G., at first entered into other business, but finally settled down to that of telescope making, and all three, under the name and style of Clark & Sons, have worked together for nearly forty years.

In 1850 Mr. Alvan Clark went to Europe and spent a great deal of his time with Mr. W. R. Dawes, the English astronomer, and while in his observatory discovered a new star, now known as companion to '99 Hercules.' Mr. Clark afterward had an extensive correspondence with Mr. Dawes, and spoke of his connection with him as the closest friendship of his life. Soon after his return from Europe in 1860 he received the first order for a large telescope in this country from the University of Mississippi, the glass being 18½ inches, three inches larger than any that had been hitherto successfully used in the world. The war prevented its sale to the southern college, and it was finally purchased by the University of Chicago. Then followed the construction of two glasses of twenty-six inches each, one being disposed of to the University of Virginia and the other placed in the observatory at Washington. Their reputation rapidly spread through Europe, and orders came faster than they could be filled. The number of instruments they have made is very large. The cheapest one cost \$300, while the national telescope was sold for \$46,000, and the cost of the Lick glass was set at \$50,000 without the mounting.

This was the work of a man who never had seen a lens in process of construction in the hands of any one out of his own shop. Mr. Clark was emphatically a self-made man. His only education was what he received in the public schools of western Massachusetts. His reputation was patiently, steadily, and justly earned. His extraordinary power seemed to be acuteness of the eye, of the touch, and of the understanding, combined with unlimited patience. Not long since he said: "I owe largely my recognition by the scientific world to Mr. Dawes. I had, as I thought, with one of my telescopes discovered several new double stars. I wrote to Dawes, asking him to verify my observations. He answered that they were real discoveries. I reported other discoveries. Mr. Dawes wrote: 'Where did you get your telescope?' 'I made it,' was my reply. I sold him that glass and five others."

PROCEEDINGS OF THE AMERICAN ASSOCIATION.

Section C.

The address of Vice-President Prescott was on the chemistry of nitrogen as disclosed in the constitution of the alkaloids. He said, "The character of nitrogen is a challenge to chemical skill. Mocking us by its abundance in its free state, the compounds of this element are so sparingly obtained that they set the rate of value in supplies for the nourishment of life, — the agent chosen and trusted for projectile force in arts of war and of peace, — yet the manufacture of its most simple and stable compound has been a vain attempt, and it is one urged anew by the chemical industries. Moreover, nitrogen holds the structure of the aniline dyes, and governs the constitution of the vegetable alkaloids. In research the nearest approaches to the molecule as a chemical centre have been reached

through organic chemistry. Carbon was the first and hydrogen has been the second element to give to organic chemistry a definition. At present, carbon is looked upon as the member for fixed position, and hydrogen as the member for exchange, in organic families. Nitrogen comes next in turn to receive attention. The study of the carbonaceous compounds of nitrogen promises to do for organic chemistry what the latter has done for general science."

The speaker then outlined the history and present state of the structural chemistry of the vegetable alkaloids, as follows: "1. Nitrogenous bases as derivatives of ammonia. 2. Nitrogenous bases represented by aniline. 3. The pyridine type in the vegetable alkaloids. The constitution of the pyridine and quinoline series was ascertained by Koerner and by Baeyer in 1870. These bodies can be obtained from bone-oil and from coal-tar. They are of a remarkable chemical structure. Like aniline, they have the closed chain of six positions, but, unlike aniline, they have one of these positions held by nitrogen. The introduction of the atom of nitrogen into the closed ring so affects the qualities of the molecule that stable addition-products are formed. About 1879 it began to appear that the vegetable alkaloids in general are of the pyridine type, of 'aromatic' composition. In this type the structure of ammonia is not violated; and the theories of Liebig, Wurtz, and Hofmann are not superseded. Within the last three or four years the veil has been drawn from the structure of the chief alkaloids of plants. Even before that, the alkaloids of black pepper, tobacco, and hemlock, of very simple composition, were studied with success. The alkaloids of the belladonna-root, the cinchona-bark, and the coca-leaf, are now subject to an increasing measure of constructive operation in the laboratory. Morphine is convertible into codeine, and the efforts to convert strychnine into brucine, and cinchonine into quinine, ought to succeed. The necessary studies of position in the pyridine molecule are being entered upon. Some good medicinal alkaloids are being made by art. It may come that the identical alkaloids of nature will be made by art. Not by chance efforts, however, nor by premature short-cuts, but, if at all, through the well-earned progress of the world's chemistry, will these results be gained. And it speaks enough for the rate of this progress to say that one of the very first of the forward steps here recounted was taken by a man still living as a contributor. Due honor for what his hands have done, and all gratitude for what his eyes have seen."

Thirty-five papers and two committee reports were presented to the section. The papers may be classified as follows: — *Analytical Chemistry*, on a new apparatus for fractional distillation, by T. H. Norton; on the improvement in stand for electrolysis, by W. H. Herrick; on a process for separation of alkaloid poisons, by Arthur L. Greene; on the determination of nitrogen by soda-lime, by W. O. Atwater; on indirect determination of calcium, by W. H. Herrick; on a new method for the preparation of anhydrous aluminum chloride, by C. F. Mabery. *Plant Chemistry* (agricultural and pharmaceutical), on the composition of wild-cherry bark, by F. B. Power and Henry Weimar; on the chemical composition of the juices of sorghum-cane in relation to the production of sugar, by H. W. Wiley; note on the chemistry of germination, and on the absorption of nitrogenous nutriment by the roots of plants, by William McMurtrie; on a compound rich in carbon occurring in some plants, by Helen C. DeS. Abbott. *Organic Chemistry*, on the fatty acids of drying oils, by L. M. Norton; on some higher homologues of cocaine, by F. G. Novy; on the salts of benzene-sulphonic acid with the amines, on some new metallic salts of benzene-sulphonic acid, on the amine salts of para-toluene-sulphonic acid, on the action of silicon fluoride on acetone, on the limits of the direct bromination of acetone and on the action between ammonium sulphocyanide and monobrom-acetone, on the action of chlorine on acenaphthene, on the urates of ammonium and the amines of the fatty acids, and on some new nitro-prussides, by T. H. Norton; on the action of aromatic amines upon certain substituted unsaturated acids, and on the constitution of the sulphur compounds in crude petroleum oils, by C. F. Mabery. *Mineral Chemistry*, on the composition of Lockport Sandstone, by H. W. Weld; on the processes of soil-formation from the north-western basalts, by E. W. Hilgard; on the occurrence in nature of a copper antimonide, and on certain alloys of calcium and zinc, by T. H. Norton; analyses of two manganese minerals, by F. C. Novy. *Theoretical Chemistry*,

on the significance of 'bonds' in structural formulas, by Spencer B. Newberry; on positive and negative units of valence, by Albert B. Prescott. *Physiological Chemistry*, on the percentage of ash in human bones of different ages, by W. P. Mason; on chemical changes accompanying osmose in living organisms as illustrated by the oyster, by W. O. Atwater; on the delicacy of the sense of taste, by E. H. S. Bailey and E. L. Nichols; on the scientific basis of feeding infants, by A. R. Leeds. *Medical Chemistry*, on the causes, progress, and cure of a recent great outburst of typhoid-fever at Mount Holly, N.J., by Albert R. Leeds. *Committee Reports*, on methods of stating water-analysis, by G. C. Caldwell; on indexing chemical literature, by H. C. Bolton.

Prof. L. M. Norton, in his experiments in drying oils, has detected the presence of several fatty acids, which are not mentioned in the books. Especially is this the case with cottonseed-oil, which contains several acids in addition to oleic. Owing to easy oxidation, it is difficult to separate these acids. The method of distillation in a vacuum was found most effective. Prof. T. H. Norton's papers on organic chemistry disclosed numerous lines of original investigation undertaken in connection with advanced students, and emphasized the growing importance of mingling original researches with instruction, which is now practised so successfully by the leading laboratories of the world. The papers on analytical chemistry contained nothing of general scientific interest. The alloys of copper and antimony and of calcium and zinc presented by Professor Norton disclosed many important facts. He found it impossible by any known method to obtain an alloy of zinc and calcium containing more than five or six per cent of the latter metal. The properties of the compound are also profoundly affected by the proportion of calcium present.

Dr. Wiley presented, in the paper on sorghum, the means of all the recorded analyses of sorghum-juices. The important fact is brought to light that this average juice is unfit for sugar-making, containing at the rate of a little over twenty pounds of available sugar to the ton of cane. In many instances, however, the percentage of sucrose in the juice is remarkably high. The successful solution of the problem of sugar-making from sorghum depends on the production of a uniform grade of sorghum reasonably rich in sucrose. This should be the work of the agricultural experiment-stations.

The sense of taste, as shown by the experiments of Professors Bailey and Nichols, is in general more delicate in females than in males. Bitter is detected in far greater dilutions than sweet or saline tastes.

This session of Section C was remarkable in being almost free from papers of a 'cranky' nature. No lurid schemes for the regeneration of the human race by chemical affinity were presented, and no intensely improbable properties of matter were described. While many of the papers were crude and some of them quite elementary, it is nevertheless true that the Chemical Section is progressing in numbers and influence and the character of its work.

Section I.

THE Section of Economic Science and Statistics this year exercised its usual latitude in the consideration of a great variety of subjects; but, under the close scrutiny of its sectional committee and the rulings of its chairman, everything objectionable was excluded and a high standard maintained. Thus, while all the subjects presented were treated in a scientific manner, the proceedings were so conducted as to meet with popular favor. Although inconveniently located on the upper floor of Hamilton Hall, so that those unacquainted with the ways of the association had difficulty in finding the place, the sessions of this section opened with a room nearly full, on Thursday, and the attendance daily increased until the closing session on Tuesday (Aug. 23), when the hall was uncomfortably crowded by the largest audience present at any sectional meeting during the week.

'The Food-Question' was, by special arrangement, made the sole topic for Thursday. The sessions, both forenoon and afternoon, were opened by Prof. W. O. Atwater of Connecticut, who treated the subject much after the style of his articles in current issues of *The Century Magazine*. He was enabled to add much interest by a fine collection of illustrative material, some of the

charts being his own, but the rest prepared at the Massachusetts Institute of Technology, and loaned for this occasion by The Industrial Education Association of No. 9 University Place in this city, through the kindness of Miss H. R. Burns. Much interest was manifested at both sessions, and the discussion took a wide range, including the economy of food in its physiological and pecuniary aspects, the food of workmen in its relation to work done, and the preparation of food, together with the 'cooking-schools' and their results. The most prominent participants in the discussions of the day were Prof. W. H. Brewer of New Haven, E. J. James of Philadelphia, S. A. Lattimore of Rochester, J. M. Ordway of New Orleans, Dr. D. E. Salmon of Washington, Mrs. Richards and Mrs. Lincoln of Boston, and R. T. Colburn of this city.

On Friday the section gave its attention to statistical and financial questions. The leading paper was by Prof. Edmund J. James of the University of Pennsylvania, and was mainly a sharp and well-presented criticism of the recent essays of Mr. Edward Atkinson upon the growth and rapidly increasing wealth of this country. Dr. James showed grave omissions in Mr. Atkinson's figures, which greatly modified the deductions from them, and, by marshalling the same statistics in a different form, reached very different conclusions, both as to the country's accumulating wealth as a whole, and the earnings of laborers. Charles S. Hill of Washington followed with a statistical paper somewhat similar in character. Then E. B. Elliott, actuary of the Treasury Department, continued his last year's exhibit of the rates of interest realized by investors in the bonded securities of the United States. He showed, that, based upon the market-prices of the government 4 and 4½ per cent bonds, the actual interest during the past year has never exceeded 2½ per cent, and at times it has fallen below 2 per cent. He predicted a net rate for some time to come, closely approximating 2 per cent.

As with the other sections, business was suspended from Friday noon till Monday morning, by the various excursions,—an interruption emphatically disapproved by many active members.

The morning session of Monday took a rather philosophic turn, although the title of the paper which gave rise to most discussion made a claim to belonging within the realm of science: it was 'The Science of Civics,' by Dr. Henry Randall Waite, and while covering broader ground, served especially as an argument and justification for the American Institute of Civics, of which Dr. Waite is president, and its work. An animated discussion ensued, dealing with ethics, politics (in its best sense), and economics, and their relations to one another. Monday afternoon, Section I joined with that of Mechanical Science in considering the question of Isthmian transit. This subject in its various bearings was clearly presented by Commodore Taylor, Surgeon Bransford, and Engineer Peary, of the United States Navy, and Mr. J. W. Miller of this city; and the interested audience seemed well convinced of the superiority of the ship-canal and the Nicaragua route over all other schemes, and the certainty of the early completion of this enterprise by American capital, and to be under the control of the United States.

Manual training, its methods and results, in public schools and special institutions, from economical, industrial, and educational aspects, formed the principal subject of the final session of the section on Tuesday. Prof. Calvin M. Woodward of St. Louis, and Prof. James of Philadelphia, read papers, and a general discussion followed entirely favorable to manual training in every form.

Yan Phou Lee of New Haven closed the session with an eloquent address upon the Chinese question from a Chinese standpoint, delivered before as large and enthusiastic an audience as any assembled at Columbia College during the meeting of the association. It was a telling arraignment of the policy and conduct of the United States in reference to the Chinese, and reminded one of an epitome of Helen Hunt Jackson's 'Century of Dishonor.'

HEALTH MATTERS. Cure of Consumption.

AMONG the first to use Bergeon's treatment for the cure of consumption by gæous enemata in this country, and certainly the first in Philadelphia, was Dr. E. T. Bruen. As a result of the treatment

of twenty-five patients, Dr. Bruen deduced the following conclusions:—

1. In nearly all cases lasting effects have been secured in the reduction of temperature, suspension of night-sweats, lessened cough and expectoration, and in some all physical signs of bronchial catarrh abolished.

2. Temporarily reduction of pulse-rate fifteen to twenty beats, and temperature one-half a degree to one degree during the administration of the gas.

3. The amount of gas introduced into the bowel has varied from three quarts to a gallon at each injection. It has been introduced very slowly, from fifteen minutes to half an hour being demanded by the operation. The administration has been practised in most cases twice in the twenty-four hours. No injurious effects from the gas have as yet been observed.

4. Administration of the gas in different amounts and varying degrees of concentration is now being practised, and also investigations into the characteristics of the sputa.

5. In only one of the cases of phthisis the effects of the gas have been entirely negative.

6. In cases of phthisis complicated by intestinal lesions, experience is still insufficient to make it possible to state positive results.

7. The ultimate value of the treatment can certainly only be established by time. The probable mode of action would seem to be antiseptic, and, by reducing suppurative and the relief of the attending serious symptoms, the patient is permitted to gain by food, exercise, and general treatment. Thus far, the value of the gas seems to be that of a useful therapeutic measure, rather than a curative plan of treatment.

8. The method of preparing the gas for use in the hospital is as follows: the carbonic-acid gas is passed through a solution of chloride of sodium and sulphide of sodium in twenty-two ounces of water. The proportion of the salts has been increased in some cases, and some trials of other combinations are being made.

Of the twenty-five cases treated in the early part of the year, Dr. Bruen has been able to follow fourteen of them continuously. Two have since died. In twelve the physical signs remain unchanged, the temperature still above normal, the flesh and strength not increased after the first gain of an average of five pounds. Yet the patients undeniably feel better. The process of suppurative, with its attendant evils, has been modified, suppressed, or controlled, and it must be admitted that the patients have been benefited by the treatment. More recently Dr. Bruen has applied this method in the treatment of twenty-four cases in private practice, and to thirteen additional hospital cases; so that, in all, he presents sixty-two cases in which the treatment has been applied in a systematic manner.

In commenting on the cases which have come under his care, in a paper read before the Association of American Physicians, Dr. Bruen says that two suggestions may be given for the failure of the treatment to give better results. The first applies only to hospital cases. It is impossible, in a large general hospital, to secure the detailed attention to diet necessary to suit the capricious appetite of the consumptive. In treating consumption it is absolutely necessary to increase the vitality of the tissues so that they will be unfavorable culture-media for the bacilli. The second suggestion is, that in cases with inherited tendencies to phthisis, or in those who acquire a phthisical tendency, there is great vulnerability of the mucous membrane, which even fosters an outbreak of catarrhal processes in the bronchial structures. In this way the good effects of the treatment are constantly opposed. He thinks that suitable climatic environment is an all-important adjunct to the proper settlement of the value of Bergeon's treatment. But it is certainly an important addition to the therapeutic equipment to have an agent capable of influencing very markedly bronchial catarrh in so many cases, especially the stay-at-homes. In a word, Bergeon's treatment is chiefly valuable in those cases of pulmonary disease attended with bronchial catarrh; but it is to be feared that the trouble and detail necessary to its successful use will prevent many from employing the method, and the limitation of its power will cause it often to be set aside for other plans of treatment.

It is more desirable, in the treatment of consumption, to adopt those measures which tend to establish the general health, than to

hunt up specific forms of treatment. Suitable climatic conditions, judicious alimentation, and appropriate personal hygiene, are the first principles in the therapeutic management of phthisis, and Bergeon's method should be considered an adjunct to these.

HYDROPHOBIA INOCULATION IN NEW YORK.—Dr. Sommer, an Hungarian physician, obtained the consent of the mayor and president of the Board of Health of New York to conduct experiments with the virus of hydrophobia upon the dogs collected by the dog-gatherers and taken to the pound. The Society for the Prevention of Cruelty to Animals have, however, interfered, and require the doctor to obtain the authority of some medical college or university in the State before they will permit him to conduct his investigations. We should think that an application, properly made, to any of the medical institutions of the city, would be followed by the granting of the requisite authority.

USE OF OPIUM.—Dr. Boynton is authority for the statement that Woodstock, Vt., consumes a large quantity of opium. There are four druggists in the town, and they report that their sales of opium in a single year are sufficient to make one hundred gallons of laudanum, equivalent to one hundred and sixty-seven ounces of morphine. Of this, only five per cent is sold to physicians. It can hardly be possible that there is any greater demand for opium in Woodstock than in other towns of the same size, and yet we can hardly believe that this represents the true condition of things in our New England towns. If so, the thought is a startling one, and should receive more than passing notice.

SEASICKNESS.—We have already mentioned a number of remedies for seasickness. Dr. Sutherland suggests another, which he employed successfully in crossing the English Channel, he escaping when almost every one was sick. He takes a tight hold of one of the pillars supporting the deck, and, as the boat rises in going over a wave, he runs uphill, as it were, reversing the direction of his run when the boat descends the wave.

CETTI'S FAST.—It will be remembered that Cetti, a Norwegian, fasted for twelve days in Berlin under the observation of Professor Virchow. In June he began another fast, of thirty days, for scientific purposes. During the fast he was detected eating gelatine jujubes, about a half-pound of which were found on his person.

SCARLET-FEVER.—Dr. Edington of Edinburgh claims to have discovered a bacillus in the blood, and desquamation, of patients suffering with scarlet-fever. The Medico-Chirurgical Society of Edinburgh has appointed a committee to investigate the bacillus and its relations to scarlet-fever.

BOOK—REVIEWS.

Romantic Love and Personal Beauty: their Development, Casual Relations, Historic and National Peculiarities. By HENRY T. FINCK. New York, Macmillan & Co. 8^o

In the current issue of an American weekly this volume is reviewed under the heading of 'A Curious Book.' This epithet it most decidedly merits. Though the first impression of the work is that of its uncommon character, this feeling gradually gives way to an ever-increasing recognition of the intrinsic importance of the argument it sets forth, until in closing its pages one feels that something has been added to his stock of knowledge, a new light has been more or less brightly cast upon many problems, and that these acquisitions will always be associated with Mr. Finck's book.

The fundamental note of the book is the evolution of love, the most conservative element of human nature, that which poets and essayists delight in pronouncing as always and always to be the same, is shown on proper analysis to be subject to that same developmental process which Darwin has associated with his name. Not only have the affections a natural history in the animal world closely affiliated with appearances in early man, but that form of love that to-day is *the love par excellence*—romantic love—is itself only a very modern development, not a thousand years old.

The passion that gives the ground-tone to modern social life, that plays the chief rôle in imaginative literature, that attracts the attention of all travellers and observers, that has revolutionized and is modifying many of the problems which to the sociologist are of

maximum importance, the passion that so permeates our mental tissue that we read ancient history and literature through the spectacles that we before our eyes,—this passion was unknown, or, where known, neglected, until modern times. This announcement is most startling. If it can be satisfactorily established, it will take its place not only as a most important historical fact, but as a richly suggestive generalization, reflecting light on certain obscure problems of anthropology, giving the marriage and courtship customs of all peoples, primitive, ancient, and modern, a newer, fuller biological meaning, as well as pointing the way to the solution of many social questions of the day which irrelevant and unscientific discussion has done much to confound.

Mr. Finck is a biologist, and includes in his treatment the arrangements for mutual attractiveness of the sexes found in plants and animals. This prevents a too narrow anthropocentric view of the affections, and escapes the danger into which literary men have fallen of regarding as typical what is almost accidental. But first the characteristics, the 'overtones of romantic love,' must be set forth. Mr. Finck enumerates eleven. (1) Individual preference. The savage chief does not hesitate to exchange one bride for another equally attractive; the lover cares for one alone. (2) Monopoly. Not only does he prefer her alone; he expects all her attentions. (3) Any neglect leads to the third 'overtone,' jealousy, which by inspiring watchfulness and fear keeps the flame aglow. (4) Coyness, a feminine trait, which by retarding increases the lover's passion. (5) Gallantry, a masculine trait, acknowledging the conquest. (6) Self-sacrifice, which may be an exaggerated gallantry or a suicidal impulse of unrequited love. (7) Sympathy. No pleasure is complete unless enjoyed by both. (8) Pride of conquest or possession. (9) Emotional hyperbolæ. The lover sees, thinks, and feels in superlatives. (10) Mixed moods. Finally, (11) Admiration of personal beauty,—that all-important æsthetic overtone that now more than ever leads the way to love.

Many of these qualities are shown by animals. Individual preferences, gallantry, jealousy, sympathy, are illustrated in many authentic anecdotes. Birds especially—and along with this goes their monogamous habit—show a much more refined and noble courtship than the lowest savages. In savage life, where courtship consists in knocking the girl on the head and carrying her away, love can hardly find a place. Even in the higher forms of courtship by purchase or service, nothing but a very rudimentary form of real love can enter. Individual preference there was none; polygamy flourished. The woman was the slave, and none of the romantic virtues were possible. In historic nations the advance is at first small. Egypt had trial marriages of one year's duration. Amongst the Hebrews polygamy, the exclusion of woman from all but the minor social duties, and the selection of the wife by the father of the suitor, prevented true romantic love, in spite of the elevation of the woman to be the companion of man, which that nation introduced. The Greeks show no true love-stories. They say much of conjugal love; filial and sisterly love is a frequent theme. Friendship and platonic love is the type of the highest Greek affection. The women were excluded from the living interests of the nation; male beauty was the admired type. Rome made an advance, but not a great one. Engagements were made by parents at a very early age. Social customs forcing the girl to marry one of the same profession as her father, and the like, prevented a choice. In later days marriage was a farce, and divorce the rule. The poets, in advance of their age, uttered a few strains of romantic love; Ovid especially pleaded for gallantry and the tender emotions. But all such beginnings were crushed by mediæval asceticism. Marriage became almost a degradation, celibacy a virtue; beauty and the personal hygiene that led to it were considered sensuous. Love was to be subdued and self-mutilation rewarded. Only with the dawn of the renaissance did love again begin. Dante was the first love-poet; Romeo was the first hero-lover of a play. The chivalry that preceded these was either merely fictitious and fashionable, or more usually an adoration of a married lady. It was not a courtship. The poets sound but a weak strain of romantic love. Even Spenser puts friendship above love. If the reader will imagine this outline filled in with a host of corroboratory passages, cited from recognized authorities, he must admit that Mr. Finck has made out a very strong case indeed. Moreover, his scheme of the evolution of love

answers a critical biological test. The law that the individual epitomizes the race holds here. Historically, maternal love is the oldest and strongest (until romantic love appears). "Then paternal, filial, and fraternal love are gradually developed, followed by friendship (Greek) and finally by love proper." The baby first and most loves its mother; then the father receives attention, followed by sisters and brothers. At school the Greek devotion and friendship develops. Finally comes true love, which, usually passing like the blind chivalry of old through a 'calf-love' stage, emerges into romantic passion.

Into the author's long and careful analysis of modern love it will be impossible to enter here. His guiding principle is that love, 'natural selection,' is the bulwark of civilization. In comparing the customs of various nations, those are regarded as highest that give freest opportunity for social intercourse of the young, that widen the play of selection, and thus lead to the amelioration of the race. It is the excluding of French girls from a rational education, the marrying them out of convents, that causes their homeliness and the degeneracy of that race. The German system of chaperonage and formal social equality in marriages is tending, though less seriously, to the same end. In England and especially in America have the agencies that lead to a betterment of the race full and free play. This is precisely the view taken by Mr. Grant Allen. He regards falling in love as the expression of the healthy instinct of mankind; and looks for the improvement of the race, not in any artificial system of scientific or any other kind of mating, but in removing the trammels from the free choice of partners,—in discourteasing all but love marriages. All this has an important practical bearing which Mr. Finck well expresses. He holds that "love may be safely accepted as a guiding-star in making a proper division of the world's labor between men and women." This point of view pleads for the true higher education of woman, for giving her that intelligence without which beauty is dead, that live interest in the world's activities without which frivolity is inevitable. The contrast between the homely, studious, earnest, retired maiden and the pretty, lively, society-loving, frivolous, but silly and ignorant girl is one that the perverseness of man has created. A natural education will go far towards removing it. Again, the tendency of civilization is to make men and women more and more different (we are not speaking of legal and social privileges); the recent attempt to make women masculine is biologically absurd. "Whatever approximation there may have been has been entirely on the part of the men, who have become less coarse or 'manly,' while woman has correspondingly increased her own refinement. The spirit of the women's rights movement is in opposition to the impulse of romantic love, and will perish accordingly. Finally, this point of view refutes the notion that intense love is inconsistent with intellectual culture. On the contrary, only the highest culture can appreciate romantic love; intelligence is an obstacle to marriage only in a silly society; the education of the head and the heart go hand in hand. True culture teaches, not that this instinct is opposed to the highest life, but that all the refinements of civilization have been gained by the virtues which it has taught men to appreciate. The evolution of romantic love will continue until it has stamped out all other artificial modes of promoting marriage.

The rest of the book is taken up with a minute discussion of personal beauty. Much interesting and readable matter is there set forth: the scientist will be glad to read that the close relation between true beauty and health is so strongly and ably set forth. Just as morality and hygiene have drawn closer together under a scientific treatment, so hygiene and æsthetics begin to overlap when looked at in the light of science.

Mr. Finck's book is sure to attract great attention. According to a literary periodical, a German translation is in preparation. The genial vein of humor that runs through much of it will attract the popular reader, and the personal interest of the many titles in the preface is sure to allure those interested in themselves. But, from a scientific point of view, this is a fault of the book. A serious paragraph suggestive of deep reflection is followed by a witty satire on society or a light fling at a local abuse. Mr. Finck wants his book to be taken seriously. A glance at the wide bearing of the topic will at once convince the reader that the serious aspect of the problem is supremely important. Consider in the first place

that romantic love is consistent only with a monogamous society and that this kind of society is the bulwark of civilization; consider, too, that the ways of finding one's mate not only gives tone to the social institutions of a nation, but, according as they are in accord with or opposed to the inexorable laws of heredity and selection, make for the amelioration or degeneration of the community; consider, next, that the education of the next generation is profoundly influenced by our views of courtship and marriage; consider how this fact will influence our conceptions of ancient life; consider that the division of labor between men and women, and the admittance of women into occupations until now monopolized by men, can only be satisfactory settled by a settlement that does not interfere with the reign of romantic love; consider, in short, that all that is deep and valuable in cultured life is here at stake, — and all must admit that a knowledge of the laws of evolution as they affect sexual selection amongst us is of the profoundest importance. Such inquiries into the nature of human faculty as Mr. Galton is pursuing are directed towards supplying this information. This knowledge is not for the many; but in the hands of the few it is to be converted into public sentiment against certain customs and ways of thinking and in favor of others, by which, eventually, misery will be checked and happiness increased. If Mr. Finck will accept a suggestion, the present writer would urge upon him the preparation of a review article embodying the main points in the evolution of love, and expounding in a strictly scientific style, and without any feuilletonistic *bon mots*, the anthropological, sociological, and psychological significance of this new¹ contribution to human development.

The Hidden Way across the Threshold. By J. C. STREET. Boston, Lee & Shepard. 8°

The Mark of the Beast revealed by the Shape of the Head. By LUCILLA R. HEDLEY, M.D. Philadelphia. 8°

THE reviewer of books like these is in no enviable position; especially as the reviews are written for those interested in science, and the books any thing rather than scientific. The first is another of those ponderous volumes — a combination of strange mysticism, excited exhortation, wild symbolism, unscientific cant, and childish credulosity — that one finds heaped up on the shelves of a second-hand book-store. The author writes powerfully, makes his points ably, appeals to his reader skilfully, and here and there makes a noble plea for the despicability of the sordid and the living of a high intellectual life. But those portions of the book in which one feels the rationality and the earnestness of the writer give the impression of being aloof from the real purpose of the work, — accidental at least, if not inconsistent.

The weirdness of this intellectual conglomerate, it is hard to describe: the cause of such writing seems to be an hypertrophy of that sentiment, common to all specialists, that the public at large does not stand in sufficiently close contact with them; that they live a life exclusive, — the life of an adept, an occultist. Mr. Street, A.B.N., fellow of the order S.S.S., and of the brotherhood Z.Z.R.R.Z.Z., is such an adept: "the mystery which hath been hidden for ages and from generations" is revealed to him. He is in the clouds, but the ladder, alas! is still to be found. The present writer, at least, fails to get the slightest inkling of the process, save that it seems much like dropping common sense and giving one's self over to wild fancy and morbid illusion.

The following extracts will perhaps be sufficient to enable the reader to decide with which one of the categories into which he is accustomed to divide books, this one belongs. Amongst the original contributions to science here announced, we read that "the Sun and Planets in space, as well as terrestrial objects, have their magnetic, odyllic, and astral emanations, and these exert influence upon each other and upon every organized being, in proportion to their size, their distance, and the velocity of their revolutions." "This Astral influence is conveyed to man, and acts upon him through the Astral light. This, the palmist tells us, is composed of the seven fluids which emanate from the seven primary planets respectively.

¹ Mr. Finck thinks that the reason why no one has called attention to this recent origin of romantic love is that no sufficient distinction has been drawn between romantic and conjugal love.

These fluids, separately and in their combinations, are tempered and modified by the sun and moon." And so on. Here is a wonderful discovery: the sensations arising from the cut nerve-strings of amputated limbs we thought explained by the physiological law of the external projection of sensation. But, no! "All this is due solely to the action of the Star-magno, or Astral, vibrating between the amputated limb and the patient. So frequent and almost universal are such occurrences [i.e., cases in which the patient feels amiss because something is wrong with his lost member: a number of such are cited] that all surgeons use the utmost caution in disposing of amputated limbs." "The Astral body, enclosing the Soul like an atmosphere, can be and has frequently been seen by attendants and physicians, leaving the animal body just at the moment of separation between Soul and body, known as death or dissolution." Under proper light, there is seen accompanying the death-rattle "a column of thin ethereal violet blue vapor vibrating and oscillating, ebbing, finally passing upward and fading away." As a piece of logic, the following cannot be excelled: "The golden sunlight produces vibration to the amount of 500,000,000 of millions in a second" proportioned amongst the several colors in such and such a way. "Of course, therefore, different colors must necessarily affect the human soul," etc. "Love comes from pink and bright red, Hope and Faith from violet, Truth of blue, Melancholy of yellow, Epilepsy of pearl white," etc.

Let us hear what the author holds regarding the material basis of modern Spiritualism, that now stands in so bad a light. He gives full details for forming spirit circles, which practically amount to employing all conditions that make rational observation impossible, and neurotic self-deception inevitable, and assures all that the failure of manifestations is always due to the bad influence of sceptics and the like. "Students of occult mysteries," he warns them without seeing the double interpretation of his words, "never permit scientific investigators or psychic-research committees to control or even be present in the room during your efforts at development of mediumship. Remember thought is a potential atmosphere. Their worldly-wise theories create opposing vibrations and congeal the Spirit. Even in large rooms and at a distance their presence is highly objectionable." If to this we add the definition of 'a medium,' the reader will be able to imagine the rest of the chapter. Here it is: "To become a medium is to learn to vibrate the Astral body as a pendulum between Spirit and mortal, and thus to reach the third state of being, the state between sleeping and waking, — Trance — a condition co-equal with both, is to have found the Key that unlocks the mysterious place where actual Soul semblances have their immortal birth."

That this omnivorous 'psychist' unfolds the theory of soul-migrations; shows the rationality of faith-cure (e.g., to cure consumption you must insist that it is not inherited, that "tubercles, hemorrhage, inflammation, and ulcers are only ugly names and beliefs, not spirit and truth of man"); expounds the mysteries of theosophy; and indorses the cabalistic literature of all ages and nations, — is easily believed. For this he has six hundred pages at his disposal.

Considering the volume as the sincere and earnest expression of an enthusiast for the spiritual side of life, — and this is the most charitable point of view, — it is still a pernicious work. It embeds the kernel of truth it contains with a husk of rubbish; it chokes up 'the threshold' with a refuse-heap. By so doing it fosters an immoral trade, — a scandalous appeal to the sentimentalities of simple-minded folk. It debases the value of true spirituality, draws men's activity away from the proper duties of life, cultivates a life of useless solitude, and, moreover, is unscientific and unprogressive. With a healthy public taste, such a book can have no success.

The second book is indeed an absurd piece of pseudo-scientific writing, and can be dismissed with a word. The idea of the book is, that the 'mark of the beast,' as mentioned in the Book of Daniel, refers only to the leopard, bear, lion, and dragon. There are given pictures of the heads of noted criminals, showing their resemblance to one or other of these animals. They had 'the mark of the beast,' and had we only known it, their crimes could have been prevented. Besides this, there is much phrenology, some little Spiritualism, several untrue statements, and a host of Scripture quotations not always relevant.

Melting and Boiling Point Tables. By THOMAS CARNELLEY. London, Harrison & Sons. 1^o.

THE issue of the second volume of Carnelley's 'Melting and Boiling Point Tables' completes the valuable compilation, which now comprises more than fifty-one thousand data systematically arranged with a view to ready reference. Beside the melting and boiling points, so far as known, of individual chemical compounds, organic and inorganic, and such information as is at hand concerning their constitution, boiling-points of miscellaneous materials and mixtures, freezing-points of mixtures and solutions, and vapor-tensions of simple substances, mixed liquids, and saline solutions, are included. The statement of the relation between the numbering of volumes and the years of issue of the more important periodicals of chemistry and physics, and an alphabetical index of the 'root-compounds' of carbon, are minor conveniences. The list of authorities and original sources of knowledge, which really is an index to the literature, is not the least important feature of the work; and the additional references to correlative information in Watts's 'Dictionary of Chemistry,' and the Journal of the Chemical Society, will be especially appreciated by readers whose consulting libraries are not full. The work, planned so ambitiously and executed with the care which is evident, forms an important contribution to the resources of workers in physics and chemistry; and the many who will make use of it may very properly felicitate themselves upon the fact that the author, who is of the few endowed with the aptitude and patience necessary to complete the undertaking satisfactorily, possessed the fortitude to enter upon a course of such colossal drudgery.

Educational Mosaics. By THOMAS J. MORGAN. Boston, Silver, Rogers, & Co. 12^o.

THIS work, compiled by the principal of the Rhode Island State Normal School, is a collection of extracts from a great number of writers, chiefly modern, on topics connected with education. Its appearance is one more sign of the great interest now taken in the subject with which it deals,—an interest that seems to grow greater every year. There has, indeed, been a great awakening in the public mind of this country in regard to education. It is not many years since our educated classes seemed to be very well satisfied with the knowledge and training they possessed, and to think it good enough for their successors; while public speakers and writers were never weary of proclaiming that our public schools were all that could be desired, and our people the most enlightened on the earth. We have learned better since those days, and have become painfully aware that our higher education is by no means what it should be, that the education of the masses is equally defective, and that the methods of teaching in all our schools admit of much improvement. The book before us faithfully reflects the present state of the public mind and the various shades of prevalent opinion. The subjects treated are necessarily very varied, yet questions of present interest are given far more space than all others; and, as both sides of every controversy are given, the reader obtains a pretty good idea of what the best thinkers on educational topics are now saying. Among the subjects most largely treated are the relative importance of the classics and the physical sciences, the need of studying English, the necessity of moral training, the higher education of women, and the improvement of the methods of teaching. The controversy between the friends of the classics and those of the physical sciences is naturally a prominent feature of the work; and, though the number of extracts is much greater on the side of the classics, this is probably due to the fact that as yet the greater number of educators are on that side. The large number of extracts relating to moral education show that our educators are alive to its importance; but they show also that there is much uncertainty as to how much education is to be given. Indeed, the art of teaching virtue seems to be as difficult and as perplexing now as it was in the time of Socrates.

General Morgan's book will be of great interest, not only to practical teachers, but to all persons interested in education. The only criticism we should be inclined to make is as to the arrangement of the extracts, which is according to the alphabetical order of the authors' names, while we should have preferred an arrangement by topics. The book is one to be taken up again and again for the

stimulating thoughts it contains; and teachers, in particular, will find it an excellent companion.

Gilman's Historical Readers. Nos. 1, 2, and 3. By ARTHUR GILMAN. Chicago, Interstate Publ. Co. 16^o.

IF the young people of this country are not properly educated, it will not be for want of books intended for their perusal. In every department of literature that is adapted to young intelligences, books in great numbers may be had at low prices, and numerous additions are made to the list every year. The quality of the books, however, often leaves much to be desired. Indeed, the writing of books for children is an art by itself, quite different in some respects from that of writing for adults, and calling for special qualifications in the writer. Many books intended for the young fail of their purpose because they are dull, or because the style is obscure, or because they contain matters above the comprehension of juvenile readers. These little books by Mr. Gilman on the study of American history are not liable to these objections. The author's style is simple and clear without being undignified, his choice of topics judicious, and his manner of telling his story such as can hardly fail to interest youthful readers. The majority of brief histories are so overloaded with details, that young readers, and indeed readers of all ages, find it impossible to grasp them all, and are apt to grow weary of the study. Mr. Gilman has, for the most part, successfully avoided this fault, only a few of his chapters being crowded with detail, and these generally for some special reason.

The first of these little readers treats of the discovery and exploration of the country, the second of the colonization period, while the third and largest of them is devoted to "the making of the American nation." In the first volume the subject is so romantic that children can hardly fail to take an interest in it; and Mr. Gilman has made the most of this quality of his subject, yet without neglecting its more important aspects, so far as these are intelligible to very young readers. The second volume presents, in the main, similar characteristics, though the subject is more complicated. The third and concluding volume is somewhat deeper in thought, as well as larger in size, than either of the others. The greater part of it is, of course, devoted to the Revolution and the early years of the national life; but the history is carried on in brief to the end of the reconstruction period, the author holding that "the making of the American nation was not completed until the supremacy of the Union was acknowledged in every part of the land. The young American who familiarizes himself with the contents of these little books will not only have gained a good general idea of the history of his country, but will have laid a good foundation for a deeper and more extensive study in later years.

The Upper Beaches and Deltas of the Glacial Lake Agassiz. (U. S. Geol. Surv., Bull. No. 39.) By WARREN UPHAM. Washington, Government. 8^o.

THIS bulletin is but an initial contribution to our knowledge of Lake Agassiz. The investigation is still in progress, and the general discussion of data and the eduction of conclusions are mainly reserved until its completion.

Lake Agassiz belongs in the same category with Lakes Bonneville and Lahontan, in that it is a large extinct lake dating from the close of the glacial epoch. But in its situation and origin, and the cause of its extinction, it is radically different from these ancient lakes of the Great Basin. The basins of the latter belong to the constructive type of Davis, being due to profound oscillations of the earth's crust, and these lakes owe their disappearance solely to climatic changes resulting in the gradual predominance of evaporation over precipitation.

The basin of Lake Agassiz, on the other hand, belonged to the obstructive type, owing its existence to the damming up of the Red River of the North and its tributaries by the southern edge of the continental ice-sheet during its gradual recession from the sources of that stream to Hudson Bay; and, although the disappearance of this lake can also be traced to a climatic change, it was not a change from humid to dry, but from cold to warm, the lake vanishing with the icy barrier that retained it. During this retreat free drainage from the melting ice could not take place, because the descent of

the land is northward. As soon as the border of the ice had receded beyond the watershed dividing the basins of the Minnesota and the Red Rivers, it is evident that a lake, fed by the glacial melting, stood at the foot of the ice-fields, and extended northward as they withdrew along the Red River valley to Lake Winnipeg, filling this valley and its branches to the height of the lowest point over which an outlet could be found. Until the ice-barrier was melted upon the area now crossed by the Nelson River, thereby draining this glacial lake, its outlet was along the present course of the Minnesota River. At first its overflow was upon the nearly level, gently undulating surface of the drift, about 1,100 feet above the sea; but in process of time this cut a channel 125 to 150 feet deep and from one to two miles wide, in which lie Traverse and Big Stone Lakes, respectively 970 and 962 feet above the sea. From this outlet the plain of the Red River valley, 30 to 50 miles wide, stretches 315 miles north to Lake Winnipeg, which is 710 feet above the sea. Along this entire distance there is a very uniform continuous descent of a little less than one foot per mile. The drift deposited by the ice-sheet upon this area, together with that which may have been dropped by floating ice borne on the waters of the lake, and the silt brought in by glacial rivers and by those of the surrounding land, were here received in a lake, shallow near its mouth, but becoming gradually deeper northward.

Beyond our national boundary, Lake Agassiz covered a broad expanse, including the basins of Lake Winnipeg, Red and Rainy Lakes, and the Lake of the Woods. Its breadth varied from 100 to 200 miles, with an extreme length of at least 600 miles and an area, at the time of its greatest extent, exceeding that of Lake Superior.

The most interesting geological features of the basin of this ancient lake now observable are the terraces or beaches formed along its shores at different levels as its outlet was gradually lowered by erosion. These beaches are continuous ridges of sand and gravel, unbroken, save where crossed by modern streams or expanded into the deltas of the ancient lake, whose outlines are thus accurately traced at four distinct levels. The highest or Herman beach is, at the southern end of the lake, 1,045 feet above the sea, or 85 feet above Lake Traverse, and the lowest beach.

Mr. Upham's careful determinations of the altitudes of the beaches have fully established the remarkable fact that the beaches are not level, but have a gradual ascent northward, as compared with the present level line or the surface which a body of water would have now if confined in this valley. The rate of ascent of the highest or Herman beach increases gradually from six inches a mile at Lake Traverse, to above sixteen inches a mile near the national boundary, the total ascent in this distance being 185 feet.

The several beaches are not parallel, the rate of ascent diminishing from the highest to the lowest beach. Thus the second beach is 120 feet, the third 65 feet, and the fourth or lowest 35 feet, higher at the national boundary than at Lake Traverse.

The altitude of the beaches is a function of the longitude as well as the latitude; for a comparison of these beaches in Dakota and Minnesota at the same latitude reveals an ascent from west to east similar to that from south to north, but of less amount, and diminishing in a similar ratio between the successive stages of the lake.

Various causes for these interesting phenomena are suggested and reserved for future discussion; but Mr. Upham indicates his adoption provisionally of the view that the divergence of these ancient shore-lines from the present level line was produced by the gravitation of the water of the lake toward the ice-sheet. At first this attraction would have been relatively large, because of the nearness of the great mass of ice on the north-east in Minnesota and northward in British America; but, as the ice retreated, it must have been gradually diminished, and reduced to a comparatively small influence by the time the ice-sheet had withdrawn so as to permit the northward drainage of the lake.

NOTES AND NEWS.

TWO new methods of determining the density of the earth are being experimented upon at Berlin. The one, by Dr. F. Richarz and Dr. A. König, has been referred to in *Science* (v. 217). These gentlemen apply a sensitive balance with a double pair of scales, one swinging above, the other below, a heavy parallelepipedic mass of lead, which consists of a number of blocks which are ex-

actly measured and weighed. The blocks are perforated, and the wires connecting the upper and lower scales pass through the shaft formed by these perforations. By an ingenious arrangement, the weights, which consist of spheres of lead, can be changed from the upper to the lower scales without opening the case in which the balance is enclosed. The principle on which the experiment is founded is, that, if one of two equal weights is below, the other above, the mass of lead, its attraction will diminish the weight of the former and increase that of the latter. The proportion between this increase and the total weight gives the means for determining the proportion between the attraction and masses of the lead and the earth. Preliminary experiments made with this balance show that a great exactness of the definite measurements may be expected. These experiments are being carried on under the auspices of the Berlin Academy of Sciences in a casemate of Spandau. At the same time J. Wibring is experimenting by another method in the astrophysical observatory at Potsdam. He uses a pendulum made of a brass tube one metre in length and four centimetres in diameter, with spheres of cast iron weighing five hundred and fifty grams at the two ends. A knife-edge of agate six centimetres in length passes through the centre of the tube, and swings on an agate rest. Two small mirrors are attached to the knife-edge, and the oscillations of the pendulum are observed through a telescope. The time of oscillation of the pendulum may be so nicely regulated that oscillations of five minutes length are perfectly regular. Near the iron spheres and opposite to one another, two iron cylinders weighing 325 kilograms are placed, the lower one attracting the lower end of the pendulum to one side, the upper one the upper end to the opposite side. The attraction of these masses affects the oscillations of the pendulum. The result of these observations for the mean density of the earth is 5.594 ± 0.032 . The mean of former reliable observations being 5.57, the new figure corresponds well with these. Both experiments will result in a more accurate and trustworthy determination of the mass of the earth.

—In a recent paper on literary catalogues, Mr. Samuel H. Sinderler makes some suggestive remarks about the system of cataloguing now so much in favor. To quote his words, "Paradoxical as it may sound, the very excellence of his [Dewey's] plan is one objection to it. Mr. Dewey multiplies co-operative advantages to those who use his system to such an extent, that if he lives long enough he will make it so much to the advantage of newly forming or growing libraries to use it, that none will be independent enough to modify it. And why should they wish to modify it? Simply because, less than fifty years ago, the present scheme could not have been formed. There was not knowledge enough in the world. There could not now be found, in any scheme then formed, place for a long range of subjects which appear in his actual classification. This is especially true in science, and who shall say that history will not repeat itself in the next fifty years? Let us rather work out the problem of the decimo-mnemonic system on different lines, each library or group of libraries for itself, according to the special needs of the same. Then new Deweys will arise and ply their ingenious arts, and in the millennium the fittest will survive. At present there is danger that the fittest will be handicapped. To give the fittest, when it comes, an earlier chance of survival is one purpose of this paper."

—Cummings's 'Electricity Treated Experimentally,' which was reviewed in the last number of *Science*, is published in America by D. Van Nostrand.

LETTERS TO THE EDITOR.

. The attention of scientific men is called to the advantages of the correspondence columns of *SCIENCE* for placing promptly on record brief preliminary notices of their investigations. Twenty copies of the number containing his communication will be furnished free to any correspondent on request.

The editor will be glad to publish any queries consonant with the character of the journal.

Correspondents are requested to be as brief as possible. The writer's name is in all cases required as proof of good faith.

Chrome considered as a Poison.

My attention has been called to an article by Mr. William Glenn of Baltimore in *Science* (x. 58), entitled 'Chrome considered as a Poison,' criticising a paper of mine in the *Boston Medical and Surgical Journal* on the same subject. Were it not that the criticism appears in a scientific journal of high standing, I should

hardly have considered it as meant to be taken seriously, but, appearing as it does, I must beg space to answer some of the writer's points in some detail. Mr. Glenn says that the paper, "curiously enough, does not offer the slightest evidence that chromium or any of its compounds, in any quantity, however large or small, can injuriously affect the animal body. Furthermore, there is no reliable tradition or literature to that effect." It is barely possible that the gentleman may have been misled by a statement in the paper referred to, that I had been unable to find any reported cases of general or local affection attributable to chrome-mordanted clothing. No evidence was offered as to the poisonous character of chromium compounds on the animal body, for the reason that it was supposed to be a matter of common knowledge with the medical gentlemen before whom the paper was read. As to literature, I suppose that everybody will concede the reliability of the few authors (out of many) whom I will quote.

Wharton and Stillé (*Medical Jurisprudence*, 4th ed. vol. ii., Philadelphia, Kay & Bro., 1884) say of bichromate of potassium, "This salt, being extensively used in dyeing, has given rise in several instances to accidental poisoning. Locally applied, its action is irritant, causing in the workmen who use it troublesome sores and ulcerations upon the hands. Taken in poisonous doses internally, its action is highly irritant also, and death has been caused by it with the symptoms usually attending the action of irritant poisons. . . . Several fatal cases have occurred in Baltimore." A number of cases are reported in detail. "Experiments upon animals have shown, that, after the subcutaneous injection of chromic acid, animals suffer from vomiting, diarrhoea, albuminuria, and finally die in a few days: after death inflammation of the kidneys is found. The same results were produced by the injection of a neutral chromate (yellow chromate of potassium)."

Taylor (*A Treatise on Poisons*, London, Churchill) says, "There can be no doubt that bichromate of potassium is an active poison," and quotes the following case from Beck's 'Medical Jurisprudence,' which is also quoted by Stillé: "Dr. Baer of Baltimore has reported the following case. A man, in drawing off a solution of the bichromate by a siphon, accidentally received a small quantity into his mouth. In a few minutes he perceived great heat in the throat and stomach, and this was followed by violent vomiting of blood and mucus. The vomiting continued incessantly until his death, which took place in five hours. On dissection the mucous membrane of the stomach, duodenum, and about one-fifth of the jejunum, was destroyed in patches. In this case the salt acted as a corrosive irritant."

Schuchardt (*Maschka's Handbuch der gerichtlichen Medicin*, Band ii., Tübingen, 1882) says, "Poisoning by chrome compounds (including lead chromate) is not rare. The chromic-acid compounds are more or less violent poisons." Reference is made to numerous cases. "According to the researches of E. Pelikau (*Beiträge zur gerichtl. Med. Toxikologie und Pharmakodynamik*, Würzburg, 1858), bichromate of potassium is very similar in action to arsenic and corrosive sublimate. It causes, when taken into the stomach, marked inflammation of the same and of the intestine; easily causes vomiting, and, after absorption into the system, calls forth a train of general symptoms, particularly albuminuria and hemorrhage from the kidneys, and causes death with more or less rapidity." Reference is made to the results of the observations of Gergens (*Arch. für experiment. Pathol. u. Pharmacol.*, Band vi., 1876), Weigert (*Die Bright'sche Nierendegeneration vom pathologisch-anatomischen Standpunkte*), and Kabierske (*Die Chromniere*, Breslau, 1880). The experiments of Gergens were repeated by Posner (*Virchow's Archiv für pathol. Anat.*, Band lxxix., Heft 2), with the same results. "The action of this poison on the general system is extraordinarily rapid and intense."

Falck (*Lehrbuch der Practischen Toxikologie*, Stuttgart, 1880) says, "Cases of poisoning by compounds of chromium are not rare. We find reported up to the present time (1880) seventeen cases, of which three were from chromic acid, two from the chromate and twelve from the bichromate of potassium. Of the seventeen cases, nine (or 53 per cent) ended fatally. . . . Workmen in dye-houses who have to deal constantly with solutions of chrome compounds are afflicted with painful deep ulcers on the hands, which heal with great difficulty; similar affections may be produced by the same

substance in the form of dust. . . . Experiments on the effects of chromates on animals have proved the intense poisonous action of these substances. According to Gergens, rabbits died after the subcutaneous injection of 0.26 of a centimetre of chromate of potassium, and showed hyperæmia of the intestinal tract, nephritis, and cystitis. According to Priestley, the vaso-motor centre is first excited, then paralyzed. Mayer found chromium in the blood, heart, liver, and kidneys."

Many more authors could be quoted on this point, but the above is, I think, enough; and, furthermore, the evidence quoted is a sufficient reply to the negative evidence of the weavers in the Philadelphia mills, the dyers, and bichromate-makers interviewed by Mr. Glenn. With regard to the cases reported by me as being caused by chrome mordants, I wish to say, in the first place, that they were not reported for the purpose of beginning an agitation against the use of bichromate as a mordant, nor was it my idea to cause needless alarm among the people. The paper was written for a medical society, and was intended to call to the attention of the members a possible cause of affections of the skin, the removal of the cause in any given case being of a certain value in treatment. I am very well aware of the great value and importance of the bichromate as a mordant, and also of the fact that to the vast majority of people clothing dyed by its aid is not likely to produce any injury under ordinary circumstances; and any idea of restricting its use as a mordant on account of an occasional idiosyncrasy would seem to me as absurd as to legislate against railroads on account of the possibility of accidents. I have worn, as have others of my acquaintance, clothing (including stockings) dyed with the aid of bichromate, without experiencing the least injury therefrom, and the same is undoubtedly true of thousands of others; but neither these facts nor Mr. Glenn's experiments are conclusive evidence that everybody is exempt. The grounds for concluding that the trouble in these cases was due to the mordant seem to me to have been justifiable. Mr. Glenn says on this point, "It would have been strange if he had not [found chromium], since most cloth is chrome-dyed. Had he examined further, equally certain he would have found iron, cellulose, keratin, and some other organic products. Why not assign to one or all of them the maladies of the patients mentioned?" My experience in the examination of cloth for irritants has proved to me that a very large proportion of textile fabrics do not contain chromium in any form whatever, and it therefore never strikes me as remarkably curious in such examinations to find no chromium. In the examination of the specimens in question, no other substance was found which could in any way whatever be considered poisonous. Chromium, then, being the only substance present which is known to act as a poison in certain combinations, was the only substance which could be reasonably suspected. Anybody who has read the original article will, I think, concede that in each case the disturbance was due to something in the cloth. That the conclusion that this something was a compound of chromium was correct, I have very good confirmatory evidence. A young man purchased a cheap pair of trousers, which he wore all summer without drawers, and without perceptible injury. Becoming faded, he had them dyed a dark blue, and shortly after, resuming them under the same conditions as before, he was troubled by an outbreak on the skin of both legs, with irritation and inflammation of a very intense character, particularly on the inner side of the thighs and about the generative organs. Through the courtesy of his physician, I was enabled to make an examination and inquiry, which brought out the fact that the dyer had used bichromate of potassium. The young man had worn the trousers a whole summer without injury, but had suffered intensely from wearing them after they had been dyed with bichromate. Would it, perhaps, be as sensible to ascribe the symptoms to cellulose or keratin?

I cannot see the application of Mr. Glenn's calculation of the loss in weight undergone in a week by a small boy's suit, and of the probable amount inhaled by the wearer, unless he assumes that in the cases reported in my paper the poison was simply inhaled. In these two cases the clothing gave off large amounts of dust, much of which was conveyed to their mouths by wet fingers. Mr. Glenn's figures (that is, that a small boy's suit loses three hundred and forty milligrams in a week) can hardly be taken as a

fixed standard, since the amount of loss will depend much on the particular kind of cloth, and upon the activity and habits of the wearer; and in such calculations it is to be considered that small boys occur in several sizes.

Mr. Glenn's theory of antidotes is in great measure correct, but it must be remembered that many so-called insolubles are soluble in the juices of the body. He goes on to say, "Chromic acid is a very active oxidizer. In contact with organic matter, it is quickly reduced to chromic oxide (a compound insoluble in any of the juices of the animal body). It is a destroyer of organic tissues, therefore. The action of both normal and alkali chromates is similar to chromic acid. They destroy organic matter by oxidizing it, chromic oxide being precipitated. . . . When such dust falls upon the mucous membrane, it is quickly reduced by the secretion it finds there, and chromic oxide is precipitated. The membrane is not attacked."

This theory of action is not the one which is held by those who consider chromic acid and chromates true irritant poisons, and as one of the latter persons I am again obliged to dissent. I cannot agree with Mr. Glenn as to the general effect or the local reactions. Wharton and Stillé (*Medical Jurisprudence*, 4th ed. vol. ii.), quoting a case of poisoning by the bichromate of potassium, in which, among other symptoms, suppression of urine occurred, remark, "The suppression of the urine is probably due to inflammation of the kidneys produced by the chromic acid." Falck (*Lehrbuch der praktischen Toxikologie*, 1880) quotes a case where violent vomiting and intense abdominal pain occurred soon after the application of chromic acid to a cancerous breast. The patient lay pulseless, with cold skin and cyanotic face, constantly vomiting, with all appearances like a case of Asiatic cholera. Death occurred after several hours. A similar but non-fatal case is reported by Bruck.

These symptoms indicate absorption into the system, and not a mere local oxidation with precipitation of a harmless oxide. The symptoms in most of the reported cases of poisoning by chromic-acid compounds are very similar to the above; and these cases of Moseitig and Bruck are particularly valuable in that the poison was not swallowed, but absorbed from a broken surface.

Speaking of the deaths in Philadelphia following the ingestion of buns colored with chrome yellow, Mr. Glenn remarks, "No one familiar with the oxidizing action of chromic-acid salts, and accustomed to making combustions with lead chromate, would find much difficulty in believing that the small quantity of lead chromate taken by any one victim was reduced while in contact with organic matter in the stomach and intestines, chromic oxide passing out with the dejecta, and lead oxide being left to produce its cumulative effects." Again I cannot agree with him, and I think he would have no difficulty in finding many others who would refuse to believe that the poisonous effects of lead chromate are always due to the lead alone. Schuchardt says in *Maschke's Handbuch*, "Chromate of lead appears to act as a corrosive poison;" and again, "Chromate of lead appears to act more powerfully than the acetate." Wharton and Stillé say, "Although this substance is insoluble in water, and under many circumstances in the stomach and intestinal fluids, sometimes it gives rise to acute poisoning owing to its decomposition after it enters the body. That such a decomposition does occur, and that the chromium may be absorbed, is shown by R. C. Smith (*Brit. Med. Journ.*, 1882, p. 8), who reported a case in which chromic acid was detected in the urine: this was a case of professional poisoning, the patient being employed in weaving yarn colored with chrome-yellow." I will briefly quote another case bearing on this point, reported by Leopold (*Vierteljahrsschrift für gerichtl. Medicin und öffentl. Sanitätswesen*, Band xvii. 29). Four persons engaged some days weaving blankets colored with lead chromate were seized with symptoms of chronic lead-poisoning. During the work the yarn gave off so much dust, that their faces and hair were quite yellow. A two-weeks-old boy was kept in the same room, but was apparently protected by a covering of white woollen cloth. After seven weeks the child became suddenly very sick. Among other symptoms, it had several yellow diarrhœic discharges daily, with restlessness and frequent screaming, during which it dug its hands under the pillows. At first it would drink, but refused food: later on, it drank with some effort, and on

the day of its death swallowed with difficulty. The lips were dry, respiration quickened, and death came slowly. On chemical examination after the autopsy, lead chromate was found in the respiratory tract and œsophagus, showing that the cloth had not been a sufficient protection. The rubber nipple which the child had used was found to be free from chromate, most probably because the dust which had adhered to it had been sucked off and swallowed. Among the post-mortem appearances was a perforation of the wall of the stomach. The death of this child was caused by exhaustion following perforation and softening of the stomach, brought on in consequence of swallowing chromate of lead. Neither the symptoms nor the post-mortem appearances could be ascribed to the influence of lead. Part of the chromate in the body was doubtless decomposed, and perforation followed. I agree with Mr. Glenn, that, "if dust from chrome-dyed yarn has any poisonous effects, weavers ought to have some knowledge of it."

Dr. Von Linstow (*Vierteljahrsschrift für gerichtl. Med. u. öffentl. Sanitätswesen*, Band xxi. 60) reports two deaths occurring in boys, aged respectively one and three-quarters and three and one-half years, who together ate six small objects made to represent bees, each piece containing 0.0042 of a centigram of chromate of lead. Both were seized with the same violent symptoms at the same time, a few hours afterward. Among other symptoms may be mentioned diarrhœa, convulsions, stupor, great thirst, and difficult deglutition. The younger child died on the second, the elder on the fifth, day after seizure. Among other post-mortem appearances observed in the elder child were destruction of the mucous membrane of the stomach in several places, and ulceration, and perforation of the duodenum. In both cases there was fatty degeneration of the liver. In the younger child there was no perforation, but the mucous membrane of the stomach was marked throughout with red points, and showed velvet-like, opaque swelling. The duodenal mucous membrane was pale, with occasional bloody points. Would anybody think of ascribing these symptoms and post-mortem appearances to lead oxide?

In conclusion, I join Mr. Glenn in the hope that investigation into the subject of chrome-poisoning will not be allowed to die of neglect.

CHARLES HARRINGTON, M.D.

Chem. Dept. Harv. Med. Sch., Aug. 12.

Poison Fangs and Glands of the Mosquito.

The general arrangement of the mouth of the female mosquito is well described by Dimmock on 'the mouth-parts of the *Diptera*.' The under lip is a large hairy tube, 2 millimetres long, open above, and serving as a sheath for the piercing-apparatus, whilst it is itself terminated by two sensitive labellæ, and by a central lancet-like ligule. Within the structure of the sheath are a large nerve, a pair of longitudinal muscles and many oblique muscles, two large tracheæ by which air can be admitted (so as to distend the organ as in *Musca*), and long filiform tendons which arise at the base of the sheath and support the terminal labellæ.

The piercing-apparatus is enclosed during rest in a strong-pointed upper lip (*labrum*) which is grooved inferiorly for their reception, and which along with them is received into the sheath-like under lip. Within this labrum are the two maxillæ, very sharp and barbed near the tip, and able to play back and forward like saws; also two mandibles, a fine styliform hypopharynx, a delicate sheath for the front segment of the œsophagus, and the œsophagus itself. The last-named organ is received within the head into a strong box-like pharynx, which is well supplied with muscles and is a suction organ. The pharynx draws in blood (and probably vegetable plasma), which it transmits by the long post-pharyngeal part of the œsophagus to the stomach lying in the abdomen of the insect.

The poison-apparatus, which hitherto has been an unknown quantity, is connected with the two mandibles. Each mandible has a large funnel-shaped base, into which is inserted the end of a poison-duct. The thickened axis of the mandible is pierced by a fine canal, which opens just below the sharp apex. The structure reminds one of a bee's sting, saving that it is duplicated. We can by pressure drive out some of the contents and observe them issuing at the sub-terminal orifice. It is probable that when the lancets pierce an object this fang-like mechanism may, by pressing on its base, automatically discharge a portion of the poison. The poison

seems by inflaming the tissues to determine a flow of blood, and also to prevent the coagulation of blood or other proteid. (The blood subsequently coagulates in the mosquito's stomach.)

The poison-duct resembles a trachea in being transversely striated, but differs by the uniform diameter of its tubule of about 6 micromillimetres, by the absence of fine ramifications, and by the great thickness of its wall. The two ducts, proceeding one to each mandible, arise by the bifurcation of a common duct in the region of the neck below the œsophagus. Behind this the difficulty of dissection is considerable, as the parts are so small that they cannot be followed with low microscopic power; they are greatly entangled among the large muscles, tracheæ, and other furniture of the prothorax, and they are easily torn so as to be lost to the search. I have succeeded, however, by working back from the neck, in spreading out the entire system. The common duct arises from three prothoracic glands, all sessile on its lower extremity like the leaves of a trefoil, each supplied with a precurrent ductlet, the three ductlets meeting at a point so as to form the common duct. The glands are each about one-third of a millimeter in length and one-twenty-fifth in diameter. The two lateral glands are of the usual salivary kind common to insects. The central or *azygos* gland is entirely different, scarcely lobed, but being a mass of brown evenly distributed granules, with oil-like globules intermingled, its ductule having finer walls than in the lateral glands. We may regard this as emphatically the poison-gland, but the intermingled products of all three have their only outlet by the common duct, and thence by its two branches to the mandibles, which therefore play the part of 'poison-fangs.'

Some tentative notes recently given before the American Association involved inaccuracies, which are here rectified and the work completed. Measurements given above are from a small species which may perhaps be identified by its maxillary palps being as long as the maxillæ themselves. They seem to be the same for all the common species.

G. MACLOSIE.

Aug. 20.

Rockwood Meteorite.

ABOUT the middle of March last there was found by Mr. Elihu Humbree, on land owned by Mr. W. B. Lenoir, eight and one-half miles west of Rockwood Furnace, Cumberland county, Tenn., several pieces of what has proved to be a meteorite of very great interest, belonging to the rare class of siderolites, resembling in general appearance the Atacama but differing very widely in the nature of the silicate.

When first found it excited the curiosity of Mr. Humbree, and, after much pounding with an axe, he succeeded in detaching several large pieces and many fragments without finding the large lump of silver in it for which he was looking, the bright specks of nickeliferous iron scattered through the mass having been mistaken by him for that metal.

Three or four weeks later Mr. Lenoir, suspecting the nature of the find, secured the whole of it (with the exception of some small pieces which had been given to friends), and forwarded samples to us for examination. Two or three weeks later, on the 2d of June, I visited Rockwood, and brought the entire find away with me, with the exception of the small pieces already mentioned: these have nearly all been gathered up since and are now in our possession.

The main mass is an irregular ellipsoid, with one side a little flattened, and noticeable by the almost entire absence of the usual pittings, which are present elsewhere on the surface.

The three greatest dimensions are $14\frac{1}{2} \times 10 \times 8\frac{1}{2}$ inches. The weight, which owing to the loss of some of the fragments cannot be determined accurately, was about 83 pounds. Three other smaller masses bring the weight of the entire find to fully 100 pounds (probably two or three pounds more), of which to the present time we have secured 96½ pounds. Specimens have been submitted to Prof. F. W. Clarke of the U. S. National Museum for examination, and very full analyses by Mr. J. E. Whitfield will be published as soon as the work is completed. The analyses thus far made show it to be in the main a silicate of alumina, lime, magnesia, and ferrous oxide, — probably in the form of anorthite and augite, with no olivine. Further analyses are being made to clear up this point.

The iron grains contain 12 per cent of nickel, with a trace of copper, and, so far as examination has gone, seem to be distributed through the mass quite evenly; one nodule of iron, however, has been observed which measures three-quarters of an inch in diameter, and exhibits the Widmannstædtian figures very characteristically on the etched surface. Other nodules of iron equally large will probably be met with by further cutting. Although the analysis shows an unusually large amount of chlorine present, decomposition has only affected the surface and in the seams, and has been so little that the original black crust is preserved over a considerable portion of it.

This brings us to the interesting question of how long it could have been exposed to the action of the weather, and it is possible some readers of *Science* can help us to determine that important point.

In the late autumn of 1880, between five and six o'clock in the afternoon, a meteor was seen passing to the north-west over Morgan county, Georgia, which "left a dense trail, not very wide, of light-colored smoke, which could be seen for at least half an hour, and which gradually spread out thin and woolly, like ordinary smoke." A loud report, thought to be about three minutes after the passage of the meteor, was heard by persons who did not see it, as well as by those who were fortunate enough to observe its flight. It would be very interesting if a connection could be traced between this meteor and the meteorite found in Tennessee. If they are the same, it would seem that it should have been seen and heard by different persons all along the line. Any information on this subject will be thankfully received.

EDWIN E. HOWELL.

Rochester, N. Y., Aug. 22.

Swill-Milk.

I HAVE read the discussion about 'swill-milk' recently published in *Science* with great interest, especially as I had thought the unhealthiness of distillery-slops as food for animals had been settled and agreed to fifty years ago. Will you permit me to cite an experience of my own bearing on the question? About fifty years ago, — I cannot give the precise date, — I worked in a 'pork-house' one winter, during which I trimmed the hams of five hundred 'still-fed' hogs. It was admitted by all hands that there was not a sound hog in the lot. But few of them were well fatted, although their appearance was good. It was not at all uncommon, thing, in cutting up a hog, to cut through an abscess, varying in size from a cherry to a half-pint; the largest one being in the region of the kidneys. The kidneys and 'tenderloin,' which lies along the vertebra in the region of the kidneys, were invariably infested with kidney-worms, and I have never had any desire to eat tenderloin, since.

The testimony of all packers in that section of country — the Miami Valley — was that all still-fed hogs were similarly diseased, though not generally so badly as this lot. The meat was soft and oily, — unfit for barrel-pork.

Some years afterwards, upon my removal to this city, I called upon the butcher of whom I purchased my meat, who was an intelligent man, and asked him if he found the livers of well-fatted cattle in a healthy condition. His answer was no, that it was very rarely that the liver of a well-fatted beef was fit for human food, especially still-fed cattle. They, he asserted, were always diseased; and he added that he never bought still-fed cattle unless they had been taken off slops and fed on corn some weeks before being killed. He asserted that he could distinguish between still-fed and corn-fed beef, after it was slaughtered, by the sight and touch.

JOHN J. JANNEY.

Columbus, O., Aug. 19.

The Pronunciation of 'Arkansas.'

IT is really exasperating to be obliged to explain and apologize every time one pronounces this word correctly in intelligent New England circles, where the later and improper pronunciation was invented and has been established parasitic upon our nomenclature. Had not the Legislature of the State officially declared the final syllable to properly have the sound of *saw*, not *sass*, or had not the inhabitants, from earliest settlements, to say nothing of the people.

of Louisiana, of which Arkansas was once a part, always pronounced it *saw*, there would nevertheless be no authority whatever for the curt and abbreviated *sass* which is generally given. The word is an attempt upon the part of the first French missionaries of Marquette's time to phonetically spell in French the name of a tribe of Indians, and no Frenchman would ever pronounce the combination of letters in the manner taught by the New Englanders. The final *s* was and is silent, and the *a* has the nasal *aw* so common in many Frenchmen's speech. As for the old comparativists, who, regardless of the inconsistency of English spelling, always inquire, "if Arkansas is Arkansaw, why is not Kansas, Kansaw," they may be glad to learn that Kansas was Kansaw, and early Anglo-American travellers so pronounced it, and even attempted to spell it phonetically in English, as can be seen in the report of Lieutenant Long's expedition to the Rocky Mountains, 1819-1821, where the word is spelled *Konsa* — the nearest combination of English letters that can approach the true French sound.

But Arkansas is not the only French geographic term that has been sacrificed to the attempt of New England lexicographers to create in that region a standard pronunciation of the English. The word *chien*, for instance, which was originally applied to the Indians from their system of police, I believe, and meant literally the 'Dog Indians,' now graces the rivers, counties, cities, and mountains of our maps as Cheyenne, — the most plausible illustration of a Yankee phonetic-pronunciation of a French-spelled word.

'Arkansaw' may be difficult to say, and may fall heavily upon our ears, but it is proper all the same, and the sooner 'Arkansas' is abolished the better for our consistency.

ROBT. T. HILL.

U. S. National Museum, Aug. 20.

Diagnosis of a New Species of Thrush (*Turdus celanops* sp. nov.) from Japan.

Diagnosis. — Back 'mummy-brown' (*Ridgway's Nomenclature of Colors*, pl. iii. Fig. 10); breast and flanks rufous tawny, unspotted; under wing-coverts gray; tail-feathers without white terminal spots; no light stripes about the eyes; second primary shorter than fifth. Adult male with head and neck black. Wing about 120 millimetres.

Type. — United States National Museum, No. 111,665.

Habitat. — 'The Seven Islands,' Idzu, Japan.

During a recent visit to 'The Seven Islands,' south of the Bay of Tokio, Mr. M. Namiye, of the Educational Museum, Tokio, among other interesting species, collected the thrush described above. Although nearest related to *T. chrysolaus*, the male of the new species is easily distinguished from all the forms belonging to the same group by the intensely black color of the head, neck, outer portion of wing, and tail. The female resembles more that of *T. chrysolaus*, but the back is browner, the tawny of the breast and flanks is deeper and more rufous, and the first (tenth, or rudimentary) primary is longer.

I am under great obligations to the authorities of the Tokio Educational Museum for the privilege of describing this interesting novelty.

LEONHARD STEJNEGER.

Smithson. Inst., Washington, D.C., Aug. 18.

Audubon's Grave.

THE letter from Mr. D. S. Martin, in *Science* of Aug. 5, interested me very much, as it undoubtedly did every American naturalist; and there is probably no appeal that could be addressed to the naturalists of this country which would meet with a more liberal response than for the means to erect a fitting monument to Audubon.

But this appeal calls up another question in my mind, and, if at this distance I be correctly informed from what I have seen in the press columns, is not the great cathedral, which is to cost some ten millions of money and to be erected in New York City, on such a footing that there seems but little doubt that the structure will eventually be completed? And, further, if I read the words of Bishop Potter aright, is not the edifice when finished to be the 'Westminster Abbey' of the United States? Surely it would seem that the time has arrived when we should be able to point to some grand monument and say, within those walls repose the remains of America's great and honored dead. Such far-reaching projects

when perfected ever tend to nationalize us, and to-day, as we are all aware, the ashes of the truly great men, men who have built up America's science, art, letters, and every calling which goes to make a nation great, are in many instances so obscurely rested, that I woe it would test the memory of the best of us to recall the spots where we have placed them.

Why not deposit the remains of our great naturalist, Audubon, in some perfectly secure vault for a few years longer, and then remove them to their final resting place, to their crypt in the great Abbey which is to be built, and then will every naturalist in the United States proudly come forward with his share towards closing the entrance of such a tomb with a fitting monument.

R. W. SHUFELDT.

Fort Wingate, N.Mex., Aug. 12.

Increasing Danger of Tape-Worm.

IN the Texas grazing region, from which has sprung, within the last two decades, the entire stock of range cattle of the western states and territories, the beef tape-worm is a most common occurrence. In fact, I do not believe I exaggerate when I say that at least every fifth person is afflicted. The cause of this is that on open ranges the eggs of tape-worm are most easily and widely distributed, and hence the cattle more frequently become infested with cysts. Stall-fed cattle, on the other hand, where the water is usually less subject to contamination, and the food cleaner, are only seldom infested, and hence tape-worm was not so prevalent in regions where the latter were used.

In the last few years, however, the shipment of range-cattle, by means of refrigerator cars, has become the chief beef supply of the East, and the danger and frequency of tape-worm greatly increased. Of course, no one should stop the use of well-cooked meat on this account, but rare and half-cooked meats can easily be avoided.

R. T. H.

Applied Optics.

WE are indebted to Prof. R. S. Heath of Birmingham, England, for a good book on our language, that at last gives us a theory, the Gaussian, that can be used in the discussion of lenses as we find them in telescopes. Heretofore, so far as I know, English writers have treated the imaginary case of lenses infinitely thin, and in practice have spoken in a vague manner of an optical centre. For a correct theory, one was obliged to recur to the memoir of Gauss, or to some of the German discussions of it.

In Mr. Heath's biography of this subject I find no reference to the writings of Biot, to which Mr. G. W. Hill called my attention some time ago. In his 'Astronomie Physique,' Biot devotes 540 pages to optical instruments, and he is so voluminous that it would require some patience to be sure of what he has done. I have the impression that he came near anticipating Gauss. Biot's first volume was published in 1841. Gauss read his memoir in December, 1840, but it was not published until 1843.

ASAPH HALL.

Washington, Aug. 20.

Queries.

14. AN EXPULSION OF SPARROWS. — A curious thing happened here a week ago to-day. About four o'clock in the afternoon, a flock of birds — hundreds apparently — flew in circles round and round our house and garden, never settling. This continued for nearly an hour without a sound. Meantime our saucy sparrows disappeared, and have not yet returned. Our trees, which at dawn and twilight resounded with their chattering, are now silent and deserted. I had an opportunity the next morning of seeing closely one of the army of extirpation, — probably a deserter, for he was the only one left. I would describe the bird as about the size of the sparrow, very slender, with full black eye, dark mouse-color, with a light, almost white, breast. This morning for the first time since their expulsion came three or four of our native sparrows, but none of the foreign residents. I am curious to know if this happened any where else. My place being large, I could not see if my neighbors were visited likewise.

W. A. G.

New Brighton, S.I., Aug. 18.

SCIENCE

FRIDAY, SEPTEMBER 2, 1887.

THE ADMIRABLE APPOINTMENT by the President of Mr. G. Brown Goode as Commissioner of Fish and Fisheries was announced this week. It meets at once the requirements of an exacting office and the exceptional provisions of the law creating it. Professor Goode was intimately acquainted with the methods of Commissioner Baird, whose scientific zeal and knowledge he shared, and his experience and attainments in practical fish culture and in the science of ichthyology make him easily first among those whose qualifications the President has been called upon to consider. But the fact that the President has been able to select from among the civil officers of the Government a known scientist, acquainted with the habits of food fishes, to serve in this important office without extra compensation, does not remove the absurdity of this special law. If Mr. Goode should die to-morrow there is absolutely no civil officer of the United States qualified, under the terms of the act, to take his place. The special law was passed when fish culture was in its infancy. Congress was willing to risk the experiment, provided it was intrusted to Professor Baird, and framed the law accordingly. The present provisions of the law have been outgrown. It is an absurdity to have a Fish Commissioner receiving not as Commissioner but as Assistant Secretary of the Smithsonian a salary of \$300 a month, and appointing and controlling a Deputy Fish Commissioner at a salary of \$416 a month. Nor is there any reason why the Fish Commissioner should not be paid a salary commensurate with the importance of his office, and be exempted from discharging the duties of two offices with the pay of one. These matters can be appropriately considered when the Senate is called upon to confirm the new Fish Commissioner.

IN WRITING of examinations a few weeks since, we mentioned the fact that we proposed to return to the same subject later. It gives us pleasure this week to present to our readers the views of Gen. Thomas J. Morgan of the Rhode Island State Normal School, Prof. W. H. Payne of the University of Michigan, Supt. Thomas M. Balliet of Reading, Penn., and Dr. B. A. Hinsdale of Cleveland, on the function and conduct of examinations. Too many of those who are engaged in the profession of teaching look upon the periodically recurring examination as supernaturally ordained, and therefore not to be altered or questioned. For such persons, and for their pupils, an examination is a dreary routine to be dreaded. It is to be looked forward to for months, and 'crammed' for with assiduity and perseverance. It is this aspect of examinations which is specially to be criticised and combated. The proper place and scope of examinations in any educational system must be determined and understood. They must work in harmony with enlightened instruction, and not project a foreign and inharmonious element into it. We trust that the present symposium will exercise a good influence toward this end.

THE QUESTION OF A SYSTEM of improved public roads is one so closely related to every material interest of the State as to place it properly among the most important questions of public economy. The science of road making and maintaining, though neither difficult nor abstruse, is nevertheless based on principles so well established and so unvarying in their operation, as to render their thorough comprehension an essential to success in securing and maintaining public roads, at once efficient and economical, whatever the

administrative system under which they are constructed. In other countries the superintendence of public highways is recognized as an important and responsible duty, and is usually assigned to specially-trained, expert government engineers, while in the United States, where the greater mileage makes the economy, if not the efficiency, of roads even more important than abroad, the States depend for this responsible service on private citizens locally and temporarily appointed to the duty, without having provided for them the technical instruction and training so essential to success under any system. In view of this state of affairs we take pleasure in recording a move on the part of the Engineering Department of Vanderbilt University, which, under due restrictions, provides for the proper instruction, free of charge, of those who may wish to know enough engineering to make them the better road-builders.

ORIGINAL RESEARCH IN THE AMERICAN COLLEGE.

OUR American colleges, with the exception of a few of the larger institutions, are unfortunately not places of original research. It has hardly seemed to have entered into the American idea of education that a college, besides being a place of instruction, should be the place for the origin of new knowledge. Of late years, however, the influence of German universities, and of some of the larger colleges in this country, has been creating the conviction that original research in some form is necessary for the life of our higher educational institutions. There are thus numerous indications that the future is to see our colleges more the home of new learning than they have been in the past. But while we are beginning to realize how greatly it is for the interest of our colleges that research should be carried on within their walls, the prospects are, that, until a complete change takes place in our system, such research will be confined to the instructors and graduates, and will not be shared in by the undergraduate student. With a few exceptional cases we find the attention of the undergraduate confined to routine work, and it is only after graduation that he is allowed to specialize so far as to take up original investigation. Now, while this is due partly to lack of facilities and opportunities, partly to lack of requisite knowledge on the part of the instructor to direct such work, partly to the difficulty of selecting work which a young student can do, and partly to the universal disinclination to make new moves, it is at the same time largely due to a more worthy reason than any of these. There are many instructors in our colleges, who have every facility for such work, who think it not wise to encourage it, even though it would make the personal work of teaching a much more congenial one. It lies outside the scope of our college course. While, then, we may hope to see a time in the not distant future when our colleges shall be places of research, it is very doubtful whether this research will ever be shared in by the undergraduate, except in isolated cases.

The reason for this lies in the peculiarly American idea of the scope of and necessity for what we call a liberal education, and not in any failure to recognize the value of research. The value of research as a means of education in stimulating the student is fully appreciated. It tends to counteract many evil tendencies of our college-work. Routine courses in science as ordinarily pursued are apt to become monotonous and tedious to the student, soon degenerating into mechanical work. With the experiments detailed for him in his text-book or laboratory directions, their results cease to interest him, and a careless habit is almost sure to be fostered. His thought is hardly stimulated at all, but is rather curbed by the feeling that he is going over a path which hundreds have followed before, and that consequently his discovering any thing new is an impossibility. It is indeed surprising to see what little thought is required, on the part of the student, to go through some of our routine science courses. He learns the text-book, mechanically

performs the experiments, and notes results, but the amount of personal thought which is stimulated is sometimes infinitesimal. Now, since the design of our college course is to make the thinking man, it is plain that something is needed to offset these tendencies, and some of our educators would find this something in original research. That a bit of research will counteract these evils in large measure is certain enough. When the student is engaged in solving some new problem, the whole aspect of his study is changed. It is no longer tedious and dull, but interesting and full of life. A new world of thought is opened, and scientific methods of thought and work become engendered. Travelling a new road, the student is ever on the watch for new facts and thoughts. Carelessness and mechanical labor are no longer possible, for he soon discovers that his success depends upon the amount of care and thought that he puts into his work. In short, original research soon does away with the school-boy, and makes the student in its best sense.

But while the value of this method of study is apparent, it by no means follows that such a course is best for our college student. Most American instructors believe at present that the evils resulting from such a course would more than counterbalance its advantages; for it is plain enough that a course founded upon research will tend to make specialists, and nothing else; and this is not the design of our colleges. The American college is quite naturally compared with the German universities; but the comparison is an utterly false one, for the aim of the two is entirely different. The German university student is studying a special course, for a special purpose, and is usually looking forward to government employment. The government appoints ministers, doctors, lawyers, teachers; and eighty per cent of the university graduates obtain such employment after passing a rigid State examination. It is this examination and government employment which serve as the inspiration of the student. The German Government has decided that a high education shall be the means of entrance into the upper circles of society. For a German who is not born noble, there is only one way of gaining an association with the upper classes, and that is by a university education and government employment. With such an inspiration, Germany could hardly help developing a high grade of education and early specialization. Considered in the light of education alone, her system has certainly been the most successful ever instituted. But in this country the conditions are very different, and such an educational system is both impossible and undesirable. Our government has set no premium on education, nor are our professional men at all dependent upon the government for success. They are dependent directly upon the people, and therefore upon a hundred unforeseen possibilities. There are other ways of improving one's condition and rising in the estimation of society than by becoming professional men, for many other paths of life are equally respected. We have no educated aristocracy, for we believe there are other good things besides learning. Our colleges have therefore a broad function to perform in meeting these conditions. They desire, not to make specialists, but to train men. They do not desire to make ministers or doctors or lawyers. This is left to professional schools, which therefore compare more nearly with the German university. The college course is one which we think a student should have before beginning a special training, believing that such preparation will result in making better professional men, better business men, and, above all, better citizens. It is the general training of lower schools broadened and expanded. German university education tends to unfit men for any course of life outside their specialties, and Germany is becoming alarmed over the increasing class of educated men who cannot obtain government employment, and are fit for nothing else. The same is true of our professional schools and advanced courses in higher universities; for they, too, fit men for narrow courses in life. But the college tries to put men in a position where they are better fitted for any path in life, from farmer to statesman. The professional school tries to make the scholar; the college, to make the man. That our plan of education is not adapted to the production of the largest number of gifted scholars may be very true; but that it is best adapted to the needs and demands of our system of society and government is the firm belief of most American educators.

Now, if we recognize this as a worthy aim of our colleges, we shall understand why original research is not encouraged on

the part of undergraduates. We hear a constant demand in this country for a liberal education. It is for this that our students go to college, for this that the course is planned. It is planned to occupy four full years, with little time left for outside work. Fortunately, however, this idea has not been strong enough to oppose successfully the introduction of the elective system, for this freedom of choice has fought its way into all colleges. Our education has been vastly improved by allowing the student the privilege of devoting his energies toward a line of studies congenial to him. This system of greater freedom is yearly widening its scope, and it is of course impossible to tell where it will end; but there is no reason for thinking it likely to go beyond a broad freedom in electives. To take another step, and introduce the earlier and narrower specialization which would result from the encouragement of original research, would be to abandon completely our belief in the value of a liberal education: for the investigator becomes the specialist from the start. His attention is withdrawn from other subjects, and, with the American's hurry to do something, he is almost sure to neglect completely all lines of learning except his own. We do not want our colleges to develop classes of men who are good for nothing outside of one line. For the general student, then, narrow specialization is always injurious. Still further than this do our colleges go, insisting that even more should the student who aims at a special line of work be cautioned against taking it up too quickly. The only time that he will ever get for acquiring knowledge of other departments of knowledge is during his college course; for, as soon as he takes up his own, he will pursue it with an eagerness which will hide all else. To begin to specialize early seems at first sight a gain in time; but it is in reality an irreparable loss, for it is beginning to build without laying a sufficient foundation. To make the best sort of a scholar requires more than an exhaustive knowledge of one thing: it requires a broad knowledge of thought. It is quite common, therefore, to find our professors recommending their own students to keep outside of their specialties as long as possible. Practically, too, it is important, for our educational positions demand it. Our institutions are not yet highly enough differentiated to offer work for very narrow specialists. We have many colleges and broad departments. They want teachers in biology, and not in entomology; teachers of physics, and not of electricity. In short, the demand in the country to-day is almost everywhere for broadly educated men, and not for the narrow students which are the inevitable result of early attention to original research. The general training the colleges must give, all special training being reserved for the professional schools and the universities. If our colleges fill this demand, they will continue to exert a powerful influence; but, if they cease to do so, the American college will disappear, and its place will be supplied by professional schools and universities. To convert our colleges into universities is impossible, since our students have had no thorough training to start with, which corresponds to the German gymnasium. In attempting to avoid the old plan of rigid courses, and by electives introduce more freedom for the student, our colleges have vastly improved our system of education. Whether or not this idea has been carried to excess is still a matter of dispute, as can be seen by comparing the views of the representatives of our two leading colleges, Harvard and Yale. But the opinion would be almost unanimous that a system which enables the student to so devote himself to one subject that all others are lost sight of, belongs not to the American college: it belongs to the university or the professional school. At all events, our colleges at present are planned to give the student a liberal education, and not a special training; and for this purpose routine courses, and not original investigations, are adopted.

Even with our elective systems in vogue, there are, as we have seen, two equally undesirable extremes. On the one hand, routine courses tend to degenerate into mechanical work and monotony, curb original thought, and generate carelessness. This is the most common fault of our American colleges. On the other hand, original research on the part of the young student encourages too early specialization, and thus defeats the plan of a liberal education. This is not as common in this country. But neither extreme is necessary for a medium course is possible, which shall in a measure avoid the evils of both extremes, and give the advantages of both

systems. Such a course we must regard as the most promising one for the future.

Doubtless we shall always meet with undergraduate students who are engaged in original research, perhaps in the future more frequently than at present; for there are certainly instances where such a method of instruction is best. It may be in the case of a student whose habits of carelessness require some measure for correction, or whose utter dependence upon teacher or text-book requires vigorous offset. It may be the student whose general ability is manifest, but whose interest in study has never been awakened: to him a problem of research may prove a lifelong blessing in rousing his slumbering energies. It may be the student who has determined to pursue some special line of scientific work, requiring no general learning, as that of an analytical chemist, or that of some of the government scientific staff: about all that can be said in this case is, the quicker one begins his work, the better. It may be the student whose general faithfulness elsewhere makes it evident that he may take up special work in his own chosen line without detriment to his general education; or it may be in other cases, where there seems to be a particular reason for it. But at most these instances will be few in number, and such work cannot apply to the bulk of students who take science courses in our colleges. For this larger class some sort of routine class-work is necessary; and the question arises whether it is not possible to so arrange it as to avoid the evils which have been and still are too largely attendant thereto. That this is possible is proved by the fact that it is already done in many places.

The methods of conducting the ordinary routine science courses in our colleges at the present time are extremely varied, ranging all the way from simple text-book recitations to plans which involve a large amount of independent work on the part of each student. Experience seems to warrant the statement that the nearer such work approaches the nature of original investigation for each student, the more successful it is in arousing his interest and stimulating his thought. But how is it possible to combine both plans? In many places in this country we find the adoption of plans adapted for this purpose, and implying the minimum amount of what we have called routine work. In the first place, text-books are cast aside, except as books of reference or as serving to give details. The student is thus made to look directly to his instructor for information. This system of lecturing or talking has been borrowed from Germany, where it is the only method of instruction, and is capable of yielding the most excellent or the most evil results, according to the faculty of the lecturer. Where it is simply repeating verbally to the class the substance of some text-book, as is sometimes done, it is much worse than giving the text-book to the student to learn. But where the lecturer's wide knowledge of his subject enables him to collect material from numerous sources, and he is able skillfully to arrange it in such a way as to lead the student from one principle to another, it will give more true knowledge than any text-book. The chief reason is its flexibility; but an equally important consideration is that it enables the lecturer to introduce inferences and conclusions, in the midst of the course, where they belong as drawn from the facts. He can pass from fact to inference, from inference to theory, at will; and he is not obliged to crowd all the principles of his science into an introduction to the course, where they will not be understood, or at the end of the course, when they have lost their interest, one of which unfortunate plans is considered necessary in all text-books. To be sure, we find good students not uncommonly objecting to lectures. This is largely because they are anxious for something to learn; for such work they have been taught to do. They find it difficult, however, to comprehend the meaning of a course which uses details only for their significance, and aims at principles of science rather than detailed information. They know how to learn a lesson, for this they have been taught; but they do not know how to think. In a large class in physiology, scarcely one failed to give the names of the microscopic layers of the retina, though not asked for them and distinctly told that they were of little importance to remember. But quite a number utterly failed to comprehend the significance of the eye as an optical instrument. The former was something to learn; the latter, something to think out. Of course, all students cannot be made to think; but, while it is impossible always to cor-

rect this error of learning simply by rote, it is certain that the lecture system, when wisely conducted, tends to correct it, while text-books tend to foster it. It is very seldom that an instructor who has once tried the lecture system gives it up, except for matters of detail. It helps to avoid old ruts, and insures the instructor that for a time, at least, the students are thinking vigorously, a fact of which he can never be sure with the use of text-books. It is one of the important means of bringing the student in contact with science itself rather than with second-hand learning.

Our science courses are now almost universally accompanied by a certain amount of practical laboratory-work, and here it is possible to enforce a great amount of independent observation and thought. Text-books; except in the form of a library of reference, can, if desired, be completely eliminated. A series of experiments following a course laid down in a text-book is of about the same value as experiments performed before the class, and not very much more; for, with the details and results given him, the student usually is concerned only in performing the experiment successfully, and not in thinking of its significance. But under the direct supervision of a wise instructor, each person's laboratory-work can be so planned as to force him to draw conclusions, and make his own discoveries. He may be told little or much, as the case may require, but always just enough to set him on the track of seeing more for himself. His experiments may be modified to suit emergencies. Numerous minor problems may be set for his solution, for which he has no answer, nor can find one except by studying the experiments, or as his instructor may be inclined to assist him.

An illustration or two may serve to make this more intelligible. A student studying biology is given a fish's skull to examine, with the aid of the instructor's directions, or some book of reference. After thoroughly mastering this, he is given in succession the skull of a frog, an alligator, a turtle, a bird, and a series of mammals' skulls, beginning with the opossum and ending with man. These he compares, in turn, with the fish's skull and with each other, using no books, but simply studying the skulls, with here and there a hint from the instructor, as it may seem desirable. Such a comparison can be completed with sufficient accuracy in a few days, and proves invariably of interest to the student. By the time it is completed, not only has he gained a good idea of the vertebrate skull in such a way as to remember it, but he has discovered for himself the spirit of comparative morphology in such a way that it can never escape him. Or, again, he may be given a book or a lecture describing a lobster, and given for dissection, not a lobster, but a crab; or he may be given a few simple animals, and asked to arrange them in what he would regard as natural groups. These illustrations I have taken from the department with which I am most familiar, but there is no difficulty in applying the same plan anywhere. There is an endless variety of such work, which shall compel the student to combine thought with the mechanical work of the laboratory. Nor does this plan prove as slow as it would at first sight appear. Perhaps it is slow at first, but the rapidity increases with every advance. Work can be constantly varied from one subject to another so as to conduct the student over the whole ground desired. It can be varied with the individual; and, if there be occasional lectures accompanying the practical work, there is no difficulty in covering all the ground necessary.

Such a course is simply the 'object method' adapted to a larger scale, and it has many advantages. It trains the observation, develops carefulness, stimulates original thought. It gives the student the elements of science, but in such a way that they mean more to him than when obtained by any easier plan. It gives him the satisfaction of feeling that he is accomplishing something on his own part, but does not so distract his attention as to injure his work elsewhere. It fits in with the requirements of a general course, and at the same time offers some of the advantages of the German system of independence on the part of the student. It is the best sort of science for the general student, for it gives him not only facts and principles, but some understanding of scientific methods of thought and observation, which is more valuable than the facts. It is the best method for the student who is to make the science his specialty; for, while introducing him to the elements, it familiarizes him with the spirit of scientific investigation, and shows him that nature is the text-book from which he is to learn.

It is plain enough that there are serious practical difficulties in the way of such courses. The chief one is in the amount of time required from the instructor for their successful management. It not only requires that the instructor should have a complete acquaintance with his subject, but requires a constant personal supervision and thought, constant variations with different students, and requires that each instructor should plan his own course. A textbook is impossible, for it defeats its own end; or, if one instructor should write a book for his own class, it would be useless for others. Indeed, it is hardly possible to have any definite course; the aim being that each student should be brought in contact with the principles of nature as best suits his own ability, and not that the class as a whole should go over a regular course. Such work is by far the most difficult sort of teaching; and with the present small faculties of many of our colleges, and the inadequate training of many of the professors, it is practically impossible. But happily the faculties are growing larger, and more and more attention is being paid to selecting instructors fitted for their departments by previous training. Fewer hours of recitation-work are demanded, and more time is left to our instructors for thought and personal teaching. In many places can be seen a constant growth of this personal contact of instructor and student, and as fast as it grows we see the routine work of classes replaced by the work of students as individuals.

Along this line, then, we may look for the future development of sciences in the American college. We may hope for an increase in the amount of original investigation; but this must come chiefly from the instructors and graduate students, and it will then serve as an inspiration to the college. We may look for larger laboratories, more apparatus, and greater facilities for practical work on the part of large classes of students; but this will be insufficient unless we see at the same time an increase in the corps of instructors. Our boards of instructors should be large enough to make possible some personal supervision of the students, so that the individual will not become swallowed up in the mass, and large enough to allow to the instructors some time for research, by which means alone they can keep pace with the times. The great demand of higher education in this country is, therefore, not for more colleges or more buildings, but for more money devoted to instruction.

H. W. CONN.

THE FUNCTION AND CONDUCT OF EXAMINATIONS.

THE professors of a German university do not assign the student lessons, or require him to hear lectures. When the time comes to grant or refuse him the degree, their sole sources of information as to his fitness to receive it are, the thesis that he hands in, and the examination to which he is subjected. As respects time, this is a system of unlimited election. That it develops splendid qualities in the student; that it is very grateful to young men who love freedom and hate task-work; and that, together with the other features of the German system, it produces scholars eminent in every branch of scholarship, — are well-known facts. In a German university, stated work is at a minimum, and the examination at a maximum, as a test of proficiency.

At the opposite end of the scale are the primary schools, in the strictest sense of that term. Here no election of work or time can be allowed beyond what extra-school conditions call for. 'Cutting' is absolutely inadmissible. The teacher cannot wait until the end of the term or month, or even day, to discover what the pupil knows: he must prescribe work every day, and, at the beginning, every hour, and then see that the work is done. This is a maximum of lesson, and a minimum of examination.

So far, all is plain and easy. But the moment that we enter the grades of school-work lying between these extremes, we meet a wide difference of opinion, and encounter serious practical difficulties. Here Germany has nothing to teach us. The method of the primary school is then continued to the end of the gymnasium course, when the student plunges at once into the fullest university liberty. The proper end is, rather, progressively to lift the pupil above the task-work level, to give him freedom, and to make him self-reliant. Two opposite tendencies are now very observable in the United States: —

1. A considerable number of colleges are allowing a limited election of time. This means, if a proper regimen is maintained, less dependence upon the daily recitation, and more dependence upon the examination.

2. In the intermediate public-school grades there is a diminishing dependence upon the examination, and an increasing dependence upon the daily work, particularly when the time comes to make the promotions; in fact, this tendency is declaring itself all along the public-school line.

These tendencies are both good; something of the freedom and enthusiasm of the university is finding its way into the college; and there is a manifest slackening of the high public-school tension of a few years ago, that was brought about by the abuse of examinations. Good results may be expected from both these movements.

The adjustment of requirement and election, of stated lessons and examinations, above the primary grades and below the college, or possibly the university, is a problem that every teacher and superintendent will be called upon to solve anew. The elements will vary, and no formula can be given. The solution in a given case will depend upon the facts that condition the home, the school, and even the individual pupil. It is often urged against examinations that they promote cramming. Teachers who have to solve this problem will do well to remember that they also tend to prevent cramming. Pupils cram for the daily recitation as well as for the examination; and as the daily recitation tends to check cramming for the one purpose, so the examination tends to check it for the other purpose.

B. A. HINSDALE.

I AM asked to write a very brief article on the function and conduct of examinations. By examinations is meant a formal set of questions answered in writing. Among the useful purposes which can be subserved by such tests are the following: —

1. They may serve as a stimulus or incentive to study. Students who know that at some period of their work they will be required to give written answers to questions based on the work done are likely to be more attentive, industrious, and interested in their work.

2. They encourage thoroughness. Those who prepare for an oral recitation may depend upon chance, or artifice, or favoritism, to help them through; but a searching examination, calling for exact written statements, is another matter, and demands better preparation.

3. They afford an opportunity, in some instances, for a review of the whole subject passed over during the term.

4. They are often valuable as an exercise in English composition, calling as they do for clear, concise, comprehensive statements.

5. They are a revelation to the pupils of their own ability and attainments, as well as of their weakness and defects.

6. They call for concentration of mind, sustained mental effort, and a ready use of one's resources, which is a valuable educational discipline.

7. They reveal to the teacher the results of his teaching, the failure or success of his methods, and thus afford an opportunity of modifying his work when necessary.

8. The tabulated results of a series of examinations, extending through several months or years, indicate with considerable certainty the student's trend of mind, habits of study, and scholarly development. These results are specially valuable to parents in deciding what is best for their children.

9. The results are helpful to superintendents and others in forming an opinion of the progress of the pupils, and the work of the teacher.

10. They give to school-work a kind of dignity, increase the student's self-respect, and impart to the teacher's mind a judicial habit, freeing him from the great tendency to judge of his pupils by sentimental regard rather than by a critical judgment.

With these ends in view, how shall the examinations be conducted?

1. They should be an ordinary, and not an extraordinary, part of school machinery. If they are held only at the close of a term, or at the conclusion of a study, the students should be prepared for them by the character of the daily recitation, and by occasional

written recitations, and 'tests,' which resemble the written examinations, but are less severe.

2. The purpose and method of the examination should be fully explained to the pupils, and their mistakes and failures should be pointed out.

3. The questions set should be adapted to the age and ability of the pupils, easy enough to encourage them to attempt all, and difficult enough to call for their best efforts; should pertain to the work actually done; should be explicit, concise, logical, and call for thought and a mastery of principles, as well as for memory.

4. Too much importance should not be attached to the results. They should be reckoned as only one element, among several, in determining the standing of the student, and his fitness for promotion or graduation. They should never be made the basis of ranking, or the sole ground of promotion.

5. They should always be regarded and treated as simply one means or device in the process of education, and should never be treated as if they were the goal to be gained. They are a means, and not an end.

6. They should not be so severe or prolonged as to overtax the students' powers, should be conducted with absolute fairness and impartiality, as well as with good sense in regard to time, place, and circumstances, and proper allowance should be made for any exceptional circumstances, such as illness on the part of the student. The 'final' examination should be held long enough before the close of the term to allow the teacher to make the proper use of the results before the class separates.

THOMAS J. MORGAN.

IN the current discussions on the use and the abuse of examinations, it seems frequently to be assumed that their one great purpose is to test,—to furnish a basis for estimating the pupil's knowledge and ability, and the teacher's skill and success in instruction. If this were really the only purpose they serve, it would be easy to justify them, notwithstanding the fact that some evils undoubtedly flow from them. These evils do not exist in examinations *per se*, but are faults of administration; and, if a teacher proposes to abolish them on the ground that they encourage immorality, he utters an indictment of his own professional skill.

But admit, with certain extremists, that examinations have no justifiable use as tests; that, for example, a pupil's fitness for promotion, or for learning a subject, is best determined by the teacher's personal knowledge, without any formal test: even then the examination can hold its ground, regarded either as a motive or as a discipline.

I feel sure that my experience in the management of public schools has taught me that the intellectual tone of a school cannot be kept at the proper pitch by any other motive. Even the best of pupils need to feel that they must study with a view to rendering a formal account of their opportunities. Here, again, the stress may be too great; but this is simply a fault of administration, which is a direct reflection on professional skill.

But leaving also the motive power and value of examinations out of account, they have a third and adequate defence in the fact that they afford a discipline of incomparable quality. The ability to render a clear, exact, and comprehensive account of what we know on a given subject, under some stress, or in view of something important depending on the result, is an endowment of supreme importance; and I know of no instrument for this purpose save a judicious examination.

As it seems to me, the only debatable question in the case is that of use and abuse: it is simply a matter of administration.

W. H. PAYNE.

THE purpose of all education must be the development of thought and character in the widest sense of these terms,—“the generation of power.”

Examinations are of use only in so far as they are in harmony with this general purpose. They are a great power for good or evil; they may be made a blessing or a curse to schools. An examination of pupils conducted by a supervising officer should have a threefold aim:—

First, it should be made a test as far as the pupils are concerned. Right here comes the danger of all examinations. What shall the

test be? Quantity of knowledge? Then ‘cramming’ will be the inevitable result; and the superintendent who thus plants thorns and thistles has no right to expect them to bring forth grapes and figs.

The examination must test power, and not mere quantity of knowledge,—power to do intellectual work. As all food that is eaten is not converted into physical force, so all knowledge acquired is not converted into mental power. The test-question in the former case is, not “How much have you devoured?” nor even “How much do you weigh?” but “How much can you lift?” So in the latter case it must be, not “How much do you remember?” but “How much can you do?”

The examination, therefore, should not require a mere reproduction of what the pupil has learned, but it should test his power of dealing with new questions and problems closely allied in principle to those which he has studied.

Secondly, it should stimulate the pupil to work in right lines. The pupil will work for the examination, and it is right that he should. If by working for it his work is wrong, the fault lies with the examiner and the examination. A superintendent has it in his power in this way to direct, in a large measure, the study of all the pupils in his schools.

Thirdly, it should test the character of the teaching, and should direct the work of the teacher. The teacher, like the pupil, will work for the examination to a very large extent. That which is made the chief test in the examination will be the motive of work with both teacher and pupil.

The examination is therefore a powerful lever, in the hands of a competent superintendent, to force school-work into right lines.

THOMAS M. BALLIET.

THE ASSOCIATION OF OFFICIAL AGRICULTURAL CHEMISTS.

THE fourth annual meeting of this Association was held in the Library of the Department of Agriculture, Washington, beginning Aug. 16, and lasting three days. The president, Dr. E. H. Jenkins of Connecticut, in his opening address, congratulated the Association on the success which had attended its efforts in securing the adoption of uniform methods for the analysis of fertilizers. He also recommended that the Constitution of the Association be amended so as to include chemists of agricultural colleges, and all official chemists having control of fertilizers, dairy products, and agricultural products in general.

The first business of the session, after listening to the President's address, was the reception of the report of the committee on foders and feeding-stuffs, of which Prof. G. C. Caldwell of Cornell was chairman. The committee had sent out a number of samples of foders and feeding-stuffs for comparative analysis, and the results obtained were presented. They showed that in the same sample widely different results were obtained by different analysts. These variations showed the necessity of adopting a strictly uniform method of analysis. Such a scheme was reported by the committee, and, after discussion and amendment by the Association, was adopted to be used by all analysts connected with the Association during the coming year.

The report of the committee on dairy products was presented by Dr. H. W. Wiley of Washington. The committee had sent out various samples of butters and butter-substitutes for examination by members of the Association. The tabulation of the analyses, as in the preceding cases, showed wide variations in many particulars. After discussion and amendment, the following method of analysis for butter and milk was adopted. For butter, preliminary examination with polarized light and selenite plate was recommended, while it was stated that the melting of butters and butter-substitutes, and their subsequent examination after cooling by polarized light, appeared to have no value as means of qualitatively sorting butters and butter-substitutes. The method of determining the specific gravity of the butter-fat at 40° C., in a picnometer, was adopted. For Reichert's method, the saponification is to be made in the flask to be used subsequently in the distillation, saturated solution of potash with a small amount of alcohol to be used, and the fat-acids subsequently to be freed by phosphoric instead of sulphuric acid.

For the estimation of fat in milk the Adam's method is recommended, viz., absorption of the milk by bibulous paper, drying, and extraction with ether. As alternate methods the procedure of Morse and Piggot or the lactocrite may be used. In the method of Morse the milk is dried by treatment with anhydrous sulphate of copper, and the fat extracted with light petroleum. Afterwards it is estimated volumetrically by saponification with standard alkali. In the method by the lactocrite the fat is separated in a centrifugal machine, revolving at the rate of 7,000 turns per minute, the milk being previously treated with an equal volume of a mixture of 1 part sulphuric and 20 parts acetic acid.

The method for analysis of fertilizers, with a few slight changes, remains as last year. The most important contribution in this matter was from Prof. M. A. Scovel of Kentucky, who showed that fertilizers containing nitrates could be treated by the Kjeldahl process, if the sulphuric acid used in digestion contained a certain portion of salicylic acid. By this means the total nitrogen existing in the three forms can be determined by an extremely simple and easy process.

The meeting was largely attended and full of practical interest from beginning to end. Two new committees, viz., one on fermented liquors and the other on sugar analysis, were appointed.

The following are the officers and committees for the coming year: President, Dr. P. E. Chazal; Vice-President, Dr. W. J. Gascoyne; Secretary, Mr. Clifford Richardson; Members of Executive Committee, Dr. E. H. Jenkins, Prof. J. A. Myers; Committees, on phosphoric acid, W. J. Gascoyne, N. W. Lord, W. E. Moses; on nitrogen, M. A. Scovel, N. T. Lupton, Wm. McMurtrie; on potash, J. A. Myers, Wm. Frear, E. H. Jenkins; on feeding-stuffs, G. C. Caldwell, W. H. Jordan, Clifford Richardson; on dairy products, H. W. Wiley, S. M. Babcock, H. P. Armsby; on fermented liquors, W. B. Rising, C. A. Crampton, G. F. Fellows; on sugar analysis, W. C. Stubbs, N. T. Lupton, H. W. Wiley.

ALASKA LETTER.

It is strange that so little is known in the United States about Alaska. It has been a possession of our government for twenty years, and even now interest in it is only beginning to be developed. Yet in it we have by far the most remarkable of all our territories. Its area is not less than 600,000 square miles, or one-fifth of that of the United States proper. It is equal in extent to all the New England states, all the middle states, Ohio, Indiana, Michigan, the Virginias, the Carolinas, Tennessee, Kentucky, and Mississippi. Sitka is as far from the parallel of the extreme western boundary of Alaska as it is from the parallel of Eastport, Me. The present governor of the territory estimates its population to be 35,261, including whites, creoles, and natives. Of this number, 10,600, including 3,100 whites, dwell in south-eastern Alaska, the part accessible to tourists.

The native race of south-eastern Alaska is the Thlinket. The Thlinkets are far superior, intellectually and industrially, to the North American Indian. They are variously said to be of Asiatic and Aztec origin, but the majority of observers believe them to be related to the Chinese. They are skillful workers in wood and metals, shrewd traders, and very amenable to civilizing influences.

The climate of south-eastern Alaska is any thing but Arctic. The observations of Sergeant John J. McLean of the Signal Service at Sitka, for the year ending Aug. 31, 1886, showed an average temperature of 44°.8 F. The maximum was 72°, reached both in July and August, and the minimum 4°, reached in January. The rainfall is very heavy, often being more than 100 inches per annum.

Alaska's resources are timber, mining, furs, and fisheries, but as they are only just being measured, it is useless to quote figures concerning them.

The trip to Wrangell, Juneau, Sitka, and the great glaciers of south-eastern Alaska is now easily and quickly made by frequent steamers from the Puget Sound ports. During the summer season there are weekly sailings, and the fastest steamer makes the round trip from Tacoma, W.T., in eleven days. Travellers should provide themselves with warm clothing, for it will be needed during the entire trip. Rubber boots or overshoes, a rubber coat, and a stout pair of walking-boots are desirable. The last-mentioned are

necessary for climbing on the Davidson and Muir glaciers, and the rubber articles are a protection against the wet weather.

For maps of the coast, the British Coast Survey maps are to be recommended, and the 'Coast Pilot' is a most valuable aid in determining the various peaks, glaciers, and channels. Though numerous books on Alaska have been issued, no one of them is satisfactory. Lieutenant Schwatka's book does not treat of south-eastern Alaska, and those that profess to do so are superficial and inexact. Hubert Howe Bancroft's 'History of Alaska' is important, but far from satisfactory.

Adequate educational provision for the native and white children has yet to be made. The Thlinkets show great ability in industrial work, and it is a source of great satisfaction to hear that an organized course of industrial training is to be put in operation in the Sitka school at once. In the 'Circular of Information' of the Bureau of Education known as No. 2, 1882 will be found an interesting paper on 'The Neglect of Education in Alaska.' B. N. Sitka, Alaska, Aug. 1.

HEALTH MATTERS.

AGAINST BERGEON'S TREATMENT.—Dr. Townsend and Dr. Hennessy report, in the *Albany Medical Annals*, nine cases of phthisis treated by gaseous enemata, after Bergeon's method. The reporters say that these cases, though few in number and somewhat incomplete, are deemed worthy of publication, as showing that this method of treatment seems as much of a failure in this dreaded malady as are others equally highly advocated at the present day. Besides these cases, four others have come under the observation of the writers, in three of which they personally superintended the administration of the gaseous enemata, the fourth being seen only once in consultation, but the records of which were accurately kept by the attending physician. With reference to all these cases, it is stated that after a fair trial of from two to four weeks it was deemed expedient and proper that it be discontinued for the two following reasons: first, it did no permanent—in fact it might almost safely be said not even transient—good; while, second, it was most disagreeable and annoying to the patients, who generally were the first to suggest, or even beg for, its withdrawal.

CHLOROFORMING WHILE ASLEEP.—In the August number of the *New Orleans Medical and Surgical Journal* is an editorial comment on the subject of chloroforming persons while asleep. The editor says that there are several points relating to the physiological action of chloroform which have an important bearing on the question. The condition of health and the age of the person are matters to be considered in regard to the possibility of chloroforming people while asleep. To adults in perfect health chloroform is a decided cerebral stimulant, and it may be stated as a rule, to which the exceptions are exceedingly rare, that healthy adults cannot be chloroformed while asleep, unless their sleep has been induced by exhaustion or hypnotic agents. Weakly adults and children take chloroform with less resistance, as the stimulant effect on the cerebrum is less in degree and shorter in duration. Weakly adults and those acutely exhausted by disease or injury may be chloroformed during sleep. Children may also be chloroformed while asleep, and especially if they are depressed on any account. The editor recently demonstrated to several physicians the ease with which chloroform could be administered to a sleeping child when in a state of depression. The case was one of cancer of the mesentery, in which the little patient had been exhausted by pain and restlessness. The victims of chloroform at the hands of burglars are usually at the time in good health. The more improbable, then, is the story usually told of such burglaries. Under all conditions anæsthesia by chloroform can be accomplished during sleep only by skillful administration. Overdosage at the outset will certainly awaken the sleeper. The ability of burglars to force the anæsthesia of several persons sleeping in the same room without raising an alarm is to be doubted. In regard to the impression which prevails that burglars impregnate the air of an apartment with chloroform vapor, so as to gradually anesthetize all the sleepers at the same time, the editor says that the weight of chloroform vapor and the readiness with which it descends make it difficult to saturate the air of a sleeping apartment, especially one

at the time well ventilated. Besides, the quantity of chloroform necessary to saturate the air sufficiently to produce anæsthesia is very considerable. Allowing one and a half grain of chloroform to the cubic inch of air, it would require thirty-eight fluid ounces to sufficiently impregnate the air of a room ten by twelve feet, with a ceiling eight feet high. It would certainly take a considerable time to vaporize this quantity of chloroform, to say nothing of the probability of awakening sleepers by any act of atomization, and even if it should succeed, what would be the effect on the burglars themselves?

MENTAL SCIENCE.

Why do we Sleep?

In an address to the Anthropological Society of Brussels, Prof. Leo Errera has given a *résumé* of some points in the chemical theory of sleep. The phenomena of sleep have in common with other vital functions the character of periodicity. An examination of such periodic functions in general may aid in ascertaining the cause of sleep. The respiratory rhythm is regulated by the amount of oxygen and carbonic acid in the arterial blood. When the blood is charged with oxygen the respiratory centre momentarily suspends activity; but soon the tissues yield their oxygen to the blood, have it replaced by carbonic acid, and the blood thus modified acts as an excitant to the respiratory centre. Ranke has shown that the fatigue and recovery of muscles is due to a similar alternation of the accumulation and discharge of certain 'fatiguing substances,' chief amongst which is lactic acid. An injection of this acid into fresh muscle renders it incapable of work; washing the acid out restores the activity. Cannot sleep be explained by a similar chemical theory? Preyer has extended the views of Binz, Obersteiner, and others (who all agree in making the accumulation of certain products of fatigue—*ermüdungstoffe*—the cause of sleep), by calling all such fatiguing products of activity 'ponogens.' These accumulate in waking life, are readily oxidizable, and absorb the oxygen intended for glands, muscles, and nerve-centres, until action is impossible and sleep sets in. Gradually the ponogens are destroyed by oxidation, slight excitation is sufficient to arouse the centres, and waking life begins. Amongst the ponogens, Preyer counts lactic acid as the chief, but the experimental demonstration of this has been unsuccessful, and the theory, accordingly, not generally adopted.

Since these researches Armand Gautier has found in the human body a series of five organic bases akin to creatine, creatinine, and xanthine, and calls them 'leucomaines' and 'ptomaines.' The physiological properties of these substances are narcotic, fatiguing, and sometimes lead to vomiting. This is just what the chemical theory requires. The periodicity of sleep would be explained by the conservation of energy being applicable to all bodily activity: work must be followed by repair; life is a slow suicide. There is, moreover, reason to believe that the action of these leucomaines is a direct one upon the brain; it is a direct intoxication of the brain-centres.

A theory of sleep must take account of three factors, work, fatigue, and sleep. The chemical theory satisfies these demands. All work, muscular or cerebral, produces waste products. These accumulate, make work more and more difficult: this is fatigue. As the process continues, the waste-products, notably the leucomaines, intoxicate the higher nerve-centres (just as a dose of morphine does), and render them incapable of action: that is sleep. The picture is, however, much more complex. There is a constant struggle against the fatigue, which for a time, by dint of hard work shown in increased secretions and so on, may succeed. We probably never arrive at the extreme limit of work; the sensation of fatigue intervenes to prevent such a disaster. Fatigue, as is well known, may extend from muscle to nerve, and from nerve to nerve-centre. We may be very tired from repeatedly lifting a weight, and not be sleepy, and may be generally sleepy without any considerable local fatigue. One is peripheral, the other central. As the waste products accumulate in the centres, motion and sensation become more and more sluggish until the time comes when the ordinary stimulation no longer arouses them, and we sleep. Partial sleep can be similarly explained. The centres go to sleep in a hierarchical order, the highest serving the most delicate function

going first. In waking, the reverse is the case; the motor centres may be asleep while the intellectual centres are awake. In somnambulism the latter may be asleep while the former are awake.

The depth of sleep according to this theory ought to be proportional to the number of cortical molecules in combination with the leucomaines. In the beginning of sleep these are abundant, the cerebral cells inactive, and a combination easy. The sleep is deep. Soon the maximum number of combinations is reached, and sleep is deepest. From here on, the leucomaines are gradually eliminated and destroyed, and sleep should decrease with a decreasing intensity. Kohlschütter's experiments on the intensity of sleep, as tested by the noise necessary to awake the patient, gives the curve for the intensity of sleep corresponding to what we should expect by our theory. Variations in our sleep caused by an excess of work, etc., are evidently similarly explicable. In short, fatigue is a poison for which sleep is the normal antidote.

This theory maintains (1) that the activity of all the tissues (and primarily of the two most active, the nervous and muscular) gives rise to substances, more or less allied to alkaloids, the leucomaines; (2) that these induce fatigue and sleep; (3) that on waking, if the body is rested, these substances have disappeared.

To complete the demonstration of these statements much careful experimentation is necessary; but the facts as far as they go make it probable that the chemical theory of sleep will gain in strength as our knowledge advances.

ETHNOLOGICAL NOTES.

THE HAWAIIAN ISLANDS.—Dr. E. Arning's researches have been very successful. He was sent there by the curators of the Humboldt Fund at Berlin, in order to study leprosy, which has recently become the plague of the natives of this group. He stayed there for two and a half years, and during this time carefully collected relics of the ancient Hawaiian culture, and succeeded in bringing to light many points of interest, thus proving that European influence, which has swamped the islands since 1820, has not totally destroyed the remembrance of olden times. When the missionaries established their schools in Hawaii, the natives rapidly adopted European customs, burnt their temples and idols, and cast the stone images of their deities into the sea. The destruction was so complete that no traces seemed to remain. Arning, in studying the disease mentioned, had ample opportunities to come into contact with the natives in the remote villages of the islands, and here he found still many relics, and received information about the ancient arts and customs. His notes on the fishery of the Hawaiians are of interest. They were skillful divers, and used to frighten the fishes out of the caves and hollows of the rocky ground with sticks, and then catch them in nets. When fishing in the canoe, they used a sacred piece of heavy wood, called *melomelo*, which was kept in the sacred part of the hut, and was placed, with many ceremonies, in the canoe. It was attached to the net in order to attract the fish by its magic spells. A variety of hooks were used for different kinds of fish and according to the time of day, irised shells being applied at noon and in a bright sun, while white ones served early in the morning and late in the evening. Arning describes their games, the wooden sledges on which they used to glide down the steep slopes of the mountains; the remarkable boards of koa-wood, shaped like an ironing board, standing on which they rode through the surf; the *moa*, a spindle-shaped piece of heavy wood, the use of which was allowed to the chiefs alone, who let it glide down the slope of a hill, at the foot of which it had to pass between two poles; and the famous game of *maika*, which is similar to the Italian 'boccia.' At the present time, when a powerful reaction against the missionaries is spreading all over the islands, the old *hula* dance has been revived, and the ancient dancing, ornaments, and musical instruments are used again. Arning describes a foot ornament made of 960 canine teeth of dogs, the work of several generations,—for dogs were slaughtered only at high festivals,—their drums, flutes, and xylophones. Arning's observations and collections form one of the most important recent contributions to Polynesian ethnology, and are the more valuable as they were made in a country which seemed to have lost all its originality by its rapid commercial development.

THE BOTOCUDOS.—Dr. P. Ehrenreich has published the results of his study of the Botocondos of the Rio Doce in the *Zeitschrift für Ethnologie*. He discusses the observations of former travellers, and compares them with his own experience, thus giving the best sketch of this interesting nation which can be obtained at the present time. Dr. Ehrenreich has collected a considerable amount of anthropological, ethnological, and linguistic material. He gives a number of craniological and anthropometrical measurements, sketches the life of the tribes, who live in a remarkably low state of civilization, and gives a vocabulary—which he has compared with the older ones of Martius—and brief grammatical notes. His researches lead him to the conclusion that the Botocondos formerly occupied a more extensive territory than they do at the present time, inhabiting a tract of land which extended from the coast far westward. They are related to the Ges nations, who inhabit the central parts of Brazil, and a member of whom was discovered by Von Steinen on the upper Xingu. It is of importance to know that the Ges and the Botocondos wear labrets and ear ornaments, that their ceramic art and methods of navigation are very primitive, and that they do not use the hammock. Ehrenreich is of the opinion that the Botocondos remained in an earlier stage of development than the Ges nations, who migrated west and came into contact with other peoples, while the former remained isolated. He believes that the remains found in the caves of the province of Minas Geraes belonged to the ancestors of the Botocondos.

ORIGIN OF THE ESKIMO.—In the *American Naturalist* of August, 1887, Mr. Lucien M. Turner criticises Dr. H. Rink's theory. The latter supposes that the Eskimo were originally an inland people, living somewhere in the north-western part of North America, whence they descended to the seacoast along the rivers. In several articles, Dr. Rink tries to prove this theory by comparing the languages and customs of the different tribes. Though convincing proofs cannot be given, it seems very probable that the Eskimo have come from the rivers and lakes in the interior of America. This theory is open to criticism, but Turner's objections fail to convince us, and do not meet Rink's arguments. The latter is right in laying stress upon the fact that the Eskimo are not so exclusively a coast people as is generally supposed. The most difficult problem of the study is the difference of the tribes west and east of the Mackenzie. Rink emphasizes the fact that the former have certain inventions which the latter have not, while other implements are more developed the farther east we come. From this fact he concludes that the Eskimo first reached the sea and came into their present environment west of the Mackenzie, near the mouth of the Alaskan rivers. This theory, though not improbable, ought to be scrutinized by a study of the anthropology of Alaskan and eastern Eskimo tribes. It seems to us that much of the difference may be due to foreign influence. An interesting paper on the anthropology of the Eskimo, more particularly of those of East Greenland, is contained in the Bulletin de la Société d'Anthropologie (ix. p. 608). While the population of western Greenland is mixed with Danish elements to such a degree that there is probably nobody of pure Eskimo descent in South Greenland, this tribe has never mixed with Europeans. They are less dolichocephalic and slightly taller than the West Greenlanders and other eastern tribes. Their noses are described as being aquiline, but this also occurs among other tribes. The researches in East Greenland which were carried out by Lieutenant Holm show definitely that the tribes of the east coast never came into contact with the ancient Normans.

BOOK—REVIEWS.

The Treatment and Utilization of Sewage. By W. H. CORFIELD and LOUIS C. PARKER. London, Macmillan, 8s.

THE fact that this work has reached a third edition is evidence of its value and usefulness. Since the second edition was published, sixteen years have elapsed, during which time great progress has been made in the methods of treatment of sewage, so that it has been necessary, in order to bring the book up to date, to incorporate much material which will not be found in the earlier editions. The historical portions have been retained in their entirety, as being not only interesting in themselves, but also, on the one hand, descrip-

tive of a state of things still to be found in many places, and, on the other, important as a record of methods and processes which have been adopted at various times, for methods and processes which have been tried and abandoned as useless are liable to be brought forward again as new at some future time unless such a record is kept. Special attention has been given in this edition to the important investigation of the British Association Sewage Committee, more especially as regards the determination of the percentage of the manurial ingredients of sewage actually utilized by irrigation on land, and recovered in the form of crops, and the accurate method devised by that committee for taking samples of sewage and effluent-water for analysis. The practical inquiry originated by the suggestion of the late Dr. Cobbold that entozoic disease might be spread through the agency of sewage farming, and the quantitative examination, with a view to its manurial value, of the compost resulting from the use of earth-closets, are described in detail. The table of contents is a very extensive one, occupying twenty-two pages, and includes many subjects of great interest and importance of which the title of the book gives no suggestion.

In the opening chapter reference is made to the early systems for the collection and removal of excreta, the midden heaps, the stagnant ditches, and the open cesspools. In some of the English towns, in 1845, the privies were in the cellars, and often overflowed. This condition of things could not but be detrimental to health, and must of necessity favor to an alarming extent the spread of many epidemic diseases. Those who question the relation between filth and disease will do well to read that chapter in Dr. Corfield's book in which he treats of this subject. He succeeds in demonstrating that the opinion that the pollution of drinking-water by excreta, and of the air by emanations from cesspools and so forth, on the one hand, and on the other the amount of general sickness, and, in many cases, of special epidemics, stand in the relation of cause and effect, is a true one. Instances are given of fever, cholera, and other forms of disease, breaking out in English towns, which are directly traceable to the filth which had been allowed to accumulate.

In the reports of the Health of Towns Commissioners it is continually pointed out that sickness is the chief cause of the non-payment of rent. One witness says: "Three out of five of the losses of rent that I now have are losses from the sickness of the tenants, who are working men. Rent is the best got from healthy houses." Another says: "Sickness at all forms an excuse for the poorer part not paying their rent, and a reasonable excuse," so that filth causes sickness, sickness inability to work, inability to work poverty and non-payment of rent, to say nothing of starvation. We not infrequently hear in this country, the statement that the State has no right to interfere, that a man's house is his castle, and that he can do what he likes within it. It is this sentiment which for so many years prevented legislation for the protection of tenants in our large and dilapidated tenement-houses, a sentiment which is, we are glad to say, being done away with, more, however, we fear, because the laboring men are beginning to realize and exercise their power than because of any general awakening of landlords to the duty which they owe to their fellow-men. Writing on this subject in 1844, with reference to the then state of Liverpool, Mr. Howe said: "The man who, in a crowded street, is living in filth and breathing a putrid atmosphere, or who makes that street a receptacle for the offal which he casts from his dwelling, becomes the instrument of danger to his neighbors by spreading infection, and he not only hazards his own life, but endangers that of others. The man who erects a flimsy edifice in a crowded thoroughfare, which by its falling may destroy life, should be prevented doing so; and he who constructs a house to let for profit and pays no attention to those matters which are essential to comfort, but, on the contrary, so constructs it as to engender fever and endanger the lives of his tenants,—all these are cases where, with propriety and in justice the legislature ought to interfere, and to insist upon such a mode of construction as will not endanger human life." The earth and ash closets are fully described and their advantages and disadvantages discussed. In speaking of this system, Dr. Corfield says that there can be no doubt that a well-managed dry-earth conservancy system, or midden and ash-pit system, is better than no system at all, but it by no means follows that they are free from danger. They both go upon a wrong principle: we do not want conservancy at all; our first object must be

to get rid of refuse-matters, and not to see how long we can keep them about our houses in a *presumed* harmless condition. The Rivers Pollution Commissioners in their first report, 1868, have no hesitation in pronouncing the dry-earth system, however suitable for institutions, villages, and camps, where personal or official regulations can be enforced, entirely unfitted to the circumstances of large towns.

The subject of sewerage is very fully treated. In the consideration of the separate system, that at Memphis, Tenn., and Pullman, Ill., are mentioned and described. The best method of sewer-ventilation is still undetermined in this country, and the sanitary journals are at the present time discussing the subject with a good deal of earnestness. On this point Dr. Corfield says that the very common plan of ventilating sewers by means of untrapped rain-water pipes from the roofs of houses is extremely dangerous. These pipes are often very loosely jointed, and the air rising from the sewer will escape through every such joint, possibly into bedrooms; and in many cases the open head of the pipe is just beneath a dormer or attic window. During heavy rain the rush of water down these pipes will force the air of the drain into the interior of the house through trapped or untrapped openings. He also condemns the practice of ventilating the sewers by means of the soil-pipes of houses, as there is constant risk of the escape of sewer-air through defective joints into the interior of the house. The house-drain should pass through a disconnecting chamber with an air inlet, and be trapped before entering the sewer. Connecting the sewers with furnace chimneys is also condemned. The Shone, Liernur, and Berlier systems of sewerage are described in a concise but thoroughly intelligible manner.

Among other interesting topics discussed, and which we are compelled to pass over for want of space, are the sanitary aspects of the water-carriage system, the value of sewage, the injury which it works to rivers, the pollution of drinking-water, the discharge of sewage into tidal waters, the straining and precipitation of town-sewage, filtration, irrigation, and the treatment and utilization of manufacturing-refuse. In speaking of the influence of sewage-farming on the public health, the author states, that, as far as nuisance is concerned, there is no doubt that if irrigation farms are badly managed they may be made a nuisance to the neighborhoods. Ordinary sewage is only in a very slight degree offensive when fresh. What is really the most offensive part of sewage farms is the black slimy mud which collects along the sides of the carriers when the sewage is not filtered before being sent to the fields. It is advisable that sewage should be filtered and strained in the manner practised at several places. There is no reason to spread a layer of comparatively worthless and necessarily offensive filth over the surface of the soil. There is good reason to expect that the utilization of the sewage of towns on the land near them, while preventing the pollution of drinking-water, and the spread thereby of cholera and typhoid fever, will at the same time maintain the purity of the atmosphere around and about the towns, and that the result will be, especially when combined with that produced by the increased demand for labor and the more plentiful supply of food, a diminution of the general death-rate.

The late Dr. Cobbold had great fear that entozoic diseases would be spread by means of sewage irrigation. Although this possibility has been borne in mind ever since Dr. Cobbold drew attention to it in 1865, there are no facts reported which connect entozoic diseases with sewage irrigation. Dr. Corfield summarizes his views on the question by saying that it has not yet been shown that sewage irrigation has ever increased the amount of entozoic disease in men or cattle. Still less that it is likely to do so to a greater extent than any other method of utilizing human excrement; and were this shown to be the case, the danger would be to a great extent obviated by some preliminary treatment, with a view to the separation of the suspended matters.

The Treatment of Sewage. By Dr. C. M. TIDY. New York, Van Nostrand. 24*.

THIS little book, which is one of Van Nostrand's 'Science Series,' contains in a very concise form a great deal of valuable information on the subject of which it treats. It goes over necessarily much of the same ground as Corfield's 'Treatment and Utilization

of Sewage,' a review of which we have already given, but in a much more condensed form.

Dr. Tidy, in marked contrast with Dr. Corfield, thinks that there is danger that entozoic diseases may be communicated to both man and beast by means of the products of sewage farms. He says that the fact has always been recognized that entozoic diseases have an external origin; i. e., that the ova or parasites come from without, and are not generated within, the human body. Millions of ova are voided with every segment discharged by the person afflicted with tapeworm, each ovum being capable of producing a measles in the flesh of an animal, and each measles a tapeworm in the body of the man. He has seen watercresses and celery grown on sewage ground, having a quantity of dried sewage matter deposited on the stems, and he has, with more than a cook's patience, tried to wash this matter off, but the tenacity with which it sticks upon the surface of the vegetable when once dry is perfectly astounding. It should be remembered in this connection that these vegetables are eaten in an uncooked state. The grass covered with sewage, eaten as it is with rapacity by the cattle, infects their bodies with the larval parasite. Thus the meat is measly, and measly meat, except for efficient cooking, means tapeworm to the human subject. Perhaps a similar story might be told of trichina, with its ten times greater danger. The farm, therefore, that receives sewage must be more liable to produce measly meat than the farm that does not receive it.

In opposition to these views of Dr. Tidy we have the opinion of Dr. Corfield, already referred to, and also that of the British Association Committee. This committee made experiments to determine this very question of the distribution of entozoic disease by means of sewage irrigation. Dr. Cobbold, at the request of this committee, examined the carcass of an ox which had been fed for two years on sewage-grown grass, and reported the perfect freedom of that animal from internal parasites of any kind, but explained this freedom in a manner which to his mind did not affect the main question. The committee did not accept this explanation, but in their report say that it appears as far as this one case goes (and it is certainly as conclusive as a single case could possibly be), there is no evidence that entozoal forms of life are to be found upon the farm at all, in any stage of their existence, or in the flesh of an animal fed exclusively for twenty-two months on sewage produce grown on the farm. This report was made in 1871, but we have Dr. Corfield's statement that since the date of that report no facts have been recorded connecting entozoic disease with sewage irrigation.

It would be interesting to know whether Dr. Tidy or others have any evidence to the contrary. It would seem as though the system had certainly been in practical operation long enough to have settled this question.

It is a matter of regret that the publisher of Dr. Tidy's book has not given the reader a table of contents or an index. In order to ascertain what it contains it must be read through from title-page to colophon, and as a book of reference its value is greatly diminished from this omission.

NOTES AND NEWS.

A SANITARY Convention was held at Traverse City, Mich., Aug. 24 and 25, under the auspices of the State Board of Health. The objects of the convention were the presentation of facts, the comparison of views, and the discussion of methods relating to the prevention of sickness and deaths, and the improvement of the conditions of living. It was not a doctors' convention, but for the people generally. Among the many subjects which were presented and discussed were the following: disposal of waste in Traverse City by sewerage and otherwise, the present and future water-supply of Traverse City, the best methods of warming and ventilation, the work of the village health-officer, the money value of sanitary work, the prevention of contagious diseases, school hygiene, foods and their adulterations, the drink problem, and the prevention of insanity.

— In the letter on 'Chrome considered as a Poison,' by Charles Harrington, in last week's *Science*, centimetre (p. 105, col. 2, 4th line) and centigram (p. 106, col. 2, 21st line) should read 'gram.'

LETTERS TO THE EDITOR.

. The attention of scientific men is called to the advantages of the correspondence columns of SCIENCE for placing promptly on record brief preliminary notices of their investigations. Twenty copies of the number containing his communication will be furnished free to any correspondent on request.

The editor will be glad to publish any queries consonant with the character of the journal.

Correspondents are requested to be as brief as possible. The writer's name is in all cases required as proof of good faith.

Wind Pressure and Velocity.

THE importance of an accurate determination of the relation between the pressure and velocity of the wind will be readily recognized. This relation is especially needed by the architect and bridge-builder, since most instrumental determinations are of the wind's velocity. The problem is much more intricate than is ordinarily supposed, and the diverse results obtained by experimenters of great ability show how the determination of the movements and behavior of gaseous media are hedged about with difficulty, and, as already pointed out in *Science* for July 8, the absolute necessity of building up the science of meteorology on a firm foundation of fact rather than theory.

There have been two methods of experimentation: the earliest, with plates rotated upon an arm seldom exceeding 10 feet in length, and, later, by the exposure of plates to direct air-motion. Borda, in 1763, with plates ranging from 16 to 85 square inches area, obtained the following relation,

$$\phi = (.0031 + .00035 c) S v^2,$$

in which ϕ = pressure in pounds on the plate, c = contour of plate in feet, S = surface in square feet, and v = velocity in miles per hour (this notation will be maintained throughout).

In 1874, Hagen tried most careful experiments with an arm of 8 feet. The velocity ranged from 1 to 3 miles per hour, but the room was so small that at the latter velocity the air was set in feeble rotation. The plates ranged in size from 4 to 40 square inches. He found, as did Borda, that the pressure per square foot increased with the size of the plate. The following is the relation established by him,

$$\phi = (.002894 + .0001403 c) S v^2.$$

This formula for this relation has repeatedly appeared in print, and each time it has been changed. This is believed to be correct.

Singular as it may seem, these experiments have been almost the only ones quoted in discussions of this question, and yet it is easy to see that they are utterly useless for determining the pressure of a 50-mile wind on the side of a building.

In November, 1886, a few experiments in Washington with an arm of 4 feet, and plates from 16 to 576 square inches area, gave the relation,

$$\phi = (.0032 + .00034 c) S v^2.$$

The agreement with Borda's results is very interesting.

Afterward, with the same style of apparatus and an arm of 16 feet, the relation found was

$$\phi = .0034 S v^2.$$

The velocity of the larger plates was only 4 miles per hour, so that this formula does not help us for greater velocities. It was certainly established that there was no difference in pressure per square foot depending on the size of the plate. Turning to experiments of the second class, we find that Thibault obtains, with plates from 1 to 1.5 square feet area exposed to the wind, the relation,

$$\phi = .00475 S v^2.$$

In France, with plates exposed on a locomotive running 44 miles per hour, the relation established was

$$\phi = .00535 S v^2.$$

In this case, probably, a slight allowance must be made for the wind with the train.

In the 'Encyclopædia Britannica,' article 'Hydromechanics,' the mean of all the better determinations is

$$\phi = .00496 S v^2.$$

We may conclude, 1st, that experiments with whirling arms of less than 16 feet are very untrustworthy; 2d, that we need determinations with rapid, straight-line motion, best obtained, perhaps, by pushing two or three platform-cars loaded with iron in front of a locomotive, exposing the plates on the front car; 3d, the relation

$\phi = .005 S v^2$ is the most satisfactory yet determined, and does not differ by more than four or five per cent from the truth.

While there has been this great difficulty in determining the above relation, there has been just as much, if not more, in connection with the relation between the velocity of the wind and that of the cups of Robinson's anemometer. Some confusion has arisen from the fact that the standard anemometer in England has 9-inch cups and 24-inch arms, while in our country we have 4-inch cups and 7-inch arms.

It has been determined, by careful experiment in England, that, if the large type of anemometer has a factor of 2.5, then the smaller should certainly have 3.00. Dr. Robinson, after a long research with a whirling machine, decided that the factor (of the smaller instrument probably) should be about 2.5. After trying a few experiments in the open air, however, he changed his view, and decided that the factor should be 3.00. In Washington, with an arm of 16 feet, and a velocity of 12 miles per hour, the factor was found to be 3.00.

Quite recently the Chief Signal Officer, through the kindness of the officials, as a preliminary to carrying on experiments on platform-cars, as suggested above, has had an anemometer placed upon a locomotive of the Baltimore & Ohio Railroad running from this city to Baltimore. Only one round trip has been tried thus far: in the outward trip the velocity of the train was about 20, and returning it was about 46 miles per hour. Allowing for the actual wind, we find the anemometer indication 46 miles going, and 47 returning. The distance was 40 miles, and we may consider that the excess of about 6 miles was due to the heaping up and flowing over of the air in front of the locomotive. All things considered, it seems probable that the factor 3.00 now used in our anemometers of 4-inch cups and 7-inch arms is entirely correct: certainly no change in the present factor can be thought of for an instant. A complete discussion of this question has already been prepared by me, and will appear in October. The other side of this question has been recently presented by Professor Ferrel in the *Austrian American Meteorological Journal*. H. ALLEN HAZEN.

Washington, Aug. 22.

The Formation and Dissipation of Sea-Water Ice.

MR. W. A. ASHE's opinion on the freezing-point of sea-water, and the conclusions he draws from his experiments, cannot be accepted. The arrangement of the experiment described in No. 228 of *Science* seems to be insufficient. A hole was cut through ice 87 centimetres (2.85 feet) thick. The water within was thoroughly agitated by stirring from below, and during the actual observation slightly agitated. The thermometer was held nearly horizontally, the bulb slightly lower than the rest of the instrument, just below the surface of the water. When the ice-film began to form, the reading of the thermometer was $-2^{\circ}.9$ C. ($26^{\circ}.7$ F.), the temperature of the air being $-24^{\circ}.8$ C. ($-12^{\circ}.6$ F.). The greatness of the difference between the freezing-point of the sea-water and the temperature of the air detracts from the value of these observations. The ice is forming so rapidly that brine is included among the crystals: it is even probable that cryohydrates are formed at the surface. On the other hand, the freezing-point of sea-water was not only found by melting sea-water ice, as Ashe assumes, but also by freezing sea-water, and was always found to be between $-1^{\circ}.6$ C. and $-1^{\circ}.8$ C. ($29^{\circ}.1$ and $28^{\circ}.8$ F.), according to the concentration of the solution. Mr. Ashe's second remark on this subject in No. 232 of *Science* does not agree with Buchanan's interesting researches on the melting of fresh-water ice in solutions of salts. He has shown by an excellent series of experiments (*Nature*, April 28 and May 5, 1887), that, when sea-water is frozen to the extent of fifteen per cent of its mass, and the crystals so formed are allowed to melt in the liquid in which they have been produced, they melt exactly as they have been formed. If snow or pure ice be immersed in the brine formed by partially freezing sea-water, it melts at the same temperature as the ice which had been formed by freezing the sea-water, so long as the chemical composition is the same in each case.

In a third letter to *Science* (No. 237), Mr. Ashe makes some remarks on the formation and character of Arctic ice. He says, that, as the density of sea-water increases till the freezing-point is reached, ice is not formed at the surface, but at a certain depth. In fact, the

cooling goes on from the surface, and is far more rapid than the motion of the water to deeper layers: therefore ice is formed before the cooled masses sink to the depth and are replaced by warmer ones.

I can confirm Mr. Ashe's observation that the new ice frequently forms first on projecting points. It seems to me that particles of ice which have formed on the shore are driven by wind and waves into the sea, and act as so many centres of congelation. As these particles and small cakes are drifting before the wind, long, narrow streamers are formed, each new opening being rapidly filled by new ice. These narrow strips do not consolidate, but are driven to a lee coast, or their motion is stopped in some other way. Then they are pressed together, the small cakes are broken and overflowed by ripples, the water freezes on top of them, and within a short time an extensive field is formed consisting of numerous small cakes pressed and piled upon one another, and cemented by the water that has overflowed them. Besides this kind of ice, which is formed while the wind is blowing, smooth floes are formed in small bays during calm weather. The latter, however, form the smaller portion of Arctic ice. This process accounts for the great quantity of brine contained in the new ice. The deeper layers contain far less salt than the surface ice, as the mechanical admixture of water takes place on the surface only. The snow, on falling on this kind of ice, forms a slush, as it melts in the brine oozing out of the ice. This mixture freezes, and thus the thickness of the ice increases on the upper and lower sides simultaneously. The different origins of the layers of ice accounts for their different character.

During the winter the ice undergoes remarkable changes. The brine contained in ice of different depths is the more concentrated the lower the temperature of the layer. It is probable that the cavities between the ice-crystals are sufficient to effect a gradual decrease in the concentration of the upper parts, which then begin to freeze, and thus become drier.

When in spring the ice begins to melt, it loses its salt rapidly, and I observed in latitude 70° north, on the west coast of Baffin Bay, that it had become entirely fresh about the end of June, the brine being removed through the capillary cavities.

A remarkable effect of mechanical action upon the dissipation of the sea-water ice may be observed at places where rapid tides are running. When the temperature of the air rises to about -20° C. (-4° F.), the ice becomes saturated with water, and is being worn off at its lower side. It seems that the lower surface of the ice is rough, consisting of ice-needles with isolated points. These are broken off by the violent motion of the water, and thus by the friction of the broken pieces the volume of the ice-sheet is continually being diminished at its lower side. In winter the same process must be going on, though not to so great an extent. Some places of this kind are open throughout the winter. Their extent is changing according to the strength of the tides; and during the spring-tides ice of about fifteen or twenty centimetres thickness, which was formed during the preceding neap-tide, is broken up and pressed under the neighboring floe: consequently the thickness of this ice would continually increase if it was not worn off at its lower surface. In fact, the ice in such places is very treacherous and thin: therefore it seems, that, according to the strength of the current, a certain low temperature is required to resist its destructive influence. Below the layer which has this temperature the ice is saturated with water and being worn off.

Mr. Ashe touches upon another subject the explanation of which seems to me insufficient. On steep coasts in the Arctic regions an ice-wall is found attached to the rocks, and reaching from high-water to low-water mark, gradually decreasing in thickness, and having a vertical side. When the tide ebbs, the wet rocks are exposed to the cold air, and of course are covered with a thin sheet of ice. This process begins before the sea is frozen over, and, as the water is still agitated by winds, the thickness of the layer formed during a single tide is considerable. This process is going on throughout the winter, and thus this ice-foot continues to increase in width. At spring-tide its level is overflowed by water, which adds to its height. It is characteristic of this ice-foot that the unbroken land-floe extends to its foot, a single crack separating the two masses. Cliffs which are washed by water throughout the winter have frequently no ice-foot at all. This shows that the floe favors its formation.

The ice on shores with a gradual slope is quite different. Here it is not attached to the bottom, as Mr. Ashe's description would imply, but originates in the following way. The ice which is formed on the surface at high water strands during the ebb-tide, and its volume is increased by the freezing of the water left on the beach. When the tide comes in again, the greater part of this ice begins to float, increases in thickness, and strands again on the rocks. By the repeated breaking of these masses on the rocks, the water is frequently exposed to the air, freezes, and thus the thickness of the ice is far more rapidly increasing than that of the unbroken floe. It is continually growing on all sides, new material being also added on the sides, and thus a heavy pressure results which affects the neighboring parts of the floe, which is frequently pressed under the level of the sea, is overflowed, and thus increases in thickness. If the slope is sufficiently gentle, this part of the floe strikes also the rocks at low water, and is added to the growing belt of grounded broken ice that surrounds the coast. Similar forms of ice are found on mud-beaches, and I believe that such is the origin of the unusually heavy mud-colored masses of Fox Basin, which is known to be extremely shallow.

The formation of the ice-foot which was described above is similar in origin and appearance to the frozen freshets which in winter form ice-walls that are firmly attached to the steep cliffs. This proves that Mr. Ashe's explanation of this fact is not correct, and that fresh water as well as sea-water may freeze firmly to the ground.

DR. FRANZ BOAS.

New York, Aug. 19.

The Geologists' Congress.

PERMIT me to say a word concerning the generally fair and full report, in *Science*, of the proceedings in Section E of the American Association. By a typographical error, a clause in the conclusion of the digest of the reporter on the Archæan is made to read "American geologists will acquiesce in the recommendations of the *committee*," etc. 'Congress,' not 'committee,' was the word used. Again, "the recommendation that all pre-Cambrian rocks should be called Archæan savors too much of pre-judgment, especially in view of the recent studies of Irving and Walcott."

These studies, which have resulted in the theory called by Professor Walcott, in his letter to the reporter, 'Prof. R. D. Irving's view,' were very carefully considered in the body of the report. The sentence above gives no idea of the entire recommendation; of how far it differs from the view of Irving, Chamberlin, Walcott, and others; nor of why it seems to best reconcile the conflicting views expressed by American geologists. 1st. The term 'Archæan' as originated by Dana received the unanimous suffrages of the Berlin Congress, and so far as the reporter could ascertain, has the indorsement of a very large majority of American geologists as a general term to cover all pre-Cambrian rocks. Irving would separate these rocks into two divisions of equal rank: to the lower (Laurentian) 'Archæan' should be applied, the upper (separated by a physical break from the first, and containing an unspecified number of smaller breaks or unconformities) he would erect into a new group of equal rank with Archæan in its new sense, and would call it, after Chamberlin, 'Agnotozoic.' He recognizes "great unconformity between the Cambrian and the Agnotozoic, besides which there are minor, though still quite extensive, unconformities between the members of the Agnotozoic itself." It is evident, from the tenor of all the views expressed on this proposed new division, that its exact rank is not certainly understood. All who recognize it believe that it has at least as high a rank as 'Paleozoic,' 'Mesozoic,' etc., but none can yet affirm that it may not consist of several such groups, divided by one or more of these 'extensive unconformities.' In view of this fact, and also of the circumstance that to a vast majority of geologists to-day the Archæan includes all pre-Cambrian rocks, it was thought that the recommendation of the reporter avoided, to the greatest degree, any pre-judgment of this question. It is as follows:—

"The division first in order of time shall have a rank of the first order, and shall be called 'Archæan.' (a) It shall comprehend all the rocks of origin anterior to the Cambrian. (b) The lowest subdivision of the Archæan shall be called the 'Laurentian.' (c) A division between the Laurentian and the Cambrian, provisionally

including the Huronian, Grand Cañon, Llano, Montalban, and Taconian (of Hunt), Animikie, and other divisions, shall be accorded a name different from any of these (such as 'Eozoic' or 'Proterozoic'), and allowing the greatest amount of liberty in the future, when it shall be determined whether this division shall be entitled to rank as one or several of the first order having numerous subdivisions as above mentioned, or with, or including, any of them of the second order like the class Laurentian. No attempt shall be made at this time to pre-judge this question, and these names and this classification shall be regarded simply as the best that can be accomplished at the present time."

This plan would seem to be possible of acceptance both by those who, like Dr. Hunt, recognize many divisions, and by those who recognize but two: The only sacrifice of individual opinion required would be as to the rank of such divisions, which the reporter doubted whether any geologist wished unreservedly to affirm. When the exact rank of the proposed new division is generally accepted, if it can be a group, the now all but universally accepted word 'Archæan' can be dropped or otherwise assigned.

As to the resolution approving the action of the committee, if it only received two or three affirmative votes, it is equally true that it received no negatives.

Philadelphia, Aug. 25.

PERSIFOR FRAZER.

The Pronunciation of 'Arkansas.'

I HAVE read with much interest Mr. Robert T. Hill's vigorous protest, in the last number of *Science*, against the mispronunciation of this word. Nevertheless, it seems to me that Mr. Hill, whose personal acquaintance with New England is comparatively recent, has been unintentionally not quite fair to "intelligent New England circles," in making them responsible for the "later and improper pronunciation." I am a New Englander by education, myself, and was taught, before I went to school, to pronounce the word properly. In school, however, our teachers insisted on the 'revised version.'

I am pretty well convinced that the mispronunciation was the invention of a class of school-teachers, unfortunately too common in New England, whose training for teaching the 'English branches' is so specialized as to carefully exclude every thing relating to foreign languages (including even the English of *Old England*). Not a few other examples might be quoted of similar 'school-ma'am' pronunciations. 'Glou-ces-ter' and 'Wor-ces-ter' are beginning to replace the proper sounds among the younger generation of 'common-school' scholars in New England, at least, and 'Norwich' and 'Harwich' are well established. It seems to me that we really do need more such protests as Mr. Hill's, before the rage for anglicizing goes away with the historical pronunciation of more of our geographical names.

In regard to the word 'Cheyenne,' I suspect that Mr. Hill has laid the blame on the wrong shoulders. How the western plain-men (who, one would suppose, would have inherited the correct pronunciation, or something like it, from the old *coureurs de bois*), came to call the 'Dog Soldier' band of Indians 'shy-ens,' instead of 'chiens' I cannot say. I do know, however, that this was the established plains pronunciation. We can scarcely blame the New England lexicographers, — or whoever first wrote the word, — therefore, for failing to recognize the French word under the universal Western pronunciation.

JOHN MURDOCH.

Smithsonian Institution, Aug. 27.

Eskimo and the Indian.

In an article on the Eskimo of East Greenland in the current number of the *American Naturalist* (p. 749), it is stated that the eminent savant Dr. Rink has recently advanced the idea that the 'kayak' of the hyperborean American aborigines is but a development from the birch-bark canoe of the neighboring Indian tribes. In glancing through Pettiot's 'Tchiglit (Mackenzie River) Dictionary,' I found what seems to be a confirmation of this theory. In the Tchiglit dialect the word for boat is *krayark*, and the bark of the birch used for canoes (*écorce du bouleau à pirogues*) is called *kreyrorok*. A comparative study of the Eskimo and the neighboring Indian dialects must certainly result in adding considerably to our stock of knowledge regarding the interesting Innuut. A few ex-

amples of Eskimo loan-words may be given here. In the dialect of the Eskimo of Churchill River the word for 'dead' is *nipa*, which agrees with *nip̄w* (Cree), *nip̄* (Chippeway), etc., being entirely foreign to the stem *tok*, which pervades the Eskimo dialects from Cape Farewell to the Anadyr. One of the Tchiglit words for 'rain' is *nipaluk*, evidently related to the Cree *nipi* (water). In Algonkin we find this series: *nipa* (moon), *nip̄* (die), *nipi* (water); and it is worthy of attention that this peculiar concatenation is repeated with the Eskimo of whom I am speaking, viz., *nipa* (dead, in Churchill River dialect), *nipaluk* (rain, i.e., water, in Tchiglit), *nipartvark* (a Tchiglit term for moon). In the far west we find the words *madsschak* (sun, in Kadiac), *maischak* (sun, in Anadyr Tchuktchi), *madje* (sun, on Kotzebue Sound), *madzak* (star, in Kadiac), which bear a suspicious resemblance to *maitsaca* (moon, in Tarahumara), *matzake* (moon, in Cora), *mecha* (in Cahita), and *metzli* (in Aztec), and would seem to indicate the great northward extension of Aztec influence along the coast of the Pacific. Thorough research will no doubt reveal much that is interesting and valuable in this regard.

A. F. CHAMBERLAIN.

Toronto, Aug. 25.

Sea-Water Ice.

IN *Science* for August 19, under the heading 'The Formation and Dissipation of Sea-Water Ice,' Mr. Ashe, in speaking of the formation of ice along the shore, and the accumulation of films of ice upon that which is submerged, makes the following statement: "Over this, at the surface of the water another film is formed, which, on reaching the level of the submerged ice, is frozen to, and remains with it in this position. This operation is repeated till the result is that a perpendicular wall of ice forms, whose outer limit is the low-water mark, terminated by a horizontal surface shorewards, at the limit of high-water mark."

If it is meant to convey the impression, as it would naturally be supposed, that this is so in all parts of the world, I must flatly contradict the statement for Cape Prince of Wales, Hudson Strait, where I was stationed, at the head of a sandy bay, during the winter of 1885-86, with the object of watching the formation and dissipation of sea-water ice. Here the distance between high and low tide mark was about three hundred yards, and, although some ice did adhere to the sand, it always came to the surface in irregular pieces shortly after the tide had risen above it. These pieces were often piled one upon another by the force of the wind, accumulated, and as the winter advanced they rose to the surface in larger masses, until the ice in the bay had reached a variable thickness under three feet, when the whole mass floated at each rising of the tide as one piece, only cracking in a few places, and, with the exception of its rough surface, no change of level could be noticed between it and the ice always floating beyond low-tide mark.

A higher tide than usual always forced its way through, within a few feet of high-tide mark, the ice cracking with a loud report here and there along the shore, the water again returning through these cracks when the tide began to fall.

Late in January a hole was cut through the ice between high and low tide mark, when the sand was found to be perfectly soft, in which living shell-fish were found.

F. F. PAYNE.

Toronto, Aug. 23.

Answers.

14. AN EXPULSION OF SPARROWS. — It was probably a flock of 'white-bellied swallows' that W. A. G. saw circling about his house on Staten Island, but they in no way caused the disappearance of the sparrows as intimated. These swallows are here now in great numbers, perching on telegraph wires and along the seashore on beach, plum, and bayberry bushes, and on hazy mornings many may be seen flying south along our shore line. As to the English sparrows, a few still remain about the houses, but this is their season of flocking, and in some fields, especially where grain has been raised, they abound. I once knew of a double row of elms where these birds congregated afternoons in late summer, and chattered in great convention until the sun went down. They were gathered from a large circle of country, and I think that W. A. G. will find a similar meeting place, where the missing sparrows will be assembled.

WM. T. DAVIS.

Tompkinsville, S.I., Aug. 29.

SCIENCE.

FRIDAY, SEPTEMBER 9, 1887.

IN A COMMUNICATION made last year to the French Academy of Medicine (*Science*, viii. p. 29), Dr. Worms gave the results of his investigations concerning color-blindness among the *personnel* of the Northern Railway. The figures which he gave showed so small a percentage of color-blind employees as to warrant the conclusion that there is not much danger to be feared for railroad travellers from these defects. More recently Dr. Worms has informed Dr. Jeffries of Boston that this percentage was found among those employed after all had been examined on entering the service previously, — an explanation which gives an entirely different phase to the matter. The statistics given by Dr. Worms, and to which we have already referred, have been repeatedly quoted as an argument by those who do not admit the prevalence of color-blindness among railroad employees, and who therefore deem color-testing unnecessary. This use of the figures of Dr. Worms, which was justifiable in view of the form in which they were originally given, should now be abandoned in view of the later information received from him. This subject of color-blindness among railroad employees is attracting the attention of thoughtful men in all parts of the world. In our own country, Massachusetts has a statute in relation to the matter. This directs that no person shall be employed upon a railroad in any capacity which requires him to distinguish form or color signals unless he has been examined as to his sight by some competent person employed and paid by the railroad company, and has received a certificate. The phrase 'competent person' is a very elastic one, and it is feared that the examiner is not in all cases competent to make the tests. The Alabama legislature has enacted a law which is pronounced to be the best yet devised to overcome this evil. It provides for examinations conducted by experts, not according to rules of their own, but guided by standards both of visual power and of color-sense which are fixed by law. The railroad employees, under this law, are divided into two groups, — one containing engineers, firemen, and brakemen, in whom a high visual power and color-sense are demanded, and the other containing gatemen, conductors, and others, to whom an inferior standard is applied. Connecticut at one time had a law upon this subject, but, after one year's trial, so many employees were found deficient that in obedience to the demand of politicians it was repealed. In one instance a board of experts found twenty-four railroad employees to be color-blind. Their report of these facts created such an outcry among their friends that another test was demanded, with flags and lanterns and not with colored worsted as in the former test. This resulted in proving that of the twenty-four, twenty-one were wholly color-blind, and three color-blind in part. Dr. Worms has recommended that exercises on the colors should be carried out in the schools to reduce the percentage of the color-blind. In commenting on this recommendation, Dr. Jeffries says that no exercise with colors can change the congenital color-blind; who are four per cent of males everywhere. We hope to see this subject agitated until the provisions which are now in force in Alabama shall apply throughout the United States. It matters little to a traveller that his life is secure in one State by reason of stringent laws against color-blindness in railroad employees, if as soon as he crosses the boundary line and passes into another State, in which no such law exists, his life may be sacrificed by a color-blind engineer who, mistaking the red light of danger for the white light of safety, runs his train through an open drawbridge into the river below.

CO-OPERATION ON THE CONTINENT OF EUROPE.

II. GERMANY.

THE reply from Germany to Lord Rosebery's circular letter (see *Science*, No. 220, p. 395) is more systematic than that from France. At the very outset the writer says that among the working-classes of Germany co-operation has met with little favor: the well-to-do classes, on the other hand, have applied its principles with considerable success in many directions. This reluctance on the part of the working-people to co-operate is ascribed in a large measure to the fact that as a class they are incapable of appreciating the value of making provision for the future. They are not yet educated up to the point of making industrial co-operation a real factor in the improvement of their condition. The tendency toward State socialism in Germany is also an obstacle to co-operative development. Statistics as to co-operation are not easily obtained in Germany. Both the government and private societies are very reticent when asked for information on commercial or industrial questions. The most observant notice of co-operative movements, so far as they concern the artisan and laboring-classes, is probably taken by the Central Association for the Welfare of the Laboring-Classes, and its organ, the *Arbeiterfreund*; while very valuable statistics are to be found in the yearly report of the Central Union of German Co-operative Societies, on all which the report from Germany is based.

Associations belonging to this Central Union of German Co-operative Societies are entitled 'Registered Associations,' and are established under the Prussian law of March 27, 1867, and the German law of July 9, 1868. These laws grant special privileges to co-operative societies; that is to say, associations not restricting themselves to any fixed number of the members composing them, and got up with a view of facilitating the obtaining of credit, the earning of a livelihood, or prosecution of husbandry by their members by means of joint management of their business. A great number of associations have united themselves under the leadership of a counsellor in the Central Union.

Such enterprises are in Germany indissolubly connected with the name of their great founder, Schulze-Delitzsch. The movement, which he started and organized with extraordinary genius, is entirely based on the principle of 'self-help.' "If a man cannot save a few pence by denying himself a couple of glasses of beer a week," said Schulze, "I can do nothing for him." The history of Schulze's attempts are briefly as follows: In 1849 he founded at Delitzsch, in Saxony, a 'sickness and death' fund, which, for a small monthly subscription, afforded help and medicine to the poorer artisans and laborers in case of illness, continuous pecuniary support in cases of incapacitation for work, and contribution towards funeral expenses in cases of death. In 1850 Schulze started a loan society, and, in re-organizing the same in 1851, he introduced the principle of unlimited liability, and completed his system, as far as essentials were concerned, by forming capital for individual members by the introduction of inalienable shares. The example thus set was quickly followed, and many mutual help societies sprang up in various parts of Germany.

The principle of unlimited liability, on which Schulze most strongly insisted as the keystone of his system, was also adopted by Raiffeisen, who founded similar societies, chiefly in agricultural districts. The double effect seems to have been to raise the credit of co-operative societies, and to confine them to persons of small means, persons of larger fortune being shy of risking their whole property.

As mentioned above, the societies on the Schulze-Delitzsch plan have been regularly organized into an association, the principal objects of which were briefly described by him in the report of 1874 as being the following: "The General Union of the German Industrial and Economical Co-operative Societies, founded on the principle of self-help, the affairs of which are at present managed

by me as a salaried agent, sends delegates of the associations belonging to it to an annual general assembly, which controls the affairs of the union as supreme authority, without interfering with the independence or with the special affairs of the individual societies. As connecting links between the central authority and individual associations, subordinate unions, which embrace the societies of various German countries or provinces, or of special branches, have been formed, whose task it is to attend to their special interest, and to communicate between them and the central authority. They prepare for the general assembly in special assemblies of their own, and enforce the resolutions of the former in their districts, while the presidents chosen by them form a committee which assists the agent in carrying on the business of the union in the interval between the general assemblies. Thus, without interfering with the free action of the individual societies, a central point is created for the exchange of experiences, for the sifting and criticising of the ever-accumulating material, for advice and help for members in any kind of embarrassment, and finally for common defence against threatening danger. Add to these advantages the most valuable business relations between the several societies in the execution of commissions, and especially in mutual assistance with capital." The resolutions of the general assembly have only the force of advice, and their acceptance is enforced only by the weight of their own reasons, and not by pressure of any kind.

The number of societies in this association increased from 171 in 1859, to 771 in 1864, and was 3,822 in 1885. At the last-named date they were distributed thus: loan and credit societies, 1,965; co-operative societies in various branches of trade, 1,146; co-operative store societies, 678; building societies, 33. At the end of 1884 the membership was 1,500,000. Of their own capital, in shares and reserve funds, they possessed 300,000,000 marks; and of borrowed capital, 500,000,000 marks.

It may be mentioned that the co-operative movement in Germany is unfortunately at present associated with the Radical political opinions. Even Schulze, though at first he kept the movement free from political color, was carried along by the tide in his later years. The consequence has been that co-operative enterprise on the self-help principle is looked upon rather with suspicion by the ruling authorities.

Co-operative store associations exist in considerable numbers in Germany, and are in the main very successful. They bear the name of *Consumvereine*. Many of the earlier associations confined themselves to making contracts with dealers, provided that the latter granted a discount to the association on all goods sold, which discount was, after deduction of expenses, divided among the members.

Those formed since 1863 have followed more and more the principle of similar English associations. They give no credit, sell at the market price, and, after providing suitable interest for the business shares of the members, divide the net profits in proportion to the goods bought, which proportion is marked by dividend counters; but there are some very well conducted societies which sell at the lowest price possible, and divide the profits equally, or in proportion to the business shares of the members. As in England, the more developed societies are gradually undertaking the production of their own goods. The South German associations have taken a step towards the establishment of a common wholesale business by forming a joint stock company for the purchase of goods at Mannheim: in North Germany this was in 1878 still regarded as premature. Nearly all the important co-operative store associations have registered themselves under the Co-operative Societies' Law.

The proper principles on which such associations should be conducted are laid down by Schulze-Delitzsch as follows: 1. Those who buy from the society should themselves be members of it (sale to non-members is, however, allowed as being likely to induce the latter to join); 2. Business shares should be gradually acquired by the members up to a normal sum by the payment of a small subscription, or by accumulation of their dividends; 3. A common reserve fund is formed by keeping back a certain number of shares, and by a small entrance fee for members; 4. Capital is borrowed on the common security of members, or (though this should be avoided) goods are bought on their com-

mon credit; 5. Sales are for ready money, the profits being divided between the reserve fund and the members' dividends; 6. The manager and officials are paid according to the work they do; 7. The number of members is unlimited, entry into and withdrawal from the society being equally free.

These rules, being stamped with the great authority of Schulze, represent the general principles on which the vast majority of co-operative associations work, and are recommended to all by the Central Union.

The number of these co-operative stores twenty-five years ago was 41; in 1885 it was 678. Their average sales in 1884 were 190,025 marks. Their average holdings in business shares are 24 marks 6 pennings per member, and in reserve funds 14 marks 3 pennings per member. One hundred and sixty-three of the societies showed, in 1884, a dividend on capital and purchases of 2,412,366 marks, or 85 per cent.

For the failures in 1884 numerous reasons are given. One society failed in consequence of their "unfortunate choice of a store-keeper;" another in consequence of quarrels among the members; a third society were obliged three times to change their storekeeper, and eventually came to an end in consequence of the impossibility of finding a suitable person; a fourth came to grief in consequence of the desire of the members to divide the reserve fund. On this latter rock many societies have split. As soon as the society finds itself possessed of any considerable sum of money, individual confidence seems to give way, and greed of the immediate possession of their own share prompts the members to dissolve the association.

Co-operative workshops are not numerous in Germany, and the general opinion is unfavorable to them.

The favorable years, from 1870 to 1873, seemed to bid well for the establishment of a system by which the workmen should be made participators in the profits of their industry; and the governments of Germany took pains not only to try the system in their own works, but to obtain information as to its working elsewhere. The initiative was taken by Bavaria; and from an inquiry made in 1874 from fifty Bavarian firms, of whom about thirty sent replies, it appeared that in most cases such participation was confined to premiums, gifts, and a percentage to overseers and foremen. These cases were chiefly the result of individual liberality on the part of employers of labor, and, as they ceased in the time of industrial depression which succeeded, they are without scientific value.

The 'Report on Arrangements for the Benefit of Workmen in the Larger Industrial Establishments of Prussia,' published in 1876 by the Prussian Government, states that at that time there were 439 cases of establishments in which the workmen shared in the profits, and 61 where they shared in the capital. A closer analysis of these figures, however, shows that in most cases such participation was confined to the foremen and overseers, and that in only 16 cases did all the workmen have a share at once in the undertaking, and in 18 others after a certain lapse of time.

Schulze-Delitzsch always declared that productive associations, i.e., "associations of a number of small masters or of wage-laborers for the purpose of industry on a large scale for common account and at common risk," was the highest form of association, and the keystone of his whole system. Such associations, he pointed out, are most easily established the less capital they require, and the more readily the goods produced are sold. They are most difficult to establish in branches of industry which, owing to minute division of labor, require the co-operation of workmen of different trades, or which entail expensive machinery.

Hitherto the general history of productive associations in Germany seems to have been pretty nearly the following: a not very large number of workmen join together to establish a common workshop and sell their products for common account. The original intention of admitting new working members is frustrated by the fact, that, whereas an individual capitalist can increase or diminish the number of his hands according to the requirements of the market, every unfavorable conjuncture has the effect, in a co-operative association, of leaving some of the members not fully occupied. When better times come, the admission of new members is looked on with disfavour, because it only renders the position of the others worse if times of depression return. There is, further,

the difficulty that the advantages shared by the new members are the result of sacrifices on the part of the old, for which the latter are not indemnified. It consequently results that the associations refuse to admit new members, and in good times employ regular workmen hired for wages and liable to dismissal, and thus in the moment of success such associations lose the essential characteristics of co-operative societies.

To meet these difficulties Schulze recommends:—

1. The admission not only of members of the trade, but, as sleeping partners, of persons who, without taking any share in the industry of the association, are yet willing to venture a deposit of capital; and of workmen who enter the association at once, but, as they cannot be employed at once, remain for the time being as wage-laborers under other employers.

2. The participation of new members in the profits only after a certain lapse of time.

3. The application of borrowed capital, and not of the society's shares, to the acquirement of such real property as is required; such borrowed capital not being reclaimable before a certain date, but receiving interest.

4. Withdrawal from the association to be subject to as long notice as possible.

As to division of the profits, most German associations agree with Schulze, that, after the reserve fund has been duly considered; five per cent interest should be added to each business share; that then half the surplus should go to swell the shares as super-dividends, the other half being divided as bonus among all the workmen and officials according to the amount of salary they have received during the year.

It is very difficult to obtain accurate information respecting co-operative undertakings for productive purposes, as, from reasons of trade, such associations are very reticent with regard to their working.

In the report of the German Co-operative Union for 1884, 145 productive associations are mentioned under the following divisions:—

21	Cabinet and instrument makers' associations.	“
17	Spinners and weavers'	“
13	Millers and bakers'	“
11	Booksellers and printers'	“
10	Tailors'	“
7	Butchers and slaughterers'	“
7	Brewers'	“
6	Cigar-manufacturers'	“
6	Carpenters, builders, and stonecutters'	“
5	Metal-workers'	“
5	Spirit and brandy distillers'	“
5	Shoemakers'	“
5	Clockmakers'	“
24	Miscellaneous	“

The same report gives statistics of 10 associations which made a net profit of 5.5 per cent, allowing of a dividend of 13.6 per cent, as against 16.0 per cent in 1883, and 13.5 per cent in 1882. Whether this dividend is paid to the members in money down or not does not appear. Of the working capital of these societies, 36.4 per cent was their own.

Herr Borchet is the only authority who believes that the workmen's participation in the profits has prevented strikes.

The most conspicuous examples of co-operation in production are the Berlin Brass-Work Company, the Windhoff Foundry at Lingen, Moller's engine-works at Kupferhammer, Keilpflug's cigar-factory in Berlin, and the cotton-mills at Hasel.

Of all co-operative enterprises in Germany, the people's banks are the most developed and the most successful, and they appear to have in a great degree overcome the indebtedness and misery which were so often the lot of the working-classes a quarter of a century ago, in consequence of the usurious interest that they were compelled to pay, especially in agricultural districts, on even the smallest loan.

The main principles on which these banks are founded are again those of Schulze-Delitzsch. They are:—

1. The loan-seekers are themselves the directors of the institution established for the satisfaction of their needs, and share the risk and the profit.

2. The transactions of the association are based throughout on business principles: the fund of the association pays to the credit-

ors, and the loan-takers pay to the fund of the association bank, interest and commission, according to the rates in the money-market. The managers, especially those who have charge of the funds, receive remuneration according to their services.

3. By full payment once for all, or by small continuous contributions on the part of the members, shares in the capital of the association are formed, according to the amount of which the profit is divided, and placed to their credit till the full normal sum is reached, by which means an ever-growing capital of its own is acquired for the business of the association.

4. By the entrance fees of members and by reservation of shares, a common reserve fund is accumulated.

5. Sums further necessary for the complete carrying-on of the business are borrowed on the common credit and security of all the members.

6. The number of members is unlimited. Entrance is open to all who satisfy the requirements of the statutes, and it is free to any one to cease to be a member after giving due notice.

Not only artisans and manufacturers, but also others, especially agriculturists, merchants, and dependent workmen, avail themselves of these banks, and they have maintained and strengthened themselves in the confidence of the public through all crises.

The Giro-Union ('Circulation Union') of German associations deserves special notice. An account is opened at the Associations' Bank in Berlin in favor of each people's bank belonging to the Union. Each bank keeps a deposit of at least 300 marks there, which can be increased by deposits in specie, by bills on Berlin or any Prussian bank, or places where there are other loan associations, or by the transference of the deposit of a third party from his account to their own: it can, on the other hand, dispose of its deposit by transference to another account, kept by the bank, or by checks, bills payable at sight, or ordered consignment in specie. Though Schulze regarded this institution as extremely important, only a minority of the people's banks belonging to the general union belong to it also.

The number of people's banks belonging to the general union was 1,961 on Jan. 1, 1885.

Co-operative societies for educational purposes would appear not to exist in Germany, where educational facilities in every branch of learning are already amply provided for, and within the reach of the poor; but co-operative associations of various kinds often provide educational, social, and recreative facilities for their members.

Societies for building dwellings for the poorer classes have met with but little success in Germany. They appear to have succeeded best in Alsace; and one at Flensburg, in Jutland, founded in 1878, possesses, according to the report of 1884-85, 19 houses, with a value of 100,000 marks, and 800 members, one of whom has the sum of 87,000 marks to his credit in the society's books.

The formerly wide-spread system by which pasture-land, forest, fisheries, etc., were held in common, has almost entirely ceased to exist in Germany, in consequence of recent legislation. On the other hand, a movement has taken place, chiefly under the same auspices as the co-operative movement on the Schulze-Delitzsch principle, by which combination now plays a very important part in German agriculture.

Dairy co-operative associations have been started in all directions. There are further associations for the purchase and use of agricultural machines, the members paying a certain sum for the use of the common property, and associations for cattle-breeding, sheep-farming, hops, vegetable, and vine-insurance, and kindred objects.

THE STONE AGES IN TUNIS.

AN interesting report on the relics of prehistoric man in the re- gency of Tunis appeared in the May number of the well-known scientific periodical, the *Materiaux pour l'Histoire Primitive et Naturelle de l'Homme*. The author, Dr. R. Collignon, deputed by the Anthropological Society of Paris for this purpose, spent three years in traversing the country in every direction, and in making the observations and collections which are described in this report. Only the principal results can here be noticed; but these, it will be seen, are of great scientific value.

The most important observations were made in the district about

Gafsa, a considerable town in the southern part of the regency, preserving the site and the name of the Roman Capsa. The author describes three remarkable hills, which rise to a moderate elevation in the neighborhood of that town. These hills, having been made posts of observation of the occupying army, are now known as Posts I., II., and III. Post I. is an eminence rising on one side, by a gradual slope, to a height of sixty metres (about two hundred feet) above the level of the town, and descending on the other side in a steep, cliff-like face, of forty-two metres, to an upland plain. This precipitous face offered to the investigator the advantages of a cutting, showing the composition of the hill from base to summit. It proved to be, in the greater part, a limestone conglomerate, in which are embedded small particles of quartz, with rolled flint-stones of various sizes, and fragments of brown siliceous. Geologically, the hill belongs to the earliest period of the quaternary or pleistocene epoch. The lower half is of stone sufficiently compact to be quarried for building-stone. Above this is a layer, about eighty feet thick, of somewhat looser and more friable conglomerate, with larger embedded stones. And this, again, is surmounted by a stratum of yellow travertine, about six metres (twenty feet) thick, containing no flints.

The remarkable fact is, that throughout the conglomerate were discovered relics of human handiwork, in the shape of wrought flints embedded in the rock. Still more remarkable is the fact that in the lower and harder stratum these relics were all of one sort, while in the upper and looser layer that sort had disappeared, and other kinds had taken its place. In the lower stratum he found specimens of that rude tool—the rudest of all tools—which is described sometimes as the 'drift- implement,' sometimes as the 'axe of St. Acheul,' and by Prof. G. de Mortillet, in his noted work 'La Préhistorique,' as the 'fist' (*coup de poing*),—a stone clipped into an ovoid or almond-like shape, and intended evidently to be grasped at the smaller end and used in pounding or hacking. With these were some of the coarse flakes, or clipped fragments, which usually accompany them. These stone fists and flakes were all in the typical forms which distinguish the work of the earliest quaternary race,—variously known as the 'River-drift,' or 'Canstadt,' or 'Chellean' race,—and were the only traces of human industry found in that stratum.

In the looser stratum above, not one of the ovoid implements was found, though a single specimen was extracted just on the line of division between the two layers. All the worked flints in the upper layer belonged to what M. de Mortillet styles the 'Mousterian' type, but were mostly of a heavy, coarse, and worn appearance. They were of various shapes,—triangular points, thick blades, rude scrapers, and the like. Dr. Collignon is of opinion that the implements in the upper conglomerate stratum were a development of those in the lower; but the facts, as described by him, do not seem decisively to bear out this opinion. Finally, in the highest stratum of all, the travertine, as has been said, no flints of any kind were found. The hill known as Post III. resembles that of Post I., except that it is lower, and that the layer of travertine is wanting.

The necessary conclusions from these facts, as set forth by the author, are, that in the earlier part of the quaternary era this region was inhabited by the race or races of men who formed these implements. During a period of great but unknown length the land gradually sank, and was finally covered by the sea. When it again rose above the surface, the currents swept away nearly all the formation which had accumulated during this subsidence, leaving only a few hills, such as have been described, to indicate the original level.

After this denudation, a new but briefer subsidence took place, giving rise to a new formation, and followed by a new elevation. These facts are shown by the evidences displayed in and around another hill, known as Post II. This is one of the 'foot-hills' of a small mountain-chain which sinks gradually into the plain at a little distance north of Gafsa. Around these hills and on their declivities are scattered many small mounds of clayey loam. These mounds rest on a layer containing many coarse Mousterian implements, exactly similar to those in the upper conglomerate of Post I. Above this layer is a stratum of argillaceous earth, between three and four metres thick, containing no flints. Then follows a thin layer or film of earth, about four inches thick, full of flint implements of every description. This layer clearly indicates what was for a considerable

period the inhabited surface. Above this layer are a few feet of earth; but the same implements are scattered profusely over the present surface, and are found below it where the soil is furrowed by the rains. They belong to every one of M. de Mortillet's 'ages,' subsequent to the Chellean and the earlier Mousterian; viz., the upper (or later) Mousterian, the Solutrean, the Magdalenian, and the Neolithic. So far as prehistoric Tunis is concerned, Dr. Collignon is satisfied that no distinction in point of time can be made among these different industries. It is clear, also, that they have continued in existence to a very recent period, since the soil which covers some of the Roman constructions holds flint implements of the same description.

A very curious fact, ascertained by Dr. Collignon, is that all these stone implements, of every age, are restricted to a comparatively narrow area in the south and west of Tunis. While they abound in that district, they are almost entirely absent from the northern and eastern portions of the country. Dr. Collignon does not attempt to explain this phenomenon. It may possibly be due to an early condition similar to that which exists at present in parts of our own continent, where two hostile races, like the Eskimo and the Athabaskan Indians, are separated by a wide space of unoccupied land.

It should be mentioned that in the middle of the Tunisian territory there is a limited area, quite distinct from that in which the stone implements occur, where megalithic monuments—dolmens and covered passages—abound. In one locality no less than four hundred dolmens were counted. These monuments Dr. Collignon believes to have been the comparatively late constructions of an intrusive tribe; and he is further of opinion that the descendants of this tribe and of the stone-implement makers still live in their respective districts, and are distinguishable by their very different physical traits. In the district of the dolmens the people are of rather low stature (1.63 metres, or about 5 feet 4 inches,—an average which must be understood as including both sexes), with long heads (index 74), and a visage short, broad, and irregular, closely resembling in outline that indicated by the Cro-Magnon crania. On the other hand, the people of the south of Tunis are comparatively tall (1.69 metres, about 5 feet 6 1-2 inches), very dolichocephalic (index 73), with retreating forehead and chin, and projecting glabella and brows; the nose turned up, and the lips thick, but with no prognathism. They are neither negroid, Berber, nor Arab. In his view, they represent the earliest ethnic stratum of the existing population, and preserve the blood and the type of the people who dwelt in this region during the stone ages.

The positive conclusions which we seem authorized to draw from Dr. Collignon's report may be stated in a few words. They are, first, that the human race is of an immense antiquity, dating back to the beginning of the quaternary age; and, second, that the first race of men, judged from the relics of their industry, were of a very low grade of intelligence, little surpassing that of the most sagacious brutes; but how far this apparent defect of intellect was real, and how far it may have been due to the circumstance, that, as M. de Mortillet has suggested, the faculty of speech was yet undeveloped, is uncertain. Finally, it is plain that the period of this earliest stone age was of a vast duration, which can only be expressed in geological terms. The same may be said of the early Mousterian era, which perhaps formed part of the first age. As for the various so-called 'stone ages' which followed, it seems impossible to make any real distinction of periods among them. They all apparently form one modern epoch, not of very great duration, and not yet closed.

CHILLED ARMOR FOR LAND-DEFENCES.

THE Gruson Works of Buckau-Magdeburg have recently published a book of some size, written by Engineer von Schuetz, in which the system of construction of chilled cast-iron armor for use in the protection of earthworks and in the making of turrets for land-batteries, as devised by Dr. H. Gruson, some years ago, is described at length, and an account is given of the results of the experiments which have been made, from time to time, by several European governments, to determine its efficiency in resisting the impact of the heaviest modern ordnance. This work has been

translated into English by Commander Grenfell, R.N., and we are indebted to the courtesy of Captain Piorkowski, Dr. Gruson's representative in this country, for an early copy. The subject and the matter of the work are of exceedingly great importance to a nation which, as is the case with our own, is destitute of the most ordinary means of defence in the event of a foreign attack either by land or sea. So serious is our case, that, as remarked in a private letter from the Admiral of the Navy just received and lying under the hand of the writer, if we desire to learn what advances have occurred during the last twenty years, we must go to England, France, Germany, Russia, and even to Constantinople, to study those of the scientific and mechanical departments of the military and naval establishments, and not to our own army or navy. This work of Dr. Gruson would seem to illustrate such advances in the defence of coasts.

Dr. Gruson's armor is simply a chilled cast-iron shield, of which the body is a strong normal iron, while the surfaces on the exposed side are chilled like the 'tread' of an American car-wheel. Such enormous masses are handled, in this case, however, that correspondingly enormous chills are needed, and the manufacture of these plates becomes a matter of extraordinary difficulty and cost. All the resources of a great establishment are drawn upon, and all the ingenuity, knowledge, and experience of an able staff are called out in the prosecution of the work. Chilling, as is well known, probably, to most of our readers, consists in the casting of a peculiar quality of cast-iron, known as 'chilling iron,' in contact with a large mass of cold iron forming that part of the mould which is to form the surface to be chilled. The sudden abstraction of heat prevents the isolation of the carbon in graphitic form, as would otherwise occur in the slow process of cooling naturally, and insures its retention in the combined form, producing a steel layer of considerable depth. The depth so secured is dependent upon the quality of the iron and the efficiency of the 'chill,' as the iron mould is called. The latter must have great thickness and good conducting power to give best results in these applications. Successfully carried out, this process gives a surface harder than tempered steel over a strong and massive interior, the best possible combination, apparently, for an armor-plate.

Dr. Gruson constructs large fixed turrets and land batteries of such plates, and the results of trial indicate them to be more reliable defences than any wrought metal, whether iron or steel, or 'compounded,' yet introduced. The weight of these shields is too great for use in naval construction. The first trials were made in 1869, at the Tegel range, and it was found that all shots fired against the chilled plates broke into fragments, and that the plates bore the hammering with remarkable success. The experimental committee reported that the chilled armor was well adapted for its use. Later trials confirmed this opinion, and the Prussian government at once gave directions for its adoption in important lines of frontier defences, and Austria, Italy, and Holland followed its example. In all these trials the chilled iron shot were found superior, if well made, to any steel shot, except in one or two cases in which makers, like Krupp and the Ternitz company, had either succeeded in securing an exceptional quality of steel, or had found remarkably effective methods of tempering. Plates were tested of from 13.77 to 49.21 inches thickness, and were attacked by guns varying from 6 to 17 inches calibre, throwing shot weighing from 61 to 2,205 pounds. The thickness of plate was usually not far from three times the diameter of the bore of the gun to be resisted. The energy of impact was, in the case of the largest gun, over 47,000 foot-tons; which was only obtained, however, by firing at short range—150 yards. In all such cases, the shield is subjected to more severe trial than would be likely to be met in actual battle. In trials last year at Spezia, with the 100-ton gun, the shot weighed a ton, and the powder charge 327 pounds, the velocity of impact being over 1,700 feet per second. The maximum penetration was four inches, the plates finally breaking up under repeated blows.

The method of proportioning is to give the plates a maximum thickness in inches equal to from one-fourth to one-third the fourth-root of the energy of the attacking shot measured in foot-tons. The total weight of each plate of which the armor is composed is not far from the weight of the gun expected to be used in the attack.

The system of defensive armor here described is one in which we have a peculiar interest. We have in the United States, in the 'Salisbury' and 'Hanging Rock,' and other brands, the best chilling irons in the world, and it would seem very possible that this may prove to be the best system for our purpose yet devised. It is especially one which we may hope to obtain permanent advantage from, as it seems probable that its advantages over other forms are not likely to be soon lost.

R. H. THURSTON.

MENTAL SCIENCE.

Heredity of Mental Traits.

STATISTICAL inquiries have become a recognized instrument of research in mental phenomena. Mr. Francis Galton has set the pattern in his study of the life-histories of English scientists, in his investigation on the heredity of physical and other traits, in his record of development in childhood, in his researches on visual imagery; and his composite photography is simply a 'pictorial average.' Students of educational science have adopted the same plan: the contents of children's minds, the record of the daily progress of infants as affected by heredity and by environment, have been registered in almost every civilized country. The increased activity in this direction is sure to bear good fruit. As soon as modern psychology substituted, for the old notion of a single, uniform, typical mind innately endowed with definite faculties and ideas, and uniformly proceeding in definite grooves, the recognition of the endless diversity in every particular of human faculty, it was no longer sufficient to introspect one mind and record the results of your exploration as psychology: one must now use every possible method, study mind from all its many aspects, call in the aid of the psychologist, the pathologist, the educationalist, the anthropologist, and the sociologist, in order to present a picture that shall have the slightest chance of truly representing the reality. That such statistical researches are unusually open to various kinds of falsification, and are apt to be 'worked' for more than their worth, every one will admit. It requires great insight as well as caution and patience to draw from a series of answers on mental topics such conclusions as are really warranted without going beyond what the facts logically yield, and again without losing the suggestiveness of incomplete records. But all this is an argument, not against the use of such methods, but for the need of *more* such researches.

The French Society of Physiological Psychology—an organization constructed on a much more useful plan than our psychic research societies, and yet including such work as the latter do—have recently issued a circular of inquiry, similar to the 'Record of Family Faculty' of Mr. Galton. This blank they send only to persons of whose reliability, scientific zeal, and accurate observing powers they have abundant evidence. Each such person fills blanks describing a person with whom he is intimately acquainted, another for his friend's father, and a third for his mother. If he have sufficient knowledge of any other member of the family to answer two-thirds of the questions on the blank concerning him or her, he is to add such information. The person whose traits are described must be at least twenty-five years old, so that his character has fully matured. It goes without saying that the records will be treated in the most confidential manner.

The questions are grouped under six heads. I. Education and social position; II. Physical traits; III. Physiological traits; IV. Pathological traits; V. Moral traits; and VI. Intellectual traits. The first group asks for one's religion; his mode of education; his origin, whether of noble kind, wealthy or poor; and so on: it outlines the environment of the individual. Under the second group are questions regarding height; weight; size of head, whether small or large for the height; shape of forehead; color of hair and eyes, etc. The physiological questions test the sensibility of the several senses,—of the eye as to near-sightedness, color-blindness, and the like; of the ear as to fineness; the development of taste and smell, and so on. They also include the temperament, i.e., nervous, melancholic, sanguine, and phlegmatic; the diet, whether a drinker of alcoholic liquors, of tea or coffee, and how strongly addicted to them, and the same regarding smoking; habits of exercise, whether regular, violent, and how taken; general health, whether robust or

not; right or left handedness; the number of hours of sleep and the time of going to bed; whether dreams are frequent, sleep is deep, and so on.

The pathological section aims to record any serious diseases, and especially of the nervous system, through which the person has passed; the disease of which he died, if the record is of a deceased person; the number and sex of his children, and the periods of their birth; the occurrence of congenital defects, and whether they were transmitted to the offspring, and so on. The moral characteristics are more difficult to describe: the plan here followed is to give the recorder the choice between opposite epithets, and at times to include a neutral group. Is the temper of the subject of inquiry joyous, sad, or changeable; calm, or violent? Is he independent in his opinions, or easily led by others? Is he vain, or modest; remarkably truth-loving, or weak in this respect; credulous, or suspecting; selfish, or generous; harsh, or gentle; timid in society, or bold; aggressive in his opinions, or mild? Has he any special talent for music, poetry, the fine arts, science, etc.? Has he pronounced religious sentiments? Is he active, regular in his habits, or sluggish and fitful? Is he intellectually inclined, miserly, or spendthrift, materialistic, or not? Such is the range of inquiry included in this scheme. The intellectual traits are of a similar nature. The maximum of intellectual work, the manner of working, the nature of the occupations; the strength of the attention, of his logical powers, of his imagination, of his insight, of his memory (and in particular of memory for forms, places, dates, numbers, names, tunes, prose, or verse), of his generalizing power, his classifying talents, and the scope of his mental tension; the soundness of his judgment, the ease of speech, the degree of precocity—these form the last of the group of questions. Throughout, any characteristic specially hereditary, either from the parents to the subject of the description, from the latter to his children, or in a collateral branch of the family, is to be especially noted as such.

To accurately fill out such a blank is by no means an easy matter; it is only of one's most intimate friends (one's family and kindred) that any thing like a complete list can be hoped for. The society does well in asking that where no definite answer is possible the question should be left unanswered; they do not want mere guesses, or phrases that say nothing. M. de Candolle, who has been influential in arranging this list, is much at home in this field of research; and in his seventy-ninth year states that there are thirty-one persons about whom he would be willing to draw up such records. This is an unusual number, and the average scientific observer is doing well if he can furnish ten such records. But even at this rate the society has good opportunities of contributing a valuable addendum to our information on the heredity of mental traits. It would be easy to criticise many points in the arrangement of the questions, and point out omissions and ambiguities, but the main point is the manner in which such answers are used: after the results of this inquiry are published, such criticism will be serviceable in making the next inquiry more thorough and valuable than this.

Recent writers have called attention to the important step in human evolution that occurs when the principles of development pass from the stage of being unconsciously intuited and uncertainly followed, to the stage when they are explicitly expressed and purposely aided. If, as many believe, the future of the race is largely in our hands, the knowledge that such researches as those here noticed will furnish, must form the groundwork on which conscious and scientifically-conducted advance will be based.

THE DUCK'S BRAIN.—It is well known that the destruction of the cerebral hemispheres of a bird's brain reduces the animal to a mere automaton. While the functions are all capable of action, all spontaneity is gone. It is a 'sleep without dreams.' M. Ch. Richet has recently called attention to the change in these appearances when only a *portion* of the cerebrum is injured. He uses ducks because the division of their brain is more distinct and the animal less liable to fatal injury by the operation than in pigeons. Only such animals are included in the observation as have recovered from the injuries of the operation. In order to detect the absence of a function as a result of the cerebral lesion, one must know the normal functions of the duck. In the language of the duck, M. Richet detects six cries, associated with pain or fright, with

being separated from a companion, with the recognition of a companion, with joy, with taking food, and with being chased by a dog. Add to this the actions occurring in attracting one another and the list is about complete. M. Richet finds that a duck whose cerebrum is partly destroyed acts exactly as a normal duck: an accurate observer could probably not tell which is which. The only difference that was found is this: when a normal duck is driven into a corner, it tries to escape by going to the side of the pursuer; a duck with an injured cerebrum huddles against the wall, and makes no such attempt. M. Richet thinks that this method of escape is really the only intelligent act a duck performs, and that the injury of the cerebrum has thus impaired the highest function; all the rest of a duck's actions are almost entirely automatic, and are performed by lower centres. The experiments accent the importance of correlating the effect of a lesion with the normal intelligence of the animal acted upon.

BOOK—REVIEWS.

On the Relation of the Laramie Molluscan Fauna to that of the Succeeding Fresh-Water Eocene and other Groups. By CHARLES A. WHITE. (U. S. Geol. Surv., Bull. No. 34.) Washington, Government. 8°.

ALTHOUGH it is not distinctly indicated in the title, this is really an important contribution to Eocene paleontology. Twenty-six invertebrate species from the Wasatch group, or lowest division of the fresh-water Eocene beds of Utah, are described and figured. The stratigraphic and geographic range of each species is presented in a table, which Dr. White has made the basis of some important conclusions concerning the relations of the Cretaceous, Laramie, and Eocene strata.

The intimate stratigraphical relation of the Laramie group to the marine Cretaceous series beneath it has been recognized by every field geologist who has studied those strata, and it is this fact, in addition to the discovery of dinosaurian remains in the Laramie, that has led them to range that group as a member of the Cretaceous series. While there seems no reason to doubt that sedimentation was continuous, not only through the marine Cretaceous series, but also from that series into and through the Laramie, it is true that there was at the beginning of the Laramie period a comparatively sudden change in the character of the previously existing molluscan fauna over the whole area which was then occupied by the Laramie waters; that is, at a certain horizon in the unbroken succession of strata there is an abrupt disappearance of all distinctively marine forms, and an equally abrupt accession of brackish-water and fresh-water forms which continue through the whole Laramie group.

On the other hand, similar evidence of continuous sedimentation from the Laramie into the Wasatch group has not hitherto been publicly announced. And wherever later strata have been discovered resting upon those of the Laramie group they have been found to be free from all fossil forms which can be reasonably referred to even a slightly saline habitat, while the Laramie strata contain many brackish-water forms throughout their vertical range.

But Dr. White has been able to show that such unconformities as exist between the Laramie and Wasatch groups are local and unimportant. And, starting with the hope that, although the physical changes attending the deposition of the last of the Laramie beds resulted in the extinction of all the brackish-water mollusca of that group, certain of the fresh-water species would yet be found to have continued their existence into the Wasatch epoch, he has proved that this is actually the case.

In other words, we seem to have conclusive proof that there is a complete and unbroken stratigraphical series in that western region, extending from the Middle Cretaceous to the top of the Eocene, and aggregating nearly or quite two miles in thickness. A remarkable fact connected with the production of this great series is that, while sedimentation was evidently not materially interrupted in at least a large part of the area within which those deposits are now found, the aqueous life was changed first from that of a purely marine character to that of alternating brackish and fresh waters, and finally to that of a purely fresh-water character; that is, the waters in which this series of strata were deposited were first

marine, then alternating brackish and fresh, and finally wholly fresh. This, of course, implies the occurrence of great physical changes upon the North American continent during the Cretaceous and Eocene periods, which, however, did not interrupt sedimentation in a large part of its interior.

Dr. White has also done stratigraphic geology an important service in his concluding remarks upon the value of fresh-water fossils in geological determinations.

"The differentiation of the mollusca into generic, family, and ordinal groups, and the diversification of specific forms among these groups, are immensely greater in marine waters than in any other. In brackish waters it is much less than in the open marine, and in lacustrine waters the minimum of differentiation is found. The large collections of fossil mollusca which have been made in different parts of the world indicate that this slight tendency to differentiation among fresh-water mollusca has always obtained in past geological time; also, that types once established have persisted through a long series of geological periods. Therefore it has become known that fossils of fresh-water origin are of little value, compared with those of marine origin, as indices of the true geological age of the strata containing them. In consequence of this, the real value of fresh-water fossils as aids in the study of stratigraphic geology has been underestimated. While it is admitted that these fresh-water forms are of little value in determining the geological age of strata, they are really of as great importance in the study of local, and even of continental, geology as are any other fossils. Indeed, it would be quite impracticable to ascertain whether the waters in which formations have been deposited were marine, brackish, or fresh, except by the character of the contained fossils.

"Fresh-water formations of considerable extent can only be produced upon continental areas, and they consequently record phases of continental history of which marine formations give no indication. In western North America the fresh-water deposits rival in extent and thickness the great marine formations; and it would have been impossible to arrive at the knowledge of them which we have now attained except by a study of their fossils. Each of these great lacustrine formations has its own distinguishing fauna, the uniform character of which over great areas is quite remarkable. So large has been the area of some of the fresh-water seas in which these deposits were formed, and so uniform the conditions under which they existed, that the geographical distribution of species in them has been nearly or quite as great as the average of that of marine mollusca. For example, some of the species of the Laramie group have been found at points more than a thousand miles apart; and in the fresh-water Eocene groups the molluscan fauna is practically identical at points as much as 200 miles apart."

The Margin of Profits. BY EDWARD ATKINSON. New York, Putnam. 12°.

MR. ATKINSON'S writings on practical economy are among the best that we have. They are always interesting and suggestive, and frequently contain information and advice of much value to those for whom they are intended. They are not original in a scientific sense, and do not profess to be, Mr. Atkinson being a man of business rather than of science; yet all his arguments rest on a scientific basis, and on carefully collected statistics. He is, moreover, in hearty sympathy with the toiling poor in their efforts to improve their condition in life—indeed, most of his writings are inspired by this motive; yet he freely criticises them when he thinks their efforts are in the wrong direction.

The book now before us contains an address delivered before the Central Labor Lyceum of Boston, together with a reply made on the same occasion by Mr. E. M. Chamberlin, and Mr. Atkinson's rejoinder to the same. The special object of the work is to show, first, that the margin of profits, that is, the share of the capitalist in the products of industry, is much smaller than workingmen generally suppose; and second, that the progress of industry and the increase of capital, while benefitting the capitalist, of course, benefits the laborer far more. To prove and illustrate the first of these propositions, he cites the example of the cotton manufacture, in which the amount of capital used is larger in proportion to the product than in any other industry; so that here, if anywhere, we might

expect the profits to be unusually large. Yet, according to Mr. Atkinson, who is thoroughly informed in the matter, the profits are but a very small portion of the cost of the goods. He says: "When you buy 40 yards of cotton cloth at \$2.50, you pay the owner of the mill 15 cents profit, but you also pay about 15 cents more to other people for profit; that is, 30 cents profit in all; and you pay \$2.20 directly for labor" (p. 28). This statement he proves by an analysis of the process of production, illustrating the same by a chart.

He then goes on to show how greatly the working classes have gained by the improvements that have taken place in production and the consequent increase of capital. He gives it as his opinion, and economists generally hold the same view, that "there has never been a period in the history of the world in which there have been so many important new inventions or so many applications of previous inventions, all tending to human welfare, as in the last twenty-five years" (p. 109). And these improvements, though at first chiefly beneficial to the few, are now, he thinks, tending rapidly and largely to the benefit of the many. He cites some statistics showing that during the past twenty-five years the cost of living has been greatly reduced, while the wages of workmen have largely increased.

Mr. Chamberlin's reply to Mr. Atkinson is very feeble indeed, not one of his opponent's arguments being met, nor any new ones of value advanced. That Mr. Atkinson's views are in the main sound there can be no doubt; yet the scientific relations of capital and labor are not yet thoroughly understood, and until they are we cannot tell precisely how improvements in production and increase of capital affect the different portions of society. Mr. Atkinson is doing important service, however, in calling attention to the service rendered to society by capitalists, inventors, and other brain-workers, and which laboring men are liable to overlook or underestimate. He gives also valuable hints on the subject of personal and domestic expenditure, showing that the poorer classes might save much more than they now do without diminishing their present enjoyment in the least. The whole book, in fact, though containing little that is new of a scientific character, cannot fail to be of use to workmen, as well as to all others who are studying the labor question from a practical point of view.

Die Klimate der Erde. Von Dr. A. WOEIKOF. 2 vols. Jena, Costenoble. 8°.

DR. WOEIKOF, professor of physical geography in the University of St. Petersburg, is well known to American meteorologists as the author of the general explanatory essay in Professor Coffin's 'Winds of the Globe,' published after the death of the latter by the Smithsonian Institution. He has also been a frequent contributor to the Austrian and German meteorological journals and to other scientific periodicals outside of Russia, and his essays on the climate of the glacial period have attracted much attention from geologists. He has travelled and observed widely abroad, as well as read exhaustively at home. Students of physical geography are therefore to be congratulated that he has condensed the results of his labors in a general work on the climates of the earth, and also that an authorized German translation of the Russian original has appeared; for it is a positive loss to science when an experience as wide and well trained as Dr. Woeikof's is not recorded as far as may be in transmissible form.

The first volume of the work includes a series of chapters on matters of general importance, several of which have been republished elsewhere, so agreeable are they in style and treatment. The chief headings are, 'Pressure and Winds, including a Consideration of Temperature Changes in Vertical Currents;' 'Atmospheric Moisture and Precipitation;' 'Influence of Snow and Ice on Climate;' 'Temperature of Bodies of Water and their Climatic Influences;' 'Daily Variations of Temperature, Moisture, and Wind;' 'Variation of Temperature with Altitude, with Particular Regard to the Effect of Topographic Form on Temperature Changes;' 'Effect of Climate on Vegetation and of Vegetation on Climate;' 'General Statement of the Distribution of Temperature and Pressure over the Earth.' There is nothing of text-book style in these chapters: they are rather essays than lessons, fit for reading by the well-informed meteorologist rather than for study in

school. Reading of this sort is greatly needed in all branches of science, and nowhere more than in meteorology. Look, for example, at the account given of the effects of melting ice and freezing water on the temperature of the adjacent air. The effects appear either in time alone, or in both time and place. When lakes freeze, they retard the early winter fall of temperature, and when they melt they retard the spring warming by an equal amount: this effect is constant in place, but varies in time. On the other hand, when snow falls, the liberation of energy in its freezing affects the temperature of the air at some distance above the earth's surface, making it warmer than it would have been if condensation had not taken place; but the same snow, melting afterwards on the ground, keeps the air there from warming as much or as soon as it would had the snow been absent. Here, then, is an effect that varies in place as well as in time. It is like carrying ice from New England to India: if this once famous industry had been extensive enough, it would have raised our mean temperature, and lowered that of the torrid zone where the ice melted.

The second volume of the work is given to a general geographic account of climate. Here a comparison naturally arises with Hann's 'Klimatologie,' that appeared a few years ago. The subjects treated are identical; the difference is only in the plan of treatment and in degree of emphasis given to one part or another by the two authors. Dr. Hann made free use of original accounts by travellers and foreign observers, and inserted abstracts of their writings in smaller type, after presenting his own general statements; he also included the various climatic tables in the text, alongside of the paragraphs that they illustrate. Dr. Woeikoff reduces the records that he consults to common form, and postpones all tables to the end of the book, where they appear with numerous diagrams that have small representation in Dr. Hann's book. Preference between two methods such as these is probably a matter of taste, my own being for that followed by the Austrian author; but the other will doubtless find equal approval. The absence of sufficient reference to earlier authors makes both books less useful than they might have been; but the insertion of the references would have materially increased the size of the volumes, already large, and I believe it was for this reason that they were omitted.

The duplication caused by the almost simultaneous appearance of these two books on one subject can only be regarded as a great advantage. They were independently prepared by leading specialists; and the careful reader, who wishes to think as well as to quote, will gain a solid, stereoscopic comprehension of the subject by approaching it from these two slightly different points of view.

Food and Food Adulterants. Part I. Dairy Products. (U. S. Dept. Agric., Bull. No. 13.) Washington, Government. 8°.

THIS bulletin, which has been prepared by H. W. Wiley, chemist, is devoted chiefly to a discussion of the best methods of detecting the adulteration of dairy-products, that of butter being treated with greater detail than any other. During the past year the division of chemistry has been supplied with apparatus for photo-micrography, and most of the illustrations, twenty-four in number, are the work of the division. Great benefit has been derived from this method of fixing the photographic appearance of the crystalline character of butter and butter substitutes. The illustrations show the crystalline appearances of butter, beef-fat, lard, butterine, and oleomargarine, and are well executed. The bulletin contains the text of the act of 1886, passed by Congress, defining butter, and imposing a tax upon, and regulating the manufacture, sale, importation, and exportation of, oleomargarine; also a detailed history of artificial butter from its first manufacture by Mège-Mouriéz, in 1870, to the present time. The writer of the bulletin believes, that, while a great deal of artificial butter has been thrown upon the market, that has been carelessly made, and therefore harmful to the health, still a butter substitute, made carefully out of the fat of a perfectly healthy bullock or swine, is not prejudicial to health. This opinion is supported by quotations from the leading authorities, such as Professors Morton, Chandler, Barker, and others. The best methods of butter and milk analysis are described in detail, both microscopic and chemical. Other bulletins are being prepared, and will soon be issued, treating of condiments, sugar, sirup and honey, drinks and canned goods, flour and meal, tea and coffee, and baking-powders.

Milton's Paradise Lost. Books I. and II. Ed. with introduction and notes, by M. MACMILLAN. New York, Macmillan. 16°.

THE difficulties of Milton's works are so great, owing to the Latinized structure of his style and his many learned allusions, that they require a commentary almost as much as the ancient classics do. Nor have our scholars neglected to provide such helps; yet for school purposes most of them leave much to be desired. The little book before us is one of the best works of the kind that we have seen, and will help to make the reading of Milton both easier and pleasanter. It is confined to the first two books of 'Paradise Lost,' which the editor rightly considers the grandest portion of Milton's works. The notes are accurate and very exhaustive, as may be seen from the fact that they fill eighty-four pages of the volume, while the text fills only fifty-four. Almost every thing is explained in them that a student would need to have explained, and the explanations are simple and clear. An introduction of moderate length gives an account of the conception and composition of 'Paradise Lost,' together with some judicious criticisms on the poem. The book may be heartily commended for educational use.

Schiller's Wilhelm Tell. With Introduction and Notes by G. E. FASNACHT. London, Macmillan. 24°.

Schiller's Wallenstein. Part I. Das Lager. With Introduction and Notes by H. B. COTTERILL. London, Macmillan. 24°.

MESSRS. MACMILLAN & CO. have, in the two books named above, made valuable additions to their Foreign School Classics series. The Wallenstein is preceded by a well-written historical sketch of the origin and character of the thirty-years' war. The difficulties in reading Wilhelm Tell do not lie in Schiller's style and diction. These are throughout transparently clear. Not so the subject-matter. The reader's progress is delayed at almost every step by historical allusions, provincialisms, topographical and meteorological terms, for the elucidation of which even the advanced student needs to have a complete cyclopædia at his elbow. All this reference-hunting involves a great waste of time, and this little edition of the work has been edited with the view to placing these side-lights at the disposal of the reader.

Higher Algebra. By H. S. HALL and S. R. KNIGHT. London, Macmillan. 16°.

THE present work is a sequel to the author's 'Elementary Algebra for Schools.' The first few chapters are devoted to a fuller discussion of ratio, proportion, variation, and the progressions, which in the former work were treated in an elementary manner. The discussion of convergency and divergency of series always presents great difficulty to the student. To render this the more intelligible, the authors have introduced a short chapter on limiting values and vanishing fractions. In the chapter on summation of series they have laid much stress on the method of differences and its wide and important applications. Permutations and combinations and the theory of probability have received due attention, also the theory of determinants and their applications. The last chapter contains all the most useful propositions in the theory of equations suitable for a first reading.

Naturæ Veritas. By GEORGE M. MINCHIN. London, Macmillan. 16°.

WE learn from the author's preface that in this poem he has related certain things, which, in a temporary absence from this earth, he received from a being who, having completed the change of existence, had attained to a knowledge of the universe far transcending the capacity of man. The poem is descriptive of the author's supposed stellar visits in quest of information, which should lay at rest his doubts in regard to the dissipation of energy. Unfortunately the journey was without result.

The Owens College Course of Practical Organic Chemistry. By J. B. COHEN. London, Macmillan. 16°.

THIS little book on organic chemistry will be received with favor, doubtless, and has already received the high indorsement of Prof. Henry E. Roscoe and Prof. C. Schorlemmer. Any course of practical organic chemistry leading up to original work must mainly consist in a careful preparation of a well-selected series of organic compounds. Dr. Julius Cohen has in this little book collected such

a series; and doubtless the book, which is a novel one, will prove useful alike to professors, assistants, and students. Its primary purpose is that of a laboratory guide.

Four Figure Mathematical Tables. By J. T. BOTTOMLEY. London, Macmillan. 12°.

THIS is a series of mathematical tables comprising logarithmic and trigonometrical tables, and tables of squares, square roots, and reciprocals. In an appendix are contained a number of useful formulas and numbers, especially for those engaged in work in physical laboratories. The book is compiled by a lecturer in natural philosophy in the University of Glasgow.

NOTES AND NEWS.

IN order to expedite the publication of short articles upon astronomical and meteorological subjects which may be prepared at Harvard College Observatory, it has been decided to print them as successive numbers of a series, which will constitute the eighteenth volume of the 'Annals of the Observatory' when a sufficient amount of material has thus been collected. Each number will be published and distributed soon after it has been prepared.

— During this month will appear, under the editorship of Dr. G. H. Rohé, a quarterly journal, *The Climatologist*, devoted to the consideration of questions in the domain of medical and sanitary climatology. As there is at present no other journal in the world exclusively occupying this special field, the editor and publishers believe that there is room for such a publication. Each number will contain forty-eight quarto pages of reading-matter, the subscription price will be fifty cents per year, and the place of publication, S. E. Cor. Baltimore and South Streets, Baltimore, Md.

— Dr. John Vansant of the United States Marine Hospital at St. Louis claims to be the first to have taken photographs by the light of fireflies. He placed twelve fireflies in a three-ounce bottle, covering its mouth with fine white bobinet. The average duration of the flash of each insect was half a second, and the luminous area on the abdomen was about one-eighth of an inch square. The time of exposure was fifty flashes.

— Lieut. J. F. Moser, U.S.N., commanding the Coast Survey steamer 'Bache,' has just submitted a report of the hydrographic work executed by that steamer from Cedar Keys southward to a point off Chasahowitzka River, and the finishing of the hydrography from Cape Romano to the delta of the Mississippi. He refers to the great difficulty of running triangulations, owing mainly to the obscurity or entire absence of former triangulations, or other ear-marks of the locality to be surveyed. St. Martin's Reef was found to continue as far north as Homosassa, thence trending eastward to join the shallow waters of Crystal River. It is on the Florida banks, of which St. Martin's Reef forms an inshore part, that many of the commercial sponges are taken, and a large number of vessels are yearly engaged on the work. The tides in this locality were found to be easily affected by winds, causing great irregularity in their range, stand, and times of movement. The coast was found to be low and rocky, and the entire bottom covered with porous rock. The anchorage off St. Martin's Reef is good and safe in any weather except a hurricane. Lieutenant Moser says the country is dreary, desolate, and uninhabited, and the coast-line consists of fringing islands, thickly covered with mangrove. On these islands oysters are found growing in trees, the spawn having attached themselves to the branches at high water and developed into oysters. Bird-life was not abundant, even sea-gulls being conspicuous by their absence. Rail and blue and white herons were found, but even these birds have been driven away by the plume-hunters.

— A. Auwers has thoroughly discussed the alleged periodical changes of the diameter of the sun, and finds that in fact they do not exist. His researches, which are founded on 19 series of observations, — 12 of which refer to the horizontal diameter, and comprise 21,000 observations, while 7 refer to the vertical diameter, — show that the periodical changes are due to the influence of the temperature upon the instruments with which the observations were made, and that for this reason the period corresponds to that of the annual period of temperature.

LETTERS TO THE EDITOR.

Experimental Physics for Schools.

FOR years one of the requirements for admission to Harvard College has been such knowledge of physics as may be obtained from the study of any one of certain well-known elementary text-books. To this requirement is now added the study of a certain astronomical text-book, but as an alternative to both the text-book physics and the astronomy there is recommended a course of study in physics involving considerable laboratory work on the part of the pupil, supplemented by instructions from a text-book or a course of lectures.

Two questions suggest themselves to the teacher of physics when he finds himself met by the proposition to give laboratory practice to a whole class: 1st. Is this desirable if practicable? 2d. Is it practicable?

Without undertaking to discuss at large the theory of a liberal education, we can note a few considerations which will enable us to answer the first of these questions with some confidence: 1st. Physics is studied partly for training and partly for information, 2d. Text-book physics alone gives but little training that cannot be given by arithmetic, algebra, and geometry, all of which studies are pursued by the pupil before he enters college. 3d. Physics as taught by the laboratory experience of the pupil gives a kind of training that is not given by any course of study *required* for admission to Harvard College or, perhaps, any other college in the country. This training is partly of the senses and partly mental. It is true that many book-studies educate the senses to a certain extent, and the logical faculties, but unfortunately it is possible for a person who is observing and logical in things which he is in the habit of studying to be quite the opposite in dealing with things which do not habitually occupy his mind. Now, laboratory physics is the only elementary study for admission to Harvard College that requires the student to look beyond the pages of a book, and although most students do look at other things than books, they are not in the habit of *studying* things outside of books. 4th. The information given by the text-book alone is wide but superficial and vague. It is like that knowledge of a country which one may get by travelling rapidly over it on a railroad train. 5th. The information given by laboratory practice alone is definite but narrow. It is like that knowledge of a country which one would get if he tried to go over the whole of it on foot. 6th. Most students show far more interest in laboratory work than in the study of a text-book, even when the same subjects are dealt with in both cases. Much of the repugnance which many students feel for physics as they study it comes from the almost painful effort of the imagination to body forth the things described in the text-books, and which might be seen directly and handled in the laboratory.

From these considerations we reach the conclusion that the course which Harvard recommends to preparatory schools is desirable, if practicable, viz., to have the pupil study intimately certain topics by the laboratory method, and to enlarge upon, apply, and connect the knowledge so gained, by means of a text-book or a course of lectures. In the opinion of the writer, a course of lectures sufficiently extensive and systematic to take the place of a text-book for this purpose is beyond the present powers of most preparatory schools.

It may be hoped that by following such a course in physics the student will escape, on the one hand, a condition of blind and helpless dependence upon text-books, and, upon the other hand, the scarcely less unfortunate state of self-sufficiency which cannot or will not profit by the literature of the science.

Harvard University has issued for the use of teachers engaged in preparing students for its college classes a pamphlet giving a list of forty laboratory exercises, with specifications of the apparatus and materials to be used in these exercises, and with directions for their performance, or references to manuals giving such directions. These exercises are to be performed by the pupil. To speak cursorily, they deal with certain distinctive characteristics of the solid, liquid, and gaseous states of matter, the determination of specific gravities, the first principles of statics and dynamics, evaporation and boiling, the determination of the fixed points of a thermometer, expansion of solids and gases, specific heat, latent heat, velocity of sound, interference of

sound-waves, photometry, plane mirrors, converging lenses, lines of magnetic force, construction of galvanic cells, action of electrical currents upon magnets, electrical resistance of wires, battery resistance, construction of electro-magnets. Nearly all of these exercises are of a quantitative character, requiring measurements of some kind. It is expected that they will be liberally supplemented with other less formal experiments, not necessarily to be performed by the student, such as are described in ordinary text-books, with problems, and with general teaching, all of such a range and character as to give effect and continuity to the course.

In considering whether such a course of physics is practicable there are several points to be looked at:—

1st. The material equipment required. It will not in general be practicable for a teacher to give proper attention to more than twelve students working in the laboratory at the same time. The cost of the *portable* apparatus and material needed to enable twelve students to follow the course marked out in this pamphlet, each working upon the same experiment at the same time but in general independently, may be any thing from \$250 to \$450, according to the amount of time and skill the teacher can devote to its preparation. I think this part of the equipment, with apparatus ready made, can be bought outright for the larger sum mentioned. There will be needed also two strong tables, each about twelve feet long and three feet wide, one or two sinks with water-faucets, and for each student a supply of gas for a Bunsen burner.

For a school already well supplied with the ordinary *illustrative* apparatus, the total cost of adding the material equipment for the laboratory course, on the scale supposed, may range from \$400 to \$800. If only one or two students are to be provided for, the cost may be not more than \$50 or \$100.

2d. The demand upon the pupil's time. In the summer of 1886, Harvard sent out to a large number of teachers of physics in preparatory schools a circular requesting answers to certain questions, one of which related to the amount of time devoted to this study in their respective schools. About eighty replies to this circular were received, and the conclusion from these replies was, that, in laying out the elementary physics courses for admission to the college, we might assume that the pupil would have for this subject the equivalent of one school exercise of about forty-five minutes daily for one school-year of thirty-five or forty weeks, with some hours of study weekly out of the school-room. The proposed course has been planned in accordance with this estimate. This is probably about as much time as will be required for elementary French or elementary German in fitting for Harvard, and not more than one-half as much as most candidates have given to prescribed Greek, or one-third as much as they have given to prescribed Latin.

3d. The arrangement of hours. Experience in the Harvard physical laboratory, with a course very similar to the one proposed for the schools, dictates the suggestions, 1, that one school-hour per week be given to a preliminary explanation, and perhaps hasty performance by the teacher, of the exercises presently to be undertaken by the pupils, the whole class being assembled for this exercise; 2, that each pupil have two consecutive school-hours per week for the actual performance of the formal experiments of the course, the class, if large, being divided for this purpose into sections of not more than twelve; 3, that the other two school-hours per week be devoted to the supplementary work of the course with the whole class assembled. In order that the time allotted for the laboratory work may be sufficient, the student should be required to plan his work and his note-taking, so far as this is practicable, before coming to the laboratory.

4th. The demand upon the teacher's time. Scholars so young as those will be who may take this course need much direction in their laboratory work. The teacher should be in the laboratory whenever work is going on there. The preparation and care of apparatus and the proper supervision of the students' note-books will take much time, especially at first. After every thing has settled into regular working order, it may require six or eight hours more, weekly, of the teacher's time to conduct a class of thirty or forty students in the experimental laboratory course than to conduct a class of the same size in the text-book course, which is to be the alternative.

5th. The fitness of teachers for such work. Probably only a

small proportion of the teachers of physics in the preparatory schools have had such a training as would enable them to arrange and conduct the proposed course without considerable effort and some mistakes. For the first year or two crude work is to be expected, but teachers who are possessed of some mechanical skill, a good general knowledge of physics, considerable energy, and a willingness to think, will quickly become accustomed to the duties of the new course.

Just how great the difficulties which have here been touched upon will appear to the preparatory schools the writer is unable to foresee, but there can be little doubt that the larger schools which send boys to Harvard will, in general, speedily adopt the experiment method in preparing boys in physics. Last July about eighty candidates presented themselves for the entrance examination in the experiment course, and, although this course as now laid out will be more severe than that which some schools have followed during the past year, it is unlikely that any school having once undertaken the experiment course will abandon it for the text-book alternative.

The enthusiasm with which many teachers welcome the opportunity to follow the experiment method is very striking, and encourages the hope that the day of perfunctory cramming in physics merely for the purpose of getting into college is nearly over.

E. H. HALL.

Romantic Love and Personal Beauty.

THE above subject in its varied aspects, to which the review of Mr. Finck's book in *Science* has called attention, must be regarded by all thoughtful men, and above all by the biologist, as one of great, possibly unsurpassed interest to mankind. The question in its broadest aspect comes to this: How are the interests of mankind dependent on conjugal mating and the circumstances under which this is brought about? As no one can pretend to see the whole truth on such a subject (or indeed any other of comprehensive range), I shall give the results of my own observations and reflections, with a view of drawing increased attention to a subject of such transcendent importance. While every one, in some vague way, recognizes the importance of the step taken when two human beings agree to join their fortunes for life, the multifarious implications of such an act require for their comprehension a biological knowledge that but few, in the present state of civilization, possess.

Mr. Finck, after enumerating the characteristics of romantic love, grants that many of these are found in the lower animals, but at the same time leads us to believe that romantic love is wholly a modern growth, or that it had no genuine existence, at all events, previously. Is this position consistent for an evolutionist? If it existed lower in the scale than man, it seems very unlikely that it should cease to exist in the higher form. Mr. Finck seems to have rather overstated the case. That it never had complete development till modern times, that it was smothered, dwarfed, or perverted, we will freely admit; but we must deny that it is purely a *new* thing. Why is it, as we know it, modern in its development? Because never before was the altruistic conception of human conduct fully developed. That a man should sacrifice himself for an inferior was utterly opposed to all ancient ideas. When this conception took shape it at once began to appear that woman, being the weaker physically at least, demanded, in harmony with the altruistic principle, the service and sacrifice of the stronger, hence gallantry, etc. Formerly this was but an undeveloped germ in the breast of man; but it was there, however, and is not an absolutely new thing. In a word, romantic love demands a relatively high moral development for its vigorous growth. Perhaps Mr. Finck would really contend for no more than this.

Darwin, consistently with the great influence he assigned to sexual selection in his scheme of organic evolution, included man with other animals. He pointed out that "the men who are rich through primogeniture are able to select, generation after generation, the more beautiful and charming women; and these [he adds] must generally be healthy in body and active in mind." No doubt this explains a great deal, but it does not explain the origin of beauty in man or woman. In explaining the high average of comeliness and the relative frequency of beauty in human beings in America, this factor enters very largely into the explanation both of the preservation and increase of beauty of form and expression,

inasmuch as in no part of the world is there such unrestricted conjugal choice. But how does beauty originate? Sometimes suddenly, the offspring being incomparably superior to the parents; more frequently by gradual improvement, though certainly very pronounced in a large proportion of cases. A Darwinian would say this was owing to fortuitous variations and natural selection. But these 'fortuitous' variations Darwin did not attempt to explain. To do this is the task of modern evolutionists. It must be a gradual process so far as details are concerned.

In a paper read at the recent meeting of the American Association, I traced the influence of monotony in the environment, among other causes, in determining race degeneracy in a small and isolated community in the Bahama Islands, and endeavored to place this upon a scientific foundation. In a somewhat elaborate paper just read before the Canada Medical Association, I have advanced a new theory as to nutrition; viz., that the nerve centres are constantly exercising an influence over the nutrition of all the tissues of the body through the nerves distributed to them. This view supplements and explains that maintained in the first paper. It seems to me that it throws an entirely new light on the whole subject of evolution, supplies, in fact, a missing link in the explanation,—at all events for all animals with a nervous system,—and accounts for the origin of variations as, so far as I know, no other theory does. It furnishes what the Lamarckians have lacked but never supplied. I cannot, of course, give in this letter the facts on which this law is founded, but may say that they are of a threefold character: clinical, pathological, and physiological.

The form, etc., of every organ depends upon its mode of growth, upon its nutrition. According to the above theory of a constant neuro-trophic influence, the nutrition is every moment dependent on the nervous system. Now as it is through this system the organism is brought into relation with its environment, so through it the environment is registering its effects every moment. One thing seems to be settled in regard to beauty: it cannot originate when the existence is a purely vegetative one, devoid of all excitement of a psychical kind. That beauty is most frequent among the classes of the community in easiest circumstances, with opportunities for varied excitement of mind (and consequently of body), can thus be understood. That the mental mood causes the face to vary very much in expression is patent to all, and is understood by the influence of the mind over the muscles through nerves by influences radiating from the nerve centres. My theory goes much further than this, however, and assumes a constant influence of the nervous system directing the nutrition of every cell and so the form of the entire organism. By such a view we are able to understand how the young being *in utero* can be moulded to beauty or the reverse, by the environment of the parent. It may be long before we are able to work out the details, but we must not be hopeless even as to that.

This then is a physiological explanation of evolution. Now, although on reflection it must appear that all final explanations of evolution must be physiological, it is remarkable that scarcely a single physiologist has undertaken the solution of any of its problems. I hope to be able in the near future to elaborate the subject from the physiological standpoint and along the lines indicated above. And it is because this explanation seems to bear so directly on vital questions like those treated by Mr. Finck that I write to *Science* on the present occasion.

It is evident that for the best results to mankind there must be the freest choice in conjugal mating. We think biology has now advanced far enough to say of certain persons that they cannot mate without danger of deterioration in the offspring, e.g., in the case of those with a pronounced consumptive or strumous ancestral history; and it says much for the character of those who, with this fear before them, have sacrificed the prospects of conjugal happiness for a time, for the good of the race, by remaining in celibacy. An accomplished, experienced, and wise physician, well educated in the principles of heredity, might often, if consulted, be justified in saying nay. That he could say that any particular union is the best possible, is going far beyond our present biological knowledge.

With the inferior animals we can predict results as to offspring with a certainty that is remarkable. But with man the environment is so much more complex, from his more involved social life, from his high cerebral development (psychical life), that it is impos-

sible to estimate all the factors in the environment; and, if we could, we do not yet know exactly how they act. But nature has not left man without a sure guide. By man's instincts (intuitions) light is supplied, in each instance, that science can as yet give only as general principles. The individual is a light unto himself, provided that he has lived an honest, pure life.

For myself, on this point, I hold the strongest views. My theory as to falling in love would be something to this effect: there are in normal minds the elements of an unformed ideal, which takes definite shape when the person answering to that ideal appears, provided there be no interfering causes. This ideal appertains rather to *type* of individual than to any special person; i.e., there is the potential capacity to love one of many individuals of the type, and the exact individual of this type chosen may be a fortuitous matter. Good results, if not absolutely the best, follow in such cases, no matter which one of the type-class is chosen. As Carlyle said, "No man can love but once, and some not then." The choice of those of opposite tendencies, etc., results in a large proportion of cases in the highest good alike to the individuals themselves, their offspring, and the race. Man and woman in the conjugal state should be the one complementary to the other. The education of the sexes should lead to as much differentiation as possible, in order that the total energy available for the race may be maximal. The education given by parents and the general education of the public should be such as to allow of the highest degree of free, intelligent conjugal choice. If this is accomplished the results as regards beauty will be equally good with those in other directions. I seem, Mr. Editor, to be just getting into the subject, but I fear I have already taken up too much of your space; the importance of such a question must be my excuse.

T. WESLEY MILLS.

Physiological Laboratory, McGill College,
Montreal, Aug. 29.

The Study of Geography.

THE efforts of the Royal Geographical Society towards the improvement of geographic teaching in England, as recently described in *Science* by Mr. Keltie, deserve particular attention, both from the success already attained and from the need of going still further. The success is conspicuous, if measured only by the recognition and opportunity given to Mr. Mackinder as reader in geography at Oxford; and the advance already gained in the character of models, maps, and illustrations is admirable and enviable; but I cannot help feeling that the shortcomings of the scheme are also apparent. It seems to me that geography itself needs as much attention as the means of teaching and illustrating it: the principles to be taught and the facts to be illustrated need fuller discussion and better choice than they have yet received. But Mr. Keltie, in his recent article in *Science*, says: "Of what is known as physical geography—the topographical surroundings of humanity—there is not much to complain: its facts and principles are pretty well known, and fairly set forth in numerous text-books. It is when we come to apply these facts to humanity, and deal with their bearings on the development of man in communities, that we find so much to desire." I sympathize fully with the second sentence of this quotation, but not at all with the first. Certainly much is still to be done in recognizing and illustrating the bearing of geographic facts on the development of human communities, but quite as much, or more, is yet to be accomplished in the careful study of the facts themselves. Mr. Mackinder, in his address to the Royal Geographical Society (*Proceedings*, March, 1887), includes these geographic facts under 'physiography,' and their relations to humanity under 'physical geography'; but the illustrations that he presents are chiefly of the latter subject, and the tendency of the Society, judging by the character of its Journal of former years and its current Proceedings, is, with small exception, in the same direction. It should be noted, however, that Mr. Mackinder gives much more importance to geologic origin of geographic forms than has been usual. Now it may be true, though I think it is not, that enough is known of physiography to serve the wants of physical geography; but it is undoubtedly true that physiography as a science in itself is in a most immature condition, and is only in recent years obtaining

recognition. Physiography now is in the low position that natural history occupied in the first half of the century, when its text-books gave brief descriptions and pretty little wood-cuts of a great variety of forms, dwelling on their slight differences more than on their great resemblances. In a score or more of years, physiography will be fortunate if it attain as high a position as is now held by biology, the successor of the old natural history, in which a few forms are first studied minutely, and the knowledge of detail thus gained is broadened by giving emphasis to the resemblances that relate these few types to all the rest of the animal and vegetable world. As far as the economic relations of plants and animals to human history are concerned, some might be content with such a statement as 'a horse is a horse'; but the study of zoology for itself, without regard to its relations to history, must regard a horse as a highly specialized form of a general type, and must discover how his specialization was accomplished.

Physiography must make the same advance. It might serve the needs of physical geography if physiography made no distinction between a new plain smoothed by constructive process and an old base-level plain smoothed by destructive process; but to physiography itself the omission of this vital distinction is absolutely fatal. Placing such apparently similar forms together would involve the same order of error as that of classing whales with fishes, or of grouping the unwrapped cephalopods of the mesozoic with the straight forms of the low paleozoic. Time must be recognized as an element in geographic description even to a greater degree than it has been by Prof. Archibald Geikie in his study of 'geographic evolution'; for topographic development is the key to a real understanding of the forms of the land about us. Physiography must, moreover, follow the example of biology in studying its simpler type-forms carefully before attempting to understand the complex associations of forms that make up a country or a continent.

Continental homologies have gone far enough already, if indeed not too far, in the present state of knowledge: attention should be directed instead to the minute morphology and systematic development of individual topographic forms. The difficulties of such work are great, especially in teaching; for while it is admitted that 'seeing is believing,' and methods of instruction in chemistry, physics, and organic natural history are all remodelled with this principle in view, geography can at best secure but an imperfect application of the principle, and has to get along with maps, views, and models, instead of studying actual forms themselves. Maps are nearly always on too small a scale, and too poorly drawn to show what ought to be seen. Photographs are of course extremely useful, but they generally include too many varieties of form, and present too much detail, to serve best in elementary instruction; and they are as a rule taken with a geographic rather than a physiographic object. Illustrations in books of travel are too often of no scientific value: the traveller is generally an explorer instead of a geographer, and the artist too often stays at home. Most of Holzel's oleographs are admirably artistic, and all are highly valuable, and they probably come as near to being 'types' as any thing published. The illustrations in the reports of our Geological Survey are also most excellent in this respect. Models are too often merely copies of actual places that have been, for such a reason as complexity of structure or the like, chosen for this kind of illustration: the model of Monte Rosa mentioned by Mr. Keltie, excellent as it must be as the work of so artistic a geologist as Professor Heim, and so appreciative a topographer as Herr Imfeld, must have about the same relation to the needs of a class in physiography as a menagerie would have to the needs of a class in biology, or as Leverrier's computations about Neptune would have to a class in mathematics. Mr. Keltie recognizes, however, that, for teaching purposes, "it should be remembered that it is not extraordinary features that are desired, but typical aspects of the earth's surface," but he does not say where we shall find a scientific and sufficient investigation of the forms that are to be chosen as 'typical aspects.' There is no such investigation. The absence of any thorough and consistent physiographic terminology at once points out the immaturity of this study. Beginnings may be found here and there, but certainly not in 'numerous text-books.' The Sixth Annual Report of the Geological Survey, just issued, contains, for example, a number of illustrations

that will be seized upon when the proper text-book appears. The choice little woodcuts on page 229, entitled 'Topographic Old Age,' and 'Topographic Youth,' are particularly good, but these terms will certainly be new to most readers.

Let me repeat, therefore, that while the principles of physiography are coming to be pretty well understood, the facts have yet to be set forth in their proper light, and the world must be explored over again to find them. Let any one who doubts this read over the ordinary books of travel and the older geological and geographical reports, and see what sort of a physiography he can make out of them. Before the methods of teaching physiography are perfected, before the proper illustrations are constructed, much discussion is needed as to the principles to be taught, and as to the forms that are to be chosen for types. The Geographical Society still has a large work before it in this direction.

W. M. DAVIS.

Cambridge, Mass., Aug. 28.

The Blair Educational Bill.

IN *Science* of Aug. 19 is a note on the Blair Bill, by James Lawrey of Iowa. Mr. Lawrey declares that "any State that would accept national aid has not the spirit necessary to a sound government." Such a statement comes with very poor grace from one who resides in a State in which the schools are most richly endowed by the general government. Whence came the great educational funds of the western States, save from the munificent bounty of the general government? Has the spirit of the people of the State of Iowa, or of any western State, been, in any way, injured by the vast donations of land by the general government to these States? I understand that the great north-west was ceded to the nation for the benefit of all the people, by certain States having a good claim to the same. The later acquisitions by purchase and by conquest were all intended certainly for all the people. But in what way are the people of Pennsylvania or of Virginia benefitted by the school funds of Iowa or Nebraska, derived from the sale of lands belonging to all the people? These great land-grants are but little understood by the people of the East. A few years ago, when in Nebraska, I was told that the school lands of that State, if laid out in a belt two miles wide, would extend from the Atlantic to the Pacific Ocean.

I believe in the aims of the Blair Bill most fully, but I think it should be modified, in several particulars. 1. The money should be given to each State for the benefit of all school children in the same, but with no other restrictions. 2. The western States should receive no benefit from the grant until the old States have been granted sums to counterbalance the grants to the western States.

It is certainly a grave mistake on the part of our rulers to collect vast sums of money, more than are needed to conduct the government in an economical manner, but when once it is collected it should be returned in the most direct manner possible.

The South needs the aid. With ungallant restrictions removed, she will accept and make good use of it, I feel as sure as I do that it would do good in my own State.

GEO. G. GROFF.

Bucknell University, Lewisburg, Penn.

Wind Pressure and Velocity.

REFERRING to Mr. H. Allen Hazen's letter in your issue of the 2d inst., I beg to call attention to the fact that the temperature of the wind enters as an important factor in the determination of the pressure due to a given velocity. In 1876 (*Engineering and Mining Journal*) I first pointed out that a variation in temperature from 0° F. to 100° F. produces a difference in the amount of pressure, for a given velocity of wind, of over one-fifth the total amount. I have since discussed the subject more fully in a little treatise on 'The Windmill as a Prime Mover' (New York, John Wiley & Sons, 1885), giving detailed formulæ and complete tables, showing the relation between the pressure and velocity of wind.

Further accurate experimental determinations are certainly necessary, but all data entering the problem (among them, the temperature of the impinging air) should be carefully noted, and given due weight in any generalization drawn from the experiments.

ALFRED R. WOLFF.

New York, Sept. 5.

SCIENCE

FRIDAY, SEPTEMBER 16, 1887.

THE LATEST NEWS from Stanley is dated Yambuya Rapids on the Aruvimi River. This is the most eastern point that could be reached by steamers, and here the overland journey to the Mvutan Nsige was to begin. The expedition, which consisted of 612 men, left Stanley Pool on May 1, on the 'Henry Reed,' of the American Baptist Mission, with 131 men on board; the 'Stanley,' of the Kongo Free State, carrying 364 men, 500 loads of baggage and goods, nine riding asses and a herd of goats, and the 'Peace,' of the English Baptist Mission, with 117 men on board, and towing two boats. The 'Stanley' towed the hull of the steel steamer 'Florida,' which had been launched the day before. Two miles above Kinshassa the 'Peace' met with an accident, her rudder being broken, and she had to return to Leopoldville for repairs. After this accident the expedition travelled steadily on; but the 'Peace' proved to be very slow, and was unable to keep up with the other steamers. A short distance below Bolobo another accident befell the expedition. The 'Stanley' struck a reef, and one of her sections was completely wrecked. Fortunately she could be restored to use by patching plates underneath. In order to make up for the time lost, Major Barttelot marched overland from Wamboko River to Kwamouth, and his party was afterward brought up to Bolobo by the 'Stanley.' Meanwhile the engineer of the 'Peace' had resolved to screw down the upper safety-valve, and by this expedient enabled the 'Peace' to proceed at the same rate as the other steamers. The journey from Bolobo to the rapids of the Aruvimi was effected without any further delays or incidents. On June 18 this place was reached, and Stanley proceeded at once to build an entrenched camp, in which Major Barttelot is to remain. While Stanley's steamers ascended the Aruvimi, Tippo-Tip was conveyed on the 'Henry Reed' to Stanley Falls station, of which he is the chief. He was accompanied by 96 Zanzibari, and Major Barttelot, who had 40 Sudanese soldiers with him, commanded the steamer. It seems that Stanley was going to leave the Arabian trader at Stanley Falls, and proceed to the Mvutan Nsige alone. Barttelot was to return the day after his arrival at Stanley Falls, and to rejoin Stanley at Aruvimi Falls. The natives of Yambuya would not allow the expedition to land, but, on hearing the steam-whistles, fled into the woods. The next day a few returned, and were sent off with presents. Stanley hoped to gain their confidence within a short time. On June 20 the 'Stanley' left the Yambuya Falls, and arrived at Leopoldville on July 2. These are the latest letters from Stanley so far; but the cable informs us that he found the river navigable above the Yambuya Falls, and that he was able to proceed in boats. Probably the 'Henry Reed' brought this news to Leopoldville. It may be that the river proves to be navigable for a long distance, and in this case Stanley's march to the Mvutan Nsige will be greatly facilitated.

THE TRANSCONTINENTAL RAILROADS.¹

THE transcontinental railroads cross great plains, high mountains, lofty plateaus, and broad basins, and follow the courses of long rivers. Nowhere do we find objects of greater interest to the traveller, geographer, geologist, or the student of natural history, than along these lines of travel. The rivers that rise on the eastern slope of the Rocky Mountains pursue an uninterrupted and peaceful course from the foot-hills, across the great plains, to the valley of the Mississippi. The rivers that rise on the western slope en-

counter range after range of mountains, some higher than the Rockies, and find their way to the ocean over high falls, through deep cañons, or by forcing a way through mountain ranges. Here is the longest persistent range of mountains in the world, — broad plateaus elevated from 8,000 to 10,000 feet above the level of the sea. Here are deep basins, with mountains so closely surrounding them that the streams, unable to find a way to the ocean, sink into the desert. Here is the valley of the Colorado, running through cañons 3,000 to 4,000 feet high, over 200 miles long, and so deep that in some places the sunlight never reaches the bottom. The rain, instead of fertilizing the ground, washes from the rocks every particle of soil, and leaves the country a desolate wilderness, devoid of vegetable or animal life. Here are high snow-mountains, and at their base deep valleys, sunk below the level of the ocean. There are mountains, more beautiful than Mont Blanc or the Matterhorn, rising directly from base to summit, 14,000 feet in height, with glaciers exceeding in extent and beauty any in Europe. From the far north to the extreme south are mines of gold, silver, and copper, and vast deposits of coal, lead, and iron-ore. Here the student of natural history finds fossils in endless variety and number, from the toothed bird to the miniature horse. As a compensation for the want of trees on the mountains, the largest and finest forest-trees in the world are found at their base, on the Pacific coast. The millions of buffaloes which formerly roamed over the plains are all gone, but their places are supplied by countless herds of cattle and flocks of sheep. Such a land is worth visiting; and the description of the country through which the railroads run, and of the roads themselves, must be of interest.

The traveller from the Atlantic to the Pacific by either of the transcontinental railroads enters the great plains, soon after crossing the 95th degree of longitude, near Winnipeg on the north, Omaha and Kansas City in the middle latitudes, or San Antonio at the south. Then commences the ascent, steadily continued until the top of the Rocky Mountains is reached. The land rises, at first slowly, then on steeper grades, and yet so gradually that the passenger on the Union Pacific reaches an elevation of one mile before he has seen the mountains or realizes that he has attained any considerable elevation. From the foot-hills, over the mountains to the Pacific Ocean, each road follows a route having its own features, so striking and distinct that no general description is of any value. The chief objects of interest are the great plains, the rocky mountains, the deep basins, the ranges of mountains west of the Rockies, and the plateau of the Colorado River; while the railroads — the work of man — vie in interest with the natural wonders.

The Great Plains.

Looking from Denver towards the west, or, better yet, from almost any part of the great plains in Colorado within 50 miles of the Rocky Mountains, are seen the foot-hills, then the mountains, rising higher and higher until lost in the distant snow-caps. Looking towards the east are the green and grassy plains falling in gentle undulations, north, south, and east, as far as the eye can reach, and for hundreds of miles beyond. These are the great plains of America, bounded by the Rocky Mountains on the west, the Arctic Ocean on the north, the Gulf of Mexico on the south, the Missouri and Mississippi rivers on the east. The great plains reach their culminating point between Denver and Colorado Springs, — at the divide between the waters of the North Platte and Arkansas rivers. From this elevation of 7,000 feet they slope north-easterly into Wyoming and Canada, towards the Arctic Ocean, easterly to the Missouri River, and southerly into New Mexico. The land, only fairly watered on the east, becomes arid towards the foot-hills of the Rockies, and, though rich and fertile, cannot be cultivated without irrigation. The rivers grow larger towards their sources, as the rainfall on the plains is insufficient to supply the

¹ The unfinished portions of the roads are included in the accompanying map.

loss by evaporation and irrigation; but there is no portion of these plains that deserves the name of desert, or that is comparable in degree of sterility with the cañoned country west of the mountains. It is only a few years since it was called the 'Desert of America,' and it was then believed that the great plains were unfit for cultivation or habitation. Then they began to be used for pasturage of cattle. Now, by a judicious system of irrigation, larger crops of wheat and grain are grown than in the great prairie States, while the detritus from the irrigating water more than compensates for the exhaustion of the soil by the crops.

The Rocky Mountains.

These mountains rise in Alaska, on the Arctic Ocean, far to the north of Sitka, and attain their highest elevation — 20,000 feet — in Mount St. Elias. They run through British Columbia, Idaho, Montana, Wyoming, and Colorado. They appear as high, level plateaus and spurs in New Mexico and Arizona, joining the Coast Range, to appear again as the Rocky Mountains or Cordilleras in Mexico, where they attain the height of 19,000 feet in Popocatepetel, passing thence through the isthmus of Central America into South America, where they form the back-bone of that continent, terminating near the Antarctic Ocean at Cape Horn. Mount Brown and Mount Hooker, in British Columbia, rival Monte Rosa in height. The highest mass of these mountains is in Colorado, where there are nearly one hundred peaks 14,000 feet in height, none of which are 500 feet above or below that height. It is impossible to give definite boundaries to the Rocky Mountains, as they enclose many ranges and systems. Major Powell of the Geological Survey classes the Rocky Mountains into the Park, the Geysers, and the Basin systems. In the mountains and plateaus of these systems bare rocks are seen to an extent rarely found on the globe, and the region is largely destitute of soil and timber. In striking contrast to this destitution are the parks in Wyoming, Colorado, and New Mexico. The largest of these are the North, Middle, and South parks of Colorado, — elevated plains containing from 800 to 1,000 square miles, 9,000 to 10,000 feet above the sea-level, surrounded by high mountains, with a fertile soil, furnishing fine pastures for cattle in summer, but with the warm season so short that wheat and grain do not ripen. In these mountains rise the great rivers of the world, — the Missouri, Mississippi, the Columbia, and Colorado, in North America; and the Amazon and La Plata in South America.

The Geysers system is in Wyoming. The mountains are not so high as in the other systems, but in their recesses lies the Yellowstone Park. Before the geysers of this park "all others in the world, even the celebrated ones of Iceland, sink into insignificance. This park seems to have been set aside by the Great Maker for the exhibition of the action of volcanic forces."

The Great Basin.

The Great Basin, so called because it has no drainage into the ocean, extends from the summit of the Rocky Mountains and the plains of the Colorado River west over one thousand miles, far into California, and from Oregon in the north over fifteen hundred miles south into Lower California, south of Los Angeles and San Diego. It includes the middle and western parts of Colorado, the whole of Utah and Nevada, and parts of Oregon and California. Numerous short ranges run invariably north and south, with deep valleys between them. The greatest of the basins is that of Salt Lake, five hundred miles long and six hundred miles wide, between the Rocky and Sierra Nevada mountains. Here rain rarely falls, and the rivers which rise in the mountains surrounding it on every side are soon dried up, or, like the Carson and Humboldt, after running from 100 to 300 miles, sink into the desert and disappear. Large lakes are formed in the deeper valleys, but the water in them is salt. For hundreds of miles the traveller sees only alkali plains, breathes alkali dust, and drinks alkali water. Far to the south-west is Death Valley, over 150 feet below the level of the ocean, so called from the number of emigrants who lost their lives from hunger and thirst in sight of the snow mountains and close to the promised land. But, as if to compensate for the desert of death, on the opposite side of the Sierras are the Yosemite and the big trees of Calaveras. The mountain ranges west of the Rocky Mountains are popularly called the Cascade, Sierras, and Coast Range.

The Cascade Mountains.

The Cascade Mountains rise in the upper part of British Columbia, follow the coast-line through British Columbia and Washington Territory, passing thence through Oregon, and die out in northern California, to be succeeded by the Coast Range. The snow-line is reached at a lower elevation than in Switzerland, and, unlike the Alps, the great mountains rise directly from the sea 14,000, 15,000, and even 20,000 feet in height. From the sides of Mount St. Elias in Alaska — the highest mountain in America — vast glaciers run into the ocean, exceeding in grandeur and extent any found in Switzerland. Mount Baker and Mount Tacoma in Washington Territory, and Mount Hood in Oregon, radiant with eternal snow, are more beautiful than Mont Blanc or the Matterhorn; the glaciers on Mount Tacoma equal those of these mountains, while, to add to the sublimity of the scene, smoke is frequently seen rising from the craters of Mount St. Elias and Mount Adams. There is probably no other country where, on the same parallel of latitude, and at the same elevation, there are such great differences in climate, soil, and vegetation as on the east and west sides of the Cascade Mountains. On the east are barren hills and plains, devoid of all vegetation save the sage-brush and bunch-grass; the climate is hot in summer, cold in winter, and dry as that of the Desert of Sahara. On the west side of the range, and not fifty miles away, the country is thickly studded with the finest of forest-trees, abounding in vegetable life, with a continuous rainfall, the climate mild in winter and temperate in summer. On the foot-hills and in the western valleys the deep green of the Douglas fir, extending for hundreds of miles, contrasts with the pure white of the snow. The only drawback is the thick clouds of smoke from burning forests, which usually darken the sun and hide the mountains from view for two or three months in the summer.

Sierra Nevada.

The Sierra Nevada Range might be called a continuation of the Cascade Mountains; but those are of volcanic origin, and the Sierra Nevada is granite, though traces of volcanic action are often found on the flanks and base. It commences at Mount Shasta, 14,400 feet high, and runs in a southerly direction to Tejon Pass, where it joins the Coast Range not far from Mount Whitney, the highest mountain in the United States south of Alaska. There are but few passes over these mountains, and the Pacific slope is very steep, the Central Pacific road descending 6,300 feet in 80 miles.

Coast Range.

This is a long range of sand-stone mountains. Rising in Oregon, south of the Columbia River, it follows the coast through Oregon and California into Mexico, where it unites with the Rocky Mountain Range proper. It is lower than the other ranges, attaining an elevation of 3,000 to 5,000 feet. At the foot of this range, far to the east, is the Willamette River in Oregon, the Sacramento and San Joaquin rivers in California, with long narrow valleys unsurpassed in richness. On the western slope the rainfall is abundant, and the valley and foot-hills are covered with a luxuriant growth of vegetation, — the redwood, Douglas fir, and other members of the *Sequoia* family, more useful than the big trees, and in large groups scarcely less imposing.

The Coast and Cascade ranges run parallel with the coast; and the Fraser, Columbia, and other large rivers, which rise in the Rocky Mountains, find a way through these ranges to the Pacific Ocean. The Fraser River forces its way through a deep cañon, 200 miles long, and makes a route for the Canadian Pacific; the Columbia River breaks through the Cascade Mountains at the Dalles, about three hundred miles south of the Fraser, and makes a way for the Northern Pacific and Oregon Short Line.

Canadian Pacific Railroad.

From Montreal this road follows the rich and fertile valley of the Ottawa 350 miles, then through a wilderness of lakes, rocks, and streams to Lake Superior, around its northern shore, past lakes and woods and over marshes, to the 94th degree of longitude, about 100 miles east of Winnipeg. A more God-forsaken country I have rarely seen, — the land too rocky, thickly wooded, and wet for cultivation, the trees too low and stunted for timber. Mines are supposed

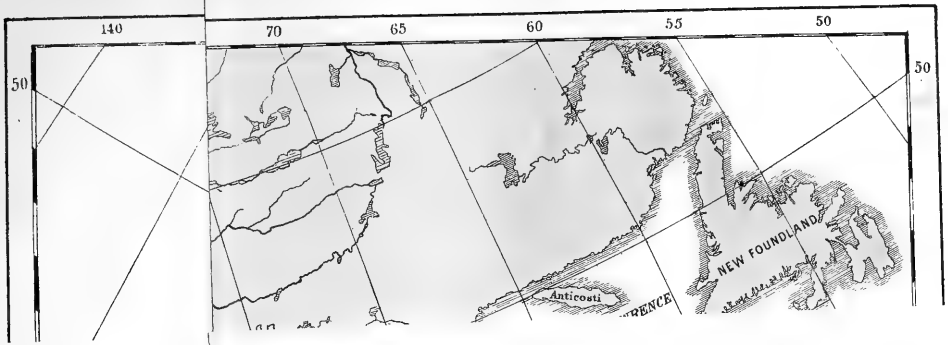

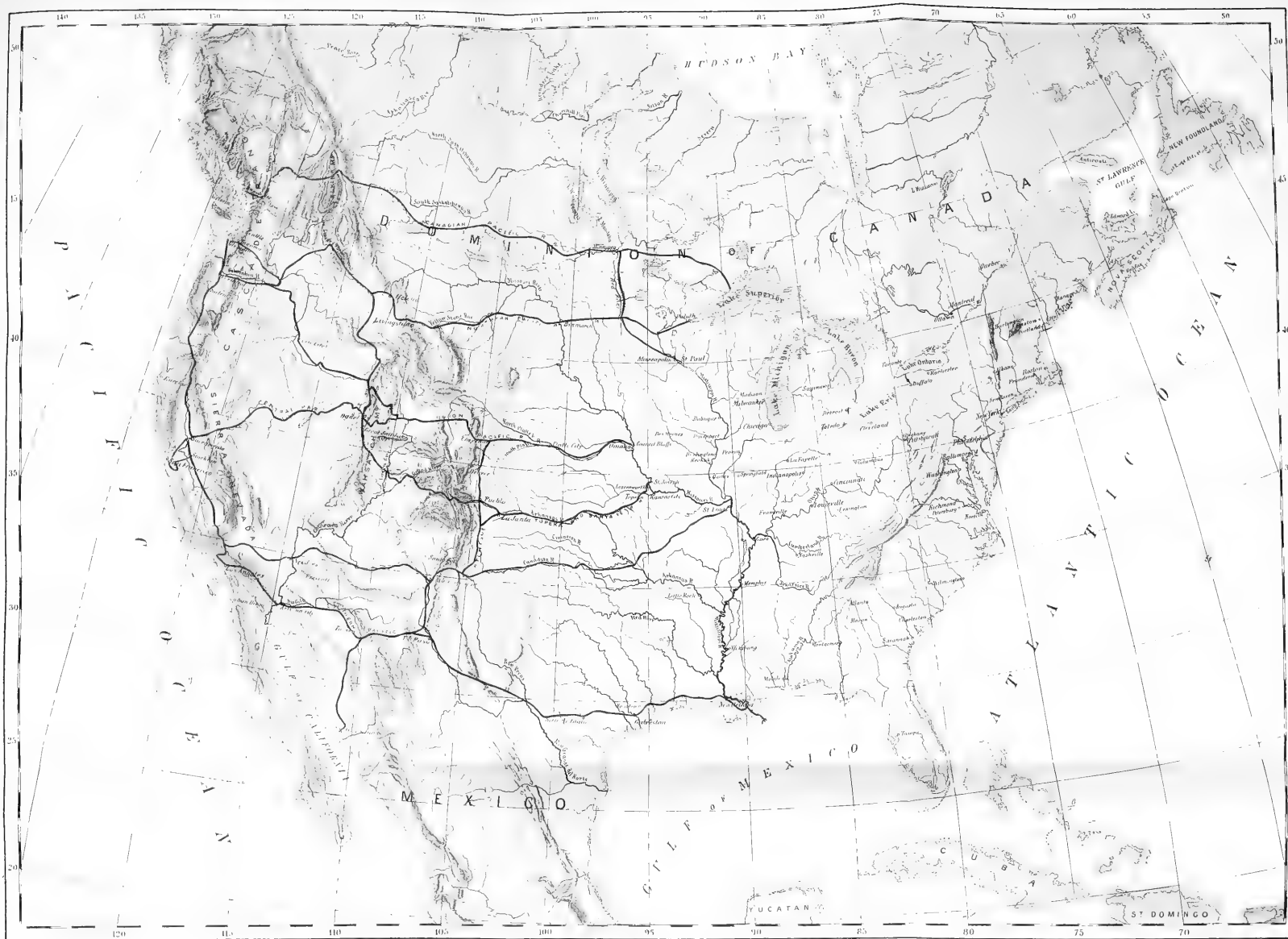

MAP OF NORTH AMERICA SHOWING THE PACIFIC RAILROADS.

SCIENCE, September 10th 1887, No. 241

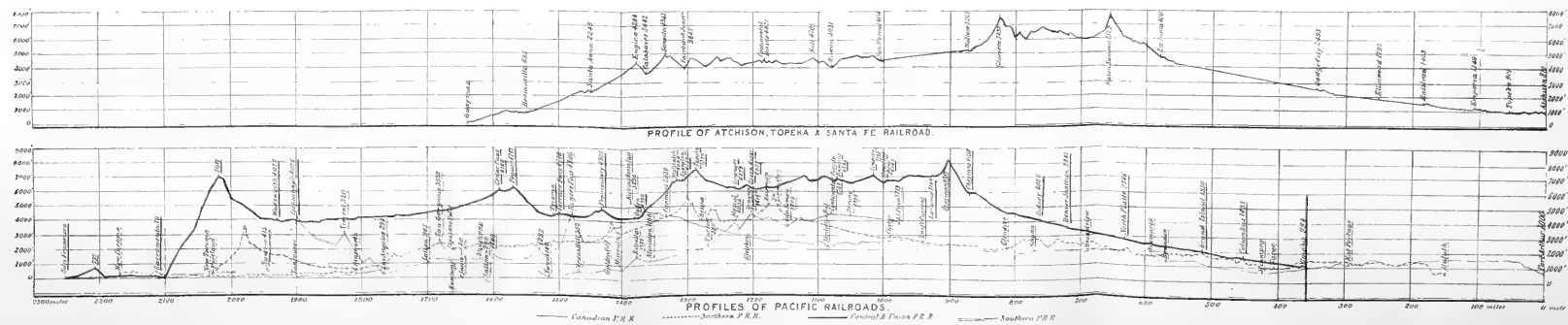

PROFILE OF ATCHISON, TOPEKA & SANTA FE RAILROAD.

PROFILES OF PACIFIC RAILROADS.

Canadian P.R.R. Northern P.R.R. Central & Pacific P.R.R. Southern P.R.R.

to exist, but not yet worked to any considerable extent. This was the most expensive section of the road, the outlay being some \$12,000,000 for 200 miles, and a single mile of the heavy cuttings and tunnels cost as much as \$750,000. The company expended \$2,100,000 for explosives, most of which were used on this section. From the 95th degree of longitude, through Winnipeg to Calgary at the foot of the Rockies, it runs across the great plains nearly one thousand miles. The plains are generally rich, and, when irrigated, yield good crops; the rainfall, light at Winnipeg, decreases towards the mountains. The country north of the railroad, on the north branch of the Saskatchewan, is richer, has a greater rainfall, and bears heavier crops. It was on the line of this branch that the first surveys were made, and, under Mount Hooker, the highest of the Rocky Mountains, a pass was found only 3,760 feet high, and a route little longer than the one finally adopted; but beyond this pass the country was so rough and the mountain ridges so numerous that another route was found after the expenditure of over \$3,000,000 in the survey of twelve thousand miles of different routes. The ascent from Winnipeg, 700 feet high, is gradual to Calgary, 2,900 feet above the sea-level, thence to the summit at Stephen, 5,296 feet, 150 miles from Calgary. Thence the route descends to the crossing of the Columbia River, where, instead of following the great bend, some 200 or 300 miles, it climbs the Selkirk Mountains to the Glacier Hotel, 4,300 feet high. The glaciers come down the mountains close to the hotel, and are easily reached by a short walk. Here are most beautiful views of glaciers, woods, and mountain peaks, affording varied and delightful excursions to the tourist. Between the first and second crossing of the Columbia River, 80 miles, the road ascends 1,788 feet, and descends 2,761 feet. The Gold Range is then crossed at a low grade, when the road strikes the Fraser River, about 100 miles west of the Columbia, and follows its course through the Cascade Mountains, in deep cañons for a long time considered impassable. After leaving the river, the road runs across the low lands to Vancouver on the sound. This is the shortest line from the 95th degree of longitude to the Pacific Ocean, with the lowest grade and the greatest length on the plains. It is claimed to be the only line that runs from ocean to ocean, and is connected with Japan and China by its line of steamers. The Canadian Pacific Railroad Company received from the Dominion Government grants of money and land far exceeding those paid to any of our railroads, and has recently obtained a subsidy for carrying the mails across the continent.

The Northern Pacific Railroad.

The Northern Pacific Railroad starts from St. Paul on the Mississippi and from Duluth on Lake Superior, 600 feet above tide-water. It runs nearly due west from Duluth, 1,000 miles to Livingstone at the foot of the Rocky Mountains. The country, after leaving Lake Superior, is rough, rocky, and is of little value except for timber, for 150 miles. There the great plains begin, and the land is fertile, producing abundant crops if well watered, for about 600 miles, when the Bad Lands are reached, about 200 miles west of the Missouri River.

The other transcontinental railroads, in crossing the plains, have a regular ascent, following the valleys of rivers, but the Northern Pacific crosses the Mississippi, Red, James, Missouri, and Little Missouri rivers, and the divides between these rivers, at right angles. While there is a general up-grade, the ascent is not as regular as on the other lines. West of the Little Missouri the up-grade continues over the Bad Lands to the valley of the Yellowstone; the road follows that valley for 330 miles, to Livingstone at the foot of the Rockies. The line passes within a few miles of the Big Horn, and there, where eleven years ago General Custer with his entire command was massacred by the Indians, now the peaceful settlers herd their cattle, and cultivate the fields of wheat and grain. At Livingstone the Yellowstone turns south, opening a way into the mountains. A branch of the road runs to the Yellowstone Park, about 50 miles distant, and the traveller is well repaid for the whole journey if he can spend a week in the park. The main line, on leaving Livingstone, crosses the first range of the Rocky Mountains at Bozeman summit, 5,570 feet in height. The road then descends to the valley of the Missouri, and follows down the river, 50 miles, towards Helena, and passes through that mining centre,

brilliantly lighted with electric lights, to Mullen Pass, where it crosses the great divide at a height of 5,547 feet, 1,200 miles west of St. Paul, thence, with a general descent, following the waters of Clarke's Forks through Montana and Idaho. Montana, the watershed between the two oceans, has an elevation of about 4,000 feet above the sea-level. The winters are, very cold, the summers hot and dry; only scanty crops can be raised, for there is little rain and few irrigating streams. The cattle range over the plains and mountains in summer, and, if properly fed and protected for two or three months, will stand the long cold winters. When storms come, the cattle, unless protected, drift before the wind for many miles until they find shelter, and when the storm abates slowly return to their grazing grounds. The general elevation of Idaho is lower than that of Montana, and its great lakes soften the temperature, while the warm winds from the Pacific Ocean temper the winter climate. There is more rainfall and better soil; wheat and grain grow in greater abundance. In both of these territories there are great stores of precious metals, the yearly product of Montana being about \$25,000,000. The road runs around the beautiful Lake Cœur d'Alene, then for many miles down the Spokane River, with its beautiful falls, to Pasco on the Columbia River. Here the road branches, one line following the Yakima River, crossing the Cascade Mountains at a height of about 4,000 feet, thence to Seattle and Tacoma on Puget Sound. The other branch follows the Columbia River, which forces its way through the Cascade Mountains, at the Dalles and Cascades, to tide-water at Portland, about 100 miles from Astoria at the mouth of the river. The route over the Cascade Mountains, reaching the fine harbors of the sound, will eventually be the main route. The Northern Pacific is comparatively free from the great alkali deserts found on the more southerly roads, and is therefore more comfortable for the traveller. Few more beautiful trips can be found than over this road by the Yellowstone Park to Tacoma, and thence by the Oregon and California road to San Francisco, and home by the Yosemite and the Atchison, Topeka & Santa Fé Railroad.

Union and Central Pacific Railroads.

The Union Pacific Railroad, with its Kansas branches, the Chicago, Burlington & Quincy, and the Atchison, Topeka & Santa Fé, cross the great plains from the Missouri River to the foot-hills of the Rocky Mountains, over a country very similar to that crossed by the Canadian Pacific, but with steeper grades. The Union Pacific begins at Omaha, runs thence 500 miles to Cheyenne on an up-grade averaging ten feet to the mile, increasing in steepness as it approaches the foot-hills; then it rises more rapidly, reaching the summit at Sherman, 8,240 feet above the sea-level, 550 miles from Omaha. From thence to the top of the Wasatch Range it runs on an elevated plateau, nowhere less than one mile and a quarter above the sea-level; it then descends rapidly 3,800 feet to Salt Lake, follows the Humboldt Mountain, and crosses the Humboldt Valley, over 300 miles, until the river sinks into the desert, then rising rapidly to the summit of the Sierra Nevada, 7,000 feet, passing by Tahoe, the most beautiful of lakes, then down a grade, which when it was built was the longest and most rapid descent in the world, to tide-water near Sacramento. On turning round a promontory called Cape Horn, near the top of the Sierras, the traveller looks down a perpendicular descent of 2,000 feet into the valley of the American River,—one of the most beautiful views in the mountains.

The Union and Central roads were the first transcontinental railroads built. The construction was carried on during the civil war, and was finished only four years after its close. The grades are much heavier than those of either of the other roads, and it runs for a longer distance through the mountains. The grades are so unfavorable, compared with other lines, that the Union Pacific has sought another outlet by the way of the Oregon Short Line to the Pacific, and the Central Pacific has found an easier route to the Atlantic by its Southern Pacific Railroad. The Oregon Short Line, a road built and leased by the Union Pacific, leaves the main road at Granger, 875 miles from Ogden, crosses the Rocky Mountains at an elevation of 6,279 feet, to the Snake River at American Falls, 1,100 miles from Ogden, and follows the valley of this river to the Columbia, at Walla Walla junction. The valley of the Snake River

is fertile. It produces fine crops with little, and in many places without any, irrigation, not on account of a greater rainfall, but from the different character of the soil. The grandest scenery in the mountains is found on the Denver & Rio Grande Western Railroad. This road starts from Ogden, the junction of the Union Central Pacific Railroad, traversing the valley of Salt Lake and its River Jordan, crossing the many ranges of the Rockies by passes over two miles above the sea-level, through deep cañons so steep and narrow that in the Royal George Cañon the road is carried along the river on a bridge, no way being found for the road on the mountain side. At the eastern terminus the Denver and Rio Grande road connects with the Atchison and Topeka at Pueblo, and with the Union Pacific at Denver.

Atchison, Topeka & Santa Fe.

Kansas City has heretofore been the starting-point of this line, but it is now being rapidly extended east to Chicago, and will soon run a through train from Chicago to the Pacific Ocean. From the eastern boundary of Kansas it follows the line of the Arkansas River 600 miles west to La Junta, 4,000 feet above the level of the sea. Here it turns and runs to the south-west, 330 miles, to Albuquerque, thence turns and runs due west to the Pacific Ocean. It crosses two ranges of the Rocky Mountains, the first at Rincon, on the boundary line between Colorado and New Mexico, the highest pass on the road, 7,600 feet; the second at the continental divide, 1,000 miles from Kansas City, 7,200 feet high; thence along a high plateau nowhere less than one mile in elevation, 700 miles, following the Little Colorado River; thence it descends rapidly 125 miles, to the Needles, where it crosses the Colorado River at the boundary line between Arizona and southern California, 477 feet above tide-water. Then the Sierra and Coast ranges are crossed, at a height of about 3,000 feet, and tide-water is reached at Los Angeles, San Diego, and San Francisco. Near Albuquerque, 900 miles west of Kansas City, is a branch of the road to Santa Fé, the old city of the plains, famous for its Mexican remains. Here, too, are the hot springs of Los Vegas, having a winter climate unequalled for health. The air is dry and bracing, and more temperate than that of the far-famed Colorado Springs. Holbrook, 1,100 miles from Kansas City, is sixty miles from the renowned Pueblos of the Moquis tribe of Indians.

The Plateau Country, so called, through which the Colorado River and its branches run, is reached either from Peach Springs, 1,400 miles from Kansas City, by a stage-road, only 16 miles, to the Grand Cañon, or from Flagg Staff, 60 miles from Point Sublime. Here is the sublimest scenery on the continent, as yet but little visited for want of easy means of access. The more it is known, the greater will be the number of visitors. The Plateau Country is the land of cañons, all of which lead down to one great trunk-channel cleft through the heart of the Plateau Country, 800 miles long, and with a depth of from 2,000 to 6,000 feet. Of the many cañons in the plateau, the Grand Cañon is the "most magnificent as well as the grandest geological section of which we have any knowledge." It is 218 miles long, from 4,500 to 6,000 feet deep, averaging 5,000 feet. Its width from crest-line to crest-line is from $4\frac{1}{2}$ to $12\frac{1}{2}$ miles, the widest portion being always the grandest. Not far from the Grand Cañon, near Peach Springs, is Little Zion Valley, a cañon running into the Grand Cañon. "In its proportions it is almost equal to the Yosemite, but in its nobility and variety of the sculptured scenery and wonderful variety of colors, there is no comparison.

Southern Pacific Railroad.

It is hardly possible to realize how recently the territory through which this road runs came into our possession. California in 1846 was an "outlying and neglected Mexican province." New Mexico, Arizona, and southern Colorado were purchased of Mexico in 1853, under the Gadsden treaty, for \$10,000,000, "because the low level of the mountains below the Gila was the natural route for a southern transcontinental railway." Soon after the purchase, schemes were formed in the East for constructing a Southern Pacific road. Fifteen years ago a few hundred miles of road were built in Texas, and the promoters applied to Congress for a subsidy. Then the managers of the Central Pacific, who controlled all the business of the Pacific slope, determined to construct the

Southern Pacific without a subsidy, and thereby retain their monopoly. The road was commenced in the year 1875, and was completed in 1881. The eastern termini of this road are at New Orleans and Galveston. Like the Canadian Pacific, it crosses the continent from ocean to ocean. It passes through the rich lowlands of Louisiana and Texas, reaching the great plains a little west of San Antonio. Near this city it meets the Rio Grande River, follows its valley, ascending by a steady grade to El Paso, 1,200 miles from New Orleans; thence through New Mexico and Arizona on an elevated plateau about 4,000 feet high for 200 miles, by the foot-hills and over the spurs of the Rocky Mountains, to the continental divide at Dragon Summit, 4,614 feet above tide-water; thence over the valley of the Gila and its branches to the Colorado River, which it crosses at Yuma near the mouth of the Gila, through a dry and arid desert rich in mines of silver, copper, and lead,—a country long desolated by the Arapahoes; thence down into the great desert of California, 260 feet below the level of the sea, and over a low range or spur of the Sierras to tide-water at Los Angeles and San Diego (the country near Los Angeles is the garden of California, where the orange-tree buds, blossoms, and ripens its fruit all the year round); then over the main range of the Sierras at Tehachapi, 4,026 feet high, and down into the valley of the San Joaquin and Sacramento rivers to San Francisco. The grade of the road is lower and more favorable than that of either of the other transcontinental roads. It is a favorite route for passenger travel in the winter and spring. In the summer the heat is so intense and the dust so thick as to render it uncomfortable.

The great plains begin at San Antonio, and run about 700 miles to the foot of the mountains near El Paso. They are much lower than in Colorado, Utah, and Wyoming, but are more arid. Occasionally on the plains west of San Antonio there has been no rainfall for one and even two years. These plains would make the finest pastures for cattle when there is sufficient rain, as the snows are light, the winters warm, and the pastures good the year through. This road and the Atchison, Topeka & Santa Fé are the only roads without snow-sheds.

The Union and Central roads, when built, relied almost entirely upon the through business, now mainly upon local business, as the through business has become of comparatively little importance because it is divided among five lines. The increase in the number of roads and the large reduction of rates have stimulated emigration, and thus the business, both through and local, is steadily and rapidly increasing. Each road now does as much business as the Union and Central when they monopolized the whole. The construction of competing roads has resulted in great benefit to the public, and, when the local business is built up, the revenues and profits of the several roads must be very large.

Other roads are also seeking new routes across the mountains. The St. Paul, Minneapolis & Manitoba has constructed several hundred miles in Dakota, and is constructing its road at the rate of five miles a day, through Manitoba and up the Missouri River to Fort Benton. It is also reported that parties in the interest of this line have commenced the construction of a line from Seattle, across the Cascade Mountains, down the Yakima River, to the Moxee Valley, and thence across to the great bend of the Columbia. The Chicago and Northwestern has already crossed the great plains in Nebraska and Wyoming, to the foot-hills of the Rocky Mountains, 1,000 miles west of Chicago, and will ultimately be forced to seek a route over the Rocky Mountains, along the northern fork of the Platte River.

Comparative Statement.

It will be interesting to compare the elevation and length of the different transcontinental railroads. The greatest average elevation of the mountain system of North America is in southern Wyoming and the western part of Colorado. It therefore follows that the passes over the mountains should be the highest in this section.

The highest railroad passes are:—

Kicking Horse Pass, on Canadian Pacific.....	5,596 feet.
Bozeman Pass, Montana, on Northern Pacific.....	5,570 "
Sherman Pass, Wyoming, on Union Pacific.....	8,235 "
Pass on Denver & South Park Railroad, Union Pacific.....	11,250 "
Marshall Pass, Colorado, on Denver and Rio Grande, about.....	12,000 "
State Line, Colorado, on Atchison, Topeka & Santa Fé.....	7,622 "
Dragon Summit, on Southern Pacific.....	4,614 "

The length of the several roads, the width of the great plains and mountains, are controlled by the configuration of the continent. The Rocky Mountains run in a south-easterly direction, while the trend of the coast is southerly, even a little south-westerly, to San Francisco, and then south-easterly to the Isthmus of Panama. This causes a diminution in the width of the great plains on the line of the Union and Central Pacific roads, and a corresponding increase in the width of the mountain systems and in the length of the road. On the Canadian Pacific the great plains are 1,000 miles wide, and the mountains about 500 miles wide. On the Union Pacific the plains are 500 miles in width, the mountains 1,300 miles.

The distances on the several roads from a common degree of longitude, say the 97th, to the Pacific Ocean, is shown in the following table:—

Canadian Pacific to Vancouver.....	1,480 miles.
Northern Pacific to Portland.....	1,620 "
Union Pacific and Oregon Short Line to Portland.....	1,724 "
Union and Central Pacific to San Francisco.....	1,885 "
Atchison, Topeka & Santa Fé to San Diego.....	1,694 "
Southern Pacific to San Francisco.....	2,024 "
Southern Pacific to San Diego.....	1,610 "

All these roads require a harbor at the terminus on the Pacific coast. North of the lower end of Puget Sound the coast is studded with islands and excellent harbors. From Puget Sound south the mountains rise almost directly from the ocean, there are few islands, and the only harbors are at the mouths of the rivers, and these are generally barred.

The Canadian Pacific finds a harbor at Vancouver on Puget Sound; the Northern Pacific was forced to cross the Cascade Mountains to reach a good harbor at Seattle and Tacoma on the sound; the Oregon Short Line has its terminus at Portland, 100 miles from the mouth of the Columbia River, where there is a bar which cannot be crossed in stormy weather; the Central and Southern Pacific have good harbors at San Francisco and San Diego; the Atchison, Topeka & Santa Fé at San Diego.

GARDINER G. HUBBARD.

PSYCHOLOGICAL MEDICINE AT THE INTERNATIONAL MEDICAL CONGRESS.

THE programme of the Section of Psychological Medicine and Diseases of the Nervous System, at the recent congress, was a highly promising one. It announced the reading of a variety of interesting papers, and a very large representation of foreign specialists amongst the readers. But the programme was widely diverged from, and, of the forty papers announced, less than half (and not, perhaps, in every respect the best half) were presented. Hardly one-quarter of the foreign delegates who were announced to present memoirs were present to do so. While thus the expectations aroused by the inviting programme were naturally destined to disappointment, the proceedings of the section are by no means to be considered unsuccessful. Like the other sections, it suffered considerably by the absence of the leading specialists of the United States. Had the acknowledged leaders of American neurology been announced to be present and to actively participate in the proceedings, not only would all the distinguished foreigners who announced their coming have had greater inducements to come, but the meeting would have recorded the high-water mark of neurological science. Judging the proceedings by the same standard that is to be applied to the entire congress, much can be said in its favor, and some interesting observations and suggestions can be culled from its deliberations. The address of the president of the section, Dr. J. B. Andrews, gave a very useful summary of the distribution and care of the insane in this country. Throughout the country there is one insane person to 545 individuals; but this ratio does not hold for all the various elements. The leaders of our civilization, and, above all, the foreign element, who have the difficult problem of adapting themselves to a violent change in their life-habits amid the pressure of a sharp competition, are the victims of mental break-down. One in every 250 of the foreign population is insane, one in 618 of the native whites, and only one in 1,097 of the colored population. But even in the last mentioned their emancipation and free admittance to civilization have more than doubled their former percentage of insanity. This fact—that insanity is a

disease of civilization—is also shown by the fact that the prevalence declines as we move towards the west and away from the cities. Insanity, moreover, is on the increase, and in this country at the startling rate of nine per cent per annum. Dr. Andrews also described the great improvement in the rational care of the insane (and this, in part, accounts for the increased longevity, and thus the increased number, of this class), and added, that, if this country had little new to show, it at least manifested its ability to keep abreast with the progress of other countries.

Dr. D. Hack Tuke of London sent a paper in which he compared the insane of this country with those of England. The difference in the nature of the asylums of the two countries makes an accurate comparison impossible, but such comparison yields much more similarity than difference. Dr. Tuke favored the 'segregation' plan, in which one patient, or at most a few, are under care in the same homestead, and welcomed the now general agreement that mechanical restraint was to be used only in exceptional cases, but that in such cases it is to be unhesitatingly employed.

Dr. H. M. Hurd of Michigan presented a valuable sketch of the development of religious insanity, tracing the relation between the nature of the morbid delusion and its physical excitant, and again with the age, sex, mental development, etc., of the individual. The healthiness of the religious sentiment lies in a just development of the emotional with the intellectual faculties.

Dr. Langdon Down of London described several interesting cases in which mental deficiency was associated with a pro-w-shaped cranium. The cause of this, Dr. Down referred to an abnormal juncture of the medio-frontal suture. The break-down in such cases may occur at any important change,—at first or second dentition, at puberty, or even later,—and the deficiency may vary from mere stammering and sluggishness of thought to marked idiocy. The education of children with this cranial mark should be a most special and careful one.

Dr. Horace Wardner of Illinois showed most conclusively the admirable effect of occupation in insanity. In a well-managed asylum eighty per cent of the inmates can be usefully employed, and this employment made an essential factor in their cure: it diverts their mind from brooding over themselves and their imaginary ills, prevents *ennui*, and establishes a healthy rhythm. Dr. Wardner cited several cases in which the occupation learned in the asylum became a means of livelihood after dismissal from the asylum. Such patients, while not cured, were yet able to begin life anew on a lower and simpler plane: they had not regained full mental power, but occupation had rescued them from chronic insanity to a condition of social usefulness.

Dr. G. Fielding Blandford of London presented before the entire congress a paper on the treatment of recent cases of insanity in asylums and in private houses, originally intended for this section. He showed how frequently a violent outbreak of mania passes away quite suddenly, and leaves the patient in full health. In all such cases the stigma, rightly or wrongly, attached to having been in an asylum can and should be avoided. The physician should have the right to keep patients of this general class outside of an asylum long enough to judge whether such a course is necessary or advisable. Dr. Blandford then gave criteria for distinguishing between cases which could be best cured in a private house and those who needed the 'judicious neglect' of a public asylum. Reform in the treatment of the insane will certainly take place in the direction indicated by Dr. Blandford.

Dr. T. W. Fisher of Boston spoke on the modern equivalents of 'monomania.' He found these in the current terms 'paranoia' (which corresponds closely to 'crankiness'), the German 'primäre verrücktheit,' and the like: he argued for the separate recognition of this form of mental alienation, and gave certain marks by which to distinguish it.

Professor Mendel of Berlin, in a paper on moral insanity, advocated a disuse of the term on the ground that it was either a form of congenital imbecility or an accompaniment of paranoia resulting from a systematic delusion, and that it was a dangerous plea to bring before the courts.

Several anatomical papers were presented. Amongst these, one by Professor Mendel, on the origin of the ocular branch of the

facial nerve, was especially important. Dr. Mendel experimented by destroying the muscles supplied by these nerve-branches (mainly the muscle raising the upper eyelid) in young animals, and then observed the atrophy of nerve fibre and cell in the central nervous system. He found that the origin of this nerve-branch was not, as is currently supposed, in the general nucleus of the facial nerve, but in the posterior part of the nucleus of the oculo-motor nerve. This is another evidence to the fact that the nerve-centres are arranged for co-ordination of function (not for topographical convenience), those nerves arising from a common centre as must frequently act together in exciting a useful movement.

Dr. Spitzka of New York showed the cerebellum of a child of five years, who had never learned to speak or walk. The cerebellum was enormously asymmetric, and the entire brain and much of the body presented striking abnormalities.

Dr. Homen of Finland described a distinction between the motor and sensory areas of the spinal nerves as brought about by atrophy resulting from amputations. Dr. Otto of Munich advocated the use of magenta as a staining for sections of the nervous system.

Quite a number of papers of much too general a character were presented. Such papers, however valuable in themselves, are too much the record of individual opinions to be profitably presented at an international meeting. Such questions as the 'definition of insanity,' 'the classification of insanity,' and the like, are sure to be profitable; at least, until we know much more of the pathological nature of mental aberration than we do now. A very opposite criticism is to be passed upon the discussion on the relation of syphilis to insanity, which aroused much interest, and was practically and profitably conducted. The leader in the discussion was Dr. G. H. Savage of Bethlehem, England.

MENTAL SCIENCE.

The Chronological Progress of Infants.

THE scientific observation of the early stages of development of the human infant, though no longer a novelty, can be said to have yielded only the first suggestions of the valuable generalizations which this study is destined in part to discover and in part to corroborate. Amongst these generalizations the most important is that psychological law which finds its analogue in the embryological law that the early life-stages of a species high in the animal scale repeat in part the mature stages of an animal lower in the scale, and announces that the mental development of the child repeats in part the development of the race. The many and suggestive analogies between the emotional traits and thought-habits of children and of savages have been frequently recorded, and their importance is more and more widely appreciated. Nor has the practical aspect of infant psychology been neglected. Once educators have recognized that this study promises a surer basis for early school-room work than any amount of simplification of exercises originally arranged for more mature minds, it makes the teacher learn from as well as teach the pupil. One educational body has asked for systematic records of child-growth, bodily and mental, and a few normal schools are substituting for the dry and often narrow course in 'Methods of Teaching,' a practical and original essay recording observations of various traits of child-life. One main purpose in all such records has been to get an average of the date and order of appearance of the several acts, instincts, emotions, ideas, and so on, in the child. In the process of obtaining such an average, much information will at the same time be gained as to the range of variation in time of appearance of the several traits, of the influence of sex, of heredity, of nationality, and of environment upon them. When such a record will be at our command, the rate of progress of any particular child, whether precocious or backward, will be easily ascertainable, and much energy be saved in propping up what needs support, in checking over-development of certain traits, and thus promoting that harmonious all-sided growth which modern education regards as its ideal. The caution in the process should be in the direction of remembering the individual variation as well as the average,—that by nature men are far from being alike, and civilization requires them to be so only in a very-restricted though important field of activity.

Dr. Stanford E. Chaillé of the Tulane University has recently

put together, in a form very convenient for others to supplement and perfect, the various stages of infant progress. He gives in a series of brief paragraphs the chief acquisitions which the average infant may be expected to exhibit for each month of the first year of life, and at intervals of several months from then to the third year. The acts whose appearance he notices include the physical signs as well as the actions on which mental growth is founded. As the article of Dr. Chaillé is itself a *résumé*, it will hardly be profitable to further epitomize the facts there given. Referring to the original paper for the facts (*New Orleans Medical and Surgical Journal*, June, 1887), it will be sufficient to state that they record the various reflexes (sucking, crying, sneezing, etc.) existing from birth, the order of the development of the senses (taste first) and the gradual change in their relative educational importance, the accommodation to the environment, the interpretation of the objective world (as the inference of distance by sight), the emotional evolution (fear being the first emotion), the expressions of pleasure and pain, the co-ordination of the muscle-movement into acts, the gradual voluntary control of hands and feet, the first sounds and attempts at language, the appreciation of colors, sounds, odors, and so on. The general conviction which this study has left upon Dr. Chaillé's mind is not in harmony with the popular belief that children are to a larger extent than adults virtuous and guileless, but agrees with the evolutionary notion that the virtues which civilization has taught us to admire are of recent growth, and not innate in the infant, whom it is more truthful to regard as a 'darling little savage,' than as a 'dear little angel.'

A point on which this paper is especially complete is the increase of weight, height, and chest-girth with each month of the first year of life, and at longer intervals from then to maturity. During the first three days of life there is a loss of weight, which should be regained by the seventh day. The greatest gain of weight occurs during the first five months, the maximum amount of growth falling probably in the second month, when the increase is from four to seven ounces weekly. From then on, the regular increase of growth which the table records takes place, leaving more room for individual variation with increase of age.

THE EFFECT OF OPIUM ON THE HIGHER ANIMALS.—It has recently been observed that opium affects apes just as it does men, producing all of the physical symptoms, and strongly suggesting the presence of some, at least, of the typical psychical accompaniments. A certain ape would always follow any opium-smoker, would look for the remnants which the smoker left unused, would cry when not admitted to the room where smoking was going on, and so on. The habit takes the same possession of them that it does of men. Apes who are in the habit of getting a little opium are inactive, dull, and useless if they miss their usual dose; and a Chinese merchant is recorded as having a large ape who howls piteously when his usual ration of the drug is denied him. Similar effects have been observed in dogs, and strikingly illustrate the functional similarity of the central nervous system of the higher mammalia.

A CHALLENGE TO THE EVIDENCE FOR THOUGHT PHANTASMS.—An article published in the *Nineteenth Century* for August, by A. Taylor Innes, and entitled 'Where are the Letters?' is in substance an attack on the nature 'of the evidence for death-bed and other coincidences, which Messrs. Myers, Gurney, and Podmore have collected in their 'Phantasms of the Living.' Most of these stories are those in which a friend or relative of the person concerned is suddenly presented with a vivid impression that the person in question, who is far distant, is threatened with danger; the case is then made out that the time of death of the individual coincided with the moment of the apparition to his friend. In a large number of cases documentary evidence of the simultaneity of the two occurrences— as when two letters, each recording one of the events, cross each other—is naturally obtainable; and the writer of the above article claims that in such cases the authors have been satisfied with the mere statement that such evidence existed without actually seeing the letters, and yet regarding such evidence as of first-class value. An actual examination shows how worthless such statements often are. In nine cases in which they did see the original manuscript the evidence is declared unsatis-

factory. On the basis of such omissions, a general distrust is thrown about the whole work, which only a very careful and accurate refutation by the authors of the work can remove.

BOOK-REVIEWS.

The Origin of Mountain Ranges, considered Experimentally, Structurally, Dynamically, and in Relation to their Geological History. By T. MELLARD READE. London, Taylor & Francis. 8°.

MOUNTAIN ranges, that show the effects of lateral compression in their folded structure, are explained by most geologists by means of Elie de Beaumont's 'contractual hypothesis: ' the interior of the earth is thought to be contracting as it cools, and the outer part, or 'crust,' wrinkles as it settles down to accommodate itself to the diminished interior. But in recent years several geologists have urged that this hypothesis was quantitatively insufficient to account for the known mountain ranges, and while these criticisms do not seem to me to be by any means fatal to the effective working of the contractual process to a considerable extent, they have served a good purpose in emphasizing the need of further search for methods of mountain-making. The want of any sufficient means of accounting for plateaus of massive elevation, also points to the importance of further study of the physics of the earth.

The illustrious Playfair, writing early in this century, thought nothing so capable of causing a slow-acting, irresistible elevatory force as the expansive power of heat; but he suggested no means of applying the heat in proper time, place, and quantity. Mr. Mellard Reade, following out an idea advanced by Capt. Thos. Hutton of New Zealand, and others, attempts to supply this deficiency as follows: mountain regions were once regions of heavy sedimentation; the slow accumulation of sediments caused a depression, and a consequent warming of the mass beneath them; the warming mass tends to expand in all directions, but can expand only vertically; and, in this conversion of cubic into linear expansion, Mr. Reade finds a sufficient cause for the extravasation of lavas, the elevation of plateaus, and the crushing deformation of mountain ranges. The last-named process seems to me only remotely connected with this cause, but the other two may find some or much explanation in it. It is necessary, in order that the process shall work efficiently, that the depression caused by sedimentation, shall for a time go on faster than the consequent ascent of the deep isogotherms; if we admit this to be possible, the hypothesis gives a qualitatively correct explanation of those paradoxical changes of level seen in the elevation of areas heavily loaded with sediments, and the depression of lands deeply denuded; it also suggests a reasonable correlation between the slow, light sedimentation of such regions as Wisconsin, and their long exemption from serious disturbance. The process therefore deserves to be discussed rather than dismissed: working with other processes, it will, I believe, come to be accepted as a useful aid to a common end.

W. M. D.

The Teaching of Geography. By ARCHIBALD GEIKIE. London, Macmillan. 12°.

THE book under review is the first volume of Macmillan's geographical series, which is edited by Archibald Geikie. It is an introduction on the teaching of geography, in which the author sets forth his views on the scope and goal of geographical science and of the methods of teaching it. The book shows in an admirable way how geography can be made a useful and attractive study, how in teaching it the mental faculties of the child can be developed and its power of observation increased.

Of course, the author's method rests on the views he holds on the aims and method of geography. He says (p. 2), "It is the special function of geography to direct our attention to the [phenomena surrounding us], to increase our knowledge of the country we live in, and thence to trace analogies and contrasts among the aspects of nature in other regions of the globe. Geography compares the topography of one continent with that of another, dwelling upon the fundamental elements of each, and showing how they have affected the distribution and development of the human population. . . . In gathering the materials for this comprehensive picture of the

earth as the dwelling-place of man, geography culls freely from almost every branch of natural science and from history."

From this standpoint the subject is admirably treated. Geikie shows how every single fact and every single observation can be made use of from a geographical standpoint,—the state of the weather, the furniture of the school-room, the silk kerchief of a child, or the coal used for fuel. He makes the study of the surroundings the starting-point for teaching phenomena of natural history, of meteorology, history, and of social science. But it seems to us that if the curriculum of a school should be planned out according to Geikie's suggestions, the geographical point of view would become too predominant. His recommendation that actual observations should always be the foundation of teaching is of eminent importance, but observations must not be exclusively treated from a geographical standpoint.

Two ends are to be kept in view in teaching: the development of the power of reasoning and of observation, and that of the heart and feelings. In the elementary stage both goals are attained by inducing the child to look at the things themselves, and to take a lively interest in them, and by training it to notice differences in things. By this method the child gains an active interest in the subject which it is taught, and a foundation is laid for future explanations and classifications. So far, Geikie's proposals cannot be excelled. But later on, the character of the natural sciences and physics makes it necessary that they deal to a great extent with generalizations and abstractions which only educate the powers of reasoning. Geography acts as an important counterbalance against this tendency, and we should wish that this fact had been more energetically emphasized by the author. He recognizes this fact, and mentions it in several passages of the book, e.g., "The objects of excursions are to train the pupils in habits of observation and reflection, to teach them the elements of topography, to enlarge their capacity for the comprehension of geography, and generally to stimulate their love of nature" (p. 73). But it is our opinion that this last point ought to be made the principal goal of geography-teaching in all grades. While the teacher of natural science chiefly develops the power of reasoning, the geographer must always try to keep alive the actual interest in the individual phenomenon as it presents itself to the eye, and in the mutual interdependence of its parts. Therefore geography must be placed in the curriculum of the school in one class with history and literature, and in advanced teaching it ought to be treated accordingly.

If Geikie's proposals for elementary teaching were accepted by teachers,—not of geography alone,—and if the historical standpoint were to be taught in the same enlightened way, a great step forward would be made.

We agree more fully with the author's views on the teaching of physical geography than with his treatment of political geography. Many subjects upon which he touches, which belong to linguistics and social science, seem to be too difficult to be grasped by a child, and others can be more adequately dealt with from an historical point of view than from a geographical one. The cultivation of land, its products, the situation of villages and roads, and similar subjects, may be treated with advantage, while money, telegraph, and post, etc., are more satisfactorily dealt with from an historical standpoint. Particular care ought to be taken in treating anthropogeographical subjects, for most of these phenomena are so complicated that the juvenile mind is unable to grasp them. Science itself has not treated these subjects in a satisfactory way, and most of its theories are vague and not well founded. We should hesitate, for instance, to lay any stress on such facts as the position of Britain in the very midst of the land hemisphere (p. 198), as upon thorough investigation it may be shown that in fact they are only of secondary importance. But the elementary problems of anthropogeography may be treated: the influence of climate upon the life of peoples and man, the means of communication, and their dependence upon the configuration of the ground, etc.

The present book, and several other publications, are proof of the stimulus the teaching of geography has received in England by the endeavors of the Royal Geographical Society. So far, little interest has been awakened on this side of the ocean, but publications of this kind cannot fail to excite the interest of American geographers.

F. BOAS.

Elements of Botany, including Organography, Vegetable Histology, Vegetable Physiology, and Vegetable Taxonomy, and a Glossary of Botanical Terms. By EDSON S. BASTIN. Chicago, G. P. Engelhard & Co. 8°.

If one can judge by the number of text-books on botany which have been published in this country during the last few years, either the number of botanical students must be very large, or the different text-books must treat the subject inadequately, for each new work has for its ostensible purpose the 'filling of a long-felt want.' What the want is, is not easy to say, unless it be a book which shall contain every thing in small compass, and that is a practical impossibility. The 'Elements of Botany,' by Professor Bastin, certainly gives a great deal in small compass, and must be considered one of the best treatises on the subject yet published in this country. It is evidently the work of a teacher, rather than a specialist, and gives the substance of what must usually be sought in several different text-books, and, while it cannot replace other well-known treatises, it forms a good introduction to them. The illustrations are numerous and generally good, and the style is clear and as attractive as could be expected considering the condensed form. Two-thirds of the book are devoted to organography and histology, — subjects which are best adapted to beginners. The chapters on physiology are very brief, but the subject is well treated. The same can hardly be said of the chapters on vegetable taxonomy, by which the author understands a description of the different classes of the vegetable kingdom. The illustrations of this part are not so good as those of the earlier parts, and the descriptions are not infrequently obscure, and also at times incorrect. The yeast-plant, for instance, cannot be said to belong to the *Schizomyces*. It is to be regretted that authors of botanical text-books to be used by beginners almost invariably crowd a general account of the different classes into a few pages at the end. Treated in this way, the subject is always unintelligible, or next to unintelligible, and the space had better be used in amplifying other subjects and the student referred to larger and special works for an account of the classes.

An Introduction to Greek Sculpture. By L. E. UPCOTT. Oxford, Clarendon Pr. 12°.

No book of similar aim and scope can compare for a moment with this little book. It was originally written as a guide to the author's collection of casts and photographs from the antique at Marlborough College. It is now enlarged somewhat, and has in view a museum of casts and photographs adapted to the needs of a school or college. Mr. Upcott mentions the religious origin of Greek sculpture, notes its peculiar characteristics, and traces its development from the half-mythical Dædalus to the Græco-Roman period. The book is at once clear, compact, and comprehensive, and the best manual of Greek sculpture in the language.

The Graphical Statics of Mechanism. By GUSTAV HERRMANN. New York, Van Nostrand. 16°.

This is a translation into English of Professor Herrmann's work, which has already been published in German and French. The great advantage which the method presents is its simplicity. By the use over and over again of a few easily mastered principles, the most complicated problem may be solved. No knowledge of higher mathematics is required in its mastery, and no handling of lengthy and involved algebraic formulas is necessary in its use. The object of the treatise is principally to facilitate study for the students of technical schools, upon whose time and industry increasing demands are made from day to day.

NOTES AND NEWS.

THE earthquake of Central Asia, the principal shock of which occurred on June 19, has a remarkable feature in common with the Charleston earthquake. In most cases chains of mountains prevent the spreading of the shocks, but in these cases high ranges were crossed. The Charleston earthquake traversed the Alleghanies, and that of Vernoye — the situation of which may be seen on our map of Central Asia (Aug. 5) — was felt on the Issik-Kul, though the chains of the Ala-tau lie between the centre of the disturbance

and that lake. The epicentre was in the district of Aksai, about fifteen miles west of Vernoye. About 800 persons are said to have been killed by falling houses and rocks rolling down from the mountains. Numerous fissures were formed on the northern slope of the Ala-tau, particularly near Vernoye. East of this place the shocks were less destructive. Part of the shore of Issik-Kul moved three feet downward. An expedition is at present at work to investigate the geological structure of the disturbed area.

— We learn that the Signal Service has ordered the abandonment of the following stations on the Pacific coast: Monterey, San Luis Obispo, Bakersfield, Modesto, Indio, San Bernardino, Carson, Yreka, Santa Rosa, and Mendocino City. As soon as the official intention was announced, the publisher of the San Francisco *Chronicle* came forward and offered to provide observers, pay for telegrams, warnings, and so forth, provided that the government would allow the instruments to remain. This offer has been accepted.

— It will be of interest to learn, says *The Publishers' Weekly*, that the adherents of the international language Volapük have just held a congress at Munich, presided over by Professor Kirchhoff of the University of Halle. It was decided to use the home spelling for proper names, to drop the ceremonial form 'you' (employing 'thou' in the singular), and to make some few simplifications in spelling and grammar. The most important action was the establishment of a Volapük academy, to whom all future grammatical and lexicographical difficulties shall be submitted. Eighteen academicians were elected, representing Germany, Hungary, Austria, Holland, Russia, Sweden, France, Spain, Portugal, Italy, Asia Minor, England, and North America. The American representative is Mr. Charles E. Sprague of New York.

LETTERS TO THE EDITOR.

* * * *The attention of scientific men is called to the advantages of the correspondence columns of SCIENCE, for placing promptly on record brief preliminary notices of their investigations. Twenty copies of the number containing his communication will be furnished, free to any correspondent on request.*

The editor will be glad to publish any queries consonant with the character of the journal.

Correspondents are requested to be as brief as possible. The writer's name is in all cases required as proof of good faith.

Is there a Diamond-Field in Kentucky?

THE great similarity of the peridotite of Elliott County, Ky., to that of the South African diamond-fields has attracted considerable attention, and hundreds of prospectors, moved by 'interesting possibilities,' have visited the region in search of gems and precious metals.

In May, 1885, when the peridotite of Kentucky was studied in the field, the character of the diamond-bearing rock in South Africa was not yet fully understood, and consequently no search was made at the time for diamonds. Recent developments, however, rendered it desirable that they should be intelligently sought for; and upon the invitation of Mr. J. R. Procter, the State geologist of Kentucky, we were sent by Maj. J. W. Powell, the director of the United States Geological Survey, to make the investigation.

The locality is easily reached by way of the East Kentucky Railroad, which ends in Carter County at Willard, where conveyance may be obtained of the farmers to traverse the remaining ten miles to the best exposures of the peridotite along Isom's Creek, in Elliott County.

The peridotite alters and disintegrates readily; but, from the fact that the declivity of the surface is considerable, the transportation of material almost keeps pace with disintegration, and there is no great accumulation of residuary deposits upon the narrow divides and hillsides. The specific gravity and durability of the gems found in connection with peridotite are generally greater than those of serpentine and other products of its alteration. On this account the gems accumulate upon the surface and in favorable positions along adjacent lines of drainage. Our plan was to search by sifting and carefully panning the stream-beds receiving the drainage directly from the surface of the peridotite, and to enlist the services of the people in the neighborhood to scrutinize the steep slopes where gems weathered out of the peridotite might be exposed. Particular attention was directed also to the examination of the

solid rock and residuary deposits which so closely resemble the diamantiferous material of the South African mines.

The accompanying map, introduced, with corrections and additions, from the United States Geological Survey, Bulletin No. 38, shows the distribution of the exposed peridotite and the soil resulting from its disintegration. It is only a sketch-map, and does not pretend to a high degree of accuracy, but will be found of great service in the field.

The embankment, which was formerly regarded as the site of an old furnace, has proved to be an Indian mound in which arrow-heads and fragments of celts have been found. Several years ago the mound was opened to a considerable depth by Mr. James Maggard, who reports ashes near its centre. The excavation made for us during our brief sojourn did not reach the ashes. The mound is composed chiefly of the sand resulting from the dis-

integration of the adjacent peridotite, and a number of pieces of peridotite, preserving all their form, but entirely altered with the exception of the garnet and ilmenite, which only appear broken up. The olivine had changed, however, to a deweylite-like mineral, so soft and of such a structure that it has received the local name of 'mutton tallow,' and, when first taken out, can be worked as readily as that substance.

It is about one hundred feet in diameter and thirty feet in height, and some large trees had originally grown on the top. Until our recent visit the actual contact of the peridotite and shale had not been observed. It is exposed in the bed of a small branch of Isom's Creek, within a hundred yards of Charles Isom's house. The intrusion of the peridotite has displaced and greatly fractured the shale, besides locally indurating it, and enveloping a multitude of its fragments. The latter are dark-colored, like the peridotite, and are strongly contrasted with the light-colored dolomitic nodules of secondary origin.

Besides the pyropes, a few of which are good enough for cutting, several fairly good specimens of a green pyroxene have been found, and are here reported for the first time. When suitably prepared, they will make worthy additions to the gem collection of the National Museum. They resemble the same transparent mineral from Arizona. The South African specimens of the mineral are a little more opaque, but of a richer green color.

During a careful search over a small area for nearly two days, no diamonds were found; but this by no means demonstrates that diamonds may not yet be discovered there.

The remarkable similarity between the peridotite of Kentucky and that of the Kimberley and other diamond-mines of South Africa is very striking, and, when this alone is considered, the probability of finding diamonds in Kentucky seems correspondingly great; but when we reflect that the carbonaceous shale, and not the peridotite itself, is the source of the carbon out of which the diamond is formed, and that the shale in Kentucky is much poorer in carbon

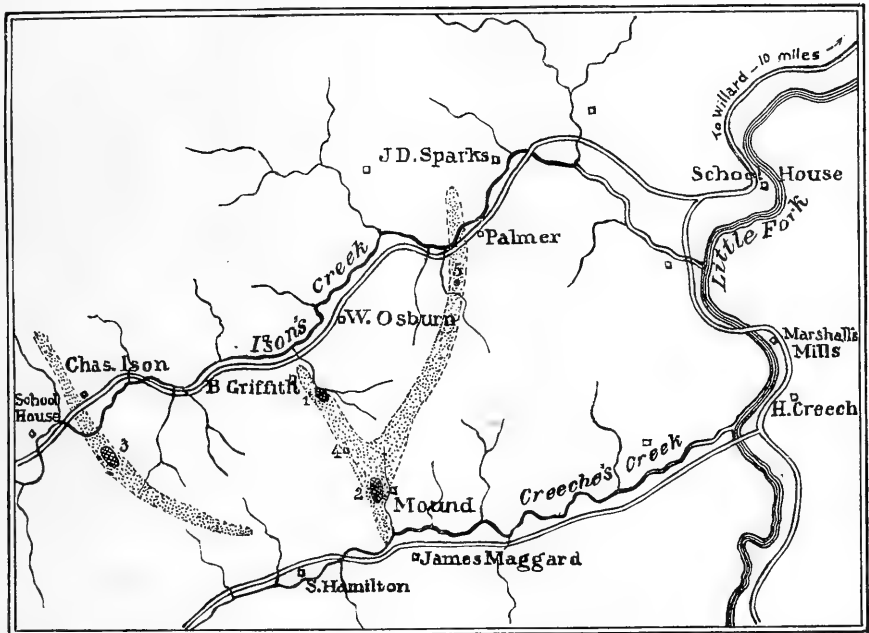

Exposed Peridotite. Soil containing Pyrope and Ilmenite. Local fragments of feldspathic Rocks.

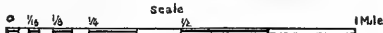

than that of the South African mines, the probability of finding diamonds there is proportionally diminished. H. Carvill Lewis (*Science*, viii. p. 346) remarks concerning the South African mines, that "recent excavations have shown that large quantities of this shale surround the mines, and that they are so highly carbonaceous as to be combustible, smouldering for long periods when accidentally fired." In the chemical laboratory of the United States Geological Survey, Mr. J. Edward Whitfield determined 37.521 per cent of carbon in the shale from near the Kimberley mine, while the blackest shale adjoining the peridotite near Charles Isom's in Kentucky, he found to contain only 0.681 per cent of carbon. After all the carbonates were removed by dilute hydrochloric acid, the residue was combusted in oxygen, and the carbon weighed as carbonic dioxide. The peridotite, at the time of its intrusion, must have been forced up through a number of coal-beds, and at a greater depth it penetrated the Devonian black shale, which is considerably richer in carbon than the shale now exposed at the surface. It is possible, and not improbable, that if the theory of the igneous origin of diamonds first proposed by Roscoe Cohen (Proceedings of

tegration of the adjacent peridotite, and a number of pieces of peridotite, preserving all their form, but entirely altered with the exception of the garnet and ilmenite, which only appear broken up. The olivine had changed, however, to a deweylite-like mineral, so soft and of such a structure that it has received the local name of 'mutton tallow,' and, when first taken out, can be worked as readily as that substance.

It is about one hundred feet in diameter and thirty feet in height, and some large trees had originally grown on the top. Until our recent visit the actual contact of the peridotite and shale had not been observed. It is exposed in the bed of a small branch of Isom's Creek, within a hundred yards of Charles Isom's house. The intrusion of the peridotite has displaced and greatly fractured the shale, besides locally indurating it, and enveloping a multitude of its fragments. The latter are dark-colored, like the peridotite, and are strongly contrasted with the light-colored dolomitic nodules of secondary origin.

Besides the pyropes, a few of which are good enough for cutting, several fairly good specimens of a green pyroxene have been found,

the Manchester Literary and Philosophical Society, Oct. 7, 1884, p. 5), and later independently advanced by H. Carvill Lewis, be true, a number of diamonds may have been formed in the Kentucky peridotite; but the general paucity of carbon in the rock adjacent to the peridotite is certainly discouraging to the prospector.

The best time to search for gems in that locality is immediately after a heavy rain, when they are most likely to be well exposed upon the surface. It is proposed to keep up the search economically by those most interested, by furnishing to responsible individuals in the vicinity a number of rough diamonds mounted in rings, for comparison, that they may know what to look for under the most favorable circumstances.

J. S. DILLER.
GEO. F. KUNZ.

New York, Sept. 12.

The Classification of Lakes.

SEVERAL years ago I presented to the Boston Society of Natural History a paper on the classification of lake-basins, in which the many varieties of lakes were grouped under three heads, according as they were made by constructive, destructive, or obstructive processes. The first heading included lakes made by mountain-folding and other displacements; the second consisted chiefly of basins of glacial erosion; the third contained the greatest number of varieties, such as lakes held by lava, ice, and drift barriers, delta and ox-bow lakes, and some others. The classification proved satisfactory, in so far as it suggested a systematic arrangement of all kinds of lakes that have been described; but it now appears unsatisfactory, inasmuch as its arrangement is artificial, without reference to the natural relations of lakes to the development of the drainage systems of which they are a part. A more natural classification is here presented in outline.

When a new land rises from below the sea, or when an old land is seized by active mountain-growth, new rivers establish themselves upon the surface in accordance with the slopes presented, and at once set to work at their long task of carrying away all of the mass that stands above sea-level. At first, before the water-ways are well cut, the drainage is commonly imperfect: lakes stand in the undrained depressions. Such lakes are the manifest signs of immaturity in the life of their drainage system. We see examples of them on new land in southern Florida; and on a region lately and actively disturbed in southern Idaho, among the blocks of faulted country described by Russell. But as time passes, the streams fill up the basins and cut down the barriers, and the lakes disappear. A mature river of uninterrupted development has no such immature features remaining. The life of most rivers is, however, so long, that few, if any, complete their original tasks undisturbed. Later mountain-growth may repeatedly obstruct their flow; lakes appear again, and the river is rejuvenated. Lake Lucerne is thus, as Heim has shown, a sign of local rejuvenation in the generally mature Reuss. The head waters of the Missouri have lately advanced from such rejuvenation; visitors to the National Park may see that the Yellowstone has just regained its former steady flow by cutting down a gate through the mountains above Livingston, and so draining the lake that not long ago stood for a time in Paradise Valley. The absence of lakes in the Alleghany Mountains, that was a matter of surprise to Lyell, does not indicate any peculiarity in the growth of the mountains, but only that they and their drainage system are very old.

The disappearance of original and mountain-made lakes is therefore a sign of advancing development in a river. Conversely, the formation of small shallow lakes of quite another character marks adolescence and middle life. During adolescence, when the head-water streams are increasing in number and size, and making rapid conquest of land-waste, the lower trunk-stream may be overloaded with silt, and build up its flood-plain so fast that its smaller tributaries cannot keep pace with it: so the lakes are formed on either side of the Red River of Louisiana, arranged like leaves on a stem; the lower Danube seems to present a similar case. The flood-plains of well-matured streams have so gentle a slope that their channels meander through great curves. When a meander is abandoned for a cut-off, it remains for a time as a crescentic lake. When rivers get on so far as to form large deltas, lakes often collect in the areas of less sedimentation between the divaricating

channels. Deltas that are built on land, where the descent of a stream is suddenly lessened and its enclosing valley-slopes disappear, do not often hold lakes on their own surface; for their slope is, although gentle, rather too steep for that: but they commonly enough form a lake by obstructing the stream in whose valley they are built. Tulare Lake in southern California has been explained by Whitney in this way.

The contest for drainage area that goes on between streams heading on the opposite slopes of a divide sometimes produces little lakes. The victorious stream forces the divide to migrate slowly away from its steeper slope, and the stream that is thus robbed of its head waters may have its diminished volume clogged by the fan-deltas of side-branches farther down its valley. Heim has explained the lakes of the Engadine in this way. The Maira has, like an Italian brigand, plundered the Inn of two or more of its upper streams, and the Inn is consequently ponded back at San Moritz and Silvaplana. On the other hand, the victorious stream may by this sort of conquest so greatly enlarge its volume, and thereby so quickly cut down its upper valley, that its lower course will be flooded with gravel and sand, and its weaker side-streams ponded back. No cases of this kind are described, to my knowledge, but they will very likely be found; or we may at least expect them to appear when the northern branches of the Indus cut their way backwards through the innermost range of the Himalaya, and gain possession of the drainage of the plateaus beyond; for then, as the high-level waters find a steep outlet to a low-level discharge, they will carve out cañons the like of which even Dutton has not seen, and the heavy wash of waste will shut in lakes in lateral ravines at many points along the lower valleys.

In its old age, a river settles down to a quiet, easy, steady-going existence. It has overcome the difficulties of its youth, it has corrected the defects that arose from a period of too rapid growth, it has adjusted the contentions along the boundary-lines of its several members, and has established peaceful relations with its neighbors: its lakes disappear, and it flows along channels that meet no ascending slope on their way to the sea.

Certain accidents to which rivers are subject are responsible for many lakes. Accidents of the hot kind, as they may be called for elementary distinction, are seen in lava-flows, which build great dams across valleys: the marshes around the edge of the Snake River lava-sheets seem to be lakes of this sort, verging on extinction: crater lakes are associated with other forms of eruption. Accidents of the cold kind are the glacial invasions: we are perhaps disposed to overrate the general importance of these in the long history of the world, because the last one was so recent, and has left its numerous traces so near the centres of our civilization; but the temporary importance of the last glacial accident in explaining our home geography and our human history can hardly be exaggerated. During the presence of the ice, especially during its retreat, short-lived lakes were common about its margin. Claypole has just described the extinct 'Lake Cuyahoga' in Ohio as of this kind. We owe many prairies to such lakes. The rivers running from the ice-front, overloaded with sand and silt, filled up their valleys and ponded back their non-glacial side-streams; their shore-lines have been briefly described in Ohio and Wisconsin, but the lakes themselves were drained when their flood-plain barriers were terraced; they form an extinct species, closely allied to the existing Danube and Red River type. As the ice-sheet melts away, it discloses a surface on which the drift has been so irregularly accumulated that the new drainage is everywhere embarrassed, and lakes are for a time very numerous. Moreover, the erosion accomplished by the ice, especially near the centres of glaciation, must be held responsible for many, though by no means for most, of these lakes. Canada is the American type, and Finland the European, of land-surface in this condition. The drainage is seen to be very immature, but the immaturity is not at all of the kind that characterized the first settlement of rivers on these old lands: it is a case, not of rejuvenation, but of regeneration; the icy baptism of the lands has converted their streams to a new spirit of lacustrine hesitation unknown before. We cannot, however, expect the conversion to last very long: there is already apparent a backsliding to the earlier faith of steady flow, to which undisturbed rivers adhere closely throughout their life.

Water-surface is, for the needs of man, so unlike land-surface, that it is natural enough to include all water-basins under the single geographic term, 'lakes.' Wherever they occur,—in narrow mountain-valleys or on broad, level plains; on divides or on deltas; in solid rock or in alluvium,—they are all given one name. But if we in imagination lengthen our life so that we witness the growth of a river-system as we now watch the growth of plants, we must then as readily perceive and as little confuse the several physiographic kinds of lakes as we now distinguish the cotyledons, the leaves, the galls, and the flowers, of a quickly growing annual that produces all these forms in appropriate order and position in the brief course of a single summer.

W. M. DAVIS.

Cambridge, Mass., Sept 7.

Corruption of American Geographic Names.

MR. MURDOCK'S friendly criticism and confirmatory note on the pronunciation of 'Arkansas,' in the last *Science*, is gratifying from the fact that it will help disseminate a proper understanding of that word. But 'Arkansas' is only one of hundreds of geographic names which have been corrupted under our very noses, so to speak, and I believe it behooves all educators to assist in their correction. In the West we have many classes of descriptive geographic names,—first, words in the Indian language, which the Spanish, French, or English (and sometimes all) have endeavored to represent phonetically in their own language, such as 'Ouachita,' 'Washita,' 'Wichita,' etc., all derived from the name of a tribe of Indians first noted by La Salle, and which has now been applied in its modifications to six rivers (not including creeks) in Indian Territory, Arkansas, and Texas, two mountain areas, and innumerable political divisions, such as counties, post-offices, etc.; second, descriptive names. To the credit of the Spaniards, it must be said that they seldom adopted Indian names, but gave either descriptive names, such as 'Sabinas,' 'Ulmas,' 'Puecos,' 'Colorado,' often of the forest-growth and character of sediment of rivers; or religious names, such as 'Corpus Christi,' 'Vera Cruz;' or sometimes a combination of both, such as 'Sangre de Cristo' Mountains.

Most of our American names in the West, and especially the South-west, are simply abominable. They are either corruptions of the French, Indian, or Spanish, or indefinite appellatives, often of lewd and repulsive meaning. This is especially true of the names given by my fellow-southerners, as they followed the law of migrations along degrees of latitude. In central and western Texas there is another corruption which is more misleading than that of mispronunciation or misspelling. The generic topographic terms are all erroneously used for the subgeneric, such as 'river' for 'creek' (or what can only be properly expressed by the Spanish *arroyo*), and 'mountain,' 'peak,' etc., for 'knolls,' 'buttes,' or 'mesas.' For instance: while there is not a true mountain in Texas east of the Pecos River, there are no less than a dozen 'Round Mountains,' 'Pilot Peaks,' 'Comanche Peaks,' 'Hog and Packsaddle Mountains,' etc., in central Texas, none of which in any way are entitled to the dignity of the terms, and which can only be described as buttes and mesas of secondary proportions. The creeks and rivers are either 'Hog' creeks, 'Muddy,' 'Snake,' 'Buffalo,' 'Dry,' 'Indian,' or 'Post Oaks.'

Not only have these corruptions been going on in the past, but they are being perpetrated at present, and our government publications are innocently the chief instruments in so doing. A remarkable instance came under my observation two years ago. While sitting upon the stone that marks the north-west corner of the State of Kansas, examining some geological specimens, and conversing with Texan cowboy friends who had 'wintered' near there a year or two, I inquired the nearest post-office. One of them informed me that a [tent] village had just been established a few miles distant, and that its name was 'Bueno.' This word, from my past experience on the Texan frontier, I knew to constitute nine tenths of the cow-boy's knowledge of pigeon Spanish (the other tenth being 'cuss' words), and that it had been imported from the Rio Grande by him into Kansas, and that the 'short-horns' (the cow-boys' term of inferiority for the Kansas settler) had been fascinated by it, and applied it to their new town. A capital idea, I thought, until I looked up the name of the town in the latest post-office guide, when, to my horror, I found my pet Spanish word 'bueno'

anglicized into 'Wano.' The other instance of governmental perpetration is on the topographic maps of both the Post-Office and War Departments, and Geological and Coast Surveys, where these dry creeks continue to appear as rivers, and buttes as mountains, etc.

Since my arrival in Arkansas, I have been delighted to find numerous minor French geographic names which have not been corrupted, such as 'L'Eau Frais,' 'Terre Noir,' 'Antoine,' and other streams; and from the oldest Anglo-American inhabitants I learn that nearly every geographic feature of southern Arkansas was named, not by French missionaries, but by the trappers and *voyageurs*, who had traded with the Indians for a hundred years or more, and who dominated here almost until the State was admitted to the Union (1836). Many descendants of these old French pioneers inhabit south-eastern Arkansas, and it is a source of gratification that the Anglo-American settlers here, however illiterate, pronounce the names with approximate correctness, even if their attempts at spelling them are oftentimes ridiculous.

ROBT T. HILL.

Ouachita River, Ark., Sept. 8.

Romantic Love and Personal Beauty.

THE latest contribution to the theory of evolution is the attempt of Mr. Finck to show that the phase of human character known as romantic (pre-nuptial) love is strictly modern, having developed within the last 1,000 years. The book in which the argument is set forth, recently reviewed in this magazine, is a remarkable combination, which one hardly knows whether to accept as a joke or in earnest. In this one work we find a scientific discussion of love as found in plants and animals, theories as to its origin and import; we find many surprising statements concerning modern society, such as that there can never be too much of flirtation, since it is one of the most valuable discoveries of the English people; that beauty in children is dependent upon the pre-nuptial love of their parents; we find directions to the maiden how to win her lover, directions to the love-sick swain as to his cure, directions to the lover how to kiss, etc.; the whole making such a curious combination that we hardly know whether to set the book aside with a laugh, or to regard it as an important contribution to knowledge. The latter feeling, however, predominates. The fundamental proposition of the discussion, viz., the strictly modern nature of romantic love, is one of great importance, giving as it does entirely new thoughts upon certain phases of modern life. It certainly merits the discussion given it, as well as the further discussion which is sure to follow the study of Mr. Finck's argument.

One cannot read this discussion of romantic love without acknowledging that Mr. Finck has made out a very strong case. The facts which are brought out plainly show that there has been a gradual but great change in the pre-nuptial relations of the sexes, and as a result a great change in the sentiments which precede marriage. A romantic love, which was curbed and repressed by the customs of ancient nations, has, under the influence of modern society, expanded into a greatly exaggerated form, until now it is the theme of about all novels, plays, and poems, occupies largely the thoughts of all young people, and is perhaps the most powerful lever for influencing the lives of mankind. But while we may go thus far with the theory, and recognize that ancient life and literature had very little of love, though modern life and literature are full of it, and that it is only modern society that recognizes the desirability of love-matches, the interpretations which may be drawn from the facts are varied. Mr. Finck interprets these facts as representing the development of a new factor in man's nature, and one which was not and could not have been present in earlier periods of history. It is at least questionable whether this interpretation be the true one.

The author is doubtless right in pointing out the impossibility of any feeling akin to the higher phases of love in the lower races of men. Romantic love is a feeling of high sensitiveness, and only those with highly developed sensibilities can experience it in its fullest degree. Indeed, the bulk of civilized people to-day are not capable of having very lofty experiences in this line. The love which Mr. Finck is writing about is largely ideal rather than actual. It belongs to emotional poets rather than to the common people.

Dante, Goethe, and Heine are exceptional, and their works do not represent the true feelings of mankind. It is the lot of very few to love as did Romeo, and most of us poor mortals cannot understand the feelings of Dante or Beatrice. Highly wrought loves are mostly found in fiction and poetry, seldom in actual life. And yet the average person of to-day is doubtless better able to appreciate such feelings than the average Greek or Roman, both because he is more capable of loving, and because women have been permitted to become more lovable. Society to-day has, then, a much higher development of this feeling than in past times. There has been an increase in the quantity of romantic love, and doubtless in the depth of it. But that romantic love of modern times is a new feeling, is not so evident.

There are many considerations which immediately suggest themselves as enabling us to understand these facts, and they may lead us to believe that romantic love can be traced back much further than 1,000 years, and that it was even in ancient times essentially the same in its nature as now. First, we must notice the change which has come over the spirit of literature in modern times: it is by no means fair to compare modern literature with the ancient upon this subject. At the time when the classics were written, books were great rarities, laboriously copied by hand, possessed only by the rich, and read only by scholars. In modern times printing has thrown all literature open to every one in civilized communities. The classical authors thus wrote to the few; the modern authors to the many. The former wrote from love of the art simply, and were supported by the patronage of rich men: the latter write for a living from the sale of their works. While the former were, therefore, free to follow wherever art led them, the majority of authors to-day must write that which will best please their readers. In former times it was only the genius who could hope to acquire any thing by writing: to-day many a writer of mediocre ability makes his living by the use of his pen. It is clear enough why such writers, wishing to obtain as many readers as possible, should choose the most common and yet most delightful experience of life as a theme. It is to these facts largely that we owe the great development of the love-literature of modern times, and partly at least the dearth of it in ancient times. If modern writers thought that only scholars would read their works, and common people know nothing about them, is it not certain that most of our love-literature would disappear? Now, it is, we believe, the development of the modern love-story and poetry, and not the isolated masterpieces of Dante and Shakspeare, which gives us the impression of the great prevalence of romantic love to-day. Blot out all our modern light fiction and other works inspired by money-getting, and Romeo and Juliet would seem as strained and out of place to-day as Mr. Finck thinks the works of Ovid were in the day in which they were written. Indeed, there are few of us now who do not regard this play of Shakspeare as much overdrawn.

We cannot, then, expect love-stories in the literature of early times, and what few references we may find to love here have for this reason the more significance. Now, the very citations used by Mr. Finck in support of his proposition seem to us to go far toward showing that romantic love was by no means an unknown experience in the ancient nations. Ovid was certainly a love-poet, and, even though he was ahead of his age, it is hardly credible that he would give directions to lovers if lovers were unknown. Modern literature gives few more romantic love-stories than that of Cleopatra. Virgil's account of the love of Æneas and Dido could not have been written by one who lived before the time of the birth of romantic love. Even Mr. Finck admits that the Hætere inspired the Greeks with feelings akin to love. Was it not, indeed, exactly the same feeling as modern love applied to a different end? Modern love does not go beyond the extent to which the love of Paris and Helen went to involve a whole nation in war. More significant still, both Greeks and Romans recognized a goddess of love, Venus; and, though perhaps they did not rigidly distinguish between romantic and conjugal love, nothing is plainer than that Venus was not the goddess of conjugal love. The whole account we have of her shows that romantic love was much more closely the idea associated with her than conjugal love. Again, Solomon's Songs, after all that is said about them, could not have been written by one of a nation who knew nothing about love. Did not Jacob

serve seven extra years for Rachel because he loved her more than Leah? This is a case which shows that in these early times romantic love existed, and manifested itself in spite of established custom, which compelled the wedding of the elder daughter first.

Or look at the matter in a different way: romantic love at all ages refuses to be trammelled by custom. The French, as Mr. Finck tells us, being unable to find love in courtship, owing to the influences which surround French girls, find it in the greater freedom of women after marriage. This gives us the numerous illicit loves of the French novel. Love leaps beyond the bounds of custom and law. Now, have we not abundant evidence that the same has been true at all times? As our author shows, the customs of ancient nations have been such as almost to preclude romantic love before marriage; but that the feeling has shown itself in other ways seems evident from the universal existence of laws against adultery, the numerous instances of conjugal unfaithfulness, and the care with which husbands have always considered it necessary to guard their wives from contact with other men. And it is suggestive that this care is the greatest where pre-nuptial love is the most strictly prohibited. Such extra-marital loves, which are implied by these facts, though sometimes nothing more than sexual passion, are in many cases the same feeling which Mr. Finck calls romantic love, only applied in a different direction. If the various 'overtones' of romantic love, which Mr. Finck has drawn up, be considered, it will be found that they all apply to this species of love, except perhaps the 'pride of conquest,' which is impossible owing to the necessary secrecy of the matter.

I suspect, therefore, that Mr. Finck has been tracing not so much the birth of a new sentiment as the growth of the institution of courtship; not so much the development of love as the gradual improvement of the condition of woman. In all cases he has drawn a parallel between the stage of development of romantic love and the freedom of woman. His argument has shown the impossibility of courtship in ancient times, rather than the impossibility of love. Where wives were stolen, or bought and sold, or where marriages are merely a matter of business, *mariages de convenance*, it is plain enough that romantic love could seldom exist in connection with marriage. But even under these circumstances the feeling existed, as is shown by the conception of the goddess of romantic love among the Greeks and Romans, the few love snatches of ancient literature, and as is shown by the numerous extra-marital loves of all times. But when in modern times and among civilized nations women have been gradually acquiring freedom and independence, and a right to appear in public before marriage, this feeling of love between the sexes, which had hitherto been usually an unlawful feeling, gradually became directed toward its legitimate end, as a precursor to wedlock. Courtship is therefore a modern institution, which has resulted from the improvement in the condition of woman. But it is more than doubtful whether the love which accompanies it is any thing more than the same feeling between the sexes which has always existed, but applied to a different condition of society.

It may seem that the above is a distinction without a difference, and indeed these suggestions are not given in criticism of Mr. Finck's work, which is certainly to be regarded as one of the valuable contributions to the history of mankind; but there is certainly room to doubt whether Mr. Finck has put the right interpretation on his facts. That Dante was the first love-poet, and that Romeo was the first love-hero of literature, may be true in a sense; and that romantic love has come to fill a place in courtship which it did not formerly hold, may be also true; but we can hardly accept the conclusion that romantic love is of strictly modern birth. The fact of the undoubted existence of extra-marital, though perhaps not pre-nuptial loves at all times, the fact that the literature and mythology of the ancients did contain references to romantic loves, the fact that such loves could not have been then regarded as ennobling owing to the marriage customs, — these, taken with the fact that literature had a different purpose then and now, seem to the present writer rather to indicate that romantic love is nothing new, but that its application to courtship as a preliminary to wedlock is a new phase of life, found only in the customs of a few of the most advanced of modern civilized races.

H. W. CONN.

Middletown, Conn., Sept. 6.

SCIENCE

FRIDAY, SEPTEMBER 23, 1887.

THE UNITED STATES HYDROGRAPHIC OFFICE has already received about three hundred reports from vessels which encountered the violent hurricanes which swept the Atlantic during the last two weeks of August and the first week of the present month. Many vessels which were in the greatest danger attribute their safety to the use of oil in the manner so persistently urged by Commander Bartlett in various editions of the 'Pilot Chart of the North Atlantic Ocean,' and such incidents will be among the most interesting facts brought out by the published report. Were it not for the conclusive testimony received from masters of vessels of all kinds, from the little fishing-schooner to the great transatlantic liner, the idea that a vessel could escape shipwreck in a hurricane by allowing a few gallons of oil to trickle overboard would be regarded as worthy of Baron Munchausen; but "truth is stranger than fiction." These hurricanes seem to have moved along the usual parabolic track, with the vertex of the curve off Hatteras and the upper branch stretching across the Atlantic towards the British Isles. Every effort is being made to collect full reports from vessels as soon as they reach port, and to compare their barometers with standards at the branch hydrographic offices. One vessel reports a barometer reading as low as 27 inches; but it was an aneroid barometer, and the reading was not recorded at the time. The most reliable report thus far received makes the lowest reading 27.91 (aneroid compared with standard, and reading corrected), on board the American steamship 'El Dorado,' Aug. 23, 4 P.M., in latitude 29° north, longitude 78° west (about 140 miles east-north-east from Cape Canaveral). With our present knowledge of the character and usual path of these terrific cyclones, and the destruction wrought in their track along our coast, on the fishing-banks, and along the great highway of transatlantic travel, it seems almost criminal carelessness for Congress not to allow greater use to be made of the telegraph cable through the West Indies and Windward Islands, by means of which several days' warning of their approach could generally be obtained, and an accurate forecast published for the benefit of commerce. The completion of the report now in preparation will be looked forward to with interest not only by mariners, but by the public generally.

THE INTERNATIONAL MEDICAL CONGRESS.

THE variety of subjects discussed in the section of special and general medicine at the recent International Medical Congress was very great. Many of the papers read were of purely professional interest, and not such as to be of any value to our readers: others, on the contrary, were of general interest, and, although read and discussed by medical men alone, still they contained much of instruction for all thoughtful minds. We shall endeavor to give a brief *résumé* of those which seem to us of greatest importance.

Dr. William Welch read a paper on vaccination during the incubation period of small-pox. His experience in one hundred and forty-four cases has been such as to prove that vaccination at this time will either prevent the attack of small-pox or so modify it as to insure the recovery of the patient. The discussion which followed brought out the statement from Dr. Parker of England, that in the large cities of that country human lymph was generally employed. Parents are required to bring their children at certain times to public stations for vaccination. Although revaccination is performed upon school-children at the age of fourteen years, this is not compulsory.

A paper on the pathogenesis of yellow-fever was read by Dr. Alvara of Mexico, in which he expressed the opinion that yellow-fever is an auto-blood-poisoning, either by the acid phosphate of soda of the same blood or by the phospho-glyceric acid set free from the lecithina as a result of the action of microbes on the blood.

Dr. Lester of Missouri regards pneumonia as an infectious disease, influenced by malaria and improper hygienic surroundings. Dr. Didamore of Syracuse referred to the discovery of the micrococcus of pneumonia and to the experiments which showed that when this is inoculated pneumonia will result.

Dr. Gihon, United States Navy, read a paper on the domain of climatology and demography as dependencies of medicine. He claimed a place for climatology as one of the sisterhood of medical sciences. Climatology and demography are contributory sciences to preventive medicine, and this is more important than curative medicine. The diseases which are truly climatic are but few. Malaria is not one of these. The reduction of the death-rate of the Italian army to one-third what it formerly was, is due to the drainage of the Roman marshes. Local unsanitary conditions cause more disease than the climate. He criticised vital statistics as usually prepared and published, stating that more facts are needed than the simple number of births, deaths, and marriages. Records, if they are to be accurate and of value, must not be voluntary, but under governmental direction.

Dr. Rohé of Baltimore, in a paper on the meteorological elements of climate and their effects upon the human organism, said that climatologists do not at the present time believe that ozone has any influence either in preventing or causing disease. Some believe that peroxide of hydrogen is an important antiseptic element in the atmosphere, but further investigation in this direction is needed.

Dr. Parker of Newport spoke of a number of health-resorts which he regarded as adapted for the stay of the sick. He recommended a wagon-trip across the plains as one of the best means of obtaining the advantages of a health-resort.

Dr. Taylor, United States Army, presented a paper on the necessity for a more careful examination of the water-supply of military posts, where an unusual amount of sickness prevails, and examination of hygienic surroundings. At some of the military posts the death-rate is great, owing to enteric and malarial fevers, which would be much reduced if proper attention were paid to the water-supply and to the general sanitation of these posts. Dr. Marston of England had no doubt but that certain epidemics of disease which he had observed among soldiers, were caused by impure water. While malaria might be in some instances due to the same cause, the influence of freshly disturbed soil was a most important one. It was believed in China that the simple scratching of the soil by chickens resulted in the production of malaria in those persons who lived near by. He had also witnessed an epidemic of goitre, which was directly traced to the use of drinking-water which contained lime salts.

Dr. Thomas of Baltimore read a paper on the causes of so-called hay-fever. The exciting causes he classified as follows: 1. Inert substances floating in air, dust, pollen, etc.; 2. Psychological impressions; 3. Meteorological changes, sunlight, wind, etc.; 4. Morbid changes or growths; 5. Irritation reflected from distant parts of the body. In speaking of the treatment, he said that the use of cocaine gives temporary relief, but there is danger to tissues from protracted use.

Dr. Collins of Philadelphia described the construction of field-hospitals, mentioning more particularly the depot field-hospital of the army of the Potomac at City Point, Va., in 1864-65. This hospital occupied two hundred acres of land, and could accommodate ten thousand patients. During the war, 71,223 soldiers were treated there. Dr. Varian of Titusville, Penn., recommended tents for hos-

pital purposes, stating that the liability to enteric fever and other camp diseases was much lessened when the sick were under canvas. The streets between hospital-tents should be at least fifty



FIG. 1.

feet in width ; and when it was necessary to heat the tents, as in winter, open fires in front of them gave the best results.

The following resolutions were adopted by the section of climatology and demography :—

“ *Resolved*, That in the opinion of the section on medical climatology and demography, of the Ninth International Medical Congress, assembled in the city of Washington, Sept. 5-10, 1887, it is important there should be established in every country a national department, bureau, or commission for the record of vital statistics upon a uniform basis, to include not only accurate returns of births and deaths, but the results of collective investigation by government officials, of facts bearing upon the natural history of disease as manifested among men, women, and children separately, especially with regard to climatic and other discoverable causes of the several forms of disease, — race, occupation, and residence being included, — that necessary preventive measures may be determined and enforced for the preservation of the public health.”

Dr. Denison of Colorado read a paper on the preferable climate for phthisis, illustrated copiously with maps and tables. He believes that climate is to be preferred for the greater number of consumptives in the United States which is between fifteen hundred feet elevation in the North in winter, and ten thousand feet in the South in summer.

Dr. Day of Louisiana presented a report which was the result of an inquiry into the facts relating to the effects of overflow of the Mississippi River, and based on communications from five hundred physicians of the South. His deductions are, (1) that overflows are injurious to the public health ; (2) that their evil effects upon health are lessened or entirely antagonized by good natural or artificial drainage, and by copious showers of rain occurring during the period of subsidence of the waters ; (3) that rice-culture is inimical to health only by reason of the improper and unsanitary manner of its cultivation.

Dr. Semmola of Naples delivered an address on bacteriology

and its therapeutic relations. He regards the tendency to consider bacteriology as the key to all pathology to be a great mistake. Microbes are not always the cause, but are often the effects, of disease. Before any microbe is to be regarded as the cause of a given disease, we ought to reproduce that disease artificially by that microbe. The experiments made have not given any satisfactory results, except in carbuncle and tuberculosis. To conclude hastily that a given microbe is the cause of any disease is to ignore the experimental method. In the present condition of bacteriology it cannot be taken as a guide for the treatment of internal diseases. Modern bacteriology may lead the way to the most fruitful field of inquiry in the future, but for the present it has produced no practical results in the cure of internal diseases. It has not yet been demonstrated in what measure microbes are the causes of diseases. In future investigations preconceived ideas must be abandoned, and scientific independence must be preserved.

Dr. Freire of Brazil read a paper on vaccination in yellow-fever, in which he renewed his claim to the discovery of a method by which yellow-fever may be prevented. He also exhibited specimens of the yellow-fever microbe. In families consisting of a considerable number of persons, if vaccination was practised after the outbreak of the fever, its progress in that family was arrested ; if not practised, all would be stricken down, and a large proportion, if not all, would die.

In addition to these papers, of which we have been able to give only the briefest *résumé*, a large number of others were presented to the congress, which were of great value and importance, and from which we shall hope to make extracts hereafter.

SOME WESTERN MUMMIES.

EARLY in the present year a party of prospectors were searching for precious metals and old Spanish mines in the wild regions of



FIG. 2.

Arizona and New Mexico. They happened to win the confidence of an Indian chief by curing his sick daughter, who had been given up by the medicine-man ; and he offered to show them a wonderful cave, where it was supposed that gold bars and immense riches

were hidden. But the cave was sealed up with adobe cement, and the Indians had never attempted to open it. The situation of this cave, which the miners at once turned to visit, is described as being



FIG. 3.

on the west side of the cañon of the Gila River, near the bend where it flows westward into Arizona. On opening the cave, they found a number of human bodies.

After this discovery, they proceeded more cautiously. The cave was found to be a natural sepulchre, not fashioned by the hands of man, about twenty-five feet in diameter, and covered with a peculiar dry dust. Along its irregular sides and roof, not a trace of any pictographs could be found; but near the entrance one body, and at the far end four others, were discovered, and all in a wonderful state of preservation. The bodies were wrapped in cloths of peculiar workmanship, some rich in texture.

The shrouds enveloping the bodies crumbled to dust at the slightest touch, as would a piece of burned linen or paper; and only three samples were saved,—one a coarse cloth, a sort of cordage; another similar but finer; and the third of a finer thread texture.

After carefully searching the cavern, and having fully satisfied themselves that its richness was all a superstitious legend, the miners prepared to convey the mummified remains to civilization. Much difficulty and many hardships were encountered during this undertaking. The Indians of that district have the greatest superstitious veneration for the burying-places of the prehistoric races, amounting in some cases to actual worship; looking upon the dead bodies as departed gods, so do they reverence the mounds and ruins in that locality. The Indians, therefore, protested against the removal of the remains; and it was only through diplomacy, bribery, and strategy that we have the bodies here to-day.

A careful examination of these remains leaves no doubt as to their genuineness. They are desiccated human bodies, wonderfully well preserved when we consider their probable age and the fact that I do not find any trace of any embalming process having been used. They are consequently nothing like the Egyptian mummies. The viscera, brain, and every thing is in its proper or normal anatomical position. Even the sexes can readily be distinguished. The skin is like dried leather or thick parchment. The hair is well

preserved on the heads and on the eyebrows of Fig. 1, and on the pubes. The teeth, nails, cartilages of the ears and nose, are in good condition, and the nipples and mammae in Fig. 4.

It is barely possible that the burying-shrouds may have been impregnated with some preservative chemicals or herbs, although hardly probable, as these cloths crumbled to dust on exposure. The only reasonable explanation is, that the hot dry air of this region absorbed all the moisture in the bodies, and literally dried them up, skin, muscles, and viscera. The Indians on this coast dry their buffalo and bear meat in a similar manner in the summer for food in the winter.

Fig. 1 represents the first body, found sitting in the same attitude at the entrance of the family sepulchre, face towards the east. It is a male body, and the giant of the whole group. His stature is the largest, and will measure five feet six or seven. The frame is well proportioned. The skin has a dirty grayish appearance, parchment-like to the touch, and closely adherent to the bones. He has a luxurious growth of black and rather coarse hair. The eyebrows are jet-black, and stiff like bristles. Very few hairs can be discovered on the face. The forehead is well developed; head measures twenty and one-half inches in circumference. The hands and feet are shapely. The dark lines circumscribing the extremities in this and the following figures are cords, with which they are retained in their original positions, and bound to the cases in which they are packed.

Fig. 2 shows the mortal remains of an elder male, not quite as tall, nor with as large a frame, measuring about five feet three. He was found sitting in his present posture between the other two bodies, at the far end of the cave. The teeth are well preserved, and the tongue is like a dried piece of bark. The cloth surrounding his extremities is a heavy fabric, through which is woven a yellowish thread. The small piece of cloth adherent to the tibio-femoral articulation is the only part of the finer shrouds that was saved.

Fig. 3 portrays the mother and the child (a little girl about four years of age). The babe was found as depicted, nestled closely to its mother's breast. This group attracts much attention. They



FIG. 4.

are the best preserved bodies in the whole group. The large figure is that of a woman about five feet tall, small hands and feet, and well-proportioned features. The child is well formed, has evidently walked, and reached about four years. Coarsely woven fabric

shrouds the lower limbs of the mother. It is of the same general characteristics as that covering the body in Fig. 1.

Fig. 4 represents the body of a younger woman, although less perfectly preserved. She has small delicate features, very small hands and feet, and the instep is highly arched. On part of the head is found long, fine black-brown hair. It comes off readily, half of it having already fallen out. From the appearance of the mammae and nipples, I should say she had born children. The pelvis is large and well formed.

The cranial, thoracic, abdominal, and pelvic viscera have not been disturbed in any case. No violence has caused death; and why these five remains of ancient civilization should have been placed side by side in a stone sarcophagus, five thousand feet up in a cave, must remain a matter of speculation for the present. Perhaps they all belonged to one family, — father, mother, and child, with husband and daughter or son and wife.

The heads are well shaped. The measurements of their skulls would place them among the meso-cephalic, or intermediate between the dolicho- and brachy-cephalic. The face is oval, high cheek-bones, long eyes sloping outwards, the fleshy lips and nose rather flat and wide. In my judgment, these are bodies belonging to a period not less than four or five hundred years ago. The owner of these bodies, Mr. Joel Docking of San Francisco, is going to place them in one of the large museums of the world.

WINSLOW ANDERSON, M.D.

EXPLORATION AND TRAVEL.

New Guinea.

SINCE the Germans have taken possession of the eastern part of the north coast of New Guinea, and the island has been divided by treaties among the Dutch, English, and Germans, explorations are carried on very vigorously. It is only a few years since d'Albertis discovered the upper part of the Fly River, and thus was the first to enter the interior of the large island for a considerable distance. Since that time English missionaries have been very active in the exploration of the south coast. Of prime importance is the work of Rev. J. Chalmers, who knows the natives probably better than any other white man. His remarks on the distribution of a light and a dark colored population of New Guinea, the former of whom he considers Malaysians, the latter Papuans, are of great interest. He states that the former, on their migration from the north-west, located between the Papuan aborigines (*Proc. Roy. Geogr. Soc.*, 1887).

The Australian colonies take a particular interest in the exploration of the island, as they are watching with jealousy the attempts of the French and Germans to gain a foothold in the Pacific Ocean. Since the close of 1885 they have equipped several expeditions, but so far they have not been very successful. In 1885 the small steamer 'Bonito' was sent out to explore the high mountain-ranges in which the Fly River has its source; but this attempt failed, as the steamer was in the hands of an unskilled captain. The only geographical result was the exploration of a small tributary of the Fly River, though the cost of this expedition was about eighteen thousand dollars.

In 1886 the well-known traveller H. O. Forbes set out to explore the Owen Stanley Mountains in the south-eastern part of New Guinea; but unfortunately he arrived on the island in the rainy season, when travelling is impossible, and later on he had to give up his intention on account of lack of means. The project has, however, been taken up again, and Mr. Vogan, the curator of the Auckland Museum, and Mr. Cuthbertson, are about to start on a journey from the south coast to Huon Bay.

Besides these attempts, which have so far had no important results, a great number of successful explorations have been carried out. The *Deutsche Kolonialzeitung* reports that a private expedition was sent by a Sydney house to the Gulf of Papua. The steamer 'Victory' reached Aird River at the northern extremity of the Gulf on March 21, 1887, and ascended the river for eighty miles. Its delta is very extensive, and was partly explored by the steamer. The river was called Douglas River. The 'Victory' returned and discovered another large river near Bald Head. It received the name of Jubilee River, and was found navigable for one hundred and

ten miles. Even at this point it was three hundred yards wide and from two to five fathoms deep. Unfortunately no map of this survey has been published so far, and therefore these discoveries could not be inserted in our sketch-map.

New discoveries in the region of Baxter River were made by J. Strachan, who explored part of the river-branches forming the delta of Fly and Baxter Rivers. The same traveller has been exploring the southern coast of Dutch New Guinea, and reports the discovery of a narrow channel leading from McClure Gulf to Geelvink Bay; but Mr. Wichmann remarks justly in *Petermann's Mittheilungen*, that the correctness of this discovery must be doubted, as A. B. Meyer, who travelled over the isthmus, states expressly that there is no connection between the bays.

The best surveys made in New Guinea during the last years are those of the officers of the New Guinea Company and of German men-of-war visiting these coasts. In these parts of our map will be found the most important and most extensive alterations, as compared to former maps. The coast from Humboldt Bay to the southern boundary has been resurveyed for the greater part, and the results have been published by the New Guinea Company (in *Nachrichten über Kaiser Wilhelms-Land*). From these publications we have taken the course of Augusta River and the coastline. South of Cape della Torre another river was discovered which was called Otilie River, but it could not be followed to any distance on account of its shallowness: it carries a great volume of water, and may be ascended by a steamer of three or four feet gauge. The course of these rivers shows that the high part of New Guinea is formed by a narrow range of mountains which begins at Geelvink Bay and continues throughout the island to its south-eastern point. The banks of the rivers are inhabited by natives, large villages being found on their upper parts. It will be of great interest to learn where the large river emptying itself at Point D'Urville has its source. So far, the rivers have been the only means of penetrating into the interior, for the vegetation is so dense that it prevents extensive journeys. The map shows that the outlines of many islands are still unknown, and we must add that the positions of the small islands and reefs are uncertain.

A great difficulty in all enterprises on New Guinea is occasioned by the hostility of the natives. In some parts the English missionaries have succeeded in gaining their confidence, particularly by the help of Polynesian teachers, but generally the natives are distrustful and aggressive. The same is true in New Ireland and New Britain; but it is hoped that in course of time better relations will be established. Recently natives of New Guinea and New Britain have begun to work on the plantations of the companies. The climate of the island is in most parts unhealthy, particularly in the swampy alluvial districts, which are very fertile. It may be, however, that it will become more healthful when the woods are cleared and the swamps drained, as was the case in northern Queensland.

ETHNOLOGY.

Mound-Exploration.

THE second bulletin of the Bureau of Ethnology is a statement by Mr. Cyrus Thomas, who is in charge of the archaeological division of the bureau, on the methods adopted for carrying on mound-exploration, and on the present state of the work of the division. His method of investigation is to mark out the several archaeological districts by searching for typical forms of remains in the different parts of the country. For the present the field of researches is limited to the district east of the Rocky Mountains. Three north and south lines were worked: the first and principal one, the immediate valley of the Mississippi from Wisconsin southward; the second, from Ohio southward through Kentucky to Mississippi; and the third, in the valley of eastern Tennessee and western North Carolina, thence southward through Georgia and Alabama to Florida. Sections which had been somewhat carefully worked over were generally passed by. The specimens found by the exploring parties are handed over to the National Museum.

Among the results so far obtained, the most important ones are mentioned in the bulletin. The links discovered directly connecting the Indians and mound-builders are so numerous and well established that there should be no longer any hesitancy in accepting the theory

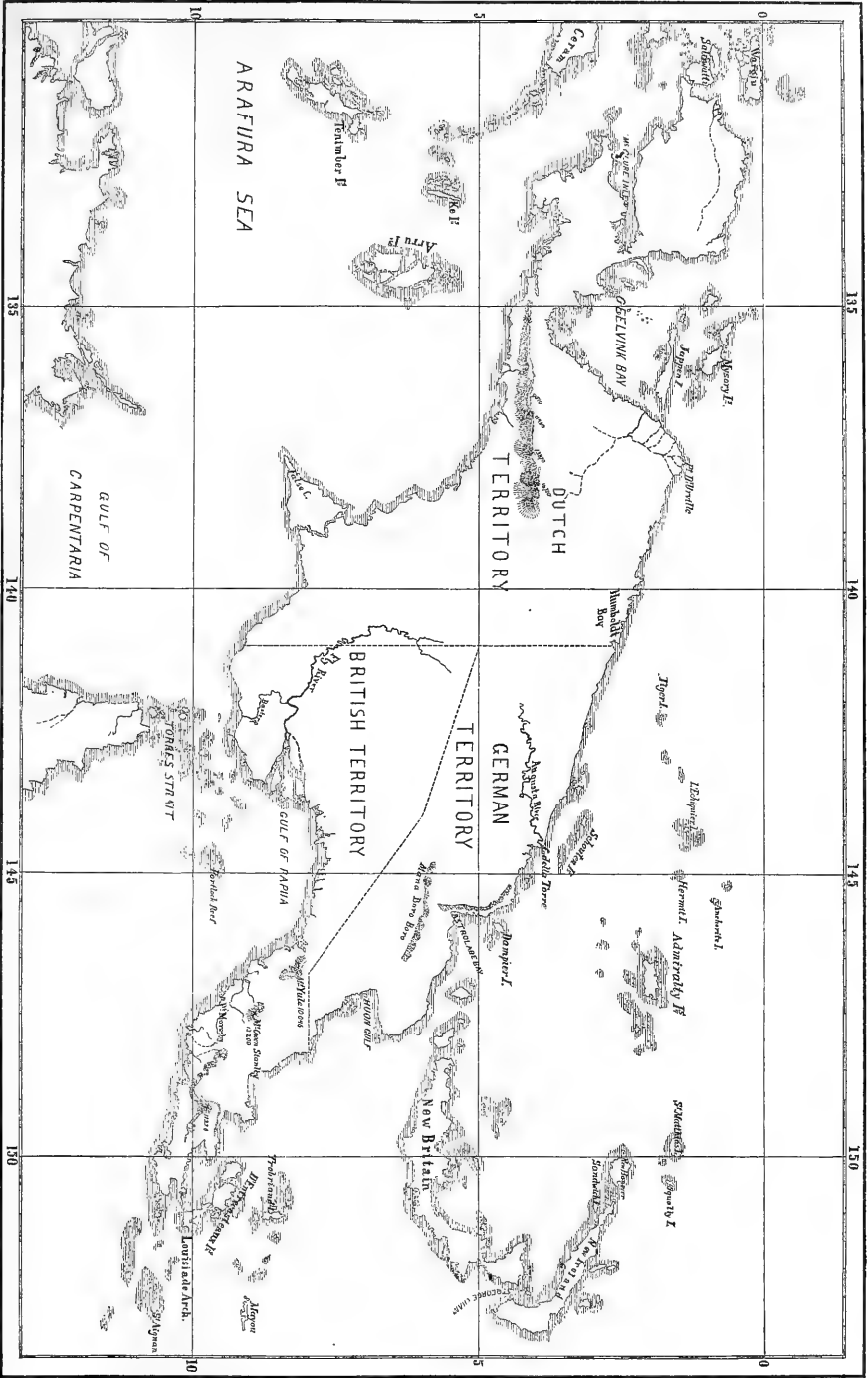

SKETCH-MAP SHOWING RECENT EXPLORATIONS IN NEW GUINEA.

that the two are one and the same people; that a great number of these ancient monuments were built at the time of the discovery of America by the Europeans and subsequent to it; and that the archaeological districts, as determined by the investigations of the mounds and other ancient works and remains, conform, to a certain extent, to the localities of the tribes or groups of cognate Indian tribes at the time of the discovery. Conclusions on early migrations of Indian tribes can only be drawn to a limited extent. The publication of the general report, which may be expected within a few years, will contain the material from which these important conclusions have been drawn.

INDIAN BASKETRY.—The annual report of the National Museum for 1884 contains several interesting ethnological papers. Prof. O. T. Mason gives a sketch of the basketry of North American aborigines, which is amply illustrated with drawings of specimens and enlarged portions of the basket-work, in order to illustrate exactly the manner of weaving. Mason discusses the methods in use all along the coast of western America from the Arctic Ocean to California, in the interior, and among the tribes of the Atlantic coast, and distinguishes three types of basketry, which he calls the twined, the coiled, and the woven ones. The first is most frequently found on the north-west coast. Coiled basket-work is almost exclusively used by the northern Tinné and by the Apache, while many tribes apply all methods of manufacture. A great difficulty in determining the areas of characteristic forms is encountered through the deficiency of the methods of many collectors, and the fragmentary state of collections; many specimens which are seemingly characteristic of one tribe having in reality a far wider distribution, while other characteristic types are wanting in the collections.

OF THE ESKIMOS.—There are two other papers of the same character in the National Museum report for 1884,—one by the same author, on Eskimo throwing-sticks; and one by Mr. John Murdoch, on bows of the western Eskimo. The standpoint from which these subjects have been treated is the same as the one indicated above. A list of the specimens upon which these studies are founded, such as is attached to Professor Mason's paper, ought not to be omitted in publications of this kind, and the fact that it is wanting detracts somewhat from the value of Mr. Murdoch's interesting paper. It is necessary for the reader to know how many specimens of each locality were studied in order to form a judgment as to how far the difference in form may be typical or accidental.

A MYTH OF THE OKINAGEN INDIANS.—Mr. A. S. Gatschet publishes an interesting myth of the Okinagen Indians in the *Globus*. He relates how the animals climbed on a chain of arrows to heaven in order to obtain the fire. The bird Tskan made a strong bow of the rib of an elk which he killed by eating its heart. Then he killed the *coyote* with his arrows, but the latter was revived by the fox. Then he shot one arrow into the sky. The next arrow he shot stuck in the end of the first one. Thus he continued until a chain was formed reaching from heaven to earth. All animals climbed up this chain, and the beaver obtained the fire. An analysis of this interesting legend shows that its elements are found among a great number of tribes of Selish lineage and among their neighbors, but it seems that the myth of the ascent to heaven is characteristic of Selish mythology. Gatschet tries to interpret this legend, and thinks the bird Tskan represents the moon, the *coyote* the sun; but this seems improbable, as the myth is extremely complicated, and is probably derived from a great number of sources. It is desirable that the mythology of the native tribes of the upper Columbia should be collected systematically, for the analysis of tradition is one of the most important methods of studying the history of the native races and the psychology of nations.

BOOK—REVIEWS.

Synopsis of the Flora of the Laramie Group. (Extract from the Sixth Annual Report of the U. S. Geol. Surv.) By LESTER F. WARD. Washington, Government. 4°.

THIS synopsis is published in advance of the completion of the author's great monograph on the Laramie flora, and is a timely and important contribution to our knowledge of the thousands of feet of debatable strata between the Cretaceous and Tertiary. The literature of the Laramie group is already large and widely scattered,

and Mr. Ward has conferred a boon upon future students of this formation by his clear and comprehensive review of previous researches and opinions.

The Laramie group is described as an extensive, brackish-water deposit, situated on both sides of the Rocky Mountains, and extending from Mexico far into the British North American territory, having a breadth of hundreds of miles, and representing some 4,000 feet in thickness of strata. When this deposit was made, an immense inland sea must have existed, whose waters occupied the territory now covered by the Rocky Mountains. These waters were partially cut off from the ocean by intervening land areas, through which, however, one or more outlets existed, communicating with the open sea at that time occupying the territory of the Lower Mississippi and Lower Rio Grande valleys. That this great inland sea spread over this entire territory, is not at all disproved by the absence of Laramie strata from large parts of it, since these parts are situated, in most cases, in mountainous regions where the upper strata might be expected to have been generally eroded away.

This Laramie sea existed during an immense period of time, and was finally but very gradually drained by the elevation of its bed, through nearly the middle of which, longitudinally, the Rocky Mountains and Black Hills now run. The exceeding slowness of this event is shown by the fact, so clearly brought out by Dr. White, that the marine forms of the Fox Hills strata, as they gradually found themselves surrounded by a less and less saline medium on the rising of the intervening land area, had time to become transformed and adapted to brackish-water existence, while these new-formed brackish-water species, when the sea at length became a chain of fresh-water lakes, had time again to take on the characters necessary to fresh-water life.

Dr. White recognizes the fact that the upheaval of the strata that formed the bottom of this sea took place, not in one uniform process of elevation, but in a prolonged series of rhythmic fluctuations of level, whose algebraic sum constituted at length a mountain uplift. But the numerous coal-seams, one above another, that characterize the greater part of these beds, and equally the successive deposits of vegetable remains at different horizons, speak even more eloquently than any animal remains can, of the oscillatory history of the bed of this sheet of water.

There may have been, and doubtless were, many islands scattered over the surface of this sea in Laramie time, and the evidence generally warrants us in assuming that a low, level country surrounded the sea, with marshy and swampy tracts. The islands and shores were heavily wooded with timber that can be as certainly known in its general character as we can know the timber of our present forests. But that for the greater part of the Laramie period there also existed at no great distance a large amount of elevated land, there can be no doubt. The deposits are chiefly siliceous in the southern districts, and argillaceous in the northern, but the nature of their deposition points unmistakably to the existence of large and turbulent rivers, that fell into the quiet sea and brought down from areas of rapid erosion immense quantities of silt corresponding to the nature of the country over which they flowed in their course. Where these elevated sources of this abundant detritus were located is one of the great problems for the present and future geologists to work out.

The author points out that the apparent impossibility of referring the Laramie group to either the Cretaceous or the Tertiary is not the fault of the investigators, but of the facts; for the real disagreement is in the organic forms and the nature of the deposits, so that omniscience itself could never harmonize them with the forms and deposits of other parts of the world: in other words, the Laramie fauna and flora have been developed under physical conditions so nearly unique that it is extremely improbable that they obtained elsewhere on the globe at the same time. And even supposing such a coincidence possible, if the Laramie invertebrate forms are the modified descendants of antecedent marine forms, there is no probability that the conditions at any other point on the earth's surface could be so nearly identical with those obtaining there, that precisely the same modifications would take place to adapt the marine forms to the brackish-water habitat. The chances are therefore infinity to one against the existence of other beds that shall

contain an invertebrate fauna identical with that of the Laramie group.

With regard to vertebrate remains, this objection does not apply; and, could they be made to harmonize with themselves, they might, perhaps, be trusted to some extent as indices of synchronism in widely separated localities. But, as shown by Cope, they do not thus agree, for the Laramie forms include genera that are regarded as characteristic of Cretaceous, and others that are regarded as characteristic of Tertiary strata. This should surprise no one. The law that has been laid down by paleontologists, that the same epochs in geologic time produced the same living forms, is contrary to the now well-established principles of geographical distribution, according to which the earth is subdivided into a large number of faunal areas more or less clearly marked off one from another.

The peculiarity of this principle, which is of most importance to paleontology, is that these territorial subdivisions represent faunas not merely different from one another, but showing different degrees of biologic development as development is supposed to have gone on in the animal kingdom. Every one knows that the fauna of Australia belongs to an undeveloped type, being marsupial in aspect so far as its mammals are concerned. The types of South America are lower than those of North America, and the latter lower than those of Asia and Europe. If all the present faunas of the globe were buried under its soil, it is clear that it would not only be impossible to harmonize the deposits of different continents, but that the inference now freely drawn by paleontologists, that the less developed forms demonstrate their existence at earlier epochs, would lead to grave mistakes and be generally false. New Zealand is now in its age of birds, while the Galapagos Islands are still in that of reptiles, or the mesozoic age.

The difficulties in the way of geological synchronism arising from the geographical distribution of organisms are not lessened when we pass from the vertebrate fauna to the flora of the Laramie group; for, taking the present flora of the globe as a criterion, we find that the geographical distribution of plants is more uneven than that of animals. Floral realms are more numerous and distinct than faunal realms; and the more serious obstacle, that some areas furnish types representing less developed floras than others, exists here, as in the case of animals. The proteaceous and myrtaceous flora of Australia may be regarded as rudely corresponding to its marsupial fauna. Hence, although the vegetable fossils of the Laramie group are especially remarkable for their great abundance and variety, Mr. Ward concedes that the age of the Laramie group cannot be proved by its flora alone.

The more particular comparison and discussion of the Upper Cretaceous or Senonian, Laramie, and Eocene floras is introduced by a table covering 72 pages, and giving the geographical and stratigraphical distribution of every authentic species from these formations. The discussion concludes with the statement that the Laramie flora as closely resembles the Senonian flora as it does either the Eocene or the Miocene flora. But this does not necessarily prove either the Cretaceous age of the Laramie group or its simultaneous deposit with any of the Upper Cretaceous beds. The laws of variation and geographical distribution forbid us to make any such sweeping deductions. With regard to the first point, it is wholly immaterial whether we call the Laramie Cretaceous or Tertiary, so long as we correctly understand its relations to the beds below and above it. We know that the strata immediately beneath are recognized Upper Cretaceous, and we equally know that the strata above are recognized Lower Tertiary. Whether this great intermediate deposit be known as Cretaceous or Tertiary is therefore merely a question of a name, and its decision one way or another cannot advance our knowledge in the least.

The synopsis concludes with notes on the various localities where the Laramie plants were collected, and 35 double plates, with 139 figures.

Types of the Laramie Flora. (U.S. Geol. Surv., Bull. No. 37.)

By LESTER F. WARD, Washington, Government. 8°.

THIS rather bulky bulletin is supplementary to the preceding synopsis. The 139 figures are reproduced on 57 octavo plates, and are accompanied by critical comments, and descriptions of the new genera and species.

NOTES AND NEWS.

ON Tuesday the 20th, in the presence of the secretary of the navy, the naval committee of the House of Representatives, and many representatives of the army and navy of this and other countries, an exhibition was given in New York Bay of the destructive capabilities of the Zalinski pneumatic dynamite gun. The results of the tests made at the time prove conclusively, that, with the present experimental and necessarily imperfect gun, a shell containing fifty-five pounds of explosive gelatine may be thrown with accuracy a distance of one mile, and exploded at the proper moment for producing the maximum of destructive effect. The target used was the two-masted schooner 'Stillman,' eighty tons' burden, late of the United States Coast Survey, but recently condemned, and reserved to be used in torpedo experimenting. She was anchored 1,980 yards from Fort Lafayette, where the gun was stationed. After two trial-shots with blank cartridges, a loaded shell was fired, which struck the water a few yards short of the target. The explosion threw a column of water nearly a hundred feet into the air, and the concussion jarred the vessel so that the mainmast was broken off a few feet above the deck. The next shot struck the vessel at or below the water-line, with an instantaneously destructive result. The schooner was lifted up, fairly torn apart amidships, and the rails were under water in less than thirty seconds, only the foremast and its standing rigging being left in view. All around this floated small fragments of the schooner. In each of these instances the gelatine was exploded by percussion in this way: a small electric battery was affixed to the side, the only thing lacking to start its operation being moisture. A thin piece of blotting-paper kept this out. When the shell was immersed, the moisture admitted generated sufficient electricity to fire a detonator of fulminate of mercury, which exploded the gelatine.

— R. Nahrwoldt has made a series of experiments on the gradual loss of electricity of electrified bodies (*Naturw. Rundschau*, ii. No. 35). In an essay published in 1878 the author proved that the discharge takes place by means of the particles of dust suspended in the air. These are electrified and then repelled from the electrifying body. The result of these experiments led Lodge and Von Obermayer to their method of clearing rooms from smoke. Later on, it was shown that a wire of platina made red-hot by electricity electrified the surrounding air, although it was almost free of dust. For this reason Nahrwoldt resumed his experiments. He found that electricity was discharged through a point only in dusty air. He made his experiments in an air-tight glass shade the sides of which were covered with a thin layer of glycerine. After the dust was precipitated on the sides of the glass through the action of the electricity, the discharge was very slight. As soon as a wire of platina was electrified, and became red-hot, electricity was again discharged through the point. Nahrwoldt concluded that this was due to particles flying from the red-hot wire. This conclusion was proved to be correct by the occurrence of platina in the deposits on the sides, and by the loss of weight of the wire. These experiments led him to the conclusion that air free of dust cannot be electrified statically.

— We learn that the pecuniary loss attending the publication of the *Zoologischer Jahresbericht* has been so great as to make it necessary henceforth to restrict the scope of the work. Systematics and faunistics are to be excluded. The *Jahresbericht* is published under the able editorial supervision of Dr. Paul Mayer of the Naples Zoological Station, and has now reached its eighth year. Four heavy volumes have hitherto been issued each year, giving accurate and comprehensive summaries of all the zoological work done during the year under review. The *Jahresbericht* is one of the most difficult, most expensive, and at the same time most valuable, zoological serials ever undertaken. About thirty reporters (*Referenten*), distributed among different countries, have been employed in collecting, summarizing, and arranging this vast work. The task has been faithfully and most thoroughly accomplished, and we most earnestly hope that the number of subscribers may be at once increased to an extent that will insure its continuance on the same broad plan that has hitherto been followed. The *Jahresbericht* has become our *vade-mecum*; and we can but regard it as a serious misfortune to have its scope narrowed. Are earnest zoologists in this country willing to see such a work as this interrupted for

want of proper support? There are probably not more than half a dozen subscribers in this whole country. Let those who appreciate the importance of the work encourage it by giving it a place in their private libraries.

LETTERS TO THE EDITOR.

**The attention of scientific men is called to the advantages of the correspondence columns of SCIENCE for placing promptly on record brief preliminary notices of their investigations. Twenty copies of the number containing his communication will be furnished free to any correspondent on request.*

The editor will be glad to publish any queries consonant with the character of the journal.

Correspondents are requested to be as brief as possible. The writer's name is in all cases required as proof of good faith.

Romantic Love and Personal Beauty.

YOUR reviewer has pointed out that the light and flippant character of Mr. Finck's style prevents his book from being taken as a serious contribution to science. He has neglected to show that the unintermitting vulgarity of its tone will cause it to have an exceedingly vicious effect upon society, if it should chance to have any effect at all. Romantic love is one of the few thoroughly beautiful and elevated things that civilization has yet produced. It is such a means of refining and subduing the brute in man, and of bringing him a little nearer to the angels, as is no other emotion which he has yet developed. When a young man and a maiden are in love, they walk in a very heaven, not of happiness only, but of delicacy and purity. The poets and the worthy novelists have invested the subject with a warm glow of high feeling and noble aspiration, and even the unworthy novelists have not dared to drag it wholly in the dust. It has been reserved for a Mr. Finck to write of it in a tone which is not equalled by the commonest and most vulgar of the daily newspapers. It is incomprehensible that a book which is offered to decent people to read should contain such a sentence as this, to take an instance at random: "Has Mr. Spencer ever kissed a girl?" Romantic love is a precious possession which the race has been slow to gain. It is possible that it is like a delicate flower, which cannot be handled by the botanist without losing its beauty and its fragrance. At all events, it is of immense importance, if it is to become the subject of scientific investigation, that it should not be vulgarized and cheapened at the very beginning by such a manner of writing as this.

Mr. Finck's book contains a number of very clever explanations of minor points in biology and psychology. His main theses are not new; and, as Mr. Conn has pointed out, it is premarital courtship, and not love, that he has shown, or that can be shown, to be very modern. His explanations, while they are extremely ingenious, always need to be carefully examined, and are seldom fortified by his reasons. His conception of how delicate a task it is to establish a relation of cause and effect may be gathered from the following passage: "Large numbers of tourists in Switzerland constantly suffer from headache, simply because they fail to have the head at night in the centre of the room, where it ought to be, because the air circulates more freely there than near the walls." His literary style is on no higher level than his taste and his logic. He speaks of "a blue-blooded youth and a ditto maiden," and of "knocking the bottom out of the theory of Alison, Jeffrey and Co." So utterly regardless is he of the common decencies of language, that it is impossible to attribute it to the proof-reader when we find him saying that one thing is the "very antipode" of another.

The second part of Mr. Finck's book is, if possible, worse than the first. His ideal of beauty is as poor and mean as his ideal of romantic love. That kind of beauty which can be heightened by pomades and powders for the complexion, and by surgical appliances for straightening noses, is not the kind which our descendants will strive to perpetuate. There is something peculiarly gross and offensive about all such topics to a right-minded person; and to find them discussed in fullest detail in a book which is expected to influence scientific opinion on a subject of profound importance, is certainly one of the most curious freaks that a nonsensical maker of a book has yet been guilty of. Mr. Finck pretends to be an admirer of expression as well as of mere animal beauty. But a fine and noble expression is absolutely incompatible

with such absorption in the details of the toilet as he recommends. It is impossible for a girl to practise 'making eyes' before her looking-glass, as he urges her to do, without showing the marks of that vacancy and insipidity by which "the faces of many fair women are utterly spoiled and rendered valueless." He quotes this other fine passage from Ruskin: "There is not any virtue the exercise of which even momentarily will not impress a new fairness upon the features;" but he is of too insensitive a fibre to know that there is also not any vanity or vice that will not in time ruthlessly destroy whatever is admirable in the face of man or woman. H.

[WE think our readers will find the above letter interesting as containing the strongly expressed views of a woman belonging to that class which believe they have discovered worthy substitutes for some of the attractions which have proved successful hitherto in bringing into existence this much-discussed romantic love.—ED.]

Grindelia squarrosa.

A VERY interesting find was made here recently by one of the High School boys, who is making botany a specialty. The 'find' consisted of several specimens of a composite plant unknown here before, but which has been decided by several competent authorities to be *Grindelia squarrosa*, a plant said by Coulter to occur "from the Saskatchewan to Texas, and westward to the Sierra Nevada."

The three or four specimens were found in a pasture, at some distance from the railroad. How they came there is the question which is puzzling those who have seen them, as their true home is said to be so far to the westward. I have heard that a few specimens were once found in Ottawa in this State, but cannot vouch for the truth of the report.

L. N. JOHNSON.

Evanston, Ill., Sept. 14.

The Term 'Topography.'

THE significance of the term 'topography' has undergone a rapid specialization in modern scientific usage that is noteworthy as an indication of the increased attention incidentally given to the study of physical geography. A conspicuous improvement in the methods of geographic teaching in England has been commented on in recent numbers of *Science*, and attributed to a growing recognition of the economic bearing of geographic facts. Mr. Keltie has shown that an entirely novel method of treatment, and a rapid advance, have resulted from this altered attitude. There is, however, tacit admission, to which Mr. Davis calls attention (*Science*, x. No. 240), that the nature of the relations of 'physiography' to human development is but vaguely understood, and that progress is at present retarded by uncertainty of aim. Mr. Davis effectively points out the difficulty: that for teaching-purposes there has not been sufficient inquiry into the principles of geographic evolution, "for topographic development is the key to a real understanding of the forms of the land about us;" that "physiography now is in a low position," and "most immature" as a science in itself. Generalization is as yet difficult, or of questionable profit: "attention should be directed instead to the minute morphology and systematic development of individual topographic forms." Physiography must make the same order of advance that biology has made out of the old natural history, with its aimless catalogues of wonders, and study the "simpler type-forms carefully before attempting to understand the complex associations of forms that make up a country or a continent." Mr. Keltie recognizes that it is "typical aspects of the earth's surface," not "extraordinary features," that will serve the purposes of the new geography; "but," as Mr. Davis points out, "he does not say where we shall find a scientific and sufficient investigation of the forms that are chosen as 'typical aspects.'" There is no such investigation. The absence of any thorough and consistent physiographic terminology at once points out the immaturity of this study. . . . 'The Sixth Annual Report of the Geological Survey,' just issued, contains, for example, a number of illustrations that will be seized upon when the proper text-book appears. The choice little woodcuts on p. 229, entitled 'Topographic Old Age' and 'Topographic Youth,' are particularly good, but these terms will certainly be new to most readers." No "scientific and sufficient investigation" of the evolu-

tion of geographic forms has been attempted, and there is no "thorough and consistent physiographic terminology;" but systematic incursions have been made into this field by meteorologists, by engineers, and notably by American geologists. The geologist is not, for example, chemist also, because chemistry aids in geologic investigation, but here, from necessity, the geologist is also physiographer. The effect of this orderly work upon the study of physiography, though in the nature of clearing away outlying obstructions to adjoining interests, is seen in the scientific beginnings of a terminology that may be assembled from the writings of Gilbert, Davis, Chamberlin, and others.

The term "topography," it would seem, has, within a few years, been appropriated as a general designation for those superficial forms which have recently received attention as both the product and the promise of so much in geologic evolution. The surveyor made little progress in hill-drawing until it was seen that many obscure geologic facts bore, in surface form, a typical expression that could be readily interpreted. As the director of the Geological Survey said recently, in his testimony before the 'Joint Commission' for the investigation of the scientific bureaus of the government, "the most fundamental connection of geology is with topography, because geology has for its purpose, either directly or remotely, the explanation of topography. . . . All the vigor and energy which are devoted to topography in modern times arise from its geologic relations." To meteorology, and to the broader problems of engineering, surface shape, or surface shaping, also bore complex relations; to engineering it set examples; to meteorology it was a known quantity in an intricate problem; to geology it was the beginning and the end. There were recognized "a topography of the land and a topography of the sea," and, in each, characteristic type-forms, both of erosion and of deposition. The type-forms of erosion were seen to vary with the nature and grouping of materials, so that each class of rocks had its own distinctive topographic expression. The recognition of a 'topography' of coal, and of the allied natural products, in the mining regions of Pennsylvania, is of acknowledged economic importance; and glacial history is traced more successfully through its splendid topographic record than through the composition characteristics of its drift.

Obviously a distinctive term is needed here, in the more discriminative modern geology and allied sciences: from recent inquiry into usage, on this point, I cannot but think that 'topography' has been adopted in this definitely restricted sense, and will hold. For example, in a standard treatise on roads, by Lieutenant-Colonel Gillman of the Engineer Corps, this occurs: "In laying out important roads, and especially in locating streets, in thickly settled districts, it is well to place contour curves upon the map. These curves indicate at once, to the practised eye, the topography of the country which they embrace." Dr. Woeikof, meteorologist and professor of physical geography in the University of St. Petersburg, devotes a chapter in his recent book, 'Die Klimate der Erde,' to the 'Variation of Temperature with Altitude, with Particular Regard to the Effect of Topographic Form on Temperature Changes,' as interpreted in *Science* of the same number with Mr. Davis's letter, cited above. In the newer geological reports abundant instance may be found of this use, for example, here and there: "Change in the character of the rocks produces corresponding change in the topography; the soft mica-schists have been worn by erosion into broad parks and valleys, intervening with rounded peaks and ridges of harder strata;" "the main topographical features of this country are the results of erosion, aided and modified by faults and folds, to which volcanic rocks have added many interesting features, mainly by the resistance which they offer to denudation;" "the contrast of hard and soft has determined the main features of the topography. . . . These have been made to give expression to the main facts of the geologic structure;" "the former [a beach line] crosses the irregularities of the pre-existent topography as a contour, the latter [a fault] as a traverse line. . . . a system of shore topography, from which the ancient lake has receded, is immediately exposed to the obliterating influence of land erosion;" "the topography was not too rough on the one hand, nor so low and flat as to be submerged, on the other. . . . as the peculiar character of the topography of the moraine varies through a somewhat wide range, and sometimes simulates very closely the

surface aspect assumed by other formations, the study of topographical types becomes one of essential importance. . . . a topographical species absolutely impossible of formation by drainage agencies." Upon the first appearance of the proof-sheets of the new topographical survey of Massachusetts, a year or more ago, the work was commented on editorially in *Science*, in part as follows: "The curious Hopper of Mount Greylock, with its deep-cut valley, is one of the best marked topographic forms in the State. . . . what is now needed is the local examination of minute topographic details so that we may learn to see and appreciate the forms about us at home; and nothing will lead sooner or surer to this long delayed end, than the publication of good topographic maps."

I do not think that the term has acquired this association through exceptional fitness of its own, though small objection can be urged on etymological grounds, but because it was in the field, and out of serious employment. Originally it meant place-description, or, as applied to surveying and maps, simply detail, or the art of portraying it. Early topography was, however, singularly unobservant of surface configuration. When the important bearing of surface expression on geologic problems came to be recognized, related topographic work became more appreciative of this additional feature in place-description. Maps of the novel sort were at once recognized as the only completely topographic maps, and to their distinctive characteristic, finally, the term 'topography' got exclusively to apply.

From this point of view, then, in a map, the expression given to the vertical element, whatever the symbol employed, is 'topography'; the drainage, — stream, pond, or marsh, — the obvious agent, destructive or constructive; and the 'culture,' an incident. The term is still in use in the old sense, among surveyors and engineers; and it may, perhaps, continue so, without confusion, as, in turn, a technical meaning.

WILLARD D. JOHNSON.

Templeton, Mass., Sept. 13.

A Living Glacier on Hague's Peak, Colorado.

FOUR years ago, Mr. W. L. Hallett of Colorado Springs, while crossing an ice-field on Hague's Peak, stepped into a crevasse which had been hidden by a thin layer of recent snow, and narrowly escaped a serious accident. The crevasse suggested to him that this snow-field was really a glacier. Since that time the place has been visited by only five or six persons. Among these were Mr. Chapin of Hartford, Conn., a member of the Appalachian Mountain Club, who is said, during last July, to have pronounced the formation to be a true glacier. I have recently examined the region, and the following is a brief statement of the principal facts observed: —

From Long's Peak northward to Hague's Peak is a line of noble mountains thirteen thousand or more feet high. The numerous tributaries of the Big Thompson River take their rise in snow or rather ice fields which are situated in basins or mountain cirques far above timber-line near the summit of the range. The upper parts of the valleys of these streams were all glaciated in ancient times, and are bordered by moraines which in some cases extend down into Estes Park. This region is marked on the maps of Clarence King as having formerly been glaciated, but no moraines are shown on Hayden's large map of Colorado. Several of the ancient glaciers are shown by the moraines to have been more than ten miles long, and some of them were at least fifteen miles. Near the post-office marked Moraine on Hayden's map, the moraines are well developed as ridges having steep slopes on each side. They are from a few feet up to about two hundred feet high, and in places are perched on the mountain-sides five hundred feet or more above the bottom of the valley. Going up these valleys, one sees a succession of terminal moraines, showing that there has been a gradual recession of the ice.

The ice-field on Hague's Peak is in a basin roughly semicircular in shape, situated on the east face of the northern spur of the mountain. The basin is small, — hardly one-fourth of a mile in diameter, — and is at the head of a deep valley which drains east, and then south-east, into the Big Thompson. This valley was once occupied by a large glacier, as shown by moraines, by a number of glacial lakelets in the bottom of the valley, and by mounded bosses of rock. Just below the ice-field a broad moraine ex-

tends across the whole valley. Having climbed to the top of this huge pile of rather angular blocks, you suddenly discover a small lake between the moraine and the ice! The moraine, in part at least, is the barrier that holds back the water of the lake. Except at the outlet of the lake, this moraine rises above the present level of the ice,—in some places fifty feet or more,—and therefore must have been formed at a time when the ice stood at a much higher level than now. The lake is rather less than one hundred yards in diameter. It is locally known as the Frozen Lake, being covered by a weak, granular sort of ice even in midsummer. Floating on the surface of the lake were several blocks of quite solid ice from six to twenty feet long, and rising from two to twelve inches above the water. These little icebergs have evidently broken off from the thin edge of the glacier, which ends in a small cliff from one to three feet high.

The material of the ice-field, though somewhat granular on the surface, is not a mass of snow, but a clear and compact ice. This was determined by observation at the crevasses, and by cutting into it. The surface is deeply furrowed by rains and the water of the melting ice running down the slopes.

The principal crevasse is curved so as to be nearly parallel with the shore of the lakelet, and is not far from one hundred feet back from it. On the upper side of the crevasse the plane of fracture is nearly at right angles to the surface of the ice, but on the lower side the ice has been tilted over; so that, while the crevasse is about ten feet wide at the surface, it is very narrow at the bottom of the ice. The lower parts of the crevasses were filled with snow and broken icicles, ice stalagmites, etc., so that only from twenty to thirty feet can be seen. How much deeper the crevasses really are, is not known; but, from the size and shape of the ice-field, it does not seem probable that the greatest depth of ice exceeds fifty or seventy-five feet. Above the main crevasse were two others large enough to be seen through the recent snow. The number of crevasses is greatest north of the centre of the glacier, where there is a more direct exposure to the sun.

Standing at the lake, you see the glacier sloping steeply down toward you from the south, the west, and the north, somewhat like the seats in a theatre. This causes the ice at the north end of the glacier to flow south, while at the south end it is flowing in nearly the opposite direction. As a result of this peculiar shape, the glacier is somewhat wider than it is long; but it is not exactly symmetrical. On the north side of the valley the ice reaches about two hundred feet farther down the valley (eastward) than on the south side, and it has also extended a tongue of ice southward across the outlet of the lake, so that the outlet is by a subglacial channel. This tongue of ice is nearly one hundred feet wide, and rises six or eight feet above the lake. Some interesting questions suggest themselves as to the cause of the ice having receded farther on the shady side of the valley, the effects of different exposures to the sun, the relative protection afforded by different-sized moraines, inequality of snowfall on the opposite sides of the valley, etc. The depth of recent snow made it impossible to properly examine beneath the edges of the moraines to determine if there is beneath them any ancient and now quiescent ice. Omitting these more complicated questions, it seems probable that the extension of that tongue of ice across the outlet of the lake is, partly at least, caused by a more rapid rate of flow of the ice on the north side of the valley, where there is a more direct exposure of the sun. The slopes of the ice are everywhere steep. In places they would be considered steep for the roof of a house.

It was of special importance to determine if moraines are now being deposited. I saw no evident moraines and only two small pieces of rock on the ice anywhere. The cliffs around the head of the glacier are nowhere very high, in places rising only a few feet above the ice, and they are surprisingly bare of loose fragments. It is just as if the greater glacier of the past had removed all loose material, and the process of weathering has not yet had time to split up the rock and furnish fresh *débris*. Some of the boulders in the lake come near the surface, and may be a recent terminal moraine. Perhaps a careful examination when the ice is bare of recent snow may reveal moraines now forming; but, if so, they must be small, since there is so little moraine-stuff being cast upon the ice.

There are several other 'snow-fields' in the vicinity of Long's Peak which show some signs of glacial flow. Stakes ought to be set on the surface of these ice masses (for they are all ice rather than snow), and their motions accurately observed.

The view from Hague's Peak is one of the finest in the Colorado Mountains. A trip to this mountain and its small but interesting glacier will rank well with the ascent of Pike's, Gray's, or Long's Peaks. The height of Hague's Peak, as given by Hayden, is 13,832 feet, only 439 feet lower than Long's Peak. The glacier is approximately in north latitude 40° 28'.

From the name of the discoverer, this is known as the Hallett Glacier.

G. H. STONE.

Colorado Springs, Sept. 13.

Condensed Milk.

A CURSORY examination of several cans of preserved milk, that were offered for sale in this State at a price below the actual cost of manufacture, revealed the fact that much of this milk was of poor quality, while some was unfit for use; hence, in the early part of this year, a thorough investigation was made of all the brands of canned milk on sale, and samples were sent to Prof. H. B. Cornwall, of the John C. Green School of Science, Princeton, for analysis. His report, here printed, is of sufficient importance to warrant its publication in advance of my annual report to the Legislature.

WM. K. NEWTON.

Office of the Dairy Commissioner of New Jersey,

Paterson, N. J., Sept. 17.

DURING the first five months of this year a number of samples of condensed milk were received from the State dairy commissioner, and analyzed by the writer, with the result stated in this paper. All but two were condensed with the addition of cane-sugar. While the milks condensed without sugar may be better for infants and invalids if not kept long in cans, yet they are not certain to remain sound, even in the sealed cans, for any length of time, and are therefore of doubtful value.

The milks preserved with cane-sugar, on the other hand, if carefully prepared, keep well in cans, and do not spoil very rapidly even after the cans are opened, provided the can is kept in a dry place and no water is mixed with it. For use with tea and coffee, and for making puddings, custards, etc., they are an excellent substitute for fresh milk.

The very large amount of cane-sugar necessary to preserve them renders them, however, an unwholesome food for infants, and they can by no means be regarded as a good substitute for fresh milk in this case.

The directions on the cans in general state, that, by adding a certain quantity of water, the condensed milk can be made to resemble cream; by adding more, it becomes the equivalent of milk. This can never be true: cream contains from three to four times as much fat as the average condensed milk, and no dilution with water will make such milk resemble cream except outwardly. It would be well if all makers would follow the course pursued by a few, and, while giving such directions as are necessary in using the milk for making desserts, etc., recommend that the advice of a physician be obtained as to the diet of infants. Condensed milk preserved with sugar can never be a fit food for infants.

In some instances very misleading statements as to the quantity of fresh milk condensed to produce the contents of the preserved milk cans were made. It will be seen that the condensation is very rarely more than threefold, and usually somewhat less.

A well-made condensed milk, with cane-sugar, should show very little if any undissolved sugar, and should be of a nearly white color, having but a faint yellowish tinge. It should have no cheesy taste or smell, and should dissolve readily in about four parts of cold water. Especially should it dissolve without showing separated flocculent particles of casein or curds.

METHOD OF ANALYSIS.

To insure thorough mixing, the entire contents of the can were emptied into a porcelain vessel and thoroughly stirred; 40 grams of the milk were weighed out and diluted with water to 100 cubic centimetres, so that 5 cubic centimetres of the diluted milk corresponded to 2 grams of the condensed milk.

In the case of sample No. 33, which curdled even when slightly warmed with water, and would not mix well with cold water, the portions needed for each determination were separately weighed out.

Total Solids.—Of the diluted milk a measured volume was diluted again with an equal volume of water, so that 5 cubic centimetres corresponded to 1 gram of the condensed milk, and then 5 cubic centimetres were dried in a flat-bottomed platinum dish (40 millimetres in diameter at the bottom), at first on the water-bath, then in an air-bath at 100° to 105° C., until the loss of weight after drying half an hour was less than 2 milligrams. Comparative experiments showed that under the above conditions the drying was as thorough as if the milk had been first coagulated with acetic acid, while the method was more convenient. At first 2 grams of milk were used, but the result was the same, while the drying was far more tedious.

Duplicate determinations were made. The greatest difference was 0.29 per cent; usually it was much less; occasionally the results were identical.

Ash.—The dried milk was ignited in the same dish at a scarcely visible red heat, until no black carbonaceous portions were left. In one case the chlorine in the ash was determined by Volhard's volumetric method, and found to be 9.52 per cent.

Fat.—Rather thick white filter-paper was thoroughly extracted with ether in a Soxhlet apparatus, and 5 cubic centimetres of the diluted milk (equal to 2 grams of the condensed milk) dropped on a nearly square strip of this paper large enough to conveniently soak up the milk. To avoid the formation of candied spots, the milk was uniformly spread over the paper by brushing with a small, narrow strip of the same sort of paper. After drying in the air, the paper was rolled to a loose cylinder, and dried in an air-bath at 100° C. for about an hour and a half. The fat was then extracted with ether for two hours in a Soxhlet apparatus; and a second extraction was made, lasting from an hour to an hour and a half longer. The second extraction usually yielded less than 4 milligrams more of fat, and often none at all. The fat determination was made in duplicate. The greatest difference was 0.2 per cent; usually only a few hundredths of a per cent.

At first, extraction after drying with sand was employed, but comparative tests showed that the paper method yielded better results in less than half the time.

It is a very difficult matter to extract all of the fat from a dried condensed-milk residue in any other way than by using paper, essentially Adams's method. Blotting-paper would not be as good as the thinner filter-paper, because there is so much cane-sugar present in some of the milks.

Caseine and Albumen.—Ritthausen's method was followed, essentially as described by Dietzsch (*Nahrungsmittel und Getränke*, Zurich, 1884); 5 cubic centimetres of the diluted milk, equal to 2 grams of the condensed milk, being further diluted with water to 40 cubic centimetres, and then treated with enough of a solution of copper sulphate (6.35 grams in 100 cubic centimetres of water) to insure quick separation of the coagulated albumen after stirring, 15 drops being added in almost every case. Then enough of a 5-per-cent solution of caustic potash was added to render the mixture nearly neutral to blue litmus-paper; an excess of the potash being avoided, as this would hold some of the caseine in solution and render the filtrate turbid. In most cases 5 drops was found to be a proper quantity. After settling clear, the fluid was decanted into a weighed filter 11 centimetres in diameter, previously dried at 100° C. The precipitate remaining in the beaker was stirred up with 20 to 30 cubic centimetres more of water, and finally the whole of the precipitate was brought on the filter, the washing being continued until 100 cubic centimetres of liquid had passed through the filter. This filtrate was preserved for the milk-sugar determination. The precipitate and filter were weighed together, after drying at 100° C., until the loss of weight after drying half an hour did not exceed 1 milligram. The filter and precipitate were next incinerated in a porcelain crucible, and the weight of the residue deducted from the weight of the dry precipitate: the difference was the weight of the albumen (including caseine) and fat; and after deducting the weight of the fat the percentage of the albumen (caseine) was calculated. S. W. Parr (*Amer. Chem. Journ.*, vii.

p. 246) has shown that the results by Ritthausen's method are "nearly, if not quite correct." It is probably the best method for condensed-milk analysis.

Milk-Sugar.—This was determined in most cases by treating 25 cubic centimetres of the filtrate just mentioned with 15 cubic centimetres of Fehling's solution (68 grams of caustic soda and 187 grams of tartrate of potassium and sodium in 500 cubic centimetres of water; 34.64 grams of copper sulphate in 500 of water; the two solutions being mixed at the time of using them combined as Fehling's solution) in a porcelain dish resting on wire gauze over a Bunsen burner. The contents of the dish were rapidly brought to boiling, and then boiled for four minutes, after which the liquid was filtered through a filter 6 centimetres in diameter, and the precipitated suboxide of copper was washed, chiefly by decantation in the dish, with about 40 cubic centimetres of water, which was also passed through the filter. As little of the precipitate as possible was brought on the filter. The filter was then dried and burned, the residue dissolved in a little nitric acid, this acid poured into the dish to dissolve the suboxide of copper, and the solution evaporated with a little sulphuric acid until all nitrous fumes were expelled. The solution was then diluted with water and the copper deposited electrolytically in a small platinum dish. Rodewald and Tollens (*Berichte*, xi. 2076) have shown, that, when milk-sugar is treated with Fehling's solution as above described, the weight of copper multiplied by 0.763 equals the weight of milk-sugar present. They worked with asbestos filters, and certainly the paper filter does retain a very little of the copper in the Fehling's solution; but a blank test showed that the filter used in these examinations of condensed milk retained only 0.0009 of a gram of copper; so that the above factor, 0.763, was used in calculating the results.

Cane-Sugar was obtained in every instance by deducting the weight of the remaining solids (milk solids) from the total solid residue of the dried milk.

GENERAL OBSERVATIONS.

The following tables, I. and II., give the results of analysis of the milks according to the method just described. The last column, headed "Times condensed," indicates the number of volumes of the original milk that were condensed to one volume. The figures in this column are obtained by dividing the figures representing the percentage of milk solids by 12.5, which is assumed as the average percentage of solids in the original milks. Hehner (*Analyst*, iv. p. 44) has calculated the condensation by dividing the percentage of milk solids not fat by 9.3, the assumed percentage of such solids in cow's milk. The figures thus obtained would differ in the case of our samples by less than 0.2 per cent in any instance. The percentage of fat in the original milk is naturally obtained by dividing the figures representing the percentage of fat in the condensed milk by those representing the condensation. Although No. 21 cannot be regarded as made from a milk originally very rich in fat, yet there is nothing to indicate that any of the samples were made from skimmed milk.

A word or two seems proper with reference to the proportions of fat and caseine. The average percentage of caseine in cow's milk is variously given by different authorities, but is probably about 0.4 per cent greater than that of fat, as the writer has calculated from figures representing a very large number of analyses given in the 'First Report of the New York State Dairy Commissioner,' p. 58. It was stated, moreover, by Wigner (*Analyst*, iv. p. 48) that some of the caseine was decomposed during the condensation of milk with sugar, and it would therefore seem that the percentage of caseine in average condensed milk should at all events not greatly exceed that of the fat. In the writer's analyses it falls slightly below. The caseine and albumen reported in many of the analyses quoted in the New York dairy commissioner's second report, pp. 152-154, are very largely in excess of the fat; exceeding it, for instance, in four out of many cases by the following figures respectively: 8.1, 6.07, 8.24, 7.72 per cent.

There seems to be but one explanation of such a result, and that is, that the condensed milks were made from partially skimmed milk, without regard to the fact that the percentage of fat actually present in the condensed milk may not be below the average.

Hehner (*loc. cit.*) found two samples of a certain brand* of con-

densed milk with 11.73 and 11.34 per cent of caseine and 7.19 and 6.98 of fat, respectively, and calculated that they were made from milks containing originally 2.5 per cent of fat; but he hesitated to call them skimmed. Judged by the above standard, they give certain indications of being skimmed.

Hassall's analyses of condensed milk cited by Hehner show in general greater condensation than those in this paper, but the average percentage of caseine is 16.85; of fat, 10.27; and here, again, skimming is certainly to be suspected.

TABLE I.
Condensed Milk with Cane-Sugar.

No. of Sample.	Percentages.							Times condensed.	
	Water.	Fat.	Caseine and Albumen.	Milk-Sugar.	Ash.	Cane-Sugar.	Milk Solids.		
20	28.75	8.90	8.71	11.08	1.62	40.94	30.31	3.67	2.42
21	25.83	8.25	10.40	13.63	2.01	39.88	34.29	3.01	2.74
26	25.91	9.14	9.17	13.09	1.86	40.83	33.26	3.43	2.66
27	31.45	8.78	8.21	11.43	1.70	38.43	30.12	3.64	2.41
28	23.91	8.94	9.45	12.60	1.85	43.25	32.84	3.41	2.62
29	27.17	9.22	8.22	11.98	1.77	41.64	31.19	3.70	2.49
30	25.00	9.88	8.92	12.58	1.85	41.77	33.23	3.71	2.66
32	25.49	8.89	9.51	13.05	1.97	41.99	33.42	3.33	2.67
33	28.70	10.22	8.52	16.74	1.81	34.01	37.29	3.43	2.98
35	28.77	11.06	7.97	15.53	2.40	34.27	36.66	3.74	2.95
36	27.44	9.66	9.24	35.17*	1.82	16.67	-	-	-
37	29.83	11.17	10.07	15.44	2.31	31.18	38.99	3.59	3.11
38	23.45	11.14	12.20	13.78	1.99	37.44	39.11	3.57	3.12
41	25.63	10.54	8.89	13.06	1.89	39.99	34.38	3.83	2.75
Average..	26.95	9.69	9.25	13.38†	1.92	38.82†	34.26	3.54	2.74

* See 'Special Remarks,' below. † Excluding No. 36.

TABLE II.
Condensed Milk without Cane-Sugar.

No. of Sample.	Percentages.							Times condensed.
	Water.	Fat.	Caseine and Albumen.	Milk-Sugar.	Ash.	Milk Solids.	Fat in Original Milk	
34	63.25	10.72	10.08	13.79	2.16	36.75	3.64	2.94
40	64.09	9.35	11.75	12.68	2.13	35.91	3.25	2.87

The results given in the second New York report (*loc. cit.*) for condensed milk with sugar are as follows:—

	Average.	Minimum.	Maximum.
Water.....	25.43	15.45	30.08
Caseine and Albumen.....	12.15	8.20	18.96
Fat.....	10.78	5.06	17.01
Milk-Sugar.....	13.48	10.11	17.77
Cane-Sugar.....	35.89	-	-
Ash.....	2.27	1.62	3.62

The average amount of cane-sugar there given is lower than that in the milks analyzed by the writer, and the latter therefore contain, on the average, less milk solids, but among them are several milks of excellent quality. The percentages of fat and caseine are the most important, provided the milk be of good quality in other respects.

SPECIAL REMARKS.

The following details are of interest in connection with the analyses in Tables I. and II. :—

No. 21 was not in perfect condition; a little gas escaped on opening the can, and the milk was soon full of bubbles, caused by fermentation.

No. 27 contained a considerable amount of undissolved cane-sugar.

No. 33 was so stiff that it would not run out of the can, had a cheesy smell, curdled even when very slightly warmed with water, was of a brownish color, and altogether was of inferior quality.

No. 34 was apparently in good preservation, but the metal of the can was darkened inside, as if the tin had been attacked.

No. 36 was a dark brown, glutinous mass, with a smoky and cheesy taste and odor. Apparently molasses or glucose had been used in place of at least some cane-sugar in preparing it, as the result of the analysis indicates. The 35.17 per cent of 'milk-sugar' could not have been pure milk-sugar, and the figures really represent only a reducing power equivalent to that amount of milk-sugar.

No. 38 was quite stiff, of a brownish color, and had a somewhat cheesy smell.

No. 40 was not in perfect condition; the tin of the can was darkened inside, and gas escaped on opening the can. The caseine and albumen given in the table were calculated from the loss; an actual determination by Ritthausen's method gave 9.28 per cent of caseine.

The other milks, not especially mentioned above, were in good condition and well put up.

The percentage of ash of all of the milks, with the possible exception of No. 35, shows that the cane-sugar used was itself free from excessive ash.

H. B. CORNWALL.

Princeton, N. J., Sept. 14.

Chalcedonized Fossils.

A CURIOUS instance of the formation of rose chalcedony on fossils was called to my attention some time ago. The fossils were mostly specimens of species of *Monticulipora*, and often the whole surface was covered with the ring-like chalcedonic formation. The cells of the coral were in most cases still plainly seen, but the whole outer aspect of the fossil was so changed as to make me think for a time that it might prove to be an undescribed species.



FIG. 1. X 2.



FIG. 2. X 4.

Fig. 1 shows the general appearance of one of the best specimens. Fig. 2 is an enlarged view of some of the rosettes. These corals are not the only ones having this peculiar feature, for certain specimens of *Streptelasma* present the same appearance. In many cases the rosettes are remarkably perfect, and in places the transition from the ordinary appearance to that of the chalcedonized surface is plainly seen.

JOSEPH F. JAMES.

Miami University, Oxford, O., Sept. 5.

SCIENCE

FRIDAY, SEPTEMBER 30, 1887.

IN A RECENT NUMBER of *Science* (x. No. 240) we had occasion to refer to the beneficent law now existing in several of the States, prohibiting the employment of color-blind persons on the railroads of those States, and instanced Massachusetts as the first one to enact such a law. At a meeting of the Brotherhood of Locomotive Engineers, just held in Boston, at which three thousand railroad-engineers were said to be present, one of the speakers who addressed the audience was received with great applause, because, as the chairman said in introducing him, "he secured the repeal of the obnoxious color-blind law," — a questionable honor, if true; but, from the best information which we are able to obtain, the law still exists, although it has been modified in a manner which in no wise weakens, but, on the contrary, rather strengthens, its practical working. It is not to be wondered at that railroad employees object to a test of their qualifications which may result in the loss of their positions, but we imagine that any attempt to repeal the law would meet with the determined opposition of the entire travelling public. The single instance which occurred in Connecticut, where twenty-one railroad employees were found wholly color-blind, is sufficient proof of the necessity of such a law, and, instead of endeavoring to repeal existing laws, a strong and continuous effort should be made to extend their provisions to other States.

DISTILLERY-MILK REPORT. — V.

THE attempt which *Science* has made to obtain facts and opinions in reference to the effect of distillery-swill upon the animals to which it was fed, both as to their health and the wholesomeness of the milk secreted by them, has been measurably successful. As was to have been anticipated, the opinions greatly outnumber the facts. To any one who has had experience in similar inquiries this will be a matter of no surprise. The difficulties surrounding a mathematical demonstration of a problem so intricate as this are well-nigh insurmountable, unless a thorough investigation is made by skilful and competent men with all the necessary means at their disposal. The fact that such an inquiry into the matter under consideration has never been made, is very evident from a perusal of the replies which *Science* has received from its correspondents. These replies show that medical and other professional men are divided as to the effect of swill-milk upon human beings, although those who regard it as unwholesome food, and as injurious to those who consume it, greatly preponderate. The evidence seems also to point to the conclusion that when distillery-swill is fed to cows in connection with other food, and the cows kept in properly ventilated and clean stables, with a sufficient amount of exercise in the open air, it is not injurious to these animals. But, on the other hand, it likewise appears, that as ordinarily fed to animals that are confined continuously in close and filthy stables, without admixture with other food, the consequences, both to the animals themselves and to their secretion, are most pernicious.

The lack of definite knowledge on a subject of such vital interest is greatly deplored by those who have expressed themselves on this point, and it would seem that the time has come for a thorough investigation into the question at issue. Until within a few years, such an inquiry could only have been made by individuals or by societies, in much the same manner as was undertaken by the New York Academy of Medicine in 1858. It is manifest that the results to be obtained in this way, valuable as they are for some purposes, cannot definitely settle the question so as to satisfy the minds of all. If the experimental stations established by both the national and State governments cannot take up an issue of such general im-

portance as this, it is very much to be regretted. Believing, however, that such is their legitimate work, we shall endeavor, by every means in our power, to bring about this desirable action on the part of the stations, and would solicit the assistance, in the accomplishment of this end, of all who have the necessary influence. We shall also take the liberty of suggesting the general plan upon which such an investigation should be carried out. This we do with the greater assurance, because we have received most valuable suggestions from Professors Law and Brewer, and Drs. Sturtevant, Newton, Salmon, and other authorities, with whom we are in perfect accord.

One suggestion made by Professor Brewer, would, if carried into practice, be a crucial experiment. He says, "If you can convince a few orphan-asylums and foundling-hospitals that it would be an innocent and harmless experiment to feed half of their children on distillery-swill milk, and the other on grass-and-grain milk, and continue this experiment for several years, on different races of children, in different localities, some of the swill-milk stables to be kept as clean as other stables may be, by some process not yet announced, and carefully record and collate all the results, the question would then be settled, in the usual acceptance of that term." The impracticability of such a plan no one appreciates better than Professor Brewer. He therefore adds, "Until some such plan for 'positive evidence' be secured, I suggest that you work at the method of cumulative evidence, which has been so rich in conclusions and beneficent in its results in other departments of sanitary science."

There appears to be some difference of opinion as to the exact chemical composition of distillery-swill, under different circumstances; so that in carrying out any experiments the following points, as suggested by Professor Law, should be ascertained and recorded: (1) Is the swill fresh? (2) Has it undergone any other than the alcoholic fermentation? (3) Is it uniform in quality as supplied from day to day? (4) At what heat is it fed? (5) Does it contain the simple original grain-products, — gluten, salts, etc., — or has there been added any chemical agent used in the manufacture of the alcoholic liquid? These inquiries are necessary, because the effect of swill when fresh may be entirely different from swill in an acid or decomposed state, and the allegation has also been made that injurious chemical agents are added. The temperature of the stables in which the experimental animals are housed should also be recorded. In short, every condition which is liable to enter as a factor into the problem should be intelligently regarded. Dr. Salmon advises that biological analyses of the milk should be made, in order to determine the relative number of germs as compared with milk from country pastures.

Hitherto chemical analysis has been mainly relied on in determining the quality of the milk; but, as Dr. Sturtevant remarks, "while this is of assistance, it cannot alone determine the questions relative to healthfulness. The question should be investigated from the chemo-physiological standpoint: determine whether substances not met with in ordinary foods can be traced through the animal to the milk; whether bacterial germs exist in the food, and whether such can be traced through the animal to the milk; whether animals of a delicate nature will succumb, or show indication of disease, when fed with suspected milk; while other individuals thrive upon a milk considered of a fine quality. The development of ptomaines in feeding substances through neglect of proper precaution should also receive investigation, as a food otherwise useful may at times become dangerous on the neglect of ordinary precaution."

Dr. Salmon does not regard the studying of milk from healthy cattle, fed upon swill under favorable hygienic conditions, as of much value towards elucidating the practical questions involved. "The question," he says, "is not, whether a small quantity of cool

and fresh swill, fed with a suitably prepared ration of other articles of food to healthy cows, having clean, roomy stables, and plenty of exercise, is injurious to the milk, but it is this: Is wholesome milk produced by feeding swill under the conditions in which it is fed in practice, and must be fed in order to make it a profitable industry? And finally, as Professor Rohé so well expresses it, "a scientific solution of the question will not be furthered by prejudiced appeals or unreasoning denunciation. Patient investigation, keeping in view all circumstances of the question, and avoiding all one-sidedness in considering the matter, will alone bring about the object desired."

With these suggestions to those having in charge the experiment stations, we leave the subject with our readers. We shall be glad to record any observations or experiences which any one may send us in the future; so that, even if public interest cannot be sufficiently aroused to bring about a proper investigation of the subject at the present time, it may, by a reminder from time to time, be kept alive until the demand for such an inquiry becomes irresistible.

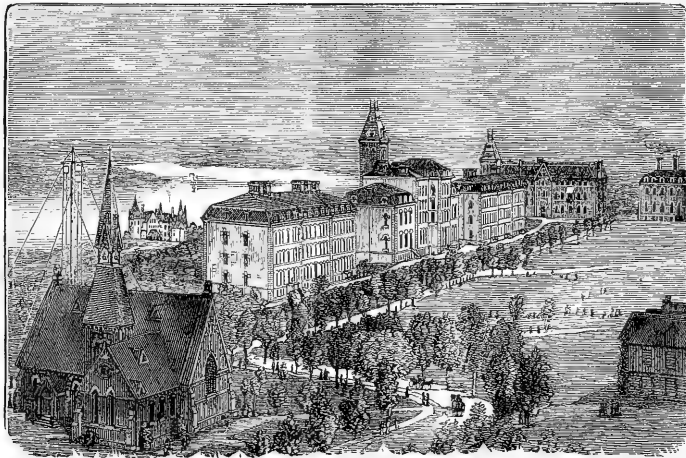

NORTHERN HALF OF CAMPUS FROM SAGE COLLEGE, CORNELL UNIVERSITY.

THE SIBLEY COLLEGE EXTENSION, CORNELL UNIVERSITY.

The extraordinarily rapid growth of the Sibley College of Cornell University since its re-organization and expansion of two years ago, with the introduction of the course and department of mechanical engineering under Professor Thurston, the extension of its shops and department of the mechanic arts under Professor Morris, and the formation of a carefully planned department of the graphic arts under Professor Cleaves,—all under the general direction of Dr. Thurston,—has compelled a corresponding extension of the accommodations for class and lecture rooms, and especially for shops and drawing-rooms. Two years ago, before this re-organization had taken effect, the number of students taking this course was very small, varying from twenty to thirty, perhaps. Last year the freshman class, including mechanical engineers in regular course, in electrical engineering, and special students with the resident graduates, numbered above eighty. The number of applicants this year is so large that the limit for the entering class is necessarily fixed by the capacity of the shops and buildings, including the mechanical laboratory. It is probable that the numbers received in all classes will exceed two hundred and fifty. When all classes are filled on the basis now taken, the college will number something over three hundred students.

But it was originally designed to accommodate very small classes; and, notwithstanding the fact that within a few years it has been more than doubled in extent, it could only accommodate,

up to the present time, about two hundred students. To prepare for the incoming class of 1887, therefore, it became necessary to still further extend its buildings. It was thought advisable to more than double the size of the wood-working shops, to increase facilities for instruction in the other shops, and to secure fifty per cent more space for drawing-rooms. The freehand-drawing class alone, this year, which includes students from several other courses not included in the mechanical engineering departments, is expected to number over two hundred and fifty students, and occupies two floors of the main building. The wood-working part of the establishment must accommodate between one hundred and one hundred and twenty-five men, and the other shops as many more. To meet this emergency, a new building was planned, into which all the laboratory apparatus used in either instruction or research could be removed; thus giving ample space, for the present at least, for the extension of the shops, by giving to them the considerable space so vacated, while the remainder of the new structure could be devoted to the purposes of the departments of drawing and machine design.

The engraving on the next page shows the extent and arrangements of the departments of the original group of Sibley College buildings. The main building is seen at the front and left; while beyond it is the laboratory building, in which instruction in chemistry and physics, and the principal part of the tuition and practice in electrical engineering, are carried on. The dynamo-room is in the rear of the main building of Sibley College, and contains a considerable number, and hardly less variety, of dynamo-electric machines, used in the course in electrical engineering principally. The lower floor of this building is devoted to the purposes of library and reading-room, museums, a lecture-room for the junior class, and the rooms of the professor of the mechanic arts. The second floor contains two large drawing-rooms, the lecture-room of the professor of mechanical engineering, and the rooms of the director. The third floor is occupied by the rooms of the professor of drawing,—his office, lecture-room, and two large drawing-rooms like those below. All these drawing-rooms are expected to be occupied by the lower classes; while the senior and junior-classes will have their drawing-rooms in the new structure, now just occupied, which building will also accommodate the resident graduates, professors, and others coming to Cornell for advanced work in this department of the university.

The accompanying plans present the arrangement of the building forming the last of the Sibley College extensions, and now just completed for occupation at the beginning of the college-year 1887-88. It is calculated to be of sufficient size to accommodate the ac-

cessions of the present year. Should the limit of numbers admitted be increased another year, further extension will be again necessary. This number (one hundred in the freshman class and about three hundred total) cannot, however, be increased until the science laboratories are enlarged. The physical laboratory, which was

courses, this limits the number which can be taken as that of the entering classes in the Sibley College as effectively as the size of the college itself. The number of students in the technical courses of Cornell University this year is not far from six hundred, in the university a thousand undergraduates.

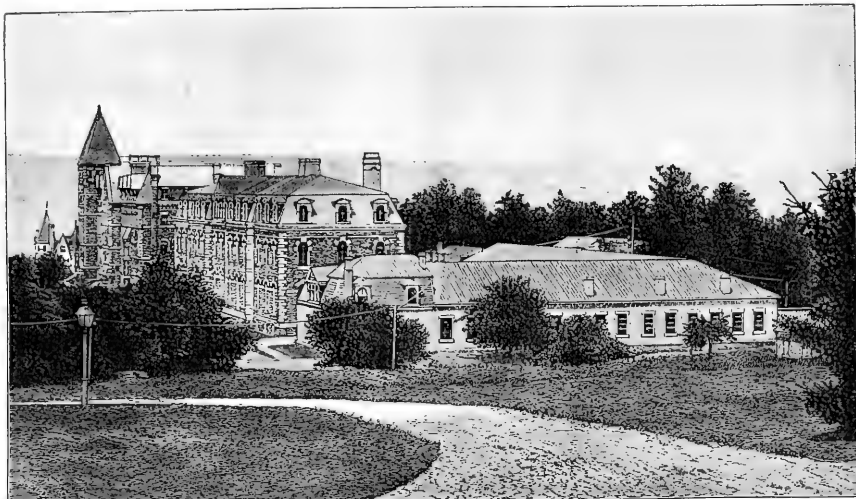

SIBLEY COLLEGE (FROM THE EAST).

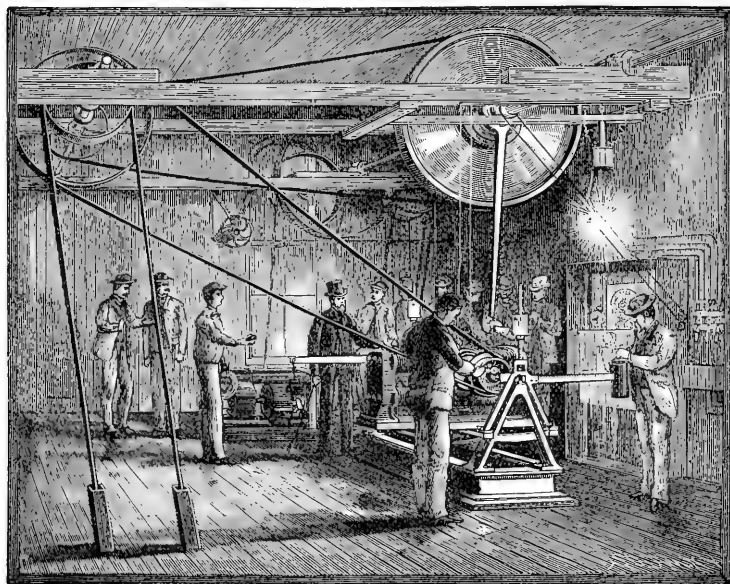

SIBLEY COLLEGE DYNAMO AND ELECTRICAL ROOM.

built to give ample accommodation to the classes of three or four years ago, and to work forty or fifty students, was last year called upon to receive eighty, and must this year accommodate one hundred. Further extension must precede any further increase in numbers received there; and as this is an essential part of the work of the mechanical engineers, both of the regular and the electrical

Referring to the plans which are given below, it will be seen that the whole upper floor, an area 150 feet long by 40 feet in width, is devoted to drawing. The larger rooms are for the use of the lower, and the smaller for the higher classes. Ultimately it is supposed that the whole building may be appropriated to the work in machine design and experimentation, the lower floor being used for the pur-

poses of research, and furnishing the data used on the upper floor in the designing of machines and structures. A room is set apart on the upper floor for the use of the professor having direction of the work, and taking charge of the building and apparatus. A toilet and coat room is provided here, also, for the use of such students as work on this floor. All these rooms are without other finish than kalsomining on the walls; but this is of a light-buff shade, and the ceilings are finished in oiled yellow pine, with the heavy beams supporting it painted a blue-white. Thus the rooms are all well lighted, and are exceedingly bright and cheery. All the heating-pipes are placed overhead; and it is expected that the experience already had with this arrangement will be here repeated, and a thoroughly equable and pleasant temperature obtained. The steam-pipes are also out of the way, and desks, tables, benches, or other furniture can be placed at the windows, and no annoyance felt from the uncomfortable proximity of the source of heat. Lockers are provided for the drawing-boards, while the tables are con-

the use of students working up their data, and another room for special research, which will contain the balances, the few pieces of chemical apparatus needed for gas-analysis, and other work which can best be done here rather than in the general and larger laboratories. The centre of the large room is reserved for a very heavy testing-machine, which it is proposed to place there at some future time.

At the left of the hall, and in the west end of the building, is a group of rooms having special interest to the engineer engaged in work related in any way to steam-engineering. The largest room of the three is devoted to tests of engines, steam-pumps, and various motors (steam, air, gas, and water driven), which will be set up permanently, and to the temporary mounting of small motors sent in for test. A steam-pipe from the boilers in the adjacent apartment, and connecting also with the larger boilers in the main part of the college group of buildings, supplies steam to the steam-engines and steam-pumps. Amongst the machinery here mounted

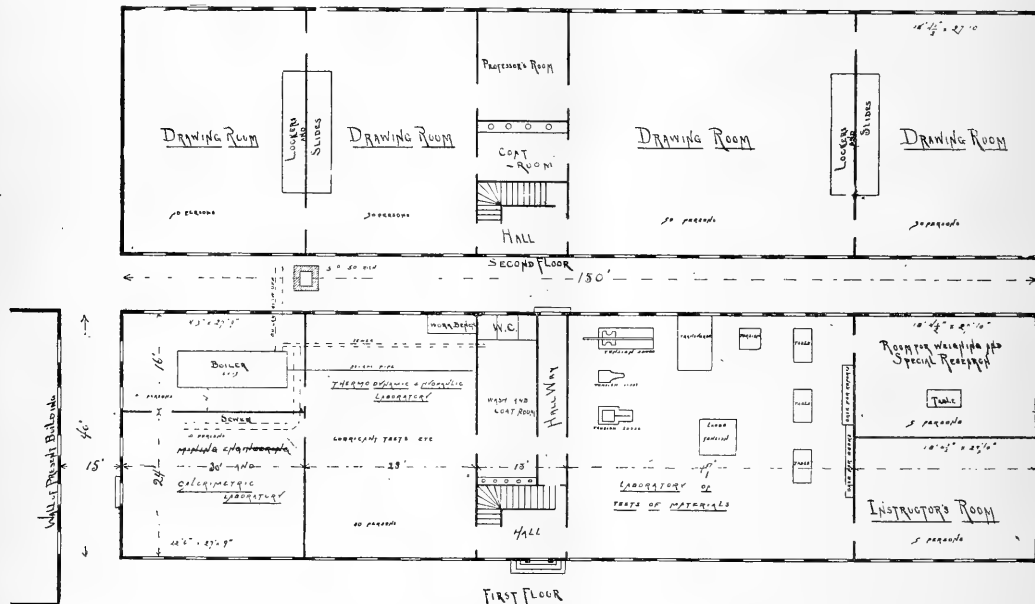

SIBLEY COLLEGE EXTENSION, CORNELL UNIVERSITY.

structed with drawers to take in the small apparatus; and cases on the walls will be arranged for T-squares and other instruments either too large to be otherwise cared for, or, being the property of the college, such as must be accessible to the instructors at all times.

The lower floor is constructed and is finished very much like the upper; but it is appropriated to a most interesting and novel part of the work of the college. In the middle of the building is a transverse hall out of which opens the toilet and coat room. At the right, on the east side of the hall, is a large room, of similar size to the great drawing-room overhead, in which are placed all the testing-machines for use in investigating the strength and other properties of the materials used in mechanical engineering and construction, including several tension-machines made by Rhiele, Fairbanks, Olsen, and Brown & Sharpe, a transverse testing-machine built by Fairbanks, an 'autographic recording testing-machine' of the Thurston pattern, designed by Bond, and built by the Pratt & Whitney Company, two sizes of Thurston's lubricant testing-machines, dynamometers of various types and sizes, and miscellaneous apparatus of similar character. Farther toward the right, and at the east end of the building, are a room for an instructor and for

are a straight-line engine built in the college workshops, a Westinghouse engine, a Brayton petroleum-engine, an Ericsson engine (given to the director by his friend, its distinguished inventor), various makes of steam-pump of the best types in the market, and other apparatus and machinery that properly fall into this class.

At the extreme west end of this floor are the boiler-room, in which are the heating-boilers, which are placed there as a reserve and for experimental purposes, and all boiler accessories. A space is reserved at one side for the large experimental boiler, which is proposed to be used in making boiler trials on a larger scale, and for investigations at pressures exceeding those commonly employed, and ranging up to possibly five hundred pounds per square inch. The second of these two rooms is appropriated to calorimetric investigations, including the calorimetric tests of the quality of steam, which are to-day — more than fifteen years after their introduction in this country by Emery and Thurston, and abroad by Hirn — just coming to be recognized as essential to any satisfactory determination of the efficiency of boilers. The various forms of calorimeter now in use will be set up here, and made useful both in regular instruction, as is all the apparatus of the laboratory, and in special researches involving their use. Just outside this end of the building

is a chimney seventy-five feet in height, and having a flue about four feet square, which will be amply sufficient to carry away the gases, and to provide good draught to all the boilers together. It is given this height, partly to give a strong natural draught, such as will be needed in investigations of the efficiencies of boilers at different rates of combustion, and to insure that the adjacent buildings, some of which may ultimately be carried up to a considerable height, may not interfere with its action, and may not receive gases blown from its top. The ceiling of these rooms, and floor of the upper portion of the building, are given the standard 'mill construction,' and consist of two floors of yellow pine, separated by an intermediate layer of cement. The floor is carried on heavy beams, and left unclathed and unplastered; the lower surface of the ceiling being given an oil finish, and the beams painted as over the upper apartments.

The structure is an example of a successful attempt to secure large, comfortable, and well-lighted rooms at small cost. The construction is as simple as possible, and the finish is of the most inexpensive character. The result is thoroughly satisfactory, if we may judge from the limited experience so far had with it.

CO-OPERATION ON THE CONTINENT OF EUROPE.

III.—AUSTRIA, ITALY, BELGIUM, SWEDEN, AND THE NETHERLANDS.

FROM Austria the answers to Lord Rosebery's circular (see *Science*, No. 220) are based on the reports of the inspectors of industries. In Vienna there are several societies founded by workmen, which, from small beginnings, have so developed that they now afford facilities of cheap supply to many thousand families. One of the most important of these associations is the *Arbeiter-Spar- und Consumverein* (Workmen's Saving and Supply Association) in Fünfhaus (registered as an unlimited liability company), founded in the year 1865 by fifteen working-men, and which now contains about 3,800 members. Any person, without distinction of station or sex, can become a member of the association. Nearly half the members, about 1,600, belong to the class of working-men, while the remainder are independent mechanics, tradesmen, small officials, pensioners, widows, etc. Each member pays an entrance-fee of 30 kr. to the reserve fund, and a subscription of 10 fl. for a share.

The members have the right of speaking and voting at the general meetings, of procuring goods at the stores of the society, and of claiming a share in the profits. In addition, each member is allowed to make savings deposits to the amount of 500 fl. These deposits yield an interest of six per cent, and can be withdrawn at any time, together with the interest, on giving notice beforehand. All goods bought must be paid for in cash.

At least five per cent of the net profits are paid to the reserve fund, so long as the latter does not amount to twenty-five per cent of the members' capital. Out of the amount which remains, interest at six per cent is paid on the shares, and, should any further sum remain, it is paid in dividends to members according to the amount of goods purchased by each during the year from the society. The association is managed by the board of directors, the council of inspection, and the general meeting. The board of directors, which is composed of the manager, the cashier, and the goods manager, are elected for a period of three years from among the members in a general meeting. The board of directors represents the society in its public dealings, and is charged with conducting all its business affairs. The members of the board receive a salary. The council of inspection, which is charged with watching over the management of the business by the board of directors, consists of fifteen elected members, who receive no salary. The general meeting has to consider and decide upon all matters of importance which affect the society, and these meetings are held quarterly. The accounts are balanced quarterly.

It seems that the governmental reports furnish no statistics of the number of co-operative societies in the whole of Austria. The only reliable information on the subject is found in a report drawn up in 1881 by Dr. Hermann Ziller, editor of the *Genossenschaft*, the organ of the General Union of Industrial and Provident Societies in Austria, of which union he is the founder and director.

The subjoined table gives the number of co-operative societies in lower and upper Austria, Salzburg, Tyrol, Vorarlberg, Styria, Carinthia, Krain, the seacoast, Bohemia, Moravia, Silesia, Galicia, Bukovina, and Dalmatia, in 1881:—

People's banks.....	1,129
Consumers' societies (selling food, clothing, etc.).....	235
Societies for assisting artisans in buying materials wholesale.....	6
Societies for supplying agricultural implements, manure, etc.....	14
Raw material and selling-depots.....	2
Selling-depot.....	1
Artisans' producing associations.....	43
Agricultural producing associations.....	61
Building societies.....	5
Trading societies.....	10
Insurance societies.....	2
Various.....	9
Total.....	1,575

All societies in Austria, of which the number of members is unlimited, and which seek to benefit them by carrying on business in common, are required, by a law passed in 1873, to be registered either as limited or unlimited liability companies; the measure of liability in the former case being fixed by their rules, which, however, do not generally make members liable for more than double the value of their shares, and their responsibility terminates by law after their membership has ceased for a year. In unlimited companies the liability extends through the second year after the expiration of membership. In 1881 something less than two-fifths of the societies tabulated above were registered with unlimited, and rather more than two-fifths with limited liability; about one-fifth were unregistered.

People's banks are the most numerous co-operative societies in Austria. As has been already seen in Dr. Ziller's table, there were 1,129 of those associations in 1881. They were unequally distributed over 10 different provinces; Bohemia having 425, Moravia 304, Galicia 140, and Lower Austria 128, the other provinces only contributing in numbers varying from 2 to 33 to the total. About half these societies were unlimited as to liability.

The people's banks may be divided into two groups. The first, the majority, are open to all classes, and their members are generally tradesmen, artisans, and farmers; the minority, which form the other category, are open only to officials. The total number of the latter kind of societies in Austria was 79, more than two-thirds of which are in Lower Austria, the metropolitan province. Only 696 societies made a return of the number of their members, which amounted to 296,648, giving an average of 426 members per society.

Austria has no co-operative societies for shipping or fishing. Of the 61 agricultural co-operative societies, 59 are dairies and cheese-farms. There is one co-operative association for bee-culture, and one for hop-growing. In 1881 five co-operative building societies existed. Their object was to provide dwellings for artisans. They were not financially successful, and are now in liquidation.

In Italy co-operation has gained much ground since 1883, though it has been known for twenty-five years. Before 1883 co-operative institutions were hampered by legal restrictions. The old commercial code did not recognize co-operative societies as such, and they had to exist as limited liability companies. The code of 1883, however, directly recognizes co-operative societies, and regulates their administration.

Instances of various kinds of co-operative associations are now to be found in Italy; but by far the most important, in regard to their numbers, capital, and success, are the co-operative or people's banks (*banche popolari*). Co-operative stores (*società co-operative di consumo*) for the purchase and retailing of provisions, fuel, and other necessities of life, are fairly numerous and successful among the working-classes in cities and towns. In many cases their establishment is due to the initiative of friendly and mutual-benefit societies, and sometimes the two objects are combined by one association.

A law passed in 1870 exempts co-operative societies from the payment of *actroi* (or local entrance dues) "upon goods provided by them for distribution solely among their own members, for purposes of benevolence, and for consumption at the homes of those persons to whom the distribution is made."

This statute led to a considerable increase in the number of co-operative stores, and cases occurred in which the privilege was abused; and the real object of the society itself, or of individual members, was to defraud the *octroi* by introducing goods for purposes of trade. In order to prevent similar occurrences, the constitution of most co-operative store associations expressly forbids the members, under pain of expulsion, from allowing strangers to deal at the store in their name, or from selling the goods obtained there.

No statistics respecting the number or capital of these stores have yet been published.

Co-operative associations for purposes of production exist in Italy under various forms, but they are not very common, though, since the new commercial code came into force, their numbers have increased considerably.

They are generally established by and limited to members of the same trade or occupation, and exist at present among masons, bakers, macaroni-makers, tailors, milliners, rope-makers, printers, etc.

The associations for production are either intended (*a*) for the purchase of raw materials, tools, etc., or (*b*) for the exercise in common of the trade to which they refer, whether in a co-operative workshop or otherwise.

The fundamental difference between the German and Italian co-operative banks consists in the varying degree of responsibility imposed on their members. While the German institutions are based on the unlimited liability of their shareholders, the Italian banks have, from the first, adopted the principle of limited liability. With regard to this difference, Italian writers point out that the assumption of unlimited liability would have deterred persons of means and education, whose assistance at the outset was more indispensable in Italy than in Germany, from becoming members, and at the same time the character and habits of the people themselves would have disinclined them from entering any associations involving so great a risk.

Some co-operative banks with unlimited liability have, it is true, been established in Italy during the last few years, chiefly in Venetia, at the suggestion of Dr. L. Wollenbourg, but these are only about ten in number.

Industrial co-operative stores are very generally established in Belgium, having as their main object the wholesale purchase, and retail sale at wholesale prices, of the chief necessaries of life to the working-classes, such as food, clothing, boots, linen, etc. Credit is not usually allowed. A certain portion, sometimes as much as fifty per cent of the profits, is set aside to form a reserve fund, the remainder being shared amongst the members in proportion to the amount of their purchases. A member, on joining one of these societies, is bound to pay in, either at once or by instalments, a certain sum to the fund. Should he not have paid it up when the dividend is declared, his share of the profits is withheld, and goes to complete his contribution.

If a co-operative society has only a small capital, no store need be opened; but contracts are made with the local tradesmen, who, in return for the society's custom, undertake to sell their goods at reduced prices to the members. The usual practice in such cases is for the members to buy their goods at the same price as the public, receiving at the time of purchase a ticket on which is noted the amount of their purchases. The owners bring their tickets at fixed periods to the committee of the society, and receive in exchange their share of the percentages allowed by the society's tradesmen, and paid direct by the latter into the common fund of the society. Such percentages rarely exceed six per cent.

Sometimes, as a substitute for this ticket-system, the societies distribute to their members counters or tokens, representing 5 fr., 2 fr., 50 c., 20 c., such tokens being of a different color for each tradesman. For instance: a member who wants to buy meat obtains from his society a counter in exchange for his money, representing the cost of the meat he requires, which he receives from the society's butcher at the ordinary rate, his purchase being entered in a special register kept by the butcher. At the end of each month the society's tradesmen receive from the committee the money equivalent of these tokens. Supposing that the butcher brings 100 fr. worth of tokens, and has agreed to allow a reduction of 10

per cent, the society pays him 90 fr., and the 10 fr. percentage goes towards the society's general dividend fund.

Both these systems obtain in large cities, where the working-classes are much scattered; but provided the society has sufficient capital, and can open one or more branch depots, the store system is, in the long-run, more advantageous to the members.

One of the most powerful of the co-operative societies in Belgium is the Flemish Vooruit Society, the centre of the socialistic movement in Belgium.

This powerful association counts on its rolls 2,700 heads of families, each of whom is bound to pay a trifling subscription annually to the general fund. The Vooruit is the type and model of all similar institutions in the other Belgian cities, is well administered, owns premises of considerable extent, and has already attained a good financial position. Attached to it is an admirably organized steam-bakery, which sells bread at a somewhat lower price than the other bakers can afford to do, the society guaranteeing to the bakery a minimum profit of at least 10 c. the kilogram. The profits of the bakery are divided as follows: a certain portion is paid into the society's own *caisse de prévoyance*, or provident fund; another into a fund for the support of the workmen in their economical struggles and strikes; a third portion is devoted to the formation of a library; and the remainder is divided amongst the members, who receive the profits in kind, that is to say, in loaves delivered gratis, according to the margin of profit left to be distributed. This division of profits is made twice annually, — at the new year, and at the summer 'kermesse' fair.

In June, 1885, the profits amounted to 43,738 fr. 20 c.; in December last, to 46,233 fr. 80 c. This bakehouse may be regarded as the mainspring of the whole Vooruit organization. It also has a clothing-store, a pharmacy, and two newspapers.

The Vooruit Society intend to push the principle of co-operation to its extreme limits, and has already very seriously crippled the small retail dealers, who formerly enjoyed the custom of the Ghent workmen.

Hitherto no official returns have been published showing the progress of co-operation throughout the kingdom, but the present government have recently re-organized an industrial department in the ministry of agriculture, which, without infringing on the freedom of the societies, will furnish precise statistics respecting all co-operative institutions.

With the exception of the cotton-manufacturing districts in the provinces of Drenthe and Overijssel, there are no great industrial centres in Holland, and, although there is a considerable amount of manufacturing industry in the country, it is too scattered to favor the formation of co-operative institutions; besides which, the southern Catholic provinces of Brabant and Limburg appear up to the present totally inaccessible to any such efforts, which are not encouraged by the clergy. The General Workman's Union of Holland does not number more than 4,000 members, and the efforts made to form regular trades-unions have as yet been attended with but partial success. There are not more than a dozen workmen's co-operative stores in the entire country, and none of them are of any importance.

Co-operative societies exist in certain parts of Sweden where there are large industrial works in the country or in small towns, the workmen subscribing together to buy the stock of supplies wholesale, the same being then sold retail to the members at a cheap rate. Any eventual surplus would probably be divided.

Co-operative stores also exist in Stockholm and other towns copied from the English system. Mr. L. O. Smith, a capitalist and member of the First Chamber, went over to England some years ago, and studied the system as worked at Manchester and other large centres of manufacture, and started the co-called *Arbetsväring*, or Working-Men's Co-Operative Society, with stores and eating-houses, or 'steam-kitchens,' as they are called, where an ample dinner can be obtained for from about four-pence to four and one half pence. These stores have been so far successful that they have lowered the prices of the necessaries of life for the working-classes; but the hope of the founders was, that, when once started, the workmen would take over the management of these stores and keep them going. This hope, however, has not been satisfactorily realized. The numbers frequenting the stores and

eating-houses have fallen off, and a tendency to go back to the private shops has manifested itself.

There are numerous co-operative building-societies in Sweden, but the system has not been extended to agriculture, nor, to any considerable extent, to fishing.

MENTAL SCIENCE.

Healing Wounds by Mental Impressions.

PROFESSOR DELBOEUF of Liège is certainly the most versatile of living investigators, when one considers the great originality and suggestiveness of all the work he does. Ancient and modern languages, logic, general physics and physiology, and especially experimental psychology, have received his attention by turns. His latest contribution is to therapeutics, and is a communication made on June 4 to the Belgian Academy, which will probably turn out to be of the greatest theoretical as well as practical importance.

We all are familiar with accounts of the wounds inflicted on themselves by African dervishes; but the statement which the narrators always make, that the wounds do not inflame, or may even be quite healed in twenty-four hours, probably often tends to discredit their whole description in the reader's mind. Delboeuf's observations now make these stories wholly plausible. It is well established that in certain hypnotic subjects a suggestion made during trance, that to a part of their body a cautery or a blister is applied, will produce, after due lapse of time, an actual vesication of the skin. The hallucinatory feeling of inflammation produces in these persons a genuine inflammation. M. Delboeuf argued from this, that the feeling of pain, however useful in other respects, must itself be an inflammatory irritant, and went on to infer that the abolition of it from an actual wound ought to accelerate its healing. He immediately thought of some hypnotic subjects whom he had made anaesthetic, and in whom he had often admired the rapidity with which the marks of punctures and pinchings disappeared, and proceeded to more systematic experiments, which, so far as they go, seem to verify his hypothesis perfectly. On a young woman whom he could make insensible by suggestion, he marked two corresponding spots, one on each arm, and made on each an identical burn with the hot iron, announcing to the patient that the one on the right should not be felt. The suggestion took effect; and the next day, when the bandages were taken off, and the left arm presented a vesicled sore with an inflammatory area three centimetres in diameter, the right arm showed only a clean scorch of the skin of the exact size of the iron (3 millimetres diameter), without redness or inflammation. On another subject similar results were obtained with burns and blisters, the spots chosen being near together on the same arm or on the neck. The experiments are few in number, and ought to be multiplied; but the reader will immediately see the vista which they open. Many of the results of the 'mind-cure,' and the strange fact, so long known, of opium controlling inflammations, are explained by M. Delboeuf's principle. So is the popular belief in 'hardening' one's self by a little judicious indifference, and neglect of one's condition. Local pain is useful in leading us to protect the wounded part from mechanical abrasion,—several of M. Delboeuf's experiments were inconclusive, because the subjects, being insensible at the seat of their injuries, allowed them to get scraped, etc.,—but it has the drawback of exciting reflex changes of nutrition of an unfavorable kind. Anesthetizing a wound prevents these reflex changes. M. Delboeuf, suggesting to a very sensitive subject that she should not feel a severe dental operation, was assured by the dentist that what he found most extraordinary in the whole performance was the absence of the salivary secretion which would usually have accompanied it.

It is to be hoped that others, with better facilities for surgical experimentation than a professor of classical literature like M. Delboeuf, will follow the example he has so happily set them.

BOOK-REVIEWS.

Technical School and College Buildings. By EDWARD C. ROBINS, F.S.A. New York, John Nostrand, 4°.

THIS handsome volume by a gentleman who holds a most honorable position among architects and friends of technical education, is inscribed to Professor Huxley. It is a treatise on the design and

construction of applied-science and art buildings, together with a description of their suitable fittings and sanitation. Its value will be apparent at once to every one, but especially to those professors and instructors who desire to utilize the results of the best European experience in their laboratories, museums, and lecture-rooms. Our medical and educational readers will recall the pains taken by the trustees of the Johns Hopkins Hospital in Baltimore to obtain the benefit of the best thought and ripest experience of the world in relation to their work, and will readily understand how a book of this scope relating to hospitals would have lightened their labors.

In this country we are now passing rapidly forward in the construction of school-buildings and laboratories, and, whether they are large or small, our desire is to have them as complete as possible. It is here that European experience is so valuable, and Mr. Robins has done us a great service in putting into a readable form accounts of what has been done in the great schools and universities of Europe. His book contains full descriptions of such famous institutions as the Bonn, Berlin, and Munich Chemical Laboratories, Du Bois-Reymond's Physiological Institute at Berlin, the laboratories of the Royal Trade School at Chemnitz, the Würzburg Physical Institute, the Royal Technical School at Stockholm, the laboratories at Charlottenburg, Zurich, Paris, and Strasburg. Most of these are accompanied with cuts and diagrams, so that their interior arrangements may be studied in minutest detail. Following these come full descriptions of the laboratories at South Kensington, Finsbury, Leeds, Bristol, Manchester, Huddersfield, Oxford, Cambridge, and other English cities. The chapters which follow on the fittings of these buildings are in one sense the most valuable of all; for they give us the most detailed information concerning the hundred and one minor things which go to make up the perfect laboratory. They discuss and describe, for example, the working-benches, demonstration-tables, drawing-rooms, and so on. The heating, ventilation, and sanitation of applied-science buildings are also elaborately treated and profusely illustrated. An appendix gives statistics as to the technical schools in Great Britain, and we find there particulars as to the area occupied by the buildings, their cubical contents, the cost of land, cost of fittings, annual expense of maintenance, number of students, and so forth.

Mr. Robins's book is one which our investigators in physics, chemistry, and biology, our university architects, and our technical educators, cannot do without.

The Natural History of Thought, in its Practical Aspect from its Origin in Infancy. By GEORGE WALL. London, Trübner, 8°.

THIS volume is in many ways a serious disappointment. Much of this effect is due to the fact that the expectations raised by the inviting titlepage are not in the least realized. Had these pages appeared with a less ambitious title, one could have judged them much more leniently than it is possible to do when considering them as an attempt to write a life-history of the thinking process; and this failure is made a hundred-fold more striking by the consideration that science is in a far better position to deal with this problem than ever before. At no very distant date it will be possible to write a natural history of thought that shall be regarded as an illustrious consummation of a most important movement,—the application (as the term 'natural history' suggests) of the biological point of view to the consideration of mental phenomena. Even now a master-hand could sketch the outlines of such a comprehensive undertaking. To blame Mr. Wall for not being such a master-hand would be very unjust; but the same cannot be said when fault is found with his lack of appreciation of the complexity of the problem before him, and the important light which recent experimentally discovered facts have shed upon it. The natural history of thought can be far better gleaned from such a volume as Mr. Tylor's 'Primitive Culture,' or (to make the comparison more immediate) from M. Perez's 'The First Three Years of Childhood,' than from the pages of Mr. Wall's book.

The volume is really a collection of educational essays, written by an observant thinker, deeply imbued with the high pedagogical value of moral training, and in particular with that portion of it usually termed 'religious,' and appreciating here and there the

scientific aspect of these problems. He writes well, says some things very forcibly, but repeats himself *ad nauseam*, crowds his pages with commonplaces, and warps his exposition by an irrelevant and forced introduction of religious considerations. With this survey of the strength and the weakness of the work, a glimpse at its contents will be in order.

In the introductory chapters, on the nature and the function of thought, the only point of note is, that, while the author fully recognizes the significance of mind in animals for the understanding of mind in man, he erects a barrier between them which the evolutionary point of view demanded by the topic finds inconsistent. This distinction between a lower and a higher field of thought, — the two sharply defined, — while of advantage in accenting the peculiarity of human evolution, is yet a decided hinderance to the taking of that general point of view which imbues mental evolution with a larger interest. Hereupon follow a chapter on language, and one on temper, containing much sound advice, but nothing noteworthy. The next four chapters aim to justify the titlepage, and deal respectively with babyhood, infancy, childhood, and youth. The characteristics of each of these periods are pleasingly sketched; but the sketch is incomplete, and dwells in a disproportionate manner upon the moral-religious side of the question. He believes in the careful training of children from their first days; denounces the practice of giving children to the care of ignorant nurses when they are supposed not to be affected by their surroundings, but are really forming habits of character for ill or good. A very apt saying is the author's remark that much that is learned in childhood is not taught, and much that is taught is not learned. And the reason for this he rightly finds in the fact that the child, in his own acquisitions, discovers (by repeated trial and failure, it is true) the natural mode of learning, with interest, timeliness, utility, and attractiveness to help him; while the teacher too often accentuates the artificiality of his task.

The latter half of the volume is devoted to chapters on the habit of thought, on the control of the thinking faculty, on memory, on judgment, on inherited capabilities, and on the early training of the mind, and, to a much too large extent, is a repetition of the first half of the book. In the chapter on inherited capabilities the writer exhibits a tendency which he has in common with other thinkers of the day. The writers in question are unwilling to dispense with the rich suggestiveness of the evolutionary point of view, and the light shed upon mental phenomena by the consideration of their physical substrata, but are equally unwilling to give up the general theories — partly religious and partly not — inculcated in their early training, but really incompatible with a consistent evolutionary treatment. The result is at times a curious mixture. The arbitrary curtailing of the evolutionary principle at one point, and an omission to carry to its full consequence the general principle with which it is at variance, give the appearance of a harmony which a deeper consideration shows to be due, not to the fact that the two lines do not run in opposite directions, but that they have been carefully kept from meeting. Mr. Wall is afraid, that, if we admit that our moral and other qualities are to some extent hereditary, this will loosen the bonds of responsibility, and do other moral havoc (a fear, by the way, not at all justified by the history of morality, which clearly shows that new duties follow in the wake of new knowledge), and so refuses to accept the doctrine. In this attempted refutation he draws heavily on preconception instead of on logic and fact. He boldly announces that the child before birth has no life at all, a statement which no biologist will accept; speaks of 'phenology' as though it were adhered to by scientific men; raises the will into a metaphysical entity, and makes it dominate the reason (as though the former were not a brain quality in the same sense as that in which he acknowledges the latter to be); and refers what we usually call inheritance to early educational influence and the different use of faculties originally alike. In short, the chapter lamentably illustrates the hopelessness of serving two masters.

To leave the reader with a brief verdict of the book, let it be said that it will be suggestive to those interested in this line of thought, but cannot be recommended to those desirous of learning in a short time the modern view of this problem; but with this verdict one must remember the inherent difficulty of the problem, and the

fact that the author pleads temporary blindness as an excuse for the literary shortcomings of the work.

Public Debts. An Essay in the Science of Finance. By HENRY C. ADAMS, Ph.D. New York, Appleton. 8°.

POLITICAL economy in the United States appears to have followed the order of development which Auguste Comte maintained was the law of evolution for all science. We have first the 'theological' stage of science. Certain *a priori* ideas regarding the nature of Deity serve as premises from which conclusions are drawn regarding the phenomena of the industrial world. Carey gives an example of this when he argues from the goodness of God that the Malthusian theory cannot be true. Perry's 'Text-Book of Political Economy' is, however, the best illustration in current economic literature of what is meant by the theological stage of science.

The second stage in the evolution of science was called by Comte the 'metaphysical.' *A priori* ideas still furnish premises for conclusions, but they are not theological: rather are they hypotheses concerning the mind of man and the material universe, which have been derived from processes of reflection. Facts are made to square with theories; and in case they cannot be made to do this, why — "so much the worse for the facts." The English orthodox political economy was well described by Comte's metaphysical stage of science; and with the theological political economy this held sway — almost undisputed sway — in the United States until some fifteen years ago. Its most distinguished representatives declared that it was not eager for facts, because it was in possession of general principles which explained the facts.

The third stage of knowledge Comte called the 'positive.' This deals with phenomena, grouping and arranging these. Comte's description of the progress of science is, I believe, now allowed to be faulty in its details, even by his most ardent admirers; but, on the other hand, those who are not his followers can scarcely deny the correctness with which he laid down certain main lines along which human knowledge has advanced, from the time when Socrates urged his disciples to give up empty speculations about the heavenly bodies for an observation of human phenomena, up to the present. The remarkable development of economic and social science in the United States, now attracting attention in Europe as well as in our own country, is due to a change of method and of purpose, both admirably illustrated in the present work on public debts. Professor Adams examines the facts of our economic history, and from them he draws conclusions respecting a sound financial policy for our Federal government, our States, and our municipalities. The older method would have been to search our history for facts to bolster up certain theories assumed before the book was begun. A change in purpose is as important as one in method. The change in purpose to which I allude is this: the tendency of modern economists is to renounce the position of mere advocates, — almost universally assumed by the older economists, — and to search for truth, like other scientific men, regardless of consequences. The old idea of the duty of an economist was that he must combat heresy, whereas heresy is something unknown to science. Clark's 'Philosophy of Wealth' and James's 'Relation of the Modern Municipality to the Gas-Supply,' both of which have been reviewed in *Science*, may be cited as other illustrations of the most recent tendencies in American economics.

The scope of this admirable work can be most readily gathered from the titles of the parts and chapters into which it is divided. Part I. treats of public borrowing as a financial policy; Part II., of national deficit financing; Part III., of local deficit financing. The opening chapter of Part I. first brings before the reader most vividly the facts in regard to the growth of public debts; and it is certain that few will read these pages without gaining a new idea of the tremendous significance of this factor in modern industrial life. Professor Adams opens his book with these words: "The civilized governments of the present day are resting under a burden of indebtedness computed at \$27,000,000,000. This sum, which does not include local obligations of any sort, constitutes a mortgage of \$722 upon each square mile of territory over which the burdened governments extend their jurisdiction, and shows a *per capita* indebtedness of \$23 upon their subjects. The total amount of na-

tional obligations is equal to seven times the annual revenue of the indebted States. At the liberal estimate of \$1.50 per day, the payment of accruing interest, computed at 5 per cent, would demand the continuous labor of three millions of men. Should the people of the United States contract to pay the principal of the world's debt, their engagement would call for the appropriation of a sum equal to the total gross product of their industry for three years; or, if annual profits alone were devoted to this purpose, they would be enslaved by their contract for the greater part of a generation." Chapters II. and III. treat of the political and social tendencies of public debts, and reveal the power of analysis which distinguishes Professor Adams in so high degree. I have particularly in mind those passages in which he shows, that, while public debts do not create class distinctions, they tend to render such distinctions perpetual. The analysis of the public debt of the United States is likewise specially interesting, for it reveals the surprising extent to which that species of property, at least, is concentrated. It appears that out of a total of \$664,000,000 registered bonds, \$410,000,000 are held in sums of \$50,000 and over. As Professor Adams pointedly remarks, this shows the absurdity of those who would have us keep our debt as an investment for widows and orphans. Chapter IV. deals with industrial effects of public borrowing, and Chapter V. answers the question, 'When may States borrow money?'

The topics of the chapters in Part II. are these: financial management of a war; classification of public debts; liquidation of war accounts; peace management of a public debt; payment of public debts.

Part III. opens with a comparison of local with national debts, and then passes on to an able account of State indebtedness between 1830 and 1850. Here, again, we see the difference between the economist as a man of science and the economist as the advocate of some powerful interest; for example, of corporations. The advocate will dwell on the evils of State enterprise when tried, and, passing lightly over those of private enterprise in the same field, will draw the conclusion that corporations can provide all things better than public bodies like cities, States, or the Federal government. Professor Adams, on the other hand, examines the entire field, conceals nothing, exposes unfortunate failures of public undertakings, and finds that in the Western States, whose history in this respect he has most carefully studied, "whether judged from the standpoints of results or of business probabilities, the State authorities showed greater foresight and greater business conservatism than individuals." While Professor Adams does not wish the States to undertake those kinds of business which are at all times subject to the control of competition, and suitable for private enterprise, he holds—and in this I fully agree with him—"that it was a mistake for the States to abdicate certain sovereign functions in favor of private corporations, for the evils thus incurred have proved greater than the evils escaped."

The remaining chapters of the book deal with municipal indebtedness and the policy of restricting governmental duties as a cure for public corruption and mismanagement. Going below the surface of things, Professor Adams finds in the improper restriction of governmental duties a chief source of bad government. It seems to me that this is beyond controversy when the facts are all reviewed. The whole history of industrial society tends to show that public duties can best be performed by public and responsible agents. It was a great step in advance when States ceased to sell their taxes to corporations and individuals, and to collect them themselves. Another step will be taken when public bodies assume the direct management of natural monopolies like gas-works, water-works, and railways. Are not these natural monopolies now a chief cause of disturbance and corruption? And how cure the disease without removing the cause, and how remove corporations from the field of natural monopolies unless governments absorb the duties they perform? In accordance with this view, Professor Adams very properly recommends the purchase of telegraph-lines by the Federal government as a solution of the difficulty which the treasury surplus occasions. We might then have as good a telegraph service as our present postal service.

It is also in accordance with this general view that Professor Adams recommends that treasury management be kept as free from bank agencies as possible. Our experience in the United

States seems to have demonstrated the wisdom of this. Before Senator Sherman became secretary of the treasury, it was customary to place Federal bonds on the market through the aid of syndicates of bankers, but he saved the United States over a million dollars in the sale of four-per-cent bonds by dealing directly with the public.

When I reviewed Professor Clark's 'Philosophy of Wealth' for *Science*, if my memory serves me correctly, I pronounced it one of the ablest works ever written by an American on the fundamental principles of political economy. I have elsewhere spoken of Professor Adams's monograph, 'The Relation of the State to Industrial Action,' as the profoundest study of the industrial functions of the State in the English language, going far ahead of any thing Mill ever wrote on that subject. I believe the present work on public debts the best work, on the topic with which it deals, to be found in any language.

In view of these facts, and others which might be cited, it does not seem rash to venture to predict that within ten years the recognized leaders of economic thought among English-speaking people will be Americans. RICHARD T. ELY.

NOTES AND NEWS.

LETTERS have been received by the *Montreal Gazette* from Dr. G. M. Dawson, in charge of the Canadian geological party exploring the Yukon district, to date of July 29. The party constructed two boats on Dease Lake, and left on June 3 to descend the Dease River to its junction with the Liard. From that place Mr. McConnell left with two men to descend the Liard. The remainder of the party, with five Indians, ascended the north fork of the Liard to Lake Francis, and, leaving their boats, crossed a long portage of sixty miles to Pelly River, near the abandoned Hudson Bay post of Pelly Banks, where they arrived on the 29th of July, all well. From this place the Indians were sent back, and Dr. Dawson, with Mr. McEvoy and two white men, remained to construct a boat and descend the Pelly to its junction with the Yukon. The country north of Dease Lake proved somewhat varied in structure, having a granitic nucleus with paleozoic rocks on its flanks ranging from Cambrian to Carboniferous, and overlying Tertiary beds. The old portage was found to be entirely disused, and the party had to struggle through tangled woods, often knee-deep in moss. They got over, however, with a month's supply of provisions for the advancing party, and leaving stores cached for the returning Indians. Being north of the latitude of 60°, they enjoyed almost perpetual daylight, and the weather was good. The country is described as possessing well-grown trees, and a great number of the ordinary eastern plants were seen in flower, with some northern and western strangers. Only the great growth of sphagnum mosses and the abundance of reindeer moss give the country a different aspect from that of British Columbia. No Indians had been seen, except those the party brought with them from the coast. Though somewhat later in the season than he had expected to be, Dr. Dawson had still good hopes of reaching the coast before the freezing of the rivers, and the lines of section made by Mr. McConnell and himself will give a good idea of the structure or resources of the country.

— Since starting the third series of his 'Butterflies of North America,' Mr. Edwards has issued his parts in more rapid succession than before, a third number having appeared within the year. As it is the most important iconographic work now issuing in this country, and in artistic merit the peer of any that have yet illustrated the natural history of America, we may once more draw attention to it. Three species are illustrated, all from the Pacific coast, to each of which a quarto plate is devoted. Two of them, species of *Melitea* and *Argynnis*, have liberal illustrations of the early stages, in which the points necessary to a good understanding of the structure of the caterpillar at different stages are especially well brought out. Considering that the insects had to be raised thousands of miles away from home, from material specially sought for, the success of Mr. Edwards is remarkable. The text in this part is almost entirely made up of technical details; and the third plate, another of the multitudinous species of *Argynnis*, is inferior in interest and in execution to the others, though the latter part would hardly be noticed were it not in a work of such uniform artistic excellence.

LETTERS TO THE EDITOR.

*. The attention of scientific men is called to the advantages of the correspondence columns of SCIENCE for placing promptly on record brief preliminary notices of their investigations. Twenty copies of the number containing his communication will be furnished free to any correspondent on request.

The editor will be glad to publish any queries consonant with the character of the journal.

Correspondents are requested to be as brief as possible. The writer's name is in all cases required as proof of good faith.

The Keweenaw System.

THE geologists interested in the discussions that have taken place during the past eight years, concerning the relations of the Eastern sandstone to the copper-bearing rocks of Keweenaw Point, will remember that one of the important localities showing that relation is situated on the Hungarian River. In company with James Osborne, F.G.S., superintendent of the Rio Tinto mines in Huelva, Spain, and William Beer of the Osceola Mine, I have revisited this locality. Owing to some changes in the bed of the stream, we are able to trace continuously the unchanged Eastern sandstone into the sandstone which has been baked and indurated by the old lava-flow, and this baked sandstone into the lava-flow or melaphyr itself, all forming a continuous exposed surface. There is no fault or plane of separation between the sandstone and trap, but the two are welded together into one mass. We procured hand specimens, which in one piece show the contact of the so-called 'Keweenaw' system with the Eastern sandstone. The contact is that made by a lava-flow with an underlying sandstone, and is the same as the contacts so often observed within the copper-bearing series, while the sandstone is observed *in situ* to pass beneath the melaphyr. It is my purpose to uncover the contact junction still further, and to publish in time a paper giving sections and detailing results at this and other localities at which the contact has been observed. The above observations sustain fully those made by myself in 1879; and in this case it would seem to forever settle, beyond any possibility of doubt, that the Keweenaw system and the Eastern sandstone are one and the same continuous geological formation, but with the copper-bearing rocks younger in point of time than the sandstone.

M. E. WADSWORTH.

Michigan Mining School, Houghton, Mich., Sept. 19.

Cause of the Purple Coloring of Pigweed-Leaves.

DURING a number of years past I have frequently been struck by a prevalent purple coloring of patches in the leaves of pigweed (*Chenopodium album*), the cause of which did not appear in any surrounding conditions, and up to this summer it has remained to me a mystery. A few weeks ago, however, while examining pigweed in search more particularly of plant-lice and leaf-miners, I again noticed the leaf-coloring, and, upon turning up some of the colored leaves, found on some of them larvæ of a leaf-hopper having the same shade of purple as the colored spots on the leaves. Further examination brought to light more of the larvæ, always on the under surface of the leaf, and within one of the colored spots. Some of the spots were found without any larvæ visible, indicating that they travel about more or less, or that they had been disturbed and had made use of their legs to get out of the way. A few days later (July 25) I examined plants in another locality similarly affected, and found, as before, the colored larvæ associated with the spots. On one leaf, I found close by the cast-off pupa-skin, which still retained enough of the markings to show its relation to the larvæ (an adult), which, on comparison, proved to be the *Thannotettix seminudus* of Say,—a species rather common throughout the country, but which, so far as I can find, has never been mentioned in connection with its food-habits or larval life. No such coloring results from the presence of plant-lice or other insects on the same plant, and it seems quite certain that we may consider this species as the cause of the peculiar phenomenon. I am not aware that any explanation has previously been given. What kind of secretion is injected into the leaf by the insect, when puncturing it to obtain its food, and how that acts to change the color in the plant-cells, are still open questions. It is evident that the simi-

larity in color of the spots and the larvæ are a protection to the latter.

HERBERT OSBORN.

Zool. Lab. Agric. Coll., Ames, Io., Sept. 20.

The Ordinates of Interest in Science at the American Association.

THE oscillations of interest in branches of science, and the rise of, and rapidly increasing interest in, the more recent and sometimes the less difficult departments of learning, as well as the apparent stagnation in the pursuit of science either locally developed or affecting larger areas of population, have been often remarked. It might seem reasonable to suppose that we might be able to review with approximate accuracy the ebb and flow of the scientific tide by watching the fluctuations of study in a representative and national body of scientific workers; in such assemblages as the American, French, and English Associations present us with, where no discriminations are made, and students of all grades and inclinations are welcomed.

The obvious and feasible method to adopt for this purpose would be to note the varying number of papers by different authors in the several classes of study, and compare their aggregates distributed over a number of years. This method we have used here, and yet a little reflection will show that it is deceptive, and possibly in instances leading to quite wrong conclusions. In the first place, while the names of all scientific men in these countries, as a rule, are found on the rolls of these associations, they may, for reasons of convenience or personal comfort, or because they are associates of smaller and more technically limited bodies, choose to publish or read their papers elsewhere. In the second place, many conscientious workers cannot enjoy the opportunity of attending the meetings of the association, and, while authors in a modest way, would be deterred from appearing upon so prominent a platform, though they become members of the association for the sake of enjoying its publications and the pleasure of its recognition. Again, the 'ambulatory' habits of the association may carry it this year into a hot-bed of geologists or in their neighborhood, and in another move it to the hunting-grounds of archæology; so that the method is defective as permitting just inferences as to the fashion or currents of scientific investigations in the association itself, and more evidently as regards the wholesale aspect of national scientific industry.

And yet, with all deductions made, there is a residuum of interest in the results of this examination. They show how evenly in some branches the 'show of hands' at the annual meetings of the association has been kept up, in others how the interest has fallen under the entire average for years, and again risen by a recuperative effort much above it; they give an idea, at least, how some lines of study exceed others in their active participants in the association, and a measure of the rising importance or popularity of others.

In computing the charts, the whole number of papers by different authors in each department has been taken, and their percentage of all the papers read or accepted, by different authors, used to fix the point of interest in the column corresponding to the number of the meeting quoted. Where an author has prepared a paper on two or more subjects, he is regarded as representing a unit of interest in each; but where he has offered a number on one subject, his activity entitles him to no further recognition, for our purpose, than the single contributions of others. The points of interest are measured from the base-line, and are meant to be strictly comparable; so that the greater general height of one series exhibits the preponderating value of that study. The determination of the proper reference of a paper is in some cases not easy, and the lines might in many ways be changed by a redistribution of the papers, according as the statistician thought the contents of a paper shifted it to a different though allied topic.

Of course, the actual number of papers by different authors in one subject may remain constant, while the percentage of interest would show a decrease, from the re-enforcement of other departments and the consequent larger aggregate of individual papers upon which to reckon. The most instructive conclusions, it seems to us, are drawn from the relative position of the average line of interest, in the different subjects, to the maxima and minima points

and the line passing through them; thus showing at periods an excess over the average, maintained for successive years, and at others a deficit of interest equally prolonged. In many instances the average line lies above the serial points for years, its position being secured by intermittent displays of interest, pushing momentarily the point of interest to a place high above it, for the year in which the display occurred.

For convenience of reference, the number of the meeting and the place of meeting are here brought together:—

- | | | | |
|------------------|------------------|-------------------|-------------------|
| 1. Philadelphia. | 10. Albany. | 19. Troy. | 28. Saratoga. |
| 2. Cambridge. | 11. Montreal. | 20. Indianapolis. | 29. Boston. |
| 3. Charleston. | 12. Baltimore. | 21. Dubuque. | 30. Cincinnati. |
| 4. New Haven. | 13. Springfield. | 22. Portland. | 31. Montreal. |
| 5. Cincinnati. | 14. Newport. | 23. Hartford. | 32. Minneapolis. |
| 6. Albany. | 15. Buffalo. | 24. Detroit. | 33. Philadelphia. |
| 7. Cleveland. | 16. Burlington. | 25. Buffalo. | 34. Ann Arbor. |
| 8. Washington. | 17. Chicago. | 26. Nashville. | 35. Buffalo. |
| 9. Providence. | 18. Salem. | 27. St. Louis. | |



ATTENDANCE.

The marked feature of this chart is the striking rise in the last five meetings, the only ones whose percentage is above the average, with the exception of the 9th and 10th. These meetings include some remarkable assemblages, such as those that met at Boston in 1880, Montreal in 1882, and Philadelphia in 1884. The phenomenal nature of those meetings brought large numbers of the members together, elicited enthusiasm, and excited public attention. The Ann Arbor and Buffalo meetings did not continue, we believe, this upward movement.

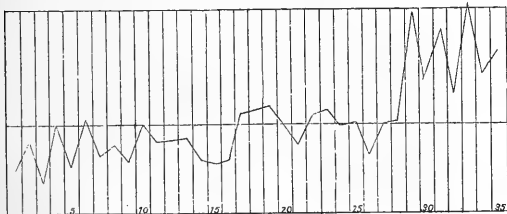

PAPERS.

The papers contributed to the successive meetings, by which is here meant only papers by different authors (except in cases where one author has written in two departments of science), show a synchronous rise with the attendance in the last meetings; but, what is more auspicious, they show an inclination upward from the first, with slight relapses, indicating a prevailing desire among investigators to bring, in some shape, their results before the audience of the association. The papers for the eighth and ninth meetings are low, however, though the attendance then is given as above the average. The rise together of attendance and papers is a healthy sign. It is assumed of necessity that the conditions for admission of a paper are no less or more stringent than formerly.

Mathematics, as might be expected from its difficult and unpopular nature, has a low percentage of interest, 4.16. We do not know how this compares with the percentage in other countries, but it must be considered in connection with astronomy, and to some extent with mechanics,—studies of a mathematical habit. Mathematics maintains itself fairly well near the average, rising and falling about equally, and in one part of the series running almost on the line.

Astronomy has a high average percentage of interest, keeps above the line of average during the first half of the association's

existence, but is pushed down in the second half by the inrushing recruits to other subjects. This is well shown by the fact that at the Boston (29) and Buffalo (35) meetings the actual number of papers assigned to this subject were only one less in each case than the number at the Washington (8) meeting, when the interest reached its highest point.

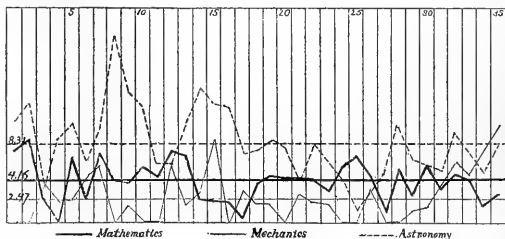

The chart of mechanics shows that after comparative apathy and violent fluctuations the points of interest have started upward with probably a significance as yet undetermined. The technical societies, engineering associations, etc., absorb the papers of the mechanical minds, and the recent accessions of papers may have some reference to the condition of these bodies.

Natural philosophy and physics has a high percentage of interest, and its points oscillate up and down over the average line with quite even regularity. Its fascinating qualities and intellectual importance will assure it a steady flow of support, though the later indications would suggest that its percentage will be lowered in succeeding years, as it fails to reach the average for four years. In this subject personal judgment and ignorance may have led us into error, and papers assigned to chemistry might almost as justly claim admission with this.

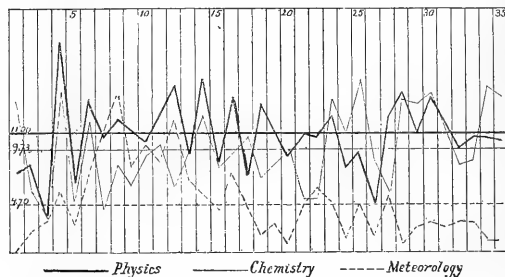

Chemistry everywhere claims attention, and each year its domain and its explorers seem increased. Yet its average of interest is kept up by spurts during the earlier life of the association, a settled higher tendency becoming established only from the 23d (Hartford) meeting, onward. The north-eastern cities seem to stimulate its life in the association, and, generally speaking, it drops as the meetings recede from the Atlantic area. This is less noticeable in recent years, and indicates a wider dissemination of its professors.

Meteorology, which has assumed such first-class prominence in practical affairs, and has attacked new problems formerly unthought of, shows a falling-away of interest in the later years of the association, its average being held up by the tall developments in the 8th to the 13th meetings, when some enthusiastic workers attracted attention to it, unopposed by the widening scope of other branches. It seems to have reached a low ebb, and may show a dangerous facility to disappear altogether.

The average percentage of interest in zoölogy is high, as might be expected; but it seems significant that its points lie beneath the average line in the former part, and above in the latter part, of the association's history. A tendency is discernible, however, toward a lower scale, as from both the 21st (Dubuque) and 29th (Boston) there has been a falling-off, producing the slopes shown in the chart. The sharp ascent in the 3d (Charleston) meeting was given

by eight papers in a total of thirty-four, but the relative interest declined after this to a low ebb for eight or nine meetings.

Botany has not been a feature in the association until recently, and its record shows a simultaneous increase in interest. It has not oscillated widely above or below the average, and has been maintained by a band of writers who, while they permitted it to reach extinction in the 11th (Montreal) meeting, have vigorously kept up its respectability. The new and younger botanists have made themselves felt, and it may be anticipated that in the next decade its percentage will rise.

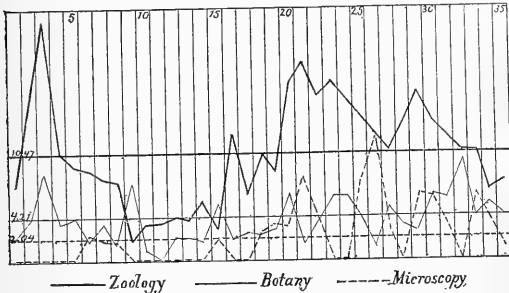

Microscopy has only in later years assumed any importance in the meetings of the association, and in the United States it is only in later years that the use of the microscope has been widely extended. Industrially, technically, in biological and botanical studies, it is beginning to make itself recognized as the handmaid of business and science. Microscopy is yet fitful and timid in its appearances at the association, but these erratic fluctuations probably precede a more even participation in its work.

Geology shows the highest percentage of interest (14.03), as might have been expected, amongst the departments. The association itself was the child of a geological club; and geology in a new country, abounding in new details, new material, new problems, apart from its intrinsic value and fascination, attracts numerous followers. Abundance of papers on this subject have always been forthcoming, in this arena met the veterans of the science, and here the everlasting quarrel over 'taconic' and 'primordial' has been fought over again and again, with the confusion of less noticeable collisions and the combat of less distinguished warriors. One thing of interest is observable; i.e., that geology is losing its hold; as with astronomy and other subjects, the growth of new departments, the increase of papers in other branches, is forcing its average down, though the actual numerical display of papers is higher.

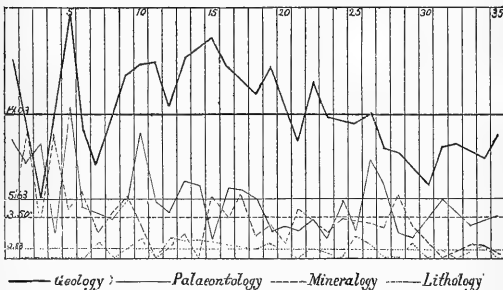

Palaeontology has a fair percentage of interest, has been quite uniform, but evincing a downward inclination, caused, as with other topics, by the enlarging horizon of the society's activities.

Mineralogy has an intermittent and rather low pulse, but from the 15th (Buffalo) to the 28th (Saratoga) meetings was in a rather healthy state, and has since kept below the average. Its average, indeed, has been sustained by the high percentages given in the earlier meetings, and its general temper is debilitated.

Lithology has barely an existence in the association. The subject is new, its students few and scattered, and much of its material absorbed in papers which are properly geological. Lithology will undoubtedly enter more largely into public scientific discussion in the future.

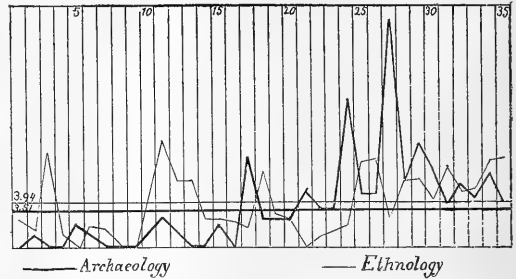

Ethnology and archaeology have been the elements of disturbance which have intruded numbers of papers in recent years, and brought down the percentage of interest in other branches not sufficiently recruited by new accessions. The significant coincidence in the general aspect of these two branches of study shows their important development in the last ten years. They threaten the supremacy of the older studies, both because of their popular character, the interesting nature of their results, and the fertile soil for anthropological investigation in our country.

And here we are suggestively reminded that a valuable analysis of the association returns might be made to determine in what quarters the scientific industry of the country is located. Finally, we offer these observations, imperfectly and too hastily prepared, as a contribution to the interest this meeting of the association should excite.

L. P. GRATACAP.

A North Carolina Diamond.

A DIAMOND weighing $4\frac{1}{2}$ carats and 873 milligrams was found on the Alfred Bright farm in Dysartville, McDowell County, N.C., in the summer of 1886, by twelve-year-old Willie Christie, the son of Grayson Christie, who was sitting on a box at a spring, and saw, about two feet from him, what he termed 'a pretty trick.' He picked it up and carried it home, where it lay on the shelf two weeks before he gave it another thought. It was then taken to the village grocer's, John Laughridge's, where various opinions were passed upon it, until at last the conclusion that it was a diamond was reached. It was then sent to Messrs. Tiffany & Co. for valuation. It is quite perfect, but not pure white, having a faint grayish-yellow tint. In form it is a distorted hexoctahedron with partial



twinning (see figures of two views). Its specific gravity is 3.549+, and it measures 10 millimetres in length and 7 millimetres in width.

This stone being more than an average find, the writer thought it would be of interest to visit the locality, and while there in June, 1887, he fully authenticated all the facts of the finding. Dysartville is sixteen and one-half miles from Morganton, twelve from Marion, eight from Bridgewater, and four from Capt. J. C. Mills's gold-mine. A number of supposed diamonds, which proved to be zircon or smoky quartz, have been found here before. No trace of garnet, peridotite, or any of the associations of the diamond, were found near the spot. The sediment at the bed of the spring was taken out and carefully examined, as also the small hollows on the adjacent hillside. This diamond must therefore have been transported in decomposing soil from distant higher ground in the vicinity, during a heavy freshet. Its value as a gem, not counting any value its American origin may attach to it, would be from about one hundred to one hundred and fifty dollars.

GEORGE F. KUNZ.

New York, Sept. 27.

SCIENCE

FRIDAY, OCTOBER 7, 1887.

ACCORDING TO A Reuter's telegram, dated Sept. 9, from St. Paul de Loanda, Major Barttelot, who was left at the camp at Yambuya, at the foot of the Aruvimi Rapids, with a garrison of about one hundred men, has forwarded the following information to Leopoldville concerning Mr. H. M. Stanley's expedition: "Major Barttelot received news from Mr. Stanley, despatched about July 12, after he had made a ten-days' march from Yambuya towards the interior. Mr. Stanley was at that date still proceeding up the Aruvimi, which he had found to be navigable up to a certain distance above the rapids. Here he launched a steel whale-boat which he had brought with him, as well as several rafts manufactured by the expedition, and which had been utilized for conveying the heavy baggage. All the members of the expedition were in good health, and provisions were easily procured in the large villages near the river. The country through which the expedition was passing showed a gradual rise towards some high table-lands. Another caravan of 480 men was following the expedition on the left bank of the Aruvimi; the advanced guard, consisting of forty Zanzibari, under the command of Lieutenant Stairs, being composed of men lightly burdened, whose duty was to search for provisions. Mr. Stanley hoped to arrive about July 22 in the centre of the Mabodi district, and expected to reach Wadelai in the middle of August, or even before. The advance had been so peaceably accomplished that Mr. Stanley had instructed Major Barttelot, that, should it continue so, he would shortly send him orders to follow the expedition by the same route at the head of the one hundred men left at Yambuya." A later telegram, dated Oct. 2, from St. Paul de Loanda, states that the further progress of the expedition was very satisfactory. About July 25 the expedition had ascended the Aruvimi to the elevated country belonging to the Mabodi district. The river becoming too narrow, they left the rafts; and the men for several days had to carry a double burden of provisions. The steel whale-boat was carried past the narrows, and again launched. Stanley calculated, that, upon arriving at the summit of the table-lands giving shape to the basin of the Aruvimi, the expedition would halt two days for a rest, and would establish a camp there to be garrisoned by twenty men, with a European officer. The districts traversed were tranquil, and little difficulty was experienced in obtaining provisions from the natives. The progress of the expedition averaged twelve miles daily. Tippo-Tip, in his last message, wrote that he was still at his post at Stanley Falls, awaiting re-enforcements. He had gained the good will of several neighboring chiefs. Owing to the disturbed state of the country, Tippo-Tip could not, as he had agreed to, organize a revictualing caravan to despatch direct to Mvutan Nsige, but he intended to do so as soon as possible. Disquiet continued between Stanley Falls and the confluence of the Aruvimi and the Kongo, and many villages had been pillaged. It is believed that the garrison which Stanley left at Yambuya has been forced to interfere to maintain order in the neighborhood. It appears from all reports that Tippo-Tip, since he has become connected with the Kongo Free State, has some difficulty in regaining his former influence over his countrymen. The disquiet on the Upper Kongo, to which reference is made in the second telegram, probably refers to the ravages of the Arabs of Stanley Falls, who extend their slave-hunting expeditions down the Kongo. It is to be hoped that Tippo-Tip's influence, supported by Major Barttelot's troops, which are stationed near the mouth of the Aruvimi, will suffice to confine their raids to the territory above Stanley Falls.

It is in accordance with Emin Pacha's former actions that he declares at the present time his intention to stay in his province, and to further the work of civilization he has so successfully begun. It appears from the meagre news that has reached America, that the messengers who were despatched to inform him of Stanley's expedition have met him, and that this is his reply to the message. Emin expresses the hope that England will help him to open a route of commerce to the Indian Ocean, but it seems more probable that communication with the Kongo will be opened by Stanley's expedition. Junker's travels show that there is no serious obstacle to travel in the region of the northern tributaries of the Kongo; and therefore it seems probable, that, while political complications close the routes of the Nile and of Uganda, Emin and Stanley may succeed in opening trading-routes from the Upper Kongo to the Equatorial Province.

IF THE PRESIDENTS of all our colleges would follow the example of President Barnard of Columbia, and publish each year a full report on the progress of the institutions over which they respectively preside, it would be an advantage not only to the institutions themselves, but to the cause of higher education in general. Mr. Charles F. Thwing, always an observant critic of college methods, emphasizes this point in a recently published article. President Barnard's report for the last academic year has just been issued, and, with its appendices, is a most valuable document. It rehearses the changes and improvements of the year, traces the work of the various schools separately, and discusses such questions as those of attendance, scholarship, the marking system, elective studies, and the wonderfully successful public lecture courses of the past two winters. We are glad to notice the steady growth of the graduate department, as it augurs well for the future of the institution. President Barnard says very little concerning the finances of the college, and we are therefore led to infer that no appreciable part of the sum asked for three years ago has been obtained. An announcement reaches us with the president's report, which should be referred to in this connection. It is the programme of courses in the Oriental and Hamitic languages offered for the present year. From this we learn that the most complete department of its kind in America exists at Columbia, and that, under the inspiring leadership of so cultured a scholar as Dr. H. T. Peck, no fewer than nineteen courses in the Oriental and Hamitic languages are announced. This is a remarkable showing, and when considered in connection with the courses of Professors Bloomfield and Haupt at Baltimore, Whitney at New Haven, and Lyon, Toy, and Lanman at Cambridge, proves that a great impetus has been given to advanced philological study in this country.

THE HIGHER SCHOOLS OF NORWAY.

THE Norwegian school-laws of the 17th of June, 1869, according to the *Zeitschrift für das Realschulwesen*, xii. 3, recognize three fundamental principles. First, all higher schools must have a lower course in common, so that it will not be necessary at the outset, with the choice of a school, to choose also one's ultimate vocation. Secondly, the length of the course must be so regulated that the pupil, upon its completion, shall be of an age to enter intelligently upon the active duties of his calling; the curriculum must also form in itself a whole, and be so arranged that the pupil who has completed it carries with him into life a good general education. Finally, the time devoted in the upper classes to preparatory studies must be so disposed that the pupil may confine himself more especially either to history-philology, on the one hand, or to mathematics-natural sciences, on the other.

The whole system of higher education in Norway is based upon the intermediate school. It is the preparatory school of the Gymnasium, — the Latin as well as the Real Gymnasium, — and has a six-years' course. The requirements for entrance are essentially the same as in the Prussian *höhere Bürgerschule*. The normal age at entrance is nine years. For the first three years the course is in common: with the fourth year it is divided. The pupil preparing for the Latin Gymnasium receives instruction in Latin seven hours per week, which continues through the remainder of the course. All others have instead the so-called 'Real' course; in the fourth year, English and drawing; in the fifth and sixth years, English, drawing, and an hour more of German. Otherwise the courses are identical. In the fifth and sixth years two hours of French are elective. A certificate of proficiency from the intermediate school is required for admission to a Gymnasium; it also entitles its possessor to enter a technical school, and is required of a dentist. A certificate in the Real course only, admits to the naval academy and to the telegraph service; in the latter case the pupil must also have been proficient in French. The future apothecary must possess the certificate of the Latin course.

The Gymnasium — the Latin Gymnasium as well as the Real Gymnasium — is the preparatory school of the university and of the higher technical schools. It has a three-years' course, arranged as follows: —

Latin Gymnasium.

	I.	II.	III.
Normal age at entrance	15	16	17
1. Religion	1	1	2
2. Norwegian and Old Norwegian.....	3	3	4
3. Latin	9	10	9
4. Greek	7	7	7
5. French.....	4	2	2
6. German	1	—	—
7. History and physical geography.....	3	3	3
8. Mathematics.....	2	3	3
Total number of hours.....	30	29	30

Real Gymnasium.

	I.	II.	III.
Normal age at entrance	15	16	17
1. Religion	1	1	2
2. Norwegian and Old Norwegian.....	3	4	4
3. English	4	5	5
4. French.....	4	2	2
5. German	1	1	—
6. History.....	3	3	3
7. Physical geography.....	1	1	2
8. Natural sciences.....	6	5	4
9. Mathematics.....	5	6	6
10. Drawing.....	2	2	2
Total number of hours.....	30	30	30

The certificate of proficiency from the Latin Gymnasium entitles its possessor to enter upon any course of study. If, however, the pupil desires to enter the military academy, he must pass an examination in mathematics, the natural sciences, and drawing, the requirements in these branches being the same as at the final examination of the Real Gymnasium.

The certificate of the Real Gymnasium entitles its possessor to enter the advanced technical courses, to pursue the study of jurisprudence, and admits to the military academy. If a graduate of the Real Gymnasium desires to study medicine, he must pass an oral examination

in Latin; the requirement, however, being the same as at the final examination of the intermediate school, not of the Real Gymnasium. The candidate must show that he has read three books of 'Cæsar's Commentaries,' twenty-four chapters of 'Cicero's Orations,' and five hundred verses of 'Phædrus.' In addition, there is a short written translation from Norwegian into Latin, in which the use of a dictionary is permitted. Most of the graduates of the Real Gymnasium who are to study jurisprudence also take this examination; on the one hand, because Roman law is an important factor in the State examination, and because those who have passed this examination have especial prerogatives in the *examen philosophicum* which precedes the state examination. In order to study theology and philology, the graduate of the Real Gymnasium must pass an oral examination in Latin and Greek, the requirements being the same as at the final examination of the Latin Gymnasium.

The system of preparatory instruction here described has existed in Norway now for some twenty years, so that it is possible to judge, to some extent, of its efficiency. Statistics show that the great majority of those who discontinue their studies after the completion of the course of the intermediate school take the Real course. Of those who take a higher course in the university and the technical schools, two thirds have been graduated from the Latin Gymnasium, one third from the Real Gymnasium. This result, however, is to be explained by the fact that the transformation of the former Latin schools into Latin Gymnasiums necessitated comparatively few changes. Where circumstances, accordingly, allowed but one higher school, the Latin Gymnasium was chosen, which offers, besides, certain tangible, if not materially important prerogatives. Real Gymnasiums and Latin Gymnasiums exist side by side only in the larger cities, the number of which in Norway is very small. Eight cities have both a Real and a Latin Gymnasium, and twelve a Latin Gymnasium alone. W. H. C.

ACCLIMATIZATION IN NEW ZEALAND.

In a former article (*Science*, viii. No. 197) reference was made to the various species of animals which had been purposely introduced into these islands. In all cases it is difficult to foretell what effect will be produced upon any species by bringing about a change in its environment, and this truth has been well exemplified in the case of many animals, now, alas! too well established in the colony. Unfortunately the age of experiments in this direction has only begun. Rabbits, having no natural enemies to keep them in check, have become such a pest and source of loss to the colony, that the latest move — taken up both by interested sheep-farmers and by the government — has been to liberate sloats, ferrets, and weasels in many parts. Slowly as these animals increase, they have already made their presence felt; not, however, in the diminution of the rabbit-pest, but by their destruction of hen-roosts, and attacks upon children. Following in the wake of settlement, but not introduced purposely by man, are many other species, mostly small and noxious. When settlers first penetrate into the untrudged parts, especially of the South Island, they are attacked by hordes of blood-thirsty sandflies and mosquitoes; while the greatest care has to be taken to ward off an abundant blowfly, which lays its eggs, or ready-hatched maggots, upon every thing exposed. Blankets, flour-bags, and clothing are just as readily 'blown' as meat or offal. But as cultivation proceeds, and the ground is cleared, these insects disappear, while common European blue and house flies take their place. The latter, like the human being they follow after, even bring their diseases with them; so that every autumn their distended bodies are found attached to window-panes by the mycelium of *Empusa musca*.

As settlement progresses, and new trees and plants begin to take the place of the old vegetation, the familiar pests of the mother-country begin to appear. *Aphides*, *Coccide*, various beetles, moths, and flies, together with parasites which infest man and beast, become all too familiar. In many cases it would seem at first as if these were going to have it all their own way. Some twenty years ago it was considered nearly impossible to grow Swede turnips in this part of the colony, so enormously abundant was the *Aphis* upon them; but within these two decades a small bird almost certainly of recent introduction from Australia, called green-eye, wax-eye, or blight bird (*Zosterops lateralis*), has increased

very much, and coincidentally with this has been such a decrease in the *Aphis*, that it has practically ceased to be a pest.

But the most conspicuous effects of man's influence is the introduction of numbers of species of plants which find themselves more or less at home in this new land. It is matter of common remark to every person coming to the colony, how English every thing looks. The wayside weeds, the grass with its daisies and ox-eyes, the fields and gardens with European chickweed, docks, and thistles,—all remind him of the old land. English plants chiefly have spread themselves over the country, wherever the settler has gone. One might expect that Australia, or America, being so much nearer, would have furnished the greatest proportion of immigrants; but this is not found to be the case. It is what Sir Joseph Hooker has called the aggressive Scandinavian flora, which so strongly asserts itself on all sides. The reasons of this are perhaps not far to seek. Nearly all the seeds brought to the colony in the earlier days of settlement came from Britain. English grasses were brought and sown down, and along with them came the weeds of English pastures. Compressed hay was brought frequently with imported stock; straw-packed goods were, and are, scattered throughout the country; and thus, in one way and another, it is the European species of weeds which have found their way here in the greatest abundance. The conditions of acclimatization are very dissimilar in different parts of the colony, extending as it does through twelve degrees of latitude, and thus embracing very different climates. The southern parts of the South Island are as different from the Bay of Islands as Scotland is from Italy. Throughout the greater part of the east side of the South Island, night frosts are experienced during the winter, even along the coast; while inland the cold is much more intense and continued, the summer being at the same time hotter. But in all other parts, frost, at ordinary levels, is the exception, while in no portion of the country are the droughts prolonged, as in Australia.

One of the results of such a distribution of climate is, that fewer introduced plants have succeeded in acquiring a foothold in the southern and colder parts than elsewhere in New Zealand; and as we go farther north we find the number of acclimatized species becoming more and more abundant. While those of Otago are chiefly such as are to be met with in England and Scotland, those of the north of Auckland are largely mixed with mid-European plants, and many of tropical and sub-tropical distribution. This is well seen by comparing the appearance at different ports. On landing in the Bay of Islands, one sees large patches of *Agave Americana* marking the sites of old gardens, but spreading far and wide, as if quite at home. The ground is carpeted with the familiar 'doab-grass,' as it is called in Bengal (*Cynodon dactylon*). Lily-of-the-Nile (*Richardia*) blocks the water-courses, while other tropical forms (*Amaranthus*, *Aponogeton*, *Lycium*, etc.) occur freely as wild plants, intermingled with others of much more temperate habitat. Pursuing his journeys south, the traveller enters Napier, and, passing from the landing-place to the town through a ravine-like cutting, finds scarlet geraniums and forests of fennel competing with mesembryanthemum and introduced fuchsias for possession of every bit of soil. He infers at once a climate quite free from frost. But now let him land at Dunedin, and none but old country friends meet him. Shepherd's purse, groundsel, and docks occupy the wayside with similar equally familiar weeds. The meadows and pastures are white with daisies and ox-eyes (*Chrysanthemum leucanthemum*), or yellow with cat's-ear (*Hypochaeris radicata*), buttercups, and self-heal (*Primella*), and, with a slight effort of imagination, he might almost fancy that he was back in 'bonny Scotland.' The tropical element is here wanting. While nearly four hundred (387) species have been recorded as occurring in the Auckland district, not more than 160 are known from Otago in the south.

It is a much-disputed question among local botanists, whether the native flora can hold its own against the introduced plants, or not. When we consider that species brought from old (from a human point of view) and long populated countries, in more or less close proximity to one another, have acquired their present characteristics after long ages of a keen struggle for existence with one another, and with herbivorous animals to fight against, we should certainly expect them to prove extraordinarily aggressive in such a

country as this. Here the animals are wanting, the climate is milder, moisture is abundant, and all the field seems to lie open. Accordingly, wherever the settler goes with the axe and plough, and, above all, with fire, the introduced plant follows him, and thrives. But it is now pretty well ascertained that if man stays his hand, the native vegetation does not continue to recede before the alien: on the contrary, it seems once more to tend to re-assert itself. That, at least, is the testimony of our two most competent botanists, Mr. Cheeseman in Auckland, and Mr. Kirk in Wellington, as well as of the writer in Otago.

The way that some plants have spread is most remarkable. The common thistle (*Carduus lanceolatus*) has gone over the country like smoke, especially following fire and cultivation. When first established, it forms thickets which frequently are impermeable; but this state never lasts long. The soil appears to refuse, at the end of two or three years, to yield up its former abundance, and the plant exhausts itself. This process in many parts is absolutely beneficial to the soil. In the limestone districts to the north of Otago, the writer has seen vast areas, which had been once ploughed, covered with an impenetrable forest of thistles six feet or more in height. In autumn the whole crop dies down, leaving the rocky soil penetrated in all directions by its long roots. As these decay, water finds its way down to the lower levels; and on ploughing the soil, and sowing a crop of winter wheat, the farmer is rewarded by a sixty-bushel crop.

Two or three species truly indigenous are now abundantly represented by the introduced European form. This is certainly the case with the dandelion (*Taraxacum*) and sowthistle (*Sonchus*), and most probably also with the smooth geranium (*G. molle*). The native form is all but extinct, the introduced being abundant.

In some cases characters are developed which appear to tend towards the formation of new varieties. Thus *Bartisia viscosa*, always considered a root-parasite in Europe, is truly established on its own roots in this country. Water-cress, which grows to a length of from two to four feet in its native habitats, attains gigantic proportions in many New Zealand streams. In the Avon at Christchurch it is frequently found with stems as thick as a man's wrist, and twenty feet in length. Sheep's-sorrel (*Rumex acetosella*) is here an unmitigated garden and field pest, especially in poor soils, where its tough underground stems will creep as much as a yard in a season, if the soil be kept well stirred. Equally remarkable is the changed character of *Poa pratensis*, so famed as a pasture-grass in the States. In New Zealand it gives a poor return as a permanent pasture-grass, while in arable land it is a curse, matting the surface soil into an unworkable mass. No doubt one cause of the troublesome nature of many of the common garden-weeds is the comparative absence of frost. Many plants which are strictly annuals in Europe or America, become biennial or perennial here. Chickweeds (*Stellaria* and *Cerastium*) and groundsel flower all the year round.

One of the most aggressive species in the country is the white or Dutch clover (*Trifolium repens*), which has shown great power of spreading, both laterally and vertically. Introduced plants are often met with also in most unexpected localities. The writer, when rambling along the slopes of Mount Torlesse, in the Canterbury Alps, was surprised to find some of the valleys—miles away from human habitation—full of a common mullein (*Verbascum thapsus*); but such instances are rare. The botanist rather wonders, that, considering how greatly specialized to their surroundings New Zealand plants are, they do not more quickly succumb to the intruders.

Finally, an interesting question, puzzling to the acclimatizer, is the difficulty of introducing certain—to him—desirable plants. Primroses and cowslips, foxgloves, and many other sylvan and meadow beauties, will not run wild. They die out if removed from the garden. The cause seems to lie in the absence of the insects necessary for their fertilization.

Both in the case of plants and animals, then, an interesting field for future observation exists in this country; and fortunately, accurate information on the whole subject has been accumulating from the very outset, so that the future naturalist has no 'dark ages' to look back to, but will always have some trustworthy record to refer to.

GEO. M. THOMSON.

Dunedin, Aug. 11.

MENTAL SCIENCE.

Brain-Growth and Body-Growth.

THE late Dr. Parrot of France was, at the time of his death, collecting anatomical material for a study of the progressive development of the several parts of the body as measured by such characteristics as size and weight. Some of this material has been arranged by Mlle. Jeanne Bertillon, and presented by her to the Anthropological Society of France. The problem there discussed is the ratio of increase in weight of the brain to the increase in weight of the body as a whole, of the height, of the heart, and of the spleen. This is ascertained for the two sexes and for the various ages, especially for the first years of life, when growth is at its maximum. As will be seen, the results given are founded on a sufficiently large number of measurements to make them generally reliable.

Expressing the weight of the body, of the heart, of the brain, of the spleen, and the height, as 1,000 at birth, their condition at several periods up to the sixth year is given in the following table:—

Age.	Weight of Body.		Weight of Heart.		Weight of Brain.		Weight of Spleen.		Height.	
	Female.	Male.	Female.	Male.	Female.	Male.	Female.	Male.	Female.	Male.
0 to 1 month.....	1,000	1,000	1,000	1,000	1,000	1,000	1,000	1,000	1,000	1,000
1 month to 3 months....	1,190	1,124	1,179	1,135	1,246	1,348	1,280	1,286	1,066	1,036
3 months to 6 months....	1,596	1,486	1,487	1,499	1,666	1,570	1,852	1,860	1,202	1,128
6 months to 1 year.....	2,257	2,150	2,280	2,191	2,170	2,137	2,322	2,453	1,356	1,315
1 year to 2 years.....	3,200	2,921	3,189	3,095	2,756	2,647	3,230	3,390	1,540	1,513
2 years to 4 years.....	4,347	4,229	4,022	3,849	3,210	3,202	4,570	4,210	1,744	1,683
4 years to 6 years.....	5,367	5,480	5,167	5,160	3,435	3,461	5,330	5,560	1,971	1,960

Thus it appears that at the end of this period the height has about doubled, the brain a little more than tripled in weight, and the weight of the body, as of the heart and spleen, more than quintupled. In another table is considered how much of this growth of the first five years has been contributed by each of the several periods of age above specified. From such a comparison, it appears that the brain develops sooner and more rapidly in early life than even the height. The percentage of the growth of the first five years, that takes place in the first six months, is, for the body-weight, only 13.66 for females, and 10.82 for males; for the heart, 11.43 and 11.88; for the spleen, 19.7 and 19.0; for the height, 20.8 and 11.40; while for the brain it is as much as 27.41 and 23.51; the first figure referring to the females, and the second to the males. The same fact is more clearly brought out by saying that at the beginning of the second year the female brain has already increased by 72 per cent of all the increase it will have made within the first five years, while the body-weight has not reached 50 per cent of the development it will have at the sixth year. Expressing the total progress at the opening of the second year in terms of the total progress at the opening of the sixth year, the following table shows in detail the relative amount of growth attained by the several parts:—

	Body-Weight.	Weight of Heart.	Weight of Spleen.	Height.	Weight of Brain.
Female.....	50.36	52.54	51.50	55.53	72.33
Male.....	42.86	50.46	52.50	45.70	66.85

The striking fact here is the advance of the female above the male. This, it has been suggested, is what one ought to expect, on the theory that the female organization is nearer the primitive type than the male, for savages (and animals) are marked by a more rapid march to maturity than civilized man. In actual weight and height, however, the male, as is well known, exceeds the female;

and on the average during the first five years, taking the female weight (and height) at 1,000, the male weight (and height) is shown below. It may be noted that the brain-ratio between the two sexes is larger than that of any other part.

Body.	Heart.	Brain.	Spleen.	Height.
1,073	1,077	1,096	1,087	1,030

Greater changes take place within the first three months than within the period from the third to the sixth month, but the maximum of growth takes place in the latter half of the first year.

The sexual differences in these respects are very marked throughout. The disparity diminishes within the first four years, to reappear in from the fourth to the sixth year with the same intensity as in the first months of life.

With which of the four measurements does the growth of the brain in weight keep the most constant ratio? Omitting the weight of the spleen as unimportant and variable by pathological and other causes, a glance at the following table will show that the body-weight and the height give no such constant ratio.

Age.	1,000 Grams of Body to 1 Gram of Brain.		100 Centimetres of Height to 1 Gram of Brain.	
	Number of Cases.	Ratio.	Number of Cases.	Ratio.
0 to 1 month.....	196	166.6	94	726.5
1 month to 3 months....	88	186.9	46	865.7
3 months to 6 months....	104	175.8	56	1,006.0
6 months to 1 year.....	120	163.1	60	1,220.0
1 year to 2 years.....	202	147.4	142	1,174.0
2 years to 3 years.....	115	128.7	95	1,371.0
3 years to 4 years.....	60	118.1	48	1,531.0
4 years to 5 years.....	44	92.8	34	1,279.0
5 years to 6 years.....	22	101.8	22	1,205.0
6 years to 7 years.....	17	100.6	13	1,264.0

If, however, we compare the weight of the brain with that of the heart, a more constant ratio is found, which Dr. Parrot would dignify with the name of the 'encephalo-cardiac' index to take rank with other anthropological indices. The constant decrease of this ratio with age is thus shown, taking 10 grams of heart to 1 gram of brain.

Age.	0 to 1 m.	1 m. to 3 m.	3 m. to 6 m.	6 m. to 1 yr.	1 yr. to 2 yrs.	2 yrs. to 3 yrs.	3 yrs. to 4 yrs.	4 yrs. to 5 yrs.	5 yrs. to 6 yrs.	6 yrs. to 7 yrs.
Ratio.....	230	257	257	235	216	192	173	158	151	151
No. of cases....	185	90	90	114	206	117	71	39	22	19

It is probable that after the sixth year the ratio would tend to remain constant. Be this as it may, Dr. Parrot has pointed out an interesting line of research, and one calculated to shed much light on the normal development of children.

THE SAVAGERY OF BOYHOOD.—Mr. John Johnston, in an article in the October issue of the *Popular Science Monthly*, brings home the forcibleness of the analogy between the traits of savages and that of developing civilized mankind. He cites a case of wanton cruelty recorded, by a boy without any apparent feeling for the cruelty of the act. Mr. Johnston, opposing the sentiment that pervades much of the literature that is supposed to be written for boys, does not predict for this boy a life of sin, but gravely contemplates the trait as a step in the normal development of youth. Pity is a late factor in moral evolution, and

a really 'good' boy is morally precocious or diseased. This view does not lower one's estimate of a boy's virtues, but accents those that are suited to his years, as well as the importance of the gradual and timely appearance of the several instincts and emotions without which civilization would be impossible.

HEALTH MATTERS.

Chest-Expansion and Consumption.

In *Science*, ix. No. 221, we gave a *résumé* of the views held by G. W. Hambleton, licentiate of the King's and Queen's College of Physicians, Ireland, on the origin and prevention of consumption. These views were presented last year at a meeting of the British Association for the Advancement of Science. Since then Mr. Hambleton has been engaged in certain experiments upon this important subject, and during this research his attention has been drawn to the fact that the size and shape of the human chest vary according as he varied its conditions. So constant was this variation as to make him doubt the present accepted theory of the inheritance of chest-types.

Taking a well-marked example of the so-called inherited consumptive chest, he subjected it to conditions that tend to develop the lungs, till it corresponded in size and shape, first with the town artisan, then with that of a man of the privileged class, and finally with that of a man of the best class of insurable lives in America. By subjecting the same chest to conditions that tend to reduce the breathing capacity, he brought it back through the same types to nearly that with which he commenced; and he claims to have produced similar results in other chests within a period measured by months. At birth the average male child of all classes has the same type of chest, but at maturity he has that of the class to which he belongs. The types of chest, Mr. Hambleton claims, vary with the conditions to which these types are subjected. Thus we have the type of chest of those who use wind-instruments, and another type of those who compress their chests in their work or by a corset. In these no one raised the question of inheritance. This variation of the chest is not peculiar to it: it is true of all other parts of the body. The shape of the head may be altered by direct pressure, and the shape and size of the feet in the same way.

According to this theory of Mr. Hambleton, the type of man after birth is solely produced by the conditions to which he is subject: hence the formation of race by man's continuance under the same conditions, and its subsequent divisions into sub-races and families by his migrations into new conditions and the minor differences therein. The field which is opened up for investigation by these views is, as Mr. Hambleton states, a wide and important one. When we have ascertained what the conditions are that produce these differences in man that together make a class or type, we shall be able to produce that class or type; and we shall also be able to tell what type of body is best suited for a given occupation, and for residence in a given country. "Then we shall train men so that we shall no longer send them into occupations with types of body unfitted for the conditions of that occupation, and consequently we shall be spared the misery and loss of those numerous breakdowns from unsuitability of type that are now daily brought before us."

These views have been referred to a committee of the association, with instructions to investigate them; and in a letter which we have received from Mr. Hambleton, he requests that they be thoroughly tested by scientific men in this country. It will, we are sure, be apparent to our readers, that, if all that is claimed for these opinions is true, a most important and valuable contribution to human knowledge has been made; and, if the practical results which are stated to have been obtained in isolated instances can be made general, the improvement in the human race which is certain to follow will be beyond all computation. We shall be glad to open our columns to those who desire to discuss the question, or have any facts bearing upon it.

FOODS CONSUMED IN WINTER. — In no particular does the difference between the customs of the people of the present day and those of their forefathers show itself more distinctly than in the amount and character of the food which they consume during the winter months. The diet of fifty years ago was characterized by

simplicity, and want of variety: that of to-day is just the opposite. This is largely due to the improvements in the processes of food-preserving, by which every form of plant and animal life is as available at one season of the year as at another. Some of these processes are so simple that there is no reason for substituting questionable methods for them, while others require so much time and attention that packers are constantly on the alert to discover a way to shorten the time and lessen the necessary watchfulness. With this object in view, chemistry is often appealed to, to solve the problems which are constantly presenting themselves. It is in this way that chemical products of various kinds find their way into the food-supply. The improvement which takes place in coffee when it is transported in sailing-ships is, now that a quicker method of transportation is employed, counterfeited by polishing and coloring; and to avoid the trouble of long treatment by heat of some vegetables and fruits, and their consequent deterioration in appearance, preservatives of various kinds are employed. One of the most commonly used of these is salicylic acid. The effect of this acid upon health has been thoroughly investigated in France, and its use in foods and drinks has been prohibited in that country since 1881. Prof. E. H. Bartley, of the Long Island College Hospital, Brooklyn, has recently examined this question with great care, and in an article which appears in the *American Analyst* his views and those of other authorities are given in full. In the use of this acid in the treatment of rheumatism, clinical observation shows that it cannot be continued for a long period of time without impairing digestion, and in its elimination it passes out undecomposed through the kidneys. It has been recognized that under these circumstances it not only irritates but inflames these organs. In preserved food we have to do with smaller quantities of the acid, as a rule; and though that this is not always the case is shown by Professor Bartley's figures. He says, "The quantity of salicylic acid usually employed in wines is from six to eight grains per gallon, and in beer from twelve to fifteen grains per gallon; or, in the case of beer, from one to one and a half grains to the glass. As many men habitually drink twenty-five glasses during the day, they take from twenty-five to thirty-seven grains of the acid per day. The medicinal dose is usually stated to be from ten to twenty grains." He also calls attention to the fact that nursing mothers are frequently recommended to drink ale, porter, or beer, with the idea that it stimulates the mammary gland, and to the additional fact that temporary renal disease is frequent during the first weeks of lactation. In conclusion, Professor Bartley says, "I should state that another serious objection to the use of salicylic acid is the fact that many samples found in the market contain more or less carbolic acid. It is now almost entirely manufactured from this very poisonous substance, and, unless great care is exercised, an appreciable amount of it is left in the finished product. Indeed, some writers think that some of the fatal accidents recorded from the use of salicylic acid have been due to the presence in it of carbolic acid. If the use of this acid is to be countenanced, impure articles will be used, and greater damage may be done than could come from the pure article. From a careful consideration of the whole subject, I am compelled to regard the use of salicylic acid in foods and drinks, and especially in lager beer, as at least open to serious objections. If it be harmless to healthy adults, the evidence of its deleterious action upon the aged and certain other classes of the community is too strong to be disregarded by sanitary authorities, and should prohibit its use for this purpose."

ETHNOLOGY.

Dwarfish Races.

A. DE QUATREFAGES has recently published an historical review of the ancient and modern reports on dwarfish tribes. While formerly the descriptions of ancient geographers were considered not trustworthy, many of them have been confirmed by recent explorations. Among these are the tales on the pygmies. Aristotle and Pliny state that a dwarfish people lived near the swamps of the upper part of the Nile. De Quatrefages considers this tribe identical with Schweinfurth's Akka, who at the present time live a little farther south. Pomponius Mela mentions dwarfs who inhabited the neighborhood of the Red Sea. This report was confirmed by

Léon des Avancher's discovery of the dwarfish Wa Berikomo, who are said to be only four and one-half feet high, and by D'Abbadie's visit to the Maze-Mollea, who live a little farther to the north.

Herodotus tells of a dwarfish black people on the banks of the Niger. His description of the land still holds good; but, instead of negroes, Berbers and Tuareg inhabit those regions. At the present time the most northern place in West Africa which is inhabited by dwarfs is Tenda-Maje, where they were met with by Mollin in 1818.

Pliny mentions, besides the dwarfs on the sources of the Nile, others living in what is now south-eastern Belutchistan, where the Brahui, a people of Dravida lineage, are found. Ktesias speaks of pygmies who inhabited Central India. Mr. Rousselet found in that region the dwarfish Bandra-Lok, who live in the Vindhias Mountains.

De Quatrefages considers all Asiatic dwarfish tribes as one group, which he calls Negrito, while the African ones are called Negritto. His researches lead him to the conclusion that the traces of this race are found from India to the eastern extremity of New Guinea, and from Ceylon throughout India, Farther India, the Philippines, to Japan. In most regions they are mixed with other races. He considers the Dravida one of the most characteristic results of this mixture. It is only on the Andaman Islands and a few other isolated points that the pure race is still in existence. The author shows that individuals of Negrito type occur among the Pariahs of India, and that isolated communities in many parts of south-eastern Asia have retained the anthropological character of this dwarfish race.

De Quatrefages considers the Negrito of all these widely separated regions one race, which originated in southern Asia. When the yellow race migrated southward and the white race eastward, they were compelled to take refuge on the islands, and to migrate to more southerly countries. Thus they populated the Eastern Archipelago, and crossed to Africa.

COELHO ON ROMANIC DIALECTS. — A recent number of the *Boletim da Sociedade de Geographia de Lisboa* contains a third article by Adolpho Coelho on Romanic dialects of Africa, Asia, and America. The principal object of these researches is a study of the development of languages by isolation and admixture of foreign elements, and much new and interesting material has been collected by the author. There is a wide field for researches of this kind in North America. Coelho gives some examples of the French of Louisiana, and a brief bibliography of jargons based on English and other Teutonic tongues, many of which are spoken on our continent. The study of these would be an important goal for an American dialect society, the organization of which was lately proposed.

METLAKAHTLA. — The *American Magazine* for July contains a paper by Z. L. White on Metlakahtla, the famous missionary station on the north-west coast of America, which contains some interesting information on the Indians of that mission. The same subject is treated in the recently published book, 'The Story of Metlakahtla,' by S. Wellcome. Though the purpose of both publications is to extol the work of Mr. A. Duncan, the missionary of the village, and to support him in a bitter contest against the Canadian Government, some valuable ethnological information is contained in them. The horrible cannibal ceremonies of the Tsimpshian, the inhabitants of Metlakahtla, are described according to Mr. Duncan's statements. The initiation of young men who are to become members of this order takes place as follows: Early in the morning the novices would be out on the beach, or on the rocks, in a state of nudity. Each had a place in front of his own gens. After he had crept about, jerking his head and screaming for some time, a party of men would rush out, and, surrounding him, would begin singing. There are three orders among the Tsimpshian and their neighbors, — the cannibals, the dog-eaters, and the dancers. The dog-eating order occasionally carried a dead dog to their novice, who forthwith began to tear it in the most dog-like manner. The party of attendants kept up a low, growling noise, or a whoop, which was seconded by a screeching noise made by means of an instrument which they believe to be the abode (or voice?) of a spirit. In a little time the naked youth would start up again, and

proceed a few yards in a crouching posture, with his arm pushed out behind him, and tossing his flowing black hair. All the while he is earnestly watched by the groups around him; and when he pleases to sit down, they again surround him and begin singing. This kind of performance goes on, with several little additions, for some time. Before the novice finally retires, he takes a run into every house belonging to his gens, and is followed by his train. When this is done, in some cases he has a ramble on the tops of the same houses, during which he is anxiously watched by his attendants, as if they expected his flight. After a while he comes down, and they then follow him to his den, which is signified by a rope made of red-cedar bark being hung over the doorway, so as to prevent any person from ignorantly intruding into its precincts. Another remarkable performance noticed by Duncan is the following: At low tide an illuminated disk with the figure of a man upon it was lit up at the water's edge. It represented the moon, and the Indians suppose that the shamans are there holding converse with the man in the moon. Metlakahtla is at the present time a thriving village, with a saw-mill and canneries. It was founded in 1862 by a party of Christian Indians, who were converted by Mr. Duncan, and emigrated with him from Fort Simpson. In course of time disagreements arose between Mr. Duncan and the Church Missionary Society, to which he belonged. In behalf of his Indians, and for developing the resources of his village, it was Duncan's policy to keep new settlers out of the northern coast of British Columbia, and his influence helped greatly to suppress the disastrous whiskey trade. But, as the white population on the coast was increasing, his policy proved detrimental to the interests of the new settlers, as Duncan had practically attained a ruling power over the whole country, from the boundary of Alaska to Vancouver Island. This was the first reason for his disagreement with the Church Missionary Society and with the Canadian Government. The outcome of these disputes is the resolution of the Metlakahtlans to emigrate to Alaska.

BOOK-REVIEWS.

Die Culturvölker Alt-Amerika's. By DR. GUSTAV BRUEHL. Cincinnati, Benziger Bros. 8°.

DR. GUSTAV BRUEHL's recent work on the civilized nations of ancient America is of great interest, as it is a comprehensive review of the culture of the Mexicans, Maya, Chibcha, and Peruvians from the point of view first expressed and developed by Morgan and Bandelier. While the Spanish chroniclers considered the constitution of these states as similar to those of Europe, Brühl endeavors to show, by an enormous mass of testimony compiled from all available sources, that there were no despots and no feudal institutions, but that the gens was the sole basis of the social organization of all American nations, even in the highest state of their civilization. The first part of the work was printed as early as 1875; but while it was in progress the views of the author were so much modified, and the amount of new material added by his own excavations and researches in Central America and furnished by other writers on this subject grew to be so large, that the publication was delayed for twelve years. The first part of the book deals with the ruins of the Mississippi valley, of Mexico, Chiapas and Yucatan, Central America, Colombia, and ancient Peru, and with those in the region of the Rio Colorado and Rio Grande. As it was printed in 1875, some of the statements made at this place must be modified; but nevertheless it is an extremely valuable handbook on this subject, on account of the clearness of the arrangement, and the care the author has taken in giving the sources of his information. A review of the methods of writing and of the calendar concludes the first part.

The second part is far more important, as here the author uses his extensive knowledge of the subject for proving the theory that the division into gentes was the foundation of the states of all American nations. He discusses the separate centres of civilization, and expresses his view that the heroes who first brought civilization to the rude tribes became their deities. He discusses the distribution of property, particularly that of land, the plan of the towns and houses, the giving of names, the religious worship, and finds his views confirmed in all these phenomena. Therefore the chapter on the social organization is by far the most important one

of the book. Though hardly any explicit statements of the division of these nations into gentes is given by the ancient authors, numerous remarks indicate that these divisions existed. Each gens had its own chief, and owned a certain tract of land. In case of war, the whole army was divided according to gentes, each gens being commanded by its own chief. A further proof for this theory is found in the laws of inheritance and marriage, and in the terms of relationship. Every gens had even its own deities, temples, worship, and its separate myths. Brühl considers the great states of Mexico and Central and South America as confederations of tribes who subjected other neighboring tribes, whom they compelled to pay a tribute. Nowhere were states formed by uniform nations.

Die Erde in Karten und Bildern. Vienna, Hartleben. 4°.

The publication under review is an atlas, accompanied by text and numerous illustrations. It belongs to a class of publications which unfortunately is still entirely wanting in America. Our atlases are expensive, gorgeously colored, and generally not well drawn, while there are a number of European atlases which are sold at a moderate price, the drawing of which meets all reasonable expectations, and which are tastefully colored. The present atlas belongs to this class, but its characteristic feature is the accompanying text. The illustrations are carefully compiled from works of travel, and represent characteristic views, animals, plants, and ethnological objects, and may be used to advantage in schools, as they convey a good idea of geographical phenomena to the reader. The text, so far as we can judge from the numbers that have reached us, is not intended to be of a scientific character, but it is a popular treatise on geography. First, physical geography is treated. This will be followed by a special part on the geography of the separate continents and countries, and the last part will treat of commercial geography. The maps are well drawn, and the lettering and the topography are clear. The physical features are distinct, as the maps are not crowded with names. This atlas shows how far German cartography is advanced as compared to our own. There is no American atlas that can compare to this cheap publication, or to the well-known 'Handatlas' by Andree. Even the large and costly maps which are published in our country do not meet the wants of geographers so well as the German publications. But there is little demand for good maps so far. So long as our teachers are content with the low class of text-books and maps which are used in most schools, publishers will be reluctant to attempt the publication of costly works of this kind: but as soon as there is a demand, good maps and good atlases will be forthcoming; for there is no absolute want of cartographers, as the publications of our government, particularly those of the Coast and Geological Surveys, show.

Comparative Morphology and Biology of the Fungi, Mycetozoa, and Bacteria. By A. DE BARY. Tr. by HENRY E. F. GARNSEY, and revised by ISAAC BAYLEY BALFOUR. Oxford, Clarendon Pr. 8°.

ONE sometimes feels that English translations of German works above the grade of comparatively elementary treatises are unnecessary, since all persons qualified to understand the subject are presumed to be able to read the original. The present translation, however, shows that this feeling is erroneous. The original work of De Bary appeared in 1834. We say original, because, although, in one sense, the work of 1834 is a second edition of the second volume of Hofmeister's 'Handbuch der physiologischen Botanik,' published in 1836, the treatment is so different, and our knowledge of the subject has widened so rapidly within the last twenty years, that there is not much resemblance between the two editions. The work of De Bary is so well and favorably known, that we need not speak at length of its merits. In the chapters on *Mycetozoa* the author includes *Myxomycetes*, *Acrasia*, and some doubtful forms, but excludes many amœbeoid forms classed by Zopf among the *Schleimpilze*. The chapters on bacteria have been to some extent replaced by the more recent 'Vorlesungen über Bacterien,' by the same author. The original, it must be admitted, is rather hard reading for foreigners, in spite of its clear scientific treatment of the subject; and all English-speaking botanists will be glad to welcome the present excellent translation, which, while preserving the sense

and spirit of the original, presents it in a form which can be much more quickly and easily absorbed, even by those who have a good knowledge of German, and are acquainted with the subject treated. American botanists will now be able to read the admirable treatise of De Bary with ease as well as with profit.

A Course of Practical Instruction in Botany. By F. O. BOWER and SYDNEY H. VINES. Part II. Bryophyta and Thallophyta. New York, Macmillan. 8°.

THE second part of the practical botany by Bower and Vines is similar in form to the first part, which appeared in 1885, and is intended to be a guide to the student who is studying botany by the type methods. The common *Polytrichum* and *Marchantia* are used as illustrations of mosses and *Hepatica*; but the bulk of the work is devoted to *Thallophytes*,—a group which does not lend itself to popular treatment in a short space, for the types of reproduction are numerous, and the illustrations must be taken largely from plants which have no common names, in this country at least. The present volume is a valuable aid in the laboratory where the instructor prepares and selects the material, but it is not adapted to those who are obliged to pursue their studies independently of competent instructors. For the latter class of students, the chapters on *Thallophytes* are, as a rule, too condensed, and the absence of plates necessarily makes the text a little obscure for beginners.

The Making of the Great West. By SAMUEL ADAMS DRAKE. New York, Scribner. 12°.

THIS is a thoroughly commendable volume. It is constructed on the same general plan as 'The Making of New England,' by the same author, though dealing with a far larger and more complex subject.

It is too often the case that brief histories of the United States are written so entirely from an Atlantic coast standpoint that the great territory west of the Mississippi receives scant treatment at the authors' hands. Mr. Drake's plan of treating the various sections separately avoids this lack of proportion, and affords an opportunity of bringing the important facts in the history of each section into the prominence which properly belongs to them. In this volume the author makes three subdivisions. In the first we find a lucid and well-illustrated account of the planting of the Spanish, French, and English civilizations on this continent. In the second the territory acquired by the Louisiana purchase is treated, and then follows the story of the advance of civilization in the West up to the time that gold was discovered in California. The third section completes the story from 1848. Mr. Drake's conception of history is that of the late John Richard Green, and his narrative is accompanied with excellent sketches of the aboriginal and conquering civilizations. For that reason, as well as because of its pleasant style, 'The Making of the Great West' would be a valuable reading-book for grammar and high-school use.

Three Good Giants, whose Famous Deeds are recorded in the Ancient Chronicles of François Rabelais. Compiled from the French by JOHN DIMITRY. Boston, Ticknor. 12°.

IN this volume the works of the old French humorist are presented in an expurgated form, and profusely illustrated by Gustave Doré and A. Robida. The result is a book for children; but what its value in that respect may be, can only be determined by experience. There is certainly not much in it that is interesting to grown-up people, the humor of it being so extravagant that it often ceases to be humor. Children's tastes, however, are different, and with them the book may become a favorite. Such attempts to preserve what is best in old writers are in themselves praiseworthy; for the world is not so rich in good literature that it can afford to part with any of it. The illustrations, which are of the same fantastic type as the story itself, will add to the attractiveness of the book.

A Collection of Letters of Thackeray. New York, Scribner. 8°.

THE series of letters from Thackeray to Mr. and Mrs. Brookfield, which were lately published in *Scribner's Magazine*, are here offered in book form. They were written between the years 1847 and 1855, after the death of Mrs. Thackeray, and when their author was in the full flush of early fame. They show him in various moods, the humorous predominating, of course, yet oftentimes with

an undertone of melancholy which enhances their interest. That he enjoyed his fame at first, and the social entertainments it brought him, is manifest; and yet in one of the latest letters of the series, written from Philadelphia, he declares that he doesn't care any more for praise, or for abuse, or for reputation of a literary sort. For the rest, the letters reveal the same qualities of mind and character that his novels exhibit, with perhaps a little more tenderness as he unbosoms himself to his friends. There is the same smooth and brilliant style, the same satirical wit and badinage, the same keen eye for the superficial elements of life, and, it must be added, the same apparent inability to see any thing deeper. Only once or twice, as on pp. 35 and 95, does he strike a deeper vein; and one cannot help wondering whether he did not care for such things, or whether he did not venture to say what he thought about them. The letters are certainly very interesting, and will doubtless long continue to be favorites with readers of English literature.

NOTES AND NEWS.

THIS year is remarkable for the number of accidents in the Swiss Alps. It is stated by a Swiss newspaper that the season's death-roll is an unusually heavy one. In the short space of not quite a month twenty-two tourists met with accidents, of whom eighteen were killed. The accident on the Jungfrau (canton of Bern) involved the loss of six lives; that on the Falkniss (Granbündten), three. One life was lost in each case in the accidents on the Morteratsch glacier (Granbündten), Molesa (Waadt), Gantrist (Bern), Leissigergrat (Bern), Säutis (Appenzell), Kaisereck (Freiburg), Dent de Corjan (Waadt), Schächental (Uri), and Diablerets (Wallis). There were no guides among the eighteen killed, and only too many persons make ascents without guides. The four injured persons were all tourists.

—Although automatic telegraphy has long been known, says the *London Times*, it has not, so far as we are aware, proved a commercial success, owing to the circumstance that the instruments used in conducting it are expensive, the system slow, and the synchronism unreliable. In this system the messages are first written with insulating ink on tinned paper, and fed into instruments whereby they are transmitted. At the other end they are received on chemically prepared paper, but the messages soon fade. A very pronounced improvement upon this system was made by Mr. E. A. Cowper, C.E., some few years since, in his writing-telegraph. Here the movement of a pen at the sending-station introduced varying resistances into two electric circuits connected with the receiving-station. The varying currents acted upon two electro-magnets at the latter station, and caused them to impart movements in two directions at an angle to each other to a receiving-pen, which was made to reproduce the writing formed by the sending-pen. Mr. Cowper, however, was not alone in his invention of the writing-telegraph, for, as not unfrequently happens, another diligent worker was busy in the same direction and at the same time. This was Mr. J. Hart Robertson, an American electrician, who, without being aware of Mr. Cowper's invention, produced an instrument upon the same plan. He found, however, that it involved heavy expense in operating, and, pushing his research further, he in course of time produced an improved instrument. This is the writing-telegraph which we recently saw in successful operation in the American Exhibition. The principle involved consists in changing the strength of the electric currents by the movements of the pen when writing, varying the pressure on a series of carbon disks included in the circuits. By this means simplicity, greater speed, and the utmost accuracy in reproduction, are secured. In this apparatus the transmitter consists of two series of carbon disks placed at right angles to each other in a hard-rubber receptacle. Each pile of disks has a screw follower for adjusting the normal pressure of the disks on each other. A rod carrying the pen or stylus is pivoted at its lower end, and has pressure-points opposite the piles of disks. The operator manipulates the stylus or pen as in writing, although he can only move the point of the stylus over a small circumscribed area. As the stylus describes the various letters, the pressure-points are pressed against the carbon disks; and as this pressure is increased or diminished, varied currents are sent into the lines to the receiving-magnets, which cause the receiving-pen to reproduce every

movement of the pen of the writer at the transmitting-station. The receiving-instrument consists of two electro-magnets set at right angles to each other. At the point where the poles would reach if extended is a rod for carrying the armatures. Near where the rod is pivoted at the bottom a spring wire is inserted, so that its armatures can easily and quickly respond to the varying attraction of the electro-magnets. The armature rod extends above the table, and carries the recording-pen. Each machine is both a sender and a receiver, and the working of the system is most simple. The operator at the sending-station uses the stylus as a pen to form imaginary letters, words, and sentences: in short, to write. He sees the writing produced by the recording-pen in ink on a slip of ordinary paper ribbon which slowly passes before his eyes. At the receiving-end the operator sees precisely the same thing going on, for the written message is being reproduced by the little pen, line for line, in perfect facsimile, on a slip of paper passing before him. We thus have a really beautiful system of written messages, and one which is already working commercially in the United States, where it is taking the place of the telephone with marked success. Instead of the repeated shouting and comparative publicity of the telephone, the message is written by the sender and the visible answer received in perfect quiet. But should the surroundings be noisy, it matters not, for the little pen silently writes away regardless of noise of any kind. The writing at both ends has all the characteristics of the writing of the sender, and the message constitutes a record which cannot be disputed, and is therefore invaluable to business-men. There is a facsimile record at each end, and neither of them can be altered without detection. The invention is at once ingenious and practical, and is the completed expression of the long-cherished desire to produce a writing-telegraph.

—On a part of Sir Joseph Banks's Museum, at the back of 22 Soho Square, being pulled down, in a recess with doors which had not been opened for about half a century, a very interesting collection of relics of Captain Cook's voyages in the South Seas has been discovered. Inside the panelling the following inscription was written in the handwriting of Sir Joseph Banks, who accompanied Captain Cook on his travels: "Instruments used, carvings, weapons, and heads, collected by Captain Cook during the voyage of the 'Endeavour.' — J. BANKS." These relics have been bought by Sir Saul Samuel, the agent-general for New South Wales, and will shortly be despatched by him to Sydney for the State House Museum at that place. Among the collection are the following interesting articles: old quadrants and other instruments used by Captain Cook on board the 'Endeavour,' four of which are in oak cases; two mummied tattooed heads of New Zealand chiefs; two native models of New Zealand canoes, one carved; two large carved canoe-paddles; carved spears and war-clubs; a native chief's paddle, beautifully worked with idolatrous carving; a very fine stone hatchet with handle, and upon it the following inscription in the handwriting of Sir Joseph Banks, "Brought to England in 1775 by Captain Cook from Otaheite;" and a wooden bowl with lip, used for handing round human blood in the days of cannibalism. There is also a carved wooden sceptre with the following words scratched on it, presumably by Captain Cook: "Made for me by Wanga. — J. C." Sir Joseph Banks's handwriting can be identified.

—As a result of his experiments on the maxillary palpi of mandibulate insects, myriapods and female spiders, Plateau comes to the conclusion that in the arthropods they subservise no functional purpose whatever, and are to be looked on as organs which have become useless, like the mammæ of male mammals. Plateau also discovers by experiment that not the slightest trace exists of any visible external respiratory movements in arachnids, such as Blanchard describes, or in chilopod *Myriapoda*, and suggests that the action must be wholly intrapulmonary, supporting himself partly by some observations of MacLeod, who thought he had discovered evidences of muscular tissue between the pulmonary lamellæ. Locy, however, was unable to discover signs of it in the young.

—Dr. Mercier is about to publish, as an introduction to the scientific study of insanity, a work on the nervous system and the mind. It will contain an exposition of the new neurology as founded by Herbert Spencer and developed by Hughlings Jackson; an account of the constitution of mind from the evolutionary stand-

point, showing the ways in which it is liable to be disordered; and a statement of the connection between nervous functions and mental processes as thus regarded.

— Captain Armstrong of the British steamship 'Alps' reports to the New York Branch Hydrographic Office, Sept. 29, 1887, as follows: 7 A.M., Sept. 23, 1887, off the south coast of Cuba (latitude $19^{\circ} 44'$ north, longitude $74^{\circ} 24'$ west), Cape Guanós bearing N. N. E., distant about 22 miles, felt the shock of a submarine earthquake, lasting about 45 seconds, causing the ship to vibrate fore and aft. At first it appeared as if the valves were thrown open to give an extra shake-up on the engine. 7 miles farther N. E. by N. felt another milder shock, lasting about 7 seconds. 8.10 A. M., about 13 miles from the first disturbance, felt three shocks, lasting about two-thirds of a second, at intervals of about a second. At 8.45 A.M. felt another mild shock, lasting about 2 seconds. The sea was quite smooth, and had been smooth during the night. When the first shock was felt, the sea appeared to rise higher in a solid body (without the least break) for about 3 seconds, and continued smooth after. Light variable winds prevailed, with calms at intervals. Barometer, 30.05; air, 79; water, 84; midnight, barometer, 29.95. The high land of Cuba was enveloped in dark lead-colored clouds, sky from N. E. by E. to S. was quite clear, and several water-spouts were visible in a N. N. E. direction. Noon, after passing Cape Maysi, the weather was clear and fine. By the charts I should think the disturbance occurred in more than one thousand fathoms of water. (Civil time.)

— A correspondent of *Nature* seeks the opinion of psychologists on the following circumstance: A female child, quick and intelligent, when about fifteen months old, learned to repeat the alphabet, shortly afterwards the numerals, days of the week, month, etc., and subsequently scraps of nursery rhymes, English and German, then to spell words of two and three letters. All this was learned readily, eagerly indeed, and for a time she remembered apparently every word acquired, indelibly. At about two years old, further teaching was for a time remitted, as she was observed to be repeating audibly in her sleep what she had learned during the day. Subsequently, tuition was resumed under a governess; but she had not only forgotten much of what she had previously known perfectly, but learns far less readily than formerly. She is now about three and a half years old, in perfect good health and spirits, quick, and particularly observant, but the capacity for learning by rote is materially diminished. She is remarkably imitative, but shows no faculty whatever for writing, and as little for music. The writer would like to hear of any parallel cases, and what the ultimate development has been, with any opinions upon the cause of their appearances.

— At the central station of the United States Fish Commission in Washington may be seen a carload of young trout from Wytheville, Va., for distribution in Maryland, Virginia, and places adjacent to Washington. The collection comprises California trout, lake trout, brook trout, and rock bass. Some handsome specimens of grayling, artificially propagated, are also shown. The young trout have all been hatched artificially and reared at Wytheville. The commission keeps them until they attain a growth of several inches, and then distributes them. A supply of trout will be sent to any person who has on his place suitable waters, and facilities to insure proper protection for the fish. A dozen young trout are sufficient to stock an ordinary pond or lake, and one hundred to stock a running stream. The fish should not be molested for at least three years, until they have had an opportunity to spawn twice. The commission will send a carload of young carp and other fish to the Kansas City Exposition in a few days. The car will remain there a few days, affording opportunity to visitors to the exposition to inspect the methods of fish-distribution. Some of the young carp will be distributed from that point, and the car will then proceed on a trip, for distribution purposes, to the South-west. It is proposed to use one of the breeding-ponds in Washington next year for raising shad. Colonel MacDonald says that a million shad could be raised to such a size, in one of these ponds, as to insure the return to the Potomac of at least two hundred and fifty thousand shad of full growth. The young shad will then be turned out into the Potomac.

— The opening address of Col. Sir Charles Warren, president of the Geographical Section of the British Association for the Advancement of Science, deals with the much-discussed subject of the teaching of geography. The views expressed in this address are of interest, as the author opposes the new methods advocated by the Royal Geographical Society, and declares that they will lead to evil results. "It seems now to be desired to promote the acquirement of knowledge at the earliest age without effort and without hard work; but this appears to be directed towards alleviating the toils of the instructor as much as the instructed; and we have now, as a result, children taught common things without any effort to strengthen their memories, and then a system of cramming introduced at a later period, when the memory has ceased to be capable of responding to the efforts made. . . . It seems to me that the remedy recently adopted is worse than the disease it was to eradicate, and that, however injurious it was to attempt to store the mind with mere names, yet the memory was trained thereby to retain something definite; and it is still worse to attempt to store the mind with mere ideas without the connection of names, and leave the memory to rust. There is obviously a middle course which may rid us of the errors of the past without leading us into still greater difficulties; and if we keep the object to be gained always in view, we cannot fail to take a direct line. We want first to lead the memory to constant exertion of such nature that it grows stronger day by day, but is not overstrained or wearied; at the same time it must be stored with useful facts, which may be quite above the capacity of the mind to comprehend at the time, but which will be required all through life: this can readily be done by means of verses or rhymes set to simple airs and committed to memory by song." As these views are expressed from so prominent a place, they require some comment. In another passage of his address, Colonel Warren says that, in consequence of the progress of science, we are fast losing our human nature, and are becoming machines, and we call it becoming civilized; that we are drifting into a condition in which we learn nothing of ourselves or by our own individual efforts. This is exactly what educationists complain about, and the reason why they demand a method of teaching which develops the mental powers. But this aim will not be reached by memorizing rhymes containing uncomprehended and incomprehensible facts. It is a misinterpretation of the method recently advocated by geographers, if Warren says that it is only directed to alleviate the toils of the teacher and of the pupil. It requires much careful preparation on the part of the teacher to represent facts to the untrained mind of a child so that they will be intelligible, and it requires the utmost exertion of the attention, memory, and the faculties of observation of the child, to meet the demands of the teacher. The remarks of Colonel Warren on the desirability of an efficient teaching of geography will be generally accepted, but there is not much difference between the memorizing which is still practised in most schools and the methods he proposes.

LETTERS TO THE EDITOR.

. The attention of scientific men is called to the advantages of the correspondence columns of *SCIENCE* for placing promptly on record brief preliminary notices of their investigations. Twenty copies of the number containing his communication will be furnished free to any correspondent on request.

The editor will be glad to publish any queries consonant with the character of the journal.

Correspondents are requested to be as brief as possible. The writer's name is in all cases required as proof of good faith.

Over-Pressure in the Schools.

WHEN we ask whether over-pressure in the schools is a fact, we receive answers ranging all the way from the most positive affirmatives to the most positive negatives. In fact, it is one of the 'burning' educational questions of the times. There now lie before me two paragraphs cut from the same number of an educational journal, that speak the two voices. In one, Dr. W. A. Hammond of New York tells the story of a little girl brought to him from school affected with St.-Vitus's-dance, in whose book-bag were an English grammar, an arithmetic, a geography, a history of the United States, an astronomy, a physiology, a French reader, a French grammar, and a treatise on general science. The doctor says the little girl had learned all these things, but had done so at the expense of her brain capital, not of her brain income. Intellectual bank-

ruptly was staring her in the face. He appears to think that this is a typical case, and concludes that we are living too much under the rule of the school-master. The other voice is spoken by Miss Mary E. Yate, principal of one of the New York schools. She has never heard of a child that was injured by the school system. Other causes hurt young people: the dissipations of child-life kills tens of thousands where study kills one. Too much candy, late parties, church sociables, story-reading at night, etc., are the real causes of ills attributed to over-study. Now, where does the truth lie?

First, if the little girls of the country are swinging to and fro from school book-bags filled as Dr. Hammond says he found one filled, teachers cannot plead social dissipation and candy as the cause of their failing health. If this is a typical book-bag, then the course of study is overcrowded, and too much work is demanded by the schools. But this is not a typical book-bag, and we may set it aside in seeking an answer to our general questions. No doubt such book-bags can be found; no doubt there is great over-pressure in some towns and cities; perhaps the average course is too full; but the little girls of the country are not carrying on at one time all the studies represented in that fateful book-bag.

Second, as a class, the physicians of the country are disposed to take the ground taken by Dr. Hammond: as a class, the teachers of the country tend to side with Miss Yate. Such are the two opposite tendencies, and I do not for the moment attempt to decide between them. But it is important to observe that the physician and the teacher alike are each pretty sure to exclude certain important elements from the problem. The physician, seeing that the school is a very prominent, perhaps the most prominent, factor in a child's life, is apt to charge to the school ills that spring from some other cause, or that spring from the school together with other causes; while the teacher, disposed to magnify his office, and to think that school-education should be the main pursuit of childhood and youth, is apt to overlook other demands, and necessary demands, that are made upon the child's time and energy. The result is, that neither the doctor nor the teacher deals with a whole child; and the two divide the child between them: whereas the doctor and the teacher should each treat the child as a whole or unit,—body and mind, home and school, work and play,—and deal with him accordingly. There are teachers who need to be reminded that they cannot absorb, and ought not to absorb, a child's time and life over and above sleeping, eating, and dressing. There are many necessary child activities that fall outside the school, although wise parents will see that these are kept within due limits. The school-master is certainly abroad, and in a sense perhaps too much abroad.

Passing to the main question, over-pressure in the schools is a fact to the same degree that over-pressure in other departments of American life is a fact. Here I see no reason to throw aside or modify the conclusion that I came to three or four years ago, of which this is the substance. Our inherited Saxon push, our national environment, our boundless opportunities, and our free institutions, in respect to courage, audacity, enterprise, and many forms of achievement, make us a people by ourselves. It would be hard to name a field of life in which our energy, impatience, and nervousness do not show themselves. It is notorious that the average American does more work, whether physical or mental, than any other average man in the world: hence it is that America is the gauge for measuring the most energetic communities of the Old World; as when Lancashire, England, is called 'America and water.' The words in which Mr. Herbert Spencer spoke of the injury done by our high-pressure life, at the dinner given him in New York four or five years ago, will not soon be forgotten. History has charged a good deal to the American spirit, and credited it with much more. Its worst effects, unfortunately, are seen in the higher fields of effort,—science, literature, education, and art,—where time is an all-important factor. The tension of the public schools is too high in the sense that the tension of our business and social life is too high: in other words, the schools partake of the national genius. Dr. Stanley Hall, some years ago, said he had seen a file of one hundred and fifty small German boys just as they marched out of the school-house at noon a quarter of a mile away; also that he had observed that the little girls at the Victoria school, Berlin, did not run a step at recess, or do any thing that an equal

number of ladies might not do. But such things as these, it hardly need be said, cannot be found in the typical American school.

The foregoing remarks have been made with almost sole reference to our public-school education considered as a whole; but they can be extended with hardly a word of qualification to our higher education, professional education, and technical education considered in the same way. While we have much in these departments of which we may well be proud, we also have much that we must excuse or altogether abandon without defence. The causes of this state of things are the restlessness and impatience of the national character: its conditions are the external facts of American life, and particularly in those communities that are less than one hundred years old. Nothing but more maturity and the established ways of an older and more orderly society, where constant forces work with more steadiness, and chance plays a less part than hitherto in success, can remedy these evils.

My answer to the question whether over-pressure in the schools is a fact, is broad and general, taking no account of a considerable number of facts that are at variance with it, and that of themselves would refute it. For example: I can name a city where the principle of emulation is greatly overstrained; the scholars of a particular class, the classes of a particular building, and all the buildings of the city, are engaged in an unending competition for 'marks'; the teachers cram the children with lessons, and the newspapers cram the people with tables of percentages; and the public seem rather to enjoy it. Such facts as these are very important in their way, but do not call for a modification of the judgment presented above. They prove that school tension is sometimes in excess of the amount found in common life.

From the premises now presented, some important conclusions follow. Speaking broadly, as before, the teachers of the public schools are not responsible for such over-pressure as exists. They show the traits of the national character; they magnify their office; they are open to severe censure in numerous individual cases; but their courses of study and their methods of instruction, they have invented to meet the popular demand. To be sure, the impression is common that teachers go counter to the wishes of parents when they hurry children through school; but the fact is, the average teacher is not so anxious to hurry the child as the average parent is to have him hurried. This proposition cannot be proved by statistics, but it will be indorsed by the sensible school superintendents of the country. The rank of their children in the classification, their position in the school, their promotion from grade to grade,—these are with numerous school-patrons a passion.

Another conclusion is, that the evils which exist cannot, for the most part, be remedied by reading school-teachers sharp lectures. The fundamental trouble is with the public; and it is simply the educational outcropping of the national genius, push, hurry, impatience. Of course, the wrong-doing of particular teachers can be corrected by criticism, or the faults of a system of city schools may be remedied by discussion; but the over-tension of the schools of the country can be fully relieved only by a toning-down of the national life, and this must come about mainly of itself. So far as discussion is concerned, the most important thing that can be done is this: to impress the public with the facts that time is an all-important element in education, and that knowledge, and, still more, mental faculties, grow, and are not made. Pressure can never take the place of time. Warmth is essential to the maturing of the peach, but the fruit-grower will not promote the process by building a fire on the roots of the tree. It is very desirable to get some of the present self-consciousness out of the lives of young children. And then, how desirable it is that boys and girls go to the high school with a full year more of life and strength behind them!

Finally, perhaps the most serious and common fault of teachers is the tendency to fuss and worry. Teachers worry more children to death than they work to death. Fretting, an excess of 'order,' an overdoing of 'position,' do more harm than books and lessons. The topic runs into moral training where we cannot follow it. But sound digestion, strong nerves, a good appetite, sleep, that "knits up the ravelled sleeve of care," good temper, self-command, cheerful confidence, and a young spirit, are important elements in moral

training; what is more, they are not properly appreciated. Not one man in a thousand knows the amount of harm that is done to young children by placing them under the tuition of testy, irritable, explosive, and neurotic teachers.

B. A. HINSDALE.

Cleveland, O., Oct. 3.

Objects in Teaching.

THE value of objects in giving correct ideas was brought forcibly to my mind not long since while teaching a class in natural philosophy at the New York State Institution for the Blind, Batavia, N.Y.

It was my custom to place before them, the day before its uses and the principles which it illustrated were to be discussed, a given piece of apparatus, that, by becoming familiar with the form and construction, its application might the more readily be appreciated. One of the class, a young man blind from infancy, with a fondness for machinery of all kinds and a quick perception of the use of such as was placed before him, would frequently study the lesson in advance, picturing to himself as carefully as possible the apparatus described. These pictures, as he told me afterwards, were far from correct.

The thorough examination and understanding of each succeeding object, of whatever kind, add so much to the stock of correct concepts, which is valuable not only for itself, but for its aid by comparison in understanding others.

One of our most successful teachers described to her class, ranging in age from eight to twelve, as vividly as she could without naming it, a ladder. Among other things, she stated that it was made of wood, had parallel sides, etc., using such terms as would seem to be most readily understood, and then asked for the name of the thing described. For some time no one could tell: various things were mentioned, one boy suggesting 'map,' the maps for the blind being cut in relief from wood, with the sides of the frame parallel.

A little girl had for the first time a bird, a stuffed specimen, placed in her hands, and was much surprised to find that it had but two legs, having supposed until then that birds had four.

Whatever may be said for or against object-teaching for seeing children, that of blind children is successful proportionately as it is objective.

J. T. MOREY.

Perkins Institution, South Boston, Mass., Oct. 3.

Color-Blindness.

IN the opening article in *Science* last week (Sept. 30) an idea was suggested, or recalled, that may be of value; and I offer it in view of the possible value. I have observed for twenty years or more a difference in the power of my two eyes, at times, to discriminate in light reds when viewed at a distance of fifty feet or more; and I think this difference in the visual power of the two organs depends very largely, if not altogether, on the way in which the eyes are used. If I have been occupied with work that called one eye into active exercise, where the mind was occupied in discussing the surface or object viewed, particularly if the light was variable, then I find persons appear different, according to which eye is used. Not only so, but the two eyes do not focus the same; the image, with the tired eye, being farther off than that from the eye that is rested, and of a dull gray color. If I go to a lecture under such circumstances, there appear to be two lecturers,—one pale and shadowy behind; and above, the other, which seems, perhaps by contrast, to take on a brighter hue. Under such circumstances, I close the tired eye,—as I have come to consider it,—and give it a rest, or go out into the fields and give it a feast on green. Now, may not the eyes of engineers vary as to visual power in the discrimination of colors with excessive use? If both eyes are exhausted and need rest, the individual would not be able to detect his own disability. Now, if that is so, it is of importance to the public that no one should be on duty for a great length of time, where the safety of any depend on the discriminating power of the eyes as to colors.

And would it not be well, in testing eyes, to note the condition of the individual,—whether fresh or tired, just from work or just from rest?

GEO. F. WATERS.

Boston, Oct. 3.

Percentage of Ash in Human Bones of Different Ages.

REFERRING to Watt's 'Dictionary of Chemistry,' under the article 'Bone,' we find two tables of analyses of bones,—one by Von Bibra, and the other by Frémy. These two scientists do not arrive at the same conclusion. Von Bibra states that "the portion of inorganic matter in bone is smaller in youth than in age, although no regular gradation can be observed;" while Frémy holds that "the bone of a fœtus was found to yield the same quantity of ash as that of a woman of ninety-seven years of age." Although the actual number of analyses made by these investigators was large, yet simple inspection of their tables will show that very few were made of the same bone in each case; and it is evident that a comparison between a femur on the one hand, and a tibia on the other, could not be trustworthy.

It occurred to me as worth while to supplement their lists; and I here present what may be considered a report of progress in that direction, very much yet remaining to be done.

The extreme difficulty of getting supplied with material the history of which is both certain and satisfactory renders the work exceedingly slow.

The bone for examination was in every instance cut from the dense portion of the shaft of the femur. No subject was taken who had, so far as known, suffered from rickets or other serious bone-disease, and women of recent confinement were also excluded. All specimens were obtained either from living persons (amputations) or those recently dead. After crushing in a steel mortar, extracting with ether, and again crushing, the ash was determined by incineration in a platinum dish. The results are in the appended table.

No.	Sex.	Color.	Nationality.	Occupation.	Died of.	Age in years.	Per Cent of Ash.	Remarks.
1	Specimen	men	lost.	-	-	-	-	-
2	Male	White	-	-	Phthisis	65	67.95	-
3	"	Negro	-	-	"	21	65.80	Had serofula
4	"	White	Russian.	Sailor	"	23	67.28	Had syphilis
5	"	"	American	Farmer	"	33	67.63	Amputation
6	Female	"	Irish	Actress	Peritonitis	23	67.99	"
7	Male	"	"	"	Phthisis	60	67.55	"
8	Female	"	Irish	"	"	24	68.20	"
9	Male	"	"	"	"	57	67.73	"
10	"	"	"	"	"	58	67.60	"
11	"	"	"	"	"	57	68.98	[bowel-disease
12	Female	Negro	Irish	"	"	?	68.20	Died of some
13	Male	White	Irish	Laborer	Killed	21	67.73	"
14	"	"	English	Brewer	"	31	65.51	Amputation
15	"	"	Irish	"	"	8	64.86	"
16	Female	"	"	Domestic	Phthisis	46	69.67	Married
17	"	"	French	"	Peritonitis	57	67.60	"
18	Male	"	American	Farmer	Old age	81	68.56	"
19	Female	"	Irish	"	Apoplexy	68	68.72	Married
20	Male	"	"	Laborer	Bronchitis	74	68.72	"
21	Female	"	American	"	Phthisis	44	68.30	Married
22	"	"	"	"	"	60	67.93	Insane.
23	Male	"	German	"	"	40	69.28	"
24	"	"	"	"	"	53	68.23	"
25	"	"	Irish	"	Phthisis	58	68.94	"
26	"	"	"	"	"	41	68.18	"
27	"	"	"	Laborer	Bright's disease	48	69.73	"
28	Female	"	American	"	Phthisis	29	69.18	"
29	"	"	"	"	"	34	66.82	"
30	Male	"	Italian	Laborer	Tetanus	29	68.47	Effect of wound
31	Female	"	American	Domestic	Typhus-fever	24	69.09	"
32	Male	"	"	"	Nephritis	40	69.35	"
33	"	"	"	"	Alcoholism	58	68.69	"
34	"	"	"	"	"	11	65.87	Amputation
35	Female	"	German	"	Phthisis	59	69.03	"
36	Female	"	Irish	"	"	29	69.03	"
37	Male	"	"	"	Pneumonia	55	69.72	"
38	"	Negro	"	"	Phthisis	45	66.06	"
39	"	White	German	Brewer	"	46	69.11	"
40	"	"	English	Tailor	"	73	69.85	"
41	"	"	Irish	Laborer	Killed	38	69.05	"
42	"	"	"	"	Phthisis	25	66.36	Drunkard
43	"	"	"	"	Hoister	63	68.07	"
44	"	"	American	Coachman	Alcoholism	43	69.11	Had syphilis
45	"	"	English	Shoemaker	"	45	65.16	Drunkard
46	"	"	"	"	"	40	66.82	"
47	Female	"	"	Lawyer	Old age	70	62.82	"
48	"	"	"	"	Prostitute	26	69.23	"
49	Male	"	German	"	Domestic	31	65.61	Bone very brittle
50	"	"	Irish	Shoemaker	"	38	64.98	"
				Laborer	"	61	63.54	"

I think enough has been done to show that the common belief in the increased brittleness of bone with advancing years being due to increased percentage of inorganic salts, is without foundation. The appended table indicates that after manhood is reached, no variation in quantity of ash takes place as the years roll on.

"The greater brittleness of the bones in age is attributed by

Frémy to the increase in the proportion of the spongy tissue, the thickness of the hard and dense portion of the bones continually diminishing as age advances."

This has not been my experience. Transverse sections of the entire bone were made in each case, in order to test this very point, by observing the relative size of dense with spongy portion, and I certainly saw nothing to warrant Frémy's conclusion.

At the same time, small columns $\frac{1}{2} \times \frac{1}{2} \times \frac{3}{8}$ inch were cut from the dense portion of the shaft, and were broken transversely on a testing-machine, in order to determine the amount of brittleness. The most brittle specimen I had (No. 48), showed a rather thicker dense portion than usual.

I find the brittleness to be in the material rather than in the bone as a structure, and, in view of the analytical results, I cannot explain that brittleness, as Von Bibra does, by holding for the gradual increase in mineral salts.

I append a very imperfect table of the results obtained on the testing-machine. Every bone, as I received it, could not be cut so as to give a column of the size required for breaking. It will be noticed, that, in general, strength of bone diminishes as age advances.

BREAKING-WEIGHT FOR COLUMN OF BONE $\frac{1}{2} \times \frac{1}{2} \times \frac{3}{8}$ INCH,
BROKEN TRANSVERSELY.

25 years of age.....	Pounds.
26 " "	75
31 " "	74
38 " "	50
43 " "	64
45 " "	58
45 " "	60
61 " "	55
63 " "	30
70 " "	54

Loss of material by the burning of the laboratory affected, in a measure, the completeness of the work.

WILLIAM P. MASON.

Rensselaer Polytechnic Institute,
Troy, N.Y., July 21.

Evidence of a Glacier-like Movement amongst Snow Particles.

It has been conclusively proved that glaciers have a movement corresponding in every way, except in amount, with that of water similarly situated. I wish here to point out that snow particles, under certain corresponding conditions, have the same movement but of greater amount.

It appears to me that it would be difficult to draw a line with certainty between those solids whose particles are capable of such movements, and those which are not. I will admit that it were easy to point out this limit for solids that would show sensible movement in limited time; but to do so for solids under unlimited time and large pressure might not be so easy or possible. It seems unlikely that the few solids we have evidence of should be the only ones possessing these movements, particularly when viewed in the light of the fact that so many solids, after being transformed from the molten to their solid condition, exhibit the effects of a movement amongst their particles in longer or shorter periods after their change of condition. It is not, however, with a consideration of this limit that we have to do at present.

In Hudson Strait we had banked around the foundation of our house-walls with moss and rocks, so as to protect ourselves against the weather. This bank had a slope inwards towards the walls from the base. When snow remained permanently on the ground, we made use of it to build up an outside wall, two feet thick and eight high, over this bank, as a further protection against the weather.

Snow, it may be necessary for me to explain, exists, in northern climates, under somewhat different conditions from that in which we are accustomed to see it; so that, very shortly after it has fallen, extreme temperatures and high winds so alter it, that, whilst essentially granular snow, it has become so hard that it requires an iron (not a wooden) shovel to cut it, when, with sufficient care, blocks of unlimited size can be hewn out of it and transported. The particles are now arranged in a high degree of tension; so much so, that, when a block is struck a blow, it gives out a sound such as could be compared with that given out by a brick tile. It was with

snow in this condition that our protecting walls were built. My attention was first called to a movement of the snow by noticing that the snow walls were leaving the building, as I at first supposed, by a 'topping' movement: I therefore built relatively heavy buttresses of snow to retain them, and then found that buttress and wall had partaken of this movement, which was of course lessened, as the buttresses had been built on comparatively level ground. In addition to this, the arches which we had made over the windows out of blocks of snow, of about a foot square and four to five feet long, had, of their own weight, passed from the arch through the straight line into very pendant inverted arches, having left a space on top of the wall between the snow blocks on either side, and become considerably attenuated on account of the increased distance covered, and at the same time remained cemented to the layer next below in the wall. W. A. ASHE.

The Observatory, Quebec, Sept., 26.

Grindelia glutinosa in Wisconsin.

THE note in *Science* of Sept. 23, on *Grindelia squarrosa*, reminds me of a curious fact concerning another species of *Grindelia*. Last July I found in the Menomonee valley, near the slaughter-houses west of the city of Milwaukee, a composite plant which I could not find in the list of Wisconsin plants published in the first volume of the 'Geology of Wisconsin.' The plant coincided completely with the description of *Grindelia glutinosa* Dunal in Gray's 'Flora of North America' (*Gamopetalae*, p. 119). I found only one specimen, apparently in perfect health, growing on the Chicago, Milwaukee, and St. Paul Railroad track. Gray states that the species ranges along "the shore of California from Humboldt County and San Francisco to Santa Barbara Islands." The seed of this specimen must have been brought to eastern Wisconsin by one of the many trains which pass through the Menomonee valley to Milwaukee. It is certainly remarkable that two species of a genus not before represented in Illinois and Wisconsin should have migrated so far to the east of their original habitat, and should have both appeared in the same summer in both States. W. M. WHEELER.

Milwaukee, Sept. 26.

Sections of Fossils.

HAVING lately had occasion to consult a paper published by the Geological and Natural History Survey of Canada, entitled 'Contributions to the Micro-Paleontology of the Cambro-Silurian Rocks of Canada,' by Mr. Arthur H. Foord, I wish to call attention to the method there pursued.

Having devoted considerable time to the monticuliporoid corals of the Cincinnati group, I have come to the conclusion that magnified views of the internal structure of these fossils are of little use in the determination of species. The paper in question deals entirely with these internal features. Several plates are given in illustration of new species, and, out of 67 figures of 12 species, 23 are of natural size. Many of these are very poor, and would be of little value in the determination of species. And as now more stress is laid upon the figure than the description, it follows that some of the species would be unrecognizable from either the one or the other. Thin sections to show the interior cannot be made without considerable skill, much labor, and time; and I think I am prepared to show, in a paper now in press, that even when made the features they show under the microscope are of no value whatever as specific characters.

JOSEPH F. JAMES.

Miami University, Oxford, O., Sept. 27.

American Caves.

IN the October *Scribner*, Professor Shaler states that the reason caves were not used as much in North America as in Europe, was, "the first peoples of this country had already attained an advancement in the arts which enabled them to make shelters," etc. This is not true. The first peoples of America were as rude as any in other continents; and the typical cave-dwellers of Europe were not any more primitive than Eskimos of recent date. It is much to be regretted that so erroneous an idea of ancient man in America should be set forth in a popular magazine. CHAS. C. ABBOTT.

Trenton, N.J., Oct. 1.

SCIENCE

FRIDAY, OCTOBER 14, 1887.

IT IS UNDERSTOOD that General Greely has decided to discontinue the collection of marine data from masters of vessels, relying upon the Hydrographic Office to furnish whatever information may be needed in the work of his office. This change went into effect Oct. 1; and at the close of this year the Signal Service will discontinue also all work in connection with the international simultaneous meteorological observations, excepting so far as may be necessary to complete the publication of the results up to Jan. 1, 1888, thus bringing to a close a period of ten years' continuous observation. It is greatly to be hoped that the Hydrographic Office will make every effort to continue this very important work, and that Congress will authorize the further publication of the results in some such form as has been hitherto done, and so well done, by the Signal Service. The importance of this comparatively modern and only really scientific method of studying marine meteorology can hardly be overestimated. Indeed, if the vessels of all nations traversing the North Atlantic could be induced by the Hydrographic Office to take not merely one observation, but three simultaneous observations daily, corresponding in time to those taken at all our Signal Service stations, it could not fail to result in such an increase in the safety and certainty of navigation, in this the most important ocean on the globe to civilized man, as to make the expense and trouble involved wholly insignificant. The marine data collected by the Hydrographic Office are immediately utilized, so far as possible, in preparing the Mascart cablegram, sent to Europe every night by the Signal Service for the benefit of westward-bound vessels, and in compiling the 'Pilot Chart of the North Atlantic Ocean,' issued the first day of each month by the Hydrographic Office as a guide to navigation. In addition to this, all such data have, of course, a further, though less immediate, value as constituting the foundation upon which future progress in the study of ocean meteorology must be largely based. Here, as in every science, old observations and methods of work guide the way to further advances; so that, with improved instruments and methods, still greater practical benefits can be looked for. The results thus obtained can nowhere be of greater importance to mankind than in the North Atlantic Ocean, the great highway between the Old World and the New.

THE ATTENTION OF SANITARIANS throughout the country is centred on New York City and Tampa, Fla. At the former there arrived, Sept. 22, the steamship 'Alesia' from Naples, Italy, with four cases of cholera on board. During the voyage eight deaths had occurred from the same disease. The passengers were not permitted to come to the city, but were at once taken to the quarantine islands in the bay of New York. Since the debarkation other cases have occurred among the passengers. The lateness of the season will undoubtedly prevent any extension of the disease to the city this year. The presence of this dreaded disease in the port of New York, and the experience of past years in which the disease became epidemic in this country, should be a timely warning to all sanitary authorities. If cholera is to prevail in the United States during the coming year, it can hardly be expected to appear before spring, before which time at least six months will be available for purposes of a thorough cleansing and purifying of filthy spots in both city and country; and that community which neglects to take the necessary preparatory measures to cope with the disease must expect to reap the consequences. In connection with this subject it will not be

amiss to recall public attention to the recommendations which were adopted by the sanitary conference which met at Washington in 1884 in anticipation of the arrival of cholera during the following summer, from which we quote, under 'Health Matters,' in another column. As cholera at New York is attracting the attention of sanitarians, equally so is the possible existence of yellow-fever at Tampa, Fla. A telegram from the deputy-collector of Tampa to the Marine Hospital Bureau announces that there have been twenty-six cases of yellow-fever in that place; and the additional information is given that the doctors disagree as to whether the disease is dengue or yellow-fever. That doctors disagree is not a strange occurrence, and that this disagreement is in reference to the existence of yellow-fever is also no new thing. When undoubted yellow-fever appears in the South, its presence is always denied, and strenuous efforts are made by the local physicians to conceal it; so that to the recognized sanitary authorities must we look for a true statement of the nature of the disease which now prevails at Tampa. Thus far, nothing authoritative has been made public. Dengue prevailed in the West Indies in 1827, and in the following year made its appearance in the South. In the city of Charleston alone there were ten thousand cases, seven-tenths of the population being attacked. It appeared again in Charleston in 1850, and along the southern coast in 1880. It is commonly known as 'breakbone-fever,' from the fact that one stage of the disease is characterized by severe pains throughout the body. It commences with a feeling of chilliness, followed by fever, during which these pains are felt. Sometimes the joints in the hands and feet become swollen, as in rheumatism. Usually there is an eruption resembling measles. The affection lasts eight days, but a considerable time elapses before the strength of the patient is fully recovered. Some authorities regard the disease as contagious, while others deny it. A micrococcus has been described as being the germ of the disease, but this lacks confirmation. Fortunately dengue is not often fatal. In this respect it exhibits a marked contrast to yellow-fever, in which the mortality varies between ten and seventy-five per cent. La Roche states the average mortality to be 1 in 2.32.

NOTHING IS ATTRACTING more attention in agricultural circles just now than the great sorghum-sugar industry. The late results obtained at the experimental sorghum station at Fort Scott, Kan., are most encouraging, and have induced sanguine views of the future of the industry, which can only be compared with the dreams of the average land-speculator. As these views are somewhat amusing, we quote below liberally from one of our correspondents. "This is a great boon for Kansas and Missouri. There are enough acres of farm-land that will produce sorghum in Missouri and Kansas to make millionaires of every man owning any quantity of land. It is said that the soil will produce from ten to fifteen tons per acre. One man can farm 50 acres of sorghum very comfortably. Fifty acres, yielding 10 tons per acre, is 500 tons of cane. From this the farmer gets \$250 worth of seed. The last run made at Fort Scott yielded 115 pounds of sugar to each ton of cane, which is 1,150 pounds per acre, or, for the 50 acres, 57,500 pounds. This, at the lowest figure possible, 5 cents per pound, is the snug sum of \$2,875. Besides this, there is a yield of 15 gallons of sirup to each ton of cane, making 150 gallons per acre, or 7,500 gallons for the 50 acres. This should sell for 20 cents per gallon, which is \$1,500 more, making the sum total of \$4,625 received from the 50 acres. After deducting the sum of \$1 per ton, the cost of milling, which is \$10 per acre, or \$500 for

the 50 acres, there is a net profit of \$4,125 from the acreage planted. This is clear net profit on the cane, and does not include any charge of profit to the people owning the mill or plant. Kansas has offered a premium of 2 cents a pound for all the sugar produced in that State, and there are 150,000 acres of sorghum grown there, and nearly a million dollars' worth of machinery has been built for experiments in testing the best manner of extracting the juices. Sorghum-sugar can be raised anywhere from the Gulf to Minnesota at less than 1 cent per pound; in fact, one of the sugar engineers of Cuba, after examining the results at Fort Scott, stated that he could put up a plant which would produce sorghum-sugar at 59 cents per hundred pounds. There is no reason why a bounty of \$500,000 a year should not be given to sugar, and as much more to flax, by the government. In thus co-operating with State experimental stations, an unexampled prosperity should result from these endeavors."

THE NICARAGUA CANAL.

ON April 24, 1887, the contract between the Nicaragua Canal Association and the Republic of Nicaragua was signed, and the work on this important route from the Atlantic to the Pacific will therefore soon be taken up.*

The principal surveys of the route are those made by O. W. Childs, in 1850-54, on behalf of the American Atlantic and Pacific Ship Canal Company, and those of the United States Surveying Expeditions, 1872-73 and 1885, the former under Commander Hatfield and later under Commander Lull, the latter under A. G. Menocal, who was chief civil engineer of the expedition of 1872-73. Our map is compiled from the maps and profiles published in the reports of these expeditions, and shows the locations of the canal in 1872 and 1885.

Lake Nicaragua, which occupies the central part of the isthmus, will form the summit-level of the canal. Its outlet is the river San Juan, which flows to the Caribbean Sea. Near the lake the river is broad and flows through an open country. It has an average depth of nineteen feet. Twenty-eight miles below Fort San Carlos the river enters a hilly country and forms numerous rapids which obstruct navigation. The last of these are the Machuca Rapids, below which the river has a depth varying from 20 to 60 feet, with but little current: this section is called 'Agua Muerte,' or dead water. At the foot of the Agua Muerte the San Carlos is received into the river, and is the first considerable tributary. This river comes from a long distance up in the Costa Rica hills, and carries a considerable amount of detritus which consists chiefly of volcanic sands. Below the confluence the San Juan changes its character altogether, and is filled with shoals and sandbars. An additional amount of detritus of a similar character is carried into the San Juan by the Serapiqui. While the upper course of the San Juan, which is almost exclusively fed by Lake Nicaragua, is not subject to freshets, its lower part, below the confluence of the San Carlos, partakes of the character of that river, which is a torrent during the rainy season, and has little water during the dry season. Therefore the lower part of the river cannot be made use of for navigation, and an independent canal to the Caribbean Sea must be built. In the location of 1872-73 the canal followed the river, and then crossed its delta to the lagoon of Greytown.

Thirteen miles below the confluence of the Serapiqui the delta of the San Juan begins. The principal arm of the river is the Rio Colorado, which flows to the eastward and empties into the sea. The other arm is the Lower San Juan, which passes more to the northward, and is divided into several mouths, which discharge their waters into the sea and into the lagoon of Greytown. The delta consists of the light volcanic sand carried into the San Juan by its southern tributaries. This silt has almost totally destroyed the harbor of Greytown by closing up the old entrance and filling a great part of the harbor. The silt is being carried into it by the Lower San Juan and the current. Therefore it is proposed to cut off the Lower San Juan, to send all the water through the Colorado into the sea, and to build a jetty for keeping the silt out of the harbor, which will be improved by dredging.

When the project of a canal through Nicaragua was first discussed, several routes from the lake to the Pacific Ocean were pro-

posed. The one advocated by Napoleon ran from the lake through the Rio Tipitapa to Lake Managua, and continued to the port of Realejo. This route, as well as those to Salinas Bay and San Juan del Sur, was found impracticable, and Brito at the mouth of the Rio Grande was chosen as terminus. The upper Rio Grande offers several difficulties on account of the freshets of the river and the narrowness of its valley. This induced Commander Lull to select the Rio del Medio route, though it requires deeper cuttings, as it avoids the upper part of the Rio Grande, while Menocal favors the Rio Lajas route.

The route proposed by Mr. Menocal extends from the harbor of San Juan del Norte, or Greytown, on the Caribbean Sea, to the port of Brito, on the Pacific, a total distance of 169.8 miles, of which 40.3 miles are canal in excavation, and 129.5 miles open navigation through Lake Nicaragua, the river San Juan, and the basin of the river San Francisco, a tributary of the San Juan. Lake Nicaragua, some 90 miles long by about 40 miles wide, the surface of which is 110 feet above sea-level, has been taken as the summit-level of the canal. Leaving the harbor of Brito, the canal follows the valley of the Rio Grande with a gradual inclination of about 12 feet to the mile, ascending by means of four locks, 26 to 29 feet lift, to the summit-level extending 8.5 miles west of the lake. From that point the canal extends easterly, and, cutting across the divide with a maximum depth of 41.4 feet above the surface of the water, reaches the lake 17.27 miles from the Pacific terminus. The summit of the divide cut through by the canal, 151.4 feet above sea-level, is much the lowest depression across the American isthmus.

The lake navigation extends from the mouth of the river Lajas to Fort San Carlos at the head of the river San Juan: through that distance not less than 28 feet of water can be carried to within 2,400 feet of the west shore, and eight miles of Fort San Carlos. For the former distance, dredging and rock excavation are necessary; and in the latter, dredging in mud to an average depth of 3.5 feet, to extend deep water from shore to shore. Other parts of the lake are very deep.

The canal then follows the river San Juan for a distance of 64 miles from the lake to Ochoa, just below the confluence of the river San Carlos (*v.* map). Here a dam is proposed, 1,255 feet long and 52 feet high, which will back the water of the river the entire distance to the lake, maintaining the surface of the latter at the proposed level of 110 feet. The upper part of the river thus deepened and widened will be converted into an extension of the lake, at no place less than 1,000 feet wide, and, with the exception of the first 28 miles from the lake, the depth gradually increases from 28 to 130 feet. Within those 28 miles, dredging and rock excavation to an average depth of 4 feet will be needed for a distance of 24 miles. The dam is located between rock abutments, and is proposed to be built of concrete resting on rock foundations 20 feet below the present water-level.

Just above the dam, a break between the hills confining the river on the north, affords a desirable basin at the entrance of the canal, which here leaves the river. After running a distance of .62 miles through the basin, it cuts across a broken country for a distance of 1.82 miles, and enters the valley of the creek San Francisco. This creek runs nearly parallel to the San Juan, from which it is separated by a range of hills, to a point about 9 miles from the dam, then, receiving a tributary from the north-east, turns abruptly to the south and empties into the San Juan. Its valley forms an irregular, flattened Y, with its foot resting on the San Juan, one arm extending westerly to within a short distance of the dam at Ochoa, the other easterly in the direction of Greytown. Across the stem of this Y will be built an embankment 6,500 feet long on the crest, with a maximum depth of 51 feet. This embankment will retain the waters of the San Francisco, forming an artificial lake of 30 to 50 feet depth, at the level of the river above the dam, or an extension of the summit-level. The outlines of this lake and the increase in width of the San Juan, after its waters are dammed up at Ochoa, are shown in our map according to information kindly furnished by Mr. Menocal. The extent of country which will be inundated by the San Carlos cannot be defined, as the valley has not been surveyed. As its character, however, is similar to that of the San Juan, the strip of

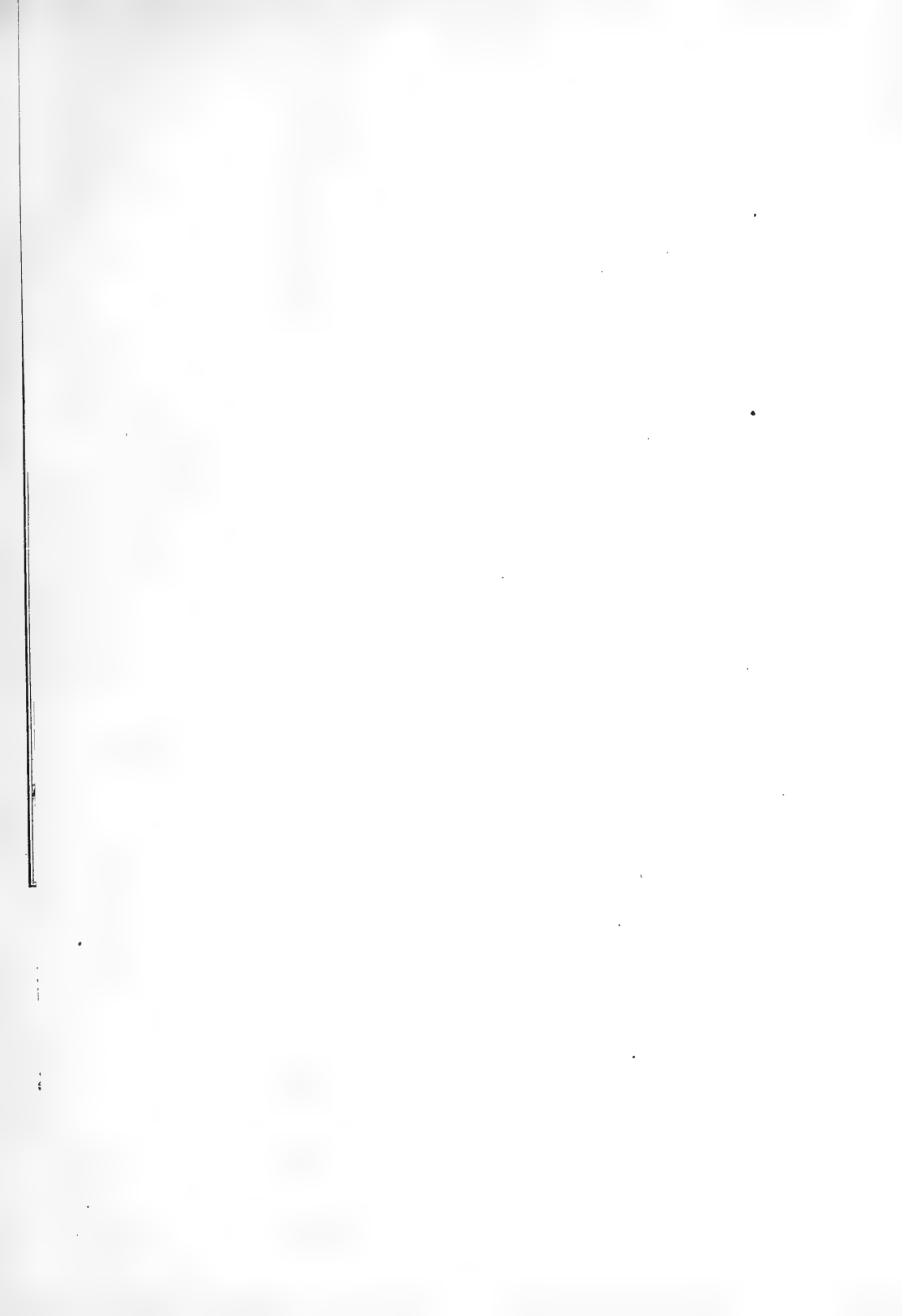



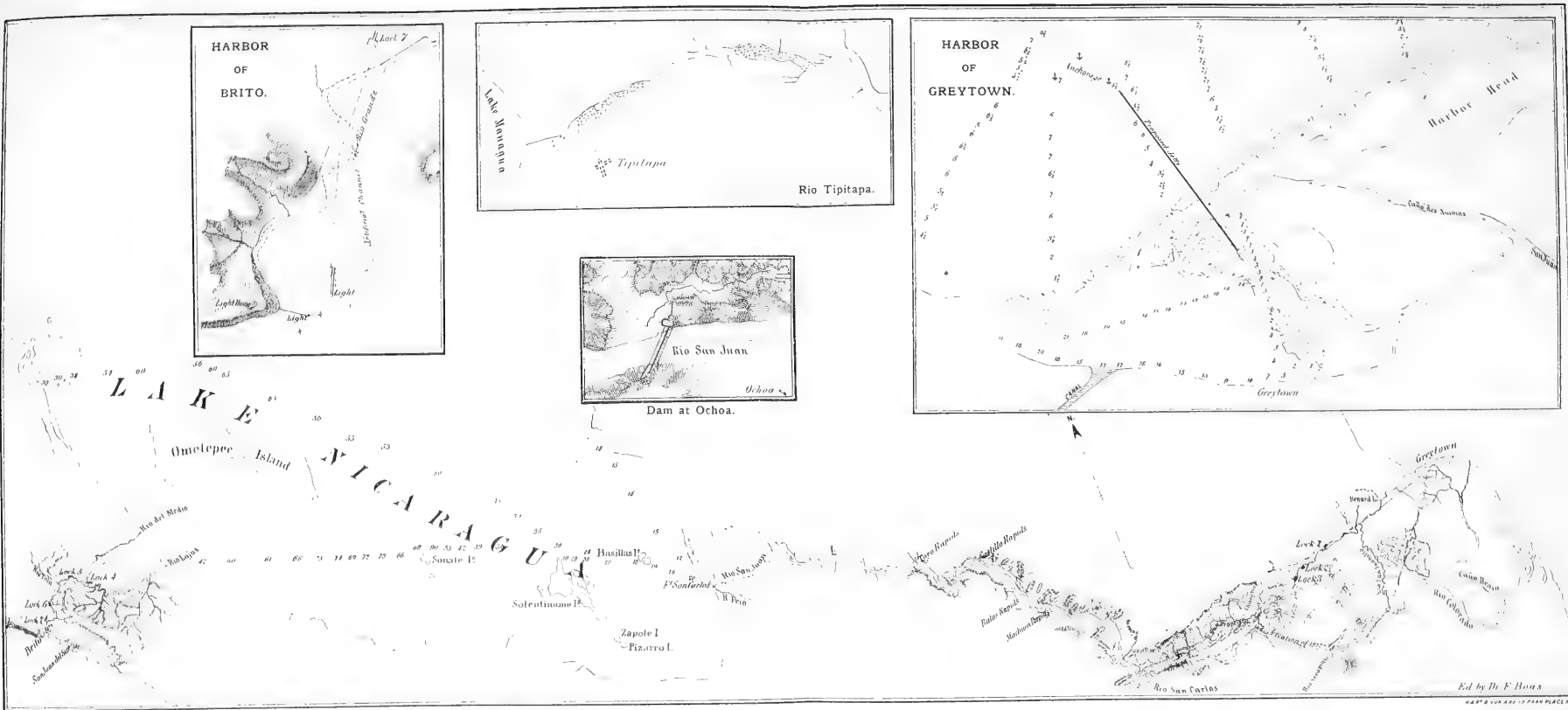

PLAN OF THE NICARAGUA SHIP CANAL

as relocated by A. G. Menocal, in charge of the U. S. Surveying Expedition of 1885.

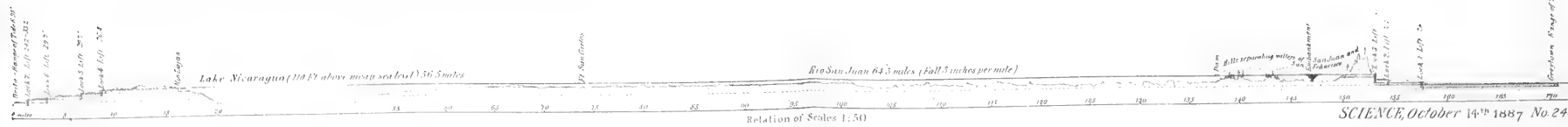

Profile of the Nicaragua Ship Canal

land will probably be very narrow. The necessary land will be granted by Costa Rica to the association. The canal route follows this deep basin to the western slope of the dividing ridge between the creek San Francisco and the river San Juanillo, 12.55 miles from the dam, and 19.48 from Greytown. Beginning at the eastern extremity of this basin, the canal cuts through the dividing ridge, the summit of which is 280 feet above sea-level, and in a distance of 14,200 feet, in which the average depth of the cutting is 119 feet above the water in the canal, strikes the eastern slope of the divide. This point is on the eastern terminus of the summit-level extending from the upper lock on the Pacific slope, a distance of 144.8 miles. Here it is proposed to carve in the solid rock, at the end of the deep cut referred to, the upper lock of the eastern branch, and drop the level of the canal 53 feet. The ground thence descends gradually to the next lock, .87 miles below, where another drop of 27 feet takes place; and the canal for a distance of about three miles is cut through a broad, slightly inclined valley to the third and last lock. This lock lowers the canal to the level of the sea, and from here it takes a direct course through the alluvial plains of the San Juanillo to the harbor of San Juan del Norte, or Greytown, a distance of 11.55 miles; from the last lock to Greytown on the east, and to Brito on the west side, the canal is enlarged, forming extensions of the harbors, where vessels can pass each other without detention. Ample provision has been made to protect the canal from surface drainage. Two basins are proposed at each lock where vessels can wait or pass each other without delay. The canal is proposed to be 80 feet wide at the bottom in deep cuts, and 120 feet in the terminal cuts and other enlarged sections; the width at the surface of the water being 80 feet in deep rock cuts, and 184, 288, and 342 feet at other points. The locks are estimated 650 feet long between mitre sills and 65 feet width of chamber. The estimated time of transit from sea to sea, on the basis of a speed of 5 miles per hour in the canal proper, 8 to 10 miles per hour in the river and lake, and 45 minutes' detention at each of the seven locks, is 30 hours. Allowing but one vessel to each lockage, 32 vessels in one day, or 11,680 in one year, can be passed through the canal. Breakwaters and dredging will be required at the harbors of Brito and Greytown to secure a free entrance.

It is estimated that the canal and its accessories can be completed in six years; and its cost, including 25 per cent for contingencies, is put down at \$64,043,697. The estimates are the result of an actual instrumental location of the entire line, and the surveys have been conducted with great care, and sufficiently in detail to insure a close estimate of cost.

The characteristic features of this location as compared to that of 1872-73 are the great extension of the summit-level eastward, which practically extends Lake Nicaragua to the divide between the San Francisco basin and the San Juanillo, by the high dam at Ochoa, and the embankment near the confluence of the San Francisco and San Juan, and the difference of the location of the upper part of the western division. Commander Lull recommended the Rio del Medio route, though it required cuttings of 134 feet, on account of better natural surface drainage, which is of the greatest importance for the stability of the work in a country with heavy rainfalls. On that line no water-course of considerable size would be taken in the canal, and, as its watershed is quite small, no fears were entertained of damages from freshets. On the Rio Lajas route the Rio Grande, a mountain stream of extensive and rapidly inclined watershed and precipitous channel, with a maximum flow of about 10,000 cubic feet per second, had to be passed. This difficulty has been overcome by Menocal by diverting it into the Juan Davila, a tributary of the Rio Lajas.

Dr. Polakowsky (*Petermann's Mitteilungen*, 1887, p. 138) raises several objections against this project, which, however, are not well founded. He says that it will be necessary to retain the present level of the San Carlos, as it would flood extensive parts of Costa Rica. This, however, cannot be true, as its course is very rapid, and as the lower part of its channel passes through a hilly country. Neither will the banks of the San Juan be flooded to any considerable extent, as may be seen from the accompanying map. The extent of land owned by private parties and required for the canal is very trifling, and therefore no considerable additional cost will be

occasioned by this item. The lands belonging to the state of Nicaragua will be given to the association without any compensation whatever. Besides the works belonging to the canal proper, the association is obliged by contract with the Republic of Nicaragua to establish a communication between the part of the San Juan not used for canal purposes and the canal by means of locks suitable for the navigation of ships of 6 feet draught, and another canal between Lake Managua and the lower part of the Tipitapa of sufficient dimensions to admit the passage of vessels drawing 6 feet, and of 150 feet length. The difference in level between the lakes is 22.34 feet. The river Tipitapa is shown in our map: it is full of rapids, and has a fall of 13 feet above the bridge of Tipitapa. This canal will be the property of the government.

Besides the land necessary for the construction of the canal, considerable land-grants are ceded to the company. On the left bank of the river San Juan from the Atlantic to Castillo Viejo it will receive alternate lots of three miles frontage and six miles in depth; from Castillo to the lake, on the south side of the river, lots two miles frontage and two miles depth; all along the south shore of the lake to the mouth of the Rio Lajas, lots of one mile square; on the northern bank of the Rio San Juan above Castillo, lots of three miles frontage and four miles in depth; and, continuing on the east shore of the lake as far as the river Tule, lots of two miles frontage on the lake and two miles depth are ceded to the company. Furthermore, it will receive forty lots of the existing public lands, each four miles frontage by five miles deep.

Though Menocal's plan is the result of frequent and thorough investigations, it is not considered as final, but the Canal Association intends to have the routes, and particularly the divides, resurveyed in the coming winter. Operations will be taken up in the present month. So far the geological features of the country traversed by the canal are still insufficiently known, and to these particular attention will be paid. From the specimens collected by Lull's and Menocal's expeditions, it appears that metamorphic rocks form the foundation of the eastern part of the country. Overlying these, volcanic lavas, such as very compact basalts, andesites, and rhyolites, were found. Borings will be made in all the localities where cuts are proposed. Particular attention will be paid to the eastern divide, as it is considered desirable to avoid the cutting of 119 feet above the water of the canal, if possible. The results of these surveys and borings will be laid before the leading engineers of North America and Europe, and not until then the final route will be adopted. It is hoped that thus unforeseen difficulties will be avoided.

The climate of Nicaragua is an important consideration, particularly while the canal is being constructed. The western part is undoubtedly healthy, while malaria prevails in the swampy delta of the San Juan. The following description of the climate by Von Franzius will be of interest.

In the north-eastern part of Central America the north-easterly trade-winds are the rainy winds from November until February. They lose their humidity on the eastern slope of the mountains, and reach the south-west side as dry winds. Particularly from November to January the trade-winds bring rain on the north-east side, in February and March rain is scarce, and in April there is none whatever. In the beginning the rain is even carried across the mountains to the south-western slope, where it extends a considerable distance down the valleys. Particularly in the saddles of the mountain ranges the rain extends south-westward. In November and December the rainy spells sometimes last for two or three weeks. They are called 'Navidades.' At the same season, when in October and November the north-easterly trade-winds make their first appearance and bring the first rain on the north-east side, the rainy season is at an end on the south-west side. The sky is clearing up, and the trade-winds begin to blow, at first squally, later on as a strong breeze. There are no thunder-storms during this season, which is called 'Verano.' The mountains are seen through a blue haze, while the air is very transparent and clear during the rainy season. The short period of calm weather crosses Central America twice, — first in March following the receding trade-winds, and then in October. The trade-winds reach the northern parts of Central America about the end of September. In the beginning of October they begin to blow in Guatemala, about the end

of October in Nicaragua, and in the beginning of November in Costa Rica and Panama. In Guatemala they blow from the middle of October until the end of April, in Costa Rica from the beginning of November until the end of March. At the end of this season, calms prevail for two or three weeks; then the south-westerly monsoon sets in, and tropical thunder-storms with heavy rains occur every day. This period begins in Panama and Costa Rica in April, in Nicaragua in May, and in Guatemala in June.

It is difficult to estimate the traffic that would make use of a canal through the American isthmus, as its opening would result in a complete revolution of trade. The route through the Suez Canal is taken by about two-thirds of the ships plying between Europe and Asia. According to C. Eggert the whole traffic of Europe with India, East Asia, and Australia, in 1883, required 5,707 ships of 7,773,658 tonnage.

From May 1, 1882, to April 30, 1883, 3,154 steamships, of 4,889,928 tons, and from May 1, 1883, to April 30, 1884, 3,407 steamships, of 5,585,504 tons, passed through the canal. Therefore it will be safe to suppose that in the beginning about two-thirds of the whole traffic which might avail itself of the American canal would make use of it. It may be that the figure will be a little lower, as some seamen will object to the locks of the canal, but this objection will readily be overcome. According to statements furnished by the Bureau of Statistics, the number and tonnage of vessels that could use a canal through Central America, amounted, in 1879, to 2,647 vessels, of 2,671,886 tons; in 1885, to 4,139 vessels, of 4,252,434 tons. From data furnished by the Statistical Bureau of Hamburg, the same traffic amounted, in 1883, to 2,404 vessels, of 2,337,346 tons. In these compilations the figures for the trade between the United States and foreign ports fairly agree, as the following table will show. The first line refers to vessels entered at and cleared from Atlantic coast ports of the United States in trade with foreign countries west of Cape Horn; the second, to vessels entered at and cleared from Pacific coast ports of the United States in trade with foreign countries east of Cape Horn. The first and third columns are according to the Bureau of Statistics of the Treasury Department; the second, from the Hamburg Bureau of Statistics.

	1879.		1883.		1885.	
	Vessels.	Tons.	Vessels.	Tons.	Vessels.	Tons.
1	273	247,567	462	462,767	721	734,236
2	455	551,929	629	792,180	714	957,784

The figures showing the trade between European ports and foreign countries other than the United States, and using the route around Cape Horn, do not agree as well:—

	1879.		1883.		1885.	
	Vessels.	Tons.	Vessels.	Tons.	Vessels.	Tons.
	1,644	1,462,897	1,313	1,082,393	2,473	2,210,675

In the figures compiled from the data of the Hamburg Bureau the traffic between the Pacific and Atlantic ports of North America is not included; but there can be no doubt that this trade will rapidly develop after the opening of the canal, and that it will form one of the most important items of income of the canal. The United States Bureau of Statistics states that vessels of 4,252,434 tons might have passed the canal in 1885. If the increase should continue at the same rate, 6,506,214 tons might use the canal when opened, on Jan. 1, 1893. The Suez Canal route is used by two-thirds of the whole traffic; but it must be considered, that, on account of the winds of the Red Sea, sailing-ships cannot make use of the canal, while on the coast of Nicaragua the winds are more favorable. But, even if we suppose that from 70 to 80 per cent of the whole traffic will take this route, the income will be very considerable. Taking 70 per cent of the whole probable traffic of 1893 passing the canal, not less than about 4,700,000 tons would

take this route. But to this must be added the trade between the interior of the United States and eastern Asia, the greater part of which takes now the route of San Francisco, and part of the trans-continental trade; therefore it is probable that the figure is too low rather than too high.

The figures given above show that the tonnage of the vessels which will use this canal averages about 1,000 tons. Therefore the traffic would amount to about 3,500 vessels annually. The average tonnage, however, will rapidly increase after the canal is once open to navigation, as was the case with vessels passing the Suez Canal. The average tonnage of vessels passing that canal is given here:—

Years...	1870	1871	1872	1873	1874	1875	1876	1877	1878	1879	1880	1881	1882	1883
Tons....	898	995	1,073	1,166	1,290	1,345	1,377	1,419	1,425	1,533	1,510	1,517	1,587	1,747

This increase is due to the increase in the number of large steamers trading between Europe and Asia. The same will be the case after the opening of the Central American Canal. Though the navigation of the neighboring seas by sailing-vessels is not so difficult as that of the Red Sea, steamers will more and more monopolize the trade.

It is hardly possible to say which country will be most benefited by the opening of a canal through Central America. For the United States it is of the greatest importance, as it will open a new and important route from the Atlantic to the Pacific ports, as well as to the west coast of South America and to the islands and west shore of the Pacific Ocean.

DR. FRANZ BOAS.

SEARCH FOR GEMS AND PRECIOUS STONES.

THE insatiate desire for ornaments and articles to decorate the person, and hence the race for the acquisition of wealth, gives employment to thousands of persons in different parts of the world, who are kept busily engaged in searching for gems and precious stones; and in this aspect Prof. P. L. Simmonds considers it in a recent number of the *Journal of the Society of Arts*. It is somewhat difficult to know where the line of demarcation as to 'gems and precious stones' is to be drawn, and what properly come within this category; for tastes differ materially, and fashions change from time to time. About one or two, however, there can be no doubt as to classification. Diamonds and pearls have always been highly esteemed and appreciated, and the demand for these is universal. But there are some stones and substances that have value chiefly in special localities; such, for instance, as jade among the Chinese and Pacific Islanders, from its hardness and rarity; amber among the Chinese, Turks, and Russians; and coral among the East Indians, Chinese, and Africans. The African race appreciate the artificial Venetian beads above any valuable gem, because they have long been familiar to them, and are the fashion.

Precious stones have been prized in all ages for their portability, and high intrinsic value in a small compass. In Christopher Marlowe's celebrated play, 'The Rich Jew of Malta,' the merchant is represented as having before him

"Bags of fiery opals, sapphires, amethysts;
Jacinths, hard topaz, grass green emeralds,
Beauteous rubies, sparkling diamonds,
And sold seen costly stones of so great price,
As one of them, indifferently rated,
And of a carat of this quality,
May serve, in peril of calamity,
To ransom great kings from captivity.
This is the ware wherein consists my wealth!"

A glance over the various regions of the globe will show us men of all races, in large companies, delving in the ground or diving in the sea for this commercial wealth. Indeed, scarcely a sea or a river but has its fleet of boats at certain seasons laden with men eagerly searching for pearls, although it is chiefly in the tropics that these boats congregate. It may prove interesting to gather a few facts connected with this important quest, taking the searchers on land first, and then investigating the rich produce gathered from the sea.

In the Indian Empire there is a great commerce carried on in gems and precious stones, although no reliable data are available,

as they are so portable, and there is no absolute necessity for records being kept. The Indian trade-returns of the last three years give the value of the imports at an average of £200,000. A large trade is carried on in them to Sewistan, Kashmir, Ladakh, Thibet, Nepal, Sikkim, Upper Burma, Siam, and Karennee. There is no doubt that through private sources four or five times the reputed values are brought in, and also exported each year to Europe.

There are in India three extensive tracts, widely separated from one another, in which the diamond has been sought for. The name of Golconda, originally applied to a capital town (now a deserted fort in the neighborhood of Hyderabad), seems to have been used for a whole kingdom; but the town itself is many miles distant from the nearest diamond-mines, and it was only the mart where the precious stones were bought and sold. The second great tract occupies an immense area between the Mahanuda and the Godavery Rivers; and the third great tract is situated in Bundelcund, near the capital of which—Punnah—some of the mines are found. For those content with a slowly paying occupation, and a hard life involving close supervision of the workers, diamond-mining will pay, provided such persons possess capital sufficient to last them a few years. The diamonds now are usually brought from Partael, close to the southern portion of the Nizam's dominions. The deepest pits are not more than twelve feet. The matrix of the diamond in those localities is a conglomerate sandstone. The appliances of modern machinery for excavation, etc., directed by men of science, may possibly bring to light gems that have not been discovered by the rude native processes of search.

It would be curious to ascertain the yield of diamonds in the East from those mines in the last three hundred and fifty years, and of Brazil in the last one hundred and fifty years since the discovery there; but no such data are obtainable, nor indeed can any reliable estimate be formed of the value of the diamonds owned in different countries. In the United States, diamonds to the value of £1,700,000 were imported in 1886. Two million and a half carats of diamonds are cut yearly in Amsterdam. Precious stones being free of duty in the chief European countries, no records are obtainable. The Brazilian mines are said to yield about £800,000 of diamonds, and India, Borneo, and Australia, £200,000; but these sums are insignificant now, in comparison with the South African yield of about £4,000,000 yearly.

The only Indian mines now worked for diamonds are the northern ones in Bundelcund. The produce, between £40,000 and £60,000, is sold locally, and only about 100 carats are sent to Europe. Diamonds have been found in Sumatra and Celebes, but Borneo alone now produces a regular supply, sending, it is computed, about 3,000 carats annually into the European market. The discovery of Cape diamonds has reduced the Brazilian mining to a minimum of about 24,000 carats. And here it may be desirable to explain what this fanciful diamond weight is. The diamond grain is equal to about four-fifths of a troy grain, hence four diamond grains are equal to one carat, or 3.174 troy grains. But, as half the rough stone has to be cut away in polishing, to estimate the value of a rough diamond we must ascertain its weight in carats, double that weight, and multiply the square of this product by £2, which may be taken as the average price of rough diamonds that are worth cutting. Formerly, indeed, the price of diamonds was as the square of their weight; but this rule no longer holds good, as their value mainly depends upon quality.

From the four principal mines in Griqualand (which all lie within a circle with a diameter of three miles), calculating the amount of diamondiferous ground removed, and the known average yield per load in each, it is found that not less than 33,000,000 carats of diamonds (or more than 6½ tons weight) must have been extracted since the first discovery; realizing, in round numbers, £40,000,000 sterling.

The yield of diamonds from the Kimberley mine alone, from the opening in 1871 to the end of 1885, is stated to have exceeded 17,500,000 carats, equal to 3½ tons weight of precious stones, in value about £20,000,000.

To obtain this, as many thousand tons of reef and ground have had to be excavated. The mine is 450 feet deep, and the cubical contents of this huge cavity measures about 9,000,000 cubic yards. Four thousand Kaffirs are employed at this mine, and more than

20,000 natives of Africa arrive yearly at the mines in search of work; so that the employment of native labor and the development of native trade are incidental benefits conferred on South Africa by the discovery of the diamond-fields.

The Dutch Government are the owners of the diamond-mines in Borneo, which are situated in the district of Landak, in the territory of Ponteyanak: they are worked by Dyaks and Malays, but with far superior skill by the Chinese. The gems are found in a yellow-colored gravel, at depths ranging to 60 feet. Advances are made to the miners, who are bound to deliver all stones at 20 per cent below their market-value.

Diamond-mining in New South Wales is likely to become of much importance, and the colonists are sanguine of being able to compete with South Africa in this trade. Twelve thousand diamonds have been obtained up to the present time, chiefly from the tertiary gravels and recent drifts in the Bingera, Inverell, and Chittagong districts. The largest diamond yet found weighed 16.2 grains, or about 5½ carats. They are of good color and quality. Companies with large capital are forming to buy up and work the extensive diamond-fields in Bingera. Other gem stones found in that colony are garnets, the common emerald (green beryl), Oriental emerald (green sapphire), royal blue sapphire, white and pale-blue topaz, and agates.

The ruby-mines of Burma, when scientifically worked, are destined to yield a vastly increased quantity of this precious stone. There has been lately a sharp competition for the lease of these mines from the British Government, and it is believed that Messrs. Streeter have secured the right for £40,000. It is creditable to England that they have such enterprising firms of jewellers, seeking the produce at the very sources of production, as is evidenced by their explorations in South Africa, their employment of fleets of boats and divers for pearl-fishing round the Australian shores, and competition against Indian and Continental firms for the Burma ruby-mines. Rubies are of various reds, and the red sapphire or Oriental ruby is next in value to the diamond.

It has been well observed that digging for gems, like all gambling speculations, is but too attractive, and great numbers of the rural population in Ceylon and elsewhere neglect the safer pursuits of agriculture for the speculative profits of the gem-pits.

Ceylon has always had a reputation for its richness in precious stones. Inferior kinds, such as the moonstone and the garnet, are found in the beds of streams about Kandy, Newara Eleya, Badulla, and some of the small rivers of the south; but the more precious stones, such as the ruby, the blue sapphire, the Oriental topaz of various yellows, the Alexandrite, and the cat's eye, must be sought within a radius of thirty or forty miles from Ratnapura, the city of gems.

The Ceylon ruby is more frequently of a rich rose color, having considerably more light and life than its Pegu rival, and is preferred by many Orientals to the pigeon-blood ruby, which, although the more costly stone, is invariably less brilliant than the Ceylon one.

The search for gem stones is carried on in the most primitive manner in Ceylon. The soil supposed to be rich in precious stones is rented for an annual sum from the government. Coolies are set to work to dig the earth, which is heaped up on one side, and then washed through a trough with variously sized perforated zinc stops, which retain all stones, according to their sizes. These are placed on a table or flat surface, and the gems are easily distinguished and picked out. The proportion of gems capable of being cut and really marketable is not more than 1 per cent.

Of the siliceous gems, the amethyst, of a purplish violet hue, is the most valuable. The best amethysts are brought from Cambay in India, and from Siberia, Ceylon, and Persia, where they are found both lining the cavities of geodes and in rolled masses. The chief supply of the blue turquoise is drawn from the peninsula of Sinai, the great mining district of the ancient Egyptians.

Among the Moors, rubies and emeralds, generally uncut, are worn set in finger-rings and huge ear-rings, and necklaces of amber and coral are also prized. The Moors consider that the risk of fraud by imitation is lessened by not having precious stones submitted to the art of the lapidary. This taste for keeping gems in the rough also prevails among many of the Indian princes.

In 1879, thousands of British subjects from Burma passed through Bangkok on their way to the sapphire-mines of Siam. The unhealthy condition of the place proved fatal to numbers, and, although many realized great profits, the rush soon abated. No royalty was charged on the gems found, but a poll-tax of six shillings was levied at the mines. A sapphire weighing 370 carats in the rough, and 111 when cut, was the largest known to have been found: The ruby, onyx, and jade are also found in this district, but the quality of none of these is such as to make them very valuable.

Year by year great changes occur in the intrinsic value of precious stones from frequent plentiful discoveries. The great find of sapphires in Kashmir and Siam reduced their value some 50 per cent. The discovery of large deposits of amethysts in the interior of Brazil caused 7,000 diamond-washers to abandon their usual calling and flock to the neighborhood of the city of Caeté, but the prices dropped so rapidly that the shipments made did not pay. The diamond market has not been materially affected by any great fall in price from the enormous production in South Africa.

Art has much to do with the manufacture of gem stones. Chalcedony, when stained by metallic oxides, rises to the dignity of a gem stone, as sard, carnelian, chrysoptase, when uniformly tinted brown, yellow, or green; as agate, onyx, sardonyx, when the colors lie in bands or strata. The dull or latent colors are developed by heat or roasting. Black onyx, that is, black stones crossed by bands of pure white, are always artificial.

The precious opal was formerly in high repute, — 'misfortune's stone,' — and yet nothing can be more beautiful than the opals of Hungary and Queensland. The fine collection of the latter was much admired at the recent Colonial Exhibition. The area in which opals are met with in Queensland is large, but only in one or two localities are opals of any value obtained. They are remarkable for their brilliancy and variety of color, rivalling in that respect those of Hungary. The ultramarine blue color so finely shown in the Queensland specimens is rare even in Hungary. They are obtained of considerable size, and are of good value. Of other gems, there have been found in Queensland, diamonds, rubies, sapphires, topazes, etc., in the tin-bearing drift of Stanthorpe. Agates, which are also employed as burnishers, are met with in large quantities in the Agate Creek, Etheridge gold-field. There they can be produced in all colors and sizes by the hundredweight.

In the opal-mines of Dubreck, Hungary, about two miles of galleries are worked under government supervision, yielding a revenue of £1,200. The opal-bearing rock is not disposed in vein or bed form: on the contrary, the precious stone is found in nests, or pockets, and it not unfrequently happens that a considerable distance may be passed in the workings without showing a sign of an opal.

Like some of their more civilized brethren, the Maories of New Zealand are passionately fond of adorning their persons with trinkets and other ornaments, especially of jade. At the present day many of the decorations formerly used have been discontinued. Ear-ornaments are still in general use: they are worn by both sexes, and are of great variety. Those of greenstone, or nephrite, are the most highly prized. The amulet, or neck ornament, is generally of greenstone, carved into the resemblance of a human figure. The image is not unlike a Hindu idol, having an enormous face and badly shaped legs of disproportionate size. The ear pendants of greenstone vary in form: some are narrow pieces, from 3 to 5 inches in length, and others are round, thin, and flat. The color of jade varies from almost white to a dark green, but the lighter shades of green are the most highly prized. It is hunted for in the fissures of the precipices and in the streams of Chinese Tartary. Much of it is found in the rivers there by divers. These men work by moonlight, under an escort of soldiers, supervised by government officers appointed for the purpose, and by whom each piece, as found, is assayed and valued. The imperial jade is of a brilliant green, approaching the emerald in color.

There are jade-quarries in Burma, situated in the Mojaung district, at the head waters of the Churdwen, about 90 miles from Bhamo. They are leased to two companies for £6,000, and the trade is entirely in the hands of the Chinese.

The imports of jade into India are to the value of £30,000 to £40,000. In India jade vases are often ornamented with jewels, or carved and wrought so as to form elegant devices. The old Delhi work in cut and gem-incrusted jade is priceless. The Chinese had cut jade for ages, but never ornamented it except by sculpture; but, when it was introduced into India, the native jewellers, with their quick eye for color, at once saw what a perfect ground it afforded for mounting precious stones, and they were the first to incrust them on jade. The Indian Museum at South Kensington possesses the choicest and grandest specimens of this work known, of the best Mogol period (Sir G. Birdwood on 'The Industrial Arts of India').

Blocks of green stone, axes, meres, charms, and other articles of jade, were shown in the New Zealand Court of the late Colonial Exhibition, evidencing the patient skill of the Maoris in working this hard material, second in this respect to the diamond, although nevertheless somewhat fragile.

Passing now from land to sea, we shall find the busy search as actively carried on. In the coral-fishery of the Mediterranean nearly 600 boats are employed, manned by about 6,000 men, the number to a boat varying from 6 to 12 hands. They are sent out from Torra del Greco, Leghorn, Liguria, Sardinia, and the Algerian ports. It is a curious sight to see a fleet of these boats, ranging in size from 3 to 14 tons, employed on the banks with their wooden windlass amidships, hauling up what is termed the 'engine,' a kind of cross-shaped dredge for tearing off the branches of coral from the rocks. About 400,000 pounds of rough coral are brought in annually to Italy; and the shaping and working of this into the varied forms it assumes for commercial purposes, gives employment to hundreds in the chief cities. The value of the coral shipped from Europe used to reach about £600,000 annually; but with the change of fashion this has declined considerably. Not long ago there was quite a rage for the pale flesh-colored coral for jewelry. Coral ornaments may again come into fashion, even if they do not fetch the high prices at which they were formerly sold. Coral has the hardness and brilliancy of agate: it polishes like gems, and shines like garnet, with the tint of the ruby. In Russia, northern Africa, and India, coral is still much in demand. The imports into India last year were to the value of £20,000.

Amber was one of the most valuable jewels of antiquity. It was endowed with manifold sympathetic effects as a talisman against rheumatism, toothache, and other complaints. The Turks still believe it to be an infallible guard against the injurious effects of nicotine: hence its extensive use for the mouthpieces of pipes. Amber is esteemed for ornaments by many. The cloudy, or milk-white, and the opaque lemon-colored, are the varieties most valued by connoisseurs. The imports to this country are to the value of about £3,000 to £4,000, but it is largely shipped also to Austria, France, Turkey, and the Eastern nations. In is principally obtained on the Prussian coast of the Baltic, from Dantzig to Memel. At one establishment near Memel dredging is carried on day and night by 'shifts' of men, 400 being so engaged. At another, in Königsberg, 2,350 persons and nineteen steam-engines are employed. The pits are 300 feet deep, and 100 carts are employed on the works. In other localities divers are employed, two to each boat, with submarine clothing and air-pumps.

The fishing for pearls and mother-of-pearl shells is carried on in very many quarters: in Lower California, the coasts of Mexico, the Bay of Panama; in the Red Sea, the Persian Gulf, Ceylon, Borneo, New Guinea, the Sooloo Isles, Fiji, the Society and other of the Pacific Islands, and on the east and west coasts of Australia. The pearl-fisheries on the coasts of Central America furnish about £100,000 worth of pearls, and employ about 1,000 divers. Our imports of pearls average in value about £100,000: France receives about the same. The marketable value of pearls is much higher in Asiatic countries than elsewhere: hence the best are sent to Bombay, where fancy prices are often given for good pearls.

At the Bahrein fishery in the Persian Gulf, many hundred boats are employed, manned by from eight to twenty men, and the value of the pearls obtained is stated to average £1,000 yearly, but this amount of course varies. The larger and more valuable pearls are believed to be sold secretly. The men receive two-thirds of the catch, after deducting expenses, and for food, etc.

The great pearl-fishery of Ceylon is carried on at stated periods on the banks of the north-west coast of the island, at the entrance to the Gulf of Manaar. As it is a government monopoly, great care is now taken to give rest to the fishery, so as to allow the oysters to attain a maturity of five or six years, which will warrant a rich yield of pearls. There is a prospect of a good pearl-fishery in 1888; and it is confidently expected that as many as 300,000,000 oysters will be fished, requiring every boat and every diver procurable in Ceylon and southern India. The small, thin shells of this oyster (*Avicula fucata*), unlike the heavy, true mother-of-pearl oyster (*Meleagrina margaritifera*), have little or no commercial value, and are chiefly burnt for lime.

When a fishery is proclaimed, the arid sands at Arippeu, on the north-west coast, become, as it were, a bustling town of tents, filled with people of varied races and occupations, including boatmen from the Coromandel coast, pearl-dealers from India, Malaya, and China, with the accompaniments of merchants and traders of all classes. The Ceylon Government takes as royalty two-thirds of the oysters gathered, which are sold by auction at the close of each day's fishing. Only a limited number of boats and divers are licensed to fish.

The fishing can be carried on only during the very calmest period of the north-east monsoon, — February to April. In these months the wind blows off the land during the night, and off the sea during the day, which enables the large fleet of fishing-boats to reach the pearl banks by daylight on each morning, returning with their cargoes shortly after noon. The boats, containing twenty men (half divers), are divided into two fleets, which go out to their work on alternate days. The price realized for the oysters varies from £2 to £7 the thousand, the value depending to a great extent on that of a sample of 5,000 lifted in the early part of the fishing. The contents of the mollusk being allowed to decay before the pearls can be obtained, the stench is horrible. The congregations of pearl-dealers, petty traders, official subordinates, and laborers on the shores, are enormous.

About the island of Borneo there is a good deal of fishing for pearls, which are found in a thin, flat, pinkish-shelled oyster, known locally as *salesiep*. This lives only in shallow brackish water at the mouths of rivers. Several boats rendezvous at the same time and place to frighten the crocodiles and sharks. Twenty or thirty persons will be in the water at once, diving, splashing, laughing, and shouting, and bringing up three or four shells at a time: extra yells from all hands salute a rather larger find than usual. Very few of the pearls obtained are of any value individually: they are chiefly seed-pearls, which are sent to China, where they are pounded up, made into powder, and this is swallowed by ladies who desire to improve their complexion; at least, such is the story. From British North Borneo the value of the pearls exported in a year is £500. Pearls of a very high price are not infrequently to be bought at Sandakar, but they come principally from the islands of the Sooloo Archipelago. The largest ever seen there was valued at £1,600.

The formation of pearls is not limited to the bivalves: they are produced on several univalves, especially on the *Strombs* and *Turbinellas*, but are more rare in these than in the bivalves. About the Bahamas group of islands and keys, the shells of the king, queen, and common conch were much sought after for sale to the cameo-cutter, but the fashion for cameo jewelry has passed away. The common conch is the ordinary pink-mouthed shell so frequently seen in milk-shops. It furnishes the rare pink pearls, so much appreciated, and these are exported from the Bahamas to the value of about £3,000 annually. Some fine collections of these pink pearls, set and unset, were shown at the Fisheries and Colonial Exhibitions in London.

It was once thought that no other pearls than those produced by the pearl oysters could obtain a rank among gems; but some of the river-pearls found in species of mussels (*Unius*) compete closely with those from the *Mollusca* of the ocean. These river-pearls are found widely diffused in France, Saxony, Bavaria, Bohemia, and Silesia, as well as in the lochs and rivers of Scotland, Ireland, and Wales. In China, the rivers of Manchuria furnish a good many. Delegates from the royal household look out for the best of these pearls there for the ladies of the imperial court.

In many of the Scotch rivers old men, women, and children may

be seen wading about the shallow fords; and, when they discover a collection of mussels, they thrust down long sticks split at the ends, and bring up the mussels wedged in the slots. In the shallow waters of the Dee, the boatmen look down into the water with a tin having a glass bottom, and when shells are discovered, they are brought up by a kind of dredge, or scoop, and frequently some fine pearls are obtained.

These pearl mussels are also found in most of the small streams of the Province of Quebec, and in the districts bordering on the lower St. Lawrence. The streams most abounding in pearl mussels are but little known, except to Indians and backwoodsmen, who are careful in guarding the secret of where these mollusks are found.

Occasionally a party of pearl-seekers may be seen paddling in a bark canoe, and portaging through a very wild region. After opening several thousand mussels, they will only succeed in securing a few good pearls. These vary in color from white to dark brown: the white are appreciated for their rarity, and the pink on account of their peculiar brilliancy. In form they are generally round or spherical, and have a hard skin with an iridescent or nacreous hue.

It would lead to too much detail to pass under review the various pearl-fisheries of the Australian coasts, the Eastern Archipelago, and the Pacific Islands, where the unclothed native divers have to brave the attacks of sharks, cephalopods, and other dangers. They especially dread the stings of the jelly-fish, which they say are speedy death to them. Enough has, however, been stated to show the importance of this wide-spreading industry of hunting for gems and precious stones. Fine collections of these are frequently brought before the public to feast their eyes on, as at the recent Colonial and Indian Exhibitions in London, and those at Amsterdam, Paris, and elsewhere.

At the Fisheries Exhibition in London, a firm of Parisian jewellers showed, among others, a very choice five-row necklace of 355 selected Oriental pearls, weighing 2,570 grains; a matchless and unique necklace and parure of Scotch pearls; a very important black pearl necklace, composed of 39 pearls, weighing 1,020 grains; a round pearl of 96 grains, being one of the finest pearls known, and worth £20 a grain; a very important collection of Oriental pearls, composed of 3,345 grains original, such as are most prized in Bombay, besides black, pink, yellow, and gray fancy pearls.

MENTAL SCIENCE.

Recent Observations in Hypnotism.

THE great attractiveness that the study of the varied and interesting phenomena of hypnotism possesses for the French physicians has been often noticed. Not a month passes without some new and often startling contribution. The leaders in this movement are eminent scientific specialists, and have been cautious about accepting all the strange doings of excitable subjects as perfectly genuine. They appreciate the readiness with which a shrewd patient can deceive the unsuspecting observer, and insist upon the most exacting tests, arranged with a full knowledge of the sources of error to be eliminated. Under such a scrutiny, many alleged marvels have taken on a less miraculous aspect, and many startling interpretations shown to lack validity. Amongst the oldest claimants to scientific recognition in this field is the statement that a magnet has a peculiar effect upon hypnotic subjects. Sometimes the application of a magnet causes trembling and tingling; again it is said to produce contractions of limbs, and cause such a contraction to pass from one side of the body to the other; and so on. Professor Delboeuf, a successful observer in this field, has very ingeniously tested these claims, and made much progress towards showing their falsity. He experimented upon a boy of fourteen, an experienced hypnotic subject susceptible to 'magnetic' influence. In the preliminary trials Professor Delboeuf had a true magnet and a wooden magnet made to look alike, and each fitting in a case alike for both magnets. He handed the boy the case containing the true magnet, but nothing happened: as soon as the magnet was drawn out, he developed a violent contracture, his usual symp-

Next, Professor Delboeuf had three steel bars made exactly alike, two of which were strongly magnetized, and the third not. He gave the boy a real magnet, and asked him whether he felt any thing. After an exploring glance of from thirty to forty seconds, the boy felt tingling sensations, then pain and the usual symptoms. The same was done with the other hand, and he was shown that the bar was a real magnet. Professor Delboeuf then drew the false magnet from his pocket and gave it to the boy: no effect followed. Then the third (true) magnet was given him, with the request that he should say whether it was a magnet or not. No contraction followed; and from now on, the boy had no clew as to the true or the false magnet. Fourteen trials were made, consisting simply in giving the boy a bar, and noting the result. In eleven of these trials he either exhibited the contraction when holding the false magnet, or failed to exhibit it when holding a true one; thus showing most conclusively that all the effects were self-induced, and suggested by his belief that a magnet was being applied. The same was repeated with another subject, with a like result.

Professor Delboeuf similarly tested the powers of the hypnosis, which is simply a small hollow magnet to be held on the finger, and, when thus giving rise to peculiar sensations, is claimed to show that the holder is a good hypnotic subject. Three hypnoscopes were made exactly alike, only two of which were magnetized. Of fifteen university students, three claimed to feel glowing sensations from the instrument, and one of these felt it all the way up to the shoulder. Strangely enough, this young man held the false hypnoscopes, and on trial proved to be the best subject. The conclusion drawn is, that the hypnoscopes is useful in detecting hypnotic subjects, not because of any magnetic sensibility, but because persons of such a susceptible temperament as to imagine sensations from it furnish one of the chief requisites for passing into this condition.

Dr. Voisin indorses this same general view. He has repeated the noted Paris observations, in which the mere approach of an hermetically sealed vial containing a certain drug affects the hypnotized subject in the same way as a strong dose of the substance in the normal state. He finds that if the utmost precautions against talking to his assistants, and other modes of suggesting the expected effect, are taken, the result is negative, and concludes that in his subject a wonderfully shrewd appreciation of suggestions accounts for all that was exhibited. He finds, too, that the application of a magnet unknown to the subject had no effect, while she is extremely sensitive when she knows a magnet is about.

Dr. Bernheim has described some remarkable cases in which the mere suggestion of a certain idea in the waking state serves to impress this idea with a lifelike reality. His subjects are young men of neurotic temperaments in their ordinary waking condition. One patient was told that a certain physician attacked him on the street and picked his pocket. He at once accepted the tale, added details of time and place, and no amount of questioning would get him to give up the notion. Turning to another patient, Dr. Bernheim asked whether he knew any thing about it. The suggestion was sufficient. The subject of the attack had told the second patient all about it in the morning, and so on. The same delusion was passed on to several patients, and accepted. These observations show a connection between what occurs in the hypnotic state and the phenomena observed in weak-willed persons. The possession by a dominant idea imposed by another or suggested by circumstances is the common mark of many of these semi-abnormal states. They also show how easily such people can be utilized for base purposes; and Dr. Bernheim believes that the son of the sexton in the famous Tisza-Eslar affair (who claimed to have seen through the keyhole the cruelties on which the trial was founded) was a case in point.

In this connection it may be added that there is a growing sense of the great danger to which this subject is liable at the hands of amateurs. Examples of its pernicious effects in individual cases are accumulating, and a most celebrated French alienist recently expressed himself thus: "Hypnotization is not as harmless as it has been made out to be: the hypnotic state is closely allied to the hysterical neurosis, and, like the latter, it may in some cases become markedly contagious. If medicine in the name of science and art has taken possession of hypnotism, it should keep it within the

strict limits of its own domain, using it as a powerful therapeutic agent, and never letting it pass into profane hands, where it is liable to be abused to the detriment of the public health.

HEALTH MATTERS.

Precautions against Cholera.

In view of the possibility of an attack of cholera during the coming year, we deem it appropriate to quote below from the recommendations of the sanitary conference held at Washington in 1884, in anticipation of the arrival of cholera:—

First, That all surface wells should be closed at the earliest possible moment, and that great care should be taken that the water-supply of all cities, towns, and villages shall be of undoubted purity.

Second, That all privy-vaults should be abolished wherever water-closets can be supplied, and that, wherever the existence of such vaults is necessary, they should be rendered water-tight in such a manner as to prevent the saturation, not only of the ground surrounding them, but also of the materials of which they are built, and that the contents of such vaults should be kept constantly disinfected, and removed to a proper place at frequent intervals.

Third, That all stagnant ponds, when practicable, should be disinfected, and when possible the water removed by drainage or pumping, and the further accumulation prevented by filling with fresh earth, or other material free from garbage or other filth.

Fourth, That great care should be exercised to keep at all times clear and free from obstruction all sewers into which passes the refuse from dwellings, factories, and other buildings, and that such examinations should be made as will detect imperfect plumbing in all buildings, and the defects immediately corrected. In this connection special attention is directed to the necessity for the thorough ventilation of all soil and waste pipes, and to the dangers connected with untrapped and unflushed soil-waste and overflow-pipes.

Fifth, That extraordinary care should be exercised in reference to all tenement-houses, lodging-houses, and in general all places where large numbers of human beings congregate; that no accumulation of garbage or other filth be permitted in cellars or yards; and that frequent and thorough cleaning and whitewashing of such structures be required; and that householders should frequently and thoroughly examine their yards, cellars, closets, and other out-of-the-way places, to see that no filth of any kind has been deposited there.

Sixth, That the food-supply be vigorously watched to exclude from the market all unwholesome meat, all milk adulterated or from diseased animals, and all unripe fruits and vegetables; and that cow-stables be kept at all times clean, well whitewashed, and free from all excremental accumulations.

Seventh, That all garbage, kitchen and household refuse, should be promptly removed from dwellings, stores, and other buildings, to a proper place, where it may be destroyed by fire, or otherwise disposed of in such manner as to occasion no nuisance.

Eighth, That such material should never be used in the filling of lots, or disposed of by throwing the same in streets or vacant property, where it may decompose and exhale offensive and deleterious gases.

Ninth, That the attention of the authorities of all institutions, both public and private, and of individuals as well, be drawn to the great importance of maintaining a habit of personal cleanliness in the persons under their charge, as being one of the most efficient means of warding off an attack of cholera, or, if it has once appeared, of greatly reducing its virulence and fatality.

Tenth, Should the cholera appear in any place in this country, the health authorities of the place should have immediate notice of the first cases, in order that prompt action may be taken for complete isolation and disinfection.

Eleventh, That all authorities of states, cities, or villages be urged to adopt measures which will result in the amelioration of all conditions such as have been referred to in the foregoing propositions, with the warning, that, in the opinion of this conference, such conditions, if permitted to continue, will greatly promote the spread of cholera when it comes, and with the assurance, that, if requisite

measures are promptly taken to remove them, the disease will be less likely to attack a community so prepared, and, if attacked, such a community will be better able to cope with the disease and to reduce its ravages to a minimum.

PUBLIC HEALTH ASSOCIATION.—The American Public Health Association will hold its fifteenth annual meeting at Memphis, Tenn., on Nov. 8, 9, 10, and 11. The following topics have been selected by the executive committee for consideration at the meeting: 1. The pollution of water-supplies; 2. The disposal of refuse matter of cities; 3. The disposal of refuse matter of villages, summer-resorts, and isolated tenements; 4. Animal diseases dangerous to man. The president, Dr. George M. Sternberg, will in his address refer to the results of his investigation of yellow-fever in Brazil and Mexico. In view of the possible existence of this disease at Tampa, Fla., referred to elsewhere, this subject will be of absorbing interest. The committee on disinfectants will present a report embodying the researches and experimental work of that committee during the past year. Clergymen, teachers, engineers, architects, builders, and all interested in the practical work of the association, are cordially invited to be present.

EXPLORATION AND TRAVEL.

Manchuria.

In *Science* of May 6, 1887, we mentioned the journey of three enterprising Englishmen through Manchuria. In a lecture delivered before the Royal Geographical Society of London, Mr. James, one of the travellers, gave a sketch of the country they traversed, from which we take the following notes: The most interesting part of the journey was that in the Chang Pai Shan (the 'Long White Mountains'). These were supposed to be more than 10,000 feet high, but the measurements of the travellers show that the loftiest peak is not more than 8,025 feet high. They are supposed to be sacred to the ancestors of the reigning dynasty of China, and it is sacrilege to trespass on them. Nevertheless the country has been rapidly settled in recent times. The colonists have formed themselves into associations or guilds for protecting their life and property against robbers, who infest all parts of Manchuria; and in this they have been so successful that their territory is the only one enjoying perfect security. Here the travellers learned that the highest peak of the mountains is the Lao Pai Shan (or 'Old White Mountain'). The road to this point led through thick forests and over bogs which were absolutely impassable for any beast of burden whatsoever: therefore they had to leave their mules behind, and continue their march by foot. The peak rises from a grassy plateau dotted with trees, through which subterranean streams make their way. The ascent to the summit was not very difficult; and here a crater 350 feet deep was found, at the bottom of which there was a beautiful blue lake, from which, according to the legend, the Manchu race sprang. The white color of the mountain is due to the color of the disintegrated pumice of which it consists. The principal rivers of Manchuria have their source in the Chang Pai Shan.

THE WELLE.—We may expect that the problem of the Welle, which has baffled geographers for a long time, will soon be solved. *Le Mouvement Géographique* says that the government of the Kongo Free State has charged Captain Van Gèle with the exploration of this river. The results of Van Gèle's ascent of the Obangi in the 'Henry Reed' are shown in the sketch-map in *Science*, No. 233. As the rapids of this river hindered his further progress, another route had to be adopted, and Van Gèle has decided to take that of the Itimbiri (Lubi). The sketch-map shows that the rapids of the Lubi are only about thirty miles distant from the Welle, and that Junker's Alikobo, the most western point reached by him, is only a few days' march from that point. Van Gèle's expedition started on July 1, in the 'Henry Reed' and 'A. I. A.', to ascend the Lubi, and proposed to cross the country in a north-westerly direction. Having reached the Welle, he intended to follow it to its mouth, and thus to ascertain whether it is identical with the Obangi or not.

DELAGOA BAY.—Consul H. E. O'Neill gives some interesting information on the state of affairs in Delagoa Bay in the August number of the Proceedings of the Royal Geographical Society. As

two important routes to the mining districts of Transvaal start from Delagoa Bay, the latter place has gained considerable importance. Though it belongs to the Portuguese, British trade is rapidly extending over this part of the coast. Upon the roads from Lorenzo Marques, which is situated on Delagoa Bay, to the interior, Englishmen are establishing themselves, and begin to monopolize the trade with the Swazi country. Over the inner frontier English gold-diggers are advancing into Portuguese territory, and many claims have already been registered in the secretariat of the government of Lorenzo Marques. The natives form one of the chief channels for the spread of English influences throughout this district. They work for a number of years in the English colonies, and then return with what money they have earned. Thus English money has become the currency of the country. The Portuguese are working on a railway from Lorenzo Marques to Barberton; but the work is advancing very slowly, and it will probably be a long time before it will be completed. Delagoa Bay is the first point at which actual contact has taken place between the British and Portuguese in South Africa; and it will be interesting to see how the latter, who have confined themselves for more than three centuries to the shores of the bay, will resist, or adapt themselves to, the vigorous life that characterizes the former.

THE SAMOA ISLANDS.—It will be remembered that in 1886 the United States, England, and Germany sent special commissioners to the Samoa Islands in order to settle the troubles that had arisen from the lively competition of these nations. It was proposed to submit the report of this commission to a conference. The Samoan troubles date from the attempt of the German Government to grant a subvention to a German firm which had plantations in Samoa. At that time the Americans, particularly Colonel Steinberger, made strenuous efforts to give a firm basis to the American influence on the islands, and made a treaty with King Malietoa. The Germans made a treaty with the same king in 1884, while the British consul tried to bring about an annexation of the islands by the colony of New Zealand. In course of time King Malietoa began to favor the Americans, and therefore the Germans supported his adversary, Tamasese. A short time ago the Germans, while the work of the commissioners was still going on, sent four men-of-war to Apia in order to demand compensation for certain plunderings. As Malietoa refused to pay, five hundred men were landed, and Tamasese was declared king of Samoa. Malietoa, who first intended to resist, followed the advice of the American and British consul, and submitted. It has been said that it is proposed to divide the islands among the three powers, but this seems improbable. The islands are at the present time of great importance, but this will be still more the case when the canal through the American isthmus is open, as they form an important station between Australia and America.

BOOK—REVIEWS.

The Social Question. By J. H. OERTER. New York, E. Glaeser.

DR. OERTER has produced a small volume on the social question, which is all the more interesting because it is from the hand of a theologian. It does not derive any special authority from this fact, but it is indicative of what that profession is beginning to realize in its capacity of public teaching. It signifies the ultimate, although perhaps gradual, emancipation from traditional speculations that have no relation to the present sphere of human conduct and duty. Theological speculation, like poetry, may have a place in our fancies and ideals; it may even exercise a very wholesome influence in stimulating thought and action upon higher planes: but it must not set itself up for fact, nor ignore the existence of facts. No class of teachers needs a knowledge of social questions, facts, and forces more than the ministry, and we are glad to know that the number is increasing of those who find time and interest for studies vital to the moral growth of the future. Dr. Oerter's book is one of a number which enable us to measure the possibilities of the ministerial profession in forwarding the cool consideration of scientific facts. Dr. Strong's 'Our Country,' although a missionary appeal, and Heber Newton's 'Study of Social Questions,' form a kind of companion issue with this in point of general thought. They are not large and thorough treatises from men who have

nothing else to do, but they show a very healthy development among a body of men who can more than hold the balance of moral and social power in the world, if only they have the knowledge on the one hand, and the courage on the other, to improve their opportunities.

Christianity in its inception was a moral and social reform, and not a body of dogmatic and traditional beliefs about either the past or the future. The foremost of the ministry are beginning to see this, and to return to the original conception of it, by what one author candidly though forcibly admits to be "in one sense a *backward* movement." Much is to be hoped for in this tendency, and it is worth recording here as a generous welcome to those who can appreciate the force and value of scientific truth, abandon their diatribes against science, and fall into line with the inevitable course of history, which usually has an optimistic outcome, unless nature has to avenge itself for the systematic pursuit of error and wrong.

The volume under notice consists of the 'Vedder Lectures' at New Brunswick Theological Seminary; and the keynote to the discussion is well expressed in the reason assigned for the present revolutionary tendencies, that "the actual inequality of possessions is regarded by the great mass as standing in direct opposition to the generally acknowledged equality of the individual rights of all men." In former times men did not have their equality or their rights admitted, and hence neither arguments nor force could avail to defend them. The author shows from Bockh that three-fourths of the population of Greece were excluded from the benefit and protection of the law; from Gibbon that one-half the population of Rome consisted of slaves, and that not more than 13.5 per cent of the population of Attica possessed real estate. The concentration of power which such a system required was enormous, and no wonder the liberation of the masses from its abuse is accompanied with alarming symptoms. But it is a pleasure to see the ministry recognizing the scientific methods of studying such facts, and not relying upon their speculations about baptism, inspiration, and the trinity to regenerate society. The author wisely treats socialism, whether legitimate or not, as an effect, a phenomenon to be accounted for, something having a cause for its existence, and not to be gotten rid of until its causes were removed. True to his profession, the views of the Old and New Testaments upon property are briefly outlined and candidly handled; but he frankly admits that "any attempt to construe out of passages of the New Testament a specific Christian idea of *property*, will always fail." This is not to exclude ethical from all relation with economical questions. It is acknowledged that we must reckon with the selfish instincts of human nature in all schemes of social government, at least until those instincts are modified. The discussion of the principles of Ricardo and the so-called 'Manchester school' is fair; and more is sympathetically narrated of Proudhon, Fourier, Karl Marx, Lasalle, Louis Blanc, and the whole history of socialistic movements, than most men of theological propensities have the will to read. But there is no disposition to espouse the vagaries of those men, although their agitation and beliefs receive the acknowledgment of being scientific facts which have to be studied.

The solution of the problem is a very good chapter, as admitting the place of ethical considerations along with economical in deciding the issue of the question. Here the author has the opportunity for urging the Christian aspects of the case, which is done in a way quite foreign to the usual homiletic method. It is made a purely scientific question of ethics and political economy. We cannot agree with him, however, that the socialism which he condemns has its support in atheism, and must be destroyed by uprooting the latter. It is a re-action against the traditional method of solving social and moral problems. The age of authority is past, and nothing but facts with reasoned scientific truth based upon them can meet the exigencies of the case. Atheism has its evils, but it will be harder to overthrow this than the system of socialism.

Brief Institutes of General History. By E. BENJAMIN ANDREWS. Boston, Silver, Rogers, & Co. 12°.

WE do not remember having seen any book which is of so much service to the advanced student of general history as this. As a guide to *seminar* work in history, it would be of the greatest value. It is dedicated to Professor Todl of Breslau, whose 'Geschichte

der Ethik' is well known to our students of philosophy; and there is no lack of congruity between the work itself and its dedication to a philosopher, for it is eminently philosophical, both in scope and in treatment. Professor Andrews calls his book a 'precipitate of general history,' and this describes it excellently. It is not an outline, and it is not a skeleton, but 'precipitate' seems to us a very happy designation.

The body of the work falls into eleven chapters, the first dealing with history and the study of history, and the last with Prussia and the New Empire. Each chapter is subdivided into short sections or paragraphs, and each of the latter is accompanied by bibliographical references of great minuteness and accuracy. In this way the student is enabled to hunt down any particular period or episode with great ease, and post himself fully before proceeding. Then each chapter is preceded by an elaborate and more general bibliography, the preparation of which shows wide reading and scholarly research.

The full value of Professor Andrews's volume cannot be appreciated by a cursory examination. We are sure that its excellence of arrangement and treatment will be seen best when it is in use. As a guide to the scientific study of history, or as a skeleton for *seminar* work, it is not surpassed by any book in the language.

Nyström's Pocket-Book of Mechanics and Engineering. Revised by W. D. MARKS. Philadelphia, Lippincott. 24°.

AS the author remarked in his first preface, every engineer should make his own pocket-book, as he proceeds in study and practice, to suit his particular business. This work was accumulated in this way during the author's professional career, and was first placed before the public in 1854. The reviser has principally confined himself to corrections in the original text, but has added an elementary article on dynamic electricity, and also one on the expansion of steam; and in notes the reviser has taken occasion to express some differences of opinion, and has referred to the literature of topics which required more space than can be given to them in a pocket-book.

Elements of Analytical Mechanics. By PETER S. MICHIE. New York, Wiley. 8°.

THIS volume, as the preface states, is a revised edition of the text taught to the cadets of the United States Military Academy during the session of 1886-87. Together with a brief chapter on hydrodynamics, it is intended to comprise a four-months' course of instruction for students well versed in elementary mathematics. The subjects treated of, after the elementary chapters on matter, force, motion, the physical units, stresses and motive forces, and gravity, are those usually taken up in a treatise on this subject. The book closes with a theory of machines. The arrangement of the subject-matter, and method of treatment adopted, are such as have received the approval of several able scientific officers who have been associated with the author in the instruction of cadets.

On the Conversion of Heat into Work. By WILLIAM ANDERSON. New York, Van Nostrand. 12°.

THE Council of the Society of Arts invited the author of this work to deliver a course of lectures upon the conversion of heat into useful work; and these lectures, which form the basis of the present work, were delivered in the winter of 1884-85. The object of the lectures was to popularize the doctrine that in heat-engines the work given out is due to the conversion of the molecular motion of heat into the visible motion which it was desired to produce, and further to illustrate, by numerous practical examples, the applicability of the doctrine of Carnot to defining the limits within which improvement in the economical working of heat-engines was possible. In the hope of making the modern views with respect to the action of heat more real and practical, the author adopted the method of working out his investigations by means of numerical examples, and comparing the results with those obtained in actual practice. All those who are interested in the elementary instruction

of physics will find this book an extremely valuable aid, and full of suggestions. The chapters on other forms of heat-engines besides the ordinary steam-engine tend to make the subject more interesting, and place in the hands of the teacher a vast amount of important information.

The Elements of Qualitative Analysis. By WILLIAM A. NOYES. Terre Haute, Ind., Moore & Lanzen. 12°.

PROFESSOR NOYES'S little book on qualitative chemical analysis is a very brief and highly condensed account of ordinary modes of proceeding in qualitative analysis of a simple kind, and the reasons thereof. Of the properties of the elements considered, only such are discussed as are immediately applicable to the scheme of analysis, though the deficiency in this respect is supplied to a certain extent in the table of re-actions, for which the author acknowledges indebtedness to Biedermann's 'Chemiker-Kalender' for 1887. Of course, such a book may serve profitably as the foundation merely, upon which the judicious instructor erects the superstructure of his teaching, and for such use it will doubtless find place. It is clearly written and well arranged.

Elements of Modern Chemistry. By ADOLPHE WURTZ. 3d Amer. ed. Tr. and ed. by W. H. GREENE. Philadelphia, Lippincott. 12°.

THE appearance of the third American edition of this well-known and excellent text-book bears witness to its popularity. The present edition is based upon the fifth French edition, and is brought well down to date.

Quantitative Chemical Analysis by Electrolysis. According to original methods, by DR. ALEXANDER CLASSEN. Tr. by WILLIAM H. HERRICK. New York, Wiley. 8°.

It is perhaps not unnatural that an author who is also an investigator should attribute to methods of his own finding greater importance than he is inclined to yield to the devices of others. Upon some such presumption only does it seem possible to explain the presence of the phrase 'according to original methods' upon the titlepage of Professor Classen's book. Scarcely more than half the fundamental methods of electrolytical analysis which are described or referred to are the author's own; and even in the schemes for the separation of elements, and in the special applications, where the original methods are employed to the utmost possible extent (and sometimes, it is to be feared, to the exclusion of more suitable ones), recourse has been had in fully a fourth of the cases discussed to the processes of others. For many years a few electrolytical methods have held high rank, and justly, among precise analytical processes, and recently the number of such has increased. To note that these are recognized (though too scantily) in the text, if not on the titlepage, is gratifying. Professor Classen has rendered great and undoubted service to analytical chemistry in arousing and directing attention to the uses of electricity in chemical analysis; but stress of severe experience (to detail which would be out of place here) compels the suggestion with reference to some, at least, of the 'original methods' that, before applying them in work demanding close accuracy of results, to scrutinize carefully and test by experiment is the part of wisdom.

Elementary Trigonometry. By T. ROACH. Oxford, Clarendon Pr. 12°.

THIS work on elementary trigonometry is the result of many years' experience in teaching the subject, both as assistant master in Repton School and as a private tutor. The book-work is divided into short portions, and at the end of each portion is introduced a set of examples illustrating the point just taught. The total number of examples in the text is more than a thousand, and to these is added a graduated collection of two hundred miscellaneous questions. The author expresses a hope to include a collection of more difficult questions on the same part of the subject in a subsequent work on higher trigonometry. At the end of the book is given a collection of papers recently set in some of the principal examinations in England, in which a knowledge of elementary trigonometry is required.

NOTES AND NEWS.

THE interior department of Canada has received advices from the exploratory survey party sent to northern British Columbia, near the Alaska boundary-line. Dr. Dawson, who is in charge, will return to Ottawa before winter sets in. The other section of the expedition, under the direction of Mr. Ogilvie, has been gathering general information regarding the country, and making a general survey. Considerable data have been gathered regarding the disputed boundary-line between the Dominion and Alaska. This, when completed, will be transmitted to Ottawa, when diplomacy will settle the boundary question. Mr. Ogilvie proposed to winter near Fort Reliance, a point about one thousand miles north of Victoria. After obtaining more men, he will endeavor to penetrate across country as far north as the mouth of the Mackenzie. His proposal to increase his party is simply a precautionary measure, as he was informed that the Eskimos on the Arctic slopes are very troublesome. He will start for home by another route, ascending the Mackenzie River, and entering civilization in the North-west Territory. He expects to reach Ottawa next fall.

— The Canadian Government is making an effort to settle the troubles at Metlakahla, which were mentioned in the last number of *Science*. Mr. A. Vankoughnet, deputy minister of Indian affairs, left on Oct. 4 for British Columbia. He has been intrusted with the task of investigating the troubles among the Metlakahla Indians, who are removing to Alaska. Bishop Sillitoe of New Westminster, British Columbia, has for the past week been the guest of Sir John A. Macdonald, the Canadian premier. It is understood that he visited Ottawa specially to urge the government to back down with the hope of persuading the Indians to remain on British soil.

— The Nautical Society of Hamburg has offered a prize of 500 marks for the best essay on the subject of calming the sea by the use of oil. An exhaustive description of experiments of the effect of oil made up to the present time is required; also a criticism of the arrangements used so far, and especially complete directions for its use by large steamers and sailing-vessels, as well as small vessels, — pilot, fishing, and life-saving boats, — besides directions for the use of oil at sea and near the coast. The essays are to be written in English or German, and sent before Nov. 1, 1887, to the president of the Nautical Society, director of the Navigation School, Capt. F. E. Matthiesen, Hamburg. Competition is not limited by nationality.

— According to *Nature*, the Syndics of the Cambridge University Press will publish early in October two works on elementary chemistry. One, intended as a companion to lecture-work, is by Mr. Pattison Muir and Dr. Charles Slater: the other, intended to be used along with the book already mentioned, is a course of laboratory work by Mr. Pattison Muir and Mr. Carnegie. Both books deal with the subject of elementary chemistry in a manner somewhat different from that usually adopted in text-books.

— Bulletin No. 35 of the United States Geological Survey, on the physical properties of the iron carburets, by Carl Barus and Vincent Strouhal, is a continuation of the work published in Nos. 14 and 27, and the investigation is still incomplete. This contribution is devoted to the internal structure of tempered steel, and the color-effect produced by slow oxidation of iron carburets. Bulletin No. 36, on the subsidence of fine solid particles in liquids, by Carl Barus, has a more obvious bearing on the proper work of the Geological Survey, since this and kindred investigations have already thrown much light upon the process of sedimentation.

— The 'Digest of the International Law of the United States,' which has been prepared by Dr. Francis Wharton and issued from the government printing-office in three volumes, is a splendid work. The able editor has brought together a most valuable collection of material, and arranged it in excellent order. This work will long remain our standard reference-book on topics of international law.

— The number of steamers existing in the world last year is estimated, says the *Journal of the Society of Arts*, at 9,969, of an aggregate burthen of 10,531,843 tons. The corresponding number of steamers existing in the world in 1885 was estimated at 9,642, of an aggregate burthen of 10,291,241 tons. The total of 9,969 steamers, representing the world's steam-shipping in 1886, was made up as follows: iron steamers, 8,198, of an aggregate burthen of 8,911,406 tons; steel steamers, 770, of an aggregate burthen of 1,206,962

tons; composite steamers, 109, of an aggregate burthen of 32,820 tons; and wooden steamers, 822, of an aggregate burthen of 380,655 tons. Of the steamers afloat in 1885, 5,792 were owned by the United Kingdom and its colonies, their aggregate burthen being 6,595,871 tons. The other countries of the world owned steamers as follows, last year: Germany, 579; France, 509; Spain, 401; the United States, 400; Norway, 287; Russia, 212; Denmark, 200; Italy, 173; Holland, 152; Brazil, 141; Japan, 105; Greece and Turkey, 82 each; Belgium, 68; Chili and the Argentine Republic, 43 each; China and Portugal, 27 each; Hawaii, 21; Mexico, 15; and miscellaneous, 50. It will be seen, that, notwithstanding the great depression prevailing in steam-shipping, the number of steamers afloat has increased to the extent of 327, as compared with 1885.

— The official returns quoted from the *Wochenschrift für Brauerei* for the first six months of the current year show the export of a total weight of 64,079 tons, being an excess of 2,789 tons as compared with the same period of 1886, but representing a decrease of 13,281 tons as against the first six months of 1885. There has been a progressive export during the earlier part of the last three years to Hamburg, Bremen, Austria, Switzerland, and Sweden, while deliveries to France and Belgium have fallen off. There is an increase this year in exports to Holland and Denmark. Trade with Great Britain and Russia has been larger than in 1886, although not up to the mark of 1885; while there is a decrease in shipments to the United States, Italy, and Spain, as compared with 1886. Imports from Austria were for the three six-monthly periods,

5,433, 6,236, and 6,829 tons; and from Great Britain, 404, 441, and 504 tons. Thus it will be seen imports have, on the whole, been increasing. The imports from Austria have always been much in excess of the exports to that country, but formerly imports from Great Britain were inferior in quantity to the direct exports thither. The quantities were as nearly as possible equalized during the period under review, but it is conjectured that a portion of the beer nominally exported to the Hamburg district was subsequently forwarded to England.

LETTERS TO THE EDITOR.

. The attention of scientific men is called to the advantages of the correspondence columns of *Science* for placing promptly on record brief preliminary notices of their investigations. Twenty copies of the number containing his communication will be furnished free to any correspondent on request.

The editor will be glad to publish any queries consonant with the character of the journal.

Correspondents are requested to be as brief as possible. The writer's name is in all cases required as proof of good faith.

Stone 'Daggers' from Missouri.

The following may be worth recording. A few days since, near this place, a farmer, digging to make a pond, in land that has never been under cultivation, found a 'deposit' of five chipped stone 'daggers' (or spear-heads?). I enclose an outline sketch of one the exact size of the specimen. The 'daggers' are of chert, and so much alike in material, that one can easily suppose them made from pieces of the same mass of stone. The workmanship, as indicated by the finish of the implements, is of superior merit. Each implement is chipped to a sharp edge all around, even at the base. They are all in perfect condition except No. 2, which received small breaks on one side of base and at extreme tip of point as it

was dug up. Four of them are nearly same size, — about seven inches long, one and a half inches wide at broadest place, and about one-fourth of an inch in thickness along the middle line. The fifth is half an inch shorter, one and one-fourth inches in greatest breadth, and nearly half an inch thick. It is hardly so well finished as the other four.

When found, they were all lying close together, their flat sides in contact, and points up, evidently so placed intentionally. They were buried about two feet below the surface of the ground. They are now in my possession.

Fayette, Mo., Sept. 30.

J. W. KILPATRICK.

Over-Pressure in the Schools.

I THINK it is an unfortunate fact that our public-school system is not elastic enough to mould itself to the needs of the individual. Grades are a necessity in it, and grades must be quite rigidly fixed. But I think that the parents can mould the system so that there shall be no over-pressure. A great source of trouble is that the parents often positively encourage the pressure. A mother brought to me her daughter, a shamefully overworked high-school scholar; no exercise, except the walk to and from school. If this mother takes my advice, and sends word to the teacher, "My daughter is not going to stand at the head of her class any more; if necessary, she will be honestly and healthily at the foot," the teacher may reply, "Then she cannot graduate, and have a diploma." Then the mother must mould the public-school system to her daughter's needs, and say, "Then she will not graduate. I am content to have



STONE DAGGER FROM MISSOURI.

it so." Perhaps she will not say this, for parental pride is one cause of the over-pressure.

Another cause is parental laziness. It is easy to keep a boy employed evenings by compelling him to stay at home and study his lessons. Otherwise he must either be allowed to choose his own amusement, in the house or out of it (which, of course, is not the best thing), or the parents must have him on their minds, and provide amusements for him, or at least have an oversight of his recreations, which is a trouble. In practice, too many parents either let their children roam the streets at night, or beg the teacher to give their children enough to do, so that they must have some lessons to occupy their evenings.

E. P. KING.

Providence, R.I., Oct. 8.

Silver in Oregon.

I FIND silver in minute quantities in several of the eruptive rocks of north-western Oregon. The upper lava-flows on the Portland Hills contain, as far as I have investigated them, amounts ranging from one-tenth of an ounce per ton (or .000034 of one per cent) to one-fourth of an ounce (or .000085 of one per cent). The lava in question is a scoriaceous micro-basalt, very much decomposed in the exposed portions, but becoming sound and hard at a few feet depth.

Specimens of volcanic tufa from an immense deposit in the western foot-hills of the Cascade Range, near the Clackamas River, yield from a 'trace' of silver up to the surprising quantity of six ounces per ton (or .0002 of one per cent).

In the assays I employed the scorification method, using test lead devoid of silver.

HERBERT LANG.

Portland, Ore., Sept. 30.

SCIENCE

FRIDAY, OCTOBER 21, 1887.

THE ENDEAVORS of the Australian colonies to raise money for resuming explorations in the Antarctic regions have so far been unsuccessful. The funds for rewards for whalers extending their cruises beyond the sixtieth degree of latitude have not been appropriated, and, since Allen Young's offer to take command of an expedition of this kind, nothing has been done. Sir Graham Berry has, in accordance with instructions from the government of Victoria, asked the British Government if they would contribute the sum of £5,000 towards an Antarctic expedition, provided the Australian colonies agreed to contribute a similar sum, and the subject is now under consideration by the British Government. The financial state of the Australian colonies is not very satisfactory at the present time, and therefore it is not likely that an energetic attempt will be made. The movement for resuming these explorations originated in Germany; but so far nothing has been done there to raise money and to send out an expedition, as the activity of explorers is almost exclusively directed towards Africa and the islands of the Pacific Ocean. Our American whalers are those who have the most immediate interest in the matter, as they frequent the neighboring seas and derive considerable quantities of whale-oil from that region. A few years ago one of them landed on m Grahra Land, and found near its shores an abundance of sea-animals; but as he had no authority to visit those dangerous latitudes, and as the ice was closing upon his ship, he did not continue his explorations. We do not think that the endeavors of the Australian colonies will be successful for some time to come, and it would be gratifying if meanwhile American enterprise would take up this important problem, in which no nation is more interested than we are, as our vessels are those which visit the Antarctic waters most frequently, and as a successful approach is most probable close to the south point of our continent. Arctic navigation shows that progress is always most promising under the shelter of land. Graham Land can be reached comparatively easy; and under its shelter, that is, on its eastern coast, important discoveries without great risk, and at no great expense, can be made. This would be a task for one of our whaling-masters who, in their swift schooners, navigate year after year the ice-covered waters of the Arctic Ocean.

IN A RECENT SERIES of articles, the London *Chemical News* has sought to show the importance of scientific research to nations, and in the closing article of the series encounters what is the main question with Englishmen, whether the present position of science in the United Kingdom is satisfactory, and, if not, why not. Answering its own queries, *The Chemical News* says, "To the former of these queries scarcely any one has the boldness to reply in the affirmative. Were all well with us in this respect, why that feeling of dissatisfied excitement rarely felt on any subject which does not fall within the programme of faction? Why do we send out commissions to scrutinize the state of scientific and technical education in continental countries? Why do we institute new colleges and training-schools of different grades, and why propose, as it has been lately done, new parliamentary action in this direction? Why do we hear complaints made, not merely at the gatherings of purely scientific bodies, but among men of business, that in this important respect, and in comparison with rival nations, we are not holding our own, not to speak of gaining ground? That along with this feeling of discontent and this craving for improvement there is an undercurrent of indifference, or even of hostility to

science, is but too true. Why, else, should Sir Henry Roscoe, in his late presidential address before the British Association, remark that science was less respected in Britain than in other civilized countries? Or how could a well-informed German contemporary take occasion to say that Britain had, whichever party happened to be in power, 'a government very unfavorably disposed to science and to her disciples' (*Eine der Wissenschaft und ihren Jüngern sehr abhold gesinnte Regierung*)? In fact, notwithstanding all that has been done of late years, all the efforts made, and all the money expended, many of the complaints urged in Babbage's 'Decline of Science' still hold good. It can no longer, indeed, be said that there is in all the universities of Britain not a single person engaged in any train of original research. We recognize with pleasure that experimental science has obtained a footing in our ancient seats of learning, and that fairly efficient laboratories—chemical, physiological, and biological—have been or are being organized. Whether these institutions, when compared with those met with abroad, e.g., at the University of Strasburg, are fairly commensurate with the importance of their task and with the wealth of the country, is another question. But we have still to complain of the paucity of research issuing from the British universities. We have tilled and manured the soil, and scattered the good seed; but the harvest, so far, is of the scantiest."

THE 'UMBRIA'S' WAVE.

MR. HENRY TOYNBEE, marine superintendent of the English Meteorological Office, has published in *Nature* of Sept. 29 a report by William Watson of the 'Umbria's' wave. Captain Watson, who is general superintendent of the Cunard line of steamers, states that no doubt there were some big waves knocking about the Atlantic on the morning of July 26, but nothing more than could, under the conditions of weather, be expected. There is no evidence of other steamers meeting an exceptionally big wave.

Abstract of Log, SS. 'Umbria.'

Date.	Wind.	Bar.	Air.	Water.	Remarks.
July 25.					
Noon	S. W.	29.60	62°	62°	Strong wind and overcast.
4 P.M.	W. S. W.	29.50	60°	61°	Fresh wind and shower.
8 P.M.	W. by N.	29.45	60°	61°	Fresh wind and clear.
Midnight	W. by N.	29.31	60°	62°	Moderate gale, force 9.
26th.					
4 A.M.	N. W. by W.	29.42	59°	61°	Moderate gale and squally, force 9.
8 A.M.	N. W. by W.	29.50	60°	62°	
Noon	N. W. by W.	29.70	59°	62°	

"4.40 A.M., sea came on board over the bows, breaking No. 2 companion-hatch, twisting the forward bridge, breaking some iron stanchions on the bridge, breaking the short bridge between the forward end of the promenade deck and the break of the forecasteel, and bending the brass rails on the port side of the main upper bridge, leaving the lower bridge intact. 8 A.M., fresh gale, force 9, with a heavy, confused sea. Noon, gale moderating and the sea going down, but still confused."

At midnight on the 25th the wind was freshening from west by north, and the weather becoming squally. A long, heavy sea was coming from west-south-west, but the ship was only taking an occasional spray over all. At 2 A.M., 26th, the wind was west-north-west, a gale, with heavy and frequent squalls, sea rising fast from north-west. At 4, the wind had veered to north-west, with heavy and frequent squalls. At this time the west-south-west sea was still very heavy, with a high north-west sea running across and over

it, making a very high and confused sea; but the ship was making 16 knots, and, though the spray was flying fore and aft, she had not up to this time taken a drop of solid water on board.

At 4.40 A.M., latitude 50° 50' north, longitude 27° 8' west, the officer of the watch noticed a heavy-breaking sea coming from the north-west: he ordered the officer at the engine-telegraphs to reduce to 'half speed,' but, before this could be done, the top of this sea came on board, but did no damage. The ship rose quickly to it; but, as this wave passed under the stern, she plunged heavily, and, dipping her bows into the second wave,—not breaking, or, as the officer of the watch expresses it, 'dead water,'—scooped up a mass of water, which, running aft over the break of the fore-castle, fell upon No. 2 companion-hatch, breaking it to pieces, also breaking the short bridge between the fore-end of the promenade deck and the break of the fore-castle. The look-out bridge between the lighthouses was twisted, and five iron stanchions and 20 feet of the iron rails on it broken, and four brass stanchions on the port side of the upper main bridge were bent. The middle part of the top-gallant fore-castle deck for 40 feet in a fore-and-aft line was sent down two inches by the weight of the water passing over it. Some water got down No. 2 hatchway and frightened a few passengers.

The second officer is certain that the first sea did no damage, as only the top of it broke over the ship; but he describes the plunge the ship took, as this wave passed astern, as very heavy, and that she went bows into the solid water of the second wave, which he is quite certain was not breaking, but 'coming smoothly along.' This made the ship "stagger, and the sensation was as if she had struck something hard." After the sea came on board, the speed was reduced to 10 knots, and was not increased till noon.

The canvas screen on the port side of the upper main bridge was spread, and the spray striking this bent the brass stanchions. The lower bridge escaped, through there being no canvas screen spread.

Although the wind was three points on the starboard bow, with a heavy sea from the same direction, it seems, from the brass stanchions on the upper main bridge having been bent aft and to starboard, and from certain marks on the fore-castle deck, that the second officer's statement, as to the damage being done by the second wave (probably due to the west-south-west sea, which was still running high and fast), is correct; and on more than one occasion, serious damage has been done by a sea coming up on the lee bow and breaking on board hours after the wind had been blowing three or four points on the other bow.

If we take into consideration a long and heavy sea from west-south-west, a north-west gale, and heavy sea from the same quarter, we shall have an ugly, confused sea. If a very powerful ship with very fine lines is driven at the rate of 16 knots through this confused sea, there is not the least occasion to call in the aid of tidal or earthquake waves to account for any damage the ship would receive.

In the engine-room there was no shock felt, and the sailors and firemen say they did not notice any thing unusual, save only some passengers making a noise.

The masthead light was extinguished through the chimney being unshipped and falling across the wick.

THE SHORTHAND CONGRESS.

THE first international shorthand congress ever held was inaugurated in London, Monday evening, Sept. 26, under the presidency of the Earl of Rosebery. We condense the report of the proceedings from an article in *The Athenæum* of Oct. 1. Though held in commemoration of events in the history of English shorthand, its interest is by no means confined to the English-speaking race, and several leading representatives of continental systems were present; while others, though not able to attend in person, sent papers on the theory and practice of the art as used in their respective countries. It is, indeed, acknowledged by common consent that England was the mother-country of modern shorthand, and that the tercentenary of English shorthand is the tercentenary of the shorthand of the world. Very little value can be assigned to the invention of Dr. Timothy Bright, which is nominally the event commemorated. It seems to be far inferior in every respect to the Tironian notes of the time of Cicero; but it is the earliest English

work on shorthand known to bibliographers, and it was followed, at an interval of only some fifteen years, by a series of publications (beginning with that of John Willis, 1602) based in the main on the same principles as are now generally employed.

France began with adaptations of the well-known English system of Taylor, but the more recent French systems follow generally a plan peculiarly their own. Their alphabet of consonants contains letters of two different lengths, but of one thickness, and their vowels consist of loops and hooks which are written in with the consonants, the finer distinctions of vowel-sound being indicated, when necessary, by detached accents. These accents are seldom or never used in fast writing: the French reporting style may therefore be described as employing a few very simple vowel-signs written in with the consonants.

The German systems are still more characteristic, being what are called 'script' systems; that is, systems which employ, instead of straight lines and circular arcs, characters requiring the same movements of the hand as the letters of common writing. The vowels are very fully expressed, sometimes by characters of their own (which are usually either upstrokes or horizontal strokes), but more frequently by modifications of the form or thickness of the consonants. It will be easily understood that these forms, not being geometrical, lend themselves with special readiness to varieties of modification, just as the Gothic style of architecture is more adaptable than the Grecian. The indication thus given is often a mere general indication of the presence of a vowel without showing what the vowel is.

The founder of the German method was Gabelsberger, whose first publication is dated 1834, and his system is still the most widely used of all. Its most prominent representatives at the congress were Dr. Zeibig, professor of the Royal Stenographic Institute, Dresden, well known for his historical publications; and the Rev. J. Alteneber, domvicar of Passau, in Bavaria. It is used for reporting the debates in the Houses of Parliament of Austro-Hungary, Saxony, and Scandinavia. Next in order, both of time and of present popularity, comes the system of Stolze, first published in 1841, but since largely modified. It is used in reporting the proceedings of the Imperial Parliament at Berlin, and was ably represented at the congress by some of its leading professors and practitioners, notably by Dr. Max Bäckler, parliamentary shorthand-writer, Berlin. Two other systems, those of Arends and Roller, have also an established position, but were not, so far as we are aware, represented at the congress. The total number of shorthand societies using these four systems is given as about 1,000, and the number of adherents about 25,000.

The French systems were represented by four parliamentary reporters from Paris; and the chief stenographer, M. Guenin, though not able to attend in person, sent a paper which was read in the congress.

In America the systems mostly used are modifications of Isaac Pitman's, one of them bearing the name of his brother Benn Pitman, while two others, which aim at a higher degree of abbreviation, are known as Graham's and Munson's. Graham's was represented by Prof. W. D. Bridge of Chautauquay University, who is an expert writer, and well informed upon the state of shorthand in America. He was, so far as we know, the only member who crossed the Atlantic to attend the congress.

The first day of papers and discussions brought out several points of interest. A well-devised list of questions on parliamentary reporting had been sent to foreign countries as well as to English colonies; and the replies, which were both numerous and full, had been ably condensed into a *précis* by Mr. Gurney-Salter, the shorthand-writer to the Houses of Parliament. A lively debate ensued, in which some of the leading men from the gallery (notably Mr. Storr of the *Times*) took part, as well as some of the foreign representatives, Dr. Max Bäckler especially distinguishing himself by his ready command of the English language. The inadequacy of the accommodation provided for reporters in the Houses of Parliament, especially as regards difficulty of hearing, was made painfully prominent, while in other countries they are for the most part placed in the body of the house, in the best situations possible.

It is the practice in the French Senate to employ always two official shorthand-writers at the same time to check one another,

and the same practice prevails at Berlin and elsewhere. There was some discussion as to the advantages of this practice. The chief advantage claimed for it by Dr. Bäckler was that it afforded better facilities for hearing, as some orators speak from the tribune, and others from their seats. One of the two writers remains in his official place in front of the tribune, and the other places himself near the speaker for the time being. In America a complete verbatim report of all debates is printed at the public expense. It is even more complete than the debates themselves, as it frequently contains speeches which are not actually delivered, but only taken as delivered (if we may use the expression), owing to lack of time.

The congress, if it serves no other purpose, will at least serve to show the general public of England that there are other systems doing good work in the world besides the one with which they are best acquainted. Mr. Gurney-Salter read a paper giving valuable information as to the official and non-official reporting performed by the staff who work under his direction. Each 'shorthand-writer' has his own 'shorthand clerk,' to whom his notes are carried every half-hour, and who reads them aloud to two longhand clerks at once, the shorthand-writer all the time never leaving his place, but writing on continuously for two, three, or more hours. When his 'turn' of writing is over, he begins to revise the longhand transcript, which is read over to him while he follows it in his own notes. This is the process pursued in taking the evidence at parliamentary committees, and about 2,800 words of manuscript are produced per hour. All the 'shorthand-writers' but one use the Gurney system, and this one is a phonographer.

Mr. Gurney-Salter also gave some interesting information as to changes which have gradually been introduced in the mode of writing certain words. Comparing the present mode of writing with that in use at the beginning of this century, he described the changes as including a briefer writing of certain words, but as consisting chiefly in two things; namely, the writing of every word separately, and a fuller insertion of vowels—not initial vowels, for they were always inserted, but vowels in the middle of words. These medial vowels are inserted by lifting the pen and writing the remainder of the word in position.

AFGHAN LIFE IN AFGHAN SONGS.

In *The Contemporary Review* for October, 1887, is an article by James Darmesteter on Afghan life in Afghan songs. Mr. Darmesteter has much to say on the political relations of Afghan to the British Empire of India, but introduces his article with some account of the native folk-songs. On the night of the 7th of April, 1886 (Wednesday, 11 P.M.), as he was sitting in the garden of his bungalow at Peshawer, gazing at the stars and the silver moon, etc., Mr. Darmesteter heard his Afghan *chaukidar* (life and property not being very safe at Peshawer, it is usual to keep an armed watchman, called *chaukidar*), old Piro, of the Khalil tribe, muttering in a broken voice fragments of a song that sounded like a love-song. He asked him to repeat the song to him. 'This he modestly declined to do for a long time, but at last he gave way, and began,—

"My love is gone to Dekhan, and has left me alone;
I have gone to him to entreat him.

'What is it to me that thou shouldst become a Raja at Azrabad?'
I seized him by the skirt of his garment and said, 'Look at me!'"

Here old Piro stopped, and neither for love nor for money could he prevail upon him to go on: his *repertoire* was exhausted. But Mr. Darmesteter's interest had been awakened, and from that night he resolved to collect what he could of the Afghan popular poetry. The field was new and unexplored. English people in India care little for Indian songs.

He had gone to the border to study the Afghan language and literature, but had soon to recognize that the so-called Afghan literature is hardly worth the trouble of a journey from Paris to Peshawer. It consists mainly of imitations and translations from the Persian, Arabic, and Hindustani. For a time, under the Moguls, an original and free spirit permeated those imitations, and Mirza Ansari, the mystical poet, or Khushhal Khan, prince of the Khatak tribe, would be accounted a true poet in any nation and any literature. But these are rare exceptions, and the theological

¹ Hyderabad, a favorite place of resort for Afghan adventurers and *soldats de fortune*.

lucubrations of the much-revered Akhun Darveza, that narrow, foul-mouthed, rancorous, and truly pious exponent of Afghan orthodoxy, the endless *rifacimenti* of Hatim Tai, the most liberal of Arabs, of Ali Hamza and the companions of the Prophet, or the ever-retold edifying story of Joseph and Zuleikha,—all seem as if they had been written or copied by mediæval monks or unimaginative children.

The popular, unwritten poetry, though despised and ignored by the reading-classes, is of quite a different character. It is the work of illiterate poets: but it represents *their* feelings; it has life in it,—the life of the people; it is simple, because the natural range of ideas of an Afghan is simple and limited; it is true to nature, because it represents those ideas without any moral bias or literary after-thought. Sometimes, therefore, it is powerful and beautiful, because it renders simply and truly powerful passions or beautiful feelings.

During a few months' stay on the border, Mr. Darmesteter collected about one hundred and twenty songs (to be published, with text, translation, and commentary, in the *Bibliothèque Orientale* of the French Asiatic Society) of every description,—love-songs, folk-lore, hymns, romantic songs, and political ballads. If we want to know what an Afghan is, let us put all books aside and receive his own unconscious confession from the lips of his favorite poets. The confession, it is to be feared, would not be much to their honor on the whole, but it will be the more sincere. This is the value of the wild, unpremeditated accents of these people: a poor thing it is, but it expresses their nature.

The Afghans (*Afghan* is their Persian name; their Indian name is *Pathan*; their national name, *Pukhtun* or *Pushtun*) are divided into three independent groups:—

1. The Afghans under British rule, or what we may call the Queen's Afghans, who inhabit the border districts along the Indus, Dera Ismail Khan, Bannu, Kohat, Peshawer, and Hazara. They were conquered in 1849, with the Sikhs, their then masters.

2. The Afghans of Afghanistan proper, or the Emir's Afghans, — the only part of the race that forms something like an organized power.

3. The Afghans of Yaghistan, "the rebel or independent country," that is to say, those Afghans who do not belong either to the British Raj or to the Emir, but live in the native national anarchy in the western basin of the upper Indus,—Svat, Buner, Panjkora, Dher, etc. The Afghan of Yaghistan is the true, unsophisticated Afghan.

The songs were collected in the British districts of Peshawer and Hazara, but most of them express, nevertheless, the general views of the Afghans to whatever part they belong: for though there is no real nationality amongst the Afghans, yet there is a strongly marked national character; and though nothing is more offensive to an Afghan than another Afghan, still there is nothing so much like an Afghan as another. Moreover, many of these songs come from Yaghistan, or Afghanistan. Songs travel quickly. The thousands of *Powindas* that every year pass twice across the Suleiman range, bringing the wealth of Central Asia and carrying back the wealth of India, bring also and carry back all the treasures of the Afghan Muse on both sides the mountain; and a new song freshly flown at Naushehra, from the lips of Mohammed the Oil-Presser, will very soon be heard upon the mountains of Buner, or down the valley of the Helمند.

There are two sorts of poets,—the *Sha-ir* and the *Dum*. With the *Sha-ir* we have nothing to do: he is the literary poet, who can read, who knows Hafiz and Saadi, who writes Afghan Ghazals on the Persian model, who has composed a Divan. Every educated man is a *Sha-ir*, though, if he be a man of good taste, he will not assume the title. Writing Ghazal was one of the accomplishments of the old Afghan chiefs. Hafiz Rahmat, the great Rohilla captain, and Ahmed Shah, the founder of the Durani empire, had written Divans, were 'Divan people,'—*Ahli Divan*, as the expression runs. The *Sha-ir* may be a clever writer, he may be a fine writer; but he has nothing to teach us about his people. We may safely dismiss him with honor and due respect.

The *Dum* is the popular singer and poet, for he combines the two qualities, like our *fongleur* of the middle ages. The *Dums* form a caste: the profession is hereditary. The *Dum* is despised

by the people with literary pretensions, who fly into a passion when one of these ignorant fellows, flushed with success, dubs himself a *Sha-ir*. He is not a Pathan by race, though he has been *pathanized*; he is a low sort of creature, whom the Khans and Sardars treat as the mediæval barons might have treated the itinerant *Jongleur*,—despised, insulted, honored, liberally paid, intensely popular amongst the people.

The novice *Dum* goes to a celebrated *Dum*, who is a master, an *Ustad*: he becomes his disciple, his *shagird*. The master teaches him first his own songs, then the songs of the great *Dums* of the present and past generations. The *Ustad* takes his *shagirds* with him to the festivities to which he has been asked, private or public, profane or religious: he takes them to the *hujra*, the 'common house' or town-hall of the village, where idlers and travelling guests meet every night to hear the news that is going round, and listen to any man that has a tale to tell or a song to sing. The *Ustad* pockets half the sum given by the host, and the other half is divided between the *shagirds*. When a *shagird* feels he can compose for himself and is able to achieve a reputation, he leaves his master and becomes himself an *Ustad*. I am sorry to say that *Dums* generally are not over-sensitive about literary honesty: plagiarism is rife among them. A *Dum* will readily sing, as his own, songs of the dead or the living. It is the custom that poets should insert their names in the last line: you have only to substitute your own name for the name of the real author or of the former plagiarist. People will not applaud you the less, though of course the injured party may retort with a satire or a stab. A good *Dum* may die a rich man. Mira would hardly open his mouth anywhere under fifty rupees. He was an illiterate man: he could not read, but he knew by heart a wonderful number of songs, and could improvise. You would ask him for a song in a certain shade of feeling; then he would go out with his men, and an hour afterwards they would come back and sing a beautiful chorus on the rebab. His song of 'Zakhmê' is sung wherever there are Afghans, as far as Rampor in Rohilkhand, and Hayderabad of Dekhan, and sets them a-dancing as soon as the first notes are struck. It was sung at the Ravul Pindi interview as the national song of the Afghans, though it is nothing more—or, rather, nothing less—than a love-song. An Irish journalist—Mr. Grattan Geary, of the *Bombay Gazette*—was struck with its melody, and had it printed. It is probably the only Afghan song that has ever been published (two songs have been translated by Mr. Thorburn in his book on Bannu, and another by Colonel Raverty in the introduction to his Afghan grammar).

The people piously inclined object to song, among the Afghans as well as elsewhere; and the Mollahs inveigh against the *Dums*. There is only one occasion when even a Mollah will approve of the song of a *Dum*: it is when the Crusade, or, as the Anglo-Indians say, the Crescentade, has been proclaimed; then is the time for the *Dum* to rehabilitate himself, as he sings the glories of the sacred war, the bliss reserved to the *Ghazi*, the roses that grow for him in the groves above, and the black-eyed hours that come from heaven and give the dying man to drink of the sherbet of martyrdom. But, in spite of the Mollahs, the *Dum* is as popular in his profane as in his semi-sacred character. Song is a passion with the Afghans; in fact, one of the few noble passions with which he is endowed. Whenever three Afghans meet together, there is a song between them. In the *hujra*, during the evening conversation, a man rises up, seizes a rebab, and sings, sings on. Perhaps he is under prosecution for a capital crime; perhaps to-morrow he will be hunted to the mountain, sent to the gallows; what matters? Every event of public or private life enters song at once, and the *Dums* are the journalists of the Afghans. Possibly the *Dum* of to-day has preserved for us faithfully enough a picture of what the Bard was with the Gauls.

ENGLISH COIN-SALES OF 1886 AND 1887.

As the English season for coin-sales will soon begin again, *The Athenæum* gives its readers some information on the general results of those which have taken place during the last ten months. The coin-selling year may be said to commence in November, and to end in July: sometimes it is extended into August, but, if so, it

never oversteps the first week of that month. Even between November and August there are certain periods which have to be avoided, especially immediately before and after Christmas and Easter. The reason for these precautions arises from the circumstance that collectors of coins are comparatively few, and some of the largest buyers live out of London: consequently those who have collections to dispose of must be careful to offer their wares for sale when these rare birds are most likely to be in town. Sales of pictures and china will generally secure a good attendance, but not so is it with coins: so these precautions must be taken.

Coin-sales may be divided into two classes,—ancient and modern; the former dealing chiefly with the coinages of Greece and Rome, the latter with those of nations of modern times. It will be found, on looking through the sale-catalogues of the last season in England, that those of modern coins predominate. Of ancient coins there have been only three collections sold: viz., a portion of the stock of the late William Webster, the well-known dealer, Dec. 22; a collection of "a gentleman relinquishing the pursuit," June 14 and 15; and a cabinet of select Greek coins, June 27 to July 1. On the modern side there have been three sales of four to six days each, in December, May, and August: others of the war medals, etc., of Capt. E. Hyde Greg; the coins of the late Joseph Mayer of Liverpool; of the late Archdeacon Pownall, vice-president of the Numismatic Society; and of Major W. Stewart Thorburn. There has been one very important sale in Paris of Roman and Byzantine gold coins, belonging to the Vicomte Ponton d'Amecourt; but, as we are concerned chiefly with what has taken place in England, we shall not enter into any particulars of that sale, beyond remarking that the prices yielded on that occasion far surpassed those of any previous sale of this class of coins. We mention it as it attracted many English buyers.

A general glance at the above-mentioned catalogues will show that there is, and has been for some few years, a considerable falling-off in the prices of ancient coins, while a more than corresponding increase has taken place in the sums realized by modern coins and medals. Rare and fine Greek and Roman coins will always command a market, but these pieces are exceptional; and a general good average depends principally on the more ordinary pieces in silver and on the copper coins. The sale of a "cabinet of select Greek coins" in June and July, when the catalogue was issued, bid fair to witness some big prices; but unfortunately, when the coins came to be examined, by far the greater portion, at least of the rarities, were pronounced to be forgeries, and the consequence was that those collectors who went to London bent on making some good purchases for their cabinets returned home with their purses but little lightened. It was a bitter disappointment to many; but it has served as a warning, to those who have collections to dispose of, to be careful and see that what they offer for sale is 'above suspicion.' A coin, before it passes from the auctioneer's hands into those of the buyer, has to undergo a severe and critical examination. It is turned over and over, its merits or demerits are discussed on all sides, and, if any doubt is expressed as to its genuineness, rumor soon spreads the doubt, and it is generally doomed. In the sale referred to, among the false coins there were many genuine pieces, and some of considerable rarity; but their character was damaged by their false brethren, and they paid the penalty of being in such bad company. The other sales show a fair average of prices for the finer pieces, but a very low one for the more common ones, especially those in copper. As an illustration we may give a few examples. Syracusan decadrachms, or 'medallions' as they are more commonly called on account of their size, realized for £19 to £20 10s.; a tetradrachm of Naxos, with seated figure of Silenus on the reverse, £7 10s.; similar coins of Aenus, £10; of Akanthus, £7 7s.; of Ariarathes IX., king of Cappadocia, £18; an electrum stater of Cyzicus, £13; a tetradrachm of Antiochus VI. of Syria, £12, etc. These pieces are all somewhat rare; but, when we examine the lots containing the smaller silver coins and those of copper, we find as many as twenty or more going for only a few shillings. These results are very disappointing, especially to those who formed collections some years ago, and consider them in the light of invested capital.

Let us now turn to the modern side, and see what is taking place with English coins and medals. Other European coins, for the

most part, must be placed outside our consideration. They never had a market in England. The fact is, these coins are much too numerous for any private individual to make any thing like a representative series of each class, and their acquisition must be left to national collections, where one naturally expects to find every coinage well represented. The result of our observations on the English side of numismatics will be found to be just the reverse of those on ancient coins, and in all cases prices have considerably advanced. Taking the sales of the last twelve months or so, we will note the prices of a few pieces, none of which can be said to be of very great rarity. Pennies of William the Conqueror, when fine, sold from £2 to £2 10s. each; a light groat of Henry VI., £7 10s.; another of Edward V., £7 5s.; a crown of Elizabeth with *u. m. 2*, £7 5s. and £7 10s.; another of James I., with reverse inscription *QVÆ DEVS CONIVNXIT NEMO SEPARET*, a common type, £7 17s. 6d.; an Oxford crown of Charles I., £11 11s.; Tanner's copy of the sixpence of Cromwell, over £50; a half-broad of Cromwell, £32 15s.; a half-crown *hammered* of Charles II., £8 8s.; a proof crown of George II., £11 5s.; a pattern crown of William IV., £21 10s., etc. Such prices as these a few years ago would have been deemed almost incredible. Even the ordinary pieces, if in any thing like fine condition, of the reigns of the Georges, William IV., and Victoria, many of which are only just out of currency, and some few still current, cannot be purchased excepting at high prices; and the copper coins and tokens of the seventeenth and eighteenth centuries have risen several hundred per cent in value. A corresponding result is also shown with regard to English medals of all classes. For some years the value of English coins had been rising steadily, but it was the Shepherd sale in 1885 which gave the great impetus, and since that time it would appear as though collectors do not place any limits on their bids if they happen to come across desirable acquisitions.

How, then, can this great change be accounted for? The answer to this question is a very simple one. The old class of coin-collectors is fast diminishing, and a new one has sprung up in its place. Twenty years ago there were in England a considerable body of collectors of ancient coins, but now they can almost be counted on one's fingers; while, on the other hand, for one collector of English coins there are now ten. This falling-off in the old stock is much to be regretted; for many a man in advanced life has been induced, by the sight of Greek and Roman coins, to open those books which had remained closed since he left school or college. On these small pieces of metal we find illustrated the myths of the gods and heroes of the Greek world; we are brought face to face with the portraits of the great generals of ancient times, Alexander the Great, Lysimachus, Julius Cæsar, and Pompey, of the long line of the Ptolemies of Egypt, of the kings of Syria, Cappadocia, and Bactria, and of the still longer series of Roman and Byzantine emperors and empresses. The student of palæography, too, will glean much information from the examples of various ancient alphabets, such as the Lycian, Cyprian, Phœnician, Greek, and Latin; and to the metrologist are laid open the various systems of weights employed by the great nations of the ancient world, and through these the principal lines of trade of the Greeks and Romans. The artist, too, will find on coins the various phases of ancient art clearly defined. They show art in its origin, in its growth towards perfection and in its perfection, in its decline, and in its degradation. These are but a few of the charms offered by the study of ancient numismatics, and it is these which will be lost when coin-collecting is abandoned.

Fortunately, while the general taste for these objects in England appears to have been on the wane, those who remained constant to the study of ancient numismatics have worked with all the more ardor, and in few departments of learning has more progress been made in the last few years. But the results of these labors, till recently, have never been embodied in a compact form, and were only to be found scattered over many volumes of periodicals and journals. The Clarendon Press has, however, taken the matter in hand, and, under the guidance of Mr. B. V. Head, has issued a 'Manual of Greek Coins' ('*Historia Numorum*'), which gives in a concise form the history and description of ancient Greek numismatics (*Athen.*, No. 3098, p. 357). It also deals with their art, metrology, types, etc. The work commences with the coinages of

Europe, beginning with that of Spain, and, journeying eastwards to Greece proper, crosses over into Asia, and ends with the series of Africa. This is the order adopted by Eckhel over a century ago, and, being generally accepted by numismatists, has been followed by Mr. Head. The work does not claim to be complete, for it was impossible to aim at completeness when the author was so limited in space; but nevertheless the student of Greek numismatics will find in it all that he needs at first, and when he has mastered it, if inclined, he can easily turn to the more lengthy dissertations, a list of which is given by Mr. Head in his introduction. The work is of so recent a date that the extent of its influence on the numismatic world cannot at present be gauged; but that it will bear good fruit we do not for a moment doubt, and it may even increase the list of those collectors whose falling-off we are now regretting.

We may add that what has been done by Mr. Head for Greek numismatics had recently been done by several other well-known numismatists for English coins and medals; and this may, perhaps, in some degree account for their popularity at the present time. Two new editions of Hawkins's work on the silver coinage have been issued, Mr. Kenyon has written on the gold coins, Mr. Montagu has described the copper coinage, and Hawkins's long-promised work on English coins has at last appeared.

HEALTH MATTERS.

Grinder's Consumption.

DR. CANEDY of Shelburne Falls, Mass., recently read a paper before the Franklin District Medical Society on grinder's consumption, being the results of his observations on the grinders employed by a cutlery company at that place, numbering, on an average, forty men and boys for the past twenty-five years. During the ten years just ended, twenty-three grinders have died with chronic disease of the air-passages, and three are now confined to the house with similar affections; and five in whom the disease has made considerable progress are still at work in the cutlery. Of all the occupations in which the workers are compelled to inhale an atmosphere loaded with irritating dust, as coal-mining and iron and metal polishing, none seems more certain or fatal in its effects than grinding. Investigations made at Sheffield, Eng., fix the average period which grinders can work at thirteen years. The first symptom which manifests itself is cough, soon followed by shortness of breath upon exertion, as walking up hill. During all this time an inflammatory process is going on in the lung, which results in a gangrenous or purulent condition; the patient having fever, and often a terrible cough. During this attack the patient is confined to bed from ten to twenty weeks. After six weeks an abscess forms in the lung, and, when the pus is expectorated, improvement begins. The progress of some cases is exceedingly slow; some of the patients living ten years or more, after being compelled to leave the shop by their cough, most of the time in chronic invalidism, and dying at last from the exhaustion dependent upon pulmonary disease.

In spite of all treatment, the inevitable tendency of the disease seems to be toward a fatal termination, and Dr. Canedy states that he has never seen any recoveries. The picture which is given us in this paper is a most distressing one; and it would seem that some attention should be paid to the subject by those in power. The improvements which have been made in unhealthy trades by the substitution of sanitary for unsanitary conditions have been so marked that some of them can certainly be applied to the reduction of the great suffering and mortality among the cutlery grinders. The State Board of Health can here doubtless find an opportunity to do more good work in a field in which it has so long and so well labored.

THE CHILDREN OF NEW YORK.—At a meeting of the New York County Medical Association, Dr. Charles A. Leale presented a paper on the prevention of chronic disease among the children of New York City. The facts which formed the basis of this paper were obtained by Dr. Leale and his associate physicians, from their gratuitous visits to the tenement-houses of this city during the summer of 1886. Their work extended over a period of six weeks, during which time they visited 3,659 families, representing 7,146 adults and 10,086 children. Of these, 217 adults and 3,376 children

were found sick; measles, diphtheria, scarlet-fever, scrofula, and syphilis being the prevailing diseases. In nearly every instance the sick children were not only without proper medical attendance, but were living in places rendering complete recovery to the majority almost impossible. To give the sick children the benefit of fresh air, 6,312 free tickets were distributed for the excursions of the St. John's Guild Floating Hospital, where they and their parents were given a sufficient quantity of good foods. Twenty-four very sick children were sent to a hospital on Staten Island, where they remained for a week or two. In the final report of one of these physicians, he gave it as his opinion that the great death-rate among children under five years of age was attributable to over-crowding, filth, filthy habits, and bad drainage. He says, "Upon a hot summer's day to enter a room in a rear house, whose walls were cracked and besmeared with refuse, and perhaps dead vermin, occupied by a family of six or eight, harboring three or four boarders, upon the floor of which might be seen soiled linen, particles of food, and children, with a mother standing about the red-hot stove, washing and cooking, and perhaps attending to a sick child, lying in a dark bed-room, suffering from cholera-infantum, diphtheria, or scarlet or typhoid fever, was a spectacle frequently indeed brought to my attention." Another physician observed a great number of cases of diseases of the eye and ear, especially among those subjected to bad hygienic conditions. All the houses, without exception, were overcrowded and in a filthy condition, the rear houses being dark and badly ventilated. In one apartment having three rooms, from twelve to fourteen persons were often found; in some of these, father, mother, and grown-up sons and daughters all sleeping in one room, without any regard for delicacy or decency. A third member of this visiting corps describes the small yard of a rear tenement, containing an open cesspool, around which groups of sickly children were playing; these children being stunted in growth, pale, and, as a rule, having some form of ophthalmia. Of thirty children found in one of these small yards, only one could be said to be in vigorous health.

CAUSE OF TYPHOID-FEVER.—Investigations made by Beumer, Peiper, and others seem to have demonstrated that a ptomaine produced by the typhoid-bacilli when injected into animals may cause a disease resembling typhoid-fever. This ptomaine was discovered by Brieger, and named by him 'typhotoxine.' It is this substance, and not the germ directly, which is the cause of typhoid-fever in man, according to the most recent theory. The *London Medical Record*, in commenting on these researches, draws the following conclusions from them: "1. The symptoms and alterations observed in animals in which cultures of typhoid-bacilli had been injected are due to the toxic substances secreted by these bacilli. 2. The noxious germs, which secrete the typhotoxine, are reproduced in the intestinal canal. From these the ptomaine is taken up by the circulation, and carried to all the organs liable to be affected by this poison. 3. It is most probable that the same takes place in abdominal typhoid-fever of man. 4. A first infection induces immunity against the injurious effect of a later infection, even of large quantities of the toxic substance. 5. Further experiments and careful clinical investigations are necessary in order to establish a scientific support of the theory of immunity from infections of sterilized cultures containing not more than a determined quantity of typhotoxine. 6. In case this theory be an ascertained fact, the reproduction of the same immunity in man would be justified by commencing with very minute doses of typhotoxine, which would be gradually increased according to the results obtained."

A TEST FOR THE CHOLERA-BACILLUS.—Bujwid, in the *Zeitschrift für Hygiene*, describes a chemical test for the detection of the presence of the cholera-bacillus. He adds to a bouillon-culture of the bacillus from five to ten per cent of ordinary muriatic acid. In a few minutes a rose-violet color appears, which increases in intensity for half an hour. It remains unchanged for several days. This re-acton occurs in bouillon-cultures ten to twelve hours old, and in gelatine-cultures after twenty-four hours. The coloring is increased by heat. It is claimed by Bujwid that this color is characteristic of the bacillus of Asiatic cholera, and distinguishes it from all others.

BOOK—REVIEWS.

The Elements of Political Economy, with Some Applications to Questions of the Day. By J. LAURENCE LAUGHLIN. New York, Appleton. 12°.

THE author of this work is impressed, as many other people are, with the importance of a more general training in economic science. Almost all of the questions with which our national government will soon have to deal are of an economic character, or involve economic considerations; while the conflict between labor and capital shows the importance of economic science in purely industrial affairs. To supply the needed information, it will be necessary to introduce the study of economics into our high schools and academies, and for this purpose good elementary treatises are necessary. Such treatises, however, are by no means numerous; and hence a work like Professor Laughlin's is to be welcomed. It is intended as an introductory work merely, and for the use of schools: "The main topics are treated, the fundamental principles are emphasized, but no effort is made to produce a detailed and exhaustive treatise" (p. vii.). The author's object, we think, has been successfully accomplished. The adaptability of the work to school use must, of course, be tested by actual practice; but it certainly has many of the qualities that such a work ought to have. The division and arrangement of topics are excellent, and the style clear; while the choice of matter is appropriate to an elementary treatise. The work is divided into two parts, the first demonstrating the principles of the science, the second applying them to the economic problems of the day. The doctrines and method of the work are those of the standard English school. Indeed, that school seems to have been followed a little too strictly; for, though its method is the leading and most productive one, yet the comparative and historical methods have their uses.

Professor Laughlin gives the usual definitions of 'wealth' and 'value,' and the usual account of the agents of production. He lays special stress, however, on the important function in contemporary industry of the skillful industrial manager. In treating of exchange, he follows Mill in the main, while adopting something from Cairnes on the subjects of supply and demand, and foreign trade. On the subject of distribution he holds the views that have prevailed generally among English writers, with the fiction of the wages fund left out. He argues that "the proportional shares of labor and capital out of the product will depend upon the relative scarcity and abundance of labor and capital" (p. 186); while "the productiveness of a country's industries determines whether the general level of wages shall be high or low" (p. 198). Interest, or the share of the capitalist, he considers a reward for abstinence merely, while the profit of the industrial manager is treated as the wages of a superior kind of labor.

In the second or practical part of the work, Professor Laughlin seeks to apply economic principles to such questions as socialism, taxation, free trade, and others, while recognizing that such questions cannot be settled by economic considerations alone. His remarks on the subjects of money and taxation, if generally read, can hardly fail to be useful. He condemns socialism, as all economists do, and holds that the prosperity and advancement of the working-classes depend on their own mental and moral improvement. He favors individualism, and deprecates undue interference by the State, holding that "it is high time that the weak and narrow-minded recourse to the State for legislation on every conceivable subject should be abandoned for a greater growth of self-help and a more independent and self-confident manhood" (p. 349). The book may be commended not only for schools, but also for private students, and we should be glad to see it extensively read by the working-people.

Animal Life in the Sea and on the Land. By SARAH COOPER. New York, Harper. 12°.

IT is impossible to give, in large type, in the space of about three hundred double-leaded, duodecimo pages, a satisfactory account of several hundred species of animals, from the lowest to the highest. Yet this is what the author attempts in this volume; and she throws in, besides, a chapter on coral-reefs, and many pages about fossils. The result is a curious cross between a grammar-school text-book

on zoölogy and a child's picture-book of animals. The chapters are divided into short, numbered paragraphs, each headed with a full-faced subtitle, in the style of a school 'reader.' This, and the rather pedagogical style, render it nearly certain that young people will not read it; while the necessary sketchiness of its contents, and the innumerable omissions, render it nearly useless as a book of reference. It may have some value in the hands of a teacher as suggesting a series of topics for elaboration, but, even so, we are confident that the patient examination of half a dozen typical specimens would furnish better results than this fragmentary treatment of several hundred. It is essentially a compilation. After reading the book, one dare not swear that the author has ever seen a single one of all the animals described, unless it be some of the common sea-creatures of the Massachusetts coast. The illustrations are attractive, reasonably accurate, and many of them artistic. The mechanical part of the book is well done.

Die Psychischen Störungen des Kindesalters. Von Dr. H. EMMINGHAUS, Tübingen.

WHILE this work by an eminent German alienist is primarily designed for specialists, it contains a number of interesting observations valuable to all who are concerned in the training of children, and illustrating from an unusual point of view certain marked characteristics of child-mind. The limitation of 'childhood' strictly to the period before the establishing of the functions that connect the individual with the race is at once significant: it gives the physiological basis for much of what is distinctive in child-life, and accents the enormity of the field of thought and feeling which the approach of adolescence suddenly reveals. As mental disease is to a large extent a concomitant of civilization, and this in turn is dependent upon a general and prolonged brain-culture, it is easy to see that the child who has not yet reached the stage where character is established, where keen competition excites each brain-cell to a maximum of action, is spared a large proportion of mental disease. This fact, then, that mental diseases are far less common among children than among adults, with the further fact that the affliction of children by a large class of mental diseases not uncommon in adults is a sporadic occurrence, it is essential to bear in mind. Since the influence of a pernicious environment is responsible for only a small share of mental breakdown in childhood, it follows that heredity — 'the sins of the fathers' — is the great disposing cause. And this shows itself in the production of two classes of children: (1) those who from birth show the marks of mental deficiency or perversity, or who, without any accident or maltreatment, are sure to show such marks within a few years; (2) those who show almost no suspicious symptoms in early childhood, but in whom the strains demanded of a civilized city child cause mental breakdown. It is this last numerous class of children that is open to the wise treatment of the intelligent parent and teacher as well as of the knowing physician. Another noteworthy point is that the mental abnormality of a child can be determined only by reference to a normal child of the same age, and with an appreciation of certain traits, which, almost always pathological when occurring in adults, are within the range of normal individuality in children. The analogy between the acts of the insane and the traits of children is often drawn. This includes more than the degenerative processes of senile dementia (second childhood), and is shown, for example, in the passion for collecting all sorts of curiosities, odds and ends, and the like (common to certain forms of mania). The most striking instance of this analogy is that of the wantonness of the actions in the transition period between boyhood and youth, for which the Germans have the term *Fliegejahr*. Here there is all the recklessness of demeanor, bigness of plans, swaggering egotism, and excitable caprice characteristic of developed mania. But it is only in the presence of predisposing causes that this period leaves the region of the normal; and the frequency of runaways from home, and other cravings for a free roaming life that appear at this age, suggest that a rational outlet for this superfluous energy might be provided.

Leaving these general considerations, a few points of illustrative value should be mentioned. In an interesting chapter on suicides in children, Dr. Emminghaus accents the importance of one-sided precocity as a disposing factor. Ideas belonging to a more mature

period of life are by accident, by exciting literature or other cause, planted in a yielding brain, that has not yet acquired the stability of will, or the firm distinctiveness of moral habit, that keeps such weird notions from realization in action. Nothing could better illustrate the mischievous tendency fostered by competitive examinations, to goad children on ahead of their years, with a show of great brilliancy, but a brilliancy dangerous by lack of a sound physiological basis. The triviality of the alleged cause of suicide is only a further evidence of the abnormality (usually hereditary) of such children.¹

Idiocy and imbecility have always been the type of mental disease in children. Their ultimate relation with other forms of insanity is likewise well understood, and it has been spoken of as nature's method of cutting off the progeny of a degenerate strain. While by its nature incurable, modern study has succeeded, by an early appreciation of the condition, in rescuing all but the severest forms from the utter helplessness formerly so common.

Finally, this very imperfect sketch of Dr. Emminghaus's point of view should not be completed without mentioning that the sharply defined plan of his work prevents him from recognizing that host of mental affections whose germs are often innate, and whose prodromal symptoms often clearly manifest in childhood, but which come to distinct view only later in life, especially at the periods of intense physiological change.

The Relative Proportions of the Steam-Engine. By WILLIAM DENNIS MARKS. Philadelphia, Lippincott. 8°.

THE little book lying before us is a volume containing matter of value and interest to technical schools. It represents the first attempt which, so far as we are aware, has ever been made to determine, by correct methods and in any considerable detail, the proportions of the parts of the steam-engine. It is a singular fact, that notwithstanding the importance of the steam-engine, and its attractiveness to scientific writers on applied mechanics, no treatise of this character has ever before been produced. The general theory of the heat-engines has, especially during the present generation and since the time of Rankine and of Clausius' work, been written and re-written by many writers, great and small, and has been elaborated with all the ingenuity that such authors are capable of; but not one has hitherto had the good judgment, the patience, and the ability, to produce a good book on the proportioning of its rods and cranks, its fly-wheels and its cylinders. Some such work has been done by a few European writers; but none have devoted themselves to the production of a special treatise upon the subject.

Professor Marks has gone into the work with a zeal which could not but be fruitful of result, and has produced a book which will be of very great value to the profession and in the schools. Collating all that could be found in standard writers on the strength of materials and on machine design, he has added much useful material as the result of his own investigations, and has thus put into convenient form and into a single volume a very large amount of fact and calculation indispensable to the student in engineering and to the designer of machinery of this kind. A chapter is devoted to the study of the proportions of the steam-cylinder and the calculation of power; another to the sizes of bolts, areas of ports, and size of piston-rods. The proportions of fastenings, such as gibs and keys; the size and shape of the connecting-rod and its connections; the sizes, forms, and proportions of crank-pins, and the proportioning of the crank in wrought or cast iron and in steel, — form the subjects of succeeding chapters; and the size of the crank-shaft in the several available metals is calculated by carefully established formulas and rules. Among the best parts of the book are the studies of the effect of the fly-wheel, and its action as a regulator. This is probably the most complete and practically valuable discussion of this subject to be found. The last chapter, that on the governor, is the least satisfactory in the book; and it would seem that the writer had not yet worked up to that point in his progress toward his ideal of his book.

¹ It is interesting to note that even in children the modes of suicide in the two sexes are strikingly different. The boys in seventy-five per cent of all cases hang themselves, in fifteen per cent drown themselves, in three per cent poison themselves, and never stab themselves. Of the girls, only ten per cent meet death by hanging, but sixty-four per cent by drowning, thirteen per cent by poison, and eight per cent by stabbing.

Two chapters are given to the study of the 'limitations of the steam-engine,' a phrase of somewhat awkward form rhetorically, but which is familiar to all engineers interested in the subject as relating to the limits set to the efficiency of the machine by the counteracting influences of 'cylinder condensation,'—another awkward phrase, meaning condensation of steam in the steam-cylinder,—and of conduction and radiation or other forms of waste which distinguish the actual from the ideal engine. Here the author takes the hitherto unconquered bull by the horns, and gains the honor of having been the first to produce a rational formula embodying what are supposed to be the laws of this method of transmission of heat, and of loss of engine efficiency due to it. The resulting expression is somewhat complicated; but it is justified by experiment, so far as comparison has been carried by its author, and may be expected to stand until further progress is made in investigation of the actual conditions,—which are unquestionably far from being few or uninvolved,—and extended research shall have thrown more light upon a problem which is to-day the most important in the whole theory of the steam-engine.

Space does not permit the criticism in detail of this or of any other part of the book. It is rich in valuable material, and although, like the angels, not absolutely without fault, in the opinion of well-informed engineers, either in matter or in manner, deserves exceptionally high praise for its wealth of excellences.

The Ancient Cities of the New World. By DÉsirÉ CHARNAY. New York, Harper. 8°.

In the present volume Désiré Charnay gives the results of his long and careful explorations in Central America, which were begun in 1857. Since that time, all his energies have been directed towards the collection and preservation of the antiquities of that country. As the expenses of his expeditions were defrayed in part by the French Government, in part by an American citizen, Mr. P. Lorillard, his collections are deposited in the Trocadero in Paris, and in Washington: they are indispensable for all future studies of the culture of ancient Central America. The book under review is as well pleasant to read—describing, as it does, the travels of the author and the present state of the country—as of scientific value, giving the results of his studies, and showing in numerous splendid illustrations the ancient monuments and other kinds of relics, as well as beautiful views and characteristic groups.

It was the main object of the expedition with which the author was intrusted to collect authentic material for a thorough study of the ancient civilization of Central America: therefore his studies were almost exclusively directed to the collecting of relics, photographing of buildings and reliefs, and making casts of the inscriptions and bas-reliefs. The material he gives in this line cannot be excelled. His researches lead him to the conclusion that the American civilization at the time of the conquest was of comparatively recent origin. It is his opinion that all its branches bear the characteristics of Toltec civilization, and that, by studying the monuments, the migrations and the gradual development of Toltec art may be discovered. A map shows the author's opinion regarding the subject. He lets the prehistoric Toltecs immigrate from the north-west. From the plateau of the City of Mexico two branches emigrated,—the Gulf branch and the Pacific branch. Subdivisions of the former invaded Yucatan. He lets the two principal divisions meet in Copan, the south-eastern terminus of their migrations. "The Toltecs," he says, "migrated south, following the coasts of both oceans. They ceased to exist as a nation after the disruption of their empire; but their scattered remnants carried on the work of civilization in Central America, on the high plateaus, and in Anahuac, evidenced in the strong resemblance that the civilizations of these various regions bear to one another." The time of the erection of the largest buildings and temples he supposes to be about the twelfth century.

We cannot accept those theories of the author referring to the connection between the art of eastern Asia and Central America. A thorough and detailed comparison has never been made, and superficial similarities of monuments and customs cannot be a sufficient proof of a common origin.

Since the present volume was written, the author has accomplished a new journey to his favorite field of explorations, a pre-

liminary report of which is being published in *Le Tour du Monde* and in the *Globus*. The recent enterprise of this devoted explorer has not been less successful than the former ones, some results of which are fortunately made accessible in the volume just published.

Living Lights. By CHARLES FREDERICK HOLDER. New York, Scribner. 12°.

MR. HOLDER has thrown into a popular form the substance of what is known about phosphorescent animals, illuminated by occasional coruscations of imagination. Most of his readers will be surprised to learn that the power of emitting light is so widely shared by animals of all classes. Not only do fire-flies fly, glow-worms glow, and zoöphytes twinkle in the sea, but sea-anemones, alcyonarians, gorgonias, star-fishes, earth-worms, crabs, shell-fish, lizards, frogs, toads, fishes, birds, monkeys, and men must be added, according to Mr. Holder, to the number of animals capable of giving forth light. In the author's preface, he says, "In the United States there are ten thousand enrolled young naturalists, comprising the Agassiz Association. As one of a committee solicited to answer questions propounded by the young people, . . . I have often been surprised at the nature of the queries, which shows that this army of young observers includes many who are not merely collectors of curiosities, but are naturalists in the best sense. They are systematic inquirers, and working in the right direction to become scientists, should they continue. It is to these young scientists . . . that this volume is addressed." While we welcome any book that will serve to awaken in the young an earnest desire to study nature, and while this fascinating volume will certainly awaken interest, it is all the more to be regretted that the author is so fond of pyrotechnical natural history. He loves to hear the sigh of pleasurable surprise that rises from his audience as he sets off a pyrosomatic rocket, or kindles pavonian flame. This fault appears especially in the illustrations, which, for young people, should be accurate, since from them they derive their lasting impressions. Not to rely on our own judgment, we quote the author's own words, "It is evident that illustrations of the phosphorescence of marine animals must be more or less conjectural;" and again (the Italics are ours), "In Plate XXVII. [XXVI.?] an ideal view is given of the possible appearance of the light of a large heron." There is no excuse for 'conjectural illustrations' and 'ideal views of possible appearances' in a book of this nature. They are distinctly misleading and wrong, and have the obvious and inevitable effect of throwing discredit on some of the more highly-colored portions of the text, into which the phosphorescence of herons, lizards, monkeys, and men seems to have been admitted on very slender evidence. Those portions of the book which record the results of Mr. Holder's own observations are the most interesting, and perhaps the least illuminated by fancy.

The Ventilation and Warming of School-Buildings. By GILBERT B. MORRISON. New York, Appleton. 8°.

IT seems a long leap from Rosenkranz's 'Philosophy of Education,' which opened the International Education Series, to this successor, which discusses practical schoolhouse-building. But Dr. Harris shows how catholic his conception of education is by including the two books in the same series.

Mr. Morrison truly says that no "subject has been more carefully and intelligently studied than the direct and ultimate effects of impure air on the human system, and on no subject is there more unanimity of competent opinion" (p. 18); but nevertheless the want of sufficient and definite information regarding the ventilation of schoolhouses is general. The lack of general information on this particular point is the more blameworthy, inasmuch as the effects of breathing impure air are not only pathological, but pedagogical and economic. The author instances this (p. 22).

A short chapter deals succinctly with the physical aspects of the air, and then the various tests for its examination are briefly described. The general theory of ventilation is illustrated by a simple experiment (p. 47); and then the natural and artificial methods of ventilation are discussed with more attention to detail. The remaining chapters discuss the general problems of ventilating and heating, and include descriptions of many of the expedients that are used for these purposes. The treatment of each question is abreast

of the times, and eminently satisfactory; and, if the book is referred to half as frequently as it should be, our schoolhouses will be healthier and better adapted to serve the purpose for which they are erected.

Azimuth. A Treatise on this Subject. By JOSEPH EDGAR CRAIG. New York, Wiley. 4^o.

THE determination of azimuth comes up as an important practical problem on board ship, in ascertaining the variation or deviation of the compass, or on land in fixing a true meridian line, and it is desirable that the necessary astronomical observations should be made under conditions which give, at least theoretically, the most accurate results attainable. Lieutenant-Commander Craig's book is a mathematical study of the spherical triangle with respect to the azimuth problem, supplementing the text-books, and he calls attention to certain statements in the latter on some points referring to the most favorable conditions of observation, which he regards as misleading.

After devoting several pages to the elementary formulæ for the solution of a spherical triangle, and the differential variations of its parts, he considers the conditions of maximum and minimum errors, and the most favorable and least favorable position of a heavenly body for observation in a given latitude. Two-thirds of the text are then taken up with an analysis of the equations to the loci of maximum and minimum errors, and the book concludes with some thirty plates illustrating these loci.

The Ethical Import of Darwinism. By JACOB GOULD SCHURMAN. New York.

THE excitement following the appearance of Darwin's works rendered a fair criticism of their merit and import impossible. The younger generation, who had been trained to some extent to think by the methods of which Darwin forms a model, were ready for the announcement, and were at once transformed into a body of enthusiastic followers. The older thinkers, and especially such as were by their profession devoted to upholding a theory of the universe established by tradition, and in entire opposition to the discoveries of science, met the new theory with violent protestations of inconsistency with established beliefs, and denounced it as fraught with danger to morality and the religious sentiment. It is only within a few years that the smoke has been lifted off the battle-field, and made it possible to calmly contemplate the justness and the outcome of the battle. As has frequently happened before, it is found that the party who asked, not "Is it true?" but "What does it lead to?" has been the loser. The general point of view of which Darwinism is an expression, the ingenious and valuable explanations which that master-hand collected, the healthy ferment penetrating through all departments of knowledge that his writing brought about,—all these have become the inalienable inheritance of mankind. On the other hand, the majority of evolutionists will admit that their doctrines have been regarded as solving certain vexed problems of mankind which really remain as unsolved as ever; and the province and exclusiveness of the mechanism of development which Darwin discovered have been likewise exaggerated. Recent writers, such as Romanes, are acknowledging the former and supplementing the latter. The one has been termed a 'pseudo-Darwinism,' and in addition to natural selection we speak of 'physiological selection,' and so on.

Professor Schurman's book gives every mark of having been written in the latter half of this decade. There is no attempt to dwarf or warp (much less ridicule) the evolutionary position: on the contrary, its strictly scientific character is appreciated, and its main tenets admirably sketched. Contrary to the usual method in such discussions, the author has taken the trouble to find out what Darwinism is. Nor do these negative virtues complete the list of the merits of the book. The author practically illustrates, by a vigorous and intelligible style, his opinion that "there is no theory, or criticism, or system (not even Kant's or Hegel's), that cannot be clearly expressed in a language which in Locke's hands was strong and homely, in Berkeley's rich and subtle, in Hume's easy, graceful, and finished, and in all three alike plain, transparent, and unmistakable." Moreover, each chapter is devoted to the expression of a real point without irrelevant matter or needless repetition. The

several chapters form a logical train of argument, and the book is thus worthy of the attention of the scientist. The unfortunate fact that so many works in this field are strikingly deficient in all these qualities makes it necessary to signalize the exceptional character of this work.

Professor Schurman holds that 'evolution' is a strictly scientific hypothesis warranted by facts, and is to be accepted, whether for the sake of argument or as a real belief, by all who seek to determine its ethical import. He denies that the system of utilitarian hedonism which Darwin and Darwinists have attached to the theory is at all a legitimate inference from that theory, and regards it as accidental, and due to the fact that these men were raised in this school of ethics. Darwinism is to him consistent with any theory of ethics, and does not favor one above another. As long as evolution simply explains the method of development, and not the fact that there is something to develop, a further philosophic theory is made necessary. In the second place, the author holds that the attempt of Darwin himself, as of his followers, to account for the existence of a moral sense, is deficient, and does not make unnecessary the assumption of an omnipotent and authoritative 'ought.'

To the reviewer's mind, this argument is open to the following criticism. In the first place, the 'ethical import of Darwinism' that we to-day are interested in is not that here discussed, but consists in very practical and momentous questions: 'How does heredity affect responsibility?' 'What does evolution show to be the best method of treating criminals?' It is in this field of practical ethics, formerly neglected or dogmatically passed upon, that the spirit of evolutionary research has and will radically modify our views and practices. Second, the author fails to recognize that the kind of chance with which evolution deals is synonymous with 'something that needs no explanation.' If I hazard the guess that a die I am about to throw will fall on 'six,' and it really does so, I say it is 'chance,' and thereby mean that it needs no further explanation. The fact that this 'chance' may have momentous consequences does not change its character. That there is a strong temptation to be dissatisfied with this casual answer will be readily admitted, and it is this temptation to which the author has yielded in a portion of his criticism. Finally, the fact that the followers of Darwin tend to take a view of life easily distinguishable from that of those who oppose him, is itself significant of the ethical import of Darwinism. It may be true that it is *a priori* as possible to be a Darwinist and at the same time an adherent of any one of a half-dozen schools of ethics; but, as a matter of fact, ethics takes its character quite as much from the relative order and dignity of the several virtues leading to the *summum bonum* as from the view of the *summum bonum* itself.

It would be unjust to close this notice without calling attention to the plea for a science of historical ethics, and the contribution to it, by way of criticism, of current theories of 'family development,' to which the last chapter is devoted.

NOTES AND NEWS.

A VOLUME of great interest to the meteorologists of the country has recently been issued by the National Academy of Sciences, containing the first chapter of a revision, by Prof. Elias Loomis, of his numerous 'Contributions to Meteorology,' or studies based on the daily weather-maps of the Signal Service during the last thirteen years. These contributions in their original form, as presented to the National Academy and published semi-annually in the *American Journal of Science*, considered one topic after another in sequence, determined by convenience rather than by system, and therefore were greatly in need of orderly revision for use by the many students who must make frequent reference to them. Translations and abstracts of the originals have appeared in France, England, and Italy; and a serviceable review and discussion of the results gained have recently been prepared by Mr. H. H. Clayton for the *American Meteorological Journal*; but a revision by the author of the papers himself has naturally an interest and a value of its own. Professor Loomis has performed a threefold service in this work,—first, in utilizing the weather-maps to an extent not approached by any one else in the country; again, in now systematizing the results gained; and, most of all, in developing his method of simple, inductive in-

vestigation, that will long stand as a model for meteorologists to follow. It is to be hoped that the later chapters of the work may appear in due time.

— Lieutenant Dunwoody of the Signal Service, who for a number of years has taken an active interest in developing the State weather-services, has recently accomplished a good piece of work in securing the adoption of a uniform system of summarizing and tabulating the data published monthly in the various State bulletins. Hitherto every State has had pretty much its own plan, and the change to a single form of statement cannot fail to be advantageous to all concerned. The reports of fifteen State weather-services are abstracted in the last monthly weather-review of the Signal Service.

— The second annual meeting of the New England Association of Colleges and Preparatory Schools will be held at the College of Liberal Arts, Boston University, Oct. 28 and 29. The programme of the meeting will be as follows: 'The Place of the Fitting-School in American Education,' paper by Prof. George T. Ladd of Yale University, discussion to be opened by Dr. Walter Q. Scott, principal of the Phillips Academy, Exeter, N.H.; 'Aims and Methods in Modern-Language Teaching,' paper by Mr. Samuel Thurber, master in Girls' High School, Boston, discussion to be opened by Prof. Richard A. Rice of Williams College; the following question may also be taken up for discussion: 'How can the Interests of Higher Education secure a more Appreciative and Hearty Support?'

— Dr. Simpson, health-officer at Calcutta, reports two simultaneous outbreaks of cholera, — one on land, and the other on the ship 'Ardenclutha,' — both being due to the same cause. The land epidemic was caused by drinking-water into which the dejections of a cholera patient had found their way. In the epidemic on board the ship it was demonstrated that milk had been drunk by those who afterwards suffered from the disease, and that to this milk cholera-infected water had been added.

— Mr. G. Taylor, in the *China Review*, March and April, 1887, gives the following amusing Chinese stories: A young tiger met an old one and said, "I got hold of a man to-day whose upper parts were so tasteless and his nether parts so sour, that, hungry as I was, I left him in disgust. I wonder what sort of a man this could be." — "A student who has had to buy his degree," was the reply. The Lord of Hades considered a certain spirit to have been a great sinner indeed, so he adjudged that he should re-enter the world to become a poor scholar with five children. "Is not that a rather light punishment?" remonstrated an angel. "No," said his Eminence, "the five hungry children will soon drive him mad." Chang and Chung mutually agreed to start a brewery. Said Chang to Chung, "You supply the rice, and I will furnish the water." — "But," queried Chung, "if the profits are divided according to the capital embarked, I am afraid it will be difficult to apportion your share." — "Oh, I'm not afraid," said Chang: "when the brew is over, give me the water; you can have the remainder." A man was seized by a tiger. The victim's son took his bow and pursued. "Hit him in the leg," cried the father, "else you'll spoil the market-value of the skin." A bibulous individual, on entering a restaurant, noticed that the wine-cups were small. After seating himself, he gave vent to a most demoniacal series of howls and groans. "What is the matter?" asked the startled landlord. "Ah!" answered the man, "my father, a hale, hearty man, met his death at a friend's table by accidentally swallowing a small wine-cup, so, whenever I see similar ones, the memory of the sad event overcomes me." It is needless to add that the cup was replaced by a larger one. A hard drinker dreamed that he had become possessed of a bottle of genuine stuff, but, determined to enjoy it thoroughly, he had begun to heat it. During the heating process he awoke. "Hoo, hoo!" he groaned, "if I had known this was to happen, I would have drunk it cold." A servant did not fill a guest's cup to the brim. The latter, holding it up, remarked, "This cup is too deep," and broke a piece off. "How is that?" cried the host. "If the upper part can't hold liquor, of what use is it?" was the smart retort.

— Dr. Daniel G. Brinton, professor of American archæology and linguistics in the University of Pennsylvania, will read twice a

week with students who desire to pursue these branches. The course on archæology will be associated with the examination of specimens and visits to typical collections. The readings in American linguistics will begin with the structure of American languages in general, and proceed to the special consideration of the Nahuatl and Algonkian groups.

— The *British Medical Journal* reports a case of leprosy which is believed to have been contracted through vaccination. A physician living in the tropics vaccinated his own son with virus obtained from a native child in whose family leprosy existed. At the time the virus was taken, the child gave no evidence of being affected with the disease, although subsequently it manifested itself in him. A third child was vaccinated by the physician with virus taken from his own son. Subsequently the son developed leprosy in a mild form; but the child who was vaccinated with virus taken from him had the disease in a most severe form, and died from it. The physician's son is now attending school in England, eminent physicians having given the opinion that there is no danger that the other students will contract the disease.

— A correspondent of *Indian Engineering* points out that the fibre industry of Burma is well worthy of attention and development, at a time when energy and capital are being expended in increasing the resources and industries of that province. The country abounds in fibre-producing plants, and the different species of bamboo, China-grass, and pineapple, grow wild everywhere. Some years since, an American missionary at Toungoo prepared a quantity of paper stock and fibre from these plants, and sent it to the United States, where it was manufactured into a superior kind of cloth, much resembling silk, and also into paper of different qualities. Subsequently the same gentleman modelled a loom from the bamboo, which he instructed the Karens how to use, and coarse cloth is now woven by them for their own use. Bamboo is pre-eminently the best substitute, if properly prepared, for esparto grass, rags, and other materials used in the production of paper, and it has been so stated by one of the leading authorities in England on commercial fibres. In Burma the bamboo grows in profuse luxuriance and variety. It ranges from the thickness of the ordinary rattan to two feet in circumference. The stems of the latter, the *Bambusa gigantea*, are used by the natives for water-pails. The bamboo needs preparation to fit it for commerce, like hemp, jute, and other articles, and this preparation, the writer argues, should take place in Burma. Favorable sites for erecting factories for this treatment are to be found on the banks of the Irrawaddy and Salween, where communication is easy both with the interior and the principal seaports. The fibres of bamboo, China-grass, and pineapple, can be treated in the same manner as jute, and spun so fine that an expert could barely distinguish the product from real silk. These fibres possess an advantage over jute, in that they require little chlorine when bleaching, and they remain stronger in consequence. At present large quantities of cloth woven from China-grass and bamboo are brought into the Rangoon markets by Chinese from Bhamo, and, although the material is not manufactured with modern looms, the quality appears so fine as to resemble tussore silk. The cultivation of jute as an experiment undertaken by the government was very successful. With a view to encourage the industry, the authorities offer to purchase good jute from Karen cultivators, and also offer a bonus for the largest production.

— By a decree dated July 20, M. Bihourd, resident-general in Annam and Tonquin, has laid down the regulations by which opium can be sold, wholesale or retail, or transported in the country. The exclusive right to open opium-shops in a district is given to a farmer or contractor, and is to extend over a definite area corresponding with one or more of the administrative divisions. A fee must be paid for each shop, of 100 francs in the three chief towns, 50 francs in the capitals of districts, and 20 francs elsewhere. Trading wholesale in the drug is only permitted in places where customs stations exist. Wholesale merchants must pay an annual tax of 600 francs for each place at which business is carried on, and they can sell only to the licensed farmers: they must keep a register open to official inspection, recording each sale, the name of the purchaser, and the place to which the opium was sent. Each

package containing more than a certain amount must be accompanied by a customs permit or certificate from the local farmer, and heavy penalties are appointed for breach of these regulations or infringement of the privileges of the farmers. The effect of the decree is to establish a monopoly in the trade in opium in the government, which will work through the licensed farmers. But no provision is made for the sale by public auction of the right to deal in opium, as is usual in British and other colonies where opium is farmed.

— We learn from *The Critic* that a periodical of a somewhat new character is to appear in The Hague (Netherlands). It will be a fortnightly in four languages,—English, French, Spanish, and Italian,—containing original correspondence on letters, arts, and science from London, Paris, Madrid, and Naples. A New York correspondent has been invited to contribute an American letter to the quartet already named. The object is to promote the study of languages. The editor of the new periodical is to be M. Taco H. deBeer, editor of *de Portefeuille*, the *Dutch Art Chronicle*, and *Literary Review*.

— A new process of electroplating natural objects, such as animals, flowers, and tissues, has been brought out in France, and, as described in *Engineering*, is as follows: An albuminous liquid is obtained by washing some slugs or snails in water to clean them, then placing them in distilled water until they give off their albuminous matter. This is filtered and boiled for an hour, then distilled water is added to make up for that lost by boiling, and also about 3 per cent of nitrate of silver. This solution is then kept in bottles hermetically sealed, and in a dark place. When required for use, about 30 grams of the liquid are mixed with about 100 grams of distilled water, and into this solution the objects to be electroplated are immersed for a few moments. They are then put into a bath consisting of about 20 per cent of nitrate of silver dissolved in distilled water, and afterwards submitted to the action of sulphurated-hydrogen gas, which reduces the nitrate of silver on the albumen-coated object. Thus treated, an organic object becomes fitted to receive the electro-deposited metal intended for it; and the layer is said to be of superior fineness to that produced by the other known processes for coating natural objects with metal by galvanoplasty. It shows the texture of the object with much delicacy.

— Improvements have been made at the glacial pot-hole on Colonel Hackley's land in Archbald Borough, Lackawanna Co., Penn. Mr. Hackley has generously appropriated the sum of five hundred dollars for the purpose of protecting it against the action of the weather, and also to make it more attractive to visitors. All the underbrush has been cleared and the ground graded, leaving the shade-trees standing, forming a little park. At present the pot-hole is divided in two by a wooden brattice for the purpose of mine-ventilation. All this timber-work will be taken out, so that the entire pot-hole can be seen.

— Reports of two journeys through Yemen have recently been published,—one of a German scientist, E. Glaser, who visited the country for the purpose of collecting Sabian inscriptions and manuscripts, in which he was eminently successful; one by the English major-general, F. T. Haig. The latter made only a flying trip through the country, starting from Hodeida on the western coast, to Sanaa, the capital, a distance of 140 miles, and from Sanaa turning due south to Aden, 260 miles. Including a week spent in Sanaa, the journey occupied, in all, thirty-one days. The object of the journey was to ascertain whether it might be possible to do any thing for the Christianization of the inhabitants. Glaser, on the other hand, staid in southern Arabia from October, 1882, to March, 1884, and from May, 1885, to February, 1886; and at the present time he is again at work in his old field. It is somewhat amusing to compare the statements of both travellers. Haig describes the severity of the Turkish taxation, and their cruelty against the natives. Glaser, on the other hand, praises the safety of the territories occupied by the Turks, and states that the English have no control whatever over the tribes inhabiting the colony of Aden, who receive an annuity amounting in the aggregate to twelve thousand dollars a year. During the last fifteen years the Turks have suc-

ceeded in establishing their authority in several parts of Arabia, but it is only in Sanaa that the influence extends into the interior. According to Haig's description, they cannot feel very safe here: "The town has an Arab population intensely hating the few thousand Turks by whom it is held down, heavily taxed, and generally obliged to furnish gratis the supplies required for the large garrison of Turkish soldiers. The latter are not allowed to go into the narrow streets for fear of assassination. There is a citadel at one part of the walls, with its guns turned significantly, not to the outside, but upon the town. Glaser staid most of his time in Sanaa, and made numerous excursions in the neighborhood. He made astronomical observations and surveys in addition to his important archaeological collections. The following notes are taken from his description in the Proceedings of the Geographical Society of Vienna. The west side of Arabia is occupied by a mountain-range from eight thousand to ten thousand feet in height. The western declivity of this range is very steep, falling abruptly to the Tihama, a plain about two thousand feet in height, with a gradual slope towards the sea. The eastern slope of the mountain-range is very gradual. The south coast of Arabia is also occupied by high mountains. While the high land between these ranges is a desert, the slopes are drained by numerous rivers, some of which are running throughout the year. The slopes of the mountains are highly cultivated, terraces being built from the summit of the range to its foot. Those which can be easily irrigated yield four crops annually, and are highly prized. Coffee is one of the principal products of this country. While Haig describes the climate of the high parts as wholesome and agreeable, it is quite the reverse according to Glaser. He says that malarial fevers prevail in the high land as well as in the low land. In Sanaa the temperature frequently falls below the freezing-point, and during the hottest season a temperature of 92° F. was observed. In winter the daily variations are very great, a temperature of 32° in the morning being followed by one of 68° after noon. The western slopes of the mountains are moistened by heavy fogs which every day ascend from the low land to the summit, though they do not extend into the interior of the country.

LETTERS TO THE EDITOR.

. The attention of scientific men is called to the advantages of the correspondence columns of *SCIENCE* for placing promptly on record brief preliminary notices of their investigations. Twenty copies of the number containing his communication will be furnished free to any correspondent on request.

The editor will be glad to publish any queries consonant with the character of the journal.

Correspondents are requested to be as brief as possible. The writer's name is in all cases required as proof of good faith.

The Scientific Swindler Again.

A MAN answering the description of the impostor given in previous numbers of *SCIENCE*, appeared at the rooms of the Boston Society of Natural History on Saturday last, having in his possession a microscope, which he offered for sale at a very low price. We suspected his character, but, having no charge against him, were unable to do any thing, and were in hopes he would return on Monday with his microscope, as he engaged to do. He did not return, and we could therefore do nothing. ALPHEUS HYATT.

Boston, Oct. 18.

Savagery in Boyhood.

EVERY thing, we suppose, must be considered hereditary in the present age; even the tendency to wear cocked hats, or to throw cabbage-heads on hallow eve. At any rate, the *Popular Science Monthly* for October brings this doctrine to bear upon the phenomena of savagery in boyhood, as noticed in *SCIENCE* of Oct. 7. The author explains that cruelty in children is the transmitted habit of ancestral savages, and observes that "the emotion of pity appeared late in the history of the race." In the same connection we may mention the intense interest which children take in narratives of warfare: torturing animals is a less general incident. But the callousness of children in contemplating the horrors of war and its consequences has always been an interesting fact to us. However, is no other analysis of this possible than the supposition that our savage forefathers were cruel? May we not be in danger of making

too much of heredity here? No doubt its importance cannot be exaggerated. But if, as the author admits, "the early appearance of the sympathies depends upon an early development of mental functions which are properly dormant until later in life," may not the cruelty of children be an incident of ignorance, and not due to the entire absence of pity? As admitted, pity is a state of mind which belongs to the reflective stage of consciousness, when we are able to compare ourselves with others, and, in however indistinct a form, to apply the method of doing as we would be done by. It is quite possible that children know nothing about the pain they inflict by cruelty and torture. They may be governed in their conduct by much the same curiosity that prevails to permit vivisection, and most probably never inflict pain for the sake of creating suffering. Blind Tom, when a boy, used to pinch and torment his brothers and sisters until they cried, and all for the sake of the pleasure he himself received from a new and peculiar kind of sound, his mind being interested in all sounds alike, and passing no intellectual or moral judgments upon their occurrence. It is no doubt much the same with most children until their experience enables them to realize a 'solidarity' of interests between themselves and others. Then they will begin to show sympathy and to shrink from producing pain, not because it is hereditary, but because social environment exerts such a pressure in favor of learning the consequences and moral significance of our actions. At the same time heredity cannot be ignored. But the phenomena of cruelty and pity are much more complex than heredity, while including it. Besides, it may be misleading to say that "the emotion of pity appeared late in the history of the race;" for it may not have been so much the sympathies that appeared late as the extent of their application. So of the individual. Pity may be instinctive, but the complicated range of circumstances which require its exercise may demand more knowledge and experience than are possible to childhood. Indeed, children may very early begin to cry from sympathy at the spectacle of suffering in others, when conscious of it, but are indifferent to its infliction upon animals, most probably because they do not realize any thing about it. Pity will show itself, then, in proportion to the extension of their knowledge of what is reciprocal to their own interests or sense of pain. Hence may we not say of sympathy, both in the race and in the individual, what T. H. Green said of humanity in comparing Greek and modern civilization; namely, that the standard of conduct in this respect was the same to the Greek as to us, but that more persons are to-day included in the right to be judged by it? That is, "the conviction of the brotherhood of all men does not bring a new conception of what is due towards those who have claims upon us, but a new view of the range of persons who have such claims." Certainly it seems a little violent to suppose the absence of sympathy altogether because the extensive conditions under which it is exercised at present were wanting in the earlier history of the race or of the individual.

J. H. H.

The Purslane-Worm (*Copidryas Gloveri* Grote).

DURING the past season the entire State of Kansas has suffered an invasion of caterpillars of a species not previously known to exist except upon the plains of Colorado, New Mexico, Arizona, and western Texas. This insect has occurred in such numbers as to suggest to many of our citizens the idea of spontaneous generation, and the writer has received many inquiries indicating alarm lest it should prove to be a new edition of the real 'army-worm,' and become a great crop-destroyer in the year 1888. Such fears, however, are entirely groundless. I have not been able to make the caterpillars eat any thing but purslane; and the insect may be regarded as a friend rather than a foe, since its chief mission in life appears to be the destruction of one of our most troublesome weeds.

The eastward progress of this species reminds one of the similar advance of the Colorado potato-beetle. My first acquaintance with it was made in August, 1884, at Deming, New Mex., nearly twelve hundred miles from Lawrence, where I captured some twenty of the moths during my summer collecting-expedition. They were attracted by the lamps at the station-hotel of the Atchison, Topeka, and Santa Fé Railroad Company. They proved to be a rare species in collections, and were in great demand among my entomological correspondents. My next acquaintance with this

insect was from two specimens of the moth captured at the electric lights in Emporia, Kan., by my student-friend and assistant, Mr. V. L. Kellogg. Professor Popenoe of Manhattan observed the caterpillars and bred the moth in 1886. Emporia and Manhattan are each about a hundred miles west from Lawrence, and the first observed appearance of the species at the latter place was in 1887. It remains to be seen whether the purslane-destroyer will become acclimated in a moister and colder climate than that of its original habitat. If it succeeds in adapting itself to its new environment, it may push on to the Atlantic seaboard, and delight the farmers and gardeners of the whole country by assisting to exterminate the hated 'pursley.' If not, it will disappear from view, as did a certain New Mexico butterfly (*Colias Mexicana*), which appeared suddenly in Kansas in large numbers in November, 1875, and has not since been observed in the State, having been unable to survive the first winter. Inasmuch as this latter immigrant has already survived one Kansas winter in safety, it is probable that it will become a permanent resident.

I would offer the following explanation of the fact that this insect, indigenous to the Far-Western plains, should so long have delayed its invasion of Kansas and its possible 'march to the sea.' Its native food-plant being a Western species of purslane (*Portulaca retusa* Engelmann), it did not extend beyond its original habitat until the building of the Atchison, Topeka, and Santa Fé Railroad had resulted in the western extension of our common Eastern purslane (*P. oleracea* L.). As soon as the Eastern purslane reached the home of the Far-Western species, forming a sufficiently continuous connection, the purslane caterpillar, finding the two plants equally palatable, began its eastward march. In precisely the same way the Colorado potato-beetle, having for its original food-plant a wild Western species of *Solanum* (*S. rostratum*), began its journey to the Atlantic just as soon as the cultivated potato (*Solanum tuberosum*) was extended westward to meet the wild *Solanum*, commonly called the Texas thistle and Santa Fé burr.

To the entomologist it will be interesting to know that the scientific name of the purslane moth is *Copidryas Gloveri*. It was described by A. R. Grote in 1868 as belonging to the genus *Eux-cirrhopteris*, but at a later date it was placed by him in the new genus *Copidryas*. Mr. Herman Strecker has referred it to the genus *Eudryas*, but the peculiarities of the caterpillar, hitherto unknown, confirm the propriety of separating it from that genus. It belongs to the family *Zygonidae*, and is a near relative of the 'beautiful wood-nymph' (*Eudryas grata*) and the 'eight-spotted forerster' (*Alypia octomaculata*). As both the latter species feed upon the foliage of the grape-vine, it would not surprise me to find the purslane-worm occasionally making use of the same food-plant. I do not, however, apprehend any serious danger of making such a discovery.

F. H. SNOW.

University of Kansas,
Lawrence, Kan., Oct. 20.

Queries.

15. IS THE TRUMPET-CREEPER POISONOUS?—I should be very glad to hear of any positive evidence in regard to the alleged poisonous property of the trumpet-creeper (*Tecoma radicans*). This beautiful vine is very abundant in this neighborhood, and there seems to be a pretty general belief that it is poisonous to the touch, the effect being like that of the poisonous *Rhus*. I have not, however, been able to get hold of any well-authenticated cases of poisoning from this plant. A child of my acquaintance was said to have been poisoned from handling it, but it is not at all certain that the eruption was not a return of a slight cutaneous affection from which the child had suffered shortly before. Such cases as this prove nothing, nor, on the other hand, does the fact that I, and others, have handled the plant with impunity. Our immunity may have been due to our individual constitutions. Every one knows, of course, that there are plenty of people who are not at all susceptible to *Rhus*-poisoning, and yet no one would hesitate to call either species of *Rhus* a very poisonous plant. As far as I can learn, the poisonous property of the trumpet-creeper is not generally recognized by botanists. I shall be very glad to hear what the experience of other people has been with this plant.

JOHN MURDOCH.

Smithsonian Institution, Oct. 22.

SCIENCE

FRIDAY, OCTOBER 28, 1887.

AT NÄÄS, SWEDEN, the third summer course of normal training in slöjd, which is the equivalent of our manual training, began towards the end of July with a total attendance of eighty. Of these, twelve were English and eighteen were Italians, sent by their government to receive the training. New and commodious buildings had been erected during the past year, and the school was favored with many distinguished visitors during the summer. Encouraged by the reception of her article in the London *Journal of Education* on slöjd, Miss Evelyn Chapman announces a slöjd training-course for teachers, to be held at Birmingham during the holidays. Miss Chapman has an efficient colleague in Miss Nyström of Stockholm, who was the first directress at the Nääs seminary. It is hoped that the efforts of these two ladies will result in introducing manual training in the board schools of Great Britain. In this country the progress of manual training has been very rapid of late, and we hear almost daily that some new locality is considering the subject. Paterson, N. J., is about to take favorable action in this matter, and Hoboken and other cities of the same State are expected to follow Paterson's example.

THE *New York Times*, a paper which has in earlier days, in the contributions of Holley and Newton and their successors, supplied much more valuable and interesting scientific matter to its readers than the average daily newspaper seems to feel called upon to give the intelligent portion of its patrons, and which has dealt less in the coarse and vulgar accounts of crime and folly which make up the average staple than many of its contemporaries, recently, under the heading, 'Is Heavy Artillery doomed?' presents an account of an invention, destined, apparently, to overthrow all existing methods of ordnance construction and operation. Since the *Times* has allowed its 'funny man' entrance into its editorial columns, its readers have sometimes been at loss to know whether some of its articles are genuine 'information,' are the product of an overworked vender of the 'humorous,' or are simply the gossip of an ignorant penny-a-liner. The several characters are sometimes found to operate in so circumscribed a field, that it is difficult to say whether the article of the day is to be assigned to one or to another of these usually far-removed classes. Possibly it may be the intention, as apparently in the article here referred to, to kill two birds with one stone, amusing the smaller and more intelligent class of readers, while gulling most mercilessly the larger and less well informed body of its patrons, who may not have had the advantages of a good common-school education. It certainly cannot be presumed that its editors are of the latter class. The general make-up and character of the *Times*, and the fact that its proof-reading and orthography are very correct, would forbid that supposition being held a moment. The story which it is so difficult to classify, and of which it is so utterly impossible to guess the origin, is that a distinguished Russian chemist has discovered a new explosive, of extraordinary power, and endowed with a capacity for evading or directly overcoming the second of Newton's laws. This new compound furnishes an exception to the general rule, and here action and re-action are *not* "equal and opposite in direction." In fact, the re-action is turned directly about, apparently, and effectively assists direct action in its destructive mission. This wonderful explosive acts in but one direction, and that is the direction which is suggested to it by its manipulators. A tube of cardboard, of tissue-

paper,—or, we may presume, the geometrician's imaginary cylinder,—serves to communicate the intent of the 'captain of the gun,' and the stored energy of the combustible starts off in the indicated direction, impelling the projectile with inconceivable force, and with not even sufficient recoil or lateral expenditure of force to crumple the imponderable gun. The latter, it may be presumed, is, when out of action, packed down like an opera-hat into the least possible space, and put in the pocket of the officer in command, or stored in the caisson until again required for the demolition of an iron-clad or the destruction of a fortress. The only really puzzling fact is, however, that the inventor of this extraordinary explosive, in the quiet seclusion of the *Times* office,—for the Russian must have become domiciled there,—does not seem to have successfully applied the tremendous brain-power, which has thus defied the laws of nature, to the completion of his work by also inventing a projectile of lightness commensurate with that of his gun, and to have endowed his explosive with a 'negative gravity' such as readers of his article must experience and appreciate. He would thus have realized the idea of Lord Lytton, and would have won immortal fame by presenting to the world the blessed 'VRILL,' which we now know only in the fictions of that great novelist. We would suggest to our neighbor of the *Times* that he secure a good supply of that marvellous 'sleetover,' and turn it, first upon his 'funny man,' and then upon those unsympathetic neighbors among the 'great New York dailies' who are prone to smile at such *facetiae*.

AT THE RECENT meeting in New York, of the American Association for the Advancement of Science, the fact that the remains of the great naturalist Audubon lie in an obscure and little-visited portion of Trinity Cemetery, New York City, and that his tomb is unmarked by any distinguishing monument, was brought to the attention of the members. The demands upon the time of all in attendance at that meeting were so great, that no action was taken by the association, although the most lively interest was expressed by individual members, and the propriety of marking the resting-place of the founder of American ornithology by a suitable monument was appreciated. The Audubon plot in Trinity Cemetery will probably be disturbed by the continuation westward of 153d Street. The trustees of the cemetery have with commendable liberality assigned the Audubon family a new lot close to 155th Street, in full sight of Audubon Park, and near the end of Audubon Avenue, when this shall be continued from the north, and are in hearty co-operation with the monument enterprise. At the first autumn meeting of the New York Academy of Sciences, a committee was appointed to solicit funds and make all arrangements for a monument. Vice-President Trowbridge then appointed as such a committee, Prof. Thomas Eggleston of the School of Mines, chairman, Prof. Daniel S. Martin of Rutgers Female College, and Dr. N. L. Britton of Columbia College. This committee has organized with Dr. Britton as secretary and treasurer, and is now ready to receive subscriptions, which will be properly acknowledged. Checks should be made payable to N. L. Britton, treasurer, and post-office orders should be drawn on Station H, New York City. The committee estimates that between six and ten thousand dollars will be required to erect and engrave a shaft worthy the memory of America's first naturalist, and, while confident that this amount will be forthcoming, desires to have interest taken in the project by scientists in all departments, in all portions of the country.

ASPECTS OF EDUCATION.

Naturalism.

THE two aspects of education which we discussed in *Science*, ix. Nos. 211, 215, 227, have reference to the different ways of training the intellect. They are, however, both liable to degenerate into pedantry. With regard to the study of language, this statement needs little proof. It is difficult, under any circumstances, to reconcile an education which is merely linguistic with the preparation of the active business of life. Perhaps the best example of such a training was the rhetoric of the Romans. Quintilian's famous treatise on education described the training of the orator, and it requires some reflection to discover how so narrow and restricted a course can be co-extensive with all that is demanded by the public service. It might, however, be so in imperial Rome. The business of Rome was to govern subject populations. A Roman statesman would have occasion for oratory in the senate, at the bar, in the governing of the province. Given the traditional inspiration which would be imbibed from a race of rulers, and the practice of public affairs, with which every Roman patrician would be familiar from his childhood, the training of the orator in its widest acceptance might be the only addition which was considered necessary. Humanism, however, lay but little stress on the public use of knowledge which it gave. It taught dead, not living languages. The greatest scholar might live secluded from the world, and, as his erudition deepened, might become less fit either to influence or to understand it.

Realism was by its nature more closely connected with actual life; but that, too, might content itself with books, and the study of books produces book-worms. The rebellion against received opinions which followed the Reformation brought every thing into question, and the groundwork of education with the rest. As feudalism disappeared, there was more need of such an inquiry. In the middle ages the education of the castle had existed side by side with the education of the cloister. The knightly arts of shooting, hawking, swimming, riding, and other bodily accomplishments, were taught to the young page, as the seven studies of the trivium and quadrivium were taught to the young monk. As years went on, the idle governing classes were gradually subdued by aggressive instruction. The schools of the Jesuits were eminently fashionable, and it became necessary to appeal once more to nature. Men of the world and philosophers said, in giving what we call a training to the mind, "Let us not forget that nature has determined the quality, and a large part of the development, of the mind which we aspire to train. If we do our utmost, we can effect but little: let us be quite sure, that, in attempting to produce this small amount of good, we do not cause real harm. Let us educate, not for the school, but for life. Let us see what inherent force will effect for the mind and character of which we think ourselves master." There is some trace of this reasoning in Rabelais; but, although he is certainly an anti-humanist, he should be classed as a realist rather than as a naturalist. The three great naturalists in education are Montaigne, Locke, and Rousseau. Although their characters were very different, there is a strong similarity in their teaching. We will give a short account of the views of each. This is the more necessary, as naturalism is now rampant in our public schools, but its advocates and supporters have little notion to what philosophers they owe the principles which they enthusiastically support.

The contrast between monkish erudition and the training for the world given in the castle of a wise noble is shown by Rabelais in the contrast between the clownish awkwardness of young Gargantua, and the modest self-possession of the page Eudæmon, who, "although not twelve years old, first asking leave of his master so to do, with his cap in his hand, a clear open countenance, beautiful and ruddy lips, his eyes steady and his looks fixed on Gargantua, standing up straight, on his feet, began to commend him with proper gesture, distinct pronunciation, and a pleasing delivery, in choice Latin," whereas all Gargantua did was to cry like a cow, and hide his face with his cap. Rabelais also lays great stress on bodily exercises, and shows that he considers the training of the body quite as important as that of the mind.

The educational ideas of Montaigne are principally contained in

two essays,—one on pedantry, the other on the instruction of children. The one deals with the objects of education, the other with its methods. Montaigne says that the end of education is not to fill the head with a mass of knowledge, but to form the understanding and the heart; not to burden the memory of the pupil, but to make him better and more intelligent. Antiquity presents us with well-educated statesmen and commanders, with philosophers fit for practical life. On the other hand, learning, which is only for show, is of no use to its possessor. If we only knew what Cicero or Plato thought about a matter, we are merely the guardians of some one else's property instead of making it a possession of our own. We warm ourselves at our neighbor's fire instead of making one on our own hearth. We fill ourselves with food which we cannot digest. The most important object of education is independence. The scholar must be able to consider and to employ what he has learned in a hundred different ways. He must be taught to prove every opinion, submit to no authority as such. Learning by heart is no learning at all. Just as we cannot dance, ride, or fence without moving the body, so we cannot speak or judge with advantage without acting for ourselves. The mind must be supported by a healthy body. There must be no coddling or spoiling by foolish parents: the boy must be hardened to endurance and to pain. We are educating, not a mind and a body, but a man, who is compounded of the two. The pupil must be taught to mix with the world, to observe carefully every thing he sees. He must learn more from experience than from books. The character of great men is more important for him to know than the dates of their actions. The greater number of sciences which we are taught are of no use. The pupil must not become a book-worm, but all the conditions of his life—his walks, his meals, solitude, and society—must be made serviceable for his training. He must be taught to speak naturally, with strength and emphasis; not by erudition, but by force of character and clearness of thought. For discipline we must use a kind severity, not punishment and compulsion. The school-life must be full of joy and cheerfulness. The most important thing is to excite a desire for study. Fathers should stimulate their children by their own example, and not keep them morosely at a distance. Montaigne says that he was first taught Latin by conversation, and he recommends the same course for imitation. He tells us that when seven years old he was entirely ignorant of French, but he was well acquainted with pure Latinity, and that without books and without tears. From this sketch we find that Montaigne's object was to educate the man of the world. He wished to bridge over the gulf between the gentleman and the scholar, which existed in his time; but he would produce a gentleman at any price, a scholar if possible.

We cannot tell whether Montaigne had a direct influence upon Locke, but there is no doubt that they agreed very materially in their views. The keynote of Locke's thoughts concerning education is a sound mind in a sound body. This, he says, is a short but full description of a happy state in this world. He that has these two has little more to wish for, and he that wants either of them will be but little the better for any thing else. The first thirty sections of his treatise are occupied with the training of the body. His maxims are summed up in the words, "plenty of open air, exercise, and sleep; plain diet, no wine or strong drink, and very little or no physic; not too warm and strait clothing; especially the head and feet kept cold, and the feet often used to cold water and exposed to wet." The next hundred sections are devoted to methods of education, but there is nothing in them about books. Virtue, wisdom, and breeding are to come before learning. These are to be taught more by precept than by example. We are to guard our children against the evil influence of servants, and to rely particularly on the persistent effect of the home. Above all, we are to teach knowledge of the world. Much of the danger which surrounds young men arises from ignorance of the world. A man forewarned is fore-armed. Breeding must come before book-learning. Teaching is for the purposes of life, and not for the school: *Non scholæ sed vitæ discimus*. The tutor you choose for your son should be a man of the world. Locke puts learning last, because he considers it as the least important learning. He says it must be had in the second place, as subservient only to greater qualities. Seek out somebody that may know how

discreetly to frame his manners; place him in his hands, where you may as much as possible secure his innocence; cherish and nurse up the good, and, generally, correct and weed out any bad inclinations, and settle in him good habits. This is the main point, and, this being provided for, learning may be had into the bargain, and that, as I think, at a very easy rate.

The subjects which Locke selects for learning are very characteristic. He begins with reading, writing, and drawing. He then goes on to French and Latin; the latter to be taught in the same way as French, by conversation and without grammar. He then passes to geography, arithmetic, astronomy, geometry, chronology, and history. Then follows ethics, a certain amount of law,—chiefly civil and constitutional law,—rhetoric and logic, and natural philosophy. Great importance is attached to acquiring a good English style. Greek is omitted; for Locke says that he is not considering the education of a professed scholar, but of a gentleman, to whom Latin and French, as the world now goes, is by every one acknowledged necessary. "When he comes to be a man, he can learn Greek for himself. What a small percentage there is, even among scholars, who retain the Greek they learned at school!" The education thus commenced is completed by dancing, music, riding, and fencing. Every one should learn one trade at least, if not two or three. Gardening and carpentering are especially recommended, but not painting. The pupil is to be well skilled in accounts and book-keeping, and his education is to be completed by foreign travel, which is to be deferred to an age when he can profit by it most completely.

Locke is a great enemy of those specious and spurious studies which were so much affected by the Jesuits. He is a declared enemy to Latin verses. "Do not," he says, "let your child make verses of any sort; for, if he has no genius for poetry, it is the most unreasonable thing in the world to torment a child, and waste his time, about that which can never succeed; and, if he has a poetical vein, it is to me the strangest thing in the world that a father should desire or suffer it to be improved. Poetry and gaming, which usually go together, are alike in this too,—that they seldom bring any advantage but to those who have nothing else to live upon. He does not care any more for music, which wastes so much of a young man's time to gain but a moderate skill in it, and engages often in such odd company that many think it better spared." Locke here would differ much from Milton, who gave music a more dignified place in his programme. In conclusion, Locke tells us that what he has written is designed for the breeding of a young gentleman, but that he is fully aware that every one cannot be educated in the same manner; that each man's mind has some peculiarity, as well as his face, which distinguishes him from all others; and that there are possibly scarcely two children who can be brought up by exactly the same method.

Although public schools in England educate their pupils very much according to the precepts of Locke, they probably do so unconsciously, and are very little aware whose example they are following. Many have heard of Locke's treatise on education, but few have read it or tried to understand it. Whatever effect he has had has been confined to his own country, and he cannot be reckoned as a great influence in Europe. Rousseau, on the other hand, burst upon the world with tremendous force. 'Emile,' although its teaching about education is so little precise and systematic, has made an epoch in educational systems, and is the parent of Pestalozzi, Froebel, and the most modern educators of the present day. The keynote of Rousseau's system is to educate in accordance with nature: he may therefore be regarded as the chief of the naturalists. It is true that his conception of nature was warped by the principles of his philosophy. He considered that man in his natural state, as he came from the hands of his Maker, was perfect, and that he has been spoiled by civilization. This idea was present to the mind of Rousseau in his very earliest writings. By what means, he asks, are we to bring back the child of nature? How are we to form that strange character, natural man? Our particular care must be to provide that he is not prevented from being natural; we must not educate him for any particular function, but merely for the art of living. A man must be taught, above every thing, to lead the life of a man, and that must be done not so much by precept as by exercise. In the time of Rousseau children of the

upper classes were brought up entirely in an artificial atmosphere. This, he says, we must do away with: great social changes may be before us, and we must prepare our children to meet them. The reformation must date from the very birth: mothers must take to nursing their own children. He says, speaking of the unnatural society of his own time, "Once let women become mothers again, and men will then become fathers and husbands." As the child grows, the advice of Milton corresponds with that of Locke. He is to be brought up in the fresh air of the country, set free from bands and swaddling-clothes, taught to endure pain and hardship and change of temperature, he is to be fed on very simple food. The father has duties as well as the mother. As soon as the child is old enough to be influenced by the father's education, it is wicked of him to hand him over to another. Rousseau passes the strongest condemnation on fathers who neglect their children, whereas he sets them the worst example by depositing all his children, as they were born, in the turning-box of the foundling-hospital. Unfortunately many fathers are so occupied that they cannot give their children the minute attention which is necessary for their education, so that there is no remedy but to find a tutor who will as nearly as possible supply the place of the father. The tie between tutor and pupil is to be of the closest character. The second book of 'Emile' is concerned with the education of a child up to twelve years of age. The principal object of this education is courage. The child must learn to bear suffering, and to put up with tumbles and knocks, without uttering a cry. Strength, health, and a good conscience are the objects to be aimed at. Do not reason too much with children at this age: they must be made obedient by authority, and reason will come later. The great object of this early education is to lose time. The child is not old enough for good impressions to be firmly fixed: we must be content with averting bad ones. A child is to learn the elements of property, that some things do and some do not belong to him; but of erudition he is to learn very little. At twelve years, Emile is scarcely to know what a book is. You have educated his character by strengthening his body: if he has the vigor of a man, he will soon have the reason of a man. During this age the process of hardening is to go on: he is to wear loose clothing, to go with his head uncovered, to lie on the damp grass when hot with exercise, sleep all night, to rise with the dawn, to know nothing but a hard bed, to fear no danger, to be accustomed to toil, unpleasantness, and pain, and to defend the soul with the breastplate of a strong body. Thus armed, he will not even be afraid of death. He is to be as much at home in the water as on dry land. He is to acquire arts which are found in the natural savage, the instinct of finding his way in dark places, of measuring distances with eyes and feet, and of beating all those of his age by swiftness of foot. He is to learn the piano rather than the violin. He is to draw from nature, to learn geometry rather by observation than by definition, to learn singing by the ear rather than by the notes. His appetite is to be the measure of his food. The sense of smell is to be educated with all his other senses. At twelve years old, he ceases to be a child: we are now to prepare him for manhood. We find that he is fresh, lively, open, and simple; his thoughts are limited but clear; he knows nothing by heart, but much by experience; he has read more in the book of nature than in any other book; his wit is not on his tongue, but in his head; his judgment is better than his memory; he only speaks one language, but that sensibly. Others may speak better: Emile will act better. He does not follow formulas and authorities, but in every thing which he says and does he is inspired by his own good sense. There is nothing artificial in his manner and bearing, but they are the true expression of his ideas, and the result of his disposition. In this language, and much of the same kind, Rousseau sketches the child of nature. One would think again, that, like Locke, he is depicting the English public-school boy; but he could not have known any such, and the country gentleman who favors such institutions would rather follow any counsel than that of a dreamy revolutionist.

The intellectual education which Emile receives between the ages of twelve and fifteen is not less remarkable than his social training. Nothing is learned from books, every thing from observation. The pupil is not asked to understand what he has taught, but to discover things for himself: for instance, as he takes his morning and even-

ing walk, he is led to observe the course of the sun, how it rises and sets in different places according to the time of the year. In this manner he is led to ask questions about the course of the heavenly bodies, the form of the earth, and the calculation of eclipses. For the study of geography, no maps are placed before him. Starting from his home, he is led to make maps for himself. In this manner the natural desire of the child for knowledge is taken as the starting-place for learning, which in itself is never allowed to be a burden or trouble. Just as growing plants require not only light, but heat, so the growing man needs not only instruction, but amusement. Emile finds out by himself the existence of the meridian line and the peculiarity of the magnetic needle. He observes that by rubbing amber, glass, or sealing-wax, he is able to attract pieces of straw. In this way he learns the properties of positive and negative electricity, and connects them with the magnet. Going to the fair, he finds a conjurer who draws a waxen duck in different directions over a basin of water by presenting to it a piece of bread: he soon guesses that the bread contains a magnet, and is able to imitate the trick to the astonishment of the conjurer. The conjurer takes his revenge by placing a stronger magnet under the table, so that the duck resists all Emile's efforts. The revelation of this trick is an avenue to still further knowledge. We see here that education is made not to depend on words, but on things. No formal instruction is given. Certain things are observed to take place, and the instruction lies in the conclusions which are to be drawn from them. In a similar way great importance is attached to what would now be called technical education. Emile is to have no books except 'Robinson Crusoe,' from whose example he is to learn how to supply all his needs. Instead of reading, he is to visit workshops and practise handicrafts: he will learn more in an hour's work than he would in a whole day's explanation. Even trades are to be estimated by their usefulness. The blacksmith is placed higher than the goldsmith: the baker is worth the whole academy of sciences. Emile must learn a trade. What trade is best for him? Agriculture is exposed to too many casual losses. Many trades are merely the handmaids of luxury, and produce nothing worth having: others are unwholesome either from confinement or from the attitude in which they are practised. There are objections to the more violent trades, such as masons and smiths. The best of all is to be a cabinet-maker, which is useful, cleanly, and instructive. The modern development of technical education seems to have followed on Rousseau's lines, and to have placed working in wood in the first rank.

Thus, when his boy's years come to an end, he possesses, not a great number of opinions and accomplishments, but the capacity for acquiring them. Such learning as he has, is thoroughly natural. He does not know even the names of history, metaphysics, morals, but he is accustomed unconsciously to reason about all of them. He is industrious, moderate, patient, and courageous. He does not know what death is, but, if necessary, he would die without a sigh. He demands nothing from others, and is under no obligation to them, but stands alone and independent in human society. He has no errors but those which are avoidable, and no faults except those from which no man is free. He has a healthy body, active limbs, a mind free from prejudices, a heart without passion. He has been scarcely affected by self-love, the first and the most natural passion: he has lived contented and happy, and free, so far as his nature allows. Do you think, asks Rousseau, that a child who has thus reached his fifteen years can have lost the years which have preceded?

Rousseau's book produced a great effect throughout Europe. It is said that Kant, the philosopher of Königsberg, whose habits were more regular than the town-clock, suspended even his daily walk in order to read him, yet the practical teacher will learn but little from him. His principal effect lay in the strength by which he combated existing prejudices. When Rousseau wrote, education had become not only formal and artificial, but hollow and frivolous. The French revolution might have altered this by its unaided force, but 'Emile' still remains the book in which the ideas of the revolution about education were expressed with the greatest eloquence and vigor.

What shall we say about naturalism in the present day? It is largely practised unintentionally. While different studies are

struggling for the mastery, the natural desire for games and open-air activity occupies the field, and claims more and more of the pupil's life. In the vast development of modern industries requiring capacities of all kinds, some educationalists have seen an indication that special courses of teaching are unnecessary or useless. Nature, they say, and the pressure of the world's business, are the best teachers. How much skilled labor is demanded by a railway? Who trained the pointsman, the engine-driver? Who directed the complicated lines of trains, following and meeting each other with lightning rapidity, yet never colliding except by a terrible catastrophe? The teacher who follows the methods, either of humanism or realism, strives to make the best of the human mind intrusted to him. He wishes to develop its faculties to their highest point, to stimulate its natural capacity to its furthest limit. But when this is done, what guaranty have we that nature has any place for the instrument we have so carefully finished? If every mind were developed to the fullest extent which its powers admit of, yet a large proportion of such minds might remain useless and barren, because they fitted into no place which human society supplies. Leave every thing to Nature, she will fashion the material better than you can, into the form in which she most requires it. This statement is a paradox; and, indeed, natural education is in its essence paradoxical. It will always have advocates and apostles, especially in times when there appears to be a danger of over-refinement or over-pressure; but the wise educationalist will turn to it as a repository of cautions and warnings rather than as an armory of weapons fit for fighting against the ever-present enemies of ignorance and sloth. OSCAR BROWNING.

THE ELECTRICAL ENGINEERING DEPARTMENT OF CORNELL.

THE equipment at Cornell in the line of electrical engineering bids fair to become, if it is not already, the most complete in the country, and probably in the world. It has been almost wholly contributed by friends of the university, at the suggestion of the director of Sibley College and others interested in its progress. The last and most important addition to the collection is that of the Westinghouse 650-light alternating current dynamo, exciter, lamps, and other material required in establishing the plant. The list of dynamos now includes the Edison, the Gramme, the Mather, the Westinghouse alternating current, the Westinghouse continuous, a number of Weston and minor makes, and all sizes, from a little toy machine made in the university shops, to the 50 or 60 horse-power machines just added to the list.

There comes with this liberality on the part of friends of the university an embarrassment of real importance: there is no immediately available room for the installation of these machines. The dynamo-room now appropriated to the purpose is hardly large enough for the 'cradle' used in conducting experiments on a single machine. The Weston machine is tucked in one corner, and the Edison and Mather machines are temporarily placed in the middle of the floor, and driven as best can be done from there. There is actually no room even to lay down the new machines now *en route* from Pittsburgh, still less to place them for use. In this emergency, the director has obtained permission from the trustees to make temporary provision for them by throwing the existing toilet-rooms into the machine-shop, thus securing a space of some fifteen or eighteen feet by nearly forty, in which to place all these machines. It has long been considered advisable, on the score of safety and convenience, to remove all heavy machinery from the main building, and this transfer of the dynamo-room will give opportunity to effect other improvements there in time. Professor Morris is already arranging new toilet-rooms, and getting ready to tear down the brick partitions which have been found to be in the way of the new arrangement. Professors Van Vleck and Smith are preparing plans for the belting and countershafting, in consultation with Professor Nichols, and the work is to be proceeded with at once. The space now given up to this machinery must, however, in time be required for the extension of the machine-shop, and it is only a question of time when a building must be constructed for this course and its collections. Nearly forty students now enter the course annually, and it is only second to the regular course in mechanical

engineering in importance in the Sibley College organization. The expenditure of all that may be needed to make its material part complete, aided as it is so effectively by its friends outside the university, will be more than justified.

Professor Thurston estimates that about \$100,000 should be expended in its permanent establishment: \$60,000 on building, including \$15,000 on water and steam power, each of which should give 150 horse-power, the one for use in ordinary work, the other whenever experimental work compels the utmost possible regularity of speed; and the balance, \$40,000, in supplying needed additions to the equipment of apparatus of exact measurement for heavy currents, and to furnish the income needed for running expenses, including fuel, one workman, and an assistant to the professor of physics, who should be placed in charge of this valuable property; which, although a part of the Sibley College establishment, is really managed by the department of physics in all except its power-supply. It is not impossible, that, as Mr. Cornell used to say, "there is some one walking around who wants to provide this" now greatly needed laboratory. It is certainly an opportunity for some wealthy and public-spirited friend of the university and of this side of its work to immortalize himself, while doing a noble work for his fellows.

THE STUDY OF MODERN EUROPEAN LITERATURE IN AMERICA.

THERE has been a marked change in the subjects of instruction and study in American colleges within the last few years. In literature, the study of French and German and early English has been substituted for Latin and Greek: physical science has won larger recognition, and political economy, history, and the science of government, have become prominent subjects of instruction. The change which has effected this result in the leading universities has been gradual, but many institutions are as yet untouched by its influence.

A comparison of the curriculum of any college now and that of fifty years ago would show that modern subjects now share the time formerly devoted exclusively to the classics, mathematics, and philosophy. The value of the old is not less, but new discoveries in science, and the recognition of the value of modern European literature, have displaced in part the former subjects of education. The pressing demands of modern life and modern culture have modified views, and the practical claim has been felt that the years of study should contribute to getting on in the world. These views have changed the direction of instruction, while the end of all education, intellectual discipline and the training of all the powers, has not been forgotten. What results have been attained, and what further changes are necessary that the new education may bear the choicest fruit?

The results of the study of the modern languages can be characterized as only in part successful. One American university still announces in its catalogue that the "modern languages are taught like the classical tongues." Until recently the instruction in French and German followed strictly the old method of teaching Latin and Greek. The fact that the language was still a living speech was ignored, and the pupil went forth as powerless in the presence of the language itself as a classical student would have been if he stood before an ancient Greek or Roman. Much time is undoubtedly still wasted by confused, illogical, and misdirected efforts on the part of teachers. The learning of a foreign tongue embodies the training of the eye to distinguish the printed words, the tongue to utter them, and the ear to recognize them when spoken. Linguistic training is not simple in the sense that one method will accomplish all these aims. There is beyond this the higher discipline of the study of language as the expression of thought, and its critical and philological study. The student who learns a living language as he learns a dead language will know no more of the one than of the other. Experience verified in the lives of all scholars shows how an ability to read a given language carries with it no practical mastery of the language: the ability to speak or write the language, and to understand it when spoken, is apart from a mere reading ability. Even the familiar sentences of the New Testament will not call up their Greek or Latin or German equivalent without special study. Instruction hitherto in modern

languages has been directed to impart a knowledge of the literature. The key to the literature has been found in the grammar and the lexicon. After a mastery of grammatical forms, reading has been begun.

The defects of this method are the same that have characterized all classical study,—the laborious acquisition of words, the perplexing idioms, the search after the true translation, now successful and now futile, a correct knowledge of which is only possible to one familiar with the genius and spirit of the language, and its idiomatic, provincial, or possibly archaic use.

The subtle flavor of a foreign expression cannot be distilled by the aid of the dictionary alone: it must come from a knowledge of the distinctive meaning and uses of words, and an intelligent apprehension of delicate shades of expression.

Only an exhaustive knowledge of literature and of the multifarious usages of popular speech can give an inner insight into the spirit of a foreign language. Such knowledge is impossible to ordinary scholars; and even advanced study, unless covering the works of different authors and periods, cannot guide the student at a distance to a critical acquaintance with the language. The method is in itself inadequate, and the results unsatisfactory. Mental discipline of a high order may be associated with this method of study; and a language is often valuable as an instrument of culture from the fact that it transplants the scholar into a new world of thought, presenting sharp features of contrast with one's native speech, exhibiting new grammatical forms and new words as the images of things.

But science has brought the nations of the world nearer; and the intellectual, political, and social life of one affects all others. Every day new discoveries in art and science and in the relations of States are flashed across the sea. Other literatures are filled with the thought, the poetry, and the throbbing life of the century. The ancient world no longer fills the domain of knowledge, and new subjects of study demand recognition.

We pass from the classical method of study to the conversational method of acquiring language, not in all cases a real advance, but in the main a positive progress. Language was studied in its common forms: familiar expressions interpreted the formal grammatical rules, and impressed them upon the mind. But multitudinous exercises often meant perpetual revolution without progress. The entire time available for the student was spent in the exhausting study of exercises: little of the literature was read, and the new tongue became a confused and endless mass of idioms. Exercises were not merely used to illustrate grammatical principles, but became an end in themselves. Few students sought an acquaintance with German or French in order to speak these languages, and yet the entire time of the student was consumed in these exercises.

A *via media* was then attained by the production of grammars, scientific in arrangement, brief and clear in statement, with exercises sufficient to illustrate the rules: idioms were simply studied to facilitate translation.

The 'natural' method, or method of oral instruction, followed. The popularity of this system has been increased by its use in the various summer schools of languages. As an accompaniment of any course of study, this method possesses real merits. Its motto is, "Learn a foreign language as a child learns its mother-tongue." This system has also been applied to teaching the classics. It requires from the first the use of the language itself by the pupil. Brief sentences are learned, and then translated so as to assert, to ask, to command, and to express conditionality: the subject becomes in turn object, and the object subject. By continuing the process, the forms of the article, adjective, and the indirect cases of nouns and pronouns, are learned. Later the forms of tenses and modes are learned. This method trains pre-eminently the memory: as a phase of instruction, it is important and valuable, but when it claims exclusive possession of the field of languages, and seeks to dominate the entire system of instruction, it is not justified in supplanting established methods.

A noteworthy application of this method has been made in teaching Hebrew, and a modified form of it has been used in instruction by correspondence.

From the Hebrew text of the Bible a living language has been constructed, and made the vehicle for the expression of familiar

thought. In many cases the English text has been retranslated orally into Hebrew. A thousand students in a single year have been engaged in this study, and the Semitic languages are now subjects of study in this country to an extent unknown before.

The modern languages are far from full recognition in the courses of study in the greater number of colleges. The demand for their study as part of a liberal education is not emphasized by their position and the amount of time devoted to them. They are tolerated rather than regarded as essential. Out of sixty-four representative colleges, fifty-eight require neither French nor German for admission to the course in arts, four require French, and two either French or German. The colleges are thus reduced to the necessity of giving elementary instruction in the modern languages; and the college does not to this extent imply advanced instruction, but simply the teaching of the rudiments. A knowledge of French and German is necessary for the highest scientific as well as classical study. The use of French and German works, the consultation of authorities found only in these languages, is impossible if their study is postponed until late in the academic course. The colleges do not reap the fruits of a knowledge of the modern languages in their subsequent instruction. The philological study of Latin embraces law Latin and the forms that have survived in French and the other Romance languages. A critical knowledge of early English is not possible without a study of the French element in English derived from the Latin. Thus the advanced study of the classics, as well as our heritage of the English tongue, is dependent upon an acquaintance with French. The study of Anglo-Saxon is promoted by a preliminary knowledge of German. Our colleges are thus fettered in their work by the lack of the elementary knowledge on the part of pupils essential to its successful prosecution. An intelligent acquaintance with modern European literature is not possible when the time which should be devoted to it is occupied with elementary study. The time which is devoted to the modern languages forms in most institutions but a small part of the regular college course, necessitating imperfect and hasty study. In sixty-four colleges conferring the degree of bachelor of arts, the amount of time required to be spent in the study of French and German is seven and three-tenths per cent of the entire four years' course. It is required that less than four per cent of the entire time of the student shall be devoted to one of these languages. It is not to be assumed that this low amount adequately represents the entire time devoted to the modern languages, for through electives in the best colleges the study can be greatly extended; but it represents the current estimate of college faculties of the value of these studies, and the amount required to enable the student to prosecute his later work. During the same period, at least twenty-five per cent of the student's time is consumed, by compulsion, in classical study, in addition to the preliminary knowledge required before entering college. The revised curriculum which has been adopted at Yale, and other colleges where the strict classical requirement has not been retained in full force, is very encouraging. Several Western and Southern institutions, as the Universities of Michigan, Indiana, and Virginia, exhibit a thorough and extended course in the modern languages. The scientific and technical schools recognize the indispensable character of a knowledge of French and German for purposes of all advanced investigation in science and engineering. The most recent discoveries in these and allied branches are published in monographs and reviews, and it is safe to say that the highest expert testimony on a question of engineering cannot be secured except from one familiar with the constantly increasing results of foreign investigation. Such results are not immediately attainable except in the language itself; and the final word which has been uttered in discovery is often of priceless value in all industrial enterprises. There is a loss in the equipment of every scientist or engineer who cannot at once obtain from original sources the knowledge which he needs. There is an additional reason why the instruction in modern languages in our scientific courses should be increased rather than diminished. The requirements for admission to these courses are less than to the classical. An exclusively professional or technical course, unless conceived in a broad spirit, fails to give a view of the connection and relation of the physical sciences. No branch of study stands alone, and can be built up from itself. Geology embraces paleontology, and paleon-

ology demands a knowledge of animal and plant forms, hence of zoology and botany. Chemistry touches, on the one hand, organic forms, and, on the other, inorganic, and involves the laws of physics. The highest results in every field of learning demand the highest preparation for them, and the student going out into life will find a sphere corresponding with his highest fitness. It is a misfortune to educate men out of sympathy with other fields of knowledge. The scholar whose work will be confined to a single branch needs the broadest attainable culture, which would be impossible for him later. Knowledge loses half its value when it cannot be communicated clearly, forcibly, and persuasively. Thus the student with an exclusively practical life before him cannot dispense, even for success in his own department, with the culture which springs from a linguistic training. The scholar with a clear insight into the meaning of words, and the power to marshal his thoughts effectively, can make his knowledge useful to himself and the world. Any course, whether technical or scientific, which sends out graduates without that literary training which will give a commanding weight to their views in any community, is to that extent defective, and fails to prepare them for the widest usefulness. Minor defects in subordinate, technical matters can be more readily repaired by experience than a lack of linguistic training, which will give clearness and definiteness to their thinking, and make the publication of the results of their experience a contribution to the world's knowledge.

The experiment by which in certain courses the modern languages are substituted for the classical, is one of extended application in the colleges of this country. In many institutions the students in courses in philosophy and literature are more numerous than the classical students.

We conclude that the elementary study of French and German should be begun in the public schools; that there are years in youth in which languages are acquired with unusual facility, which should be improved in any system of education.

This would enable the instruction in the modern languages in colleges to be advanced in character, so that by their use the full value of a literary, scientific, or historical course could be realized.

By requiring French or German for admission to technical courses, the benefits of a thorough knowledge of these languages would be attained without crowding the strictly professional studies, and some literary study should accompany the whole four years' course in such schools.

W. T. HEWETT.

BRITISH UNIVERSITIES AND THE TRAINING OF TEACHERS.

THERE is no professorship of education at any university of England, Wales, or Ireland. At the universities of Cambridge and London there are special examinations for teachers, on the results of which certificates or diplomas are granted; but there are no educational degrees. Technically speaking, therefore, education is not a university subject in these countries. At Cambridge, under the auspices of a teachers' training syndicate appointed by the university early in 1879, lectures on teaching have been given for eight years past; but they are not permanently established, and may come to an end at any time. They are, as a rule, fitfully and poorly attended, and cannot as yet be pronounced a decided success. Except in the training-colleges and at the College of Preceptors, there is no other systematic course of lectures for teachers outside Scotland. In Scotland there are two chairs of education, established in 1876 out of funds left by the well-known Dr. Bell, — one at Edinburgh, and the other at St. Andrew's. Both these chairs are very ill endowed. In 1886 a school-masters' diploma was established at the University of Edinburgh.

I shall not attempt to criticise this state of things, — looked at from any point of view, it is far indeed from satisfactory, — but I shall endeavor in the space at my disposal to describe what is actually being done for the training of teachers by these various agencies.

I will begin with Cambridge, and first as to its courses of lectures. They usually consist of one set on psychology in its bearing on teaching, delivered as a rule by Mr. James Ward of Trinity College; another set on the history of education; and a series of dis-

connected lectures on practice delivered by prominent head masters and other teachers. Amongst these last may be mentioned as especially valuable the lectures on stimulus and on discipline, by Mr. Arthur Sidgwick, formerly an assistant master at Rugby; and one on 'A Day in a Class-Room,' by Dr. Abbott, head master of the City of London School. As far as I know, only one connected course of lectures on the practice of education has ever been delivered before the university; viz., that by Mr. Fitch, which has since appeared as his well-known 'Lectures on Teaching.' It may well be doubted whether the sporadic lectures by eminent school-masters above referred to can be properly said to form a part of training in any real sense; but they are certainly more attractive than a prolonged course, and are in many ways suggestive and stimulative. The reasons why these lectures as a whole are not more satisfactorily attended are mainly two,—first, because undergraduates, while reading for their degrees, have very little time to devote to other subjects; and, second, because it is the habit at our universities to look upon lectures as merely preparation for examinations, and to value examinations solely by the prizes attached to them. Now, there are no prizes attached to the teachers' examinations, and the head masters of our public schools practically ignore them altogether, while the University Agency for the supply of masters does not even mention the certificates on its form of qualifications. It is no wonder, therefore, that undergraduates do not crowd the lecture-room. It is only fair, however, to state that the lectures on education suffer no more than others under similar drawbacks. The writer of this paper, when lecturing at Cambridge a short while ago, on the history of education, can remember on one occasion to have counted as many as seventeen undergraduates present. At the time there were about nineteen hundred undergraduates at the university, of whom perhaps one-quarter were destined to become school-masters, at least for a time.

Before a candidate can enter for the examination of the Cambridge Teachers' Training Syndicate, he or she must have given evidence of something of the nature of a sound general education. The test is not, as at London and Edinburgh, that the candidate must be a graduate of the university. Some nine fairly simple examinations are named, one of which must have been passed; or, to make the condition still more elastic, the candidate must have "been presented for examination by a training-college approved by the syndicate." This lowering of the initial test, no doubt, still further removes education from the status of a university subject; but it renders the examination far more widely available, especially for women, who form about nine-tenths of the candidates as a rule. In the examination of June, 1886, held at the three centres, Cambridge, London, and Cheltenham, fifty-one candidates passed, of whom only three were men (students of the Finsbury Training-College). There are two certificates granted,—one for the theory, history, and practice of teaching; and, where this has been won, another may be obtained for practical efficiency in teaching. The subjects for the former are:—(1) The theory of education: (a) the scientific basis of the art of education, or pure psychology; (b) the elements of the art of education, or the application of psychology to school-work in the training of the faculties (the senses, memory, conception, etc.). (2) The history of education in Europe since the revival of learning, a general knowledge being required of systems of education which have actually existed, of the work of eminent teachers, and of the theories of leading writers on education up to the present time. A more detailed knowledge is required of special subjects set from year to year. For example, the special subjects for 1887 are, 'John Amos Comenius, his Life and Educational Works,' by Professor Laurie, and 'The Life and Work of Arnold,' those for 1888 will be 'Locke's Thoughts concerning Education,' and 'The Teaching of the Jansenists at Port Royal.' (3) The practice of education: (a) method, which deals with actual teaching and examination; (b) school management, which deals with hygiene, furniture, apparatus, time-tables, etc. One paper is set on each of three groups of subjects; and a fourth paper is added, containing a small number of questions of an advanced character on each of the three groups. It is into this paper that questions on physiology and physical training are usually introduced; but, notwithstanding this, I cannot but think that these last-named subjects are not sufficiently represented. Candidates

must be twenty years old before entering for the examination, and must pay a fee of fifty shillings to the syndicate.

The certificate for practical efficiency, as I have pointed out, can only be obtained by those who already hold the certificate which I have just described. Candidates must "have been engaged in school-work for a year in some school or schools recognized for the purpose by the syndicate." Training-colleges of course come under this designation, "if the syndicate is satisfied with the duration and character of the training in practical work received by the candidates." The bases for the certificate are, (a) examination of the class taught by the candidate; (b) an inspection of the class while being taught; (c) questions put to the teacher in private after the inspection; and (d) a report made by the head master or mistress. I do not think there have been many candidates for this certificate other than the students of those few training-colleges which are established for teachers of middle and higher schools. But then they are almost the only people who use the examination at all.

It may be as well to mention here that the syndicate does not prescribe the use of any particular books for its examination, except those mentioned under the head of 'special subjects.' Mr. Ward has, however, from time to time put forth a list of some of those books which may be safely recommended to students, and from which they can make their own choice. I need scarcely say that Dr. Barnard's admirable compilations play a prominent part in this list.

I have given a very full description of the Cambridge scheme, both because I consider it, on the whole, the best unconnected with a training-college in Great Britain, and because by so doing I shall be saved the trouble of entering into such minute detail again. Let me mention here, for the information of the curious in such matters, that in the charter of Cavendish College, founded at Cambridge in 1876, the objects mentioned are, "(1) To enable students somewhat younger than ordinary undergraduates to pass through a university course, and obtain a university degree; (2) To train in the art of teaching those students who intend to become school-masters; (3) To secure the greatest possible economy in cost as well as time." I cannot ascertain that any steps have ever been taken to realize the second object. Probably all that was meant was that the college was intended to provide 'pupil-teachers' in the elementary schools, with an opportunity for finishing their general education. Who knows but that some day we may get it to mean both that and something more?

The University of London is simply a corporation for examination purposes. It provides no lectures of any kind; that is, it does not educate, but only tests education. It is hoped by many that before very long this state of things may be changed; but for the present the fact stands as I have stated it. For the present, therefore, the only part the University of London can play in the higher training of teachers is that of an examiner. As I have already said, it possesses an 'examination in the art, theory, and history of teaching.' Unlike the University of Cambridge, it restricts its examination to its own graduates, and it grants a 'teacher's diploma' on the result. There is no restriction as to age, and the fee is five pounds. Four papers are set,—one on 'mental and moral science in their relation to the work of teaching;' two on 'methods of teaching and school management;' and one on 'the history of education.' The science and the methods are very much the same as at Cambridge; but the history consists solely of set books. It is described as "the lives and work of eminent teachers, and the systems of instruction adopted in foreign countries." The set books for 1887 are as follows: 'History of the University of Cambridge from the Earliest Times to 1535 A.D.' by Bass Mullinger; 'Education and School,' 'Theory and Practice of Teaching,' by E. Thring; 'On the Action of Examinations,' by Latham; 'Quelques mots sur l'Instruction publique en France,' by Michel Bréal.

There are no doubt great advantages in the direction of definiteness and thoroughness to be derived from the use of set books; but, on the other hand, it leads to this unsatisfactory position,—that in 1887 teachers will gain their diploma without having shown any particular knowledge of the public instruction of England, Germany, and Switzerland, and, what is worse, without having shown any particular knowledge of the theories and methods of Froebel and Pestalozzi. As a matter of fact, one or two questions on these last

are generally introduced into the other papers. It may be well to note that among the many things coming under the head of methods of teaching and school management we find mentioned physical exercises, drill, and recreation. But there is another point of still greater importance. The University of London grants but one certificate,—not two, as does Cambridge,—and includes in that one, as a *sine qua non*, practical skill in teaching and in the management of a class. No directions are given as to how this last and most difficult test is to be applied. But hitherto the plan adopted has been to require the candidates to send in sketches of lessons on four different subjects chosen by themselves, and to give one or two of these lessons to a class in the presence of the examiners. But inasmuch as, in the necessity of things, such classes as can be got near at hand have to be chosen, the teachers know nothing personally of the children, and are quite in the dark as to the actual knowledge which the class possesses. The consequence is, that the test is far from satisfactory, and merely serves to show what a teacher will do under very distressing circumstances. At the best, it can only reveal whether a teacher is altogether incompetent: all the higher qualities must remain unassessed. A large part of those who take degrees at the University of London are the teachers of elementary and middle schools; and these, by the time they have graduated, have already had many years of school experience: hence the insistence on the practical test as an integral part of the London examination for teachers. The Cambridge examination is rather designed for those who intend to become school-masters and school-mistresses. The London examination has only been in existence some three or four years, and so far has been but very little made use of.

As I said at the commencement, there are two chairs of pedagogy in Scotland,—one at the University of Edinburgh, and the other at the University of St. Andrew's. Their work is sufficiently alike to allow one description to do for both. I will choose the chair of Edinburgh, held by Prof. S. S. Laurie.¹ This chair was founded in 1876, and commenced work with fourteen students,—a number which has steadily been added to, until the total has now reached fifty-one. Of these students, about three-fifths are 'senior students' of the denominational training-colleges, who, having passed a qualifying examination in Latin and mathematics, and stood in the first division of the government list of successful candidates for Queen's scholarships (i.e., entrance scholarships at the training-colleges), are allowed to attend the university. The remainder are students who have graduated or are about to graduate. This latter class will not be likely to attend in larger numbers until either the subject of education is included in the studies qualifying for an M.A. degree, or an act is passed requiring all school-masters in Scotland above the elementary grade to hold a diploma in education. A long course of eighty-five lectures is delivered between the first of November and the first of April. Of these lectures, about a dozen are purely psychological, dealing with the intelligence and moral nature; fifty are on method, dealing with principles of teaching and the detailed application of these; the rest are on the history of education. These last naturally vary considerably from year to year; but every year a careful analysis of Quintilian and Locke is given. I must confess that the choice of these two last as staple subjects seems to me peculiar. All the students attend three examinations, and write three essays. These form the subject of professorial criticism. Those students who have not been, or who are not, training-college students practise the art of teaching in the normal schools (by permission), and are examined by the head masters of those schools on practical matters of school management. The head masters report to the professor. Last year the university instituted a school-masters' diploma specially for secondary school-masters, which, however, is to be conferred only on graduates in arts of Edinburgh. Candidates, moreover, must have attended the class of the theory, art, and history of education in the university, and must pass an examination in these subjects conducted by the professor and an examiner appointed by the university court. The subjects of examination in April, 1887, were, (a) the professor's lectures; (b) Locke, 'On the Conduct of the Human Understanding'; (c) Milton, 'Tractate on Education'; (d) Comenius, 'Great

Didactic.' Each candidate must further give evidence either that he has attended a course of practical instruction in a training-college; or that he possesses the government qualification in the practice of teaching required of graduates and provided in the 'Scottish Code'; or that he has taught publicly for at least one year in a school, and holds such a certificate of practical skill from the head master as may be considered satisfactory by the university. Lastly, each candidate must satisfy the university of his practical aptitude as a teacher in some special subject or subjects in which he has received instruction in the university or in any institution recognized by the university as qualifying for degrees. I may note in conclusion that the fee for the diploma is two guineas. I have not yet been able to ascertain whether St. Andrew's is likely to follow the lead of Edinburgh in instituting a school-masters' diploma.

It only remains for me to speak of the College of Preceptors in London. This institution provides three courses of evening lectures for teachers, and confers diplomas of three grades,—associateship, licentiatehip, and fellowship. The lectures are on (a) psychology and its relation to teaching; (b) practical teaching; and (c) the history of education. The courses used to consist of ten lectures each; but in future the number of lectures on the first two subjects will be doubled. They are open free to all members of the college (annual subscription one guinea), or to any one else on payment of half a guinea for each course.

The examinations for the three kinds of diploma all include tests of a general education of gradually increasing severity; but these tests may be omitted in the cases of persons possessing a university degree, or who have passed some examination equally satisfactory to the college. What most concerns us here are the strictly pedagogic subjects. To begin, then, with the associateship. Candidates must give evidence of having been at least one year engaged in teaching, or of having attended a year's course of the lectures for teachers at the college. The subjects are, (1) the elements of mental and moral science; (2) physiology, with special reference to its application to the laws of health and to physical and mental education; and (3) lesson-giving and criticism of methods, including the sketching of a lesson on some assigned subject, the suggesting and discussing of cases of difficulty in teaching and discipline, and the proposing and criticising of methods. For the licentiatehip the candidates must give evidence of having been at least two years engaged in teaching. The subjects are the same as for the associateship, with the addition of logic in its application to education; while the third section now includes "a thesis on the life, character, methods, and influence of some distinguished educator to be selected by the candidate, or a description of the organization and methods of some school of repute derived from personal inspection and examination." The candidates for the fellowship must give evidence of having been not less than five years engaged in teaching. Sections No. 1 and No. 2 are the same as before, but of a more advanced character. Section 3 becomes "government of a school, including lesson-giving and school organization in all its departments." Section 4 is "the history of education and educational methods, with studies of distinguished educators, English and foreign; and a description and discussion of the methods and organization of schools and colleges of note at home and abroad." The fees in the first case, for examination and diploma together, are two guineas; in the second, three guineas; and in the third, six guineas. Examinations are held twice a year,—at midsummer and Christmas. During 1886, for the three diplomas together, 136 candidates entered,—70 men and 66 women. Of these, 45 obtained the associateship, 4 the licentiatehip, and 1 the fellowship. This will serve to show both how much the examinations are used, and the severity observed in awarding the diplomas.

I fear that all this will read as a very dry statistical account. It would have been pleasanter and easier to have flowered forth into criticism and exhortation; but those who really wish to know how matters now stand, will, I believe, find my facts more useful than my views are ever likely to be.

H. COURTHOPE BOWEN.

The total number of children within the age of compulsory school years in Prussia is 5,500,000, of whom 4,800,000 attend school. There are more than 700,000 teachers, in 33,000 elementary schools. The average number of pupils to one teacher is 78.

¹ The chair at St. Andrew's is held by Prof. J. M. D. Meiklejohn, whose name and work must be well known in the United States.

EXPLORATION AND TRAVEL.

Brazil.

DR. HASSLER, who returned last April from an interesting journey through the Brazilian province of *Matto Grosso*, has described the results of his journey in a lecture delivered before the Geographical Society of Bern. The expedition, which was organized by the Brazilian Government, consisted of Dr. Hassler, an Englishman, a Brazilian lieutenant with forty soldiers, and several natives. They ascended the Paraguay, and began their explorations from Cuyabá, the capital of *Matto Grosso*. Having ascended the Rio Cuyabá, they crossed the divide between the La Plata and Amazon systems, and tried to reach the Rio des Morts. Having first struck the little-known rivers feeding the Xingú, they found the Rio des Morts, which they descended to its confluence with the Araguaya, and followed the latter river to its confluence with the Tocantins. They returned by the Araguaya, and, having traversed an extensive part of the plateau of *Matto Grosso*, they reached the Rio Lourenço, and returned by this way to Asuncion. Dr. Hassler discovered and explored several large tributaries of the Araguaya. The region traversed by this expedition is not far east from where Von der Steinen made his important discoveries in 1883, and the results of this journey will undoubtedly form a valuable contribution to our knowledge of the geography of central Brazil. The topography of the plateau of *Matto Grosso* and of its northern slope is little known, and it is fortunate that the Brazilian Government should at last undertake the exploration of this extensive country. Dr. von der Steinen, who is now on his way to the sources of the Xingú, was unable to carry out his plan, to reach the *Matto Grosso* from the east coast of Brazil, but had to take the Paraguay route. His last letter is from Cuyabá. The expedition was detained in Brazil by the prevalence of cholera in the Argentine Republic. They used this time for exploring the *sambagui* (or shell-heaps) of Santa Catharina. They intended to start from Cuyabá to the head waters of the Xingú, where they will establish a camp and study the interesting Indian tribes inhabiting this remote region.

NEW GUINEA.—Since we published the sketch-map of New Guinea in No. 242 of *Science*, several interesting reports on new journeys have been published. Dr. Schrader, the leader of the expedition of the New Guinea Company, has ascended the Augusta River in a small steamer some distance beyond the point reached on the first expedition. The Proceedings of the Royal Geographical Society say that Mr. C. H. Hartwig and Mr. G. Hunter succeeded last July in reaching the summit of the Owen Stanley Range. They appear not to have reached the highest elevations, but by a judicious choice of route, along the valleys of the Kemp Welsh and Musgrave Rivers, ascended to the saddle between Mounts Obree and Brown, and crossed to the eastern or inland slope of the range. They started with twenty-seven friendly natives, but had some difficulty, in commencing the ascent, with the hostile tribe who guard the great mountain *Paranagora*, which they believe to be the abode of the spirits of the departed. Their hostility was eventually overcome by peaceable measures, and upward of two hundred of them followed the expedition in the ascent, conciliated by the daily supply of meat of wild pigs, which the travellers obtained by means of their rifles, though the chief cause of the success is attributed to the great experience of Mr. Hunter, who had for a long time prepared for the expedition by making friends with the tribes, several of whose languages he speaks fluently. The flora is described as magnificent in the extreme, including palms of many species, tree-ferns, marantas, orchids, and an endless variety of tropical flowering plants. East of the range the country is more open and richly grassed. The same number of that journal contains a full report of the discovery of two large rivers, the Douglas and Jubilee Rivers, emptying at the head of the Gulf of Papua, accompanied by a map and several illustrations. Their discovery was mentioned in a recent issue of *Science*. The well-known traveller, Capt. Adrian Jacobsen, has been sent out to New Guinea and the neighboring islands by the Ethnological Museum of Berlin, principally for making collections among the various Papuan tribes.

TIMBUKTU.—Timbuktu and the upper Niger have lately attracted considerable attention. The French are rapidly extending their possessions toward this important place, starting from the

Senegal. The Geographical Society of Paris has published several sketch-maps showing the advance that has recently been made. The upper Gambia and the neighboring districts have been surveyed, and extensive stretches of land on the upper Niger have been placed under French protectorate, which now extends from the right bank of the Niger to Sierra Leone and Liberia, including the whole of Futa-Djallon. Roads are being built, and much advance is being made in our knowledge of these districts. While this is a safe and reliable way of progress, Mr. George Angeli's scheme of a railway from Cape Juby to Timbuktu seems rather vague, and unlikely to be carried out. Of great interest is an approach to the upper Niger by Dr. A. Krause through a country which was formerly considered impenetrable. We mentioned the beginning of his journey, on which he started from the Gold Coast, in No. 218 of *Science*. He succeeded in entering the totally unknown region in the great bend of the Niger, but had to return when about one hundred and fifty miles from Timbuktu. The results of this journey will be of great importance. As it is generally accepted that journeys in Africa are very expensive, it will be of interest to learn that Krause had no more than twenty-five dollars on landing.

STANLEY FALLS.—The London *Times* publishes an interesting letter of Major Barttelot on the state of affairs in Central Africa. This letter makes it clear that Tippo-Tip's authority in Stanley Falls is very limited, and that he will require support from the Kongo Free State to suppress the slave-hunters, who extend their raids almost to the confluence of the Aruvimi. The Kongo Free State has decided to send some troops to his assistance, and, in case this effort should prove unsuccessful, to endeavor to obtain the support of the Sultan of Zanzibar. If Tippo-Tip is true to his obligations, it may be that the efforts of the state will be successful.

HEALTH MATTERS.

Vital Statistics in Massachusetts.

THE Massachusetts State Board of Health has issued the forty-fifth registration report of that State, containing the vital statistics for the year 1886. During this year the public health has markedly improved; the birth-rate being greater, and the death-rate less, than in any other year since 1879. 50,788 births, 18,018 marriages, and 37,244 deaths were recorded, being an increase of 1,998 births and 966 marriages, and a decrease of 850 deaths, as compared with 1885. The death-rate was 18.85; the birth-rate, 25.69; and the marriage-rate, 9.12. The number of illegitimate births was 1,034, or 20.3 per thousand. The rate in Russia is 29, and in Bavaria 152, the average for Europe being 64. In Massachusetts, and also in Rhode Island, Connecticut, and Vermont, as well as in most countries of Europe, the marriage-rate has decreased during the past twenty-five years. 601 divorces were granted during 1886, 45 less than in 1885, but 105 more than the average for the preceding twenty years. Of these, 20.8 per cent were for adultery, 45.7 for desertion, 16.3 for intoxication, 5.3 for extreme cruelty, 10.3 for cruel and abusive treatment, and 1.2 for neglect to provide maintenance. The infant mortality was greater than in any year since 1875, and also greater than the average of the past fifteen years. The average age of all persons at death was 34 years, the extremes being 48.63 in Barnstable County, and 30.29 in Suffolk. The ratio of deaths from zymotic diseases to all deaths has steadily decreased from 28.6 in 1876, to 18.5 in 1886. The death-rate from consumption has decreased from 3.25 per thousand in 1867, to 2.98 in 1886; that from cancer has, during the same period, increased from 0.29 to 0.56. During the ten years ending 1886, there have been the following deaths: from typhoid-fever, 8,466; from whooping-cough, 2,765; from diphtheria, 15,288; from measles, 1,832; from scarlet-fever, 5,130; and from small-pox, 193. The increase in the mortality from diseases of the brain during the past twenty-five years is very marked. In 1865 the rate per ten thousand for this class of disorders was 12.06; in 1865, 14.39; in 1870, 14.35; in 1875, 16.42; in 1880, 17.00; and in 1885, 20.01. In this class are included apoplexy, softening of the brain, paralysis, insanity, cephalitis, and brain disorders generally. There were but 32 deaths reported from ague and remittent fever during the year: 62.5 per cent of these were in the five western counties, having but twenty-six per cent of

the population. One-fourth of the whole number occurred in Hampden County. Eastern Massachusetts suffered severely from malarial fevers in 1884, 1885, and 1886, but few of the cases, however, proved fatal.

MICHIGAN SANITARY CONVENTION.—A sanitary convention is to be held at Albion, Mich., under the auspices of the State Board of Health, Dec. 6 and 7. The objects of the convention are the presentation of facts, the comparison of views, and the discussion of methods relating to the prevention of sickness and deaths, and the improvement of the conditions of living. It is intended to be a convention of the people generally. Among the subjects which it is expected will be presented and discussed are the following: 1. The present and future water-supply of Albion; 2. Disposal of waste in Albion by sewerage and otherwise; 3. School hygiene; 4. Money-value of sanitary work; 5. Restriction and prevention of communicable diseases, from four standpoints,—(a) of the State Board of Health, (b) of the health-officer, (c) of the clergyman, (d) of the lawyer.

CHLOROFORMING WHILE ASLEEP.—We had occasion in a recent number of *Science* to refer to the possibility of chloroforming persons while asleep without awaking them. In confirmation of the statement which was then made, that under favorable circumstances this could be accomplished, we quote a case which occurred in the New Orleans Charity Hospital and is reported in the *New Orleans Medical and Surgical Journal*. A child six years of age was suffering from pleurisy, and it became necessary to draw off the fluid effusion which had accumulated in his chest. He was very much afraid of the operation, and it was determined to attempt it while he was asleep. On the following day, while sound asleep, chloroform was administered without awaking the child, and twenty-four ounces of fluid were withdrawn. The child continued to sleep throughout the night, and when it awoke the following morning knew nothing of the operation.

FLIES AS CARRIERS OF CONTAGION.—A report was made to the French Academy of Sciences by Spillman and Hanshalter, giving the results of their investigations into the possibility of flies acting as carriers of contagion. These observers examined the excrement and intestines of flies that had fed on the contents of spit-cups used by consumptive patients, and found the bacilli of consumption in abundance. These bacilli were also found in the dried excrements of flies scraped from the windows and walls of rooms occupied by consumptives. These facts are in perfect consonance with the recommendations of the American Public Health Association, that the sputa of consumptive patients should be received in vessels in which disinfectants have been placed.

THE PLYMOUTH TYPHOID EPIDEMIC.—Our readers will remember the epidemic of typhoid-fever which created such consternation in Plymouth, Penn., in 1885. The population at that time was 8,000. Of these, 1,153 contracted the fever, and 114 died, a mortality of nearly 10.33 per cent. It is now stated that typhoid again prevails to an unusual extent in Plymouth, and that fears are entertained of another epidemic. There are said to be thirty cases of the fever there at the present time. In connection with the subject of typhoid-fever, there have been reported in France three cases in which the disease seems to have been transmitted through the air. A patient suffering with typhoid-fever stopped at a hotel in Eaux-Bonnes. In four weeks she recovered, but the three daughters of the hotel-keeper were attacked. Eaux-Bonnes is said to have a bountiful supply of excellent spring water, and there was no other case of typhoid in the town. The discharges from the stranger were thrown, in an undisinfected state, into the water-closet, the door of which communicated with the room in which the landlord's daughters slept, at a distance of only three feet. It seems reasonable in this instance to eliminate the drinking-water from the factors in causing these three cases, and to charge the infection to the neglect of disinfection of the excreta.

SEASICKNESS.—The *Semaine Médicale* contains the views of Dr. W. Skinner on seasickness. He looks upon it as the expression of certain purely functional or dynamic disturbances of the organism, some of the symptoms indicating a general fall of the arterial blood-pressure. The starting-point is probably a reflex inhibition

coming from the sensorium or from the nerves of the abdominal organs, which is brought about by a contusion or stretching of these organs due to the motions of the vessel. His treatment consists in the use of vaso-motor stimulants, strychnia, atropia, and caffeine, introducing them hypodermically. Dr. Skinner reports thirty-nine cases in which his treatment was efficacious, one of them being an infant of two years and a half.

HYDROPHOBIA.—In the latter part of September three children died in England from hydrophobia, having been bitten by rabid dogs. Their mother was bitten at the same time, and has gone to Paris to be treated by Pasteur. Another child, not of the same family, was bitten by a rabid dog at Lancaster. Seven days after, he went to Paris, where he remained a month under treatment. The day after his return the first symptoms of hydrophobia appeared, and in two days proved fatal.

YELLOW-FEVER AT TAMPA.—Dr. Porter, president of the Key West Board of Health, has gone to Tampa, Fla. He reports that the disease which lately appeared there is undoubtedly yellow-fever. To Oct. 14, there had been eighty cases, of which twelve had proved fatal.

MENTAL SCIENCE.

Bilateral Asymmetry of Motion.

DR. J. LOEB of the University of Würzburg has made some very interesting observations on the motion of the two arms. A thread is stretched between two uprights at such a height, that, with the fore-arm bent at a right angle at the elbow, it can be conveniently held between the thumb and forefinger of either hand. In the first series of observations, the two hands started together at the middle of the string, and moved outwards to either side until signalled to stop by the experimenter. The object was to move the two hands with equal speed; but it was found that every subject either constantly moved the right hand farther than the left, or the left constantly farther than the right. Right-handed persons who were not handicraftsmen, usually allowed the right hand to make the longer excursion, and contrariwise for the left-handed. The difference between the movements of the two hands varied from one-tenth to one-half of the space moved over. If, instead of the operator's signal, a clamp was placed upon the thread on one side to indicate when the subject should stop, the general result was the same, though the hand on the side of the clamp usually moved more cautiously.

Thinking it probable that the difference was due to the difference in the nature of the voluntary impulse imparted to the two hands, Dr. Loeb himself moved one of the subject's hands to one side, while the latter was to simultaneously move the other out to an equal distance. But the result was as before: the asymmetry constant for each person remained; and that, too, no matter whether the right hand was passively moved and the left hand moved voluntarily, or the reverse. The size of the error, however, is reduced in the sense, that, compared with a voluntary motion under the same conditions, a passive motion seems larger. This Dr. Loeb thinks may be due to the fact that there was a conscious fear of moving the active hand too far, and that the attempt to correct this resulted in an error in the opposite direction. All the above observations were made upon persons ignorant of the resulting asymmetry. Those who were informed of the result, or discovered it for themselves, thereafter much diminished their error.

The next variation consisted in having the two hands move, not in opposite, but in the same direction; that is, either with the left hand starting in the middle and the right hand to the right side to move towards the left, or with the right hand in the middle and the left hand to the left side to move towards the right. As before, the two movements were simultaneous, were to be made equal in extent, and the motion of one hand was arrested by a clamp set upon the string. Here a new law enters; and the result is, that, independently of the hand and of the direction of the motion, the motion from the exterior towards the middle is always distinctly larger than from the middle towards the exterior.

To eliminate the asymmetry between the two hands, the experiment was made with one hand only, first moving out a given dis-

tance, and then attempting to repeat the motion. The general result was, that the reproduced motion was larger than the original, when the motion was made on the hand's own side,—for the right hand on the right side, and for the left hand on the left.

In conclusion, Dr. Loeb asks the question, "On what basis does the mind conclude that the motions of the two hands are equal?" He answers that it is due to the time element. There is an unconscious attempt to translate space into time, because we can judge the latter more accurately; and, in several series of experiments in which the time was recorded, it was found, that, even when the two hands moved quite different distances, the times of the two motions were approximately the same. The mind, then, judges two motions to be the same when they are innervated by equally intense impulses, and consume equal times; and the asymmetry is referred to the fact (due to increased practice, or what not) that an equal impulse will impart a larger motion to the one (the preferred) hand. That other factors enter into the problem is not to be doubted: for example, if one thread is rough and the other smooth, the same distance on each will seem longer on the rough thread, by more frequently stimulating the skin. Dr. Loeb promises a continuation of the observations.

FALSE TESTIMONY OF CHILDREN.—The trial at Tisza-Eszlar is probably sufficiently well in mind to serve as a type of the false evidence given by children. Dr. A. Motet has collected a number of similar cases, and shows very distinctly that the children in question are quite generally the subjects of morbid tendencies. Frequently they are the offspring of a degenerate stock, and are characterized by weakness of will, and a love for excitement. The analogy between these suggestions accepted and elaborated by these children in a waking condition, and precisely the same phenomena in hypnotic states, is evident. Dr. Motet suggests several hints by which such testimony can be prevented from imposing upon the courts, and urges that a careful physician be summoned when any such suspicious testimony by a child is deposed. It illustrates anew the close connection between responsibility and nervous affections as well as between the doctor's study and the court's dictum.

SMELL AND TOUCH VERSUS SIGHT.—Dr. Fauvelle calls attention to the inverse relation between the development of the visual and the olfactory apparatus, and holds that smell, when supported by touch, can in some forms of life outweigh sight. The snout, when it occurs, is always at the most anterior portion of the body in progression, and through this heralding position becomes endowed with a most delicate sensibility, often of mobility too, and at the same time brings into prominence the olfactory mechanism. The changes in the form of this naso-labial organ of touch follow all the changes in the prominence of the organ of smell, and prevent a special development of the organ of vision. In man and the primates this loses its importance and yields to sight, which superiority is assigned to the parallelism of the visual axes, and establishing of the biped position, where the organ of smell is no longer at a prominently anterior position of the body.

BOOK—REVIEWS.

Industrial Education, a Guide to Manual Training. By SAMUEL G. LOVE. New York and Chicago, E. L. Kellogg & Co. 8°.

It is inevitable that there should spring up in the earlier stages of a movement for educational reform a large literature. Some of this will naturally be good; but much of it, owing to superficial knowledge or misconception, will be bad. Public opinion on the reform in question is in large measure formed by these early books, and for that reason, if for none other, the critic should scan them with great care.

Mr. Love's book is one of the first in this country that undertakes to explain in detail what manual training really means; and, as a great many people are just now asking the very question which it professes to answer, it will naturally have a large number of readers. But it is extremely important that only correct information should be given concerning manual training, and that one or two sources of general confusion as to its purpose and aim should be removed.

We have read Mr. Love's book carefully with these points in view. The book is divided into five parts and an introduction. The first part discusses the claims of manual training, and the second describes what has been done in Jamestown, N.Y.,—in which town Mr. Love is superintendent of schools,—in development of this training, and gives the course of study pursued therein. The third, fourth, and fifth parts discuss the organization and carrying-out of manual training in the various grades of the primary, grammar, and high schools, respectively. Mr. Love has worked conscientiously, and has beyond question accomplished a great deal of good. His fellow-citizens seem (pp. 27–29) to approve his work, and to be in harmony with his ideas. But, we regret to say, taking Mr. Love's own language as the expression of his ideas, he himself is still very much in the dark as to what the movement in favor of manual training really signifies.

Those persons who have an insight into the real aim of manual training know how difficult it is to make others understand that the manual training urged is mental training: for no one who understands our public-school education would for a moment urge that any thing which is not purely and simply educational should find a place in it. Manual training would not train the hand *per se*, but the hand as the servant of the mind, and as one of the mind's agents of expression. Manual training, which is technical and not mental, must be provided for, but apart from and not in the public schools. This has been insisted upon so often lately, that we had hoped the point was clear to all, and it is extremely discouraging to find Superintendent Love marking off his manual training as something foreign to mental training, as he explicitly does in several passages of his introduction, and impliedly does throughout the book. In fact, the author's idea is that manual training should be added on to the school course, as a matter of privilege. The correct idea is that manual training should be incorporated in the common-school course as a matter of right. The two conceptions differ widely in theory, and still more in practice. For example: the clear-sighted advocate of manual training would never urge, as does the author (p. 7), that it should be introduced because "very many children dislike books." This argument, if pursued logically, would create havoc in any system of education.

Every once in a while the author seems to approximate the proper point of view, as when (p. 33 *et passim*) he classifies writing, drawing, gymnastics, and card-board work together under the head of manual training. But when we turn to his carpentry course, and see how wholly blind he is to the proper relation of drawing to constructive work, we despair again.

Minor criticisms might be passed on various portions of the book, but this fatal misconception of manual training in general renders them unnecessary.

Superintendent Love has proved to the satisfaction of himself and his townsmen that the old-fashioned curriculum does not satisfy the educational demands of to-day, and in adopting manual training he did a wise thing; but his book proves that he adopted it for the wrong reasons and in the wrong way.

Philosophy of Theism. By BORDEN P. BOWNE. New York, Harper. 8°.

PROFESSOR BOWNE'S reputation as a thinker rests on a secure foundation, and that alone would entitle this his latest volume to careful consideration. But the 'Philosophy of Theism' will command attention and respect on its own account, for it is in many ways a remarkable book.

In the first place, it is a new evidence of the interest now being taken in the philosophy of religion, and may well take a place beside the volumes of Flint, Diman, Fisher, and others as a masterly exposition of the theistic argument. It is superior in profundity to the recent philosophico-religious books of Royce and Abbott, although we miss in it some of the flashes of brilliancy which make the latter books such interesting reading and constitute so much of their charm.

But Professor Bowne's aim in the work before us is not, as it seems to us, wholly religious. He aims to show that both theism and modern science stand upon a common substructure; namely, the philosophy of belief or faith. Indeed, the author goes even

farther than this. He claims that a common postulate underlies not only theism and natural science, but our whole mental life. His position may best be elucidated by this passage from the preface: "Kant pointed out that the ontological argument properly proves nothing, and that the cosmological and design arguments depend on the ontological. The argument, then, is not demonstrative, and rests finally on the assumed existence of a perfect being. In a different form I have maintained the same position; but, so far from concluding that theistic faith is baseless, I have sought to show that essentially the same postulate underlies our entire mental life. There is an element of faith and volition latent in all our theorizing. Where we cannot prove, we believe. Where we cannot demonstrate we choose sides. This element of faith cannot be escaped in any field of thought, and without it the truth is helpless and dumb."

Professor Bowne starts with the very evident fact that man is religious. He points out that we may properly inquire as to the source of religion, as to its history, and as to its foundation. Merely pausing to aim a shaft at that sensationalistic philosophy which would trace religion to some non-religious sources, the author sets aside the first two questions as beyond his province, and addresses himself to the third. In an analysis of the data of the religious consciousness, it is conceivable that one of these results might be reached. Either the theistic idea might be found to be (1) contradictory or absurd; (2) an implication of the religious sentiment only, and without any significance for pure intellect; or (3) a demand of our entire nature, intellectual, moral, æsthetic, and religious. To establish the last alternative is Professor Bowne's aim in this volume. He paves the way for his constructive argument by pointing out the unnaturalness of subjective idealism and the irrationality of chronic scepticism. It is not possible for us to follow the author's elaborate argument. He aims to establish on the principle noted above, the unity of the world-ground and then its intelligence and personality. Its metaphysical attributes, its ethical nature, and its relation to the world, form the subjects of subsequent chapters. The influence of Lotze, so strongly marked in the author's work on metaphysics, is still seen here, and particularly in his treatment of interaction. A brief concluding chapter passes from the intellectual to the practical applications of the theistic implication. The steps in the closely reasoned argument can hardly be indicated without doing them an injustice. We therefore refrain from making the attempt, and earnestly commend Professor Bowne's book to all philosophical students. Even where it fails to convince, it will stimulate and enlighten.

NOTES AND NEWS.

THE death has been announced of Gustav Robert Kirchhoff, the famous physicist. He was born March 24, 1824, and became lecturer of physics at the University of Berlin in 1847. In 1850 he was appointed professor in Breslau, and in 1854 in Heidelberg. It was here that he and Bunsen made their famous optical researches which led to the discovery of spectral analysis. The results of these investigations were published in Berlin in 1861, under the title 'Untersuchungen über das Sonnenspectrum und die Spectren der chemischen Elemente.' It is well known that these discoveries were the foundation of astrophysics, and that they led to numerous unexpected discoveries in chemistry. But this is only one of Kirchhoff's important works, which covered all parts of mathematical physics, particularly the theories of electricity, galvanism, and elasticity. In 1875 he accepted the professorship of physics at the University of Berlin.

LETTERS TO THE EDITOR.

Romantic Love and Personal Beauty.

YOUR correspondent of Oct. 14 might have observed a feature in this book which would have explained and justified the repulsion she felt in reading it. The author cannot resist the temptation to be funny. He may be coarse, or refined; but he must be witty. He cannot carry us along in an uninterrupted narrative of sober and well-digested facts. He must stop to make us laugh, or suffuse his pages with ill-disguised humor that constantly divides our interest between fact and fancy. This is hardly tolerable in what aims to be in many respects a scientific discussion. It spoils both

its science and its wit. The instance quoted, "Did Herbert Spencer ever kiss a girl?" is not a solitary one. French and German girls simulating horror of some men whom "they secretly consider a darling creature," he says, have a who "spring-chicken coyness." Of a certain class he says, "It would be absurd to include in this statement people of refinement, who through misfortune have been plunged into abject poverty. They do not belong to the '*Great Unwashed*' (οἱ μαλλοί)." Again: "The modern ideal of woman is exclusively feminine, i.e., devoid of hackles, spurs, cock-a-doodle-do, and pugnacity." "As for those old maids who are neither ugly nor masculine, some of them are quondam coquettes, who practised their arts just one season too long, and '*got left*' in consequence." "There is one difference between undervalued men of genius and old maids: the men of genius admit that they are in advance of their age, and are proud of it; the old maids never, at least *hardly ever*." Then, in the passage about woman's universal tendency to fall in love with officers, he says it is not because of their valor: "for they have perhaps never yet been opposite the '*business end*' of a rifle." If you want to win a woman's love, "put brass buttons on your coat, have it dyed blue, and wear epaulettes and a waxed mustache. This love charm *has never been known to fail*." "What is fat? It is an accumulation of unburnt *body-fuse*." Then this generalization of woman's love: "O Arthur! how happy I would be alone with you on a quiet island in the distant ocean!" — "Have you any other desire, dearest Ella?" — "Oh, yes! do get me a season-ticket for the opera." "As a rule, the preliminaries to animal marriages are doubtless brief. If a healthy, vigorous male comes across a mature, healthy female, it is usually a case of mutual *veni, vidi, vici*." We might go on with pp. 5, 6, 9, 11, 22, 38, 103, 114, 122, 123, 164, 196, and no doubt to the end of the book, with numerous instances of just such coarse humor in a scientific work. We have referred only to the most striking, and his pages everywhere abound in the use of some word or phrase that takes all the color of seriousness out of the narrative. Nor is the trait of which we complain confined to this book. In a letter to the *Nation* of Oct. 20, the same author, speaking of Oregon, which he says is called "Boomerland," could not resist adding, "As I write, I hear a mother scolding her baby for putting a handful of dirt in her mouth. Real estate is too valuable hereabouts to be thus squandered in luxurious living."

Such a man cannot write science. He cannot state rightly a plain fact: he can only see fun, and that of the coarsest kind too frequently. It is provokingly offensive in such a mass of facts as this book collects, because there is such a mixture of things which we have to consider seriously, along with the absurd. But at the same time you cannot take it so seriously as to condemn his theories: for you may be criticising an exhibition of wit or a joke. On the other hand, too many of his facts are collected from poetry, newspapers, and the by-paths of literature, to possess either psychological value or scientific interest. It is only his pedantic references to evolution, sexual selection, etc., which every one must take seriously to-day, and some pertinent moral reflections on customs and manners, that can give any flavor of scientific earnestness at all to the book. The encyclopedic collection of facts and quotations makes it seem pretentiously scientific, and no doubt much of it is intended to be; but the flippant tone everywhere visible, and its humorous levity so frequent, ought to disarm all serious censure except for bad taste. His use of evolution is not dangerous, because he has only a dilettante's knowledge of it. The book needs 'editing.'

J. H. H.

Answers.

15. IS THE TRUMPET-CREEPER POISONOUS?—While I was in south-west Missouri during 1879, I found a general belief that the trumpet-vine (*Tecoma radicans*) was poison to the touch, like *Rhus toxicodendron*. Upon investigation, however, I found that most people were in the habit of confounding the two, *Rhus toxicodendron* there climbing to the tops of tall trees, often having stems three or four inches in diameter, the external characteristics of the two vines being somewhat alike. I could not learn that the idea had any other foundation than this failure to distinguish between the two species, and am satisfied that *Tecoma* is never poisonous in any case.

WILLIAM F. FLINT.

Winchester, N.H., Oct. 24.

SCIENCE

FRIDAY, NOVEMBER 4, 1887.

THE NUMBER OF PERSONS who have been killed by explosions in mines during the past fifty years is 11,000, as stated by Mr. Ellis Lever in a recent number of the *London Times*. This number is, however, only a small proportion of those who have met their deaths by colliery accidents. The number of deaths through accidents of all kinds in mines since the Queen's accession is nearly six times greater, — 60,000, Mr. Lever says, — while 4,000,000 persons have been maimed or otherwise injured. Mr. Burt, M.P., an undoubted authority, states that the average number of those killed in mining operations is now 1,200 a year, and that 100,000 persons annually are injured in following the hazardous occupation of the miner. What are the causes which conduce to this terrible loss of human life? Mr. Lever says the want of a better and safer light is mainly responsible. The Royal Commission on Accidents in Mines has condemned as unsafe the lamps of Davy, Clancy, and Stephenson. The House of Commons confirmed the conclusions arrived at by the royal commissioners, and government inspectors of mines are now advocating and hoping for the immediate and universal introduction of the electric light into coal-mines. This state of affairs leads the English *Electrical Review* to say that it is to the electric light that the miner must look for emancipation from many of the horrible dangers to which he is subject. There are many forms of electric lamps now competing for the favor of miners and mine inspectors, and some of them possess undoubted advantages over the older types of safety-lamps. But there are also, in most of these, serious drawbacks which prevent their speedy introduction to mine uses. Weight, complication, and cost are among the principal disadvantages; and it behooves electricians to give their utmost thought to the task of overcoming the difficulties which the peculiar needs of the miner present. We have it on the testimony of Sir Frederick Abel that very great progress has been made towards providing the miner with a thoroughly safe, sufficiently portable, and generally efficient self-contained electric lamp since the Royal Commission submitted its final report; but the same authority is of opinion that strenuous exertions are yet needed before the comparatively heavy first cost of electric lamps will be so greatly counterbalanced by their durability and simplicity in construction and maintenance as to afford hope of their being generally or even very extensively substituted for oil-lamps. So that it is evident that the electrician is, in this direction as in many others, still behind the needs of the age, and behind what is expected of him.

AN EARLY MAP OF THE FAR WEST.

THE classic transcontinental expedition of Captains Lewis and Clarke, under instructions of President Jefferson to cross the plains and mountains to the Pacific Ocean, left the Mississippi on their venturesome journey, May 14, 1804. Their first winter encampment was made among the Mandan Indian villages, not far from the present site of the town of Bismarck. During the winter of 1804-05 their time was mainly occupied in preparation for the continuation of their journey westward. They were in frequent communication with the Indians, and received occasional visits from a few straggling French *voyageurs* and traders of the North-west Fur Company, who came from their headquarters in Canada as far as the Missouri. On the eve of the departure of the expedition, the following spring, Captain Lewis sent back a number of men with despatches, journals, and collections addressed to the government at Washington.

Among the articles forwarded was a map, prepared by Captain Lewis from all available data, of the country lying between the Mississippi River and the Pacific Ocean. The information obtained of the country to the westward of their winter quarters was for the most part derived from Indians more or less acquainted with the country near the head waters of the Missouri and Columbia.

In a letter of transmittal to President Jefferson, dated Fort Mandan, April 7, 1805, Captain Lewis says, "The map which has been forwarded to the secretary of war will give you the idea we entertain of the connection of these rivers, which has been formed from the corresponding testimony of a number of Indians who have visited that country, and who have been separately and carefully examined on that subject, and we therefore think it entitled to some degree of confidence." In a following paragraph, he adds, "You may therefore expect me to meet you at Montachello in September, 1806. On our return we shall probably pass down the Yellowstone River, which, from Indian information, waters one of the finest portions of this continent."

On Feb. 19, 1806, President Jefferson, in a message to Congress communicating the discoveries of Lewis, says, "During his stay among the Mandans, he had been able to lay down the Missouri, according to courses and distances taken on his passage up it, corrected by frequent observations of longitude and latitude; and to add to the actual survey of this portion of the river, a general map of the country between the Mississippi and Pacific, from the thirty-fourth to the fifty-fourth degrees of latitude. . . . Copies of this map are now presented to both houses of Congress."

After despatching the party for the return trip, the main body of the expedition crossed the mountains, wintered near the mouth of the Columbia, and, returning, reached St. Louis in September the following year.

As is well known, they brought back a large amount of most valuable geographical knowledge. In the map compiled by Captain Clarke, published in the authorized editions of the history of the expedition (Philadelphia and London, 1814), the main features of the country are in very many essential particulars different from the way they were originally represented on the preliminary map forwarded from Fort Mandan. The map was never ordered by Congress, and, so far as I can ascertain, was never published. It seems quite probable that after the return of the expedition means may have been taken to suppress so erroneous a production. At all events, no mention is made of this map in the published history of the expedition. In their journal they say, "At the same time that we took our departure, our barge, manned with seven soldiers, two Frenchmen, and Mr. Gravelines as pilot, sailed for the United States loaded with our presents and despatches."

To-day, however, the original drawing has considerable historic interest, as it gives the opinions of the highest authorities of the time upon the physical geography of the country and its inhabitants, and at the same time presents a clear idea of the value of the aid they received from Indian guides and others.

One of the copies of this map has been preserved in the Archives of the War Department, and through the courtesy of Gen. J. C. Duane, chief of engineers, I have been able to photograph it for reproduction.

The only public reference to this map which has come to my attention is a short editorial notice in the *Medical Repository*, New York, 1806. The journal was edited by Dr. Samuel Latham Mitchell, who was also a member of the House of Representatives. While in Congress, he served upon the Committee on Commerce and Manufactures, and in that capacity advocated all measures for the exploration of the Louisiana Purchase. There is evidence to show that he was one of the pioneers in Congress in favor of the exploration of the Far West by the general government. A copy of the map accompanies this communication. It was reproduced for

other purposes, but it cannot fail to interest a large number of the readers of *Science*. By reference to the map, it would appear that Captains Lewis and Clarke received no intimation whatever of the interior drainage of the Columbia. They represent the entire area of the Great Basin and the Snake River country as drained by the Missouri and the Yellowstone. The Yellowstone, named by them before reaching it, is shown as a longer river than the Missouri, rising as far south as the 39th parallel of north latitude, near the sources of the Rio Grande. In their map published in 1814 the drainage-area is already much restricted, and the river represented as finding its source in a large lake.

It is well known to all students familiar with the history of the North-west that the Yellowstone received its name in very early times. To most visitors to the Yellowstone National Park, however, the origin of the name is always a matter of special inquiry. It may be well, therefore, to add that Lewis and Clarke encamped near the junction of the Missouri and Yellowstone, April 26, 1805, seventeen days after leaving Fort Mandan. In their journal occurs the following: "This river, which had been known to the French as the *Roches jaunes*, or, as we have called it, the Yellowstone, rises, according to Indian information, in the Rocky Mountains; its sources are near those of the Missouri and the Platte, and it may be navigated in canoes almost to its head."

On the map there is one very significant designation to a comparatively small river quite remote from the country the party intended to traverse. In the region which has since been set apart as the National Park a small stream is shown tributary to the Yellowstone River, and curiously designated as 'Stinking Cabin River.' 'Brimstone' and 'Stinking Water' are names found on the maps of this region since the days of Colter's trip through the Yellowstone Park region, in 1807. But this still earlier name suggests that some adventurous *voyageur* unknown to history had already penetrated the country which has since become world-renowned for its remarkable thermal waters.

On the north side of the Missouri, Milk River is well represented on the map, but undesignated except by the amusing note, "The Indians call this the river which scolds at all other rivers."

The coast-line of the Pacific and Puget Sound is of course taken from early English admiralty charts, and doubtless in the possession of the distinguished explorer, Meriwether Lewis.

ARNOLD HAGUE.

SANITARY SCIENCE AND EDUCATION.¹

GENTLEMEN,—When I accepted the invitation of your president to participate in this discussion, it was not in the hope of being able to add any thing to the general store of information on sanitary topics, for sanitation and hygienic science are subjects that, on their technical side, I know very little about; but I accepted Dr. Newton's invitation because as a teacher, and one who is engaged in the training of teachers, I desired to express my appreciation of the importance of sanitary science for sound educational doctrine and correct educational practice, and to add my testimony to that of the other gentlemen who are to address you, to the fact that your researches and conclusions are of the greatest practical value to us.

Mens sana in corpore sano is as much to be prayed for now as it was in the time of Juvenal, and we are far better equipped than was the satirist or his contemporaries to work toward that end. The sound mind and the sound body seemed to the Roman to be two distinct and separate things whose conjunction was desirable. We have come to know that the two are so intimately related, indeed so interdependent, as to be practically one thing. Aristotle furnished the educators of antiquity with a psychology upon which to base their praxis. It was a wonderful achievement. But the great modern science of physiology, whose beginnings are to be seen in the discoveries of Servetus, Harvey, Leeuwenhoek, and others, compelled the entire rewriting of that science; and the result is an infinitely more complex and accurate and practical, though less final psychology, than that which was bequeathed to

us by the great Stagyrte. This new psychology has taught us how truly vital the dependence of mind on body is. We know, for example, that a decreased or impoverished supply of blood to the brain produces mental inertia and lassitude. We know that an organ develops by exercise, and that the neglect of an organ or its excessive stimulation is alike harmful, no matter whether the organ be mental or physical. We can promptly and surely trace the mental results from unduly intense or too prolonged brain-work, from lack of exercise, and from improper nutrition. We are aware, in like manner, of the bodily results induced by the various emotions and passions, by expectant attention, by concentrated will-power, and other mental phenomena.

Now, it seems to me that it is just at this point that the sanitarian and the educator join hands. Both having a full understanding of the relation that subsists between mind and body, the former brings the results of his studies to the latter, and formulates them into suggestions and rules for the teacher's guidance. The teacher, in return, adopts these suggestions and rules as parts of his science, and communicates to the sanitarian in due time the effects that follow such adoption. Thus sanitary science is aided in one of its most important applications, and the science of education adds a most valuable chapter to its book.

Perhaps this co-operation of sanitarian and educator is more ideal than real, but it is nevertheless far more noticeable now than it was twenty-five or even ten years ago. This is proved, if proof be needed, by the fact that instruction in physiology and hygiene, and in the mental and physical effects of stimulants and narcotics, has been generally added to the curriculum of the common school within that period. It is not to be disputed, on the other hand, that much remains to be done. An illustration of this will be found in one of the opening pages of a recent book on the ventilation and warming of school-buildings, by Mr. Morrison of Kansas City. The author reminds us (p. 18) that "no subject has been more carefully and intelligently studied than the direct and ultimate effects of improper air on the human system, and that on no subject is there greater unanimity of competent opinion." School-building goes on, however, year after year, and it goes on in too many cases utterly regardless of whether a child vitiates two cubic feet of air per hour or two thousand cubic feet, whether 62° F. is the better average temperature or 82°, or whether 45 per cent of saturation is desirable in the atmosphere or 70 per cent. Nevertheless, science and common sense are making headway, and there is every reason to believe that in a few years' time all the school-buildings that are erected, however humble and unpretentious they may be, will be well ventilated and properly heated.

You will pardon, Mr. President, my apparent digression from the four specified subjects of this evening's discussion, for it seems to me that it is only on such broad lines as those which I have indicated, that these questions can profitably be considered. It would be no great advantage were we to bring together a mass of merely empirical statements. We must get below the statements to the facts and principles which explain them. We want to get at the philosophical and scientific reason for the relation that sanitation bears to education. We want to understand exactly what it is that is common to both sciences. That much being clearly before us, the application of the results of the former science to the problems of the latter is not a difficult matter.

The educational topics before you are four: (A) the length of school days and terms, (B) recesses, (C) competition, (D) industrial education. I shall pass over the first two in order to say a word about each of the others. These are competition and industrial education. Permit me a few words concerning each.

Competition may be defined as a common striving for the same end. It involves two or more competitors. As a principle it has long been dominant, not only in business-life, but in the science of economics. It has been prescribed as the proper stimulus for all stagnation, and as the solvent for all difficulties. Of late years, however, a school of economic thinkers has arisen which asserts that unrestricted competition is an evil to humanity and to the State. We are told that it is proved to be demoralizing, destructive, and, as a principle of political economy, inefficient. Have not you sanitarians and have not we teachers reached an analogous conclusion as to competition in our common field? Is not competition, when

¹ Abstract of an address by Nicholas Murray Butler, Ph.D., president of the Industrial Education Association's College for the Training of Teachers, delivered at the thirteenth annual meeting of the New Jersey Sanitary Association, held at Trenton, Oct. 28, 1887.

left to itself, in danger of emphasizing material success at the expense of the disciplinary process? I take it we are all agreed that how a pupil learns is of more importance than what he learns. His faculties are developed and his character formed by the process of learning, far more than they are by the thing learned. The tendency of unrestricted competition is to alter this relation, to exalt the result, and to depreciate the process. This is contrary to the teaching of mental hygiene, and in consequence is to be condemned by sanitarians and educators alike. I say nothing of the pallid faces, the disordered nerves, the sleepless nights, and the loss of appetite, that result from competition for competition's sake. Were those results not present, I should still oppose it as an unsound educational principle. Therefore I repeat, competition must be restricted and kept within reasonable bounds. This topic gives rise to many other fruitful suggestions, but I must pass them by.

There remains the subject of industrial education. Let me, in as few words as possible, place that properly before you, and then I am confident that the attitude toward it of a science of sanitation that is broad enough to demand a well-developed mind in a well-developed body will not be for a moment doubtful.

Industrial education is not technical education, the preparation for trades. It is a term invented to signify an education in which mental training through the hand and the eye occupies its proper place beside mental training through the memory and the other means of approach to the mind. Mental training through the hand and the eye is generally known as 'manual training,' which term is only satisfactory in case its proper signification is understood. This manual training is graded instruction, the object of which is to develop the pupil's powers of expression. No piece of knowledge is really our own until we can express or apply it. Mere memorized knowledge is parrot knowledge. It is mentally indigestible and innutritious. It is the pastry of the intellect. Well enough, perhaps, if taken in proper quantities and at proper times, but very unsatisfactory and unwholesome as a steady diet.

Reading and writing both appeal in a measure to the child's powers of expression, but not sufficiently nor in the most natural and simplest way. Expression by means of language is abstract and comparatively difficult. When carried to any great degree of fluency or accuracy, it is universally looked upon as an accomplishment. The earlier and simpler methods of expression are by gesture, by delineation, and by construction. Industrial education takes these powers of expression, delineation, and construction, and trains them together with the other faculties. Drawing and construction, the latter in material suited to the strength and capacity of the pupil, are reduced to a system, and go hand in hand with instruction in the three R's. Thus the sense of form, of proportion, of accuracy, and of truth is developed as is possible in no other way. The judgment and the executive faculty, the most important of all our powers in the practical work of life, are provided for and trained in the scheme of industrial education, though accorded no place in the old-fashioned curriculum.

Now, sanitation has been called the 'science of preventive medicine,' and lectureships with that title have been founded in Great Britain. In connection with this description of your science, let us remember that we are told on high authority that the number and variety of diseases and disorders that are traceable to the mind are rapidly increasing. If this statement is true (and I know of no reason to doubt it), in what direction can our sanitarians better expend their energies than in furthering the adoption and development of an educational system that is complete, that is thorough, and that is healthy? This is certainly a proper field for the activities of 'preventive medicine.'

Time will not permit me to follow out this suggestive theme. I will simply state, in conclusion, a few of the reasons why I consider industrial education a matter of importance to sanitarians. In industrial education, properly organized and administered, I claim that we have for the first time a system that trains all the mental faculties, and each at the proper time and in proper proportion. It gives us no abnormal and mechanical memories without judgment and executive ability, no hunched backs without arms and legs. Every faculty is considered, every power is taken into account. The conditions of nineteenth-century life are kept in mind,

and the ideally educated man is not held to be the mediæval recluse or the eighteenth-century English gentleman. Incidentally, industrial education affords a pleasant and healthful alternation of exercise from faculty to faculty. No one is overstrained, no one is allowed to become atrophied and die. Muscular exertion is called in to supplement and relieve mental activity.

My own belief is that the mere recital of these facts determines the attitude of sanitarians toward the system which permits and causes them. As friends of educational and scientific progress you will approve industrial education, and then as sanitarians you will indorse it as a long step toward the much-to-be-desired *Mens sana in corpore sano*.

THE AMERICAN ORIENTAL ASSOCIATION.

THE fall meeting of the American Oriental Society was held on Oct. 26 and 27, at the Johns Hopkins University. Since the establishment of this university a little over ten years ago, Baltimore has grown to be one of the great centres of education and learning in this country. A 'university' atmosphere pervades the place, and the large audience that gathered in Hopkins Hall at the opening session on Wednesday afternoon may be taken as an indication that the interest felt there for higher studies and researches extends to regions that seem (but only seem) to lie so far off as those covered by the Oriental Society.

In the absence of Professor Whitney, who, although considerably improved in health, is still obliged to be sparing of his strength Vice-President Dr. W. H. Ward of New York presided.

The reading of papers was begun by Professor Haupt of the Johns Hopkins, who presented the prolegomena to his forthcoming Assyrian grammar, — a work on which he has been engaged for a number of years. The extent of the literature in cuneiform characters is appreciated only by very few persons; and even of those present at the meeting, no doubt quite a number were surprised, to learn, that, as far as known to us, it covers a period of at least forty centuries. There is a short inscription of King Sargon of Agade, the date of which can be fixed with certainty at 3800 B.C., and on the other side Antiochus Soter (280–261 B.C.) tells us in a cuneiform tablet of a temple he had erected in honor of a Babylonian deity. Professor Haupt, after speaking of the various periods to be distinguished in Babylonian-Assyrian literature, dwelt at length on some of the features of the Assyrian language, showing, more especially, the relationship that existed between it and the cognate Semitic tongues. In a brief discussion of the paper, Professor Jastrow, after alluding to the eagerness with which students and scholars have been looking forward for some time to the grammar of Professor Haupt, who stands to-day without a superior, and with but few equals among Assyriologists, spoke of the 'Sumer-Akkadian' controversy, which is attracting considerable attention just at present. He regretted the confusion which incautious writers are bringing about by unnecessarily complicating the points at issue with questions and theories that have no bearing on the subject.

Professor Bloomfield followed with an exhaustive study of certain magical rites in cases of disease, as laid down in the Athavar-Veda. Professor Lyon of Cambridge announced the recent purchase by the Harvard University of a collection of Babylonian so-called 'contract tablets.' These tablets, of which the British Museum possesses many thousand specimens, have afforded us a wonderful insight into the daily life of the ancient Babylonians and Assyrians. They show us that legal proceedings were quite as complicated in days of antiquity as they are to-day; they give evidence of extensive commercial transactions in those days; and, while the lengthy inscriptions of the kings give us valuable information of the wars and campaigns, these little bricks tell us much of the ways and manners of the people.

The most interesting feature of the convention was the gathering, at the residence of President Gilman, of the university in the evening, which partook partly of the nature of a reception, and in part of an informal session of the association. Besides the members of the Oriental Society, a number of prominent gentlemen, including some of the trustees of the university, had been invited. President Gilman welcomed his guests in a few well-chosen remarks, where-

upon Mr. H. F. Allen, a fellow at the Johns Hopkins, made the announcement that the Semitic seminary of the university proposed publishing at an early date a complete Assyrian glossary. The work would be issued under the superintendence of Professor Haupt, and, while not intending to supersede the great Assyrian dictionary now in course of publication by Prof. Friedrich Delitzsch of Leipzig, will aim to supply the need of students of Assyrian better than the latter work does. The principles which will guide the compilers in their work were briefly set forth. Professor Haupt followed with a second announcement, also of great interest to Semitic scholars, regarding a series of contributions to Semitic comparative philology, which he proposes editing in conjunction with the above-mentioned Professor Delitzsch; and it must have seemed to many as though an Assyriological 'craze' had broken out when Dr. Cyrus Adler added a third announcement, which was no less gratifying than the preceding ones.

The National Museum at Washington has recently entered into an arrangement with the Johns Hopkins University with a view of obtaining as complete a collection as possible of facsimiles and casts of seals coming from Mesopotamia, and to include eventually in the collection also important cylinders and tablets bearing cuneiform inscriptions. The beginning will be made with the antiquities scattered throughout the museums and private collections in this country. Besides the copy of each piece to be deposited in Washington, another copy will be given to the Johns Hopkins, in consideration of which the latter institution will superintend the collection at the national capital. The project is one which promises to arouse considerable interest; and the hope that it may yet lead to an exploring and excavating expedition from this country to the mounds in Mesopotamia, which still harbor such untold treasures, may not be an utterly futile one.

Professor Gilman exhibited photographs of the famous Greek manuscript, 'The Teachings of the Apostles,' the discovery of which some years ago created a veritable sensation. The original manuscript is in an Eastern monastery, but the photographic reproductions are executed with an excellence that makes them fully as reliable for students as the original copy. Dr. Binion of Baltimore had some specimens of a magnificent illustrated work on the art of ancient Egypt, which he is about issuing. The cost of the work, which will contain all the important Egyptian monuments, will be one hundred and fifty dollars a copy. Professor Frothingham closed the interesting programme with a description of a monastery he recently saw in Italy, dating from the Byzantine period, and which possesses a most remarkable twelve-sided tower, — the only instance of the kind in the world.

Thursday morning again found the members in Hopkins Hall. Professor Lanman presented a brief paper from Professor Whitney. Dr. Peet had an interesting treatise on animal and sun worship among the American Indians, which brought forth some curious points of coincidence between the religious notions of the Indians and other ancient peoples. Dr. Cyrus Adler of the Johns Hopkins presented two papers bearing on Assyriological research. One of these treated of the views of the Assyrians on life after death. They believed in a future life, but the notion of a future punishment does not seem to have arisen among them, nor do we find that any distinction is made by them between the abode of the good and of the wicked. It is probable that they supposed all would share in the life to come.

Professor Hopkins of Bryn Mawr called attention to some proverbs in the Mahabharata paralleling those found among other nations. Among these, there is the 'golden rule,' which, however, is formulated negatively in the Sanscrit: "Do not unto others what thou wouldst not have others do unto you." A discussion followed in which several members participated. Professor Lanman remarked that in Chinese the maxim also has the negative form, as is also the case in the Talmud, where the saying is put in the mouth of the famous rabbi Hillel.

Mr. Allen had a suggestive paper on a proposed method of transliterating the letters of the Semitic languages. There is scarcely any point in regard to which scholars differ so much as in the method of reproducing the Semitic sounds, and yet it is eminently desirable that some uniform method be adopted. The system proposed by Mr. Allen endeavors to proceed upon the principles of

phonetics, and has at least the advantage of simplicity; but whether it will meet with the approbation of scholars remains to be seen.

Further papers were presented by Dr. Ward on some Babylonian mythological symbols; by Professor Bloomfield on 'The Fire-Ordeal Hymn in the Athavar-Veda,' by Dr. T. W. Jackson; and finally one — which, however, was only read in abstract by Professor Lanman — from Mr. Rockhill, of the American legation at Peking, on the relations of Corea to China. Mr. Rockhill is engaged in important researches which promise to clear up many obscure points in Chinese history. In a communication to Secretary Lanman, he cites an instance to show how untrustworthy the ordinary information concerning China is. It seems that in the recent census an entire province was overlooked, which contained some sixty million inhabitants; so that the figures usually given must be changed to three hundred and seventy-nine millions. A number of new members, both corporate and corresponding, were elected, and the following honorary members: Sir Henry C. Rawlinson, the well known Assyriologist, and editor of the great publication undertaken by the British Museum, 'The Cuneiform Inscriptions of Western Asia;' Prof. George F. Böhlan, a distinguished Sanscrit scholar of Germany, and editor of the latest volume of the 'Sacred Books of the East;' and Prof. Edward Sachau of the University of Berlin, who has been called to take charge of the Oriental institute which has just been established by the German Government for the training of diplomats and officials in the Eastern service. All the chief European capitals, with the exception of London, now possess institutions of this nature, where the important Oriental languages are taught, and it has been said that the Emperor of Brazil contemplates the establishment of one at Rio Janeiro. The Berlin school has opened with the amazingly large number of one hundred pupils.

The next meeting of the Oriental Association will be held in Boston during the month of May, 1888.

HEALTH MATTERS.

Cholera Cases at Quarantine.

In *Science* of Oct. 14 we noted the arrival at New York of the steamship 'Alesia' from Italy, with cholera on board. Since then another steamer, the 'Britannia,' from the same ports, has arrived. This vessel was detained at quarantine, and during this detention one of the passengers, a child, was taken sick with what is now known to have been cholera. Two other cases of cholera have developed on this same vessel, the latter of them on Oct. 24. It is said that the report of the surgeon of the vessel gave not the slightest indication of the existence of cholera on board, and it is more than probable, that, had not the arrival of the 'Alesia' with developed cholera on board occurred prior to that of the 'Britannia,' the cases of cholera which occurred on the latter steamer would have first been heard of in some hotel or boarding-house of New York.

So far as we have seen, no statement has yet been made of the health of the passengers and crew of the 'Britannia' during the voyage from Italy to New York. It would be criminal on the part of the surgeon of that steamer to have concealed the fact if cases of cholera occurred during the voyage; and, if they did not, it would seem to be a warrantable inference that cholera may develop on a ship even after a voyage across the Atlantic, and that, as happened in the case of the 'Britannia,' the health-officer is justified in detaining in quarantine a vessel from ports in which cholera is known to exist, even though she may not have had sickness on board during the voyage. It is stated that urgent demands were made on the health-officer to permit the 'Britannia' to come to the city without detention, and that it was claimed that the sickness of the child passenger was simply cholera-infantum.

Dr. Smith is to be congratulated on having exercised the authority which the State has conferred upon him, in having detained the 'Britannia,' and he may be assured that the people of this great country will uphold him in the exercise of the most arbitrary powers so long as the public health is in the imminent danger that it is in at the present time. A lack of intelligent action now may result in the introduction of cholera germs, which, though they may lie dormant during the winter, may result in a plentiful harvest when next summer comes.

AMERICAN CATTLE-PLAGUE.—Dr. Frank S. Billings, director of the patho-biological laboratory of the State University of Nebraska, claims to have discovered the germ of the American cattle-plague, commonly known as Texas-fever. This germ, he says, belongs to that class of septic germs represented by our swine-plague and rabbit septicæmia. It is a bacterium. It colors at its poles, and has a clear or non-coloring middle piece to its body. It has a motility in hanging drop-cultures, and also in the blood serum from the original blood of a diseased animal. Dr. Billings gives no experimental evidence to support his claim, but states that this will follow in course of time.

HEALTH OF PRISONERS.—Dr. Watkins, inspector of the State Board of Health of Louisiana, has recently examined the prisoners in the parish prison of New Orleans. He found a number of the inmates suffering from acute dropsy of the legs, arms, face, and body, due to confinement and insufficient and unwholesome food. Each prisoner is allowed a piece of bread and a pint of tea early in the morning, and one meal consisting of soup, the beef cooked in the soup, and bread. The beef is supplied by a contractor at five cents and a half per pound, and has been repeatedly condemned by the resident surgeon.

TYPHOID-FEVER CONTAGION.—We have repeatedly called the attention of our readers to what we believe to be a dangerous error in the management of typhoid-fever. The tendency to look upon drinking-water as the usual, if not indeed the only, channel by which the disease is propagated, is so prevalent among sanitarians and physicians, that other means are very liable to be overlooked, and the necessary precautionary measures neglected. An instance of the probable communication of this fever by other instrumentality than water is reported by M. Bonamy of Nantes. Two households used drinking-water from the same source. In one six cases of typhoid-fever occurred, four of which were fatal: in the other no cases occurred. It is true that this is negative evidence. It is, however, notwithstanding, of some value; not perhaps taken alone, but in connection with other facts which have from time to time been recorded touching the methods by which typhoid is propagated.

SCARLET-FEVER IN LONDON.—Scarlet-fever is very prevalent in London, there being in the hospitals alone nineteen hundred cases under treatment.

YELLOW-FEVER AT TAMPA.—The disease which appeared in Tampa, Fla., in the early part of October, has developed into undoubted yellow-fever. To Oct. 24 there had been 180 cases reported, with 27 deaths. Under the auspices of the United States Marine Hospital Bureau, a hospital has been provided, and a corps of experienced nurses has been obtained from Savannah to take care of the sick. The weather is very favorable for the spread of the fever, and the extension of the disease to the suburbs of the town is conceded.

EXPLORATION AND TRAVEL.

The Kuango.

MR. MENSE, who accompanied the energetic missionary Grenfell on his exploration of the lower Kuango, has described the interesting journey in a lecture delivered before the Geographical Society of Berlin. He describes the exploring of the tributaries of the Kongo as not connected with great difficulties, which only begin when an overland journey is attempted. In the trip up the Kuango a lady even participated. The principal difficulty was the obtaining of fuel for the boiler of the steamboat. Food was plentiful, as the river swarmed with hippopotamuses. In many places their meat could be bartered for fuel. When arriving near Kindjungi, a reef running right across the river, the hippopotamuses got scarce, but in their stead an abundance of shell-fish was found. The intercourse with the natives was generally peaceable; but, as those tribes who had hostile intentions had no fire-arms, their attacks were not dangerous. Grenfell had provided his steamer with a net of steel, which protects the crew and the passengers from the arrows. The reef Kindjungi stopped the progress of the expedition. The river forms a fall three feet in height, and has dangerous whirlpools. It rushes through a narrow gorge cut about a thou-

sand feet into the plateau, which consists of laterite. The tribes inhabiting this district have had no intercourse with Europeans. They wear self-manufactured clothing, and their language differs from those spoken near Stanley Pool. The country is thickly wooded, and caoutchouc is found in considerable quantities. Elephants and buffaloes are numerous, but there are only few villages. The lower part of the river runs through a grassy plain, while near Kindjungi the country becomes mountainous. As Major von Mechow descended the Kuango to Kindjungi, and as Dr. Büttner reached its middle course coming from the west, the position of the whole river is now fairly laid down.

TRAVELS IN AFRICA.—Captain van Gèle's attempt to reach the Welle, according to *Le Mouvement Géographique*, has unfortunately been unsuccessful. When he arrived on the upper Itimbiri, he unexpectedly found the country uninhabited and poor. As he was not prepared for this, and had no provisions to last him for a journey through unknown territory, he had to return. He will probably resume his enterprise. According to the Proceedings of the Geographical Society of Berlin, Dr. H. Meyer has succeeded in reaching the summit of the Kilima Njaro, while all former travellers failed in their attempts. The summit is occupied by a crater. It is covered with snow, which sends forth a glacier that extends to a comparatively low level. The Germans are making vigorous attempts to penetrate into the extensive unknown area of West Africa. Two expeditions are being organized in Kamerun to explore the interior, which forms the watershed between the Kongo and Benue systems. Lieutenants Kund and Tappenbeck, who made important discoveries in the southern Kongo basin, will push eastward, while Dr. Zindgraff will try to penetrate into the interior in a north-easterly direction. So far, the hostility and jealousy of those tribes who command the trade between the interior and the coast have prevented all expeditions from entering the unknown country.

GREENLAND.—The Danish expedition to the coast of northern Greenland, says *Nature*, has just returned to Copenhagen. It has been absent since the spring of 1886, and was directed by Mr. C. Ryder. During the two summers it was enabled to proceed from latitude 72° to latitude 74½°. It investigated the Upernivik glacier during the winter. Many meteorological, magnetic, and astronomical observations were made, many anthropological measurements were taken, and botanical and zoological collections have been brought back. The investigations of the western coast of Greenland are not likely to be continued for the present. It is to be regretted if the latter statement should be true. The Danish expeditions to Greenland have resulted in so numerous and valuable contributions to our knowledge of this immense island that their continuation seems very desirable. The exploration of Melville Bay is of the greatest importance, as here many questions regarding the character of the ice of Davis Strait must be solved, and as its topography is utterly unknown; but so far the Danes have not extended their researches beyond their most northern settlement, Tassiussak, which lies at the southern extremity of Melville Bay.

BRITISH COLUMBIA.—Dr. George M. Dawson, chief of the party sent by the Canadian Government to explore the country adjacent to the Alaska boundary, has returned to Victoria. Two of his party, Messrs. Ogilvie and McConnell, will winter in the district, making astronomical observations, which will give data for the establishment of the international boundary. The expedition so far has secured a great deal of geological, geographical, and general information of the country. The point from which the doctor turned back was at the junction of the Lewis and Pelly Rivers. It is one thousand miles north of Victoria. There the flora was found to differ but little from that on the banks of the Fraser. A great deal of open, grassy country exists along the streams tributary to the Yukon. No areas of tundra or frozen swamps, such as are to be met with in the interior of Alaska, were discovered by the expedition. The doctor's conclusion is that the whole country from Cassian to the vicinity of Forty Mile Creek, on the Yukon River, yields more or less gold in placer deposits. This would constitute a gold-bearing region fully five hundred miles in length by an indefinite width, and which so far, in comparison to the area, has been very little prospected.

BOOK-REVIEWS.

Psychologie im Umrisse auf Grundlage der Erfahrung. Von Dr. HARALD HÖFFDING. Tr. from the Danish by F. BEN-DIXEN. Leipzig.

Essai de Psychologie Generale. Par CHARLES RICHEL. Paris, Bibliotheque de Philosophie Contemporaine.

Few philosophical reformations have a more instructive history than that which introduced experimental methods and scientific conceptions into the study of mental phenomena. The cleft between the student of matter and the student of mind had no existence in the harmonious mental culture of Greek philosophers. The nature that is the common storehouse of the *physicist*, the *physiologist*, and the *physician*, was also the mine from which the philosopher drew his lore. The great modern revival that separates the sciences, and forces a medical congress to separate into nineteen sections to insure that he who reads will be understood, has left the philosopher in the high altitudes of the mountain-top, while the busy scientists throng down into the mine. Not until our day has the philosopher taken much interest in the carloads of rich ore dug out by the miners, and come to seriously consider the announcement that this patient digging had discovered many rich veins of thought suggesting those unifying generalizations for which he was searching in the clouds. The good effects of this change of method and re-arranging of interest are easily discerned. The 'know thyself' has been interpreted as including the whole man, body and mind, past and present, as modified by all kinds of natural and artificial agencies. But the most distinctly new contribution that this revival of nature-philosophy has brought about is the origination of a scientific psychology, borrowing its methods as well as many of its facts and conceptions from other sciences, — and so re-uniting what should belong together, — while maintaining its distinct character by the use to which it puts this material, and the point of view from which it regards it.

The two volumes before us are both typical results of the new psychology. The one comes from the professor of philosophy in the University of Copenhagen; the other, from a professional physiologist of Paris.¹ Their purpose is to set forth in plain language the conclusions which experimental research and observation have allowed us to draw regarding the nature and function of psychical phenomena, and to delineate the general conceptions to which these facts give warrant. As text-books, both will be eminently useful, and an English version of either would be a welcome contribution to our literature. The point at which the works divide is that the one is written especially for those in whose minds the philosophical interest is uppermost, while the other appeals more directly to the physiologist.

Professor Höffding, while seeing in objective research the central method of psychology, fully recognizes in self-consciousness a most important supplementary means of study. Not only that we can only make our own what we assimilate to our past selves, — the deposit of a host of conscious acts, — but also that the higher mental processes are amenable to no other mode of study. On the other hand, he recognizes in consciousness a somewhat subordinate concomitant of certain psychical acts, and regards with equal interest such acts as have not this accessory; moreover, he holds that the latter can alone determine what is the 'naturally' correct mode of viewing the former. The author thus sees growing around the central 'natural' view of man several psychologies, — a physiological psychology, a psychophysics, a comparative psychology, a sociological psychology. He does not attempt a strict definition of his science, and is more anxious that it should receive the benefit of a number of lights reflected from several quarters than that it should stand out as a distinct, self-made, smoothly finished specimen.

'The experimental basis' on which this psychology rests, includes quite as much such every-day facts as are made interesting by the tact of a humane observer, as rows of formidable tables fresh from the laboratory. The criticism passed upon Wundt's 'Physiological Psychology,' that it is simply a physiology with a psychology attached, would not be applicable here. Professor Höffding makes the physiology distinctly subordinate to the psychology,

while constantly utilizing the facts that physiologists have discovered. For the non-technical student this is perhaps the better plan: it retains for psychology that general broadening interest which its pursuit as a technical speciality may for a time weaken. The plan of the work is somewhat different from those of our text-books of psychology, and is an improvement upon them. After defining his point of view, he considers the relations between body and mind as well from the physiological as the philosophical point of view, and passes to the study of the conscious and the unconscious, treating the phenomena of instinct, unconscious cerebration, etc. Here, as elsewhere, his acceptance of the evolutionary theory, and his use of the analogy between the growth of the individual and that of the race, give life to his pages. He next accepts the trifold division of the intellect, the feelings, and the will, though accenting the fact that each depends upon the other, and the development of all three follow the same path. His chapters upon the mutual relations of intellect, emotions, and will, are full of sound educational material. He devotes an unusual space to the emotions, while rather slighting the will. To single out any points for special treatment would hardly be serviceable: the important aspect of the volume is its modern appreciation of the intimate connection between fact and theory. Dr. Höffding has made a distinct advance in the problem of adopting new psychological results into the body of accepted truth, which serves to educate the next generation.

The main purpose of M. Richet's work is to give a useful summary of those general propositions regarding the functions of the nervous system that have a direct psychological bearing. In this he has succeeded very well, and his success makes us realize the progress made in recent years. It is a book of this nature that impresses one with the rapidity with which mental science is taking on that long-desired scientific aspect. It is no longer meaningless to speak of psychological laws.

What M. Richet means by 'general psychology' can be best gathered from the titles of his chapters. These treat of irritability, the nervous system, reflex action, instinct, consciousness, sensation, memory, ideation, will. Under each heading the treatment is general, stating in brief the conclusions accepted by modern psychology. Within two hundred pages one has here a convenient handbook of the main principles on which an elementary course in psychology should be based.

There is one point in the volume which M. Richet has singled out for separate treatment elsewhere, and which should be noticed here. Between an ordinary reflex action and a conscious act, the author introduces a 'psychic reflex,' and by this he means all those involuntary acts which have become so by interposition of conscious, inferential elements. The dog that trembles when his master shakes a stick at him; the man who feels nausea while reading of a disaster; the vertigo experienced when looking down from a height; many kinds of laughter, as of tears, fear, pain, and pleasure, — are likewise psychic reflexes. These actions all take place involuntarily, but they would not happen if a psychic element did not intervene. Disgust would not occur if the tale were written in an unknown tongue. A psychic reflex is a response to a peripheral irritation insignificant in itself, but so transformed by an act of the mind as to put in operation the reflex centres of the spinal cord. This distinction is a convenient one, and the term will doubtless be adopted.

Ancient Nahuatl Poetry. By DANIEL G. BRINTON. Philadelphia, The Author. 8p.

THE recent volume of the author's valuable Library of Aboriginal American Literature, the seventh of this series, contains a number of ancient Mexican poems with translation, notes, a brief vocabulary, and an introduction. The poems are from a manuscript volume in the library of the University of Mexico, entitled 'Cantares de los Mexicanos y otros opusculos,' and printed from a copy made by Abbé Brasseur de Bourbourg. It is unfortunate that the author has not been able to have the texts collated with the original, but his efforts in this direction were unsuccessful: therefore it is probable that some corrections will have to be made in the texts. But scientists will nevertheless be thankful to Dr. Brinton for the publication of the interesting collection of poems

¹ M. Richet is also editor of the *Revue Scientifique*.

which are here for the first time made accessible to the student, and it is to be hoped that all that is extant of ancient Nahuatl literature will be printed ere long.

The texts are preceded by a brief introduction, in which the character of Mexican poetry is discussed. The importance of poetry, music, and dance among the Mexicans is set forth, and their method of delivering the songs is described. Of particular interest are the remarks of the author on prosody; and these are the more weighty, as he has studied this subject among many North American tribes. It is very difficult to decide whether accent or quantity is the ruling element of poetry, and the author does not attempt to decide which is more important. It seems to us that this question can only be solved by studying music and poetry jointly.

Dr. Brinton finds another wide-spread peculiarity of Indian poetry occurring in Mexican poetry. It is the inordinate lengthening of vowels and reduplicating of syllables for the purpose of emphasis or of metre, and the insertion of meaningless interjections for the same purpose. It is an interesting question whether the accent in Mexican poetry is always on the vowel, or whether certain combinations of consonants can form a syllable, as is the case in some American languages. The instrumental accompaniment of the songs is described, and the connection of the rhythm of the drums with the prosody is emphasized. In the present collection, as well as in those of other nations, we find a peculiar poetical language which makes their translation very difficult. Dr. Brinton describes this poetic dialect as abounding in metaphors. Birds, flowers, precious stones, and brilliant objects are constantly introduced in a figurative sense, often to the point of obscuring the meaning of the sentence. The grammatical structure is more complicated and elaborate than in ordinary prose writing, and rare words occur frequently. The rhetorical figure known as aposiopesis, when a sentence is left unfinished and in an interjectional condition, in consequence of some emotion of mind, is not rare, and adds to the obscurity of the wording. The last peculiarity is characteristic of the popular songs of all nations, while the occurrence of rare words may be due to the fact that many of them are sacred songs. The richness of metaphor, and the complicated grammatical structure, are also wide-spread qualities of poetry.

Dr. Brinton considers some of the songs as belonging to a time anterior to the Conquest, and gives in the brief notes which accompany each of the twenty-seven songs his reasons for this opinion. Undoubtedly most of them belong to the time of about 1500. Others are evidently ancient songs, composed before the Spaniards influenced the native customs and ideas, and this makes the present collection the more interesting. It is welcome material for the student of the Mexican aborigines.

Guatemala, the Land of the Quetzal. By WILLIAM T. BRIGHAM. New York, Scribner. 8°.

THE author terms his book very properly 'a sketch.' It is the tale of his journeys in Guatemala, adorned with some remarks on the geography and history of the country. The author does not claim to give any new information, but it is pleasant to follow him on his ride through a semi-civilized country. The book is profusely illustrated, and the illustrations have the merit of being new, characteristic, and trustworthy, most of them being reproductions of photographs. The scientific contents are selected somewhat at random, but will serve the purpose which the author has principally in view,—"to awaken among Americans greater interest in the much-neglected regions between the Republic of Mexico and the Isthmus of Darien." There are several maps in the volume, but they are of no great value. The map of Guatemala, which is claimed to have been compiled from various sources, is only a very rough sketch of that country. By far the greatest portion of the book is taken up by the author's journeys; and this is the most interesting part, as it gives a fair idea of Central American life, and valuable hints to future travellers. It is followed by a chapter on the ancient inhabitants of Guatemala, a brief history of the Republic, and a sketch of its volcanoes and produce. In an appendix, which the author compares to the attic-room of a thrifty housewife, information about a variety of subjects and a partial bibliography of Central America are given.

The Principles of Elocution. By ALEXANDER MELVILLE BELL. 5th ed., revised and enlarged. Washington, John C. Parker. 12°.

VERY many intelligent readers of the great orators, ancient and modern, must have experienced a feeling of keen regret that they themselves were unable even to approximate the directness, force, and fluency of those masters of the art of expression. It would almost seem that the power to rouse multitudes to action, to stir the deepest and most masterful emotions, to control and direct action, by the use of language, is so dangerous a one that it has been granted to but few. As a matter of fact, however, oratory or eloquence is nothing more than highly developed and cultivated power of expression. It implies the possession of something to express. The full head and the sympathetic heart are essentials.

But without aiming at the ambitious height of eloquence, there is a power of forceful and adequate expression by the use of language that belongs to us as human beings, but which is almost wholly overlooked in the training of the young. Not only is this undesirable in itself, but the conditions of our modern life render it more so. In politics, in religion, in practical life, and in social activity, men are endeavoring to communicate their own thoughts and convictions to others; and very many are the embarrassments that result from the lack of ability to properly express these thoughts and convictions. There is, therefore, a practical as well as a sentimental reason why our natural gift of expression should be cultivated.

All of this is very familiar to Mr. Bell, and, in addition, he has given so much time and study to the working-out of the practical applications of the thing, that he is to-day easily our first authority on the subject. In this last edition, the fifth, of his 'Principles of Elocution,' he has given us the ripest fruits of his thoughts and study.

Mr. Bell deprecates in his introduction the neglect of elocution, and ascribes it to two causes,—first, it is neglected because it is misunderstood and therefore undervalued; and, second, it is misunderstood because it has been confounded with recitation, and otherwise misrepresented by many writers on the subject. Mr. Bell defines (p. 6) elocution as "the effective expression of thought and sentiment by speech, intonation, and gesture." Inasmuch as it involves the exercise of language, elocution must embrace the physiology of speech. It must study carefully the instrument of speech, so that the elocutionist may have all its parts under his complete control. The author therefore takes the pupil back to respiration as the first step toward making him an expressive and agreeable speaker. Suggestions in respiration lead naturally to the principles of vocalization, and these to those of vowel formation. From this point on, the book is made up largely of practical exercises on the successive steps in the elocutionary process. These exercises and illustrations are a peculiarly valuable feature of the book; for they are not roughly thrown together, but carefully arranged on scientific principles.

We know of no higher praise of Mr. Bell's book than to say that it is pre-eminently fitted to be recognized in our high schools and colleges as the authoritative exponent of that branch of training which has too long been left out of their curriculum.

Bau und Verrichtungen des Gehirns. Von Dr. JOSEF VICTOR BOHON. Heidelberg.

Uebersichtliche Zusammenstellung der Augenbewegungen, etc. By Dr. E. LANDOLT. Tr. by Dr. H. MAGNUS. Breslau.

THESE contributions to the anatomy and physiology of the nervous system are evidences of the time and attention now devoted by the Germans to the preparation of aids to instruction—whereby the student can readily obtain correct notions of his subject. Especially in the nervous system, where recent research from a variety of sources has so essentially altered the accepted views, is such an elementary reconstruction of the subject necessary. Dr. Rohon's pamphlet contains a lecture delivered before the Anthropological Society of Munich, setting forth in clear language the main outlines of current notions of the structure and functions of the brain. The main interest in the pamphlet will centre in the colored chart, which illustrates with great clearness the points referred to in the text.

Dr. Magnus presents a chart for the use of physicians and instructors, showing the main points with regard to the motion of the eyes that one ought to retain. The main laws of motion of Donders, Helmholtz, Listing, etc., are given; then a cut illustrating the origin of the motor nerves of the eye. This is followed by a table giving the origin, course, insertion, axis of rotation, etc., for each muscle of the eye. The second part of the chart explains very clearly the effect of paralysis of each of the muscles; how such paralysis limits motion of the eye; what position the eye assumes; whether double images arise, and how they are placed; and so on. The chart shows careful preparation, and will doubtless be widely used.

The Journal of Morphology. Ed. by C. O. WHITMAN, with the co-operation of EDWARD PHELPS ALLIS, Jun. Vol. I., No. 1. Sept., 1887. Boston, Ginn & Co. 8°.

THE new zoological periodical, the first number of which has been so long expected, has at last made its appearance in the shape of a thick and handsome volume of more than two hundred pages, issued from the well-known press of Messrs. Ginn & Co. of Boston. It has been delayed almost unpardonably long, and yet its make-up and the character of its contents compel us to forget the delay, and confess that it was well worth waiting for. The plates alone would make the journal unique among American periodicals devoted to the subject; for they are mostly from the hands of Werner and Winter, the Frankfort (Germany) lithographers, whose names alone are ample guaranty of excellence. In brief, the journal appears to us admirable in almost every particular. The paper is good; the press-work is well done; the minor details of arrangement of footnotes, titles, headings, etc., give evidence of care and forethought.

In this periodical we have a substantial token of the progress of two distinct undertakings of which all American scientists ought to be proud. The first is that of Dr. Whitman, the editor, whose hope and struggle for many months have been to set going in the right way a zoological periodical that shall worthily represent American morphologists before the world, and be a suitable outlet for our strong and increasing zoological literature. Professor Whitman has certainly succeeded in making a good start.

A word is due also to the publishers, Messrs. Ginn & Co., for their courage in undertaking such a periodical, which can never be expected to be a financial success, as the demand must always be extremely limited. The difficulty of establishing such a journal will be the better understood when we consider that the proceedings of societies, supported by large endowments, meet with practically no sale, but are distributed throughout the world by exchange, and furnish a very excellent means for the placing on record of such papers as are given in this magazine.

The other undertaking is that of Edward Phelps Allis, Jun., of Milwaukee, with whose co-operation the journal is edited by Dr. Whitman. Mr. Allis first formed, and then put into active operation, the idea of a private biological laboratory of research. For this he was fortunate to secure Dr. Whitman as director, and to it the name of the 'Lake Laboratory' has been given. Besides the director, Mr. Allis has added to his laboratory Dr. William Patten as assistant, and it is understood that Mr. Allis is himself at work upon important investigations.

NOTES AND NEWS.

IN September a school of Oriental languages was opened at Berlin, the object of which is to give merchants and civil officers an opportunity to learn the languages of Asia and Africa. The staff of the school consists of two teachers of the Arabian language, while Persian, Chinese, Suaheli, and Herero have one teacher each. These have studied the languages they teach in the country where it is spoken, and they are assisted by natives. This school will undoubtedly prove of great value to the commerce of Germany with the countries of Asia and Africa. The merchant or consular official who understands and speaks the language of the country in which he lives and works will have a great advantage over competitors who have to make use of the service of interpreters. Formerly students had the opportunity of studying Oriental languages at German universities, but there they were taught from an exclusively

scientific point of view; and it is well known that a language learned in this way, though its grammar may be well mastered, is of no practical value to the student, particularly where the difference between the written and spoken languages is great, and where the dialects are numerous. In the new school the languages are taught as living languages, and this gives the institute its principal importance.

— The semi-annual session of the National Academy of Sciences will be held at Columbia College, Nov. 8, at noon, and continue for three or four days.

— The question of teaching physiology and hygiene to elementary classes in the public schools is one that is far from a successful solution. With a criminal rashness, legislatures have been induced to prescribe alcohol-teaching as a requirement, and the result has been to create noxious temperance-tracts with a smattering of physiology attached, instead of scientific text-books. A very great improvement in this direction is a recently issued primer of health lessons by Dr. Jerome Walker. Around the main facts of physiology, the author has woven an attractive text, fully and well illustrated, and has given the subject that kind of interest which healthy children appreciate. He has very much reduced the space usually allotted to alcohol and narcotics, but it may be questioned whether the reduction is sufficient. A few very objectionable passages (considering the age of the children to whom the book is addressed) still remain. On the whole, Dr. Walker has set an example in the right direction, and the instruction to teachers is not the least valuable chapter in the book.

— One of the subjects discussed at the annual meeting of the French Association for the Advancement of Science, which has just been held at Toulouse, was the project for making a maritime canal between Bordeaux and Narbonne. The different phases of this project, which was first mooted twenty years ago, were passed in review by M. Wickersheimer, deputy for one of the departments through which the canal will pass. The latest project was prepared this summer by a company which has been formed for the purpose of making the preliminary survey; and according to this scheme, the canal, which would be about three hundred and thirty miles in length from sea to sea, would start from the western side of Bordeaux, and follow the left bank of the Garonne for a distance of fifty miles, crossing that river at Castel-Sarrasin by a *pont-canal* (or aqueduct), and follow the right bank of the river as far as Toulouse, where a large port would be created. From Toulouse to the Mediterranean seaboard at Narbonne, the maritime canal would be quite independent of the railway from Bordeaux to Cette, but it would twice cross the Canal du Midi. The curves of the canal would be of the same radius as those in the Suez Canal; that is to say, not less than 6,000 feet, and there would be 38 locks, the fall of which would range from 20 feet to 30 feet. The depth would be about 24 feet, but if the minister of marine should determine to make use of it for the first-class ironclads of the French navy, contrary to what was originally determined, the company will be prepared to make it three feet deeper. It is estimated that the mean speed of vessels passing through the canal will be seven miles an hour, and they would be drawn by locomotives running along a line of rails placed on the banks, a force of from 1,000 to 1,200 horse-power being required to produce this rate of speed. The canal is to be lighted by electricity, the electric light being generated upon the engines used for the traction of the vessels. The total cost is estimated at £130,000,000, or less than half of the estimate originally prepared. The distance saved for vessels coming from the western ports of France into the Mediterranean would be 680 miles.

— It is noted in the *Journal of the Society of Arts*, London, that while the consumption of the other dietetic articles used for beverages — tea, coffee, and chicory — show a decline last year, cocoa is marked by a considerable increase. This is remarkable, since for about four years, from 1875 to 1879, it remained pretty stationary at about 10,000,000 pounds, but after 1880 it began to make steady progress, advancing from 10,500,000 pounds in that year to over 15,000,000 pounds last year. Of powdered cocoa and chocolate England received 1,332,000 pounds, chiefly from Holland. She

also imported 3,211 hundredweight of husks and shells of the cocoa-bean, which are also used up for cheap cocoa. There are about ten chocolate and cocoa manufacturers in Holland, whose yearly requirements of cocoa-beans may be estimated at 3,000 tons, in round numbers, principally of Guayaquil, Caracas, and Domingo kinds. They mostly manufacture cocoa preparations, known by the name of soluble cocoa, cocointe, and cocoa-powder; viz., the roasted and powdered cocoa-beans deprived of most of their natural fat, or the cocoa-butter, which is used as a valuable ingredient by manufacturers of chocolate and cocoa sweetmeats, and also for pharmaceutical preparations. In the early part of last month no less than twenty-five tons of this cocoa-butter was sold in Holland, and fifty tons in London. The oldest of the Dutch cocoa-works was founded on a small scale more than a century ago, and most of the other works have existed from forty to sixty years; but all of them remained insignificant until the before-mentioned powdered preparations found their way to foreign countries, especially England and Germany, where certain Dutch brands of powdered cocoa have been very well received and enjoy a large sale. There are people who suppose that the superiority of the Dutch cocoa-powder is to be attributed to a peculiar mode of manufacture, different from the methods followed in other countries. The idea to extract the fat from the roasted cocoa-beans, and to sell the powder, is said to have originated in the brain of a Dutch chocolate-maker about 1830. It is now generally practised in France and England. The average consumption in the United Kingdom last year, per head of the population, was, of cocoa, 0.41 pounds; coffee, 0.86; tea, 4.87. Tea brings into the revenue £4,500; coffee, only £200,000; and coffee mixtures and chicory, £5,273. The latter seem to be declining.

LETTERS TO THE EDITOR.

* * * The attention of scientific men is called to the advantages of the correspondence columns of SCIENCE for placing promptly on record brief preliminary notices of their investigations. Twenty copies of the number containing his communication will be furnished free to any correspondent on request. The editor will be glad to publish any queries consonant with the character of the journal.

Correspondents are requested to be as brief as possible. The writer's name is in all cases required as proof of good faith.

Recent Methods in the Study of Bryozoa.

In *Science* for Oct. 7, Prof. Joseph F. James refers to certain new methods in the study of *Bryozoa*, and doubts their efficacy in classification; he also refers to a forthcoming publication which shall make this clear. Pending the publication of this paper by my esteemed friend, I cannot help expressing my decided approval of the methods he calls in question. Theoretically, development has proceeded in two lines,—one internal, to accommodate itself to the needs of internal function; and one external, to accommodate itself to environment, to the world with which the being comes in contact. Variations of function are far less frequent than those of environment; hence internal structure may still be very similar when external features have already extensively varied. Hence internal structure usually furnishes the reliable characters, which distinguish genera and higher groups; external features are used for specific determination.

Very few who have practically attempted the classification of paleozoic *Bryozoa* into genera as defined according to the old method have failed to see that such genera contained heterogeneous assemblages of forms, often ran into each other, and contained no distinct positive characters which were useful when great numbers of *Bryozoa* were to be classified. The new method has furnished solidity to this structure. The species fall into easily recognized groups, as distinct as those of other organisms on the same scale of development; all this simply because of the abandonment of external characteristics in the distinguishing of genera, for those of an internal nature, made easily accessible by the slide and the microscope.

In this department of study, Prof. H. A. Nicholson took the first decided stand, and is still contributing at short intervals valuable papers on this interesting group of fossils; but I believe that to one of our fellow-countrymen, Mr. E. O. Ulrich, belongs the credit of the perfection of this system. His work, which expresses his matured views on this subject, is now in the press, forming a part of Vol. VIII. of the forthcoming 'Illinois Report.' By his kindness

I have been permitted to see plates, and furnished with private extracts from the same, and I feel free to say that it will be a monumental work in history of the study of *Bryozoa*.

The practical test of the theory of development, which holds good everywhere else in animated nature, is also satisfactory here. Instead of artificial we have natural classification, and that also of a more definite and practical form. It remains to be seen whether microscopic sections are sufficient to determine the species. A circumstance peculiar to *Bryozoa* makes this in almost all cases possible. The form, size, and arrangement of cells may be readily seen in tangential section; the presence of interstitial cells may also be thus discovered; whereas the little elevations or low spines around the apertures of some cells may be seen in the sections as spiniform tubuli. Elevated patches of cells may usually be recognized by the local increased size of cells in the sections, and maculae will be shown by judicious longitudinal sections.

It remains to be seen what characters of specific importance cannot be shown in microscopic sections. One of these is the size of the specimen; another, its method of branching; a third, its general contour. These may all be expressed by a simple drawing, taking no cognizance of individual cells. Besides the details above referred to, microscopic slides will of course furnish numerous others referring to internal structure alone. The fact, however, is, that not only do microscopic slides reveal the characteristic features of the surface, but they often reveal them in a much better way than the specimens at hand; for these may be abraded, perhaps ever so little, but just enough to rub away the little spines, or to remove the walls of interstitial cells, and, by thus exposing the diaphragms of the same, lead to the conclusion that they do not exist. Any one who has ever looked over a quart-measure of specimens without finding one suitable for description will know what this means.

As regards the publication of Mr. Foord, 'Contributions to the Micro-Paleontology of the Cambro-Silurian Rocks of Canada,' it is an excellent exemplification of the methods (for this is what Professor James criticises) of the advanced school of students of the *Bryozoa*, and is a practical recognition of the merits of a work done by an American paleontologist. All of the species figured are accompanied by magnified sections of the same, and all except *Monticulipora Westoni* have also figures of the specimen's natural size; and perhaps the shape of that species, "Zoarium irregularly hemispherical," would not be difficult to grasp by the working paleontologist. The fact that Prof. H. A. Nicholson, immediately after the separation of Mr. Foord from the Geological Survey of Canada, was pleased to publish papers conjointly with that gentleman, serves to show what that eminent authority's opinion as to the merits of Mr. Foord's specific work was.

These remarks I hope represent fairly the claims of the new school as to the advantages of their methods of study. One observation alone remains to be made. I suppose that Professor James was not in earnest when he objected to the new method on account of the difficulty of making slides, no more than the physicist who should object to the advance made in his science simply on account of some of the refined mechanisms now used in his department, no more than the student of *Echinostraca* who should object to the classification reached in his science from the difficulty in finding a specimen which is willing to be quiet enough to let itself be accurately drawn. He simply expresses the difficulty he finds in leaving his old methods of study and adapting himself to new ones, and this accidentally escaped into print, not in the form in which he would be willing to have it remain at second thought. But the truth is, that microscopic slides are not difficult to make. Messrs. W. F. and John Barnes of Rockford, Ill., manufacture an instrument which I know from experience to be both cheap and useful. The specimen to be cut is ground with emery until a plane is formed having the same direction as the intended section. Then successively finer grades of emery are used until a fine polish is obtained, which can be made very fine indeed by using polishing-powder sprinkled over a piece of plate glass. Then the specimen is carefully washed, dried, and glued with Canada balsam to the slide which is to retain the specimen. Then the specimen is ground away until only a thin sheet remains fastened in the Canada balsam, after which it is again smoothed, washed, and protected by a thin cover-glass. Forty to sixty slides can be made in a day.

Some of my first slides I find useful to this day, and every day adds experience, or a word from some friend working in the same field. The difficulty of making sections is a myth.

Cambridge, Mass., Oct. 31.

AUG. F. FOERSTE.

Search for Gems and Precious Stones.

IN reference to the interesting article of Prof. P. L. Simmonds on the search for gems and precious stones, read before the Society of Arts of England recently, reprinted in your issue of Oct. 14, allow me to suggest a few corrections. Professor Simmonds estimates the yield of the Brazilian diamond-mines at £800,000 annually, while a little later on he says that the yield has dwindled to 24,000 carats, which at the outside will not yield more than £2 to £3 a carat, and that of India, Borneo, and Australia at £200,000, when these latter figures would probably cover the annual product of Brazil as well as that of the other three countries named. Australia produces so very little as scarcely to be a factor in the computation. Even before the opening of the African mines, in 1867, the estimated value of the product of Brazil from 1861 to 1867 was only £1,888,000, or something over £300,000 per annum, at a time when Brazilian diamonds commanded a higher price than at present, and now they produce much less. His statement that the opal is out of fashion would have been true several years ago, but is not to-day, when more of these stones are sold, and at better prices, than ever before.

The carat is given as 3.174 grains; whereas, since there are 151.5 English diamond carats in an English Troy ounce of 480 grains, an English carat would be 3.1683168 Troy grains, or, less exact, 3.168. A diamond carat is always divided into four diamond grains equaling .792074 of a Troy grain. If 31.103 grams equal an English Troy ounce, a carat would be .205304 of a gram.

An international syndicate composed of London, Paris, and Amsterdam jewellers, wishing to establish a uniform carat, in 1877 confirmed .205, however, as the true value of a carat, in which case we have 151.76 carats in an ounce Troy.

These may seem trifling differences, but yet they are enough to affect a \$10,000 lot of diamonds, worth \$100 a carat, to the amount of \$4.83 between the 3.174 carat and the 3.168 carat, and \$19.80 between the former and the syndicate carat.

It would perhaps have been better to make the reference to imperial jade, which he mentions several times, under the head of the jade-quarries of Burma, as this (*Felsit*) imperial jade is jadeite, not jade, and is generally only emerald green in spots or streaks, the mass being a dead white, lending a vividness to the green which occasionally almost rivals the emerald, and has the hardness of 7.

Of the articles of jade shown by the New Zealand Court at the colonial exhibition, England, Professor Simmonds says, "Evidencing the skill of the Maoris in working this hard material, the second in this respect to the diamond, although much more fragile," etc. This would lead one to infer that the material possesses great hardness, when, in fact, the hardness of jade is only 6.5, less even than that of rock crystal, and it can be worked with sand, by which laborious means, undoubtedly, all of the aboriginal ornaments of the Maori were made. So far as its fragility is concerned, it is the toughest of all known minerals, and this is the reason why it is so difficult to work. It would require less time to polish twenty surfaces of agate, which is harder than jade, than it would to polish one of jade on the same wheel. Krantz, the mineral-dealer of Bonn, having a fifty-pound piece of jade which he wished broken into small hand specimens, a friend kindly offered him the use of a large half-ton trip hammer to break it with. At the first blow the hammer was demolished, and the jade was only fractured by being heated and thrown into cold water.

We frequently hear minerals or gems loosely spoken of as second or third in hardness to the diamond. On the Mohs scale of hardness, the diamond is represented by 10, the sapphire by 9, topaz 8, and quartz 7; but, although the difference on the scale is only 1, there is room for several substances between the diamond and the sapphire; and, as we have no such known substance in nature, we place diamond on 10. In reality, so great is the difference between these two substances, that, if the hardness of the sapphire is 9, that of the diamond would be fully 100, relatively to the rest of the scale. Professor Simmonds also says that coral has the hardness

and brilliancy of agate. Quartz and agate are placed at 7 in the Mohs scale, whereas coral has only the hardness of about 3, the same as that of marble (calcite), and can be scratched by fluorite. It is impossible to see how this opaque substance can be said to "shine like a garnet, with the tint of the ruby."

A word, in closing, about the hardness of agate and rock crystal. Mineralogically these are classed together at 7; but in reality the crystalline varieties should be 7, and the crypto-crystalline varieties 7.3, since they will readily scratch quartz, and quartz will not scratch them.

New York, Oct. 31.

GEORGE F. KUNZ.

Living Lights.

WE have noticed in your journal (*Science*, x. No. 246) a review of the book on phosphorescence called 'Living Lights.' The writer, it seems, must have made a very hasty perusal to have failed to see that the statements therein are not conjectural, but in each case are from individuals we are accustomed to honor as credible witnesses.

The fact of this review being in the columns of a science journal is, of course, the only reason for our interest in it. The most charitable construction which we can put on this surprising exhibition of lack of knowledge is that the reviewer did not notice the array of great names which support the statements of the book, for we cannot think that any one would knowingly dispute the words of such men — and naturalists.

The reviewer starts off by throwing discredit and ridicule on the entire world of luminosity, seemingly denying that attribute to all living objects. He says, "Not only do fire-flies fly, glow-worms glow, zoöphytes twinkle in the sea, but sea-anemones, alcyonarians, gorgonias, star-fishes, earth-worms, crabs, shell-fish, lizards, frogs, toads, fishes, birds, monkeys, and men must be added," etc.

Such a feeling of embarrassment in approaching the task of replying to such, for one is impressed with the notion that some occult jest is intended; but again we are reminded of the character of the journal, and a feeling of surprise follows at the incomprehensible lack of knowledge displayed regarding the subject in hand.

The reviewer continues, "There is no excuse for conjectural illustrations, and ideal views of possible appearances." Shall we inform him that twelve of the plates in 'Living Lights' are process copies taken from lately published bulletins of M. Filhol, M. Dubois, and from sketches of the deep-water dredged objects obtained by the gentlemen of the 'Challenger,' 'Travailleur,' 'Porcupine,' 'Majenta,' and others, several of whom kindly furnished the author with advanced papers for use in his work?

Thus for twelve of the illustrations: for the remaining ones, it were absurd indeed to defend them. The former, as being matter not yet widely extant, some of it not published outside of society bulletins, may well be regarded as unfamiliar. The quotation which the reviewer takes from the book is treated so as to mislead. The author evidently meant to convey that it is difficult to represent the phenomenon of luminosity in marine animals, as their integrity is injured on exposure to air, though no question is entertained of their luminosity. A kindly review of this portion would rather praise the caution exhibited by the author in stating that the pictures may possibly not exactly portray the real appearance as it exists in the sea. The statements of the reviewer are so sweeping and (possibly) damaging among those not informed, it would seem advisable to state facts, though it is a humiliating thought that the brilliant work of so many eminent men should in such quarters be unknown.

It is but justice to do this, as the author of 'Living Lights' is at present beyond reach, at a distance from home, and of course unable to reply seasonably.

The statement, "zoöphytes twinkling in the sea" might well have covered the ground for one group, without enumerating "sea-anemones, alcyonarians, gorgonias," etc., also; but this enumeration will serve to suggest what objects concern us, as those arranged for false attributes. We presume that few will deny the luminous gift to fire-flies, glow-worms, etc., which are mentioned in this connection. Let us, then, pass to the sea-anemone record. Colonel Pike of Brooklyn, an American naturalist not to be questioned, has given at length his testimony, and we know that the author himself has an experience as to their luminosity, which,

coupled with that of Van Benedin and numerous other European zoölogists, we assume is weight enough to give respectability.

The luminosity of gorgonias, sea-worms, star-fishes, etc., is a well-known fact to us from long residence on the Florida reefs; but, should it be desirable to fortify such evidence, we would refer to testimony of Sir Wyville Thompson, and several other successful dredgers.

It would have saved somewhat of the task of this *exposé*, had the reviewer read the history of the *Brisinga*, the luminous star-fish, which 'Living Lights' gives amply, and illustrates by process picture from the original, through courtesy of M. Filhol and M. Dubois, the latter having had some of the dredgings of the 'Talisman' for examination. The work of Charles Abjordsen of Norway, on the luminosity of this creature, is also extant, who pleasantly named it *Gloria maris*. M. Quatrefages may also be called to testify, if need be, whose valuable work on the luminosity of the star-fishes is well known. P. Martin Duncan and some others are remembered in this connection.

The crustaceans are next summoned to show cause. Must we arraign our own Verrill and Smith? Shall the ancient Viviani be questioned? May we lightly dispute the words of Nordenskiöld, Giglioli, Sir Joseph Banks, MM. Eydoux and Souleyet, Norman, Vaughn, Thompson, Murray, V. Willemoes Suhm, and a host of others whose descriptions of the luminosity of crustaceans are not in sober earnest to be called "displays of pyrotechnical natural history"? The attractive picture of *Colossendeis*, copied from M. Filhol's delightful work, is one with others which the reviewer chooses to designate as "conjunctural illustrations" and "ideal view for which there is no excuse."

Regarding fishes, Dr. Gunther's views and statements are considered good science. His kindly correspondence with the author pleasantly confirms all that he has written on phosphorescence of fishes.

M. Carlo Emery, of the Italian Zoölogical Schools, kindly communicated his experiments to the author, with drawings, on the luminosity of the insect *Lucciola italica*. It were better due this eminent naturalist in the pages of an American science journal to acknowledge his original investigations in the spirit of science, rather than pronounce them examples of "pyrotechnical natural history," etc.

It certainly cannot be necessary to go further; but as the picture of a heron was particularly mentioned as "distinctly misleading," etc., it may be well to direct attention to the facts in the case. Attention to the text will show that the author carefully and at much trouble set about gaining, if possible, any additional knowledge concerning the alleged luminosity of the breast of the night-heron. It has long been a widely known belief among hunters that the powder-down patches on the heron's breast are at times luminous. We have learned from very many ornithologists that the belief was familiar to themselves, and in general there is an inclination to consider it true. The editor of 'Living Lights' received some remarkable confirmations of the long-existing say-so, and in his book plainly exhibits several of the most convincing, — no less than positive statements in answer to categorical inquiries by the author.

It chanced that we were able to ask the opinion of the eminent English naturalist, Mr. Alfred Russell Wallace, to whom this subject was familiar. He expressed readiness to believe the existence of luminosity in such birds, notwithstanding the literature on the subject is so meagre, and quoted the well-known case of the lantern-fly. Mr. Wallace was an explorer in South America, as is well known, and in answer to our question he said, "I did not observe the phenomenon of luminosity in the lantern-fly, but Madam Mérian, the distinguished entomologist, and the Marquis Spinola, did; the former giving detailed accounts of several which emitted such powerful luminosity, on opening the box in which they were confined, that she was alarmed. I am therefore not entitled to deny the statements."

Regarding the higher animals and man, as in relation to the phenomenon of luminosity, the long-recorded example of the brilliant eyes of the South American monkey should be regarded; and if the statements concerning man, as published by Dr. Phipson in his nearly unique treatise on this subject, as quoted by the author, are not entitled to respect, and protection from the assertion that such "statements are distinctly misleading and wrong . . . and

highly colored, and admitted on very slender evidence," then we have no remedy.

In a few words, the considerable fresh material in 'Living Lights' should have received favorable notice; for, added to the large amount of facts in marine zoölogy long familiar to the author through actual personal contact with marine life on all parts of our coast, on the extreme northern and on the Florida shores, and on the two oceans, here is presented noticeable examples of luminosity in every grand division of zoölogy, and in the vegetable and mineral worlds, all furnished by the eminent zoölogists, with accompanying figures, which the reviewer has chosen to ignore or ridicule.

The amount of information and data obtained by the author through the United States Fishery Commission is very great, and it is due to the memory of the late lamented commissioner to say that the work of the 'Albatross' and 'Fish Hawk' exceeds all others in the contributions to science derived from the deep-sea dredgings. The history of luminous marine animals, judged by those acquainted with marine zoölogy, is by no means exhausted.

A.

New York, Oct. 26.

Sorghum-Sugar.

In an article under the above caption published in *Science* about a year ago (viii. p. 361), I ventured to make the following prediction with reference to the experiments which were being carried on in Kansas under the direction of the United States Department of Agriculture:—

"The indications from the present results are most hopeful,—that, with the expenditure of a small fraction of the money and brains that have been required to develop the sugar of the beet, the sorghum-sugar industry will take a leading place among American industries, and enable Uncle Sam to accomplish a long-cherished hope, viz., of making his own sweets."

The results of this season's work, while it is not yet fully completed, would seem to show that this prediction is in a fair way to be fully confirmed within a very few years, for a great advance has already been made towards the solution of the problem of the profitable production of sugar from sorghum.

The final outcome of last year's work was extremely discouraging to many friends of the industry, and it was only by strenuous efforts on the part of the few who still retained their faith, that the necessary appropriation for the continuation of the experiments could be obtained from Congress. Many thought that the question would be definitely settled by the experiments last year, and, as the results achieved were chiefly of a negative character, they considered that it was proved a failure. Perhaps too much was expected to be accomplished in so short a time. It has often been the case with great undertakings, and in the accomplishment of scientific problems, that their prospect looked darkest just before the dawn of their success. Such has been the case with sorghum-sugar. Negative results frequently contribute greatly toward ultimate success, and the lessons taught by some of last year's failures have been turned to very valuable account in this year's work.

The two difficulties mentioned in the article referred to as encountered in last season's work — viz., the cleaning of the chips, and the treatment of the juice — have been successfully grappled with. The former is accomplished by ingenious yet simple mechanical devices. The cane is fed, leaves and all, to an ordinary ensilage-cutter, which cuts it all into pieces about one and a half or two inches in length. These are carried to a height by an elevator, and thence dropped through a series of separating-fans, where the refuse, consisting of the blades and sheaths, is blown out; its separation from the sections of cane being quite complete on account of the much greater weight of the latter. The cleaned pieces of cane are then carried to a small cylindrical cutter, whose operation is very similar to that of a planing-machine, and which cuts the cane into quite small chips, or shreds. Thus the diffusion is effected upon well-cleaned cane, — a fact which doubtless contributes greatly to the purity of the juices obtained. The inversion of the juice in the cell, which is very apt to occur with sorghum on account of its large content of various vegetable acids, is controlled by the use of precipitated carbonate of lime, which is added to the contents of

each cell. By this a considerable proportion of these acids is neutralized. In the treatment of the juice the solution of the problem seems to have rested rather in the simplification of the method to be used than in its further complication. In fact, it is really a return to first principles, as it were; for the method which was finally adopted, and which has given such excellent results, is the old method of liming the juice to a slightly alkaline re-action, and boiling and skimming in an open pan. No filtration is used whatever, the scums being simply returned to the cells, where they are again extracted, so that no loss of sugar is sustained. Treated in this way, the diffusion juice shows a higher coefficient of purity than juice obtained from the same cane by pressure, also an increased ratio of sucrose to glucose.

Single experimental runs have given a yield as high as one hundred and thirteen pounds of 'first sugar' to the ton of cleaned cane, with seventeen and a half pounds of 'second sugar,' or a total of one hundred and thirty pounds to the ton. This is at least twice as large a yield as has ever been obtained by pressure extraction, even under the most favorable conditions. The results on the season's work have not yet been ascertained.

The people of Kansas are highly pleased over the results of the work so far, and, with characteristic Western energy, are preparing to rush into the sugar-business immediately, and make Kansas, in the language of the local newspapers, 'rival Louisiana' as a sugar-producing State. A few words of caution to these would-be sugarcrowers might not come amiss. No industry requires more careful management, or a greater amount of scientific knowledge and skill, to make it a success, than the production of sugar. In order to compete with other sugar-producing countries and plants, the most careful system of cultivation should be combined with the most skilful and economical methods of manufacture. The beet-sugar industry of Europe may well serve as a model in this respect, in that the proper cultivation of the beet-roots is regarded as of prime importance, and in the manufacture of the sugar every pound of waste or by-product is utilized, and every ton of fuel is made to yield its maximum equivalent of power. The most careful and thorough scientific supervision is exercised over the entire process of manufacture. At the present prices for sorghum-seed, which is in great demand for planting for forage purposes and for the sirup, a yield of any thing in the neighborhood of one hundred pounds of sugar to the ton of cane would afford a very wide margin on the cost of production, since the cane can be grown for one dollar and fifty cents per ton; but the success of the industry would necessarily involve the reduction of the prices for these important by-products to a much lower figure, and cut off a very considerable proportion of the present profits in the production. On the other hand, much is to be hoped from the apparently great adaptability of the plant to the soil and climate of a large area of this country, and from scientifically conducted experiments for the increase of its saccharine content. Judging from analogy, it is reasonable to expect that the latter can be greatly increased by the well-known methods of selection and cultivation. Sorghum-cane has been grown on the grounds of the Department of Agriculture at Washington, which contained as high as eighteen per cent of sucrose in the juice, or sixteen per cent of the cane. If a field of sorghum could be raised which would average fifteen per cent of sucrose without too great an expenditure for cultivation, the question of the profitable production of sugar from the plant would be solved at once.

This much, at least, can be said of the experiments that have been carried on by the Department of Agriculture: they have shown that good marketable sugar can be made from sorghum-cane in sufficient quantities to pay at the present prices for the products and by-products of the manufacture. The question as to whether we are to have a national sugar-industry in the United States will probably work out its own solution before many years.

These experiments in the manufacture of sugar should have a particular interest for scientific men, for their success means not only a triumph of science, but also a complete vindication of the policy of giving governmental aid to scientific investigations. The development of the sorghum-sugar industry so far has been carried on entirely by the Department of Agriculture, with appropriations made by Congress for that purpose. Numerous objections have been raised against these appropriations, and both loud and deep

have been the repinings as the years went on and no practical outcome was obtained. In case they are crowned with ultimate success, these objectors will be most fitly answered; for the money spent would be but as a molecule of water to the Mississippi River in comparison with the stream of wealth which would flow from the establishment of a national sugar-industry. Let us hope the lesson will have its effect upon the people in the adoption of a still more liberal policy in aiding scientific research in the future. The experiments in the application of the diffusion to Louisiana cane will be commenced some time in October. From the favorable results which were obtained last fall at Fort Scott in operating upon a few carloads of cane after the close of the sorghum season, it may reasonably be expected that the yield obtained will be very satisfactory, although the problem is somewhat more difficult than in the case of sorghum, as the results obtained by mill-extraction from the Southern cane are much superior to those obtained from sorghum.

C. A. CRAMPTON.

Fort Scott, Kan., Oct. 23.

The Purslane-Worm.

IT may be of interest to note that the 'purslane-caterpillar,' described in a recent number of *Science* (x. No. 246), has made its appearance at this point; at least, a new species of caterpillar, new to all observers, and feeding on purslane, has made itself very conspicuous for a few months past. In this vicinity the early summer was very dry, and the purslane, which is not yet so common a weed with us as farther east, was not very plentiful. But late in August, after a series of heavy showers, it sprang up, *more suo*, abundantly, and with it came this stranger in such numbers as to attract the notice of one quite unlearned in such matters. Both the plant and its boarder flourished along the line of a railroad leading south-east into Kansas, from which State it is in all probability an emigrant; but, if so, one would think that it must have advanced farther last season than your Kansas correspondent noted.

GEO. M. WHICHER.

Hastings, Neb., Oct. 25.

Queries.

16. PENNSYLVANIA POT-HOLES.—Can you tell me where I can find an account of the glacial pot-hole noticed in your 'Notes' in No. 246? I presume it may be in some volume of the Second Geological Survey of Pennsylvania, but I do not know which one. Perhaps some of your readers can say, if you cannot.

JOSEPH F. JAMES.

Oxford, O., Oct. 23.

17. DOES BITUMINOUS COAL CONTAIN ANY BITUMEN?—Many text-books and dictionaries define bituminous coal as containing bitumen, and mislead the student into the belief that its name is due to this fact. In Vol. VI., 'Encyclopædia Britannica,' ninth edition, Mr. H. Baurman, F.G.S., Royal School of Mines, says on p. 46, under the subject coal, "The most important class of coals is that generally known as bituminous, from their property of softening, or undergoing an apparent fusion, when heated to a temperature far below that at which actual combustion takes place. This term is founded on a misapprehension of the nature of the occurrence, since, although the softening takes place at a low temperature, still it marks the point at which destructive distillation commences, and hydrocarbons both of solid and gaseous character are formed. *That nothing analogous to bitumen exists in coals, is proved by the fact that the ordinary solvents for bituminous substances, such as disulphide of carbon, and benzole, have no effect upon them, as would be the case if they contained bitumen soluble in these re-agents.* The term is, however, a convenient one, and one whose use is almost a necessity from its having an almost universal currency among coal-miners." Impressed with the above statement, and recognizing its importance to teachers of science especially, I call attention to it, under the head of 'Queries,' that hereafter truth shall be taught, and not error. I sometimes entertain a suspicion that many errors continue to be accepted as facts, because writers simply copy from their predecessors, instead of actually testing or proving them to be facts.

GEORGE GLENN WOOD, M.D.

Muncy, Penn., Oct. 28.

SCIENCE

FRIDAY, NOVEMBER 11, 1887.

THE ANNOUNCEMENT which has been going the rounds of the press, of the perfecting by Mr. Edison of his phonograph, certainly seems startling, and one which might be denied without arousing surprise; but it now appears as if the world were soon to be treated to another great fruit of inventive genius, and that one of the great R's may soon be displaced. Mr. Edison, in a letter to the editor of *The Engineering and Mining Journal*, has expressed in his frank and usual hearty way such utter confidence in the successful performance of all, or even more than all, that is hoped for, that we look forward to the receipt of our first phonograph with anxious curiosity. Those who remember the phonograph of ten years ago will recall that it was next to impossible to reproduce tones that were absolutely distinct; that is, sufficiently distinct to be recognized without difficulty or mistake by some person who had not heard the original utterances. To-day these difficulties have been overcome; and the sender of a message, after setting the machine in motion, need only talk into the machine with his natural and usual voice, then withdraw the phonogram, which corresponds to the old sheet of tinfoil, which could not be withdrawn, and mail to his friends in this way his verbatim utterances. These phonograms will cost but little more than an ordinary sheet of letter-paper, and will be made in various sizes to accommodate messages varying in length from eight hundred to four thousand words. On the receipt of such a phonogram, it can readily be placed in the apparatus of the receiving instrument, and it will at once speak out with distinctness and clearness equal to that of the human voice at the same rate of speed at which it was originally dictated. These phonograms will not be obliterated by the first use, but may be kept on file, ready for reproduction whenever necessary.

THE OCTOBER NUMBER of the *Journal of the Society for Psychical Research* contains this statement; "It will be remembered that the earliest experiments in thought-transference described in the society's Proceedings were made with some sisters of the name of Creery; and that, though stress was never laid on any trials where a chance of collusion was afforded by one or more of the sisters sharing in the 'agency,' nevertheless some results obtained under such conditions were included in the records. In a series of experiments recently made at Cambridge, two of the sisters, acting as 'agent' and 'percipient,' were detected in the use of a code of signals; and a third has confessed to a certain amount of signalling in the earlier series to which I have referred. This fact throws discredit on the results of all former trials conducted under similar conditions. How far the proved willingness to deceive can be held to affect the experiments on which we relied, where collusion was excluded, must of course depend on the degree of stringency of the precautions taken against trickery of other sorts, as to which every reader will form his own opinion." The prompt publication of this damaging discovery, and it is a very damaging one, is only another evidence of the thorough candor and fair-mindedness with which Messrs. Myers and Gurney have conducted the experiments in behalf of the society. These Creery girls, daughters of a Devonshire clergyman, and from ten to seventeen years of age when the experiments were originally tried, were among the first in whom the so-called 'telepathy' was discovered. The record of the experiments with these girls was one of the most interesting chapters in the society's early history. It is extremely mortifying,

therefore, to find them tainted with fraud; and the exclamations, "I told you so!" will be numerous. Yet it does not follow that all the experiments were worthless. A searching revision of them must, however, be made, and we may rest assured that the able and untiring executive officers of the society will make it.

AN INVESTIGATION OF DREAMS.

THE American Society for Psychical Research is collecting accounts of cases where one person has had some remarkable experience, such as an exceptionally vivid and disturbing dream, or a strong waking impression amounting to a distinct hallucination, concerning another person at a distance, who was, at the time, passing through some crisis, such as death, or illness, or some other calamity. It appears that coincidences of this sort have occurred, but it may be alleged that they are due to mere chance. For the determination of this, it is desirable to ascertain the proportion between (a) the number of persons in the community who have not had any such experiences at all; (b) the number of persons who have had such experiences coinciding with real events; (c) the number of persons who have had experiences which, though similar to the foregoing in other respects, did *not* coincide with real events.

The society has therefore issued a circular requesting every one who receives it in the course of the next six months to repeat the questions given below, *verbatim*, to as many trustworthy persons as possible, from whom he does not know which answer to expect, and who have not already been interrogated by some one else, and communicate the results. The questions are so framed as to require no answer but 'yes' or 'no.' Special attention is drawn to the fact that the object of the inquiry would be defeated if replies were received only from persons who have had remarkable experiences of the kind referred to (whether coincident with real events or not); and there should be no selection whatever of persons who have had such experiences. In case of negative answers only, it will be sufficient if the collector will send (not for publication) his own name and address, with the replies which he has received.

If there are any affirmative answers, the society desire to receive also (not for publication) the name and address of any person who answers 'yes.' If the experience has been coincident with a real event, they specially request the percipient to send an account of it.

All communications should be sent to the secretary, Richard Hodgson, 5 Boylston Place, Boston, Mass., from whom additional copies of the circular may be obtained. It is of the utmost importance to obtain answers from a very large number of persons, and it is hoped that many thousands of replies will be received. The questions are as follows:—

I. Have you, within the past year, when in good health, had a dream of the death of some person known to you (about whom you were not anxious at the time), which dream you marked as an exceptionally vivid one, and of which the distressing impression lasted for at least as long as an hour after you rose in the morning?

II. Have you, within the past three years but not within the past year, when in good health, had a dream of the death of some person known to you (about whom you were not anxious at the time), which dream you marked as an exceptionally vivid one, and of which the distressing impression lasted for at least as long as an hour after you rose in the morning?

III. Have you, within the past twelve years but not within the past three years, when in good health, had a dream of the death of some person known to you (about whom you were not anxious at the time), which dream you marked as an exceptionally vivid one, and of which the distressing impression lasted for at least as long as an hour after you rose in the morning?

IV. Have you, at any time during your life but not within the past twelve years, when in good health, had a dream of the death of

some person known to you (about whom you were not anxious at the time), which dream you marked as an exceptionally vivid one, and of which the distressing impression lasted for at least an hour after you rose in the morning?

V. Have you, within the past year, when in good health, and completely awake, had a distinct impression of seeing or being touched by a human being, or of hearing a voice or sound which suggested a human presence, when no one was there?

VI. Have you, within the past three years but not within the past year, when in good health, and completely awake, had a distinct impression of seeing or being touched by a human being, or of hearing a voice or sound which suggested a human presence, when no one was there?

VII. Have you, within the past twelve years but not within the past three years, when in good health, and completely awake, had a distinct impression of seeing or being touched by a human being, or of hearing a voice or sound which suggested a human presence, when no one was there?

VIII. Have you, at any time during your life but not within the past twelve years, when in good health, and completely awake, had a distinct impression of seeing or being touched by a human being, or of hearing a voice or sound which suggested a human presence, when no one was there?

HEALTH MATTERS.

Cholera at Quarantine.

It will, we imagine, be somewhat of a surprise to our readers to learn that there have been thirty-eight cases of cholera at the quarantine islands in the port of New York since Sept. 22; and yet from reputable sources this seems to be the fact. From the report just made to the College of Physicians of Philadelphia, and published in an extra issue of the *Medical News*, we learn that eight persons sick with cholera were removed from the steamship 'Alesia,' to which *Science* referred in its issue of Oct. 14, to Swinburne Island; five of these died; subsequently twenty-seven others were stricken with the disease, of whom nine died: of the passengers of the 'Britannia,' whose arrival from Italy was recorded in *Science* of Nov. 4, three have been attacked with cholera, at least one of whom has died,—a total of thirty-eight cases and fifteen deaths. So far as we know, no new case has developed since Oct. 24.

The report to which we allude is a most important one, and one which will attract the attention and thoughtful consideration of physicians and sanitarians, not only in the United States, but throughout the civilized world. On Oct. 5, the College of Physicians of Philadelphia appointed a committee to consider the present danger of the importation of cholera into this country, and to secure concerted action among the medical societies of the land in urging upon the State and National authorities the adoption of a uniform and efficient system of quarantine for all exposed ports. This committee consisted of Drs. James C. Wilson, E. O. Shakespeare, and R. A. Cleemann. It will be remembered that Dr. Shakespeare was selected by President Cleveland to investigate cholera in Europe and India. These gentlemen investigated the quarantine stations at New York, Philadelphia, and Baltimore, and presented their report Oct. 28. The following day an extra issue of the *Medical News* of Philadelphia, one of the leading medical journals, was published with the following editorial comment: "The paramount importance to the public of preventing the importation of cholera into the United States calls for a special issue of the *Medical News*, giving in full the report of the commission appointed by the College of Physicians of Philadelphia . . . to investigate the condition of affairs in the quarantine of New York. It will be seen that the grave dangers which exist may render prompt action necessary with a view to establishing some national system of quarantine for the protection of the country."

The committee visited personally the quarantine stations at the three ports mentioned, and made a careful and thorough examination of every thing pertaining thereto. It will be impossible for us to do more than refer to their conclusion. In reference to the stations at Philadelphia and Baltimore, they say that it is evident that they fail in the most essential requisites of the necessary number of properly equipped buildings for the isolation and observation

of a large number of immigrants. In regard to the station at New York, they find the buildings to be sufficiently large and numerous, and to have adequate arrangements for heating and cooking, but that they are not divided into a sufficient number of small compartments to permit the strict isolation of the immigrants into small groups. The water-closets and bath-tubs are inadequate, the pumps by which sea-water is obtained for flushing the water-closets were out of order, and the soil-pipes from the water-closets had a number of right angles in their course to the sea, thus interfering with thorough scouring. There is no provision for the general washing of clothing, and the immigrants performed this work for themselves in such proximity to the underground cisterns of water as to render it possible for this water to become infected. The use of this cistern-water for drinking had been forbidden, and other water supplied for this purpose; but there were no means of enforcing the order, and access to the cistern could be had at all times. The lack of bedsteads, chairs, tables, and proper eating utensils, added to the hardships of the immigrants and to the dangers of infection.

The committee comment on the absence of a resident medical officer, and of an adequate force of watchmen, patrolmen, and attendants. The possibility of occasional clandestine communication between the detained immigrants and their friends by means of small boats, constituted a danger to the country difficult to estimate, and against which, so far as could be learned, there were no precautions. At Swinburne Island, where the hospital is situated, there were, at the time of the committee's visit, nine cases of cholera in the wards, and they noted with surprise the absence of a resident physician. It was also a reversal of modern ideas to find male nurses in charge of female patients. The clothing of patients is sent back to Hoffman Island to be disinfected, although there is a disinfecting-chamber in connection with the hospital; and the committee were informed that the convalescents were, as soon as they were strong enough to be about, returned to Hoffman Island without having been previously bathed and disinfected.

In reference to the steamship 'Britannia,' it would appear that the committee believe that cholera appeared during the voyage from Italy, and that its existence was either not recognized by the ship's surgeon, or else concealed by the deliberate falsification of the ship's sanitary record. In either case the committee think that this has seriously increased the present danger of the ultimate introduction of cholera into the country through the port of New York. They state that the continuance of cholera among the passengers of the 'Alesia' so long after their removal to the station of observation, in itself demonstrates the inefficiency of the measures which have been adopted and enforced, and further add, that, although they have not heard of the development of the disease anywhere on the mainland, nevertheless, in view of the almost uncontrollable tendency of cholera to spread at times, and of the original insufficiency and the present faulty constitution of the police force on Hoffman Island, they feel impelled to believe that the immunity up to the present time has been owing to singular good fortune rather than to good management.

Having pointed out the defects of the quarantine stations, the committee turn their attention to the principal cause; namely, the cost of supplying these defects. Were it not for the question of money, there would have been physicians constantly in attendance at the New York station, and, consequently, better management and discipline would have been maintained; while at Philadelphia and Baltimore there would have been adequate establishments provided for the isolation and observation of large bodies of immigrants. The remedy suggested is to put quarantine into the hands of the national government. The committee recognize the difficulties in bringing this about, but at the same time they regard this as the only efficient remedy.

In reference to this report of the Philadelphia committee, we have little to say at this time. It certainly is a very serious indictment of the quarantine stations and methods of the three ports specifically mentioned, and of the other ports of entry upon the Atlantic and Gulf coasts, in reference to which the committee state, that, although they have not inspected them, there is no reason to believe that they are in any respect superior. It will not answer to say, as officials are reported in the daily press to have said, that this is an attack by a jealous city upon New York in order to divert

commerce from its port, nor are all the charges contained in the report to be met by the statement that the governor of the State of New York is responsible, by reason of having vetoed appropriations. The report is a serious reflection upon public officials in whom the public and sanitarians have placed implicit reliance, and should be met in the same official way that it has been issued. Unless it is so met, the quarantine authorities must not expect public confidence; and, whether they do or not, we fear they will not receive it. We shall be only too glad to open the columns of *Science* to them, and present their statements as fully as we have those of the committee of Philadelphia physicians.

AMERICAN ASSOCIATION FOR THE ADVANCEMENT OF PHYSICAL EDUCATION.—The American Association for the Advancement of Physical Education will hold its third annual meeting at the Adelphi Academy, Brooklyn, on Nov. 25. The following programme has been announced: paper by the retiring president, Prof. Edward Hitchcock, A.M., M.D., Amherst College; 'Physical Training in Elementary Schools in the United States' (extract from report of New Hampshire Board of Health for 1887), E. H. Fallows, Adelphi Academy; motion by C. G. Rathman, N. A. T. B., relative to physical training in elementary schools in the United States; discussion; report of work done by the N. A. T. B. the past year, H. M. Starkloff, M.D., president N. A. T. B.; 'Physical Measurements, their Use to the Individual,' Edward Hitchcock, jun., M.D., Cornell University; discussion opened by W. L. Savage, A.M., M.D., director Berkely Lyceum, New York City; general discussion; 'Military Training as an Exercise,' J. W. Seaver, M.D., Yale University; discussion opened by Gen. E. L. Mollineux, Brooklyn, N. Y., and John White, Ph.D., head master Berkely School, New York City.

REMOVAL OF NEEDLES FROM THE BODY.—Dr. Littlewood describes in the *Lancet* a method which he has used successfully in seven cases for the removal of needles from the body. The part supposed to contain the needle is thoroughly rubbed over with an electro-magnet, so as to magnetize the metal, if present. A delicately balanced magnetic needle is held over the part. If the needle is present, its position can be ascertained by the attraction or repulsion of the poles of the magnetic needle. Having ascertained the presence of the needle, and rendered the part bloodless and painless, an incision is made over the needle; the electro-magnet is then inserted in the wound, and the needle felt for and withdrawn. If the needle is firmly embedded, the positive pole of a galvanic battery is placed on the surface of the body of the patient, and the negative pole in contact with the needle, which becomes loosened by electrolysis, and can then be easily removed by the electro-magnet.

ETHNOLOGY.

Were the Toltecs an Historic Nationality?

DR. BRINTON has for a long time maintained that the Toltecs were no historic nationality, but an entirely legendary people. In a lecture delivered before the American Philosophical Society on Sept. 2, he takes up the question, and ably defends his standpoint which he first expressed in 1868 in his 'Myths of the New World.' The present paper was written to criticise the statements of Charnay and others who maintain the historical character of this people. The enthusiastic Frenchman Désirée Charnay considers the Toltec civilization the basis of all Central American culture, and traces their migrations from the northern boundary of Mexico to Copan; but the reasons which he brings forth to support his theory, and which are entirely founded on the character of Central American arts, are not at all conclusive. The Mexican and Central American styles are not sufficiently studied to draw any conclusions as to what is original in each tribe, and what is borrowed from the other; and Charnay's assertion of a connection between East Asian and Central American arts warns us from accepting his arguments without a thorough criticism. Brinton's opinion is that the emigration of the Toltecs from the north, the foundation of Tula in the sixth century, and the dispersion of the Toltecs all over Central America, are entirely fabulous. He compares the facts known

about Tula and the legends as told by the best authorities, and finds that Tula was nothing else than one of the stations the Aztecs occupied in their migrations. To explain the wide celebrity of the place, which extended to Guatemala and Yucatan, Brinton recurs to its etymology. As the meaning of the name, which is not of rare occurrence in Mexico, he gives 'the place of the sun,' and this, he thinks, brought it into connection with many a myth of light and of solar divinities. This process is one often occurring in the development of folk-lore. There can be no doubt that Brinton's opinion, that no immediate truth underlies the myth which makes Tula the birthplace and abode of gods, and its inhabitants the civilizers of Central America, is correct.

ANTHROPOLOGY IN THE AMERICAN AND BRITISH ASSOCIATIONS FOR THE ADVANCEMENT OF SCIENCE.—It is of interest to compare the papers read in the Section of Anthropology of these two associations. While the section of the British Association devoted much of its time to considering theoretical questions, such as the probable existence of an Archaean white race, the origin of totemism, etc., such questions were hardly touched upon at the meeting of the American Association, which devoted most of its time to listening to the reports of results obtained by explorers in the ethnological and archaeological field. This may in part be due to the fact that the field of researches in America is so vast. The amount of unknown material is so large, that every year brings some new and unexpected discoveries. But there is another characteristic feature of the American Association. What little discussion of theories there was, referred principally to the discussion of classifications,—a subject which seems to have been entirely wanting among the papers of the British Association. If we consider that classifications are only a help, not an aim, of science, and that the great goal of ethnology and anthropology is to outline the early history of mankind and to work out the psychology of nations, we must concede that the work of the British Association is superior to ours. We do not mean to say that there are no vague theories held by British scientists, or that no eminent work is done by Americans; but the favorite studies of ethnologists as a whole, and as expressed in the subjects of papers presented to the English Association, seem to be of a more general and of a higher scientific character than they are here. We mention a few of the papers read at the Manchester meeting of the British Association according to the reports published in *Nature*. Mr. I. Taylor discussed the probable origin of the Aryans. He dwelled on the recent linguistic researches, which show that the primitive Aryans must have inhabited a forest-clad country in the neighborhood of the sea, covered during a prolonged winter with snow; the vegetation consisting largely of the fir, the beech, the oak, and similar trees, while the fauna comprised the bear, the fox, the hare, the deer, and the salmon. These conditions restrict it to a region north of the Alps and west of the Black Sea. The author attempted to show, both from the anthropological and the linguistic point of view, that the Aryans have evolved from a Finnic people. J. S. Stuart maintained the existence of an Archaean white stock, from which he is inclined to derive so widely different phenomena as the American and Chinese civilizations, as well as the origin of Hittites, Iberians, and Picts. C. Staniland Wake treated the problem of totemism from the point of view that the totem is the re-incarnated form of the legendary ancestor of the gens or family group allied to the totem,—a view which is undoubtedly correct in many cases. S. J. Hickson gave a few remarks on certain degenerations of design in Papuan art. It would have been more proper to speak about conventionalism in Papuan art,—a field that offers many interesting problems, and to which Dr. O. Uhle of Dresden recently made a valuable contribution in the publications of the Ethnological Museum of Dresden. Miss A. W. Buckland spoke about the custom of tattooing, which, although almost universally practised, varies so much in the mode of performing the operation; the various methods seeming to have such definite limits as to make them anthropologically valuable as showing either racial connection or some intercourse formerly existing between races long isolated. This paper belongs to a class of inquiries which have of late been carried on by a number of ethnologists, and which yield valuable results. We call to mind Prof. E. S. Morse's researches on the

release of arrows, which lead the distinguished scientist to so remarkable conclusions. The well-established fact that the non-existence of certain color-names does not prove color-blindness, was shown by Mr. W. E. A. Axon to hold true among the English gypsies. Besides these papers, reports on new explorations were not wanting. Papers on psychophysics, which we consider an important branch of anthropology, were not included in the list of papers read before the Section of Anthropology of the British Association.

MENTAL SCIENCE.

Drawing among Primitive Peoples.

The application of the inductive method to the study of mental facts—and that, too, from its first appearance in Locke or Herbart—inevitably brought into prominence the observation of minds different from our own, and in particular of peoples less advanced than ourselves in the march of civilization. The seed thus sown has borne good fruit; and in the works of Lubbock and Tylor, of Bastian, of Steintal and Lazarus, and many others, we have an excellent foundation for an anthropological psychology. The object of this movement is not only to record as far as possible the probable history of our early attempts at culture and the long succession of gradually outgrown customs and beliefs, but also to co-ordinate the various works of mental evolution, to arrange them in some serial order,—as Romanes does with animal evolution,—and thus help to furnish the categories for a general psychology, which will be none the less scientific because it needs to be enlivened by the tact of a humane observer.

Among the characteristics that contribute most to this end are, what have always been and still remain the two great kinds of human expression, language and handiwork, and especially art. The permanence of the latter mode of expression makes it of crucial value to the anthropologist. Dr. Richard Andree, in reviewing the art-productions of savage tribes as shown by their drawings, emphasizes the great development which this talent can attain in conjunction with a low state of psychical development. Travellers often mention the power of savages to rapidly sketch characteristic figures, and among the oldest relics of the cave-dwellers we find distinct tracings of animal forms. As in so many other respects, an analogy is present between the drawings of primitive men and of children. Figure sketching (in outline) and ornamentation are the prominent characteristics of both; while the power of landscape-sketching, as well as a sense for natural beauty, is a much later acquisition. Among the forms drawn, plants are seldom found: what is full of motion and life—the horse, etc.—first attracts the attention, and is transferred to bone, clay, or stone. At times ornamental and figure work go together, but much often a development of the one or other alone is possible. The Maoris and the Fiji-Islanders confine themselves to ornaments, and seldom draw a figure. Among the Australians the development of ornamentation has stopped at a certain stage,—with recurrent stereotyped forms of wedges, crosses, and 'herring-bone' patterns,—while scenes from their doings are recorded with much fidelity, and color is often used to lend reality to the design. The Bushmen excel in painting (though without perspective), and trace with great accuracy the scenes of daily life, of hunting, warring, etc. As figure-painting allows of very various development, we find different styles of conventionalism—the art of ancient Peru is a notable example—in different tribes. Other peoples—and here the Arctic tribes stand in the first rank—aim at a faithful representation here; ornamentation finds no place, and such subjects as fishing, sleighing, etc., are the usual ones. The attempts at human forms are often failures; but the drawings of their most common animals, as the reindeer, are sufficiently exact to serve as a means of zoological identification.

Even the humerus is found on the primitive 'canvas,' and especially among the fun-loving negro tribes. Exaggeration of small peculiarities (as in children) is the marked trait. The natives of the Loango coast carve in a spiral on elephant's tusks a whole carnival of ridiculous figures,—sailors, officers, *savants*, etc.

The material of the artist is very various. Many cut and daub

their utensils; the Peruvians decorate their woven fabrics; the Australians draw on blackened bark; the Africans carve in ivory. The universal imitative bent, of which the desks and walls of a school-room often show striking evidence, appears in many curious savage 'art-galleries.' On the island of Depuch, off the north-west coast of Australia, are found scratched on the smooth rock a crowd of men, birds, fish, crabs, bugs, etc., and colored black, white, red, yellow, and (seldom) blue. This seems to have been a pastime of these fishermen for generations.

While the drawing talent is thus quite a general one, the possibility of a large development of it is limited. It usually stagnates in conventionalism, and seldom reaches the stage, as it does in the Eskimo, of being utilized as a pictographic language.

In conclusion, Dr. Andree calls attention to the fact that almost everywhere the men alone are the artists. In one case this rather anomalous phenomenon leads to curious results. Among the Papuans of New Guinea, vessels and implements of wood are quite generally decorated, while the pots made by the women are devoid of all ornamentation.

RE-ACTION AND INHIBITION TIME.—If it is arranged that a certain action is to take place at a given signal, it will be found that a quite constant time elapses between the signal and the re-action. Besides executing a motion, we can exert our will towards restraining an act; and this not always by the contraction of an antagonistic muscle, but by a direct inhibitory action of the nervous centres. Dr. Gad of Berlin has measured the time necessary to thus inhibit the action of the muscles used in mastication, and announces the important result that this time is the same as is necessary for an ordinary re-action. This is true not only under ordinary conditions, but the variations in the time by practice, by fatigue, under the influence of narcotics, etc., for the two acts, is about the same, as is shown in the following table:—

	Re-action-time.	Inhibition-time.
Before practice	0.25 sec.	0.30 sec.
After practice	0.15 " "	0.14 " "
With weak stimulus	0.20 " "	0.17 " "
With strong stimulus	0.12 " "	0.11 " "
After fatigue	0.12 " "	0.16 " "
8 minutes after taking alcohol	0.12 " "	0.09 " "
30 minutes after taking alcohol	0.25 " "	0.20 " "

In short, the mechanism of inhibition works as accurately and as delicately as that of re-action.

A REMARKABLE CASE OF AMNESIA.—The many strange phenomena of amnesia have been enriched by the experience of one of the ablest living psychologists, Professor Bain. Some months ago Professor Bain fell from his horse, and was unconscious for about three hours afterwards. During this time his shoulder, which had been sprained by the accident, was set without his knowledge. Upon regaining consciousness, it was found that he had lost all remembrance of what had occurred an hour before the accident, as well as of the three hours following. He was found on a different road from that which he can remember having intended to take, and so must have changed his mind. Of this he has lost all recollection; otherwise there were no mental effects. The editor of *Mind*, who tells the story, adds another case in which a gentleman, after falling from a carriage, remained unconscious for nearly four months. Upon re-awakening, not only was this interval a total blank to him, but the events of the week preceding the accident were equally lost. Important transactions which he had made during that week were forgotten. This suggests that there may be some relation between the duration of unconsciousness after the accident and the memory-blank before. At all events, the phenomena, mysterious as they are, deserve to be recorded. The authenticity and careful analysis of the above cases add to their value.

EXPLORATION AND TRAVEL.

Notes from the Arctic.

MR. WILLIAM DÜVEL, who returned a few days ago from Cumberland Sound on board the New London schooner 'Eira,' gives us some interesting information on the events in Cumberland Sound during the last years. The whalers, who had been unsuccessful for a great number of years, have been more fortunate since 1885, while the catch of the Davis Strait fishery shows a sudden falling-off. In 1884, when ten vessels were fishing in Lancaster Sound, the catch aggregated some eighty whales, but in the following years

lowest temperature of last winter was -46° F. The snowfall was very scanty, the ice being hardly covered with any snow. As, in addition to this, the ice was very smooth, travelling in winter was easy. In February, however, the much-dreaded dog-disease made its appearance, and swept away the dogs of the natives. In Black Lead, among a party of thirty-three natives, only nine dogs remained. In the spring of 1886 the same disease made its first appearance in the settlements of Davis Strait, where it was unknown up to that time.

Last summer the ice of Cumberland Sound broke up on the 6th of July. As the whaling in the Sound has become more profitable,

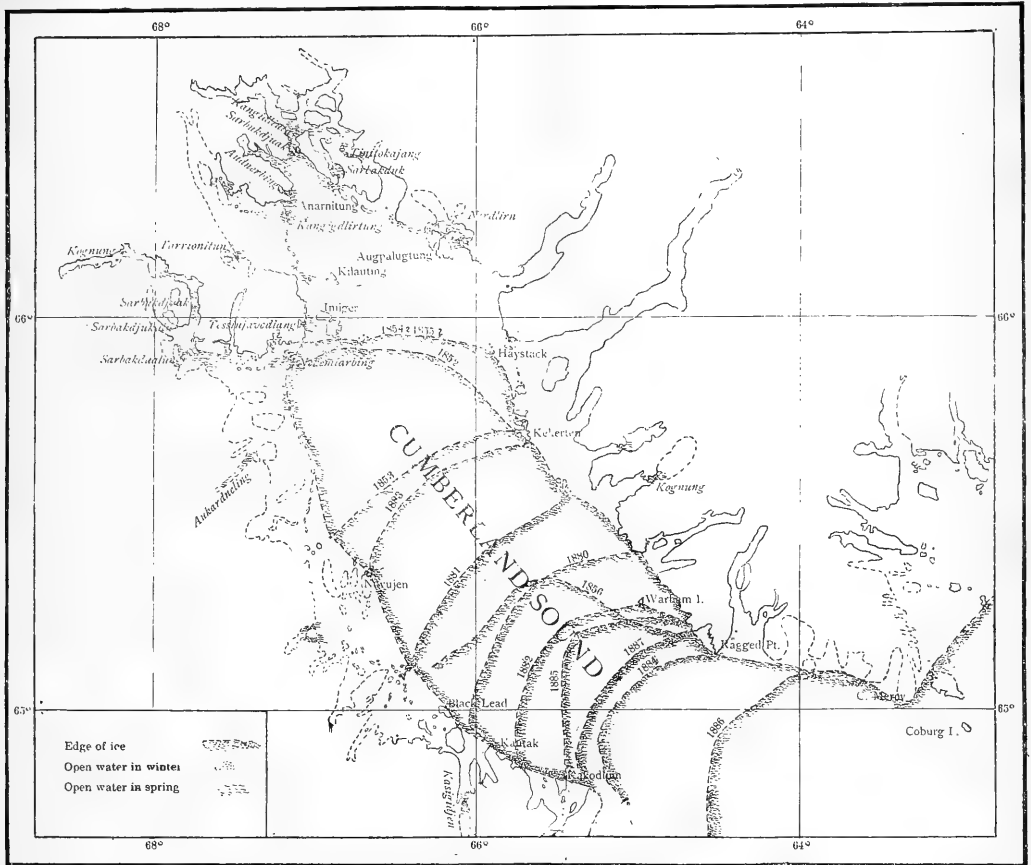

ICE-CHART OF CUMBERLAND SOUND. Compiled by Dr. F. Boas.

not more than ten or twelve were caught by the whole fleet. In 1884, the pack-ice was remarkably loose, and the first ship entered Cumberland Sound as early as the middle of July. The floe, however, which was attached to the land, lasted until the 5th of August, a date unprecedented in Cumberland Sound. This corresponds to the character of the land-ice in Davis Strait, which, as was formerly reported by Captain Spicer, did not break up in three subsequent summers, from 1884 to 1886. In 1885 the land-floe in Cumberland Sound extended very far south, as may be seen on the accompanying sketch-map. In 1886 its position was a little farther north, while last winter it extended again to the entrance of the Gulf. This fact is very remarkable, as in many former years the head of the open water reached up to Kekerten, and even as far as Haystack. The

a greater number of vessels frequent the Sound, and several permanent stations are established. There is a Scottish station in Kekerten, while American whalers have stations on Black Lead, in Nugumut, and in Hudson Strait. The sanitary condition of the natives was very good. In Cumberland Sound five deaths occurred during the last year, while three children were born in a single settlement. In the fall all natives belonging to the tribe inhabiting the west coast of Cumberland Sound gathered in Black Lead, and celebrated the great annual festival which is known to all the tribes of northern Labrador and Baffin Land, and in which masked men, who represent certain spirits, make their appearance. Early in spring south-westerly winds carried the heavy pack-ice of Davis Strait into the Sound, and kept it there for a number of weeks.

While in 1883 and 1884 a great number of flat icebergs, most of which were the scattered remains of one enormous berg, filled the Sound and the neighboring parts of Davis Strait, this form was not observed during the last years; all bergs, with one single exception, being very high and pointed.

The ice-chart of Cumberland Sound, which accompanies these notes, has been compiled from observations made by F. Boas in the winter of 1883-84, and from reports of American and Scottish whalers. The edge of the floe as indicated on the map shows the greatest extent of the ice in each year, which is attained about the end of February. Besides this, the water-holes, which are kept open throughout the winter by swift-running tides, are indicated on the map, and so are the places where the ice is worn through by the currents in March and April.

BRITISH COLUMBIA. — Dr. G. M. Dawson has kindly sent us a more detailed account of his work in British Columbia. Leaving Victoria early in May, the expedition reached Fort Wrangel, from which point they proceeded up the Stikine River to Cassian. The expedition consisted of two branches, Dr. Dawson leading the geological department, while Mr. W. Ogilvie made an instrumental survey of the country, on behalf of the Dominion Land Office. His surveys extend from the seacoast by way of the Lewis River, up the Yukon to the 141st meridian, which constitutes the eastern boundary of Alaska, and his measurements will serve as a basis for further work in the district. The object of Dr. Dawson's researches was a thorough exploration of the tributaries of the upper Yukon. Messrs. R. G. McConnell and James McEvoy were his special assistants. His party proceeded up the Stikine River as far as Dease Lake, where they built three boats. As soon as the ice broke up and left the lake, which was on the 18th of June, later than it ever has been known, they went down the Dease River and into the forks of the Dease and Liard Rivers. Here Mr. McConnell separated from the rest of the party for the purpose of descending and surveying the Liard and the Mackenzie Rivers. Dawson went up the Liard and Frances Rivers to Francis Lake, which drains into the Liard, and not into the Pelly River, as shown in most maps of that country. From Francis Lake, the party crossed a difficult portage of about fifty miles to the Pelly River. From here Dawson sent back the five Indians who had accompanied him from the coast, and then proceeded down the Pelly River, accompanied by Mr. McEvoy and Messrs. Lewis and Johnston of Victoria, in a small canvas boat which they had built on reaching Pelly River. At the confluence of the Pelly and Lewis Rivers, Mr. Ogilvie and his party were met. After whipsawing the lumber and building another boat for the purpose, the Dawson party ascended the Lewis River, which Mr. Ogilvie had already surveyed instrumentally. A geological survey of the country along the Lewis River was made. Then the party crossed the Chilcat portage to the head of Lynn Canal, and came by canoe to Juneau, where, after waiting for a few days, the steamer 'Ancon' was taken for Victoria. Mr. Ogilvie, in separating from the rest of the party, continued down the Yukon River, prosecuting his survey. He intends wintering on that river, and resuming his work in the spring, continuing it over to the Mackenzie River. He will return next fall to Winnipeg by way of that stream and the Hudson Bay Company's route to Carlton on the Saskatchewan. Mr. McConnell will probably winter at Fort Simpson, on the Mackenzie River, and continue his explorations from that point next summer.

BOOK-REVIEWS.

Our Heredity from God, consisting of Lectures on Evolution. By E. P. POWELL. New York, Appleton. 12°.

We have not yet recovered from the re-adjustment of the views of life brought about by the new knowledge which the movement of which Darwin is the centre has accumulated. From the very first, the notion of evolution was most strongly opposed, because it was antagonistic to certain widely spread but in no way verified beliefs. As the facts in favor of a derivative theory became more complete and the theory more invincible, a shifting of the 'theologist's' position took place. Some held that evolution simply described a method, but in no way removed the necessity of an anterior cause; others attempted a twisted and allegorical interpretation of the

authoritative beliefs so as to minimize the antagonism between them and the doctrines of evolution; but in every direction, and without regard to the final outcome, evolution has introduced into ethical discussion a healthy ferment, the fruits of which the next generation will appreciate even more than the 'liberals' of this. The variability of moral codes and their close interdependence with the environment and thought-habits of different peoples have been emphasized; and the too dogmatically asserted connection between moral actions and religious rites and beliefs has been broken through. That among the products of this violent fermentation should be found much that is analogous to waste-matter is not striking. Truth-loving disciples of science do not hesitate to admit that some of their over-ardent brethren have overstepped the lines of strict validity in claiming for evolution the solution of many of the vexed world-problems of mankind. The very fact that this aggressive kind of writing has been taken up by the lower ranks of evolutionists, while its leaders have rather acted upon a policy of reserve and awaited developments, makes it easy to admit that one does not always open a book treating the moral aspects of evolution with an anticipation of pleasure or instruction. Mr. Powell's book is both deeply interesting and scientifically valuable.

'Our Heredity from God' is a poor title; not only because the author uses the term 'God' in an unusual sense, but because the book is really a study of evolution with special reference to its moral and religious bearings. Mr. Powell avows himself a disbeliever in any personal deity, and is among that ever-increasing body of thinkers who draw their enthusiasm and inspiration from a contemplation of the vastly suggestive generalizations of science, and the deep significance of a natural morality. The author has not inherited this position, but has worked his way to it through a period of traditional sectarianism; and this leaves its mark in the many references to the biblical cosmogony. It may well be questioned whether it is still worth while antagonizing this biblical account of genesis as though it posed as a scientific explanation (which its truest admirers never claimed). With this exception, Mr. Powell is content to let the facts speak for themselves, simply placing them in such a light that their ethical import may be reflected, and adding to the exposition a depth of natural feeling that leads to an admiration of the man. Science is certainly not as cold as she is often pictured to be. It is impossible to give even in outline a sketch of the long and accumulative argument by which the moral beauty and religious satisfaction of the evolutionary aspect of nature is unfolded in Mr. Powell's mind. All that can be done is to cite a few sentences which shall at the same time illustrate the attractive style and happy suggestiveness that make the pages readable. What Mr. Powell means by the title of his book may perhaps be gathered from these words: "The hypothesis of evolution opens our eyes to the magnificent panorama of an eternal unfolding of relations of life, full of purposive love, which rising from the vast unfathomableness of the sentient universe, at last lifts us as conscious beings near to the heart of the Supreme All in All; and with Him, and in Him, and by Him, bid us consciously to live, and move, and have our being. This I call our heredity from God. To trace our descent from animal progenitors is but a fraction of the problem: the longer sweep of vision beholds an ancestry that embraces all life and all purposive being."

The author holds that the widest gap is not between man and the animals, but between savage and civilized man: he adores civilization as man's handiwork, and regards as most immoral all that hinders its progress. Many of the notions associated with religious doctrines are thus condemned and fearlessly denounced. The view, however, is broad enough to see in many such beliefs stages of ethical development. They are denounced, not because they never formed an advance step in moral evolution, but because they cease to do so any longer. Contrasting, thus, man's present with his past history, — still epitomized in the early stages of each one of us, — Mr. Powell sees a glorious future, when the development of ethical notions, now barely dreamt of, will be wide-spread, in accordance with the sound ethical nature of the universe.

Among the sentences worth repeating for their own sake are the following: "Suspension of judgment is another faculty that is steadily becoming the common property of mankind. It is a growing power, under civilization, to hold the mind in hand, to restrain it by

ascertained laws." "All religions, all philosophies, all parties, have sought to establish an eternal camp at some mile-stone of progress, but all have failed. It is difficult to grasp the full force of this idea—the individual. . . . Men of lower races are much of one pattern. Civilization is an individualizing process; so in turn men of intense character have done most of the propelling that has constituted civilization." "The first need of a plant is precisely the first need of an animal; and that of man is the same. This common need of all life is to find out facts,—facts about what is not itself,—and then to adapt itself to what it finds out." "Nowhere in nature has there been as much parasitic life as among human beings. It takes a large degree of wit to live idly, and off your neighbor's industry. But some vegetables learned to do this before man did it; and many animals have done the same. The result has been degeneration, loss of structure, loss of faculty, and, as a rule, final helplessness and degeneration of the whole being." "But it is not simply at the height of national existence that this impulse for self-preservation responds to the mimicry of lower life. You will observe its operation in our social customs and common propensities; for it is a fact that not any thing is more dreaded or shunned by average human beings than originality,—that is, unlikeness to others. It has always been dangerous. It is even yet likely to secure for its possessor a great deal of annoyance." "Strange views break out all over the globe by apparent spontaneity. . . . Darwin, and Wallace, and Haeckel, without intercommunication, propounded simultaneously the hypothesis of evolution. It is as when three mountain-tops of equal height catch the morning sunbeam at the same moment."

Sixth Annual Report of the United States Geological Survey (1884-85). J. W. POWELL, director. Washington, Government. 4°.

ALTHOUGH on account of the tardy appearance of this volume, for which the management of the survey does not appear to be responsible, the administrative portions have lost some of their freshness and interest, the work as a whole fully sustains the splendid reputation of its predecessors. These annual reports are admirably designed, when promptly issued, to place the Geological Survey *en rapport* with the general public: for they consist of, first, the report of the director, which is devoted to the organization, new features, and general operations of the survey; second, the short administrative reports of the chiefs of divisions, showing in greater detail the progress made in every department of the survey during the year; and third, and most important of all, the scientific papers or monographs completed during the year. The monographs are also published separately, and appear in the annual report *in extenso* or in abstract form, as convenience or their general interest may demand. The bulletins of the survey are shorter but more technical papers, which are not represented in the annual report; the object being to include in this volume only the results of most general interest, with the view of making it a somewhat popular account of the doings of the survey, that it may be widely read by the intelligent people of the country.

The report is accompanied by the following monographs: 'Mount Taylor and the Zuni Plateau,' by Capt. C. E. Dutton; 'Driftless Area of the Upper Mississippi Valley,' by T. C. Chamberlin and R. D. Salisbury; 'The Quantitative Determination of Silver by Means of the Microscope,' by J. S. Curtis; 'Seacoast Swamps of the Eastern United States,' by Prof. N. S. Shaler; 'Synopsis of the Flora of the Laramie Group,' by Prof. L. F. Ward.

The last-named paper has already been noticed in the pages of *Science*, and several of the others are of such great importance and general interest as to demand fuller comment than it is possible to accord them in this preliminary notice.

The force of the survey is now, and must be for several years to come, largely devoted to the construction of a topographic map of the United States; and the director's report begins with the plan and progress of this work, and illustrations of the lettering and conventional signs to be used on the map. The scale of the map is approximately one mile, two, or four miles to the inch, according to the character and prospective needs of the country; the map is constructed in contours, with vertical intervals of 10, 20, 50, 100, and 200 feet, varying with the scale of the map and the magnitude of

relief features; and, finally, the map is to be engraved in sheets, of which the unit is to be the square degree, i.e., one degree of latitude and one of longitude. An area of 57,508 square miles was surveyed in the year 1884-85, at an average cost of about three dollars per square mile.

The organization of the survey is more fully explained here than in any of the previous reports. Besides the large topographic corps under Mr. Henry Gannett, it includes the following divisions, each chief or head of division being provided with a strong corps of assistants: 1. Glacial geology, in charge of Prof. T. C. Chamberlin; 2. Volcanic geology, in charge of Capt. Clarence E. Dutton; 3. Archæan geology of the Appalachian region, including all the metamorphic or crystalline strata, of whatever age, extending from northern New England to Georgia, in charge of Prof. Raphael Pumpelly; 4. Archæan geology of the Lake Superior region, in charge of Prof. Roland D. Irving (it is not proposed at present to undertake the study of the crystalline schists of the Rocky Mountain region); 5. Areal, structural, and historical geology of the Appalachian region, in charge of Mr. G. K. Gilbert; 6. A thorough topographic and geologic survey of the Yellowstone National Park is in the charge of Mr. Arnold Hague. When the survey is completed, Mr. Hague's field will be extended so as to include a large part of the Rocky Mountain region. The general geologic work relating to the great areas of fossiliferous formations is very imperfectly and incompletely organized, and this must continue to be the case until the topographic survey approaches completion.

The paleontological work of the survey is carried on in five laboratories, as follows: vertebrate fossils, in charge of Prof. O. C. Marsh; invertebrate fossils of quaternary age, in charge of Mr. William H. Dall; invertebrate fossils of cenozoic and mesozoic age, in charge of Dr. C. A. White; invertebrate fossils of paleozoic age, in charge of Mr. C. D. Walcott; and vegetable fossils, in charge of Mr. Lester F. Ward.

The chemical laboratory, with a large corps of chemists, is in charge of Prof. F. W. Clarke. There is a physical laboratory in the survey, with a small corps of men engaged in physical researches of prime importance in geology. A large corps of lithologists is engaged in the microscopic study of rocks. Besides the division of mining statistics, economic geology is represented by two parties, in charge of Mr. George F. Becker and Mr. S. F. Emmons, engaged in studying various mining districts in the West.

The survey also comprises a division, in charge of Mr. W. H. Holmes, organized for the purpose of preparing illustrations for paleontologic and geologic reports. Illustrations will not hereafter be used for embellishment, and, so far as possible, will be prepared by relief methods, and held permanently for the use of the public at large in scientific periodicals, text-books, etc. The large geologic library and the bibliographic work of the survey are in charge of Mr. C. C. Darwin.

The remaining topics discussed by the director are the publications, appointments, and finances of the survey, and the relations of the Government and State surveys.

Elementary Text-Book of Physics. By Profs. W. A. ANTHONY and C. F. BRACKETT. 3d ed. New York, Wiley. 8°.

THIS is the first appearance, in a complete form, of a long-expected text-book from two well-known American physicists. It is designed to furnish what is necessary and sufficient for that part of a well-adjusted college course which is devoted to the study of physics, and it is the only college text-book of that science which has appeared in this country for several years, aside from revisions and new editions of old works.

Many institutions have hitherto made use of English books, or of translations from the French which have come to us through English hands. This volume is offered as a substitute for such works, and it is little enough to say that it will be found in general to be a very acceptable one. In some respects the book is almost unique. When compared with those largely in use at the present time, it illustrates in a very striking manner the great progress in college instruction in physics during the past decade.

In its plan there is a distinct recognition of the competent instructor with a well-stocked cabinet at his command. Pictorial representations of apparatus are entirely wanting, and the illustra-

tions are only such simple diagrams as are required to elucidate the text. Besides being an advantage in other respects, this plan sets free a vast amount of space which can be utilized in the more thorough presentation of the principles of the science. For illustrations of these principles, by experiment or from facts drawn from observation, the instructor is held responsible, as he is also for their practical application.

In adopting this plan, the authors have unquestionably made a decided advance. Although the treatment is mathematical wherever desirable, it is assumed that the student has no knowledge of the differential and integral calculus. In several instances the method of limits has been used, however, and students who are familiar with the calculus will have no difficulty in its application. The subject is treated in the usual five grand divisions, mechanics, heat, magnetism and electricity, sound, and light.

Many physicists will not be able to agree entirely with the authors in some of their fundamental definitions and statements in the chapters upon mechanics. A close examination of these reveals several inconsistencies, into which they appear to have been led by the adoption of certain time-honored definitions and terms. Some of these questions have received a good deal of attention during the past few years, in the columns of this journal and elsewhere, and probably the disputants are no more nearly in agreement than they were in the beginning; but it seems tolerably certain that even the average student will experience a certain turbidity of mind when he places the definition of 'momentum' (viz., "the *momentum* of a body is its quantity of motion") and that of 'motion' (viz., "the change in position of a material particle is called its *motion*") a very little nearer together than they are now found on the pages of the book. The first sentence of the introduction, "Every thing which can affect our senses we call *matter*," has a ring of materialism about it which one would hardly expect from at least one of the two famous institutions of learning from which the book comes.

If these and other similar statements are admitted to be defects, they are of minor importance, and do not materially detract from the general excellence of the treatise. It is to be greatly regretted, however, that the publisher has not done his part as well as the authors have done theirs. In mechanical execution the book is substantial, but very far from attractive in its appearance.

Industrial Peace. By L. L. F. R. PRICE. New York, Macmillan. 8°.

THOSE who have given attention to the treatment of the labor-question in England have heard of Arnold Toynbee, the young Oxford graduate who founded an institution in the eastern part of London for the purpose of bringing young men of education into contact with the ignorant poor. After the death of Toynbee at an early age, a memorial fund was raised in his honor, and devoted to the work of spreading information by lectures and publications on the subjects in which he was interested; and the volume before us is the first to be issued by the trustees of that fund. The greater part of the work was first read before the Statistical Society of London, and was published in the journal of that society for March, 1887.

Mr. Price opens his work by remarking, what is sometimes lost sight of by enthusiastic reformers, that "there is not, nor indeed is it probable that there can be, any single panacea for social ills. . . . So diversified are the details of even contemporaneous industrial society, that any scheme which professes to cure all economic maladies by a uniform unalterable method of treatment may almost be said to carry with it its own condemnation" (p. 1). Some persons, he remarks, think that co-operation is destined to remove all industrial difficulties; but upon this point he thinks that experience is not encouraging. Co-operative distribution has prospered in England to a surprising extent; but in co-operative production there were in 1884 only £800,000 of capital employed, and only 6,300 men. He believes, therefore, that whatever advance may be made in co-operation and profit-sharing, the old relation of wage-payer and wage-receiver will still continue; and the object of his essay is to inquire by what means this relation can be made more harmonious.

The means that he relies on are the creation of boards of conciliation and arbitration, and the establishment of sliding scales of

wages. As an example of the former class, he describes the formation and working of the board of conciliation organized in 1869 in the iron trade of the north of England, which he considers an excellent test of the system, since the fluctuations of wages in the iron trade are greater than in most others, and also because before the board was organized the relations between workmen and employers was very unfriendly. In spite of these difficulties, however, the method of conciliation has proved a great success. The machinery consists of a board comprising representatives of both sides and a standing committee appointed by the board. All questions are first investigated by the committee, and, if they cannot agree, the matter is laid before the board; and, if an agreement is not reached there, an arbitrator is called in to render a decision. The system is similar to the *conseils de prud'hommes* that exist in France and Belgium; but Mr. Price objects to these on account of their legal character, which is contrary to the traditions of English, and, we may add, of American life. He examines at length the working of the boards of conciliation, and then proceeds to consider the method of sliding scales, by which wages are made to vary with the price of the product. The establishment and maintenance of such scales have been attended with considerable difficulty, owing to disagreements as to what standard of prices and wages should be taken as a basis; but nevertheless they have proved successful in many English collieries, and are still in force there. The special advantages of these scales, in Mr. Price's opinion, are their elasticity and their automatic action; but he does not fail to point out at considerable length the difficulties attending the working both of the sliding scales and of the boards of conciliation. The chief of these are, "the possibility that the decision might fail to secure loyal adherence, the contentiousness connected with the preparation and discussion of elaborate arguments, and the difficulty of determining upon a satisfactory basis and of ascertaining accurate data" (p. 89).

Such is a brief analysis of the methods of 'industrial peace' that have been tried with no little success in England; and we would earnestly recommend a study of them to the leaders of our American trade-unions and to the employers with whom they are perpetually contending. It is the duty as well as the interest of both parties to maintain peace, and any methods that have been successfully employed for this purpose ought to be carefully considered by them, and, if possible, put into practice. They will not, of course, solve all industrial problems; but the substitution of peaceful methods for contentious ones would of itself be a great gain, and would pave the way for further improvements in the future.

Elementary Practical Physics. By B. STEWART and W. W. H. GEE. Vol. II. Electricity and Magnetism. New York, Macmillan. 16°.

ALL who are familiar with the contents of the first volume of this work will extend a hearty welcome to the second. Every teacher of physics by laboratory methods has felt the need of a good handbook or guide, which, in the hands of the student, would afford some relief from the labor of giving individual instruction in the details of manipulation, which, when the number of students is large, becomes simply enormous.

Since the publication of Pickering's 'Physical Manipulations' fifteen years ago, the pioneer in this field, a number of attempts have been made to supply the want. It is safe to say that none have been more successful in producing a book at once satisfactory in plan and material than Professors Stewart and Gee, in this series, the second volume of which has now appeared.

In its general character it resembles the first volume. One of the leading features of the series, very prominent in this volume, is the fulness of detail concerning all operations, the making of every experiment, and the nature and construction of every piece of apparatus used. Nearly all of the instruments described are such as were constructed in the laboratory of the authors: they are simple in design, and instructions for their reproduction are so clear that even the unskillful can hardly fail. The amateur instrument-maker is also greatly aided by the numerous diagrams and cuts illustrating methods of construction.

The value of this feature of the work can hardly be overestimated, for it is a fact that many good teachers have little inventive

or mechanical skill. Besides, it will generally be admitted that the construction of the simpler apparatus by the student himself is a most valuable and useful exercise, giving him a firm and lasting hold upon fundamental principles which he can attain in no other way. But this attention to detail does not stop with the instrument itself. All of various steps to be gone over in its use, its proper adjustments, the errors to be looked out for, etc., are carefully considered; and in nearly every instance a numerical example is provided, generally taken from real laboratory note-books, and the solution and reduction are gone through with.

In short, in this respect, as many others, the book comes as near taking the place of the living instructor as can well be imagined. It must not be understood that the book is for the beginner in the study of electricity. It must at least be taken in connection with, and better after, a course in some elementary text-book on the subject, and, in addition, may go along with a course of lectures upon fundamental theories. The recognition of this fact is shown in the plan of the book itself, in which, in the first three chapters, the student is introduced to the leading principles of the science, its nomenclature, units of measure, etc., that the less elementary chapters which follow may offer less difficulty.

The chapter on resistance measurement is naturally full and complete, nearly all important and useful methods being given. A full discussion of the tangent galvanometer is given, together with the methods of determining its constants. Related to this is the determination of the magnetic elements, and a good deal of space is devoted to a very complete description of the Kew magnetometer: its use is described, and a series of observations is completely worked out. Other parts of the work are equally worthy of commendation, especially the series of appendices at the end, containing among other things a number of valuable hints as to the manipulation of material used in the construction of apparatus.

Nearly all of the formulas used in the reduction of observations are derived from elementary propositions, but the mathematical treatment of the subject is elementary, and well suited to the character of the work. In addition to its adaptability to class-room work, the book can be highly recommended to private students of electricity and magnetism.

Introduction to a Historical Geography of the British Colonies
By C. P. LUCAS. Oxford, Clarendon Pr. 12°.

THIS little book is the first instalment of a larger work, to be published in parts, and dealing separately with the various dependencies of the British Empire. It gives not only a brief history of the founding of the British colonies, but treats of colonization generally, ancient and modern, and gives some chapters to what may be called the philosophy of colonization. Mr. Lucas defines a colony as a body of persons who have left their native country and permanently settled in another, and who in their new home form the bulk of the inhabitants. He then proceeds to consider the motives of colonization, the chief of which he finds to be these four: "love of enterprise, desire of wealth, social or political discontent, and religion." He does not attribute so exclusive an influence to over-population in the mother-country as some writers do, but thinks that the other motives have in many cases been more important than this. He gives a brief but interesting account of the influence of religion in the founding of colonies and the conquest of dependencies, and also of the effects of climate and race. A colonizing race should be not only enterprising and inclined to emigrate, but also endowed with an aptitude for commerce, and especially for law and government. Of these characteristics the last named is the most important: "Colonizing on any large scale must imply dealing with subject races, and the past has shown, that, in spite of other defects, the people which can govern will in the end prevail" (p. 27).

The brief history of colonization, ancient and modern, which the book contains, and the special account of the English colonies with which it closes, contain a large amount of information in a small compass, and, though treating of matters that are familiar to most readers of history, will be useful for reference. If the projected historical geography of England's colonies is carried out as well as it is begun, it will prove a valuable addition to historical literature.

Electricity for Public Schools and Colleges. By W. LARDEN.
London, Longmans, Green, & Co. 12°.

THE ceaseless activity in all matters pertaining to electricity is shown in the continued appearance of books relating to the subject, in all parts of the world and in all languages.

This book is intended, as its title implies, to serve as a text-book for high-class public schools, and for colleges in which a thorough training in the fundamental principles of electricity and magnetism is furnished, in the development of which the instructor is restricted to elementary mathematics.

Few institutions of learning in this country can offer to their students more than this, and, in fact, not very many have found it possible to make use of a separate treatise upon the subject, except, of course, in the way of special elective courses.

Of the several books containing an elementary treatment of electricity and magnetism which have appeared within the last ten or fifteen years, this by Larden has the advantage of being one of the most recent, and in breadth of treatment, and thoroughness of execution, one of the best.

Only elementary mathematics is made use of, and it is therefore necessary occasionally to state a proposition on authority. Frequent references are given, however, to treatises in which such propositions will be found fully discussed. In some instances where elementary demonstrations are presented, the author has not selected the easiest and most simple. An illustration of this statement is to be found in his proof of the condition under which a battery gives a maximum current. Some of his discussions are also open to the objection of an excessive conciseness and brevity of statement, thus presenting difficulties which the average student of the class for which the book is intended will have difficulty in overcoming. The diagrammatic illustrations have been drawn especially for the work, and are generally very clear. A number of cuts of complete and well-known forms of apparatus are also furnished.

Among the commendable features of the book may be mentioned a very full discussion of induction machines (electro-static), including the Voss machine, the Holtz machine, and others, the operation of which is often very perplexing to students.

The author is not fortunate in his chapter on atmospheric electricity, and especially where he attempts to account for the varying potential of the atmosphere.

The treatment of electric measurements is tolerably full, sufficiently so for a book of this kind, in which one ought not to expect to find all of the now nearly innumerable methods and devices. The chapter on Joule's law and the conservation of energy is especially complete, although not long; and other chapters, on electro-dynamic induction, the dynamo, induction coils, etc., will be found quite satisfactory. Many teachers and students of the science will welcome the book, and find it useful in their work.

The Science of Politics. By WALTER THOMAS MILLS. New York, Funk & Wagnalls. 12°.

IN taking up a book with the above title, we naturally expect to find it treating of the duties and functions of the State, or of its organization or its history; but these topics are scarcely touched upon in the work before us. The author himself states his subject to be the duties of citizenship and the means of performing them; but he confines himself mostly to the treatment of political parties. Mr. Mills, as he tells us on his titlepage, is a journalist; and the influence of his profession is a little too plainly visible in this work, the style showing some of that offhand infallibility which many journalists affect. As regards matter, the book is not specially profound or original, yet it nevertheless contains much that is good. The author has in the main very correct ideas as to the nature and functions of parties and the rights and duties of the citizen with regard to them. He sees clearly that a party without principles is worthless, and that the fact that a party has done well in the past is no guaranty that it will always do well in the future. He vigorously maintains the right to bolt a bad nomination, and the right and duty of leaving an old party and joining a new one in case the old one proves recreant to its trust. Such views as these are not yet so widely accepted in this country as they ought to be; and, if this book should be read by the right persons, it can hardly fail to

have a beneficial influence. Mr. Mills sees, as most of us do, the evils attendant on caucuses and on party management generally, but he does not suggest any thing new in the way of remedy. He has also some good remarks on the folly of mere office-seeking and the nobleness of disinterested statesmanship. We are sorry to have to add that the typography of the book is very bad indeed. Such misspellings as 'monopolies,' 'forsee,' 'weich' for 'which,' and 'ptofit' for 'profit,' are frequent. On p. 159 there are three words misspelled; and on p. 73 is the following sentence: "A party as a party cannot refuse to meet an issue *squarly* at the ballot box, and then as a party *squarly* meet it anywhere else." Surely American typography can do better than that.

Grundriss der Psychologie. Von Dr. F. WOLLNY. Leipzig, Thomas, 8°.

It is difficult to classify this pamphlet. It is not an elementary text-book, because it lacks all system, and treats special topics. It is not a technical contribution, for it is full of commonplaces, and has no definite end in view. Perhaps it is best to regard it as an expression of the author's interests, and as such it has little interest. The author declares his atheistic tendencies, and introduces much not very relevant ethical matter. After discussing in a very unsystematic and eclectic manner the elementary mental powers,—sensation, will, perception, memory,—both separately and in combined action, he adds a few short chapters on sleep and dreams, on insanity, on animal mind, and on alleged higher psychic powers. About the only noteworthy passages are to be found in the preface and in the appendix. The former announces that the author intends to keep psychology and physiology distinct, and has no sympathy with tedious and meaningless psychophysical experiments. As a matter of fact, the topics treated often demand a physiological treatment, and many of the chapters begin with the statement of such a fact. Instead of taking it from a physiological text-book, the author records it as his own experience. It is difficult to take his objections seriously. The appendix contains a great 'discovery.' The human body is susceptible to magnetic influence. Furthermore, if one person in the neighborhood of a magnet concentrates his attention upon another, a subtle connection between the two is made, and one can read the thoughts of the other without sensory transfer. To this so-called 'fact' are added a host of fanciful notions with much mysticism. It is queer in what various forms these unscientific notions arise. Finally, the book is written in orthodox German style,—ponderous, 'bagged' sentences and involved constructions.

Italian Grammar. By C. H. GRANDGENT. Boston, Heath, 12°.

In this volume the author, who is tutor in modern languages in Harvard University, has attempted, and very successfully we think, to put into convenient form and small compass sufficient of the grammar of the Italian language to meet the requirements of the ordinary student. The book, though representing Italian as at present spoken and written, gives as many obsolete forms as may be necessary for a student of the Italian classics. It is prepared specially for use in colleges, but it will prove serviceable to any student familiar with English grammar.

NOTES AND NEWS.

A PARTY of forty engineers and their assistants, about a hundred and fifty in all, will leave this city about the end of this month for Nicaragua, to locate the exact route of the inter-oceanic canal, and to obtain data from which to make accurate estimates as to the cost of the work. The expedition will be in charge of Engineer Perry, and will be joined a few weeks later by Chief-Engineer Menocal.

—A recent public test of the consolidated railway telegraph system of train-telegraphy, made on the Lehigh Valley Railroad, gave very satisfactory results. On a train moving sixty miles an hour, messages were sent and received to and from other trains on the road, and communication was had with this city and with different stations on the line.

—We have received from the Clarendon Press the first number of *Annals of Botany*, edited by Isaac Bayley Balfour, Sydney How-

ard Vines, and William Gilson Farlow, assisted by other botanists. The contents are, 'On Some Points in the Histology and Physiology of the Fruits and Seeds of *Rhamnus*,' by H. Marshall Ward; 'On the Structure of the Mucilage-secreting Cells of *Blechnum occidentale*, L., and *Osmunda regalis*, L.,' by W. Gardiner and Tokutaro Ito; 'On Laticiferous Tissue in the Pith of *Manihot Glaziovii*, and on the Presence of Nuclei in this Tissue,' by Agnes Calvert and L. A. Boodle; 'Anomalous Thickening in the Roots of *Cycas Seemannii*, Al. Braun,' by W. H. Gregg; notes; review of Sachs's 'Physiology of Plants;' and record of current literature.

—The fifth biennial report of the Kansas State Historical Society shows the work of the society for the two years ending Jan. 18, 1887. The society was then eleven years old. The primary object of the society is that of collecting, arranging, and cataloguing a library of the materials of Kansas history, including books, pamphlets, newspapers, maps, pictures, and, in short, every thing which contains information concerning and going to illustrate the history of Kansas. Incidentally, so interwoven has been the history of Kansas with that of the whole country, and so much has it enlisted a general interest, its library has come to be the recipient, largely by gift, of not only the materials of the history, but of every thing of a literary and scientific character relating to all parts of the country. The total of the library in January last, was of bound volumes, 8,352; unbound volumes, 21,103; bound newspaper files and volumes of periodicals, 5,986; making the total of the library, 35,441. Its yearly accession of the files of local newspapers is no doubt greater than that of any other library in the country. The regular issues of all the local newspapers, daily and weekly, published in every county in Kansas, are freely given the society by the publishers, and are bound, and placed on the shelves of the library. Thus is being preserved the best of all materials of the history of every town and neighborhood in the State. The report, among other lists and tables, contains a list of the newspapers at the present time published in Kansas; viz., 72 dailies, 12 semi-weeklies, 722 weeklies, 38 monthlies, 1 semi-monthly, 1 bi-monthly, 4 quarterlies, and 2 occasionals, numbering 852 in all. The library is the property of the State, and is kept in rooms in the State Capitol.

—Among the latest issues of the Clarendon Press (Macmillan & Co.) is a batch of classical books that are worthy of careful examination. The list includes the 'Phormio' of Terence, Cicero's Catilinarian orations, 'The Knights' of Aristophanes, the 'Eclogues' of Vergil, the first book of Tacitus' 'Annals,' and, in the Elementary Classics Series, the seventh book of Cæsar's 'Commentaries.' They are all gotten up in that attractive and elegant way that characterizes the Macmillans' work. Particular attention is due, perhaps, to Dr. Merry's careful and accurate edition of the 'Knights' of Aristophanes. Both introduction and notes are extremely well done.

—A series of lectures (twenty to twenty-four in number) will be given at the Museum of Comparative Zoölogy, Cambridge, by Professor Whitney, on geographical methods and results. The course will begin on Wednesday, Nov. 9, at 3 P.M. Admission free; but tickets must be obtained of the lecturer, by application through the mail or in person; and in their distribution, since the accommodation is limited, preference will be given to teachers, for whom the course is specially intended.

—The frequently observed longevity of eminent English scientists is again shown in the high ages at which recently deceased fellows of the Royal Society have died. Of fourteen fellows, six lived to more than eighty years, and only one was under sixty at the time of his death. The average age at death of the fourteen is no less than seventy-five years.

—Oscar Harger, for eighteen years the chief assistant of Prof. O. C. Marsh, died in New Haven, Nov. 6. Mr. Harger was born at Oxford, Conn., and was graduated from Yale College in the class of '68. He was one of the high-stand members of his class, and was looked upon at graduation as a young man of exceeding great promise. When he graduated, his health had been considerably impaired in consequence of hard study and application to literary and other work, which he did in order to secure money to pay his expenses through college. In 1870 Mr. Harger became assistant

instructor in geology at Yale, and rapidly became known among literary men as a logical thinker and superior instructor. He acquired a knowledge of local botany that was considerably more extensive than was possessed by any other scientist in the city or state. Professor Marsh valued his assistant very highly, and the two geological works of which Professor Marsh is the author were given to the printers in Mr. Harger's handwriting, having been very largely prepared by him under the immediate direction of the professor. In 1878 Mr. Harger married Miss Jessie Craig, sister of James R. and Alexander Craig of New Haven. Mrs. Harger survives him, but he leaves no children.

— Mr. P. W. M. Trap of Leyden is about to issue the first number of the *Internationales Archiv für Ethnographie*, which will be edited by Dr. J. D. E. Schmelz, curator of the National Ethnographical Museum at Leyden. The principal object of the new journal is the study of 'descriptive ethnology'; i. e., of the material, form, method of manufacture, and use of objects made by peoples still extant. It will be illustrated by color-plates, a magnificent sample of which accompanies the publisher's announcement.

— In *Science* of Nov. 4, p. 226, 23d line of 'Search for Gems and Precious Stones,' '792074' should read '792079.'

LETTERS TO THE EDITOR.

* * * *The attention of scientific men is called to the advantages of the correspondence columns of Science for placing promptly on record brief preliminary notices of their investigations. Twenty copies of the number containing his communication will be furnished free to any correspondent on request.*

The editor will be glad to publish any queries consonant with the character of the journal.

Correspondents are requested to be as brief as possible. The writer's name is in all cases required as proof of good faith.

Cheyenne.

YOUR espousal of the true pronunciation of 'Arkansaw' should give a shock to New England self-conceit, unaware that the New England type of mind is essentially shallow.

In regard to the name 'Cheyenne.' In youth I was able to speak enough Sioux to trade with the Indians. The French trappers told me that the Sioux say that the first Cheyennes they ever saw had their thighs painted red, and they (Sioux) remarked to them, *Shah-ee-ai-loo-hah*, which means, 'You have painted yourselves red.' They call the Cheyennes '*Shy-ai-lah*,' an abbreviation of the above sentence. *Shah-shah* means 'red'; and *loo-yah*, 'you have.' The change to 'Cheyenne' might easily occur in the transfer from Indian to white, and the first attempt to spell it by Frenchmen would of course be with *ch* instead of *sh*. The 'squaw-men,' trappers and hunters, do not believe it has any connection with the French word *chien*, notwithstanding the name of the Cheyennes in the intertribal sign-language is 'wolf-ears made with forefingers and thumbs at sides of head.'

GEO. WILSON.

Lexington, Mo., Nov. 5.

The American Physique.

LAST spring I received a letter from an English gentleman who is interested in anthropology and biology, asking me if there were any facts to sustain the impression abroad that the white man is deteriorating in size, weight, and condition in the United States. I had no positive information of my own to give, and I could only refer my correspondent to the data of the measurement of soldiers, and to some other investigations of less importance.

It occurred to me, however, that, since by far the greater part of the men of this country are clad in ready-made clothing, the experience of the clothiers might be valuable, and that, from their figures of the average sizes of the garments prepared by them for men's use, very clear deductions could be made as to the average size of the American man.

I therefore sent a letter to two clothiers in Boston who have been long in the business, one in Chicago, one in New York, one in Baltimore, one in Detroit, one in Texas, and one in Montreal. The information received in return is to this effect.

In any given thousand garments the average of all the returns is as follows: chest-measure, 38 inches; waist, 33½ inches; length

of leg inside, 32½ inches; average height ranging from 5 feet 8½ to 5 feet 9 in New England, up to 5 feet 10 for the average at the South and West. A few deductions of weight are given from which one can infer that the average man weighs between 155 and 160 pounds.

These measures cover the average of the assorted sizes of garments which are made up by the thousand. There are a few small men who buy 'youths' sizes' so called, and a few larger men who buy 'extra sizes.' The remarks made in some of these letters are interesting.

My correspondent in Chicago states, "that, so far as relates to the assertion that the race in this country deteriorates, our experience teaches us that the contrary is the case. We are now, and have for several years past been, obliged to adopt a larger scale of sizes, and many more extra sizes in width as well as length, than were required ten years ago. I find that occupation and residence have a great deal to do with the difference in sizes, the average of sizes required for the cities and large towns being much less than that required for the country. Again, different sections vary very much in those requirements. For instance, an experienced stock-clerk will pick out for South and South-western trade, coats and vests, breast-measure 35 to 40, pants always one or two sizes smaller around the belly than the length of leg inside; for Western and Northern trade, coats and vests, breast-measure 37 to 42, pants 33 to 40 around the belly, 30 to 34 length of leg inside."

My correspondent in Texas gives the average 38 inches chest, 33 to 34 inches waist, 32½ leg-measure, 5 feet 10 inches height, adding, "We find that the waist-measure has increased from an average of 32, to 33 inches during the past five years, and we think our people are becoming stouter built."

My correspondent in Baltimore had previously made the same statement; to wit, "Since the late war we have noticed that the average-sized suits for our Southern trade has increased fully one inch around the chest and waist, while there has been no apparent change in the length of pants."

I asked this firm if the change could be due to the fact that the colored people had become buyers of ready-made clothing, but have for reply that the fact that the negroes are buying more ready-made clothing now than previous to the war, accounts in only a small degree for the increase of the size, but is due almost entirely to the increased physical activity on the part of the whites. The experiences of this firm covers thirty-five years.

My correspondent in New York states that "for the last thirty years our clothing, numbering at least 750,000 garments yearly, has been exclusively sold in the Southern States. We find the average man to measure 37 inches around the chest, 32 to 33 around the waist, 33 to 34 inches length of leg inside, average height 5 feet 10 inches. The Southerner measures more in the leg than around the waist, — a peculiarity in direct contrast to the Western man, who measures more around the waist than in the leg."

My correspondent in Canada gives the following details; experience covers twenty years, about 300,000 garments a year: —

Breast-measure.....	36,	37,	38,	39,	40,	41,	42,	44
Waist	32,	33,	34,	35,	36,	37½,	39,	42.
Cut per 1,000 of above sizes.....	30,	150,	240,	240,	140,	50,	60,	20.
Average weight for each size.....	140,	150,	160,	155,	175,	150,	200,	205.

"The information about the weight I got from a custom tailor of some years' experience, and cannot, of course, vouch for its correctness."

My correspondent in Detroit says, "We notice marked peculiarities in regions where dwell people of one nationality. The Germans need large waists and short legs; the French, small waists and legs; the Yankees, small waists and long legs; the Jews, medium waists and short legs. We have found a decided demand for larger sizes than we formerly used."

This subject is foreign to my customary work. I give these statements as a matter of general interest, and perhaps some of the students who are engaged in this branch of investigation may take a hint from this method and extend it still further.

Possibly the average size for a woman could be deduced from the data of the manufacturers of knit goods. From what I know of the business of the clothiers to whom I made application, I should infer that the figures which I have submitted above would cover more than one hundred million garments; and I know of no better

method of coming at a rough-and-ready conclusion regarding the size of men, than the one which I have adopted.

This subject has interested me from the standpoint of better nutrition. It will be observed that the American man is decidedly gaining in size and weight. If this has happened during twenty years of the American frying-pan, dyspeptic bread, pale pie, and cooking in general under the supervision of cooks who were sent from the wrong place where the meat did not come from, what may be expected when the American woman learns how to cook? Cannot some one obtain data for comparison with these sizes from the statistics of military recruits and conscripts in Europe, or from the contractors for army clothing?

EDWARD ATKINSON.

Boston, Nov. 3.

The Sense of Smell.

It is quite customary, when treating of the senses, to speak slightly of smell and taste, as if they were of little importance in the economy of life. When the subject of training the senses is under consideration, little is ever said of training the nose, while much space is devoted to educating the eye, the ear, and the hand. It is certainly true that smell does not rank with sight and hearing, and demands less care, perhaps, for its cultivation; and yet it plays an important rôle, and should receive its due share of attention in any scheme of education.

The function of smell is fourfold. Like the higher senses, it belongs to the intellectual endowments. It is a part of the mind. Through it the mind is reached, roused, and quickened. The percepts and concepts gained through the sense of smell can be named, described, analyzed, compared, and classified. They may thus become the means of a good degree of intellectual life. Smell is a source of knowledge. Through it the mind discerns those qualities in things which we denominate odor. This knowledge it can obtain in no other way. A surprisingly large number of objects have their own peculiar odor. The onion, the carrot, the beet, and all other vegetables have characteristic odors; so have fruits, flowers, spices, and many gases, as well as animals, meats, etc. The knowledge of the kind, quality, and condition of things that can be obtained by the sense of smell, is very extensive. Not only the druggist, the chemist, the cook, but others likewise, make much practical use of the nose as a source of knowledge, having its own special scientific interest. But smell does a highly important work in enabling us to detect foul, hurtful odors. The nose is placed at the entrance to the mouth as a sentinel to guard it from receiving unwholesome food. It is the watch-dog of the stomach. A fourth, scarcely less important function of smell is that of giving pleasure. The nose is capable of ministering to our happiness even more, perhaps, than the touch or the taste. One with a cultivated nose has delights that another knows not.

There is even a greater need for some systematic training of the sense of smell than of the so-called higher senses. The ordinary experiences of life and the regular work of the school-room necessarily give to the eye, ear, and mind considerable exercise; while the smell is called into use much less frequently out of school, and scarcely at all in school. Besides, the words expressive of smell percepts and concepts are far less numerous and exact than corresponding words for sight and hearing; so that the training incident to the use of language is likely to be far less extensive and accurate in the case of the nose than in that of the eye, ear, and hand. Add to this the low estimate generally placed upon the sense of smell, and the popular indifference to its training, as shown in the fact, that, while we have elaborate schemes for training the eye in knowledge of form and color, we have practically none for training the nose in the performance of its proper functions, and we may challenge for this useful member the sympathy and interest due to neglected merit and overlooked modesty.

In every primary school there should be some special attention paid to the education of this sense. This should aim to secure, first, the frequent exercise of the sense until it acquires strength proportionate to its duties. It should not be overworked, nor called into undue prominence, but should receive its proper share of attention till it acquires both strength and sensitiveness. Second, the training should be such as to develop a high power of discrimi-

nation, so that the pupil can discern quickly and accurately the different odors that are presented. Third, the growth in discriminative power should be accompanied *pari passu* with language. Each distinct odor should be named, and the closest association should be created between the idea and the word, so that the one shall recall the other. The pupil should be exercised in analyzing complex odors, so as to be able to detect the presence of different substances in the same compound. He should be instructed in noxious smells, which indicate the presence of harmful substances, and should have some knowledge of the disagreeable odors, their origin, and the method of their removal.

Boys might receive a little special training as a preparation for laboratory or scientific work, and girls be instructed in view of their possible duties as cooks or housekeepers. A few very simple principles suffice for suggesting a plan of carrying this scheme into effect. The work should be begun in the primary grades. This is a period of sense-activity, when the child is being aroused to mental life through sense-perception, acquainting itself with the sense-qualities of the universe, and storing up ideas for future use. If the senses are neglected at this period, the opportunity for training them may never return. At first the work should be simple, making very light demands upon the sense. A few common fruits, flowers, and spices or gums may be used, with a view of forming a sharp discrimination, quick recognition, and accurate naming. The drill exercises should be very brief, aiming at thoroughness rather than multiplicity, and may be alternated with lessons in form, color, place, number, etc. The lessons should be graded so as to increase in difficulty, and should be so systematized as to secure the fourfold end of varied activity, knowledge, health, and pleasure. Each step forward in sense-discrimination should be accompanied with drill in oral and written language. For ordinary purposes it will be sufficient to make the child well acquainted with perhaps one hundred distinct odors, separate and in combination; and these for the most part should be of those things a knowledge of which will be of most service in daily life.

When the sense has been properly trained in childhood, and a habit of wise use established, the pupil will be able to call it into exercise on all needful occasions, and, on the basis of this general culture, can, if need be, secure a highly specialized development of the sense, meeting all the requirements of extraordinary occasions.

THOMAS J. MORGAN.

Providence, R.I., Nov. 3.

Answers.

15. IS THE TRUMPET-CREEPER POISONOUS?—The belief is general in many parts of the South and South-west that both the trumpet-creeper and the Virginia creeper (*Ampelopsis quinquefolia*) are poisonous. I have always acted upon the opinion that this belief is as unfounded in the one case as in the other. A little experience of the poisonous *Rhus* will make an ignorant person afraid of every vine found growing in the woods.

JOHN C. BRANNER.

Little Rock, Ark., Oct. 31.

15. IS THE TRUMPET-CREEPER POISONOUS?—No. This is *Tecoma radicans*, and climbs trees, posts, walls, etc., by means of thousands of rootlets. It is trained around many verandas and about door-yards for ornament. No one was ever poisoned by it. It has been often mistaken for *Rhus radicans* of Linnæus (the climbing variety of *R. toxicodendron*), which also climbs by means of thousands of rootlets. The stems of the two clinging to trees resemble each other very much. I have had many cases of *Rhus*-poisoning, but never heard of any thing being poisoned by the *Tecoma*. Many times when persons have exclaimed in alarm, "That is poison-vine, don't touch it!" I have, to their consternation, seized the leaves of *Tecoma*, rubbed them over my face and hands, and even chewed them. With sixty years of daily intimacy with these plants, I feel justified in these statements. D. L. PHARES.

Agricultural College P. O., Miss., Nov. 5.

16. The Archbaed pot-holes were described by Dr. John C. Branner in the Proceedings of the American Philosophical Society, vol. xxiii., pp. 353-357 (read Feb. 19, 1887), and Mr. Charles A. Ashburner in the 'Annual Report of the Pennsylvania Geological Survey for 1885,' pp. 615-626.

CHARLES S. PROSSER.

Cornell Univ., Ithaca, N.Y., Nov. 7.

SCIENCE

FRIDAY, NOVEMBER 18, 1887.

THE CLOSING SESSION of the National Academy of Sciences, which was held Friday at Columbia College, was perhaps the most interesting of the series that occupied the greater part of last week. Unfortunately, in view of this fact, the attendance was smaller than on any of the previous days, as several of the members had accepted an invitation from Professor Edison to visit Menlo Park. The session opened with an interesting paper by Prof. W. P. Trowbridge. It has always been a puzzle how the muscular action necessary to keep birds on the wing so long as they often remain could be possible; and Professor Trowbridge explained the recent discovery by his son, which is that birds of prey and some others have the power to lock securely together those parts of the wing holding the extended feathers and corresponding to the fingers of the human hand. The action of the air on the wing in this condition extends the elbow, which is prevented from opening too far by a cartilage, and the wings may keep this position for an indefinite length of time, with no muscular action whatever on the part of the bird. While resting in this way, the bird cannot rise in a still atmosphere; but, if there be a horizontal current, it may allow itself to be carried along by it, with a slight tendency downward, and so gain a momentum by which, with a slight change of direction, it may rise to some extent, still without muscular action of the wings. The professor also believed it quite possible for a bird to sleep on the wing. In discussing this paper, Prof. J. S. Newberry said that he had once shot a bird which came slowly to the ground as if still flying, but reached it dead. He believed that it had died high in the air; but he had never been able to account for the manner of its descent till now, when he found an explanation in the statement of Professor Trowbridge. Professor Newberry read a paper on the future of gold and silver production. Beginning with gold, he said that he had spent a part of nearly every summer since 1855 among the mines of the West, and he believed that the production of the United States was past its maximum. The present annual production amounts to \$30,000,000. In the northern parts of the mountains of the West there is probably gold, and it may be hoped that a considerable contribution to the gold of the world will be made from this region. There are no important deposits of gold in Mexico. The western coast of South America, rich in silver, is poor in gold. It is likely that the ancient inhabitants practically exhausted the supply, and the images of this metal which they buried with the dead have been sought, with some success. The product of Europe is about \$30,000,000 annually, more than three-fourths of which is from the Ural Mountains. We need not expect any such quantities of gold as flooded the world from California, Australia, and New Zealand, but it may be hoped that the present production may be kept up for many years. The problems of silver-production for the future seem to lie wholly within our own country. There has been a production amounting to more than six thousand millions of dollars since the discovery of America, and it is likely to reach from forty to fifty millions annually for some years to come. The mines of Peru and Bolivia are the most famous in the world, and it is estimated that they have yielded \$2,493,268,800. Their yield has been comparatively little for many years. On Wednesday evening Mrs. Henry Draper gave a reception at her home, No. 271 Madison Avenue, to the members of the academy. The leading feature was an account given by Prof. E. C. Pickering, director of the Harvard Observatory, of the work in stellar photog-

raphy under the provisions of the Henry Draper Memorial Fund. A full list of the papers read is given in another column.

AT THE ANNUAL FALL MEETING of the trustees of Princeton, held Nov. 10, Dr. McCosh resigned the office of president, his resignation to take effect at the end of next term. In closing his annual report, Dr. McCosh said, "For several years past I have been sensitive as to whether I may not be continuing in my office to the detriment of the college. I am so far relieved by finding that no such effect has yet followed. Our entrance class this year, 179, is larger than ever it was before; as also our total number of students, 603. It was 264 when I came here, and this while we have gradually been raising our standard of scholarship. Thanks to our generous benefactors, our grounds and buildings, books and apparatus, have been doubled or trebled. But having been in your service for over nineteen years, and being several years above the threescore and ten, the time has come to look to my retiring from the presidency of the college. I see it clearly to be my duty to ask the board to accept my resignation at its next meeting in February, and appoint a successor to me, it being understood that I retain my office till the beginning of the third term. I leave the college in a healthy state, intellectually, morally, and religiously." Dr. McCosh was born in Ayrshire, Scotland, in 1811. Educated in the universities of Glasgow and Edinburgh, he early began to show signs of literary and philosophical talent of a high order. His first serious work, an essay on the Stoic philosophy, obtained for him the honorary degree of M.A., and he was ordained a minister of the Church of Scotland at Arbroath in 1835. In 1839 he removed to Brechin, and from that time he took a prominent part in the disputes which arose in connection with the disruption of the Scotch Church, and the organization of the 'Free Church,' which was effected in 1843. His next work to attract attention was 'The Method of the Divine Government, Physical and Moral,' which was a theological application of Sir William Hamilton's philosophy. In 1851 he was appointed professor of logic and metaphysics in Queen's College, Belfast, and wrote, in collaboration with Prof. G. Dickie, 'Typical Forms and Special Ends in Creation,' and 'Intuitions of the Mind,' which were followed by 'An Examination of Mill's Philosophy.' Dr. McCosh was elected president of the College of New Jersey at Princeton in 1868, and has held that office up to the present time. Among the works he has written in the mean time may be mentioned, 'The Laws of Discursive Thought,' 'Treatise on Logic,' 'Christianity and Positivism,' the 'Scotch Philosophy, Biographical, Expository, and Critical, from Hutcheson to Hamilton,' and his famous 'Reply to Professor Tyndall's Belfast Address.'

THE 'ACT OF GOD' AND THE RAILWAY-COMPANY.

So far back that memory of man runneth not to the contrary—imported into the very earliest English jurisprudence from the Roman Code—was the theory of Nemesis, of the Inevitable, the Unavoidable. When it reached our motherland and Christian times, and clamored for recognition in the Common Law, our reverent Norman-Saxon lawyers, to be sure, called it the 'Act of God.' But it was the Stoic 'Fate' of the Roman—his 'Nemesi,' his 'Adrastea'—just the same; and the earliest English digests declared that 'the Act of God or of the public enemy' discharged all legal responsibility. In our day the doctrine is oftener laughed at than applied. A Western counsel for a railway-company, who, in defending an action for damages for haystacks destroyed by fire communicated from the company's locomotive, claimed that his

client had no control over the winds of heaven, speedily found himself out of court—his client should have used spark-arresters. But until a very recent date, courts of justice habitually saved time and routine labor by assuming accidents far less remote from their proximate causes than the distance between a haystack and a smoke-stack to be 'Acts of God;' though, indeed, a very recent English court, while recognizing the principle, declared that a shipwreck, to be a veritable act of God, must have happened in extremely bad weather.

But, though to-day in the United States the principle has all but disappeared from our digests, its existence is rather suggested by the somewhat startling fact, that, in all our recent chronicle of railway casualty (and I confine myself to the United States in this paper, because our safety appliances are invariably the latest, costliest, and most elaborate in the world, our corps of watchmen and care-takers the most numerous, and our estimates of the value of human life incomparably the largest), as a rule the simplest accident is the deadliest, and the utmost perfection of life-saving appliances (whose adoption saves in nine hundred and ninety-nine cases in the thousand) may yet turn out to be helplessness itself in the thousandth case when the calamity arrives: in other words, the disaster, when it comes, will be found to consist in the operation of some perfectly familiar law of nature (as of gravitation or inertia), set in motion by the simple oversight of some trained and trustworthy subordinate; which would have resulted from identical causes thirty centuries ago to the most primitive of conveyances equally as well as to our own limited expresses, with their air-brakes, vestibules, and coupler-buffers.

In examination of the history of railway-accidents in the United States, the physical conformation of the country should not be overlooked. As railways were first constructed among us, and had their formative days of operation in the Eastern States rather than among the flatlands and ordinarily easy grades of the Ohio valley, it was only natural that the bulk of experiment, mismanagement, error, and fatality, should have been expended on our Atlantic slopes. The period of the railway in the United States is yet one very insignificant in point of years. To-day, in 1887, the maps of our territory of greatest railway-development have Lake Michigan and the Mississippi, instead of the Atlantic Ocean, for their east. But by the time that railway-construction had begun to extend westwardly from those boundaries, those greatest insurances of safety—the air-brake, the coupler-buffer, the steel rail, the improved means of communication between the engineer, conductor, and his crew, which had been slowly wrought out in the East—had come into practical use. Hence it is that the Pacific railroads, though spanning gorges, climbing summits, and surmounting problems of construction to which the achievements of our Atlantic slope railroads are moderate, have no such records of manslaughter and destruction as we find in the records of Eastern rail-transportation. At present every American railway is equipped—is obliged by law to be equipped—with the last improvement in safety-insuring devices, not only for the convenience of the passenger, but for the safety of the employee against his employer as well as against fellow-employee. And it is an amenity to the credit of the railway system (which ought not to be lost sight of in these days when wage-workers are taught to look upon any thing incorporated as their deadliest foe) that it has introduced into the common law of the land the principle that an employer's duty to his employees is only discharged by furnishing him the safest tools for his work which the strides of science have devised.

Until within a very few months, these strides of science seemed to have happily abolished—in the United States—the great railroad-disasters of the past. Since the frightful catastrophe at Carr's Rock on the Erie Railway of twenty years ago, science and experience have rendered the giddy curves and bold escarpments of its Delaware division as safe as the tangents crossing an Iowa prairie. The Angola and Ashtabula terrors on the Lake Shore Railway wound up practically the list for that line; while, had it not been for a phenomenal piece of silly and unaccountable carelessness at Spuyten Duyvel (when Mr. Wagner, an inventor of parlor-car conveniences, was crushed to death in one of his own coaches), the New York Central would have closed up its own perspective of great calamities at New Hamburg, something in

the neighborhood of fifteen years ago. But this fifteen years of wonderful immunity from great railway-disaster—most wonderful when we consider that it corresponds with an era of railway-building in the United States unparalleled in the history of human industry—has been brought to a termination by a rapid succession of calamities, grouped into a period of ten months, which, in point of loss of human lives (and no other point is worth considering), are, if not the most terrible in railway annals, yet fall little in horror below the Wigan slaughter, or the annihilation at Tay Bridge, of the multiple horrors of which (analogous to those of shipwreck and railwreck combined) no living tongue shall ever tell the story. These five occurred during the first ten months of the present year, (1) on the Baltimore and Ohio Railroad at Republic, Jan. 4, 1887; (2) on the Central Vermont Railroad at White River, Vt., Feb. 11; (3) on the Boston and Providence Railroad at Forest Hills, March 14; (4) on the Toledo, Peoria, and Western Railroad at Chatsworth, Aug. 10; and (5) at Kout's Station on the Chicago and Atlantic Railway, Sept. 12 of the present year. These five are, I think, remarkable not only because breaking in upon the long immunity, but because upon examination it will, I think, be found that they were each and all due, not to any defect of machinery, signals, or other mechanical appliances which the corporation could have supplied, or to any defective or careless management, but to those unaccountable omissions of trained minor servants to perform a unaccountable detail of their routine work—a detail which it was their second nature to perform—which it would have ordinarily required a physical effort for them *not* to perform, or to have kept them from performing; that is to say (for it is difficult to exactly formulate it in words), an instantaneous mental incapacity on the part of a trained workman or care-taker, over which laws, rules, and incorporations have no control, and against the possibility of which neither hope of reward nor fear of loss or punishments can afford any defence or protection whatever. They all occurred on perfectly equipped roads, and from the simplest natural causes. Each of the accidents might have happened to the rudest contrivance of primeval or prehistoric man,—to the cart which used the section of a tree-trunk for a central wheel, or to the hollowed tree-trunk which itself formed a means of water-transportation, as will appear from their recapitulation.

The Republic accident was in this wise: a freight-train, which had ample time to make a run of some dozen miles to get out of the way of a through express coming in an opposite direction, which had made that run easily every night for years, for once failed to accomplish it. All the mechanical appliances and motive power of the train were in perfect order; its crew were old servants of the company. But the weather was exceptionally cold, the water in the tank of the engines was all but congealed, and the crew of the freight-train found themselves encroaching on the time of the express. Here was not only no novel situation, but, on the contrary, perhaps the simplest which can occur in any railway management. There was no emergency to meet. Probably not an hour passes in a day but that, somewhere in the vast railroad operations of the country, the case is paralleled. But here at Republic, on the night of the fourth day of January, 1887, the hand sent ahead with the signal failed to carry it: two trains met. The old catch problem of the irresistible force meeting the immovable body demonstrated itself; namely, the trains were destroyed, and twenty human beings lost their lives.

Just a month later, Feb. 5, came the disaster at White River. A night express thundered upon a bridge, which was supposed to be properly inspected. Every mechanical portion of the train was working as it should; every servant of the company was at his post; nevertheless, the locomotive left the rails instead of following them; the express-train was plunged to the frozen surface of the river fifty feet below; and, of its three hundred passengers, thirty-two never breathed again, or were roasted in slow agony from burning *débris* upon a floor of ice. Every bridge on every railroad-line in the nation is ordered to be watched. A corporation must act by its agents. This bridge had probably been hourly inspected for years, but somebody had failed to inspect it on the fifth day of February, 1887. Another month went by, and on the morning of the 14th of March a packed train on the Boston and Providence Railroad of three hundred mechanics and working-women was

moved into Boston for the day's business. Somebody had failed to report or to discover a flaw in the iron-work of a bridge at a point called Forest Hills. The locomotive followed the rails. Every thing upon the train was in perfect order; no appliance in the company's power to provide was lacking; but the bridge sank. The entire train except two rear cars was piled up in kindling-wood in a defile made by a passing road below; and from the undistinguished mass forty persons were drawn out dead. Four months of absence of great calamity by rail was then to succeed. But on the evening of the 10th of August an excursion party, gathered at Peoria and other points in Illinois, was to be carried to Niagara Falls. There were sixteen cars loaded with excursionists, and two engines were needed to draw them. The ordinary rules were observed, and due notice of the extra movements of such an unusual train was duly wired ahead for the guidance of watchmen and track-walkers. All went regularly; but it seems that a side-fire had been kindled on the right of way for clearing-up purposes, and that some track-walker whose duty it was to watch it had allowed it to communicate to the beams of the wooden bridge at or near Chatsworth. The train reached the bridge, but the bridge was already disabled by fire. It sank as did the one at Forest Hills, and eighty-five passengers were killed,—a most unprecedented death-list for an American railway-accident. Compared to the above, the fifth of these fast-recurring disasters seems almost dwarfed, and yet it was the most wonderful—from the standpoint of our present examination—of all. An engine drawing an express passenger-train on the Chicago and Atlantic Railway became disabled by the breaking of an eccentric strap. The engineer hauled up at a water-tank for repairs. A freight-train which followed, relying upon the schedule which the first train should ordinarily make, ran into the rear of the train with the disabled engine. Nine persons only were killed,—a small list compared with those we have previously noted. But doubtless it is as terrible to the victim to be killed in a list of nine as in a list of eighty. It was the story of the Republic disaster over again. Some brain had failed to do the regular act which it had performed for years as regularly as clock-work.

Now here, in less than nine months, one hundred and eighty-six lives, all precious to their owners if to nobody else, are sacrificed. Nobody but the claim agents of the corporations can ever know the number of wounded and maimed (nor even they, since many of those who escape do not care to press their undoubted claims), and the stockholders of the unfortunate corporation do not care to advertise the dead loss of material which it costs in cash to replace its ruined rolling-stock and transported material, lest the newspapers of the country dilate upon the preference shown for income over flesh and blood, and lash the popular dislike of corporations into fury with the stereotype with which every railway-accident fills our admirable press. But allowing four to one,—a minimum allowance,—nearly eight hundred more human beings have suffered a loss of limb or extreme physical pain, and several hundred thousands of dollars' worth of direct expenses incurred, for every one of these accidents, which should never, in the ordinary course of human procedure, have happened at all.

I say, should never have happened; but where shall the responsibility be placed? By law it is placed, and rightly, so far as human laws go, upon the railway-companies. But every railway-officer knows that the penalty his company suffers for such accidents as the five above described is exemplary,—a vindication only, so far as the companies themselves are concerned. That they have done, were doing at the time the accident happened, all that experience and science had taught them how to do, or that their professional or expert brethren employed in the same industry could have done under like circumstances, they know, and every railroad-man in the country knows, perfectly well. But the railway-official also knows very well, however, and realizes very submissively, that for these accidents he will be held to answer, and *not* before a jury of experts, or of his peers. The newspapers in no one of the above instances fail to ascribe these accidents to the 'greed of corporations.' The 'greed of corporations,' to be sure, is only another name for the duty of every corporation to pay dividends, if they can; and doubtless, were there no such duty or no such chance of payment, there would be no railroads, from the simple disinclination of ordinary

mortals to invest money in costly enterprises without hope of return or increment. But waiving that consideration, certainly it is hedging on the superfluous and the elementary to say that no railway-company courts accidents; that, no matter how large any individual loss by reason of the casualty may be, the company (that is to say, its stockholders collectively) must be the largest losers of all. When Sir James Coke said that corporations had no souls, he did not utter an epigram: he simply stated a fact. A corporation has no sentiments: it is simply put together for business purposes, because a number of individuals see in association the means of investing in a lawful industry too heavy for any one of them to singly handle. An attempt to earn dividends is properly described as 'greed,' of course. But what reader of newspaper denunciation pauses to subtract from any particular year's 'greed,' of any particular corporation, the million of dollars or less that a great disaster like that at Chatsworth or Forest Hills draws out of a company's treasury? Whatever the present state of clamor against corporations may develop, it is at least apparent, from considerations of pure 'greed,' that a railway-corporation is not a Moloch, or a contrivance incorporated for the purpose of burning or mutilating human beings, or crushing their bones, or mangling their limbs. Philares is said to have built a hollow bronze ox in which to roast his subjects for fun, and the druids to have made wicker cages in which to burn as many living babies as possible for economy's sake. But bronze oxen and wicker cages are comparatively inexpensive, and there were no courts handy in which damages could be recovered by the survivors. Locomotive engines and Pullman coaches are, however, rather costly receptacles in which to holocaust passengers. In spite of newspaper declamation, is it not self-evident that no railway-company gloats over the ruin caused by an accident upon its line?

To return to the five accidents above mentioned. In not one of them does it appear from the reports to the company—the newspaper accounts, or even the findings of the local coroner's jury (a class of valuable material which is not apt to be over complimentary to the railway-company)—that any of the mechanical agencies—operating-gear, engines, couplings, air-brakes, signals, wheels of the trains wrecked—were old, superannuated, or in bad repair; that the track was in bad condition; or that ordinary wear and tear had been allowed to remain unmet or exceeded. The utmost that can be said was, that, out of some three millions of men employed in the service of the railway-companies of the United States, five seem, for some utterly unaccountable reason, to have each failed in his duty of a moment, and that that moment in which he failed happened in the course of chance to be the supreme and crucial moment respectively in the lives of some two hundred human beings. It is too late in the day to call these failures, perhaps, 'Acts of God,' but what else are they? They are not the fault of the company. The company has no control over the minds of their servants. It could, indeed, negatively control their minds by so overworking them that nature refused longer to perform its functions. And for the safety of the community we think the law ought to take cognizance of a company which overworked its employees, and hold it to the same responsibility in that case as in cases where the company furnished dangerous conveyances to its patrons, or old, worn, and imperfect machinery to its servants. But in the five cases above selected there is no such allegation. The men sent out to warn an approaching train at Republic and at Kout's Station for once omitted their routine duty. The track-walker at Chatsworth forgot the bonfire kindled on the right of way. The bridge-inspector at White River and at Forest Hills failed to discover, or, discovering, to report, a flaw in a girder or a brace. To say that the companies failed to provide proper persons to perform these duties, is to say that they were willing to take the risk of losses running into millions rather than spend from five to a hundred dollars in cash. And most people who know any thing, know that (newspaper reporters and leader-writers, even, to the contrary) that is not the way railroads are managed in the United States, at all events. And we may add, that, had it been, the above enumerated accidents would not have waited until the year of grace 1887 to have transpired. The railroad-company, then, is at the mercy of its employees. I will not cite figures, because figures can be 'cooked.' But if anybody will sit down and compute the millions spent annu-

ally—not on public grounds, but for the purely selfish purpose of avoiding expensive accidents (that is, in self-preservation)—by the railways of the United States, in premiums for new inventions, in training-schools and shops for the education of its servants and the development of improvements, for the purchase of the latest devices for the saving of life and property, he will find his command of figures taxed to express the aggregate result. And if he will remember the number of courts and lawyers in this great country of ours, and the general gusto with which juries mulct railway-companies, he will not wonder, I think, that science cannot move fast enough in devising improvements to be utilized in the physical management of railways. The presumptive margin of profit in railway-operation is small enough as it is; but when the recurrence of such accidents as those at Republic, at White River, at Forest Hills, at Chatsworth, and at Kout's Station are admitted into the forecast, it is apt to produce a rather considerable shrinkage in the prospect, or in the temptation of stockholders to build more railroads.

Congress has lately established a bureau at Washington for the filing of railway-schedules, and for discovering what, if any, 'long hauls' and 'short hauls' can possibly be "under substantially similar circumstances and conditions." What public benefit this bureau may become to the public, it remains to be demonstrated. But, if the establishment of another bureau or commission to devise a means for supplying railway-companies with infallible employees were contemplated by the government, the government's good intentions, at least, could not well be questioned. Of the three millions of railway-employees in this nation, the percentage who do not do their duty is too microscopic for expression in decimals; but the railway-industry happens to be one in which an invisible percentage of carelessness produces enormously visible calamitous results; that is the price we pay for being carried back and forth to our business at five miles in ten minutes instead of five miles in an hour. But before the absolutely infallible employee is found, some eminent counsel of a railway-company may yet be bold enough to claim, that, since railroad-companies cannot take their brakemen and track-walkers from the class of the community which produces Sumners, Websters, and Conklings, the unknown mental processes which sometimes lead a brakeman or a track-walker, from causes entirely and subjectively mental, to happen to think of something else than his routine duty, ought to discharge a corporation which has no soul—if not from pecuniary damages for loss of life, limb, or property it has no agency in procuring, at least from newspaper declamation, and charges of sacrificing its passengers and patrons to mere 'greed.' Since, however we may explain it, it happens to be one of the most persistent of truths that accidents are of more frequent occurrence upon bankrupt or non-dividend paying than upon solvent and dividend paying railroads, one might say, logically speaking, that the 'greed' of a railway-company was a public security rather than a danger.

There is an apparent moral to be drawn from these records of casualty, which, from one point of view, perhaps, is safe enough. We may say, and say with great truth, that no achievement of applied science can be substituted for human watchfulness and care, but only for human skill. But to this there would be exceptions. The automatic hay-press, which rams and packs and binds not only, but debouches the completed ball in time to pack another in the place from which that ball is debouched; the Hoe printing-press, which counts the sheets it prints; and hundreds of others,—are watchfulness personified (and I am told that there are mechanics employed in the most delicate processes of watch-making which are said even to correct a chance misplacement of the material to be worked upon); but, since the operation of none of these is occupied with the transportation of human beings, should these automata fail, no lives are lost, and no public outcry awakened. The better statement is, I think, that no machine can counteract human wilfulness or neglect. The machine can only do the share of work allotted it. If the man fails in his, no accuracy of invention can suffice. A dial may register the failure of a watchman to visit a certain point so many times a night, and tell its unalterable tale in the morning. But, where a train of human freight rushes on to death and disaster, death and disaster tell the tale, upon the instant of the dereliction, and when it is too late to correct the fault or supply the omission. And the public sacrifices with its denuncia-

tion the owners of the machine, and not the man or men who ought to have cleared its track but did not.

Everybody must trust somebody, corporations must trust everybody they employ: nay, more, the railway-company must not only trust everybody, but it is at the mercy of every track-walker on its line; and, worse than that, every passenger that a railway transports, every pound of freight it moves, is at his mercy too. Should that track-walker's eye be turned from an obstruction or overlook a detail, the eternal vigilance of every other servant of the company is worse than useless. The crash must come, and all the sooner because the machinery which moves the train is of the latest and best, and the coaches the completest and most luxurious, that human ingenuity has devised. Penalties, threats, the prospect of rewards, alike fail to make the man do his duty, or to prevent his forgetfulness or wilful absence of mind or body at a crucial point, or the intellectual hiatus of a moment which causes his hand to forget once in a half a million of times the required act which it is quite his second nature to do at all the other times. What is it? Is it an 'Act of God?' Is it inevitable necessity, or is it Nemesis?

The physical perils of the sea appear to have been already overcome. But the peril of panic remains, that no human ingenuity can prevent, and no human discipline, however it may foresee, control. The wheelsman of the 'Ville de Havre' had watched a vessel steering towards them for hours in a clear night; but when that vessel was about to crush the great steamer, the very thought of the monumental magnitude of the approaching peril paralyzed that wheelsman's brain, and the brain-paralysis steeled his hand, and he could not turn his wheel the few points that meant safety to a priceless human freight. What is there to provide against here? Shall we still preserve the antique phrase 'Act of God,' or merely say that it is fate or luck? Call it what we will, there is yet, it would seem, an element in all mundane affairs for which nothing human can invent an antidote or remedy, and which possibly should relieve us, under our human laws, of the responsibility. Whether or not mere human framers of human laws ever devise a statute for the emergency, of one thing, however, we can, I think, be sure enough; namely, if a relief from this 'Act of God' should ever come, it will be because science, and not the reporters, nor yet the leader-writers of our daily newspapers, have grappled with the problem. Every thing except the human brain, the human brain appears to have conquered or to be in a fair way to conquer. But to go outside of itself to control itself—that, it seems, so far, to have been unable to do.

APPLETON MORGAN.

SOUND-BLINDNESS.

THE phenomena of color-blindness are well known, and have been carefully investigated. We know that some persons can see to great distances, discern minute objects, enjoy works of art, and yet are unable to distinguish certain colors. Physiologists, and especially psychologists, have also found that there is a similar series of phenomena to be observed in connection with the sense of hearing. If a word were coined to describe these phenomena, it would naturally be 'sound-deafness,' but many who have written on this subject seem to prefer the term 'sound-blindness.'

A writer in the London *Journal of Education* uses the term 'sound-blindness,' and seems to have come to the subject from a pedagogic standpoint. He states that the difficulties which some persons have in learning to spell and in learning how to pronounce foreign languages suggested to him the possibility of the existence of such a thing as sound-blindness,—an inability to distinguish particular shades of sound, arising from some organic defect in the ear which is distinct from deafness, as that term is commonly understood.

The writer in question noticed that a small boy, in writing down a line of poetry which he had learned by heart, had spelled the word 'very' 'vogh't.' When some experiments were tried, it was found that the boy could hear no difference between 'very,' 'perry,' and 'polly,' and yet he was not deaf. The boy in question had great difficulty in learning to read, and, on inquiry being made, many teachers were found who testified to the fact that it is quite a common thing to meet with children who are very slow in learning to read precisely, because sounds, different to the teacher, were not different to them. It was also found, that, when a class of

boys reads aloud, some of them often give, instead of a word, its synonyme, though the latter be quite different in sound from the former. "The boys who were most apt to do this were the boys whose power of hearing was already under suspicion; and I inferred that they associated the printed letters, not with their sound, but with the concrete thing which they represented, much as if they had been a picture."

Another interesting observation is that of a boy of eleven years of age, who is a bad speller, and, when writing from dictation, makes mistakes in words which have an *r* or an *l* in them. He cannot pronounce those letters; but his failure is believed to be the result of a defect of ear, though he is by no means deaf, quite as much as the result of a defect of tongue or palate. Some of his misspellings are 'sunderelents' for 'sundry rents,' 'compreated' for 'complicated,' 'laserlacioms' for 'lacerations.'

The writer points out that a want of power to distinguish vowel-sounds is quite as likely to be the cause of bad spelling in common words as carelessness amounting to *malice prepense*, or a weakness in the machinery which connects the movements of the hand with the orders of the ear. He continues, "We might have expected, that, on the analogy of color-blindness, vowel-sounds would be more likely to be confused than consonant-sounds. So far as my present experiments have gone, I infer that the inability to distinguish consonants is as common as a want of discrimination between vowels."

"The confusion caused by explosive consonants is, however, more remarkable than that from vowels; the inexperienced ear which is dull at catching consonants is capable of any distortion of sounds. To illustrate this, an experiment was tried with a class of eleven boys, averaging ten and a half years of age, and all able to read fluently, one or two of them being somewhat extensive readers. Some short ordinary words were selected, which nearly all got right, and then words specially to test the power of hearing, some of which, it was hoped, the subjects of the experiment had never heard before. Here are the variations of five words (the italicized vowels show interchange in the hard-vowel scale):—

1. different capable	ultramarine	spectroscope	Epaminondas
1. dirfreat capubl	ultramean	spaccrow	apnonas
2. different	ultramarine	specoroscope	aparondas
3. diferent caperbul	altremerine	speckshow	aponedondas
4. differant caperble	altremerrein	speckros-cop	achappynomeen
5. diferant camble	oltzmer	spkerrope	appanaxend
6. dirfrent capble	untzmerrein	specteroskop	eupameondeous
7. different capabybely	ultreian	spesptrocope	emeandos
8. drifent capebibel	ultreinn	spectuscope	epermandes
9. different capabile	ultermeriem	spectroctrope	aporymondas
10. diferant ackable	ultomarine	spretting	apanenondes
11. differint caperble	ultrumeree	spatroscope	appongamanges

"The room was a small one, and the words slowly pronounced twice, each word being written immediately after it had been read out. The majority of these boys are unusually intelligent. The worst speller but one recited, soon after his eighth birthday, 'The Battle of the Lake Regillus.'

"Twenty words in all were read out. Among them were 'yellow,' which all got right; 'instance,' five right, one of the best readers giving 'insentsess;' 'aniline,' of which there appeared these variations, 'haniyne,' 'aniling,' 'anelile,' 'animiene,' 'aleine,' the rest being at any rate phonetically correct.

"In the majority of these misspellings we at once detect want of experience in the use of the arbitrary connection between signs and sounds, and feel confident of improvement in course of time; but when we find a particular phonetic mistake frequently recurring, such as the substitution of *l* for *n* in 'aniline,' we suspect some defect either in the writer or dictator; and if the possibility of mispronunciation in the reader is eliminated, then we have to look for defect of ear or hand, or both, in the writer. Supposing that in correcting the misspellings we find that one or two subjects cannot recognize a word after the correct spelling has been shown them, while others have no difficulty, we must conclude that the ear is at fault, in the one or two; and if we find that the same individuals can recognize some sounds and not others, then the phenomenon of sound-blindness is established, and we have a satisfactory reason for the fact that some persons seem to spell natu-

rally, while others never learn; as, indeed, how should a man learn to spell even phonetically to whom not only the printed sign, but also the distinction of sounds, is arbitrary and conventional? and how should he not learn whose ear is a torturing conscience? Sound-blindness will account for dialectic variations. The ear being, as physiologists tell us, an even more delicate and complex structure than the eye, we can understand that the physical conditions of certain localities may produce insensibility to particular variations of sound. Perhaps the interminable rattle of London may account for the awful vowel-system of commercial men in the metropolis."

ETHNOLOGY.

American Languages.

In the Proceedings of the Canadian Institute, Toronto, October, 1887, Mr. A. F. Chamberlain discusses the relation of American and Asiatic languages in connection with the question of the origin of the Indians. The concluding remarks of his article are so judicious that we wish to repeat them here: "The case for the eastern Asiatic origin of the American peoples rests too much upon apparent phonetic resemblances. Before any (phonetic) law like that of Grimm can be discovered and demonstrated between the American and related linguistic families, a thorough understanding of the relations which exist between the individual members of each branch of the American stock is requisite and of paramount importance." But we believe that an application of such principles to Chamberlain's own remarks will show that they are not well founded.

The author first discusses the Eskimo dialects, and gives a brief comparative vocabulary of different tribes in order to show their similarity. The words contained in this table are not taken from the best originals, and, besides, words of different meaning are compared. What the author considers as differences of dialect must in many cases be ascribed to a difference of the grammatical forms, or to the nationality of the collector. As his material is of so little value, the comparative Eskimo-Turanian vocabulary cannot be considered a good proof for his opinion that the American and Turanian languages have a common origin. We cannot consider the similarities of sound between the two groups other than fortuitous. There is another point of view in the paper which we cannot accept. Chamberlain uses the migration legends as a proof of earliest migrations. To a certain extent this may be right, but it is well known, that, if a tribe changes its seat, its legends are attached to new localities, and for this reason no conclusion on the migrations in a very remote period can be made from such facts. The migration of legends among aboriginal tribes is a problem of great difficulty, and one in which rash conclusions ought not to be made. The study of European folk-lore has shown that the origin of legends and their migrations are often wonderful, and that the most painstaking care must be taken in dealing with this subject. These considerations prevent us from accepting Chamberlain's theories as superior to those propounded by other authors. Our knowledge of American and North Asiatic ethnology and philology has not yet arrived at that stage in which we can deal satisfactorily with the question discussed by Chamberlain.

ETHNOGRAPHICAL MUSEUMS.—Dr. Kristian Bahnsen publishes an interesting account of his thorough study of the principal European ethnographical museums ('Ethnografiske Museer i Udlandet,' in *Aarbøger for nord. Oldk. og Historie*). His concluding remarks are of particular interest, as they refer to the much-discussed question of museum arrangement. He shows that the arrangement according to objects has gradually been abandoned by all museums, and that the ethnological method, i.e., the arrangement according to tribes, has been adopted in its stead. He says about the former, the sociological plan, "The plan as a whole is absolutely wrong, in the first place, because those groups which ought to be the principal divisions in an ethnological museum, are made subdivisions. The ethnic individuality, which is a whole, is decomposed into a great number of elements. By an arrangement according to the character and purpose, the objects are taken out of their natural place, and they want the environment, which alone can explain their real meaning. In each stage of civilization there is a deep connection between the several ethnological peculiarities

of a people. Although this connection is not that 'harmony' from which conclusions have been made from the development in one region upon a similar development in another, it exists, influenced by numerous conditions, — climate, nature of the land, mental development, intercourse with adjacent countries, etc., — and it is necessary to convey the idea of such a connection in a museum, the object of which is to throw light upon the origin of a certain stage of civilization. Groups of objects, severed from their ethnic environment, may be valuable for the study of industry and technology, but an ethnographical museum cannot be arranged in this way, as objects belonging together from an ethnographical point of view are separated, while others of entirely different origin are united in one group. The other system of arranging museums is the ethnographical one. The system according to which all objects belonging to one tribe are placed together, and the single tribes are joined to ethnic groups according to their affinity, is so simple and natural in itself, that it has been generally accepted. It is a long time since ethnologists have ceased to invent more or less valueless systems of mankind which played an important part in the early history of ethnography. The attempt is being made to construct, by the use of strict inductive methods, the science of ethnology on the foundation of careful researches on single tribes and nations; and not until this has been done will problems of the mutual relation of tribes be taken up. In this way the foundation is laid for researches on the history of civilization. There is no lack of theories on the material and intellectual development of man, on the progress and decline of primitive nations; but here, also, the only way to reach satisfactory results is the inductive method; here also, a vast number of researches is necessary, before it is possible to gain that general point of view which is the ultimate aim of ethnology. In consideration of these facts, the ethnological arrangement is the only one fit for a museum. It does not give a solution of great problems, it does not give results of doubtful value, but it gives, what must be asked by the descriptive treatment of ethnography, the material arranged in such a way that it may be as easily accessible to students as possible. It is only in this way that the museum is able to illustrate the different states of civilization which occur in a single tribe, and, as the principal groups of nations are kept together, it shows the peculiar development in each group. All museums of any importance have adopted the ethnographic principle in laying out their plans, but not all have been equally successful in carrying their plans out. There are collections in which incidental arrangements disturb the general plan, and they show that the utmost consistency in adhering to the plan is necessary, else the museum will become a mere store-room." Dr. Bahnson further says, that, in carrying out such a plan in a large museum, the ethnological collections of each tribe must be subdivided according to sociological principles. These statements and views of the author are of great weight, as they are based on the study of a great number of collections and of a vast material. He shows plainly that there is no foundation to the alleged impossibility of arranging ethnological collections on an ethnological plan, and his idea that such a museum is the only one that can serve for the study of the history of civilization is undoubtedly correct.

THE BASQUES. — Chamberlain's view in regard to the connection between the Basques and Americans is in part founded on the alleged similar character of their languages. Many grammatical forms of the Basque consist of a combination of mutilated elements, and it was believed that this process was similar to the synthesis of American languages. Recent researches do not confirm this view. W. J. van Eys, one of the most learned Basque scholars, considers such combinations or contractions as similar to those occurring frequently in the vulgar dialects of Romanic and Teutonic languages. He mentions the Dutch *hy't'm*, which stands for *hebt gy het hem*. Our 'ain't ye' for 'are you not,' and others, belong to the same class. He ascribes the occurrence of such contractions in literary Basque to the late date at which the literature of this people developed. Gerland, who gives a very clear sketch of the Basque language and its relation to the ancient Iberian in 'Gröber's Grundriss der romanischen Philologie,' expresses the same opinion, and thus far-reaching conclusions on the connection between Americans and Basques must fall to the ground.

HEALTH MATTERS. Cholera and Cold Weather.

In a recent editorial in the *New York Medical Record* the statement was made that "cholera is always stopped by cold weather, and an epidemic here now would be impossible." In a letter to the editor of that journal, Dr. Reginald H. Sayre of New York takes exception to the statement, and quotes a number of instances to show that cholera is one of those scourges whose march is not stopped by heat or cold, high or low altitude, dryness or dampness, or any other condition of the weather. He says, —

"In 1830 the cholera appeared in Moscow in the month of October, and continued its ravages until the end of December, in spite of the severities of a Russian winter, and caused the death of 8,130 persons out of a population of 250,000, or about 1 in 30. From Moscow it went north to Yarasy, thence to Rybinsk, sixty leagues north of Moscow, where it appeared on March 19, 1831, in spite of the ice and snow which covered the ground.

"In October, 1831, the cholera appeared in Great Britain, and continued there until March, 1832, doing most of its destruction in December. About one-third of the people affected died.

"On the 27th of March, 1832, the disease appeared in Paris, and the mortality was so frightful that 861 people died in ten days.

"In 1848 the emigrant ship 'New York' left Havre on the 9th of November, having no sickness on board, and no cholera being then in Havre. During the voyage the weather became bitterly cold. There were some German emigrants on board, from a town where cholera had prevailed, who had a trunk which had belonged to a man who had died of cholera. They opened the trunk, took out the clothing, and wore it. On Nov. 22 a child died of cholera, and seven persons in all succumbed to it before reaching New York harbor. They were strictly quarantined, and the disease limited to those who died on Staten Island in the quarantine.

"About this same time another vessel from Havre, bound for New Orleans, developed the cholera on the twenty-seventh day out, and, owing to imperfect quarantine regulations, the disease spread rapidly through the town soon after the arrival of the vessel, there being then no other cases in the United States except those in the quarantine on Staten Island. From New Orleans the disease travelled to Memphis, appearing there toward the end of December, and at St. Louis in the first week of January, 1849. Toward March several places in the Upper Mississippi valley were affected, and then gradually the disease moved east through Chicago, which it reached in May, to New York, which became infected then, and *not till then*, although the disease had been imported to the city six months previously, but had not been allowed to land; and the city in this way kept free from infection until the cholera effected a flank movement, by way of New Orleans, and attacked her in the rear, having made its progress in spite of the winter, and having attacked the cities through which it passed in the cold weather.

"These facts in regard to the prevalence of cholera in spite of cold, and the well-known futility of a quarantine on land, make any attempt to lull the medical profession into a false sense of security fraught with great danger to the country, and I have therefore wished to call attention to the fact that cholera is *not* stopped by cold, and that to be quarantined effectively it must be arrested in our ports, which can only be done by having a general quarantine under the direction of the Federal Government."

In answer to this, the editor of the *Record* says that cholera has never prevailed in New York City in the winter-time, and rarely in any northern latitude save under very peculiar and exceptional circumstances. In support of this view, he quotes from Ernst's 'Reference Handbook of the Medical Sciences,' which states that "the progress of an epidemic is invariably arrested by cold, the winter season having always stopped those of which we have any record." He further says that cholera has frequently been imported into warm New Orleans in the winter-time, notably in 1873, when it commenced in February. But it did not winter over that year, or notably any other year. But constant importations into New Orleans almost every month of the year during the California gold-fever times sent much cholera to St. Louis and Chicago, and other Western places, almost every month in the year; so that it seemed to winter over, but, in fact, was kept alive by almost incessant new importations. The effect of cold on the further spread of cholera,

and upon the vitality of its germs, is a matter of deep moment at the present time, and we shall be glad to receive any information from our readers which will throw light upon the subject.

SEWER-GAS.—In an editorial on the subject of the air of sewers, the *New York Medical Journal* refers to the fact that some authorities do not regard sewer-air as of itself usually deleterious, while others attribute to it cases of sickness which have from time to time been reported, and asks how this apparent discrepancy is to be accounted for. Sewer-air is regarded by some sanitarians as dangerous only when it contains the germs of specific diseases; but the many instances in which it has seemed to be the sole cause of persistent sore throats, headaches, and diarrheal troubles without the development of any well-defined disease would seem to militate against this view. Dr. Playfair reports a case in the *Lancet* in which serious symptoms were developed in a puerperal woman, which were undoubtedly due to exposure to foul air from the house-drains. In the Proceedings of the Royal Society is a paper on this subject by Professor Carnely and J. S. Haldane, M.B., in which it is shown that the air of large and well-ventilated sewers is comparatively free from noxious gases, and contains proportionately fewer micro-organisms than the outer air of the same locality. These observers also found that most of the micro-organisms found in the sewer-air were drawn in from the outer air, and not developed in the sewer; that micro-organisms tend to settle instead of remaining in the air; and that, when bubbles of sewage burst, a number of micro-organisms are set free into the air. The editor of the *New York Medical Journal* states that it has been noticed that illness traced to defective drainage is more frequent in houses where there are holes in the pipes, open joints, or unused fixtures, than where there is simply an absence of traps under fixtures in constant use. Holes in vertical or branch pipes, and open joints, will often be found covered about the edge with slime deposited from fluids that have spurted through the holes during their passage. The outer border of this deposit is often dry and crumbling, and from that point to the edge of the opening will be found all degrees of moisture. He asks whether it may not be that such deposits around holes and lining dry unused pipes are the real breeding-places of the micro-organisms believed to be productive of so much sickness in houses, every outward current of air passing into the room being loaded with them. He calls attention to what is undoubtedly the fact, that pathogenic micro-organisms may produce their injurious results by being swallowed, as well as inhaled, and that the immunity of sewer-men, scavengers, and plumbers may be due to tobacco-chewing, and the ejection of the buccal fluids instead of their deglutition. The value of bacteriological science was well illustrated recently in the recognition of the cholera microbe, the comma bacillus or cholera spirillum, in cultures obtained from the excreta of cases at the quarantine of New York, which were suspected to be cholera. Such cultures were made by Drs. Biggs, Prudden, Kinyoun, Armstrong, and Weeks, and the microbe was discovered by each one of these investigators, thus determining absolutely the nature of the disease. In a paper on the diagnostic value of the cholera spirillum, read before the Society of Bellevue Hospital Alumni, Dr. Biggs gives a history of his experiments, and states that this is, he believes, the first case in this country where a diagnosis of Asiatic cholera has been based upon biological examinations.

HEALTH OF SCHOOL-CHILDREN.—The following recommendations have been made by the State Board of Health of New York, and will doubtless be brought before the Legislature at its next session: I. That its organic law be so amended as to authorize its executive officer, where an emergency arises and the local board of health of the town or village in which the emergency occurs has not organized and appointed a health-officer, to appoint a physician as acting health-officer at the expense of the town or village concerned, who shall, until such time as a board of health for said place has been organized, as provided for in Chapter 270, Laws of 1885, have and exercise, under the direction of the secretary of the State Board of Health, all the powers and duties of a board of health regularly appointed. II. That the following requirements be embodied in a law as essential to the sanitary welfare of the school-children of the State: (a) Building should rest upon a good dry founda-

tion, and be constructed to insure the comfort of children during inclement weather; (b) Class-rooms should be arranged so as to admit light from left side and back of pupils, and the area of windows should be one-fourth of floor-space; (c) Not less than 250 cubic feet of air-space should be allowed per pupil, and provision for changing air should be made, so as to secure each pupil not less than thirty cubic feet of fresh air per minute; (d) The temperature of the school-rooms should in winter be maintained at a range not to exceed from 68° F. to 70° F.; (e) Closets should be provided for each sex, entirely separate from each other, and having entirely separate means of access; when situated outside the building, they should be about fifty feet distant, and should be connected with it by a covered walk; privy-vaults should be utterly abolished; movable boxes or buckets should be placed under the seats, and earth or ashes provided as a deodorant; buckets should be cleaned out at least once a week; (f) In addition to his other powers over schools, the superintendent of public instruction should have authority to oblige school-trustees to make improvements or repairs in school-buildings for sanitary purposes, whenever the local board of health considers such necessary, and their judgment is supported by that of the State Board of Health.

YELLOW-FEVER AT TAMPA.—During the week ending Nov. 2, there were at Tampa, Fla., 74 cases of yellow-fever, with 9 deaths. The total number of cases during the epidemic is approximately 325, of which 48 have proved fatal. On the 3d instant there were three new cases and 2 deaths. The quarantine inspector telegraphs that he thinks the epidemic is rapidly subsiding. Two cases, one of which died, occurred three weeks ago at Manatee, Fla., but there has been no spread of the disease. At Manatee, having a population of 300, it is reported that there are 16 cases of yellow-fever, and that there have been 3 deaths from that disease.

OLD OBSERVATIONS ON HYDROPHOBIA.—In a letter to the *Boston Medical and Surgical Journal*, Dr. Goodale of the Botanic Garden of Harvard University says, "In the course of my reading, I have chanced upon the following passage, which may prove of some interest to your readers. It is taken from 'Observations on Hydrophobia,' by James Thacher, M.D., Plymouth, Mass., 1812. It seems as if Dr. Thacher's project was in a fair way of being carried into successful execution, after a lapse of more than seventy years. From p. 300 of the work cited above, the Italics standing as in the original: 'Experiments made upon the canine poison in brutes, might be considered as an arduous and hazardous undertaking, but it is not to be deemed altogether impracticable and I will suggest the following project for the purpose. In the first place, dogs when affected with madness, instead of being killed, should be confined and secured that the disease may run its course, and for the ascertainment of many useful facts connected with its several stages. If experiments on dogs should be deemed too hazardous, let other animals of little value be selected, provided a sufficient number can be procured. Having provided for their security in some proper enclosure, let them be inoculated with the saliva of the mad dog, by the point of the lancet, which would undoubtedly prove as effectual as the dog's teeth. The animals thus infected, are to be the subjects of various experiments and the most attentive observation. With some, the inoculated part might be cut out at different stages, to ascertain the latest period in which it may be done successfully. To others, various counter-poisons and specific remedies might be applied to the wound and administered internally. In fact, it would be difficult to determine, *à priori*, the extent of the advantages of this novel plan, if judiciously conducted. You may smile at my project, but however chimerical and visionary it may appear, I would rejoice to be the Jenner of the proposed institution; though I might fail in realizing my thousands, I could pride myself in being the candidate for the honor, and the author of an attempt to mitigate the horrors attending one of the greatest of all human calamities.'" It will be seen from this that Dr. Thacher anticipated Pasteur by many years.

In *Science* of last week, first column, 4th line from bottom, '1886' should read '1885,' same column, 6th line from bottom, '1885' should read '1886.'

BOOK—REVIEWS.

The American Journal of Psychology. Ed. by G. STANLEY HALL. Baltimore.

THE announcement made some months ago, that a journal devoted to the scientific aspects of psychology was to be published under the auspices of the Johns Hopkins University, excited considerable comment. Some seemed to think that we had philosophical journals in abundance, and whatever surplus energy America had in reserve in this direction might well be utilized in strengthening the journals of England and the continent; others doubted whether so small a department could really supply material enough to sustain even a quarterly periodical; while those who have not yet become acclimatized to the new atmosphere that is slowly but surely displacing the old, dogmatic, non-progressive, and lifeless treatment of psychological topics, intimated that they saw in the new-come a further belittling of a noble study, and the harbinger of a much hated 'materialism.' The first number of the journal proves beyond a doubt, that, for a time at least, the material will not be wanting, and quite as certainly shows that the movement in favor of an experimental psychology is strong and important enough to merit a separate organ of publication. If we add to this the guaranty of sound scholarship and all-sided appreciativeness that the name of the editor (as also of the university from which it comes) affords, we seem justified in welcoming the journal as an ornament to American science, and as promising to mark an era in the development of one of the most significant movements of our age.

The two main purposes of the journal are to publish original studies, and to review the psychological literature. The first is represented by four articles, all worked out upon an experimental basis; while the critiques and notices fill no less than seventy-eight finely (perhaps too finely) printed pages. The leading article is contributed by Dr. Warren P. Lombard, and describes a very remarkable series of experiments upon the variations in the extent of the 'knee-jerk' under various conditions of the nervous system. It is well known that if one leg is supported, and the knee partly flexed (most conveniently by crossing one leg over the other), a sudden blow upon the ligament just below the knee-pan will cause an involuntary and jerky movement of the foot. This apparently insignificant phenomenon became of special importance when it was observed that it was generally absent in a common form of spinal-cord affection known as *Tabs dorsalis*. The nature of the process is discussed in quite an extensive literature, and the two main opinions regard it as (1) a simple reflex act, with a direct course from the tendon to the lumbar cord and back to the muscle, and (2) as an act not reflex (because the time it takes is much too short), but rather as a mechanical effect under the influence of a reflex centre, — a 'tone' rendering the muscle more or less susceptible to such stimuli. In either case the variations in the extent of the movement are co-ordinated with the condition of the nervous centres, and thus become an index — and, as Dr. Lombard shows, an incredibly delicate index — of a very mysterious central process. Previous observers had shown that a violent contraction, such as clinching the hands, or even slighter movements, as well as strong sensory stimuli, just before the striking of the ligament, greatly increased the extent of the resulting movement. This was explained by supposing that the effect of the movement was to increase the irritability of the cord-centres (perhaps by removal of inhibitory influence from the brain), on whose integrity the knee-jerk depends. Dr. Lombard was able to secure more delicate results by substituting a blow from a hammer swinging through a definite arc, and striking with a constant force for the unequal movement of the hand, and the writing of the resulting movement of the foot on smoked paper instead of its rough estimation by the eye. The first result of this method was to show that the extent of successive knee-jerks produced by equal blows of the hammer was very different; and this, too, when the subject was lying perfectly at ease, and so avoided all re-enforcements by voluntary motion. On comparing these variations with those resulting from true re-enforcements, it was clear that they might be due to very slight changes in the individual; and, by taking the average of a score of movements, it was found that their extent varied quite constantly with the force of the blow.

Dr. Lombard then subjected himself for two weeks to a tedious routine of work, recording his knee-jerk under precise conditions at eight definite times of the day, and keeping a diary of his general condition, as well as recording the condition of the temperature, barometer, etc. In this way he accumulated the records of over six thousand observations, suggesting several interesting results. In brief, he shows that this index of the condition of the nervous system is sufficiently delicate to be regularly influenced by the time of day (it begins low, rises very much after breakfast, and then gradually sinks with several ups and downs); by the taking of a meal (notably rising after breakfast); by fatigue, either physical or mental (in both cases showing marked decrease); by the slightest movement (i.e., the re-enforcements by talking, swallowing, etc.) or attractive sensations of sound, light, etc.; by all kinds of mental excitement; by holding the breath (a very marked increase when held for a minute or so); by the state of the thermometer (in general diminishing as the temperature increases), as of the barometer (quite closely rising and falling with a rise and fall in the barometric column).

An adequate idea of the delicacy of these variations with different mental conditions can only be gained by a citation. "One day during the experiments a procession passed the end of the street, a short distance away, and the effect of the music was very evident. The twenty-five experiments of the examination which had just been made had shown the average knee-jerk to be 32 millimetres. At the approach of the procession, the subject resumed his place on the apparatus, but the first blow was not struck until the first band was passing the end of the street, — 60,¹ 71, 74, 70, 60, 55; another band immediately followed, and it began to play 'My Maryland' just before it reached the street, — 62, 76, 76, 74, 71, 66, 59, 64, 59; this was followed by a drum corps, — 48, 55, 51, 55, 53, 49, 52; and then the music died away in the distance, and only the ordinary street-sounds remained, — 40, 45, 37, 30, 39, 53, 37, 29." In short, not only does music re-enforce the knee-jerk, but the character of the music, especially its emotional power, determines the amount of such influence. That these results are not the result of an anticipation by a theory is shown very conclusively by the fact that on several occasions Dr. Lombard fell into a more or less deep sleep during the experiments, and, if the blow happened to come just after dreaming of an exciting event, the knee-jerk (very low by the inactive condition of the subject) showed a sudden rise. The phenomena are thus taken outside the conscious realm. It seems no illegitimate use of the imagination to picture the time when the inquiry after one's health will take the form of, "How is your knee-jerk?" or the poet describing the effect of anger will exclaim, "Truly, my knee-jerk arose."

The remaining articles — on dermal sensitiveness to gradual pressure-changes, by Prof. G. Stanley Hall and Yuzero Motora; on a method for the experimental determination of the horopter, by Christine Ladd-Franklin; and on the psychophysic law and starmagnitudes, by Dr. Joseph Jastrow — are of a more technical character; and this is a very laudable feature, for it serves not only to frighten off the many dilettanti of psychic research, but to justify the strictly scientific methods of psychology. Professor Hall and Mr. Motora describe a new method of experimentation, by which a weight pressing upon the finger is either gradually increased or gradually diminished, and the sensibility is measured by the time necessary for the subject to decide in which direction the change has been made. The problem is a very complex one, involving not only the amount of change, the rapidity of change, and the initial pressure, but also the 'confidence' of the subject. The interesting results reached are only preliminary, but foretell a hopeful future for this valuable new method. Mrs. Franklin describes a very striking illusion, consisting of the appearance of a third line at right angles to the plane of the paper, on which a pair of crossed lines, with their acute angle towards the observer, are viewed in a certain position relative to the eyes. These small upright phantom-lines are so distinct that they furnish a means of determining the shape of the horopter (i.e., the sum of the points which in a given position of the eyes will seem single), at least in its simpler forms. Dr. Jastrow utilizes the comparison of the photometrically measured illuminating powers of the stars (made by the Harvard Observatory)

¹ The numbers refer to the extent of the knee-jerk in millimetres

with the naked-eye estimation of their serial magnitudes, to find what is the relation between the two series; i. e., as the magnitudes increase by apparently equal intervals of brightness, how do the measured illuminating-powers increase? He finds, that, as the psychophysical law requires, the latter increase by a constant *ratio*, but that this ratio is not exactly constant, but decreases slightly (according to a formula given in the paper) with the brightness of the stars.

The critical portion of the journal will perhaps arouse more comment than the original part, because it comes more in conflict with current views on psychological topics. While not taking an aggressive tone, the policy of the journal is evidently to plainly and forcibly state the broader inferences upheld by a technical study of mental facts, and, if necessary, to fearlessly combat views opposed to or neglecting such considerations. The able detailed review of the work of the English Society for Psychic Research is sure to attract attention. The point of view is decidedly negative. The evidence in favor of 'telepathy' is regarded as entirely inconclusive by lack of a host of necessary precautions, as well as a consideration of other modes of explanation. It is an aspect of the question the importance of which will be more and more generally recognized as the first gust of enthusiasm excited by apparently wonderful results subsides. A review of the psychological text-books of Professors McCosh, Bowne, and Dewey is a destructive criticism of the standpoints from which these writers set out, while Professor Ladd's 'Physiological Psychology' receives very just proportions of praise and blame.

In addition to this, there is a review of the 'brain-localization' question by Dr. Starr, of Mr. Galton's views on the persistency of type by Professor Brooks, of Delage's researches on the functions of the semicircular canals by Professor Sewell, and a note on logical machines by Mr. C. S. Peirce, together with a large number of useful minor reviews and notes. An undue number of misprints disfigure some of the pages.

Greeko-Slavonic Literature. By M. GASTER. London, Trübner, 8°.

THE importance of researches on the growth of folk-lore is more and more recognized. While in the early times of this study the lore of each nation was considered as an outcome of its ancient mythology, later on the interdependence of the traditions of nations widely separated in space and time was more clearly understood, and researches on the origin and migration of legends became of greater importance. While this historical point of view is the leading one in the inquiries of most students, the psychological character of each nation as influencing its folk-lore must not be disregarded. The present volume treats of the connection between European folk-lore and the early literature of Slavonic nations. The author treats first of the influence of Bogomilism upon the religious literature which later on became folk-literature of the European nations. He traces the latter back to Greek texts which came to Constantinople from the east, and passed thence to the Bogomils. A second source, equally Oriental in its origin, was supplied by Jewish legends. He discusses the Apocrypha of the Old and New Testaments in its influence upon European literature, and shows in a few instances the interesting phenomena of their transition from tales into ballads, and from ballads into lyrics, in which the name of the hero disappears gradually, and a personal song is changed into a general impersonal one. The author finds in the belief of witchcraft in the Graal legend and other traditions, not those relics of hoary antiquity which they are generally considered, and as which they have become the object of a reconstructive mythology, but a result of the Christian legends and myths, which became the property of the people at a comparatively recent date. In discussing the origin of the romantic literature, Gaster favors the opinion that it was also introduced into Europe by the Slavonic nations, and rejects Benfey's theory that it was communicated to the western people by the Mongolians. In an appendix Gaster tries to solve the problem of the origin of the Glogolitic alphabet, and shows that a connection with the Armenian alphabet is at least probable. The whole volume is an extremely interesting study of the growth of folk-literature, and shows how intricate the channels are from which its sources flow. Great care must be taken in treat-

ing questions of this kind, particularly among nations which have no literature, where historical facts, upon which the study must be founded, are entirely wanting. Particularly in this case rash conclusions must not be made until we are better acquainted with the psychological laws of the growth of folk-lore. The historical method as applied by Gaster is the only one that can lead to satisfactory results, but it must be supplemented by an inquiry into the assimilation of legends by different nations and their blending with the more ancient stock of folk-lore. The latter point has been disregarded by the author, and therefore some of his conclusions on the Oriental origin of certain legends cannot be accepted until fuller proof is given.

An Elementary Treatise on Analytical Mechanics. By WILLIAM G. PECK. New York, Barnes, 12°.

THIS is, as its title implies, an elementary treatise on the subject named, and is of substantially the same character as the majority of works of similar purpose, intended for the introduction of the student into the study of analytical mechanics. Dr. Peck, however, has the advantage, as an author, of having had an unusually extended and very fortunate experience in teaching, and his book may be taken as the embodiment of so much of the subject as he has found the average college-man capable of taking up during the average college course of advanced mathematics. It is intended, as stated in the preface, to include all the principles needed by students in technical courses of study, and the calculus is used to a moderate extent in their development.

This work is by no means such a treatise as that of Bartlett, and is necessarily given a much more condensed and less logical form. It covers, however, the full range of work which the student can be ordinarily expected to take, and it may be made to pave the way most satisfactorily to the use of advanced treatises and the works on applied mechanics which are now studied in the best technical schools and schools of engineering. Its accuracy is vouched for by the reputation and experience of its author, and its plan may be seen by inspection to be good and satisfactorily complete. Kinetics and the doctrine of energy are given the place to which they are entitled,—a place denied them in books following the older writers on this subject. We should suggest that the discussion of the mechanics of gases and vapors might be enlarged profitably by the introduction of the pure thermodynamics of the subject, and that the last chapter, that on machines, might be improved by the revision of the descriptive matter, and by a study of modern examples of such apparatus. No criticism lies against this work especially; but it is time that all these elementary treatises on this subject were pruned of their antique illustrations,—the compound balance, for example,—and modern sketches substituted, such, for example, as Dr. Peck gives us in his article on the rotary-pump. On the whole, this book is one of the very best of its class; and the writer has found, by experience in its use, that it is a most excellent text-book.

NOTES AND NEWS.

THE account of the recent trial in England of the Spanish cruiser 'Reina Regente,' resulting in the development of a speed of 20.6 knots over a measured mile, has been received with keen interest at the Navy Department, where every effort has been made to design vessels of like high speed to meet the demands of Congress. The number of war-ships able to make above 19 knots is much smaller than is commonly supposed, and, in fact, the records of the department show that but two other vessels have been able to attain that speed. These are the 'Dogall,' built in England for the Italian Government, which made one run over a measured mile at the rate of 19.66 knots per hour; and the 'Orlando,' built by private contractors for the English Government, which made one run at the rate of 19.25 knots per hour. It is said at the department that these two vessels, together with the 'Reina Regente,' are the outcome of efforts to reach 19 knots, running through many years; and the small measure of success attained renders it unsafe to guarantee so high a speed for the cruisers now building, and known as the 19-knot cruisers.

—A complete list of the papers presented at the meeting of the National Academy of Sciences, held at Columbia College, New

York, recently, is as follows: 'Seismoscopes and Seismological Investigations,' T. C. Mendenhall; 'On the Primary Specializations of the True Fishes,' E. D. Cope; 'A Study of the Behavior of Metals under Variations of Temperature,' William A. Rogers; 'Chemism in its Relations to Temperature and Pressure,' T. Sterry Hunt; 'On the Mechanical Origin of the Structures of the Hard Parts of the *Mammalia*,' E. D. Cope; 'Progressive Series in Chemistry,' T. Sterry Hunt; 'Kilauea, a Basalt Volcano,' J. D. Dana; 'Circulation of the Sea through New York Harbor,' Henry Mitchell; 'On a Study of Color Contrast,' Ogden N. Rood; 'On the Relative Variability of Men and Women,' 'On a New Form of Reproduction in Medusæ,' and 'On the Lucayan Indians,' W. K. Brooks; 'Experiments in Measurements of Static Electricity in Absolute Units,' and 'On Potential as measured by Work, a Mathematical Discussion,' A. M. Mayer; 'A Comparison of Antipodal Faunas,' Theo. Gill; 'On a Discovery Recently made in Connection with the Flight of Birds,' W. P. Trowbridge; 'On the Determination of Star Magnitudes by Photography,' E. C. Pickering; 'On the Constant of Aberration,' A. Hall; 'The Cretaceous Coals of Western North America,' and 'The Future of Gold and Silver Production,' J. S. Newberry; 'The Temperature of the Moon,' S. P. Langley; 'On a Method of Making the Wave-Length of Sodium Light the Absolute Standard of Length,' A. A. Michelson and E. W. Morley.

— The increase of interest in the sciences centring about a scientific education in England is well shown in the announcements of lectures to be given in connection with the Association for the Education of Women at Oxford. The three courses are, on mind, its conditions and functions, by Mr. W. L. Courtney; on the outlines of the history of education, by Mrs. Scott; and on elementary physiology, by Mr. Dixey.

— It is encouraging to see the appearance of new editions of books of acknowledged excellence. Macmillan's publishing-house has just prepared new editions of Lotze's 'Metaphysics' and of Sidgwick's 'Principles of Political Economy.' The latter contains some emendations and omissions from the text of the first edition, and the preface credits Schönberg with exerting an influence on the author's economic thought. The new edition of Lotze is in two volumes, handsomely gotten up, and offered at a very low price. We trust it will be widely read, for the *Spectator* only expressed the opinion of all philosophical workers when it said, "No man of letters, no specialist in science, no philosopher, no theologian, but would derive incalculable benefit from the thorough study of Lotze's system of philosophy."

— The Industrial Education Association is about to issue leaflets giving concise information on points of its work regarding which questions are continually asked. The first will be ready in a few days, and will state compactly what the argument for manual training is.

— Several of the commissioners of Chinese customs, in their reports for the past year, which have just reached this country, says the London *Times*, refer to the competition in the English market between teas from India and China. The commissioner at Hankow says that at that port for the year the fine teas bought for England have lost all around. "All tea-buyers say that Indian tea is the tea of the future for people who can afford to pay for a good article. There is no reliable market for choice China tea, Cheap tea—'beautiful two-shilling tea'—bought here to land at sixpence a pound, is what seems to be wanted. It can be sold at a price to suit any pocket, and can be made quite drinkable and given a body by the addition of a few pennyworths of good, full-flavored Indian." Similarly the commissioner at Foochow remarks that one feature of the tea trade of the year has been the neglect of teas over a shilling a pound in the London market almost throughout the season. This discourages the production of the finer kinds of tea in China. Year by year the competition of the Indian teas displaces the finer qualities of the China leaf, "in spite of which there are many of experience in the trade who maintain that if the old quality were again forthcoming from China she would soon recover the position she seems to be losing in the world's consumption of this article." In Shanghai the commissioner reports an increase in the export of tea, but says it is due to the improved

demand in England and Russia for low-grade teas, but the merchants have lost no medium and fine quality teas, the rates for them being unprecedently low. "This depreciation in their value in England is partly assignable to a falling-off in the Russian demand for fine tea; but the want of keeping properties in China leaf, probably owing to hasty and imperfect preparation, has also a good deal to do with it." Fine China teas have not been bought for Russia because of an increase in the import duty, and, in place of increasing the price to the retail purchaser, an inferior leaf has been purchased."

— The German Academical Union, in its last general meeting at Berlin, laid down the following principles of reform for the German schools: (1) The children are in many ways overburdened by the present scholastic system; (2) There is not sufficient harmony between the school and the home life; (3) The training of the body is not attended to in proportion to that of the mind; (4) The exclusive privileges belonging at present to the classical schools, as securing an entrance to the learned professions, ought to be extended to the modern schools; (5) There ought to be an easy access from the elementary schools to the middle and higher schools; (6) The *Einheitsschule* is the most pressing need of the present time.

— The forty-third annual meeting of the Massachusetts Teachers' Association will be held in the Girls' High-School building, Boston, Friday and Saturday, Nov. 25 and 26. The following programme is published:— Nov. 25, 'English in Secondary Schools,' by William R. Shipman, D.D., professor of rhetoric, Tufts College, discussion to be opened by W. C. Collar, head master of Roxbury Latin School; 'What the Public demands from the Public Schools,' by N. A. Calkins, superintendent of schools, New York City; 'The Care of Children,' by Henry C. Hardon, master of the Shurtleff School, Boston; 'The Care of Our Younger School-Children,' by Ann E. Newell, Alger Primary School, Boston; 'Can the Principles of Civil Government be taught in Schools?' by Albert Bushnell Hart, Ph.D., instructor in history, Harvard University, discussion to be opened by Ray Greene Huling, principal of the High School, New Bedford; 'Some Notes on Secondary Schools in Europe,' by George A. Bacon, Ph.D., editor of *The Academy*, Syracuse, N.Y.; 'Arithmetic in the Grammar School,' by Francis A. Walker, Ph.D., LL.D., president of the Massachusetts Institute of Technology, discussion; 'Modifications needed in the Grammar-School Curriculum,' by A. P. Stone, LL.D., superintendent of schools, Springfield, discussion; 'Language,' by George I. Aldrich, superintendent of schools, Quincy, discussion to be opened by Larkin Dunton, LL.D., head master of the Normal School, Boston; 'Sight-Reading,' by Mary I. Lovejoy, principal of the Broadway School, Chelsea, to be followed by class exercises, illustrating progressive stages in the first, second, and third years, discussion to be opened by William T. Harris, LL.D., Concord. Nov. 26, 'Report of the Committee on Necrology,' by Nathaniel T. Allen, chairman; 'Grammar-School Education' (report of the Committee on Educational Progress), by Ray Greene Huling, chairman; 'Character as an Object of School-Education,' by Louisa P. Hopkins, supervisor of schools, Boston, discussion to be opened by Robert Swan, master of the Winthrop School, Boston; 'How to secure the Better Preparation of Teachers,' by Ellen Hyde, principal of the State Normal School, Framingham, discussion to be opened by A. G. Boyden, principal of the State Normal School, Bridgewater.

LETTERS TO THE EDITOR.

*. * The attention of scientific men is called to the advantages of the correspondence columns of SCIENCE for placing promptly on record brief preliminary notices of their investigations. Twenty copies of the number containing his communication will be furnished free to any correspondent on request.

The editor will be glad to publish any queries consonant with the character of the journal.

Correspondents are requested to be as brief as possible. The writer's name is in all cases required as proof of good faith.

Amnesia.

It seems to me that cases of amnesia like those mentioned in *Science* for Nov. 11 are not very rare; certainly three such cases have fallen under my own observation within the last twenty years.

One was of a lady who suffered from violent puerperal convulsions, followed by fever, which rendered her practically unconscious for ten days. After her recovery she found that she had lost entirely the recollection of every thing that happened during the week before her sickness.

In another case two gentlemen of my acquaintance, while driving across a railroad, were struck by the engine. One of them was instantly killed: the other was so seriously injured that he was unconscious for twenty-four hours, and for several weeks lay at the point of death; after his recovery he never regained the recollection of going to drive on that fatal morning.

In another instance a gentleman well known to me was thrown from his carriage by a runaway horse and by collision with another team. He was rendered insensible for fifteen or twenty minutes, and after regaining consciousness, although he remembered his horse running away with him, he never had any recollection of the collision or of falling.

In each of these cases there seems to have been some relation between the length of the period of unconsciousness after the sickness or accident, and the memory-blank before it.

JOSEPH HALL.

Hartford, Conn., Nov. 12.

Changes in Indian Languages.

THAT unwritten languages might change more rapidly than those which are preserved in books is very evident, though the verses of Chaucer and Spenser would puzzle the modern school-boy. Yet the vocabulary of an unlettered people has elements of stability in its comparatively few words, and often in the songs and ceremonies preserved through many generations. How rapidly they may change is not so easily proved, for this requires accurate vocabularies made long ago, which must be carefully compared with a language at a recent period. A moderate basis may be found for such a comparison in the case of some of the New York Iroquois, who early attracted the attention of learned men, and from this may be drawn a few suggestions.

I make this comparison now, in the case of the Mohawks, between Father Bruyas' lexicon, written about A. D. 1700; the 'Mohawk Prayer-Book' of 1769; and Schoolcraft's 'Notes on the Iroquois,' written in 1845. The later prayer-book of Rev. Eleazar Williams might also be cited, as the work of an educated man brought up as a Mohawk; but its marked differences from all other books printed in that language would require a good deal of comment. Father Bruyas' lexicon is of radical words, and deals with phrases and verbs much more than with nouns and adjectives; yet I make the comparison on the latter. In a little over one hundred words common to both Schoolcraft and the missionary, fifty-one differ almost entirely, while fifty-eight are either alike, or so nearly so as to have the resemblance apparent. Perhaps half of the latter number are modified forms of the same words. These represent the changes of an existing Indian language in about a century and a half, so far as they may be called changes. About one fourth are the same as they were in A. D. 1700; another fourth are partially changed; nearly one-half differ entirely.

It is to be remembered in this, that, in a language whose words are often descriptive, several words might represent the same object, and often do so, while a writer may choose but one of these. Many synonyms appear in Bruyas' vocabulary and in the 'Mohawk Prayer-Book'. One of these words, once common, might disappear and be succeeded by another, not new, but for a time obscure. In Schoolcraft's vocabulary each English word has a single Mohawk word as its equivalent. There may have been many others which do not appear.

The 'Mohawk Prayer-Book' of 1769 was the work of several hands, and has comparatively few of the words found elsewhere. I have not made a close comparison, but have noted twenty-five names agreeing with Bruyas, and thirty with Schoolcraft, while it has very many given by neither. It is hard to catch or represent the Iroquois inflection, and so spelling has made a difference where the word is clearly the same, though possibly changed. Thus 'ice' was rendered *Gawisa* in 1700, *Owiese* in 1769, and *Osie* in 1845, the latter perhaps approaching our own word. Some words which

I have classed as similar are much farther apart than these, often differing greatly.

As this paper is only suggestive, I note some changes in the Onondaga language, based on a comparison of Zeisberger's dictionary, made subsequent to 1750, and Schoolcraft's vocabulary of 1845. In comparing nouns and adjectives common to both, out of one hundred and fifty, I find eighty-six entirely or widely different, and sixty-four the same or plainly similar. In regard to the nature of these changes, the same remarks apply as to the Mohawk. Relatively the latter might be called a written language, and had changed much less in a century and a half than the Onondaga had in less than a century. In a sense the latter might seem almost a new language. Many words in it, of course, are new, as those of animals and articles of which their fathers knew nothing, and doubtless others were assumed for familiar things when some one hit on a new characteristic. The word for 'hog' is expressive of its voice, and is better rendered by Zeisberger as *Kweas kweas* than by the modern *Quis quis*. *Git git* does very well for a hen, and others as good might be cited. The Oneidas and Onondagas formed different names for the elephant, yet easily understood by both; the one calling it 'that great naked animal,' and the other terming it the 'long nose.' The Onondaga name for the black raspberry is descriptive, 'the plant that bends over,' and many are quite as picturesque. This shows how a vivid imagination could readily multiply or change names among a primitive people, and how verbs might persist long after nouns had vanished. Place such a people by themselves, amid new scenes, and how quickly their speech might alter! The Onondagas have not moved over twenty miles in two hundred and fifty years, yet how much their tongue has changed in less than half that time! A migration to new and distant homes would have produced many new words, and then the language would have remained much the same for a time, waiting for other disturbing causes.

W. M. BEAUCHAMP, D. D.

Baldwinsville, N. Y., Nov. 12.

Distillery-Milk.

AFTER the grain is mashed (corn comprises three-quarters of the grain used), it is cooled and run into the fermenting-tubs, where the yeast is added. The period of fermentation is seventy-two hours the first three days in the week, and ninety-six hours the last four days, which include Sunday; this length of time being considered by the government sufficient to ferment all of the saccharine. It is during this period that the acetic acid is formed, unless very great care is taken. It does not necessarily follow that acetic acid appears but acetic fermentation occurs more often than otherwise.

At the expiration of the fermenting period, the 'beer' (the entire mass in fermentation) is run through the 'still' at a temperature supposed to evaporate all the alcohol and fusel-oil; which vapor is run into a worm from the top of the still, and the 'slops' run from the bottom of it. The mash or beer can be distilled so as to leave little if any alcohol or fusel-oil in the slops, or feed; but in general practice there is a trace of alcohol and fusel-oil left in the feed.

I have tested slops coming from a still when the instrument varied from 0 to 3 per cent alcohol. No test was made for fusel-oil. So large a per cent of alcohol as 3 per cent is unusual, and it would be found very unprofitable to the distiller. The slops are fed to the cows while hot. Each cow's ration is thirty-six gallons a day. If the water was evaporated from that quantity of slops, it would leave about twelve pounds of grain; or, in other words, there is 2,400 per cent more water than grain in the slops.

With the entire system in practice to-day, the food is not desirable for milch-cows, but it might be made so. But the sanitary conditions at Blissville and Chicago were a thousand times more harmful to the cows, and necessarily to the milk also, than the food upon which they were fed. I speak from observation of cows under good and bad sanitary conditions and care, fed on distillery slops.

The Germans would be horrified to see any kind of animals surrounded by the conditions at the places named. Europeans excel Americans in the sanitary condition and care of their stables and stock, etc.

Our general system is not only wasteful, and based on false economy, but the quality of milk is not up to a proper standard. As a matter of fact, the milk supplied to New York City is inferior (much of it is unwholesome, and unfit for use) to that of any city in Europe.

The question of still-fed milk is of little moment as compared to milk from so much greater quantity of other and more injurious feed, now in general use, and as compared to the sanitary conditions and treatment of the cows, stables, and milk, and the water the cows consume,—one of the most important elements in dairying. There is not one well in a hundred that furnishes pure water.

Brewers' and glucose grains are shipped into the country by the millions of bushels annually. Brewers' grains are good feed for milch-cows if fed the day they are produced. Glucose grains, with the sulphuric-acid treatment necessary in the factory, are injurious to both cow and milk. These grains are sent into the country wet and hot, fermenting, souring, and spoiling as they go. So the farmers' cows, with every shipment, have feed in a state of fermentation, often rotten, and fit only for the dung-hill. Distillers' slops, as fed, have undergone fermentation, while the grains are fed while fermenting,—a strong point in favor of slops. B. M. W.

New York, Nov. 2.

Microscopic Sections of Corals.

In *Science*, No. 248, Mr. A. F. Foerste takes exceptions to a note of mine in No. 244, and contends that the internal features of Lower Silurian monticuliporoids are not only of value in classification, but that they are the ones most worthy of study, and of almost sole use. I ask space for a brief reply.

I have, in the first part of a paper on monticuliporoids, given quotations and references showing that even by the new method of work in the corals it is not always possible to separate either species or genera. To state that this method gives 'solidity' to classification, and allows "the species to fall into easily recognized groups" is, I believe, a mistake. Dr. Nicholson, for example, in speaking of two genera, says (*Tabulate Corals*, p. 99), "There is, indeed, no feature in the way of internal construction which could be brought forward as separating *Striatopora* from *Pachypora*; and in distinguishing these two types we have to fall back upon a well-marked external character." The distinctions between *Dekayia* and *Monticulipora* are external, and not internal. Between species there is even less difference. One of Mr. Ulrich's species, for instance, is almost the exact counterpart of another: so here, again, the separation is made on external features.

My examination and study of the descriptions of the genera made by Mr. Ulrich has led me to discard all of them. The features upon which they are based are so few, so trivial, and so inconsistent, that it becomes an utter impossibility to separate them with any certainty. I have not had the opportunity of seeing Mr. Ulrich's latest ideas in regard to the subject upon which he has written so much, so that I cannot tell how he may have modified or changed his conclusions: It is my belief, however, that it is impossible for one who studies the descriptions of genera and species as given by Mr. Ulrich to state positively, after he has examined a specimen macroscopically and microscopically, that he has a desired genus or species in hand.

Mr. Foerste lays stress upon the form of the cells as seen in tangential section. The same features are to be seen on the exterior, and are free from errors likely to result from sections made at a slightly different angle from the one intended. "Elevated patches of cells" cannot be recognized in internal sections in very many cases, as Mr. Foerste states is the case; for these are often of the same size and shape as surrounding cells. It were useless to deny the difficulty of finding specimens suitable for description. In many cases it were best had they not been described at all.

Finally, in relation to the difficulty of studying microscopic characters, I have but this to say: that it is not the difficulty itself or alone, but the unreliability of the work. I would be the last one to discard a method of work simply because it was difficult. But when it becomes difficult (and there can be no denying this, in spite of the assertion to the contrary), tedious, and uncertain, and when finally we are compelled to fall back upon external features because the internal ones fail, I contend that their use for ordinary

practical work in the field or in the study is of little or no value. I can quote no higher authority than Mr. Archibald Geikie (*Text-Book of Geology*, pp. 85-88, where elaborate directions are given for making rock sections; Professor Prestwich also considers it "an expensive and tedious process," *Geology*, i. p. 43) as to the tediousness of the process, nor a better one than Dr. Nicholson, as to the uncertainty of the results (*Palaozoic Tabulate Corals*, and *The Genus Monticulipora*). In conclusion, I can only refer to the paper on the subject by Mr. U. P. James and myself, for the full expression of my views, and I shall be happy to furnish a copy of the paper to any of those desirous of seeing these views in full for their own satisfaction.

JOSEPH F. JAMES.

Miami University, Oxford, O., Nov. 7.

Indian Names.

THE publication of the 'Early Map of the Far West,' in your last issue (*Science*, x. No. 248) gives occasion to draw attention to the changes in pronunciation which have been brought about by pedagogic conceit. 'Arkansas' or 'Arcansaw,' of Lewis's map, gives the old pronunciation. 'Chipaway' of Lewis's map gives the true pronunciation of 'Chippewa.' 'Ojibwa' is the same word, and is pronounced 'Ojibway.' The pronunciation of 'Kansas' has not changed. It is given as 'Kanzas' in Lewis's map, and 'Canzes' in the map of Louisiana by De L'Isle, eighteenth century. 'Iowa' has suffered much from the pedagogues. The polite pronunciation now is 'I-o-wah,' with the accent on the first or second syllable. The old pronunciation was 'I-o-way,' accent on the last syllable. In Lewis's map the word is found as 'Ayauwais;' in De L'Isle's map, as 'Aiaouez' or 'Yoways.' 'Euisconsin' (Wisconsin) has fortunately remained unchanged; so has 'Pani,' which we now spell 'Pawnee.'

I once met an Indian who called himself a 'Taw-wah,' accent on first syllable. Unable to recall a tribe of such name, I had him repeat the word several times, and at length discovered an almost silent vowel before the T. It is Ottawa. I am not sure, however, whether this man pronounced his tribal name correctly, for he had long lived among the whites, and had gone to school. I find that tribe's name in Jeffery's map of Louisiana and Canada, 1762, given as 'Outawais,' where the final syllable is 'way.'

JOSEPH D. WILSON.

Chicago, Nov. 8.

The Temperature Sense.

IT may be interesting to those who have been acquainted with the experiments of Goldscheider, and of Dr. Donaldson and Prof. G. Stanley Hall in Johns Hopkins University, to prove the existence of a separate system of nerves for temperature, to know that the discovery was anticipated by Sir. William Hamilton. His observations of psychological phenomena seem to have been nearly as extensive as his philosophic reading. In his edition of Thomas Reid's works (vol. ii. p. 875), after commenting on a singular and exceptional case of paralysis, in which sensations of touch did not seem to be localized, he takes the occasion to hazard the conjecture, based upon observations of his own, that there is a distinct set of nerves for sensation of temperature. His language is,—

"I may notice also another problem, the solution of which ought to engage the attention of those who have the means of observation in their power. Is the sensation of heat dependent upon a peculiar set of nerves? This to me seems probable, (1) because certain sentient parts of the body are insensible to this feeling, and (2) because I have met with cases recorded, in which, while sensibility in general was abolished, the sensibility to heat remained apparently undiminished."

J. H. HYSLOP.

Baltimore, Md., Nov. 10.

Answers.

16. PENNSYLVANIA POT-HOLES.—Described in Report Z, Geological Survey of Pennsylvania, p. 111, footnote, by Professor Lesley; also in the *Scranton Republican* of Nov. 4, 1887.

JOHN C. BRANNER.

Little Rock, Ark., Nov. 7.

SCIENCE

FRIDAY, NOVEMBER 25, 1887.

NOTHING IS GAINED by maintaining profound secrecy and mysterious silence regarding the affairs of any institution that appeals to the general public for support and encouragement. This is especially true in the case of educational institutions; and, as a rule, those colleges which have frankly stated their financial condition and needs have been the first to be provided with the means of readjusting and supplying them. The more progressive of the alumni of Columbia College have for many years insisted that that college was out of touch with the community because of the unwillingness of the trustees to make known their plans and to ask for financial aid. There was unquestionably much force in this position; and it was not surprising, therefore, that when, three years ago, after a century of dignified reserve, an appeal was finally made for four million dollars to equip the university, no response was received. It is to the credit of the alumni that they persistently criticised the policy of the trustees, until now the point has been yielded by the latter. Hereafter the alumni and friends of the college will receive each year a digest of the annual reports of the president and treasurer on the state of the college. The first of these digests has just been issued, and a copy is before us. We need not refer to that portion of it which is taken from President Barnard's report, for that was commented on in *Science*, No. 244. The abstract of the treasurer's report, however, is new, and it presents many points of interest. It shows the total income last year to have been \$388,544.13, and the total expenditure \$365,582.25. The surplus was \$22,961.88. By far the major portion of the income (\$224,062.61) was derived from rents, the next largest item being students' fees (\$142,127.50). Of the amount expended, \$249,199.67 went for salaries of professors and instructors, and only \$8,744.25 was used to buy books with. The bonded debt of the college is shown to be \$330,240, and the available cash to meet it will be, by June 30, 1888, \$239,317. It will therefore be seen, that while Columbia is heavily in debt at present, yet in two years at most the debt will be paid, and then a large annual surplus will be available for the much-needed extensions. It will be a glad day not only for Columbia, but for the cause of university education in this country, when its board of trustees has sufficient money to vote a generous sum for the purchase of books, to properly equip the graduate departments in philosophy and social science, — in which particularly the demand exceeds the supply, — and to make marked extensions of the scientific departments. We hope yet to hear that President Barnard has been able to work out these problems, and to crown his distinguished and successful administration by the creation of a university faculty of philosophy — in the German sense — which shall be absolutely distinct from the faculties of arts and mines, as at present organized. In this step lies the possibility for Columbia's becoming the metropolitan university.

BY THE SUDDEN DEATH of Rev. Edward Thring of Uppingham School, England, the cause of sound education is deprived of the services of one of its ablest and best advocates. Mr. Thring's name is as familiar on this side of the Atlantic as in Great Britain, and his 'Theory and Practice of Teaching' has had many readers in this country. Mr. Thring was born in 1821, and was just completing his sixty-sixth year when he died. For thirty-four years he has labored as a teacher, having been made head master of Uppingham School in 1853. When Mr. Thring went to Uppingham, he found a local grammar-school of an Elizabethan foun-

dition. He leaves it one of England's great public schools. Mr. Thring's cardinal principle was the necessity for giving every pupil individual care, and not treating a whole school as a mass. The faithful application of this principle was one cause of his great success as an educator. As a speaker and writer he was direct and inspiring, and his voice and pen will be greatly missed. Mr. Thring stood side by side with Mr. Quick and Mr. Fitch, as one of the three great public educators of England.

THE FORTHCOMING CROP REPORT from the Department of Agriculture will contain an interesting article from J. R. Dodge, the statistician of the department, on India in wheat-competition, that will go far toward dispelling the growing fear that competition from India would seriously affect the wheat-growers of the United States in the markets of Europe. Mr. Dodge points out the significant facts, that, while a large increase in the wheat-growing area of India is impossible, the annual home consumption of wheat is constantly increasing; and that, while it is true that with improved methods of agriculture the present acreage will become more productive, the increasing prosperity of the people will bring about a corresponding increase in wheat-consumption. Mr. Dodge thinks that much of the increase in the exportation of wheat from India which followed the opening-up of railroads into the interior was due to the shipping of the accumulated surplus that had been stored up for use in the famine years. The conclusion to be drawn from Mr. Dodge's article is, that the export for 1887, of about 42,000,000 bushels, is very near the maximum that may be expected from India.

ASPECTS OF EDUCATION.

The English Public School.

THE term 'public school' is difficult to define. In England it has a meaning different from what it has in America. The American public school is a school supported by the community, and open to all the world. When it is said that public schools are the backbone of the American system of education, it is implied that there exists all over America a number of schools affording a liberal education, either free or very inexpensive, accessible to all classes of the community alike. An English public school implies something exclusive and privileged. A public-school man is different from other men. The question as to whether a particular school is a public school or not, depends not upon its size or its efficiency, but upon its social rank. The American public schools are day schools; the English public school in the strict sense is essentially a boarding-school. Our public schools are few in number, confined to particular districts, costly, and very diverse in individual character; yet it is said that they represent more completely than any other English institution the chief peculiarities of our national life. It is the public school that forms the typical Englishman: it is the ordinary boy of the upper classes who gives his character to the public school. We have to inquire, first, what are the English public schools? second, how did they come to be what they are? third, what are their principal characteristics, and what relation do they bear to the educational system of England?

When the English Government undertook, some twenty-five years ago, to inquire into the condition of our secondary education, nine schools were singled out from the rest as pre-eminent. These were Winchester, Eton, Westminster, Charter House, Harrow, Rugby, Merchant Taylor's, St. Paul's, and Shrewsbury. Captain de Carteret Bisson, in his valuable work 'Our Schools and Colleges,' apparently disputes the right of the last three, and reckons our public schools at six. These six, between them, do not educate much more

than four thousand boys; and yet they are so typical of all schools which may have a claim to the title of public, that we may conveniently confine our consideration to them. Of these, Winchester dates from the fourteenth century; Eton from the fifteenth; Westminster, Harrow, and Rugby from the sixteenth, these three having all been founded within eleven years of each other; and Charter House from the seventeenth. Westminster, the oldest of the schools, has probably kept its character most unchanged. It has never been a fashionable or a court school. It has maintained unimpaired its close connection with New College at Oxford. Nothing can show more clearly the strength and unity of English traditions than the fact, that, five hundred years after the establishment of the two foundations of William of Wykeham, they should stand in the face of England, holding the highest place, one as a college, and the other as a school. Eton, the next on our list, is confessedly the first of public schools, but it was not always so. During the first eighty years of the seventeenth century, Westminster undoubtedly held the position of pre-eminence. Dr. Busby, who read the prayer for the King on the morning of Charles I.'s execution, and who refused to take off his cap in the presence of Charles II., was the first schoolmaster of his time in England. But Westminster was faithful to the Stuarts: Eton supported the cause of the Whigs. Its supremacy, beginning in the reign of William III., continued in that of Anne, reached its height under the Hanoverian kings. George III. took a strong personal interest in the school. Eton boys walked on the terrace of Windsor Castle in court dress, and the King often stopped to ask their names and to speak to them. William IV., with boisterous good humor, continued the favor of his dynasty. He took the part of the boys in their rebellion against the masters, and he used to invite the boys to entertainments, at which the masters stood by and got nothing. During this period Eton became a political power in England. The upper school at Eton is decorated with the busts of statesmen who swayed the destinies of England, and who were the more closely connected together from having been educated at the same school. Chatham, North, Fox, Grenville, and Gray are among the ornaments of that historical room. Eton and Christ Church had the monopoly of education for public life, and the claim of the school to this distinction received its fullest recognition when Lord Wellesley, after a career spent in the most important offices of the state, desired that he might be laid to his last rest in the bosom of that mother from whom he had learned every thing which had made him famous, successful, and a patriot. Better known, perhaps, is the boast of his brother, the Duke of Wellington, that the battle of Waterloo was won in the playing-fields of Eton.

Charter House, established in London, has held since its foundation a position very similar to that of Winchester, not of great importance in politics or fashion, but highly influential and respected. These four schools were probably founded for the purposes which they have since succeeded in carrying out. Eton was always a school for the governing classes. Winchester and Charter House have received the uninterrupted support of the gentry and clergy of England. The history of Harrow and Rugby has been different. They have been lifted by circumstances into a position for which they were not originally intended. They were founded as local schools, — one in the neighborhood of London, the other in the heart of the midlands, — for the instruction, first of the village lads, and then of such strangers as came to be taught. But they have reached, owing to special circumstances, a position equal to that of any of their rivals. Harrow emerged from obscurity in the middle of the eighteenth century, owing, as it is said, her success to head masters who were sent to her from Eton. Rugby is known throughout the world as the school of Arnold, who was head master from 1827 to 1841. Even before his time it had attained a high rank among English schools; but he, followed by a line of distinguished successors, left it in scholarship and energy of thought at their head. Rugby and Baliol are to English education after the reform bill, what Eton and Christ Church were before it. This sketch will show how different the genesis of our public schools has been, and what various courses they have pursued to arrive at the same conclusion.

We will now briefly trace the history of the education they aim at. Their curriculum is essentially classical: indeed, a public-

school man means, in common parlance, one who has been educated mainly in Greek and Latin. The two oldest schools, Winchester and Eton, founded before the Reformation, naturally began with monkish learning. There was a great deal of grammar and a great deal of church-going. The pupils were children, and were treated as such. Westminster was founded after, and in consequence of, the Reformation, and the breach with the old learning necessitated new arrangements.

The author of the Protestant curriculum of public education was John Sturm, the friend of Roger Ascham, the head master of the great school of Strasburg during a large portion of the sixteenth century. A complete account of Sturm's methods and organization is preserved, and we may be sure that its main outlines were adopted at Westminster and at Eton. Latin grammar and Latin style were made the principal subjects of education. The school was launched upon the full flood of humanism. The connection between a scholar in the narrow sense, that is, a man not of erudition but of finished taste and polished style, and the gentleman, was now fully established. Sturm was so despotic in the arrangements of his school, that he not only laid down what boys were to learn at each epoch of their career, but he forbade them to learn any thing else. It was as great a fault to begin a subject prematurely as to neglect it in its due time.

Many of Sturm's arrangements are familiar to public-school men who are now living, but in the following century they underwent a further change. This was due to the Jesuits, who obtained their reputation partly by their devotion to the study of Greek, and partly by the pains they took to understand the individual character of their pupils. The Jesuits have probably done more harm to sound education than any prominent body of men who ever undertook the task. They had two objects in view, — to gain the favor of the rich and powerful, and to prevent the human mind from thinking. Humanistic education skilfully employed was an admirable instrument to this end. It flattered the pride of parents, while it cheated the ambition of scholars. The pre-eminence given in education to original Latin verses is typical of the whole system of the Jesuits. No exercise could be more pretty and attractive, or bear more clearly the outward semblance of culture and learning, yet no employment could more effectually delude the mind by an unsubstantial phantom of serious thought. The sturdy humanism of Sturm became corrupted by the graceful frivolity of the Jesuits, and in this condition public-school education remained until the efforts of a few obscure reformers, the genius and energy of Arnold and the growth of the new spirit in England, forced it into other channels.

Arnold is typical of the new public school, but we must distinguish between Arnold and the Arnoldian legend. Like other great reformers, his name has become a nucleus round which the reputations of all other reformers, good as well as bad, have coalesced. The most prominent fact about Arnold is, that he was the first Englishman of quite first-rate ability who devoted himself to school-education. The traditions of Sturm and the Jesuits shrivelled up before the manly touch of a teacher who was fit to be prime minister. After his career no one could despise the profession of a schoolmaster. What did Arnold actually effect? He taught boys to govern themselves. He substituted for a system in which the governors were allowed any license on condition that they denied it to every one else, one in which the responsibility of the ruler was rated even more highly than the obligation of the ruled. He also taught boys to think for themselves, to pierce beyond the veil of words into the substance of things, to see realities, to touch and taste and handle the matter of which they had before only talked. Thus he produced a vigorous character and a manly mind. Rugby boys, on passing to the university, thought and acted for themselves. They might be pardoned if in the first flush of enthusiasm they acted priggishly and thought wildly. But Arnold's teaching contained within it germs of much which he had never contemplated, and of which he would have disapproved. It contained the germs of the modern civilized life in schools, of which Rugby knew nothing in 1840. Far, indeed, is the cry from that dim and crowded dining-room where boys, sitting at a bare table, wiped their knives on the iron band which surrounded it, and ate their meat and pudding off the same plate, to the luxurious arrangements of a modern pre-

paratory school. It contained the germ of modern-side education. Arnold did not know that he was passing from Melancthon to Comenius, and that the study of things once set rolling would soon displace the study of words. It contained the germs of a new confidence and friendship between boy and master quite as different from the sly sentimentality of the Jesuits as it was from the pompous neglect of the old-fashioned courtly don. It contained, alas! in germ the subjection of the master to the boy in standard, tastes, and habits, which threatens to be the ruin of our public schools. It crystallized also the idea, which otherwise might have disappeared, that a head master must be of necessity a clergyman, and that no school could be properly conducted unless its chief sums up in the pulpit every Sunday afternoon what are supposed to be the spiritual results of the week's emotions. It stamped also with permanence, by a natural misunderstanding, that conviction of a head master's autocracy which prevents the formation in England of a profession of education. The history of English public schools since Arnold is merely the carrying-out under varying circumstances of the teaching of his example, and the development, sometimes of disastrous ends, of abuses to which that example may seem to lend currency.

A few words only are needed in conclusion as to the present and future of our public boarding-schools. Nothing has altered their character more than their growth in numbers, which has been the result of popularity. In Arnold's time no public school except Eton exceeded three hundred boys. Arnold and his contemporary head masters might boast with truth that they knew every boy in their school by sight, his habits, his capacity, his friends. A school thus governed by one man, and penetrated by his influence, differed not only in degree, but in kind, from a school which has of necessity become a confederation. In a public school of Arnold's date games were still amusements. Formerly neglected and ignored by pedagogues, they became the nurse of every manly virtue when a more sympathetic eye was turned upon them. Tom Brown's school-days represents the heroism of the forties,—the high-water mark where boyish enterprise and independence reached their height under the influence of manly recognition. During the last quarter of a century, games have become a serious business, instead of the wholesome distraction of public-school life. They are organized as elaborately as the work. Masters are appointed to teach them like any other branch of study: they form the basis of admiration and imitation between boy and boy, and the foundation of respect and obedience between boy and master. It is difficult to keep large numbers of boys, with only five years difference in their ages, quiet and wholesome without a large development of games. They have been admitted to their full share in the school curriculum. A public boarding-school is no longer a place where, amidst much liberty and idleness, there reigns a high respect for character and intellect, and where the ablest boys are left ample room to fashion each other and themselves. It is a place where the whole life is tabulated and arranged, where leisure, meditation, and individual study are discouraged, and where boys are driven in a ceaseless round from school to play-room, from play-room to school, regarding each as of equal importance, and bringing into the most delicate operations of intellectual growth the spirit of coarse competition which dominates in athletics.

It is difficult to say what changes public boarding-schools are destined to undergo, or whether in an age in which education is so much extended a system so expensive and so exclusive can continue to flourish. The last few years have witnessed the growth of large public day-schools, and any development of national education would be certain to increase their number. Although the Arnoldian system is little applicable to them on its best side, yet they are of necessity free from most of the abuses to which that system has given rise. An idea may grow up that the home is, after all, the best place for children, and that children are the best safeguard of a pure and happy home. Should English society in its new development prefer a kind of education which is the normal type of all countries but our own, which improved communication makes it easier to adopt, we shall still have public schools of which we should be proud: they will continue to represent our best national qualities, but they will be very different from the public boarding-schools of the past.

OSCAR BROWNING.

THE NÄÄS SEMINARY FOR TEACHERS OF MANUAL TRAINING.¹

If any inquiring friend of manual training endeavors to find Nääs on any ordinary map of Sweden, he will be disappointed. It is an old Swedish country-seat, beautifully situated on the pretty lake Sävälängen, about ten hours' journey from Gothenburg. The railway from Gothenburg to Stockholm passes in the vicinity, and the intending visitor to Nääs leaves the train at Floda station. From Floda to Nääs is a short journey by boat or on foot. The two settlements are not more than an hour's walk apart.

Nääs itself is situated on the highest point of a narrow strip of land. The lake here is about thirty metres broad, and is spanned by a substantial stone bridge. The castle is attractive, but represents no particular style of architecture. On both sides of the lake are beautiful woods in which the birch and the alder predominate. The situation is as lovely as nature and art can make it.

Herr August Abrahamson bought this place about fifteen years ago. He began at once to set aside a certain portion of his great wealth, acquired as a merchant in Gothenburg, to aid the population of his own neighborhood, and to improve their condition. He began by rebuilding many of the peasants' poor houses, and by teaching them something of systematic agriculture. Afterwards he built three schools in which instruction is given free, and for their support he donated the handsome sum of 225,000 crowns, or over \$50,000.

In the year 1872, Herr Abrahamson opened a school for boys from ten to fourteen years of age.² The curriculum of this school contains twenty-two hours weekly of instruction in religion, language, history, geography, natural science, writing, arithmetic, singing, and gymnastic and military exercises,³ and twelve hours weekly of instruction in manual training. The manual training has in this, as in almost all the other schools of Sweden (those of Gothenburg alone are an exception), no other aim than to prepare the boys for any trade whatsoever. The aim is thus a purely pedagogic one. Manual training is treated as a means of education, and is placed side by side with the other school-studies. By means of the methodical instruction in the use of tools and in the construction of one hundred objects, carefully arranged and graded, the pupil acquires a general manual ability which is of great advantage to him, no matter what calling he afterwards follows. Besides this, the manual training furnishes a healthy physical exercise, and, with the gymnastic instruction, affords an excellent means of escape from over-brainwork. It is also found that manual training gives the pupils a love for work and an enjoyment in it, and develops in a thorough manner their independence, attention, industry, and perseverance.

In the year 1874, Herr Abrahamson established a similar school for girls between ten and fourteen years of age; and the aim of this school was not only to instruct the girls in the usual subjects of a school course, but to make them adepts in the domestic arts. In the plan of studies, twenty-one hours a week are devoted to the usual studies, and fifteen hours a week to manual instruction.

Herr Abrahamson was, however, determined to extend his philanthropy as widely as possible, and to work for the cause of education, not in his neighborhood alone, nor in Sweden only, but in general. Thoroughly imbued with the idea of working out an harmonious scheme of instruction for children, to the completion of which the greatest educators have urged as necessary a graded course of instruction in manual work, Herr Abrahamson founded in June, 1875, the Seminary for the Instruction of Teachers in Slöjd (manual training); and this institution has since acquired a wide and well-deserved reputation.

During the first five years of its existence, the seminary course had in view the preparation of special teachers for the courses in manual training. The course lasted one year. To enter the seminary, a candidate must be at least eighteen years of age, in good health, and with such preparation in school-subjects and physical

¹ From S. Rudin's Bericht über eine Studienreise.

² The Swedish public schools are of two distinct grades,—the elementary school, for children of from six to ten years of age; and the common school proper, for children of from ten to fourteen years.

³ The Swedish boys receive in the public school their military instruction, and are exercised in the handling of weapons, as are cadets in other countries.

exercises as was necessary to pass the examination for graduation from the Swedish common school. The instruction given in the seminary was partly theoretical, and partly practical. The theoretical instruction occupied eighteen hours weekly, and included arithmetic, geometry, physics, mechanics, mechanical drawing, and pedagogics. The practical instruction occupied eighteen hours a week, and was intended to teach the use of the various implements of the joiner, the turner, the modeller, and the smith, to impart familiarity in the use of these tools, and to enable the pupils to make the furniture and implements that are found in every household. For practice, the students gave instruction, under the supervision of a trained teacher, in the schools for boys and girls above mentioned. On graduating, the student had to pass an examination in the theoretical subjects, and demonstrate his practical ability and his fitness to teach. On meeting these requirements satisfactorily, a diploma was awarded.

In 1880 this plan of instruction was essentially altered. The scientific subjects were dropped, and the entire time devoted to instruction in manual training. The length of the course was reduced to six weeks, and the training was arranged to meet the needs of certificated teachers who wished to fit themselves in these other subjects. Several, usually four or six, of these six-weeks' courses are given each year, and so popular have they become that many applicants have to be turned away. An account of one of these courses is interesting. That given in 1885 from July 8 to Aug. 18 was attended by 42 students, of whom 28 were Swedes, 3 Norwegians, 1 a Dane, 1 a German, 1 a Swiss, and 8 were female teachers from Sweden, Norway, and Finland. Six hours daily were spent in the workshop, under the supervision of Herr Salomon. The same gentleman, who is the director of the seminary, lectured seven hours each week on the historical development and the methods of manual training, and also presided twice weekly at assemblies of the students, held for the purpose of discussing the Nääs system in general and in its details. The results of these discussions were registered in a book kept for the purpose, and they accomplished diverse improvements in the details of the course.

Throughout the course a religious service was held daily, which was opened and closed with prayer and sacred song. No one was compelled, however, to attend this service.

The programme of instruction included a daily lecture from seven to eight o'clock in the morning, slöjd exercise from 9.30 to 1.30 and from 2 to 6 P.M., excepting Saturdays, when the slöjd ended at noon, and the remainder of the day was devoted to school-work and trial lessons. Two evenings weekly were given over to the discussions, and two more to lectures by Director Salomon. Herr Abrahamson was often seen in the work-rooms, and for every student he had a cheering word or a suggestion, and his personal influence was strongly felt among them.

In his lectures, Director Salomon developed the ends which manual training is to subserve, with great ability and perspicuity. He distinguished these ends as formal and material. The formal ends, he showed, were, (1) to arouse a desire for work and a pleasure in it; (2) to accustom pupils to independence, and to fit them for it; (3) to instil the virtues of exactness, order, and accuracy; (4) to train the attention; and (5) to train pupils in habits of industry and perseverance.

The material ends of manual training, Herr Salomon explained to be as follows: (1) to win the interest of the children, and therefore (2) to give them something useful to work at; (3) to require and promote orderliness and exactness; (4) to develop cleanliness and neatness; (5) to provide an opportunity to exercise and develop the sense of form; (6) to appeal to both the mental and physical powers of the child; (7) to strengthen the muscles; (8) to afford a relief from long-continued sitting at school; (9) to train the pupil to methodical and accurate expression; and (10) to promote a general ability to do hand-work.

NICHOLAS MURRAY BUTLER.

A PLEA FOR THE STUDY OF LOGIC.

MOST intelligent persons are very lavish in their expressions of admiration for the many important aids to the science of education, and consequently to the armamentarium of the teacher, which have been developed during the last fifty years. And yet, notwithstand-

ing our progress in the methods and appliances which aid the teacher so much, many of our best educators are not satisfied with much of the work at present accomplished, and remedies are suggested from various quarters. It seems to me that most persons fail to appreciate the direct cause of the trouble, and in consequence their proposals are not such as will cure the ills of our great school system.

The object of an education should be to so train the faculties which nature has given the student, and to impart to him such knowledge, that he will be the better prepared to fill that particular station in life for which he seems destined, and which will enable him to grow in knowledge with his years, if he will continue the same methods of study after his graduation.

The school and college course should be regarded only as a beginning; and by reason of this education, if it has been as successful as we have a right to expect, the further acquisition of knowledge will be much easier. It is a source of great satisfaction to perceive that the old idea of a higher education, which consisted in turning out a polished man or woman upon society, who was almost wholly ignorant of the laws of nature, and especially so in all that pertained to their own organization, is no longer defended in the institutions of learning in this country. It is so at least in those worthy of any consideration as educational centres, and yet much remains to be accomplished under the new régime.

One of the desirable objects at present is to educate a man so that he may be able to overlook intelligently the whole field of knowledge, and to know how and where to obtain what he needs. The departments of human learning are already so numerous, that a general education can give but an insight and acquaintance with the many; while, if excellence in any one is desired, one must become a specialist.

Up to the present time, our greatest achievements in knowledge have been effected by our adherence to a certain form of reasoning known as the 'scientific method,' which combines the inductive and deductive processes. Until the full recognition and definition of this combination, progress was painfully slow, and was often retarded by the timely discovery that what had previously been regarded as truth, was, by reason of the imperfect methods made use of, only partly true, or altogether false. Certainly we had a right to expect that when the new method had been worked out, and had achieved grand results, every educator would be enthusiastic in its praise, and never cease to urge its study upon those who are seeking the knowledge in possession of the race at the present time, and especially upon those who hope that they themselves may be able to make some additions to the common fund of knowledge. But instead of this, it seems to have been forgotten, at least as any thing of importance with which young students should become acquainted; and when it is taught, it is reserved until they have nearly completed their school-education.

The very principles that would be of incalculable advantage to the student, if inculcated early, are reserved until he has, perhaps, formed vicious habits of statement and reasoning, and which are not then so easily described. Perhaps the greatest defect of our educational system at present is the almost universal manner in which logic as a study has been ignored by our educators.

It may be urged that the logical principles are contained in some of the other branches taught; and as, in this way, knowledge is gradually increased, the pupil naturally appreciates the laws of reasoning involved in these studies, and therefore does not need the separate study of logic. But I do not believe this ground is well taken; for, although it is true that we are all to some extent logicians, too many are very imperfect ones, and they are unfortunately in the majority.

When a boy is placed at a trade involving the use of tools, the first step usually taken is to acquaint him with their construction, use, and care. But such delicate and intricate instruments as those which make up the human mind, seem to call for no special knowledge or training as to their use or care. Would it not be fully as wise to teach the younger scholars in the beginning of their education, soon after learning to read cleverly, — say, between the age of ten and twelve, — the fundamental principles of correct reasoning? The study of logic would be likely to cultivate the faculty of observation, which is so necessary in a true education.

Professor Farlow of Cambridge gave utterance, in the *Popular Science Monthly* about a year ago, to these sentiments in the following language: "I have said enough to show that unless my experience is an exceptional one, in spite of all the talk on the subject, boys at school are not taught to observe as they should be, and that even those teachers who use good text-books, frequently use them as means of imparting facts easily and quickly by the old method, rather than as an aid in the scientific training of the faculties which must form the basis of any serious study of biology." And again he says, "It seems a great pity that students should come to college so ill fitted, as are the majority, to undertake biological work. But we must accept things as they are; and there is no use in attempting to take the second step before the first has been taken. If the school can not or will not teach observation, then it must be taught in college, no matter if it does seem to be child's work. In colleges, however, it is absolutely impossible to find the time or the means for training every one to become an observer, and we are obliged to distinguish between two different classes of persons in arranging courses in biology."

These are the words of a professor in one of our best universities, as to the condition of the students sent there from the best schools in our land. In his sphere as an educator he has discovered this logical deficiency in the students who are anxious for a higher education. In a different sphere of life, no part of which has been spent in teaching, I have observed this great deficiency among the people who have received their education in our public schools, as well as in some of our colleges. There must be a cause for such a general condition as that referred to, and the one to which I attribute it may not be the only one, or a correct one. Be that as it may, it will perhaps occasion no surprise when the position is taken that the most important factor tending to perpetuate this imperfect development of our perceptive faculties is that logical methods have not been taught in our schools.

I believe nothing of greater importance can be taught children in the earlier periods of their education than this; but it should not be attempted by simply placing text-books in their hands. The teachers should first be familiar with the elementary principles of logic themselves, and spend a portion of each day, or several days each week, in an endeavor to teach the pupils the art of observation, together with the proper use of words, and how to draw correct conclusions from an observation. It is of vast importance that words should be correctly used in the formation of terms and propositions; and the study of reading and grammar alone is not likely to secure this.

If you do not teach children these principles of logic in early life, when they grow up, they are too prone to accept all that has been taught them as true, because the source from whence they received it was so eminently respectable. Thus they will lose or suppress their critical impulses, which are so necessary to mental growth: they will, in fact, be smothered by authority, and the result will be just what Professor Farlow has described as the deficiencies of his students.

Logic will continually incite the pupil to question things; and to do that, they must be observed and their characters noted, whether they be objects in the animal world about them, or some arrangement of words by which an endeavor is made to express a definite idea. The assertion made by some, that we are naturally logical, only tends to confirm the importance of these principles in any system of education. We can hardly have too many persons in this world who understand logical methods of reasoning, no matter how many there may be to whom reasoning according to these principles comes without education.

We know too well that most persons use exclusively the *post hoc, ergo propter hoc* method of reasoning; and they make up the impressionable portion of humanity. The views generally entertained about the nature of evidence are also exceedingly varied and fanciful. One has only to listen to a group of men of ordinary education and a fair endowment of common sense, discussing any subject of interest, to become convinced that this defect of early education is a glaring fact.

Even among laborers and mechanics, we can see the disastrous effect of this deficiency in early training. Could they have had these principles drilled into them by teachers who really under-

stood and practised them, they would be more inquisitive in their work, in order to see whether it was the best that could be effected for the end in view.

It is useless to cite examples, for they are familiar to all. Much has very justly been said, in derision of the differences of opinion among professional men, upon topics which should not, from their nature, give rise to such varied conclusions; and especially has this been enlarged upon in its application to the medical profession. "Is there any sufficient reason for such a state of things?" has often been asked. This is probably not to be attributed to one cause alone, where so many different individuals have to be taken into account, although I believe it is to be explained in large part by their deficiencies in the science of logic; otherwise the uniformity of their conclusions based upon the same facts would be greater.

The records of medical literature are filled with rubbish, that no man, with any knowledge of the elementary principles of logic, would think for a moment worthy of preservation. A medical man has, for example, a peculiar and protracted case of disease: he employs a number of different remedies, and after weeks, or perhaps months, the patient recovers. The delighted physician at once rushes into print with an account of the wonderful virtues of the remedy last administered to his patient, and no suggestion as to the insufficiency of the evidence adduced in order to establish a new truth seems to intrude itself upon his consciousness. And it is in this way, and for this reason more than any other, it seems to me, that medicine continues to deserve the designation of an art rather than that of a science.

But it may be asked, is there no danger that the uniformity that might result from such a general study of logic would become so great as to hinder the development of new ideas and methods? I think not. For although the methods of logic to which we owe our greatest triumphs—and consisting of the four following steps: (1) preliminary observation, (2) construction of hypotheses, (3) deductive reasoning, (4) the process of verification—are the nearest possible approach to perfection in reasoning, and may not be at present susceptible of improvement, it would not prevent some genius from unfolding a new and better system, should such be within the bounds of possibility. I think we need have no fear, even though we were all accomplished logicians, that there would be too much uniformity in our conclusions.

Thinking is no doubt the most important function or attribute of man; and, as the brain will continue to think, let us do what we can to encourage its very best performance.

In an examination of such reports as I could obtain from the Bureau of Education at Washington, with the view of ascertaining whether any of our schools were teaching logic, I was unable to find it in the curriculum of any State, though it is true that only a few were given. The sole reference to it in connection with the schools of the United States was in a list of books considered suitable for teachers' libraries, and prepared by the librarian of the Bureau of Education, which recommended Professor Jevons's 'Elementary Lessons in Logic,' and a work by John Stuart Mill.

In a programme of the studies in a mixed school in a certain department in France, I found the upper class, from eleven to thirteen years of age, devoting thirty-five minutes in the afternoon to a recitation of which logical analysis was a part; and this is the only reference to it as an object of study I have been able to find.

Professor Agassiz, in speaking of the study of natural history being of great value to all scholars in urging its importance, goes on to say, "The difficult art of thinking can be acquired by this method in a more rapid way than any other. When we study logic or mental philosophy in text-books which we commit to memory, it is not the mind we cultivate, it is the memory alone. The mind may come in, but if it does in that method, it is only in an accessory way. But if we learn to think by unfolding thoughts ourselves from the examination of objects brought before us, then we acquire them for ourselves, and we acquire the ability of applying our thoughts in life. It is only by the ability of observing for ourselves that we can free ourselves from the burden of authority. So long as we have not learned how to settle a question for ourselves, we go for authority, or we take the opinion of our neighbor; that is, we remain tools in his hands, if he choose to use us in that

way, or we declare our inability of having an opinion of our own. How shall we form opinions of our own otherwise than by examining the facts in the case? and how can we learn these facts which are unchangeable, those facts over which man, with all his pride, can have no control?"

I have no hesitation in thus quoting Professor Agassiz, although he seems to be against me, judging from his reference to logic alone, because his remarks seem so applicable to what I am urging, in that they so strongly inculcate the necessity for logical training (and which the study of natural science gives) in what is certainly a convincing manner. Still, I am fully persuaded that he would not have spoken in this way about logic, if it had been understood that it was to be taught in the way he urged with natural history; viz., to take the objects or words and propositions in use every day, and apply these principles to them. It then becomes something very much higher than a mere feat of memory, and I fail to see why instruction in logic would be any waste of time, even when natural history was being studied, and where the kind of work to which Professor Agassiz refers is out of the question; and for the present this seems to be the case in all our grammar-schools. The great desideratum is the proper presentation and teaching of logic by those who really understand it themselves.

In conclusion I would say that it is very difficult for me to understand why, if logic is ever worthy of study, it is not more necessary in the beginning of an education than at its close. I will therefore hope that all who are engaged in the profession of teaching will give this subject their serious consideration, and perhaps trial. Let us not forget that logic teaches us to reason correctly; that good reasoning will give us more knowledge, and this will give us power; which, if combined with good character, cannot help making its possessor more valuable to himself and to his fellows.

S. J. BUMSTEAD.

THE AMERICAN PUBLIC HEALTH ASSOCIATION.

THE American Public Health Association held its fifteenth annual meeting at Memphis, Tenn., on Nov. 8, 9, 10, and 11. The attendance was good, among those present being many of the prominent sanitarians of the United States and Canada. At the first session ninety-four new members were elected. The annual address was delivered by the president, Dr. George M. Sternberg, U.S.A. The following is an abstract of the address:—

"It was due to the yellow-fever epidemic of 1878, in which Memphis was the chief sufferer, that steps were taken at our meeting of that year, in the city of Richmond, to urge upon Congress the importance of a national board of health. Recognizing the fact that epidemics do not respect State boundary-lines, and that an efficient sanitary service in times of emergency requires a liberal expenditure of money, and unity of action on the part of sanitary officials, we urged the formation of a central health board, and for a time it seemed as if our well-meant plans would be crowned with success. Indeed, they were crowned with partial success, for all must recognize that in the early days of its existence the National Board of Health accomplished much good. It is unnecessary for me to refer to the various circumstances which conspired to paralyze the effective energy of this board. Unhappily it is a thing of the past, and the hopes which we had founded upon this our bantling are but a memory of the past. But we should not be discouraged that our first effort has failed. A careful consideration of the circumstances which led to this failure may enable us to mature a better plan. Such a plan, indorsed by the judgment of the experienced sanitarians here assembled, and properly presented to our national legislators, could not fail to receive respectful attention.

"One thing appears to me to be thoroughly demonstrated by the experience of the past; namely, that a central health board, to be efficient, must be attached to one of the departments of the government now in existence, so that it may be under the protection of a cabinet officer. It would be useless to ask at the present time that the sanitary interests of the country may be represented by an additional cabinet officer, a minister of public health, although there can be no doubt that the interests involved are sufficiently important to justify such an innovation. But we may at least demand that the sanitary interests of the people of the United States shall receive the same consideration from the national government that is

accorded to the educational interests, the agricultural interests, etc. We may at least ask for a bureau of public health, with a commissioner at its head, and with the necessary secretaries and clerical force to make it efficient; and attached to such a bureau should be a well-equipped laboratory, in which expert bacteriologists, chemists, and sanitary engineers should be employed in the experimental investigation of unsettled sanitary problems, such as the natural history of disease-germs, the best methods of destroying them, protective inoculations against infectious diseases, problems in sanitary engineering (such as the disposal of sewage, domestic sanitation, etc.), food-adulterations, and a variety of other questions of equal importance, which will readily occur to you. I do not approve of the plan of having a central board of health, composed of members located in various parts of the country. Such an organization is cumbersome, and it cannot be expected that a board which is only assembled at long intervals, and of which the members are occupied by various pursuits, which claim their time and best thought, will render the most efficient service. On the other hand, by diversity of opinions they may greatly embarrass their executive officer, who must necessarily be located in Washington. Nor, in my opinion, would a board composed of officials at the head of various departments in Washington, such as the surgeon-general of the army, the navy, and the marine-hospital service, as has been suggested, be much better. These officials are fully occupied with the duties pertaining to their office, or at least have not sufficient leisure to undertake the executive work of a central health bureau. I would therefore expect better results from the untrammelled action of a single commissioner, who would be responsible directly to the cabinet officer to whose department his bureau was attached, and who would necessarily be controlled by the law defining the nature of his duties. In this case it is evident that the good accomplished would depend largely upon the fitness of the man selected for the special duties intrusted to him, and that a political appointment in the first instance, or the removal of a suitable man for political reasons, would entirely defeat our object.

"We may, however, ignore this possibility, and trust to the good judgment of the chief executive and the growing public sentiment in favor of retaining efficient bureau officers, without regard to party changes.

"In connection with a bureau of public health, it would certainly be desirable to have an advisory board of health, to which the commissioner could refer questions for consideration, or which could advise him of new measures, or desirable changes in his regulations, which, after full discussion, commended themselves to the judgment of the board. Such a board should have no executive power, and the members should receive no pay beyond their actual expenses in attending the appointed meetings. I would suggest that such a board should consist of the surgeons-general of the army, the navy, and the marine-hospital service, and of the presidents of State boards of health. One annual meeting in Washington would probably answer the purpose for which a board would be constituted, except in case of an actual or threatened epidemic, when it might be convened, at the suggestion of its president or of the commissioner of health.

"I request your careful consideration of the plan here suggested, and, if it meets your approval, would urge the importance of taking such action at the present meeting as will insure its being properly brought before the Congress of the United States."

Dr. Sternberg referred to the epidemic of yellow-fever at Memphis in 1878, and the sanitary improvements made in the city since that time, and then gave its inhabitants the following advice:—

"Do not allow yourselves to fall into a state of inaction and false security because for several years our foe has been kept at bay. Although it is now evident that yellow-fever is not epidemic in any portion of our land, and we have learned by recent experience that by proper measures it is possible to exclude it for a series of years, even from the city of New Orleans, yet there are so many possibilities of its introduction, in spite of the vigilance of those who have charge of the gateway of the Mississippi valley, that it would be folly to neglect those local measures of sanitation which remove the vulnerability of cities in the presence of the germs of pestilential diseases. Shutting the door is of prime importance, and while the keys are in the hands of our energetic and able colleague, Dr. Holt,

we may feel comparatively safe. But the efficient president of the Louisiana State Board of Health cannot guarantee that all avenues of approach are securely guarded, inasmuch as some of these avenues are quite beyond his control. This is exemplified by the Biloxi epidemic of 1886. Local outbreaks, such as that at Biloxi, and the epidemic at Key West and at Tampa during the present year, show that the conditions upon our Gulf coast are no less favorable to the presence of yellow-fever than they were in former years; and that our immunity depends solely upon the exclusion of an exotic germ. Unfortunately, also, the Biloxi epidemic illustrates the very greatest liability of physicians to fall into error with reference to the diagnosis, when yellow-fever unexpectedly makes its appearance outside of its habitual range. History repeats itself in this particular. The early cases in an epidemic, which are often mild, are pronounced to be malarial-fever; and this diagnosis is often sustained by those who have committed themselves to it, when no reasonable doubt remains in the minds of unprejudiced physicians as to the true nature of the malady.

"The question whether it is practicable to make a city, which lies in the area subject to invasion, proof against epidemics of yellow-fever and cholera, is one of very great importance. At the International Sanitary Conference at Rome the delegates from England and from India opposed all quarantine restrictions as unnecessary, and pointed to the fact that for years there has been constant and free communication between cholera-infested ports in India and the seaport cities of England, but that cholera has not effected a lodgement in that country. Dr. Thorne Thorne, of the local government board, a delegate to the conference, ascribed this immunity to the sanitary improvements which have been carried out in England during the past ten or twelve years. He stated, that, during the period included between the years 1875 and 1884, an amount exceeding six and one-quarter millions sterling per annum had been expended in England 'under private and public acts mainly of a sanitary character.' Dr. Thorne Thorne, in his report of the proceedings of the conference referred to, says,—

"Lastly, I would note that I took occasion to explain to the technical commission that expenditures such as I have referred to are, with only very trivial exceptions, voluntarily incurred in the interests of public health.

"I then went on to show, in connection with this expenditure, that the average annual mortality for England and Wales was now only 19 as opposed to 22 per 1,000 in the decennial period 1861-70, and this notwithstanding increase in population of some 5,000,000; and taking the continued fever mortality of this country as that which, in point of causation, most nearly resembled cholera, I pointed out, that whereas, in the five years 1865-69, this mortality was at the rate of 934 per 1,000,000 living, it had steadily fallen to 428 per 1,000,000 during the period 1880-82, and that it is now only 307 per 1,000,000.'

"In a later communication, published in the *Practitioner* for October, 1887, Dr. Thorne Thorne gives fuller details of the English system of protection against cholera as follows: 'Having deliberately abandoned the system of quarantine, we began many years ago to organize the system of medical inspection with isolation. The medical inspection comes first into operation on our coasts. The customs officers board the vessel coming into our port, and they at once communicate to the sanitary authority the occurrence of any case of cholera, choleraic diarrhœa, or suspected cholera. A vessel so affected is detained until the medical officer of health has examined every member of the crew and passengers. Those actually sick of cholera or choleraic diarrhœa are at once removed to the port sanitary hospital, and any person certified to be suffering from any illness which that officer suspects may prove to be the cholera is detained for a true period of observation not exceeding two days. The medical inspection is thus followed by isolation of the sick. Unlike a quarantine system, this process does not interfere with the healthy, or expose them to risk by herding them together with the sick; but the names of the healthy, and the places of their destination, are taken down, and the medical officers of health of the districts in question are informed of the impending arrivals. This part of our system has been named our first line of defence, but it would be of little value if we stopped there. Our main trust is in the promotion of such local sanitary administration

in every part of the country as shall rid us of the conditions under which alone cholera can spread. In periods of emergency, as during the past three years, a special medical survey of such districts as are most exposed to risk is organized under the supervision of the medical officer of the local government board, and, where needed, the sanitary authorities are urged to action. Important as have been the results of the recent survey, they would go for little were it not for the steadily maintained work of the sanitary authorities and their officers throughout the kingdom; and we who have been taunted abroad for opposing quarantine, because its restrictions touched our commercial interests and pockets, may justly feel proud that in England and Wales alone the people have, during the past ten years, of their own accord, and apart from government dictation, spent, by way of loan or in current expenditures, over £80,000,000 sterling for purposes mainly of a sanitary character. And we may fairly ask whether any corresponding expenditure has in other countries given evidence of real faith in a quarantine system.'

"Without denying the value of the sanitary improvements which have been carried out in England, and the possibility that her immunity from cholera is largely due to them, the delegates from more exposed countries, such as France and Italy, demanded a quarantine station upon the Suez Canal, and pointed out the fact that their seaport cities were not in such a sanitary condition that they could hope to escape the ravages of the pestilence, in case of its introduction, and that to place them in such a state of defence would require time and the expenditure of large sums of money. It was noticeable that those countries (such as Turkey, Egypt, and Spain) where sanitary improvements have made the least progress were the most exacting with reference to quarantine restrictions. They evidently looked upon these as their only hope, and were advocates of the old-fashioned time-quarantine, which, as carried out in these countries, has often been attended with barbarities which are intolerable for civilized nations. Self-preservation is, indeed, the first law of nature; but it is barbarous to sacrifice the life of another to save our own, and, in guarding the lives of a community, we are bound to show due consideration for the health and comfort of those who are believed to be the possible bearers of disease-germs.

"Recognizing this humane principle, a majority of the delegates to the sanitary conference of Rome were anxious to effect a compromise between the old-fashioned time-quarantine and the British practice, which they could not rely upon for the countries of southern Europe. It was believed that such a compromise was practicable, and that the plan agreed to by a majority of the delegates present was more reliable than a simple quarantine of detention. I must refer you to the published transactions for the details of this plan; but in brief it consisted of a sanitary supervision of ships at the port of departure, when this was an infected port or in communication with an infected locality; in the sanitary supervision of ship and passengers while in transit, by a properly qualified physician upon all passenger-ships; and in such detention at the port of arrival as might be necessary for the disinfection of the ship, the personal effects of the passengers, etc. If one or more cases of cholera should appear on board during the voyage, they were to be isolated, and rigid measures of disinfection carried out, and the action of the health authorities at the port of arrival was to depend upon how effectively this had been done. In short, the treatment of the vessel and its passengers was not to be determined in advance by arbitrary rules, but was to be governed by an intelligent consideration, by an expert, of all the circumstances relating to the sanitary history of the ship from the date of its departure from the infected port. This rational quarantine service, which is far less burdensome to the commerce of a country than the arbitrary time-quarantine of former days, has proved itself to be also more effectual in accomplishing the end in view. This is amply proved by recent experience in our own country, where, to a large extent, the principles indicated control the action of the health-officers of our principal seaports. Look at the city of New Orleans, where epidemics of yellow-fever were formerly so frequent as to lead to the belief that the disease was endemic, and a necessary evil appertaining to the situation of the Crescent City. Happily, under an efficient quarantine service, she has now a record of seven years' exemption from the dreaded pestilence."

In discussing cholera and its probable appearance in the United States, Dr. Sternberg said, —

"It is perhaps too soon to speak with confidence with reference to the action taken by the sanitary officials of the port of New York upon the recent arrival of two cholera-infected vessels from the Mediterranean; but we have good reason to hope that the measures taken will prove sufficient, and that this pestilential disease, which has for several years been threatening us from a distance, has not effected a lodgement upon our shores. Whether it would be practicable to put our seaports in such a state of sanitary defence that it would be safe to open the door and defy the foe, is extremely doubtful. I have never believed that yellow-fever was excluded from New Orleans in 1862 and 1863 by the sanitary regulations enforced by General Butler, as has been claimed. The exemption from this disease enjoyed by the unacclimated soldiers from the North, who filled the hospitals in that city at the time mentioned, was due, in my opinion, to the absence of commerce during the military occupation of the city, and to the rigid enforcement of quarantine restrictions.

"But I do believe that this and other cities similarly located can be preserved from such devastating epidemics as have too often occurred in the past, and that, by the carrying-out of needed sanitary improvements and the constant supervision of expert sanitary officials, supported by an enlightened public sentiment and sufficient appropriations, the ravages of pestilential diseases may be restricted within very narrow limits.

"As regards cholera, the system of local defence is even simpler than in the case of yellow-fever. Ample evidence demonstrates that the epidemic extension of this disease depends largely, if not exclusively, upon the water-supply. Where this is subject to contamination by the discharges of the sick, there cholera is liable to become epidemic. On the other hand, cities like Rome, in Italy, which have an ample supply of pure water, drawn from a source not likely to be contaminated, seem to be cholera-proof, notwithstanding the filth and squalor in which a considerable portion of the population live. The same thing is seen in Naples, which in 1884 suffered terribly, but which, since the completion of its new system of water-works in 1885, has enjoyed a comparative immunity, notwithstanding the fact that cholera still prevails in Italy, and that we have evidence of its presence in a malignant form in the city referred to. When I was in Naples, in 1885, the mayor of the city invited a number of the delegates to the sanitary conference to the municipal palace for the purpose of conferring with them with reference to projected sanitary improvements, and especially with reference to the best system of sewerage for the city, which, up to the present time, remains destitute of sewers, and which, I may add, is a noted stronghold of typhoid-fever. In the course of the conversation, I suggested to the mayor Colonel Waring's American system, which has been tested with such favorable results in this city. My recommendation was sustained by the distinguished German bacteriologist, Dr. Robert Koch, who was one of the delegates present. I may remark that I have recently received a letter from Dr. Koch, asking me to give him full particulars with reference to the details of this system as carried out in the city of Memphis."

In commenting upon quarantine as at present practised in this country, the president said that he considered it a wrong principle that commerce should be taxed for the support of quarantine establishments. In his judgment, the people who are protected should pay the cost of such protection. He was not so much concerned with the unjust tax laid upon ship-owners as with the gross injustice to passengers practised at many ports in various parts of the world where they are so unfortunate as to be detained at a quarantine station. He narrates the history of a case of this kind which fell under his own observation. He says, "When I left Brazil, in the month of August last, small-pox was epidemic both in Rio de Janeiro and at Para. Our ship touched at Para, and five days later at Barbadoes. A passenger for this port was not allowed to land, because of the prevalence of small-pox in Brazil. Proceeding to St. Thomas, less than two days' sail from Barbadoes, our passenger was again refused permission to land, except to go to the quarantine station for a certain number of days. This was all right, but the conditions upon which he would be received seemed

to me to be all wrong. Either he himself or the ship must guarantee the payment of the quarantine fees, which would be three dollars a day for his board, and five dollars a day to the quarantine physician, if he were alone. If others were at the station at the same time, this fee would be divided between them. One can easily imagine what a hardship such a tax would be for a person of limited means, who had only provided himself with funds for the journey he had undertaken. The agent of the ship refused to take any responsibility, and our passenger had no resource but to submit to the imposition, or to come on to New York, paying his passage to that port."

Another illustration of the evils arising from the present system of supporting quarantine establishments was given by Dr. Sternberg, in his address, as being his own experience when he recently arrived at New York quarantine on his return from Brazil. "With the deputy health-officer, who boarded our ship, came a man with a jug. I was informed by one of the officers of the ship that he was to disinfect the vessel. Being somewhat curious to know the method of disinfection employed, I asked the ship's surgeon to go with me to inspect, when, after a detention of less than one hour, we had started from the quarantine station for our wharf. We found that the man with the jug had lowered a bucket by means of a rope through one of the hatches between decks. Upon pulling up this bucket, I found that it contained two or three pounds of some powder which had been wet, probably with acid solution, and which gave off an odor of chlorine. No doubt, when first lowered between decks, there had been a considerable evolution of chlorine; but, in the vast space to be disinfected, it was so diluted that at the end of an hour I did not detect the odor of chlorine-gas when I lifted the hatch, and it was only by approaching my nose to the bucket that I was able to ascertain what disinfectant had been used. The most curious part of the story is, that I was informed that the bucket had been lowered between decks to disinfect a quantity of hides which were stored in the hold. What was the object of this 'disinfection'? Evidently not to disinfect, for no one at the present day would think of maintaining that the hides in the hold had been disinfected by the procedure of the man with the jug. The only object that I can conceive of depends upon the fact that there is a fee for disinfecting, which must be paid by the agents of the ship; at least, I was so informed by one of the officers of the ship."

The president referred to the fact that while exotic pestilential diseases, such as yellow-fever and cholera, were the levers which move corporations to make necessary sanitary improvements, these are, as compared with certain indigenous or naturalized infectious diseases, of secondary importance. The chief aim of the American Public Health Association should be to ascertain what measures are most effectual for the restoration of their endemic maladies, such as typhoid-fever and the malarial fevers, and for the banishment of all diseases in which the contagion is given off from the persons of the sick, such as scarlet-fever and small-pox. So far as the diseases of the class last mentioned are concerned, we may safely say that we know how they may be banished from a community; viz., by isolation of the sick, and disinfection of all infectious material, and, in the case of small-pox, by vaccination. The main mission of the sanitarian, therefore, is to insist upon the thorough execution of these measures.

Other topics dealt with in the address were the necessity for instruction of the people in the principles of personal hygiene, in which labor Mr. Henry Lomb of Rochester had borne so noble and generous a part, by giving prizes for essays on the construction of the homes and the composition of the food of the working-man; the erection of laboratories, such as that at Johns Hopkins University, the Hoagland at Brooklyn, and others at New York, Philadelphia, Boston, and Ann Arbor; the infectious diseases of animals, — anthrax, swine-plague, hydrophobia, etc. With reference to the germ of cholera, Dr. Sternberg said, —

"With reference to cholera, I may say to you that recent researches give support to the conclusions of Koch as to the pathogenic rôle in this disease, of the spirillum discovered by him in the intestines of cholera patients. Its constant presence in this disease seems to be demonstrated, and it is now generally admitted by bacteriologists that there are definite characters by which it may be distinguished from similar organisms obtained from other

sources, such as the Finkler-Prior spirillum and the cheese spirillum of Deneke, which closely resemble it.

"Lustig, director of the cholera hospitals at Trieste, examined the dejecta in one hundred and seventy cases of cholera, and found the spirillum of Koch in every case: on the other hand, the bacillus of Emeric was only found in forty out of the whole number of cases examined. Tizzoni and Cattani also found Koch's spirillum in the contents of the intestine in twenty-four cases examined by them during the epidemic at Bologna in 1886. At Padua, also, researches made by Canestrini and Morpurgo gave the same result: the spirillum was constantly found in the dejecta in recent cases. These observers state that the cholera spirillum retains its motility and reproductive power for a considerable time in sterilized distilled water. They were able to obtain cultures after two months from such water. This important fact has been verified by Pfeiffer, who found, however, that in the presence of common saprophytic bacteria the cholera microbe soon died out. Hueppe has shown that the cholera spirillum forms reproductive elements, which he calls arthrospores. These are not so readily destroyed by desiccation as are the fresh bacilli, but they have nothing like the resisting power to heat and chemical agents which characterizes the endogenous spores of the bacilli. The exact proportion in which various disinfecting agents are destructive of the vitality of the cholera spirilla has now been determined with great precision, and will be stated in detail in the report of the committee on disinfectants for the present year. This committee has also made extended experiments of the same kind, in which the typhoid bacillus and various other pathogenic organisms have served as the test of germicidal power. The chemical products developed in cultures as a result of the vital activity of the cholera spirillum have been studied by Bitter, Buchner, and Contani. The last-named author claims to have demonstrated the presence of a poisonous ptomaine in cholera cultures, which, when injected into the peritoneal cavity of dogs, gives rise to symptoms resembling those of cholera. A recent observation of value is that of Buijwid, who finds that bouillon cultures of the cholera spirillum have a peculiar chemical re-action by which they may be distinguished. According to this author, the addition of a 5-10-per-cent solution of hydrochloric acid to such a culture gives rise, within a few minutes, to a rose-violet color, which subsequently, when exposed to light, changes to a brownish shade. The re-action does not occur in impure cultures. The Finkler-Prior spirillum is said to give a similar re-action after a longer time, but the color first developed is of a more brownish hue."

The etiological rôle and biological character of the typhoid bacillus, discovered by Eberth in 1880, were fully discussed. Dr. Sternberg says that there is very little doubt that this organism is the cause of typhoid-fever, although no satisfactory proof by inoculation in lower animals has as yet been found. This, however, he does not regard as surprising, inasmuch as we have no evidence that any of the animals experimented upon are liable to contract the disease, as man does, by drinking contaminated water. In speaking of malaria and its causative micro-organism, he said,—"Among the most important investigations of the past year are those of Councilman of Baltimore, and Osler of Philadelphia, with reference to the presence of micro-organisms in the blood of malarial-fever patients. Both of these observers confirm the discovery of Laveran, who in 1880 announced, as the result of extended researches made in Algeria, that blood drawn from the finger of such patients during a febrile paroxysm contains a parasitic infusorium, which presents itself in different phases of development, and which in a certain proportion of the cases was observed as an actively motile flagellate organism. Osler and Councilman have found all of the forms described by Laveran; and the last-named observer reports that in recent researches in which blood was obtained directly from the spleen, the flagellate form was almost constantly found. Whether the amœboid 'plasmodium' found by Marchiafava and Celli, of Rome, represents an early stage in the development of this organism, or whether it simply represents a change in the red-blood corpuscles, which occurs also in other diseases, as is claimed by Mosso, has not yet been definitely determined. It is somewhat curious that just when we are receiving satisfactory evidence of the parasite of Laveran in the blood of malarial-fever patients, the

bacillus of Klebs and Tomassi-Crudelli, which appeared to be dead and buried, has again been introduced to our notice by the distinguished German botanist Ferdinand Cohn. In his paper, published in June last, he gives an account of the researches of a young physician named Schiavuzzi, who has made researches in the vicinity of Pola, a malarial region in Istria. The method followed was that of Klebs and Tomassi-Crudelli; viz., examination of the air and water in malarial localities, and inoculation experiments in rabbits.

"The bacillus was constantly found in the air, and the rabbits inoculated presented symptoms and pathological lesions believed to be identical with those of malarial-fever in man. I cannot at the present time go into a critical discussion of the evidence presented, but would refer you to an experimental research made by myself in New Orleans in the summer of 1880, in which I repeated the experiments of Klebs and Tomassi-Crudelli, and arrived at the following general conclusions:—

"Among the organisms found upon the surface of swamp mud, near New Orleans, in the gutters within the city limits, are some which closely resemble, and perhaps are identical with, the bacillus malarie of Klebs and Tomassi-Crudelli; but there is no satisfactory evidence that these, or any of the other bacterial organisms found in such situations, when injected beneath the skin of a rabbit, give rise to a malarial-fever corresponding with the ordinary paludal fevers to which man is subject.

"I see no reason to modify the opinion here expressed, notwithstanding the indorsement given by Cohn to the results announced by Schiavuzzi. These researches relating to organisms in the air and water, and experiments on rabbits, especially in the hands of an inexperienced investigator, cannot have any great scientific value in the elucidation of an etiological problem. The sources of possible error are too numerous, and the method is in any case inadequate for the complete solution of the problem. It is essential that the infectious agent, especially one so easily demonstrated as this bacillus, be proved to be present in the blood or tissues of malarial-fever patients; and in the absence of such proof, experiments on rabbits, and researches in the air of malarial regions, can have but little weight. It may well be that in the swampy districts of warm climates, where malarial-fevers prevail, one or more species of bacilli will be found in the air or in the water, which are absent from the drier air and running waters of non-malarious uplands; but this is simply an interesting fact in natural history, relating to the distribution of organisms of this class, and by itself cannot be accorded any value in a consideration of the important question of etiology. The method of research pursued by Laveran, by Marchiafava and Celli, by Councilman and by Osler, is the true one, and none of these gentlemen have encountered the bacillus of Klebs and Tomassi-Crudelli in their extended researches. On the other hand, they are in accord as to the presence in the blood of a flagellate organism, and of certain spherical and crescentic bodies, which are believed to represent different stages in the life-history of this infusorium."

The address, taken as a whole, is one of the best which has ever been delivered before the association, and will doubtless excite great interest among sanitarians. We shall take occasion to refer hereafter to some of the recommendations made by Dr. Sternberg.

THE THEOSOPHICAL MOVEMENT IN INDIA.

ERNST VON WEBER prints in *Ueber Land und Meer* an interesting paper on the theosophists of India, and accompanies it with the illustration which is reproduced on p. 262. He calls attention to the fact that students of *Völkerpsychologie* cannot fail to be impressed by India's awakening from her long intellectual sleep. To-day the new and fresh intellectual life may be observed from the Himalayas to Ceylon, and from the Indus to the fruitful lands of Burmah. This movement owes as much to the spread of the English language as to any other one cause. It is now customary for all educated Hindus to be able to speak the English language fluently, and the British Government has helped this on by its system of schools.

The Aryan Hindu is naturally of a metaphysical and speculative turn of mind, and it is therefore not to be wondered at that the

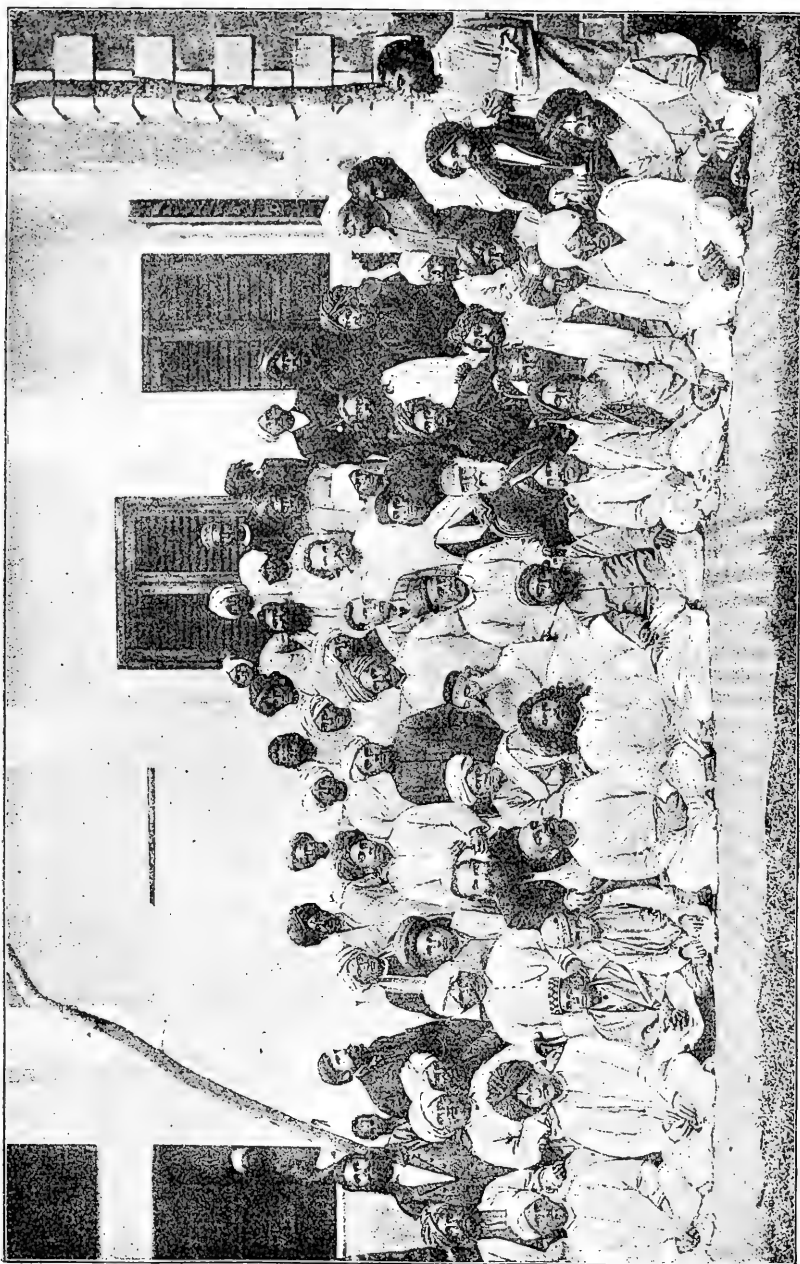

Prince Harisinghjee.

Mr. Leadbeter.
General Morgan.

Subbia Rad.
Colonel Olcott.
Bavanshangar.

E. v. Weber.

Mr. Cooper.

ANNUAL CONGRESS OF THE THEOSOPHICAL BROTHERS AT ADYAR.

newly aroused intellectual activity should have found expression in the so-called theosophical movement. The first impulse to this idealistic development did not come, however, from India itself, but from abroad. It came from the land which, as the writer cynically expresses it, is the most unfruitful soil for idealistic fruit, the United States of America. It was in New York, as long ago as 1875, that Colonel Olcott laid the corner-stone of the theosophical structure which was soon to exercise so wide-spread an influence. The principles of the cosmopolitan brotherhood of theosophists, which in certain particulars resemble those of the Freemasons or those of the Jewish set of the Essenes, rapidly spread through other countries. The indefatigable apostle of the new society did his work so well, that the number of associate societies, which in 1879 was only two, increased in 1883 to ninety-three, and in 1886 to one hundred and thirty-two. Of this last number, 107 are in India, 8 in Europe, 15 in America, 1 in Africa, and 1 in Australia. The headquarters and administrative centre of all these societies is Adyar, a rural capital in Madras, where Colonel Olcott dwells, on the banks of a river in a paradise of palms and flowers. His villa also serves as the gathering-place where each year in Christmas week more or fewer of the delegates of the theosophical societies throughout India assemble in convention. Colonel Olcott has managed to imbue thousands of men of the higher circles of India with his ideas. He is greatly honored by his fellow-theosophists, and is loved as a father and benefactor. His occasional journeys through the country are like triumphal processions, and his influence over the cultured classes of the Hindus throughout India is extraordinary.

Some idea of the objects and aims of the Theosophical Society may be gathered from the following selection from the declaration of principles adopted at the annual assembly of the delegates in 1886. The objects of the society are there set forth as, (1) to lay the foundation for a universal brotherhood of man, without distinction of race, religion, or color; (2) to promote the study of the Aryan and other Oriental literatures, religions, and sciences; (3) to investigate hitherto unknown natural forces and the psychical powers of man (which is pursued by a part of the brotherhood only). The brotherhood invites to membership all those who love their fellow-men, and who believe the divisions following from differences of race, religion, and color, to be an evil; all students and scholars; all earnest seekers after truth; all philosophers in the East as well as in the West; all those who love India and desire the return of its former spiritual greatness; and, finally, all those who are striving after permanent good, and not mere passing pleasures and the interests of a worldly life, and who are ready to make personal sacrifices in order to attain to knowledge of the highest good. The society professes no special religion, and has in no wise the character of a sect, for it includes followers of all religions. It demands of all its members only such tolerance of other faiths as each man asks for his own. The society interferes in no way with the Indian laws of caste, nor with any other social customs and usages.

To exemplify these tolerant principles, the assembly hall at Adyar contains life-size portraits of the representatives and founders of all the great religions. One of the matters in which the society is busily engaged is the collecting of rare books of the old Indian literature, written often on palm-leaves. The value of this Sanscrit library increases daily, and it is hoped to make it in time the most complete in the world.

The illustration on p. 262 shows the delegates who assembled at Adyar in 1885. The beautiful Indian costumes, with their bright colors, and the high turbans often sewn with gold and silver threads, made the group peculiarly artistic and pleasing. Among the distinguished theosophists shown are President Olcott, Prince Harisinghee, the English general Morgan, the theosophist evangelist Leadbeater (formerly an Anglican clergyman), the Sanscrit scholar Bavanishangar, Mr. Cooper Oakley, an American and the editor of the *Theosophist*, and the Hindu philosopher Subba Rad. At these assemblies it is noticed by visitors that the delegates confine themselves to a vegetarian diet, and do not partake of any liquor whatsoever. The assembly closed with a brilliant garden-party, at which old Sanscrit songs were sung to Indian music, and the delegates were sprinkled with rose-water and bedecked with flowers.

BOOK-REVIEWS.

The Education of Man. By FREDRICH FROEBEL. Tr. by W. N. HAILMANN. New York, Appleton. 12°.

Elementary Psychology and Education. By J. BALDWIN. New York, Appleton. 12°.

DR. HARRIS is issuing the volumes of his International Education Series with great promptness. Volume V. in the series is Froebel's classic work translated. Since this was written, now more than sixty years ago, its readers have increased in number year by year. Inaccessibility and bad translations have hindered its progress in this country, but both these obstacles are now overcome, and no teacher who is imbued with the spirit of his profession will fail to have the 'Education of Man' by him for careful study and constant reference. We believe that posterity will award to Froebel the highest place among modern educators. He was infinitely more practical than the authors of 'Emile' and 'Levana,' and infinitely more profound and philosophical than Pestalozzi. The spirit of the kindergarten is Froebel's greatest achievement; the kindergarten itself is a mere detail. The spirit runs through all sound education, and the great manual-training movement, now the distinguishing feature of our educational development, is but another manifestation of it. The present translation of Froebel is a very good one, and leaves little to be desired. We regret that the translator has disfigured the text and broken the continuity by interjecting observations of his own.

Volume VI. is Baldwin's 'Elementary Psychology and Education.' Of it we cannot conscientiously say any thing complimentary, and we confess our surprise at its finding a place in the series. We do not object to making psychology as elementary as one pleases, but we do object to making it pre-Kantian. The present author may have heard of the *Kritik der reinen Vernunft*, but he certainly has never read it. We agree most heartily with Dr. Harris, that a teacher should know something of psychology, and we would go considerably further than he does in emphasizing the fact. But we submit that to teach psychology that is positively wrong and unscientific under the pretence that it is elementary, is worse than to teach nothing of it at all. Illustrations of loose statement and positive error abound in this book. We read, for example, of "sense-perception, conscious perception, and noumenal perception." The 'enduring self,' matter, mind, space, causation, right, beauty, and the like, are included under 'noumena.' We are told also that "choice is uncaused cause," and the fact that "literature represents man as free and responsible" is cited as an argument for freedom of the will. It is not profitable to multiply the evidences of the author's incapacity to write the book. It is in no respect worthy of a place in this series.

NOTES AND NEWS.

ANOTHER important acquisition to our store of knowledge has recently been made, says *Nature*. Glucose, commonly called grape-sugar, has been artificially prepared by Drs. Emil Fischer and Julius Tafel in the chemical laboratory of the University of Würzburg. This happy achievement, which is announced in the number of the *Berichte* just received, is one which has long been looked forward to, and which cannot fail to give deep satisfaction in chemical circles all over the world. As is generally the case in syntheses of this description, not only has the sugar itself been actually prepared, but, what is at least quite as important, considerable light has been thrown upon that much-discussed question, the constitution of sugars. A most remarkable, and yet only to be expected, attribute of this artificial sugar is that it is found to be entirely incapable of rotating a beam of polarized light. As is well known, there are several naturally occurring varieties of glucose, all of which may be expressed by the same empirical constitution, and all possessing the power of rotating the plane of polarization: dextrose, or grape-sugar, the best-known of these varieties, as its name implies, deviates the plane of polarization to the right, as do several other less important varieties; while levulose, or fruit-sugar, rotates the plane to the left. But in artificially preparing a glucose there is just as much tendency for one kind to be formed as another, and the probability is that both dextro and lævo are simultaneously formed, and thus neutralize each other, producing a totally inactive mixture. It may be that, as in the case of racemic acid,

the two kinds are formed side by side, and neutralize each other in the solution; or it may even be, that, as is the case with truly inactive tartaric acid, there is a true neutralization within the molecule itself. Which of these hypotheses is correct is a question for further work to decide.

— Gaillard's 'French for Young Folks' (New York, Werner) is constructed on a sound pedagogic plan, has numerous and good illustrations, and is nicely gotten up. It devotes special attention to the subject of French pronunciation, and gives some very practical directions on the subject. We only question whether the introductory chapters do not employ too many long words to be easily comprehended by the beginner.

— The Fish Commission steamer 'Albatross' left Washington last week on her extended cruise to the Pacific coast. The voyage was arranged by the late Professor Baird, and is now being carried out by his successor, Mr. G. Brown Goode, the new commissioner. The 'Albatross' has been engaged for several years in the deep-sea work of the Fish Commission in the Atlantic, the results obtained being of great economic and scientific value. There has come a demand from the Pacific coast for similar work there, where the fisheries have not been developed to any extent, little being known of the number or character of the food-fishes of that coast. To hunt out the food-fishes, locate their habitats, and to develop the resources of the great Pacific, is the task before the 'Albatross,' which is thoroughly equipped for the scientific work. The scientific party aboard will consist of Prof. Leslie A. Lee of Bowdoin, who goes as chief naturalist; Mr. Thomas Lee, who has been engaged on the deep-sea work of the commission for a long time; and Mr. C. H. Townsend, who has just returned from an expedition to Central America. The 'Albatross' is officered and manned by the navy, and is under the command of Lieut.-Com. Zera L. Tanner. The 'Albatross' will reach California next May. Stops will be made *en route*, which will delay the voyage somewhat, the time being occupied by the scientists in making shore-collections. The ship goes out without any definite period fixed as to its return, but it is not probable the vessel will be seen in the Atlantic again for three or four years. It is deemed important to carry on investigations not only in the latitude of California, but off the Alaska coast. The ship will touch frequently at ports on the Pacific coast, and be in constant communication with the Fish Commission. It is probable, too, that from time to time other scientists will join her for the purpose of doing special work. The scientific outfit of the vessel is declared by those who have examined it to be the best that was ever put aboard a vessel.

— Dr. Cohn, oculist at Breslau, has invented a new apparatus for testing the eyesight of children. This is a matter which is scarcely attended to at all in this country. Periodical tests have shown that there is much more small mischief in the eyes of young students than is generally supposed, which can easily be stopped if the necessary precautions are taken in time. Dr. Cohn's invention consists of a white board twenty-five centimetres square, to which are fastened six rows of hooks, shaped thus □, one centimetre square. He who possesses a normal eyesight will be able to tell, at a distance of six metres in ordinary daylight, in which direction — upwards, downwards, to the right, or to the left — the hooks, which are painted of different colors, are turned. Pupils who cannot do this injure their eyes by constantly looking at the blackboard. The same board may be used to determine whether the ordinary daylight is sufficient for the rooms. As soon as the teacher cannot distinguish the direction of the hooks at a distance of six metres without straining his eyes, the gas ought to be lighted at once.

— In the December number of *Harper's* is an article by Mr. George F. Kunz, the gem expert of Messrs. Tiffany & Co., on the precious stones of America. Mr. Kunz makes it clear that the alleged recent discoveries of diamonds in Kentucky amounts to nothing; but sapphires, spinels, crystals of topaz, beryls, garnets the finest in the world, tourmalines, amethysts, and turquoises are obtained in several localities in considerable profusion. The striking feature of the article is the lithographed page of these gems, containing a diamond, Manchester, Va.; sapphire, Helena, Montana; sapphire, Franklin, N.C.; topaz, Crystal Peak, Col.; emerald, Stony Point, N.C.; aquamarine, Stoneham, Me.; beryl (golden-colored),

Litchfield, Conn.; garnets (cut and natural), Gallup, N.M.; peridot, Gallup, N.M.; tourmaline, Mount Mica, Paris, Me.; tourmaline (green with red centre), Paris, Me.; lithia emerald (hiddenite), Stony Point, N.C.; amethyst, Stow, Me.; cairngorm stone, Pike's Peak, Col.; turquoise, Nevada; arrow-points of obsidian, carnelian, and agatized wood, Oregon; pearl, Paterson, N.J. To produce this plate, fully twenty impressions were required, and we believe this was the first colored plate ever published in *Harper's*.

— At a special meeting of the Board of Regents of the Smithsonian Institution held Nov. 18, Prof. S. P. Langley was elected secretary of the institution, to succeed the late Prof. S. F. Baird.

LETTERS TO THE EDITOR.

* * * *The attention of scientific men is called to the advantages of the correspondence columns of Science for placing promptly on record brief preliminary notices of their investigations. Twenty copies of the number containing his communication will be furnished free to any correspondent on request.*

The editor will be glad to publish any queries consonant with the character of the journal.

Correspondents are requested to be as brief as possible. The writer's name is in all cases required as proof of good faith.

Cheyenne.

In the note published in your issue of Nov. 11, I made an unaccountable mistake, and wish to correct it. The Cheyennes are the 'cut-arms,' and in the sign-language are designated by drawing the hand, in imitation of a knife, across the biceps of the arm. It is the Pawnees whose sign is wolf-ears made with thumb and forefinger.

Your types say *loo-yah* erroneously for *loo-hah*.

The French trappers told me a legend of the Sioux to the effect that once in holding a council they were disturbed by the noisy play of the children, and moved over to another creek to hold the council in quiet. In attempting to overtake their parents, the children took the back track on which the village had lately come in. They kept going, and the boys and girls grew up and intermarried, and became another tribe, the Cheyennes. The Sioux call themselves *Lah-ko-ta* (the *t* strongly dental), not Dakota, meaning 'cut-throats,' the sign being the open hand drawn edgewise across the throat.

GEO. WILSON.

Lexington, Mo., Nov. 15.

The 'Act of God' and the Railway-Company.

RETURNING from New York Nov. 12, the train was crowded with passengers. At the forward end of the car was a large stove full of red-hot coals. This stove had no guard, nor hardly any thing to prevent it from upsetting. A slight collision would have emptied the contents of the stove, and probably several people would have been burned to death. Would Mr. Appleton Morgan consider such an affair an 'Act of God'?

ASAPH HALL.

Washington, Nov. 19.

Changes in Indian Languages.

I OBSERVE a blunder I made in attributing the word *quisquis* ('a hog') to Schoolcraft instead of Zeisberger, in my communication on changes in Indian languages, in *Science* of Nov. 18. The Onondagas now pronounce it *kweaskweas*, almost in four syllables, and with a resemblance to a hog's melodious note. I may add that the Onondagas divide 'Hiawatha,' a name of their own, differently from many white people. It is pronounced by them 'Hi-a-wat-ha.' 'Onodaga' they sound like the whites in talking with them, but retain the old broad sound among themselves.

W. M. BEAUCHAMP.

Baldwinsville, N.Y., Nov. 19.

Natural History Notes on Alaska.

IN my 'Natural History Notes on Alaska,' forming Part III. of the 'Report of the Cruise of the Steamer "Corwin" in the Arctic Ocean in 1885,' which has recently been published as Ex. Doc. 153, Forty-ninth Congress, second session, I notice two plates of fishes, and one plate representing a plant. I desire to say that I never saw these plates before they appeared in this sketch, nor can I explain how they came to be inserted in it. I disclaim all responsibility for the plates, and I do not indorse them. They are inaccurate, and absurd pictures of what they purport to represent.

CHAS. H. TOWNSEND.

Washington, Nov. 20.

SCIENCE

FRIDAY, DECEMBER 2, 1887.

A VERY SIGNIFICANT DISCUSSION on the subject of manual training took place at the late annual meeting of the school superintendents of New York State, held at Rochester. A year or two ago such a discussion would not have been possible. In the first place, the superintendents themselves would not have been able to discuss the subject intelligently at that time, nor would it have been regarded as at all a pressing matter. The events of the last twelve months have, however, conspired to bring about the result which made possible the discussion to which we refer. The continued agitation of the subject by those best qualified to discuss it, the increase of the intelligent literature on manual training, and the magnificent display of the results of this training which was made at the meeting of the National Educational Association at Chicago last July, have all had their effect. They have brought light to many minds where darkness was before, and produced a conviction even among the most determined scoffers at the movement. The discussion at Rochester was introduced by Superintendent Cole of Albany, in which city a very gratifying progress has been made toward the introduction of manual training, and whose school board has a most intelligent idea of the whole subject. The superintendents of Newburg, Dunkirk, Ogdensburg, Binghamton, Owego, and Elmira seem to have been to a greater or less extent in favor of manual training. The event of the discussion, however, must have been the remarks of State Superintendent Draper, for it was reserved for him to advocate manual training in the public schools, not because it is disciplinary, but because of its eventual utility. The attitude of the State superintendent only shows to what remarkable extremes the complete misunderstanding of this subject may be carried. We have frequently heard manual training opposed because of its utility, and because it was claimed that it has no disciplinary value; but Mr. Draper is the first person who has discussed the subject in public who has sufficiently misunderstood the whole subject to advocate it on that ground. He is reported as saying that he had no sympathy with the argument advanced, that industrial training should be carried on for its intellectual force. He claimed that the present school system of the State contained all the intellectual force that was needed. We fancy that the mere statement of these two propositions is sufficient comment upon them. It is hardly necessary to undertake to controvert them seriously. It would be interesting to know, however, whether Mr. Draper proposes to carry his theory into practice, and to eliminate from the school course all subjects which have a disciplinary value, and to replace them with those which have a practical utility. If so, the coming generation in New York may not know how to read, write, cipher, draw, and parse, but it certainly will be able to manage a steam-engine, lay transatlantic cables, and drive horse-cars.

THE DANGER TO COMMERCE from derelict vessels on the high seas cannot be too often pointed out, as it is not generally realized how long they are liable to keep afloat and pursue their aimless course,—a constant menace to navigation, and the cause, no doubt, of the loss of many a fine vessel by collision. This is well illustrated by the following instances, taken from the records of the Hydrographic Office, and it should be remembered that no such record can be complete. Long intervals often elapse without any report being made, and the track during this time, assumed as a straight line on the chart, must generally fall short of the actual

distance travelled. The ship 'Ada Iredale' (voyage from Androsan, Scotland, to San Francisco) was burned in the South Pacific through the spontaneous combustion of the coal with which she was laden. She was abandoned Oct. 15, 1876, latitude $13^{\circ} 30'$ south, longitude $107^{\circ} 45'$ west, about 1,900 miles east from the Marquesas Islands. The crew of twenty-three men reached the Marquesas group in twenty-five days, with the loss of one man and one of their three boats. The still burning wreck of the vessel drifted slowly to the westward in the south equatorial current, to Tahiti, Society Islands, 2,423 miles distant, and was towed into port by the French cruiser 'Seignelay,' June 9, 1877. She continued to burn till May, 1878, when she was repaired, and as a handsome iron bark, named 'Annie Johnston,' has done good service in the trade with China. The drift was 2,423 miles, and the time nearly eight months. The ship 'Oriflamme' was abandoned, on fire, in June, 1881, latitude $18^{\circ} 12'$ south, longitude $92^{\circ} 42'$ west. On Oct. 24 the steamship 'Iron Gate' (voyage from Adelaide, Australia, to Portland, Ore.) passed in latitude $13^{\circ} 27'$ south, longitude $125^{\circ} 19'$ west, an iron ship, apparently burned, with no masts standing, and sent a lifeboat alongside, but could see no signs of life. On Feb. 12, 1882, the hull of an iron ship laden with coal and iron drifted ashore on the island of Raroia, one of the Paumotu or Low Archipelago (latitude $15^{\circ} 55'$ south, longitude $142^{\circ} 12'$ west). She was visited by some natives, who brought away a small bell upon which was engraved "'Oriflamme,' 1865." She was completely burned out, and in a short time sank in deep water. The drift was 2,840 miles, and the time about eight months. The abandoned schooner 'Twenty-one Friends' was first reported March 24, 1885, about 160 miles off the capes of Chesapeake Bay, latitude $36^{\circ} 45'$ north, longitude $72^{\circ} 40'$ west. The Gulf Stream carried her in a direction about east-north-east, to latitude $51^{\circ} 30'$ north, longitude $27^{\circ} 40'$ west (2,130 miles in four months and a half). Thence she drifted in an easterly and south-easterly direction towards the northern coast of Spain, and was last reported Dec. 4 of the same year in latitude 45° north, longitude 8° west (about 130 miles north-north-east from Cape Finisterre). She was reported, in all, twenty-two times, which in itself shows how especially dangerous such a derelict is on the North Atlantic. The drift was 3,525 miles, and the time eight months and ten days.

A CONSPIRACY OF SILENCE.

THERE is an interesting discussion going on in England at present between Professor Huxley, Professor Bonney, and the Duke of Argyll. The question at issue is whether the influence of a great name has become so great in science as to interfere with free discussion in questions of a purely scientific nature. It seems that some seven or eight years ago Mr. Murray offered an explanation of the origin and structure of coral reefs which controverted some of the opinions expressed by Darwin. It is maintained by one side that this theory of Murray's has not been given free publication and discussion, and that, while it is intrinsically more probable than the older theory of Darwin, it is still held in obscurity by a conspiracy of silence on the part of the leading men of Great Britain. To make clear the present state of the controversy, we publish below the articles published in *Nature* by Professor Bonney and the Duke of Argyll.

[COMMUNICATION FROM PROFESSOR BONNEY.]

THE Duke of Argyll is eminent as a statesman, and has won distinction as a man of science. The mental qualities, however, which lead to success in these capacities are widely different; nay, in the opinion of some, are almost oppugnant. To the man of

science, truth is as a 'a pearl of great price,' to buy which he is ready to part with every thing previously obtained: to the statesman, success is the one thing needful, for the sake of which hardly any sacrifice appears too great. This is not said wholly as a reproach: it "takes all sorts to make a world." The ardor of the follower of the ideal, which may degenerate into recklessness, is wholesomely checked and beneficially qualified by the calmness of one who has to deal practically with mankind, and has learned by experience that evolution rather than catastrophic change is the law of life, and is in accordance with the analogy of nature. Still the two types of mind are commonly diverse, and the Duke of Argyll has recently afforded a remarkable instance of the extreme difficulty of combining in one person these apparently opposite characters.

This instance is afforded by an article which appeared in the *Nineteenth Century* for September last, and is commented on by Professor Huxley in the number for the present month. The duke's article bears the somewhat imposing title of 'The Great Lesson.' Professor Huxley's reply forms a part of an article entitled 'Science and the Bishops.' As the charge which the duke has in effect brought against men of science is a very grave one, and as some of the readers of *Nature* may not be constant readers of the chief monthly magazines, a brief notice of both accusation and reply may not be without interest.

The moral of 'The Great Lesson' is practically, 'Beware of idolatry.' The scientific world, in the duke's opinion, has been for some time bowing down to the idol of Darwin and the theory of evolution, which is the fundamental dogma of that cult. Like a prophet of old, he raises a warning voice, and points out that the feet of the golden image are in part composed of clay. In the North has been hewn the stone which shall shatter those fragile supports and lay the idol prone in the dust. To abandon metaphor, this is the state of the case. Among the results of Mr. Darwin's labors during the voyage of the 'Beagle' in the years 1831-36, when he accumulated that vast store of observations which served as a foundation for 'The Origin of Species by Means of Natural Selection,' was a theory of the formation of coral reefs and atolls, set forth in a volume entitled 'On the Structure and Distribution of Coral Reefs' (published in 1842 and republished in 1874). Of this theory the duke gives an outline in 'The Great Lesson,' executing this portion of his task so fully in the spirit of a just judge, and with so little of the craft of an advocate, as to leave nothing to be desired for lucidity of statement and cogency of reasoning. In fact, in the judge's summing-up, the case for the defence appears stronger than that for the prosecution; so much so, indeed, as to suggest that the difference is due to their inherent merits rather than to the mode of statement. However, be that as it may, the duke thus pronounces judgment, and in so doing passes a censure, stinging if deserved, on the men of science of this generation.

These are his words (*Nineteenth Century*, p. 305):—

"Mr. Murray's new explanation of the structure and origin of coral reefs and islands was communicated to the Royal Society of Edinburgh in 1880, and supported with such a weight of fact and such a close texture of reasoning, that no serious reply has ever been attempted. At the same time, the reluctance to admit such an error in the great idol of the scientific world, the necessity of suddenly disbelieving all that had been believed and repeated in every form for upwards of forty years, of cancelling what had been taught to the young of more than a whole generation, has led to a slow and sulky acquiescence, rather than to that joy which every true votary of science ought to feel in the discovery of a new truth, and—not less—in the exposure of a long-accepted error."

Again:—

"The overthrow of Darwin's speculation is only beginning to be known. It has been whispered for some time. The cherished dogma has been dropping very slowly out of sight. Can it be possible that Darwin was wrong? Must we indeed give up all that we have been accepting and teaching for more than a generation? Reluctantly, almost sulkily, and with a grudging silence so far as public discussion is concerned, the ugly possibility has been contemplated as too disagreeable to be much talked about; the evidence old and new has been weighed again and again, and the obviously inclining balance has been looked at askance many times.

But, despite all averted looks, I apprehend it has settled to its place forever, and Darwin's theory of the coral islands must be relegated to the category of the many hypotheses which have indeed helped science for a time, by promoting and provoking further research, but which in themselves have now finally kicked the beam."

This, then, is 'The Great Lesson':—

"It is that Darwin's theory is a dream. It is not only unsound but is in many respects the reverse of the truth. With all his conscientiousness, with all his caution, with all his powers of observation, Darwin in these matters fell into errors as profound as the abysses of the Pacific."

This is plain speaking. In words which admit of no ambiguity the duke declares that Darwin was wrong; that Mr. Murray set him right; and that the latter, instead of receiving a welcome, was met with a virtual conspiracy of silence on the part of scientific men. Of these three assertions,—which are to a considerable extent independent one of another,—the first and second are obviously very much matters of opinion, because, if the third statement be true, it is clear that no verdict has been delivered by experts, but that, like an Irish jury, they have professed themselves unable to agree, because the facts were so strong that even they could not bring in a verdict of acquittal. The third assertion, however, is much more a matter of fact, not difficult to substantiate, and at any rate, if incorrect, easy to disprove.

In regard, then, to the first and second, it may suffice to follow Professor Huxley's example, and be content with expressing a doubt as to the accuracy of the duke's assertions. In the face of statements so definite as those quoted above, this may seem presumptuous. They read almost like the sentence of an ecclesiastical court, which it is heresy to question. *Caledonia locuta est, causa finita est*, seems to be their tone; and if one whisper a doubt, one expects the familiar conclusion, *Anathema sit!* But men of science, as all the world knows, are sceptics. Have they yet awakened and rubbed their eyes, and said of Darwin's theory, "Lo! it was a dream"? What says Professor Huxley? He asserts that Darwin's confidence in the accuracy of his own theory was not seriously shaken, as the duke alleges, and quotes as conclusive evidence a letter from Professor Judd, who gives the results of a conversation which he had with Darwin no long time before the death of the latter. Professor Huxley also intimates that to himself, though tolerably familiar with coral reefs, the new theory is at first sight so far from fascinating, that, until he can devote a considerable time to a re-examination of the whole subject, he must be content to remain "in a condition of suspended judgment," and that Professor Dana, "an authority of the first rank on such subjects," has pronounced against the new hypothesis in explicit terms. Undoubtedly, Mr. Murray has obtained distinguished converts, but with such differences of opinion among those best qualified to judge, it is certainly going further than is warranted by facts to insinuate, if not to assert, that he has convinced the scientific public. Very probably more than a minority of them are in my own position, which perhaps I may be pardoned for stating. They, like myself, have never had the opportunity of forming an independent judgment upon the matter, but they see some very serious difficulties—difficulties which are of a general rather than of a special nature—in the new explanation. At present these difficulties do not appear to them to have been overcome; so that, while admitting that Mr. Murray's hypothesis may sometimes apply, and that Darwin either may have expressed himself a little too sweepingly, or may have been understood so to do, the theory of the latter is capable of a more general application, and presents less serious general difficulties, than does that of Mr. Murray.

We come, then, to the third charge, which is the most serious one, because it affects the morality of scientific men; and many of them, like myself, are old-fashioned enough to resent being called a knave more than being called a fool. Has Mr. Murray been met by 'a conspiracy of silence'? The duke, in asserting this, must have been strangely oblivious of, or among the cares of a statesman, have failed to keep himself *au courant* with the literature of geology. Professor Huxley denies the assertion, and adduces in his support an answer to an inquiry which he had addressed to Professor Judd. The facts according to these authorities are briefly as follows: Mr. Murray's views were duly published, as the

duke himself states; they were favorably regarded by the authorities at the 'Challenger' office; they were expounded, one might almost say advocated, on more than one occasion by Dr. A. Geikie. His text-book in the year 1882 not only took the leading place, as it still does, but also was then the only complete text-book on a large scale for this country. On p. 468 is a full statement of Mr. Murray's views. They have also been referred to at more or less length in many treatises and journals, both English and foreign. As Professor Judd remarks, "If this be a 'conspiracy of silence,' where, alas! can the geological speculator seek for fame?"

Thus the main charge is disproved. One special item in it, however, as peculiarly offensive, yet calls for a brief notice. The duke states, "Mr. John Murray was strongly advised against the publication of his views in derogation of Darwin's long-accepted theory of the coral islands, and was actually induced to delay for two years." Now, if these words do not amount to an imputation of bad faith on the part of Mr. Murray's adviser, and are not by insinuation extended to others, I do not know what they mean, or why they have been penned. But, as Professor Huxley observes, "whether such advice were wise or foolish, just or immoral, depends entirely on the motive of the person who gave it." The remark is perfectly just. Who, I would ask, who is old enough to look back on a quarter of a century of work, has not occasionally said, "Wait a bit," to some younger friend, who has come in the first incandescence of a brilliant hypothesis? I have so sinned. Sometimes I have been wrong and my young friend right, but not always. Still, I know myself fallible. As the late master of Trinity said, "We are all fallible mortals, even the youngest amongst us." Yet I am not ashamed. I will not put on sackcloth and ashes, and I mean to sin again. Perhaps it is because I am naturally unimaginative; perhaps I am come to the season of autumn leaves; but I have always looked askance at a brilliant hypothesis, and now distrust it more than ever. I have lived long enough to see many a one go up *whoosh!* like a sky-rocket, all stars and sparks, and come down exploded, all stick and stink.

So the 'great lesson' has been read, and the scientific world, I fear, has not repented or rent its clothes. But it has heard, and not without indignation. The Duke of Argyll has made grave charges against the honor and good faith of men of science, and they ought to be grateful to Professor Huxley for his prompt repulse of the attack and his stern rebuke of the assailant. As it seems to me, reply is only possible on one point; namely, the special charge mentioned above. Hence the Duke of Argyll is bound to establish or to withdraw the accusation.

Men of science are justly sensitive on this question. Doubtless they are no more exempt from human frailty than any other class of men: we all fail sometimes—nay, too often—to live up to our ideal standard; still, such shortcomings are not common, and any thing like a 'conspiracy of silence' or any kind of scientific 'boycotting' is a thing so improbable as to be almost incredible. Each man must testify according to his own experience: so in conclusion, though it may be deemed impertinent, I will express my own. I have lived now for not a few years among the rank and file of scientific men on more intimate terms than can have been possible for the Duke of Argyll, owing to his exalted station and his high occupations of state, and I am bound to declare, that, in a fairly wide experience, I have never found men as a class less self-seeking or more earnest in their desire for truth, more steadfast as friends, or more generous as antagonists. T. G. BONNEY.

[COMMUNICATION FROM THE DUKE OF ARGYLL.]

THE article which I contributed to the September number of the *Nineteenth Century*, on the coral islands of the Pacific, has done what I intended it to do. It has called wide attention to the influence of mere authority in establishing erroneous theories and in retarding the progress of scientific truth. The vehement assault made upon it in the current number of the same review by Professor Huxley, and the article by Professor Bonney in this journal, are to me gratifying evidences of success. But both of these writers are entirely wrong in the interpretation they put on a few expressions in my paper. They interpret these expressions as conveying imputations on the probity and honor of scientific men in the habitual and wilful suppression or discouragement of what they know

to be truth. But there is nothing to justify this interpretation. I have made no such accusation, and, if any one else were to make it, I should join the two indignant professors in repudiating it. Scientific men are not only as good as other men in this way, but generally a great deal better. Professor Huxley has been irritated by some 'anonymous sermon,' which I have not seen, and for which I am not responsible. He admits that it is in this anonymous production that the 'sland'ers' against scientific men have taken the peculiarly offensive form; but he maintains that this unknown writer has been 'inspired' by my article on coral islands. On the strength of this assumption,—which may be true, for aught I know,—he goes on through some seven pages to dissect certain parts of my paper, and to read into it a great deal that is due to his own excitement, and to nothing else.

I have no difficulty in expressing clearly, and without any circumlocution, exactly what I do mean, and what I have intended to say. Professor Bonney interprets it very fairly, in abstract, when he says that the moral of my paper is, 'Beware of idolatry.' Some theory, hypothesis, or doctrine is propounded by a great man. It becomes established, partly perhaps by certain inherent elements of strength, or, at all events, of attractiveness. But soon it stands unassailable and unassailed upon the vast foundations of general acceptance and admitted authority. It becomes what Professor Huxley on a celebrated occasion, and with at least a momentary insight, called 'a creed.' The effect of such a position is tremendous. Some men who see cause to doubt are daunted. They keep silence. Others are prevented from even thinking on the subject. A few who do think, and who do doubt, and who do venture to express their doubts, are discouraged and discountenanced. A great many others take refuge in a suspended judgment, even after the production of evidence, which, in the absence of a 'creed' and of authority, would have been deemed conclusive. In all this there may be, and in general there is, nothing worse than timidity on the part of those who are the laggards, or the opponents, in some great advance. It is more difficult for some men than for others to face a prevalent opinion or an accepted doctrine. It is all very well to say, as Professor Bonney says, that "to the man of science truth is a pearl of great price, to buy which he is ready to part with every thing previously obtained." But scientific men are human. They are, I admit, immensely superior to the politicians, especially just now. But they have their failings; and every one who knows the history of science must be able to call to mind not one instance only, but many instances, in which the progress of knowledge has been delayed for long periods of time by the powerful and repressive influences of authority, exerted in one or other of many ways.

My contention is, that Darwin's theory on the origin of the coral islands is a case in point. I believed in it, or accepted it, for many years, as others did. Professor Bonney admits that I have described it not only fairly, but as forcibly as if I were still its advocate. This is exactly what I tried to do. I now hold that it has been disproved, and has been replaced by another theory quite as grand, and more in harmony with other natural laws which are of universal operation, but have been only lately recognized. I affirm, further, that this new theory or explanation has been received with the timidity, the discouragement, the discountenance, and the obstruction which are characteristic in such cases. That Dr. Geikie has supported it, is most creditable to him. But his voice is not enough to disprove the truth of my contention. That Professor Huxley and Professor Bonney should be unable to make up their minds upon such evidence as has been before us now for several years, is, in my opinion, a strong confirmation of the law which is operating upon them. There are some discoveries in science—some explanations of curious phenomena—which are self-luminous. They shine with their own light. The moment they are suggested, with a few cardinal and certain facts to illustrate them, they are their own proof. Every thing that turns up speaks in support of them. My conviction is that such is the character of Mr. Murray's theory of the coral-island formations in the Pacific.

Professor Huxley challenges me to re-affirm with better proof the fact I allege,—that Mr. Murray has met with discouragement. I respond at once to that challenge. I have seen the letter from Sir Wyville Thomson in which that naturalist urged and almost insisted that Mr. Murray should withdraw the reading of his papers

on the subject from the Royal Society of Edinburgh. This was intaker or somebody informed me." Then the culprit is brought before him, and the fact revealed that he indirectly aided a criminal.

February, 1877. No special reason was assigned, but the terms of the letter indicate clearly that Sir Wyville dreaded some injury to the scientific reputation of the body of naturalists of whom he was the chief, and for whom, as connected with the 'Challenger' expedition, he was in some degree responsible. He had not himself at that time, I believe, fully accepted the new doctrine. But that would have been no sufficient reason for discouraging free discussion, if it were indeed as free as it ought to be. In my article I understated the delay which was thus occasioned. Three years, not two, elapsed before Mr. Murray was at perfect liberty to advocate his views in the proper place, before a scientific body.

But the challenge of Professor Huxley has brought to my knowledge a new bit of circumstantial evidence to the same effect, which is highly significant. Among the investigators of the Pacific corals, no man has done better work than Dr. Guppy, surgeon of H.M.S. 'Lark.' Since my article was written, his volumes on the Solomon Group of islands have been published. The geological volume is an admirable memoir. It is the record of observations as patient, detailed, and conscientious as have ever been made on the great geological problem which is at issue. After his return home, he was advised by Mr. Murray to offer a paper on his researches to the Geological Society of London. He did so in the spring of 1885. But his paper was refused, much to Dr. Guppy's disappointment. It was not orthodox. His facts effectually removed some difficulties in the way of Mr. Murray's theory,—facts which in more than a corresponding degree were adverse to the theory of Darwin. As a consequence the Royal Society of Edinburgh has had the honor of receiving and publishing Dr. Guppy's most interesting memoir. As a Scotchman, I am proud of this contrast. I make no accusation of wilful unfairness against the authorities of the Geological Society of London, of which my critic Professor Bonney was, I believe, at that time the president. They did not consciously discourage truth. On the contrary, they probably smelt heresy. But if their minds had been free from this prepossession,—if they had been alive to the breadth and sweep of the questions at issue, and open to receive with welcome the crucial evidence bearing upon them which is contained in Dr. Guppy's paper,—the rejection of it would have been impossible.

As regards Darwin's own state of mind upon the subject, I can only say that my information was as good as that in the possession of Professor Huxley. I am not struck by the perfect candor of his reference to Darwin's letter to Professor Semper in October, 1879. If he had quoted the very next sentence to that which he does quote, a very different impression would have been left on the reader's mind. But I attach no importance to this point. I prefer to believe that Darwin's mind was open to conviction, and to hope that others will follow his example.

ARGYLL.

THE AMERICAN PUBLIC HEALTH ASSOCIATION.¹

DR. CARL HORSCH of Dover, N.H., read a paper entitled 'The Necessity of Burial-Permits and Inspection of Bodies of Deceased Persons.' He based this necessity on the following grounds. (1) It is the best safeguard against the possibility of premature burial, and also that the apparently dead may not be placed in cold rooms or on ice, and frozen to death. (2) Cases of concealed contagious and infectious diseases will be detected, and an epidemic may be averted. (3) Murder and suicide may be detected; and if cremation, the surest method for the destruction of disease-germs, is generally established, there will be also less danger that the body of a murdered person will be cremated, and the crime concealed. (4) Life-insurance frauds may be prevented. (5) Where the fear exists of being buried alive, the family physician can overcome that fear by that examination, and his assurance that the loved one is dead. (6) In order to sign a certificate for a burial-permit legally, that inspection gives the most important evidence. If a physician gives his signature to such a certificate without seeing the body, he may be brought in the following unpleasant position: he is called into court, the certificate is laid before him, the questions asked, "Did you sign that certificate?" Answer, "Yes." "Did you know that the person was dead?" The only answer could be, "The under-

¹ Continued from *Science* of Nov. 25.

before him, and the fact revealed that he indirectly aided a criminal.

Dr. Rohé, secretary of the committee on disinfectants, presented the report of that committee. The following conclusions were drawn from their work:—

1. The temperature required to destroy the vitality of pathogenic organisms varies with the different organisms.

2. In the absence of spores the limits of variation are about 10° C. (18° F.)

3. A temperature of 56° C. (132.8° F.) is fatal to the bacillus of anthrax, the bacillus of typhoid-fever, the bacillus of glanders, the spirillum of Asiatic cholera, the erysipelas coccus, the virus of vaccinia, of rinderpest, of sheep-pox, and probably of several other infectious diseases.

4. A temperature of 62° C. (143.6° F.) is fatal to all of the pathogenic and non-pathogenic organisms tested, in the absence of spores (with the single exception of *sarcina lutea*, which in one experiment grew after exposure to this temperature).

5. A temperature of 100° C. (212° F.), maintained for five minutes, destroys the spores of all pathogenic organisms which have been tested.

6. It is probable that some of the bacilli which are destroyed by a temperature of 60° C. form endogenous spores, which are also destroyed at this temperature.

Dr. John S. Billings, U.S.A., read a paper on some forms of tables of vital statistics, with special reference to the needs of the health-officer.

A resolution was adopted to appoint a committee, with Dr. Sternberg as its chairman, to study experimentally the methods and effects of protective inoculation against infectious diseases.

Dr. Horsch presented a paper entitled 'Inspection of Animals required for Food,' in which he recommended the inspection of animals by competent persons before they are slaughtered, and a thorough examination of their viscera afterwards.

Dr. Azel Ames, jun., of Chicago presented a paper on the meat-food supply of the nation, and its future. In it he gave statistics of the resources of the country with reference to its animal food, and showed, that, as the population increased and the grazing country diminished, these resources were proportionately declining. He criticised adversely the policy of the general government in dealing with the public lands. Legislation was asked of Congress for the suppression of pleuro-pneumonia, and for the taking of a thorough census of the cattle of the country and their products. Dr. Ames denounced the tax imposed by the oleomargarine act as being unjust to the poor, and wrong in principle, and demanded its repeal.

A paper by Dr. J. H. Rauch, secretary of the State Board of Health of Illinois, dealing with the subject of cholera and quarantine, excited great interest. Dr. Rauch described the defects of the quarantine at the port of New York, and said that in the West its results were looked upon with distrust. He asked that the entire quarantine system of the United States should be placed under national control. In the discussion which followed, Dr. A. N. Bell criticised most severely the arrangements of the New York quarantine, but expressed the opinion that the measures which had been applied by the health-officer in the management of the passengers of the steamers 'Alesia' and 'Britannia' had been successful.

The paper of Dr. Dickinson was discussed by a number of the members of the society. Dr. Eliza M. Mosher remarked that the point of greatest interest in connection with the subject was whether the loose corset injured the health of the wearer, and, if so, what could be offered as a substitute. Most girls, according to her experience, wore them sufficiently tight to limit respiratory movements. It was difficult to measure the injury done, since the chest was already crippled, and its expansion was below its possibilities. In addition to the thinning of the abdominal wall described by Dr. Dickinson, there was atrophy of the entire surface covered by the corset, with lack of development of muscular tissues due to restricted movement. This was apparent by the often-repeated remark of ladies that they could not sit up straight without their corsets. It was often observed how useless were the arms of most young ladies for any manual labor, even though their lower extremities were capable of long-continued muscular movement. A well-developed nipple was almost an unknown thing with a woman or girl who had worn

a corset for any length of time. The respiratory murmur below the fifth rib was very faint compared with the sounds above, and these ladies found it impossible, as a rule, to move the strength 'spirometer' the fraction of a degree. From these facts, she concluded that the capacity of the chest had become limited, and the muscular fibre of the diaphragm impaired, by the unyielding walls of the corset-prison. Not very great compression upon the line of attachment of the diaphragm was required to interfere with its contractile power. Loss of strength in the abdominal muscles and diaphragm prepared the way for a slow and painful, if not instrumental, labor. Loss of respiratory capacity implied increase in rapidity of the heart's movements: this meant weakening of its force, and thus came the cold extremities and easily chilled skin so common in those who wore corsets. She had not been able to demonstrate the displacement of the liver spoken of, because doubtless the examinations were made with the corset off. With a large experience in treating girls suffering from displacements of the uterus (mainly retroversion and downward crowding), little could be done to relieve the sufferers until the corset was laid aside. Active muscular movements and corsets were not compatible, and unless the corset and its equivalent, tight clothing, were discarded, she was not sure but girls were better off without active physical exercise. What could we substitute for the corset, which, without producing pressure or displacement, would give the trim and tidy look so much admired by the sterner sex? A good dressmaker had more to do with this matter than the corset had. An underwaist without bones, with skirts snugly fastened to it; a dress-waist well shaped, containing a few bones, and loose enough to permit a long breath without limitation,—would make nine girls out of ten look just as trim and tidy as a corseted waist. If something more supporting was demanded, the 'Ferris waist' was all that was required. Without steels in front, and without bones, if worn loosely with the skirts attached, it might be accounted healthful. Dr. R. G. Eccles spoke of the comfort women derived from the corset. He had noticed that the more intelligent the women, the more they were corset-wearers. Dr. Jerome Walker spoke of the evils of corset-wearing, among which he mentioned the shallow breathing as particularly objectionable. Dr. William Anderson thought if we educated the women to despise the corset, it would disappear. The president remarked that we did not use our chests to their full capacity except when making unusual exertion. A woman under ordinary circumstances had her breathing but little restricted. If the servant laced herself in her ordinary working costume as she did on Sunday, she would suffer severely.

MENTAL SCIENCE.

The Mechanism of Attention.

M. TH. RIBOT, whose useful compilations on English and German psychological movements, on heredity, on the diseases of memory, of will, and of personality, have gained for him a world-wide reputation, contributes to the *Revue Philosophique* (of which he is the editor) an interesting and convenient account of the mechanism of the processes of attention.

Attention is not so simple a phenomenon as popular analysis makes it. It is not always one and the same state, but varies indefinitely in intensity, from the momentary attention necessary to brush off a fly, to the most complete absorption. This intensity is gained either by the accumulative results of a long-continued strain, or by an intense focusing of all energies to one group of sensations. Regarding attention thus as a state varying in degree, we are ready to make a distinction on which M. Ribot lays much stress; namely, between spontaneous and voluntary attention. Our notion of attention is derived almost exclusively from the latter. Attention we regard as a purposive effort. But this is really not the typical nor the most important aspect of attention. The former has been much neglected, and to it M. Ribot devotes his first article. The distinction between the two forms of attention is easily made clear. The first is a natural impulse to let such things make an impression upon us as excite our interest. The second is an artificial product of civilization, that we have learned at school. To look at flowers and be impressed by them is a result of spontaneous attention; to

dissect and minutely analyze their parts, of voluntary attention. The main characteristic of attention, and especially of its typical, natural form, now under discussion, is its motor aspect. As Maudsley puts it, whoever is incapable of controlling his muscles is incapable of controlling his attention. All attention, however, is, in a sense, an abnormal, exceptional state. Such states cannot last long, because they are opposed to the ever-present change that is the law of life. We see this abnormality when attention is carried to the extreme, producing clouding of the mind, a mental void, or vertigo. Their analogy with fixed ideas and states of ecstasy is also close. The normal process of 'cerebrising' consists of an ever-changing focusing on one set of impressions, then a diffusion of these to give place to another group, and so on in an ever-successive lighting and skipping; the laws of association governing the order and connection of the several foci. Normal thought is thus a 'poly-ideism,' while attention is a 'mono-ideism.' It is a focus concentrating into itself all the available energies; it is the substitution of unity for diversity. Attention is further characterized by being directed towards an end: it is not a subjective process, but is adaptive, convergent. If a definition be desirable, we might define attention as "an intellectual mono-ideism with spontaneous or artificial adaptation of the individual."

Spontaneous attention is well seen in children and in the higher animals. Its cause is universally an *emotional* state. It is only the sensation-exciting, the interesting, the agreeable or disagreeable, that is naturally attended to. An animal incapable of feeling pleasure and pain would by that fact be incapable of attention. This general fact is exemplified in the biographies of great men, showing in some cases how the hero of the tale is for a long while restless, listless, until he falls upon the occupation that interests him, enthuses him, and brings out his genius by focusing his attention to a single line of thought. This passion for work has its analogue in other less desirable passions. The drunkard's attention is critically intense in the presence of the glass. But these intense states cannot endure long, and they only last as long as they do because a small amount of flitting really goes on, continuous as the state seems to us.

The physical conditions and accompaniments of attention are of great importance. The general law under which they are to be considered is that there is no thought without a tendency to its expression in motor terms. Thought is initial action. The motor expressions of attention are visible in three directions,—the vaso-motor phenomena, the respiratory phenomena, and the expressional phenomena. The first is recognized in the increase of blood in certain parts of the brain under mental work, as ascertained by direct experiments of Mosso and others. The slightest mental strain produces this result. The second is characteristic of the attitude of attention. The breath is slowed or held; sighs occur; and all this suggests the abnormality of the process. The third kind of movements are psychologically the most interesting; and many theories, notably that of Darwin, have been proposed to explain their origin. Duchenne experimented by applying electrical stimuli to muscles of etherized patients, and noting the facial expression thus aroused. He regarded the contraction of a single muscle as characteristic of one emotion. The frontal muscle furrowing the forehead is the muscle of attention; the orbiculars contracting the orbital space and lowering the eyelid of reflection, and so on. The motor expressions will be different according as the attention is directed inwards (reflection, contemplation) or outwards, as is usually the case. The motor expressions of the two are opposed: in one the forehead is lowered, in the other the eyelid is lowered, the mouth closed as in effort, and so on. Darwin calls the attitude of reflection that of difficult vision turned inwards. The general attitude of attention is immobility, a tendency to unity of action, to convergence. It is a concentration of both motions and thoughts; and the degree of attention is inversely to the amount of motion. An attentive audience is quiet: an inattentive one shuffles and moves in a hundred ways.

To this rule there is an apparent exception in the common habit of walking, beating, etc., when deep in thought. This is to be accounted for by the increase of brain-activity thus brought about. Such movements are dynamogenic, re-enforcing, arousing the motor centres, and thus adding to the available energy.

The accompanying motions of attention are not merely signs of the former, but are essential, constituent factors of it. Suppress the expressive movements, and you suppress the whole process. The fundamental rôle of these movements is to keep up and reinforce the attentive consciousness. The brain in attention acts both as an intellectual and as a motor organ.

A special form of spontaneous attention is surprise, and it is simply an exaggerated form of it. Descartes has given a good account of it, recognizing (though in other terms) the increase of nervous influxes that accompany it, the direction of energy towards muscles, and the typical facial expression. Surprise is a shock caused by the unexpected, a sort of emotional hiatus. This lasts until the object that caused the surprise is apperceived, recognized, adapted to. In surprise one feels much, and knows little; and the intense emotion rivets the attention. On the physical side the symptoms are exaggerated, the eyelids are widely opened,¹ perhaps the mouth too.

The utility of attention in the struggle for life is evident. The moment differentiation is clear, one part of the organism concentrates the energy and arouses a rudimentary attention. Riccardi places the origin of attention in the arthropods. The attention gets centred upon the most perfect sense in the animal, whichever that is. In the higher animals attention is marked, and in all such as play, showing thereby a surplus of energy, there is also an attention to objects not directly useful in the struggle for existence. This is the higher form of attention, equally evident in children.

In a succeeding article Professor Ribot will give a similar exposition of voluntary attention.

PRIMITIVE MIND.—An interesting glimpse into the thought processes of unenlightened peoples is furnished by the following observation of the Ainos (a degenerate Japanese tribe distinguished for their long growth of hair) during the recent eclipse. The Aino is said not to be imaginative, but, on being shown the eclipse through a smoked glass, he cried out that the sun was fainting away and dying. A silence ensued, broken by an exclamation of fear that the sun would dry up. They brought water and sprinkled it upwards towards the sun, crying, "O god, we revive thee! O god, we revive thee!" Some squirted the water upwards with their mouths, some threw it up with their hands. A group of women and girls sat down with their heads between their knees, as if expecting some calamity. Their tradition with regard to the eclipse says that "when my father was a child, he heard his old grandfather say that his grandfather saw a total eclipse of the sun. The earth became quite dark, and shadows could not be seen; the birds went to roost, and the dogs began to howl. The black, dead sun shot out tongues of fire and lightning from its sides, and the stars shone brightly. Then the sun began to return to life, and the faces of the people wore an aspect of death; and, as the sun gradually came to life, these men began to live again." Otherwise they have no theory of the eclipse, but their personification of the phenomenon is evident.

EXPLORATION AND TRAVEL.

Wissmann's Expedition across Africa.

LIEUTENANT WISSMANN, whose journeys in the Kongo basin won him a well deserved fame as a traveller and energetic explorer, has just returned from his second expedition across the African continent. In the spring of 1886 he started from Angola for Luluaburg, a station of the Kongo Association which is situated in the empire of the Muata Yambo. Since Pogge's first journey in 1876, there have been six Muata Yambos, and, as at the death of the ruler the capital is changed, six capitals of the empire. We gave a report of Wissmann's expedition from Luluaburg to the Baluba country in No. 228 of *Science*. On his return from this excursion, he found one building of the station, which contained twenty-one rooms, burnt down, and the commander sick with malaria. His description of the station is of some interest. It consists of a number of houses for the officers of the station, barracks, a house for twelve women, stables, and a prison. The latter is called the cold house,¹ as it is not permitted to have a fire in it during the

¹ That this is instinctive is borne out by the fact that it occurs in those blind from birth, and in whom opening the eyes could not thus increase sensation.

night,—a regulation which is much feared by the negroes, the nights being very cool on the high plateau. The station is protected by a stockade, and a *glacis* three hundred feet in width. The roads in the neighborhood of the station are fifteen feet wide, and kept very clean. About two thousand feet from the station a village of the Bassilange is situated.

Wissmann's expedition, when starting from Luluaburg in October, 1886, consisted of eighty-nine persons, among whom were an interpreter, a Zanzibari, and thirteen Angola men, while the rest were Bassilange. The number of people, however, rapidly increased to about one thousand, and the Lukugesha, the empress of the Muata Yambo Empire, and the son of Kalamba, with their followers, joined the expedition. When they arrived on the Lubi, an excursion into the country of the Benangongo, who live on the right bank of the river, was made. Then the river was followed to its confluence with the Sankuru, which was crossed below the mouth of the Lubi. It was originally Wissmann's intention to explore the country north-east of this river, which forms the watershed between the Sankuru and the Kongo. He found, however, the state of affairs in the country east of the Sankuru so much changed since the time when he visited it first, four years ago, that he was unable to carry out his purpose. While formerly the cowry was the principal object of barter, now guns and ammunition were in demand. The slave-trade is flourishing. The chiefs of the Bassonge and Bassenge, frequently supported by slave-traders, make raids upon the neighboring tribes in order to procure slaves. These are bartered to the traders for guns and ammunition, or for ivory to the Bakuba, who buy the women for their household, the men for being sacrificed at burials. A short time before Wissmann's arrival a chief of the Bakuba had died, and two hundred slaves were killed when he was buried. Travelling eastward, Wissmann crossed a vast belt of primeval forest which is inhabited by Batetela and the dwarfish Watwa. The woods are almost void of large animals, and even birds are scarce. On the Lukassi the expedition was attacked by the natives, who killed several persons with their poisoned arrows. But after a lively skirmish the natives were driven off, and, when the expedition reached their villages, they were found deserted. During the month of January, 1887, Wissmann crossed a territory depopulated by war and small-pox. The country of the industrious Beneki, whom he visited on his first journey, he found entirely devastated. Famine and small-pox prevailed among the members of the expedition, and it was not until the Lomami was crossed that matters became more favorable. At last Nyangwe was reached. Wissmann found the Arabs of this place in a state of great excitement on account of the events at Stanley Falls. Nevertheless he succeeded in returning the Bassilange to their native country, but Wissmann himself had to give up the hope of further explorations, and proceeded on the well-known route to the Tanganyika and by way of Lake Nyassa to Zanzibar, whence he returned to Europe.

The results of this expedition are not so important as it was hoped they would be when Wissmann started from Luluaburg. An expedition from the Kongo southward, or from Luluaburg north-eastward, is what is wanted to give us a more thorough knowledge of the hydrography of Central Africa.

THE HUDSON BAY EXPEDITION OF 1886.—Lieutenant Gordon's report of the last expedition of the 'Alert' to Hudson Bay makes it clear that all hopes of establishing a trading-route from England to the west coast of Hudson Bay must be abandoned. The navigation of Hudson Strait proved extremely dangerous on account of the prevailing fogs, the strong tides, and the narrowness of the waters, but principally on account of the heavy ice of Fox Basin, which frequently obstructs the western entrance of the Strait, and of the faulty working of the compass. Besides, vessels navigating these waters must be fortified for meeting the ice, and must not be larger than two thousand tons, because a larger ship would be somewhat unwieldy, could not make such good way through the loose ice, and, being unable to turn so sharply, she would get many a heavy blow, that a smaller ship would escape. Gordon supposes that navigation can be opened between the 1st and 10th of July, and that the closing of the season would be about the first week of October. These results of Lieutenant Gordon's experience agree exactly with what was maintained by all experts when the scheme was first propounded; but at that time their

views were disregarded in Canada. Although the principal object of the expedition has failed, its scientific results are considerable. These consist chiefly of the meteorological and hydrographical observations of two years, from the fall of 1884 to the fall of 1886, and other occasional remarks of the observers. The results of these observations are laid down in a meteorological atlas of Hudson Bay, but it seems to us that the available material is too scanty for constructing the monthly isothermal lines over so vast a territory. The report is accompanied by a plan of Churchill Harbor and York Roads (at the mouth of Nelson River), from the surveys of Lieutenant Gordon. The general track-chart is not very elaborate, and in many parts not up to date. Several changes in the coast-line appear, for which no evidence is given; e.g., the division of the main island of Southampton into two parts. The publication of several charts and plans based on surveys of the expedition is promised at the end of the report.

ETHNOLOGY.

The Eskimo Tribes.

DR. RINK, who has for a long time maintained the American origin of the Eskimo, has published the results of his long-continued observations and studies in the eleventh volume of the *Meddelelser an Grønland*. Fortunately the volume, the publication of which has long been wished for by all students of Arctic America, is written in English, and thus made accessible to a wide circle of readers. Rink has propounded his views on the origin of the Eskimo in several papers, which were published in various journals. He believes that they descended from the interior of Alaska to the coast of the Arctic Ocean, and gradually spread eastward. His arguments, which form the first part of his book, are based on a comparison of the implements, dress and ornaments, domestic industry and arts, religion and folk-lore, and sociology of the Eskimo of the various parts of Arctic America. The results of this investigation are, that the hunting-implements are the more highly developed the farther we proceed eastward, that the style of dress and habitations show a gradual approach to the Greenland style from west to east, and that the western tribes occupy a higher stage of social organization than the eastern ones. Among the customs which prevail among the western tribes, but gradually disappear eastward, he mentions the use of the labret, and the religious festivals in which masks are used.

Conclusions drawn from these facts are necessarily open to discussion, as these phenomena may be explained in different ways. I think attention should be called to the fact that all the peculiarities of the western tribes may be derived from an influence of the North-west American culture. We have the extensive use of masks, the peculiar wooden hat of the southern Eskimo tribes, the use of the labret, the festivals in which property is given away, the houses built on the same plan as Indian houses, the sweat-bath, the existence of slavery, and the high development of the art of carving. The existence of so many similar or identical phenomena in two neighboring nations cannot be fortuitous. Besides, I have to mention that the folk-lore of the tribes of British Columbia refers to the Eskimo country and to the Eskimo as plainly as possible. The legends of tribes of Vancouver Island speak of a country in the far west, where the sea is always covered with ice, where the nights are very long, and where people live who use skin boats. Considering the great uniformity of Eskimo life all over Arctic America, I cannot but conclude that here an immediate influence of the North-west Americans upon the Eskimo had place, and that west of the Mackenzie we do not find the latter in their primitive state of culture. It is not impossible, that, in consequence of this influence, inventions and customs which were originally Eskimo (as the kayak) became more neglected than they are in other regions where foreign influences were not so strong.

But we have to consider several other points. The use of masks representing mythical beings, which is peculiar to North-west American tribes, is not entirely wanting in the east. The giving-away of property at certain festivals, and the use of the singing-house, with a central fire and places for the people all around the wall, may also be traced as far as Davis Strait. It may even be that the plan of the stone or snow house of the central Eskimo,

with elevated platforms on three sides of a central floor, must be traced back to a square house similar to that of the western tribes.

I will not enter into a discussion of the similarity between Eskimo and Indian folk-lore, as we are not sufficiently informed about this subject. The few traces which are common to both are so wide-spread that they cannot be considered proof of an early connection between these nations. The story of the dog who was the ancestor of certain tribes, the transformation of chips of wood into salmon, the idea that animals are men clothed in the skins of animals, stories of children who were deserted by their relatives and became rich and powerful by the help of spirits, are common to the folk-lore of North-west America and the Eskimo.

It seems that the only safe conclusions one can arrive at are the following. The Eskimo reached an ice-covered ocean as one body. At that time their religious ideas and implements were similar to what we observe at the present time. They knew the kayak and the sledge, they lived probably in large square houses, they had domesticated the dog, and it is not improbable that they had certain festivals which referred to the seasons or to the sun. Besides this, we are inclined to suppose that they were fishermen, and were accustomed to the use of boats before they came to the Arctic Sea. These conclusions seem to point out that the Eskimo spread from the great rivers of central Arctic America.

In order to make satisfactory progress in the puzzling problem of the origin of the Eskimo, the influence of the North-west Americans upon their Arctic neighbors, and the origin of the folk-lore of the Tinné and western Eskimo, must be studied. In our present state of knowledge, we can consider the American origin of the Eskimo only a theory, which is more probable than an immigration from Asia.

The principal part of Rink's book is an excellent treatise on the Eskimo grammar, and a comparative list of the independent stems of the Eskimo dialects. The stems are arranged in alphabetic order, and to each is added the dialect in which it occurs. As the Greenland dialect is by far the best known, it is made the basis of the list, and all other dialects are referred to it. A discussion on the modes of spelling applied by different writers and the probable differences of dialects precedes the linguistic part. We believe that the material for studying the phonetic laws of the Eskimo language is large enough to allow a more thorough investigation, and we consider the latter very desirable. Among the contents of the collection of stems, we have to call particular attention to the Greenland words occurring in traditions and in the sacred language of the priests. These words, as well as those which I collected among the central Eskimos, tend to show that many of the Alaskan stems which are lost in the common language still exist in the sacred language, and thus the most distant branches of the Eskimo stock are linked closer together. Besides, Rink has shown that a number of words that were considered exclusively western occur in certain derivations among the eastern tribes. Among these I mention the word *suk* ('man') of Alaska, which is found as *suwosek* in the east. All recent researches tend to show that foreign influences upon the language are very slight, and the difference of dialect is probably entirely due to evolution.

The work of Dr. Rink will be highly appreciated by all ethnologists, and we have only to add the wish that the learned author will publish the originals of his large collection of Eskimo traditions, which would be highly welcome to students of American philology.

F. BOAS.

BOOK - REVIEWS.

The Children of Silence; or, The Story of the Deaf. By JOSEPH A. SEISS. Philadelphia, Porter & Coates. 8°.

THE object of this book is to excite interest in behalf of the deaf and dumb; and the means by which the author aims to do this is by presenting statistics of the numbers thus afflicted, the sad condition in which the deprivation leaves them, and an account of what has been done for their relief. Judged by the lenient standards which one must apply when considering it as a benevolent enterprise, the work is quite successfully done, and throughout urges the reader to a deeper knowledge of the subject than is here available. Regarded as a contribution to educational science, a less favorable

verdict must be passed. There is a lack of unity in the pages, and a much more serious lack of appreciation of the best literature (even that in English) on the subject. Books of this order have been frequently published, and have done much good in arousing the public to an intelligent interest in the lives of the defective classes. In 1835 Mr. John R. Burnett published at Newark, N.J., his 'Tales of the Deaf and Dumb,' which, though introducing much irrelevant matter, shows a deeper insight into the mental condition of the deaf-mute than the pages of Dr. Seiss; and, best of all, the 'Lost Senses,' by Kitto, contains a highly valuable description of the world, from the deaf man's point of view, by an eminent and observant scholar. Neither of these sources seems to have been utilized by the author. Again, in discussing intermarriage of near relatives as a cause of deafness, the author leaves the most interesting contribution to the subject (the memoir of Prof. Graham Bell) with a merest notice, though this is one of the topics to which he devotes most space.

The statistical element in the volume is as good as any thing we have. There are about thirty-five thousand deaf-mutes in the United States, but the defective method of taking the previous statistics makes it impossible to say whether deaf-mutism is on the decrease or not. The most probable average ratio of deaf-mutes to the population at large is 1 to 1,500, and this would give about a million of deaf-mutes in the world; and yet (in the United States at least, and probably elsewhere) the deaf form the smallest element of the defective classes, including under this term the blind, deaf, idiotic, and insane. Deafness, however, is a disease of childhood, and the number of deaf persons of school age is double that of the blind. It is interesting to add that there are about six deaf males to five deaf females, and that the notion that the deaf have an immunity from other diseases of the sense-organs is not borne out. Among the causes of deafness the intermarriage of near relatives is regarded as a very serious one. While some authors look upon such marriages as harmless when both parties are of a sound constitution, yet the bulk of the evidence is decidedly opposed to such unions, and finds in their offspring an undue proportion of nervous defects of all kinds. That the intermarriage of deaf-mutes is a fertile source of the increase of deaf-mutes is now generally admitted, and some regard one-third of all cases as due to this origin. A very large number of deaf-mutes are deaf from birth; and of those who become deaf, a very large percentage lose their hearing in the first, second, or third year of life. After this the liability to deafness rapidly decreases.

The relation between deafness and muteness is not a necessary one: it is because the ear educates the vocal mechanism that deaf persons become mute, not because their vocal organs are not correctly formed. This fact makes it possible to teach the deaf to vocalize; and the system by which they are taught to read the sounds on the lips of the speaker, while they answer by speaking as well as they can, is already the most widely adopted, and seems destined to supersede the finger-alphabet for general purposes. The question whether the blind or the deaf suffer the worse affliction has often been asked; and it is not generally known that on this point there is quite an agreement, among those most competent to judge, in favor of the blind. The deprivation of spoken language is in our civilization the most serious deficiency. The unsympathetic nature of the deaf as contrasted with the cheerfulness of the blind, as well as the fact that eminent blind persons are much more numerous than eminent deaf ones, speak for blindness as the less serious loss.

The history of the treatment of the deaf-mutes is an interesting one. Among savages they were generally considered as monsters, and put to death; for a long time they were held on a par with idiots; and the idea of their being educable was regarded as preposterous. When it is remembered that the first institute for their instruction was founded in 1765, and that the demonstration not long before of a deaf-mute's capacity to read was regarded as a miracle, one appreciates the truly modern mode of regarding them. It is not many years ago that they were first regarded as having the right of citizenship and other legal privileges.

While Dr. Seiss has thus put together in a shape likely to attract readers some useful information, he has left the field free for a really valuable and scientific treatise on deaf-mutism. Such a treatise

should contain a full account of the way in which they were regarded by different peoples, a history of the methods used to educate them, a psychological analysis of their state as illustrated by recent research, with special attention to their language, a good account of the physiology and pathology of deafness, and as much biographical matter as is really authentic. Such a general cyclopædia of deaf-mutism, and of blindness too, would be a great addition to the scientific appreciation of a most interesting portion of the human species.

NOTES AND NEWS.

THE Aristotelian Society of London has issued a very attractive programme of its winter work. The president, Mr. S. H. Hodgson, read a paper entitled 'The Unseen World' on Nov. 7, and the subsequent meetings are to be devoted to the following subjects: Nov. 21, 'The Psychological Laboratory at Leipzig'; Prof. J. M. Catteli; Dec. 5, 'Is Mind Synonymous with Consciousness?' the president, Messrs. S. Alexander, Bernard Bosanquet, D. G. Ritchie, and G. F. Stout; Dec. 19, 'Philosophy during the Period of the Renaissance,' Miss C. E. Plumpton; Jan. 9, 1888, 'Darwinism in Relation to Design,' G. J. Romanes; Jan. 23, 'The Philosophical Importance of a True Theory of Identity,' Bernard Bosanquet; Feb. 6, 'Wundt's Theory of Apperception,' J. S. Mann; Feb. 20, 'The Real Essence of Religion,' Rev. E. P. Scrymgeour; March 5, short papers on various subjects; March 19, 'Attention,' G. F. Stout; April 9, 'Heracitus and his Philosophy,' Dr. Clair J. Grece; April 23, 'Conscience Theories,' Pasco Daphne; May 7, 'What is the Distinction between Desire and Will?' Professor Bain, W. R. Sorley, J. S. Mann; May 28, 'The Demarcations and Definitions of the Subject Sciences,' Professor Bain.

— The second number of the *Journal of Morphology* will appear about the first of January. The endeavor has been to produce, without counting expense or effort, a journal that will stand in the very first rank, and worthily represent its department of American science. The first number has been out long enough to be passed upon by the scientific public, and we think we may say without hesitation that the verdict has been as favorable as could possibly have been desired. Professor Mark of Harvard University writes, "The first number of the *Journal of Morphology*, so anxiously awaited by zoölogists, seems to me to surpass in every way the expectations even of those who have had the highest hopes for its success. Evidently no pains have been spared by either editor or publisher to make it first class. Every one in the country interested in zoölogy will be justly proud that at last we possess a zoölogical magazine which is equal to the best European publications." As a specimen of foreign opinion, we may quote from Prof. J. B. Carnoy of Louvain, Belgium: "This new review is splendid. I congratulate you sincerely on having treated science as it deserves." Of course, the expense of such a publication is very great, and the circulation necessarily limited; but it is, of course, very desirable that the journal should be self-supporting. All interested should at once send in their subscriptions to Ginn & Co.

— At a meeting of the Engineers' Club of St. Louis recently, Professor Nipher exhibited a steam-pipe 5 feet long and 6 inches in diameter, one end of which had been closed with a plain cast-iron cap. The cap of the pipe had been blown off bodily, without being broken up. The break extended around the cap just at the end of the pipe which had been screwed into it. He explained that the cap had been blown off by a ball from a Winchester rifle. This was done by standing the pipe vertically on its closed end, filling it with water, and firing vertically down upon the water. The floor upon which the pipe stood had yielded, and the cap of the pipe had been forced down so quickly that the pipe could not follow, so that the cap and pipe parted company. To force this cap off required a force of between 135,000 and 150,000 pounds, or about 70 tons. The ball was a 38-caliber ball, and the charge was the ordinary one of 40 grains of F. G. Dupont rifle-powder. The pipe weighed, exclusive of the cap, 96 pounds, and the cap weighed 9 pounds. The ball was greatly flattened by the water, but had not battered against the bottom of the pipe. Other experiments showed that the ball was stopped by the water by the time it had reached a depth of one foot.

— The appointment of Dr. J. H. Kidder assistant commissioner of fish and fisheries gives very general satisfaction. Dr. Kidder has devoted the recent years of his life to the work of the commission, which has been most valuable in its results. He is a profound student, and takes a deep interest in his work. The appointment is commended on all sides, and, should Dr. Kidder consent to remain in the commission, the government will secure a most faithful and efficient officer.

— A steam-catamaran, intended for whale and walrus hunting in the Arctic regions, is being built at Montreal, Canada. It has two steel cigar-shaped hulls, each sixty-five feet long, and built in two compartments, one for water ballast, and the other to carry petroleum for fuel. The catamaran is constructed so that it may be taken apart for transportation on the deck of a whaler.

— About a year ago the steamer 'Gluckauf,' the first vessel specially constructed for the transportation of petroleum in bulk across the Atlantic, was described in *Science*. A year's trial has convinced the leading oil-exporters that the new method of shipment is far more economical and expeditious than the old system of transportation in casks and cases, and as a result several tank vessels are now being built in England to ply between New York and the different European ports. The fact that Russia is shipping petroleum in bulk from Batoum, on the Black Sea, direct to Europe and India, has perhaps hastened the adoption of the bulk system by the American exporters.

— Seventeen steel canoes form part of the equipment of the Nicaragua Canal Company's surveying parties, which sail from this city in a few days. The canoes are built of galvanized steel one-twentieth of an inch thick, and are intended for the transportation of the different parties to their stations along the route of the canal, as well as to facilitate the making of the surveys.

LETTERS TO THE EDITOR.

* * * Correspondents are requested to be as brief as possible. The writer's name is in all cases required as proof of good faith. Twenty copies of the number containing his communication will be furnished free to any correspondent on request.

Eskimo and the Indian.

THE subject of past relations between the Indian and the Eskimo must, in the light of recent investigations into the origin and migrations of the latter, become intensely interesting. In the issue of *Science* for Sept. 2, I gave an instance or two of what seemed to be loan-words from the Indian to the Eskimo. These concerned only the Central Eskimo. I have since succeeded in tracing these words throughout the Eskimo territory from Labrador to Siberia, as follows:—

Labrador.....	<i>nip̄lar-poh</i> ('foggy')
Hudson Bay.....	<i>nepewoke</i> ('sunset')
Churchill River.....	<i>nip̄alutuk̄ini</i> ('to rain')
" " " ".....	<i>nipa</i> ('dead')
Mackenzie River.....	<i>nip̄aluk̄</i> ('rain')
" " " ".....	<i>nip̄aluk̄-iaar̄k̄</i> ('to rain')
" " " ".....	<i>nip̄ta-iaar̄k̄</i> ('moon's quarter')
" " " ".....	<i>nip̄i-yar̄k̄</i> ('sunset')
" " " ".....	<i>nip̄i-yoar̄k̄</i> ('to set,' of stars)
Tschuakkak Island.....	<i>nip̄tschuk̄u</i> ('rain')
Malemute.....	<i>nip̄t̄iga</i> ('night')
Tchuktschi of Anadyr.....	<i>nep̄tschuk̄</i> ('rain')

With these I would compare the following:—

Miami.....	<i>nip̄anoue</i> ('cold')
" " " ".....	<i>nep̄eh</i> ('water')
Penobscot.....	<i>nip̄ongi</i> ('night')
" " " ".....	<i>neebunst</i> ('moon')
Chippeway.....	<i>nip̄</i> ('I die')
" " " ".....	<i>nibi</i> ('water')
Cree.....	<i>nip̄iw</i> ('dead')
" " " ".....	<i>nip̄iy</i> ('water')
Algonkin.....	<i>nip̄a</i> ('die')
" " " ".....	<i>nip̄oin̄</i> ('death')
" " " ".....	<i>nip̄an</i> ('sleep')
Lenape.....	<i>nip̄aoni</i> ('by night')
Massachusetts.....	<i>nep̄asuhadt̄</i> ('moon')
" " " ".....	<i>nip̄pe</i> ('water')
Narragansett.....	<i>nep̄p̄itchewo</i> ('die')
" " " ".....	<i>nip̄</i> ('water')
" " " ".....	<i>nep̄ouchittow̄</i> ('kill')
Minsi.....	<i>nip̄ahump̄</i> ('moon')
" " " ".....	<i>nibi</i> ('water')
Montauk.....	<i>nep̄a</i> ('moon')
" " " ".....	<i>nip̄</i> ('water')
Mohawk.....	<i>nup̄</i> ('die')
" " " ".....	<i>nibey</i> ('water')

and elsewhere throughout the great Algonkin stock of languages. Now, if we adopt the view of Mr. Horatio Hale, that the primitive seat of the Huron-Algonkin-Cherokee family was "on the banks of the St. Lawrence," and that of Dr. Franz Boas, that the primitive seat of the Eskimo race was "in the west of the Hudson Bay region," have we not an explanation for the coincidences noted above, and may we not expect more as research progresses? Dr. Rink, in his 'Eskimo Tales and Legends,' tells us of a journey made ages ago, by the Eskimo, in search of copper, to a southern country and people. Now, the word for 'copper' in the Eskimo dialects is *Kanooyak* (Hudson Bay), *Kannooyark* (Mackenzie River), *Kannujak* (Unalashka), *Kanuja* (Kadiak), *Kannujak*, *Kennijak* (Tchugazz), and it is interesting to find that in Mohawk the word for 'copper' is *quennies*, and in Iroquois *kanadzia*. Did the Eskimo borrow this word from the Iroquois, or did both borrow it from a people with whom they both must have come into contact, the copper-using mound-builder of the Ohio and Mississippi valleys?

The following short list of words common to the Eskimo and more southern tribes of American aborigines may serve to strengthen the views advanced by Dr. Boas and Mr. Hale:—

Above.....	<i>ehneken</i> (Iroquois)
" " " ".....	<i>inyyak</i> (Unalashka, 'sky')
Bone.....	<i>onna</i> (Huron)
" " " ".....	<i>hrownik̄</i> (Hudson Bay)
" " " ".....	<i>kaenyoka</i> (Huron)
" " " ".....	<i>anaga</i> (Kadiak)
Brother.....	<i>anayva</i> (Mackenzie River)
" " " ".....	<i>jattatege</i> (Onondaga)
" " " ".....	<i>aḡt̄w̄da</i> (Aleutan)
Child.....	<i>chankhok̄</i> (Huron)
" " " ".....	<i>iyayo</i> (Mackenzie River)
" " " ".....	<i>quennies</i> (Mohawk)
" " " ".....	<i>kanadzia</i> (Iroquois)
" " " ".....	<i>kannooyak</i> (Hudson Bay)
" " " ".....	<i>ennisera</i> (Iroquois)
" " " ".....	<i>eḡn̄isera</i> (Mohawk)
" " " ".....	<i>aḡhynak̄</i> (Tchuktschi)
" " " ".....	<i>annehak̄</i> (Unalashka)
" " " ".....	<i>anyark̄</i> (Mackenzie River)
Do.....	<i>bonis</i> (Iroquois)
" " " ".....	<i>tchene-yoar̄k̄</i> (Mackenzie River)
Duck.....	<i>soluck</i> (Mohawk)
" " " ".....	<i>tchorler̄k̄</i> (Mackenzie River)
Ear.....	<i>suntunke</i> (Nottoway)
" " " ".....	<i>eschintak̄</i> (Tchuktschi)
Father.....	<i>aitaa</i> (Huron)
" " " ".....	<i>ata</i> (Tuscarora)
" " " ".....	<i>atta</i> (Tchuktschi)
Fingers.....	<i>ayinga</i> (Huron)
" " " ".....	<i>aihanka</i> (Tchuktschi)
Fire.....	<i>yoniks</i> (Tuscarora)
" " " ".....	<i>chene-yoar̄k̄</i> (Hudson Bay, 'to burn')
" " " ".....	<i>achita</i> (Huron)
" " " ".....	<i>ochaita</i> (Onondaga)
" " " ".....	<i>etscheak</i> (Kotzebue Sound)
" " " ".....	<i>ak̄seit̄</i> (Greenland, 'hand')
Good.....	<i>iyayner̄</i> (Iroquois)
" " " ".....	<i>ayunitor̄k̄</i> (Mackenzie River)
Hand.....	<i>chotta</i> (Iroquois)
" " " ".....	<i>eshet</i> (Kadiak)
" " " ".....	<i>ishak</i> (Aleutan)
" " " ".....	<i>woatschera</i> (Huron)
Head.....	<i>maschko</i> (Tchuktschi)
" " " ".....	<i>hechkwaar</i> (Iroquois)
" " " ".....	<i>kakhairar</i> (Mackenzie River)
Lip.....	<i>enitha</i> (Nottoway)
" " " ".....	<i>anehak̄</i> (Tuscarora)
" " " ".....	<i>anuk</i> (Greenland)
" " " ".....	<i>innuk</i> (Mackenzie River)
Man.....	<i>aingahon</i> (Huron)
" " " ".....	<i>ongyich</i> (Mohawk)
" " " ".....	<i>angut</i> (Greenland)
" " " ".....	<i>angut</i> (Hudson Bay)
" " " ".....	<i>anehak̄</i> (Huron)
" " " ".....	<i>eanuk</i> (Tuscarora)
" " " ".....	<i>ana</i> (Nottoway)
" " " ".....	<i>anaha</i> (Kadiak)
" " " ".....	<i>annak̄</i> (Unalashka)
" " " ".....	<i>annaan</i> (Aleutan)
Mother.....	<i>iyaynga</i> (Huron)
" " " ".....	<i>chinga</i> (Tchuktschi)
" " " ".....	<i>quchikaha</i> (Seneca)
" " " ".....	<i>kaavachtuk̄</i> (Tchuktschi)
" " " ".....	<i>onyeiak̄</i> (Seneca)
" " " ".....	<i>oniyeḡht̄</i> (Mohawk)
" " " ".....	<i>annu, anyya</i> (Tchuktschi)
" " " ".....	<i>anyasa</i> (Iroquois)
" " " ".....	<i>ahnak̄</i> (Unalashka)
" " " ".....	<i>annaan</i> (Aleutan)
" " " ".....	<i>oxley</i> (Huron)
" " " ".....	<i>uk̄shioik̄</i> (Kadiak)
" " " ".....	<i>uk̄schuk̄</i> (Tchuktschi)
" " " ".....	<i>ek̄enak̄</i> (Tuscarora)
" " " ".....	<i>aganak̄</i> (Kadiak)
" " " ".....	<i>aganak̄</i> (Tchuktschi)

I have also found resemblances no less remarkable between the Eskimo and the Cherokee-Choctaw, as well as the Tlingit and the

languages of British Columbia. All this, it seems to me, argues in favor of the indigenous, American origin of the Eskimo.

A. F. CHAMBERLAIN.

University College, Toronto, Nov. 12.

It seems to me that the similarities of sound mentioned in Mr. Chamberlain's letter cannot be admitted as evidence of a connection between the Eskimo and other American languages. The Eskimo words which he classes together are derivatives of entirely different stems, that cannot be traced to a common root. In the first table we recognize the following stems: *nīpta-* ('clear weather'), *nīpīg-* ('to stick'), *nīpāg-* ('to vanish'). Under the heading *man* the words *inuk* and *angut* are classed together, although they have no connection whatever. In comparing languages, complicated derivatives must not be used, but the words must first be traced to their stems, and the meaning of the stems must be ascertained as well as the phonetic laws obtaining in the dialects of the stock, before it is possible to make a satisfactory comparison. Fortuitous coincidences of sound like those given by Chamberlain cannot be admitted as evidence of relationship. F. BOAS.

New York, Nov. 25.

Rate of Change in American Languages.

THE letter of Dr. Beauchamp (*Science*, Nov. 18) opens an interesting linguistic question. My own impression is that the rapidity of changes in unwritten, at least American, languages has been overestimated.

Sagard, in the preface to his 'Dictionnaire de la Langue Huronne' (Paris, 1632), asserted that the Huron was constantly changing, so that in a generation or two it would seem like a new language. Two hundred years afterwards, Duponceau took Sagard's very imperfect book, tried it on some intelligent Hurons, and found that "the language had not undergone any essential change" (*Mémoire sur les Langues de l'Amérique du Nord*, pp. 444, 445).

In 1578 Jean de Lery printed his 'Histoire d'un Voyage fait en la terre du Bresil', containing long conversations in Tupi. Three hundred years later, Dr. Nogueira republished these conversations, with their equivalents in modern Tupi. The differences are surprisingly small,—with proper allowances for dialect and varying phonetics, scarcely more than between Lery's French and the French of to-day (see NOGUEIRA, *Apontamentos sobre o Abaíteenga ou Lingua Geral dos Brasís, Rio de Janeiro*, 1876).

I have recently completed a comparison between the Alagüilac of Guatemala, which is the most southern dialect known of the Nahuatl, by means of a vocabulary obtained in 1878, with that tongue as spoken in the valley of Mexico in 1550, preserved in the 'Vocabulario' of Molina. The separation of the two peoples could not have been less than four hundred years; but the divergences are so slight that I could easily have believed the Alagüilac words to have been obtained by a German (my informant was of that nationality) in ancient Tezucuo.

Dr. Beauchamp, in referring to conflicting orthographies of the same word, points out a real but not the only cause of apparent without actual change in these tongues. He also touches on the confusion liable to occur from the natives forming diverse figurative compounds to express objects and ideas new to them. I was struck with this lately in comparing the expressions in the Lenapé for 'faith,' 'regeneration,' 'repentance,' and such theological terms, as introduced, on the one hand, by the Moravian missionaries, and, on the other, independently, by the Anglican Church. They are usually totally dissimilar.

But a much more curious and important law underlies the apparent variability of many American tongues. I refer to that of 'alternating consonants' and 'permutable vowels.' In a number of these languages it is entirely optional with the speaker to articulate any one of three or four consonantal sounds for the same phonetic element. For example: he may at will pronounce the syllabic *ton* either thus, or *lon*, *not*, *rot*, etc., alternating the elements *l*, *n*, *r*, *t*, at will. I have little doubt but that something of the same kind obtained in ancient Accadian, which will explain why the same cuneiform character stands indiscriminately for the sounds *ku*, *tus*, *fun*, and *dur*; and the recent researches of Dr. Carl Abel on the phonetic modifications of the ancient Coptic radicals hint strongly at the prevalence of this peculiarity in that venerable speech.

In America, I name as special examples of this the Klamath and the Chapanec. But that these phonetic variations are within fixed limits, and do not involve the integrity of the language, is curiously proved by the last mentioned. Remesal, the early ecclesiastical historian of Chiapas, states that the Chapanec was introduced into that department from Nicaragua many generations before the Conquest; probably it was not later than the year 1300. Now, in 1872, my late friend, Dr. C. H. Berendt, collected in Nicaragua, from a few old Indians, the only survivors of their tribe who spoke its tongue, a number of words and phrases of a dialect called the 'Mangue.' A comparison proves it to have been beyond question a very close relative of the Chapanec, essentially the same in fact, though separated from it for more than five hundred years (see an article on the Mangue by me in the *Proceedings of the American Philosophical Society*, 1885).

As in the Turanian tongues, the Turkish, for example, there is a 'vocalic echo,' the leading vowel of the word forcing the others to assimilate to it in sound, so in some American tongues there is a 'consonantal echo,' the presence of one consonantal sound requiring more or less changes in the others. The Tupi, the Chapanec, and the Klamath offer examples of the 'consonantal echo,' while a certain degree of the 'vocalic echo' is observable in the Kiche and Cakchiquel.

These phonetic laws must be thoroughly understood and allowed for, before any one pronounces positively on the rate of change in American languages. DR. D. G. BRINTON.

Media, Penn., Nov. 23.

Amnesia.

THE cases cited in *Science* (Nov. 11, 18, pp. 232, 250) remind me of the following. Some twenty-seven years ago, a neighbor of mine (a young man of twenty-five or under), springing from the vaulting-horse in a gymnasium to catch the trapeze, fell, striking apparently upon his shoulders, and was taken up insensible. Consciousness soon returned, perhaps in a fraction of an hour, but there was no recollection of the few hours just previous to the fall. As recovery progressed, however, it was said that his recollections came down closer and closer to the time of the accident; and that in a week or less he could even remember taking the leap, though not his striking the mattress.

Whether it be common that the progress of recovery should thus lessen the period covered by the amnesia, might no doubt be learned from such data as many professional athletes could furnish. An athlete once told me how, some years before, he had fallen on his forehead in the circus, and had been taken up for dead. His recovery, I think, had taken several months. He could remember, not indeed the blow, but the sense of powerlessness with which, in mid-air, he had realized that "his balance was lost." But perhaps he did not say whether, a few hours or weeks after the accident, his recollections had come down so far. J. E. OLIVER.

Cornell University, Nov. 18.

THE cases of amnesia mentioned in *Science* of Nov. 18 recall in my own experience cases which may be of sufficient interest to be recorded.

When about fifteen years old, I went into a stable to stanchion cows for milking. About an hour afterwards I was found wandering about the yard unconscious, and bleeding profusely from wounds in the face. I have not been able to this day to tell how I was hurt. I have no recollection, beyond going into the stable and fastening a few cows. My hat was found under the cattle's feet. My front teeth were loosened, a hole cut through my lip, and my shoulder in front badly bruised. I was feeling well at the time, and have never fainted, and cannot refer the injury to that cause. The nature of the injury would indicate that it came from the front, and must have appealed to my senses in their normal state.

From other experiences I have always believed that it is more common to remember the cause of an injury producing temporary unconsciousness than to forget it. I became unconscious once from drowning, but remembered vividly every thing when restored. I was once prostrated by lightning, but remember having seen the flash.

I think one's remembering the cause of an injury depends largely

on whether it appeals strongly and for some time to the senses, especially of sight.

I know, from personal experience and observation, that it is not uncommon for man to temporarily lose the power of the senses under excitement, while the body still performs its normal functions intelligently. Perhaps this would explain the third case mentioned by Mr. Hall. The gentleman remembered the runaway, but became so excited in checking the horse that his senses were oblivious to all surroundings.

In my own case the cause evidently acted before my eyes, and I have been led to believe that the cause of an injury may act so suddenly as to produce unconsciousness before the impression made on the senses can reach the brain.

Another case was unconsciousness produced by poisoning with sulphuretted hydrogen. I went into the attic to regulate a generator, and shut the trap-door, as I had to pass over it to reach the generator. There was but one window in the room. It was down, and about fifteen feet away. There being no gas at the hoods in the laboratory led me to think the iron sulphide was out. I disconnected the tubing, and found high pressure, which forced several gallons of gas into my face. It produced involuntary respiration, and my lungs were drawn full. Deeply impressed that my only hope of life was fresh air, I started for the window at once. Almost instantly I began to get dizzy, and my vision was strongly impaired. The window, only a few feet away, seemed very remote, and no larger than my hand. My rapid advance toward it gave me the strange impression that my legs were half a mile long. I became unconscious before reaching the window, and all is a blank until I found myself rushing down the stairs, two stories below, still impressed with the necessity of reaching pure air. In an unconscious state, I raised the window about eight inches, raised the trap-door, and fell headlong down the stairs to the laboratory, and was found by one of the students deathly pale, the blood settled under my eyes, my muscles rigid, and large drops of cold perspiration on my face. Soon after the student reached me, I began to show signs of recovery, and suddenly sprang to my feet, exclaiming, "I must have air!" and rushed down the stairs, regaining consciousness on the way.

This case shows suspension of a train of thought which was taken up where it was left off, and pursued after a season of unconsciousness. It also shows several intelligent trains of thought pursued in the absence of general consciousness, leaving no impression on the memory. I have often asked myself what directed me to raise the window and the trap-door, and have wondered whether there are centres in the brain to direct intelligent action for self-preservation in the absence of consciousness.

My intention was to open the window for air, but I have no knowledge of having done it. This has led me to ask whether impressions made on the brain during consciousness may not be automatically executed after the avenues to the external world are closed. May not a state of partial unconsciousness, as in somnambulistic sleep, be produced by injury, and well-directed trains of thought be executed and leave no impression on the memory?

A friend of mine has a blank of three weeks in her life while sick with typhoid-fever, yet was unconscious only the last ten days of the time. I have always explained such cases on the basis that bodily condition has much to do with the indelibility of impressions made on the brain. When the body is weak, the impressions are weak and forgotten. Even in a state of health there are many perceptions that make no lasting impression. F. L. HARVEY.

Maine State College, Orono, Me., Nov. 22.

American Microscopes. — A Complaint.

EVERY autumn when the colleges and medical schools of the country begin their academic years, there are many students who come to their instructors seeking advice in regard to the purchase of microscopes. Often they appear already furnished with an instrument of which they are anxious to learn that the lenses are particularly good.

As it has been my duty for several years to conduct a large class in practical histology, I have had frequent applications for advice about microscopes, and have seen and examined a great many different stands, and the lenses of many manufacturers. I have had

therefore, opportunities to test the practical convenience and advantages of the many sorts of microscopes which the students have brought along with them. The result of this experience is the conviction that it is undesirable to recommend a student to purchase any microscope whatsoever of American manufacture, and to always counsel him to obtain, if possible, one of the German or French instruments.

In order to make my judgment more clear, I may add that I know of no American microscope which I should like to purchase at any price, for my own use in histological or embryological work.

I venture to express this adverse opinion in regard to American microscopes in the hope of inducing some of our opticians to manufacture a stand for a microscope suitable for the use of students of histology and biology. It appears to me that the simple model now almost universally adopted in Europe is far superior to every thing offered us in rivalry to them by our own dealers.

To justify myself, I should like to give, first, the reasons for my disapproval of the American forms; and, second, the reasons for my preference of German forms. The fundamental error in microscopes of American manufacture is that they are for the most part constructed with a view of, I might almost say, entrapping inexperienced purchasers. The zeal of the maker is turned too much to decorative lacquering and nickel-plating: he adds to his stands as great a variety of mechanical contrivances and adjustments as the price of the stand will permit, and many of these contrivances are not really commendable for their utility. In the majority of cases the stands are made to tilt, which, for one that uses the microscope for real work, is an almost useless luxury, because he who really works in histology necessarily examines fresh specimens in fluids, or at least constantly has on the stage of his microscope preparations in various stages of unreadiness, and not mounted in a permanent form. All this implies the constant use of fluids, and, if the stage of the microscope is inclined, the use of liquids is impracticable. Any one, therefore, who uses his microscope for the ordinary purposes of a student or an investigator, or in connection with clinical or pathological work, very soon falls out of the habit of tilting his microscope. Hence it is, that, while making a microscope to tilt renders it considerably more expensive, it adds nothing essential to the convenience of the stand for laboratory work. This same fact, that most of the work must be done with the tube of the microscope vertical, renders it indispensable that the microscope should not be too high; so that we must put down the ten-inch tube as a bad feature for a student's microscope. A rack and pinion is undoubtedly advantageous: it renders the use of the microscope more convenient, and increases its durability by diminishing the strain upon the stand during the coarse adjustment of the focus. When this adjustment is effected by shoving the tube with the hand, the microscope wears out sooner than with the rack-and-pinion movement; yet even the rack and pinion, which are so generally put on our American microscopes, are not indispensable, and the greater part of the histological and embryological investigations of the past twenty years have been made without the employment of this convenience.

The stage of the American microscope is very faulty. The large movable glass plate with a hole through it is a toy fit only for an amateur or fancy collector: it interferes with the use of fluids, and with the freedom of movement of the slide over the field of the microscope,—the two things which are most indispensable in practice. A good stage should be large and flat, with nothing upon it except a pair of spring clips and a hole for a diaphragm. The diaphragms are often a matter of particularly fanciful construction. Thus the Iris diaphragm is often introduced to allure the inexperienced, but it is not a good form except in conjunction with an acromatic condenser. There are other details of construction which are equally open to unfavorable criticism, but it is unnecessary to go into their discussion.

Unfortunately, while we see so much pains expended upon the brass-work of the microscope, we see a neglect of the optical members of the instrument; so that the microscope as a whole is converted into a showy piece of apparatus, and the eye-pieces and objectives are generally, though not always, of a decidedly inferior character: when they are really good, the lenses are very expensive.

If, now, our manufacturers would reverse the distribution of their

painstaking, and make a simple stand of small size and compact model with first-class lenses, they would furnish something which could be recommended to students and others by conscientious advisers.

Turning now to the consideration of continental microscopes, so universally used in Europe, and now happily gaining supremacy in this country, we see at once that they conform to the practical requirements which are disdained in the making of most American microscopes.

They are built with a firm base. The stage is easily reached by the fingers when the hand is resting upon the table. It carries no superfluous appendances, but is large and flat. The eye-piece is of such a height, that when the instrument is vertical it is easy to look into it. Concerning the lenses, it must be said that most of the European manufacturers are very conscientious in regard to those which they furnish. There are, of course, some makers who put upon the market objectives of inferior quality, and which are sold as such, and therefore at a correspondingly low price. This is of course legitimate, as there is a demand for cheap microscopes.

The price of these desirable microscopes is very much less than that of undesirable American ones. According to our system of protection, the physicians, scientific men, and students are taxed enormously if they buy a foreign instrument. Put into plain English, this means that we are heavily fined if we secure what we require in the way of microscopes, while a small number of manufacturers, whose money-making is of very little significance to the public, receive a bonus for furnishing an inferior article at a high price. Thus what is really important is sacrificed for what is unimportant. Many valuable members of the nation are sacrificed by being obliged to pay* for the advantage of a small number of men who have never shown themselves willing to supply to those by whose sacrifices they benefit, the kind of instrument wanted.

Can any thing be more unjust? and are not we, who are engaged in university careers, in the practice of medicine, or any other useful occupation requiring the employment of microscopes, justified in complaining of the condition of affairs, which is little short of a national calamity? Is it unreasonable to ask the manufacturers of microscopes in this country to furnish us instruments of the kind we really need, as some sort of acknowledgment of the money they extract from us whether we will or not?

In expressing myself so decisively and emphatically upon the subject of American microscopes, I have not considered it necessary to give a detailed discussion of the relative merits and demerits of the different makes, because what I have expressed is the opinion, in these matters, of all the competent judges with whom I have talked on the subject.

I know positively that many of the best scientific men of America are ready to join me in saying, as I said at the beginning, that there is no American microscope which we should like to buy at any price for our own use.

CHARLES SEDGWICK MINOT.

Boston, Nov. 24.

The 'Act of God' and 'Fuerza Mayor.'

MR. MORGAN's article in *Science* of Nov. 18, 'The "Act of God" and the Railway-Company,' is highly interesting, and suggests an illustration drawn from comparative national jurisprudence. The English common-law doctrine of the 'Act of God' appears very scientifically elaborated in the laws of Mexico under the title of 'fuerza mayor.' Our neighboring republic is greatly advanced in the science of law. While certain disturbing elements there interfere somewhat with the practical application of statutes at times, according to our views at least, nowhere on the continent has the science of law been more carefully studied, and the results of that study more accurately defined and set forth in both constitutional and statutory form. Religious faith, too, in Mexico is to-day as living and active a force in common personal life with the great body of the people as it was in Europe in the middle ages; and this fact again, as Mr. Morgan's article suggests, illustrates how, while the limitations of the Old-World doctrine have been gradually narrowing in the United States, it still holds its ground in Mexico with proportions which practically make it the leading condition of all contracts, expressed and implied.

As an instance of how this provision enters into express contracts,

let us take the great railway-concessions to the leading American companies. In these concessions 'fuerza mayor' generally appears in three distinct places. The obligations of the company to build within certain fixed periods are suspended in case of 'fuerza mayor.' The concessions are forfeited by the companies carrying any foreign armed force or goods contraband of war, unless they can show that this was done because they were unable to resist 'fuerza mayor.' Certain bounties granted to the railways cease during the time that the operation of the lines is suspended, even if the suspension should take place by reason of 'fuerza mayor.'

In the smaller transactions of daily life this doctrine continually appears as an unwritten law, which suspends all other laws, or contracts, or obligations. Superior force, which often in Mexico means what would simply be called disaster in the United States, is to the Mexican mind a good defence against almost any obligation. For instance: should one lease a boat for a month at a fixed sum, and unusual storms prevent using the boat for half the month, that would be ample reason why the lessee should tender only half the rent to the lessor, and he feel constrained to accept the offer.

'Fuerza mayor' is translated as 'superior force,' or 'uncontrollable circumstances.' These circumstances are nowhere, to my knowledge, defined, but the facts of what are uncontrollable circumstances are to be decided in each case. The coercion of an armed force is 'fuerza mayor.' The violence of storms is 'fuerza mayor.' The flooding of a river is 'fuerza mayor.' And, as before remarked, very generally what we are apt to consider as disaster, in Mexico becomes 'fuerza mayor,' and operates to relieve a contract of its obligations. To the American mind a contract made must be carried out, and disaster, if there is any, falls on the man who has loosely guarded his contract. In the confluence of the American and Mexican civilizations now taking place, it becomes an interesting question how this wide difference between the usage and thinking of the two countries will adjust itself.

W. W. NEVIN.

New York, Nov. 21.

The American Physique.

In order to find out how closely the figures of makers of knit goods would correspond to those of the clothiers, I sent a letter to one of the largest manufacturers. I enclose his reply, together with the figures. You will observe that the figures on men's ware correspond very closely with those of the clothiers, making allowance for the tighter fit of the undergarments.

EDWARD ATKINSON.

EDWARD ATKINSON, ESQ.

Dear Sir,—Your favor of the 11th inst. was duly received, but the article referred to was not enclosed. It is impossible to give a perfect assortment of sizes of underwear for men and women, as the assortment varies in the weight of goods, and the section of country they are for. I enclose, however, a copy of an average order for 1,040 dozen of men's shirts and drawers, and one for 507 dozen ladies' vests and drawers, which will show very closely the sizes that we sell, and the proportion of shirts and drawers:—

	26	28	30	32	34	36	38	40	42	44	46	48	50	52
Men's shirts.....					88	124	128	84	52	32	16	10	4	1
Men's drawers.....	40	88	104	92	68	44	28	20	12	4	2			
	26	28	30	32	34	36	38	40	42	44	46	48	50	52
Ladies' vests.....	45	113	127½	82½	34½	15	7½	3½						
Ladies' Drawers.....	4¾	15	22	18	12	6	3							

Queries.

18. METEOR-FALL.—A few days ago there appeared in the newspapers a circumstantial account of the fall of a two-ton meteorite in front of a bank in the town of Amsterdam, N.Y. I have seen nothing but this first announcement about it, and fear the whole story may be a canard, yet would like to know that it was a genuine happening. Can you report the matter in *Science*, and doubtless oblige many others besides?

C. H. AMES.

Boston, Nov. 27.

SCIENCE

FRIDAY, DECEMBER 9, 1887.

IN OUR ISSUE of Oct. 28 we called attention to the fact that a committee had been appointed by the New York Academy of Sciences to raise funds to erect a monument over the remains of Audubon, who now lies buried in the south-western portion of Trinity Cemetery, near 153d Street and North River. Two or three years ago some gentlemen who visited the cemetery noticed the name of Audubon on a vault which was then in much need of repair, and finding, on inquiry, that this was the burial-place of the great ornithologist, suggested the plan of having his remains removed to a more conspicuous position. On making proper representations to the authorities of the cemetery, they were met with great courtesy; and after some months, with the consent of the Audubon family, it was decided to change the position of the plot to a place which will be opposite the extension of Audubon Avenue when it is continued to 155th Street, as it probably will be. This plan was accepted by the Audubon family during the last summer, and it was then proposed to erect in the new plot, by national subscription, a monument worthy of the greatness of the man. After these arrangements had been completed, the plan was laid before the meeting of the American Association for the Advancement of Science in this city, but no action was taken. At the first meeting of the New York Academy of Sciences this fall, a committee was appointed to raise funds for the monument. Since the date of its appointment, this committee has been quietly at work. After organizing, it communicated with different scientific societies all over the country, from which the most enthusiastic replies have been received. It was decided by the committee, that, on account of the near advent of the election, it was unwise to do much active work at that time; but now that the election is over, the committee are actively at work, are preparing the designs for the monument, and wish to solicit subscriptions from all parts of the United States. The whole country has for years been justly proud of Audubon's work, which was received both at home and abroad with the greatest enthusiasm. It is considered one of the greatest treasures of any public or private library. Some of the copper-plates of this great work now hang in our museums, and are framed and hung like valuable pictures in the houses of patrons of the arts in this city. It is the founder of American ornithology that it is sought to honor, to whom natural history in this country is almost as much indebted as England is to White of Selborne. It is hoped that every one that loves nature will subscribe, and ask others to subscribe, to this fund. It is intended by the committee, as soon as the monument is ready, to have some public ceremonial worthy of the occasion at its unveiling in Trinity Cemetery, and in this way bring into further prominence the great services which Audubon has rendered to the scientific study of natural history in this country. Contributions, however small, may be sent to the treasurer, Dr. N. L. Britton, of the School of Mines of Columbia College.

IT IS CURIOUS to watch the different approaches made to the same question by various countries. There is now, as is well known, a very general movement throughout this country in favor of what is known as manual training in education. After much misapprehension and tedious explanation the leaders of this movement have finally managed to make the educational public understand that they advocate manual training mainly for its educational value, and only incidentally for the economic benefits which will

undoubtedly flow from it. In England, however, where a similar movement is gaining force, the point of view is almost exclusively the economic, and but little is heard of the educational value of manual training. The Englishman desires manual training to take the form of technical or trade instruction, in order that England's waning commercial supremacy may be restored and retained. It is very necessary, therefore, in following the English movement in favor of manual training, to understand that its arguments and its point of view are wholly at variance with those of the American movement to introduce manual training into the public schools. Indeed, Mr. William Mather, one of the best authorities in England on the subject, as well as one of the few Englishmen who thoroughly comprehend the American movement, has said that the English mind has not yet sufficiently advanced educationally to adopt the American view, and that the only sort of manual training which can be successfully advocated in England at present is that which will come under the head of technical education. The inaugural address delivered at University College, Liverpool, by Prof. Hele Shaw, and reported in a recent number of *Nature*, illustrates excellently what is said above. Professor Shaw began his address by calling attention to the vast and almost incredible change which the present century has witnessed in the industries of the world, and he emphasized the fact that a few years ago circumstances combined to make Great Britain the principal commercial and manufacturing country of the world. The artificial conditions which brought about this state of things could not and did not last. Foreign nations began to establish mills and work-shops of their own, and, what was of even greater importance, they recognized the necessity of spreading technical knowledge by all possible means. To accomplish this, technical schools instituted and supported by the state, at which instruction could be obtained free or at a merely nominal expense, were established by the more progressive countries. The result has been that during the past twenty years numbers of highly educated men have been sent out who were prepared, on becoming foremen, managers, or employers of labor, to take advantage of the latest discoveries and improvements in the various branches of industry, in other words, to use their brains with their hands. The eventual effect of this on England's industrial status could be safely predicted, and that it was disastrous the reports of the recent royal commissions on trade depression and on technical education conclusively prove. It must not be thought, however, that the English themselves are not alive to what is going on about them, and the importance of late assigned to the subject of technical education proves that they are looking in the right direction for the remedy. The National Association for the Promotion of Technical Education has on its roll of membership some of the foremost men of science, men of business, and men of literature in Great Britain. The special government bill which was introduced on this subject at the last session of Parliament is proof that official circles are alive to what is needed. Professor Shaw then asks what the term 'technical education' really means, and with a touch of humor says that one very general answer to the question is, "Something to meet the German competition." "This," he adds, "grotesque as it may seem, is much nearer the truth than most of the other definitions of technical education." Of these he quotes a number, and then proceeds to discuss the results attained by the Science and Art department during the past ten years. The other central agency, which has been at work for several years in promoting technical instruction, is the City and Guilds Institute of London, and he points out the very interesting and valuable results

which this institution has accomplished. "When it is considered," he continues, "what splendid technical training the workshops and manufactories of England have afforded, there will appear to be very good reasons why, originally, technical schools were not so extensively instituted in England as on the continent." The speaker pointed out that England was, taken as a whole, after all not in such a deplorable state with regard to technical education, and then described that education as of two kinds, general and special. "General technical education may be said to be that necessary in all large centres of population, being the preparation for such callings as engineering, architecture, medical science, and other professions which a certain percentage of the inhabitants will always follow, besides training of another kind suitable to the artisan class. Special technical education is that necessary in a locality where there are special industries, instances of which will readily suggest themselves." The remainder of the address was devoted to considering the educational work of Liverpool and its technical requirements. This brief abstract will suffice to show how diverse are the means of approach to the manual training problem which are being followed in England and in this country.

PHYSICAL TRAINING.

THE American Association for the Advancement of Physical Education held its third annual meeting in Brooklyn on Nov. 25, and was well attended. Prof. Edward Hitchcock of Amherst College presided. Papers were read by him, and also by E. H. Fallows of the Adelphi Academy. The title of the latter paper was 'Physical Training in Elementary Schools in the United States,' being an extract from the report of the Board of Health of New Hampshire. Dr. Edward Hitchcock, Jun., of Cornell University, read a paper on the uses of physical measurements to the individual. In the attempts to establish anthropometry on a scientific basis the weight of individuals was first taken as a standard, but this had to be abandoned, and he thought we could now say with a certain degree of exactness that human measures increase with the height. It is extremely difficult, if not indeed practically impossible, to secure the exact dimensions of any man. Especially is this so when it is attempted to obtain the measurements of the chest and shoulders. Six experts might examine the same individuals, and their measurements would probably all differ. The testing of lung capacity is very variable, some individuals giving results which are of value, while others do not use the thoracic muscles at all, but simply bring into play the muscles of the pharynx. Some foreign countries, recognizing the difficulties in the way of obtaining exact measurements of parts which were liable to vary, had adopted the length and breadth of the head, ear, foot, and finger, and the height of a man in the sitting position, as the best, making use of them in descriptions of criminals. Dr. Hitchcock thought that to determine the physical powers of an individual, good judgment on the part of the examiner was of great value. In fact, a good judgment without measurements he regarded as better than good measurements without judgment.

Dr. Savage, director of the Berkeley gymnasium, New York, and Dr. Sargent of Harvard University discussed Dr. Hitchcock's paper. The latter said that while some foreign nations had done more in obtaining and recording measurements of parts of the human body, the United States was far ahead in true anthropometry, that is, the measurement of the whole man; but this subject was still in its infancy, and it would be folly for the association to publish views which in the present inexact state of the science of anthropometry might and probably would be controverted in a short time. He did not think it was proper for an association which had had but two or three years' experience to express views which might be taken by the world at large as a basis for physical education. For his part he regarded it as a life-work, and he proposed to remain silent until he had arrived at results which he could swear by. Dr. Hitchcock of Amherst differed with Dr. Sargent. No science ever approached exactitude except through a long course of mistakes and subsequent corrections.

The next paper was on military training as an exercise, by Dr. J.

W. Seaver of Yale College. He took the ground that while military training was well adapted to the adult, it was not the best for the young. The element of sport or fun which characterized the active life of all animals in their early years should not be wanting in the exercise of the human young. General Molineux of Brooklyn, in the discussion of this paper, said that although colleges, by their well-equipped gymnasiums, had done much for their students, they had done but little for the masses. He hoped to see physical training adopted in the public schools, and urged the association to do all in its power to accomplish that object. He thought that military training even for the youth was very valuable, not only as a means of developing their strength but as fitting them for the defence of their country, a duty which they might be called upon to perform. John S. White, LL.D., head master of Berkeley School, New York, took similar ground with General Molineux, but believed that calisthenics and military drill should be combined in the development of youth. At the termination of the discussion the association adjourned.

AMERICAN PUBLIC HEALTH ASSOCIATION.¹

ONE of the most instructive papers read before the American Public Health Association at its recent meeting at Memphis was that of Dr. E. M. Hunt, Secretary of the State Board of Health of New Jersey. It is entitled 'The Prevention of Microphytic Diseases by Individual Prophylaxis.' It is so full of suggestion, and the subjects which it discusses are matters of such general interest, that we reproduce the paper *in toto*.

[PAPER BY DR. E. M. HUNT.]

During the last twenty-five years no subject has been more prominently before the students and practitioners of hygiene than the consideration of new methods, or new applications of old methods, for the prevention of disease.

This inquiry, to some extent, involves investigation into the specific entity of disease. But a still more hopeful direction of investigation is to find out what fertilizes it or makes it more likely to be severe, what sterilizes it or makes it more likely to be mild, or what will make the human system resistful to the sedation or propagation of the disease, so that it will not occur.

The first great discovery in this direction was that of the modifying influence of inoculation.

It could not have been merely the cathartic and the changed diet of a few days that reduced the mortality from inoculated small-pox to such a minimum. The prevalence of the custom was at once the certification of the terror of the caught disease and the innocency of the conferred or inoculated disease. Yet it was the same disease without any effort at attenuation.

It was the introduction of the virus into the skin or areolar tissue, instead of by inhalation, that seemed to result in modification. Its approach was through the periphery, instead of by a central and vital organ. The chief safety was in the fact that the involvement of the lungs and the secondary fever were avoided.

Somehow, by the metastasis or diversion or mode of attack, the system grew tolerant of the malady, and was able to throw it off with comparative harmlessness.

It has fallen to my lot frequently to see the same remarkable mitigation in the inoculation of cattle with the virus of contagious pleuro-pneumonia.

When the infection is conveyed by the breath, it seizes upon the lungs and pleura. Frequently, in three days after it is manifested, the spongy organ of two or three pounds has become so solidified with tenacious lymph that it has a weight of thirty pounds, and death is the speedy result.

But introduce this virus into the muscular tissue of an extremity and all symptoms are more gradual. There are local swelling, the throwing-out of lymph amid muscular tissue, and slight constitutional disturbance; but the lungs escape, and fatal cases are exceedingly rare. Not only this, but other animals will not contract the disease, and immunity is secured. These facts as to the effect of the different modes of conveyance of a disease have their practical bearings, and still invite investigation.

¹ Continued from *Science* of Dec. 2.

It was another wonderful fact when scurvy yielded to the preventive art. The great naval hospital at Haslar, England, had been built with special reference to the fearful inroads that this disease was making amid the British fleets. When, in 1796, Sir Gilbert Blane and other medical officers of the navy obtained the order that lime-juice be supplied to the seamen, the terror of that disease was taken away. Studying the facts by the history and peculiarities of that disease, we cannot dismiss it as a mere error of dietetics. It was not simply that fruits and fresh vegetables prevented the disease. It was a far-reaching lesson as to how diseases may be modified by medicines as well as by foods; how the presence of something administered may prevent a disease.

As to the next wonder of the preventive art, that of Jennerian vaccination, it is so often presented as to need only our passing recognition. Yet it is to be remembered that it is a subject not yet exhausted. Whether something of the modification is owing to the mode and place of introduction, whether it is a modified small-pox, whether it is attenuated virus and may be in different degrees of attenuation, and so differently protective, these and other questions are left over to be determined in this period when the microscope, the pathological, the chemical, and the biological laboratories have come to the aid of the clinician, and we can study and compare the accumulated facts.

The Pasteurian vaccination may stand next, if not in order of time, since Pasteur opened his Copenhagen address by profound acknowledgment of his indebtedness to Jenner as the great forerunner of preventive medicine.

Here the mode and place of introduction, degree and permanency of effect, and the nature and cause of the so-called attenuation, are still before us with unanswered inquiry.

Next, while the doctrine of the prevention by isolation is old, yet new methods and new results, as to it, almost make it a new preventive art. Sea and land quarantines are modified, and ought to be. How far it is to be isolation of the person, or only isolation of the personal effects, is unsettled. What the forsaking of an infected house or ship will do, what the camping-out of all the well from a sick city will do, what isolation alone will do, as in Leicester, with small-pox, and what is the most perfect plan of organized systematized isolation,—all these are before every health-officer as large and most practical questions.

Next comes disinfection, in all it means by the new light of biology and the study of micro-organisms—whether it be the destruction of animal or vegetative parasitic life—of these as larvæ, as spores, or as sporeless plants, at any and all stages of existence and development; also what is meant by inhibiting or thwarting action, even when we do not destroy life; also what disinfectants can do with the surroundings in destroying the pabulum or nutrient media; also what these can do in the system, either to destroy the microbe which is setting up pernicious activity there, or in some way to deprive it of its food or limit its power.

For the present we confine ourselves to the last item. So soon as it became certain that many diseases depend upon, or are associated with, micro-organisms, the inquiry was in order, whether there could not be some method utilized and applied by which the presence or activity of these in the blood-tissues or secretions could be so interfered with as to prevent or mollify disease. Passing for the present certain facts as to septic and non-pathogenic organisms, which, introduced into the system, may of themselves, or by their ferments or alkaloids (ptomaines), cause disease, we confine our inquiry to the question whether it is possible to thwart the action of the specific or pathogenic micro-organisms in their attempt to invade or after they have invaded the system. We get some light or some analogy as to this from considering the life-history and behavior of these organisms outside the system. First of all, we find that pathogenic organisms are dependent for their growth on the presence of the suitable nourishing material. In this respect they are far more selective than the septic organisms, which "find in almost all animal and vegetable fluids the substances necessary for nutrition." It is further found that there are substances which inhibit the growth of, or altogether destroy, these micro-organisms, such as corrosive sublimate, salicylic acid, etc. To do this they do not always need to be germicides.

Far short of destruction, such substances are capable of restrain-

ing the morbid action so far as to thwart their pernicious activity, which, in the case of an invading disease, is really the gravity of the disease.

Klein gives abundant evidences and references, on p. 208 of his book on 'Micro-organisms and Disease,' to show that "pathogenic micro-organisms are capable of suffering some modifications in their morphological and physiological behavior." He adds, "Now, it is known of many micro-organisms, bound up with infectious diseases, that temperature, the medium in which they grow, and the presence or absence of certain chemical compounds, are capable of materially affecting them" (Klein, p. 207).

Inasmuch as this growth and multiplication are known to go on in the bodies of living animals, and to constitute the identity and gravity of many diseases, it is a radical and very essential and hopeful inquiry whether we may not, by some change in the animal, or in some of those chemical compounds referred to, either destroy the micro-organism or inhibit its activity.

It is very suggestive of the possibility of this to remind ourselves of the probable reason why some are unsusceptible to disease. Dr. Klein (p. 247) argues that it is because there is "something or other present in a particular tissue to which the latter owes its immunity."

He infers, that, although this is "dependent upon the life of the tissue, it is not identical with any of the characters constituting its life." He says, "The most feasible theory seems to me to be this, that the inhibiting power is due to the presence of a chemical substance produced by the living tissues." This puts the body in such a condition that in the particular case, "the organisms cannot thrive and produce the disease." It is true that he suggests that the germicide or inhibitive material is a product of living tissue. This is not necessarily so, or, if so, would not necessarily be a product of the living tissue of the human body.

If the non-activity of the organism, and so the non-occurrence of the disease, is owing to "the presence of a chemical substance" in the tissues or blood, it is a very pertinent and natural inquiry whether we can not and do not produce the same result by putting, and for a time sustaining in the system, certain "chemical substances," which, so introduced, interfere with the processes sought to be set up, and which would constitute the disease.

The analogy is strengthened by the fact that chemical products are so much coming to be suspected or recognized as constituting the virus or specificity of diseases in which the micro-organisms are the initiative factors.

Still more, however, it behooves us to find out whether, either in chemical or laboratory experience, there has been any confirmation of such views. In clinical experience we have long had not only the fact that quinine will cure chills and fever, but that it is a substance which, introduced into the human system in advance, will prevent those processes which constitute the disease. So soon as it was made probable that the malarial diseases belong to the species or genera of microphytic diseases, so soon it seemed probable that the result was due to this inhibitive effect of the alkaloid. As a result of experiences with epidemics of diphtheria and scarlet-fever, so long ago as at our Chicago meeting in 1877 (see *American Public Health Association*, vol. iv, p. 348), I presented a paper on this mode of assisting and preventing pestilential diseases (see also two articles on the subject in *The Medical Record*, vol. ii, 1877).

The next year the subject was more fully presented in a paper read at the Richmond meeting.

In the intervening time Professor Cabell was so impressed by the facts presented, as to note it in his address before the American Medical Association in the spring of 1878. A reference to the paper of 1878 will show how fully this idea was insisted upon and illustrated. It was claimed that by the use of certain medicines we could prevent the sedation or interrupt the development of that which constituted the infection. Many of the facts in support of this view at that time were collated, and since then, from time to time, medical men have corroborated these views from their own experience.

It is of value that since then we have come into a knowledge of several other diseases as microphytic, and this has greatly fortified the position then taken.

Says L. Brunton, "Facts seem to point to ferments or enzymes as the agents by which the tissues are built up and pulled down in their constant change, which continues during life; and the action of drugs on these enzymes is becoming one of the most important questions of pharmacology" (see *American Public Health Association*, vol. vi, p. 103).

From time to time in the last five years the journals have contained records as to this possibility of individual prophylaxis. But all this was only the clinical experiences of physicians. Too often these are not accorded the same consideration as what are called crucial or laboratory experiments.

It has recently been necessary for Sir James Paget, as president of the Pathological Society of London, to contend that clinical observation is scientific, and that the sick-room is a laboratory with its crucial experiments, as real as those in which culture-experiments are instituted.

But now experimental tests have come directly to our aid in determining the effects of prophylactic remedies. Before this we knew that arsenic, potassium chloride, quinine, and excess of iron, etc., could be made constant for days and weeks in the blood by medication.

In 1884, under the direction of the Local Government Board of England, Dr. J. T. Cash instituted a series of experiments as to chemical disinfectants, and made report thereon. The object of the earlier investigations, recorded in a late report, was to inquire whether certain substances belonging to the aromatic series, when introduced into the body of a living animal, were capable of preventing the development of a particular virus within that animal. Later research was extended to a metallic salt (corrosive sublimate), which acts otherwise than aromatics with regard to albuminous bodies.

It was with this that the most decided result was secured. The result sought was to find "its power of resisting, in the condition in which they occur within the animal body, the multiplication of the active principle of the virus against which they are directed to such an extent that the virus is destroyed, or only reproduces itself so fully as to cause a modified or abortive attack of the disease in the animal body experimented on." The disease chosen for the experiments was anthrax, the severest test of all. The result of the first series of experiments was such as to show that the previous administration of corrosive sublimate may considerably modify the course of the anthrax disease in rabbits. The paper concludes by saying, "that, although these few experiments are not conclusive, they cannot fail to encourage the hope that we may yet succeed in creating with precision, within the animal economy, by the action of this and perhaps other drugs, a temporary condition of resistance (in this case seven weeks), which may so limit the activity of the anthrax virus that it will merely produce a passing, and at the same time protecting, disorder, instead of a fatal disease."

The next year (1885) Dr. Cash made to the Local Government Board a further report on mercury as a means of prophylaxis to anthrax. In this he says, "I have followed up the investigation of the prophylactic action of the perchloride still further, and the favorable opinion I was before led to entertain of its efficacy has been abundantly confirmed."

Dr. Klein has also satisfied himself of the restraining powers of the perchloride of mercury. Tomassi-Crudelli and others claim that arsenic has the same control as a preventive of malaria. These results may be taken as a confirmation of the clinical evidence given, and of the view we long since expressed as to the coming importance of various allied modes of prophylaxis in the prevention of various communicable diseases.

Henceforth we have mentioned some other prophylactics which we believe to have been effectual in preventing or mitigating some of the parasitic diseases. With this new evidence, I believe the time has come for a thorough testing, both by the practitioner and the biological investigator, of this new method of preventing and controlling disease. There are now many who believe that the real action of some of our most successful remedies is just this: the mitigation or prevention of a microphytic disease does not necessarily mean the destruction of the organism, but its inhibition *in loco*, or the modification of its chemical action on the tissues or of its products so as to render it harmless. It is a part of that anti-

septic medication which Professors Yeo and Brunton, and many others, recognize as steadily gaining ground for approval.

If, in an individual case of exposure, or an outbreak in a family or a neighborhood, this kind of prophylactic treatment is available, it is easy to forecast the wonderful beneficence of the result.

If, for instance, in an outbreak of diphtheria in a family or in a neighborhood, we can put all persons exposed to it for a few days upon a prophylactic treatment, or if in the first outbreak of cholera in a locality all exposed persons can be rapidly brought under the inhibitive effect of a prophylactic administered promptly and continuously, we will have in our possession a mode for the limitation or prevention of epidemics far more likely to have practical application than any system which involves the cutting of the skin, or the introduction in any form of the actual virus of the disease. At any rate, with two such modes of defence at hand, we might hopefully expect to substitute the word 'sporadic' for 'epidemic,' and to bring many a vagrant pestilence within the range of our control.

The present age of advancing medical art will be rendered still more notable if it can be found that simple and active medication, on the outbreak of any communicable disease, will protect all those exposed thereto from contagion, or so modify its effect as to make the attack benign.

THE ALASKAN SOCIETY OF SITKA.

It seems that the opening-up of Alaska to tourists is to result in some real benefits to science. An exceptionally intelligent and influential body of visitors appears to have visited the Territory during the past summer; and in the last issues of the *Alaskan* and the *North Star*, both of which are published at Sitka, are to be found the practical results of the presence of the body of visitors referred to. The *North Star* states that the training-school at Sitka particularly interested the tourists, and their interest seems to have taken a practical form. In this paper's account of the visit we read that at the instigation of President Butler, of the College for the Training of Teachers in New York City, and under his leadership, a large subscription was made for the purpose of equipping the kindergarten and the wood-working departments of the training-school. The list of subscribers is printed in full in the *Alaska* papers, and it contains the names of many prominent persons in the educational, political, and business worlds.

The same visitors were very much impressed with the necessity of taking steps to preserve information concerning the folk-lore and arts of the native Alaskan population. After leaving Sitka, Presidents Gilman and Butler were appointed a committee to draw up a constitution for a society which should have for its object the collection and preservation of such information. This constitution was drawn up, and signed by most of the visitors, and was then submitted to the residents of Sitka, who a few weeks ago called a public meeting, and proceeded to organize a society, which is to be known as the Alaskan Society of Sitka. The constitution as adopted states that the purpose of the society is to collect and preserve information in regard to the arts, history, language, religion, and folk-lore of the native population of Alaska, and also in regard to the structure, climate, mineral resources, fisheries, flora, and fauna of the country, and in brief to observe, collect, record, and publish facts in regard to the entire Territory, continental and insular.

The members of the society are the following founders, and such others as may be elected to membership from time to time. The founders are Pres. D. C. Gilman of Baltimore, Pres. Nicholas Murray Butler of New York, Senator C. B. Farwell of Chicago, Edwin H. Abbott, Esq., of Milwaukee, Prof. Louis Dyer of Cambridge, Prof. A. V. Young of Evanston, Ill., Thomas Hill, Esq., of San Francisco, and Elliot F. Shepard, Esq., and John B. Pine, of New York.

Resident members are to be chosen from the residents of Sitka, who by their tastes, studies, or pursuits are qualified to promote the objects of the association. Corresponding members are to be chosen from those interested in the object of the society in all parts of Alaska, and from those officers who have been stationed in the Territory. Honorary members are to be chosen from those who have in any way distinguished themselves in promoting the study of Alaskan geography, natural history, ethnography, or other branches

of science. An annual report is to be made, and scientific papers may be published from time to time in the name of the society, after they have obtained the approval of a committee of scientists to be designated by the directors.

It is also intended to establish a museum at Sitka in which a large portion of the material to be collected by the society can be preserved. It is doubtful if any of our Territories possesses greater geographical and ethnographical interest than Alaska, and we trust that the Alaskan Society of Sitka will make the best use of its opportunities, and collect material which will be invaluable for scientific purposes.

So little is generally known in the United States concerning the meteorology of Alaska, that it will be of interest to read the summary of the report of the Signal Service officer stationed at Sitka, for the month of September last. The highest barometer for the month was 30.38, and the lowest 29.26. The monthly range of the barometer was 1.12. The mean temperature was 57°, the highest point reached being 60°.5 and the lowest 36°.5. The least daily range of temperature was 5°.5, and the mean daily range 11°.6. The mean daily dew-point was 45.5, and the mean daily relative humidity 80.7. The total movement of the wind during the month was 6,030 miles, the highest velocity reached being 46. The total precipitation for the month was 10.57 inches, and on 20 days .01 of an inch or more of rain fell. The number of clear days during the month was 5, of fair days 8, and of cloudy days 17. On three days light frost occurred.

HEALTH MATTERS.

The Corset.

DR. ROBERT L. DICKINSON, lecturer on obstetrics at the Long Island College Hospital, has prepared a very elaborate paper on the corset, discussing from a scientific standpoint the questions of pressure and displacement caused by it. This paper was read before the Brooklyn Pathological Society, where it excited great interest and discussion. It has been published in full, with seventeen figures, all of which were drawn by the author of the paper, illustrating the effects of corset-pressure on the chest and abdomen and their contained organs, in the *New York Medical Journal* of Nov. 5. Dr. Dickinson says: "Ridicule, argument, and invective have been freely expended upon the artificial small waist since the days of Martial and Galen. Yet the habit of corset-wearing has received little systematic study, and men's opinions are widely at variance. We frequently meet with the statement that corset-wearing works great injury; we discover a catalogue of five and ninety different diseases and disorders due to tight lacing; we find Bouvier, who has written the elaborate and interesting history of this article of dress, vigorously asserting that 'the modern corset, moderately tightened, is without appreciable influence on the health of the healthy woman;' and we encounter all shades of opinion between these extremes. But unsupported assertion is poor evidence, although a general impression must carry some weight. To obtain clear perceptions of the action of the corset, I have endeavored to measure the amount of pressure it exerts, to ascertain the distribution of the pressure, and to determine the displacements resulting therefrom, studying the subject with as little bias as possible, stating bald facts, and rarely expressing opinions."

The first tests which Dr. Dickinson applied were to determine the external pressure by the manometer; and as a result he gives a table of the various pressures within the body, as that of the blood and of the expiratory force of the lungs, when compared with the pressure exerted by the corset.

In reference to the words 'tight' and 'loose' as applied to corsets, the author says these words need to be defined. They lack precision, but are necessary. We cannot determine any limit of contraction in inches as the dividing-line, since in certain cases an inch and a half lessening of waist-measure with one woman will cause more pressure and more distress than five inches in another. The guide must be the patient's sensations, when we can trust her testimony, and signs that are readily appreciated, such as the restricted respiration and movement, evident discomfort when the corset is first hooked, flushing of the face in a warm room, and the

indentations in the skin after removal of the corset. Appearance goes for nothing: a large bust and wide hips or shoulders give an impression of slenderness in the waist which may be entirely deceitful. The least pressure he has estimated from a corset is twenty-one pounds: the greatest pressure is eighty-eight pounds. Within the half-minute that follows any exertion, such as rising, lying down, turning over, or straining, the mercury in the manometer rises from a half-inch to an inch and a half, then gradually falls to its steady level. On taking off a corset, one often observes that if the circumference of the waist is taken at once, and again a few minutes later, an increase of about an inch will have occurred. Six inches difference between the circumference of the waist over the corset and the waist with the corset removed is the greatest difference which he has measured. Five and a half and five he met with once each. In the woman who wears no corsets the many layers of bands about the waist, on which heavy skirts drag, are sufficient to cause considerable constriction, as Dr. Mosher states. The thoracic cavity suffers less diminution in size and alteration in shape from corset-wearing than the abdominal. The principal constricting effect is exerted below the fifth rib. The inferior edge of the lung is compressed, and its ability to distend the lower part of the pleural cavity seriously crippled. Compensation in part is effected by the tendency of the corset, when firmly adjusted, to raise the shoulders, forcing the upper lobes to do the breathing, as Sibson has proved, raising the thoracic, or five upper ribs, widening the interspaces (also a constant condition, in the female), and in this way expanding the highest part of the conical thoracic cavity. Freer play of the apices in women who wear corsets would lead one to expect consolidation at these points to be relatively less frequent than in men, while affections at the base should be more commonly met with. An increased tendency to emphysema of the upper lobes might also be anticipated.

The author raises this interesting question, May the peculiar character of the respiration in women be attributed to the use of corsets? Two observers who are especially qualified to testify have stated the case very forcibly. Sibson says, "In the adult female the form of the chest and abdomen and the respiratory movements are often undoubtedly modified by tight lacing. The form of the chest and the respiratory movements do not differ perceptibly in girls and boys below the age of ten. Although the form of the chest remains nearly the same until the age of twelve, the abdominal movement is then somewhat less, and the thoracic somewhat greater, in girls than boys. At this age and earlier, stays are worn, and, though they do not compress the body materially, yet they restrain the free expansion of the lower ribs during free exercise. After the age of fourteen the form of the chest and the respiratory movements differ materially in females and males. I think it probable that in females, even if they wore no stays, the thoracic respiration would be relatively greater, and the diaphragmatic less, than in man; but this is only surmise. Delicate men," he says further, "approximate to the female thoracic breathing; vigorous women, to the male abdominal breathing; and long-distance runners have the least thoracic breathing of all men (in the quiescent condition). The diaphragm would seem, therefore, to be a muscle capable of developing to meet increased demands as much as any other that the athlete strengthens."

Walshe says, "The agricultural woman, who knows not stays, breathes more like a man than the town female. Besides, during sleep the conditions of pectoral and ventral action of the female are much less strikingly different from those in the male than in the waking state: the waist is relieved for a time from constriction. And, further, the male and female dog breathe almost exactly alike, as do the horse and mare: the action is abdominal and lower costal."

Dr. Dickinson calls attention to the observations of Dr. Mays of Philadelphia, who has recently studied the respiratory movements of Indian girls in the Lincoln Institution, and whose results have been referred to in *Science*. These girls had always worn loose clothing. They ranged between ten and twenty years of age. Tracings from their costal and abdominal respiratory movements showed a very close analogy to those of the civilized male, and that, "so far as the Indian is concerned, the abdominal is the original type of respiration in both male and female, and that the costal type in

the civilized female is developed through the constricting influence of dress around the abdomen. This is markedly shown in the greater prominence of the costal movements in those girls who were either one-half or three-fourths white, and who were hence dominated to a greater or less extent by the influence of civilized blood. . . . It is also evident that the costal type of respiration in the civilized female is not due to the influence of gestation."

Long-continued compression, by the corset, of the wall of the abdomen in the epigastric and hypochondriac regions, gradually brings about a thinning of its adipose layer. Below the ring of constriction the fat accumulates. The woman who abhors 'a stomach' yet adopts the most effective means of cultivating one. Flabby, old, or obese persons are especially prone to pile up panniculus adiposus below the navel. Many stout young men in good condition have been examined, and not one has been found in whom this tendency is evident. On the contrary, the fatty layer above the umbilicus is usually thicker than that below it. These men wear suspenders. In eleven healthy women below thirty who have been in the habit of wearing corsets (of varying degrees of tightness) the fat below the navel has always been found to be more than twice as thick as that above, while one to three is no uncommon ratio. That this is not normal is proved by the fact that in two teachers of gymnastics measured for me by Dr. Mosher the fatty layer was thicker above. With a corset that is 'quite tight,' but not so tight as the patient "could bear it, as in a new dress or at a ball," the displacement of the uterus is a third of an inch. The distance seems insignificant, and may only be considered of importance in view of the following facts: 1st, That this is almost the deepest position to which the structures can be forced by straining down; 2d, That the long-continued action of the depressing force is exerted during the period of growth; 3d, In view of the results likely to ensue in case of weakened and enfeebled supports, in case of increased size and weight of the uterus (normally present during menstruation), and in case of incipient displacement; it naturally follows, 4th, That this forcing downward is sufficient to render the uterine supports tense (be they ligament, 'column,' or pelvic surroundings *in toto*), and that in their taut condition any extra or added stress, like deep breathing, or exertion, or bending, might well be enough to each time slightly overstrain these stretched supports. Slowly and steadily as this force acts, yielding must in time occur. In fact, Engel states that in every one of thirty autopsies in which evidences of tight lacing were found, prolapsus of the uterus was present in some degree, except where adhesions had prevented it. Will not this account in part for the uterine troubles of women supposed to be due to many of their sedentary occupations, such as sewing-machine work? The man bending forward relaxes his abdominal wall, and enormously lowers his intra-abdominal pressure by so doing (Schatz), but the corseted female, who writes or sews, produces the opposite effect. The earlier corsets are worn, the more the liver would be affected, since it is proportionately much larger in the child than in the adult. Previous to puberty its weight may be as much as one-thirtieth, or even one-twentieth, of that of the entire body: in the adult it averages one-fortieth. "The practice of tight lacing," says Murchison, "may cause displacements and malformations of the liver, which may simulate enlargement, and which are of considerable importance in diagnosis. Tight lacing may act on the liver in three ways,—according to the situation, the tightness, and the duration of the constricting cause. (a) The liver may be displaced upward or downward, according as the pressure is applied below or above. The precise situation where the pressure is applied will vary with the prevailing fashion of dress; but most commonly in this country the displacement is downward, and this may be to such an extent that the lower margin reaches the ilium, and the liver appears to fill up the whole of the right side and front of the abdomen. [Frierichs and other writers speak of this amount of change in location]. (b) In consequence of lateral compression the liver may be elongated in its vertical diameter so that a larger portion of it is brought into apposition with the abdominal and thoracic walls. This is a very common result of tight lacing. (c) When the pressure is exerted by a tight cord, it may produce deep fissures in the substance of the liver, as the result of which, portions of the organ may be more or less detached, and may even be felt as movable tumors through

the abdominal parietes. Apparent enlargements of the liver from tight lacing are far more common than is generally believed."

If, from the testimony of these five observers,—Braun, Corbin, Engel, Frierichs, and Murchison,—the extreme mobility of the liver has been proved, although we grant that these extremes result from tight lacing, are we not justified in believing that even a loosely adjusted corset must definitely displace so mobile an organ? The difference between the looest corset and the tightest is less than might be imagined. Dr. Dickinson has not been able to double the pressure on requesting a patient to lace her loose corset to the utmost she could bear.

Engel found the stomach displaced in the following remarkable manner. It was shoved to the left. Its long axis, from a horizontal or oblique direction, was changed to a vertical, so that the lesser curvature ran down directly to the left of the spinal column. The pyloric end was depressed as far as the fourth lumbar vertebra. Constriction not unlike the liver-furrow was occasionally met with, but without pathological changes in the walls. The pancreas may be dragged down to a perpendicular position on the face of the vertebral column, reaching down to the promontory. These were extreme cases, of course.

A few of the most palpable changes brought about by corset-pressure have thus been briefly described. There are many others as much more important as they are more subtle and difficult of proof, such as the disturbances of abdominal circulation, the effect on digestion, the limitation of exercise, and the slowly increasing action on the general health.

The conclusions reached by the author of this interesting paper, are: 1. The maximum pressure at any one point was 1.625 pound to the square inch. This was during inspiration. The maximum in quiet breathing was over the sixth and seventh cartilages, and was 0.625 of a pound. 2. The estimated total pressure of the corset varies between thirty and eighty pounds,—in a loose corset about thirty-five pounds, in a tight corset sixty-five pounds. 3. Within half a minute after hooking the corset, such an adjustment occurs that a distinct fall in pressure results. 4. The circumference of the waist is no criterion of tightness. The difference between the waist-measure with and without corsets gives no direct clew either to the number of pounds pressure or to the diminution in vital capacity. Relaxation and habit seem to affect these factors largely. 5. The capacity for expansion of the chest was found to be restricted one-fifth when the corset was on. 6. The thoracic character of the breathing in women is largely due to corset-wearing. 7. The thoracic cavity is less affected by the corset than the abdominal. 8. The abdominal wall is thinned and weakened by the pressure of stays. 9. The liver suffers more direct pressure, and is more frequently displaced, than any other organ. 10. The pelvic floor is bulged downward by tight lacing one-third of an inch (0.9 cm).

BOOK-REVIEWS.

The Study of History in American Colleges and Universities. By HERBERT B. ADAMS, Ph.D. Washington, Government. 8°.

The Study of History in England and Scotland. By PAUL FREDERICQ. Baltimore, Johns Hopkins University. 8°.

By a pleasant coincidence these two volumes reach us together, and they have a great and reciprocal interest. When Dr. Adams comes to look over the present series of his Studies, we believe that he will find it the most interesting, and perhaps the most valuable, of all. It will be remembered, that, after half of the series had been devoted to studies of local government, a pleasant essay on a recondite subject in the political history of the United States was introduced, and that this was followed by Dr. Adams's own contribution on the literature of charities. The present paper, which is translated from the French by Miss Henrietta Leonard, is the report on the study of history in England and Scotland, which was prepared by Professor Fredericq at the invitation of the Belgian minister of public instruction. The report is very complete, and the author seems to have spared no pains to gather all the information available. Courses of study and examination-papers have been drawn upon *ad libitum*.

The author finds that the "study of history in Scotland" is something which does not exist. He says frankly that "history is in reality excluded from the curriculum of Scottish universities." At Aberdeen and St. Andrew's it is not taught at all, except when some historical information is necessarily imparted in the course of instruction in literature. He is hopeful, however, that a new act of Parliament will remedy this glaring defect, and afford history at least a decent recognition in the land of Robertson, Walter Scott, and Carlyle.

With Cambridge and Oxford, Professor Fredericq was very much impressed, and he grows quite enthusiastic over the system of fellowships which permits men like Max Müller and Mr. S. R. Gardner to secure an academic income while devoting their lives, not to teaching, but to advancing the cause of science. The historical instruction at the two universities is outlined for us by the author, and we learn exactly what courses each professor and fellow gives, and how he gives them. The description of Professor Sealey as "a master whose first care is to make his pupils think for themselves," is a very pleasant one, and his adaptation of the German *Seminar* method is highly praised. Mr. Oscar Browning, well known in this country for his pedagogical writing, also comes in for a special word of praise.

At Oxford it was found that the programme of the historical instruction was more grandiloquent than the instruction itself justified. The lecturers are referred to as generally restricting themselves to an elementary style of teaching, and as not using any of the scientific equipment on which the continental student depends so much. Professor Fredericq notes that "the remarkable development in historical instruction that has taken place at Oxford since 1870, and at Cambridge since 1875, leads one to think that the practical course will soon be felt a necessary complement to the already brilliant theoretical course." The corps of instructors at both universities is ample; and, when modern methods and *quellenstudie* shall have replaced much of the present antiquated instruction, then, we are led to believe by the perusal of this essay, little else can be asked for.

Dr. Adams's paper on the study of history in American colleges and universities is quite as painstaking and far more comprehensive a study than that of Professor Fredericq. The substance of some of the chapters has previously appeared as articles in *Education*, but they are now reproduced, with many additions. Dr. Adams traces the study of history at Harvard from its foundation up to the preparation of Mr. Winsor's 'Narrative and Critical History of America,' and at Yale from the seventeenth century to the foundation of the courses now given by Professors Wheeler and Dexter. To Columbia College the writer awards the honor of being the first institution in America to recognize history as worthy of a professorial chair. His sketch of the historical teaching at Columbia, which embraces the work of Vardill, Anthon, McVickar, Lieber, and Burgess, is in many respects the most interesting in the volume, and to it a very appreciative account of the School of Political Science is added. The University of Michigan and Cornell receive separate and generous treatment. The chapter on the Johns Hopkins University is a slightly revised reprint of Dr. Adams's earlier paper on the subject. We were very much interested in reading of the excellent instruction being given in the colleges for women, particularly at Wellesley. The paper concludes with an extract from Mr. Carroll D. Wright's impressive address before the Economic and Historical Associations at Cambridge in May last, and some statistical tables.

Read in connection with each other and together with Professor Fredericq's articles on the teaching of history in Germany and France, published some little time ago in the *Revue Internationale de l'Enseignement*, these pamphlets afford us the data for determining with some approach to exactness the comparative value of the historical instruction now being given at the world's great colleges and universities. We find advance everywhere, — promising, hopeful advance. The spirit of Savigny, Ranke, and Draysen is abroad; and the work of Freeman and Seelye in England, and of Burgess, Emerton, Adams, and Channing in this country, is in the right direction, and productive of excellent results. But the next generation will be even better able than our own to appreciate what the modern method of studying and teaching history really means.

The Family: An Historical and Social Study. By CHARLES FRANKLIN THWING and CARRIE F. BUTLER THWING. Boston, Lee & Shepard. 8°.

BOOKS on sociology increase in number and interest. The one under notice is indeed a very good summary upon the subject in its historical, social, and moral aspects; but it gives no hint of a definite purpose other than can be ascertained by reading it. It is without a preface, — an omission which we think a defect in so important a discussion.

The first chapter treats of the prehistoric family, and examines this institution in the Semitic and Aryan races, as a type of different social structures. "The Semitic family is patriarchal, the Aryan is individual: one makes the father the unit, the other makes the family itself the unit; one is polygamous, in the other monogamy prevails; one gives all duties to women, the other gives some duties to men, and some rights to women. The patriarchal Semitic system is the germ of monarchy; the Aryan family is the beginning of the political commonwealth." The patriarchal system is shown to prevail among the Greeks, Romans, and Hebrews, with the strict responsibility of woman for fidelity, and considerable laxity in tolerating male infidelity. Then Christianity modified this system. Two characteristics mark its influence and improvement upon previous conceptions of the family: monogamy and mutual chastity. The same rule of purity was applied to the husband as to the wife, which had been limited previously to the latter. The middle ages are considered to mark a conflict between the Roman patriarchal system, and the republican conception of the family in northern races, based upon the capacity to bear arms. It is a chaotic period, the first of which shows little respect for woman. The decline of virtue in the Roman Empire had to burn out its course; but the rise of chivalry was the restoration of the Christian conception, which in one form or another continues to make improvement.

The general contrast between modern and ancient conceptions of social life is that between the individual and the family. The individual is the legal and social centre of modern life; the family, of the ancient. In modern jurisprudence the individual is made to suffer for his own crime alone; in ancient, the family and kinsfolk were also made to suffer for the crime of a guilty member. This is important for illustrating the tendency in individualism to distribute the rights and responsibilities among a larger number than the centre of a group or community. This elevates woman above the position of a servant or of property.

The drift of rural into urban population is noticed, and is thought to endanger the family in such a way as to require correction by a re-action in the opposite direction. We think, however, that economic forces have determined this more than moral, although the latter are strong factors in the movement. Fourierism, the Oneida Community, and Mormonism do not pass unnoticed.

The last two chapters are an elaborate discussion of divorce in a very scientific manner, but with some unconsciousness of the difficulties in the way of correcting the evils of it, due to social customs which must first be amended before the problem of divorce can be solved. The causes of divorce are assigned to two classes, — general and special. The general are, (1) growth of individualism, (2) secularization of marriage, (3) change in social and political condition of woman. The special are, (1) husband's belief in ownership of wife's person, (2) property, (3) wife's failure to assume her share of the burdens of the family. The remedy lies, as the author thinks, (1) in a proper conception of a woman's responsibilities, (2) in a higher standard of belief and practice as to domestic institutions, (3) in the restoration of marriage to a religious basis, and (4) in uniformity of law as to marriage and divorce.

We will not criticise this. The subject merely suggests the remark that there is a growing tendency to make married life a commercial matter, one of the most dangerous influences that ever affected human life. On the other hand, both as a corrective of this, and as a check upon population of which Malthus may not have dreamed, there is a tendency to enfranchise woman, socially and legally, so as to make her independent of the marital relation for her support. It is not a little remarkable, that, just as population is beginning to approach the limits of its expansion by occupying all the material resources for its subsistence, the combined in-

fluence of chivalry, Christianity, and individualism should have anticipated the pressure which their occupation or exhaustion must produce by emphasizing the moral, social, and legal rights of woman, and thus confer upon society the power to exercise a check upon the terrible consequences of over-population. Evolution seems to be creating motives and an environment that will modify the effects of the most powerful of human instincts, and just at a time that will prevent the pressure from being too abruptly imposed upon civilization.

Conscious Motherhood; or, The Earliest Unfolding of the Child in the Cradle, Nursery, and Kindergarten. By EMMA MARWEDEL. Chicago, Interstate Publ. Co. 8°.

THE reviewer has a difficult choice to make with regard to the proper mode of viewing such a book as this. He is tempted, in the first place, to regard the book as a scientific contribution, and finds the justification of such a method in the fact that the psychological development of infant mind is well on its way towards assuming the character of a scientific body of truths. Regarded as such, no favorable notice can be passed upon it. It lacks throughout a systematic and symmetrical exposition: it fails to distinguish the important from the trivial, the scientifically established from the popularly supposed: it uses new words where we have good technical words in their stead, e.g., 'sensoric,' 'motoric,' 'peripheric,' for 'sensory,' 'motor,' 'peripheral,' the German 'rinde' instead of 'cortex,' and so on: it includes several rather serious blunders in stating anatomical and physiological points, and shows the mark of an 'atechnical' hand. In this sense the contribution here made is of no high order of merit, and adds little of value to our knowledge of the subject.

If, on the other hand, the reviewer asks himself the questions, "What will be the practical effect of the book?" "How does it stand as a means of propagating sound doctrines not yet universally understood?" he has the pleasanter task of finding many commendable doctrines emphatically expressed. The keynote of the volume, as indicated in its title, is to arouse mothers to a proper appreciation of their privileges and duties. Education begins in the cradle: the child is not one being in its infancy and another when it comes under school influence. There is a continuous psychical development paralleled by a physical development, taking place independently of the technical 'instruction' and based upon natural laws. These laws are to be explicitly unfolded, and are to form the guiding spirit under which the child is to be viewed and its true education directed; to reveal the all-important truth of the supreme value of these early years of life when habits far deeper than the artificial learning of later years are laid down, when the most difficult actions of life are learned, when the child is passing with lightning speed through the history of the race, epitomizing the characteristics of remote ancestors as well as of its parents. The duty of this sphere of education falls upon mothers: it is to be rescued from the hap-hazard spirit in which it is cultivated, to be made a serious occupation and not a dilettanti toy, to be recognized as the true mission of 'conscious motherhood.' The advancement of woman is to consist in the increase in dignity and importance of the duties which have in all ages fallen to her share. The appeal is a noble one; and while not always made with a full view of the many-sidedness of the problem involved, is presented in a way likely to attract the audience to which it specially addresses itself.

The author is the head of a kindergarten in San Francisco, and an enthusiastic follower of Froebel, taking from him some of his peculiar symbolism and mystic imagery. Her other altar is erected to Professor Preyer, as the representative of the modern scientific study of child-mind; and from these two lines of interest she confidently awaits the time when the relation of mother and child will be practically appreciated in all its fullness, grandeur, and importance. The offshoot which the kindergarten has sent off from the technical education will spread down to the home, there to plant the real root of a natural education. Her next greatest interest is in developing the technical side of kindergarten work; she here falls into the common error of overestimating the importance of doing things in just such and such a way to the neglect of the importance of having them done in any of half a dozen ways: her

devices are plausible, but worthless if made a ritual. What is wanted is a good teacher with a talent for adapting all methods.

So much for the original portion of the book. The second part is devoted to a *résumé* of the work of Preyer on child-mind. The work of selecting the abstracts and putting them into good English is fairly well done. Here and there the real important point is omitted, and much detail is found in its place; and the physiological portion is rarely accurately set forth. But the object of the translation is to arouse an interest in the observation of children, and in this good cause the book is a desirable aid.

Die Welt in ihren Spiegelungen unter dem Wandel des Völkergedankens. Von A. BASTIAN. Berlin, Mittler. 8°.

IN the present publication the author sets forth his ideas of the principles on which the science of ethnology must be founded. He considers ethnology the only sound basis of psychology. His arguments are these. The inductive method of science as developed in our century is founded on comparison. If psychology is to attain the same scientific character which the natural sciences have reached, the same methods must be applied. If, however, psychology is exclusively based on the facts given by our self-consciousness, it is impossible to apply this comparative method, as only a single phenomenon — our own *psyche* — is given. The first thing to be done, therefore, is to establish sound methods of psychology. The connection between physical and psychical phenomena must be studied by the science of psychophysics. The study of psychical phenomena can only be begun after an exhaustive knowledge of such phenomena has been gained; therefore it is necessary to know all ideas that exist, or have existed, in any people, at any time. These must form the material for psychical researches. He calls this method the 'statistics of ideas.' Bastian has emphasized these theories in all his recent publications, and his point of view is one of eminent importance. It cannot be said too frequently that our reasoning is not an absolutely logical one, but that it is influenced by the reasoning of our predecessors and by our historical environment: therefore our conclusions and theories, particularly when referring to our own mind, which itself is affected by the same influences to which our reasoning is subject, cannot be but fallacious. In order to give such conclusions a sound basis, it is absolutely necessary to study the human mind in its various historical, and, speaking more generally, ethnic environments. By applying this method, the object to be studied is freed from the influences that govern the mind of the student.

There are two objects of ethnological studies. The one is to trace an idea in its origin and growth and in its offshoots; but, after this has been done, the problem remains to be solved, what are the psychical laws that govern the growth of ideas in the mind that holds them? We may know the whole history of an idea, still we do not know why this idea is taken up by a certain people and developed in a certain way, or why similar ideas are found in regions widely apart. It is this branch of ethnology which Bastian has in view when he again and again emphasizes the absolute necessity of collecting what can be collected. The individuality of uncivilized nations is disappearing so rapidly that we may expect it to die out ere long. For this branch of ethnology particularly, all phenomena of the life of uncivilized nations are of the highest importance, and therefore their study must be carried on vigorously.

Bastian calls the present volume 'Prolegomena to the Statistics of Ideas.' We find in it a vast amount of material referring to the ideas of uncivilized races, and of scientific men of various epochs, on life and death, on the origin of the world, and on its end. It is accompanied by a collection of pictures illustrating these ideas.

F. B.

Naturforschung und Schule. Von W. PREYER. Stuttgart.

IN this pamphlet Professor Preyer, the noted physiologist, vigorously attacks the present educational system of Germany. His main thesis is that the *Gymnasium* — which, in spite of a few concessions, still proclaims as the necessary education for all cultured Germans a long drill in the classics, and still holds the only key to the university and the governmental posts — is an institution entirely out of date, ignoring all that enormous addition to human

knowledge which forms the pride of our civilization, and using methods that are in direct antagonism to the teachings of modern educational science.' What he asks is, that the *Realschule*, where science is represented and the classics find but a small place, shall be placed on equal footing with the *Gymnasium*; that its certificate be on a par with that of the *Gymnasium* as a credential for entering the university and as a step toward official advancement. When the two systems are allowed to compete on equal terms, a healthy rivalry will give each its proper position in the educational system.

In support of this position, Professor Preyer recounts some interesting facts. In the first place, the present constitution of the *Gymnasium* is complained of. It puts too much strain on book-knowledge, on memory-cram, on non-useful accumulation of dead words, and allows no place to fresh, living facts. A very small portion (only about fifteen per cent) go through the *Gymnasium* and receive the mark of proficiency, and many of these are older than they should be. The school must be arranged so that the majority of the pupils pass the examination with credit. Their physical health suffers, as is shown very conclusively by the number of rejections for the military service. The number suffering from shortsightedness (*myopia*) is startling. Furthermore, the university professors are very rapidly coming to prefer students who have some practical training; and more than half have, in answer to a circular, expressed themselves in favor of placing the two schools on an equal footing. The students of the sciences are increasing, in recent years very rapidly; and yet the whole world of science must accept all such recognitions of its disciplinary and culture value as patronizing concessions from the powerful 'dead-word' scholars. Professor Preyer wants no concessions, but a complete recognition that the 'new education' offers a training at least as valuable, from a practical as well as a humanitarian standpoint, as the traditional schooling of Germany.

As the charge is often brought that the objectors do not state what they want, but only what they object to, the author sketches a plan of school which he regards as in harmony with the needs of modern life and the teachings of a sound physiology. "Much more time must be devoted in the schools to character-building, that is, to moral education and to physical culture, and much less to instruction, that is, memory work." First of all, he asks a thorough systematic course in the mother-tongue, so that every young man can express himself correctly and promptly, can write a satisfactory letter, and arrange what he has to say so that it is readily understood,—an accomplishment very rare among present university students. He wants a sound course in general practical ethics; a good knowledge of French and English; a drill in *Heimatskunde*, so that every German knows his own country; a careful instruction in history; a systematic training of the senses and observing powers, by drawing, by manual skill, by scientific tasks of all kinds,—mathematics, physics, chemistry, and physiology. In addition, the hygienic condition of schools and scholars should be under the official charge of a physician, whose special duty it shall be to prevent the many causes of mental breakdown now so prevalent.

The usual counter-arguments, that our culture is staked upon that of Greece and Rome, that these things are necessary for their culture-power, etc., Professor Preyer admits, as far as they mean that every opportunity should be given to study them, but entirely opposes when it is held that *all* must study them without reference to their future career. Those who believe in the 'new education' must now, like Professor Preyer, send their sons to the *Gymnasium* to spend years in (to them) comparatively useless instruction, spoiling their powers for fresh fact investigation, and then suddenly emerge in the sphere of university freedom where they attempt to forget their previous word-lore, and strive to re-adjust themselves to a new field of activity; must do this in order to secure for their sons the entry into the full privileges of the university and the governmental appointments. The removal of this restraint he regards as a national necessity, and sees the fate of Germany hanging upon its speedy adjustment to the needs of modern living.

One sees from this pamphlet that the Germans have their educational problems still to work out, and must go through bitter controversies before advance is realized, quite as much as we in

America. Our institutions are younger and more plastic: they should accordingly be in the van of the 'new education.'

M. Tullii Ciceronis Cato Major et Lælius. With an Introduction and Commentary by Austin Stickney, A.M. (Harper's Classical Series, under the editorial supervision of HENRY DRISLER, LL.D.) New York, Harper, 12^o.

PROFESSOR DRISLER is laying classical instructors under great obligation to him by providing them with a series of text-books whose editors have kept always in view the practical needs of the college class-room. In so many of the editions of Greek and Latin authors lately issued from the press, both in England and this country, there is an attempt on the part of the editors to overwhelm the student with a display of erudition whose only effect is to discourage him from any attempt to search for the notes that he really needs, but which are only to be found *nantes in gurgite vasto*. In the series now publishing, however, in which Professor Stickney's volume is the seventh, the results of careful and scholarly investigation are set forth without any unnecessary and tiresome recapitulation of details, that are of course interesting to the critical linguist, but of no importance to the undergraduate, for whom these volumes are primarily designed.

Professor Stickney has, in the 'Cato Major et Lælius,' given us a companion to his excellent edition of the 'De Officiis,' and one that exhibits the same good judgment and knowledge of the needs of the class-room. The notes are admirably selected, concisely given, and amply illustrated. Of course, after what Mr. Reid has done in his masterly edition of these two treatises, one does not look for much original matter; but a great deal that Mr. Reid discusses and illuminates with the light of his own very elegant scholarship is of interest only to the critical student of Cicero, and presupposes an extensive acquaintance with that author. Professor Stickney's purpose is a different one. Conciseness is his object; and the only criticism that one can reasonably make is, that brevity is sometimes gained at the expense of strict accuracy of statement, as in the note on *quo . . . via* (vi. 16), where the true locative force and form are ignored in his explanation; while in the same chapter the interesting form *cedo* is passed over with a mere translation. So, too, Cicero's blundering derivation of *occatio* is allowed to stand, and the famous *viam quam . . . ingrediendum sit* is dismissed with the perfunctory remark that it is "an archaism," though any fifth-form boy of an inquiring turn of mind would feel a genuine interest in a fuller explanation.

The orthography of the book is, in the main, that of C. F. W. Müller's edition, and is consistent and Ciceronian,—a delightful contrast with that of so many school editions published in this country. The few changes which Professor Stickney has introduced are, on the whole, improvements upon the Leipzig text.

H. T. P.

Die Kunst Glücklich zu Sein. Von PAUL MANTEGAZZA. Jena. (Translated from the Italian.)

We have recently become very much interested in the personal characteristics of eminent men. So many of us feel that the changed conditions of modern life carry with them so entire a re-adjustment of habits and views, that many of the commonly accepted guides for conduct are no longer applicable. We thus look about to see how men wiser than ourselves have solved these old yet ever new problems. A prominent magazine has recently collected short accounts of the education of living scholars. In a similar autobiographical strain they have discussed the 'objects of life,' and from what literary resources they drew most aid. Sir John Lubbock reveals his practical philosophy by discoursing upon the 'pleasures of life.'

In the above little volume the eminent Italian anthropologist, Mantegazza, expounds in a highly entertaining manner his optimistic life-philosophy. The author has no sympathy with the view that this life is a vale of tears: he believes that the good is the promotion of life. Health and morality are both life-favoring, and both lead to happiness. Practically, happiness is rare because it is hunted after too eagerly and too consciously, and not quietly enjoyed by the way; again, because it is regarded as implying the satisfaction of all wishes, while such a condition would really lead

to a state of stagnation. There is an art of being happy, a very essential part of which is the power to enjoy the little every-day comforts of living, and the absence of excessive worry about the morrow. To assure the reader that all this is not simply theory, the author plainly announces that he is happy. This is indeed a healthy optimism, and, if happiness is at all a scientific topic, the anthropologist is entitled to an authoritative voice in the matter. But one cannot escape the conviction, even in the midst of the most glowingly pictured pages, that the balmy air of Italy has allowed the poet to run away with the scientist, and that the problem of living is not so simple as we would like it to be. Be this as it may, these pages contain the very interesting observations of a very interesting man.

Winter: From the Journal of Henry D. Thoreau. Ed. by H. G. O. BLAKE. Boston and New York, Houghton, Mifflin, & Co. 12°.

THIS volume is the third that has been made of selections from its author's journal. This singular man withdrew to a great extent from the interests and the society of his fellow-men, and devoted himself to the contemplation of nature. He was a naturalist; yet there is very little of scientific interest in the volume before us. He blames men of science for giving too exclusive attention to the physical structure of animals, with too little regard for their mental characteristics and their habits of life; yet he has not much to say on these subjects himself. He was evidently more interested in the æsthetic aspect of nature than in the scientific, though he shows but little insight into the deeper poetical significance of natural objects. His remarks run largely on the trivial every-day aspects of things, such as the tracks of animals on the snow, the appearance of buds and catkins in the winter, and the bark of the yellow birch; and he goes into ecstasies over the humming of a telegraph wire, which he declares to be superior to all the poetry of antiquity (p. 106). The journal is full of complaints about the loss of early friendships, several of Thoreau's friends having become estranged from him, which he seems to have been at loss to account for. But surely a man who took so little interest in human affairs as he seems to have done could hardly expect very warm sympathy from others. The journal contains many observations on moral and intellectual matters, which are often of much higher value than the descriptions of natural objects that make up the greater part of the work. The author's delineation of the character of Washington is correct and well expressed, and he has several remarks here and there on the subject of authors and authorship which are quite interesting. Thoreau's style is generally clear and refined, both in descriptive and in reflective passages; and if he had had a higher purpose in life, and more interest in the affairs of men, he might have been an eminent author.

Natural Law in the Business World. By HENRY WOOD. Boston, Lee & Shepard. 16°.

THE author of this work is a practical business-man, and writes throughout from a practical point of view. He disclaims all pretension to scientific profundity, yet he shows a clear grasp of scientific principles and of their relations to the business world. He speaks of his work as "an honest attempt to trace out the working and application of natural law, as it runs through the economic and social fabric, in a plain and simple manner" (p. 5). The attempt, we think, is in the main successful. The author's style is direct and clear, and his method of treatment better fitted to win the attention of practical but unscientific minds than the method of the regular economists.

The main thesis of the book is the supremacy in industry of the law of supply and demand, and the necessity of adherence to this law as a condition of industrial prosperity. Many other subjects, however, are treated in the various chapters, which cover a wide range of topics. Mr. Wood is strongly opposed to labor combinations, partly because of their antagonism to capital, and partly because they are sometimes unjust to non-unionists, and because, as he thinks, they unduly restrict the individual freedom of their own members. In condemning them so strongly as he does, we think he goes too far, for he seems to have judged them almost exclusively by their bad side, without regard to the benefits which may

and often do result from them. He shows, however, a lively interest in the laborers themselves and a strong desire for more harmonious relations between them and their employers. He emphasizes the fact that brain labor is more important than muscular labor, a fact that is too often overlooked by labor agitators; but he honors honest labor of every kind, and declares that labor is a blessing, and not a curse. Socialism, of course, meets with Mr. Wood's unsparing condemnation, and he looks with little favor on any species of State interference. The chapters on the unequal distribution of wealth, on dependence and poverty, on the railroad system, and on the management of corporations, are well considered, and worthy of perusal by both laborers and capitalists. The book is now issued in cheap form, with paper covers, and deserves a wide circulation.

NOTES AND NEWS.

THE twentieth annual meeting of the Kansas Academy of Science was held in the Capitol Building, Topeka, Oct. 26, 27, 28, 1887. There was an excellent attendance of members, but the local attendance was not quite equal to that of last year. The capital has too many things in the way of meetings, etc., so the citizens become a little weary. The papers read were unusually valuable. The Academy of Science is growing. The annual meeting next year will be held in Wichita in October. The following is a list of the papers read: address of the retiring president, Rev. John D. Parker, on 'Progress in Astronomy'; Lucien J. Blake, 'Practical Electricity and the Laws of Energy'; H. W. Everest, 'The Utilization of Mental Power'; Robert Hay, 'The Lignite of the Kansas Dakota,' and 'Notes on Salt in Kansas'; W. R. Lighton, 'On the New Coal-Shaft at Leavenworth'; F. H. Snow, 'Fossil Flora of the Kansas Dakota,' and 'A List of the Fauna and Flora of the Kansas Coal-Measures'; D. S. Kelly, 'Notes on Fossil Elephas from Morton County'; Joseph Savage, 'A Fossil Deposit at Garden Park, Colorado'; E. H. S. Bailey, 'On the Recently discovered Ellsworth Salt-Beds'; Robert Hay, 'Notes on Building-Stones in Kansas'; N. S. Goss, 'On the Nesting of the Mississippi Kite and Snowy Plover in Central-Southern Kansas,' 'Notes on the Yellow-Tailed Cassiques,' and 'Feeding-Habits of the White Pelicans'; F. H. Snow, 'Notes on the Purslane-Worm (*Copidryus Gloveri*)'; W. Knaus, 'Notes on *Calopteron reticulatum* Fab.,' Charles R. Carpenter, 'On the Black Rot of the Grape'; Mrs. A. L. Slosson, 'Personal Observations on the Kansas Flora'; F. H. Snow, 'The Desmids of Kansas'; W. A. Kellerman, 'Some New or Little-Known Kansas Plants'; L. E. Sayre, 'Report of Further Observation on the Loco-Weed,' and 'The Resin of *Silphium laciniatum* (Rosin-Weed)'; W. R. Lighton, 'Notes on the Circulation of the Sap'; J. T. Lovewell, 'Alcohol in Temperance-Drinks'; T. H. Dinsmore, 'Should Malt be considered an Intoxicant?' and 'On the Effect of Oxygen on Animal Life'; E. H. S. Bailey, 'On the Relation between Taste and the Acidity of Certain Acids'; L. E. Sayre, 'The Action of Chromate of Lead upon the Gastric Fluid'; T. H. Dinsmore, 'Color-Blindness in the State Normal School'; J. T. Lovewell, 'Further Studies on the Rainfall in Kansas'; F. H. Snow, 'Rain Cycles in Kansas'; George E. Curtis, 'Weather-Predictions in the United States'; T. B. Jennings, 'Needs and Utility of the Kansas State Weather-Service'; George B. Curtis, 'The Exposure of Meteorological Instruments,' and 'Chimney-Hoods'; W. S. Franklin, 'Continuation of Some Studies of Lissajous Figures.'

—The steamship "Hondo" sailed on Wednesday, Nov. 30, with the Nicaragua Canal Association's survey expedition. The work will be in immediate charge of E. S. Peary. The instructions issued by Chief-Engineer Menocal are very minute. The *Engineering News* says that five parties will be organized. First the survey by all the parties of the north-eastern section of the canal, with special attention to Greytown Harbor, is contemplated, estimated to take three months' time, when most of the parties are to be moved over to the comparatively short western section. The important detail of boring to ascertain the nature of the material is not to be neglected. The present idea is that six to nine months in all will cover the work of preliminary location enough to base tolerably exact estimates on.

— The annual meeting of the American Society for Psychical Research was held in Boston last week. After the opening remarks, Dr. Minot introduced Prof. H. P. Bowditch, who presented the report of the committee on thought transference. "Among the conditions possibly favorable to thought transference, supposing it to be a genuine phenomenon, the effect of a sudden and unexpected impression made on the mind of the agent seemed particularly worthy of investigation. For this purpose experiments were made in which a brilliantly illuminated figure or diagram could be suddenly displayed to the agent while sitting in a darkened room. The chairman of this committee, Mr. Hodgson, and Dr. W. S. Bigelow took part in these experiments, which were twenty or thirty in number, and conducted on different days in the month of July last. As absolutely no evidence of thought transference was obtained, the details of the experiments may be omitted. The suggestion made in the last report of this committee, that a drug might be discovered which by its action on the cerebral centres might favor thought transference, seemed also worth testing. For this purpose experiments were tried, with Mr. Hodgson acting both as agent and percipient while partially under the influence of ether, but the results differed in no respect from those obtained when he was in the normal state." In some other experiments made by Mr. Hodgson, Professor Bowditch added, there was a degree of success which warranted a continuation of the investigation. "It will be evident to those who have followed the work of the American Society thus far, that the attempt to obtain evidence as to the reality of 'thought transference' has been attended with very meagre results. If thought transference be a genuine psychological phenomenon, it is evident that the conditions favorable to its manifestation are not generally understood. Judging from our experience thus far, it would seem that an inquiring attitude of mind is certainly not one of these favoring circumstances." Other interesting reports to which the audience listened were those of the committee on experimental psychology, by Dr. Minot; the committee on apparitions and haunted houses, by Prof. Josiah Royce; the committee on hypnotic phenomena, by Mr. Charles B. Cory; and the committee on mediumistic phenomena, by Dr. W. N. Bullard.

— The reports of M. Larrieu, late missionary in China, who maintains that the great wall of China has never existed (*La Grande Muraille de Chine*, Paris, 1887), has been widely spread by the American daily papers. He claims that the wall consisted merely of watch-towers, built of earth and bricks, about twenty-five feet high and a thousand feet apart. In a few places they were connected by an embankment. He also says that the wall north of Peking and the palisades west of Sian-tung never existed. These views cannot be correct, as numerous travellers have seen the wall or its ruins. In regard to the palisades of Sian-tung, H. E. M. James, who recently visited Manchuria, says that at the present day they have disappeared entirely, though a mound or row of trees occasionally marks the place where they stood. The gateways, however, he found still maintained as customs-posts, at which transit duties are levied. Undoubtedly the wall consisted in many parts of earth, but there is no reason to maintain that it never existed.

LETTERS TO THE EDITOR.

* * * Correspondents are requested to be as brief as possible. The writer's name is in all cases required as proof of good faith.
Twenty copies of the number containing his communication will be furnished free to any correspondent on request.
The editor will be glad to publish any queries consonant with the character of the journal.

Rock Specimens from Cumberland Sound, Baffin Land.

THE following specimens were collected by Mr. W. Whiting of the whaling-station of Messrs. Williams & Co., New London, Conn., on Umanaktuak, an island on the south-west coast of Cumberland Sound. The specimen No. 10 was found by an Eskimo on a hunting excursion, and sold as a curiosity to Mr. Whiting, from whom I received the specimens for examination.

1. *Boulder from the Bed of a Torrent Umanaktuak.*— Compact limestone, almost black, and somewhat argillaceous. It weathers dark gray, and shows on the surface slightly projecting, fine, parallel lines of stratification from one-quarter to one-half an inch apart. No trace of fossils can be detected, either by inspection

or in microscopic sections. Under the microscope it is seen to consist of gray, rounded, fine calcareous grains with a few black ones, all apparently deposited from water.

2. *South-west Corner, Umanaktuak.*— Graphite with rusty surfaces, and holding drusy white quartz.

3. *Same Locality.*— A decomposing black crystalline rock, which, on microscopic examination, proves to consist of graphite, with hornblende, a triclinic felspar, and a little quartz. It breaks into angular fragments along thin layers of graphite, which are sliken-sided, and give each one the appearance of a piece of this mineral alone.

4. *Little Hill (Kaqodloaping), Umanaktuak.*— Hornblende gneiss, of a rather coarse 'pepper-and-salt' appearance, consisting of about equal parts of quartz and felspar, forming the white portion, and of black hornblende with smaller quantities of brown mica, the dark.

5. *Big Hill, Umanaktuak, High Level.*— Light gray gneiss of medium texture, composed of about equal parts of orthoclase and quartz, with a subordinate proportion of fine scales of black mica. Occasional crystals of the felspar are much larger than the rest.

6. *Big Hill, Umanaktuak, Shore Line Eastward.*— Gray gneiss, consisting of layers of mixed orthoclase and quartz, alternating with others composed of scales of brown mica.

7. *Umanaktuak.*— Rusty mica-schist of medium texture, the quartz in small proportion.

8. *Vein in Umanaktuak.*— Translucent white vitreous quartz having exactly the appearance of alum.

9. *Umanaktuak.*— White rather coarsely crystalline felspar and quartz, with a few small scales of white mica, being a very light-colored variety of granite, apparently from a small vein.

10. *About 40 Miles Inland, in a South-Westerly Direction from Umanaktuak.*— Foliated graphite with rusty surfaces and partings.

11. *Umanaktuak.*— Vitreous translucent gray quartz with thin plates of brown mica traversing it in different directions.

These specimens indicate the ordinary Laurentian system, and are of much the same character as on the north side of Hudson Strait, where the rocks appear to be allied to those of the lower Ottawa valley, and to be somewhat nearer and more modified than the great mass of the Laurentian in the Hudson Bay territories.

DR. ROBERT BELL,

Assistant Director Geological Survey of Canada.

Ottawa, Nov. 28,

'Eskimo and the Indian.'

I WISH to add my voice to emphasize Dr. Boas's criticism of the method employed in Mr. Chamberlain's article with the above title. Though I should be sorry to hurt Mr. Chamberlain's feelings, I am obliged to say that there has been a great deal too much of the same sort of work done, and erroneous comparisons of this kind seem particularly alluring to those who attempt the study of the comparative philology of American languages on a large scale.

One reason for these errors is not far to seek. 'They of course are obliged to work with the published vocabularies of the Eskimo language. Now, as they have no knowledge of this language (and the number of those who have even an elementary knowledge of it, outside of the Danish settlers in Greenland, might almost be counted on the fingers), they are entirely unable to realize how bad most of those vocabularies are phonetically. Even the best of these, Dr. Rink's lately published comparative list of stem-words (see Dr. Boas's article in *Science*, Dec. 2), is written in the modern Greenlandic alphabet, which, in my opinion, masks many important phonetic relations, and they seem to have a sort of fatal instinct for getting hold of the oldest and least phonetic vocabularies. This is specially evident in Mr. Chamberlain's list of words. Dr. Boas has sufficiently disposed of the first table, but to show how misleading such things are, I have taken the trouble to go through his second list, taking such words as can be recognized as Eskimo words at all, and showing how their resemblances to the Indian words are due to a misapprehension of the real sound of the words. In expressing the sounds phonetically, I have used the alphabet employed by the Bureau of Ethnology in writing Indian languages, as the one with which I am most familiar. I think it will be sufficiently intelligible.

1, *hrownik*, 'bone,' is the well-known Eskimo word *saueq* (the initial *s* is perhaps merely an aspirate in some parts of the central region).

2, *anaywa*, 'brother,' is a misprint or misquotation of *añayoa* of Father Petitot's Mackenzie vocabulary. This means 'his elder brother,' being the well-known *añayo* (Greenland spelling, *angajo*) with the so-called suffix.

3, *tcene-yoarh*, 'do,' is phonetically *tceneyoaq*, the regular Mackenzie dialectic variant of *sanavog*, 'he works.'

4, *anyarkh*, 'day' (Mackenzie), is a misprint for *anyaph*, defined by Petitot as 'four long.'

5, *tschintak*, 'ear' (Tchuktschi = Asiatic Eskimo), is an evident error for *siuta*, 'his ear.' In this case the correction makes the comparison a little better, for the words compared at least begin with the same letter.

6, *atta*, 'father,' is the baby-word *atata*, *adada* (perhaps the same as 'daddy').

7, *ahanka*, 'fingers,' is probably a Reindeer Chukch or Siberian word.

8, *oonoktook*, 'to burn,' is a well-known compound of which the stem-word is *wvog*.

9, *akseit*, 'foot' (hand), is properly *axcait* (Greenland spelling, *arssait*), which appears in the other dialects as *aggait*, *adrigai*, etc.

10, *ayuntork* 'good' (Mackenzie), is really a compound, *ayüüt-sog*, 'not bad' (Greenland spelling, *ajungziok*).

11, *eshet*, 'hand' (Kadiak), is evidently *arssait* again.

12, *kakhairar*, 'lip' (Mackenzie), is meant for *kakiviap* of Petitot's vocabulary, which is a well-known compound of *kakih*.

13, *anaha*, etc., 'mother,' is evidently another well-known baby-word, *anana*, sometimes *amama* (really, I think, *mama*).

14, *chinga*, 'nose' (Tchuktschi), is *gingá*, 'his nose,' of all the dialects. (The initial sound is perhaps nearer to *k*, though a well-marked guttural.)

15, *annu*, *annju*, 'snow,' should probably be *anigo*.

16, *ukshiook*, *uktschuk*, 'winter,' is *ukioq* in at least five other dialects.

17, *aganak*, 'woman,' loses all resemblance to *ekening* in the forms in which it is usually seen, *axnaq*, *añna*.

Thus I have shown that out of twenty-five comparisons, at least seventeen depend on a total misapprehension of the pronunciation or meaning of the words for even the "fortuitous coincidences of sound" alluded to by Boas.

I must, however, do Mr. Chamberlain the justice to say that his remarks about the possibility of the Eskimo name for copper having been derived from the language of the Indians from whom they obtained the copper, are certainly suggestive. The Greenlandic word for copper is *kangnusak*, which is much more like *kanadzia* than the words used for comparison by Mr. Chamberlain, and this word is called a stem-word, *i.e.*, nothing is known of its etymology. Such a case is, however, of no value in arguing any relationship between the two languages.

JOHN MURDOCH.

Smithsonian Institution, Dec. 3.

The Eskimo Tribes.

I HAVE just read with great interest the notice by Dr. F. Boas (in *Science* of Dec. 2) of Dr. Rink's latest work. Dr. Boas has to a certain extent anticipated my own intentions, as I had already handed in to the publishing committee of the Washington Anthropological Society a somewhat lengthy review of the same work for publication in the first number of the new periodical which that society is about to publish. I have, however, discussed the subject in much greater detail than would be suitable for the columns of *Science*, and therefore venture to believe that my paper has not been rendered superfluous even by Dr. Boas's excellent article.

I am glad to find that Dr. Boas agrees, in the main, with the conclusions I had arrived at myself, though I have had the boldness to carry further than he has done the theory of the dispersion of the Eskimo race on this continent. In my discussion of Dr. Rink's arguments, there were so many points of interest that the question of Indian influence entirely escaped my attention, so that I am much pleased to see that Dr. Boas has presented this side of the question. A somewhat detailed study of the arts of the Western Eskimos leads me to agree entirely with his opinion.

I am strongly inclined to believe, though the evidence is not yet complete, that the use of the birch-bark canoe by some of the Eskimos on the Alaskan rivers, which Dr. Rink believes is an evidence of their primitive culture, is simply an adoption of the habits of their Indian neighbors, induced by the fact that where they live it is easier to obtain birch-bark than sealskins. Though it is by no means unlikely that, as Dr. Rink believes, the Eskimo skin-boat is descended, so to speak, from a birch canoe, I do not believe that the canoes just mentioned are in the same line of descent.

Dr. Boas's view of the condition of the Eskimos before their separation into their present divisions seems to me highly probable, though I think a little more study will enable us to add to it considerably.

I have already at hand nearly enough linguistic material to prepare a good-sized list of the animals that must have inhabited the original home of the Eskimos.

In conclusion, I most heartily concur in Dr. Boas's opinion that Dr. Rink's work will be highly appreciated by all ethnologists. It certainly deserves to be.

JOHN MURDOCH.

Smithsonian Institution, Dec. 3.

Queries.

19. WHO FIRST SAID IT?—The very interesting discovery announced by Professor Trowbridge, that birds have a power of sleeping on the wing, brings to mind that it is not a recent observation, but was anticipated by a very astute philosopher and poet, Edgar A. Poe. In a poem which he says was written in his youth, and published more than thirty years ago, are these lines:—

"O is it thy will
On the breezes to toss?
Or capriciously still
Like the lone albatross,
Incumbent on night
(As she on the air)."

To which he appends this marginal note: "The albatross is said to sleep on the wing." This poem, however, was criticised by another philosophic writer, 'John Phœnix,' who gave it as his opinion that the poet invented the fact in natural history because he found there were no words to rhyme with 'toss' but 'hoss' and 'albatross.' This is now happily discredited; but the question remains, Who first 'said it'?

Clinton, Io., Nov. 26.

P. J. F.

Answers.

18. METEOR-FALL.—In reference to the query "Was the Amsterdam meteorite a hoax?" the following from the *Amsterdam Democrat* of Nov. 19 explains it in fewer words than perhaps I can: "A man came down from Fort Hunter this morning to see the 'aerolite.' A meteorologist from Troy arrived in town to-day, having come in haste without his dinner, and was much disappointed when told that the 'aerolite' was a hoax. It is also stated that a party are on their way hither from Philadelphia. A big stone did fall in the place indicated. The only trouble is, instead of falling from the sky, it fell from a wagon, which was loaded and broke down with it, that's all, but it rather spoils the sensation." Newspaper statements report that on Aug. 30 a meteorite had been seen by a number of people on Main Street between Howard and Milk Streets, Spokane Falls, Wash. Ter. It was said to have struck the electric wires, cutting one of them in two. It was described to be a ball of fire ten feet in diameter. This proved to be nothing but the crossing of the electric light wires, which resulted in the melting of one of them. On the evening of Nov. 7 a large meteor shot over St. John's University, St. Cloud, Minn., and descended within two miles of the University. A vigorous search was made by professors and students, but no trace of the meteorite was found. It was concluded by all that it had fallen in the lake, in the direction of which the meteor had passed. The many sensational accounts of meteoric falls at Wellsburg, N.Y., Evansville, Ind., the Georgia metal ball, etc., are all the productions of a so-called reporter's fertile brain.

GEORGE F. KUNZ.

New York, Dec. 5.

SCIENCE

FRIDAY, DECEMBER 16, 1887.

THE AMERICAN SOCIETY FOR PSYCHICAL RESEARCH evidently finds difficulty in securing haunted houses to be submitted to their searching investigations. Professor Royce, who is the chairman of the committee on apparitions and haunted houses, jocularly referred to this difficulty in his report at the recent meeting of the society in Boston. As Professor Royce said, the name, suggesting as it does that the time of the committee is mainly spent in visiting haunted houses and ghost-ridden graveyards, does not describe its actual office. The committee has often expressed its willingness to visit haunted houses, or to pass the night in any promising place, for the sake of seeing, explaining, or of converting from the error of its ways, any genuine ghost in the city or in the neighborhood of Boston. The committee has heard of several houses that once were believed to be haunted, but in no case has the present condition of these houses warranted any interference on the committee's part. The phenomena have in all cases so far reported ceased for some time, usually for many years. A more hopeful field is in the direction of tracing some coincidence between a dream or presentiment and its supposed verification by events afterwards, but even in this direction the results are so scattering as hardly to justify the belief in any special significance in the few coincidences which have been traced.

AMERICAN PUBLIC HEALTH ASSOCIATION.¹

ONE of the most original papers presented at the recent meeting of the American Public Health Association was by Dr. E. M. Hunt, secretary of the New Jersey State Board of Health, on the origin of some diseases. It was as follows:—

[PAPER BY DR. E. M. HUNT.]

The class of diseases variously known as contagious, transmissible, or communicable has ever attracted the most earnest consideration of medical men and of all sanitarians. By the quickness and often obscurity of their invasion, by the malignant type they too often exhibit, and by the large areas over which they extend, they not only make large demands upon the skill of the profession, but arrest the attention of all mankind.

The study of epidemiology has enlarged their numbers, and now shows us that many diseases once regarded as constitutional or septic are in reality specific and pathogenic or mostly parasitic.

The prevention and limitation of this class of maladies must ever, therefore, largely occupy the attention of all of those who study the causes, the courses, and the results of disease.

The study of their etiology is always a fundamental inquiry. While to a degree it is possible to treat a disease skilfully without knowing its causes, it is always more satisfactory and generally more skilful to know something of the causes.

But what do we mean by etiology or causes? Surely not always, not generally, the beginning or efficient or final cause. Professor Semmola of Naples, at the recent meeting of the Medical Congress at Washington, may have startled some by these words: "Medicine, like all other sciences, never demands why, well knowing that the first causes of things are inaccessible, and that to every scientist it should suffice to know in which physical and chemical conditions this or that phenomenon manifests itself, so that he can modify and govern it at his will." This is true. The best that we can generally hope is to find the conditions, physical, chemical, or biological, in which phenomena manifest themselves. The word

'cause' is often in the same sentence used in two or three different senses. In our etiology we must remember that by 'cause' we mean mostly the 'conditions under which phenomena manifest themselves;' also that these conditions (thus called causes) mean the modifying influences present in the host or person, and the modifying influences of surroundings, much oftener than they mean any thing in the specific entity which we are so often calling the germ, and then calling it the cause.

While reaching back toward the beginning, even though we seldom reach the starting-point, we do come to see how it is true of every disease, as of every living thing, that it must have had a beginning. It is not a mere platitude to say that there was a day when the first case of small-pox occurred.

Nor does it necessarily belong to the sphere either of creation or spontaneous generation. A case of some new disease may put in an appearance, as did cholera on the Ganges, or a case of a known and existing disease may happen that is not derived from another precisely like it, but occurs because analogous conditions to those which gave rise to the first case of the kind have again occurred, and produced a pronounced deviation.

So it is possible that at the same time, as to some one disease, we may have cases of a communicable disease which have arisen from previous cases, and other cases that have resulted from a combination of influences or conditions such as gave rise to the first case. There are at least two reasons why the old dictum of *omne vivum ab ovo* cannot now be applied with the precision or with the finality with which it used to be quoted.

I. There is such a thing as evolution, which, while recognizing an original type, also recognizes departures from the normal which may have come to be so representative and paramount as to constitute newness in all essential particulars. Since we have come to recognize that many diseases are but developments and cultures of microphytic or microbic life, we very appropriately turn to the facts of botany, not only for illustration, but for verification of our theories. And what a change has taken place in its facts since the days of Linnæus! We no longer cling to the divisions of orders, genera, and species so closely laid down by him. We recognize two forces,—nature or heredity, and environment. A plant inherits a likeness which it tends to retain, but it is often so modified by environment as greatly to change, and so sometimes as even to lose, its identity. Environment comes to predominate over heredity. The horticulturist often takes a plant which he has found to be subject to variations, and fixes and perfects it in some one of them by cultivation.

Professor Huxley has recently contributed to the Linnæan Society a paper on the classification of gentians, in which he claims that gentians are all specialized; that is, become gentians from some other form. Permanency of type has so many exceptions, that variations of type, and the power to give fixity to some of these variations by means of cultivation or environment, must be accepted as a doctrine and a fact. Species and genera have variations, sports, modifications not dreamed of by the earlier botanists. Some of these departures are so marked and so predominant as to obscure the relationship and so far ignore it as to have individuality of their own. If, as we know, cultivation or surroundings can change a poisonous plant into a mild one, or can wholly modify it, it is not remarkable that a microphytic disease should lose its apparent identity, and at length in a new culture-medium, or under special conditions, become specialized. It is a law abundantly illustrated in the vegetable world, that environment causes variations, and that some of these variations tend to fixity of type, while others do not. All the wonderful facts of evolution show full well that we may in this way have what in respect of symptoms and treatment is a new disease. Yet it is not a *de novo* origin in an absolute sense, or, if practically *de novo*, it is not *de nihilo*. It is, that a

¹ Continued from *Science* of Dec. 9.

series of changes has been evolved by environment, by conditions in persons or in surroundings, until the result of some of these changes becomes self-assertive, and prevails over its heredity so as to secure for a longer or shorter period a fixity of its own. This fixity may be a new disease.

II. The history of hybrids, the so-called accidents of their occurrence, and the fertility of hybrids, are such that we are forced to look upon them as new forms of life — as becoming established into an autonomy or individuality of their own.

The horticulturist in some of the wonderful productions of new plants in the last score of years has come to be familiar with hybridisms that wholly obscure origin, and that come to have a fixity of their own as much as some new diseases with which we have to deal, or as much as cases of disease which we cannot trace to a contagious source.

All this has been greatly emphasized by what we have come to know as the fertility of hybrids. Not over thirty years ago the general view of botanists was that hybrids were sterile. But so numerous are the exceptions, and so abundant have been the results of new cultivations, that this view is fully disproven. Says a recent botanical authority, "Among plants there are many instances of hybrids between species being perfectly fertile, and continuing so for an indefinite period. Experiments during the last twenty-five years have increased the number of such fertile crosses manifold.

Fertility of hybrid plants is the rule, and sterility the exception. So far as plants are concerned, there is not the slightest ground for considering sterility as a distinctive bar, separating species. These hybrids come to have a specificity of their own so different from the parentage as to be unrecognizable, and so specialized as to be permanent." As another expresses it, "The hybrid becomes an individual not responsible to its species."

Nor is this confined to plants with spores. Some of our most skillful horticulturists are now producing varieties of ferns by hybridism, and every now and then some so-called chance growth or sport shows wide departures.

The bearing of all this on the parasitic forms of disease is not far to seek. If, as now seems so nearly proven, so much of disease has to do with elementary and minute forms of vegetative life, it is easy to see how the facts of evolution and hybridism have a bearing upon the appearance and propagation of disease. The light of the botanical world and its marvellous revelations as to the actualities and possibilities of the origination of new forms distinct from the parentage, penetrates the hidden sphere of disease-origin, and shows how some diseases cease, how others arise, how some lapse back to their heredity, while others are made permanent or specialized by their environment, and how others still are hybridized into specific forms, and acquire a fertility and fixity of their own. This range of deviation is so wide as to account for very many of the anomalies of disease, and for the organization, cessation, or modification of form.

In reply to my inquiry on this particular point, Mr. Mehan, the distinguished botanist of Germantown, Penn., writes me, "All hybrids, that we know by actual experiment *are* hybrids, are fertile as far as I know, and reproduce their originals just the same as if they were 'original' species. I think almost every botanist of note believes in abundant, fertile hybrids in nature. Coming down nearer to your own line of thought, I believe it is conceded that all lichens are hybrids between fungi and algae. It is tenable that new forms of disease are continually coming into existence, which can only arise from new forms of disease-producing plants (microscopic fungi) being evolved from older species; but I do not know whether there is an opinion that these new forms are the result of hybridization or of that natural law of change which seems to be a constituent part of existence — in vegetation, at least."

In a paper read by Dr. M. W. Taylor before the Epidemiological Society of London, April 13, 1887, he notes the fact that many of the fungoid varieties were but "conversions of elementary states of penicillium and oidium. It is also maintained by Zopf (the botanist) that there may be a pleomorphism amid pathogenic micro-organisms, and that there are stages of intermediate forms resulting from the nature of the nutrient media" (see *Lancet*, May 7, 1887, pp. 933, 934).

The view is, we believe, gaining ground, that harmless micro-

phytes may become pathogenic, and that the different forms of micro-organisms present have relation to each other, and that the culture-medium in disease, viz., the person and his surroundings, determines the character of the micro-organisms full as much as the micro-organisms determine the character of the disease.

If the views as to the microphytic origin of most of the communicable diseases are correct, the study of the laws of this evolution and hybridism is vital. We believe it is in this direction that we are to account for the origin of new diseases, or for such variations in type as obscure or destroy identity. If we can, through this study, arrive at the evidence that in this sense many diseases begin, we have a new department of study, in that we are called upon to define with accuracy how and why this origin takes place, in order that we may thwart or circumvent the conditions.

If it is the result of evolution through a long series of changes, it behooves us to study the normal, and to watch and record all the gradations by which the unfriendly result is attained, so that, at some stage, we may intercept the progressive and threatening changes that are occurring, or ascertain what condition of the person, or what condition of surroundings, constitutes the influence which brings about the change, or provides the fertilizing medium for the disease, and causes it to break forth. If it is the result of a hybridism which occurs spontaneously or rapidly, we need to study precisely what forms of vegetative life thus incline to coalesce, under what condition the union occurs, and how their conjunction, development, and fertility are to be interrupted.

If special conditions of some parts, — as the throat, for instance, — or certain conditions of the secretions, furnish a special soil or culture-fluid for the propagation of low forms of vegetative life, this is to be studied with exactness.

In each of these lines the same method of technical study and close record and analysis of facts by competent observers which has prevailed in the study of minute plant-life by botanists, and which has obtained in many other sciences, will, in this comparatively new field of biological and botanical research, accomplish equally valuable results. In it we are attempting to find out how much and under what circumstances micro-organisms imperil human life.

The practical value of such an inquiry is apparent, for sooner than is the case with most of the studies of nature, the results will be applicable in the prevention and treatment of disease. It will be a great gain if we can come to know, that either under the laws of evolution, or as the result of admixture or hybridism, symptoms and pathological effects become specialized so as to constitute a new disease which maintains its type.

As examples of how proximity of different diseases may modify symptoms, we have many suggestive facts in the history of disease. Yellow-fever is believed by many to be a mongrel, born on the high seas by admixture of the jungle-fever of Africa with the typhus of the pent-up hold of the filthy vessel. It is not certain that typhoid-fever was not once nearer to typhus, until it came to be called abdominal typhus, and then to have modifications because surroundings and the acquired power of self-propagation gave it an autonomy of its own.

It is not even now certain that there are not grades of cesspool and other adynamic fevers that will some day declare another well-marked departure from what we now call typhoid, and come to have an individuality of their own. It is not certain, that, when Sydenham treated scarlet-fever and measles as one disease, their lines of difference were as well marked as now.

Diphtheria so often seems to have a localized origin, and common forms of sore throat are so often seen to pass away from their general into a special type, that it will not be strange if we can come to the law of departure (see views expressed in the *Sanitary Record* of Aug. 15, 1887, p. 88, and the contribution of Dr. Wordin, in the *Connecticut State Health Report for 1887*, that diphtheria results from the special virulence of a micrococcus which is not specific, put present in forms of foul or septic sore throat).

While typho-malarial fever has no pathognomonic lesion to distinguish it from the ordinary typhoid, yet we do know it has symptoms to distinguish it. The advances of biological investigation have put us in regions of new possibilities, that do not involve spontaneous generation, but yet do render probable what is equiva-

lent from the *de novo* origin of cases of disease which afterward are chiefly communicated by the first and succeeding cases.

Having settled that such origins do take place, we shall then pry into the secret of the laws of combinations and the conditions which favor the evil evolution or the facts of hybridism, and seek to combat these by starting similar processes in opposite directions, or by sterilization, neutralization, disinfection, and all the details of radical sanitation.

Such a view of the occurrence of old or new diseases, and of the reasons for fixity in some and changing forms and types in others, leads to several practical results.

1. The study of parasites, or germs, as they are called, is only one of the methods of informing ourselves as to the phenomena of disease, and in itself is not likely to be the key to rational and successful treatment.

2. Our attention should be directed, far more than now, to the study of conditions and circumstances under which new forms appear; to the influence of persons and surroundings, instead of, to the mere finding of a specific form. The latter would, of course, be most valuable as one of the facts in the chain of evidence, but we should not, as now, seek so much to look to it as the cause of disease as to inquire what conditions have caused this or that particular microphyte to be present.

3. We should be able to account for the occasional occurrence of a disease independent of any previous case, and for changing types of disease and new diseases, and would come to treat diseases less by their names and more in view of their type and the effect of surroundings upon them.

4. The tendency of all this is to magnify the importance of close observation, and to lead us to feel that success in warding off disease, and in treating it when it appears, depends mostly upon close observation and that experience which is derived from actual practice.

If we are looking to the biological laboratory for the natural history of disease, or to the chemical laboratory for the application of remedies, we shall surely fail. It is not so much that we need to find the specific germ or the specific methods. The world is always looking after specifics. But the science and art of sanitation has far more to expect from a study of the conditions of persons and surroundings under which diseases, or types and modifications of disease, manifest themselves, as also from a study of the prevention or obliteration of such conditions, than it has to expect from the finding of microphytes as the source of disease, and seeking to cure disease by expelling micro-organisms or attenuating them.

Our only design in this paper is to awaken inquiry as to modes of accounting for the localized origin of disease, without any antecedent case, on the proposition that the laws of evolution, environment, hybridism, or modification by culture, give rise to diseases so different from their prototypes as to have individuality and permanency of their own.

Because such inquiry is relevant to prevention, there is good reason to believe that by ascertaining the laws of these transformations and modifications of type and of the origination of special varieties, we shall ere long find new means for the prevention or limitation of many diseases.

'The Malarial Germ of Laveran' was the title of a paper read by Dr. William T. Councilman of Baltimore. He considers that this organism probably belongs to the *Protozoa*, a group of unicellular organisms noted for the varied changes of form which the individual examples undergo in the course of development. Of the malarial germ there are ten more or less distinct forms, of which five are always found in intermittent-fever. During the chill of the fever a definite form is seen, in which multiplication takes place by segmentation. One form has actively moving filaments. This was found in blood taken from the spleen in ten cases of malarial cachexia, and in five cases of intermittent-fever. Dr. Councilman says that too much importance cannot be assigned to this organism as a means of making a differential diagnosis between malarial-fever and typhoid-fever. In outbreaks of fever which occur in small country-towns, where it is of the greatest importance that the character of the disease should be recognized promptly, the advantage of this mode of diagnosis is most evident. There is too much

reason for believing that in localities where malarial-fevers prevail, epidemics of typhoid-fever are frequently mistaken for fevers of a malarial type.

Mr. H. Lomb of Rochester offered prizes of \$500 and \$200 for the best essays on practical sanitary and economic cooking adapted for persons of moderate and small means. Dr. LaBerge, health-officer of Montreal, described the system employed in that city for the collection of garbage, and for its destruction by the Mann furnace. Committees were appointed on State boards of health, pollution of water-supply, disposal of garbage, animal diseases and animal food, forms of statistics, incorporation, protective inoculation, Lomb prize essays, national health legislation, and improvement of the sanitary and medical service on emigrant ships. It was decided to hold the next meeting of the association at Milwaukee. The following officers were elected for the ensuing year: president, Dr. Charles N. Hewitt, Red Wing, Minn.; vice-presidents, Drs. G. B. Thornton, Memphis, and Joseph Holt, New Orleans; executive committee, Drs. Henry B. Baker, Michigan, S. H. Durgin, Massachusetts, and J. N. McCormack, Kentucky. The secretary, Irving A. Watson, M.D., of Concord, N.H., holds over.

THE SURFACE-TEMPERATURES OF THE OCEANS.

A NUMBER of researches on the surface-temperatures of the oceans, which have recently been published, throw a new light on this complicated phenomenon. The maps accompanying the present number of *Science* have been constructed according to Dr. O. Krümmel's maps, showing the surface-temperatures of the oceans. As the Arctic Ocean must be considered part of the Atlantic, of which it forms the most northern extremity, it was desirable to include it in the map. Besides this, the Antarctic Ocean exerts a great influence upon the southern part of the Atlantic Ocean, and therefore the latter has also been included in the map, which shows two-thirds of the earth's surface in a perspective projection. The lateral parts, however, have been left off, as they do not belong to the system of the Atlantic Ocean. The Pacific Ocean has been constructed in the same way, the map extending from its northern limits to the entrance of the Atlantic Ocean. The latter map makes it very clear that the Pacific Ocean forms a comparatively well-defined basin connected by narrow straits with the basin of the Atlantic and Indian Oceans. Its southern limit is indicated by the east coast of Australia, Wilkes Land, Graham Land, and the southern portion of America.

A glance at the lines showing the surface-temperatures of the oceans reveals the remarkable fact that the warm water is accumulated in the western parts of the oceans. Krümmel designates water of more than 24° C. (75° F.) as 'tropical water.' In August the belt of such water is 21 degrees of latitude wide in the eastern part of the Atlantic, while it occupies 61 on its western side. In February it is 22 degrees wide in the eastern part, while it is 56 degrees wide in the western. In the Pacific Ocean it does not occupy more than 17 degrees in August and 25 degrees in February, while in the western parts its width is 57 degrees and 49 degrees respectively. In comparing the amount of tropical and extratropical water, Krümmel finds that twenty-nine per cent of the whole surface of the oceans has always a temperature of more than 25° C., while almost one-half of it temporarily attains this temperature.

It will be observed that in certain parts of the oceans the lines of equal temperature are much crowded, and show sharp angles. This is entirely due to currents, which carry warm water to high latitudes, and cold water to warmer regions. Thus the influence of the Agulhas current may be observed in the sharp angles of these lines near the Cape of Good Hope, while the cold Cape Horn current lowers the temperature along the eastern coast of South America. The influence of the Gulf Stream may be seen in the crowding of the lines of equal temperature near Newfoundland.

The accumulation of warm water in the western parts of the oceans is entirely due to the action of the trade-winds, which blow continually from the eastward, and drive the warm water of the ocean westward, where it is accumulated on the coasts of the continent. Buchanan has explained this phenomenon in a paper on similarities in the physical geography of the great oceans, which has been published in the *Proceedings of the Royal Geographical*

Society. The trade-winds, he says, produce not only dry places on the land, but also comparatively dry places on the sea, and therefore the areas of maximum density or salinity of the surface-water are situated in the trade-winds region. In passing over the surface of the ocean, the winds impart motion to the water immediately under their influence. The effect of this is to produce a general motion of the denser intertropical water towards the equa-

west coast of North Africa the line of 24° C. (75° F.) extends far southward. Similar phenomena occur on the west coast of America. Formerly the reason for the low temperature of these waters was looked for in polar currents, but recent observations show that it is caused by cold water of deeper layers rising to the surface. So far as we are aware, E. Witte was the first to express this opinion, in a paper published in 1878; but recently a considerable

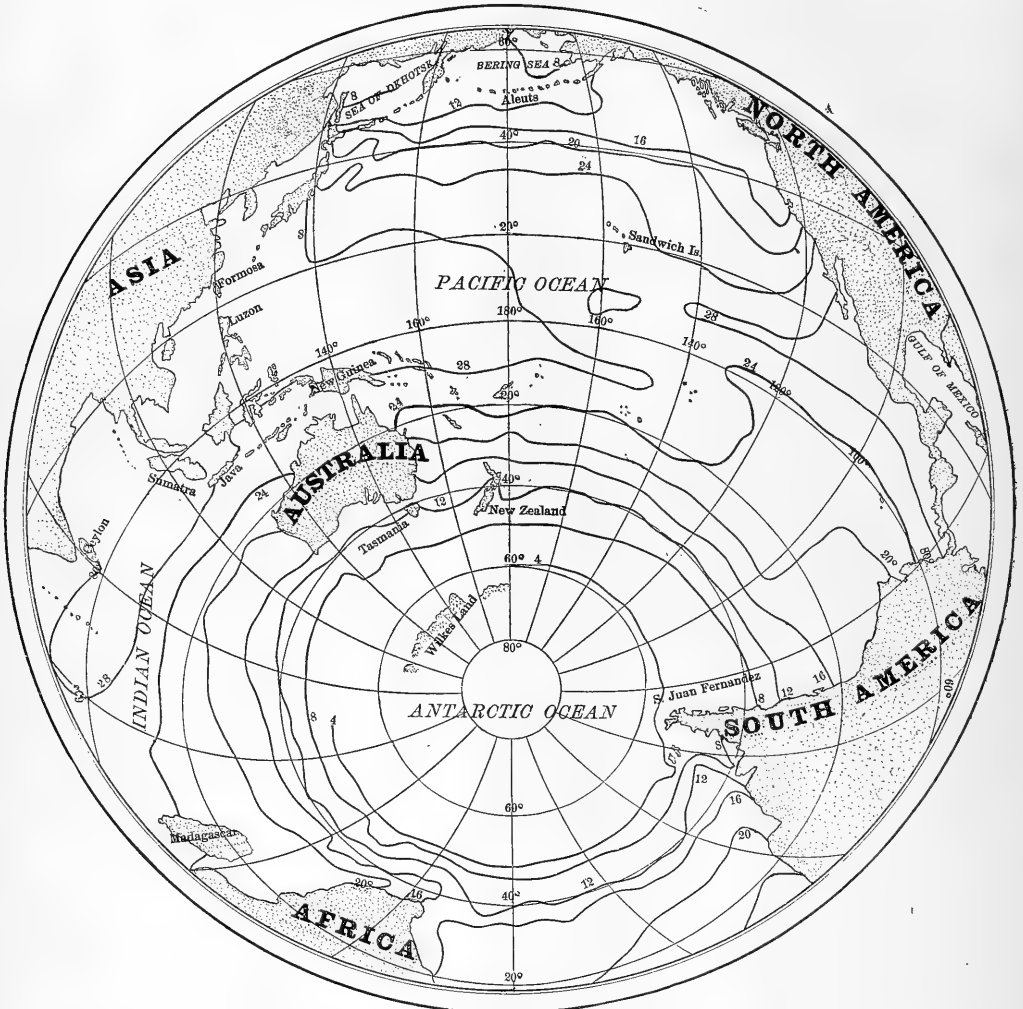

MAP OF THE PACIFIC OCEAN, SHOWING THE SURFACE-TEMPERATURES IN AUGUST (ACCORDING TO O. KRÜMMEL).

tor and towards the west. At the same time the surface-water is evaporated, and thus becomes more concentrated than the deeper and colder layers. In consequence of its greater salinity, the warm surface-water sinks to a certain depth, and thus conveys its higher temperature to the deeper layers. Thus the western parts of the ocean are supplied with water of high temperature, which is collected in the Atlantic Ocean in the immense bay formed by the coasts of North and South America.

Another remarkable fact is shown in our map. It is the prevalence of cold water along many coasts. In South Africa we see the line of 16° C. (61° F.) extending far northward, and on the

amount of material has been contributed by numerous investigators. Among these, I mention Buchanan's researches in the region of the counter equatorial current on board the 'Buccaneer,' Captain Hoffmann's observations off Cape Guardafui, and Dr. G. Stappf's off Angra Pequena in South Africa. All these observations tend to show, that wherever the prevailing winds are blowing off the shore, and the water is thus removed without a possibility of being replaced by superficial currents, cold water rises to the surface. But it has been pointed out in an essay published in the *Annalen der Hydrographie*, that, wherever a current is deflected from a coast, cold water must rise to the surface. This fact accounts for the low

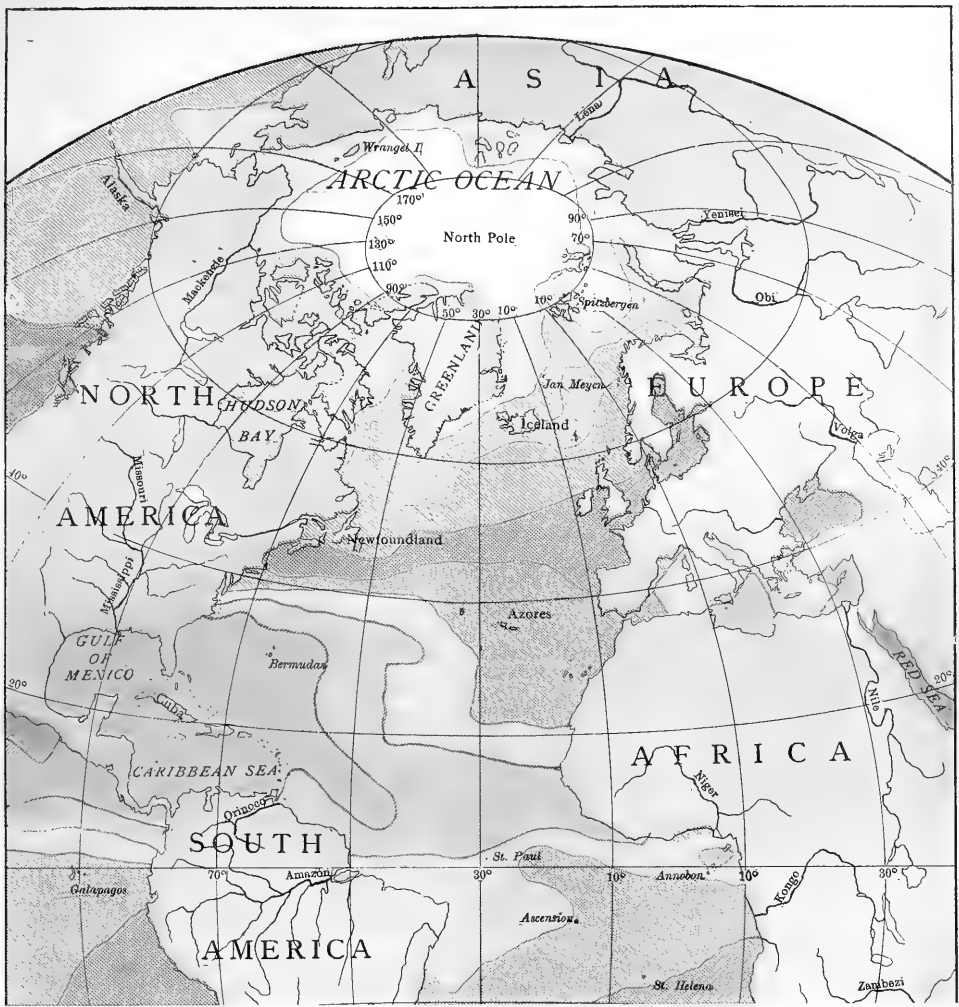

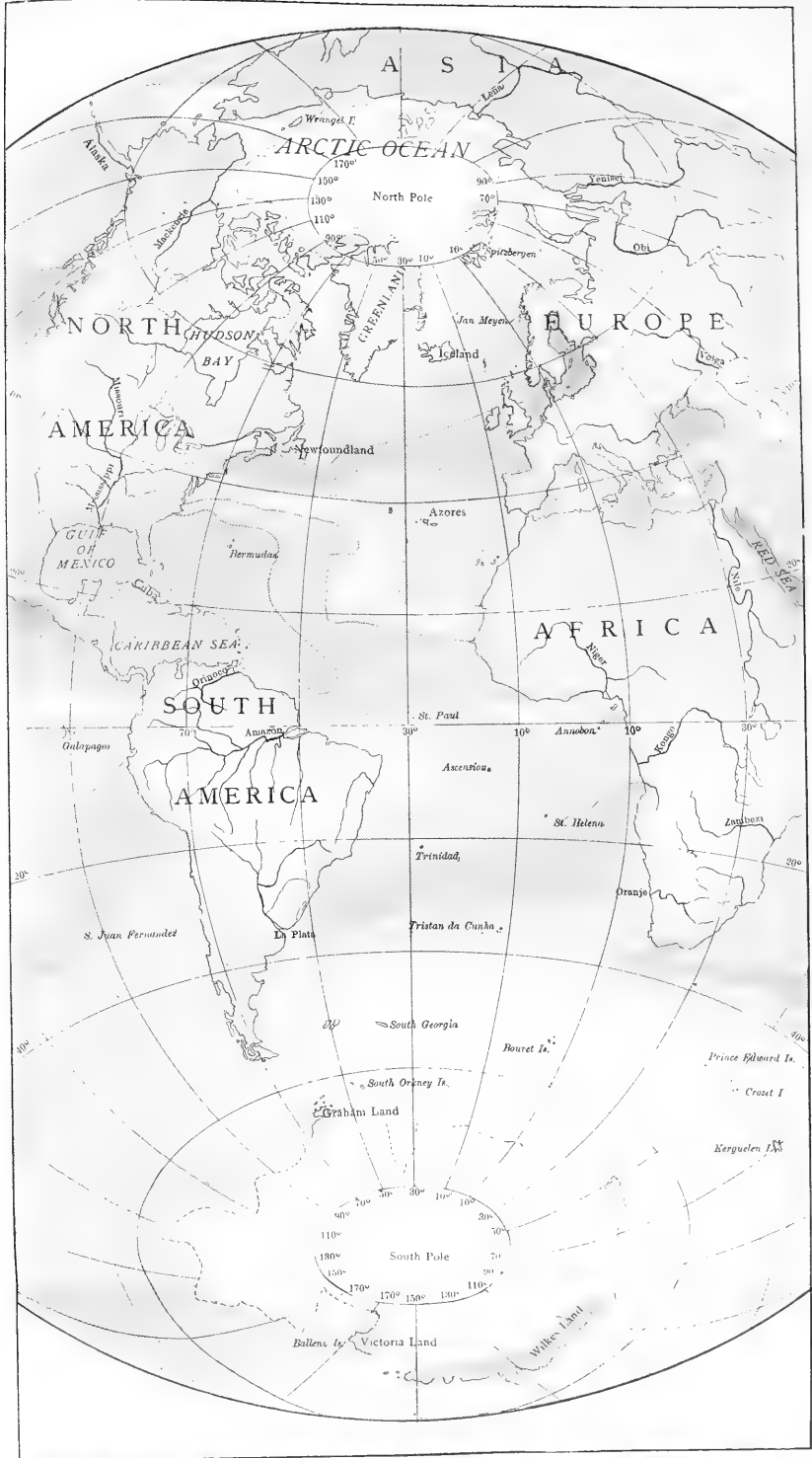

0°-1° C. 4°-8° C. 8°-12° C. 12°-16° C. 16°-20° C. 20°-24° C. 24°-26° C. 26°-28° C. 28°-30° C. 30°-32° C.

Map Showing the Surface Temperatures of the Atlantic Ocean in August.

According to O. Krümmel.

temperature off the west coasts of California and South America. A number of profiles showing the temperatures of the Pacific Ocean off the coast of California, which were published by Dr. C. M. Richter in the *Bulletin of the California Academy of Sciences*, show very plainly the rising of cold water near the shore; and although the author tries to prove, by means of these charts and profiles, the existence of a cold current, they seem to be far more in favor of the theory advanced above.

It will be seen that in the equatorial parts of the Atlantic Ocean two regions of remarkably cold water occur. One of these is on the coast of Guinea; the other, east of St. Paul. Krümmel believes that they are also due to a submarine source, the cold water of the depth taking the place of the warm dense water which is driven westward by the wind. He points out that it is situated between the equatorial current and the counter equatorial current, and that thus the cold water supplies a deficiency caused by two currents flowing in opposite directions. Therefore this area of cold water does not exist in February, when both currents are less strong. The Guinea current he considers entirely caused by the southern equatorial current, and as supplying the Gulf of Guinea with water instead of that which is drawn from it by the southern equatorial current. We ought to point out here the fact shown by Buchanan, that all counter equatorial currents are very superficial, that their velocity is the greater the less the density of this water, and that the isothermal gradients are very great below these currents, as the light water of the surface prevents the heat from penetrating into the ocean.

The problems of the equatorial circulation of the oceans is extremely complicated, and the observations mentioned above show that the vertical as well as the horizontal circulation of the waters must be studied. The dynamics of the counter equatorial current are particularly obscure, and a careful investigation of its density, temperature, and strength is very desirable.

MENTAL SCIENCE.

The Mechanism of Attention.¹

VOLUNTARY attention is an artificial act: it grafts itself upon spontaneous attention, and takes its nourishment from this. In spontaneous attention the object acts by its intrinsic power; in voluntary attention the subject brings an alien power to bear upon the process. Spontaneous attention represents the maximum of attraction between subject and object; voluntary attention, the maximum of resistance. It is the voluntary form of attention that is here to be considered.

In the first place, how is so artificial a process as voluntary attention brought about? The method, says M. Ribot, is to make attractive artificially what is not so naturally; to arouse an artificial interest in things naturally uninteresting. The process by which this is done is infinitely varied, but consists always of arousing an interest by playing upon some emotional state.

The infant, according to Preyer, at first is under the sway of spontaneous attention alone; it looks only at bright objects, at sustenance-giving objects. At about the end of the third month it explores the field of vision, and glances at less and less (selfishly) interesting objects; and it is the same with the other senses. The path is from the most intense, most impressive sensations to the finer, more delicate ones. The child naturally flits from one sensation to another: to fixate and hold one sensation is an art that must be learned. A child, for example, refuses to learn to read, but is vastly interested in the pictures in the book. The father says that reading will show the meaning of the pictures. This acts as an artificial inducement, and the child goes to work, substituting an artificial attention to arbitrary signs for the natural attractiveness of pictures. M. Ribot distinguishes three periods in this substitution process. In the first we can appeal to bodily feelings alone. The child can be taught voluntary attention only by playing upon its fear, its egoistic tendencies, by rewards, sympathetic emotions, natural curiosity. In the second period the emotional nature is still the most powerful motive, but the kind of emotion is higher. One can here appeal to ambition, to emulation, to duty. In the final period the attention is maintained by habit. The student at his

desk, the workman at his shop, often wish they were elsewhere; but the habit as formed by past appeals to pride, ambition, etc., chains them to their tasks. Art has done its work, and attention has become second nature. Granted a certain environment, and the work goes on almost of itself. Many persons never reach this third organized stage of voluntary attention: there is a vast body of unsteady, Bohemian, vagabond types of character in whom voluntary attention is sporadic only, and not habitual.

The training of animals proceeds by the same steps. An ape is taught to do things meaningless to it by connecting such acts with rewards and punishments. The factor of attention in the process is well shown, in that such animals are selected for training as most readily attend amid distractions.

The genesis of voluntary attention is to be found in its utility. When the conditions of life become at all hard, and especially if they become so by more or less sudden changes, the power of adaption to them is dependent upon voluntary attention to details; upon consideration of something besides the immediately attractive and useful. The savage is lazy, is inspired only by chase, by war, by play; his interest is in the unknown, the unforeseen, the chance. He is not capable of continuous labor. In half-civilized communities work is repugnant. Voluntary attention is a factor of civilization, and is maintained with effort. The most constant characteristic of criminals is lack of power to pursue a steady calling; and the Italian anthropologists regard this as a reversion to primitive habits. Voluntary attention thus came in, and is maintained as a sociological power.

While we all have quite a definite notion of the feeling of effort in fixing the attention, the nature of the process escapes our observation. We feel that the struggle is to focus the thought upon one topic to the exclusion of others, all knocking for admittance into consciousness. The question is not, 'How does a concept come to be attended to?' but 'How is it maintained in the focus of attention? How do we inhibit other concepts?' The answer is very incomplete. The physiology of inhibition is in its infancy. The fact itself simply states that the excitation of a nerve may not only produce motion, but may cause a motion to cease. Stimulating the pneumogastric nerve arrests the heart-beat. The highest form of this power of inhibition is attention: this Ferrier locates in the frontal lobes of the brain. The intelligence would thus be proportionate to the development of these lobes; stimulation of them would never produce movements; and their disease would cause no paralysis, but a lowering of the mental life. All this is found to be true. Inhibition is likewise late in appearing, coming long after impulsive will in child-development. We know only the initial and final steps of the process, the will not to do an action, the fact that it is not done; but we have good reason to believe that the muscles play an active rôle in the process.

Attention may be fixed upon three kinds of mental objects,—perceptions, images, ideas. In perception the dominance of the motor element is evident. In seeing, touching, etc., there is always a motion; and the law that the more mobile the part the more sensitive it is, is quite a general one. To fixate an object steadily without moving the eye soon reduces the field of vision to a blank; a weight constantly pressing upon the skin is soon not felt. Consciousness is always of change, and change is based upon movement. Attention is the repression of foreign, irrelevant movements and the concentration upon pertinent ones. Distraction is a diffusion of movements. Next with regard to images. Here the attention is turned inwards, and becomes reflection; but the motor element has not been lost. The motor element of the perception is only weakened (not lost) in its recollection. The two processes are the same in kind, and differ only in degree. As the vividness of the recollection increases, it approaches the perception in the prominence of the motor element. The intense thought of falling down an abyss has led some persons to throw themselves down. Mind-reading is really muscle-reading. When we pass to ideas (and especially abstract ideas), the problem is more difficult. M. Ribot confines his attention to three types of ideas. The first are such as are formed by the fusion of like images without the aid of a word. Their type is the idea of a class, a species. This is within the grasp of animals, children, and deaf-mutes. It is a generic image, like a composite portrait. Here the question as to the motor

¹ A résumé of an article by Prof. Th. Ribot (*v. Science*, No. 252).

element is unnecessary, because there is no voluntary reflection involved in attaining this idea. The second class includes the fusion of images in different objects, still without the aid of words, and is represented in the common abstraction. This is a much higher process, and many peoples have stood still at the early stages of it. The Fuegians have no abstract terms; the Indians have words for 'red oak,' for 'white oak,' but not for 'oak' in general; the Tasmanians have words for different kinds of trees, but not for 'tree.' In all these processes there is a motor element in the word, and perhaps in the image too. Finally, as the image becomes more and more abstract, the word becomes more and more fundamental. That the word contains a prominent motor element (varying, however, in its strength in different persons) is generally accepted, and is shown by the fact that this element in language can be lost while the rest remains unlost.

We are thus led to the conclusion that thought without motion is impossible; and, though we cannot have the opportunity of demonstrating this absolutely, we can make it extremely probable. Severe activity is incompatible with intense thought. To direct one's attention is work, and the less natural interest in the topic the more fatiguing the strain. It is not a purely mental process, but is connected with nerve-activity and such movements. Monodism is work, destruction is rest.

Finally the hints as to the action of attention to be derived from experimental study should be noted. In re-acting to a stimulus, the time is shortened when the attention is fixed, and is lengthened when the attention is wandering. So, too, the more cultured classes can re-act more quickly than the ignorant, because their power of voluntary attention is drilled. If the physical state prevents sharp attention, the time is lengthened. A headache lengthened a re-action-time from .133 to .171 of a second, and severe fatigue to .183 of a second. In various stages of paralysis the time lengthened to .166, .281, and .755 of a second; while in hypnotism, when there is an extraordinary concentration on one perception, the time was shortened from .328 to .193 of a second. Again: the most influential factor in the re-action-time is the expectedness of the impression. If the sensation is preceded by a signal announcing its approach, the time is much shortened. According as the nature, intensity, and time of the stimulus is known, the time is more and more shortened. The unexpected delays the re-action. Again: Wundt has shown that when two impressions — say, the ring of a bell and the movement of an indicator — are simultaneous, the one that is attended to gets first perceived. The adjustment accommodation of the attention in all these cases is again a motor act.

SCARLET-FEVER REPORT. — I.

The success which has followed from the collective investigation into the subject of distillery-milk and its effects on the lower animals and man when used as food, which was made by *Science* in June, has induced this journal to undertake other inquiries into similar matters which affect the public health. Correspondence has been opened with a number of prominent sanitarians of the United States, and as a result scarlet-fever has been selected as the next subject for inquiry. The following letter has been prepared, and forwarded to leading sanitarians and physicians, and others: —

The prevalence of scarlet-fever in all parts of the civilized world, and the great mortality therefrom, amounting in England alone during five years to 88,273 deaths, have induced *Science* to institute an inquiry into the reasons for such a condition of things, — whether it is a fact that this disease is not amenable to control by sanitation; or whether sanitarians have not suggested any practical method by which it may be controlled; or whether parents, teachers, health authorities, and others neglect to carry out the recommendations which sanitary science has made. With the object of helping to determine these questions, will you kindly answer the following inquiries:

1. Do you believe that scarlet-fever ever arises, at the present time, *de novo*, as distinct from a pre-existing case? If so, on what grounds do you base that belief?
2. Is there any doubt in your mind that scarlet-fever is a com-

municable disease, and, if so, what reasons have you for that doubt?

3. If you believe it to be communicable, can you give any instances which have come under your own *personal* observation, tending to prove its communicability? If so, please give them in detail.

4. Have you any information touching the communication of bovine scarlet-fever to man, either by contagion or the milk of the affected animal?

5. When does a patient who has had scarlet-fever cease to communicate it to others?

6. Can you give any instances which have come under your own *personal* observation in which clothing, toys, books, or other articles have communicated the disease? If so, please give them in detail.

7. How long have you *personally* known such articles to retain the infection?

8. Should boards of health require reports of cases of scarlet-fever to be made to them, and, if so, by whom and why?

9. What is the duty of boards of health if such reports are received?

10. Is there any plan which, if put into execution, would, in your judgment, prevent the spread of scarlet-fever?

11. If so, can you give instances in which it has practically done so?

12. Do you believe that any thing can be done, by the use of remedies or otherwise, to prevent well persons from contracting scarlet-fever when they are exposed to it?

13. Can you give any *evidence* not under your own *personal* observation, but sufficiently authenticated by competent authorities, printed or otherwise, touching any of the questions propounded in this circular?

To these inquiries a large number of answers have been received, which we now propose to lay before our readers: —

[WILLIAM K. NEWTON, M.D., Paterson, N.J., State dairy commissioner.]

Below please find answers to your circular relating to scarlet-fever:

1. I have often seen isolated cases of this disease beginning at a time when no other case existed in the city. Many times I have seen a single case begin without any probability of an exposure to another case, but I do not think that we are justified in accepting the theory that the disease may arise *de novo* because of our inability to find the original case. But there is much to lead us to study this side of the question, for filth may be a possible cause.

2. It is no doubt communicable.

3. It is communicable, and scores of instances might be mentioned to substantiate this statement. Cases where children have been exposed at school for a few minutes to one sick with the disease have come under my notice, and, where they have not had the disease before, they have taken the disease in due time. It is a common occurrence for children exposed to the sick to contract this disease.

4. No personal information. The London *Lancet* during the past two years has contained many articles on this subject.

5. As long as there is any roughness of the skin.

6. Have known of many instances where woollen clothing has been the means of carrying the disease.

7. Three weeks.

8. Yes, if the proper officers are prepared and authorized to enforce strict separation and quarantine. If reports are required, and on receipt by the authorities are filed, or only tabulated, and no repressive measures employed, no good is done; and the reports should not be required, for they only go to swell the statistics without benefit. The attending physician is the proper person to notify the authorities, and for this work he should be compensated. Reports from the householder or the family are not reliable, and are not promptly made. As was said, these reports are for the purpose of enabling the health authorities to restrict the spread of the disease, and, if notification is required, restrictive measures should be followed up.

9. The reports should first be recorded, and the location of the case marked on a map of the city kept for that purpose, the latter entry being a record of location to enable us to ascertain if locality

has any thing to do with the disease. Next the proper officer should be sent to the house to instruct the family in methods of disinfection, and to note the condition of the house. He should leave with the family a circular, issued by the board of health, giving an account of the disease, its methods of spreading, and its dangers, also brief directions for disinfection. On the recovery of the patient, or in case of death, the premises should be disinfected by an officer of the board. People from infected houses must be excluded from school, church, factories, etc., and a strict quarantine maintained until the premises shall have been disinfected. In case of death, the body should be interred as speedily as possible and no public funeral allowed. No person should be allowed to enter the house except the regular attendants.

10. If the above plan is rigidly carried out, it is possible to check the spread of the disease; but at present it is not possible to strictly quarantine or isolate cases of this disease, because many think it a mild one and of little consequence. Again, many cases are so mild that the sick person is not confined to the bed or even the house, and hence mingle with the well, and these mild cases are often not recognized.

11. I know of no instance where the spread of scarlet-fever has been certainly and completely stopped by restrictive measures; but could we enforce rules as rigidly as is done in epidemics of small-pox or cholera, where the public is prepared for harsh methods, it is probable that the disease might be stamped out for a time.

12. I know of none.

[SAMUEL W. ABBOTT, M.D., Boston, Mass., secretary State Board of Health of Massachusetts.]

In answer to your circular relative to scarlet-fever, I have the honor to reply as follows; my reply being based upon an active country-practice of twenty years, and also upon five years' experience as the health-officer, and secretary of this board, during which time I have had opportunity to observe a considerable number of epidemics of scarlet-fever of varying extent and severity.

1 and 2. No.

3. An instance under my observation is the following: A health-officer visited a public institution for the purpose of giving advice as to preventive measures. While there he saw several children ill with scarlet-fever, in various stages of the disease, and examined them at the bedside. He then returned to his home, a hundred miles distant. On his way home, and before returning to his family, he took the precaution to take a thorough bath, and, on reaching home, sent his clothing to a cleansing establishment. About eight days afterward, three of his children were taken ill with scarlet-fever, one of whom died on the fifth day afterward. There were no other cases of scarlet-fever in the town at that time.

4. A limited outbreak occurred last spring in the town of Wellesley. Four children were taken ill in two families who took milk from one man who had two cows. There were no other cases in the town at that time. One of these cows had an eruption on the udder, which, on examination by a competent veterinary surgeon, did not appear to have the characteristics described by recent English reports. I do not regard this as a conclusive case.

5. Not until after desquamation has been completed, and all germs of the disease originating from the patient have been destroyed.

6. I have no doubt that such is the case, but have no positive evidence on this point.

8. Yes, by the attending physician, who is the only competent authority to judge of the character of the disease. The law of this State makes it incumbent on both physician and householder to report, but reports from the latter are rare.

9. To isolate the sick, and see that proper measures are taken for the continuance of such isolation, and of disinfection upon recovery; and in case of death the funeral should be private.

10. Nothing short of complete isolation of the sick, and absolute destruction of all germs of the disease.

11. The following statistics are suggestive. By circulars, reports of boards of health, public lectures, and by every possible means, the contagiousness of scarlet-fever has been taught, and the community has been led to see the dangerous character of the disease, and its destructiveness as compared with other diseases, until public opinion will tolerate much more decisive measures than were possible twenty years since. The following table (from the

'Massachusetts Registration Report for 1886') shows that the disease has not been so destructive in the past fifteen years (1872-86) as it was in the previous fifteen years (1857-71) in this State:—

Mortality from Scarlet-Fever, 1857-86.

YEARS.			YEARS.				
Deaths.	Percentage of Deaths to Deaths from All Causes.	Death-Rates per 10,000 Living.	Deaths.	Percentage of Deaths to Deaths from All Causes.	Death-Rates per 10,000 Living.		
1857 . . . 2,013	9.36	17.2	1872 . . . 1,377	3.93	8.9		
1858 . . . 1,051	4.99	8.8	1873 . . . 1,472	4.34	9.4		
1859 . . . 1,038	4.88	8.6	1874 . . . 1,382	4.33	8.6		
1860 . . . 916	3.92	7.4	1875 . . . 1,684	4.81	10.2		
1861 . . . 1,137	4.66	9.2	1876 . . . 1,222	3.79	7.4		
1862 . . . 1,261	5.42	10.1	1877 . . . 467	1.53	2.8		
1863 . . . 1,399	5.01	11.1	1878 . . . 404	1.33	2.4		
1864 . . . 1,503	5.21	11.9	1879 . . . 850	2.63	4.9		
1865 . . . 807	3.06	6.4	1880 . . . 574	1.63	3.2		
1866 . . . 385	1.58	2.9	1881 . . . 397	1.09	2.2		
1867 . . . 828	3.63	6.2	1882 . . . 318	.87	1.7		
1868 . . . 1,369	5.35	9.9	1883 . . . 575	1.52	3.5		
1869 . . . 1,405	5.39	9.1	1884 . . . 627	1.69	3.6		
1870 . . . 683	2.49	4.7	1885 . . . 587	1.54	3.0		
1871 . . . 867	3.10	5.8	1886 . . . 332	.89	1.7		
Average 15 yrs. (1857-71)		4.51	8.5	Average 15 yrs. (1872-86)		1.97	3.9

Undoubtedly several extensive epidemics might upset these statistics. I think, however, that the length of time included (30 years), and the size of the population (1,231,067 in 1860, and 1,942,141 in 1885), may be taken as conclusive that something has modified the progress of the disease, the death-rate in the last fifteen years being less than one-half as large as that of the fifteen years previous (1857-71). If the period of ten years 1857-66 be compared with the last ten years (1877-86), the result is still more striking, the death-rate of the latter period from scarlet-fever being less than one-third as great as that of the former period.

12. By remedies. No.

13. I beg leave to mention one or two popular errors in this connection. There is a singular notion that physicians' families are comparatively exempt from infectious diseases. On the contrary, I can call to mind at least a dozen families of country physicians in active practice, within five miles of my present home, which have been invaded by this destructive disease. Another error is the notion that a dead body is more dangerous than a living one. There is no evidence, so far as I can learn, in support of such a notion. One living, breathing body, sick with infectious disease, must necessarily produce more infectious material than a dead one.

[R. B. S. HARGIS, M.D., Pensacola, Fla.]

In relation to the questions concerning scarlet-fever stated in your circular, I proceed at once to answer them in order:—

1. I have seen scarlet-fever on two occasions, in an isolated house,—no other cases in the city nor in the neighboring places,—the source of which could not be traced to any focus of infection outside the walls of the dwellings in which the cases existed. I have also seen measles, a congener of scarlet-fever, undoubtedly a contagious disease, spring up spontaneously, and spread from a single isolated place all over the city, thus apparently arising *de novo*. Upon careful and anxious inquiry in regard to the above-mentioned instances of spontaneous development of scarlet-fever and measles in isolated places, I was informed that none of the parties in those houses had had any correspondence, by letter or otherwise, or purchased or received any fabrics, or indeed articles of any kind, from persons at a distance anywhere. All infectious and contagious diseases are associated, as a rule, with cutaneous eruptions or glandular

affections, and capable of propagation by inoculation. Whooping-cough may be an exception so far as eruptions and glandular affections are concerned.

2. I have not the least doubt of the communicability of scarlet-fever. I know that it can be propagated by *fomites*. Diseases that can be communicated and transmitted by *fomites* are absolutely contagious: this is self-evident, and cannot be disputed with any show of reason.

3. I know a remarkable instance of the communicability of scarlet-fever by things. It occurred in my own family, living more than two thousand yards from any infected place. The subjects of it got the disease from the clothes of a person who had visited a house in which there were two or more cases.

4. I have no information touching bovine virus.

5. I have known children who had had scarlet-fever, a week after the process of desquamation had been completed, and after anti-septic baths, and their clothes and house environments had been subjected to a disinfecting process, to return to school, and mingle freely with other pupils without communicating the disease to any one. Some writers in the medical journals express the opinion that from four to six weeks should be allowed to elapse before those who have recently had scarlet-fever be permitted to have free intercourse.

6. This question is answered in Paragraphs 1 and 3.

7. I have no experience with regard to the length of time the infection of scarlet-fever may be retained in any articles, but authors will be referred to when Question 14 is under consideration.

8. Boards of health should be empowered by legislative enactments in every State to enforce physicians, and the laity also,—every citizen who may know of a case, or even a 'suspicious case,' anywhere in his vicinity, or indeed in any place from which the disease might be introduced,—to report without delay to the proper authorities.

9. The duty of boards of health and others in authority is to act promptly on receipt of the report of the first case of scarlet-fever, and enforce isolation and disinfection rigorously; and it should be made incumbent on the attending physician to change his clothes, and bathe, etc., before visiting other houses not infected. I have known the morbid principle, both of small-pox and yellow-fever, to be carried in men's beards, and communicated to their wives and children. Indeed, the *materies morbi*, or germs of all contagious diseases, can be transmitted from place to place by any thing capable of absorbing, or holding adherent to it, any substance, dead or living, whether in a solid, fluid, or gaseous form.

10. Besides what I have already indicated in answer to Question 9, I know of no other plan of preventing the spread of scarlet-fever except inoculation and the administration of small doses of belladonna, which should be considered as only a small part of the plan already indicated.

12. As just stated in answer to Question 9, I should state that I gave belladonna to three children for whooping-cough, living in the same house, situated in the very heart of a district infected with scarlet-fever, which was epidemic, and whose parents communicated freely with persons who had the disease, and every one of them escaped.

13. Touching the questions stated in your circular, I can give no further evidence of importance as the result of my own personal observations, but refer to the following authorities, which I have selected from many others in my library: viz., Watson's 'Practice of Medicine' (American edition, edited by Dr. Francis Condie), p. 1180; Ziemssen's 'Cyclopædia of the Practice of Medicine,' vol. ii. pp. 161 *et seq.*; Aitken's 'Science and Practice of Medicine,' 6th edition, vol. i. p. 480.

Scarlet-fever, in my opinion, is certainly amenable to control by proper sanitary measures under ordinary circumstances; but if a case occurs in a town or city where there exists a certain condition of the atmosphere, or certain meteorological states of the air (of which we know very little, and which has been significantly termed 'epidemic constitution of the air'), spreading diseases will extend *per se* through it as a medium. Yellow-fever does this, and travels about forty feet a day, and thus, by the concurrent existence of a line of personal communication, spreads over a city and its suburbs, and even beyond. Small-pox has been known to spread

from certain centres (hospitals, for example) for over one thousand yards. It is shown lately (see *The American Journal of the Medical Sciences* for July, 1887, p. 300) by the 'Report of the Local Government Board of England' that from small-pox hospitals, the *materies morbi* of *variola* will travel *per se* through the air to the extent of at least half a mile.

I would refer you to the *Medical News*, Nov. 26, 1887, p. 627, for a short but excellent paper on the contagion of scarlet-fever. From its tenor the contagious nature of scarlet-fever is admitted, but it is assumed that it is caused by a germ or living organism which has not been shown to exist. I am one of a small minority among the medical profession who cannot accept the germ theory of disease. Germs of microscopical organisms may, nay, no doubt do, carry contagion, but have no etiological relations as to the primary cause, or *causa causans*, of contagious diseases; and I say this in spite of my familiarity with the literature of the subject,—the latest experiments of Pasteur, Koch-Klein, Edington, Jamieson, Dale, Unger, and others are right now in arm's reach of me, and have been carefully read by me, several for the third time,—I cannot yet accept the germ theory of disease.

[G. C. ASHMAN, M.D., Cleveland, O., health-officer.]

1. I do not. But I think it possible, and even probable, that some of the lower animals have scarlatina, or a disease of which scarlatina in man is a modification.

2. None whatever.

3. (a) An instance where clothing worn by children having the disease in January was brought into another family the following April, cases occurring within ten days thereafter; (b) an instance of school-books used in a family suffering from scarlatina in June, upon being opened and used by other children the following September, appeared to cause the disease; (c) a large number of instances where physicians and others coming in contact with cases have appeared to carry a germ of disease to their own or other families.

4. None.

5. I do not know. My observation leads me to the conclusion that the disease is communicable at any stage after fever begins, and at least until desquamation is completed; and this last stage is often very prolonged.

6. As in No. 3.

7. Three to four months.

8. Most certainly. By the physician or other person making diagnosis. For the prevention of extension, thereby saving life and health. As it is a disease of childhood chiefly, prompt notification of school authorities enables them to exclude infected or infectious children from schools. A placard upon the infected house notifies all who are about to enter of the nature of danger to which they are exposed. It educates the people, and favors isolation.

9. To notify the public of danger, and to render the infected such assistance as may be necessary; to have, if possible, a hospital to which all cases not otherwise isolated should be removed promptly; to give information as to the nature and prevention of the disease.

10. Yes, prompt and complete isolation of every case.

11. An instance of a child in a family of four, none of whom had had the disease; the child affected at once isolated in the same house; the skin in every part washed twice a day with a solution of mercuric chloride (1 to 1,000), and all secretions and excretions treated by the same solution; the isolation maintained for nine weeks; no communication in any way.

12. Yes, in a measure. I believe there is in every individual a natural resistance to diseases, varying in individuals and the same individual at different times, and in respect to certain diseases. This natural resistance is at its best when all bodily functions are best performed.

13. Text-books can do it better.

[To be continued.]

BOOK—REVIEWS.

Higher Grounds. Hints toward settling the Labor Troubles. By AUGUSTUS JACOBSON. Chicago, McClurg & Co. 16¢. \$1.

THIS is a small book, as books go nowadays, for it may easily be read through at a sitting. But it demands comment out of

all proportion to its size, for it is both original and powerful. The author's style is clear, crisp, and concise, and, as we shall show by some quotations, is very striking and attractive. Take this as a specimen: "Everybody wants to settle the labor question, but nobody is willing to sacrifice any thing to settle it; nobody appears to be willing to pay out any money to settle it. The labor question will not be settled without sacrifice; it will not be settled without a large expenditure of money. To settle the labor question without sacrifice, would be to get something for nothing. The settlement of the labor question will in some way have to be paid for." The one hundred and sixty pages of the book are full of just such epigrammatic passages as that.

Mr. Jacobson's line of argument is this. The so-called labor problem is the great problem, not only of our time, but of all times. It cannot be settled without expense, and large expense at that. Although any thing but settled, it has already cost this country hundreds of millions of dollars in the way of disturbance of business. The demand of the man who is at the bottom for better things in life is in the nature of things. It is a demand which sooner or later must be met, and it is to the interest of every one that it should be met. The man who works with his hands sells by the quantity, and at the lowest possible prices, all he produces. Whatever he has to buy he buys at the highest retail price. In the game of life the cards are stocked against the man who labors with his hands. Nearly all the wealth of modern times is earned by steam, which does for man his work. The wealth which steam earns should belong to all mankind; but, instead of going to the many, it goes to the few, and the many continue to hopelessly drudge and slave on. But the labor question is not merely a question of fewer hours and more pay: it goes deeper than that. It can be settled, but it can be settled by nothing short of revolution. This revolution, however, will be peaceful: there will be no lawlessness, no destruction of property, nobody would be maimed, nobody would be killed. The revolution is to be effected through the manual-training school.

In June, 1886, the Chicago Manual-Training School sent an entirely new product into the world. It graduated a class of boys about eighteen years of age, who three years before had never touched tools with a view to becoming skilled in their use. Yet, without neglecting their books, they had in those three years drawn the plans for several steam-engines, had made the patterns in wood, had done the chipping, filing, and lathe-work (the casting was done elsewhere, because the school lacked facilities for doing it), had put together the engines, and had run them. This manual education was not special, but general. It mattered not what profession the boys chose: it was useful to them. The product of the manual-training school does not compete with the wage-earning masses, for his skill and intelligence raise him above them. The manual-training school is popular, and destined to become still more so; for at the present time the school facilities that exist for the children of the laboring people, after they are ten or twelve years old, are only a hollow mockery. The manual-training school should become part of the American school system; and, to enable all children to get the benefit of the school, parents or guardians should be paid for keeping the children at school. The compensation should begin at the child's twelfth year, and be fifty dollars per year: it should continue till his twentieth year, when it should be three hundred dollars a year. The proposition includes both boys and girls. The expense thus incurred would be enormous, and could not be met by any taxation now in vogue. It could be met, however, by a graduated tax upon estates. In war times we had a succession tax, and it never failed to be collected, simply because the probate judge could declare no estate settled until the tax had been paid. The law imposing this tax was passed in 1861, and amended in 1862. Both acts were signed by Abraham Lincoln. In war times we also had a graduated income tax; so that a graduated tax is not new to the American people. But the income tax was odious, because only the scrupulous paid, and the unscrupulous escaped by swearing falsely. A succession tax is a fair tax, because nobody can escape paying it. The State of New York has a graduated succession tax, passed by the Legislature of 1885. It is now proposed to enact a graduated tax for all estates. It should be $\frac{1}{2}$ per cent on estates less than \$25,000, $\frac{1}{4}$ per cent on all above

\$25,000 and less than \$50,000, $\frac{1}{2}$ per cent on all above \$50,000 and less than \$100,000, then increasing gradually until it becomes 10 per cent on estates above a million, and 50 per cent on estates above five millions. The tax would not fall heavily upon anybody. It would only be \$2.50 on an estate of \$1,000, and only \$1,000 on an estate of \$100,000. It would yield from twenty-five to fifty millions annually in New York City, and from three to six millions annually in Chicago. Its proceeds would be ample for the proposed expenditure. This measure is expedient, and as just as any tax measure can be. It would increase individual power and individual intelligence, and would produce no unhappiness or suffering. The very rich man might say that he should be permitted to do what he likes with his own; but this he cannot do now, and in the nature of things will never be allowed to do. The law interferes at every step, and tells him what he may do with his own, and what he must not do. Many rich men give as much now for benevolent objects as the succession tax would take from their estates; but they rarely give it so as to accomplish the most good. Untold benefits would arise from this law. The child-labor problem would be settled, because it would now pay to keep the children at school. Wages would rise, because the competition of thousands under twenty years of age, who are now laborers, would be withdrawn. Intelligence shall make the people strong, the people shall be the government, and the strength of the people shall be the strength of the government. This is, in briefest outline, Mr. Jacobson's argument. Its novelty, its brilliancy, and its apparent cogency, nobody will deny; but will it stand the test of practicability? We are compelled to ask this question seriously, because Mr. Jacobson's proposition is made thoughtfully and in good faith: it is not the vagary of a fanatic, or the ravings of a lunatic. «It is a business proposition, and as such it demands fair treatment.

The second half of Mr. Jacobson's book is devoted to an explanation and eulogy of the manual-training school. We will grant for the sake of argument — though we agree with Mr. Jacobson in the matter, and therefore really grant nothing — that the manual-training school will accomplish all that is claimed for it by its thoughtful and influential advocates. It is then necessary to consider obvious objections to Mr. Jacobson's plan. So far as the graduated tax on estates is concerned, it is an excellent, safe, and easily collected tax. And while it may at first sight seem absurd to talk about subsidizing parents to keep children at school, yet we must take other considerations into account. It is just as absurd, and no more so, to levy a school-tax upon a man who has no children to be educated. Furthermore, it is an expense incurred in order to solve the labor question, which Mr. Jacobson holds, and rightly, cannot be solved without sacrifice and expense. All this being acceded to, it remains to ask whether the proposed tax would pay the bill. The author claims that it would, but offers no statistics in support of his assertion. An examination of the census of 1880 may enlighten us. Mr. Jacobson proposes to pay certain fixed sums per annum for each child over twelve and under twenty. In 1880 there were 8,347,731 such children in the country. To be reasonably successful, Mr. Jacobson's plan should reach at least three-fourths of them. If it should reach so many, and payments were made at the rates laid down by the author, the disbursements under this head in 1880 would have amounted to the enormous sum of \$919,502,737.50, or nine times more than our present total outlay for educational purposes. In the census year there died 756,893 persons. Of these, 202,806 were children under five years of age, whose opportunities of accumulating fortunes were restricted. But let us suppose that one-half of all those who died, or 378,447 persons, left estates valued at \$1,000 and over (we are construing these figures in as liberal a spirit as possible toward Mr. Jacobson, and if we err it is not against his theory). Suppose now, and it is almost unreasonable to suppose so, that 370,000 of these left fortunes averaging \$5,000, that 8,000 left fortunes averaging \$25,000, that 400 left fortunes averaging \$100,000, and that 47 left fortunes averaging \$1,000,000. If Mr. Jacobson's graduated succession tax were levied on these estates, it would net \$10,830,585, making no deduction for cost of collection. And this \$10,830,585 seems paltry when brought face to face with \$919,502,737.50. Mr. Jacobson claims, however (p. 44), as was quoted above, that the tax would at present yield from three to six millions annually in Chicago, and from twenty-five to fifty

millions annually in New York City. We cannot understand on what he bases that assertion. Take the two cities separately. The Illinois counties of Cook and Lake, that in which Chicago is situated and its neighbor on the north, lost 11,433 inhabitants by death in 1880. Of these, 6,230 were infants under five. If, of the remaining 5,203, 5,000 had died with average estates of \$5,000, 175 with \$100,000, and 28 with \$1,000,000, — a most preposterous assumption, — then in those two counties Mr. Jacobson's tax would have netted \$3,075,000. But the conditions are impossible. It is the same with New York. In 1880, New York and six adjoining counties had 25,239 deaths of persons over five years of age. Making an assumption regarding their estates as preposterous as that made in the case of Chicago, the return from Mr. Jacobson's tax would have been less than \$7,000,000.

Two things are very evident, — first, that Mr. Jacobson made no estimate of what his plan would cost; second, that he very much overestimates the number of fortunes of \$20,000,000 and over, in this country. His tax is 50 per cent on fortunes of \$5,000,000 and over, to be sure; and, if a few persons possessing that sum were to die at once, the return would be far greater than we have estimated. But such persons do not all die at once, and moreover, in the long-run, our overestimate of the number of millionnaires would suffice to make up the sum their deaths would contribute. It might even happen that Mr. Jacobson's estimate of the number of immense fortunes is approximately true: the amount raised by the tax would still be far short of the necessary expenditure. The plan is a brilliant one. It has many excellent points. We admire its author's enthusiasm for the manual-training school. His suggestion as to a graduated tax on estates commends itself to our judgment. But as a plan to solve the labor-problem, it will not work. This is partly because the income under the plan would not pay the expenditure, and partly because the labor problem is, in many respects, the problem of human nature. In Mr. Jacobson's sense of the word 'solution,' it cannot be solved.

NOTES AND NEWS.

THE annual meeting of the Association of the Colleges of Ohio will be held at Athens, Dec. 26, 27, and 28, 1887. The following is a list of the papers expected: Monday, Dec. 26, opening address, by Pres. Eli T. Tappan, commissioner of common schools. Tuesday, Dec. 27, 'The Aim of the College,' by Prof. C. L. Ehrenfeld, Wittenberg College; 'Rhetorical Studies and Literary Work in College,' by Prof. W. B. Chamberlain, Oberlin College; 'The Claims of Classical Archæology on Classical Teachers,' by Prof. B. Perrin, Adelbert College; 'Geology and Mineralogy in our Colleges,' by Prof. J. F. James, Miami University; Symposium, 'The Elective System with Us, What we Do and What we Think,' by the presidents or other representatives of all the institutions in the association. Wednesday, Dec. 28, 'Preparation for College in Ohio,' by Prof. Charles Chandler, Denison University. Meetings of the association will be held in the chapel of the Ohio University; entertainment at the Central Hotel, at \$1.50 per day, and at the Warren House at \$2 or less, according to the number stopping there. Trains leave Columbus for Athens at 7.45 A.M., 3.10 P.M., and 6.10 P.M., standard time.

— A literary and musical entertainment was given at the residence of Mr. and Mrs. H. Herrman in New York on Wednesday evening, Dec. 7, in aid of the Erminnie A. Smith memorial prize fund at Vassar College. The evening was a very enjoyable one, there being two hundred and fifty persons present, and a fine collection being furnished by Mrs. Herrman.

— The five lessons on problems in physical geography delivered by Prof. W. M. Davis, under the auspices of the Teachers' School of Science of the Boston Society of Natural History, during the winter of 1886-87, were so novel and useful to teachers, that he has been invited to give a course during the coming winter upon the physical geography of the United States. This course will be in part a continuation of last year's lessons; but the addition of new matter, new models, more extended illustrations, and the special attention given to our own country, will make the lectures practically distinct from those given last winter.

LETTERS TO THE EDITOR.

* * * Correspondents are requested to be as brief as possible. The writer's name is in all cases required as proof of good faith. Twenty copies of the number containing his communication will be furnished free to any correspondent on request. The editor will be glad to publish any queries consonant with the character of the journal.

Conspiracy of Silence.

THE discussion published in a recent number of your journal (*Science*, x. No. 252), relative to the faith of scientists, is the revival of a topic which seems to have been long since definitely settled. If history can be credited, scientific men in every age have fought vigorously against progress. An interesting example is furnished by a brilliant French novelist, Mr. Paul Féval, and probably few will fail to recognize the truth of the following quotation: —

"Il fallut cependant des années encore pour que ce savant et illustre corps, le marine de l'Etat, voulût bien prendre en considération cette force qui fait reculer le vent et se rit de la violence même des courants. Il est vrai que l'Académie professoral, vers le même temps, cette opinion: qu'une vitesse de dix lieues à l'heure, sur un chemin de fer, supprimerait la respiration chez l'homme et tuerait tous les malheureux assez fous pour se livrer à ces folles expériences. Il serait puéril d'accuser notre marine ou nos académies. Le monde est ainsi fait. Tout progrès gêne quelque intérêt ou froisse quelque orgueil.

"Dans le doute, abstiens-toi, disait la sagesse antique; la sagesse moderne répond: *Si tu ne sais pas, empêche!* Fera-t-on jamais le compte des hommes et des idées mis à mort au nom de ce fantôme idiot que les sages nomment l'*invraisemblance?*"

The naive confession of Mr. Bonney practically concedes the whole case. Here are two theories of the formation of coral reefs, each dependent upon a certain set of facts, accessible to all investigators. Mr. Bonney says that the scientific method is to wait, and not to investigate. He is not able, he says, to make up his mind which theory is correct. Is this really a scientific method?

The ideal scientist, it will readily be admitted, is a person whose sole aim is to discover the truth of any matter under investigation, regardless of all personal or partisan feelings. The actual man of science, for the reason that he is a man, is influenced, unconsciously it may be, by his human characteristics, and frequently allows prejudice to overcome reason. In the particular case already considered in your columns, it appears that Mr. Murray discovered some facts which were unknown to Darwin, and that, these facts admitted, Darwin's theory must necessarily be modified. This is the precise point which Mr. Bonney adroitly evades: does he believe the facts stated by Mr. Murray; and, if so, can he reasonably continue to accept Darwin's theory? What excuse is there for waiting, unless, indeed, Darwin is an idol whose sayings, because they were made by him, must be received with reverence by all his followers?

This theory of Darwin's is only one of a number of beliefs which scientists uphold with obstinacy, in the face of contrary evidence; but, as is well said by the writer already quoted, —

"Mais, en tout siècle, les sages eurent beau se coucher au travers de la grande route vù marche l'humanité, l'humanité passa. L'invraisemblance, grotesque épouvantail, recule ses brouillards devant la lumière. Des miracles, déclarés impossibles, se promènent paisiblement dans nos rues. Et tout va vite: voyez! il y a de cela quarante ans à peine; en cherchant bien, vous trouverez certes encore, vivant et grignotant sa bribe du budget, quelqu'un de ces Spartiates dont la main tremblotante essaya d'arrêter la vapeur!"

It may be of interest to glance briefly at another celebrated theory, which has been treated by scientists in a manner very similar to that pursued in the case of coral formations. About the year 1844, Messrs. Favre and Silbermann experimented on the heat evolved by the combustion of certain elementary and a few compound combustibles. Their experiments, far surpassing in accuracy all those hitherto made, were accepted by scientific men generally, and their results are given in most text-books and treatises on heat. These distinguished experimenters did not think it necessary to test the heating-power of the familiar compound, coal, but considered that it could be calculated with sufficient accuracy by analyzing the coal, and assuming that the heating-power was the same as the sum of the heating-powers determined for the various combustible elements, less the unavailable heat of so much of the

hydrogen as would unite with oxygen in the formation of water; and this is the theory contained in most modern text-books on combustion prepared for the use of English-speaking students, and generally employed in calculations by the scientific men of England and the United States.

About the year 1860, Messrs. Scheurer-Kestner and Meunier-Dollfus made experiments on the heat evolved by the combustion of various coals; using the same method as that employed by Messrs. Favre and Silbermann, and checking the latter's experiments on wood charcoal and hydrogen gas, before testing the coals. The experiments on coals showed that it was incorrect to calculate the heat of combustion of coal from the heat of its combustible constituents as determined by Favre and Silbermann; or, in other words, that it was not correct to assume that the carbon in coal was of the same density as wood charcoal, and that the hydrogen of the coal was in a gaseous state: these being the necessary assumptions, when Messrs. Favre and Silbermann's constants are used in the formula to which reference has been made above. The report of Messrs. Scheurer-Kestner and Meunier-Dollfus has been well named 'classical,'—all operations and calculations being fully detailed,—so that, speaking rationally or scientifically, the conclusion seems inevitable that a scientific investigator must either find some error or accept the results. Well, how has the scientific world, that is to say, the English-speaking scientific world, received these results? Generally by ignoring them, and going on in the good old way, according to the creed formulated by Messrs. Favre and Silbermann. Here is a scientific (?) statement made by one investigator who has carefully studied the report (Mr. B. F. Isherwood, in *Journal of the Franklin Institute*, July, 1884):—

"The results of the calorimetrical experiments made by Scheurer-Kestner and Meunier-Dollfus on the heat of combustion of the Alsatian coals, were never accepted by the British scientists, notwithstanding that no error was ever pointed out in either the apparatus or the method employed. Nor could the writer ever accept them, although he bestowed the closest scrutiny and study upon them."

This is science, with a vengeance! "I can't find any mistakes in the methods or calculations," says the scientist, "but the results are opposed to my present belief, and I can't accept them. I have published numerous treatises containing calculations founded on the methods and data of Favre and Silbermann, and these new results, which would condemn my work, must be ignored or denied."¹

The statement contained in the above quotation, that the results of the experiments made by Messrs. Scheurer-Kestner and Meunier-Dollfus were never accepted by the British scientists, is not absolutely correct. Mr. John Percy, in the last edition of his treatise on fuel, gives the results, and calls attention to the inaccuracy of the ordinary method of calculation. Similar corrections are made in the last supplement of Watt's 'Dictionary of Chemistry.'

Quite recently, Messrs. Scheurer-Kestner and Meunier-Dollfus have repeated their former experiments, obtaining substantially the same results as before; and it seems probable that right methods of calculating the heat of combustion of coal will be generally adopted before long. If the results are true, they will certainly be accepted, some day; but the length of time during which they have patiently awaited admission to the temple inhabited by English-speaking scientists is a sufficient answer to the question, 'If a new fact, overturning some established theory, is presented, do the scientists examine it critically, and either disprove or accept it, or do they ignore it as long as they can, and only take it into their hearts when worn out by its persistent demands?' If a *truth* is announced, there need be no fear that it will not prevail in the end; but numerous facts, similar to that just cited, sufficiently disprove

¹ Scientific men seem to hunt in couples, so to speak; and Mr. Bonney, in answering the Duke of Argyll (*Nature*, Nov. 24), argues in the same manner as his American brother in the above quotation. He does not accept the new theory, and thinks that no reasons are required for his disbelief. Here are his words:—

"To conclude, the Duke still—and this is our special complaint—treats the matter rather according to ecclesiastical than to scientific method. He is fully persuaded of the excellence of Mr. Murray's hypothesis, and considers it to be 'one of those discoveries in science which are self-luminous, and must carry conviction to all.' Very well, but there are some people, not very few in number, who do not share this opinion."

Hail to the new science, announced by Mr. Bonney! The voice of many people is the voice of God.

the theory fondly entertained by many scientists, that they have reached the ideal state where they desire only to know the truth, regardless of consequences.

Another brilliant French writer, Mr. Alexander Dumas, well sums up the matter, as follows:—

"Il est vrai que peut-être les contemporains ne me croiront pas. . . . Qu'importe! je l'aurais dit; d'autres me croiront: la vérité est une de ces étoiles qui peuvent rester des mois, des années, des siècles, dans les profondeurs du ciel, mais qui finissent toujours par être découvertes un jour ou l'autre. J'aime mieux être le fou qui se voue à la recherche de ces étoiles-là, que le sage qui salue et qui adore, les uns après les autres, tous ces soleils que nous avons vus, se lever, que l'on nous a donnés pour des astres immutables, et qui, à tout prendre, n'ont jamais été que des météores plus ou moins durables, plus ou moins brillants, plus ou moins trompeurs, toujours fatals!"

RICHARD H. BUEL.

New York, Dec. 7.

The 'Act of God' and 'Fuerza Mayor.'

MR. APPLETON MORGAN'S 'Act of God' and Mr. Nevin's 'fuerza mayor' appear to me to be pretty much alike, and to threaten a new peril to railway travel,—a peril, according to Mr. Nevin, which in Mexico is already to be encountered. I tremble to think what might happen, for example, if the engineer of the locomotive should happen to sneeze just as he passed a signal that a bridge had been carried away somewhere on the Mexican Central Railroad by "the flooding of a river." Here would be a double 'fuerza mayor;' for an inclination to sneeze is certainly irresistible, and, besides, "the flooding of a river" certainly relieved from the responsibility for the irresistible inclination, even if, according to Mr. Nevin, it did not relieve the watchman from the duty of putting up the danger-signal. But, although we may have to take our lives in our hands when we travel by rail in Mexico (according to Mr. Nevin), I hope that time has not yet come in the United States.

In short, this is the actual practical answer to Mr. Morgan's cleverly reasoned and delightfully *insouciant* paper. It may not be the answer a railway lawyer would write, or would recognize as sufficient, but, from the travelling public's standpoint, it is all there: to be said. It is all very well for the sleek attorneys of great railroad corporations to say that so long as the company provides, as Mr. Morgan says, "the last improvement in safety-insuring devices," its responsibility for the safety of those it transports ceases. "Let us bow to the Divine Will, gentlemen of the jury," says Mr. Morgan. "An overruling Providence has decreed that my client should "roast thirty-two human beings in slow agony on a floor of ice at White River. But our track was in perfect order, our engine was all right, we were running on time. We are not legally to blame." Would Mr. Appleton Morgan have bowed to the Divine Will if he had happened to have been rescued in a half-roasted condition at White River, less an arm, or an eye, or a leg? I venture to say he would have done nothing of the sort. I venture to say he would have commenced proceedings against the company for twenty-five thousand or fifty thousand dollars as soon as he could swear to a complaint. And yet Mr. Morgan will concede that the accident at White River could not have happened in spite of the Divine Will.

The people of this nation do not exist at the will and pleasure of the railway-companies; nor is this nation governed by Mexican laws. Mr. Morgan's familiarity with his subject enables him to write very plausibly concerning the rights and duties of railway-companies; but he cannot convince me, for one, that they are not more sinning than sinned against. If the principle of the 'Act of God' is to be resurrected in the United States, as in Mexico, where is the line to be drawn, and who is to draw it,—the railway-companies, or their ingenious lawyers?

GEORGE BRADWIN.

Jersey City, Dec. 6.

The Flight of Birds.

My friend, Prof. Frank H. Storer, has called my attention to an important note on the wings of birds, by that accurate and indefatigable investigator, Prof. Jeffries Wyman. It is to be found on p. 169, vol. v., *Proceedings of the Boston Natural History Society*. This note is all too short, but forms an interesting adjunct to the:

paper by Professor Trowbridge, read before the National Academy, and noticed in *Science* of Nov. 18, 1887. Those who heard or have read Professor Trowbridge's paper will remember that it reported the discovery by his son of a peculiar structure in the primary wing-feathers of soaring birds, by which they are locked when expanded, and are thus maintained in position without muscular effort. This structure is shown only in the primary feathers, and is therefore a character belonging to the last division of the arm.

Professor Wyman, in the note referred to, describes "a peculiar arrangement of the bones and ligaments in the wing of the pintailed duck, by which, while the wing is fully extended, all the segments of this extremity are fixed and retained in position independently of muscular action." His account of the mechanism of the wing is as follows:—

"The structure of the articulations of the elbow and wrist is such, that during flexion and extension the radius advances and recedes upon the ulna, carrying with it the upper carpal bone, and this last the hand: in this way flexion and extension of the bones are effected. The lower carpal bone is attached to the upper by strong ligaments: consequently, when the upper carpal bone is drawn over the extremity of the ulna as the radius recedes, the lower one is drawn up between the hand and the extremity of the ulna, and, acting as a wedge, maintains the hand extended, until it is displaced by the reversed action of the radius." This structure, according to Professor Wyman, shows how the extension of the bony framework of the wing may be maintained indefinitely without fatigue. The structure of the primary wing-feathers described by Professor Trowbridge indicates that they too may be locked in position, and thus the rigidity of the wing may be maintained automatically to its extremity.

None of the members of the National Academy who took part in the discussion which followed the reading of Professor Trowbridge's paper seemed to have any knowledge of this discovery of Professor Wyman; and it was remarked, that, while the facts cited by Professor Trowbridge seemed to explain the automatic extension of the primaries which are appendages of the *manus*, the rigidity of the arm itself, apparently manifested in the flight of soaring birds, was yet unaccounted for. That missing link was supplied by Professor Wyman, but, from his characteristic modesty, so quietly announced that it has been known to few.

The case cited by me at the meeting of the National Academy was a turkey-buzzard, shot when soaring over the prairies in the Sacramento valley. Its wings remained rigidly extended, and it descended slowly like a parachute and settled in the grass very near me, quite dead; even then the wings remaining expanded.

Professor Storer gives other interesting examples. He says, "Upon the New England seaboard nothing is more familiar to old gunners than the phenomenon that a bird shot in mid-air will often 'set his wings' and scale down toward the horizon, to reach the water dead, often at a great distance from the boat whence the shot was fired. Even in childhood I remembered to have wondered, when 'assisting' at the shooting of duck and coot, as to the meaning of the not infrequent exclamation, 'That fellow has set his wings; watch him!'"

Dr. Storer writes that he was present at the meeting of the Boston Natural History Society, Sept. 1, 1855, when Professor Wyman exhibited his preparation of the duck's wing, and gave an explanation of its structure which seemed a demonstration.

Now, if some good anatomist would review the subject again, combine the results reached by Professor Wyman and Professor Trowbridge, and illustrate his memoir with good figures, he would make an important contribution to biological science.

J. S. NEWBERRY.

New York, Dec. 10.

The Origin of the Tritubercular Type of Mammalian Dentition.

PROFESSOR COPE has fully demonstrated that the molar teeth of many divisions of the higher mammalia are derived from the tritubercular type of molar which is so abundant in the mammals of the Puerco, or lowest eocene period. He has further ('Origin of the Fittest,' p. 347) shown that the tritubercular type may be traced back to the single cone of the reptilian crown by the follow-

ing succession: 'first, a simple cone or reptilian crown alternating with that of the other jaw; second, a cone with lateral denticles; third, the denticles to the inner side of the crown forming a three-sided prism, with tritubercular apex, which alternates with that of the opposite jaw,' etc. In the last meeting of the American Association for the Advancement of Science, Professor Cope applied this succession to the origin of what he has called the 'tritubercular-sectorial' molar, citing the molars of Owen's genus *Spalacotherium* as an instance of the transformation into the tritubercular crown *in process*. I had independently arrived at the same conclusion, and, moreover, found that the origin of the tritubercular crown in all its various stages could be traced in the mesozoic mammalia. This is traced in a memoir now publishing by the Philadelphia Academy. I am glad to be able to confirm Professor Cope's views in every particular, for his numerous and suggestive papers upon the mechanical genesis of tooth forms have placed comparative anatomists generally in his debt. Among the mesozoic mammalia the simple large cone with small lateral denticles is seen in the American triassic genus *Deomotherium*. From the same beds *Microconodon* furnishes a more advanced stage in the growth of the lateral denticles into cusps. The mandibles of Jurassic genera *Phascolotherium*, *Menacodon*, *Spalacotherium*, furnish three stages of the rotation inwards of the lateral cusps, accompanied probably by the rotation outwards of the lateral cusps in the upper jaw. In *Stylodon* this process is complete, the teeth being distinctly tritubercular, with the addition of a posterior heel, the upper molars reversing the pattern of the lower. In another line of genera the lateral cusps show no tendency to rotate inwards, but continually augment in size, such as *Triconodon* and its successors, leading to the modern *Thylacinus* type of molar. In *Amphitherium* and many other genera it appears as if the posterior lateral cusp had never been acquired, and the crown is re-enforced by the inward extension of the cingulum, as seen in an early stage in *Diplocynodon*. In *Kurtodon*, by the union of the external tubercles in the upper jaw, we observe a columnar molar of the rodent type. It now appears as if we should soon be in possession of sufficient data to trace the entire history of the multi-cuspid and multi-fanged mammalian molar from the single reptilian cone and fang.

HENRY F. OSBORN.

Princeton, N.J., Dec. 12.

Iroquois and Eskimos.

IN connection with the discussion which has recently appeared in *Science* on the ancient relations of the Iroquois and Eskimos, a passage which I recently came across in the manuscripts of the Moravian missionary Christopher Pylæus is worthy of note.

The active work of Pylæus was between 1740 and 1750, and he became an accomplished scholar in one or more of the Iroquois dialects. In July, 1749, the Iroquois sent a deputation to a council at Philadelphia, when Pylæus acted as interpreter. In his notes of his conversations with the deputies he has the following:—

"*Tschieckrohne* heissen die Grönlander; . . . *Tschie*, ein Seehund. Die drei obgenannte Seneker wussten nicht nur von den Grönlandern, sondern auch ihrer Contry (*sic*), Landsart, Kleidung, Nahrung," etc.

Of course, Pylæus used the term 'Greenlanders' as generic for 'Eskimos.' Evidently the Iroquois, who pushed their war parties to the south as far as the present State of Louisiana, carried their excursions also as far north as the shores of the Frozen Ocean.

D. G. BRINTON.

Media, Penn., Dec. 7.

The Sioux.

IN your issue of Nov. 25 (p. 264) your correspondent from Lexington, Mo., says, "The Sioux call themselves *Lah-ko-ta*." In this he is correct; but when he adds, "not Dakota," he is in error. The sounds of *l* and *d* are interchanged among certain Dakota dialects. The Sioux who dwell east of the Missouri say *Dakota*, while most of those on the west side (Tetons) say *Lakota* (*vide* Riggs's *Grammar and Dictionary of the Dakota Language*, p. 133).

In giving the meaning of the name as 'cut-throats,' he is at variance with the best authorities on the Dakota language.

W. MATTHEWS.

Washington, D.C., Nov. 26.

SCIENCE

FRIDAY, DECEMBER 23, 1887.

A MOST INTERESTING CELEBRATION took place in Philadelphia on Dec. 12. The occasion was the one-hundredth anniversary of the birth of Thomas Hopkins Gallaudet, the pioneer of the movement for the instruction of the deaf in this country. A short biographical sketch of Gallaudet was read, and one of his poems was recited by four deaf girls in the sign-language. The address of the evening was delivered by Prof. A. Graham Bell of telephone fame, and well known for his researches into the heredity of deaf-mutism. Professor Bell gave an interesting history of the knowledge of deaf-mutism, pointing out how completely its nature was misunderstood until within very recent times. Not two centuries ago the legal status of a deaf-mute was like that of an idiot. The notion of his being capable of receiving education was ridiculed, and the only attempts to make them speak was by a church miracle. Three names in the eighteenth century stand out as the successful teachers of the deaf, — Heimcke, De l'Épée, and Braidwood. Gallaudet became interested in the deaf-mute by meeting the young daughter of his neighbor at Hartford, Dr. Cogswell. He succeeded in teaching her a little; and when, later, it was found out how many more were similarly afflicted, a meeting was called at Dr. Cogswell's house, and it was decided to send young Gallaudet to England to learn the methods of teaching, and introduce them into America. He arrived in England, and found that Braidwood had bound all his teachers under a heavy fine not to reveal his methods to any one. It was a money-making institution, and after long delays he saw that it was hopeless to stay in England. He then fortunately met the Abbé De l'Épée, who welcomed him to France with open arms, taught him all he had to teach, and sent with him one of his most talented pupils, Laurence Clerc, to spread the great gift to America. On their arrival they founded the institution at Hartford, which soon gave rise to others all over the land. The perseverance and self-sacrifice of Gallaudet were the means of bringing a life worth living to thousands of the deaf of America. The address was interpreted into the sign-language as rapidly as it was spoken, and was greatly appreciated by the many deaf persons in the audience. The two sons of Gallaudet, both of whom are engaged in continuing the work of their father, — one as the president of the deaf-mute college at Washington, the other as a pastor for the deaf, — were present, and made remarks suitable to the occasion.

THE DEATH HAS BEEN ANNOUNCED of Gustav Theodor Fechner, professor of experimental physics at the University of Leipzig. Fechner has been before the scientific world in many fields of activity, and for many years. He began his career as a physicist, and for many years devoted himself to experimental work, and edited a physical journal. But the chief work of his life was begun when nearly sixty years old. This was the work on psychophysics, — a field hitherto touched upon in only the most meagre way, and owing its scientific recognition as well as its systematic development to him. He here announced the psychophysical law, stating the relation between the intensity of the stimulus and that of the resulting sensation, and verified it with a large number of ingenious and laborious experiments. Around this central conception of Fechner's has sprung up a large literature, in part criticising his fundamental points, in part developing and adding to his work and his methods. Whatever the final outcome of the move-

ment, it will always owe its vitality and its scientific development to Fechner. This interest was maintained by Fechner until his death. Two more books on psychophysics appeared from his pen, and a large number of articles, the last of which were written only a few years ago. Fechner's mind was characterized by two streams of interest; the one leading him to exact science, the other to a somewhat imaginative speculation. He was deeply impressed with the poetic, the mystic side of nature, and struggled to make the world seem rational without losing any thing of grandeur or mystery. These two streams of thought come nearest to meeting in the second part of his psychophysics, but it is greatly to his credit that he succeeded so well in keeping science and speculation apart. Only once did he seriously confound the two, and that was in the somewhat subordinate part he played in 'the fourth-dimension experiments' of Zöllner. Besides his scientific works and his speculative ones, he was the author of a book of poems and a book of riddles. He died at the advanced age of eighty-six. He had been troubled for many years by a double cataract, and was prevented from doing much work by this disease.

THE WOMAN'S TEMPERANCE PUBLICATION ASSOCIATION of Chicago has just issued a little book by William T. Hornaday, entitled 'Free Rum on the Congo.' This book is an earnest appeal to Americans for the suppression of the liquor traffic in Africa, especially in the Kongo basin. As might be expected, the author ascribes the destructive influence of European civilization upon the natives of all countries almost solely to the influence of alcohol, and overlooks other important agents which nobody, however deep his sympathy with the unfortunate victims of European civilization may be, can remedy. The physical destruction of uncivilized races is brought about by diseases introduced by Europeans, among which alcoholism takes its place, although not by any means the most prominent one. But the mental deterioration of the natives is not less important. The cheap products of European manufacture, which are in every respect superior to those of native manufacture, make the native arts and industries decline rapidly, and vanish within a few years. As nothing new is given to the natives in place of their lost arts, their lost culture, they sink to a far lower stage than they occupied before the advent of the whites. It is at this moment that the missionary generally makes his appearance. It is only in rare instances that he succeeds in raising the natives to a higher standard. Generally the Christianity he introduces is nothing else than a new fetich instead of the old one. He is taught that agriculture is the only means of civilizing a nation, and applies this theory regardless of the character of his pupils and without effect. Thus the native falls into a state in which he requires European products, and has little to offer in exchange. He is not accustomed to work hard and steadily, and therefore the sole effect of his contact with the white man is the promotion of his laziness and of all his bad propensities. In these two facts lies the root of the destruction of uncivilized peoples. Alcoholism is only a small part of the evil influences threatening the natives, and the suppression of the liquor traffic will not go far to improve their condition. It is well known that the negroes throughout Africa, with the exception of a few tribes, were acquainted with alcoholic drinks before the advent of the whites. The Kaffres, the Balunda, the Waganda, brew beer and make palm-wine, which they drink in excessive quantities. But rum and gin are more dangerous, as they contain more alcohol; and a law prohibiting their importation would be a gain for the natives. But the Woman's Temperance Association, in endeavoring

to arouse an interest in the suppression of alcohol traffic in Africa, ought to know, that, even if its aims were reached, the negroes would be little better off. There is only one way to improve their state: it is to develop their arts and industries; to improve the methods of agriculture where such is practised, to further stock raising and trading where the negroes are stock raisers and traders. After this has been done, the missionary may be able to Christianize his pupils. The intelligent missionaries, who understand that an improvement of the material welfare of the natives must precede any teaching of religion, are not many. The author, whose aims are very praiseworthy, has not grasped the question of education of the natives. He overestimates one cause of their ruin, and underestimates their faculties. The spread of Mohammedanism shows that the native is well able to protect himself from alcohol, if his other energies are not destroyed by foreign influence. This shows that the principal problem is not the prohibition of alcohol, which of course is the chief aim of the Woman's Temperance Association, but the stimulation of the energies, and development of the faculties, of the natives.

THE GERMAN SYSTEM OF NORMAL SCHOOLS.¹

IN Germany schools have a social as well as an educational rank. They may in general be divided into lower, middle, and higher schools. The tuition, which is common to all, is graded, so that the poorer and lower social classes are driven into the lowest grade of schools. These are called *Volks*, or people's schools. In Prussia ninety-one per cent of all children attend them; in Bavaria, ninety-six per cent. Their course of study is rounded up and complete in itself. This school leads into no higher school. The length of its course of study is eight years,—from the age of six to that of fourteen. It is for this grade of schools that the German normal schools prepare, and have always prepared, teachers. The higher schools are taught by classically trained university men, even in the elementary grades.

German normal schools arose in the middle of the eighteenth century, and were established and maintained almost wholly from philanthropic motives. They educated pious young people for a business to which was attached neither competence nor worldly honor. Externally their growth was greatly stimulated by the rise of that great democratic wave which has swept through the world during the present century; and furthermore, by that fear of an uneducated proletariat which arose with the French revolution; and, finally, by that high patriotism which saw in the education of the German people the hope of freeing Germany from the domination of Napoleon. Internally the normal schools received a new birth through the educational revival which arose with Rousseau and Pestalozzi.

But at the close of the Napoleonic wars, Germany relapsed into the old police state, and soon suffered the internal contradiction of a free intellectual development of the people in its schools, and the cast-iron rigidity of a bureaucratic and despotic system of government. This contradiction culminated in the revolution of 1848. A re-action followed, and the normal schools, which had grown numerous, were accused of being the main disseminators of revolutionary ideas. In 1854 there followed the three famous Prussian Regulations, which eliminated from the normal schools the spirit of Pestalozzi and modern development, and reduced them to medieval handmaids of the Church and a bureaucratic State. Other German powers followed the example of Prussia. Authority took the place of self-activity in the schoolroom, and German education sank from its high estate. This was the condition of education in Germany until the great day of German unity, which came at the close of the Franco-Prussian war. The oppressive Regulations were repealed, the spirit of progress and free development of mind returned, and Germany resumed her former place as the leader of educational advancement. The number of normal schools increased, until there were enough to supply all teachers needed for the people's schools. The number in 1882 in Prussia was one hundred and eleven, nine of which were for women, the rest for men, there being no co-education in German normal schools. Each

school has a director, a head teacher, four ordinary teachers, and one assistant. It is attended by about a hundred students, about two-thirds of whom board in the school. The board is very cheap, not exceeding a dollar a week. The State pays the deficit, if one occurs. I apprehend that the main reason for this close connection with the school is to be found in the tendency of the normal students to imitate the excessive beer-drinking and carousing so common among the students of the university. The employment of women as teachers in Germany is yet regarded as an experiment in many parts of the country, and occurs usually only in graded girls' schools. Director Leutz of Karlsruhe said to me, "So far, they give good satisfaction, for they are still young and fresh, but who knows what they will become when they get old and cross?"

The fact that Germany can supply all its *Volks* schools with graduate teachers from the normal schools, finds its explanation in these facts: 1. All students take a continuous course, and all graduate, as indeed they must before they can become teachers; 2. Nearly all graduates remain teachers, for a German rarely becomes that for which he was not specially educated; 3. Teaching is a profession in Germany, since none but trained persons are allowed permanently to teach in that country. The teacher is a civil officer, and holds his position with a life-tenure. I find by computation that the average length of service of Prussian teachers for the last fifty years is sixteen and nine-tenths years; so that, aside from the increase in the number of schools, but five and nine-tenths per cent of the whole number of teachers must be renewed yearly. Director Rein of Eisenach, in Sachen-Weimar, and Director Leutz of Karlsruhe, in Baden, both assured me that not more than five per cent of the number of teachers in those states is renewed yearly. This makes it possible, with a reasonable number of normal schools, perhaps one for each hundred thousand inhabitants, to supply trained teachers for all schools. Every year, however, in Illinois, over twenty per cent of all teachers are beginners. At this rate, to supply our Illinois schools with trained teachers, it would take one hundred and forty-two normal schools, each having one hundred students, a three-years' course, and graduating thirty-three students annually. We have, in reality, two normal schools, which graduate from twenty-five to forty students each year.

German normal schools are administered by the state educational minister or commissioner, a provincial school commission, and by the director.

The same difficulties which have beset us, concerning the proper preparation of candidates for the normal schools, exist in Germany. Most of their candidates come naturally from the *Volks* or people's schools; but, as we have seen, their course of study is strictly elementary, and closes when the student is at the age of fourteen. The common rule is to require three years of preparation before entering the normal school. This preparation is obtained in any one of three ways: 1. Privately (this happens in villages where only the *Volks* school is found); 2. In the advanced grades of middle and higher schools; 3. In special preparatory schools. Of this kind, Prussia has thirty, whereas each normal school of Saxony has its own preparatory school. The pupils are here taken at fourteen direct from the *Volks* school, and graduated six years later. The course of study in the preparatory schools is purely academic, and consists of (1) religion, (2) German (reading, grammar, etc.), (3) mathematics (arithmetic, algebra, geometry), (4) history, (5) geography, (6) natural science, (7) writing, (8) drawing, (9) singing, (10) violin, (11) piano, (12) harmony, (13) gymnastics.

That every normal school must have a model and training school has long since been established by law in Germany, and is no longer a question of debate. As the late Director Kehr, of the Halberstadt Normal School, said, "a normal school without a training-school would be like a swimming-school without water." The only feature to which I wish to call your attention is the fact that in Prussia each training-school has a country or district school department, i.e., a model of a school taught by one teacher, so that the students have a complete picture of a village ungraded school. I do not dwell upon the subject of the training-school, for I believe that this country has now become pretty thoroughly converted to the idea that the training-school is a necessary part of any thoroughly equipped normal school. Some of you will remember, how-

¹ Read at the National Teachers' Association, in Chicago, July, 1887.

ever, in the discussion of my paper on model schools, at Saratoga, in 1883, that one of your members indulged in a prophecy concerning a gentleman who was advocating the need of training-schools in New England normal schools, to the effect, that, if the gentleman lived five years longer, he would not know so much about the subject as he did then. Only four of the years set by the prophecy are past; but, if that gentleman has even begun to know less on this topic than he did then, he can tell us to-day, for, by a coincidence, he is to discuss this paper also. I may remark in passing, that the training work takes place during the second and third years of the course, and consists of, observation, 60 hours; model lessons by the faculty, 120 hours; trial lessons by the pupils, 80 hours; special preparation for teaching in the training-school, 40 hours; teaching in the training-school, about 200 hours; critical discussion of class exercises conducted by the pupils, 40 hours.

We come now to what has long been a serious problem in American normal schools; viz., the arrangement of the curriculum, and the relation of academic to professional work. There has been a growing feeling in some parts of this country that the normal school has no business with academic training, but should confine itself strictly to professional work. I judge from last year's report to this body, that some, wishing to conform to modern sentiment but not seeing how to do so in reality, have apparently rechristened some of their departments; so that that which used to be known as academic work, has now become professional work of the strictest kind. This may look well on paper, but it only retards a true solution of the difficulty.

It may in general be remarked that the curriculum of the Prussian normal school consists of the same subjects pursued in the preparatory course, together with the theoretical and practical professional work proper. From this we may infer, what is the fact, that it is the concurrent testimony of schoolmen in Germany that no amount of theory about teaching the various branches can equal a thorough review and study of them in their relation to the teacher and the children to be taught. Academic instruction is, then, in their view, a necessary branch of normal-school instruction, and not something which, under changed conditions of preparation, might be dismissed with profit. This does not mean, however, that academic instruction in a normal school should not differ essentially from academic instruction in a high school. As I apprehend the matter, it is in this particular that we have the most room for improvement. I will explain, later, the way in which I think this improvement can be made.

No subject is pursued for less than one year, while many subjects, such as history, geography, drawing, gymnastics, and certain branches of music, are studied throughout the entire three years. Many other subjects are studied continuously for two years. This arrangement is made possible by the fact that attendance by the students is continuous throughout the entire course, whereas our broken attendance compels us to make the school term the unit of time for a study. It is curious that the number of hours per week assigned to any given subject does not exceed two, except for arithmetic and algebra, biblical history, and teaching in the training-school.

Such, in brief, is the German normal school system. But what of it? What does it mean for us? Can we attain to any such results? What are the conditions by which its development must be determined?

The average American normal school may, perhaps, be fitly defined as a high school with a training attachment, having the limitations of a low-grade high school, and the ambition of a high-grade college.

In order that the changes which I have to suggest may be seen to have some basis in reason, I wish to make certain propositions, which, since I shall not have time to demonstrate them, may be considered as self-evident truths until they are shown to be erroneous:—

1. That, since the great majority of students who enter a normal school leave at or before the end of the first year, the curriculum for this year ought to be a fair, though elementary, representation of a complete professional education. In the Illinois Normal School at Normal, seventy-two per cent of the students do not enter upon the second year's work. If the principle stated is a sound one, no

great educational department ought to be entirely neglected in the first year's course; yet in our curriculum, psychology follows theory and art of education, and is found first in the second year. Again, natural science is a great and growing department of education, yet we meet its first manifestation in our course of study in the second term of the second year. I propose to put physiology, at least, into the first year's course. A little further on, I shall propose changes in the theoretical professional work.

2. That the education given in the great mass of normal schools must, in the nature of things, remain elementary in character. College and university trained teachers do not compete for positions in the district and village schools, even in old countries, where the struggle for existence is sharpest; much less are they likely to do so in this country. Schools paying from three hundred dollars to five hundred dollars only, must be filled by persons having only secondary education. Since, then, the normal school cannot compete with the college in higher education, it is idle to load up the curriculum with so many college studies, but is wiser to spend more time on fewer subjects. For example: we at Normal teach six sciences, one of which gets fifteen weeks, while each of the others is studied for a bare twelve weeks. Further, we devote six weeks to the history of education, and another six weeks to Rosenkranz's 'Philosophy of Education,'—the best yet the most difficult of works on education in the English language. It needs no argument to show the folly of making so many beginnings which lead to so little, or of making so large a contribution to the mushroom education of the times. I make the very modest proposal in regard to natural science, that astronomy be dropped, and that the two great representative sciences, physics and zoölogy, receive at least two terms each.

3. That any serious attempt greatly to raise the standard of admission will end in driving most of the male students out of the normal school. Witness the advanced State normal school at Milwaukee, which enrolls but one man. Any other normal school which demands the completion of a high-school course of study as a condition of entrance, will, I imagine, contain few male students. From this it follows, that, if the normal school is made purely professional, it is likely to become purely female.

4. That every normal school in America should teach gymnastics two hours a week throughout its entire course. It is exceedingly rare to see a stoop-shouldered or consumptive-looking man in Germany. Sitting one day in the Garden of the Luxembourg, in Paris, I began to count the number of round-shouldered people who passed. All classes were represented. Of those I counted, thirty-six were straight, and sixty-three were more or less round-shouldered, many of them seriously so. Gymnastics is thoroughly universal in all German schools, but is, or at least has not been, in France.

5. That our normal schools should make a much more serious business of music. There is not time to discuss this point.

6. That since the normal school is elementary in its scope, and since the American teacher, unlike the German, has no limits set to what he may become, the thing of most lasting benefit which the normal school can do for him and the State is to quicken him to the widest professional growth. I have little doubt that some of the early normal schools, with their one-year courses, did far more towards implanting a growing inspiration in their pupils than we do with our three years of grind. To this end I would have a more rational and far-reaching professional course of study. I propose, therefore, the following: *First year*, first term, observation; second term, elementary psychology; third term, elementary theory and practice of teaching. *Second year*, first term, logic and advanced psychology; second term, history of education; third term, philosophy of education (Rosenkranz). *Third year*, entire year, two to three hours per week, illustrative teaching, united with the principles of methodology,—a subject which, so far as I am aware, has received little or no attention in American normal schools.

7. That it is time for the normal school in America to pass that stage of its development in which it is a high school with a training attachment, and that therefore, aside from the strictly professional work, a more pedagogical treatment of the academic branches is needful. To this end I propose the following: (a) that the teacher in charge of any given branch should give instruction in that subject throughout its entire scope as an organic whole, and not merely

in its high-school phases; (b) that he should consider his subject in its rise and development as a factor in education; (c) that he should present an historical view of his subject in regard to methods as the best safeguard against a mechanical and slavish copying of educational devices; (d) that he should consider the educational function and value of his subject; (e) that he should treat his subject in its co-ordinate relation to the other subjects of the curriculum.

8. That, finally, since a large part of normal-school work is to fit teachers for the district and country school, it is advisable to have a type of this kind of school in the training department.

CHAS. DEGARMO.

THE CONTENTS OF CHILDREN'S MINDS.

IT will be remembered that several sets of interesting investigations have been carried on in Germany and France with a view to determine what the actual content and capacity of the child's mind are. In 1882 Prof. G. Stanley Hall tried experiments with Boston school-children, similar to those made abroad, and published his results in the *Princeton Review*. The December issue of the London *Journal of Education* contains the record of a similar investigation undertaken by an English teacher. The following abridged report of it is not only of interest in itself, but especially for the purpose of comparison with the results of the attempts elsewhere made for the same purpose. The answers were given by six children. Unfortunately, the results obtained under the heads of 'Observation' and 'Information'—the most valuable of all—are very briefly given in the original. The following are some of them:—

What is bread made of? What is the use of sleep? How would you get a garden full of flowers? What is the color of railway-signals? How do chickens come into the world? In respect to all these questions, the children failed to differentiate to any great extent. To the question 'How many legs has a spider?' A answered, "Six;" and E, "I almost think six. I killed all the spiders in aunt's garden yesterday."—"Why?"—"Oh, just for sport." To the question 'Mark the length of a foot on this bit of paper,' A marked 1 foot 3 inches; B had never heard of a foot; C, 8 inches, remarking, "Some people's feet are as long as this, aren't they?" D drew a correct foot, having toes and heel; E marked 2 inches; F, a foot and a half. To the question 'Who rules over England?' A and E answered, "Queen Victoria;" B, "The King, I don't know who the King is;" C and F did not know; and D made a rigmorale statement about railway-lamps, because he could not answer the question, but wished to show that he knew something else.

The questions were put to each child alone, and they had no opportunity for talking about them with their companions. The questions were introduced after a friendly talk with the child, and after shyness had somewhat worn off. The attempts to draw out a child's moral notions almost invariably failed, as the children grew shy. The children are indicated by letters. A, B, and C were girls, aged respectively 8, 7, and 6. A was F's sister, and came from a cultivated home, as did all but C. D, E, and F were boys, aged respectively 7, 7, and 6. A had been running wild for weeks, F for months. D had attended school for a short time. C and F had had home teaching. The children enjoyed the questioning greatly, and it was more difficult to keep them to the point than to extract answers from them.

Below are given a selection of the questions and answers, under the heading of the faculty which they were designed to test:—

Reasoning Power.

1. Why do children have to go to bed so much earlier than grown-up people?

A. Because it is better for them; I don't know why. Is it to make them stronger?

B. Because they are not so old. I don't know anything else.

C. Because they are little. To make them get up early.

D. Because they get so tired. I think it is a good plan.

E. Because they get so tired, and because they are smaller.

F. Because children are younger, and they must get more sleep, and that they don't get so tired as grown-up people.

2. If your porridge is hot, why do you eat the outside edge first? A [had never heard of porridge, so took soup]. Because it would be cooler. I don't know why.

B [pea-soup taken]. Because it is colder; because the edge of the plate goes round it.

C [porridge]. The edge, because it is cooler, because the plate is cold.

D. I should eat the edge first because it is cooler; because it touches the mug, and the mug is cold.

E. Round the edge because it is coolest, because it is against a cold basin.

F [had heard of, but never seen, porridge; soup taken]. Because it is cooler. I don't know why it is cooler.

3. Do crossing-sweepers like fine or wet weather better? Why?

A. Wet, because they have more crossings to sweep, and will get more money.

B. Fine, because it does not rain.

C. Wet weather, because they get more money.

D. Fine, because he can be outter more, and can sweep the roads more. Do they get money for it? I should not do it unless I had money given to me.

E. Fine weather. Well, perhaps they do like wet weather for more sweeping. They like it wet, and then to leave off raining while they sweep.

F. Wet, because they get more money, because people don't want to walk in the mud.

4. What is the good of going to school?

A. To learn your lessons; to learn every thing. ["Will you have learnt every thing when you leave school?"] No. ["Then why don't grown-up people go to school?"] A looked puzzled, then said] Because they know what little people don't, but they don't know every thing.

B. To learn to write and to play.

C. To get you clever. I think every one gets clever who goes to school.

D. Because it teaches you to know things when you grow up. ["What things?"] Oh! about trains and how the lines are made and laid down, and all that—and—Oh! [he looked quite awe-struck] is it not a wonderful thing how an engine is made?

E. To learn things; reading and writing, sums, and the multiplication-table.

F. To learn something. I don't know any thing else.

5. I gave the child several sticks of the same length, and asked it to make a cage for a bear with four sticks, so that it could not get out; then with three sticks, then two.

A. I don't know how. ["Try."] How big is the bear? [Gave a piece of paper to represent bear.] First took five sticks, then right with four, then right with three. ["Now try with two."] Promptly, "I can't, unless the bear can get in here," putting the sticks side by side, and she slipped the bit of paper between, but said at once, "It would slip out at the end."

B. Did all right; tried a little with two sticks, then said emphatically, "No."

C. Four and three right at once; when asked to try two, said roughly, "I'll have to make a cage with one next, I can't do it with two."

D. Four, right; three, first wrong, then right; with two, tried again and again, and needed help to see that it could not be done.

E. Four and three, right; then said, "I don't know how we are going to manage with two." He tried, but at once gave up.

F. Four, right; three, "I can't"; then, very quickly, "Yes, I can"—right. Tried two, but said at once, "No, I can't."

Imagination.

1. What is the moon?

A. A light.

B. A man. I don't know why I think so.

C [laughing]. *We* call it a cheese, but it isn't really. I don't know.

D [reverently]. The moon is God. ["Is that exactly what you mean?"] No; I mean because God made the moon; I don't know what it is at all.

E. I know it is a big thing, and I think to myself it's something like the sun: it shines just as bright.

F. Don't know, never thought.

2. What is thunder?

A. When clouds meet together and make a great noise; when they bang together.

B. Don't know.

C. Thunder makes a noise, that's what it is.

D. Long pause; then, "Is thunder God? Well, God sends thunder, does not he?" Then followed a long outpour on the folly of standing under a tree during a thunder-storm.

E. A rolling thing that makes a great deal of noise, that's what it is.

F. Nasty little beasts. Further inquiry brought out, "It kills nasty little beasts that eat the cabbages."

3. If you went up in a balloon higher and higher, what would you come to at last?

A. The sky. The sky is heaven. [Very shyly] I forget what heaven is.

B. We should come to the sky: the sky is water.

C. I don't know.

D. I don't know; but I know if you go up high enough you can't breathe [here followed remarks too numerous and rapid to be taken down].

E. Clouds and heaven.

F. Come to the sky. I don't know what the sky is.

4. What age do you think it would be nicest to be, and why?

A. I don't know. I don't want to grow older all of a sudden.

B. Twelve [but she was too shy to tell me why].

C. Seven, because it is a year older, because then I should not have to go to school so long.

D. Nine, because I think then I should know a little more.

E. Well, for myself, I should think about thirty, because you would be of age, and could do nearly what you liked. I should go to theatres and cricket, and play football and run races. ["Shall you do any work?"] Oh, yes! ["What should you do?"] Well, if I had my own choice, I should not mind being a coachman, that's what I like—*horses*. ["Do you like dogs too?"] Well, I haven't had much to do with dogs.

F. Twenty, because I could wear trousers then—and what age would *you* like to be?

5. What do dogs think about? Can they talk to each other? How?

A [much amused]. Oh! I don't know; I don't know if they think or not. They talk in their way, I don't know what they say.

B. Don't know. I don't think they do think. No.

C. They don't think at all, do they? They can bark, not talk properly, but they understand each other.

D. Think about nothing but eating. No, except they can bark.

E. *Some* dogs think about biting people, some about eating things, and some dogs think about being kind to people. They talk in a dog language that people can't understand.

F. Biting and fighting. I don't know any thing else. Yes, they bark.

6. If you could go to the bottom of the sea, what should you expect to see?

A. Sand and stones and fish. I don't think there is any thing else.

B. Animals, fishes, sand, and stones; nothing else.

C. You would not see any thing, because it is so dark when you are under the sea.

D. I have never seen the sea. ["Tell me what you think it is like."] It's blue, and the waves come up higher than

this chair. I should see a lot of sand, and a lot of shells, and a lot of fishes, and a lot of crabs. They bite your legs dreadfully, crabs do.

E. Fish and shells, seaweeds, and some boats, perhaps, that had sunk; jelly-fish, I dare say, and I've heard [very mysteriously] that there are mermaids, but I don't think so, do you?

F. Fishes, people which have been drowned.

7. What are fairies? Where do they live?

A. There aren't such things.

B. Don't know. They are fairies; they are just fairies. I don't know where they live.

C. Don't think I ever heard of them.

D. Fairies are spirits: they look rather like an angel. Yes, rather. We can't see angels; there might be an angel in this room, and you and I could not see it. Angels are so light, any one could lift an angel. When Jesus was on earth there were angels. Do you know what wonderful things Jesus could do? [A fluent story of the paralytic man followed.] That was years ago, they don't do such things nowadays. Fairies live under trees; acorns are their tea-cups.

E. I know there are those, because there was one screamed out to mother. Very little things, I expect, not much larger than this [he measured about an inch and a quarter]. They live in the woods and under toad-stools. I expect they come into our houses at night.

F. There are none.

Sense of Beauty.

1. What flower do you think the prettiest, and why?

A. Oh! they are all so pretty; I don't know. ["Suppose I promised to give you a nosegay of several pretty flowers, which would you choose?"] Forget-me-nots and violets and daisies and may-blossoms; I don't know what else.

B. Gardinias, because they smell so nice.

C. A rose, because it is a very pretty flower; there is nothing else like a rose.

D. A sunflower, I think, don't you? ["I think I like some others better."] Oh! but just you remember how long they last, and those tiny flowers don't last very long. I say [very confidentially], do you like bread-and-butter pudding? ["Not much."] I'll tell you what I like, and I am sure you will too, and that's suet-pudding smoking hot with raisins in it [a long outpour on puddings followed].

E. A rose. It has a lot of sort of little things inside, petals, red and yellow, cream-colored and white.

F. A white rose. I like them because I think them prettier than any other flower. I don't know what it is like. I can't tell you.

2. What is the most beautiful thing you ever saw?

A. Don't know [thought hard, still didn't know. "Have you seen any beautiful thing lately?"] Yes, the sea, when it is calm, and sometimes when it's rough.

B. Roses.

C. Stuffed animals and things.

D [thought a long time, then asked] An animal? ["Just as you think, any thing."] Well, then, I think an air-ball; how difficult they must be to make! [Too rapid a description followed to be taken down.]

E. I like the mountains very much. ["Have you ever seen any?"] Oh! I've been to Italy and France and Paris. I was very little, but I remember the mountains.

F. I don't know. [He thought hard, and then said, almost as if watching them] Fireworks, sky-rockets, lovely!

BOOK-REVIEWS.

Grundzüge der physiologischen Psychologie. Von WILHELM WUNDT. 2 vols. 3d ed. Leipzig, Engelmann. 8°.

PROFESSOR WUNDT of the University of Leipzig has indelibly associated his name with the development of the scientific study of

mind that plays so prominent a rôle in the science of this century. Beginning his career as a physiologist, he soon saw in the pursuit of his specialty the opportunity of bridging over the gap between body and mind, or, better, of restoring to its original unity the study of the two as different aspects of one phenomenon. The field of physiological psychology had been simply touched upon here and there. It lacked systematic treatment as well as recognition as a distinct science. Both of these he attempted to supply; and the attempt, considering the inherent difficulty of the subject, has been eminently successful. He published the first systematic text-book in this field in 1874, a second and much enlarged edition appeared in 1880, and the third has just appeared. In these thirteen years the growth of the science has been rapid, and the fact that the validity of this increase is in great part not yet tested makes it necessary to record much that our successors will be able to omit. But independently of this technical aspect of the study, science owes a debt to this movement similar to that it owes to Darwin. The one introduced the same rejuvenating ferment into the discussion of philosophical problems as has the other into that of biological problems. It has given meaning to facts formerly isolated and uninterpreted, has erected a sign-post directing the way for the future, and has prevented much useless and irrelevant speculation. It is to be hoped that the objects and methods of this science are to-day too well known to need more than a mention in this connection.

The question of most natural interest in the notice of this text-book is the extent and nature of the changes that have been made in passing from the second to the third edition. While the author has made alterations in all parts of the work, the topics that have been most altered are the following, and they indicate very well the fields in which recent research has been active. The anatomy and physiology of the central nervous system, and particularly of the parts connected with the highest psychic activities, have been much revised. Next, the experimental study of sensation, both qualitatively and quantitatively, has received valuable additions from many hands. The chapter on auditory perceptions has been rewritten, and that describing the measurement of the times of psychic processes has been made to include the most recent studies, especially those made in Professor Wundt's own laboratory. Whether these changes justify the publication of a new edition is a question upon which opinions will differ. A great deal of what has been added has been already published in the *Philosophische Studien*, edited by Professor Wundt; and, as most of this material is only of technical interest, its incorporation into a text-book is hardly an advisable step. Again, the advance in the knowledge of facts has brought with it an advance in the presentation of theoretical views, and Professor Wundt has hardly undertaken the radical kind of revision that the appreciation of these would justify: in other words, if a text-book in physics were written upon the plan of this work, it would amount to a cyclopædia, and the reader of that cyclopædia would be at a loss to distinguish the important and clearly established from the unessential and provisional. The book has grown thicker where it should have grown deeper. Finally, at the risk of singling out a trivial matter, an American reader is very much struck with the absence of all mention of the studies that have been contributed to this science on this side of the Atlantic within the last few years. These studies to a large extent fall in those chapters that have been most fully revised; and this, together with the fact that they have been noticed in Professor Ladd's 'Psychology,' makes the cause of this omission all the more strange.

Spezial Karte von Afrika. Gotha, Justus Perthes: 9.

THE second edition of this valuable work on African geography is now complete. It consists of ten sheets, and contains all the new discoveries made during the last years. The coloring of the new edition is more delicate than that of the first edition, and the political boundaries have been indicated in colors that do not obscure the physical features of the country. The map is carefully compiled from all the available material, and is indispensable to the student of African geography. Although it is only a year since the first edition was completed, the additions to our knowledge of some parts of Africa are so considerable that the sheets had to be practi-

cally redrawn. On the sheet Kongo we find the results of Capello and Ivens's journey, Reichard's journeys west of the Tanganyika, and the numerous explorations on the tributaries of the Kongo. The contour line of 1,000 metres, which was indicated by a heavy buff line in the first edition, has been corrected according to recent observations, and is shown by a broken red line. Another technical improvement of the new edition is the use of a dark green color for indicating oases. On the sheet Western Sudan we find A. Krause's important journey through Mosi indicated, although the details are not yet known. The leading principles in constructing the map are thoroughly scientific. The lettering and the outlines show plainly the parts that are known by exploration, and those which are only known by reports of natives. The scale is 1:4,000,000 (about 60 miles to an inch), large enough to show all important features of the geography of Africa.

The Driftless Area of the Upper Mississippi. By T. C. CHAMBERLIN and R. D. SALISBURY. (A monograph accompanying the Sixth Annual Report of the Director of the United States Geological Survey.) Washington, Government. 4°

IN no direction is the Geological Survey advancing the science more rapidly than in the department of glaciology. The monograph on the great terminal moraine has done more than any other single research to make the continental ice-cap a reality, and to silence the iceberg theory of the drift; and the present contribution is scarcely less valuable or wide-reaching in its conclusions.

In the midst of the great mantle of drift that overspreads the Upper Mississippi basin, there lies a drift-barren tract of about ten thousand square miles,—the driftless area of Wisconsin and adjoining States. This island in the sea of drift is unique; and, strangely enough, the margin of the drift on almost every hand lies on a slope descending toward the driftless area. Probably no other district on the globe is so favorably situated to serve as a standard of comparison and contrast between glaciated and unglaciated areas, and a means of estimating the results of the drift agencies. All of the formations of that region, with their attendant topographies, sweep curvingly across the driftless area from an ice-ridden region on the one hand, to a like ice-ridden region on the other, displaying in a most striking manner the contrasts that arose from the single factor of glaciation. The driftless region is especially instructive concerning glacial extension and restriction, and it throws important light upon the movements of the ice-sheet over a very large adjacent territory. The great drift-burdened ice-stream, as it moved south-westward from the Canadian heights, was divided and diverted; and the separated currents swept around the area, and mingled their burdens below it.

The facts bearing upon these and many minor aspects of the driftless area are marshalled and discussed in a masterly manner, the more important features being also clearly exhibited in a series of well-executed maps and cuts. Among the subordinate contrasts which this region presents, none are more noticeable than the absence of falls in the driftless area, and their comparative abundance beyond its limits,—falls indicating a youthful, and usually a post-glacial, topography. And certainly there could be no more convincing evidence that the region has never been invaded by glaciers than is to be found in the fragile pinnacles of rock which abound over a large part of its surface.

The residuary earths of the driftless area are compared physically, microscopically, and chemically with the glacial clay or till. Nearly one million measurements of the ultimate particles show that the residuary earths are much finer grained and more homogeneous than the drift clay; and they are also remarkably free from calcareous matter, which forms a large proportion of all the true drift of that region.

In its remarkably sinuous course across the continent, the great terminal moraine impinges upon the eastern side of the driftless area, and affords specially fine contrasts between the characteristics of driftless and drift-bearing regions; while upon the west it is bordered by the loess; and the much-disputed question as to the origin of this interesting formation is settled provisionally in favor of its being essentially an aqueous or lacustrine deposit of glacial clays.

In the concluding chapter, on the history and genesis of the drift-

less area, it is shown more clearly that the marginal phenomena confirm Professor Chamberlin's previously published classification of the quaternary epochs. He recognizes (1) an earlier glacial epoch, in which two successive ice-sheets were separated by an interglacial period sufficiently marked to permit the growth of vegetation over the surface; (2) a prolonged interglacial epoch, during which the land was elevated to the extent of eight hundred to one thousand feet, and again forest-clad; (3) a later glacial epoch, during which the great terminal moraine was formed, while subordinate moraines and vegetal deposits testify to repeated recessions and advances of the ice; (4) the Champlain epoch, during which marine and lacustrine deposits were formed; (5) the terrace epoch, when the streams carved the flood-plains of the Champlain epoch into terraces.

The origin of the driftless area is found in the fact that the elevated land lying north-east of it must have acted as a wedge to divide the ice, while the diverging troughs of Lake Superior and Lake Michigan tended to prevent the streams from re-uniting immediately south of the obstruction. Climatic influences also probably played an important part in staying the progress of the ice which was advancing directly toward the driftless area. In the language of the authors, diverted by highlands, led away by valleys, consumed by wastage where weak, self-perpetuated where strong, the fingers of the *mer de glace* closed around the ancient Jardin of the Upper Mississippi valley, but failed to close upon it.

A History of Elizabethan Literature. By GEORGE SAINTSBURY. New York, Macmillan. 12°. \$1.75.

This book forms the second part of a general history of English literature from the earliest period to the present day. The whole work will be completed in four volumes, by four different writers, each specially qualified for his individual task. Mr. Saintsbury has been for many years an enthusiastic student of the period of which he treats, and he here gives the main results of his studies in a clear and well-ordered form. He wisely confines himself in the main to the purely literary aspects of his subject, with much less attention to biography and bibliography than some writers would give. He allows considerable space to the minor writers, a knowledge of whom he thinks essential to a correct understanding of the period. His enthusiasm for his subject is almost unbounded, and some readers will think it excessive. He styles the Elizabethan era "the greatest period in the greatest literature of the world," and seems too little aware of its defects. His admiration for Shakespeare is carried to the verge of idolatry, and he does not appear to see any faults at all in him.

Spenser he esteems almost as highly, and thinks the 'Faerie Queen' the greatest poem in the English language. With regard to the forms of poetry, he maintains that "every English metre since Chaucer at least can be scanned, within the proper limits, according to the strictest rules of classical prosody,"—an opinion with which very few persons will agree. The greater part of the book is of course devoted to the writers of verse, yet the prose writers are treated with sufficient fulness. Bacon, in Mr. Saintsbury's opinion, was more of a rhetorician than a philosopher, and might better have gone into the Church than into politics. Hobbes is spoken of as the first prose writer whose style is clear and uninvolved; while the general style of the period is well characterized in the remark, that at that time "the sense of proportion and order in prose composition was not born." Mr. Saintsbury's work, notwithstanding some defects, will be valuable both to the student and to the general reader; and, if the other volumes of the series are equally well done, the whole work will be the standard history of English literature.

Hegel's Philosophy of the State and of History. By GEORGE S. MORRIS. Chicago, Griggs & Co. 16°.

This book is the sixth in the series of philosophical classics now in course of publication under the editorial supervision of Professor Morris. It gives in a brief, by no means superficial form the theories of Hegel on the constitution of the state and of civil society, and also on the philosophy of history. Hegel's terminology is so strange to the English reader, and his processes of thought often so obscure, that it is not an easy task to make his meaning plain and comprehensible, but Professor Morris has succeeded in doing this as well

as could be expected. The theory of the state which the German philosopher has given is not in all respects such as the people of a free country are likely to accept. He repudiates the intention of describing an ideal state, such as Plato and others have dreamed of, and he has little respect, apparently, for such attempts on the part of others; yet it is not difficult to see that a constitutional monarchy is in his eyes, if not an ideal state, at least the most perfect type that has yet been devised. He divides the powers of government into three classes,—the legislative power, the executive power, and the power of ultimate decision, which properly resides in the monarch alone. He is strongly in favor of a representative assembly to take part in legislation, but he regards with great distrust the influence of public opinion, which is the inevitable consequence of representation. On the subject of war, Hegel is not in accord with the peacemakers, his view being that "war is to nations what wind is to the sea,—it preserves them from stagnation and putrescence."

On the subject of history the views of Hegel are in some respects a little behind the age, owing partly to the new theories of development which now prevail, and partly to the discovery and interpretation since his time of the ancient records of Egypt and Assyria. Still his theories are well worth pondering. He holds that history as a whole is "the development of the conception of freedom,"—a remark that seems to apply rather too exclusively to mere political history. He passes in review the history of the leading nations, briefly characterizing the civilization of each, and showing the connection of them all with the life of modern Europe. In the course of this exposition he has many interesting observations on special points which we should be glad to quote if space permitted, but we must content ourselves with recommending our readers to look them out for themselves.

NOTES AND NEWS.

In compliance with what seems to be a wide-spread desire on the part of the geologists of America, a few have united in an effort to establish an American journal devoted to geology and its allied sciences. The subscription price is three dollars per year, and the place of issue for the present is Minneapolis, Minn., where correspondence should be addressed to *The American Geologist*. From all geologists the editors solicit original contributions and items of scientific news. The editors and publishers, for the year beginning Jan. 1, 1888, are as follows: Prof. S. Calvin, Iowa City, Io.; Prof. E. W. Clappole, Akron, O.; Dr. Persifer Frazer, Philadelphia, Penn.; Prof. L. E. Hicks, Lincoln, Neb.; Mr. E. O. Ulrich, Newport, Ky.; Dr. A. Winchell, Ann Arbor, Mich.; Prof. N. H. Winchell, Minneapolis, Minn.

—A company has been incorporated for building a railroad from Winnipeg to Fort Simpson, British Columbia, crossing the Rocky Mountains by way of the Peace River Pass. This is one of the routes surveyed by the Canadian Pacific Railroad. It was recommended, as the distance from Fort Simpson to eastern Asia is still shorter than that from Vancouver. Part of the country through which this road would pass is suitable for agricultural purposes. The charter compels the incorporation to build at least fifty miles each year, the whole distance being a little more than sixteen hundred miles.

—The second number of the bibliographies of Indian languages by James C. Pilling has just been issued by the Bureau of Ethnology. It treats of the Siouan stock. The plan of this bibliography is the same as the one followed in the 'Bibliography of the Eskimo Language,' which was referred to in No. 235 of *Science*. The dictionary plan has been followed to its extreme limit, the subject and tribal indexes, references to libraries, etc., being included in one alphabetic series. The arrangement is excellent, and makes the bibliography very handy for use.

—The Pennsylvania State College Agricultural Experiment Station was established by vote of the trustees June 30, 1887, in accordance with the provisions of the Hatch act, and will continue and greatly enlarge the experimental work of past years. It investigates such subjects as are of immediate importance to the farmer of the State, and publishes the results in reports and bulletins, which are distrib-

uted free of charge to all citizens of the State who apply for them. Specimens of agricultural products, when of public interest, are examined and reported upon free of charge. The board of directors is as follows: H. P. Armsby, Ph.D., director; William Frear, Ph.D., vice-director and chemist; William A. Buckhout, M.S., botanist; George C. Butz, B.S., horticulturist; William C. Patterson, superintendent of farm. Correspondence is invited, and inquiries upon agricultural matters will be answered as far as possible. Address Agricultural Experiment Station, State College, Centre County, Penn.

— We learn from *Nature* that in a Russian paper of Oct. 22 last, appears a preliminary report of the examination by Latschinof and Jeroefief, professors of mineralogy and chemistry respectively, of a meteoric stone weighing four pounds, which fell in the district of Krasnoslobodsk, Government of Pensa, Russia, on Sept. 4, 1886. In the insoluble residue, small corpuscles showing traces of polarization were observed. They are harder than corundum, and have the density and other characters of the diamond. The corpuscles are said to amount to one per cent. of the meteoric stone. Carbon, in its amorphous graphitic form, has been long known as a constituent of meteoric irons and stones. Lately, small but well-defined crystals of graphitic carbon, having forms often presented by the diamond, were described as having been found in a meteoric iron from western Australia. If this supplementary discovery be confirmed, we may at last be placed on the track of the artificial production of the precious stone.

— The loss of electricity by a conductor in moist air, says *Nature*, has been lately studied by Signor Guglielmo (Turin Academy). He finds that with potentials less than 600 volts, moist air insulates as well as dry air, but with higher potentials there is more loss in moist air, and more the moister the air and the higher the potential. The potential at which the difference becomes perceptible is the same for a ball as for a fine point. It occurs with extremely smooth surfaces, and so cannot be attributed to discharges in consequence of roughness of surface. With equal potential, the loss of electricity has the same magnitude, whatever the dimensions of the balls used as conductors. In air saturated with vapors of insulating substances, the loss of electricity of a conductor is nearly the same as in dry air.

— According to *Nature*, frozen fish are now imported into France, and a society formed in Marseilles for the purpose of developing the trade (the Société du Trifent) has a steamer and a sailing-vessel engaged in it. The steamer 'Rokelle' lately came into Marseilles with some 30,000 kilograms of frozen fish in its hold, the temperature of which is kept at 17° C. below zero by means of a Pictet machine (evaporating sulphurous acid). The fish are caught with the net in various parts of the Mediterranean and Atlantic. After arrival they are despatched by night in a cold chamber. Experiment has shown that fish can be kept seven or eight months at low temperature without the least alteration. These fish are wrapped in straw or marine algæ, and have been sent on to Paris, and even to Switzerland.

— We learn from *Nature* that the fourth session of the International Geological Congress will be held next year in London. The congress was founded at a meeting of the American Association for the Advancement of Science, at Buffalo, in 1876, the first session being held at Paris in 1878, the second at Bologna in 1881, the third at Berlin in 1883. The following is a list of the organizing committee appointed to carry out the arrangements: H. Bauerman; W. T. Blanford, F.R.S.; Rev. Prof. T. G. Bonney, F.R.S.; Prof. W. Boyd Dawkins, F.R.S.; John Evans, F.R.S.; Prof. W. H. Flower, F.R.S.; Arch. Geikie, F.R.S.; Prof. James Geikie, F.R.S.; Sir Douglas Galton, F.R.S.; Prof. A. H. Green, F.R.S.; Rev. Prof. S. Haughton, F.R.S.; Prof. T. H. Huxley, F.R.S.; W. H. Hudleston, F.R.S.; Prof. T. McK. Hughes; J. W. Hulke, F.R.S.; Prof. E. Hull, F.R.S.; Prof. J. W. Judd, F.R.S.; Prof. J. Prestwich, F.R.S.; F. W. Rudler; H. C. Sorby, F.R.S.; Sir W. W. Smyth, F.R.S.; W. Topley; Rev. Prof. Wiltshire; Henry Woodward, F.R.S. The duty of this committee will be to nominate the officers, to appoint executive committees, and to fix the exact date of meeting. The congress at Berlin requested that the meeting should be held in London between Aug. 15 and Sept. 15.

— The theory is advanced by Professor Mendeleef that petroleum is of mineral origin, and that its production is going on, and may continue almost indefinitely. *Engineering* states that he has succeeded in making it artificially by a process similar to that which he believes is going on in the earth, and experts find it impossible to distinguish between the natural and the manufactured article. His hypothesis is that water finds its way below the crust of the earth, and then meets with carbides of metals, particularly of iron, in a glowing state. The water is decomposed into its constituent gases; the oxygen unites with the iron, while the hydrogen takes up the carbon, and ascends to a higher region, where part of it is condensed into mineral oil, and part remains as natural gas, to escape where it can find an outlet, or to remain stored at great pressure until a bore-hole is put down to provide it a passage to the surface. Oil-bearing strata occur in the vicinity of mountain ranges, and it is supposed that the upheaval of the hills has dislocated the strata below sufficiently to give the water access to depths from which it is ordinarily shut out. If the centre of the earth contains large amounts of metallic carbides, we have in prospect a store of fuel against the days when our coal will be exhausted.

— In 'Notice to Mariners,' No. 94, published by the United States Coast Survey, some very interesting information is given regarding the Gulf Stream. Between Rebecca Shoal and Cuba the current was found to vary in velocity, the maximum velocity arriving about nine hours and twenty minutes before the transit of the moon, and between Cuba and Yucatan the greatest velocity was found at ten hours before the moon's transit. The greatest velocity of the current was observed fifty-one miles south of Rebecca Shoal, at which point the stream moved 3.73 knots per hour. Between Yucatan and Cuba the stream's greatest velocity was 6.32 knots, about thirty miles from Yucatan toward Cape San Antonio.

— The United States Coast Survey Steamer 'Blake,' Lieut. J. E. Pillsbury commanding, will continue the investigation of the Gulf Stream currents during the coming winter and spring months at the places mentioned below; and shipmasters, when in the vicinity, are requested to look out for and keep clear of her. During January and the first part of February the 'Blake' will be anchored about six hundred miles north-east of Barbadoes Islands, and in the track of vessels bound to the United States from the South Atlantic or off the South American coast to the eastward of Trinidad Island; the last part of February and until May, between the West India Islands, commencing at Trinidad, and ending at the old Bahama channel. When at anchor, she will hoist three balls from the fore-topmast stay, and at night-time she will show from the same point three lights, — red, white, and red.

LETTERS TO THE EDITOR.

* * * Correspondents are requested to be as brief as possible. The writer's name is in all cases required as proof of good faith. Twenty copies of the number containing his communication will be furnished free to any correspondent on request.

The editor will be glad to publish any queries consonant with the character of the journal.

Conspiracy of Silence.

I THINK your correspondent (Dec. 16, p. 298) is unjust to Professor Bonney, placing a meaning on his words which they will indeed bear, but which was not Professor Bonney's meaning. I am not a Darwinist, and have never accepted the Darwinian hypothesis so called; and I can therefore dispassionately defend Professor Bonney. But I should like to volunteer a rather unnecessary defence of men of science as a class, whether Darwinists or anti-Darwinists, whom your correspondent attacks indiscriminately. 'Conspiracy' is an ugly word; and it is, as both Professor Huxley and Professor Bonney assert with good reason, not only an ugly word, but an improbable thing; and not only improbable, but (as the scientific world is now constituted) impossible in a large way. A conspiracy within the limits of one scientific institution, to suppress a paper, may be planned and executed with some success by one or more of its officers and one or more of its members opposed to the writer of that paper. Thus far, but no farther, can a scientific conspiracy go. The thing has been often done, and will be often done; but it is a foolish thing to do, perfectly futile, injurious to the society in which it happens, and in the end injurious to the conspirators. But the writer of a paper, if it be a good one, can find many other ways of publishing it, without encountering a con-

spiry. If it be a poor paper, it will probably be suppressed several times before it gets published; and no one is to blame for that but its author. But a general conspiracy among men of science to suppress views because they are new, and unacceptable to old fogies, is impossible; and your correspondent and the Duke of Argyll must certainly know that fact; and it will remain a fact, in spite of any number of instances of special local repression that can be cited. When such repression happens, the fault lies with the man of new views, who will not or can not speak out boldly; who will not or can not make his conclusions irresistibly; who is too shy, or too limited in his personal associations, or too obscure in his language, to compel general attention to what he believes.

Younger men of science with new ideas seem to think that older men in science have no business of their own to attend to, but must drop all their personal investigations to discuss and investigate, prove or disprove, each new theory as soon as it is promulgated. The fact is, every new presentation in any department of science is read with interest and attention by scores, hundreds, and in some rare cases by thousands, of experts working in that particular department. But, if it be an important new theory, it requires, on that account, to be carefully studied; which, of course, takes time, — months, sometimes years. The delay will always be in proportion, first to the importance, and second to the difficulty, of the subject-matter of the theory. The few whom it most interests are separately making up their minds about it, and consulting each other. The wisest and strongest minds take the longest time, resisting all pressure to force them to a premature conclusion. But there is a personal equation. Men of science differ greatly in their reticence and in their cautiousness. What is denounced by the author of the novelty, and by his friend or friends, as a conspiracy of silence, and a scandal to science, is in fact the involuntary cautiousness of men who know much and have been often mistaken; and it is the glory of science that it keeps its head level, as it keeps its eyes open and its heart warm. Let your correspondent reflect that there are two natural classes of men of science, — the daring and useful, and the cautious and useful. Both classes are equally useful and equally honorable; and the charge of a conspiracy of silence can no more justly be brought against the one class than the charge of a conspiracy of notoriety against the other.

Whenever "Mr. Bonney says that the scientific method is to wait, and not to investigate," I shall go to London to ask him what he can mean by such language; but if I have to wait until he actually says so foolish a word, I shall never again see London. In fact, Mr. Bonney never has said any thing of the sort, in the sense assigned to his words by your correspondent; meaning by 'scientific method' the mode of pursuing truth proper for all the pursuers of truth. What he meant in his rebuke of the Duke of Argyll is evident: he meant that any one man of science not engaged in a given special line of research can not and dares not make up his own mind as to the validity of one of two opposing theories until those others who have that special line of research in hand have practically reached some consent on the subject.

Your correspondent's quotation from Professor Bonney (on p. 299, footnote) does him another injustice. Mr. Bonney writes, "Very well, but there are some people, not very few in number, who do not share the opinion." Your correspondent exclaims, "Hail to the new science! The voice of many people is the voice of God." But the people of Mr. Bonney are not the people of Mr. Buel. Professor Bonney has said plainly enough that by 'people' he means such men as Darwin and Dana, the greatest investigators of these special coral phenomena. If Mr. Murray's 'people' are numerous, Mr. Darwin's and Mr. Dana's 'people' are also numerous. Most of the 'people' on both sides are of no value as reasoners on coral formation; but a few — a very few on both sides — have some right to an opinion. But Mr. Huxley and Mr. Bonney do not claim to be of these few — on either side. Of course they wait.

It is a curious fact, and rather pathetic withal, that a man of science seldom or never opens his mouth but he puts his foot in it. At all events, there is always some half-man of science standing by ready to say so, and run for a doctor. But curious and even pathetic as the fact may be, it has its good and its bad consequences: it makes thoroughbred experts more cautious, both in framing their own opinions respecting the researches of others,

and in expressing such opinions publicly; and it makes experts of the second, third, and fourth order of breeding correspondingly reckless in both thinking and speaking.

J. P. LESLEY.
Philadelphia, Dec. 19.

A Wind-Register for Direction and Velocity.

FOR some years it has been considered very important that not only the total amount of wind should be recorded on self-registers, but that some simple means should be brought into use by which the recording sheet should give directly the number of miles or kilometres per hour of wind blowing from the various points of compass.

The plan usually adopted is to mark off on the velocity record the spaces of time during which the wind was blowing from the various quarters as indicated by the record sheet for the directions, or the direction is stamped on the velocity sheet at regular intervals of time (say, every ten minutes) by the automatic closing of an electric circuit by means of a clock.

A method of registering the wind's velocity so as to give a minimum amount of labor in reading the recording sheet has suggested itself to me, and I have given below a short account of the principles of construction. I do not remember having seen mention of

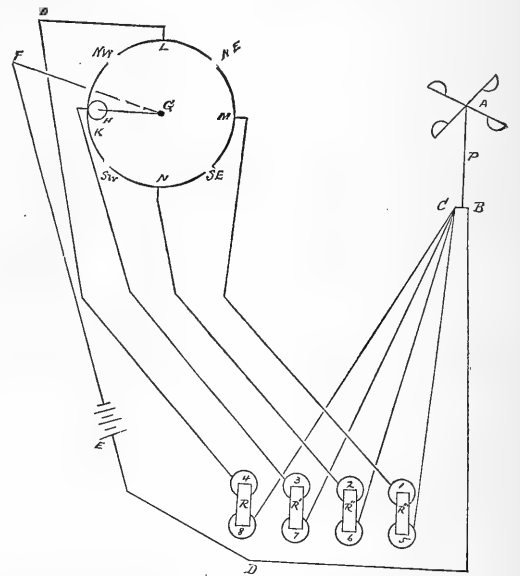

such an apparatus before, but it is so simple that it is probably not wholly new; and a similar form of instrument may even be in actual use, but, if so, I cannot recall any such, and I am somewhat familiar with the instruments of the various meteorological observatories.

In the accompanying figure, *A* represents the Robinson anemometer; *P*, the supporting frame; and *C* and *B*, the posts to which the conducting wires are attached in the ordinary form of electrical self-registering anemometer, in which *C* and *B* have metallic connection through *P* at the completion of each mile or kilometre of wind as shown by the anemometer dial: at other times the connection between *C* and *B* is broken. By means of a wire, *B* is connected with one pole of the battery *E*. Wires also pass from *C* to binding-screws on 5, 6, 7, 8, electro-magnets of the recording apparatus.

The left-hand part of the diagram is shown in horizontal plan. *G* is the lower end of a rod passing from the roof to the room beneath. This rod being in rigid connection with the wind-vane, it will revolve with the latter. Near the lower end of the rod, at *G*, an arm is placed at right angles to the rod, and terminates in the small friction-wheel *H*.

This wheel H runs along a metallic rim encircling G ; the rim not being continuous, but having small breaks at the points touched by the wheel H when the vane points NE, SE, SW, NW . These breaks are so short that when H , in its revolution around G , leaves one segment of the rim, it almost instantly rests against the next.

The segment Z is connected with the binding-screw of 4, by the wire passing through O . Similarly K is connected with 3, N is connected with 2, and M is connected with 1.

The wire GF is in metallic connection with GH , and is also connected with the free pole of the battery E .

We will now suppose that the anemometer and vane are exposed to the wind, and the wind is from the west. We shall then have the arrangement shown in the diagram.

The metallic connection $C73KHGFEDB$ will be complete; and whenever the anemometer closes the circuit BC , the armature R' will be attracted by the double coil magnet 37. So, for any winds between SW and NW , the armature R' will indicate each mile or kilometre of wind. Similarly the armatures R, R'', R''' will indicate northerly, southerly, or easterly winds.

By attaching recording pencils to the armatures R, R', R'', R''' and allowing a chronograph sheet to pass beneath them, we can register in separate columns the amount of wind from the four points. By doubling the number of segments, electro-magnets, and recording pencils, the velocities can be recorded for eight points of compass.

The recording pencils can be made to register their marks in lines running side by side and parallel, and within narrow limits, by bending the pencil-holders attached to the armatures in such a manner as to bring the pencil-points close together, and into an alignment transverse to the motion of the recording sheet.

In reading the record sheet, the sums of the registrations in the separate columns will give directly the amount of wind blowing from the different quarters.

So far as the apparatus for wind, direction, and velocity is concerned, the method that I have here described is applicable to most of the electrical registering anemoscopes and anemometers now in use, with very little change; but the registering apparatus (chronographs, pencils, electro-magnets, etc.) will require more alteration, especially for the American form of cylinder chronograph. The European chronographs, with the long narrow paper strips for recording sheets, will answer the purpose very well, and they are usually of much better construction than the cheaper American chronographs.

In actual practice a single wire connecting $C5678$ would be used in place of the four wires shown in the diagram ($C5, C6, C7, C8$).

It might perhaps also be found best to make a continuous record of the wind direction by means of a cylinder encircling the rod G with a sliding pencil, the motion of this last being regulated by the chronograph clock-work.

FRANK WALDO.

Cincinnati, O., Dec. 12.

American Microscopes.

THE complaint which Dr. Minot makes in a recent number of *Science* (x. No. 252) about the tendency of American microscope-makers to furnish instruments which are much more decorative than useful, and which are seriously lacking in the optical excellence which the genuine scientific worker requires, expresses, I think, the feeling of every one who is frequently called upon to purchase microscopes, or advise about their construction.

It seems to me, however, a matter for regret that Dr. Minot, through inadvertence, I feel sure, should have made so sweeping and indiscriminate a condemnation of all American microscopes. I think that he must have been unaware of the excellent instruments which have been furnished of late from the workshop of J. Grunow in New York.

The useless and positively objectionable features which Dr. Minot so justly attributes to the American microscope in general, are absent from these new forms of stand, while the requirements which he so admirably summarizes are just those which Mr. Grunow has succeeded in covering.

A firm base; low, large solid stage, with simple clips for the slide; excellent brass-work; with or without knee, nose-piece, and rack and pinion, coarse adjustment, Abbé condenser, as the purchaser may desire; and optical qualities in the lenses which bring them strictly within the category of first-class,—these are the qualities which the new Grunow instruments present. Forty of these microscopes have recently been added to the supply of the laboratory of the Alumni Association of the College of Physicians and Surgeons, New York, after a full personal examination of instruments supplied by the more prominent continental makers.

I feel greatly indebted to Dr. Minot for clearly indicating, as only an accomplished microscopist like himself could, the direction in which American microscope-makers should work, and I am certain that he will learn with pleasure that by one American maker at least, his requirements are being scrupulously met.

T. MITCHELL PRUDDEN.

New York, Dec. 12.

THE issue of *Science* of Dec. 2 contained an article which is so sweeping in its denunciation "of any microscopes whatsoever of American manufacture," and its commendation of the German or French instruments, and places the motives of American manufacturers in such questionable light, that as one of them, and especially in consideration of circumstances hereinafter mentioned, I consider it proper to say something in answer.

The objections in the article can be enumerated as follows:—

1. "The fundamental error in microscopes of American manufacture is that they are for the most part constructed with a view of, I might almost say, entrapping inexperienced purchasers. The zeal of the maker is turned too much to decorative lacquering and nickel-plating; he adds to his stands as great a variety of mechanical contrivances and adjustments as the price of the stand will permit, and many of these contrivances are not really commendable for their utility."

The supply of a product is created and controlled by the demand for it. As the microscope is an instrument for scientific research, it is used by a class of people of more than ordinary intelligence; and, as most of the instruments purchased pass through the hands of persons of wide experience, they are fully capable of determining what is best suited to their wants, and will certainly not permit the maker to prescribe what they should take. The American instruments as constructed to-day are almost generally a combination of improvements, such as have suggested themselves to the practical mind of the advanced American worker, and which have been adopted and carried out by the maker; and this co-operation between worker and maker has long been a matter of congratulation. That the majority of American innovations are real improvements is shown by the fact that the need of them is felt abroad, and that many of them are being gradually embodied into foreign instruments. That the American maker "adds to his stands as great a variety of mechanical contrivances and adjustments as the price will permit," is certainly not to his discredit, neither is the fact that he endeavors to make the outward appearance of his instruments conform to that of its general workmanship.

2. "In the majority of cases the stands are made to tilt, which, for one that uses the microscope for real work, is almost useless luxury."

Whether an instrument shall be used in an upright or inclined position depends upon the requirements of the worker. It is true that "in the majority of cases the stands are made to tilt;" but as this feature adds, not a considerable, but, on the contrary, a very trifling expense, there is no reason why it should not be used continually in an upright position if so desired; and it gives the additional advantage that it may be inclined, and there is no doubt that much real work is accomplished when it is in this position. However, instruments without the joint are catalogued by some makers, and may be had by those who desire them; but the fact that the maximum ratio of instruments without joint, as against those with them, is as 1 to 100, is sufficient evidence of the desirability and inexpensiveness of the hinge.

3. "This same fact . . . renders it indispensable that the microscope should not be too high, . . . so that we must put down the ten-inch tube as a bad feature for a student's microscope."

To the best of my knowledge, *all* American makers provide draw-tubes to their smaller instruments, by means of which they may be contracted to as great an extent as any of the foreign ones, and in my opinion the ten-inch tube is most decidedly not an undesirable feature. For a long time many of the best microscopists of this country, as well as of Europe, have complained of the want of unanimity among manufacturers in the construction of those parts which are absolutely necessary in the microscope. Thus the size of screw in objectives is probably definitely settled in favor of the English standard, as this is almost universally accepted; and when not, it is by a few German and French makers. The length of tube has for many years been the subject of agitation, and the tendency is slowly but surely in favor of the ten-inch standard, and by far the largest proportion of instruments are now constructed accordingly.

4. "The stage of the American microscope is very faulty."

The stage of the American microscope does not differ materially from the majority of foreign ones. In almost all of the cheaper forms it is "large and flat, with nothing upon it except a pair of spring clips and a hole for a diaphragm." I am quite sure that it is not only the amateur or fancy collector who uses the supplementary glass stage; and as to the mechanical stage, I think that this originated in Europe, and is used even more there than in this country.

5. "Then the Iris diaphragm is often introduced to allure the inexperienced, but it is not a good form except in conjunction with an achromatic condenser."

The apparatus is a European invention: it is widely used, and highly valued by many persons. No doubt many would be pleased to know what optical or mechanical reason exists, which prevents it from being a good form. Besides this, the honesty of the American manufacturer will not permit him to stoop to any subterfuge whatsoever to allure a purchaser; and the application of the Iris diaphragm to an instrument can in no manner be construed to be such, especially as the purchaser may select the diaphragm of his preference.

6. "There are other details of construction which are equally open to unfavorable criticism, but it is unnecessary to go into their discussion." If there are any other points, it seems but proper that they should be stated.

7. "The eye-pieces and objectives are generally, though not always, of a decidedly inferior character: when they are really good, the lenses are very expensive."

This statement is a condemnation of American optical work, which, with a knowledge of the literature on the subject, and acquaintance of work which has been and is to-day produced, simply cannot be made. Many of the important improvements have been inaugurated by American opticians, and their work has been of a high character, — a fact which is willingly conceded by a large number of European microscopists who are fully qualified to judge. That they have not retrograded is evinced by what they are doing at the present day. Taken as a whole, I believe it can be safely claimed that American objectives are of a higher grade, and more uniform, than the European. More than this, the prices, comparing quality for quality, are to-day fully as low as, and have been the means of lowering, the prices of those which have been brought to this country. The quality and prices of objectives, more than any other part of the microscope, are less liable to conjecture and difference of opinion, from the fact that they can be determined by actual comparison.

8. "Many valuable members of the nation are sacrificed by being obliged to pay for the advantage of a small number of men who have never shown themselves willing to supply to those by whose sacrifices they benefit, the kind of instruments wanted. . . . Is it unreasonable to ask manufacturers of microscopes in this country to furnish us instruments of the kind we really need, as some sort of acknowledgment of the money they extract from us whether we will or not?"

This complaint is not borne out by facts. As already stated, there are, among all the manufacturers of microscopes, none more progressive than the Americans. They have ever been ready to accept suggestions and to make improvements when occasion to do so presented itself. They are of sufficient business sagacity to

undertake to make whatever may be called for, when there is a prospect of a reasonable remuneration for the outlay. I hope I may be excused in mentioning my personal experience in this connection.

Some years ago it came to the notice of the firm of which I am a member, that there was at a certain quarter a decided opposition to American instruments, and an influence exerted on students in favor of certain foreign ones.

To find the cause thereof, I made a special trip to Boston, and, visiting a number of gentlemen, learned that the reason of their preference was the pattern of the European instruments. Among the gentlemen consulted was the writer of the article in *Science*. I expressed a willingness to undertake to make an instrument which should meet his views, and, after receiving a general outline of his preference, returned home and began to construct an instrument in accordance therewith.

After the completion of this, I made it the object of a second visit. The instrument was thoroughly inspected and criticised, and a number of minor changes recommended, which, upon my return home, were strictly carried out. The instrument was again sent for examination, April 23, 1884, accompanied by a letter, from which the following extracts are made:—

"As you will see, we have adopted the suggestions as made by you and Prof. —, and believe that they add considerably to the value of the instrument. . . . We send the instrument for examination, and hope you will make it severe; for we are anxious to make just such an instrument, which you consider best suited to students' use, and are convinced that we are able to do it."

Later, in reply to an inquiry about his opinion of the Instrument, we received the following:—

"We have examined the Harvard microscope, and find it to be very excellent in many respects, and the objectives good."

(Signed) CHARLES S. MINOT.

During my visits I was kindly treated, received every reasonable encouragement and the promise of support in the undertaking, and was therefore the more surprised to read such charges.

If European instruments are now happily gaining supremacy, it must be of exceedingly recent date. Many scientists of this country 'happily' manifest great interest and pride in home productions; and as the American manufacturers undoubtedly will endeavor to combine in their instruments efficiency with high standard of workmanship, as they are perfectly willing to make whatever may be required, and as they will ever welcome improvements by whomsoever suggested, there seems no reasonable doubt that the 'supremacy' will be in future, as it is now, on the American side.

EDWARD BAUSCH.

New York, Dec. 13.

DR. C. S. MINOT, the able histologist of Harvard Medical School, has, in a late number of this journal, given expression very freely to his views in regard to the respective merits of microscopes of foreign and domestic make. While the present writer cannot agree in detail with Dr. Minot's conclusions, many of the points made against American instruments are, unfortunately, justified more or less completely by the facts, and by the experience of teachers and pupils in biological schools throughout the country, but similar charges can be aimed with just as much truth and equal force against many of the instruments which are imported from abroad and commended as laboratory instruments. There are many of them that I would absolutely not take as a gift if I could get the best instruments of American make, and the best of those made abroad are open to objections when considered merely as tools for general biological work. A microscope is, or ought to be, an instrument of precision, and as such it is a tool which, according as it is well or poorly made, will work satisfactorily or unsatisfactorily in the hands of the skilled manipulator. I hold that nothing is too good as a tool for either pupil or teacher in biology. Histological research and technique have reached that degree of development and perfection within the past fifteen years, that the man who was a master in histology that long since, if he were to return to the work in one of the many recently founded biological laboratories in the United States, would find that in cytology both.

pupils and teachers were speaking a language which he could scarcely understand. He would also find that it was a common thing for a teacher to demonstrate to his pupils with actual specimens, day after day, things which in his own day it was utterly impossible to demonstrate except by the most laborious and roundabout methods, and which at best gave unsatisfactory results. With this enormous advance in technique or in the processes of research, has arisen a demand for a better class of laboratory instruments, which, while they are compact, simple, and of moderate height and weight, are constructed with a view to durability, and at the same time admit of use for all the ordinary purposes of the investigator or student. Such instruments should possess such qualities as would enable one to use them for the most elementary as well as for the most advanced work requiring the highest grade of manipulative skill. The senseless catering of makers to the lovers of 'brazen elephants' (as I once heard an eminent histologist express himself), with their large and costly instruments, has wrought a kind of mischief which teachers have every now and then to contend against, in the tendency of poorly informed tyros buying at large cost these brazen giants, which they soon find are not what they want.

My own deliberate conviction is, that the ideal microscope for the student and investigator still remains to be devised; that neither Europe nor America has yet produced it; and that any attempt to produce such an instrument, without considering every possible and reasonable demand that can ever be made of it as a table microscope, must end in failure. Looking over the vast amount of rubbish which is constantly being figured in microscopical journals as something new and valuable, one is often tempted to make the comment, "Why could not that person have been more usefully employed than in devising that perfectly useless piece of apparatus?" There are, however, many exceptions; and I do not mean to be understood as scoffing at all new pieces of apparatus, because many of them first devised within the last ten years have been of the greatest value.

How is this ideal microscope to be realized? Who will design it, and who make it after it is designed? I would suggest that every piece be made to a standard gauge, and that thus, if any parts are broken or worn out, they may be replaced with a minimum of trouble. I would advise that the existing rack and pinion be replaced by a better construction, as no rack and pinion yet made is so constructed as to remain firm and steady after prolonged use of the instrument. The fine adjustment can be made a part of the coarse adjustment, provided the cogs of the rack and pinion are accurately cut; and this adjustment can be placed at the back of the instrument, near the fingers of the manipulator. In this way a source of weakness in the construction of both American and foreign instruments may be avoided. The outside tube in which the optical tube slides must be fixed, and form a part of its support. The optical tube must be short; tube length, with draw-tube out, not over 155 millimetres, so as not to make the instrument uncomfortably high when the tube is vertical. The support for the tube must be in a single, solid piece, which may also support the simple, flat, wide stage covered with a thin piece of hard rubber firmly fastened to its upper surface. The stage clips must be so placed that they do not interfere with moving the slide over the whole width of the stage. The base or tripod upon which the whole rests must be cast in a single piece, and the joint at the back, between the base and the supporting piece for the tube, to be made simple and strong, and so that it may be quickly tightened by the manipulator if it should get loose. This joint for tilting I hold to be necessary for certain kinds of work and for photography. The mirror bar must be large and strong, and made as nearly concentric with the surface of the stage as possible. The attachment for the condenser should be made so that it is firm, and so that the condenser is easily swung into and out of position, and rapidly adjusted up or down with as little accessory mechanism as possible. A condenser of the Abbé type is of course the only one to be considered for general work, and it should be as short as possible, so as to make it possible to keep the stage as low down or near the table as is consistent with ready and successful illumination. The concave mirror should be larger than on the most of the laboratory microscopes used here and abroad.

Now a word as to the camera lucida. This absolutely necessary piece of apparatus must be adjustable to every eye-piece, and it should be available for use with the tube upright, inclined, or horizontal, without the addition of any desks or drawing-boards to the outfit of the microscope. If the rack and pinion is properly constructed, and an adjustable or sliding collar with the Royal Society screw fitted into the optical tube or body, with this camera, and a proper combination of eye-pieces and long or short focus objectives, drawings of objects may be made, ranging from 5 to 1,500 diameters, without difficulty, and the use of an embryograph largely if not entirely dispensed with. Searcher eye-pieces might be added to the combination, which would make the outfit still more complete and varied for the use of the investigator who needs to make figures of the subjects which he studies.

It will thus be seen that the prime requisites in the microscope for the investigator are simplicity and mechanically correct construction. No instrument yet made fulfils in the largest possible measure these requirements. Mr. Zentmayer has really added important improvements to the instruments constructed in this country; and for solidity and fewness of pieces, his work (which has always been honest) has been among the very best. American observers of world-wide reputation have used American instruments and objectives with success. Among these may be mentioned men no less famous than Profs. H. James Clark, Alpheus Hyatt, and Joseph Leidy, while Prof. J. F. Rothrock's studies with American lenses upon the strength of wood as illustrated by sections has started a most important line of practical inquiry.

But notwithstanding this, as stated at the beginning, the ideal microscope is still to be placed upon the market. To have the matter assume the importance which it demands, I would suggest that the American Society of Naturalists, at their next meeting, take into consideration the question of securing a satisfactory design for a standard instrument. Let this be done by offering a prize to be competed for, and let us for once have something like uniformity of pattern in this most important instrument of research. The teacher would then have no difficulty in suggesting to his pupils what make of microscope they should buy, and every maker would not be offering instruments departing more or less from a recognized standard.

And finally, as suggested by Dr. W. P. Wilson, now that the surplus from revenue and tariff is stirring the political wiseacres at Washington, where a plethoric treasury is threatening the financial prosperity of the country, let our universities and colleges make an appeal to members of Congress, in co-operation with the American Society of Naturalists, to have the absurd tariff on imported scientific books and apparatus removed. This senseless tax on knowledge, which it seems is to be catalogued among the 'luxuries,' is a glaring and shameful disgrace to American institutions. As it is, neither American publishers nor manufacturers are profiting to any extent from this absurd regulation, nor are they likely to, even after the duties are removed.

JOHN A. RYDER.

University of Pennsylvania, Dec. 15.

Sound-Blindness.

IN *Science* for Nov. 18, p. 244, I observe some remarks on certain phenomena of defective hearing, which, from their supposed analogy to color-blindness, is called 'sound-blindness.' I am very much interested in the facts, but the name I do not at all like. It seems to me very misleading. But neither is the term 'sound-deafness,' which was proposed as a possible substitute, any better. Comparing the eye and the ear, 'sound-deafness' corresponds with 'light-blindness;' but these terms express simply blindness and deafness without qualification. The correspondent of *color-blindness* is not *sound-deafness*, but *pitch-deafness*. But the phenomenon spoken of in the article referred to is neither *sound-deafness* nor *pitch-deafness*; for the characteristic of vowel-sounds is not musical pitch, but *timbre*. In so far as the phenomenon is physiological at all, the defect is therefore *timbre-deafness*. But it seems to me that the defect is probably, largely at least, a defect of perception, and not of sensation, and therefore psychological, not physiological.

JOSEPH LÉCONTE.

Berkeley, Cal., Dec. 9.

SCIENCE

FRIDAY, DECEMBER 30, 1887.

THE PILOT CHART OF THE NORTH ATLANTIC OCEAN for December, issued by the United States Hydrographic Office, calls special attention to the importance of an understanding among transatlantic steamship companies and captains relative to the routes followed by eastward and westward bound vessels, in order to diminish as much as possible the dangers of collision on this great race-track of the 'ocean greyhounds.' A reprint from the chart is devoted to a brief discussion of the routes recommended this month, with the addition of a chart showing graphically their positions relative to the December storm-belt; storm-tracks are plotted by means of dotted lines; and the average force and frequency of prevailing winds in each 5° ocean square north of the 40th parallel are also given, as indicated by the results of the international system of simultaneous meteorological observation, so far as now available. It is an appropriate time to bring up this subject, now that the proposed international conference relative to the increase of safety at sea bids fair to be held. The well-known 'steam-lanes' planned by Maury in 1855 at the suggestion of Capt. R. B. Forbes have never been followed to any great extent, and indeed were never obligatory. At present each captain is allowed to use his own discretion to a very large extent, and almost every consideration is secondary to the desire to 'beat the record' by making a fast passage. If the thousands of passengers who cross the ocean every season could read the thoughts of their captains during the sleepless nights they pass on the bridges of their vessels, while rushing at full speed through a dense fog, it would hardly add to their comfort. The hydrographer, in his recommendations, marks out a new policy, and instead of the old lanes plots two routes on the chart, — eastward-bound vessels to follow the southern line, or nothing to the northward of it; and westward-bound vessels the northern line, or nothing to the southward of it; the two lines crossing the 50th meridian in 45° and 46° north latitude respectively. This is regarded as the best and only practicable solution of the question likely to meet with general acceptance, all things considered. The great difference between this plan and Maury's lanes is in the much wider limits allowed, which are thought to be necessary and reasonable on account of present conditions of navigation, the different destinations of vessels, the increased knowledge and better forecasting of the weather, and the necessity of room to allow for change of course in avoiding storms whose probable paths are now comparatively well known. The prompt use which is thus made by the Hydrographic Office, of the results of the simultaneous observations made by international agreement and published by the United States Signal Service, shows an appreciation of this important system of observation which is especially gratifying as indicating that the collection of these observations from masters of vessels will be energetically continued, now that it is in the hands of this office. It is understood that General Greely has, at the request of Commander Bartlett, ordered the immediate compilation of ten-year normals for each ocean square in the North Atlantic, for use in connection with the Pilot Chart; and the vast interests involved make this subject of such paramount importance, that it is a cause for congratulation that the United States has taken the lead not only in the inauguration of the system and the collection and publication of the observations, but also in the immediate and practical utilization of the results.

THERE IS IN SESSION this week at Trenton, N. J., a body which is something of a novelty in educational organizations, but from which great good is expected. We refer to the New Jersey Council of Education. We do not know of the existence of any similar body in any other State, and we do not believe that the organization of the New Jersey Council is as yet very well or generally understood. In his presidential address at the meeting of the New Jersey State Teachers' Association last year, Superintendent C. E. Meloney of Paterson advocated the formation of a State council of education which should have general unofficial supervision over the educational interests and educational legislation of the State. The idea proved to be a popular one, and a committee was appointed to prepare a plan for the organization of the council. The body has since been regularly organized, and is now holding its first annual meeting. Its constitution lays down as its aims the investigation and discussion of topics relating to education, the dissemination of information bearing on these topics, the consideration and recommendation of the best means of advancing the educational interests of the State, and the consideration of means by which the policy of the State may be modified in view of the progress of educational thought. The constitution limits the membership to forty-eight, and these are divided into three classes, each class to serve three years. The places of the sixteen whose terms expire each year are to be filled at the time of the meeting of the State Teachers' Association. The election of members rests with the council itself, but one-half of the nominations to fill vacancies are to be made by the State Teachers' Association, and one-half by the council. The names of the present members of the council show that its deliberations are to be participated in by representatives of every phase of education, from the sub-primary to the university. The council proposes to be the embodiment of the power of the teaching profession of the State, and will unquestionably do a great service in the cause of educational advancement. The present president of the council is Superintendent W. H. Barringer of Newark, and his address at the present meeting was to be on 'Education as a Problem.' The various working committees and their chairmen are as follows: school organization, Principal B. C. Gregory of Newark; course of study, Superintendent C. E. Meloney of Paterson; high schools and colleges, President Merrill E. Gates of Rutgers College; normal and training schools, Principal J. A. Reinhart of Paterson; supervision of schools, Superintendent Charles Jacobus of New Brunswick; school law, Principal J. M. Green of Long Branch; examination and tenure of office of teachers, Superintendent Randall Spalding of Montclair; hygiene and sanitation, Prof. S. A. Farrand of Newark; moral education and discipline, Dr. J. H. Vincent of Plainfield; statistics, Mr. A. Scarlett of Burlington; industrial education, President Nicholas Murray Butler of Paterson. It will be seen at a glance that the New Jersey Council is a working, not a talking body, and the example it sets could well be followed in other States.

THE RECENT MEETING of the American Public Health Association at Memphis, Tenn., of which a summary has been given in *Science*, was one of the most interesting and important which that association has ever held. Nine years ago its members convened in Richmond, Va., many of them having just come from cities which had been almost decimated by yellow-fever, first among which was Memphis itself. The National Board of Health had its birth in this meeting; and had the same broad and liberal spirit which characterized that meeting been fostered and encouraged, that board

would doubtless be in existence to-day, having had nearly ten years of experience, which would have enabled it to cope with any epidemic which might visit our shores. But petty jealousies arose, and as a result that board has now no existence. Its work was of the best, and five volumes of its records attest this fact. The need of a national health department in some form was dwelt upon at length by the president, Dr. Sternberg, in his address. He thinks that at the present time it would be useless to ask that the sanitary interests be placed under the charge of another cabinet officer, a minister of public health, but that sanitarians should demand that their interests receive the same consideration from the national government as is accorded to the educational and industrial interests of the country. He recommends the organization of a bureau of public health, with a commissioner at its head, with the necessary assistance to make it efficient. It has been suggested that a board of health would be better than this plan contemplates, its members coming from different sections of the country. Dr. Sternberg is right, we think, when he speaks of such a board as not calculated to do the best work. Another plan is to have such a board made up of the surgeon-generals of the army, navy, and marine-hospital service; but these officers are already fully occupied with their duties, and could not with advantage undertake the executive work of a central health bureau. Such a board would act well as an advisory body, but its work should be limited to that. It is sincerely to be hoped, that, as a result of the discussion of this important question, the next Congress will provide for a central health organization. Such action would meet with the hearty support of sanitarians throughout the United States, and would do much to quiet the minds of these gentlemen who to-day look with anxiety and concern upon the possibilities which might occur should cholera or other epidemic disease visit this country in the present unsettled condition of its sanitary administration.

SNOW HALL OF NATURAL HISTORY AT LAWRENCE, KAN.

THE Legislature of the State of Kansas, during its biennial session of the year 1885, appropriated fifty thousand dollars for the purpose of erecting a natural history building for the University of Kansas. The erection of such a building was rendered imperative by the extensive botanical, entomological, zoological, and geological collections brought together under the supervision of Prof. F. H. Snow, whose connection with the institution dates from its foundation in the year 1866. The building was completed in the autumn of 1886, and was formally named and dedicated to the purposes for which it was erected, on Nov. 16 of that year. It has two principal stories, each sixteen feet in height, together with a basement and attic so commodious and well lighted as to make the structure practically four stories in height. The building from basement floor to attic roof is divided into two portions, partially separated from each other by the main entrance-hall and stairways. The portion to the west of the entrance is devoted to the exhibition of the various cabinets, while the opposite portion is assigned to the work of instruction. The collections belonging to each department are upon the same floor with the laboratories of that department, easily accessible to both students and instructors. The arrangement of the various apartments is so well indicated in the accompanying plans as to require no verbal description. This arrangement was suggested by Mr. J. H. Emerton of New Haven, Conn., who furnished the preliminary plans which formed the basis upon which the Legislature was solicited to make the appropriation. Mr. Emerton's outlines were placed in the hands of Architect J. G. Haskell of Topeka, Kan., who completed the architectural adaptations in the matters of construction, light, heat, ventilation, and exterior style, in a successful and satisfactory manner. The rooms most naturally grouped themselves so as to form a rectangular building; but for the purpose of increasing the volume of light, and also improving the architectural effect, their form was somewhat changed.

The building is most admirably lighted; the volume being so

great that on a cloudy day the occupants of laboratories need not seek proximity to the windows for microscopical work, and the museum halls may have cases arranged in any desired relation. The large museum rooms are lighted on three sides, and necessarily have one side not lighted. To prevent this from being a dark side, a plate-glass window, eight feet wide and eleven feet high, opposite the centre of the unlighted wall, was added to the ordinary means of lighting, and has the effect of giving uniformity of volume throughout the entire space.

The exterior is in the Romanesque style, with rock-face ashlar and cut stone dressings, the stone being from the well-known Cottonwood quarries of Kansas. The main approach is by a broad flight of buttressed stone steps under a handsomely decorated portico, the decorations being suggestive of the uses of the building. Numerous stone panels are provided about the building, which may, if desired, be utilized for illustrations of natural history subjects cut in bas-relief.

The construction of the building is nearly fire-proof. All bearing-girders are of iron, and all floors are deadened with mortar on corrugated iron laid between the joists. All partitions are non-combustible, all lathing is of wire cloth, the roof is covered with slate and dressed with iron cornices, ridge and hip rolls. All interior finish is polished hard wood, so that little material is presented to feed combustion.

Heating is by steam, the 'indirect' method being employed to furnish the rooms with warm fresh air, and the 'direct' method for securing proper temperature.

Fresh air is introduced into the building by means of a 'plenum' extending under the entire building, and connecting with the outer air by arched openings and areas. Ventilation is accomplished by means of large flues leading from near floor and ceiling of all rooms to a large iron chamber in the attic, in which sufficient radiation is located to insure a successful movement of the foul air through a ventilating cupola to the exterior.

The construction of the building was by contract with McFarland & Son of Lawrence, and completion was accomplished within the prescribed appropriation, and without 'extras.'

INDIAN WHEAT.

AT a recent meeting of the English Farmer's Club, Professor Wallace of Edinburgh University read a paper on agriculture in India.

Professor Wallace said he went to India not only to study agriculture in view of the important influence it was likely to exercise over British agriculture, and forestry in view of the likelihood of a chair of forestry being established at his university, but he had the further object of wishing to see for himself why it was that the government had practically given up the idea of improving Indian agriculture. He found that the apathy on the part of the government in the direction of advancing agriculture was exhibited not only in the case of the native scholars, but was general. Practically all that was left of the Agricultural Department was the name, and this was not always recognized in the presidencies. The ryots' faith in the proposals of the government to improve their practices had entirely vanished. The speaker then went on to explain the character of the Indian cattle, and showed that these were raised, not for meat, but for sinew; and he pointed out the lessons to be learned from color, the black cattle better resisting heat. As to the wheat-growing, he said, that, in order to produce wheat for the market, the ryots increased the area cultivated by taking in more land from the wastes or jungle the most convenient, in the first instance, to their holdings; but, in addition to this, they grew wheat in many cases in place of some other crop. There was a limit to the extension of the so-called 'substitution' wheat area; and the area of extended wheat-growth was, as time went on, always becoming more difficult to increase, and, even after difficulties are surmounted, less remunerative. A tract of country where extension would be the main source of wheat-supply skirted the eastern border of the desert of north-western India. Supplies of wheat were also expected to be forthcoming from the rich black soils of the southern Maharashtra country when the railway communication was better established. It had been thought by some that the future supplies of Indian wheat would so increase as to flood the English markets to

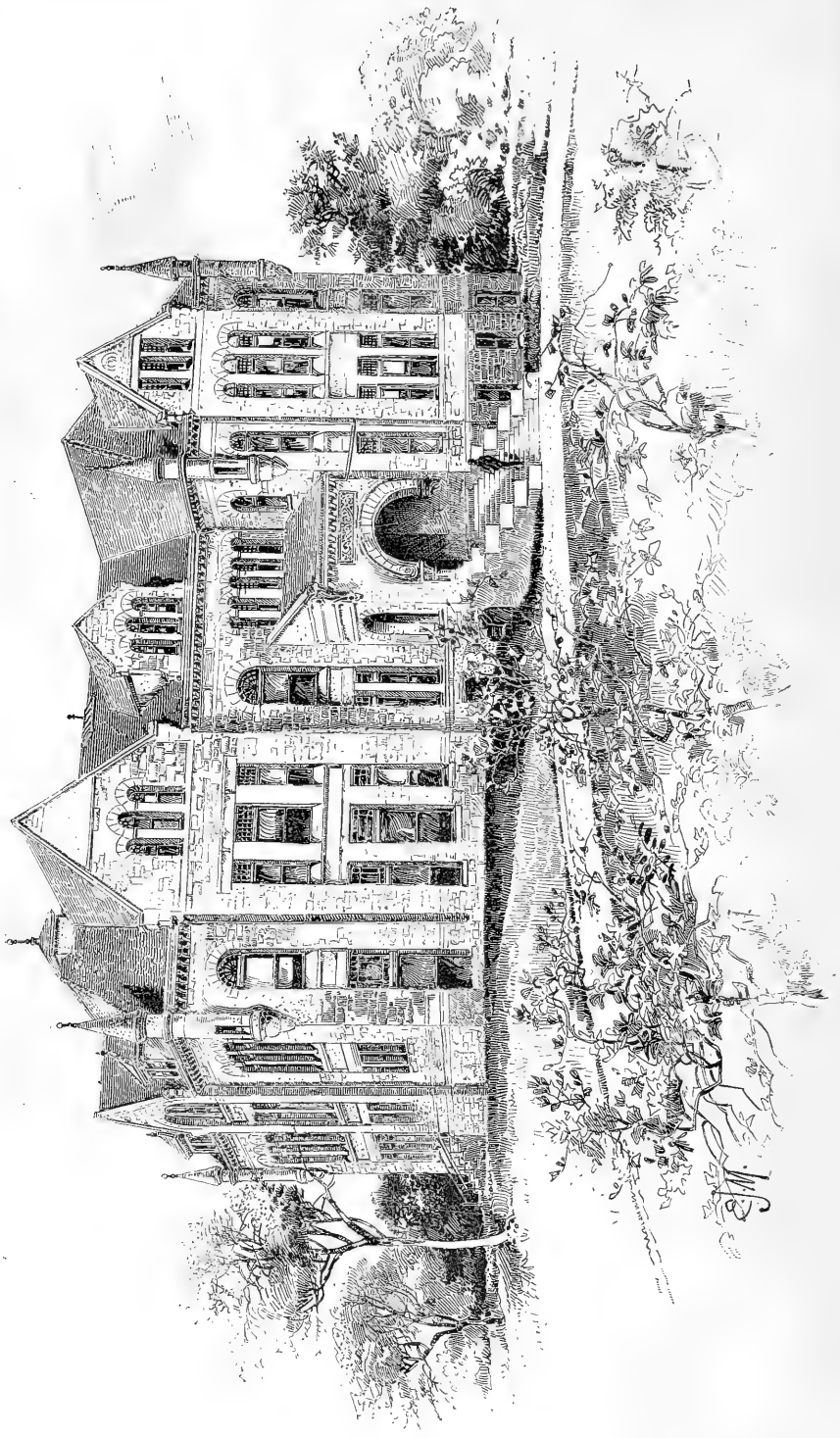

N. H. H. HEAT.
V. V. V. VENTILATION.

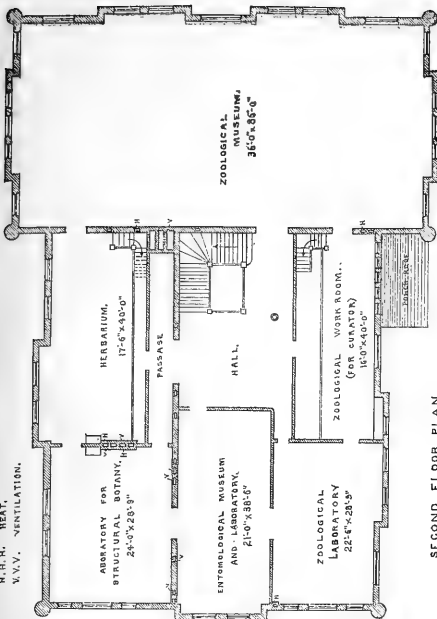

SECOND FLOOR PLAN

N. H. H. HEAT.
V. V. V. VENTILATION.

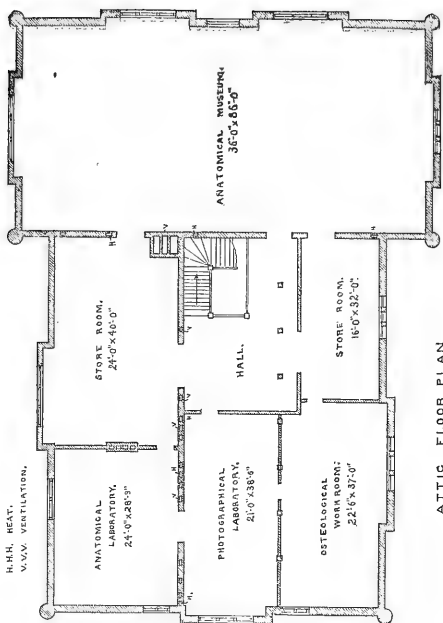

ATTIC FLOOR PLAN

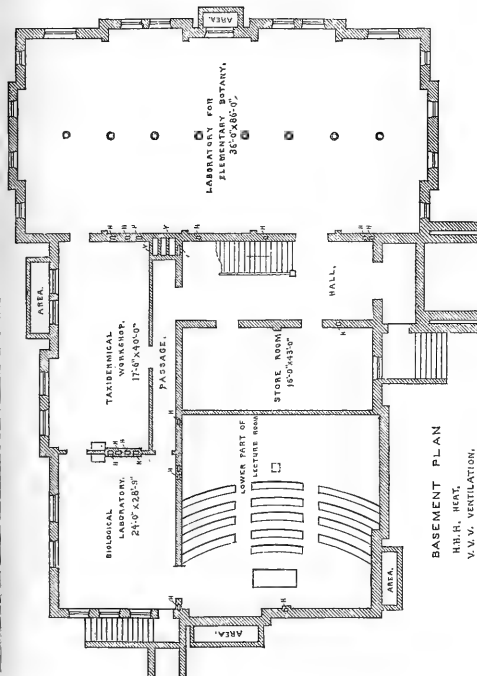

BASEMENT PLAN
N. H. H. HEAT.
V. V. V. VENTILATION.

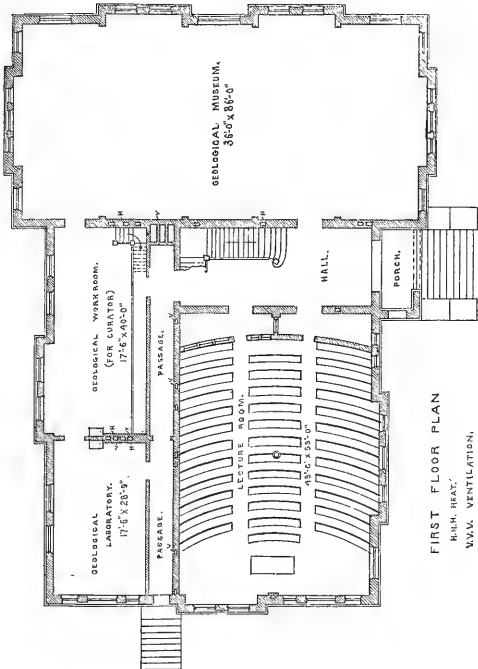

FIRST FLOOR PLAN
N. H. H. HEAT.
V. V. V. VENTILATION.

SNOW HALL OF NATURAL HISTORY AT LAWRENCE, KAN.

(MR. J. C. HASKELL, TOPEKA, KAN., ARCHITECT.)

overflowing. He did not deny that Indian wheat would for many years remain a substantial item in the annual wheat imports, but there was no indication that the amount of it would increase at any thing like an alarming rate. With the extension of railways, new wheat-growing districts would be tapped, but the supply of easily available land was by no means unlimited, and the drawbacks and disadvantages were far more numerous than most people supposed. He then commented upon the likelihood of the yield decreasing and the quality degenerating by too frequent growth on the same land. He believed that the land was not seriously impoverished by the native systems of rotation, or by the practice which they had of growing mixed crops; but it would be strange if they altered those time-honored practices, and grew wheat year after year with successful results, as if the land were in the condition of virgin soil. It had been the history of every great wheat-growing region that the yield and quality came down if the land was not kept up by manuring, as in England. He cited America as a typical example. The point where the best wheat grew had steadily marched westward, and he claimed that it had left as a record of its course the ruins of disused and deserted mills. It is not perfectly clear wherein he has evidence of this. Sir Donald Mackenzie Wallace, the author of 'Russia,' and now private secretary to the viceroy of India, related an excellent illustration of the case in point. A district in southern Russia was suddenly stricken with the wheat-growing mania. For a few years the yield, for size of grain, quality, and quantity, was simply marvellous; in a few more years the excess in every way became normal; and in yet a few more years, the produce diminishing in every respect, it became impossible for wheat-growing to continue, and the people had to go back to their rye-crops and other coarser grains. He dealt with the character of the wheats grown in India, and commented upon their inferiority in several respects.

Sir James Caird, in thanking Professor Wallace for his interesting lecture, said that he thought Mr. Wallace had not given as much credit as they deserved to the various agricultural departments in India for their exertions. But in a country so populous, and with an agricultural practice to a certain extent established by a long line of experience of climate and soil, the cultivators have not been slow to avail themselves of the extending facilities of transport, which, in regard to cost on the great railway-lines in India, are now brought very much on a par with the charges in America. An increasing demand, caused by facility of transport, has stimulated production, and has shown that instruction in the art of agriculture is not so much required as access to good markets. India has a great variety of products, and though wheat interests British agriculturists more than any other, cotton stands highest on the list of exports, next to it opium, then oil-seeds, then rice, and fifth wheat. But wheat had, no doubt, gained the most increase of any. The rapid extension of exports of native produce from India in the last ten years is, indeed, very remarkable. The total value in 1877 was sixty-five millions sterling, and in 1886 eighty-five millions,—an increase of nearly thirty per cent. There could be no great deficiency in the knowledge of the cultivators where such a result was possible; and probably the best aid that the government of India could give to native agriculture would be to proceed steadily with the construction of railways in all the richer parts of that vast country which are still without them. With regard to a continued supply of wheat to Europe, he agreed with Professor Wallace that there is neither the same facility for its increased production as in America, nor the same likelihood of a surplus. The population of India and the native states at the last census was two hundred, and fifty millions. It is believed to be increasing at a rate which, in ten years, might add twenty million more mouths to be fed. This increase must be provided for, and the periodical return of famines must not be forgotten. We are within a short period of the time when one will be due. He did not, therefore, think that Europe could depend on India so much as America for future supplies of wheat.

HEALTH MATTERS.

Quarantine Systems.

THE quarantine systems of the United States were fully discussed at the Memphis meeting. For years that of New York has been

regarded as the best which could be found along either coast, and its methods have been copied by the quarantine officers of other ports. The condition, however, in which the quarantine arrangements were found to be, when the 'Alesia' and 'Britannia' arrived last fall with cholera on board, has done much to destroy the confidence which up to this time had been reposed in the New York system. For the defects which then existed, and many of which doubtless still exist, the responsibility has not yet been determined. The health-officer places it upon the governor of the State, inasmuch as he has vetoed appropriations which were needed to put the hospital islands and appliances in fit condition to receive immigrants suffering from epidemic disease. On the other hand, it has been attempted to throw the blame on the health-officer himself for not supplying what was needed at his own expense. This latter criticism is unjust. He is not called upon, either as a matter of obligation or duty, to expend the amounts necessary to remedy the defects, and certainly there is no precedent for it either at the port of New York or elsewhere.

During nearly fifteen years of active connection with health organizations, the writer can recall but one instance in which a sanitary official paid out of his own pocket the amounts necessary to prosecute sanitary work, when the authorities failed or refused to appropriate public funds for that purpose. That official was Dr. Davenport of Boston, chemist and milk-inspector of the board of health. The amount expended was, if we remember correctly, more than three thousand dollars, and the last we heard he had not been repaid. If there are other instances, we should be glad to put them on record.

The Philadelphia committee reflected very severely on the management of the quarantine authorities at New York, and their complaints have not been fully met. It appears, however, that cholera has not spread from the hospital islands, and it is to be hoped that the measures taken to extinguish it have been successful. The systems at Baltimore and Philadelphia have been condemned as entirely inadequate to the task of coping with epidemic disease should it make its entrance at either of these ports. These defects were the foundation for the request, made especially by Western sanitarians, that a national quarantine system should be organized, whose restrictions should be similar at all the ports of the United States, thus leaving no port unprotected, but keeping such a vigilant watch over all, that cholera and yellow-fever might with certainty be excluded.

The quarantine system of Louisiana has been brought to such a state of perfection by Dr. Joseph Holt, president of the State Board of Health, that it is now looked upon as the best in the United States. A description of this system was given by Dr. Holt at the Memphis meeting, and is a part of the report of the committee on disinfectants. In this description the writer says there are three maritime approaches to New Orleans,—the Mississippi River, the Rigolets, and the Atchafalaya River. The two latter are closed against all vessels from quarantined ports, compelling such to use the Mississippi as the only available route to New Orleans. The quarantine is a system composed of three stations, the first of which is an advance-guard inspection station situated at Port Eads, one hundred and ten miles below New Orleans. Here vessels are boarded by the medical officer, who inquires as to their sanitary record and present condition. If from a non-quarantined port, and all is well, they go to the city. If a vessel comes from a quarantined port, but gives no evidence of present or past sickness among passengers or crew, she proceeds to the upper station, seventy miles below the city, where she is subjected to sanitary treatment. If, on the other hand, the vessel gives evidence of being infected, she is sent to the lower station, located on Pass à l'Outre, one hundred and three miles below New Orleans. The sick are at once removed to a hospital. The vessel, with the well on board, is thoroughly disinfected by the aid of the quarantine tugboat. The atmosphere below decks is completely replaced with one heavily charged with sulphurous oxide, and wherever possible a solution of bichloride of mercury is applied to effect thorough disinfection.

In speaking of this treatment, Dr. Holt says, "A ship known to be infected with one of the three great pestilential diseases—small-pox, cholera, or yellow-fever—can stand and must endure extraordinary treatment, even if clothing is wetted and some articles

damaged. 'They who go down to the sea in ships' assume the perils of the voyage, among which is this occurrence of finding themselves on an infected vessel, and being compelled to undergo a cleansing; for they have no right to bring their perils ashore and endanger others." The ship, with those on board, is held ten days for observation, and then allowed to proceed to the upper station, where she undergoes further treatment, and then goes to the city.

The methods practised by Dr. Holt are very thorough, and in their application, a tugboat, fitted up with all the necessary machinery, is employed. The bedding of the vessel, together with cushions, mattresses, carpets, rugs, etc., is removed from the ship to a commodious building in close proximity to the disinfecting wharf, where they are treated by moist heat at a temperature of not less than 230° F. During this process of steaming, every article is perceived to be saturated and intensely hot, the steam freely penetrating to the interior of mattresses, double blankets, etc.; but so great is the heat in the texture of the fabrics as to immediately expel all moisture upon drawing the racks and exposure to the open air. Shirts and collars instantly assume the crisp dryness they possessed before exposure, losing the musty smell of long packing in a trunk. Silks, laces, and the most delicate woollen goods show no signs of injury whatever from the treatment. Articles of leather, rubber, and whalebone would be injured by the heat, and are therefore disinfected with the bichloride-of-mercury solution. The time required to charge the chamber with apparel for disinfection is thirty minutes; time required for action of moist heat, twenty minutes; for removal of articles, fifteen minutes,—a total of sixty-five minutes.

The report of Dr. Holt is amply illustrated with figures of the apparatus used in disinfection, and the method of its application, and should be in the possession of every sanitarian as furnishing a model which can be adapted to the requirements of every quarantine station.

MENTAL SCIENCE.

Ideas of Number in Animals.

THE study of comparative psychology labors under two difficulties: the facts upon which it is to build cannot be accurately ascertained without great difficulty; and the interpretation of the facts is a still more delicate and laborious task. Civilized man has looked upon the facts of nature with so entirely a modern mind, that it is a rare gift to be able to appreciate the elementary thought-processes of uncivilized communities or of animals. Every attempt at improving the methods of presenting these phenomena should be received with sympathetic consideration, without regarding as final what is probably only a step to something better. Mme. Clemence Royer has recently made a study of the mathematical powers of animals that deserves the consideration of all students of psychology.

Among men we find all grades of mathematical ability, from that of a Newton and Laplace to that of one who cannot conceive the abstract notion of number. What the savage lacks is not the knowledge of the difference between three men and ten men, but the power to abstract the notion 'three' from men, trees, hands, and so on. The first step in this process is the distinction of unity from plurality, then of duality, etc., from plurality. The relic of this appears in the prevalence of the dual number in rudimentary languages.

What impresses itself upon the primitive mind is the sensory images of objects: he knows the difference between four trees arranged in a quadrilateral and in a row, between the general look of three trees and of four trees, but cannot see any thing in common between four trees and four stones. He is a poor arithmetician, but a good geometer; he is impressed by space relations, not by numerical characteristics. He can judge of distance, of the outlines, of the sizes of objects, but all by an instinctive visual talent. If, then, arithmetical notions appear late in human development, we can hardly expect it to be prominent among animals, lacking an intellectual language. What we can speak of as the language of animals is limited to the expression of the emotions. Their mathematical distinctions are sensory in nature. They distinguish between unity and plurality of certain objects, but we cannot credit

them with abstract notions of 'one' and 'two.' They have a kaleidoscopic, photographic memory, not an abstract verbal one. All the wonderful powers of animals finding their way, of regularity in time, must be accounted for by an accuracy in the perception of outlines, and the unconscious registration of general intervals by feelings of fatigue, number of steps, and so on.

There is no unit of distance or time. Distance is to them a perception, not an idea. Just so a dog, in attacking a boar, accurately judges the length of his leap, the size and strength of the enemy; but this does not involve any mathematical calculations. The apparent understanding of language by trained dogs comes under the same head. The dog does not appreciate the phonetic value of the words, but takes his clew from the intonation, the little gestures, and the like. The horse understands the 'language of the bit' better than that of his master. Animals, in brief, have their geometrical sense of relations well developed (better than men in some respects), but are not arithmeticians.

They do not, however, lack all appreciation of number. They do distinguish between numbers, for this is necessary to their existence; but their distinction, when it goes above a few simple units, is in the form of a bunch-estimate, depending as much on the arrangement of the group as on its size. They cannot estimate as we do when we divide an army into regiments, into companies, and so on, and thus estimate the number of men.

Birds, it is true, are much alarmed if an egg be removed from their nests, but they are equally alarmed if the arrangement of the eggs be disturbed; thus indicating that it is the general disturbance that causes the alarm, not a counting of the eggs. The mother recognizes her young individually, and thus can notice the absence of one; but she probably sees no more difference between the eggs than we do, and judges their number only by their arrangement. Cats probably distinguish their young by differences in the fur, and so on: they are little affected if one kitten be removed; but, if more than four be taken away, they are greatly disturbed, and especially so if but one be left. If the kittens are weaned, the loss is not taken so seriously.

Dogs notice the absence of one of their number; but that they recognize each other individually is shown by their preferences and jealousies, both among themselves and towards men. Shepherds' dogs do not count their fold, but simply have a general picture of its size. Likewise trained dogs do not count, but have simply learned to associate mechanically certain geometrical forms with certain actions. Sir John Lubbock's dog, that brings a different label according as it wants something to eat, to go out, and so on, does not appreciate the intellectual value of the letters, but regards the label as an artificial means for gaining certain ends. The dog's faculties in these respects, however, seem to be not inferior to those of the Bushmen, who count only to two, and call all above that 'many.' Number is here concrete only with reference to objects where plurality is a useful trait: it is never abstract, and so can no more reach the stage of mathematical art than can their emotional language reach the stage of ideational abstraction to which ours has attained. By this is not meant that animals can form no abstract notions, but that their general notions are very limited in scope, and are along the line of directly useful interests only. The animal thinks by generic images, does not err in its judgments, is not liable to fallacies, all of which are distinctly human because we think by the intervention of words; and this difference forms the difficulty of our communication with them.

Animal-trainers have ignored these facts, not recognizing that geometry is more fundamental than arithmetic, and have attempted to make animals arithmeticians when nature has made them geometers. Ourselves accustomed to look on every thing from its numerical aspect, we fail to see how trivial a part this plays in animal life.

There remains the consideration of number, not of objects in space, but of succession in time. This faculty has been claimed for the higher animals. There are many stories of pets keeping up the same action at regular intervals, and always the same number of times per day or per week,—the story of a dog who always wanted three pieces of sugar, of the dog who would always keep out of the way on Sunday, and so on. Mme. Royer explains this as due to ordinary associations without the intervention of abstract

notions of time-units. Houzeau took his dogs out walking every alternate day, and after ten walks did not notice a spontaneous desire of the dogs to go out, although they enjoyed the walk. The dogs did not estimate the interval, but took hints from trifling indications. They notice the return of a complex series of circumstances. On the other hand, Houzeau ascribes an instinctive time-sense to the crocodile that comes back to its eggs after a definite interval, varying from ten to fifteen days in different species. The mules on the horse-cars in New Orleans make five trips a day, and are always very restless on completing their fifth trip. Such facts need more exact experimentation before they can be ascribed to real counting on the part of the animals.

THE INFLUENCE OF SENSATIONS ON ONE ANOTHER. — Under this head Dr. Urbanschtsch of Vienna reports some curious experiments, the value of which must be left to future research to decide. His general conclusion is, that the excitation of one sense-organ increases the acuteness of the others. If a disk be regarded at such a distance that its color is indistinct, the hearing of a sound will bring out the color. The beating of a watch is heard more clearly with the eyes open than with the eyes closed. Red and green increase auditory perceptions; blue and yellow weaken them. The fact that we listen to music with our eyes closed is due to other reasons, and also to the fact that the *ensemble* appears best when the tones are not at their clearest. Smell, taste, and touch are open to the same influence. Red and green increase the sensitiveness of each of these senses; yellow and blue weaken their sensitiveness. Touch and temperature have a reciprocal influence. If one tickles the skin and plunges it into warm water, the tickling ceases; if into cold water, the tickling brings out the feeling of cold. These observations are regarded as showing the same re-enforcing action between sensations as has been shown to exist between motions, and as offering a mode of explanation of those curious associations between colors and sounds so insistent in some minds.

BOOK—REVIEWS.

Greek Life and Thought, from the Age of Alexander to the Roman Conquest. By J. P. MAHAFFY. New York, Macmillan. 12°. \$3.50.

THIS work is in the main a continuation of the author's previous volume, 'Social Life in Greece from Homer to Menander,' though somewhat wider in its scope. It lacks the absorbing interest that belongs to the history of the great days of Greece, but it has a new interest of its own in the spread of Hellenic civilization in Egypt and western Asia. The work is not confined to the moral and social life of the times, though this is the most prominent feature, but contains a great amount of information and discussion on almost every phase of Hellenic life. The political interest of the age immediately succeeding the death of Alexander centres partly in the division of his empire into various kingdoms, and partly in the struggles of the cities in European Hellas to recover their independence. Of the various kingdoms of the Hellenistic world, Egypt was, in Mr. Mahaffy's opinion, the most important and the most prosperous, — a fact which he attributes in great part to the statesmanlike genius of its founder, the first Ptolemy. In dealing with the cities of Greece, the author shows a lack of sympathy with the spirit of freedom and local patriotism which is not quite creditable in a citizen of a free country and a historian of Hellenism. It is true, the struggles of the cities to regain their autonomy proved unavailing, and perhaps they were not sufficiently cosmopolitan in their views; yet freedom is better than empire, and, while we acknowledge the defects and the failure of the patriots, we cannot but sympathize with their misfortunes.

Of the moral life of the period, we get glimpses from many points of view, and yet, as a whole, it is somewhat difficult to judge. The sins of the royal courts, especially the frequent murders, the use of torture, and the perpetual wars, are sufficiently prominent; yet Mr. Mahaffy thinks that the morality of private life was purer and more refined than it was in earlier times. In one respect there was certainly a real moral advance; it was during this period that the great schools of ethical philosophy were founded, and men came to regulate their lives by reason instead of by tradition and custom.

The author gives an interesting account of the philosophical schools at Athens, which were established by law as religious corporations with regular endowments; and he shows clearly that during most of the period under review they were highly respected and influential.

The intellectual life of the Hellenic world is treated by the author with considerable fullness. The history of physical and mathematical science is omitted, on the ground that the author lacks the special knowledge requisite for treating it. In art the Rhodian and Pergamene schools are of course the most conspicuous; and Mr. Mahaffy shows, that, though this was an age of decadence, the number of excellent artists was by no means small. In literature, after the decline of the New Comedy at Athens, the chief interest centres in Alexandria. The establishment of the Museum and the great library in that city, and the liberal patronage of both by the Ptolemies, made the place the chief seat of literature, as it afterwards became of philosophy. Of the quality of this literature, Mr. Mahaffy expresses the opinion usually held of it by modern scholars. It was distinguished by erudition and imitation of earlier models rather than by original genius or power of style. It is worthy of note, however, that it was at Alexandria that the practice arose of writing poems, and afterwards prose fictions, on the theme of romantic love, — a theme which has since become the most prolific in literature.

The concluding chapter of the book gives an account of the introduction of Hellenic civilization into Rome consequent on the conquest of Greece by the Roman arms; but the subject is only just introduced, as the author intends writing another work on the spiritual life of Hellenism in the Roman Empire. Those who have read his other works will look with interest for the promised volume.

Mount Taylor and the Zuñi Plateau. By Capt. C. E. DUTTON. Washington, Government. 4°.

STUDENTS of American geology who have learned to expect in Captain Dutton's contributions important results ably elaborated, and presented in a style which is simply fascinating, — clear and graphic, and worthy of the geological wonderland in which it has been his fortune to work, — will experience no disappointment in this paper. The district to which it relates (longitude 107° to 109° , and latitude 35° to 36°) lies in the western part of New Mexico, and in the south-eastern corner of the great plateau country, and embraces two distinct geological problems of the first order, — the volcanic region of which Mount Taylor is the culmination, and the Zuñi Plateau. Captain Dutton's previous studies, as well as those of Gilbert, Powell, and others, were confined mainly to the western side of the plateau province, and especially to the portion traversed by the Grand Cañon of the Colorado. But although no geologist possessing any breadth of comprehension could enter the plateau country, and, after gaining an extended knowledge of its physical features, fail to perceive that it is a great unit, and sharply delimited from every thing which surrounds it, it was still extremely desirable to study the south-eastern extensions of these vast masses of strata and the features carved out of them, in the hope that problems which could be only half solved on one side of the plateau could be completely solved on the other. It was felt that the history and evolution of this unique region could be ascertained satisfactorily only by knowing the whole. The survey, therefore, embraced the first opportunity of attacking it from the eastern side; and the admirable monograph before us sufficiently attests the wisdom of this policy.

With the view of putting this new field at once into its natural relations with the whole of which it forms a part, Captain Dutton begins with a summary account of the plateau country in its entirety. The area of the plateau country, south of the Uinta Mountains, is about one hundred and thirty thousand square miles. A shaded map shows its form and its position with reference to the other portions of the western United States. The topographic features and extraordinary scenery of this region have been described many times, and it is deemed needless to descant upon them; but several pages are devoted to the general geologic features underlying these wonderful reliefs. The strata are normally approximately horizontal; and such slight inclinations as occur are very persistent, car-

rying the strata from very high altitudes to very low ones. But no structural features of the plateau country are more truly characteristic than the monoclinical folds and faults.

The marginal portions of the plateau country abound in volcanic rocks and extinct volcanoes, while they are almost wholly wanting in the great central areas. The eruptions vary in age from the middle eocene almost to the present, the latest being probably less than three centuries old. This volcanic border is so nearly complete, that, if a geologist were making the circuit of the plateau province, he could so shape his route that for three-fourths of the way he would be treading upon eruptive materials, and pitch his camp upon them every night.

The classic group of laccolites known as the Henry Mountains is situated in the northern plateaus, and it is now known that this highly interesting type of eruption has been repeated at various points in the province. But perhaps no geological feature of the plateaus is of greater interest in connection with this monograph than the 'swells,' of which the San Rafael 'Swell' is the type; for the Zuñi Plateau is a noble example of this structure. There is a considerable number of swells in the plateaus, and they are of great importance by reason of their association with the most impressive features of the region. They are the localities of maximum erosion, — the centres from which the dissolution of the strata, through the wasting of their edges, has proceeded outwards, in ever-expanding circles, one bed or formation following another, until thousands of feet in thickness, and thousands of square miles in area, have been swept away. Along with this denudation has occurred a doming-up of the strata into a broad, gently swelling boss.

Captain Dutton's beautiful colored map, and the accompanying sections, bring out the topographic and geologic features of the region to which this monograph especially relates with wonderful distinctness. They show that the Zuñi Plateau is simply a great swell in a vast regional expanse of mesozoic rocks, breaking for a brief space the continuity of that system of strata, and presenting a well-marked monocline on either flank, a long, gentle slope of the strata on the north-east, and a short, abrupt slope on the south-west. From its broad surface the mesozoic has been denuded, leaving the edges of the strata, more or less upturned, to face it round about on all sides in rainbow cliffs. Away from the plateau the strata resume their normal horizontality, and the cretaceous becomes again everywhere the surface of the land. Vast and imposing is the expanse of this mighty cretaceous system. If we could rise in a captive balloon two thousand feet above the Zuñi Plateau, the radius of vision would embrace more than twenty thousand square miles covered with it. Yet this is but a trifle in comparison with its whole extent, which embraces half of the North American continent. Its thickness is equally matter of wonder. Whence came this stupendous mass of material? This is undoubtedly one of the most important and difficult questions in American geology.

North-east of the Zuñi Plateau, beyond the noble valley of the San José, rises Mount Taylor. It is a large volcanic cone planted upon a lofty and very extensive mesa of cretaceous strata heavily sheeted over with lava, the lava-cap being seldom less than three hundred feet thick. The cone occupies but a small part of the high platform on which it stands. It is merely the focus and culminating point of a rather large field of volcanic action. It is also clear that the immense cap of lava did not all come from this main orifice, but that the greater part was disgorged from numberless vents scattered over its entire surface, both the concentrated and the diffuse types of volcanic action being well exhibited in the same tract.

The great mesa on which Mount Taylor stands is only one of a series, and it forms only a small part of a great volcanic field. From its southern and eastern margins other mesas of similar composition are plainly visible; and it is certain that the sheet of lava once extended, perhaps without a break, across the broad intervening valleys of erosion, for they are now thickly studded with volcanic necks. These necks are ancient vents which have been exposed and left in striking relief by the wearing-away of the softer cretaceous strata over which their flows once spread. They form one of the most interesting and instructive features of the region, and Captain Dutton has described and illustrated them in considerable detail. It is impossible to follow him further in these interest-

ing descriptive chapters; but we must pass on to the general conclusions.

In the stratigraphy of the plateau country there is no fact of greater importance than the general if not complete absence of Devonian and Silurian strata below the carboniferous. In the Grand Cañon of the Colorado the carboniferous beds rest directly and conformably upon the Cambrian; and in the Zuñi Plateau the Cambrian is also wanting, and they repose upon the Archæan. But, although we thus have evidence of considerable areas of dry land in the Far West before carboniferous time, the strata of the latter age present, except where interrupted by subsequent erosion, one almost universal sheet of marine sediments over the whole western country.

The whole tenor of the evidence accords well with the inference that the surface of the plateau country during the Jura-Trias coincided very nearly with sea-level, but was continually oscillating from a little above to a little below that level, and *vice versa*. This is proved by the character of the sediments and the numerous unconformities by erosion, only without any discordance of dip. At one time it was a land area, sustaining a great forest vegetation, through which many species of dinosaurs wandered; at another it was overflowed by the ocean, and received deposits of fine sand, clay, and gypsum. Whatever may be the true explanation, it is a most extraordinary fact that three thousand to four thousand feet of strata were accumulated upon an area of over ninety thousand square miles, and yet the surface of deposition was maintained throughout at approximately the same level.

Very similar considerations are presented by the cretaceous system. As in the Jura-Trias, there were alternations of land and sea; and whenever the sea withdrew, the land thus laid bare bloomed with forests and swarmed with dinosaurs. Here we find, for the first time in the West, conditions favorable for the formation of coal. From top to bottom the shaly beds of the cretaceous include coal-seams and carbonaceous layers, while the intervening beds abound in fossil leaves. The carboniferous age of the Appalachians repeated itself here in the closing stages of the mesozoic, and upon a scale of equal if not greater grandeur.

An interesting question arises here. How does it happen that coal did not form in the Western Trias also? That vegetation was exuberant in that age is fully attested by the enormous abundance of fossil plants, which are usually silicified. The problem still awaits solution, but certain it is that the Jura-Trias has never yielded in the West a trace of carbonaceous matter. Its trees and shrubs have turned into stone instead of coal.

The source of the detritus forming the mesozoic strata of the West is found chiefly in the Great Basin of Utah, Nevada, etc. The fact is general that these strata grow thinner from west to east, indicating a western origin for its sediments. But the stupendous volume of the sediments in the United States and British America also indicates that they came from a source which was much more extensive than any island; in short, from some continental area, including the Great Basin, and having a shore-line many hundreds of miles long, with numerous large rivers discharging sand and silt.

The movements which ultimately isolated the plateau province, and gave it its distinctive history and development, began in the Laramie period; and during eocene time its area was a vast inland lake with an outlet. In this lake eocene sediments were deposited to a maximum thickness of five thousand feet toward the north, and thinning southward, indicating that they were derived mainly from the Rocky, Uinta, and Wasatch ranges, which were then in existence. The plateau lake finally disappeared in the miocene period, and thus closed the long period of almost continuous deposition which began in early carboniferous time, and during which from ten thousand to fifteen thousand feet of sediments were accumulated.

All this region proclaims an ancient erosion far more vigorous than the present. This is seen in the wide, eroded valleys, fit for the passage of great rivers, but vacant now of flowing waters, their troughs half filled with alluvium, and the grass growing over their flood-plains. We are obliged to refer this erosion to the miocene, and the great elevation of the country which followed it probably occurred during the piocene.

The elevation of the Zuñi Plateau was attended by the marked bulging or protrusion of limited portions of the Archæan mass carrying up with them the overlying sediments, and forming Mount Sedgwick and other elevations borne upon the plateau. The forms of these granite bosses, as well as the remarkable metamorphism of the immediately overlying carboniferous sandstone, would seem to suggest very strongly that they may be true localities. And this view relieves us of the necessity of accounting for the softening *in situ* of the Archæan so near the surface, since these bosses can never have been covered by more than ten thousand feet of strata. There is evidence that the basic eruptions which built up Mount Taylor and the volcanic caps of the mesas were subsequent to some part of the principal erosion of the country, though contemporaneous with a large part of it.

None of Captain Dutton's conclusions will interest the general student more than those relating to the formation of mountains. He traces a series of mountain forms from the extreme simplicity of structure disclosed in the Zuñi Plateau to the comparatively complex structure of the Wasatch and Basin ranges, and finds a generic idea running through them all. It is the idea that was taught us when we were school-boys, that mountains consist of granitic or metamorphic cores, with sedimentary strata upturned upon their flanks.

"Within the past twelve or fifteen years it has become a widely accepted view among the geologists of Europe and America that the forces which have elevated mountains are derived from the strains set up in the outer envelopes of the earth by the secular cooling and shrinkage of its interior; but it should be borne in mind that geological science has flourished most in those countries where the best known and most thoroughly studied mountains and ridges are greatly plicated. To the European geologist the Alps and the Jura have always been the most commanding and interesting of orographic structures. To the Briton the highlands of Scotland and Wales have been equally absorbing fields of research, in which the solution of the problem of mountain-building has been attempted. In America geology had its first and most rapid growth in the Appalachian region, and, when it sought fresh fields in the Pacific slope, it first found them in the Coast Ranges and in the Sierra Nevada. All of these regions are more or less plicated; and it is not to be wondered at that a universal conviction should have grown up that plication and mountain-building are only different names for one and the same thing, or that the process which built the mountains folded the strata at the same time. But as soon as the geologists penetrated the vast mountain-belt which lies east of the Sierra and west of the Great Plains, and proceeded to a careful study of the forms there presented, a wholly different state of affairs was revealed. Not a trace of a systematic plication has yet been found there. The terms 'anticlinal' and 'synclinal' have almost dropped out of the vocabulary of the Western geologist. The strata are often flexed, but the type of the flexure is the monocline."

"The Rocky Mountain region discloses whatever it has to tell us about physical geology with marvellous clearness and emphasis, but there is no teaching more clear or more emphatic than the absence of plicating forces from among the agencies which have built its magnificent ranges and hoisted its great plateaus. They have been lifted by vertical forces acting beneath them. The country at large shows no traces of a widespread, universal, horizontal compression; on the contrary, it discloses the absence of such stress."

These statements are undoubtedly correct, so far as the paleozoic and later formations, and the existing reliefs of the West, are concerned; and Captain Dutton probably did not intend that they should be applied to the Archæan strata of that region, since these are everywhere as strongly plicated as the rocks of any district on the globe. When these ancient crystalline schists of the Rocky Mountain region were folded up, mountains of the Appalachian type must have been formed. But these were largely swept away by erosion before the beginning of the grand cycle of events which Captain Dutton has outlined.

NOTES AND NEWS.

AT a meeting of the Biological Society of Washington, Dec. 17, an interesting paper was read by Mr. C. L. Hopkins on the sense of

smell in buzzards. This much-debated point was strongly set forth by Mr. Hopkins relating his experience in Florida. It was the uniform testimony of the Florida 'crackers' that buzzards obtained food by smell. He observed that buzzards never left their roosts on damp, foggy mornings until the ground and shrubbery were dry. They would then move slowly across the wind until a scent was struck, when they would work up the wind until the carrion was found. Sometimes they would drift down the wind, past their prey, until they struck the scent, which would be followed up, finding the object of their search sometimes in the densest scrub. He had on several occasions killed wild hogs in the scrub, and after dressing them, and taking what meat he wished, would see twenty or more buzzards coming down with the wind. On several occasions, covered offal had been detected by them. They had also discovered a buried snake. Several other instances were related, which, in Mr. Hopkins's opinion, conclusively proved that buzzards find some of their food by scent, though that did not preclude the possibility or probability that they obtain other food by sight.

—An interesting event took place at the Perkins Institute for the Blind at South Boston on Dec. 21. It was the celebration of the fiftieth anniversary of the entrance into that institution of Laura Bridgeman, the famous blind deaf-mute. Her first instructor, Dr. Samuel G. Howe, is long since dead; but his wife, Mrs. Julia Ward Howe, presided at the reception. The phenomenal education of Miss Bridgeman will always remain a monument of pedagogic skill. She lost her sight and hearing when two years old, and her taste and smell are both very defective. She speaks by making the manual signs of the deaf-and-dumb, and reads the similar motions of the 'speaker' by feeling the letters as they are formed. She does this with marvellous rapidity, and all the addresses were interpreted to her as they were delivered at the reception. Among the speakers were Dr. Edward Everett Hale and Dr. Phillips Brooks.

—The only railway extending into the Arctic zone runs north from the port of Lulea, in Sweden, at the head of the Gulf of Bothnia, toward the iron-mines of the Gellivara Mountains. The first train to cross the Arctic circle passed over this road a few weeks ago.

—Mr. J. A. Brashear gave an exhibition at his works, Allegheny, Penn., on Dec. 8, 9, and 10, of the large star spectroscope designed and constructed for the Lick Observatory, Mount Hamilton, California.

—The secretary of the committee for the organization of the American Folk-Lore Society, W. W. Newell, Cambridge, Mass., announces that the society will organize in a meeting to be held on Jan. 4 in Cambridge, Mass. The number of members amounts at the present time to two hundred, and, as the society has thus obtained an income sufficient to support a journal, it will begin work. The plan of organizing a society of this kind must recommend itself to all interested in the science of man. The scope of the society's work will be the study of the relics of Old English folk-lore, the lore of negroes in the Southern States of the Union, lore of the Indian tribes of North America, and that of French Canada, Mexico, etc. Furthermore, the study of the general problems of folk-lore, and publication of the results of special students in this department, will form one of the objects of the society. Our country is particularly adapted to the study of certain problems connected with folk-lore, such as the development of European and African lore in a new environment, and the origin of a new lore in mixed races. The material furnished by such researches is of prime importance for a study of the psychology of nations. It is hardly necessary to emphasize the fact that the collection of the rapidly vanishing remains of Indian folk-lore must be carried on vigorously, and on an intelligent plan, else it will be too late. The publications of the society will undoubtedly contain a vast amount of interesting material, and will amply repay the annual fee of three dollars. Our knowledge of the subject of American lore is still so slight, that almost any one who comes into contact with Indians, negroes, or the less educated white men, can make valuable contributions to this science; and therefore we would wish that the membership of the new society were thousands instead of hundreds.

— An interesting geographic sketch lies before us, which refers to a country but seldom described. It is Charles Bell's 'The Selkirk Settlement and the Settlers' (Winnipeg, 1887, 44 pp.), its contents being a concise history of the Red River Country of Canada from its discovery. It is also made to include local information from original documents lately discovered, and many biographical notes from old Selkirk colonists. A considerable portion of the pamphlet is taken up by the narration of the Selkirk colony's foundation under the leadership of Miles MacDonell, born in Inverness, Scotland, in 1769, and selected by Lord Selkirk in 1810 for the purpose above mentioned. The colonists started from Stornoway to the number of one hundred and twenty-five, and consisted of Londoners, Scotchmen, Irishmen, and inhabitants of the Orkney Islands. The party did not arrive at Red River, Manitoba, before August, 1812, and then set themselves to erect buildings on the west bank of Assiniboine River. The colony already exceeded the number of two hundred colonists, when in 1814 trouble arose with the employees of the North-west Company. Several bloody conflicts took place before tranquillity was restored, four years after. Numerous woodcuts contribute largely in enlivening our interest in the narrative presented by Mr. Bell.

— The explosion of a water-reservoir or boiler in the kitchen of the Kirby House, Milwaukee, recently was perfectly recorded in the vibrations given by the shock to a ruling-machine in the bindery of *The Sentinel*. The machine is directly opposite one of the windows of the bindery, and was in full motion when the explosion took place, drawing straight lines. The first impulse of the shock carried the pen nearly half an inch from the true line; then for some distance it approached the true line again without wavering, when it suddenly drew waving lines for the final reactionary vibrations. The lines are just such as are made by the seismometer in an earthquake shock.

— Recent soundings in Lake Leman and the Lake of Constance have shown that the beds of the Rhone and of the Rhine may be traced for a considerable distance on the bottom of the lakes. It is well known that the deposits of these rivers form a flat cone extending far into the lakes. On these cones embankments are found which enclose the bed of the river. That of the Rhine is cut into the deposits, while that of the Rhone is not deeper than the surface of the cone. F. A. Forel has studied these phenomena thoroughly. He determined the density of the water of the Rhone and of Lake Leman, and found that the former is almost throughout the year denser than the latter. A series of experiments on the influence of suspended matter upon the density of water shows, that, if the matter is moving vertically downward, the density of the mixture may be found by adding the weight of the suspended matter to that of the liquid, and dividing the total by the volume of the mixture. As the Rhone carries a great amount of suspended matter, the latter must be taken into consideration; and Forel's researches show that the density of the water of the Rhone, as dependent on its temperature and the amount of dissolved and suspended matter, is greater than that of the lake except during a brief period in spring. On the sides of the current, where it adjoins the stagnant water of the lake, the suspended matter is precipitated, and thus the dikes are formed. It is possible, that, in addition to this, the water of the rivers has a slight eroding action.

— On Dec. 1, Sir John Lubbock, we learn from *Nature*, read a paper before the Linnean Society, in continuation of his previous memoirs, on the habits of ants, bees, and wasps. He said it was generally stated that the English slave-making ant (*Formica sanguinea*), far from being entirely dependent on slaves, as was the case with *Polyergus rufescens*, the slave-making ant *par excellence*, was really able to live alone, and that the slaves were only, so to say, a luxury. Some of his observations appeared to throw doubt on this. In one of his nests the ants were prevented from making any fresh capture of slaves. Under these circumstances, the number of slaves gradually diminished, and at length the last died. At that time there were some fifty of the mistresses still remaining. These, however, rapidly died off, until at the end of June, 1886, there were only six remaining. He then placed near the door of the nest some pupæ of *Formica fusca*, the slave ant. These were at once carried in, and soon came to maturity. The mortality

among the mistresses at once ceased, and from that day to this only two more have died. This seems to show that the slaves perform some indispensable function in the nest, though what that is still remains to be discovered. As regards the longevity of ants, he said that the old queen ant, which had more than once been mentioned to the society, was still alive. She must now be four-tens years old, and still laid fertile eggs, to the important physiological bearing of which fact he called special attention. He discussed the observations and remarks of Graber as regards the senses of ants, with special reference to their sensibility towards the ultra-violet rays, and referred to the observations of Forel, which confirmed those he had previously laid before the society. Professor Graber had also questioned some experiments with reference to smell. He, however, maintained the accuracy of his observations, and pointed out that Graber had overlooked some of the precautions which he had taken: his experiments seemed to leave no doubt as to the existence of a delicate sense of smell among ants. As regards the recognition of friends, he repeated some previous experiments, with the same results. He took some pupæ from one of his nests (A), and placed these under charge of some ants from another nest (B) of the same species. After they had come to maturity, he placed some in nest A, and some in nest B. Those placed in their own nest were received amicably; those in the nests of their nurses were attacked and driven out. This showed that the recognition is not by the means of a sign or password, for in that case they would have been recognized in nest B, and not in nest A. Dr. Warsmann had confirmed his observations in opposition to the statement of Lespis, that white ants are enemies to those of another nest, even belonging to the same species: the domestic animals, on the other hand, can be transferred from one nest to another, and will be amicably received. In conclusion, he discussed the respective functions of the eyes and ocelli, and referred to several other observations on various interesting points in the economy of the social *Hymenoptera*.

— The reports of the German factory inspectors for 1886 contain some interesting statistics respecting the hours of labor, accidents, etc., in various districts and in different employments. On the whole, the number of work-people increased, in the fifteen districts for which reports are published, from 596,561 in 1884, to 642,386, being an increase of 33,496, or 7.7 per cent, of males, and 12,329, or 7.6 per cent, of females. The industries in which the chief increase took place were textiles, food, wood, and carving. There was a great decrease in the number employed in mining. In some districts there was a great lack of employment, while farmers were complaining that they could not find laborers to do their work. In Bavaria, in 29.4 per cent of all industries the hours of labor were from 11½ to 16 hours daily; in 59.6 per cent from 10 to 11 hours; and in the remainder from 11 down to 5 hours. The last-named time applied only to the work of putting the quicksilver on the backs of looking-glasses. Excessively long hours prevail in breweries, where they are never less than 16 hours a day. In the Düsseldorf district nearly 40 manufacturers of textiles have entered into a convention not to make the working-day longer than 12 hours. According to a regulation made in 1885, all accidents in factories must be brought to the knowledge of the inspectors. This accounts for the apparently enormous increase in the number of accidents: 2,394 were brought to the inspectors' notice during the year. These are arranged under two heads: (1) The causes; (2) The consequences to the victim. More than one-half are put down to inevitable accident, and more than one-third to carelessness and want of skill. More than four-fifths were attended only with temporary incapacity for work. The work-people appear to understand and enter into the spirit of the recent insurance laws; but it seems from the reports that the increase of children's labor, the night-work of women, and the prolonged hours of labor of women and children in certain places, are the next subjects connected with German labor that call for legislative regulation and interference.

— The attempt is being made to organize a debating club in the American Geographical Society for the purpose of discussing geographical questions and results of new investigations. It is hoped that all cultivators of geophysics, geography, commercial geography, and allied sciences, as well as teachers of geography and those interested in its study, will join the club. All intending to become

members of the club will please send their names and addresses to Dr. F. Boas, 47 Lafayette Place, New York.

—Mr. Montagu Kerr has left for Zanzibar to undertake a journey of some venture across Africa. Mr. Kerr has already done good work in Africa, in the journey which he made, almost single-handed, from the Cape to the Zambesi and Lake Nyassa, partly through new country and among some very troublesome tribes, whom he managed with great tact. In his present expedition, which he undertakes entirely at his own charge, Mr. Kerr means to proceed through Massai-land to the north end of Victoria Nyanza, and thence to Emin Pacha's station at Wadelai. His further course will be to some extent guided by Emin Pacha's advice; but his present intention is to proceed westwards to the Lake Chad region, where he hopes to do some good exploring work, and then, if possible, go on to the Niger and descend that river. Mr. Kerr has a strong letter of recommendation from the Marquis of Salisbury to the British consul at Zanzibar. It is possible that when he reaches Zanzibar Mr. Kerr may meet Mr. Stanley, or at least hear of the results of his mission, and may thus be led somewhat to modify his plans. But whatever course he may take, if he keeps his health, he is pretty sure to do some good work. He has, since his return from his last expedition, done every thing possible to qualify himself for scientific observation, and is quite prepared to pass muster as a Mohammedan in the most fanatical Moslem districts. Mr. Kerr is furnished with a set of instruments by the Royal Geographical Society. All who know him have confidence in his pluck and discretion.

—In the October *Monthly Weather Review*, the long drought of 1887 is discussed. During the six months from May to October inclusive, the rainfall has been largely deficient over the district between Dakota, Michigan, Kentucky, and Kansas. Less than one-half the usual amount of rainfall during these months has fallen in central Ohio. Less than three-fourths of the average amount of rain has fallen during these few months from Michigan, Ohio, and Kentucky westward, to include Missouri and Iowa. Of special interest is a compilation of excessive rainfalls in the month of October for a series of from ten to sixteen years. In a letter to the *Engineering News*, General Greely says, "It is the intention of this office to continue this discussion by months. A systematic effort has been made to make the data for succeeding months more complete and full than for October. In addition, the chief signal-officer has issued instructions to the observers, calling their especial attention to heavy rainfalls." The *Engineering News*, in an editorial, had emphasized the importance of measurements of heavy rainfalls; and in reply to this the chief signal-officer writes, that if the engineers of the country are in earnest about this matter, and will persuade Congress to appropriate twenty-five hundred or three thousand dollars for the purpose of buying self-registering rain-gauges, efforts will be made to spend the money economically, and to distribute the gauges so as to completely cover the country. It is very desirable that the plan should be carried out, as these observations, in connection with the gauge measurements published in the reports of the chief of engineers, would be highly valuable from a scientific as well as from a practical point of view, as the interval between excessive rainfalls and floods and the influence of the character of the rainfall upon that of the flood is of eminent importance for the low parts of the country and for the construction of roads, canals, and other works.

—The first number of *The American Geologist* has just been issued. It is stated in the prospectus that the journal will be devoted to geology in its widest sense, and to allied sciences in all those directions where their special investigations bear directly upon the constitution and history of the globe. A journal of this character will be highly welcomed by all interested in the subject; and, as the amount of geological work done in North America is very great, it will undoubtedly flourish, and become indispensable to students of American geology. The continuous increase in the number of journals devoted to special sciences is highly gratifying, as it is proof of a rapid progress of science, and as it prevents the scattering of investigations in one branch of science through numerous journals. The editors are Prof. S. Calvin, T. W. Claypole, Dr. Persifer Frazer, Dr. L. E. Hicks, E. O. Ulrich, Dr. A. Winchell, and

Prof. N. H. Winchell. It is published in Minneapolis. The first number contains interesting communications on the International Congress of Geologists, on geological problems and observations in Minnesota and Iowa, editorial comments, and a review of recent literature.

LETTERS TO THE EDITOR.

. Correspondents are requested to be as brief as possible. The writer's name is in all cases required as proof of good faith.

Twenty copies of the number containing his communication will be furnished free to any correspondent on request.

The editor will be glad to publish any queries consonant with the character of the journal.

The Mechanism of the Flight of Birds.

THE subject of the interesting letter by my friend Prof. J. S. Newberry in a late number of *Science* is an extremely important one, which has lately been discussed before the National Academy of Sciences and the Linnaean Society of New York, by Professor Newberry, Professor Trowbridge, and others. Much as I regret my absence on those occasions, I am still more sorry to be obliged to dissent without qualification from the position taken by these gentlemen, which is, to my knowledge, quite untenable. Since the matter has been published, I crave permission to state the facts in the case, and incidentally to present the very curious history of the discovery of the remarkable mechanism of flexion and extension in birds' wings, involving what I would call the 'precession and recession of the radius along the ulna.'

First. With regard to the alleged locking of the primaries: 1. It does not take place; 2. Did it take place, flight would be impossible.

Second. Extension of the carpo-metacarpus upon the antebrachium is automatically effected whenever the antebrachium is extended upon the brachium; and, conversely, flexion of the carpo-metacarpus upon the antebrachium is automatically effected whenever the antebrachium is flexed upon the brachium. In other words, the elbow and wrist of a bird work together, and neither can be bent or straightened to any considerable extent without the other being also bent or straightened. This motion, be it observed, in the cubito-carpal joint, is not flexion and extension in the usual technical sense of those terms, but is the movement commonly called, as in human anatomy, adduction and abduction. Moreover, the peculiar movement of the cubital bones (radius and ulna) which produces pronation and supination (as in man and many other mammals which use their fore-paws as hands) is reduced to a minimum, if not absolutely *nil*, in a bird's wing. It is just these points: (a) substitution of adduction and abduction for flexion and extension; (b) substitution of the lengthwise sliding back and forth of the radius along the ulna, or recession and precession, for that rolling sidewise of the radius upon the ulna which is pronation and supination; and (c) the reciprocal interaction of the elbow and wrist-joint,—it is just these points, I aver, which are the gist of the peculiar mechanism of birds' wings, so far as the bones themselves are concerned.

All these points are fully described, and illustrated by figures, in two of my works; namely, 'Proceedings of the American Association for the Advancement of Science, for 1871' (vol. xx., pub. 1872, pp. 278-284); and 'Key to North American Birds' (2d edition, 1884, pp. 106 seq.).

Third. The history of the case is curious, showing the quadrupled discovery of the precession and recession of the radius by four independent observers: (a) Bergmann (1839), (b) Wyman (1855), (c) Coues (1871), (d) Garrod (1875). To take these up in reverse order:—

(d) GARROD (A.H.), 'On a Point in the Mechanism of the Bird's Wing,' *Proceedings of the Zoological Society*, Feb. 16, 1875, pp. 82-84. [The gist of the paper is the peculiar sliding motion of the radius along the ulna. Garrod writes as an independent discoverer, as no doubt he was, or he would of course have referred to the previous writers.]

(c) COUES (E.), 'On the Mechanism of Flexion and Extension in Birds' Wings,' *Proceedings of the American Association for the Advancement of Science*, xx. for 1871, pub. 1872, pp. 278-284; abstract in *American Naturalist*, v. 1871, pp. 513, 514; reproduced in substance, *Key to North American Birds*, 1884, pp. 106 seq. [See text above. The writer, like Garrod, was ignorant when he made the discovery that any one had preceded him.]

(b) WYMAN (J.) [Remarks on a duck's wing, etc.] *Proceedings Boston Society of Natural History*, v. 1855, p. 169. [As I say in my 'Bibliography,' *Bull. U.S. Geogr. Surv. Terr.*, v. 1880, p. 952, this is a paper "showing mechanism of flexion and extension, contributing to fixity of the limb, independently of muscular action." Wyman evidently discovered it himself, and was ignorant of Bergmann's discovery.]

(a) BERGMANN (Dr. C.), 'Ueber die Bewegungen von Radius und Ulna am Vogelflügel,' Müller's *Archiv f. Anat. u. Phys.*, vi. 1839, pp. 296-300. [This is an important, interesting, and so far as I know a novel paper on the peculiar mechanism of the fore-arm of birds, before mentioned in none of the works of Meckel, Cuvier, Tudemann, Wagner, etc. The sum of his paper is, that sliding motion lengthwise of the bones, whereby extension of the fore-arm upon the arm, and flexion of the same, respectively reproduce the same movements at the wrist.]

The last four paragraphs are extracted from my 'Bibliography of Ornithology,' most of which is still unpublished.

It is fortunate that the mechanism of the wing does not permit the primaries to lock in the manner that has been supposed, for, if it did so, birds could not fly.

One point more, and I hasten to conclude remarks that I wish were not necessarily so ungracious. The 'fixing of the wing' of a mortally wounded bird, in the manner described by Professor Newberry, does not bear on the case. It is simply a muscular rigidity, due to nervous shock, and of a part with the convulsive muscular action which, under similar circumstances, results in the well-known 'towering' of hard-hit birds. ELLIOTT COUES.

Smithsonian Institution, Washington, Dec. 21.

THE recent discovery of the power possessed by soaring birds to set their wings when fully expanded, and to remain locked independent of muscular action, explains to my mind a phenomenon that has puzzled me for many years. It has been my custom for many seasons to spend a few days each fall duck-shooting at the lakes bordering the Illinois River in central Illinois. The birds were almost invariably shot in mid-air, while flying rapidly by, and often, when not killed at once, they would set their wings and sail gradually down to the water or ground, which they would reach dead, the distance being from one hundred yards to a quarter of a mile, apparently corresponding to the height of the bird when shot. And it was a maxim with duck-shooters on these lakes, "That bird is killed, for he has set his wings."

Besides the ducks, I have seen this phenomenon illustrated in the wild turkey and prairie-hen. In wing-shooting the wild turkey, if it set its wings, and gradually came to the earth a quarter of a mile or more away, we always marked the spot, well expecting to find the dead body when we reached it. With Mr. J. S. Newberry, I trust that some student of anatomy will take up this subject, and demonstrate it to a certainty. W. S. STRODE, M.D.

Bernadotte, Ill., Dec. 22.

Eskimo and Indian.

CONSIDERING the intimate knowledge of the Eskimo language possessed by the two gentlemen who have passed their criticisms upon my remarks on the subject of the past relations of the Eskimo and the Indian, it would be of little avail for me to enter into any lengthy argument upon the matter, although I still consider that there is room for difference on many of the points raised. On a later occasion, I intend elsewhere to treat the subject, both in its ethnographic and philological aspects, on somewhat broader lines than in the article referred to. The evidence in favor of some relation in the past between the Eskimo and the Iroquois seems to me to be convincing, aside altogether from philological data. Kohlmeister and Kmoch (p. 37) state that there is a legend among the Eskimo that the "Greenlanders originally came from Canada, and settled on the outermost islands of the coast, but never penetrated into the country before they were driven eastward to Greenland." Dr. Brinton (in his *Myths of the New World*, p. 24, note) says, "It is curious that the traditions of the *Tuscaroras*, who placed their arrival on the Virginia coast at about 1300, spoke of the race they found there (called *Tacci* or *Dogi*) as eaters of raw flesh, and ignorant of maize." Dr. Rink (*Tales and Traditions of the*

Eskimo, p. 11) has the following interesting passage *in rem*: "In the most remote ages the Eskimo, on their trading expeditions, appear to have overpassed their present southern limits. This may be gathered partly from *pure Eskimo words* being found in the language of more southern tribes, partly from the sagas of the old Scandinavians, who seem to have met travelling Eskimo, even to the south of Newfoundland." With regard to the general subject, M. Petitot ('*De la prétendue origine orientale des Algonkins*,' *Bull. Soc. d'Anthrop. de Paris*, vii. p. 248) expresses himself thus: "Ce qui est bien certain c'est que les *Inini* ne sont pas sans posséder de nombreux rapports de moeurs, de coutumes, de physionomie, de traditions, et même de langue avec leurs voisins les *Pieds-Noirs* les *Tetes-Plates*, et même avec les *Esquimaux*." Elsewhere the same writer observes, "Il n'ai pu trouver dans l'esquimaux du Mackenzie un seul mot qui provint de l'idiome *dend-dindji*. Il aura plus de corrélation grammaticale avec le *cris*, dialecte algonquin . . . si dans cette langue les pronoms ne précédaient aussi la racine verbal comme en *dndé*, au lieu de la suivre. La consonnance des mots y est à peu près la même. Dans les deux langues on remarque quantité de mots commençant par une voyelle et terminés en *ak, ik, ok, in, it*" (*Vocab. Français-Eskimaux*, Introd. p. v). This, to be sure, may not be strong evidence, but it points in a certain direction. From a comparative study of the Eskimo and Iroquois-Algonquin languages, it is certain there is much to be learned. If I have not succeeded in proving, from philological evidence, relations in the past between these people, I can only wait until others shall have done so. Mr. Murdoch has referred to the lack of phonetic vocabularies, and the errors consequent upon the use of such as are at present available. Surely, all the blame cannot be laid upon investigators, who endeavor to do good work with poor material. A glance at the 'Eskimo Bibliography,' lately compiled by Mr. Pilling, is sufficient to convince one that a very great portion of Eskimo linguistic material (and presumably the most valuable, because the most recent and scientific) is still in manuscript in the Library of the Bureau of Ethnology and other great institutions. When this shall have been published, and so distributed throughout the continent, so as to insure facility of access to students, then, I trust, the evidence of past relations between the Eskimo and Indian will be forthcoming, and the fact of their occurrence be capable of proof on scientific grounds. Elsewhere I have discussed the broad question of the pre-history of the Eskimo race, judging them to have been the dolichocephalic people who formerly extended over a great portion of the North American and perhaps of the South American continent. They have been intruded upon and pushed back by more warlike and aggressive races. Not a little interesting is the remarkable correspondence of the Botocudos and other South American tribes in many respects to the Eskimo; and the same remarks apply to some of the so-called 'fossil-men' of Brazil.

A. F. CHAMBERLAIN.

Toronto, Dec. 17.

Weather-Predictions.

PERHAPS it can hardly be said that there is a science of weather-prediction at the present time; yet interest in the subject is increasing, and there are several persons in this country who are issuing daily scientific forecasts. While the basis upon which forecasts shall be issued admits of little discussion, yet it is far otherwise with their verification, and it would seem that much confusion has arisen on this account. The following comparison of weather-forecasts is given with the hope that others will enter the field outlined, and that a general discussion may clear up some of the misty points. The forecasts were made during October for Boston, Mass., by Mr. Clayton at Blue Hill, and by the writer at Washington, D.C. The predictions were for 'fair,' 'rain,' and halfway between, or 'threatening.'

The verifications were to be by the observations at Boston, made at 7 A.M., 3 and 10 P.M., each day. As there was no specific record of 'threatening,' the amount of clouds was to determine this condition. The prediction was made at Blue Hill at 2 P.M. each day from an examination of the Signal Service observations made over the country at 7 A.M., together with a study of the local conditions at 2 P.M. The Washington prediction was necessarily made from the 7 A.M. observation alone. The interval predicted for was from

midnight of each day to the succeeding midnight. The following table exhibits each prediction and the weather that followed:—

Prediction.		Weather.				Prediction.		Weather.			
(1)	(2)	7	3	10	rain	(1)	(2)	7	3	10	rain
rain	rain	cloudy	cloudy	clear	.05	fair	fair	clear	clear	clear	0
rain	rain	fog	clear	cloudy	.02	fair	threat.	fair	cloudy	cloudy	.01
rain	threat.	cloudy	fair	clear	0	fair	threat.	cloudy	clear	clear	0
fair	threat.	clear	fair	cloudy	0	rain	fair	clear	cloudy	cloudy	0
fair	threat.	clear	fair	fair	0	rain	rain	lt. rain	cloudy	cloudy	.96
fair	fair	clear	fair	fair	0	fair	fair	clear	cloudy	cloudy	0
fair	fair	cloudy	cloudy	cloudy	0	fair	fair	clear	fair	clear	0
rain	rain	lt. rain	cloudy	cloudy	.76	rain	fair	cloudy	cloudy	cloudy	0
fair	fair	fair	fair	clear	0	rain	threat.	clear	clear	cloudy	0
fair	fair	fair	cloudy	clear	0	fair	fair	fair	cloudy	cloudy	0
fair	fair	clear	cloudy	clear	0	th.	fair	cloudy	cloudy	fair	0
fair	fair	clear	clear	clear	0	rain	threat.	cloudy	clear	fair	0
						th.	fair	fair	cloudy	fair	0

It will be seen that the prediction was the same in fifteen cases, and eleven of these were fully verified. In order to obtain a fair comparative estimate for the remaining ten days, the predictions and the succeeding weather were referred to Prof. I. Russell, who decided that No. (1) agreed better with the weather twice, and No. (2) eight times. If these ten be regarded half verified, we shall obtain for No. (1) 48 per cent and No. (2) 60 per cent.

The predictions were also referred to Professor Upton, who suggested two schemes for verification, by one of which he computed No. (1) 67.2 per cent, and No. (2) 69.6 per cent; and by the other, No. (1) had 61.0 per cent, and No. (2) 65.0 per cent. As Professor Upton preferred the second scheme, I give it in detail. His plan was as follows:—

Arrange all possible weather-combinations in a table, and give to each prediction a certain weight according to its position in the table, as follows:—

Weather.			Predictions.		
			fair	threatening	ra
clear	clear	clear	3	0	0
clear	clear	fair	4	1	0
clear	fair	fair	4	1	0
fair	fair	fair	4	1	0
clear	clear	cloudy	3	2	0
clear	fair	cloudy	3	2	0
fair	fair	cloudy	3	2	0
clear	cloudy	cloudy	2	3	1
fair	cloudy	cloudy	2	3	1
cloudy	cloudy	cloudy	1	4	2
trace	of	rain	0	3	3
	rain		0	2	4

In this scheme it is possible that too much weight has been given 'fair,' and too little 'threat.' However, as the prediction 'threat.' seems of doubtful utility, it should have less weight.

This discussion has brought out one fact of great interest regarding methods of verification. Mr. Clayton verified the same predictions by the observations at Blue Hill, a station very near Boston. He makes the percentage 85. This great difference of 24 per cent seems very surprising, and can hardly be due to the difference in weather at the two places. It seems probable that this difference is due to the method of verification, and that a mere percentage obtained from an arbitrary verification cannot be relied on for com-

paring the relative merits of two predictions. It is to be hoped that a further discussion of this question may lead to clearer light and understanding of the methods of prediction and verification best suited to the needs of the public.

Washington, D.C., Dec. 14.

H. A. HAZEN.

The Chinese Wall.

THE note on the Chinese wall in a late issue of *Science* (x. No. 253), calling attention to Abbé Larriue's assertion that the wall does not exist, recalled to mind Abbé Huc's account. Turning to it, I find that he was a believer in it, and with good reason. In Vol. II. of his 'Journey through Tartary, Thibet, and China,' p. 31, he gives the following account, which may interest some of your readers, and serve to correct an erroneous impression:—

"The part of the wall immediately to the north of Pekin . . . is really fine and imposing; but it must not be supposed that this barrier is equally large and solid throughout its whole extent. We have had occasion to cross it at more than fifteen different points, and have often travelled for days together without ever losing sight of it; and instead of the double battlemented stone wall which is seen at Pekin, it is sometimes a very humble-looking wall of clay; and we have even seen it reduced to its simplest expression, and composed only of stones piled up together."

Thus, though the wall may not and does not have the magnitude and solidity often attributed to it, yet in one form or another it certainly seems to exist, and is not, as we are told Abbé Larriue says, 'a huge Chinese lie.'

JOSEPH F. JAMES.

Miami Univ., Oxford, O., Dec. 20.

Tornado Force.

I SEND you some facts in relation to tornado force and its peculiarities of action, which may not be uninteresting to your readers, on either side of the question, involving the nature of the force or forces.

The tracks examined by me did not present continuous lines of destruction, but areas of destruction separated by intervals entirely or almost entirely exempt from destructive forces, from which it is inferred, that while the storm, in its common and ordinary features, pursued its way steadily onward by bodily transference, the tornadoic action was developed interruptedly, and progressed by successive transplantings.

The first area examined, tornado of April 23, 1883, was composed of two distinct parts. The first was a long rectangular space of about half a mile in length, from west-south-west to east-north-east, and a hundred and fifty to two hundred yards in width. Within this space the trees were prostrated from south-east, south, south-west, and west, and intermediate points; and, wherever two or more were found lying across each other, the one thrown from the direction nearest to east, or farthest round from west, was always at the bottom. Thus, those thrown from south always lay on top of those from south-west, those from south-west on top of those from south and south-east, and those from west were always on top of all other directions. This order was without an exception. The rectangular area terminated at the east end in an irregularly circular area of about eight hundred yards diameter, either east and west or north and south. Bisecting this area both ways, and dividing it into four quadrants, the south-west and south-east were found to correspond in all respects with the rectangular area, except that in the south-east there was a greater proportion of trees thrown down from east-south-east and south-east than in the other sections; and in the south-west quadrant, near the centre, a tree thrown from south-west was overlain by one from south, the single exception to the order noted above. In the north-east quadrant the destruction was less than in either of the others, and trees were thrown down from east, north-east, north, north-west, and west. In the north-west quadrant the trees were thrown from north, north-west, and west, chiefly from north-west, west-north-west, and west; and in the instances where they crossed each other, the order in relation to the west was similar precisely to that of the other parts, progressing from east round by north to west, as, on the other side, the progression was from east round by south to west; so that in these, the north-east and north-west quadrants, trees thrown from north-east lay under those from north, those from north under those from

north-west, while, as in the south quadrants and in the rectangular space, those from west were on top of all. The central line, west to east, through the circular area, corresponded very closely with the prolongation of a line running through the north border of the rectangular area. In the south-west quadrant a slim pine seventy to seventy-five feet high was left standing, surrounded by seven stumps or shafts varying in height from ten or fifteen to forty or more feet, and in distance from the standing tree, from five to twenty-five feet. Near the centre of the circular area two trees stood side by side, east and west of each other, and so near that their trunks at the bases could not have been more than a few inches apart, if they did not actually touch. The tree on the east side was thrown from west to east, and the other in the opposite direction, from east to west. Two pines fifty to sixty feet high and thirty to forty feet apart, one in the south-east, the other in the north-east quadrant, and about equidistant from the east and west central line dividing these quadrants, were thrown towards the central line, the one from north to south, the other from south to north (tornado of Dec. 22, 1884). They apparently fell simultaneously, and met in the fall; for their broken trunks and branches were mingled together in a confused heap, the branches of one tree undistinguishable from those of the other. The cabin of Isaac Johnson, a negro laborer, situated in the track, near the western end of the rectangular area, was partially unroofed and otherwise damaged. He stated that his table-ware—plates, spoons, knives and forks—went flying out of the door like so many birds; and after the storm he found his fanner securely poised on a stump, bottom upwards, about seventy yards from his cabin; and on the fanner lay his nutmeg-grater, as though placed there by hand (the fanner is a shallow, tray-like vessel made of straw). The trunks of some trees, pine and hickory, seemed to have been rent asunder, as by a splitting force acting within the trunks, and in these cases the upper segment was scarcely ever entirely separated from the stump; and from both stump and upper fragment, long, thin, lath-like splinters projected, some of them eight to ten feet in length, an inch or two in width, and a half to three-quarters of an inch in thickness. About half a mile to the east of the eastern terminus of this tornadic area, the second area of destruction began, and presented a rectangular area like the first, several hundred yards in length; but here the conformity with the first ended, the forces appearing to have become scattered. The circular area was undeveloped, the north-east and south-east quadrants being entirely wanting, and the north-west quadrant defective, in so far as the forces acting from north and north-west were concerned. The south-west quadrant presented patches of destruction here and there, with features similar to those of the like quadrant of the first area; and here, too, was a single exception to the order in which the forces everywhere else acted, namely, a tree thrown from south overlying one from south-west. The trees prostrated in the north-west quadrant were thrown from the same directions as those in the south-west, as though the forces acting in this section had burst through the barriers of the central line, or, finding them defective, had swept on through the north-west quadrant, thus giving a zigzag shape to this area.

Appearances seem to indicate that the work of destruction began and progressed throughout all parts of each area almost if not quite simultaneously.

During the tornado of Dec. 22, 1884, in Clarendon County, a lady, perceiving the approach of the storm, was in the act of closing a glazed door, which extended down to the floor and opened on a piazza; but before she could fasten it, the house was enveloped by the tempest, the door flew open, and she was drawn out and dashed violently against the balustrade running around the piazza, and received injuries and bruises which confined her to bed for several weeks. In the same room there was a heavy pine press, the door of which was locked. This door was burst open, torn from its hinges, and, in the language of the narrator, "shivered into kindling splinters." There was no other damage done to the house, at least none mentioned. I have examined the tracks of three tornadoes, — April 23, 1883; Feb. 19, 1884; and Dec. 22, 1884, — and they corresponded so exactly in their various parts, that the conviction is irresistible that the features described, especially those indicating the directions and order in which the forces acted, will be invariably found in the track of every tornado.

Notwithstanding the intense atmospheric disturbance, which, judging from ordinary thunder-storms, is of just such a character as to produce vast supplies of electricity, the usual electrical manifestations, lightning and thunder, are tame, and out of all proportion to the intensity of the atmospheric disturbance in the tornado as compared with an ordinary thunder-storm. In the tornado there are never, I think, any discharges from the clouds to the earth; objects are never struck by lightning; the thunder, when it occurs, is always high up among the clouds, and rolls away across the sky in long reverberating peals; showing that the static electricity is confined to the upper clouds, and the supply by no means superabundant. What, then, becomes of the electricity of the lower clouds? Does it remain dormant, or does it in some way aid in the destruction?

Stateburg, S.C.

W. W. ANDERSON, M.D.

The Study of Languages.

IN the number of *Science* issued July 8 of this year, p. 19, is the following passage: "The advantages of the ability to read an ordinary classical author without the aid of a dictionary are so obvious as to need no comment."

I was called from home immediately after reading the above, hence my delay in seeking from the writer an extended explanation of the means by which the student can read an ordinary Latin author without a dictionary.

Is there really any practical method by which he can accomplish this, except by employing his dictionary so faithfully that he has no further use for it?

I do not believe an accurate knowledge of a language can be acquired by reading at sight one page or any number of pages, unless the student comprehends the exact signification of each word as he passes it. It is true, such an exercise increases his facility in understanding the words and sentences he has already studied.

Reading aloud over and over again what one has already read, together with committing to memory poems and passages from prose authors, is, I believe, the best if not the only practical method of acquiring an ability of reading Latin or any language at sight.

H. L. E.

Chicago, Dec. 20.

Queries.

20. STAR OF BETHLEHEM. — I see paragraphs going the rounds of the papers about the 'Star of Bethlehem,' that is claimed to be a binary system, and to give its maximum light once in three hundred years. Some claim it was the star in the east, seen by the wise men. Please tell us in *Science* if there is any thing in these rumors, and, if so, where in the heavens the star can be seen.

JOHN D. PARKER.

Fort Riley, Kan., Dec. 24.

21. GLOBULAR LIGHTNING. — The following report from the Hydrographic Office relates to one of the rarest and most inexplicable forms of lightning. Can any of the readers of *Science* give any information on the subject? A globe of fire floats leisurely along in the air in an erratic sort of a course, sometimes exploding with great force, at other times disappearing without exploding. On land it has been observed to go into the ground and then reappear at a short distance, and where it entered the soil it left a rugged hole some twenty feet in diameter. Although there is no doubt as to the facts regarding the phenomenon, no satisfactory explanation of the cause has ever been given. It is, of course, entirely different in character from St. Elmo's fires, so often seen on board vessels during thunder-storms: these remain stationary at the yard-arms and mast-heads, and are analogous to the 'brush discharge' of an electric machine. Captain Moore, British steamship 'Siberian,' reports, "Nov. 12, midnight, Cape Race bearing west by north, distant ten miles, wind strong south by east, a large ball of fire appeared to rise out of the sea to a height of about fifty feet, and come right against the wind close up to the ship. It then altered its course, and ran along with the ship to a distance of about one and one-half miles. In about two minutes it again altered its course, and went away to the south-east against the wind. It lasted, in all, not over five minutes. Have noticed the same phenomenon before off Cape Race, and it seemed to indicate that an easterly or south-easterly gale was coming on."



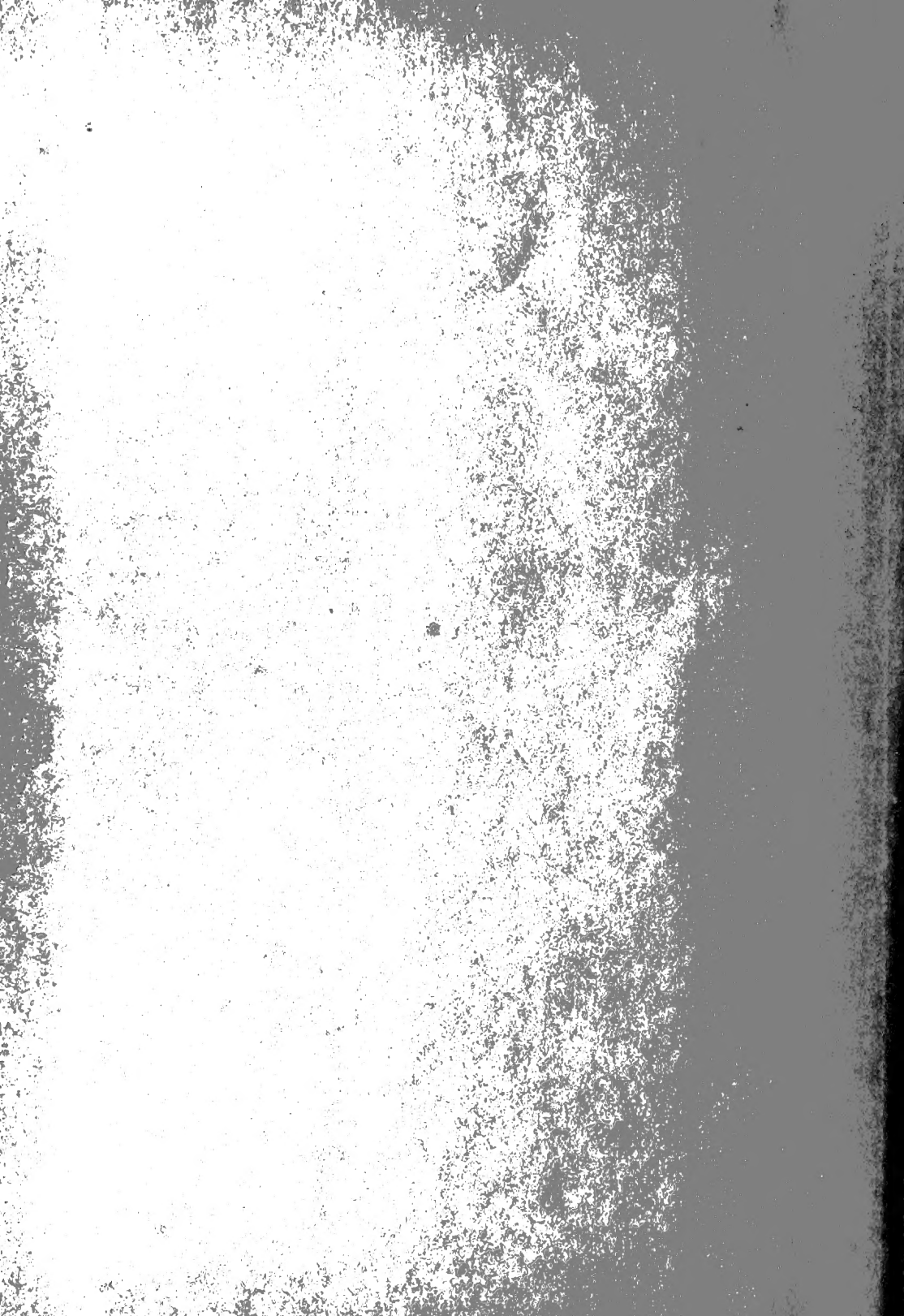

SMITHSONIAN INSTITUTION LIBRARIES



3 9088 01301 4014