

UNIVERSITY OF TORONTO

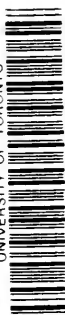

3 1761 01086234 0

Digitized by the Internet Archive
in 2007 with funding from
Microsoft Corporation



The Library
of the
David Dunlap Observatory

Presented by

Dr. C. A. Chant.

Oct. 25, 1935

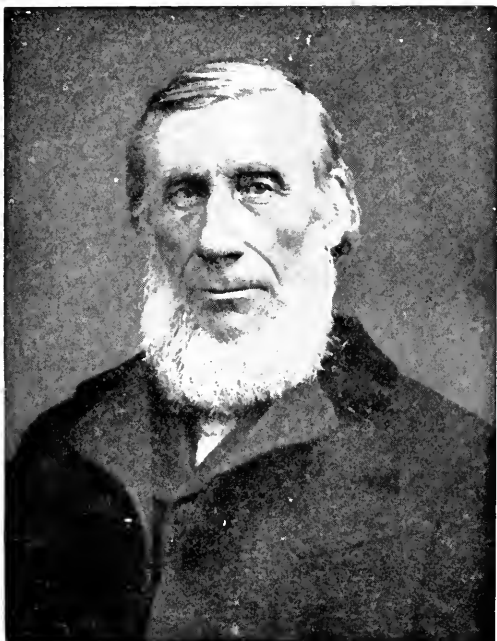
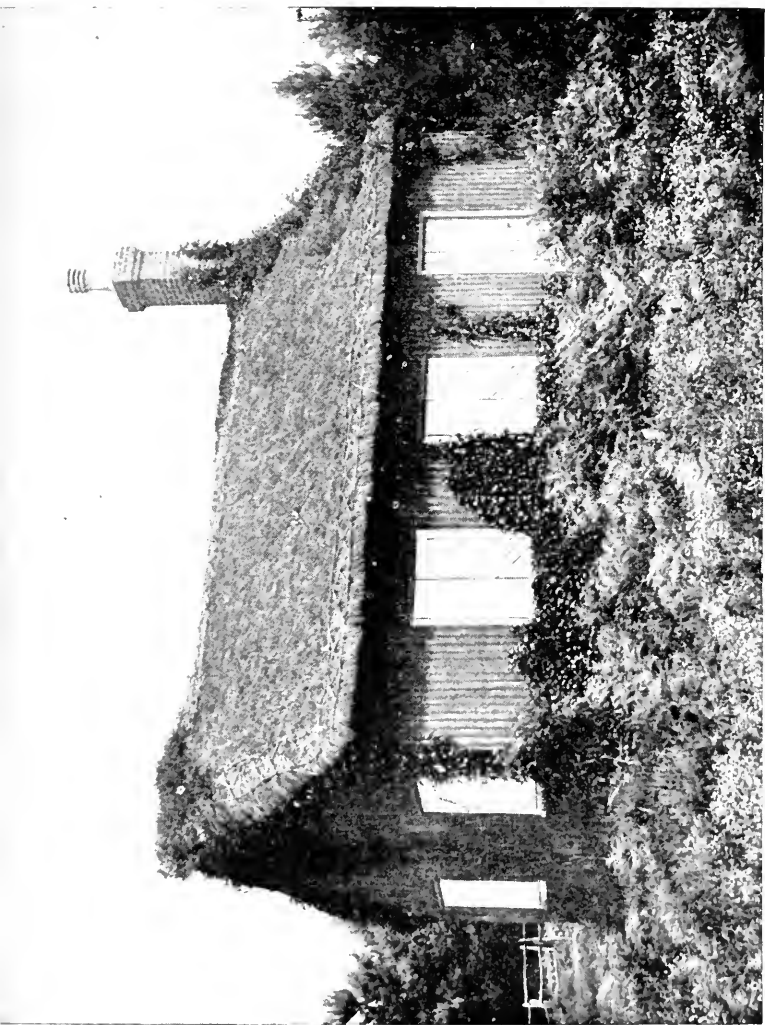

Photo Elliott & Fry

JOHN TYNDALL



PROFESSOR TYNDALL'S WORKSHOP NEAR HIS HOME AT HINDHEAD, SURREY



LIGHT

PROFESSOR JOHN TYNDALL'S WORKS.

- Essays on the Floating Matter of the Air*, in Relation to Putrefaction and Infection. 12mo. Cloth, \$1.50.
- On Forms of Water*, in Clouds, Rivers, Ice, and Glaciers. With 35 Illustrations. 12mo. Cloth, \$1.50.
- Heat as a Mode of Motion*. New edition. 12mo. Cloth, \$2.50.
- On Sound*; A Course of Eight Lectures delivered at the Royal Institution of Great Britain. Illustrated. 12mo. New edition. Cloth, \$2.00.
- Fragments of Science for Unscientific People*. 12mo. New revised and enlarged edition. Cloth, \$2.50.
- Light and Electricity*. 12mo. Cloth, \$1.25.
- Lessons in Electricity*, 1775-'76. 12mo. Cloth, \$1.00.
- Hours of Exercise in the Alps*. With Illustrations. 12mo. Cloth, \$2.00.
- Faraday as a Discoverer*. A Memoir. 12mo. Cloth, \$1.00.
- Contributions to Molecular Physics* in the Domain of Radiant Heat. \$5.00.
- Six Lectures on Light*. Delivered in America in 1872-'73. With an Appendix and numerous Illustrations. Cloth, \$1.50.
- Farewell Banquet*, given to Professor Tyndall, at Delmonico's, New York, February 4, 1873. Paper, 50 cents.
- Address* delivered before the British Association, assembled at Belfast. Revised, with Additions, by the author, since the Delivery. 12mo. Paper, 50 cents.

New York : D. APPLETON & Co., 1, 3, & 5 Bond St.



Thomas Young

SIX LECTURES ON LIGHT

DELIVERED IN AMERICA IN 1872-1873

BY

JOHN TYNDALL, D.C.L. LL.D. F.R.S.

PROFESSOR OF NATURAL PHILOSOPHY IN THE ROYAL INSTITUTION

SECOND EDITION

NEW YORK:
D. APPLETON AND COMPANY,
1, 3, AND 5 BOND STREET.
1886.

UNIVERSITY OF TORONTO LIBRARY

QC
361
T99
1886



ILLUSTRATIONS.



THOMAS YOUNG *Frontispiece*

PLUMES PRODUCED BY THE CRYSTALLIZATION OF

WATER *To face p. 249*

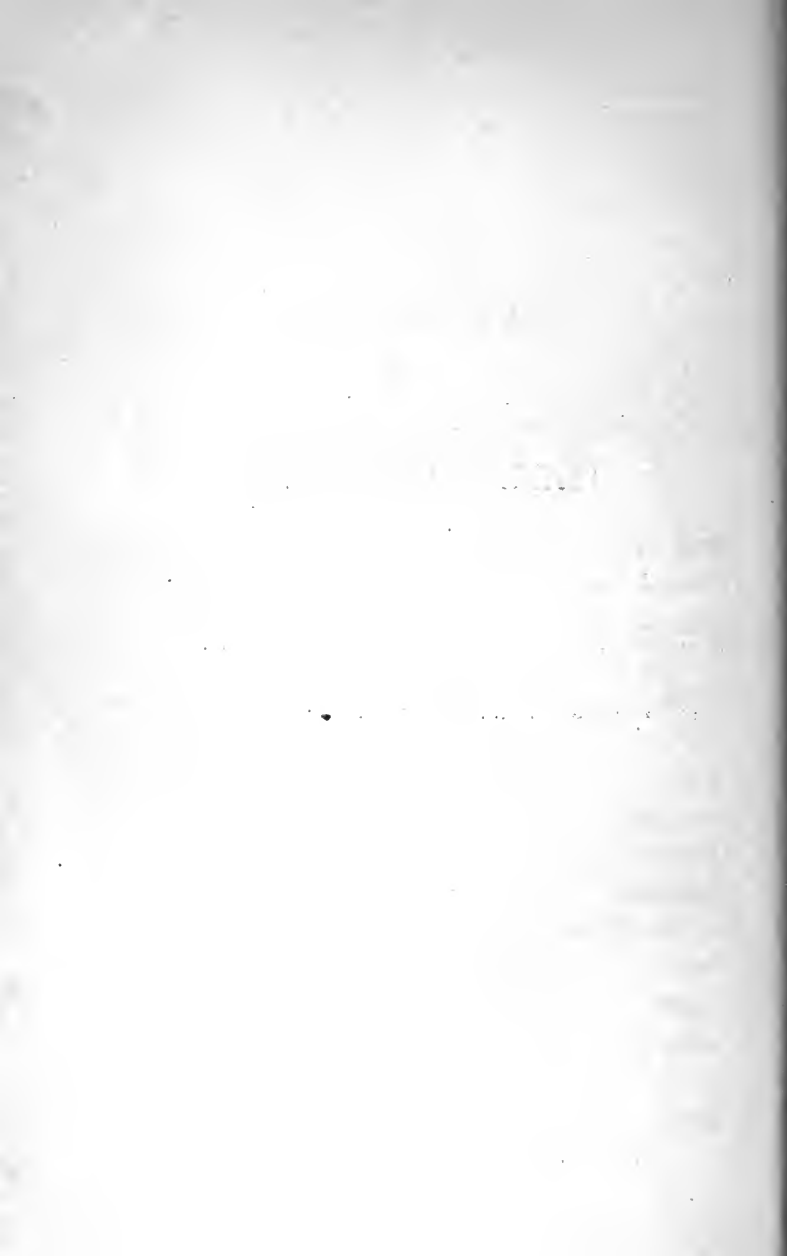

PREFACE

TO THE

SECOND ENGLISH EDITION.

THE REASONS for giving these Lectures are briefly set forth in the Introduction to the first of them; while the grounds of their publication are stated in the 'Preface to the American Edition.'

During their delivery, the experimental facts were before the audience, forming visible links in the logic of each discourse. Here, by the use of plain language, I have endeavoured to reproduce distinct images of these facts, and to show them in their proper relations.

With a view to this end I have sought to raise the Wave-theory of Light to adequate clearness in the reader's mind, and to show its power as an organizer of optical phenomena.

From what has been recently written on such questions, it is to be inferred that the origin, scope, and

warrant, of physical theories generally, constitute a theme of considerable interest to thoughtful minds. On these points I have ventured, particularly in the second and third Lectures, to state the views which my own reflections have suggested to me.

To produce a systematic treatise on Light was, of course, quite wide of my aim. My desire rather was to throw into a small compass, an exposition for which I should have been grateful at a certain period of my own studies. I wished in the first place, as the prime condition of all satisfactory progress, to clear the reader's mind of all indistinctness regarding elementary facts and conceptions; and to whet incidentally the desire for further knowledge.

I wished, moreover, for the sake of that numerous portion of the community who are interested in the material results of science, to trace effects to their causes, by showing how such results receive their primary vitalization from the thoughts of men with no material end in view. The 'Summary and Conclusion,' which might be read as an introduction, is for the most part devoted to this object. I have added in an Appendix three brief Addresses by distinguished Americans, which possess more than a passing interest.

To the first English edition of these Lectures, Dr. Young's 'Reply to the Edinburgh Reviewers' was appended. Numbers of scientific men were, to my knowledge, but imperfectly acquainted with this great

discussion; while the general public knew nothing whatever about it. The end contemplated having been gained, the 'Reply' is here omitted; and in lieu of it a portrait of Dr. Young, engraved with great success by Mr. Adlard, forms the frontispiece of the volume.

JOHN TYNDALL.

ROYAL INSTITUTION: *May* 1875.

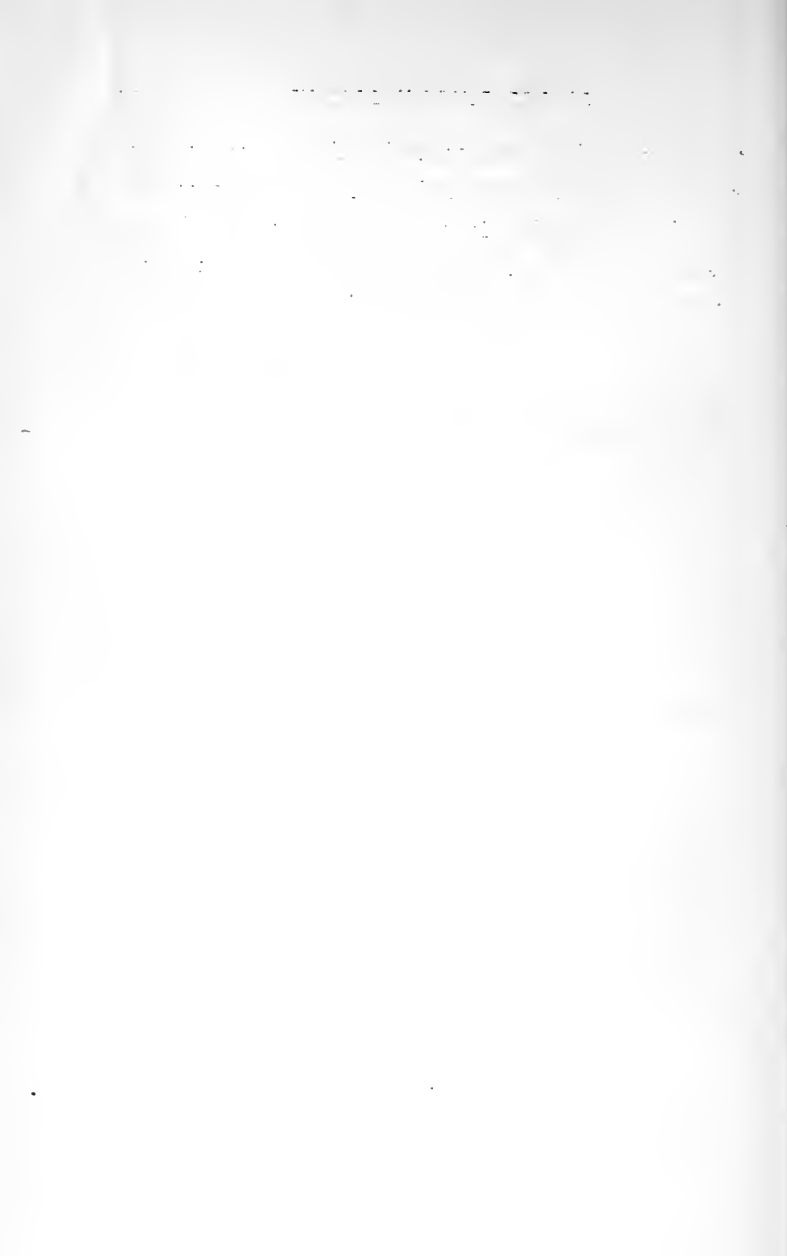

PREFACE

TO

THE AMERICAN EDITION.

MY eminent friend Professor JOSEPH HENRY, of the Smithsonian Institution, Washington, did me the honour of taking these Lectures under his personal direction, and of arranging the times and places at which they were to be delivered.

Believing that my home duties could hardly be suspended for a longer period, I did not, at the outset, expect to be able to prolong my visit to the United States beyond the end of 1872.

Thus limited as to time, Professor HENRY began in the North, and, proceeding southwards, arranged for the successive delivery of the lectures in Boston, New York, Philadelphia, Baltimore, and Washington.

By this arrangement, which circumstances at the time rendered unavoidable, the lectures in New York would have been rendered coincident with the period of the presidential election. This was deemed unsatisfac-

tory; and the fact being represented to me, I at once offered to extend the time of my visit so as to make the lectures in New York succeed those in Washington. This proposition was cordially accepted by my friends.

To me personally this modified arrangement has proved both pleasant and beneficial. It gave me a much-needed and delightful holiday at Niagara Falls; it, moreover, rendered the successive stages of my work a kind of *growth*, which reached its most impressive development in New York and Brooklyn.

My reception throughout has been that of a friend by friends; and now that my visit has become virtually a thing of the past, I look back upon it as a memory without a single stain of unpleasantness. Excepting one inexorable event, nothing has occurred that I could wish not to have occurred; while from beginning to end I have been met by expressions of good-will on the part of the American people never, on my part, to be forgotten. Indeed, 'good-will' is not the word to express the kindness manifested towards me in the United States.

Would that it had been in my power to meet the wishes of my friends more completely, by responding to the invitations sent to me from the great cities of the Interior and the West, and from Canada. But the character of the lectures, and their weight of instrumental appliances, involved such heavy labour that the need of rest alone would be a sufficient reason for my pausing here.

Besides this, each successive mail from London brings me intelligence of work suspended and duties postponed through my absence.

The Royal Institution possesses an honorary secretary who has devoted the best years of an active professional life and the best energies of a strong mind to its interests. And if anything of the kind should ever be founded here, the heartiest wish that I could offer for its success would be, that it may be served with the singleness of purpose, and self-sacrificing love, bestowed by its managers and its members on the Royal Institution; and by none more unceasingly than by Dr. BENGE JONES. But he, on whom I might rely, is now struck down by a distressing illness;¹ and, though others are willing to aid me in all possible ways, there can be no doubt as to my line of duty. I ought to be at home. I ask my friends in the Interior and the West, and in Canada, to take these things into consideration; and to think of me not as one insensible to their kindness, but as one who, with a warmth commensurate with their own, would comply with all their wishes if he could.

One other related point deserves mention. On quitting England I had no intention of publishing these Lectures, and, except a fragment or two, they were wholly unwritten when I arrived in this city. Since that time, besides lecturing in New York, Brooklyn, and New

¹ He died, working for the Institution to the last, on Sunday morning, April 20, 1873.

Haven, the Lectures have been written out and carried through the Press. Many evidences of the rapidity of their production will appear; but I thought it due to those who listened to them with such unwavering attention, as also to those who wished to hear them, but were unable to do so, to leave them behind me in an approximately authentic form.

The constant application which this work rendered necessary has cut me off from many social pleasures; it has prevented me from making myself acquainted with the working of institutions in which I feel a deep interest, and from availing myself of the generous hospitality offered to me by the clubs of New York. In short, it has made me an unsociable man. But, finding social pleasure and hard work incompatible, I took the line of devoting such energy as I could command, not to the society of my intimate friends alone, but to the people of the United States.

In the opening lecture are mentioned the names of gentlemen to whom I am under lasting obligations for their friendly, and often laborious aid. The list might readily be extended, for in every city visited willing helpers were at hand. I must not, however, omit the name of Mr. RHEES, Professor HENRY'S private secretary, who not only in Washington, but in Boston, gave me most important assistance. To the Trustees of the Cooper Institute my acknowledgments are due; and to the Directors of the Mercantile Library at Brooklyn.

I would add to these a brief but grateful reference to my high-minded friend and kinsman General HECTOR TYNDALE, for his long-continued care of me, and for the thoughtful tenderness by which he and his family softened, both to me and to the parents of the youth. the grief occasioned by the death of my junior assistant in Philadelphia.

Finally, I have to mention with warm commendation the integrity, ability, and devotion with which, from first to last, I have been aided by my principal assistant, Mr. JOHN COTTRELL.

JOHN TYNDALL.

NEW YORK: *February* 1878



CONTENTS.

LECTURE I.

	PAGE
Introductory—Uses of Experiment—Early Scientific Notions— Sciences of Observation—Knowledge of the Ancients regarding <u>Light</u> —Defects of the Eye—Our Instruments—Rectilineal Pro- pagation of Light— <u>Law of Incidence and Reflection</u> —Sterility of the Middle Ages— <u>Refraction</u> —Discovery of Snell— <u>Partial and</u> <u>Total Reflection</u> — <u>Velocity of Light</u> —Rømer, Bradley, Foucault, and Fizeau—Principle of Least Action—Descartes and the Rain- bow—Newton's Experiments on the Composition of Solar Light— His Mistake regarding Achromatism—Synthesis of White Light —Yellow and Blue Lights produce White by their Mixture— Colours of Natural Bodies— <u>Absorption</u> —Mixture of Pigments contrasted with Mixture of Lights	1

LECTURE II.

Origin of Physical Theories—Scope of the Imagination—Newton and the Emission Theory—Verification of Physical Theories— The Luminiferous Ether— <u>Wave-theory of Light</u> —Thomas Young—Fresnel and Arago—Conception of Wave-motion— Interference of Waves—Constitution of Sound-waves— <u>Analogies</u> <u>of Sound and Light</u> —Illustrations of Wave-motion—Interference of Sound Waves—Optical Illustrations—Pitch and Colour— <u>Lengths of the Waves of Light</u> and Rates of Vibration of the Ether-particles—Interference of Light—Phenomena which first suggested the Undulatory Theory—Boyle and Hooke—The Colours of thin Plates—The Soap-bubble—Newton's Rings— Theory of 'Fits'—Its Explanation of the Rings—Overthrow of the Theory—Diffraction of Light—Colours produced by Diffrac- tion—Colours of Mother-of-pearl	42
--	----

LECTURE III.

	PAGE
Relation of Theories to Experience—Origin of the Notion of the Attraction of Gravitation—Notion of Polarity, how generated—Atomic Polarity—Structural Arrangements due to Polarity—Architecture of Crystals considered as an Introduction to their Action upon Light—Notion of Atomic Polarity applied to Crystalline Structure—Experimental Illustrations—Crystallization of Water—Expansion by Heat and by Cold—Department of Water considered and explained—Bearings of Crystallization on Optical Phenomena— <u>Refraction</u> — <u>Double Refraction</u> — <u>Polarization</u> —Action of Tourmaline—Character of the Beams emergent from Iceland Spar—Polarization by ordinary <u>Refraction</u> and <u>Reflection</u> —Depolarization	93

LECTURE IV.

Chromatic Phenomena produced by Crystals in Polarized Light—The Nicol Prism—Polarizer and Analyzer—Action of Thick and Thin Plates of Selenite—Colours dependent on Thickness—Resolution of Polarized Beam into two others by the Selenite—One of them more retarded than the other—Recompounding of the two Systems of Waves by the Analyzer—Interference thus rendered possible—Consequent Production of Colours—Action of Bodies mechanically strained or pressed—Action of Sonorous Vibrations—Action of Glass strained or pressed by Heat—Circular Polarization—Chromatic Phenomena produced by Quartz—The Magnetization of Light—Rings surrounding the Axes of Crystals—Biaxial and Uniaxial Crystals—Grasp of the Undulatory Theory—The Colour and Polarization of Sky-light—Generation of Artificial Skies	124
--	-----

LECTURE V.

Range of Vision not commensurate with Range of Radiation—The Ultra-violet Rays—Fluorescence—Rendering invisible Rays visible—Vision not the only Sense appealed to by the Solar and Electric Beam—Heat of Beam—Combustion by Total Beam at the Foci of Mirrors and Lenses—Combustion through Ice-lens—Ignition of Diamond—Search for the effective Rays—Sir William Herschel's Discovery of dark Solar Rays—Invisible Rays the Basis of the Visible—Detachment by a Ray-filter of the Invisible Rays from the Visible—Combustion at Dark Foci—Conversion of Heat-rays into Light-rays—Calorescence—Part

played in Nature by Dark Rays—Identity of Light and Radiant Heat—Invisible Images—Reflection, Refraction, Plane Polarization, Depolarization, Circular Polarization, Double Refraction, and Magnetization of Radiant Heat	162
---	-----

LECTURE VI.

Principles of Spectrum Analysis—Prismatic Analysis of the Light of Incandescent Vapours—Discontinuous Spectra—Spectrum Bands proved by Bunsen and Kirchhoff to be characteristic of the Vapour—Discovery of Rubidium, Cæsium, and Thallium—Relation of Emission to Absorption—The Lines of Fraunhofer—Their Explanation by Kirchhoff—Solar Chemistry involved in this Explanation—Foucault's Experiment—Principles of Absorption—Analogy of Sound and Light—Experimental Demonstration of this Analogy—Recent Applications of the Spectroscope—Summary and Conclusion	192
---	-----

APPENDIX.

President Barnard's Address	229
Professor Draper's Address	235
President White's Remarks	238
Professor Tyndall's Remarks	242
Measurement of the Waves of Light	247
Water Crystallization	249
On the Spectra of Polarized Light	250
INDEX	265

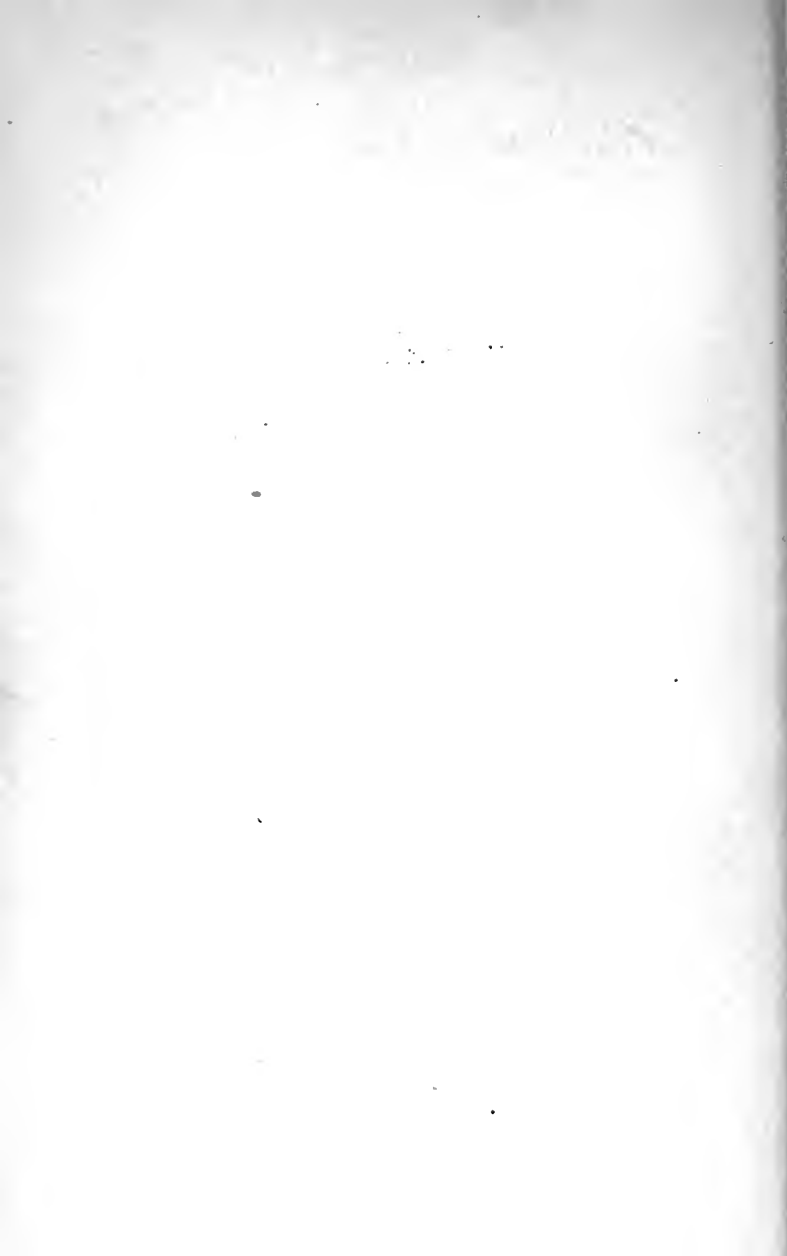

W. Campbell

ON LIGHT.

Sold to G. A. Avedon,
LECTURE I.,

W. Campbell

INTRODUCTORY—USES OF EXPERIMENT—EARLY SCIENTIFIC NOTIONS—SCIENCES OF OBSERVATION—KNOWLEDGE OF THE ANCIENTS REGARDING LIGHT—DEFECTS OF THE EYE—OUR INSTRUMENTS—RECTILINEAL PROPAGATION OF LIGHT—LAW OF INCIDENCE AND REFLECTION—STERILITY OF THE MIDDLE AGES—REFRACTION—DISCOVERY OF SNELL—PARTIAL AND TOTAL REFLECTION—VELOCITY OF LIGHT—RÖEMER, BRADLEY, FOUCAULT, AND FIZEAU—PRINCIPLE OF LEAST ACTION—DESCARTES AND THE RAINBOW—NEWTON'S EXPERIMENTS ON THE COMPOSITION OF SOLAR LIGHT—HIS MISTAKE AS REGARDS ACHROMATISM—SYNTHESIS OF WHITE LIGHT—YELLOW AND BLUE LIGHTS PRODUCE WHITE BY THEIR MIXTURE—COLOURS OF NATURAL BODIES—ABSORPTION—MIXTURE OF PIGMENTS CONTRASTED WITH MIXTURE OF LIGHTS.

§ 1. *Introduction.*

SOME twelve years ago I published, in England, a little book entitled the 'Glaciers of the Alps,' and, a couple of years subsequently, a second book, entitled 'Heat as a Mode of Motion.' These volumes were followed by others, written with equal plainness, and with a similar aim, that aim being to develope and deepen sympathy between science and the world outside of science. I agreed with thoughtful men¹ who deemed it good for neither world to be isolated from the other,

¹ Among whom may be mentioned, especially, the late Sir Edmund Head, Bart., with whom I had many conversations on this subject.

or unsympathetic towards the other, and, to lessen this isolation, at least in one department of science, I swerved aside from those original researches which had previously been the pursuit and pleasure of my life.

The works here referred to were, for the most part, republished by the Messrs. Appleton of New York,¹ under the auspices of a man who is untiring in his efforts to diffuse sound scientific knowledge among the people of the United States; whose energy, ability, and single-mindedness, in the prosecution of an arduous task, have won for him the sympathy and support of many of us in 'the old country.' I allude to Professor Youmans. Quite as rapidly as in England, the aim of these works was understood and appreciated in the United States, and they brought me from this side of the Atlantic innumerable evidences of goodwill. Year after year invitations reached me² to visit America, and last year I was honoured with a request so cordial, signed by five-and-twenty names so distinguished in science, in literature, and in administrative position, that I at once resolved to respond to it by braving not only the disquieting oscillations of the Atlantic, but the far more disquieting ordeal of appearing in person before the people of the United States.

This invitation, conveyed to me by my accomplished friend Professor Lesley, of Philadelphia, and preceded by a letter of the same purport from your scientific Nestor, the celebrated Joseph Henry, of

¹ At whose hands it gives me pleasure to state I have always experienced honourable and liberal treatment.

² One of the earliest of these came from Mr. John Amory Lowell of Boston.

Washington, desired that I would lecture in some of the principal cities of the Union. This I agreed to do, though much in the dark as to a suitable subject. In answer to my inquiries, however, I was given to understand that a course of lectures showing the uses of experiment in the cultivation of Natural Knowledge would materially promote scientific education in this country. And though such lectures involved the selection of weighty and delicate instruments, and their transfer from place to place, I at once resolved to meet the wishes of my friends as far as the time and means at my disposal would allow.

§ 2. *Subject of the Course. Source of Light employed.*

Experiments have two great uses—a use in discovery and verification, and a use in tuition. They were long ago defined as the investigator's language addressed to Nature, to which she sends intelligible replies. These replies, however, usually reach the questioner in whispers too feeble for the public ear. But after the discoverer comes the teacher, whose function it is so to exalt and modify the experiments of his predecessor as to render them fit for public presentation. This secondary function I shall endeavour, in the present instance, to fulfil.

I propose to take a single department of natural philosophy, and illustrate, by means of it, the growth of scientific knowledge under the guidance of experiment. I wish, in this first lecture, to make you acquainted with certain elementary phenomena; then to point out to you how those theoretic principles by which phenomena are explained, take root, and flourish

in the human mind, and afterwards to apply these principles to the whole body of knowledge covered by the lectures. The science of optics lends itself to this mode of treatment, and on it, therefore, I propose to draw for the materials of the present course. It will be best to begin with the few simple facts regarding light which were known to the ancients, and to pass from them in historic gradation to the more abstruse discoveries of modern times.

All our notions of Nature, however exalted or however grotesque, have some foundation in experience. The notion of personal volition in Nature had this basis. In the fury and the serenity of natural phenomena the savage saw the transcript of his own varying moods, and he accordingly ascribed these phenomena to beings of like passions with himself, but vastly transcending him in power. Thus the notion of *causality*—the assumption that natural things did not come of themselves, but had unseen antecedents—lay at the root of even the savage's interpretation of Nature. Out of this bias of the human mind to seek for the antecedents of phenomena all science has sprung.

We will not now go back to man's first intellectual gropings; much less shall we enter upon the thorny discussion as to how the groping man arose. We will take him at a certain stage of his development, when, by evolution or sudden endowment, he became possessed of the apparatus of thought and the power of using it. For a time—and that historically a long one—he was limited to mere observation, accepting what Nature offered, and confining intellectual action to it alone. The apparent motions of sun and stars first drew towards them the questionings of the intellect, and accordingly astro-

onomy was the first science developed. Slowly, and with difficulty, the notion of natural forces took root in the human mind. Slowly, and with difficulty, the science of mechanics had to grow out of this notion; and slowly at last came the full application of mechanical principles to the motions of the heavenly bodies. We trace the progress of astronomy through Hipparchus and Ptolemy; and, after a long halt, through Copernicus, Galileo, Tycho Brahe, and Kepler; while from the high table-land of thought raised by these men Newton shoots upward like a peak, overlooking all others from his dominant elevation.

But other objects than the motions of the stars attracted the attention of the ancient world. Light was a familiar phenomenon, and from the earliest times we find men's minds busy with the attempt to render some account of it. But without experiment, which belongs to a later stage of scientific development, little progress could be made in this subject. The ancients, accordingly, were far less successful in dealing with light than in dealing with solar and stellar motions. Still they did make some progress. They satisfied themselves that light moved in straight lines; they knew also that light was reflected from polished surfaces, and that the angle of incidence of the *rays* of light was equal to the angle of reflection. These two results of ancient scientific curiosity constitute the starting-point of our present course of lectures.

But in the first place it will be useful to say a few words regarding the source of light to be employed in our experiments. The rusting of iron is, to all intents and purposes, the slow burning of iron. It develops

heat, and, if the heat be preserved, a high temperature may be thus attained. The destruction of the first Atlantic cable was probably due to heat developed in this way. Other metals are still more combustible than iron. You may light strips of zinc in a candle flame, and cause them to burn almost like strips of paper. But we must now expand our definition of combustion, including under this term not only combustion in air, but also combustion in liquids. Water, for example, contains a store of oxygen, which may unite with and consume a metal immersed in it; it is from this kind of combustion that we are to derive the heat and light employed in our present course.

The generation of this light and of this heat merits a moment's attention. Before you is an instrument—a small voltaic battery—in which zinc is immersed in a suitable liquid. An attractive force is at this moment exerted between the metal and the oxygen of the liquid; actual union, however, being in the first instance avoided. Uniting the two ends of the battery by a thick wire, the attraction is satisfied, the oxygen unites with the metal, zinc is consumed, and heat, as usual, is the result of the combustion. A power which, for want of a better name, we call an electric current, passes at the same time through the wire.

Cutting the thick wire in two, let the severed ends be united by a thin one. It glows with a white heat. Whence comes that heat? The question is well worthy of an answer. Suppose in the first instance, when the thick wire is employed, that we permit the action to continue until 100 grains of zinc are consumed, the amount of heat generated in the battery would be

capable of accurate numerical expression. Let the action then continue, with the thin wire glowing, until 100 grains of zinc are consumed. Will the amount of heat generated in the battery be the same as before? No, it will be less by the precise amount generated in the thin wire outside the battery. In fact, by adding the internal heat to the external, we obtain for the combustion of 100 grains of zinc a total which never varies. We have here a beautiful example of that law of constancy as regards natural energies, the establishment

FIG. 1.

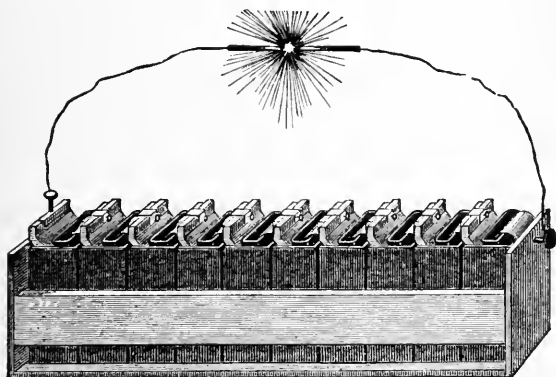

of which is the greatest achievement of modern scientific philosophy. By this arrangement, then, we are able to burn our zinc at one place, and to exhibit the effects of its combustion at a distance. In New York, for example, we may have our grate and fuel; but the heat and light of our fire may be made to appear at San Francisco.

Removing the thin wire and attaching to the severed ends of the thick one two rods of coke, we obtain, on bringing the rods together (as in fig. 1), a small star of

light. Now, the light to be employed in our lectures is a simple exaggeration of this star. Instead of being produced by ten cells, it is produced by fifty. Placed in a suitable camera, provided with a suitable lens, this powerful source will give us all the light necessary for our experiments.

And here, in passing, I am reminded of the common delusion that the works of Nature, the human eye included, are theoretically perfect. The eye has grown for ages *towards* perfection; but ages of perfecting may be still before it. Looking at the dazzling light from our large battery, I see a luminous globe, but entirely fail to see the shape of the coke-points whence the light issues. The cause may be thus made clear: On the screen before you is projected an image of the carbon points, the *whole* of the lens in front of the camera being employed to form the image. It is not sharp, but surrounded by a halo which nearly obliterates the carbons. This arises from an imperfection of the lens, called its *spherical aberration*, due to the fact that the circumferential and central rays have not the same focus. The human eye labours under a similar defect, and from this and other causes it arises that when the naked light from fifty cells is looked at, the blur of light upon the retina is sufficient to destroy the definition of the retinal image of the carbons. A long list of indictments might indeed be brought against the eye—its opacity, its want of symmetry, its lack of achromatism, its absolute blindness, in part. All these taken together caused Helmholtz to say that, if any optician sent him an instrument so full of defects, he would be justified in sending it back with the severest censure. But the eye is not to be judged from the

stand-point of theory. It is not perfect, as I have said, but on its way to perfection. As a practical instrument, and taking the adjustments by which its defects are neutralized into account, it must ever remain a marvel to the reflecting mind.

§ 3. *Rectilineal Propagation of Light. Elementary Experiments. Law of Reflection.*

The ancients were aware of the rectilineal propagation of light. They knew that an opaque body, placed between the eye and a point of light, intercepted the light of the point. Possibly the terms 'ray' and 'beam' may have been suggested by those straight spokes of light which, in certain states of the atmosphere, dart from the sun at his rising and his setting. The rectilineal propagation of light may be illustrated by permitting the solar light to enter by a small aperture in a window-shutter a dark room in which a little smoke has been diffused. In pure *air* you cannot see the beam, but in smoke you can, because the light, which passes unseen through the air, is scattered and revealed by the smoke particles, among which the beam pursues a straight course.

The following instructive experiment depends on the rectilineal propagation of light. Make a small hole in a closed window-shutter, before which stands a house or a tree, and place within the darkened room a white screen at some distance from the orifice. Every straight ray proceeding from the house or tree stamps its colour upon the screen, and the sum of all the rays will, therefore, be an image of the object. But, as the rays cross each other at the orifice, the image is inverted. At present we may illustrate and expand the subject thus :

In front of our camera is a large opening (L, fig. 2), from which the lens has been removed, and which is closed at present by a sheet of tin-foil. Pricking by means of a common sewing-needle a small aperture in the tin-foil, an inverted image of the carbon-points starts forth upon the screen. A dozen apertures will give a dozen images, a hundred a hundred, a thousand a thousand. But, as the apertures come closer to each other, that is to say, as the tin-foil between the apertures vanishes, the images overlap more and more.

FIG. 2.

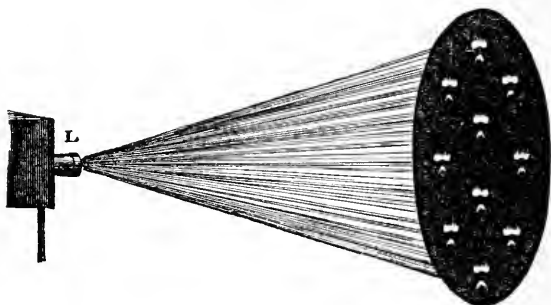

Removing the tin-foil altogether, the screen becomes uniformly illuminated. Hence the light upon the screen may be regarded as the overlapping of innumerable images of the carbon-points. In like manner the light upon every white wall on a cloudless day may be regarded as produced by the superposition of innumerable images of the sun.

The law that the angle of incidence is equal to the angle of reflection has a bearing upon a theory, to be subsequently mentioned, which renders its simple illustration here desirable. A straight lath (pointing to

the figure 5 in fig. 3) is fixed as an index perpendicular to a small looking-glass (M) capable of rotation. A beam of light is first received upon the glass and reflected back along the line of its incidence. The index being turned, the mirror turns along with it, and at each side of the index the incident and the reflected beams (L o, o R) track themselves through the dust of the room. The mere inspection of the two angles

FIG. 3.

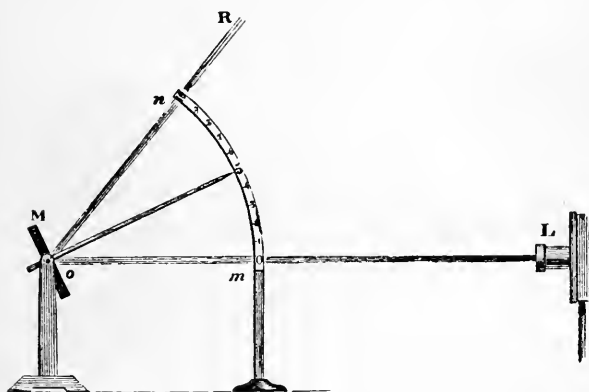

enclosed between the index and the two beams suffices to show their equality, while if the graduated quadrant be consulted, the arc from 5 to m is found accurately equal to the arc from 5 to n . A card placed edgewise upon a table without inclination to the right or to the left is said to be perpendicular to the plane of the table. The complete expression of the law of reflection is that the angles of incidence and reflection are equal; and that the incident and reflected rays always lie in a plane perpendicular to the reflecting surface.

This simple apparatus enables us to illustrate another

law of great practical importance, namely, that, when a mirror rotates, the angular velocity of a beam reflected from it is twice that of the reflecting mirror. A simple experiment will make this plain. The arc ($m n$, fig. 3) before you is divided into ten equal parts, and when the incident beam and the index cross the zero of the graduation, both the incident and reflected beams are horizontal. Moving the index of the mirror to 1, the reflected beam cuts the arc at 2; moving the index to 2, the arc is cut at 4; moving the index to 3, the arc is cut at 6; moving the index to 4, the arc is cut at 8; finally, moving the index to 5, the arc is cut at 10 (as in the figure). In every case the reflected beam moves through twice the angle passed over by the mirror.

One of the problems of science, on which scientific progress mainly depends, is to help the senses of man, by carrying them into regions which could never be attained without such help. Thus we arm the eye with the telescope when we want to sound the depths of space, and with the microscope when we want to explore motion and structure in their infinitesimal dimensions. Now, this law of angular reflection, coupled with the fact that a beam of light possesses no weight, gives us the means of magnifying small motions to an extraordinary degree. Thus, by attaching mirrors to his suspended magnets, and by watching the images of divided scales reflected from the mirrors, the celebrated Gauss was able to detect the slightest thrill of variation on the part of the earth's magnetic force. By a similar arrangement the feeble attractions and repulsions of the diamagnetic force have been made manifest. The minute elongation of a bar of metal by the mere warmth

of the hand may be so magnified by this method as to cause the index-beam to move through 20 or 30 feet. The lengthening of a bar of iron when it is magnetized may be also thus demonstrated. Helmholtz long ago employed this method to render evident to his students the classical experiments of Du Bois Raymond on animal electricity; while in Sir William Thomson's reflecting galvanometer the principle receives one of its latest, and most important applications.

§ 4. *The Refraction of Light. Total Reflection.*

For more than a thousand years no step was taken in optics beyond this law of reflection. The men of the Middle Ages, in fact, endeavoured on the one hand to develop the laws of the universe *à priori* out of their own consciousness, while many of them were so occupied with the concerns of a future world that they looked with a lofty scorn on all things pertaining to this one. Speaking of the natural philosophers of his time, Eusebius says, 'It is not through ignorance of the things admired by them, but through contempt of their useless labour, that we think little of these matters, turning our souls to the exercise of better things.' So also Lactantius—'To search for the causes of things; to inquire whether the sun be as large as he seems; whether the moon is convex or concave; whether the stars are fixed in the sky, or float freely in the air; of what size and of what material are the heavens; whether they be at rest or in motion; what is the magnitude of the earth; on what foundations is it suspended or balanced;—to dispute and conjecture upon such matters is just as if we chose to discuss what we think

of a city in a remote country, of which we never heard but the name.’¹

As regards the refraction of light, the course of real inquiry was resumed in 1100 by an Arabian philosopher named Alhazen. Then it was taken up in succession by Roger Bacon, Vitellio, and Kepler. One of the most important occupations of science is the determination, by precise measurements, of the quantitative relations of phenomena; the value of such measurements depending greatly upon the skill and conscientiousness of the man who makes them. Vitellio appears to have been both skilful and conscientious, while Kepler’s habit was to rummage through the observations of his predecessors, to look at them in all lights, and thus distil from them the principles which united them. He had done this with the astronomical measurements of Tycho Brahe, and had extracted from them the celebrated ‘laws of Kepler.’ He did it also with Vitellio’s measurements of refraction. But in this case he was not successful. The principle, though

¹ The spirit of those ancient heroes of the faith is still to be found in unexpected places. In the April number of the *Contemporary Review*, after describing how modern science came to be what it is, my friend Dr. Acland puts the following language into the mouth of Bishop Wilson:—‘What is surprising to me is the labour that you have taken to attain so very little. You deserve for this the utmost credit a reasonable being can desire; for you, being so accurate and so painstaking, seem well aware of the uncertainty of some of your data, and of the possible futility, therefore, of some of your conclusions. For I am told that, with all your pains, your sciences contain within them so many examples of proved errors, that, being candid men, you must often feel the material ground under your feet to be very slippery.’ Schelling thus expresses his contempt for experimental knowledge: ‘Newton’s Optics is the greatest illustration of a whole structure of fallacies, which in all its parts is founded on observation and experiment.’ There are some small imitators of Schelling still in Germany.

a simple one, escaped him, and it was first discovered by Willebrord Snell, about the year 1621.

Less with the view of dwelling upon the phenomenon itself than of introducing it in a form which will render intelligible to you, subsequently, the play of theoretic thought in Newton's mind, the fact of refraction may be here demonstrated. I will not do this by drawing the course of the beam with chalk on a black

FIG. 4.

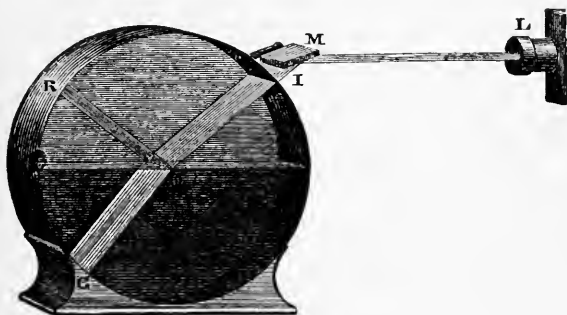

board, but by causing it to mark its own white track before you. A shallow circular vessel (R I G, fig. 4), with a glass face, half filled with water rendered barely turbid by the admixture of a little milk or the precipitation of a little mastic, is placed with its glass face vertical. By means of a small plane reflector (M), and through a slit (I) in the hoop surrounding the vessel, a beam of light is admitted in any required direction. It impinges upon the water (at O), enters it, and tracks itself through the liquid in a sharp, bright band (O G). Meanwhile the beam passes unseen through the air above the water, for the air is not competent to scatter the light. A puff of tobacco smoke into this space at

once reveals the track of the incident-beam. If the incidence be vertical, the beam is unrefracted. If oblique, its refraction at the common surface of air and water (at O) is rendered clearly visible. It is also seen that *reflection* (along O R) accompanies refraction, the beam dividing itself at the point of incidence into a refracted and a reflected portion.¹

The law by which Snell connected together all the

FIG. 5.

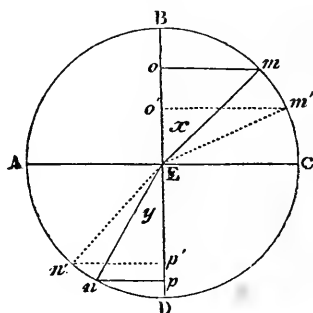

measurements executed up to his time, is this: Let A B C D (Fig. 5) represent the outline of our circular vessel, A C being the water-line. When the beam is incident along B E, which is perpendicular to A C, there is no refraction. When it is incident along m E, there is refraction: it is bent at E and strikes the circle at n. When it is incident along m' E, there is also refraction at E, the beam striking the point n'. From the ends of the incident beams, let the perpendiculars m o, m' o' be drawn upon B D, and from the

¹ It will be subsequently shown how this simple apparatus may be employed to determine the 'polarising angle' of a liquid.

ends of the refracted beams let the perpendiculars $p n$, $p' n'$ be also drawn. Measure the lengths of $o m$ and of $p n$, and divide the one by the other. You obtain a certain quotient. In like manner divide $m' o'$ by the corresponding perpendicular $p' n'$; you obtain in each case the same quotient. Snell, in fact, found this quotient to be *a constant quantity* for each particular substance, though it varied in amount from substance to substance. He called the quotient the *index of refraction*.

In all cases where the light is incident from air upon the surface of a solid or a liquid, or, more generally still, when the incidence is from a less highly refracting to a more highly refracting medium, the reflection is *partial*. In this case the most powerfully reflecting substances either transmit or absorb a portion of the incident light. At a perpendicular incidence water reflects only 18 rays out of every 1,000; glass reflects only 25 rays, while mercury reflects 666. When the rays strike the surface obliquely the reflection is augmented. At an incidence of 40° , for example, water reflects 22 rays, at 60° it reflects 65 rays, at 80° 333 rays; while at an incidence of $89\frac{1}{2}^\circ$, where the light almost grazes the surface, it reflects 721 rays out of every 1,000. Thus, as the obliquity increases, the reflection from water approaches, and finally quite overtakes, the reflection from mercury; but at no incidence, however great, when the incidence is from air, is the reflection from water, mercury, or any other substance, *total*.

Still, total reflection may occur, and with a view to understanding its subsequent application in the Nicol's prism, it is necessary to state when it occurs. This

leads me to the enunciation of a principle which underlies all optical phenomena—the principle of reversibility.¹ In the case of refraction, for instance, when the ray passes obliquely from air into water, it is bent *towards* the perpendicular; when it passes from water to air, it is bent *from* the perpendicular, and accurately reverses its course. Thus in fig. 5, if $m E n$ be the track taken by a ray in passing from air into water, $n E m$ will be its track in passing from water into air. Let us push this principle to its consequences. Supposing the light, instead of being incident along $m E$ or $m' E$, were incident as close as possible along $c E$ (fig. 6); suppose, in other words, that it just grazes the surface

FIG. 6.

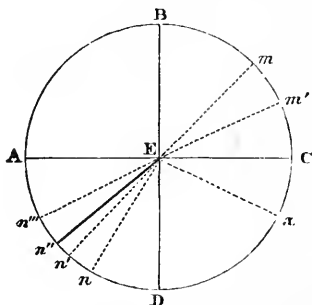

before entering the water. After refraction it will pursue the course $E n''$. Conversely, if the light start from n'' , and be incident at E , it will, on escaping into the air, just graze the surface of the water. The question now arises, what will occur supposing the ray from the water follows the course $n''' E$, which lies beyond $n'' E$? The answer is, it will not quit the water at all, but will be *totally* reflected (along $E x$). At the under surface

¹ From this principle Sir John Herschel deduces in a simple and elegant manner the fundamental law of reflection.—See *Familiar Lectures*, p. 236.

of the water, moreover, the law is just the same as at its upper surface, the angle of incidence ($\text{D E } n'''$) being here also equal to the angle of reflection ($\text{D E } x$).

Total reflection may be thus simply illustrated:— Place a shilling in a drinking-glass, and tilt the glass so that the light from the shilling shall fall with the necessary obliquity upon the water surface above it. Look upwards towards that surface, and you see the image of the shilling shining there as brightly as the shilling itself. Thrust the closed end of a glass test-tube into water, and incline the tube. When the inclination is sufficient, horizontal light falling upon the tube cannot enter the air within it, but is totally reflected upward: when looked down upon, such a tube looks quite as bright as burnished silver. Pour a little water into the tube; as the liquid rises, total reflection is abolished, and with it the lustre, leaving a gradually diminishing shining zone, which disappears wholly when the level of the water within the tube reaches that without it. Any glass tube, with its end stopped water-tight, will produce this effect, which is both beautiful and instructive.

Total reflection never occurs except in the attempted passage of a ray from a more refracting to a less refracting medium; but in this case, when the obliquity is sufficient, it always occurs. The mirage of the desert, and other phantasmal appearances in the atmosphere, are in part due to it. When, for example, the sun heats an expanse of sand, the layer of air in contact with the sand becomes lighter and less refracting than the air above it: consequently, the rays from a distant object, striking very obliquely on the surface of the heated stratum, are sometimes totally reflected upwards,

thus producing images similar to those produced by water. I have seen the image of a rock called Mont Tombeline distinctly reflected from the heated air of the strand of Normandy near Avranches; and by such delusive appearances the thirsty soldiers of the French army in Egypt were greatly tantalized.

The angle which marks the limit beyond which total reflection takes place is called the *limiting angle* (it is marked in fig. 6 by the strong line $E n''$). It must evidently diminish as the refractive index increases. For water it is $48\frac{1}{2}^{\circ}$, for flint glass $38^{\circ} 41'$, and for diamond $23^{\circ} 42'$. Thus all the light incident from two complete quadrants, or 180° , in the case of diamond, is condensed into an angular space of $47^{\circ} 22'$ (twice $23^{\circ} 42'$) by refraction. Coupled with its great refraction, are the great dispersive and great reflective powers of diamond; hence the extraordinary radiance of the gem, both as regards white light and prismatic light.

§ 5. *Velocity of Light. Aberration. Principle of least Action.*

In 1676 an impulse was given to optics by astronomy. In that year Olav Røemer, a learned Dane, was engaged at the Observatory of Paris in observing the eclipses of Jupiter's moons. The planet, whose distance from the sun is 475,693,000 miles, has four satellites. We are now only concerned with the one nearest to the planet. Røemer watched this moon, saw it move round in front of the planet, pass to the other side of it, and then plunge into Jupiter's shadow, behaving like a lamp suddenly extinguished: at the second edge of the shadow he saw it reappear, like a lamp suddenly lighted. The moon thus acted the part of a signal light to the

astronomer, and enabled him to tell exactly its time of revolution. The period between two successive lightings up of the lunar lamp he found to be 42 hours, 28 minutes, and 35 seconds.

This measurement of time was so accurate, that having determined the moment when the moon emerged from the shadow, the moment of its hundredth appearance could also be determined. In fact, it would be 100 times 42 hours, 28 minutes, 35 seconds, after the first observation.

Røemer's first observation was made when the earth was in the part of its orbit nearest Jupiter. About six months afterwards, the earth being then at the opposite side of its orbit, when the little moon ought to have made its hundredth appearance, it was found unpunctual, being fully 15 minutes behind its calculated time. Its appearance, moreover, had been growing gradually later, as the earth retreated towards the part of its orbit most distant from Jupiter. Røemer reasoned thus:—'Had I been able to remain at the other side of the earth's orbit, the moon might have appeared always at the proper instant; an observer placed there would probably have seen the moon 15 minutes ago, the retardation in my case being due to the fact that the light requires 15 minutes to travel from the place where my first observation was made to my present position.'

This flash of genius was immediately succeeded by another. 'If this surmise be correct,' Røemer reasoned, 'then as I approach Jupiter along the other side of the earth's orbit, the retardation ought to become gradually less, and when I reach the place of my first observation, there ought to be no retardation at all.' He

found this to be the case, and thus not only proved that light required time to pass through space, but also determined its rate of propagation.

The velocity of light, as determined by Rømer, is 192,500 miles in a second.

For a time, however, the observations and reasonings of Rømer failed to produce conviction. They were doubted by Cassini, Fontenelle, and Hooke. Subsequently came the unexpected corroboration of Rømer by the English astronomer, Bradley, who noticed that the fixed stars did not really appear to be fixed, but that they describe little orbits in the heavens every year. The result perplexed him, but Bradley had a mind open to suggestion, and capable of seeing, in the smallest fact, a picture of the largest. He was one day upon the Thames in a boat, and noticed that as long as his course remained unchanged, the vane upon his mast-head showed the wind to be blowing constantly in the same direction, but that the wind appeared to vary with every change in the direction of his boat. 'Here,' as Whewell says, 'was the image of his case. The boat was the earth, moving in its orbit, and the wind was the light of a star.'

We may ask in passing, what without the faculty which formed the 'image,' would Bradley's wind and vane have been to him? A wind and vane, and nothing more. You will immediately understand the meaning of Bradley's discovery. Imagine yourself in a motionless railway-train, with a shower of rain descending vertically downwards. The moment the train begins to move the rain-drops begin to slant, and the quicker the motion of the train the greater is the obliquity. In a precisely similar manner the rays from a star verti-

cally overhead are caused to slant by the motion of the earth through space. Knowing the speed of the train, and the obliquity of the falling rain, the velocity of the drops may be calculated; and knowing the speed of the earth in her orbit, and the obliquity of the rays due to this cause, we can calculate just as easily the velocity of light. Bradley did this, and the 'aberration of light,' as his discovery is called, enabled him to assign to it a velocity almost identical with that deduced by Rømer from a totally different method of observation. Subsequently Fizeau, and quite recently Cornu, employing not planetary or stellar distances, but simply the breadth of the city of Paris, determined the velocity of light: while Foucault—a man of the rarest mechanical genius—solved the problem without quitting his private room. Owing to an error in the determination of the earth's distance from the sun, the velocity assigned to light by both Rømer and Bradley is too great. With a close approximation to accuracy it may be regarded as 186,000 miles a second.

By Rømer's discovery, the notion entertained by Descartes, and espoused by Hooke, that light is propagated instantly through space, was overthrown. But the establishment of its motion through stellar space led to speculations regarding its velocity in transparent terrestrial substances. The index of refraction of a ray passing from air into water is $\frac{4}{3}$. Newton assumed these numbers to mean that the velocity of light in water being 4, its velocity in air is 3; and he deduced the phenomena of refraction from this assumption. The reverse has since been proved to be the case—that is to say, the velocity of light in water being 3, its velocity in air is 4; but both in Newton's time and ours the

same great principle determined, and determines, the course of light in all cases. In passing from point to point, whatever be the media in its path, or however it may be reflected, light takes the course which occupies *least time*. Thus in fig. 4, taking its velocity in air and in water into account, the light reaches G from I more rapidly by travelling first to O, and there changing its course, than if it proceeded straight from I to G. This is readily comprehended, because in the latter case it would pursue a greater distance through the water, which is the more retarding medium.

§ 6. *Descartes' Explanation of the Rainbow.*

Snell's law of refraction is one of the corner-stones of optical science, and its applications to-day are million-fold. Immediately after its discovery Descartes applied it to the explanation of the rainbow. A beam of solar light falling obliquely upon a rain-drop is refracted on entering the drop. It is in part reflected at the back of the drop, and on emerging it is again refracted. By these two refractions, at its entrance and at its emergence, the beam of light is decomposed, quitting the drop resolved into coloured constituents. The light thus reaches the eye of an observer facing the drop, and with his back to the sun.

Conceive a line drawn from the sun to the observer's eye, and prolonged beyond the observer. Conceive another line drawn through the eye, enclosing an angle of $42\frac{1}{2}^{\circ}$ with the line drawn from the sun, and prolonged to the falling shower. Along this second line a rain-drop, at its remote end, when struck by a sunbeam, will send a ray of red light. Every other drop similarly situated, that is, every drop at an angular distance of

$42\frac{1}{2}^{\circ}$ from the line aforesaid, will do the same. A circular band of red light is thus formed, which may be regarded as the boundary of the base of a cone, having the rays which form the band for its surface, and its apex at the observer's eye. Because of the magnitude of the sun, the angular width of this red band will be half a degree.

From the eye of the observer conceive another line to be drawn, enclosing an angle, not of $42\frac{1}{2}^{\circ}$, but of $40\frac{1}{2}^{\circ}$, with the prolongation of the line drawn to the sun. Along this line a solar beam striking a rain-drop will send violet light to the eye. All drops at the same angular distance will do the same, and we shall therefore obtain a band of violet light of the same width as the red band. These two bands constitute the limiting colours of the rainbow, and between them the bands corresponding to the other colours lie.

Thus the line drawn from the eye to the *middle* of the bow, and the line drawn through the eye to the sun, always enclose an angle of about 41° ; to account for this was the great difficulty, which remained unsolved up to the time of Descartes.

Taking a pen in hand, and calculating by means of Snell's law the track of every ray through a rain-drop, Descartes found that, at one particular angle, the rays, reflected at its back, emerged from the drop *almost parallel to each other*. They were thus enabled to preserve their intensity through long atmospheric distances. At all other angles the rays quitted the drop *divergent*, and through this divergence became so enfeebled as to be practically lost to the eye. The angle of parallelism here referred to was that of forty-one degrees, which observation had proved to be invariably associated with the rainbow.

From what has been said, it is clear that two observers standing beside each other, or one above the other, nay, that even the two eyes of the same observer, do not see exactly the same bow. The position of the base of the cone changes with that of its apex. And here we have no difficulty in answering a question often asked—namely, whether a rainbow is ever seen reflected in water. Seeing two bows, the one in the heavens, the other in the water, you might be disposed to infer that the one bears the same relation to the other that a tree upon the water's edge bears to its reflected image. The rays, however, which reach an observer's eye after reflection, and which form a bow, would, were their course uninterrupted, converge to a point vertically under the observer, and as far below the level of the water as his eye is above it. But under no circumstances could an eye above the water-level, and one below it, see the same bow—in other words, the self-same drops of rain cannot form the reflected bow and the bow seen directly in the heavens. The reflected bow, therefore, is not, in the usual optical sense of the term, the *image* of the bow seen in the sky.

§ 7. *Analysis and Synthesis of Light. Doctrine of Colours.*

In the rainbow a new phenomenon was introduced—the phenomenon of colour. And here we arrive at one of those points in the history of science, when great men's labours so intermingle that it is difficult to assign to each worker his precise meed of honour. Descartes was at the threshold of the discovery of the composition of solar light; but for Newton was reserved the enunciation of the true law. He went

to work in this way: Through the closed window-shutter of a room he pierced an orifice, and allowed a thin sunbeam to pass through it. The beam stamped a round white image of the sun on the opposite wall of the room. In the path of this beam Newton placed a prism, expecting to see the beam refracted, but also expecting to see the image of the sun, after refraction, still round. To his astonishment, it was drawn out to an image with a length five times its breadth. It was,

FIG. 7.

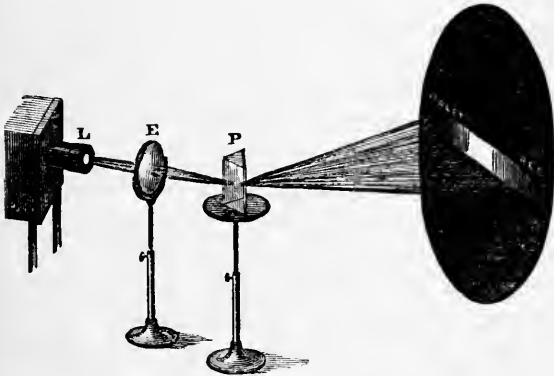

moreover, no longer white, but divided into bands of different colours. Newton saw immediately that solar light was *composite*, not simple. His elongated image revealed to him the fact that some constituents of the light were more deflected by the prism than others, and he concluded, therefore, that white solar light was a mixture of lights of different colours, of different degrees of refrangibility.

Let us reproduce this celebrated experiment. On the screen is now stamped a luminous disk, which may

stand for Newton's image of the sun. Causing the beam (from L, fig. 7) which produces the disk to pass through a lens (E) which forms an image of the aperture, and then through a prism (P), we obtain Newton's coloured image, with its red and violet ends, which he called a *spectrum*. Newton divided the spectrum into seven parts—red, orange, yellow, green, blue, indigo, violet; which are commonly called the seven primary or prismatic colours. The drawing out of the white light into its constituent colours is called *dispersion*.

This was the first *analysis* of solar light by Newton; but the scientific mind is fond of verification, and never neglects it where it is possible. Newton completed his proof by *synthesis* in this way: The spectrum now before you is produced by a glass prism. Causing the decomposed beam to pass through a second similar prism, but so placed that the colours are refracted back and reblended, the perfectly white luminous disk is restored.

In this case, refraction and dispersion are simultaneously abolished. Are they always so? Can we have the one without the other? It was Newton's conclusion that we could not. Here he erred, and his error, which he maintained to the end of his life, retarded the progress of optical discovery. Dollond subsequently proved that, by combining two different kinds of glass, the colours can be extinguished, still leaving a residue of refraction, and he employed this residue in the construction of achromatic lenses—lenses yielding no colour—which Newton thought an impossibility. By setting a water-prism—water contained in a wedge-shaped vessel with glass sides (B, fig. 8)—in

opposition to a wedge of glass (to the right of B), this point can be illustrated before you. We have first of all the position (dotted) of the unrefracted beam marked upon the screen; then we produce the narrow water-spectrum (W); finally, by introducing a flint-glass prism, we refract the beam back, until the colour disappears (at A). The image of the slit is now *white*; but though the dispersion is abolished, there remains a very sensible amount of refraction.

FIG. 8.

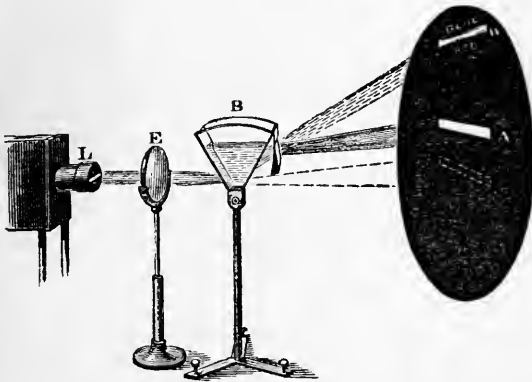

This is the place to illustrate another point bearing upon the instrumental means employed in these lectures. Bodies differ widely from each other as to their powers of refraction and dispersion. Note the position of the water-spectrum upon the screen. Altering in no particular the wedge-shaped vessel, but simply substituting for the water the transparent bisulphide of carbon, you notice how much higher the beam is thrown, and how much richer is the display of colour.

To augment the size of our spectrum we here employ (at L) a slit, instead of a circular aperture.¹

The synthesis of white light may be effected in three ways, all of which are worthy of attention: Here, in the first instance, we have a rich spectrum produced by the decomposition of the beam (from L, fig. 9). One face of the prism (P) is protected by a

FIG. 9.

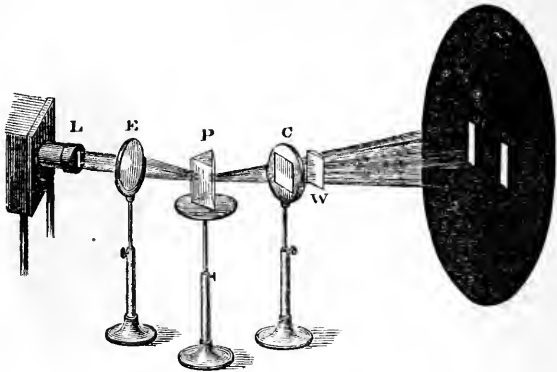

diaphragm (not shown in the figure), with a longitudinal slit, through which the beam passes into the prism.

¹ The low dispersive power of water masks, as Helmholtz has remarked, the imperfect achromatism of the eye. With the naked eye I can see a distant blue disk sharply defined, but not a red one. I can also see the lines which mark the upper and lower boundaries of a horizontally refracted spectrum sharp at the blue end, but ill-defined at the red end. Projecting a luminous disk upon a screen, and covering one semicircle of the aperture with a red and the other with a blue or green glass, the difference between the apparent sizes of the two semicircles is in my case, and in numerous other cases, extraordinary. Many persons, however, see the apparent sizes of the two semicircles reversed. If with a spectacle glass I correct the dispersion of the red light over the retina, then the blue ceases to give a sharply-defined image. Thus examined the departure of the eye from achromatism appears very gross indeed.

It emerges decomposed at the other side. I permit the colours to pass through a cylindrical lens (C), which so squeezes them together as to produce upon the screen a sharply-defined rectangular image of the longitudinal slit. In that image the colours are re-blended, and it is perfectly white. Between the prism and the cylindrical lens may be seen the colours, tracking themselves through the dust of the room. Cutting off the more refrangible fringe by a card, the rectangle is seen red; cutting off the less refrangible fringe, the rectangle is seen blue. By means of a thin glass prism (W), I deflect one portion of the colours, and leave the residual portion. On the screen are now two coloured rectangles produced in this way. These are *complementary* colours—colours which, by their union, produce white. Note that, by judicious management, one of these colours is rendered *yellow*, and the other *blue*. I withdraw the thin prism; yellow and blue immediately commingle, and we have *white* as the result of their union. On our way, then, we remove the fallacy, first exposed by Helmholtz, that the mixture of blue and yellow lights produces green.

Restoring the circular aperture, we obtain once more a spectrum like that of Newton. By means of a lens, we gather up these colours, and build them together, not to an image of the aperture, but to an image of the carbon-points themselves.

Finally, in virtue of the persistence of impressions upon the retina, by means of a rotating disk, on which are spread in sectors the colours of the spectrum, we blend together the prismatic colours in the eye itself, and thus produce the impression of whiteness.

Having unravelled the interwoven constituents of

white light, we have next to inquire, What part the constitution so revealed enables this agent to play in Nature? To it we owe all the phenomena of colour, and yet not to it alone; for there must be a certain relationship between the ultimate particles of natural bodies and white light, to enable them to extract from it the luxury of colour. But the function of natural bodies is here selective, not creative. There is no colour generated by any natural body whatever. Natural bodies have showered upon them, in the white light of the sun, the sum total of all possible colours, and their action is limited to the sifting of that total, the appropriating from it of the colours which really belong to them, and the rejecting of those which do not. It will fix this subject in your minds if I say, that it is the portion of light which they reject, and not that which belongs to them, that gives bodies their colours.

Let us begin our experimental inquiries here by asking, What is the meaning of blackness? Pass a black ribbon through the colours of the spectrum; it quenches all of them. The meaning of blackness is thus revealed—it is the result of the absorption of all the constituents of solar light. Pass a red ribbon through the spectrum. In the red light the ribbon is a vivid red. Why? Because the light that enters the ribbon is not quenched or absorbed, but in great part sent back to the eye. Place the same ribbon in the green of the spectrum; it is black as jet. It absorbs the green light, and leaves the space on which it falls a space of intense darkness. Place a green ribbon in the green of the spectrum. It shines vividly with its proper colour; transfer it to the red, it is black as jet. Here

it absorbs all the light that falls upon it, and offers mere darkness to the eye.

Thus, when white light is employed, the red sifts it by quenching the green, and the green sifts it by quenching the red, both exhibiting the residual colour. The process through which natural bodies acquire their colours is therefore a *negative* one. The colours are produced by subtraction, not by addition. This red glass is red because it destroys all the more refrangible rays of the spectrum. This blue liquid is blue because it destroys all the less refrangible rays. Both together are opaque because the light transmitted by the one is quenched by the other. In this way, by the union of two transparent substances we obtain a combination as dark as pitch to solar light. This other liquid, finally, is purple because it destroys the green and the yellow, and allows the terminal colours of the spectrum to pass unimpeded. From the blending of the blue and the red this gorgeous purple is produced.

One step further for the sake of exactness. The light which falls upon a body is divided into two portions, one of which is reflected from the surface of the body; and this is of the same colour as the incident light. If the incident light be white the superficially reflected light will also be white. Solar light, for example, reflected from the surface of even a black body, is white. The blackest camphine smoke in a dark room through which a sunbeam passes from an aperture in the window-shutter, renders the track of the beam white, by the light scattered from the surfaces of the soot particles. The moon appears to us as if

‘Clothed in white samite, mystic, wonderful;’

but were she covered with the blackest velvet she would still hang in the heavens as a white orb, shining upon our world substantially as she does now.

§ 8. *Colours of Pigments as distinguished from Colours of Light.*

The second portion of the light enters the body, and upon its treatment there the colour of the body depends. And here a moment may properly be given to the analysis of the action of pigments upon light. They are composed of particles mixed with a vehicle; but how intimately soever the particles may be blended, they still remain particles, separated it may be by exceedingly minute distances, but still separated. To use the scientific phrase, they are not optically continuous. Now, wherever optical continuity is ruptured we have reflection of the incident light. It is the multitude of reflections at the limiting surfaces of the particles that prevents light from passing through glass, or rock-salt, when these transparent substances are pounded into powder. The light here is exhausted in a waste of echoes, not extinguished by true absorption. It is the same kind of reflection that renders the thunder-cloud so impervious to light. Such a cloud is composed of particles of water mixed with particles of air, both separately transparent, but practically opaque when thus mixed together.

In the case of pigments, then, the light is *reflected* at the limiting surfaces of the particles, but it is in part *absorbed* within the particles. The reflection is necessary to send the light back to the eye; the absorption is necessary to give the body its colour. The same

remarks apply to flowers. The rose is red in virtue, not of the light reflected from its surface, but of light which has entered its substance, which has been reflected from surfaces within, and which in returning *through* the substance has had its green extinguished. A similar process in the case of hard green leaves extinguishes the red, and sends green light from the body of the leaves to the eye.

All bodies, even the most transparent, are more or less absorbent of light. Take the case of water: in small quantities it does not sensibly affect light. A glass cell of clear water interposed in the track of our beam does not perceptibly change any one of the colours of the spectrum derived from the beam. Still absorption, though insensible, has here occurred, and to render it sensible we have only to increase the depth of the water through which the light passes. Instead of a cell an inch thick, let us take a layer, ten or fifteen feet thick: the colour of the water is then very evident. By augmenting the thickness we absorb more of the light, and by making the thickness very great we absorb the light altogether. Lampblack or pitch can do no more, and the only difference between them and water is that a very small depth in their case suffices to extinguish all the light. The difference between the highest known transparency, and the highest known opacity, is one of degree merely.

If, then, we render water sufficiently deep to quench all the light; and if from the interior of the water no light reaches the eye, we have the condition necessary to produce blackness. Looked properly down upon there are portions of the Atlantic Ocean to which one would hardly ascribe a trace of colour: at the most a

tint of dark indigo reaches the eye. The water, in fact, is practically *black*, and this is an indication both of its depth and purity. But the case is entirely changed when the ocean contains solid particles in a state of mechanical suspension, capable of sending light back to the eye.

Throw, for example, a white pebble into the blackest Atlantic water; as it sinks it becomes greener and greener, and, before it disappears, it reaches a vivid blue green. Break such a pebble into fragments, these will behave like the unbroken mass: grind the pebble to powder, every particle will yield its modicum of green; and if the particles be so fine as to remain suspended in the water, the scattered light will be a uniform green. Hence the greenness of shoal water. You go to bed with the black water of the Atlantic around you. You rise in the morning, find it a vivid green, and correctly infer that you are crossing the bank of Newfoundland. Such water is found charged with fine matter in a state of mechanical suspension. The light from the bottom may sometimes come into play, but it is not necessary. The subaqueous foam generated by the screw or paddle-wheels of a steamer also sends forth a vivid green. The foam here furnishes a *reflecting surface*, the water between the eye and it the *absorbing medium*.

Nothing can be more superb than the green of the Atlantic waves when the circumstances are favourable to the exhibition of the colour. As long as a wave remains unbroken no colour appears, but when the foam just doubles over the crest like an Alpine snow-cornice, under the cornice we often see a display of the most exquisite green. It is metallic in its brilliancy. But

foam is necessary to its production. The foam is first illuminated, and it scatters the light in all directions; the light which passes through the higher portion of the wave alone reaches the eye, and gives to that portion its matchless colour. The folding of the wave, producing, as it does, a series of longitudinal protuberances and furrows which act like cylindrical lenses, introduces variations in the intensity of the light, and materially enhances its beauty.

We are now prepared for the further consideration of a point already adverted to, and regarding which error long found currency. You will find it stated in many books that blue and yellow lights mixed together produce green. But blue and yellow have been just proved to be complementary colours, producing white by their mixture. The mixture of blue and yellow *pigments* undoubtedly produces green, but the mixture of pigments is totally different from the mixture of lights.

Helmholtz has revealed the cause of the green in the case of a mixture of blue and yellow pigments. No natural colour is *pure*. A blue liquid or a blue powder permits not only the blue to pass through it, but a portion of the adjacent green. A yellow powder is transparent not only to the yellow light, but also in part to the adjacent green. Now, when blue and yellow are mixed together, the blue cuts off the yellow, the orange, and the red; the yellow, on the other hand, cuts off the violet, the indigo, and the blue. Green is the only colour to which both are transparent, and the consequence is that, when white light falls upon a mixture of yellow and blue powders, the green alone is sent back to the eye. You have already seen that the fine

blue ammonia-sulphate of copper transmits a large portion of green, while cutting off all the less refrangible light. A yellow solution of picric acid also allows the green to pass, but quenches all the more refrangible light. What must occur when we send a beam through both liquids? The experimental answer to this question is now before you: the green band of the spectrum alone remains upon the screen.

The impurity of natural colours is strikingly illustrated by an observation recently communicated to me by Mr. Woodbury. On looking through a blue glass at green leaves in sunshine, he saw the superficially reflected light blue. The light, on the contrary, which came from the body of the leaves was crimson. On examination, I found that the glass employed in this observation transmitted both ends of the spectrum, the red as well as the blue, and that it quenched the middle. This furnished an easy explanation of the effect. In the delicate spring foliage the blue of the solar light is for the most part absorbed, and a light, mainly yellowish green, but containing a considerable quantity of red, escapes from the leaf to the eye. On looking at such foliage through the violet glass, the green and the yellow are stopped, and the red alone reaches the eye. Thus regarded, therefore, the leaves appear like faintly-blushing roses, and present a very beautiful appearance. With the blue ammonia-sulphate of copper, which transmits no red, this effect is not obtained.

As the year advances the crimson gradually hardens to a coppery red; and in the dark green leaves of old ivy it is almost absent. Permitting a concentrated beam of white light to fall upon fresh leaves in a dark

room, the sudden change from green to red, and from red back to green, when the violet glass is alternately introduced across the beam and withdrawn, is very surprising. Looked at through the same glass, the meadows in May appear of a warm purple. With a solution of permanganate of potash, which, while it quenches the centre of the spectrum, permits its ends to pass more freely than the violet glass, striking effects are also obtained.¹

This question of absorption, considered with reference to its molecular mechanism, is one of the most subtle and difficult in physics. We are not yet in a condition to grapple with it, but we shall be by-and-by. Meanwhile we may profitably glance back on the web of relations which these experiments reveal to us. We have in the first place in solar light an agent of exceeding complexity, composed of innumerable constituents, refrangible in different degrees. We find, secondly, the atoms and molecules of bodies gifted with the power of sifting solar light in the most various ways, and producing by this sifting the colours observed in nature and art. To do this they must possess a molecular structure commensurate in complexity with that of light itself. Thirdly, we have the human eye and brain, so organized as to be able to take in and

¹ Both in foliage and in flowers we have striking differences of absorption. The copper beech and the green beech, for example, take in different rays. But the very growth of the tree is due to some of the rays thus taken in. Are the chemical rays, then, the same in the copper and the green beech? In two such flowers as the primrose and the violet, where the absorptions, to judge by the colours, are almost complementary, are the chemically active rays the same? The general relation of colour to chemical action is worthy of the application of the method by which Dr. Draper proved so conclusively the chemical potency of the yellow rays.

distinguish the multitude of impressions thus generated. The light, therefore, at starting is complex; to sift and select it as they do, natural bodies must be complex; while to take in the impressions thus generated, the human eye and brain, however we may simplify our conceptions of their action,¹ must be highly complex. Whence this triple complexity? If what are called material pur-

¹ Young, Helmholtz, and Maxwell reduce all differences of hue to combinations in different proportions of three primary colours. It is demonstrable by experiment that from the red, green, and violet *all* the other colours of the spectrum may be obtained.

Sir Charles Wheatstone has recently drawn my attention to a work by Christian Ernst Wünsch, Leipzig, 1792, in which the author announces the proposition that there are neither five nor seven, but only three simple colours in white light. Wünsch produces five spectra, with five prisms and five small apertures, and he mixes the colours first in pairs, and afterwards in other ways and proportions. His result is that 'red is a *simple* colour incapable of being decomposed; that orange is compounded of intense red and weak green; that yellow is a mixture of intense red and intense green; that green is a *simple* colour; that blue is compounded of saturated green and saturated violet; that indigo is a mixture of saturated violet and weak green; while violet is a pure *simple* colour. He also finds that yellow and indigo blue produce *white* by their mixture. Yellow with bright blue (hochblau) also produces white, which seems, however, to have a tinge of green, while the pigments of these two colours when mixed always give a more or less beautiful green. Wünsch very emphatically distinguishes the mixture of pigments from that of lights. Speaking of the generation of yellow, he says, 'I say expressly *red and green light*, because I am speaking about light-colours (Lichtfarben), and not about pigments.' However faulty his theories may be, Wünsch's experiments appear in the main to be precise and conclusive. Nearly ten years subsequently Young adopted red, green, and violet as the three primary colours, each of them capable of producing three sensations, one of which, however, predominates over the two others. Helmholtz adopts, elucidates, and enriches this notion. (Popular Lectures, p. 249. The beautiful paper of Helmholtz on the mixture of colours, translated by myself, is published in the 'Philosophical Magazine' for 1852. Maxwell's excellent memoir on the Theory of Compound Colours is published in the 'Philosophical Transactions,' vol. 150, p. 57.)

poses were the only end to be served, a much simpler mechanism would be sufficient. But, instead of simplicity, we have prodigality of relation and adaptation—and this apparently for the sole purpose of enabling us to see things robed in the splendours of colour. Would it not seem that Nature harboured the intention of educating us for other enjoyments than those derivable from meat and drink? At all events, whatever Nature meant—and it would be mere presumption to dogmatize as to what she meant—we find ourselves here, as the upshot of her operations, endowed with capacities to enjoy not only the materially useful, but endowed with others of indefinite scope and application, which deal alone with the beautiful and the true.

LECTURE II.

ORIGIN OF PHYSICAL THEORIES—SCOPE OF THE IMAGINATION—NEWTON AND THE EMISSION THEORY—VERIFICATION OF PHYSICAL THEORIES—THE LUMINIFEROUS ETHER—WAVE-THEORY OF LIGHT—THOMAS YOUNG—FRESNEL AND ARAGO—CONCEPTION OF WAVE-MOTION—INTERFERENCE OF WAVES—CONSTITUTION OF SOUND-WAVES—ANALOGIES OF SOUND AND LIGHT—ILLUSTRATIONS OF WAVE-MOTION—INTERFERENCE OF SOUND WAVES—OPTICAL ILLUSTRATIONS—PITCH AND COLOUR—LENGTHS OF THE WAVES OF LIGHT AND RATES OF VIBRATION OF THE ETHER-PARTICLES—INTERFERENCE OF LIGHT—PHENOMENA WHICH FIRST SUGGESTED THE UNDULATORY THEORY—BOYLE AND HOOKE—THE COLOURS OF THIN PLATES—THE SOAP-BUBBLE—NEWTON'S RINGS—THEORY OF 'FITS'—ITS EXPLANATION OF THE RINGS—OVERTHROW OF THE THEORY—DIFFRACTION OF LIGHT—COLOURS PRODUCED BY DIFFRACTION—COLOURS OF MOTHER-OF-PEARL.

§ 1. *Origin and Scope of Physical Theories.*

WE might vary and extend our experiments on Light indefinitely, and they certainly would prove us to possess a wonderful mastery over the phenomena. But the vesture of the agent only would thus be revealed, not the agent itself. The human mind, however, is so constituted and so educated, as regards natural things, that it can never rest satisfied with this outward view of them. Brightness and freshness take possession of the mind when it is crossed by the light of principles, shewing the facts of Nature to be organically connected.

Let us, then, inquire what this thing is that we

have been generating, reflecting, refracting and analyzing.

In doing this, we shall learn that the life of the experimental philosopher is twofold. He lives, in his vocation, a life of the senses, using his hands, eyes, and ears in his experiments: but such a question as that now before us carries him beyond the margin of the senses. He cannot consider, much less answer, the question, 'What is light?' without transporting himself to a world which underlies the sensible one, and out of which spring all optical phenomena. To realize this subsensible world, if I may use the term, the mind must possess a certain pictorial power. It must be able to form definite images of the things which that world contains; and to say that, if such or such a state of things exist in that world, then the phenomena which appear in ours must, of necessity, grow out of this state of things. If the picture be correct, the phenomena are accounted for; a physical theory has been enunciated which unites and explains them all.

This conception of physical theory implies, as you perceive, the exercise of the imagination. Do not be afraid of this word, which seems to render so many respectable people, both in the ranks of science and out of them, uncomfortable. That men in the ranks of science should feel thus is, I think, a proof that they have suffered themselves to be misled by the popular definition of a great faculty instead of observing its operation in their own minds. Without imagination we cannot take a step beyond the bourne of the mere animal world, perhaps not even to the edge of this one. But, in speaking thus of imagination, I do not mean a riotous power which deals capriciously with facts, but

a well-ordered and disciplined power, whose sole function is to form conceptions which the intellect imperatively demands. Imagination, thus exercised, never really severs itself from the world of fact. This is the storehouse from which the materials for all its pictures are derived; and the magic of its art consists, not in creating things anew, but in so changing the magnitude, position, and other relations of sensible things, as to render them fit for the requirements of the intellect in the subsensible world.¹

Descartes imagined space to be filled with something that transmitted light *instantaneously*. Firstly, because, in his experience, no measurable interval was known to exist between the appearance of a flash of light, however distant, and its effect upon consciousness; and secondly, because, as far as his experience went, no physical power is conveyed from place to place without

¹ The following charming extract, bearing upon this point, was discovered and written out for me by my deeply lamented friend Dr. Bence Jones, late Hon. Secretary to the Royal Institution:

‘In every kind of magnitude there is a degree or sort to which our sense is proportioned, the perception and knowledge of which is of the greatest use to mankind. The same is the groundwork of philosophy; for, though all sorts and degrees are equally the object of philosophical speculation, yet it is from those which are proportioned to sense that a philosopher must set out in his inquiries, ascending or descending afterwards as his pursuits may require. He does well indeed to take his views from many points of sight, and supply the defects of sense by a well-regulated imagination; nor is he to be confined by any limit in space or time; but, as his knowledge of Nature is founded on the observation of sensible things, he must begin with these, and must often return to them to examine his progress by them. Here is his secure hold; and as he sets out from thence, so if he likewise trace not often his steps backwards with caution, he will be in hazard of losing his way in the labyrinths of Nature.’—(*Maclaurin: An Account of Sir I. Newton's Philosophical Discoveries. Written 1728; second edition, 1750; pp. 18, 19.*)

a vehicle. But his imagination helped itself farther by illustrations drawn from the world of fact. 'When,' he says, 'one walks in darkness with staff in hand, the moment the distant end of the staff strikes an obstacle the hand feels it. This explains what might otherwise be thought strange, that the light reaches us instantaneously from the sun. I wish thee to believe that light in the bodies that we call luminous is nothing more than a very brisk and violent motion, which, by means of the air and other transparent media, is conveyed to the eye exactly as the shock through the walking-stick reaches the hand of a blind man. This is instantaneous, and would be so even if the intervening distance were greater than that between earth and heaven. It is therefore no more necessary that anything material should reach the eye from the luminous object, than that something should be sent from the ground to the hand of the blind man when he is conscious of the shock of his staff.' The celebrated Robert Hooke first threw doubt upon this notion of Descartes, but afterwards substantially espoused it. The belief in instantaneous transmission was destroyed by the discovery of Rømer referred to in our last lecture.

§ 2. *The Emission Theory of Light.*

The case of Newton still more forcibly illustrates the position, that in forming physical theories we draw for our materials upon the world of fact. Before he began to deal with light, he was intimately acquainted with the laws of elastic collision, which all of you have seen more or less perfectly illustrated on a billiard-table. As regards the collision of sensible masses, Newton knew

the angle of incidence to be equal to the angle of reflection, and he also knew that experiment, as shewn in our last lecture (fig. 3), had established the same law with regard to light. He thus found in his previous knowledge the material for theoretic images. He had only to change the magnitude of conceptions already in his mind to arrive at the Emission Theory of Light. He supposed light to consist of elastic particles of inconceivable minuteness shot out with inconceivable rapidity by luminous bodies, and that such particles impinging upon smooth surfaces were reflected in accordance with the ordinary law of elastic collision. The fact of optical reflection certainly occurred *as if* light consisted of such particles, and this was Newton's sole justification for introducing them.

But this is not all. In another important particular, also, Newton's conceptions regarding the nature of light were influenced by his previous knowledge. He had been pondering over the phenomena of gravitation, and had made himself at home amid the operations of this universal power. Perhaps his mind at this time was too freshly and too deeply imbued with these notions to permit of his forming an unfettered judgment regarding the nature of light. Be that as it may, Newton saw in Refraction the action of an attractive force exerted on the light-particles. He carried his conception out with the most severe consistency. Dropping vertically downwards towards the earth's surface, the motion of a body is accelerated as it approaches the earth. Dropping in the same manner downwards on a horizontal surface, say through air on glass or water, the velocity of the light-particles, when they came close to the surface, was, according to Newton, also accelerated. Ap-

proaching such a surface obliquely, he supposed the particles, when close to it, to be drawn down upon it, as a projectile is drawn by gravity to the surface of the earth. This deflection was, according to Newton, the refraction seen in our last lecture (fig. 4). Finally, it was supposed that differences of colour might be due to differences in the size of the particles. This was the physical theory of light enunciated and defended by Newton; and you will observe that it simply consists in the transference of conceptions born in the world of the senses to a subsensible world.

But, though the region of physical theory lies thus behind the world of senses, the verifications of theory occur in that world. Laying the theoretic conception at the root of matters, we determine by deduction what are the phenomena which must of necessity grow out of this root. If the phenomena thus deduced agree with those of the actual world, it is a presumption in favour of the theory. If, as new classes of phenomena arise, they also are found to harmonize with theoretic deduction, the presumption becomes still stronger. If, finally, the theory confers prophetic vision upon the investigator, enabling him to predict the occurrence of phenomena which have never yet been seen, and if those predictions be found on trial to be rigidly correct, the persuasion of the truth of the theory becomes overpowering.

Thus working backwards from a limited number of phenomena, genius, by its own expansive force, reaches a conception which covers them all. There is no more wonderful performance of the intellect than this; but we can render no account of it. Like the scriptural gift of the Spirit, no man can tell whence

it cometh. The passage from fact to principle is sometimes slow, sometimes rapid, and at all times a source of intellectual joy. When rapid, the pleasure is concentrated and becomes a kind of ecstasy or intoxication. To any one who has experienced this pleasure, even in a moderate degree, the action of Archimedes when he quitted the bath, and ran naked, crying 'Eureka!' through the streets of Syracuse, becomes intelligible.

How, then, did it fare with the Emission Theory when the deductions from it were brought face to face with natural phenomena? Tested by experiment, it was found competent to explain many facts, and with transcendent ingenuity its author sought to make it account for them all. He so far succeeded, that men so celebrated as Laplace and Malus, who lived till 1812, and Biot and Brewster, who lived till our own time, were found among his disciples.

§ 3. *The Undulatory Theory of Light.*

Still, even at an early period of the existence of the Emission Theory, one or two great names were found recording a protest against it; and they furnish another illustration of the law that, in forming theories, the scientific imagination must draw its materials from the world of fact and experience. It was known long ago that sound is conveyed in waves or pulses through the air; and no sooner was this truth well housed in the mind than it was transformed into a theoretic conception. It was supposed that light, like sound, might also be the product of wave-motion. But what, in this case, could be the material forming the waves? For the

waves of sound we have the air of our atmosphere ; but the stretch of imagination which filled all space with a *luminiferous ether* trembling with the waves of light was so bold as to shock cautious minds. In one of my latest conversations with Sir David Brewster, he said to me that his chief objection to the undulatory theory of light was that he could not think the Creator guilty of so clumsy a contrivance as the filling of space with ether in order to produce light. This, I may say, is very dangerous ground, and the quarrel of science with Sir David, on this point, as with many estimable persons on other points, is, that they profess to know too much about the mind of the Creator.

This conception of an ether was advocated, and indeed applied to various phenomena of optics, by the celebrated astronomer, Huyghens. It was espoused and defended by the celebrated mathematician, Euler. They were, however, opposed by Newton, whose authority at the time bore them down. Or shall we say it was authority merely? Not quite so. Newton's preponderance was in some degree due to the fact that, though Huyghens and Euler were right in the main, they did not possess sufficient data to *prove* themselves right. No human authority, however high, can maintain itself against the voice of Nature speaking through experiment. But the voice of Nature may be an uncertain voice, through the scantiness of data. This was the case at the period now referred to, and at such a period by the authority of Newton all antagonists were naturally overborne.

Still, this great Emission Theory, which held its ground so long, resembled one of those circles which, according to your countryman Emerson, the force of

genius periodically draws round the operations of the intellect, but which are eventually broken through by pressure from behind. In the year 1773 was born, at Milverton, in Somersetshire, one of the most remarkable men that England ever produced. He was educated for the profession of a physician, but was too strong to be tied down to professional routine. He devoted himself to the study of natural philosophy, and became in all its departments a master. He was also a master of letters. Languages, ancient and modern, were housed within his brain, and, to use the words of his epitaph, 'he first penetrated the obscurity which had veiled for ages the hieroglyphics of Egypt.' It fell to the lot of this man to discover facts in optics which Newton's theory was incompetent to explain, and his mind roamed in search of a sufficient theory. He had made himself acquainted with all the phenomena of wave-motion; with all the phenomena of sound; working successfully in this domain as an original discoverer. Thus informed and disciplined, he was prepared to detect any resemblance which might reveal itself between the phenomena of light and those of wave-motion. Such resemblances he did detect; and, spurred on by the discovery, he pursued his speculations and his experiments, until he finally succeeded in placing on an immovable basis the Undulatory Theory of Light.

The founder of this great theory was Thomas Young, a name, perhaps, unfamiliar to many of you, but which ought to be familiar to you all. Permit me, therefore, by a kind of geometrical construction which I once ventured to employ in London, to give you a notion of the magnitude of this man. Let Newton stand erect in his age, and Young in his. Draw a straight

line from Newton to Young, tangent to the heads of both. This line would slope downwards from Newton to Young, because Newton was certainly the taller man of the two. But the slope would not be steep, for the difference of stature was not excessive. The line would form what engineers call a gentle gradient from Newton to Young. Place underneath this line the biggest man born in the interval between both. It may be doubted whether he would reach the line; for if he did he would be taller intellectually than Young, and there was probably none taller. But I do not want you to rest on English estimates of Young; the German, Helmholtz, a kindred genius, thus speaks of him: 'His was one of the most profound minds that the world has ever seen; but he had the misfortune to be too much in advance of his age. He excited the wonder of his contemporaries, who, however, were unable to follow him to the heights at which his daring intellect was accustomed to soar. His most important ideas lay, therefore, buried and forgotten in the folios of the Royal Society, until a new generation gradually and painfully made the same discoveries, and proved the exactness of his assertions and the truth of his demonstrations.'

It is quite true, as Helmholtz says, that Young was in advance of his age; but something is to be added which illustrates the responsibility of our public writers. For twenty years this man of genius was quenched—hidden from the appreciative intellect of his countrymen—deemed in fact a dreamer, through the vigorous sarcasm of a writer who had then possession of the public ear, and who in the *Edinburgh Review* poured ridicule upon Young and his speculations. To the cele-

brated Frenchmen Fresnel and Arago he was first indebted for the restitution of his rights; for they, especially Fresnel, remade independently, as Helmholtz says, and vastly extended his discoveries. To the students of his works Young has long since appeared in his true light, but these twenty blank years pushed him from the public mind, which became in turn filled with the fame of Young's colleague at the Royal Institution, Davy, and afterwards with the fame of Faraday. Carlyle refers to a remark of Novalis, that a man's self-trust is enormously increased the moment he finds that others believe in him. If the opposite remark be true—if it be a fact that public disbelief weakens a man's force—there is no calculating the amount of damage these twenty years of neglect may have done to Young's productiveness as an investigator. It remains to be stated that his assailant was Mr. Henry Brougham, afterwards Lord Chancellor of England.

§ 4. *Wave-motion, Interference of Waves, 'Whirlpool Rapids' of Niagara.*

Our hardest work is now before us. But the capacity for hard work depends in a great measure on the antecedent winding up of the will; I would call upon you, therefore, to gird up your loins for our coming labours. If we succeed in climbing the hill which faces us to-night, our future difficulties will not be insurmountable.

In the earliest writings of the ancients we find the notion that sound is conveyed by the air. Aristotle gives expression to this notion, and the great architect

Vitruvius compares the waves of sound to waves of water. But the real mechanism of wave-motion was hidden from the ancients, and indeed was not made clear until the time of Newton. The central difficulty of the subject was, to distinguish between the motion of the wave itself, and the motion of the particles which at any moment constitute the wave.

Stand upon the sea-shore and observe the advancing rollers before they are distorted by the friction of the bottom. Every wave has a back and a front, and, if you clearly seize the image of the moving wave, you will see that every particle of water along the front of the wave is in the act of rising, while every particle along its back is in the act of sinking. The particles in front reach in succession the crest of the wave, and as soon as the crest is passed they begin to fall. They then reach the furrow or *sinus* of the wave, and can sink no farther. Immediately afterwards they become the front of the succeeding wave, rise again until they reach the crest, and then sink as before. Thus, while the waves pass onward horizontally, the individual particles are simply lifted up and down vertically. Observe a sea-fowl, or, if you are a swimmer, abandon yourself to the action of the waves; you are not carried forward, but simply rocked up and down. The propagation of a wave is the propagation of a *form*, and not the transference of the substance which constitutes the wave.

The *length* of the wave is the distance from crest to crest, while the distance through which the individual particles oscillate is called the *amplitude* of the oscillation. You will notice that in this description the

particles of water are made to vibrate *across* the line of propagation.¹

And now we have to take a step forwards, and it is the most important step of all. You can picture two series of waves proceeding from different origins through the same water. When, for example, you throw two stones into still water, the ring-waves proceeding from the two centres of disturbance intersect each other. Now, no matter how numerous these waves may be, the law holds good that the motion of every particle of the water is the algebraic sum of all the motions imparted to it. If crest coincide with crest and furrow with furrow, the wave is lifted to a double height above its sinus; if furrow coincide with crest, the motions are in opposition, and their sum is zero. We have then *still* water. This action of wave upon wave is technically called *interference*, a term to be remembered.

To the eye of a person conversant with these principles, nothing can be more interesting than the crossing of water ripples. Through their interference the water-surface is sometimes shivered into the most beautiful mosaic, trembling rhythmically as if with a kind of visible music. When waves are skilfully generated in a dish of mercury, a strong light thrown upon the shining surface, and reflected on to a screen, reveals the motions of the liquid metal. The shape of the vessel determines the forms of the figures produced. In

¹ I do not wish to encumber the conception here with the details of the motion, but I may draw attention to the beautiful model of Prof. Lyman, wherein waves are shown to be produced by the *circular* motion of the particles. This, as proved by the brothers Weber, is the real motion in the case of water-waves.

a circular dish, for example, a disturbance at the centre propagates itself as a series of circular waves, which, after reflection, again meet at the centre. If the point of disturbance be a little way removed from the centre, the interference of the direct and reflected waves produces the magnificent chasing shown in the annexed

FIG. 10.

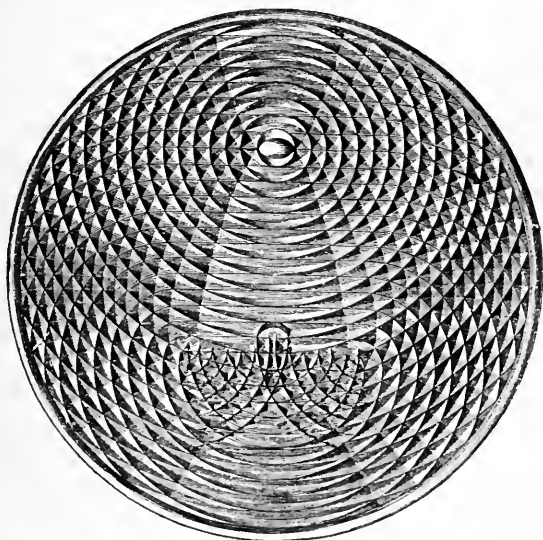

figure.¹ The light reflected from such a surface yields a pattern of extraordinary beauty. When the mercury is slightly struck by a needle-point in a direction concentric with the surface of the vessel, the lines of light run round in mazy coils, interlacing and unravelling themselves in a wonderful manner. When the vessel is square, a splendid chequer-work is produced by the

¹ Copied from Weber's *Wellenlehre*.

crossing of the direct and reflected waves. Thus, in the case of wave-motion, the most ordinary causes give rise to most exquisite effects. The words of your countryman, Emerson, are perfectly applicable here:—

‘Thou can’st not wave thy staff in the air,
Or dip thy paddle in the lake,
But it carves the brow of beauty there,
And the ripples in rhymes the oars forsake.’

The most impressive illustration of the action of waves on waves that I have ever seen occurs near Niagara. For a distance of two miles, or thereabouts, below the Falls, the river Niagara flows unruffled through its excavated gorge. The bed subsequently narrows, and the water quickens its motion. At the place called the ‘Whirlpool Rapids,’ I estimated the width of the river at 300 feet, an estimate confirmed by the dwellers on the spot. When it is remembered that the drainage of nearly half a continent is compressed into this space, the impetuosity of the river’s escape through this gorge may be imagined.

Two kinds of motion are here obviously active, a motion of translation and a motion of undulation—the race of the river through its gorge, and the great waves generated by its collision with the obstacles in its way. In the middle of the stream, the rush and tossing are most violent; at all events, the impetuous force of the individual waves is here most strikingly displayed. Vast pyramidal heaps leap incessantly from the river, some of them with such energy as to jerk their summits into the air, where they hang suspended as bundles of liquid pearls, which, when shone upon by the sun, are of indescribable beauty.

The first impression, and, indeed, the current explanation of these Rapids is, that the central bed of the river is cumbered with large boulders, and that the jostling, tossing, and wild leaping of the water there are due to its impact against these obstacles. A very different explanation occurred to me upon the spot. Boulders derived from the adjacent cliffs visibly cumber the *sides* of the river. Against these the water rises and sinks rhythmically but violently, large waves being thus produced. On the generation of each wave there is an immediate compounding of the wave-motion with the river-motion. The ridges, which in still water would proceed in circular curves round the centre of disturbance, cross the river obliquely, and the result is, that at the centre waves commingle which have really been generated at the sides. This crossing of waves may be seen on a small scale in any gutter after rain; it may also be seen on simply pouring water from a wide-lipped jug. Where crest and furrow cross each other, the wave is annulled; where furrow and furrow cross, the river is ploughed to a greater depth; and where crest and crest aid each other, we have that astonishing leap of the water which breaks the cohesion of the crests, and tosses them shattered into the air. The phenomena observed at the Whirlpool Rapids constitute, in fact, one of the grandest illustrations of the principle of interference.

§ 5. Analogies of Sound and Light.

Thomas Young's fundamental discovery in optics was that the principle of Interference was applicable to light. Long prior to his time an Italian philosopher,

Grimaldi, had stated that under certain circumstances two thin beams of light, each of which, acting singly, produced a luminous spot upon a white wall, when caused to act together, partially quenched each other and darkened the spot. This was a statement of fundamental significance, but it required the discoveries and the genius of Young to give it meaning. How he did so will gradually become clear to you. You know that air is compressible; that by pressure it can be rendered more dense, and that by dilatation it can be rendered more rare. Properly agitated, a tuning-fork now sounds in a manner audible to you all, and most of you know that the air through which the sound is passing is parcelled out into spaces in which the air is condensed, followed by other spaces in which the air is rarefied. These condensations and rarefactions constitute what we call *waves* of sound. You can imagine the air of a room traversed by a series of such waves, and you can imagine a second series sent through the same air, and so related to the first that condensation coincides with condensation and rarefaction with rarefaction. The consequence of this coincidence would be a louder sound than that produced by either system of waves taken singly. But you can also imagine a state of things where the condensations of the one system fall upon the rarefactions of the other system. In this case the two systems would completely neutralize each other. Each of them taken singly produces sound; both of them taken together produce no sound. Thus, by adding sound to sound we produce silence, as Grimaldi in his experiment produced darkness by adding light to light.

The analogy between sound and light here flashes upon the mind. Young generalized this observation. He

discovered a multitude of similar cases, and determined their precise conditions. On the assumption that light was wave-motion, all his experiments on interference were explained; on the assumption that light was flying particles, nothing was explained. In the time of Huyghens and Euler a medium had been assumed for the transmission of the waves of light; but Newton raised the objection that, if light consisted of the waves of such a medium, shadows could not

FIG. 11.

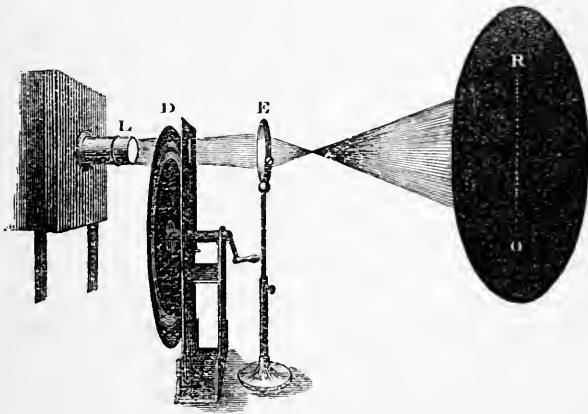

exist. The waves, he contended, would bend round opaque bodies and produce the motion of light behind them, as sound turns a corner, or as waves of water wash round a rock. It was proved that the bending round referred to by Newton actually occurs, but that the inflected waves abolish each other by their mutual interference. Young also discerned a fundamental difference between the waves of light and those of sound. Could you see the air through which sound-

waves are passing, you would observe every individual particle of air oscillating to and fro in the direction of propagation. Could you see the luminiferous ether, you would also find every individual particle making a small excursion to and fro; but here the motion, like that assigned to the water-particles above referred to, would be *across* the line of propagation. The vibrations of the air are *longitudinal*, those of the ether *transversal*.

It is my desire that you should realize with clearness the character of wave-motion, both in ether and in air. And, with this view, I bring before you an experiment wherein the air-particles are represented by small spots of light (R O, fig. 11). They are derived from a clean spiral, drawn upon a circle of blackened glass (D), so that when the circle rotates, the spots move in successive pulses over the screen.¹ In this experiment you have clearly set before you how the pulses travel incessantly forward, while their component particles perform oscillations to and fro. This is the picture of a sound-wave, in which the vibrations are longitudinal. By another glass wheel (D, fig. 12) we produce an image of a transverse wave (O R), and here we observe the waves travelling in succession over the screen, while each individual spot of light performs an excursion to and fro across the line of propagation.

Notice what follows when the glass wheel is turned very quickly. Objectively considered, the transverse waves propagate themselves as before, but subjectively the effect is totally changed. Because of the retention of impressions upon the retina, the spots of light

¹ The apparatus is constructed by that excellent acoustic mechanician, M. Rudolf König, of Paris.

simply describe a series of parallel luminous lines upon the screen, the length of these lines marking the amplitude of the vibration. Here the impression of wave-motion has totally disappeared.

The most familiar illustration of the interference of sound-waves is furnished by the *beats* produced by two musical sounds slightly out of unison. When two tuning-forks in perfect unison are agitated together

FIG. 12.

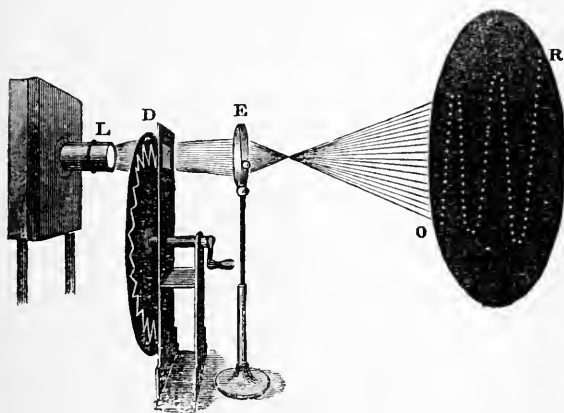

the two sounds flow without roughness, as if they were but one. But, by attaching with wax to one of the forks a little weight, we cause it to vibrate more slowly than its neighbour. Suppose that one of them performs 101 vibrations in the time required by the other to perform 100, and suppose that at starting the condensations and rarefactions of both forks coincide. At the 101st vibration of the quickest fork they will again coincide, that fork at this point having gained one whole vibration, or one whole wave-

length upon the other. But a little reflection will make it clear that, at the 50th vibration, the two forks are in opposition; here the one tends to produce a condensation where the other tends to produce a rarefaction; by the united action of the two forks, therefore, the sound is quenched, and we have a pause of silence. This occurs where one fork has gained *half a wave-length* upon the other. At the 101st vibration, as already stated, we have coincidence, and, therefore, augmented sound; at the 150th vibration we have again a quenching of the sound. Here the one fork is *three half-waves* in advance of the other. In general terms, the waves conspire when the one series is an *even* number of half-wave lengths, and they destroy each other when the one series is an *odd* number of half-wave lengths in advance of the other. With two forks so circumstanced, we obtain those intermittent shocks of sound separated by pauses of silence, to which we give the name of beats. By a suitable arrangement, moreover, it is possible to make one sound wholly extinguish another. Along four distinct lines, for example, the vibrations of the two prongs of a tuning-fork completely blot each other out.¹

The *pitch* of sound is wholly determined by the rapidity of the vibration, as the *intensity* is by the amplitude. What pitch is to the ear in acoustics, colour is to the eye in the undulatory theory of light. Though never seen, the lengths of the waves of light have been determined. Their existence is proved *by their effects*, and from their effects also their lengths may be accurately deduced. This may, moreover, be done in many

¹ Sound, 1st and 2nd ed., Lecture VII.; and 3rd ed., Chap. VIII. Longmans.

ways, and, when the different determinations are compared, the strictest harmony is found to exist between them. This consensus of evidence is one of the strongest points of the undulatory theory. The shortest waves of the visible spectrum are those of the extreme violet; the longest, those of the extreme red; while the other colours are of intermediate pitch or wave-length. The length of a wave of the extreme red is such that it would require 36,918 of them, placed end to end, to cover one inch, while 64,631 of the extreme violet waves would be required to span the same distance.

Now, the velocity of light, in round numbers, is 190,000 miles per second. Reducing this to inches, and multiplying the number thus found by 36,918, we find the number of waves of the extreme red, in 190,000 miles, to be four hundred and fifty-one millions of millions. *All these waves enter the eye, and strike the retina at the back of the eye in one second.* In a similar manner, it may be found that the number of shocks corresponding to the impression of violet is seven hundred and eighty-nine millions of millions.

All space is filled with matter oscillating at such rates. From every star waves of these dimensions move, with the velocity of light, like spherical shells in all directions. And in ether, just as in water, the motion of every particle is the algebraic sum of all the separate motions imparted to it. One motion does not blot out the other; or, if extinction occur at one point, it is strictly atoned for, by augmented motion, at some other point. Every star declares by its light its undamaged individuality, as if it alone had sent its thrill through space.

§ 6. Interference of Light.

The principle of interference, as proved by Young, applies to the waves of light as it does to the waves of water and the waves of sound. And the conditions of interference are the same in all three. If two series of light-waves of the same length start at the same moment from a common origin (say A, fig. 13), crest coincides with crest, sinus with sinus, and the two

FIG. 13.

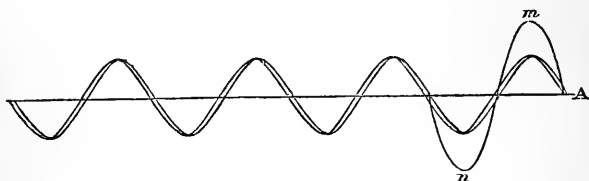

systems blend together to a single system ($A m n$) of double amplitude. If both series start at the same moment, one of them being, at starting, a whole wave-length in advance of the other, they also add themselves together, and we have an augmented luminous effect. The same occurs when the one system of waves is any *even* number of semi-undulations in advance of the other. But if the one system be half a wave-length (as at $A' a'$, fig. 14), or any *odd* number of half wave-lengths in advance, then the crests of the one fall upon the sinuses of the other; the one system, in fact, tends to *lift* the particles of ether at the precise places where the other tends to *depress* them; hence, through the joint action of these opposing forces (indicated by the arrows) the light-ether remains perfectly still. This

stillness of the ether is what we call darkness, which corresponds with a dead level in the case of water.

FIG. 14.

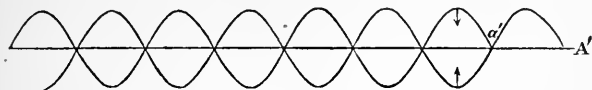

It was said in our first lecture, with reference to the colours produced by absorption, that the function of natural bodies is selective, not creative; that they extinguish certain constituents of the white solar light, and appear in the colours of the unextinguished light. It must at once flash upon your minds that, inasmuch as we have in interference an agency by which light may be self-extinguished, we may have in it the conditions for the production of colour. But this would imply that certain constituents are quenched by interference, while others are permitted to remain. This is the fact; and it is entirely due to the difference in the lengths of the waves of light.

§ 7. *Colours of thin Films. Observations of Boyle and Hooke.*

This subject may be illustrated by the class of phenomena which first suggested the undulatory theory to the mind of Hooke. These are the colours of thin transparent films of all kinds, known as the *colours of thin plates*. In this relation no object in the world possesses a deeper scientific interest than a common soap-bubble. And here let me say emerges one of the difficulties which the student of pure science encounters in the presence of 'practical' communities like those of

America and England ; it is not to be expected that such communities can entertain any profound sympathy with labours which seem so far removed from the domain of practice as many of the labours of the man of science are. Imagine Dr. Draper spending his days in blowing soap-bubbles and in studying their colours ! Would you show him the necessary patience, or grant him the necessary support ? And yet be it remembered it was thus that minds like those of Boyle, Newton and Hooke were occupied ; and that on such experiments has been founded a theory, the issues of which are incalculable. I see no other way for you, laymen, than to trust the scientific man with the choice of his inquiries ; he stands before the tribunal of his peers, and by their verdict on his labours you ought to abide.

Whence, then, are derived the colours of the soap-bubble ? Imagine a beam of white light impinging on the bubble. When it reaches the first surface of the film, a known fraction of the light is reflected back. But a large portion of the beam enters the film, reaches its second surface, and is again in part reflected. The waves from the second surface thus turn back and hotly pursue the waves from the first surface. And, if the thickness of the film be such as to cause the necessary retardation, the two systems of waves interfere with each other, producing augmented or diminished light, as the case may be.

But, inasmuch as the waves of light are of different lengths, it is plain that, to produce self-extinction in the case of the longer waves, a greater thickness of film is necessary than in the case of the shorter ones. Different colours, therefore, must appear at different thicknesses of the film.

Take with you a little bottle of spirit of turpentine, and pour it into one of your country ponds. You will then see the flashing of those colours over the surface of the water. On a small scale we produce them thus: A common tea-tray is filled with water, beneath the surface of which dips the end of a pipette. A beam of light falls upon the water, and is reflected by it to the screen. Spirit of turpentine is poured into the pipette; it descends, issues from the end in minute drops, which rise in succession to the surface. On reaching it, each drop spreads suddenly out as a film, and glowing colours immediately flash forth upon the screen. The colours change as the thickness of the film changes by evaporation. They are also arranged in zones, in consequence of the gradual diminution of thickness from the centre outwards.

Any film whatever will produce these colours. The film of air between two plates of glass squeezed together, exhibits, as shown by Hooke, rich fringes of colour. A particularly fine example of these fringes is now before you. Nor is even air necessary; the rupture of optical continuity suffices. Smite with an axe the black, transparent ice—black, because it is pure and of great depth—under the moraine of a glacier; you readily produce in the interior flaws which no air can reach, and from these flaws the colours of thin plates sometimes break like fire. But the source of most historic interest is, as already stated, the soap-bubble. With one of these mixtures employed by the eminent blind philosopher Plateau in his researches on the cohesion figures of thin films, we obtain in still air a bubble ten or twelve inches in diameter. You may look at the bubble itself, or you may look at its projection upon the screen; rich colours

arranged in zones are, in both cases, exhibited. Rendering the beam parallel, and permitting it to impinge upon the sides, bottom, and top of the bubble, gorgeous fans of colour overspread the screen, rotating as the beam is carried round the circumference of the bubble. By this experiment the internal motions of the film are also strikingly displayed.

Not in a moment are great theories elaborated: the facts which demand them are first called into prominence by observant minds; then, to the period of observation, succeeds a period of pondering and of tentative explanation. By such efforts the human mind is gradually prepared for the final theoretic illumination. The colours of thin plates, for example, occupied the attention of the celebrated Robert Boyle. In his 'Experimental History of Colours' he contends against the schools which affirmed that colour was 'a penetrative quality that reaches to the innermost parts of the object,' adducing opposing facts. 'To give you a first instance,' he says, 'I shall need but to remind you of what I told you a little after the beginning of this essay, touching the blue and red and yellow that may be produced upon a piece of tempered steel; for these colours, though they be very vivid, yet if you break the steel they adorn they will appear to be but superficial.' He then describes, in phraseology which shows the delight he took in his work, the following beautiful experiment:—

'We took a quantity of clean lead, and melted it with a strong fire, and then immediately pouring it out into a clean vessel of convenient shape and matter (we used one of iron, that the great and sudden heat might not injure it), and then carefully and nimbly

taking off the scum that floated on the top, we perceived, as we expected, the smooth and glossy surface of the melted matter to be adorned with a very glorious colour, which being as transitory as delightful, did almost immediately give place to another vivid colour, and that was as quickly succeeded by a third, and this, as it were, chased away by a fourth; and so these wonderfully vivid colours successively appeared and vanished till the metal ceasing to be hot enough to hold any longer this pleasing spectacle, the colours that chanced to adorn the surface when the lead thus began to cool remained upon it, but were so superficial that how little soever we scraped off the surface of the lead, we did, in such places, scrape off all the colour.' 'These things,' he adds, 'suggested to me some thoughts or ravings which I have not now time to acquaint you with.'¹

He extends his observations to chemical essential oils and spirit of wine, 'which being shaken till they have good store of bubbles, those bubbles will (if attentively considered) appear adorned with various and lovely colours, which all immediately vanish upon the retrogressing of the liquid which affords these bubbles their skins into the rest of the oil.' He also refers to the colours of glass films. 'I have seen one that was skilled in fashioning glasses by the help of a lamp blowing some of them so strongly as to burst them; whereupon it was found that the tenacity of the metal was such that before it broke it suffered itself to be reduced into films so extremely thin that they constantly showed upon their surfaces the varying colours of the rainbow.'²

¹ Boyle's Works, Birch's edition, p. 675.

² Page 743.

Subsequent to Boyle the colours of thin plates occupied the attention of the celebrated Robert Hooke, in whose writings we find a dawning of the undulatory theory. He describes with great distinctness the colours obtained with thin flakes of 'Muscovy glass' (talc), also those surrounding flaws in crystals where optical continuity is destroyed. He shows very clearly the dependence of the colour upon the thickness of the film, and proves by microscopic observation that plates of a uniform thickness yield uniform colours. 'If,' he says, 'you take any small piece of the Muscovy glass, and with a needle, or some other convenient instrument, cleave it oftentimes into thinner and thinner laminae, you shall find that until you come to a determinate thinness of them they shall appear transparent and colourless; but if you continue to split and divide them further, you shall find at last that each plate shall appear most lovely tinged or imbued with a determinate colour. If, further, by any means you so flaw a pretty thick piece that one part begins to cleave a little from the other, and between these two there be gotten some pellucid medium, those laminated or pellucid bodies that fill that space shall exhibit several rainbows or coloured lines, the colours of which will be disposed and ranged according to the various thicknesses of the several parts of the plate.' He then describes fully and clearly the experiment with pressed glasses already referred to:—

'Take two small pieces of ground and polished looking-glass plate, each about the bigness of a shilling: take these two dry, and with your forefingers and thumbs press them very hard and close together, and you shall find that when they approach each other

very near there will appear several irises or coloured lines, in the same manner almost as in the Muscovy glass; and you may very easily change any of the colours of any part of the interposed body by pressing the plates closer and harder together, or leaving them more lax—that is, a part which appeared coloured with a red may be presently tinged with a yellow, blue, green, purple, or the like. Any substance,' he says, 'provided it be thin and transparent, will show these colours.' Like Boyle, he obtained them with glass films; he also 'produced them with bubbles of pitch, rosin, colophony, turpentine, solutions of several gums, as gum arabic in water, any glutinous liquor, as wort, wine, spirit of wine, oyl of turpentine, glare of snails, &c.'

Hooke's writings show that even in his day the idea that both light and heat are modes of motion had taken possession of many minds. 'First,' he says, 'that all kind of *fiery burning bodies* have their parts in motion I think will be very easily granted me. That the spark struck from a flint and steel is in rapid agitation I have elsewhere made probable; . . . that heat argues a motion of the internal parts is (as I said before) generally granted; . . . and that in all extremely hot shining bodies there is a very quick motion that causes light, as well as a more robust that causes heat, may be argued from the celerity wherewith the bodies are dissolved. Next, it must be *a vibrative motion*.' His reference to the quick motion of light and the more robust motion of heat is a remarkable stroke of sagacity; but Hooke's direct insight is better than his reasoning; for the proofs he adduces that light is 'a vibrating motion' have no particular bearing upon the question.

Still the Undulatory Theory was undoubtedly dawning upon the mind of this remarkable man. In endeavouring to account for the colours of thin plates, he again refers to the relation of colour to thickness: he dwells upon the fact that the film which shows these colours must be transparent, proving this by showing that however thin an opaque body was rendered no colours were produced. 'This,' he says, 'I have often tried by pressing a small globule of mercury between two smooth plates of glass, whereby I have reduced that body to a much greater thinness than was requisite to exhibit the colours with a transparent body.' Then follows the sagacious remark that to produce the colours 'there must be a considerable reflecting body adjacent to the under or further side of the lamina or plate: for this I always found, that the greater that reflection was, the more vivid were the appearing colours. From which observations,' he continues, 'it is most evident, *that the reflection from the under or further side of the body is the principal cause of the production of these colours.*'

He draws a diagram, correctly representing the reflection at the two surfaces of the film; but here his clearness ends. He ascribes the colours to a coalescence or confusion of the two reflected pulses; the principle of interference being unknown to him, he could not go further in the way of explanation.

§ 8. *Newton's Rings. Relation of Colour to Thickness of Film.*

In this way, then, by the active operation of different minds, facts are observed, examined, and the precise

conditions of their appearance determined. All such work in science is the prelude to other work; and the efforts of Boyle and Hooke cleared the way for the optical career of Newton. He conquered the difficulty which Hooke had found insuperable, and determined by accurate measurements the relation of the thickness of the film to the colour of displays. In doing this his first care was to obtain a film of variable and calculable depth. On a plano-convex glass lens (D B E, fig. 15)

FIG. 15.



of very feeble curvature he laid a plate of glass (A C) with a plane surface, thus obtaining a film of air of gradually increasing depth from the point of contact (B) outwards. On looking at the film in monochromatic light he saw, with the delight attendant on fulfilled prevision, surrounding the place of contact a series of bright rings separated from each other by dark ones, and becoming more closely packed together as the distance from the point of contact augmented (as in fig. 16). When he employed red light, his rings had certain diameters; when he employed blue light, the diameters were less. In general terms, the more refrangible the light the smaller were the rings. Causing his glasses to pass through the spectrum from red to blue, the rings gradually contracted; when the passage was from blue to red, the rings expanded. This is a beautiful experiment, and appears to have given Newton the most lively satisfaction. When white light fell upon the glasses,

inasmuch as the colours were not superposed, a series of *iris-coloured* circles was obtained. A magnified image of *Newton's rings* is now before you, and, by employing in succession red, blue, and white light, we obtain all the effects observed by Newton. You notice that in monochromatic light the rings run closer and

FIG. 16.



closer together as they recede from the centre. This is due to the fact that at a distance the film of air thickens more rapidly than near the centre. When white light is employed, this closing up of the rings causes the various colours to be superposed, so that after a certain thickness they are blended together to white light, the rings then ceasing altogether. It needs but a moment's reflection to understand that the colours of thin plates are never unmixed or monochromatic.

Newton compared the tints obtained in this way with the tints of his soap-bubble, and he calculated the corresponding thickness. How he did this may be thus made plain to you: Suppose the water of the ocean to

be absolutely smooth ; it would then accurately represent the earth's curved surface. Let a perfectly horizontal plane touch the surface at any point. Knowing the earth's diameter, any engineer or mathematician in this room could tell you how far the sea's surface will lie below this plane, at the distance of a yard, ten yards, a hundred yards, or a thousand yards from the point of contact of the plane and the sea. It is common, indeed, in levelling operations, to allow for the curvature of the earth. Newton's calculation was precisely similar. His plane glass was a tangent to his curved one. From its refractive index and focal distance he determined the diameter of the sphere of which his curved glass formed a segment, he measured the distances of his rings from the place of contact, and he calculated the depth between the tangent plane and the curved surface, exactly as the engineer would calculate the distance between his tangent plane and the surface of the sea. The wonder is, that, where such infinitesimal distances are involved, Newton, with the means at his disposal, could have worked with such marvellous exactitude.

To account for these rings was the greatest difficulty that Newton ever encountered. He quite appreciated the difficulty. Over his eagle-eye there was no film—no vagueness in his conceptions. At the very outset his theory was confronted by the question, Why, when a beam of light is incident on a transparent body, are some of the light-particles reflected and some transmitted? Is it that there are two kinds of particles, the one specially fitted for transmission and the other for reflection? This cannot be the reason ; for, if we allow a beam of light which has been reflected

from one piece of glass to fall upon another, it, as a general rule, is also divided into a reflected and a transmitted portion. The particles once reflected are not always reflected, nor are the particles once transmitted always transmitted. Newton saw all this; he knew he had to explain why it is that the self-same particle is at one moment reflected and at the next moment transmitted. It could only be through *some change in the condition of the particle itself*. The self-same particle, he affirmed, was affected by 'fits' of easy transmission and reflection.

§ 9. *Theory of 'Fits' applied to Newton's Rings.*

If you are willing to follow me in an attempt to reveal the speculative groundwork of this theory of fits, the intellectual discipline will, I think, repay you for the necessary effort of attention. Newton was chary of stating what he considered to be the cause of the fits, but there can hardly be a doubt that his mind rested on a physical cause. Nor can there be a doubt that here, as in all attempts at theorising, he was compelled to fall back upon experience for the materials of his theory. Let us attempt to restore his course of thought and observation. A magnet would furnish him with the notion of attracted and repelled poles; and he who habitually saw in the visible an image of the invisible would naturally endow his light-particles with such poles. Turning their attracted poles towards a transparent substance, the particles would be sucked in and transmitted; turning their repelled poles, they would be driven away or reflected. Thus, by the ascription of poles, the transmission and reflection of

the self-same particle at different times might be accounted for.

Regard these rings of Newton as seen in pure red light: they are alternately bright and dark. The film of air corresponding to the outermost of them is not thicker than an ordinary soap-bubble, and it becomes thinner on approaching the centre; still Newton, as I have said, measured the thickness corresponding to every ring, and showed the difference of thickness between ring and ring. Now, mark the result. For the sake of convenience, let us call the thickness of the film of air corresponding to the first dark ring d ; then Newton found the distance corresponding to the second dark ring $2d$; the thickness corresponding to the third dark ring $3d$; the thickness corresponding to the tenth dark ring $10d$, and so on. Surely there must be some hidden meaning in this little distance d , which turns up so constantly? One can imagine the intense interest with which Newton pondered its meaning. Observe the probable outcome of his thought. He had endowed his light-particles with poles, but now he is forced to introduce the notion of *periodic recurrence*. Here his power of transfer from the sensible to the subsensible would render it easy for him to suppose the light-particles animated, not only with a motion of translation, but also with a motion of rotation. Newton's astronomical knowledge rendered all such conceptions familiar to him. The earth has such a double motion. In the time occupied in passing over a million and a half of miles of its orbit—that is, in twenty-four hours—our planet performs a complete rotation, and, in the time required to pass over the distance d , Newton's light-particle must be supposed to perform a complete rota-

tion. True, the light-particle is smaller than the planet, and the distance d , instead of being a million and a half of miles, is a little over the ninety thousandth of an inch. But the two conceptions are, in point of intellectual quality, identical.

Imagine, then, a particle entering the film of air where it possesses this precise thickness. To enter the film, its attracted end must be presented. Within the film it is able to turn *once* completely round; at the other side of the film its attracted pole will be again presented; it will, therefore, enter the glass at the opposite side of the film *and be lost to the eye*. All round the place of contact, wherever the film possesses this precise thickness, the light will equally disappear—we shall therefore have a ring of darkness.

And now observe how well this conception falls in with the law of proportionality discovered by Newton. When the thickness of the film is $2d$, the particle has time to perform *two* complete rotations within the film; when the thickness is $3d$, *three* complete rotations; when $10d$, *ten* complete rotations are performed. It is manifest that in each of these cases, on arriving at the second surface of the film, the attracted pole of the particle will be presented. It will, therefore, be transmitted; and, because no light is sent to the eye, we shall have a ring of darkness at each of these places.

The bright rings follow immediately from the same conception. They occur between the dark rings, the thicknesses to which they correspond being also intermediate between those of the dark ones. Take the case of the first bright ring. The thickness of the film is $\frac{1}{2}d$; in this interval the rotating particle can perform

only half a rotation. When, therefore, it reaches the second surface of the film, its repelled pole is presented; it is, therefore, driven back and reaches the eye. At all distances round the centre corresponding to this thickness the same effect is produced, and the consequence is a ring of brightness. The other bright rings are similarly accounted for. At the second one, where the thickness is $1\frac{1}{2}d$, a rotation and a half is performed; at the third, two rotations and a half; and at each of these places the particles present their repelled poles to the lower surface of the film. They are therefore sent back to the eye, and produce there the impression of brightness. This analysis, though involving difficulties when closely scrutinised, enables us to see how the theory of fits may have grown into consistency in the mind of Newton.

It has been already stated that the Emission Theory assigned a greater velocity to light in glass and water than in air or stellar space; and that on this point it was at direct issue with the theory of undulation, which makes the velocity in air or stellar space greater than in glass or water. By an experiment proposed by Arago, and executed with consummate skill by Foucault and Fizeau, this question was brought to a crucial test, and decided in favour of the theory of undulation.

In the present instance also the two theories are at variance. Newton assumed that the action which produces the alternate bright and dark rings took place at a *single surface*; that is, the second surface of the film. The undulatory theory affirms that the rings are caused by the interference of waves reflected from both surfaces. This also has been demonstrated by experiment.

By a proper arrangement, as we shall afterwards learn, we may abolish reflection from one of the surfaces of the film, and when this is done the rings vanish altogether.

Rings of feeble intensity are also formed by *transmitted* light. These are referred by the undulatory theory to the interference of waves which have passed *directly* through the film, with others which have suffered *two* reflections within the film. They are thus completely accounted for.

§ 10. *The Diffraction of Light.*

Newton's espousal of the emission theory is said to have retarded scientific discovery. It might, however, be questioned whether, in the long run, the errors of great men have not really their effect in rendering intellectual progress rhythmical, instead of permitting it to remain uniform, the 'retardation' in each case being the prelude to a more impetuous advance. It is confusion and stagnation, rather than error, that we ought to avoid. Thus, though the undulatory theory was held back for a time, it gathered strength in the interval, and its development within the last half century has been so rapid and triumphant as to leave no rival in the field. We have now to turn to the investigation of new classes of phenomena, of which it alone can render a satisfactory account.

Newton, who was familiar with the idea of an ether, and who introduced it in some of his speculations, objected, as already stated, that if light consisted of waves shadows could not exist; for that the waves would bend round the edges of opaque bodies and

agitate the ether behind them. He was right in affirming that this bending ought to occur, but wrong in supposing that it does not occur. The bending is real, though in all ordinary cases it is masked by the action of interference. This inflection of the light receives the name of *Diffraction*.

To study the phenomena of diffraction it is necessary that our source of light should be a physical point, or a fine line; for when luminous surfaces are employed, the waves issuing from different points of the surface obscure and neutralize each other. A *point* of light of high intensity is obtained by admitting the parallel rays of the sun through an aperture in a window-shutter, and concentrating the beam by a lens of short focus. The small solar image at the focus constitutes a suitable point of light. The image of the sun formed on the convex surface of a glass bead, or of a watch-glass blackened within, though less intense, will also answer. An intense *line* of light is obtained by admitting the sunlight through a slit, and sending it through a strong cylindrical lens. The slice of light is contracted to a physical line at the focus of the lens. A glass tube blackened within and placed in the light, reflects from its surface a luminous line which, though less intense, also answers the purpose.

In the experiment now to be described a vertical slit of variable width is placed in front of the electric lamp, and this slit is looked at from a distance through another vertical slit, also of variable aperture, and held in the hand.

The light of the lamp being, in the first place, rendered monochromatic by placing a pure red glass in front of the slit, when the eye is placed in the straight

line drawn through both slits an extraordinary appearance (shown in fig. 17) is observed. Firstly, the slit in front of the lamp is seen as a vivid rectangle of light, but right and left of it is a long series of rectangles, decreasing in vividness, and separated from each other by intervals of absolute darkness.

The breadth of these bands is seen to vary with the width of the slit held before the eye. When the slit is widened the bands become narrower, and they crowd more closely together; when the slit is narrowed, the

FIG. 17.

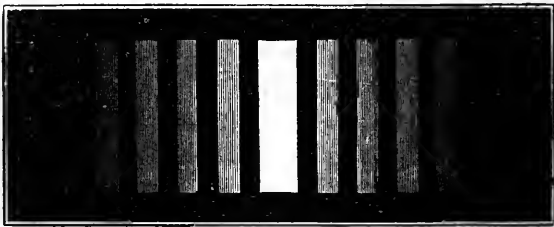

individual bands widen and also retreat from each other, leaving between them wider spaces of darkness than before.

Leaving everything else unchanged, let a blue glass or a solution of ammonia-sulphate of copper, which gives a very pure blue, be placed in the path of the light. A series of blue bands is thus obtained, exactly like the former in all respects save one; the blue rectangles are *narrower*, and they are *closer together* than the red ones.

If we employ colours of intermediate refrangibilities, which we may do by causing the different colours of a spectrum to shine through the slit, we obtain bands of colour intermediate in width and occupying interme-

diate positions between those of the red and blue. The aspect of the bands in red, green, and violet light is represented in fig. 18. When *white light*, therefore, passes through the slit the various colours are not superposed, and instead of a series of monochromatic bands, separated from each other by intervals of darkness, we have a series of coloured spectra placed side by side. When the distant slit is illuminated by a candle flame, instead of the more intense electric light, or when a distant platinum wire raised to a white heat

FIG. 18.



by an electric current is employed, substantially the same effects are observed.

§ 11. *Application of the Wave-theory to the Phenomena of Diffraction.*

Of these and of a multitude of similar effects the Emission Theory is incompetent to offer any satisfactory explanation. Let us see how they are accounted for by the Theory of Undulation.

And here, with the view of reaching absolute clearness, I must make an appeal to that faculty the importance of which I have dwelt upon so earnestly

here and elsewhere—the faculty of imagination. Figure yourself upon the sea-shore, with a well-formed wave advancing. Take a line of particles along the front of the wave, all at the same distance below the crest; they are all rising in the same manner and at the same rate. Take a similar line of particles on the back of the wave, they are all falling in the same manner and at the same rate. Take a line of particles along the crest, they are all in the same condition as regards the motion of the wave. The same is true for a line of particles along the furrow of the wave.

The particles referred to in each of these cases respectively being in the same condition as regards the motion of the wave, are said to be in the same *phase* of vibration. But if you compare a particle on the front of the wave with one at the back; or more generally, if you compare together any two particles not occupying the same position in the wave, their conditions of motion not being the same, they are said to be in different phases of vibration. If one of the particles lie upon the crest, and the other on the furrow of the wave, then, as one is about to rise and the other about to fall, they are said to be in *opposite* phases of vibration.

There is still another point—and it is one of the utmost importance as regards our present subject—to be cleared up. Let O (fig. 19) be a point in still water which, when disturbed, produces a series of circular waves: the disturbance necessary to produce these waves is simply an oscillation up and down of the point O . Let $m n$ be the position of the ridge of one of the waves at any moment, and $m' n'$ its position a second or two afterwards. Now every particle of water,

as the wave passes it, oscillates, as we have learned, up and down. If, then, this oscillation be a sufficient origin of wave-motion, then each distinct particle of

FIG. 19.

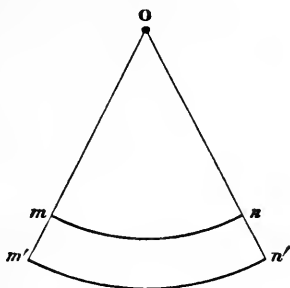

the wave $m n$ ought to give birth to a series of circular waves. This is the important point up to which I wished to lead you. Every particle of the wave $m n$ does act in this way. Taking each particle as a centre, and surrounding it by a circular wave with a radius equal to the distance between $m n$ and $m' n'$, the coalescence of all these little waves would build up the larger ridge $m' n'$ exactly as we find it built up in nature. Here, in fact, we resolve the wave-motion into its elements, and having succeeded in doing this we shall have no great difficulty in applying our knowledge to optical phenomena.

Now let us return to our slit, and, for the sake of simplicity, we will first consider the case of monochromatic light. Conceive a series of waves of ether advancing from the first slit towards the second, and finally filling the second slit. When each wave passes through the latter it not only pursues its direct course

to the retina, but diverges right and left, tending to throw into motion the entire mass of the ether behind the slit. In fact, as already explained, *every point of the wave which fills the slit is itself a centre of a new wave-system, which is transmitted in all directions through the ether behind the slit.* This is the celebrated principle of Huyghens: we have now to examine how these secondary waves act upon each other.

Let us first regard the central band of the series. Let A P (fig. 20) be the width of the aperture held before the

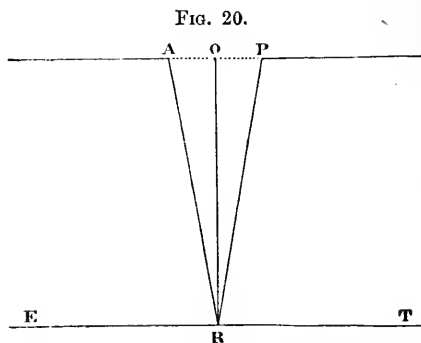

eye, grossly exaggerated of course, and let the dots across the aperture represent ether particles, all in the same phase of vibration. Let E T represent a portion of the retina. From O, in the centre of the slit, let a perpendicular O R be imagined drawn upon the retina. The motion communicated to the point R will then be the sum of all the motions emanating in this direction from the ether particles in the slit. Considering the extreme narrowness of the aperture, we may, without sensible error, regard all points of the wave A P as equally distant from R. No one of the parti:l

waves lags sensibly behind the others : hence, at R, and in its immediate neighbourhood, we have no sensible reduction of the light by interference. This undiminished light produces the brilliant central band of the series.

Let us now consider those waves which diverge laterally behind the slit. In this case, the waves from the two sides of the slit have, in order to converge upon the retina, to pass over unequal distances. Let A P (fig. 21) represent, as before, the width of the

FIG. 21.

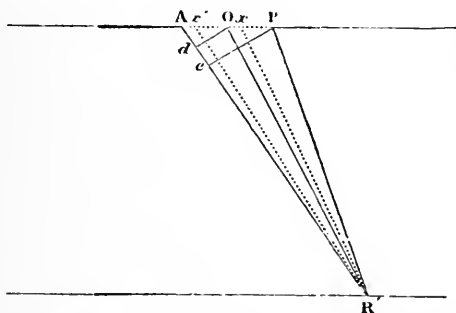

second slit. We have now to consider the action of the various parts of the wave A P upon a point R' of the retina, not situated in the line joining the slits. Let us take the particular case in which the difference in path from the two marginal points A, P, to the retina is a whole wave-length of the red light ; how must this difference affect the final illumination of the retina ?

Let us fix our attention upon the particular oblique line that passes through the *centre* O of the slit to the retina at R'. The difference of path between the waves which pass along this line and those from the two

margins is, in the case here supposed, half a wave-length. Make $e R'$ equal to $P R'$, join P and e , and draw $O d$ parallel to $P e$. A e is then the length of a wave of light, while $A d$ is half a wave-length. Now the least reflection will make it clear that not only is there discordance between the central and marginal waves, but that every line of waves such as $x R'$, on the one side of $O R'$, finds a line $x' R'$ upon the other side of $O R$, from which its path differs by half an undulation, with which, therefore, it is in complete discordance. The consequence is that the light on the one side of the central line will completely abolish the light on the other side of that line, absolute darkness being the result of their coalescence. The first dark interval of our series of bands is thus accounted for. It is produced by an obliquity of direction which causes the paths of the marginal waves to be a *whole wave-length* different from each other.

When the difference between the paths of the marginal waves is *half a wave-length*, a partial destruction of the light is effected. The luminous intensity corresponding to this obliquity is a little less than one-half—accurately 0·4—that of the undiffracted light.

If the paths of the marginal waves be three semi-undulations different from each other, and if the whole beam be divided into three equal parts, two of these parts will, for the reasons just given, completely neutralize each other, the third only being effective. Corresponding, therefore, to an obliquity which produces a difference of three semi-undulations in the marginal waves, we have a luminous band, but one of considerably less intensity than the undiffracted central band.

With a marginal difference of path of four semi-undulations we have a second extinction of the entire beam, because here the beam can be divided into four equal parts, every two of which quench each other. A second space of absolute darkness will therefore correspond to the obliquity producing this difference. In this way we might proceed further, the general result being that, whenever the direction of wave-motion is such as to produce a marginal difference of path of an *even* number of semi-undulations, we have complete extinction; while, when the marginal difference is an *odd* number of semi-undulations, we have only partial extinction, a portion of the beam remaining as a luminous band.

A moment's reflection will make it plain that the wider the slit the less will be the obliquity of direction needed to produce the necessary difference of path. With a wide slit, therefore, the bands, as observed, will be closer together than with a narrow one. It is also plain that the shorter the wave, the less will be the obliquity required to produce the necessary retardation. The maxima and minima of violet light must therefore fall nearer to the centre than the maxima and minima of red light. The maxima and minima of the other colours fall between these extremes. In this simple way the undulatory theory completely accounts for the extraordinary appearance above referred to.

When a slit and telescope are used, instead of the slit and naked eye, the effects are magnified and rendered more brilliant. Looking, moreover, through a properly adjusted telescope with a small circular aperture in front of it, at a distant point of light, the point is seen encircled by a series of coloured bands. If

monochromatic light be used, these bands are simply bright and dark, but with white light the circles display iris-colours. If a slit be shortened so as to form a square aperture, we have two series of spectra at right angles to each other. The effects, indeed, are capable of endless variation by varying the size, shape, and number of the apertures through which the point of

FIG. 22.

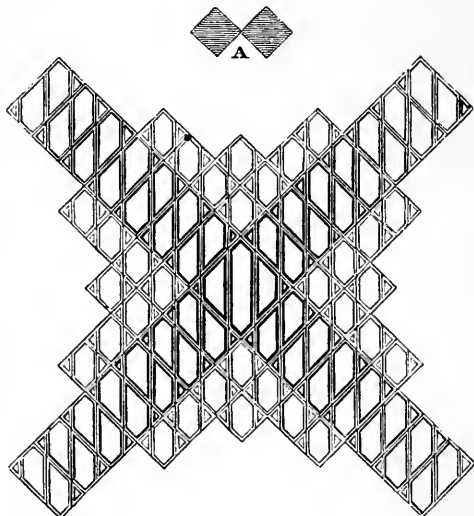

light is observed. Through two square apertures, with their corners touching each other as at A, Scherzer observed the appearance shown in fig. 22. Adding two others to them, as at B, he observed the appearance represented in fig. 23. The position of every band of light and shade in such figures has been calculated from theory by Fresnel, Fraunhofer, Herschel, Scherzer, and others, and completely verified by experiment.

Your eyes could not tell you with greater certainty of the existence of these bands than the theoretic calculation.

The street-lamps at night, looked at through the meshes of a handkerchief, show diffraction phenomena. The diffraction effects obtained in looking through a bird's feathers are, as shown by Schwerd, very brilliant.

FIG. 23.

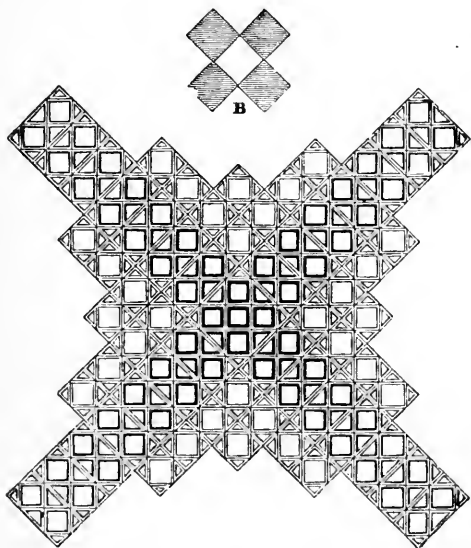

The iridescence of certain Alpine clouds is also an effect of diffraction which may be imitated by the spores of *Lycopodium*. When shaken over a glass plate these spores cause a point of light, looked at through the dusted plate, to be surrounded by coloured circles, which rise to actual splendour when the light becomes intense. Shaken in the air the spores produce the same

effect. The diffraction phenomena obtained during the artificial precipitation of clouds from the vapours of various liquids in an intensely illuminated tube are exceedingly fine.

One of the most interesting cases of diffraction by small particles that ever came before me was that of an artist whose vision was disturbed by vividly-coloured circles. He was in great dread of losing his sight; assigning as a cause of his increased fear that the circles were becoming larger and the colours more vivid. I ascribed the colours to minute particles in the humours of the eye, and ventured to encourage him by the assurance that the increase of size and vividness on the part of the circles indicated that the diffracting particles were becoming *smaller*, and that they might finally be altogether absorbed. The prediction was verified. It is needless to say one word on the necessity of optical knowledge in the case of the practical oculist.

Without breaking ground on the chromatic phenomena presented by crystals, two other sources of colour may be mentioned here. By interference in the earth's atmosphere the light of a star, as shown by Arago, is self-extinguished, the twinkling of the star and the changes of colour which it undergoes being due to this cause. Looking at such a star through an opera-glass, and shaking the glass so as to cause the image of the star to pass rapidly over the retina, you produce a row of coloured beads, the spaces between which correspond to the periods of extinction. Fine scratches drawn upon glass or polished metal reflect the waves of light from their sides; and some, being reflected from opposite sides of the

same scratch, interfere with and quench each other. But the obliquity of reflection which extinguishes the shorter waves does not extinguish the longer ones, hence the phenomena of colour. These are called the colours of *striated surfaces*. They are beautifully illustrated by mother-of-pearl. This shell is composed of exceedingly thin layers, which, when cut across by the polishing of the shell, expose their edges and furnish the necessary small and regular grooves. The most conclusive proof that the colours are due to the mechanical state of the surface is to be found in the fact, established by Brewster, that by stamping the shell carefully upon black sealing-wax, we transfer the grooves, and produce upon the wax the colours of mother-of-pearl.

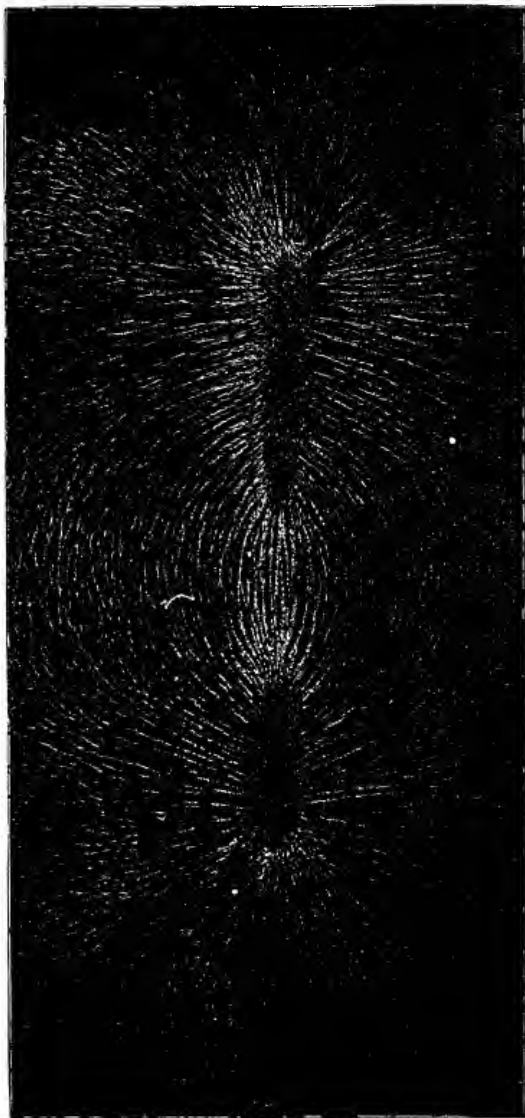

LECTURE III.

RELATION OF THEORIES TO EXPERIENCE—ORIGIN OF THE NOTION OF THE ATTRACTION OF GRAVITATION—NOTION OF POLARITY, HOW GENERATED—ATOMIC POLARITY—STRUCTURAL ARRANGEMENTS DUE TO POLARITY—ARCHITECTURE OF CRYSTALS CONSIDERED AS AN INTRODUCTION TO THEIR ACTION UPON LIGHT—NOTION OF ATOMIC POLARITY APPLIED TO CRYSTALLINE STRUCTURE—EXPERIMENTAL ILLUSTRATIONS—CRYSTALLIZATION OF WATER—EXPANSION BY HEAT AND BY COLD—DEPORTMENT OF WATER CONSIDERED AND EXPLAINED—BEARINGS OF CRYSTALLIZATION ON OPTICAL PHENOMENA—REFRACTION—DOUBLE REFRACTION—POLARIZATION—ACTION OF TOURMALINE—CHARACTER OF THE BEAMS EMERGENT FROM ICELAND SPAR—POLARIZATION BY ORDINARY REFRACTION AND REFLECTION—DEPOLARIZATION.

§ 1. *Derivation of Theoretic Conceptions from Experience.*

ONE of the objects of our last lecture, and that not the least important, was to illustrate the manner in which scientific theories are formed. They, in the first place, take their rise in the desire of the mind to penetrate to the sources of phenomena. From its infinitesimal beginnings, in ages long past, this desire has grown and strengthened into an imperious demand of man's intellectual nature. It long ago prompted Cæsar to say that he would exchange his victories for a glimpse of the sources of the Nile; it wrought itself into the atomic theories of Lucretius; it impels Darwin to those daring speculations which of late years have so agitated the public mind. But in no case in framing

theories does the imagination create its materials. It expands, diminishes, moulds and refines, as the case may be, materials derived from the world of fact and observation.

This is more evidently the case in a theory like that of light, where the motions of a subsensible medium, the ether, are presented to the mind. But no theory escapes the condition. Newton took care not to encumber the idea of gravitation with unnecessary physical conceptions; but we know that he indulged in them, though he did not connect them with his theory. But even the theory as it stands did not enter the mind as a revelation dissevered from the world of experience. The germ of the conception that the sun and planets are held together by a force of attraction is to be found in the fact that a magnet had been previously seen to attract iron. The notion of matter attracting matter came thus from without, not from within. In our present lecture the magnetic force must serve us as the portal into a new subsensible domain; but in the first place we must master its elementary phenomena.

The general facts of magnetism are most simply illustrated by a magnetized bar of steel, commonly called a bar magnet. Placing such a magnet upright upon a table, and bringing a magnetic needle near its bottom, one end of the needle is observed to retreat from the magnet, while the other as promptly approaches. The needle is held quivering there by some invisible influence exerted upon it. Raising the needle along the magnet, but still avoiding contact, the rapidity of its oscillations decreases, because the force acting upon it becomes weaker. At the centre the oscil-

lations cease. Above the centre, the end of the needle which had been previously drawn towards the magnet retreats, and the opposite end approaches. As we ascend higher, the oscillations become more violent, because the force becomes stronger. At the upper end of the magnet, as at the lower, the force reaches a maximum ; but all the lower half of the magnet, from E to S (fig. 25), attracts one end of the needle, while all the upper half, from E to N, attracts the opposite end. This *doubleness* of the magnetic force is called

FIG. 25.

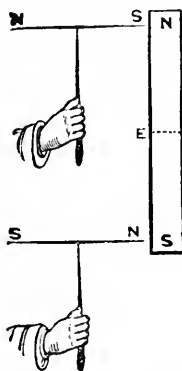

polarity, and the points near the ends of the magnet in which the forces seem concentrated are called its *poles*.

What, then, will occur if we break this magnet in two at the centre E? Shall we obtain two magnets, each with a single pole? No; each half is in itself a perfect magnet, possessing two poles. This may be proved by breaking something of less value than the magnet—the steel of a lady's stays, for example, hardened and magnetized. It acts like the magnet. When broken, each half acts like the whole; and when

these parts are again broken, we have still the perfect magnet, possessing, as in the first instance, two poles. Push your breaking to its utmost sensible limit, you cannot stop there. The bias derived from observation will infallibly carry you beyond the bourne of the senses, and compel you to regard this thing that we call magnetic polarity as resident in the ultimate particles of the steel. You come to the conclusion that each atom of the magnet is endowed with this polar force.

Like all other forces, this force of magnetism is amenable to mechanical laws; and, knowing the direction and magnitude of the force, we can predict its action. Placing a small magnetic needle near a bar magnet, it takes up a determinate position. That position might be deduced theoretically from the mutual action of the poles. Moving the needle round the magnet, for each point of the surrounding space there is a definite direction of the needle, and no other. A needle of iron will answer as well as the magnetic needle; for the needle of iron is magnetized by the magnet, and acts exactly like a steel needle independently magnetized.

If we place two or more needles of iron near the magnet, the action becomes more complex, for then the needles are not only acted on by the magnet, but they act upon each other. And if we pass to smaller masses of iron—to iron filings, for example—we find that they act substantially as the needles, arranging themselves in definite forms, in obedience to the magnetic action.

Placing a sheet of paper or glass over a bar magnet and showering iron filings upon the paper, I

notice a tendency of the filings to arrange themselves in determinate lines. They cannot freely follow this tendency, for they are hampered by the friction against the paper. They are helped by tapping the paper ;

FIG. 26.

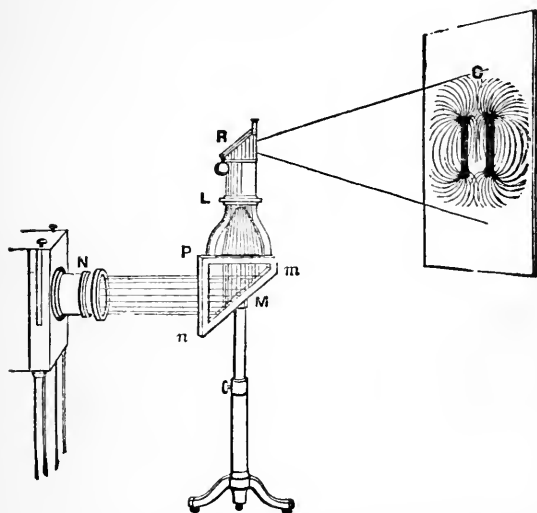

N is the nozzle of the lamp ; M a plane mirror, reflecting the beam upwards. At P the magnets and iron filings are placed ; L is a lens which forms an image of the magnets and filings ; and R is a totally-reflecting prism, which casts the image G upon the screen.

each tap releasing them for a moment, and enabling them to follow their tendencies. But this is an experiment which can only be seen by myself. To enable you all to see it, I take a pair of small magnets and by a simple optical arrangement throw the magnified images of the magnets upon the screen. Scattering iron filings over the glass plate to which the small magnets are attached, and tapping the plate, you see the arrange-

ment of the iron filings in those magnetic curves which have been so long familiar to scientific men.¹

The aspect of these curves so fascinated Faraday that the greater portion of his intellectual life was devoted to pondering over them. He invested the space through which they run with a kind of materiality; and the probability is that the progress of science, by connecting the phenomena of magnetism with the luminiferous ether, will prove these 'lines of force,' as Faraday loved to call them, to represent a condition of this mysterious substratum of all radiant action.

But it is not the magnetic curves, as such, but their relationship to theoretic conceptions that we have now to consider. By the action of the bar magnet upon the needle we obtain a notion of a polar force; by the breaking of the strip of magnetized steel, we attain the notion that polarity can attach itself to the ultimate particles of matter. The experiment with the iron filings introduces a new idea into the mind; the idea, namely, of *structural arrangement*. Every pair of filings possesses four poles, two of which are attractive and two repulsive. The attractive poles approach, the repulsive poles retreat; the consequence being a certain definite arrangement of the particles with reference to each other.

§ 2. *Theory of Crystallization.*

Now, this idea of structure, as produced by polar force, opens a way for the intellect into an entirely new

¹ Very beautiful specimens of these curves have been recently obtained and *fixed* by my distinguished friend, Prof. Mayer, of Hoboken, to whom I am indebted for the original of the woodcut placed in front of this Lecture.

region, and the reason you are asked to accompany me into this region is, that our next enquiry relates to the action of crystals upon light. Prior to speaking of this action, I wish you to realise intellectually the process of crystalline architecture. Look then into a granite quarry, and spend a few minutes in examining the rock. It is not of perfectly uniform texture. It is rather an agglomeration of pieces, which, on examination, present curiously-defined forms. You have there what mineralogists call quartz, you have felspar, you have mica. In a mineralogical cabinet, where these substances are preserved separately, you will obtain some notion of their forms. You will see there, also, specimens of beryl, topaz, emerald, tourmaline, heavy spar, fluor-spar, Iceland spar—possibly a full-formed diamond, as it quitted the hand of Nature, not yet having got into the hands of the lapidary.

These crystals, you will observe, are put together according to law; they are not chance productions; and, if you care to examine them more minutely, you will find their architecture capable of being to some extent revealed. They often split in certain directions before a knife-edge, exposing smooth and shining surfaces, which are called planes of cleavage; and by following these planes you sometimes reach an internal form, disguised beneath the external form of the crystal. Ponder these beautiful edifices of a hidden builder. You cannot help asking yourself how they were built; and familiar as you now are with the notion of a polar force, and the ability of that force to produce structural arrangement, your inevitable answer will be, that those crystals are built by the play of polar forces with which their molecules are endowed. In virtue of these forces,

atom lays itself to atom in a perfectly definite way, the final visible form of the crystal depending upon this play of its molecules.

Everywhere in Nature we observe this tendency to run into definite forms, and nothing is easier than to give scope to this tendency by artificial arrangements. Dissolve nitre in water, and allow the water slowly to evaporate; the nitre remains, and the solution soon becomes so concentrated that the liquid condition can no longer be preserved. The nitre-molecules approach each other, and come at length within the range of their polar forces. They arrange themselves in obedience to these forces, a minute crystal of nitre being at first produced. On this crystal the molecules continue to deposit themselves from the surrounding liquid. The crystal grows, and finally we have large prisms of nitre, each of a perfectly definite shape. Alum crystallizes with the utmost ease in this fashion. The resultant crystal is, however, different in shape from that of nitre, because the poles of the molecules are differently disposed. If they be only *nursed* with proper care, crystals of these substances may be caused to grow to a great size.

The condition of perfect crystallization is, that the crystallizing force shall act with deliberation. There should be no hurry in its operations; but every molecule ought to be permitted, without disturbance from its neighbours, to exercise its own rights. If the crystallization be too sudden, the regularity disappears. Water may be saturated with sulphate of soda, dissolved when the water is hot, and afterwards permitted to cool. When cold the solution is supersaturated; that is to say, more solid matter is contained in it than corresponds to

its temperature. Still the molecules show no sign of building themselves together.

This is a very remarkable, though a very common fact. The molecules in the centre of the liquid are so hampered by the action of their neighbours that freedom to follow their own tendencies is denied to them. Fix your mind's eye upon a molecule within the mass. It wishes to unite with its neighbour to the right, but it wishes equally to unite with its neighbour to the left; the one tendency neutralizes the other, and it unites with neither. But, if a crystal of sulphate of soda be dropped into the solution, the molecular indecision ceases. On the crystal the adjacent molecules will immediately precipitate themselves; on these again others will be precipitated, and this act of precipitation will continue from the top of the flask to the bottom, until the solution has, as far as possible, assumed the solid form. The crystals here produced are small, and confusedly arranged. The process has been too hasty to admit of the pure and orderly action of the crystallizing force. It typifies the state of a nation in which natural and healthy change is resisted, until society becomes, as it were, supersaturated with the desire for change, the change being then effected through confusion and revolution.

Let me illustrate the action of crystallizing force by two examples of it: Nitre might be employed, but another well-known substance enables me to make the experiment in a better form. The substance is common sal-ammoniac, or chloride of ammonium, dissolved in water. Cleansing perfectly a glass plate, the solution of the chloride is poured over the glass, to which, when the plate is set on edge, a thin film of the liquid

adheres. Warming the glass slightly, evaporation is promoted, but by evaporation the water only is removed. The plate is then placed in a solar microscope, and an image of the film is thrown upon a white screen. The warmth of the illuminating beam adds itself to that already imparted to the glass plate, so that after a moment or two the dissolved salt can no longer exist in the liquid condition. Molecule then closes with molecule, and you have a most impressive display of crystallizing energy overspreading the whole screen. You may produce something similar if you breathe upon the frost-ferns which overspread your window-panes in winter, and then observe through a pocket lens the subsequent recongelation of the film.

In this case the crystallizing force is hampered by the adhesion of the film to the glass; nevertheless, the play of power is strikingly beautiful. Sometimes the crystals start from the edge of the film and run through it from that edge, for, the crystallization being once started, the molecules throw themselves by preference on the crystals already formed. Sometimes the crystals start from definite nuclei in the centre of the film; every small crystalline particle which rests in the film furnishing a starting-point. Throughout the process you notice one feature which is perfectly unalterable, and that is, angular magnitude. The spiculæ branch from the trunk, and from these branches others shoot; but the angles enclosed by the spiculæ are unalterable. In like manner you may find alum-crystals, quartz-crystals, and all other crystals, distorted in shape. They are thus far at the mercy of the accidents of crystallization; but in one particular they assert their superiority

over all such accidents—*angular magnitude* is always rigidly preserved.

My second example of the action of crystallizing force is this: By sending a voltaic current through a liquid, you know that we decompose the liquid, and if it contains a metal, we liberate this metal by the electrolysis. This small cell contains a solution of acetate of lead, which is chosen for our present purpose, because lead lends itself freely to this crystallizing power. Into the cell are dipped two very thin platinum wires, and these are connected by other wires with a small voltaic battery. On sending the voltaic current through the solution, the lead will be slowly severed from the atoms with which it is now combined; it will be liberated upon one of the wires, and at the moment of its liberation it will obey the polar forces of its atoms, and produce crystalline forms of exquisite beauty. They are now before you, sprouting like ferns from the wire, appearing indeed like vegetable growths rendered so rapid as to be plainly visible to the naked eye. On reversing the current, these wonderful lead-fronds will dissolve, while from the other wire filaments of lead dart through the liquid. In a moment or two the growth of the lead-trees recommences, but they now cover the other wire.

In the process of crystallization, Nature first reveals herself as a builder. Where do her operations stop? Does she continue by the play of the same forces to form the vegetable, and afterwards the animal! Whatever the answer to these questions may be, trust me that the notions of the coming generations regarding this mysterious thing, which some have called 'brute matter,' will be very different from those of the generations past.

There is hardly a more beautiful and instructive example of this play of molecular force than that furnished by the case of water. You have seen the exquisite fern-like forms produced by the crystallization of a film of water on a cold window-pane.¹ You have also probably noticed the beautiful rosettes tied together by the crystallizing force during the descent of a snow-shower on a very calm day. The slopes and summits of the Alps are loaded in winter with these blossoms of the frost. They vary infinitely in detail of beauty, but the same angular magnitude is preserved throughout: an inflexible power binding spears and spiculæ to the angle of 60 degrees.

The common ice of our lakes is also ruled in its deposition by the same angle. You may sometimes see in freezing water small crystals of stellar shapes, each star consisting of six rays, with this angle of 60° between every two of them. This structure may be revealed in ordinary ice. In a sunbeam, or, failing that, in our electric beam, we have an instrument delicate enough to unlock the frozen molecules without disturbing the order of their architecture. Cutting from clear, sound, regularly-frozen ice a slab parallel to the planes of freezing, and sending a sunbeam through such a slab, it liquefies internally at special points, round each point a six-petalled liquid flower of exquisite beauty being formed. Crowds of such flowers are thus produced. From an ice-house we sometimes take blocks of ice presenting misty spaces in the otherwise continuous mass; and when we enquire

¹ A specimen of the plumes produced by water crystallization is figured, and an account of it given, in the Appendix.

into the cause of this mistiness, we find it to be due to myriads of small six-petalled flowers, into which the ice has been resolved by the mere heat of conduction.

A moment's further devotion to the crystallization of water will be well repaid; for the sum of qualities which renders this substance fitted to play its part in Nature may well excite wonder and stimulate thought. Like almost all other substances, water is expanded by heat and contracted by cold. Let this expansion and contraction be first illustrated:

A small flask is filled with coloured water, and stopped with a cork. Through the cork passes a glass tube water-tight, the liquid standing at a certain height in the tube. The flask and its tube resemble the bulb and stem of a thermometer. Applying the heat of a spirit-lamp, the water rises in the tube, and finally trickles over the top. Expansion by heat is thus illustrated.

Removing the lamp and piling a freezing mixture round the flask, the liquid column falls, thus showing the contraction of the water by the cold. But let the freezing mixture continue to act: the falling of the column continues to a certain point; it then ceases. The top of the column remains stationary for some seconds, and afterwards begins to rise. The contraction has ceased, and *expansion by cold* sets in. Let the expansion continue till the liquid trickles a second time over the top of the tube. The freezing mixture has here produced to all appearance the same effect as the flame. In the case of water, contraction by cold ceases, and expansion by cold sets in at the definite temperature of 39° Fahr. Crystallization has virtually here commenced, the molecules preparing themselves for the

subsequent act of solidification which occurs at 32° , and in which the expansion suddenly culminates. In virtue of this expansion, ice, as you know, is lighter than water in the proportion of 8 to 9.¹

A molecular problem of great interest is here involved, and I wish now to place before you, for the satisfaction of your minds, a possible solution of the problem :—

Consider, then, the ideal case of a number of magnets deprived of weight, but retaining their polar forces. If we had a mobile liquid of the specific gravity of steel, we might, by making the magnets float in it, realize this state of things, for in such a liquid the magnets would neither sink nor swim. Now, the principle of gravitation enunciated by Newton is that every particle of matter, of every kind, attracts every other particle with a force varying as the inverse square of the distance. In virtue of the attraction of gravity, then, the magnets, if perfectly free to move, would slowly approach each other.

But besides the unpolar force of gravity, which belongs to matter in general, the magnets are endowed with the polar force of magnetism. For a time, however, the polar forces do not come sensibly into play. In this

¹ In a little volume entitled 'Forms of Water,' I have mentioned that cold iron floats upon molten iron. In company with my friend Sir William Armstrong, I had repeated opportunities of witnessing this fact in his works at Elswick, 1863. Faraday, I remember, spoke to me subsequently of the completeness of iron castings as probably due to the swelling of the metal on solidification. Beyond this, I have given the subject no special attention; and I know that many intelligent iron-founders doubt the fact of expansion. It is quite possible that the solid floats because it is not *wetted* by the molten iron, its volume being virtually augmented by capillary repulsion. Certain flies walk freely upon water in virtue of an action of this kind. With bismuth, however, it is easy to burst iron bottles by the force of solidification.

condition the magnets resemble our water-molecules at the temperature say of 50° . But the magnets come at length sufficiently near each other to enable their poles to interact. From this point the action ceases to be solely a general attraction of the masses. An attraction of special points of the masses and a repulsion of other points now come into play; and it is easy to see that the rearrangement of the magnets consequent upon the introduction of these new forces may be such as to require a greater amount of room. This, I take it, is the case with our water-molecules. Like the magnets, they approach each other for a time *as wholes*. Previous to reaching the temperature 39° Fahr., the polar forces had doubtless begun to act, but it is at this temperature that their action exactly balances the contraction due to cold. At lower temperatures, as regards change of volume, the polar forces predominate. But they carry on a struggle with the force of contraction until the freezing temperature is attained. The molecules then close up to form solid crystals, a considerable augmentation of volume being the immediate consequence.

§ 3. *Ordinary Refraction of Light explained by the Undulatory Theory.*

We have now to exhibit the bearings of this act of crystallization upon optical phenomena. According to the undulatory theory, the velocity of light in water and glass is less than in air. Consider, then, a small portion of a wave issuing from a point of light so distant that the portion may be regarded as practically plane. Moving vertically downwards, and impinging on an horizontal surface of glass or water, the wave would go

through the medium without change of direction. But, as the velocity in glass and water is less than the velocity in air, the wave would be retarded on passing into the denser medium.

But suppose the wave, before reaching the glass, to be *oblique* to the surface; that end of the wave which first reaches the medium will be the first retarded by it, the other portions as they enter the glass being retarded in succession. It is easy to see that this retardation of the one end of the wave must cause it to swing round and change its front, so that when the wave has fully entered the glass its course is oblique to

FIG. 27.

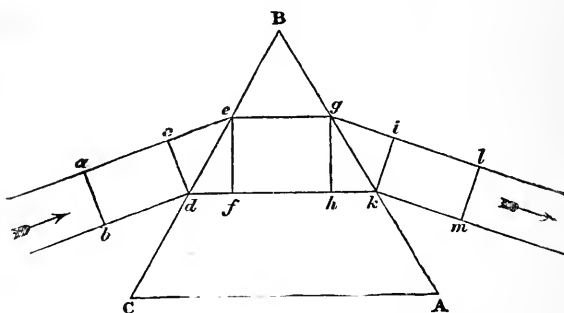

its original direction. According to the undulatory theory, light is thus *refracted*.

With these considerations to guide us, let us follow the course of a beam of monochromatic light through our glass prism. The velocity in air is to its velocity in glass as 3 : 2. Let $A B C$ (fig. 27) be the section of our prism, and $a b$ the section of a plane wave approaching it in the direction of the arrow. When it reaches $c d$, one end of the wave is on the point of entering the

glass, and while the portion of the wave still in the air passes over the distance ce , the wave in the glass will have passed over only two-thirds of this distance, or df . The line ef now marks the front of the wave. Immersed wholly in the glass it pursues its way to gh , where the end g of the wave is on the point of escaping into the air. During the time required by the end h of the wave to pass over the distance hk to the surface of the prism, the other end g , moving more rapidly, will have reached the point i . The wave, therefore, has again changed its front, so that after its emergence from the prism it will pass on to lm , and subsequently in the direction of the arrow. The refraction of the beam is thus completely accounted for; and it is, moreover, based upon actual experiment, which proves that the ratio of the velocity of light in glass to its velocity in air is that here mentioned. It is plain that if the change of velocity on entering the glass was greater, the refraction also would be greater.

§ 4. *Double Refraction of Light explained by the Undulatory Theory.*

The two elements of rapidity of propagation, both of sound and light, in any substance whatever, are *elasticity* and *density*, the speed increasing with the former and diminishing with the latter. The enormous velocity of light in stellar space is attainable because the ether is at the same time of infinitesimal density and of enormous elasticity. Now the ether surrounds the atoms of all bodies, but it is not independent of them. In ponderable matter it acts as if its density were increased without a proportionate increase of elasticity;

and this accounts for the diminished velocity of light in refracting bodies. We here reach a point of cardinal importance. In virtue of the crystalline architecture that we have been considering, the ether in many crystals possesses different densities, and hence different elasticities, in two different directions; and the consequence is, that some of these media transmit light with two different velocities. But as refraction depends wholly upon the change of velocity on entering the refracting medium, and is greatest where the change of velocity is greatest, we have in many crystals two different refractions. By such crystals a beam of light is divided into two. This effect is called *double refraction*.

In ordinary water, for example, there is nothing in the grouping of the molecules to interfere with the perfect homogeneity of the ether; but, when water crystallizes to ice, the case is different. In a plate of ice the elasticity of the ether in a direction perpendicular to the surface of freezing is different from what it is parallel to the surface of freezing; ice is, therefore, a double refracting substance. Double refraction is displayed in a particularly impressive manner by Iceland spar, which is crystallized carbonate of lime. The difference of ethereal density in two directions in this crystal is very great, the separation of the beam into the two halves being, therefore, particularly striking.

I am unwilling to quit this subject before raising it to unmistakable clearness in your minds. The vibrations of light being transversal, the elasticity concerned in the propagation of any ray is the elasticity at right angles to the direction of propagation. In Iceland spar there is one direction round which the crystalline molecules are symmetrically built. This direction is

called the axis of the crystal. In consequence of this symmetry the elasticity is the same in all directions perpendicular to the axis, and hence a ray transmitted along the axis suffers no double refraction. But the elasticity along the axis is greater than the elasticity at right angles to it. Consider, then, a system of waves crossing the crystal in a direction perpendicular to the axis. Two directions of vibration are open to such waves: the ether particles can vibrate parallel to the axis or perpendicular to it. *They do both*, and hence immediately divide themselves into two systems propagated with different velocities. Double refraction is the necessary consequence.

By means of Iceland spar cut in the proper direction,

FIG. 28.

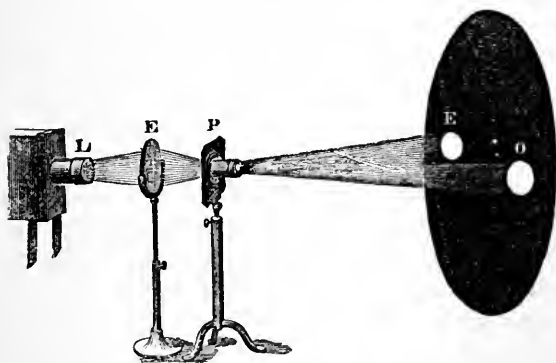

double refraction is capable of easy illustration. Causing the beam which builds the image of our carbon-points to pass through the spar, the single image is instantly divided into two. Projecting (by the lens E, fig. 28) an image of the aperture (L) through which the light issues from the electric lamp, and introducing the spar

(P), two luminous disks (E O) appear immediately upon the screen instead of one.

The two beams into which the spar divides the single incident-beam have been subjected to the closest examination. They do not behave alike. One of them obeys the ordinary law of refraction discovered by Snell, and is, therefore, called the *ordinary ray*: its index of refraction is 1.654. The other does not obey this law. Its index of refraction, for example, is not constant, but varies from a maximum of 1.654 to a minimum of 1.483; nor in this case do the incident and refracted rays always lie in the same plane. It is, therefore, called the *extraordinary ray*. In calc-spar, as just stated, the ordinary ray is the most refracted. One consequence of this merits a passing notice. Pour water and bisulphide of carbon into two cups of the same depth; the cup that contains the more strongly-refracting liquid will appear shallower than the other. Place a piece of Iceland spar over a dot of ink; two dots are seen, the one appearing nearer than the other to the eye. The nearest dot belongs to the most strongly-refracted ray, exactly as the nearest cup-bottom belongs to the most highly refracting liquid. When you turn the spar round, the extraordinary image of the dot rotates round the ordinary one, which remains fixed. This is also the deportment of our two disks upon the screen.

§ 5. *Polarization of Light explained by the Undulatory Theory.*

The double refraction of Iceland spar was first treated in a work published by Erasmus Bartholinus, in 1669. The celebrated Huyghens sought to account for

this phenomenon on the principles of the wave theory, and he succeeded in doing so. He, moreover, made highly important observations on the distinctive character of the two beams transmitted by the spar, admitting, with resigned candour, that he had not solved them, and leaving that solution to future times. Newton, reflecting on the observations of Huyghens, came to the conclusion that each of the beams transmitted by Iceland spar had two sides; and from the analogy of this *two-sidedness* with the *two-endedness* of a magnet, wherein consists its polarity, the two beams came subsequently to be described as *polarized*.

We may begin the study of the polarization of light, with ease and profit, by means of a crystal of tourmaline. But we must start with a clear conception of an ordinary beam of light. It has been already explained that the vibrations of the individual ether-particles are executed *across* the line of propagation. In the case of ordinary light we are to figure the ether-particles as vibrating in all directions, or azimuths, as it is sometimes expressed, across this line.

Now, in the case of a plate of tourmaline cut parallel to the axis of the crystal, a beam of light incident upon the plate is divided into two, the one vibrating parallel to the axis of the crystal, the other at right angles to the axis. The grouping of the molecules, and of the ether associated with the molecules, reduces all the vibrations incident upon the crystal to these two directions. One of these beams, namely, that whose vibrations are perpendicular to the axis, is quenched with exceeding rapidity by the tourmaline. To such vibrations many specimens of the crystal are highly opaque; so that, after having

passed through a very small thickness of the tourmaline, the light emerges with all its vibrations reduced to a single plane. In this condition it is what we call *plane polarized light*.

A moment's reflection will show that, if what is here stated be correct, on placing a second plate of tourmaline with its axis parallel to the first, the light will pass through both; but that, if the axes be crossed, the light that passes through the one plate will be quenched by the other, a total interception of the light being the consequence. Let us test this conclusion by experiment. The image of a plate of tourmaline ($t t$, fig. 29) is now before you. I place parallel to it another

FIG. 29.



FIG. 30.

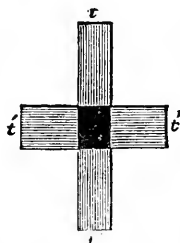

plate ($t' t'$): the green of the crystal is a little deepened, nothing more; this agrees with our conclusion. By means of an endless screw, I now turn one of the crystals gradually round, and you observe that as long as the two plates are oblique to each other, a certain portion of light gets through; but that when they are at right angles each other, the space

common to both is a space of darkness (fig. 30). Our conclusion, arrived at prior to experiment, is thus verified.

Let us now return to a single plate; and here let me say that it is on the green light transmitted by the tourmaline that you are to fix your attention. We have to illustrate the two-sidedness of that green light, in contrast to the all-sidedness of ordinary light. The light surrounding the green image, being ordinary light, is reflected by a plane glass mirror in all directions; the green light, on the contrary, is not so reflected. The image of the tourmaline is now horizontal; reflected upwards, it is still green; reflected sideways, the image is reduced to blackness, because of the incompetency of the green light to be reflected in this direction. Making the plate of tourmaline vertical, and reflecting it as before, it is in the upper image that the light is quenched; in the side image you have now the green. This is a result of the greatest significance. If the vibrations of light were longitudinal, like those of sound, you could have no action of this kind; and this very action compels us to assume that the vibrations are transversal. Picture the thing clearly. In the one case the mirror receives, as it were, the impact of the *edges* of the waves, the green light being then quenched. In the other case the *sides* of the waves strike the mirror, and the green light is reflected. To render the extinction complete, the light must be received upon the mirror at a special angle. What this angle is we shall learn presently.

The quality of two-sidedness conferred upon light by bi-refracting crystals may also be conferred upon it by ordinary reflection. Malus made this discovery in 1808, while looking through Iceland spar at the light of

the sun reflected from the windows of the Luxembourg palace in Paris. I receive upon a plate of window-glass the beam from our lamp; a great portion of the light reflected from the glass is polarized. The vibrations of this reflected beam are executed, for the most part, parallel to the surface of the glass, and when the glass is held so that the beam shall make an angle of 58° with the perpendicular to the glass, the *whole* of the reflected beam is polarized. It was at this angle that the image of the tourmaline was completely quenched in our former experiment. It is called *the polarizing angle*.

Sir David Brewster proved the angle of polarization of a medium to be that particular angle at which the refracted and reflected rays inclose a right angle.¹ The polarizing angle augments with the index of refraction. For water it is $52\frac{1}{2}^\circ$; for glass, as already stated, 58° ; while for diamond it is 68° .

And now let us try to make substantially the experiment of Malus. The beam from the lamp is received at the proper angle upon a plate of glass and reflected through the spar. Instead of two images, you see but one. So that the light, when polarized, as it now is by reflection, can only get through the spar in one direction, and consequently produce but one image. Why is this? In the Iceland spar, as in the tourmaline, all the vibrations of the ordinary light are reduced to

¹ This beautiful law is usually thus expressed: *The index of refraction of any substance is the tangent of its polarizing angle.* With the aid of this law and an apparatus similar to that figured at page 15, we can readily determine the index of refracting any liquid. The refracted and reflected beams being visible, they can readily be caused to enclose a right angle. The polarizing angle of the liquid may be thus found with the sharpest precision. It is then only necessary to seek out its natural tangent to obtain the index of refraction.

two planes at right angles to each other; but, unlike the tourmaline, both beams are transmitted with equal facility by the spar. The two beams, in short, emergent from the spar, are polarized, their directions of vibration being at right angles to each other. It is important to remember this. When, therefore, the light was polarized by reflection, the direction of vibration in the spar which coincided with the direction of vibration of the polarized beam transmitted it, and that direction only. Only one image, therefore, was possible under the conditions.

You will now observe that such logic as connects our experiments is simply a transcript of the logic of Nature. On the screen before you are two disks of light produced by the double refraction of Iceland spar. They are, as you know, two images of the aperture through which the light issues from the camera. Placing the tourmaline in front of the aperture, two images of the crystal will also be obtained; but now let us reason out beforehand what is to be expected from this experiment. The light emergent from the tourmaline is polarized. Placing the crystal with its axis horizontal, the vibrations of its transmitted light will be horizontal. Now the spar, as already stated, has two directions of vibration, one of which at the present moment is vertical, the other horizontal. What are we to conclude? That the green light will be transmitted along the latter, which is parallel to the axis of the tourmaline, and not along the former, which is perpendicular to that axis. Hence we may infer that one image of the tourmaline will show the ordinary green light of the crystal, while the other image will

be black. Tested by experiment, our reasoning is verified to the letter (fig. 31).

FIG. 31.

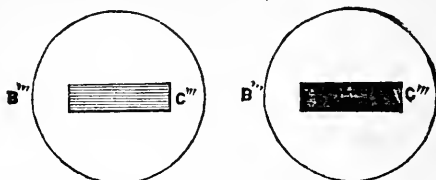

Let us push our test still further. By means of an endless screw, the crystal can be turned ninety degrees round. The black image, as I turn, becomes gradually

FIG. 32.

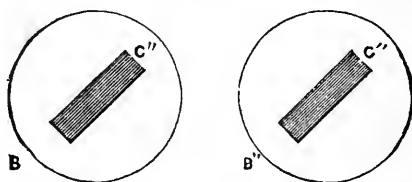

brighter, and the bright one gradually darker; at an angle of forty-five degrees both images are equally bright (fig. 32); while, when ninety degrees have been

FIG. 33.

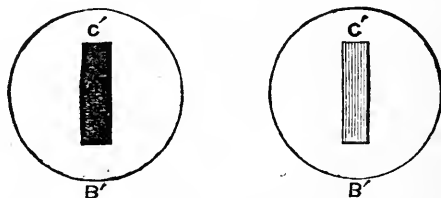

obtained, the axis of the crystal being then vertical, the bright and black images have changed places

exactly as reasoning would have led us to suppose (fig. 33).

Given the two beams transmitted through Iceland spar, it is perfectly manifest that we have it in our power to determine instantly, by means of a plate of tourmaline, the directions in which the ether-particles vibrate in the two beams. The double refracting spar might be placed in any position whatever. A minute's trial with the tourmaline would enable you to determine the position which yields a black and a bright image, and from this you would at once infer the directions of vibration.

Let us reason still further together. The two beams from the spar being thus polarized, it is plain

FIG. 34.

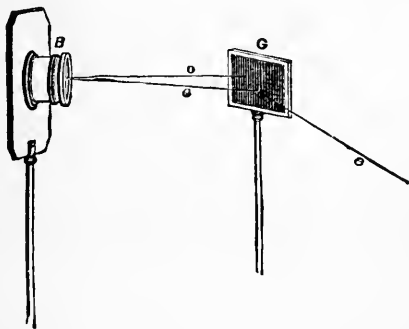

(B is the bi-refracting spar, dividing the incident light into the two beams *o* and *e*, *o* is the mirror.) The beam is here reflected *laterally*. When the reflection is *upwards*, the other beam is reflected as shown in fig. 35.

that if they be suitably received upon a plate of glass at the polarizing angle, one of them will be reflected, the other not. This is a simple inference from our previous knowledge; but you observe that the inference is justified by experiment. (Figs. 34 and 35.)

I have said that the whole of the beam reflected from glass at the polarizing angle is polarized; a word must now be added regarding the far larger portion of the light which is *transmitted* by the glass. The

FIG. 35.

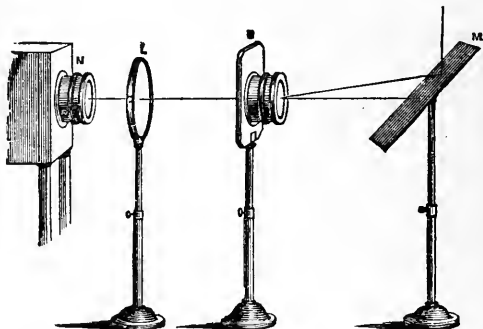

transmitted beam contains a quantity of polarized light equal to the reflected beam: but this is only a fraction of the whole transmitted light. By taking two plates of glass instead of one, we augment the quantity of the transmitted polarized light; and by taking a *bundle* of plates, we so increase the quantity as to render the transmitted beam, for all practical purposes, *perfectly* polarized. Indeed, bundles of glass plates are often employed as a means of furnishing polarized light. Interposing such a bundle at the proper angle into the paths of the two beams emergent from Iceland spar, that which, in the last experiment, failed to be reflected, is here transmitted. The plane of vibration of this transmitted light is at right angles to that of the reflected light.

One word more. When the tourmalines are crossed, the space where they cross each other is black. But

we have seen that the least obliquity on the part of the crystals permits light to get through both. Now suppose, when the two plates are crossed, that we interpose a third plate of tourmaline between them, with its axis oblique to both. A portion of the light transmitted by the first plate will get through this intermediate one. But, after it has got through, *its plane of vibration is changed*: it is no longer perpendicular to the axis of the crystal in front. Hence it will get through that crystal. Thus, by pure reasoning, we infer that the interposition of a third plate of tourmaline will in part abolish the darkness produced by the perpendicular crossing of the other two plates. I have not a third plate of tourmaline; but the talc or mica which you employ in your stoves is a more convenient substance, which acts in the same way. Between the crossed tourmalines, I introduce a film of this crystal with its axis oblique to theirs. You see the edge of the film slowly descending, and as it descends, light takes the place of darkness. The darkness, in fact, seems scraped away, as if it were something material. This effect has been called, naturally but improperly, *depolarization*. Its proper meaning will be disclosed in our next lecture.

These experiments and reasonings, if only thoroughly studied and understood, will form a solid groundwork for the analysis of the splendid optical phenomena next to be considered.

LECTURE IV.

CHROMATIC PHENOMENA PRODUCED BY CRYSTALS IN POLARIZED LIGHT
—THE NICOL PRISM—POLARIZER AND ANALYZER—ACTION OF THICK
AND THIN PLATES OF SELENITE—COLOURS DEPENDENT ON THICK-
NESS—RESOLUTION OF POLARIZED BEAM INTO TWO OTHERS BY THE
SELENITE—ONE OF THEM MORE RETARDED THAN THE OTHER—RE-
COMPOUNDING OF THE TWO SYSTEMS OF WAVES BY THE ANALYZER
—INTERFERENCE THUS RENDERED POSSIBLE—CONSEQUENT PRODUC-
TION OF COLOURS—ACTION OF BODIES MECHANICALLY STRAINED OR
PRESSED—ACTION OF SONOROUS VIBRATIONS—ACTION OF GLASS
STRAINED OR PRESSED BY HEAT—CIRCULAR POLARIZATION—CHROMA-
TIC PHENOMENA PRODUCED BY QUARTZ—THE MAGNETIZATION OF
LIGHT—RINGS SURROUNDING THE AXES OF CRYSTALS—BIAXIAL AND
UNIAXIAL CRYSTALS—GRASP OF THE UNDULATORY THEORY—THE COLOUR
AND POLARIZATION OF SKY-LIGHT—GENERATION OF ARTIFICIAL SKIES.

§ 1. *Action of Crystals on Polarized Light: the
Nicol Prism.*

WE have this evening to examine and illustrate the chromatic phenomena produced by the action of crystals, and double-refracting bodies generally, upon polarized light, and to apply the Undulatory Theory to their elucidation. For a long time investigators were compelled to employ plates of tourmaline for this purpose, and the progress they made with so defective a means of inquiry is astonishing. But these men had their hearts in their work, and were on this account enabled to extract great results from small instrumental appliances. But for our present purpose we need far larger apparatus; and, happily, in these later times this need has

been to a great extent satisfied. We have seen and examined the two beams emergent from Iceland spar, and have proved them to be polarized. If, at the sacrifice of half the light, we could abolish one of these, the other would place at our disposal a beam of polarized light, incomparably stronger than any attainable from tourmaline.

The beams, as you know, are refracted differently, and from this, as made plain in § 4. Lecture I., we are able to infer that the one may be totally reflected, when the other is not. An able optician, named Nicol, cut a crystal of Iceland spar in two halves in a certain direction. He polished the severed surfaces, and reunited them by Canada balsam, the surface of union being so inclined to the beam traversing the spar that the ordinary ray, which is the most highly refracted, was totally reflected by the balsam, while the extraordinary ray was permitted to pass on.

Let bx, cy (fig. 36) represent the section of an elongated rhomb of Iceland spar cloven from the crystal. Let this rhomb be cut along the plane bc ; and the two severed surfaces, after having been polished, reunited by Canada balsam. We learned, in our first lecture, that total reflection only takes place when a ray seeks to escape from a more refracting to a less refracting medium, and that it always, under these circumstances, takes place when the obliquity is sufficient. Now the refractive index of Iceland spar is, for the extraordinary ray less, and for the ordinary greater, than for Canada balsam. Hence, in passing from the spar to the balsam, the extraordinary ray passes from a less refracting to a more refracting medium, where total reflection cannot occur; while the ordinary ray passes from a more

refracting to a less refracting medium, where total reflection can occur. The requisite obliquity is secured by making the rhomb of such a length that the plane

FIG. 36.

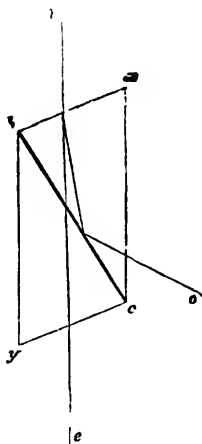

of which $b c$ is the section shall be perpendicular, or nearly so, to the two end surfaces of the rhomb $b x, c y$.

The invention of the Nicol prism was a great step in practical optics, and quite recently such prisms have been constructed of a size and purity which enable audiences like the present to witness the chromatic phenomena of polarized light to a degree altogether unattainable a short time ago. The two prisms here before you belong to my excellent friend Mr. William Spottiswoode, and they were manufactured by Mr. Ladd. I have with me another pair of very noble prisms, still larger than these, manufactured for me by Mr. Browning,

who has gained so high and well-merited a reputation in the construction of spectroscopes.¹

§ 2. Colours of Films of Selenite in Polarized Light.

These two Nicol prisms play the same part as the two plates of tourmaline. Placed with their directions of vibration parallel, the light passes through both; while when these directions are crossed the light is quenched. Introducing a film of mica between the prisms, the light, as in the case of the tourmaline, is restored. But notice, when the film of mica is *thin* you have sometimes not only light, but *coloured* light. Our work for some time to come will consist of the examination of such colours. With this view, I will take a representative crystal, one easily dealt with, because it cleaves with great facility—the crystal gypsum, or selenite, which is crystallized sulphate of lime. Between the crossed Nicols I place a thick plate of this crystal; like the mica, it restores the light, but it produces no colour. With my penknife I take a thin splinter from the crystal and place it between the prisms; the image of the splinter glows with the richest colours. Turning the prism in front, these colours gradually fade and disappear, but, by continuing the rotation until the vibrating sections of the prisms are parallel to each other, vivid colours again arise, but these colours are complementary to the former ones.

Some patches of the splinter appear of one colour, some of another. These differences are due to the different thicknesses of the film. As in the case of

¹ The largest and purest prism hitherto made has been recently constructed for Mr. Spottiswoode by Messrs. Tisley & Spiller.

Hooke's thin plates, if the thickness be uniform, the colour is uniform. Here, for instance, is a stellar shape, every lozenge of the star being a film of gypsum of uniform thickness: each lozenge, you observe, shows a brilliant and uniform colour. It is easy, by shaping our films so as to represent flowers or other objects, to exhibit such objects in hues unattainable by art. Here, for example, is a specimen of heart's-ease, the colours of which you might safely defy the artist to reproduce. By turning the front Nicol 90 degrees round, we pass through a colourless phase to a series of colours complementary to the former ones. This change is still more strikingly represented by a rose-tree, which is now presented in its natural hues—a red flower and green leaves; turning the prism 90 degrees round, we obtain a green flower and red leaves. All these wonderful chromatic effects have definite mechanical causes in the motions of the ether. The principle of interference duly applied and interpreted explains them all.

§ 3. *Colours of Crystals in Polarized Light explained by the Undulatory Theory.*

By this time you have learned that the word 'light' may be used in two different senses; it may mean the impression made upon consciousness, or it may mean the physical agent which makes the impression. It is with the agent that we have to occupy ourselves at present. That agent is a substance which fills all space, and surrounds the atoms and molecules of bodies. To this interstellar and interatomic medium definite mechanical properties are ascribed, and we deal with it in our reasonings and calculations as a body possessed of

these properties. In mechanics we have the composition and resolution of forces and of motions, extending to the composition and resolution of *vibrations*. We treat the luminiferous ether on mechanical principles, and, from the composition, resolution, and interference of its vibrations we deduce all the phenomena displayed by crystals in polarized light.

Let us take, as an example, the crystal of tourmaline, with which we are now so familiar. Let a vibration cross this crystal oblique to its axis. Experiment has assured us that a portion of the light will pass through. The quantity which passes we determine in this way. Let $A B$ (fig. 37) be the axis of the tourmaline, and let $a b$

FIG. 37.

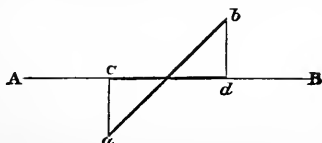

represent the amplitude of the ethereal vibration before it reaches $A B$. From a and b let the two perpendiculars $a c$ and $b d$ be drawn upon the axis: then $c d$ will be the amplitude of the transmitted vibration.

I shall immediately ask you to follow me while I endeavour to explain the effects observed when a film of gypsum is placed between the two Nicol's prisms. But, prior to this, it will be desirable to establish still further the analogy between the action of the prisms and that of the two plates of tourmaline. The magnified images of these plates, with their axes at right-angles to each other, are now before you. Introducing between them a film of selenite, you observe that by turning the film round it may be placed in a position

where it has no power to abolish the darkness of the superposed portions of the tourmalines. Why is this? The answer is, that in the gypsum there are two directions, at right angles to each other, in which alone vibrations can take place, and that in our present experiment one of these directions is parallel to one of the axes of the tourmaline, and the other parallel to the other axis. When this is the case, the film exercises no sensible action upon the light. But now I turn the film so as to render its directions of vibration *oblique* to the two tourmaline axes; then, you see it exercises the power, demonstrated in the last lecture, of restoring the light.

Let us now mount our Nicol's prisms, and cross them as we crossed the tourmalines. Introducing

FIG. 38.

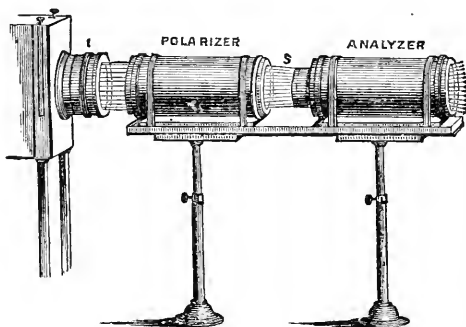

our film of gypsum between them, you notice that in one particular position the film has no power whatever over the field of view. But, when the film is turned a little way round, the light passes. We have now to understand the mechanism by which this is effected.

Firstly, then, we have a prism which receives the light from the electric lamp, and which is called the *polarizer*. Then we have the plate of gypsum (supposed to be placed at S, fig. 38), and then the prism in front, which is called the *analyzer*. On its emergence from the first prism, the light is polarized; and, in the particular case now before us, its vibrations are executed in a horizontal plane. We have to examine what occurs when the two directions of vibration in the gypsum are oblique to the horizon. Draw a rectangular cross (A B, C D, fig. 39) to represent these

FIG. 39.

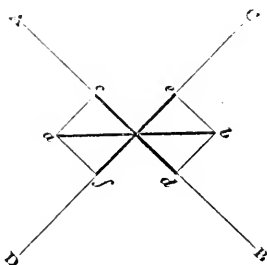

two directions. Draw a line (*a b*) to represent the amplitude of the vibration on the emergence of the light from the first Nicol. Let fall from the two ends of this line two perpendiculars on each of the arms of the cross; then the distances (*c d, e f*) between the feet of these perpendiculars represent the amplitudes of two rectangular vibrations, which are the *components* of the first single vibration. Thus the polarized ray, when it enters the gypsum, is resolved into its two equivalents, which vibrate at right angles to each other.

In one of these two rectangular directions the ether

within the gypsum is more sluggish than in the other; and, as a consequence, the waves that follow this direction are more retarded than the others. In fact, in both cases the undulations are shortened when they enter the gypsum, but in the one case they are more shortened than in the other. You can readily imagine that in this way the one system of waves may get half a wave-length, or indeed any number of half-wave lengths, in advance of the other. The possibility of interference here at once flashes upon the mind. A little consideration, however, will render it evident that, as long as the vibrations are executed at right angles to each other, they cannot quench each other, no matter what the retardation may be. This brings us at once to the part played by the analyzer. Its sole function is to recompound the two vibrations emergent from the gypsum. It reduces them to a single plane, where, if one of them be retarded by the proper amount, extinction will occur.

But here, as in the case of thin films, the different lengths of the waves of light come into play. Red will require a greater thickness to produce the retardation necessary for extinction than blue; consequently, when the longer waves have been withdrawn by interference, the shorter ones remain, the film of gypsum shining with the colours which they confer. Conversely, when the shorter waves have been withdrawn, the thickness is such that the longer waves remain. An elementary consideration suffices to show that, when the directions of vibration of the prisms and the gypsum enclose an angle of forty-five degrees, the colours are at their maximum brilliancy. When the film is turned from this direction, the colours gradually fade, until, at the point

where the directions of vibration are parallel, they disappear altogether.

The best way of obtaining a knowledge of these phenomena is to construct a model of thin wood or paste-board, representing the plate of gypsum, its planes of vibration, and also those of the polarizer and analyzer. Two parallel pieces of the board are to be separated by an interval which shall represent the thickness of the film of gypsum. Between them, two other pieces, intersecting each other at a right angle, are to represent the planes of vibration within the film; while attached to the two parallel surfaces outside are two other pieces of board to represent the planes of vibration of the polarizer and analyzer. On the two intersecting planes the waves are to be drawn, showing the resolution of the first polarized beam into two others, and then the subsequent reduction of the two systems of vibrations to a common plane by the analyzer. Following out rigidly the interaction of the two systems of waves, we are taught by such a model that all the phenomena of colour obtained by the combination of the waves when the planes of vibration of the two Nicols are parallel are displaced by the *complementary* phenomena when the planes of vibration are perpendicular to each other.

In considering the next point, we will operate, for the sake of simplicity, with monochromatic light—with red light, for example, which is easily obtained pure by red glass. Supposing a certain thickness of the gypsum produces a retardation of half a wave-length, twice this thickness will produce a retardation of two half wave-lengths, three times this thickness a retardation of three half-wave lengths, and so on. Now, when the Nicols

are parallel, the retardation of half a wave-length, or of any *odd* number of half wave-lengths, produces extinction; at all thicknesses, on the other hand, which correspond to a retardation of an *even* number of half wave-lengths, the two beams support each other, when they are brought to a common plane by the analyzer. Supposing, then, that we take a plate of a wedge-form, which grows gradually thicker from edge to back, we ought to expect in red light a series of recurrent bands of light and darkness; the dark bands occurring at thicknesses which produce retardations of one, three, five, etc., half wave-lengths, while the bright bands occur between the dark ones. Experiment proves the wedge-shaped film to show these bands. They are also beautifully shown by a circular film, so worked as to be thinnest at the centre, and gradually increasing in thickness from the centre outwards. A splendid series of rings of light and darkness is thus produced.

When, instead of employing red light, we employ blue, the rings are also seen: but, as they occur at thinner portions of the film, they are smaller than the rings obtained with the red light. The consequence of employing white light may be now inferred; inasmuch as the red and the blue fall in different places, we have *iris-coloured* rings produced by the white light.

Some of the chromatic effects of irregular crystallization are beautiful in the extreme. Could I introduce between our Nicols a pane of glass covered by those frost-ferns which the cold weather renders now so frequent, rich colours would be the result. The beautiful effects of the irregular crystallization of tartaric acid and other substances on glass plates, now presented

to you, illustrate what you might expect from the frosted window-pane. And not only do crystalline bodies act thus upon light, but almost all bodies that possess a definite structure do the same. As a general rule, organic bodies act thus upon light; for their architecture implies an arrangement of the molecules, and of the ether, which involves double refraction. A film of horn, or the section of a shell, for example, yields very beautiful colours in polarized light. In a tree, the ether certainly possesses different degrees of elasticity along and across the fibre; and, were wood transparent, this peculiarity of molecular structure would infallibly reveal itself by chromatic phenomena like those that you have seen.

§ 4. *Colours produced by Strain and Pressure.*

But not only do natural bodies behave in this way, but it is possible, as shown by Brewster, to confer, by artificial strain or pressure, a temporary double-refracting structure upon non-crystalline bodies, such as common glass. This is a point worthy of illustration. When I place a bar of wood across my knee and seek to break it, what is the mechanical condition of the bar? It bends, and its convex surface is *strained* longitudinally; its concave surface, that next my knee, is longitudinally *pressed*. Both in the strained portion and in the pressed portion the ether is thrown into a condition which would render the wood, were it transparent, double-refracting. For, in cases like the present, the drawing of the molecules asunder longitudinally is always accompanied by their approach to each other laterally; while the longitudinal squeezing is accompanied by

lateral retreat. Each half of the bar exhibits this antithesis, and is therefore double-refracting.

Let us now repeat this experiment with a bar of glass. Between the crossed Nicols I introduce such a bar. By the dim residue of light lingering upon the screen, you see the image of the glass, but it has no effect upon the light. I simply bend the glass bar with my finger and thumb, keeping its length oblique to the directions of vibration in the Nicols. Instantly light flashes out upon the screen. The two sides of the bar are illuminated, the edges most, for here the strain and pressure are greatest. In passing from longitudinal strain to longitudinal pressure, we cross a portion of the glass where neither is exerted. This is the so-called neutral axis of the bar of glass, and along it you see a dark band, indicating that the glass along this axis exercises no action upon the light. By employing the force of a press, instead of the force of my finger and thumb, the brilliancy of the light is greatly augmented.

Again, I have here a square of glass which can be inserted into a press of another kind. Introducing the uncompressed square between the prisms, its neutrality is declared; but it can hardly be held sufficiently loosely in the press to prevent its action from manifesting itself. Already, though the pressure is infinitesimal, you see spots of light at the points where the press is in contact with the glass. On turning a screw the image of the square of glass flashes out upon the screen. Luminous spaces are seen separated from each other by dark bands.

Every two adjacent luminous spaces are in opposite mechanical conditions. On one side of the dark

band we have strain, on the other side pressure; while the dark band marks the neutral axis between both. I now tighten the vice, and you see colour; tighten still more, and the colours appear as rich as those presented by crystals. Releasing the vice, the colours suddenly vanish; tightening suddenly, they reappear. From the colours of a soap-bubble Newton was able to infer the thickness of the bubble, thus uniting by the bond of thought apparently incongruous things. From the colours here presented to you, the magnitude of the pressure employed might be inferred. Indeed, the late M. Wertheim, of Paris, invented an instrument for the determination of strains and pressures, by the colours of polarized light, which exceeded in accuracy all previous instruments of the kind.

And now we have to push these considerations to a final illustration. Polarized light may be turned to account in various ways as an analyzer of molecular condition. It may, for instance, be applied to reveal the condition of a solid body when it becomes sonorous. A strip of glass six feet long, two inches wide, and a quarter of an inch thick, is held at the centre between the finger and thumb. On sweeping a wet woollen rag over one of its halves, you hear an acute sound due to the vibrations of the glass. What is the condition of the glass while the sound is heard? This: its two halves lengthen and shorten in quick succession. Its two ends, therefore, are in a state of quick vibration; but at the centre the pulses from the two ends alternately meet and retreat from each other. Between their opposing actions, the glass at the centre is kept motionless; but, on the other hand, it is alternately strained and

compressed. The state of the glass may be illustrated by

FIG. 40.

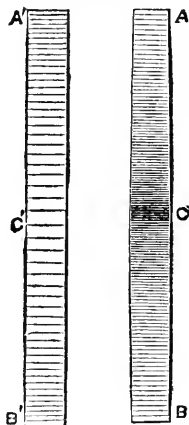

a row of spots of light, as the propagation of a sonorous

FIG. 41.

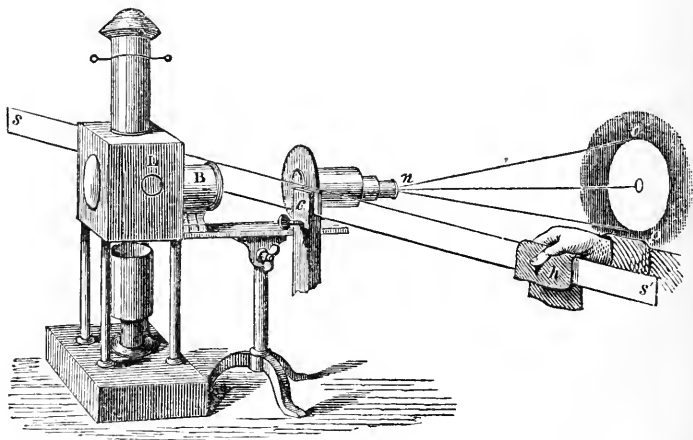

pulse was illustrated in our second lecture. By a simple mechanical contrivance the spots are made to vibrate to and fro: the terminal dots have the largest amplitude of vibration, while those at the centre are alternately crowded together and drawn asunder, the centre one not moving at all. (In fig. 40, AB may be taken to represent the glass rectangle with its centre condensed; while $A'B'$ represents the same rectangle with its centre rarefied. The ends of the strip suffer neither condensation nor rarefaction.)

If we introduce the strip of glass (ss' , fig. 41) between the crossed Nicols, taking care to keep it oblique to the directions of vibration of the Nicols, and sweep our wet rubber over the glass, this may be expected to occur: At every moment of compression the light will flash through; at every moment of strain the light will also flash through; and these states of strain and pressure will follow each other so rapidly that we may expect a permanent luminous impression to be made upon the eye. By pure reasoning, therefore, we reach the conclusion that the light will be revived whenever the glass is sounded. That it is so, experiment testifies: at every sweep of the rubber, a fine luminous disk (o) flashes out upon the screen. The experiment may be varied in this way: Placing in front of the polarizer a plate of unannealed glass, you have a series of beautifully coloured rings, intersected by a black cross. Every sweep of the rubber not only abolishes the rings, but introduces complementary ones, the black cross being, for the moment, supplanted by a white one. This is a modification of a beautiful experiment which we owe to Biot. His apparatus, however, confined the observation of it to a single person at a time.

§ 5. *Colours of Unannealed Glass.*

Bodies are usually expanded by heat and contracted by cold. If the heat be applied with perfect uniformity, no local strains or pressures come into play; but, if one portion of a solid be heated and other portions not, the expansion of the heated portion introduces strains and pressures which reveal themselves under the scrutiny of polarized light. When a square of common window-glass is placed between the Nicols, you see its dim outline, but it exerts no action on the polarized light. Held for a moment over the flame of a spirit-lamp, on reintroducing it between the Nicols, light flashes out upon the screen. Here, as in the case of mechanical action, you have luminous spaces of strain divided by dark neutral axes from spaces of pressure.

Let us apply the heat more symmetrically. A small square of glass is perforated at the centre, and into the orifice a bit of copper wire is introduced. Placing the square between the prisms, and heating the wire, the heat passes by conduction to the glass, through which it spreads from the centre outwards. You immediately see, bounding four luminous quadrants, a dim cross, which becomes gradually blacker by comparison with the adjacent brightness. And as, in the case of pressure, we produced colours, so here also, by the proper application of heat, gorgeous chromatic effects may be produced. The condition necessary to the production of these colours may be rendered permanent by first heating the glass sufficiently, and then cooling it, so that the chilled mass

shall remain in a state of permanent strain and pressure. Two or three examples will illustrate this point. Figs.

FIG. 42.

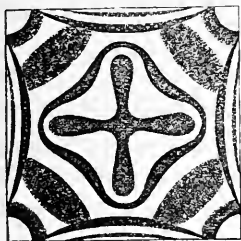
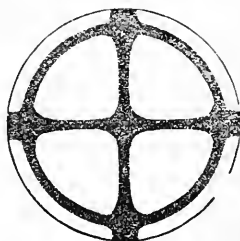
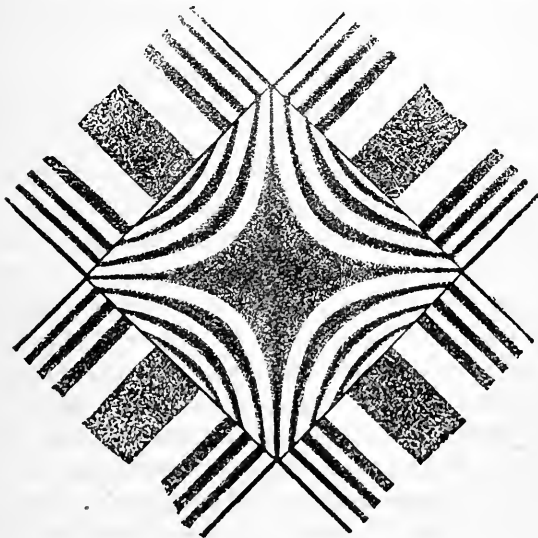

FIG. 43.



42 and 43 represent the figures obtained with two pieces of glass thus prepared. Two rectangular pieces

FIG. 44.



of unannealed glass, crossed and placed between the polarizer and analyzer, exhibit the beautiful iris fringes represented in fig. 44.

§ 6. *Circular Polarization.*

But we have to follow the ether still further into its hiding-places. Suspended before you is a pendulum, which, when drawn aside and liberated, oscillates to and fro. If, when the pendulum is passing the middle point of its excursion, I impart a shock to it tending to drive it at right angles to its present course, what occurs? The two impulses compound themselves to a vibration oblique in direction to the former one, but the pendulum still oscillates in *a plane*. But, if the rectangular shock be imparted to the pendulum when it is at the limit of its swing, then the compounding of the two impulses causes the suspended ball to describe not a straight line, but an ellipse; and, if the shock be competent of itself to produce a vibration of the same amplitude as the first one, the ellipse becomes a circle.

Why do I dwell upon these things? Simply to make known to you the resemblance of these gross mechanical vibrations to the vibrations of light. I hold in my hand a plate of quartz cut from the crystal perpendicular to its axis. The crystal thus cut possesses the extraordinary power of twisting the plane of vibration of a polarized ray to an extent dependent on the thickness of the crystal. And the more refrangible the light the greater is the amount of twisting; so that, when white light is employed, its constituent colours are thus drawn asunder. Placing the quartz between the polarizer and analyzer, you see this vivid red, and, turning the analyzer in front, from right to left, the other colours

of the spectrum appear in succession. Specimens of quartz have been found which require the analyzer to be turned from left to right to obtain the same succession of colours. Crystals of the first class are therefore called right-handed, and of the second class, left-handed crystals.

With profound sagacity, Fresnel, to whose genius we mainly owe the expansion and final triumph of the undulatory theory of light, reproduced mentally the mechanism of these crystals, and showed their action to be due to the circumstance that, in them, the waves of ether so act upon each other as to produce the condition represented by our rotating pendulum. Instead of being plane polarized, the light in rock crystal is *circularly polarized*. Two such rays, transmitted along the axis of the crystal, and rotating in opposite directions, when brought to interference by the analyzer, are demonstrably competent to produce all the observed phenomena.

§ 7. *Complementary Colours of Bi-refracting Spar in Circularly Polarized Light. Proof that Yellow and Blue are Complementary.*

I now remove the analyzer, and put in its place the piece of Iceland spar with which we have already illustrated double refraction. The two images of the carbon-points are now before you, produced, as you know, by two beams vibrating at right angles to each other. Introducing a plate of quartz between the polarizer and the spar, the two images glow with complementary colours. Employing the image of an aperture instead of that of the carbon-points, we have two coloured

circles. As the analyzer is caused to rotate, the colours pass through various changes; but they are always complementary. When the one is red, the other is green; when the one is yellow, the other is blue. Here we have it in our power to demonstrate afresh a statement made in our first lecture, that, although the mixture of blue and yellow pigments produces green, the mixture of blue and yellow lights produces white. By enlarging our aperture, the two images produced by the spar are caused to approach each other, and finally to overlap. The one is now a vivid yellow,

FIG. 45.

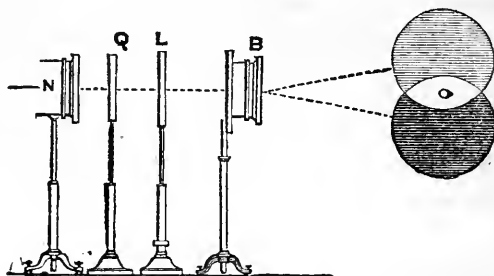

the other a vivid blue, and you notice that where the colours are superposed we have a pure white. (See fig. 45, where N is the end of the polarizer, Q the quartz plate, L a lens, and B the bi-refracting spar. The two images overlap at O, and produce white by their mixture.)

§ 8. *The Magnetization of Light.*

This brings us to a point of our inquiries which, though rarely illustrated in lectures, is nevertheless so likely to affect profoundly the future course of

scientific thought that I am unwilling to pass it over without reference. I refer to the experiment which Faraday, its discoverer, called the 'magnetization of light.' The arrangement for this celebrated experiment is now before you. We have first our electric lamp, then a Nicol prism, to polarize the beam emergent from the lamp; then an electro-magnet, then a second Nicol, and finally our screen. At the present moment the prisms are crossed, and the screen is dark. I place from pole to pole of the electro-magnet a cylinder of a peculiar kind of glass, first made by Faraday, and called Faraday's heavy glass. Through this glass the beam from the polarizer now passes, being intercepted by the Nicol in front. On exciting the magnet light instantly appears upon the screen. By the action of the magnet upon the ether contained within the heavy glass, the plane of vibration is caused to rotate, the light being thus enabled to get through the analyzer.

The two classes into which quartz-crystals are divided have been already mentioned. In my hand I hold a compound plate, one half of it taken from a right-handed, and the other from a left-handed crystal. Placing the plate in front of the polarizer, I turn one of the Nicols until the two halves of the plate show a common puce colour. This yields an exceedingly sensitive means of rendering visible the action of a magnet upon light. By turning either the polarizer or the analyzer through the smallest angle, the uniformity of the colour disappears, and the two halves of the quartz show different colours. The magnet produces an effect equivalent to this rotation. The puce-coloured circle is now before you on the screen. (See fig. 46, where

N is the nozzle of the lamp, H the first Nicol, Q the biquartz plate, L a lens, M the electro-magnet, with the heavy glass across its poles, and P the second Nicol.) Exciting the magnet, one half of the image becomes suddenly red, the other half green. Interrupting the current, the two colours fade away, and the primitive puce is restored.

FIG. 46.

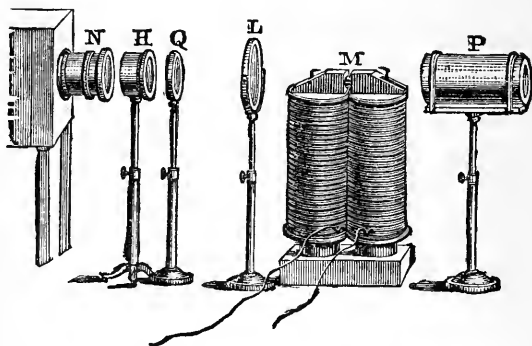

The action, moreover, depends upon the polarity of the magnet, or, in other words, on the direction of the current which surrounds the magnet. Reversing the current, the red and green reappear, but they have changed places. The red was formerly to the right, and the green to the left; the green is now to the right, and the red to the left. With the most exquisite ingenuity, Faraday analyzed all those actions and stated their laws. This experiment, however, long remained rather a scientific curiosity than a fruitful germ. That it would bear fruit of the highest importance, Faraday felt profoundly convinced, and recent researches are on the way to verify his conviction.

§ 9. *Iris-rings surrounding the Axes of Crystals.*

A few words more are necessary to complete our knowledge of the wonderful interaction between ponderable molecules and the ether interfused among them. Symmetry of molecular arrangement implies symmetry on the part of the ether; atomic dissymmetry, on the other hand, involves the dissymmetry of the ether, and, as a consequence, double refraction. In a certain class of crystals the structure is homogeneous, and such crystals produce no double refraction. In certain other crystals the molecules are ranged symmetrically round a certain line, and not around others. Along the former, therefore, the ray is undivided, while along all the others we have double refraction. Ice is a familiar example: its molecules are built with perfect symmetry around the perpendiculars to the planes of freezing, and a ray sent through ice in this direction is not doubly refracted; whereas, in all other directions, it is. Iceland spar is another example of the same kind: its molecules are built symmetrically round the line uniting the two blunt angles of the rhomb. In this direction a ray suffers no double refraction, in all others it does. This direction of no double refraction is called the *optic axis* of the crystal.

Hence, if a plate be cut from a crystal of Iceland spar perpendicular to the axis, all rays sent across this plate in the direction of the axis will produce but one image. But, the moment we deviate from the parallelism with the axis, double refraction sets in. If, therefore, a beam that has been rendered *conical* by a converging lens be sent through the spar so that the central ray of

the cone passes along the axis, this ray only will escape double refraction. Each of the others will be divided into an ordinary and an extraordinary ray, the one moving more slowly through the crystal than the other; the one, therefore, retarded with reference to the other. Here, then, we have the conditions for interference, when the waves are reduced by the analyzer to a common plane.

Placing the plate of Iceland spar between the crossed Nicol's prisms, and employing the conical beam, we have

FIG. 47.

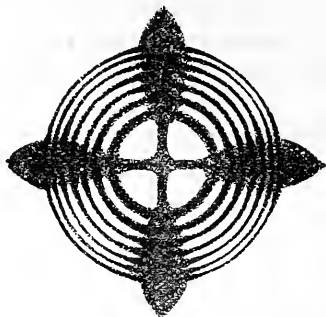

upon the screen a beautiful system of iris-rings surrounding the end of the optic axis, the circular bands of colour being intersected by a black cross (fig. 47). The arms of this cross are parallel to the two directions of vibration in the polarizer and analyzer. It is easy to see that those rays whose planes of vibration within the spar coincide with the plane of vibration of *either* prism, cannot get through *both*. This complete interception produces the arms of the cross. With monochromatic light the rings would be simply bright and black—the bright rings occurring at those thicknesses of the spar which cause the rays to con-

spire; the black rings at those thicknesses which cause them to quench each other. Turning the analyzer 90° round, we obtain the complementary phenomena. The black cross gives place to a bright one, and every dark ring is supplanted also by a bright one (fig. 48). Here,

FIG. 48.



as elsewhere, the different lengths of the light-waves give rise to iris-colours when white light is employed.

Besides the *regular* crystals which produce double

FIG. 49.

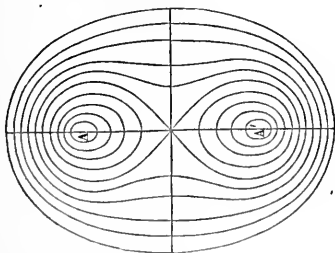

refraction in no direction, and the *uniaxal* crystals which produce it in all directions but one, Brewster discovered that in a large class of crystals there are *two* directions in which double refraction does not take place. These are called *biaxal* crystals. When plates of these crystals, suitably cut, are placed between the

polarizer and analyzer, the axes ($A A'$, fig 49) are seen surrounded, not by circles, but by curves of another order and of a perfectly definite mathematical character. Each band, as proved experimentally by Herschel, forms a *lemniscata*; but the experimental proof was here, as in numberless other cases, preceded by the deduction which showed that, according to the undulatory theory, the bands must possess this special character.

§ 10. *Power of the Undulatory Theory.*

I have taken this somewhat wide range over polarization itself, and over the phenomena exhibited by crystals in polarized light, in order to give you some notion of the firmness and completeness of the theory which grasps them all. Starting from the single assumption of transverse undulations, we first of all determine the wave-lengths, and find all the phenomena of colour dependent on this element. The wave-lengths may be determined in many independent ways. Newton virtually determined them when he measured the periods of his Fits: the length of a fit, in fact, is that of a quarter of an undulation. The wave-lengths may be determined by diffraction at the edges of a slit (as in the Appendix to these Lectures); they may be deduced from the interference fringes produced by reflection; from the fringes produced by refraction; also by lines drawn with a diamond upon glass at measured distances asunder. And when the lengths determined by these independent methods are compared together, the strictest agreement is found to exist between them.

With the wave-lengths at our disposal, we follow the ether into the most complicated cases of interaction

between it and ordinary matter, 'the theory is equal to them all. It makes not a single new physical hypothesis; but out of its original stock of principles it educes the counterparts of all that observation shows. It accounts for, explains, simplifies the most entangled cases; corrects known laws and facts; predicts and discloses unknown ones; becomes the guide of its former teacher Observation; and, enlightened by mechanical conceptions, acquires an insight which pierces through shape and colour to force and cause.'¹

But, while I have thus endeavoured to illustrate before you the power of the undulatory theory as a solver of all the difficulties of optics, do I therefore wish you to close your eyes to any evidence that may arise against it? By no means. You may urge, and justly urge, that a hundred years ago another theory was held by the most eminent men, and that, as the theory then held had to yield, the undulatory theory may have to yield also. This seems reasonable; but let us understand the precise value of the argument. In similar language a person in the time of Newton, or even in our time, might reason thus: Hipparchus and Ptolemy, and numbers of great men after them, believed that the earth was the centre of the solar system. But this deep-set theoretic notion had to give way, and the theory of gravitation may, in its turn, have to give way also. This is just as reasonable as the first argument. Wherein consists the strength of the theory of gravitation? Solely in its competence to account for all the phenomena of the solar system. Wherein consists the strength of the theory of undulation? Solely in its competence to disentangle and explain phenomena

¹ Whewell.

a hundred-fold more complex than those of the solar system. Accept if you will the scepticism of Mr. Mill¹ regarding the undulatory theory; but if your scepticism be philosophical, it will wrap the theory of gravitation in the same or greater doubt.²

§ 11. *The Blue of the Sky.*

I am unwilling to quit these chromatic phenomena without referring to a source of colour which has often come before me of late in the blue of your skies at noon, and the deep crimson of your horizon after the set of sun. I will here summarise and extend what I have already said upon this subject in another place. Proofs of the most cogent description could be adduced to show that the blue light of the firmament is reflected light. That light comes to us across the direction of the solar rays, and even against the direction of the solar rays; and this lateral and opposing rush of wave-motion can only be due to the rebound of the waves from the air itself, or from something suspended in the air. The solar light, moreover, is not reflected by the sky in the proportions which produce white. The sky is blue, which indicates an excess of the smaller waves. The blueness of the air has been given as a reason for the blueness of the sky; but then the question arises. How, if the air be blue, can the light of sunrise and sunset, which travels through vast distances of air, be yellow, orange, or even red? The passage of the white solar

¹ Removed from us since these words were written.

² The only essay known to me on the Undulatory Theory, from the pen of an American writer, is an excellent one by President Barnard, published in the Smithsonian Report for 1862.

light through a blue medium could by no possibility redden the light; the hypothesis of a blue air is therefore untenable. In fact the agent, whatever it be, which sends us the light of the sky, exercises in so doing a dichroitic action. The light reflected is blue, the light transmitted is orange or red. A marked distinction is thus exhibited between reflection from the sky and that from an ordinary cloud, which exercises no such dichroitic action.

The cloud, in fact, takes no note of size on the part of the waves of ether, but reflects them all alike. Now the cause of this may be that the cloud particles are so large in comparison with the size of the waves of ether as to scatter them all indifferently. A broad cliff reflects an Atlantic roller as easily as a ripple produced by a sea-bird's wing; and in the presence of large reflecting surfaces, the existing differences of magnitude among the waves of ether may also disappear. But supposing the reflecting particles, instead of being very large, to be very small, in comparison with the size of the waves. Then, instead of the whole wave being fronted and in great part thrown back, a small portion only is shivered off by the obstacle. Suppose, then, such minute foreign particles to be diffused in our atmosphere. Waves of all sizes impinge upon them, and at every collision a portion of the impinging wave is struck off. All the waves of the spectrum, from the extreme red to the extreme violet, are thus acted upon; but in what proportions will they be scattered? Largeness is a thing of relation; and the smaller the wave, the greater is the relative size of any particle on which the wave impinges, and the greater also the relative reflection.

A small pebble placed in the way of the ring-ripples produced by heavy rain-drops on a tranquil pond will throw back a large fraction of each ripple incident upon it, while the fractional part of a larger wave thrown back by the same pebble might be infinitesimal. Now to preserve the solar light white, its constituent proportions must not be altered; but in the scattering of the light by these very small particles we see that the proportions *are* altered. The smaller waves are in excess, and, as a consequence, in the scattered light blue will be the predominant colour. The other colours of the spectrum must, to some extent, be associated with the blue: they are not absent, but deficient. We ought, in fact, to have them all, but in diminishing proportions, from the violet to the red.

We have thus reasoned our way to the conclusion, that were particles, small in comparison to the size of the ether waves, sown in our atmosphere, the light scattered by those particles would be exactly such as we observe in our azure skies. And, indeed, when this light is analysed, all the colours of the spectrum are found in the proportions indicated by our conclusion.

By its successive collisions with the particles the white light is more and more robbed of its shorter waves; it therefore loses more and more of its due proportion of blue. The result may be anticipated. The transmitted light, where short distances are involved, will appear yellowish. But as the sun sinks towards the horizon the atmospheric distance increases, and consequently the number of the scattering particles. They weaken in succession the violet, the indigo, the blue, and even disturb the proportions of green. The

transmitted light under such circumstances must pass from yellow through orange to red. This also is exactly what we find in nature. Thus, while the reflected light gives us, at noon, the deep azure of the Alpine skies, the transmitted light gives us, at sunset, the warm crimson of the Alpine snows.

But can small particles be really proved to act in the manner indicated? No doubt of it. Each one of you can submit the question to an experimental test. Water will not dissolve resin, but spirit will; and when spirit which holds resin in solution is dropped into water, the resin immediately separates in solid particles, which render the water milky. The coarseness of this precipitate depends on the quantity of the dissolved resin. Professor Brücke has given us the proportions which produce particles particularly suited to our present purpose. One gramme of clean mastic is dissolved in eighty-seven grammes of absolute alcohol, and the transparent solution is allowed to drop into a beaker containing clear water briskly stirred. An exceedingly fine precipitate is thus formed, which declares its presence by its action upon light. Placing a dark surface behind the beaker, and permitting the light to fall into it from the top or front, the medium is seen to be of a very fair sky-blue. A trace of soap in water gives a tint of blue. London milk makes an approximation to the same colour through the operation of the same cause: and Helmholtz has irreverently disclosed the fact that a blue eye is simply a turbid medium.

§ 12. *Artificial Sky.*

But we have it in our power to imitate far more closely the natural conditions of this problem. We can

generate in air artificial skies, and prove their perfect identity with the natural one, as regards the exhibition of a number of wholly unexpected phenomena. It has been recently shown in a great number of instances that waves of ether issuing from a strong source, such as the sun or the electric light, are competent to shake asunder the atoms of gaseous molecules. The apparatus used to illustrate this consists of a glass tube about a yard in length, and from $2\frac{1}{2}$ to 3 inches internal diameter. The gas or vapour to be examined is introduced into this tube, and upon it the condensed beam of the electric lamp is permitted to act. The vapour is so chosen that one, at least, of its products of decomposition, as soon as it is formed, shall be *precipitated* to a kind of cloud. By graduating the quantity of the vapour, this precipitation may be rendered of any degree of fineness, forming particles distinguishable by the naked eye, or particles which are probably far beyond the reach of our highest microscopic powers. I have no reason to doubt that particles may be thus obtained whose diameters constitute but a very small fraction of the length of a wave of violet light.

Now, in all such cases when suitable vapours are employed in a sufficiently attenuated state, no matter what the vapour may be, the visible action commences with the formation of a *blue cloud*. Let me guard myself at the outset against all misconception as to the use of this term. The blue cloud here referred to is totally invisible in ordinary daylight. To be seen, it requires to be surrounded by darkness, *it only* being illuminated by a powerful beam of light. This cloud differs in many important particulars from the finest ordinary clouds, and might justly have assigned to it an inter-

mediate position between these clouds and true cloudless vapour.

It is possible to make the particles of this *actinic cloud* grow from an infinitesimal and altogether ultra-microscopic size to particles of sensible magnitude; and by means of these, in a certain stage of their growth, we produce a blue which rivals, if it does not transcend, that of the deepest and purest Italian sky. Introducing into our tube a quantity of mixed air and nitrite of butyl vapour sufficient to depress the mercurial column of an air-pump one-twentieth of an inch, adding a quantity of air and hydrochloric acid sufficient to depress the mercury half an inch further, and sending through this compound and highly attenuated atmosphere, the beam of the electric light; gradually within the tube arises a splendid azure, which strengthens for a time, reaches a maximum of depth and purity, and then, as the particles grow larger, passes into whitish blue. This experiment is representative, and it illustrates a general principle. Various other colourless substances of the most diverse properties, optical and chemical, might be employed for this experiment. The *incipient cloud*, in every case, would exhibit this superb blue; thus proving to demonstration that particles of infinitesimal size, without any colour of their own, and irrespective of those optical properties exhibited by the substance in a massive state, are competent to produce the blue colour of the sky.

§ 13. *Polarization of Sky-light.*

But there is another subject connected with our firmament, of a more subtle and recondite character

than even its colour. I mean that 'mysterious and beautiful phenomenon,' the polarization of the light of the sky. Looking at various points of the blue firmament through a Nicol's prism, and turning the prism round its axis, we soon notice variations of brightness. In certain positions of the prism, and from certain points of the firmament, the light appears to be wholly transmitted, while it is only necessary to turn the prism round its axis through an angle of ninety degrees to materially diminish the intensity of the light. Experiments of this kind prove that the blue light sent to us by the firmament is polarized, and on close scrutiny it is also found that the direction of most perfect polarization is perpendicular to the solar rays. Were the heavenly azure like the ordinary light of the sun, the turning of the prism would have no effect upon it; it would be transmitted equally during the entire rotation of the prism. The light of the sky is in great part quenched, because it is in great part polarized.

The same phenomenon is exhibited in perfection by our actinic clouds, the only condition necessary to its production being the smallness of the particles. In all cases, and with all substances, the cloud formed at the commencement, when the precipitated particles are sufficiently fine, is *blue*. In all cases, moreover, this fine blue cloud polarizes *perfectly* the beam which illuminates it, the direction of polarization enclosing an angle of 90° with the axis of the illuminating beam.

It is exceedingly interesting to observe both the growth and the decay of this polarization. For ten or fifteen minutes after its first appearance the light from

a vividly illuminated incipient cloud, looked at horizontally, is absolutely quenched by a Nicol's prism with its longer diagonal vertical. But as the sky-blue is gradually rendered impure by the introduction of particles of too large a size, in other words, as real clouds begin to be formed, the polarization begins to deteriorate, a portion of the light passing through the prism in all its positions, as it does in the case of skylight. It is worthy of note that for some time after the cessation of perfect polarization the *residual* light which passes, when the Nicol is in its position of minimum transmission, is of a gorgeous blue, the whiter light of the cloud being extinguished. When the cloud texture has become sufficiently coarse to approximate to that of ordinary clouds, the rotation of the Nicol ceases to have any sensible effect on the quantity of the light discharged at right angles to the beam.

The perfection of the polarization in a direction perpendicular to the illuminating beam was also illustrated by the following experiment executed with many vapours. A Nicol's prism large enough to embrace the entire beam of the electric lamp was placed between the lamp and the experimental tube. Sending the beam polarized by the Nicol through the tube, I placed myself in front of it, the eyes being on a level with its axis, my assistant occupying a similar position behind the tube. The short diagonal of the large Nicol was in the first instance vertical, the plane of vibration of the emergent beam being therefore also vertical. As the light continued to act, a superb blue cloud visible to both my assistant and myself was slowly formed. But this cloud, so deep and rich when looked at

from the positions mentioned, utterly disappeared when looked at vertically downwards, or vertically upwards. Reflection from the cloud was not possible in these directions. When the large Nicol was slowly turned round its axis, the eye of the observer being on the level of the beam, and the line of vision perpendicular to it, entire extinction of the light emitted horizontally occurred when the longer diagonal of the large Nicol was vertical. But a vivid blue cloud was seen when looked at downwards or upwards. This truly fine experiment, which I should certainly have made without suggestion, was, as a matter of fact, first definitely suggested by a remark addressed to me in a letter by Professor Stokes.

All the phenomena of colour and of polarization observable in the case of skylight are manifested by those actinic clouds; and they exhibit additional phenomena which it would be neither convenient to pursue, nor perhaps possible to detect, in the actual firmament. They enable us, for example, to follow the polarization from its first appearance on the barely visible blue to its final extinction in the coarser cloud. These changes, as far as it is now necessary to refer to them, may be thus summed up:—

1. The actinic cloud, as long as it continues blue, discharges polarized light in all directions, but the direction of maximum polarization, like that of skylight, is at right angles to the direction of the illuminating beam.

2. As long as the cloud remains distinctly blue the light discharged from it at right angles to the illuminating beam is *perfectly* polarized. It may be utterly quenched by a Nicol's prism, the cloud from which it

issues being caused to disappear. Any deviation from the perpendicular enables a portion of the light to get through the prism.

3. The direction of vibration of the polarized light is at right angles to the illuminating beam. Hence a plate of tourmaline, with its axis parallel to the beam, stops the light, and with the axis perpendicular to the beam transmits the light.

4. A plate of selenite placed between the Nicol and the actinic cloud shows the colours of polarized light; in fact, the cloud itself plays the part of a polarizing Nicol.

5. The particles of the blue cloud are immeasurably small, but they increase gradually in size, and at a certain period of their growth cease to discharge perfectly polarized light. For some time afterwards the light that reaches the eye through the Nicol is of a magnificent blue, far exceeding in depth and purity that of the purest sky; thus the waves that first feel the influence of size, at both limits of the polarization, are the shortest waves of the spectrum. These are the first to accept polarization, and they are the first to escape from it.

LECTURE V.

RANGE OF VISION NOT COMMENSURATE WITH RANGE OF RADIATION—THE ULTRA-VIOLET RAYS—FLUORESCENCE—RENDERING INVISIBLE RAYS VISIBLE—VISION NOT THE ONLY SENSE APPEALED TO BY THE SOLAR AND ELECTRIC BEAM—HEAT OF BEAM—COMBUSTION BY TOTAL BEAM AT THE FOCI OF MIRRORS AND LENSES—COMBUSTION THROUGH ICE-LENS—IGNITION OF DIAMOND—SEARCH FOR THE RAYS HERE EFFECTIVE—SIR WILLIAM HERSCHEL'S DISCOVERY OF DARK SOLAR RAYS—INVISIBLE RAYS THE BASIS OF THE VISIBLE—DETACHMENT BY A RAY-FILTER OF THE INVISIBLE RAYS FROM THE VISIBLE—COMBUSTION AT DARK FOCI—CONVERSION OF HEAT-RAYS INTO LIGHT-RAYS—CALORESCENCE—PART PLAYED IN NATURE BY DARK RAYS—IDENTITY OF LIGHT AND RADIANT HEAT—INVISIBLE IMAGES—REFLECTION, REFRACTION, PLANE POLARIZATION, DEPOLARIZATION, CIRCULAR POLARIZATION, DOUBLE REFRACTION, AND MAGNETIZATION OF RADIANT HEAT.

§ 1. *Range of Vision and of Radiation.*

THE first question that we have to consider to-night is this: Is the eye, as an organ of vision, commensurate with the whole range of solar radiation—is it capable of receiving visual impressions from all the rays emitted by the sun? The answer is negative. If we allowed ourselves to accept for a moment that notion of gradual growth, amelioration, and ascension, implied by the term *evolution*, we might fairly conclude that there are stores of visual impressions awaiting man, far greater than those now in his possession. Ritter discovered in 1801 that beyond the extreme violet of the spectrum there is a vast efflux of rays which are totally

useless as regards our present powers of vision. These ultra-violet waves, however, though incompetent to awaken the optic nerve, can shake asunder the molecules of certain compound substances on which they impinge, thus producing chemical decomposition.

But though the blue, violet, and ultra-violet rays can act thus upon certain substances, the fact is hardly sufficient to entitle them to the name of 'chemical rays,' usually applied to distinguish them from the other constituents of the spectrum. As regards their action upon the salts of silver, and many other substances they may perhaps merit this title; but in the case of the grandest example of the chemical action of light—the decomposition of carbonic acid in the leaves of plants, with which my eminent friend Dr. Draper has so indissolubly associated his name—the yellow rays are found to be most active.

There are substances, however, on which the violet and ultra-violet waves exert a special decomposing power; and, by permitting the invisible spectrum to fall upon surfaces prepared with such substances, we reveal both the existence and the extent of the ultra-violet spectrum.

§ 2. *Ultra-violet Rays: Fluorescence.*

The method of exhibiting the action of the ultra-violet rays by their chemical action has been long known; indeed, Thomas Young photographed the ultra-violet rings of Newton. We have now to demonstrate their presence in another way. As a general rule, bodies either transmit light or absorb it; but there is a third case in which the light falling upon the body is

neither transmitted nor absorbed, but converted into light of another kind. Professor Stokes, the occupant of the chair of Newton in the University of Cambridge, has demonstrated this change of one kind of light into another, and has pushed his experiments so far as to render the invisible rays visible.

A large number of substances examined by Stokes, when excited by the invisible ultra-violet waves, have been proved to emit light. You know the rate of vibration corresponding to the extreme violet of the spectrum; you are aware that to produce the impression of this colour, the retina is struck 789 millions of millions of times in a second. At this point, the retina ceases to be useful as an organ of vision, for though struck by waves of more rapid recurrence, they are incompetent to awaken the sensation of light. But when such non-visual waves are caused to impinge upon the molecules of certain substances—on those of sulphate of quinine, for example—they compel those molecules, or their constituent atoms, to vibrate; and the peculiarity is, that the vibrations thus set up are *of slower period* than those of the exciting waves. By this lowering of the rate of vibration through the intermediation of the sulphate of quinine, the invisible rays are brought within the range of vision. We shall subsequently have abundant opportunity for learning that transparency to the visible by no means involves transparency to the invisible rays. Our bisulphide of carbon, for example, which, employed in prisms, is so eminently suitable for experiments on the visual rays, is by no means so suitable for these ultra-violet rays. Flint glass is better, and rock crystal is better than flint

glass. A glass prism, however, will suit our present purpose.

Casting by means of such a prism a spectrum, not upon the white surface of our screen, but upon a sheet of paper which has been wetted with a saturated solution of the sulphate of quinine, and afterwards dried, an obvious extension of the spectrum is revealed. We have, in the first instance, a portion of the violet rendered whiter and more brilliant; but, besides this, we have the gleaming of the colour where, in the case of unprepared paper, nothing is seen. Other substances produce a similar effect. A substance, for example, recently discovered by President Morton, and named by him *Thallene*, produces a very striking elongation of the spectrum, the new light generated being of peculiar brilliancy.

Fluor spar and some other substances, when raised to a temperature still under redness, emit light. During the ages which have elapsed since their formation, this capacity of shaking the ether into visual tremors appears to have been enjoyed by these substances. Light has been potential within them all this time; and, as well explained by Draper, the heat, though not itself of visual intensity, can unlock the molecules so as to enable them to exert their long-latent power of vibration. This deportment of fluor spar determined Stokes in his choice of a name for his great discovery: he called this rendering visible of the ultra-violet rays *Fluorescence*.

By means of a deeply-coloured violet glass, we cut off almost the whole of the light of our electric beam; but this glass is peculiarly transparent to the violet and ultra-violet rays. The violet beam now crosses a large jar filled with water, into which I pour a solution of

sulphate of quinine. Clouds, to all appearance opaque, instantly tumble downwards. Fragments of horse-chestnut bark thrown upon the water also send down beautiful cloud-like striæ. But these are not clouds: there is nothing precipitated here: the observed action is an action of *molecules*, not of *particles*. The medium before you is not a turbid medium, for when you look through it at a luminous surface it is perfectly clear.

If we paint upon a piece of paper a flower or a bouquet with the sulphate of quinine, and expose it to the full beam, scarcely anything is seen. But on interposing the violet glass, the design instantly flashes forth in strong contrast with the deep surrounding violet. A most beautiful example of such a design has been prepared for me with his thallene by President Morton: placed in the violet light it exhibits a peculiarly brilliant fluorescence. From the experiments of Dr. Bence Jones, it would seem that there is some substance in the human body resembling the sulphate of quinine, which causes all the tissues of the body to be more or less fluorescent. The crystalline lens of the eye exhibits the effect in a very striking manner. When, for example, I plunge my eye into this violet beam, I am conscious of a whitish-blue shimmer filling the space before me. This is caused by fluorescent light generated in the eye itself. Looked at from without, the crystalline lens at the same time is seen to gleam vividly.

Long before its physical origin was understood this fluorescent light attracted attention. Boyle, as Sir Charles Wheatstone has been good enough to point out to me, describes it with great fullness and exact-

ness. 'We have sometimes,' he says, 'found in the shops of our druggists a certain wood which is there called *Lignum Nephriticum*, because the inhabitants of the country where it grows are wont to use the infusion of it, made in fair water, against the stone in the kidneys. This wood may afford us an experiment which, besides the singularity of it, may give no small assistance to an attentive considerer towards the detection of the nature of colours. Take *Lignum Nephriticum*, and with a knife cut it into thin slices: put about a handful of these slices into two or three or four pounds of the purest spring water. Decant this impregnated water into a glass phial; and if you hold it directly between the light and your eye, you shall see it wholly tinted with an almost golden colour. But if you hold this phial from the light, so that your eye be placed betwixt the window and the phial, the liquid will appear of a deep and lovely ceruleous colour.'

'These,' he continues, 'and other phenomena which I have observed in this delightful experiment, divers of my friends have looked upon, not without some wonder; and I remember an excellent oculist, finding by accident in a friend's chamber a phial full of this liquor, which I had given that friend, and having never heard anything of the experiment, nor having anybody near him who could tell him what this strange liquor might be, was a great while apprehensive, as he presently afterwards told me, that some strange new distemper was invading his eyes. And I confess that the unusualness of the phenomenon made me very solicitous to find out the cause of this experiment; and though I am far from pretending to have found it, yet

my enquiries have, I suppose, enabled me to give such hints as may lead your greater sagacity to the discovery of the cause of this wonder.’¹

Goethe in his ‘*Farbenlehre*’ thus describes the fluorescence of horse-chestnut bark:—‘Let a strip of fresh horse-chestnut bark be taken and clipped into a glass of water; the most perfect sky-blue will be immediately produced.’² Sir John Herschel first noticed and described the fluorescence of the sulphate of quinine, and showed that the light proceeded from a thin stratum of the solution adjacent to the surface where the light enters it. He showed, moreover, that the incident beam, although not sensibly weakened in luminous power, lost, in its transmission through the solution of sulphate of quinine, the power of producing the blue fluorescent light. Sir David Brewster also worked at the subject; but to Professor Stokes we are indebted not only for its expansion, but for its full and final explanation.

§ 3. *The Heat of the Electric Beam. Ignition through a Lens of Ice. Possible Cometary Temperature.*

But the waves from our incandescent carbon-points appeal to another sense than that of vision. They not only produce light, but heat, as a sensation. The magnified image of the carbon-points is now upon the screen; and with a suitable instrument the heating power of the rays which form that image might be readily demonstrated. In this case, however, the heat is spread over too large an area to be very intense.

¹ Boyle’s Works, Birch’s edition, vol. i. pp. 729 and 730.

² Werke, b. xxix. p. 24.

Pushing out the lens, and causing a movable screen to approach our lamp, the image is seen to become smaller and smaller; the rays at the same time becoming more and more concentrated, until finally they are able to pierce black paper with a burning ring. Pushing back the lens so as to render the rays parallel and receiving them upon a concave mirror, they are brought to a focus; paper placed at that focus is caused to smoke and burn. Heat of this intensity may be obtained with our ordinary camera and lens, and a concave mirror of very moderate power.

We will now adopt stronger measures with the radiation. In this larger camera of blackened tin is

FIG. 50.

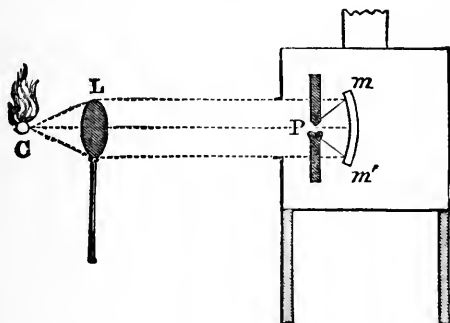

placed a lamp, in all particulars similar to those already employed. But instead of gathering up the rays from the carbon-points by a condensing lens, we gather them up by a concave mirror ($m m'$, fig 50), silvered in front and placed behind the carbons (P). By this mirror we can cause the rays to issue through the orifice in front of the camera, either parallel or convergent. They are now parallel, and therefore, to a certain extent,

diffused. We place a convex lens (L) in the path of the beam ; the light is converged to a focus (C), and at that focus paper is not only pierced and a burning ring formed, but it is instantly set ablaze.

Many metals may be burned up in the same way. In our first lecture the combustibility of zinc was mentioned. Placing a strip of sheet-zinc at this focus, it is instantly ignited, burning with its characteristic purple flame. And now I will substitute for our glass lens (L) one of a more novel character. In a smooth iron mould a lens of pellucid ice has been formed. Placing it in the position occupied a moment ago by the glass lens, I can see the beam brought to a sharp focus. At the focus I place a bit of black paper, with a little gun-cotton folded up within it. The paper immediately ignites and the cotton explodes. Strange, is it not, that the beam should possess such heating power after having passed through so cold a substance? In his arctic expeditions Dr. Scoresby succeeded in exploding gunpowder by the sun's rays converged by large lenses of ice; here we have succeeded in producing the effect with a small lens, and with a terrestrial source of heat.

In this experiment, you observe that, before the beam reaches the ice-lens, it has passed through a glass cell containing water. The beam is thus sifted of constituents, which, if permitted to fall upon the lens, would injure its surface, and blur the focus. And this leads me to say an anticipatory word regarding transparency. In our first lecture we entered fully into the production of colours by absorption, and we spoke repeatedly of the quenching of the rays of light. Did this mean that the light was altogether annihilated?

By no means. It was simply so lowered in refrangibility as to escape the visual range. It was converted into heat. Our red ribbon in the green of the spectrum quenched the green, but if suitably examined its temperature would have been found raised. Our green ribbon in the red of the spectrum quenched the red, but its temperature at the same time was augmented to a degree exactly equivalent to the light extinguished. Our black ribbon, when passed through the spectrum, was found competent to quench all its colours; but at every stage of its progress an amount of heat was generated in the ribbon exactly equivalent to the light lost. It is only when absorption takes place that heat is thus produced; and heat is always a result of absorption.

Examine the water, then, in front of the lamp after the beam has passed through it: it is sensibly warm, and, if permitted to remain there long enough, it might be made to boil. This is due to the absorption, by the water, of a certain portion of the electric beam. But a portion passes through unabsorbed, and does not at all contribute to the heating of the water. Now, ice is also in great part transparent to these latter rays, and therefore is but little melted by them. Hence, by employing this particular portion of the beam, we are able to keep our lens intact, and to produce by means of it a sharply-defined focus. Placed at that focus, white paper is not ignited, because it fails to absorb the rays emergent from the ice-lens. At the same place, however, black paper instantly burns, because it absorbs the transmitted light.

And here it may be useful to refer to an estimate by Newton, based upon doubtful data, but repeated by

various astronomers of eminence since his time. The comet of 1680, when nearest to the sun, was only a sixth of the sun's diameter from his surface. Newton estimated its temperature, in this position, to be more than two thousand times that of molten iron. Now it is clear from the foregoing experiments that the temperature of the comet could not be inferred from its nearness to the sun. If its power of absorption were sufficiently low, the comet might carry into the sun's neighbourhood the temperature of stellar space.

§ 4. *Combustion of Diamond by Radiant Heat.*

Faraday thus describes the burning of a diamond in oxygen by the concentrated rays of the sun. It was effected at Florence, in presence of Sir Humphry Davy, on Tuesday the 27th of March, 1814:—‘To-day we made the grand experiment of burning the diamond, and certainly the phenomena presented were extremely beautiful and interesting. A glass globe containing about 22 cubical inches was exhausted of air, and filled with pure oxygen. The diamond was supported in the centre of this globe. The Duke's burning-glass was the instrument used to apply heat to the diamond. It consists of two double convex lenses, distant from each other about $3\frac{1}{2}$ feet; the large lens is about 14 or 15 inches in diameter, the smaller one about 3 inches in diameter. By means of the second lens the focus is very much reduced, and the heat, when the sun shines brightly, rendered very intense. The diamond was placed in the focus and anxiously watched. On a sudden Sir H. Davy observed the diamond to burn

visibly, and when removed from the focus it was found to be in a state of active and rapid combustion.'

The combustion of the diamond had never been effected by radiant heat from a terrestrial source. I tried to accomplish this before crossing the Atlantic, and succeeded in doing so. The small diamond now in my hand is held by a loop of platinum wire. To protect it as far as possible from air currents, and also to concentrate the heat upon it, it is surrounded by a hood of sheet platinum. Bringing a jar of oxygen underneath, I cause the focus of the electric beam to fall upon the diamond. A small fraction of the time expended in the experiment described by Faraday, suffices to raise the diamond to a brilliant red. Plunging it then into the oxygen, it glows like a little white star, and it would continue to burn and glow until wholly consumed. The focus can also be made to fall upon the diamond in oxygen, as in the Florentine experiment: the result is the same. It is simply to secure more complete mastery over the position of the focus, so as to cause it to fall accurately upon the diamond, that the mode of experiment here described was resorted to.

§ 5. *Ultra-red Rays: Calorescence.*

In the path of the beam issuing from our lamp I now place a cell with glass sides containing a solution of alum. All the *light* of the beam passes through this solution. This light is received on a powerfully converging mirror silvered in front, and brought to a focus by the mirror. You can see the conical beam of reflected light tracking itself through the dust of the room. A scrap of white paper placed at the focus

shines there with dazzling brightness, but it is not even charred. On removing the alum cell, however, the paper instantly inflames. There must, therefore, be something in this beam besides its light. The *light* is not absorbed by the white paper, and therefore does not burn the paper; but there is something over and above the light which *is* absorbed, and which provokes combustion. What is this something?

In the year 1800 Sir William Herschel passed a thermometer through the various colours of the solar spectrum, and marked the rise of temperature corresponding to each colour. He found the heating effect to augment from the violet to the red; he did not, however, stop at the red, but pushed his thermometer into the dark space beyond it. Here he found the temperature actually higher than in any part of the visible spectrum. By this important observation, he proved that the sun emitted heat-rays which are entirely unfit for the purposes of vision. The subject was subsequently taken up by Seebeck, Melloni, Müller, and others, and within the last few years it has been found capable of unexpected expansions and applications. I have devised a method whereby the solar or electric beam can be so *filtered* as to detach from it, and preserve intact, this invisible ultra-red emission, while the visible and ultra-violet emissions are wholly intercepted. We are thus enabled to operate at will upon the purely ultra-red waves.

In the heating of solid bodies to incandescence this non-visual emission is the necessary basis of the visual. A platinum wire is stretched in front of the table, and through it an electric current flows. It is warmed by the current, and may be felt to be warm by the hand.

It emits waves of heat, but no light. Augmenting the strength of the current, the wire becomes hotter; it finally glows with a sober red light. At this point Dr. Draper many years ago began an interesting investigation. He employed a voltaic current to heat his platinum, and he studied, by means of a prism, the successive introduction of the colours of the spectrum. His first colour, as here, was red; then came orange, then yellow, then green, and lastly all the shades of blue. Thus as the temperature of the platinum was gradually augmented, the atoms were caused to vibrate more rapidly; shorter waves were thus introduced, until finally waves were obtained corresponding to the entire spectrum. As each successive colour was introduced, the colours preceding it became more vivid. Now the vividness or intensity of light, like that of sound, depends not upon the length of the wave, but on the amplitude of the vibration. Hence, as the less refrangible colours grew more intense as the more refrangible ones were introduced, we are forced to conclude that side by side with the introduction of the shorter waves we had an augmentation of the amplitude of the longer ones.

These remarks apply not only to the visible emission examined by Dr. Draper, but to the invisible emission which precedes the appearance of any light. In the emission from the white-hot platinum wire now before you the very waves exist with which we started, only their intensity has been increased a thousand-fold by the augmentation of temperature necessary to the production of this white light. Both effects are bound together: in an incandescent solid, or in a molten solid, you cannot have the shorter waves without this intensification of the longer ones. A sun is possible

only on these conditions; hence Sir William Herschel's discovery of the invisible ultra-red solar emission.

The invisible heat, emitted both by dark bodies and by luminous ones, flies through space with the velocity of light, and is called *radiant heat*. Now, radiant heat may be made a subtle and powerful explorer of molecular condition, and, of late years, it has given a new significance to the act of chemical combination. Take, for example, the air we breathe. It is a mixture of oxygen and nitrogen; and it behaves towards radiant heat like a vacuum, being incompetent to absorb it in any sensible degree. But permit the same two gases to unite chemically; then, without any augmentation of the quantity of matter, without altering the gaseous condition, without interfering in any way with the transparency of the gas, the act of chemical union is accompanied by an enormous diminution of its *diathermancy*, or perviousness to radiant heat.

The researches which established this result also proved the elementary gases, generally, to be highly transparent to radiant heat. This, again, led to the proof of the diathermancy of elementary liquids, like bromine, and of solutions of the solid elements sulphur, phosphorus, and iodine. A spectrum is now before you, and you notice that the transparent bisulphide of carbon has no effect upon the colours. Dropping into the liquid a few flakes of iodine, you see the middle of the spectrum cut away. By augmenting the quantity of iodine, we invade the entire spectrum, and finally cut it off altogether. Now, the iodine, which proves itself thus hostile to the light, is perfectly transparent to the ultra-red emission with which we have now to deal. It, therefore, is to be our ray-filter.

Placing the alum-cell again in front of the electric lamp, we assure ourselves, as before, of the utter inability of the concentrated light to fire white paper. Introducing a cell containing the solution of iodine, the light is entirely cut off; and then, on removing the alum-cell, the white paper at the dark focus is instantly set on fire. Black paper is more absorbent than white for these rays; and the consequence is, that with it the suddenness and vigour of the combustion are augmented. Zinc is burnt up at the same place, magnesium bursts into vivid combustion, while a sheet of platinized platinum placed at the focus is heated to whiteness.

Looked at through a prism, the white-hot platinum yields all the colours of the spectrum. Before impinging upon the platinum, the waves were of too slow recurrence to awaken vision; by the atoms of the platinum, these long and sluggish waves are broken up into shorter ones, being thus brought within the visual range. At the other end of the spectrum, by the interposition of suitable substances, Professor Stokes *lowered* the refrangibility, so as to render the non-visual rays visual, and to this change he gave the name of *Fluorescence*. Here, by the intervention of the platinum, the refrangibility is *raised*, so as to render the non-visual visual, and to this change I have given the name of *Calorescence*.

At the perfectly invisible focus where these effects are produced, the air may be as cold as ice. Air, as already stated, does not absorb the radiant heat, and is therefore not warmed by it. Nothing could more forcibly illustrate the isolation, if I may use the term, of the luminiferous ether from the air. The wave-motion of the one is heaped up, without sensible effect

upon the other. I may add that, with suitable precautions, the eye may be placed in a focus competent to heat platinum to vivid redness, without experiencing any damage, or the slightest sensation either of light or heat.

The important part played by these ultra-red rays in Nature may be thus illustrated: I remove the iodine filter, and concentrate the total beam upon a test-tube containing water. It immediately begins to sputter, and in a minute or two it *boils*. What boils it? Placing the alum solution in front of the lamp, the boiling instantly ceases. Now, the alum is pervious to all the luminous rays; hence it cannot be these rays that caused the boiling. I now introduce the iodine, and remove the alum; vigorous ebullition immediately recommences at the invisible focus. So that we here fix upon the invisible ultra-red rays the heating of the water.

We are thus enabled to understand the momentous part played by these rays in Nature. It is to them that we owe the warming and the consequent evaporation of the tropical ocean; it is to them, therefore, that we owe our rains and snows. They are absorbed close to the surface of the ocean, and warm the superficial water, while the luminous rays plunge to great depths without producing any sensible effect. But we can proceed further than this. Here is a large flask containing a freezing mixture, which has so chilled the flask, that the aqueous vapour of the air has been condensed and frozen upon it to a white fur. Introducing the alum-cell, and placing the coating of hoar-frost at the intensely luminous focus, not a spicula of the dazzling frost is melted. Introducing the iodine-cell, and

removing the alum, a broad space of the frozen coating is instantly melted away. Hence we infer that the snow and ice, which feed the Rhone, the Rhine, and other rivers with glaciers for their sources, are released from their imprisonment upon the mountains by the invisible ultra-red rays of the sun.

§ 6. *Identity of Light and Radiant Heat. Reflection from Plane and Curved Surfaces. Total Reflection of Heat.*

The growth of science is organic. That which to-day is an *end* becomes to-morrow a *means* to a remoter end. Every new discovery in science is immediately made the basis of other discoveries, or of new methods of investigation. Thus about fifty years ago, Ørsted, of Copenhagen, discovered the deflection of a magnetic needle by an electric current; and about the same time Thomas Seebeck, of Berlin, discovered thermo-electricity. These great discoveries were soon afterwards turned to account, by Nobili and Melloni, in the construction of an instrument which has vastly augmented our knowledge of radiant heat. This instrument, which is called a *thermo-electric pile*, consists of thin bars of bismuth and antimony, soldered alternately together at their ends, but separated from each other elsewhere. From the ends of this 'thermo-pile' wires pass to a galvanometer, which consists of a coil of covered wire, within and above which are suspended two magnetic needles, joined to a rigid system, and carefully defended from currents of air.

The action of the arrangement is this: the heat, falling on the pile, produces an electric current; the current,

passing through the coil, deflects the needles, and the magnitude of the deflection may be made a measure of the heat. The upper needle moves over a graduated dial far too small to be directly seen. It is now, however, strongly illuminated; and above it is a lens which, if permitted, would form an image of the needle and dial upon the ceiling. There, however, it could not be conveniently viewed. The beam is therefore received upon a looking-glass, placed at the proper angle, which throws the image upon a screen. In this way the motions of this small needle may be made visible to you all.

The delicacy of this apparatus is such that in a room filled, as this room now is, with an audience physically warm, it is exceedingly difficult to work with it. My assistant stands several feet off. I turn the pile towards him: the heat from his face, even at this distance, produces a deflection of 90° . I turn the instrument towards a distant wall, judged to be a little below the average temperature of the room. The needle descends and passes to the other side of zero, declaring by this negative deflection that the pile feels the chill of the wall. Possessed of this instrument, of our ray-filter, and of our large Nicol prisms, we are in a condition to investigate a subject of great philosophical interest; one which long engaged the attention of some of our foremost scientific workers—the substantial *identity of light and radiant heat*.

That they are identical in *all* respects cannot of course be the case, for if they were they would act in the same manner upon all instruments, the *eye* included. The identity meant is such as subsists between one colour and another, causing them to behave alike as regards reflection, refraction, double

refraction, and polarization. Let us here run rapidly over the resemblances of light and heat. As regards reflection from plane surfaces, we may employ a looking-glass to reflect the light. Marking any point in the track of the reflected beam, cutting off the light by the dissolved iodine, and placing the pile at the marked point, the needle immediately starts aside, showing that the heat is reflected in the same direction as the light. This is true for every position of the mirror. Resuming, for example, the experiments made with the apparatus

FIG. 51.

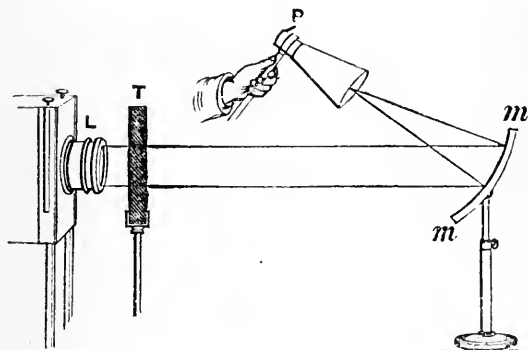

employed in our first lecture (fig. 3, p. 11); moving the index attached to the mirror along the divisions of our graduated arc (M O), and determining by the pile the positions of the invisible reflected beam, we prove that the angular velocity of the heat-beam, like that of the light-beam, is twice that of the mirror.

As regards reflection from curved surfaces, the identity also holds good. Receiving the beam from our electric lamp on a concave mirror (*m m*, fig. 51), it is gathered up into a cone of reflected light; mark-

ing the apex of the cone by a pointer, and cutting off the light by the iodine solution (T), a moment's exposure of the pile (P) at the marked point produces a violent deflection of the needle.

The common and total reflection of a beam of radiant heat may be simultaneously demonstrated. From the nozzle of the lamp (L, fig. 52) a beam impinges upon a plane mirror (M N), is reflected upwards, and enters a right-angled prism, of which $a b c$ is the section.

FIG. 52.

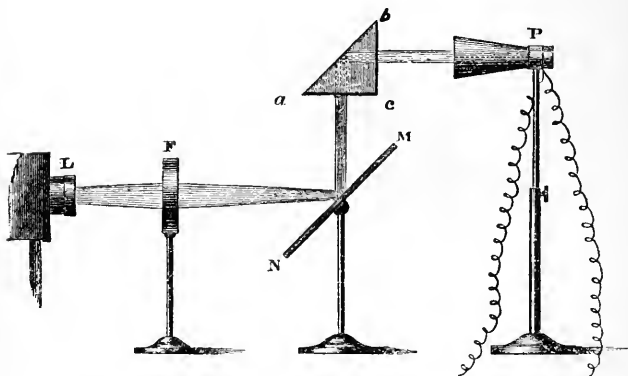

It meets the hypotenuse at an obliquity greater than the limiting angle,¹ and is therefore totally reflected. Quenching the light by the ray-filter at F, and placing the pile at P, the totally-reflected heat-beam is immediately felt by the pile, and declared by the galvanometric deflection.

¹ Defined in Lecture I.

§ 7. *Invisible Images formed by Radiant Heat.*

Perhaps no experiment more conclusively proves the substantial identity of light and radiant heat, than the formation of invisible heat-images. Employing the mirror already used to raise the beam to its highest state of concentration, we obtain, as is well known, an inverted image of the carbon points, formed by the light rays at the focus. Cutting off the light by the

FIG. 53.



ray-filter, and placing at the focus a thin sheet of platinized platinum, the invisible rays declare their presence and distribution by stamping upon the platinum a white-hot image of the carbons. (See fig. 53.)

§ 8. *Polarization of Heat.*

Whether radiant heat be capable of polarization or not was for a long time a subject of discussion. Bérard had announced affirmative results, but Powell and Lloyd failed to verify them. The doubts thus thrown upon the question were removed by the experiments

of Forbes, who first established the polarization and 'depolarization' of heat. The subject was subsequently followed up by Melloni, an investigator of consummate ability, who sagaciously turned to account his own discovery, that the obscure rays of luminous sources are in part transmitted by black glass. Intercepting by a plate of this glass the light from an oil flame, and operating upon the transmitted invisible heat, he obtained effects of polarization, far exceeding in magnitude those which could be obtained with non-luminous sources. At present the possession of our more perfect ray-filter, and more powerful source of heat,

FIG. 54.

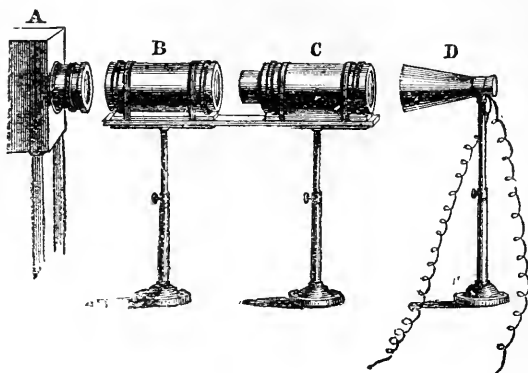

enables us to pursue this identity question to its utmost practical limits.

Mounting our two Nicols (B and C, fig. 54) in front of the electric lamp, with their principal sections crossed, no light reaches the screen. Placing our thermo-electric pile (D) behind the prisms, with its face turned towards the source, no deflection of the galvanometer is observed. Interposing between the

lamp (A) and the first prism (B) our ray-filter, the light previously transmitted through the first Nicol is quenched; and now the slightest turning of either Nicol opens a way for the transmission of the heat, a very small rotation sufficing to send the needle up to 90° . When the Nicol is turned back to its first position, the needle again sinks to zero, thus demonstrating in the plainest manner the polarization of the heat.

When the Nicols are crossed and the field is dark, you have seen, in the case of light, the effect of introducing a plate of mica between the polarizer and analyzer. In two positions the mica exerts no sensible influence; in all others it does. A precisely analogous deportment is observed as regards radiant heat. Introducing our ray-filter, the thermo-pile, playing the part of an eye as regards the invisible radiation, receives no heat when the eye receives no light; but when the mica is so turned as to make its planes of vibration oblique to those of the polarizer and analyzer, the heat immediately passes through. So strong does the action become, that the momentary plunging of the film of mica into the dark space between the Nicols suffices to send the needle up to 90° . This is the effect to which the term 'depolarization' has been applied; the experiment really proving that with light and heat we have the same resolution by the plate of mica, and recombining by the analyzer, of the ethereal vibrations.

Removing the mica and restoring the needle once more to 0° , I introduce between the Nicols a plate of quartz cut perpendicular to the axis; the immediate deflection of the needle declares the transmission of the heat, and when the transmitted beam is properly

examined, it is found to be circularly polarized, exactly as a beam of light is polarized under the same conditions.

§ 9. *Double Refraction of Heat.*

I will now abandon the Nicols, and send through the piece of Iceland spar (B, fig. 55), already employed to illustrate the double refraction of light, our sifted

FIG. 55.

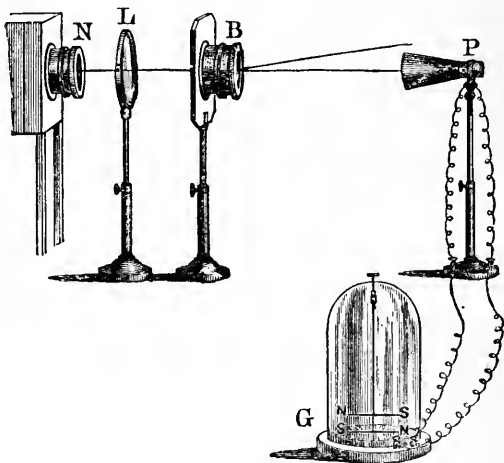

beam of invisible heat. To determine the positions of the two images, let us first operate upon the total beam. Marking the places of the light-images, we introduce between N and L our ray-filter (not in the figure) and quench the light. Causing the pile to approach one of the marked points, the needle remains unmoved until the point has been attained; here the pile at once detects the heat. Pushing the pile across

the interval separating the two marks, the needle first falls to 0° , and then rises again to 90° in the second position. This proves the double refraction of the heat.

I now turn the Iceland spar: the needle remains fixed: there is no alteration of the deflection. Passing the pile rapidly across to the other mark, the deflection is maintained. Once more I turn the spar, but now the needle falls to 0° , rising, however, again to 90° after a rotation of 360° . We know that in the case of light the extraordinary beam rotates round the ordinary one; and we have here been operating on the extraordinary heat-beam, which, as regards double refraction, behaves exactly like a beam of light.

§ 10. *Magnetization of Heat.*

To render our series of comparisons complete, we must demonstrate the magnetization of heat. But here a slight modification of our arrangement will be necessary. In repeating Faraday's experiment on the magnetization of light, we had, in the first instance, our Nicols crossed and the field rendered dark, a flash of light appearing upon the screen when the magnet was excited. Now the quantity of light transmitted in this case is really very small, its effect being rendered striking through contrast with the preceding darkness. When we so place the Nicols that their principal sections enclose an angle of 45° , the excitement of the magnet causes a far greater positive augmentation of the light, though the augmentation is not so well *seen* through lack of contrast, because here, at starting, the field is illuminated.

In trying to magnetize our beam of heat, we will adopt this arrangement. Here, however, at the outset, a considerable amount of heat falls upon one face of the pile. This it is necessary to neutralize, by permitting rays from another source to fall upon the opposite face of the pile. The needle is thus brought to zero. Cutting off the light by our ray-filter, and exciting the magnet, the needle is instantly deflected, proving that the magnet has opened a door for the heat, exactly as in Faraday's experiment it opened a door for the light. Thus, in every case brought under our notice, the substantial identity of light and radiant heat has been demonstrated.

By the refined experiments of Knoblauch, who worked long and successfully at this question, the double refraction of heat, by Iceland spar, was first demonstrated; but though he employed the luminous heat of the sun, the observed deflections were exceedingly small. So, likewise, those eminent investigators De la Povostaye and Desains succeeded in magnetizing a beam of heat; but though, in their case also, the luminous solar heat was employed, the deflection obtained did not amount to more than two or three degrees. With obscure radiant heat the effect, prior to these experiments, had not been obtained; but, with the arrangement here described, we obtain deflections from purely invisible heat, equal to 150 of the lower degrees of the galvanometer.

§ 11. *Distribution of Heat in the Electric Spectrum.*

We have finally to determine the position and magnitude of the invisible radiation which produces these results. For this purpose we employ a particular form

of the thermo-pile. Its face is a rectangle, which by movable side-pieces can be rendered as narrow as desirable. Throwing a small and concentrated spectrum upon a screen, by means of an endless screw we move the rectangular pile through the entire spectrum, and determine in succession the thermal power of all its colours.

When this instrument is brought to the violet end of the spectrum, the heat is found to be almost insensible. As the pile gradually moves from the violet towards the red, it encounters a gradually augmenting heat. The red itself possesses the highest heating power of all the colours of the spectrum. Pushing the pile into the dark space beyond the red, the heat rises suddenly in intensity, and at some distance beyond the red it attains a maximum. From this point the heat falls somewhat more rapidly than it rose, and afterwards gradually fades away.

Drawing a horizontal line to represent the length of the spectrum, and erecting along it, at various points, perpendiculars proportional in length to the heat existing at those points, we obtain a curve which exhibits the distribution of heat in our spectrum. It is represented in the adjacent figure. Beginning at the blue, the curve rises, at first very gradually; towards the red it rises more rapidly, the line C D (fig 56, next page) representing the strength of the extreme red radiation. Beyond the red it shoots upwards in a steep and massive peak to B; whence it falls, rapidly for a time, and afterwards gradually fades from the perception of the pile. This figure is the result of more than twelve careful series of measurements, for each of which the curve was constructed. On superposing all these curves, a

FIG. 56.

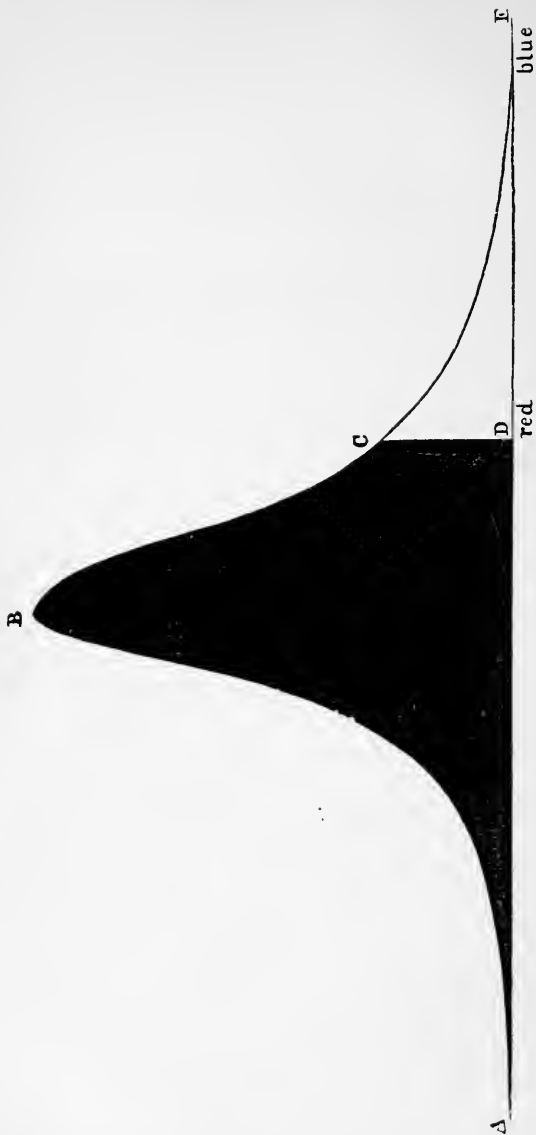

SPECTRUM OF ELECTRIC LIGHT.

satisfactory agreement was found to exist between them. So that it may safely be concluded that the areas of the dark and white spaces, respectively, represent the relative energies of the visible and invisible radiation. The one is 7·7 times the other.

But in verification, as already stated, consists the strength of science. Determining in the first place the total emission from the electric lamp; then by means of the iodine filter determining the ultra-red emission; the difference between both gives the luminous emission. In this way, it is found that the energy of the invisible emission is eight times that of the visible. No two methods could be more opposed to each other, and hardly any two results could better harmonize. I think, therefore, you may rely upon the accuracy of the distribution of heat here assigned to the prismatic spectrum of the electric light. There is nothing vague in the mode of investigation, or doubtful in its conclusions.

LECTURE VI.

PRINCIPLES OF SPECTRUM ANALYSIS—PRISMATIC ANALYSIS OF THE LIGHT OF INCANDESCENT VAPOURS—DISCONTINUOUS SPECTRA—SPECTRUM BANDS PROVED BY BUNSEN AND KIRCHHOFF TO BE CHARACTERISTIC OF THE VAPOUR—DISCOVERY OF RUBIDIUM, CÆSIUM, AND THALLIUM—RELATION OF EMISSION TO ABSORPTION—THE LINES OF FRAUNHOFER—THEIR EXPLANATION BY KIRCHHOFF—SOLAR CHEMISTRY INVOLVED IN THIS EXPLANATION—FOUCAULT'S EXPERIMENT—PRINCIPLES OF ABSORPTION—ANALOGY OF SOUND AND LIGHT—EXPERIMENTAL DEMONSTRATION OF THIS ANALOGY—RECENT APPLICATIONS OF THE SPECTROSCOPE—SUMMARY AND CONCLUSION.

WE have employed as our source of light in these lectures the ends of two rods of coke, rendered incandescent by electricity. Coke is particularly suitable for this purpose, because it can bear intense heat without fusion or vaporization. It is also black, which helps the light; for, other circumstances being equal, as shown experimentally by Professor Balfour Stewart, the blacker the body the brighter will be its light when incandescent. Still, refractory as carbon is, if we closely examined our voltaic arc, or stream of light between the carbon-points, we should find there incandescent carbon-vapour. And if we could detach the light of this vapour from the more dazzling light of the solid points, we should find its spectrum not only less brilliant, but of a totally different character from the spectra that we have already seen. Instead of being an unbroken succession of colours from red to violet, the carbon-vapour would

yield a few bands of colour with spaces of darkness between them.

What is true of the carbon is true in a still more striking degree of the metals, the most refractory of which can be fused, boiled, and reduced to vapour by the electric current. From the incandescent vapour the light, as a general rule, flashes in groups of rays of definite degrees of refrangibility, spaces existing between group and group, which are unfilled by rays of any kind. But the contemplation of the facts will render this subject more intelligible than words can make it. Within the camera is now placed a cylinder of carbon hollowed out at the top to receive a bit of metal; in the hollow is placed a fragment of the metal thallium. Down upon this we bring the upper carbon point, and then separate the one from the other. A stream of incandescent thallium vapour passes between them, the magnified image of which is now seen upon the screen. It is of a beautiful green colour. What is the meaning of that green? We answer the question by subjecting the light to prismatic analysis. Sent through the prism, its spectrum is seen to consist of a single refracted band. Light of one degree of refrangibility, and that corresponding to this particular green, is emitted by the thallium vapour.

We will now remove the thallium and put a bit of silver in its place. The arc of silver is not to be distinguished from that of thallium; it is not only green, but the same shade of green. Are they then alike? Prismatic analysis enables us to answer the question. However impossible it is to distinguish the one *colour* from the other, it is equally impossible to confound the *spectrum* of incandescent silver vapour with that of

thallium. In the case of silver, we have two green bands instead of one.

If we add to the silver in our camera a bit of thallium, we shall obtain the light of both metals. After waiting a little, we see that the green of the thallium lies midway between the two greens of the silver. Hence this similarity of colour.

But why have we to wait a little before we see this effect? The thallium band at first almost masks the silver bands by its superior brightness. Indeed, the silver bands have wonderfully degenerated since the bit of thallium was put in, and for a reason worth knowing. It is the *resistance* offered to the passage of the electric current from carbon to carbon, that calls forth the power of the current to produce heat. If the resistance were materially lessened, the heat would be materially lessened; and if all resistance were abolished, there would be no heat at all. Now, thallium is a much more fusible and vaporizable metal than silver; and its vapour facilitates the passage of the current, to such a degree, as to render it almost incompetent to vaporize the more refractory silver. But the thallium is gradually consumed; its vapour diminishes, the resistance rises, until finally you see the two silver bands as brilliant as they were at first.¹

We have in these bands a perfectly unalterable characteristic of the two metals. You never get other bands than these two green ones from the silver, never other than the single green band from the thallium, never other than the three green bands from the mixture of both metals. Every known metal has its

¹ This circumstance ought not to be lost sight of in the examination of compound spectra. Other similar instances might be cited.

own particular bands, and in no known case are the bands of two different metals alike in refrangibility. It follows, therefore, that these spectra may be made a sure test for the presence or absence of any particular metal. If we pass from the metals to their alloys, we find no confusion. Copper gives green bands; zinc gives blue and red bands; brass, an alloy of copper and zinc, gives the bands of both metals, perfectly unaltered in position or character.

But we are not confined to the metals themselves; the *salts* of these metals yield the bands of the metals. Chemical union is ruptured by a sufficiently high heat; the vapour of the metal is set free, and it yields its characteristic bands. The chlorides of the metals are particularly suitable for experiments of this character. Common salt, for example, is a compound of chlorine and sodium; in the electric lamp it yields the spectrum of the metal sodium. The chlorides of copper, lithium, and strontium yield, in like manner, the bands of these metals.

When, therefore, Bunsen and Kirchhoff, the celebrated founders of *spectrum analysis*, after having established by an exhaustive examination the spectra of all known substances, discovered a spectrum containing bands different from any known bands, they immediately inferred the existence of a new metal. They were operating at the time upon a residue, obtained by evaporating one of the mineral waters of Germany. In that water they knew the unknown metal was concealed, but vast quantities of it had to be evaporated before a residue could be obtained, sufficiently large to enable ordinary chemistry to grapple with the metal. They, however, hunted it down, and it now stands among chemical substances as the metal

Rubidium. They subsequently discovered a second metal, which they called *Cesium*. Thus, having first placed spectrum analysis on a sure foundation, they demonstrated its capacity as an agent of discovery. Soon afterwards Mr. Crookes, pursuing the same method, discovered the bright green band of thallium, and obtained the salts of the metal which yielded it. The metal itself was first isolated in ingots by M. Lamy, a French chemist.

All this relates to chemical discovery upon earth, where the materials are in our own hands. But it was soon shown how spectrum analysis might be applied to the investigation of the sun and stars; and this result was reached through the solution of a problem which had been long an enigma to natural philosophers. The scope and conquest of this problem we must now endeavour to comprehend. A spectrum is *pure* in which the colours do not overlap each other. We purify the spectrum by making our slit narrow, and by augmenting the number of our prisms. When a pure spectrum of the sun has been obtained in this way, it is found to be furrowed by innumerable dark lines. Four of them were first seen by Dr. Wollaston, but they were afterwards multiplied and measured by Fraunhofer with such masterly skill, that they are now universally known as Fraunhofer's lines. . To give an explanation of these lines was, as I have said, a problem which long challenged the attention of philosophers, and to Kirchhoff, Professor of Physics in the University of Heidelberg, belongs the honour of having first conquered this problem.

(The positions of the principal lines, lettered according to Fraunhofer, are shown in the annexed sketch)

(fig. 57) of the solar spectrum. A is supposed to stand near the extreme red, and J near the extreme violet.)

The brief memoir of two pages, in which this immortal discovery is recorded, was communicated to the Berlin Academy on October 27, 1859. FIG. 57.

Fraunhofer had remarked in the spectrum of a candle flame two bright lines, which coincide accurately, as to position, with the double dark line D of the solar spectrum. These bright lines are produced with particular intensity by the yellow flame derived from a mixture of salt and alcohol. They are in fact the lines of sodium vapour. Kirchhoff produced a spectrum by permitting the sunlight to enter his telescope by a slit and prism, and in front of the slit he placed the yellow sodium flame. As long as the spectrum remained feeble, there always appeared two bright lines, derived from the flame, in the place of the two dark lines D of the spectrum. In this case, such absorption as the flame exerted upon the sunlight was more than atoned for by the radiation from the flame. When, however, the solar spectrum was rendered sufficiently intense, the bright bands vanished, and the two dark Fraunhofer lines appeared with much greater sharpness and distinctness than when the flame was not employed.

This result, be it noted, was not due to any real quenching of the bright lines of the flame, but to the augmentation of the intensity of the adjacent spectrum. The experi-



ment proved to demonstration, that when the white light sent through the flame was sufficiently intense, the quantity which the flame absorbed was far in excess of that which it radiated.

Here then is a result of the utmost significance. Kirchhoff immediately inferred from it that the salt flame, which could intensify so remarkably the dark lines of Fraunhofer, ought also to be able to *produce* them. The spectrum of the Drummond light is known to exhibit the two bright lines of sodium, which, however, gradually disappear as the modicum of sodium, contained as an impurity in the incandescent lime, is exhausted. Kirchhoff formed a spectrum of the lime-light, and after the two bright lines had vanished, he placed his salt flame in front of the slit. The two dark lines D immediately started forth. Thus, in the continuous spectrum of the lime-light, he evoked, artificially, the lines D of Fraunhofer.

Kirchhoff knew that this was an action not peculiar to the sodium flame, and he immediately extended his generalization to all coloured flames which yield sharply defined bright bands in their spectra. White light, with all its constituents complete, sent through such flames, would, he inferred, have those precise constituents absorbed, whose refrangibilities are the same as those of the bright bands; so that after passing through such flames, the white light, if sufficiently intense, would have its spectrum furrowed by bands of darkness. On the occasion here referred to, Kirchhoff also succeeded in reversing a bright band of lithium.

The long-standing difficulty of Fraunhofer's lines fell to pieces in the presence of facts and reflections like these, which also carried with them an immeasurable

extension of the chemist's power. Kirchhoff saw that from the agreement of the lines in the spectra of terrestrial substances with Fraunhofer's lines, the presence of these substances in the sun and fixed stars might be immediately inferred. Thus the dark lines D in the solar spectrum proved the existence of sodium in the solar atmosphere; while the bright lines discovered by Brewster in a nitre flame, which had been proved to coincide exactly with certain dark lines between A and B in the solar spectrum, proved the existence of potassium in the sun.

All subsequent research verified the accuracy of these first daring conclusions. In his second paper, communicated to the Berlin Academy before the close of 1859, Kirchhoff proved the existence of iron in the sun. The bright lines of the spectrum of iron vapour are exceedingly numerous, and 65 of them were subsequently proved by Kirchhoff to be absolutely identical in position with 65 dark Fraunhofer's lines. Ångström and Thalén pushed the coincidences to 450 for iron, while, according to the same excellent investigators, the following numbers express the coincidences, in the case of the respective metals to which they are attached:—

Calcium	75	Nickel	33
Barium	11	Cobalt	19
Magnesium	4	Hydrogen	4
Manganese	57	Aluminium	2
Titanium	118	Zinc	2
Chromium	18	Copper	7

The probability is overwhelming that all these substances exist in the atmosphere of the sun.

Kirchhoff's discovery profoundly modified the conceptions previously entertained regarding the constitution of the sun, leading him to views of that con

stitution which, though they may be modified in detail, will, I believe, remain substantially valid to the end of time. The sun consists of a nucleus which is surrounded by a flaming atmosphere of lower temperature. That nucleus may, in part, be *clouds*, mixed with, or underlying true vapour. The light of the nucleus would give us a continuous spectrum, like that of the Drummond light; but having to pass through the photosphere, as Kirchhoff's beam passed through the sodium flame, those rays of the nucleus which the photosphere can emit are absorbed, and shaded lines, corresponding to the rays absorbed, occur in the spectrum. Abolish the solar nucleus, and we should have a spectrum showing a bright line in the place of every dark line of Fraunhofer, just as, in the case of Kirchhoff's second experiment, we should have the bright sodium lines of the flame if the lime light were withdrawn. These lines of Fraunhofer are therefore not absolutely dark, but dark by an amount corresponding to the difference between the light intercepted and the light emitted by the photosphere.

Almost every great scientific discovery is approached contemporaneously by many minds, the fact that one mind usually confers upon it the distinctness of demonstration being an illustration, not of genius isolated, but of genius in advance. Thus Foucault, in 1849, came to the verge of Kirchhoff's discovery. By converging an image of the sun upon a voltaic arc, and thus obtaining the spectra of both sun and arc superposed, he found that the two bright lines which, owing to the presence of a little sodium in the carbons, or in the air, are seen in the spectrum of the arc, coincide with the dark lines D of the solar spectrum. The lines D he

found to be considerably strengthened by the passage of the solar light through the voltaic arc.

Instead of the image of the sun, Foucault then projected upon the arc the image of one of the solid incandescent carbon points, which of itself would give a continuous spectrum; and he found that the lines D were thus *generated* in that spectrum. Foucault's conclusion from this admirable experiment was 'that the arc is a medium which emits the rays D on its own account, and at the same time absorbs them when they come from another quarter.' Here he stopped. He did not extend his observations beyond the voltaic arc; he did not offer any explanation of the lines of Fraunhofer; he did not arrive at any conception of solar chemistry, or of the constitution of the sun. His beautiful experiment remained a germ without fruit, until the discernment, ten years subsequently, of the whole class of phenomena to which it belongs, enabled Kirchhoff to solve these great problems.

Soon after the publication of Kirchhoff's discovery, Professor Stokes, who, ten years prior to the discovery, had nearly anticipated it, borrowed an illustration from sound, to show the reciprocity of radiation and absorption. A stretched string responds to aërial vibrations which synchronize with its own. A great number of such strings stretched in space would roughly represent a medium; and if the note common to them all were sounded at a distance they would absorb the vibrations corresponding to that note. That is to say, they would absorb the vibrations which they can emit.

When a violin-bow is drawn across this tuning-fork, the room is immediately filled with a musical sound, which may be regarded as the *radiation* or *emission*

of sound from the fork. A few days ago, on sounding this fork, I noticed that when its vibrations were quenched, the sound seemed to be continued, though more feebly. It appeared, moreover, to come from under a distant table, where stood a number of tuning-forks of different sizes and rates of vibration. One of these, and one only, had been started by the sounding fork, and it was the one whose rate of vibration was the same as that of the fork which started it. This is an instance of the *absorption* of the sound of one fork by another. Placing two unisonant forks near each other, sweeping the bow over one of them, and then quenching the agitated fork, the other continues to sound; this other can re-excite the former, and several transfers of sound between the two forks can be thus effected. Placing a cent-piece on each prong of one of the forks, we destroy its perfect synchronism with the other, and no such communication of sound from the one to the other is then possible.

I have now to bring before you, on a suitable scale, the demonstration that we can do with *light* what has been here done with sound. For several days in 1861 I endeavoured to accomplish this, with only partial success. In iron dishes a mixture of dilute alcohol and salt was placed, and warmed so as to promote vaporization. The vapour was ignited, and through the yellow flame thus produced the beam from the electric lamp was sent; but a faint darkening only of the yellow band of a projected spectrum could be obtained. A trough was then made which, when fed with the salt and alcohol, yielded a flame ten feet thick; but the result of sending the light through this depth of flame was still unsatisfactory. Remembering that the direct

combustion of sodium in a Bunsen's flame produces a yellow far more intense than that of the salt flame, and inferring that the intensity of the colour indicated the copiousness of the incandescent vapour, I sent through the flame from metallic sodium the beam of the electric lamp. The success was complete; and this experiment I wish now to repeat in your presence.¹

Firstly then you notice, when a fragment of sodium is placed in a tin spoon and introduced into a Bunsen's flame, an intensely yellow light is produced. It corresponds in refrangibility with the yellow band of the spectrum. Like our tuning-fork, it emits waves of a special period. When the white light from the electric lamp is sent through that flame, you will have ocular proof that the yellow flame intercepts the yellow of the spectrum; in other words, that it absorbs waves of the same period as its own, thus producing, to all intents and purposes, a dark Fraunhofer's band in the place of the yellow.

In front of the slit (at L, fig. 58) through which the beam issues is placed a Bunsen's burner (*b*) protected by a chimney (*C*). This beam, after passing through a lens, traverses the prism (*P*) (in the real experiment there was a pair of them), is there decomposed, and forms a vivid continuous spectrum (*S S*) upon the screen. Introducing a tin spoon with its pellet of sodium into the Bunsen's flame, the pellet first fuses, colours the flame intensely yellow, and at length bursts into violent combustion. At the same moment the spectrum is

¹ The dark band produced when the sodium is placed within the lamp was observed on the same occasion. Then was also observed for the first time the magnificent blue band of lithium which the Bunsen's flame fails to bring out.

furrowed by an intensely dark band (D), two inches wide and two feet long. Introducing and withdrawing the sodium flame in rapid succession, the sudden appearance and disappearance of the band of darkness is shown in a most striking manner. In contrast with the adjacent brightness this band appears absolutely black, so vigorous is the absorption. The blackness, however, is but relative, for upon the dark space falls a portion of the light of the sodium flame.

FIG. 58.

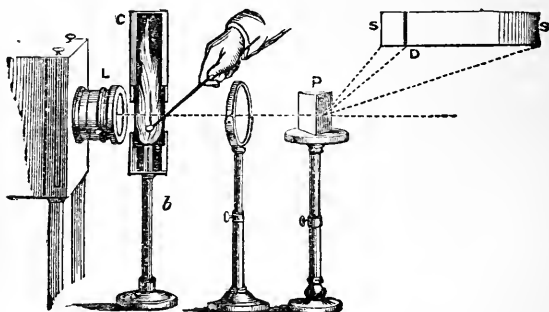

I have already referred to the experiment of Foucault; but other workers also had been engaged on the borders of this subject before it was taken up by Bunsen and Kirchhoff. With a few modifications here introduced, I have already used the following language regarding the precursors of the discovery of spectrum analysis, and solar chemistry:—‘ Mr. Talbot had observed the bright lines in the spectra of coloured flames, and both he and Sir John Herschel pointed out the possibility of making prismatic analysis a chemical test of exceeding delicacy, though not of entire certainty. More than a quarter of a century ago Dr. Miller gave

drawings and descriptions of the spectra of various coloured flames. Wheatstone, with his accustomed acuteness, analyzed the light of the electric spark, and proved that the metals between which the spark passed determined the bright bands in its spectrum. In an investigation described by Kirchhoff as 'classical,' Swan had shown that $\frac{1}{2,500,000}$ of a grain of sodium in a Bunsen's flame could be detected by its spectrum. He also proved the constancy of the bright lines in the spectra of hydro-carbon flames. Masson published a prize essay on the bands of the induction spark; while Van der Willigen, and more recently Plücker, have also given us beautiful drawings of spectra obtained from the same source.

'But none of these distinguished men betrayed the least knowledge of the connection between the bright bands of the metals, and the dark lines of the solar spectrum; nor could spectrum analysis be said to be placed upon anything like a safe foundation prior to the researches of Bunsen and Kirchhoff. The man who, in a published paper, came nearest to the philosophy of the subject was Ångström. In that paper translated by myself, and published in the "Philosophical Magazine" for 1855, he indicates that the rays which a body absorbs are precisely those which it can emit, when rendered luminous. In another place, he speaks of one of his spectra giving the general impression of the *reversal* of the solar spectrum. But his memoir, philosophical as it is, is distinctly marked by the uncertainty of his time. Foucault, Thomson, and Balfour Stewart have all been near the discovery, while, as already stated, it was almost hit by the acute but unpublished conjecture of Stokes.'

Mentally, as well as physically, every year of the world's age is the outgrowth and offspring of all preceding years. Science proves itself to be a genuine product of Nature by growing according to this law. We have no solution of continuity here. All great discoveries are duly prepared for in two ways: first, by other discoveries which form their prelude; and, secondly, by the sharpening of the enquiring intellect. Thus Ptolemy grew out of Hipparchus, Copernicus out of both, Kepler out of all three, and Newton out of all the four. Newton did not rise suddenly from the sea-level of the intellect to his amazing elevation. At the time that he appeared, the table-land of knowledge was already high. He juts, it is true, above the table-land, as a massive peak; still he is supported by it, and a great part of his absolute height is the height of humanity in his time. It is thus with the discoveries of Kirchhoff. Much had been previously accomplished; this he mastered, and then by the force of individual genius went beyond it. He replaced uncertainty by certainty, vagueness by definiteness, confusion by order; and I do not think that Newton has a surer claim to the discoveries that have made his name immortal, than Kirchhoff has to the credit of gathering up the fragmentary knowledge of his time, of vastly extending it, and of infusing into it the life of great principles.

With one additional point we will wind up our illustrations of the principles of solar chemistry. Owing to the scattering of light by matter floating mechanically in the earth's atmosphere, the sun is seen not sharply defined, but surrounded by a luminous glare. Now, a loud noise will drown a whisper, an intense light will quench a feeble one, and so this circumsolar

glare prevents us from seeing many striking appearances round the border of the sun. The glare is abolished in total eclipses, when the moon comes between the earth and the sun, and there are then seen a series of rose-coloured protuberances, stretching sometimes tens of thousands of miles beyond the dark edge of the moon. They are described by Vassenius in the 'Philosophical Transactions' for 1733; and were probably observed even earlier than this. In 1842 they attracted great attention, and were then compared to Alpine snow-peaks reddened by the evening sun. That these prominences are flaming gas, and principally hydrogen gas, was first proved by M. Janssen during an eclipse observed in India, on the 18th of August, 1868.

But the prominences may be rendered visible in full sunshine; and for a reason easily understood. You have seen in these lectures a single prism employed to produce a spectrum, and you have seen a pair of prisms employed. In the latter case, the dispersed white light, being diffused over about twice the area, had all its colours proportionately diluted. You have also seen one prism and a pair of prisms employed to produce the bands of incandescent vapours; but here the light of each band, being absolutely monochromatic, was incapable of further dispersion by the second prism, and could not therefore be weakened by such dispersion.

Apply these considerations to the circumsolar region. The glare of white light round the sun can be dispersed and weakened to any extent, by augmenting the number of prisms; while a monochromatic light, mixed with this glare, and masked by it, would retain its intensity

unenfeebled by dispersion. Upon this consideration has been founded a method of observation, applied independently by M. Janssen in India and by Mr. Lockyer in England, by which the monochromatic bands of the prominences are caused to obtain the mastery, and to appear in broad daylight. By searching carefully and skilfully round the sun's rim, Mr. Lockyer has proved these prominences to be mere local juttings from a fiery envelope which entirely clasps the sun, and which he has called the *Chromosphere*.

It would lead us far beyond the object of these lectures to dwell upon the numerous interesting and important results obtained by Secchi, Respighi, Young, and other distinguished men who have worked at the chemistry of the sun and its appendages. Nor can I do more at present than make a passing reference to the excellent labours of Dr. Huggins in connexion with the fixed stars, nebulæ, and comets. They, more than any others, illustrate the literal truth of the statement, that the establishment of spectrum analysis, and the explanation of Fraunhofer's lines, carried with them an immeasurable extension of the chemist's range. But my object here is to make principles plain, rather than to follow out the details of their illustration. This latter would be a task requiring only time for its execution, but requiring more of it than I have now at my command.

SUMMARY AND CONCLUSION.

My desire in these lectures has been to show you, with as little breach of continuity as possible, something of the past growth and present aspect of a department of science, in which have laboured some of the greatest intellects the world has ever seen. My friend Professor Henry, in introducing me at Washington, spoke of me as an apostle; but the only apostolate that I intended to fulfil was to place, in plain words, my subject before you, and to permit its own intrinsic attractions to act upon your minds. I have sought to confer upon each experiment a distinct intellectual value, for experiments ought to be the representatives and expositors of thought—a language addressed to the eye as spoken words are to the ear. In association with its context, nothing is more impressive or instructive than a fit experiment; but, apart from its context, it rather suits the conjuror's purpose of surprise, than that purpose of education which ought to be the ruling motive of the scientific man.

And now a brief summary of our work will not be out of place. Our present mastery over the laws and phenomena of light has its origin in the desire of man to *know*. We have seen the ancients busy with this problem, but, like a child who uses his arms aimlessly, for want of the necessary muscular exercise, so these early men speculated vaguely and confusedly regarding

natural phenomena, not having had the discipline needed to give clearness to their insight, and firmness to their grasp of principles. They assured themselves of the rectilinear propagation of light, and that the angle of incidence was equal to the angle of reflection. For more than a thousand years—I might say, indeed, for more than fifteen hundred years subsequently—the scientific intellect appears as if smitten with paralysis, the fact being that, during this time, the mental force, which might have run in the direction of science, was diverted into other directions.

The course of investigation, as regards light, was resumed in 1100 by an Arabian philosopher named Alhazan. Then it was taken up in succession by Roger Bacon, Vitellio, and Kepler. These men, though failing to detect the principle which ruled the facts, kept the fire of investigation constantly burning. Then came the fundamental discovery of Snell, that cornerstone of optics, as I have already called it, and immediately afterwards we have the application by Descartes of Snell's discovery to the explanation of the rainbow. Following this we have the overthrow, by Ræmer, of the notion of Descartes, that light was transmitted instantaneously through space. Then came Newton's crowning experiments on the analysis and synthesis of white light, by which it was proved to be compounded of various kinds of light of different degrees of refrangibility.

Up to his demonstration of the composition of white light, Newton had been everywhere triumphant—triumphant in the heavens, triumphant on the earth, and his subsequent experimental work is, for the most part, of immortal value. But infallibility is not the

property of man, and, soon after his discovery of the nature of white light, Newton proved himself human. He supposed that refraction and dispersion went hand in hand, and that you could not abolish the one without at the same time abolishing the other. Here Dollond corrected him.

But Newton committed a graver error than this. Science, as I sought to make clear to you in our second lecture, is only in part a thing of the senses. The roots of phenomena are embedded in a region beyond the reach of the senses, and less than the root of the matter will never satisfy the scientific mind. We find, accordingly, in this career of optics the greatest minds constantly yearning to break the bounds of the senses, and to trace phenomena to their subsensible foundations. Thus impelled, they entered the region of theory, and here Newton, though drawn from time to time towards the truth, was drawn still more strongly towards the error, and made it his substantial choice. His experiments are imperishable, but his theory has passed away. For a century it stood like a dam across the course of discovery; but, like all barriers that rest upon authority, and not upon truth, the pressure from behind increased, and eventually swept the barrier away. This, as you know, was done mainly through the labours of Thomas Young, and his illustrious French fellow-worker Fresnel.

In 1808 Malus, looking through Iceland spar at the sun reflected from the window of the Luxembourg Palace in Paris, discovered the polarization of light by reflection. In 1811 Arago discovered the splendid chromatic phenomena which we have had illustrated by the department of plates of gypsum in polarized

light; he also discovered the rotation of the plane of polarization by quartz-crystals. In 1813 Seebeck discovered the polarization of light by tourmaline. That same year Brewster discovered those magnificent bands of colour that surround the axes of biaxial crystals. In 1814 Wollaston discovered the rings of Iceland spar. All these effects, which, without a theoretic clue, would leave the human mind in a jungle of phenomena without harmony or relation, were organically connected by the theory of undulation.

The theory was applied and verified in all directions, Airy being especially conspicuous for the severity and conclusiveness of his proofs. The most remarkable verification fell to the lot of the late Sir William Hamilton, of Dublin, who, taking up the theory where Fresnel had left it, arrived at the conclusion that at four special points of the 'wave-surface' in double-refracting crystals, the ray was divided, not into two parts, but into an infinite number of parts; forming at these points a continuous conical envelope instead of two images. No human eye had ever seen this envelope when Sir William Hamilton inferred its existence. He asked Dr. Lloyd to test experimentally the truth of his theoretic conclusion. Lloyd, taking a crystal of arragonite, and following with the most scrupulous exactness the indications of theory, cutting the crystal where theory said it ought to be cut, observing it where theory said it ought to be observed, discovered the luminous envelope which had previously been a mere idea in the mind of the mathematician.

Nevertheless this great theory of undulation, like many another truth, which in the long run has proved a blessing to humanity, had to establish, by hot con-

flict, its right to existence. Great names were arrayed against it. It had been enunciated by Hooke, it had been applied by Huyghens, it had been defended by Euler. But they made no impression. And, indeed, the theory in their hands was more an analogy than a demonstration: It first took the form of a demonstrated verity in the hands of Thomas Young. He brought the waves of light to bear upon each other, causing them to support each other, and to extinguish each other at will. From their mutual actions he determined their lengths, and applied his knowledge in all directions. He finally showed that the difficulty of polarization yielded to the grasp of theory.

After him came Fresnel, whose transcendent mathematical abilities enabled him to give the theory a generality unattained by Young. He seized it in its entirety; followed the ether into the hearts of crystals of the most complicated structure, and into bodies subjected to strain and pressure. He showed that the facts discovered by Malus, Arago, Brewster, and Biot were so many ganglia, so to speak, of his theoretic organism, deriving from it sustenance and explanation. With a mind too strong for the body with which it was associated, that body became a wreck long before it had become old, and Fresnel died, leaving, however, behind him a name immortal in the annals of science.

One word more I should like to say regarding Fresnel. There are things better even than science. Character is higher than Intellect, but it is especially pleasant to those who wish to think well of human nature when high intellect and upright character are found combined. They were, I believe, combined in

this young Frenchman. In those hot conflicts of the undulatory theory, he stood forth as a man of integrity, claiming no more than his right, and ready to concede their rights to others. He at once recognized and acknowledged the merits of Thomas Young. Indeed, it was he, and his fellow-countryman Arago, who first startled England into the consciousness of the injustice done to Young in the *Edinburgh Review*.

I should like to read to you a brief extract from a letter written by Fresnel to Young in 1824, as it throws a pleasant light upon the character of the French philosopher. 'For a long time,' says Fresnel, 'that sensibility, or that vanity, which people call love of glory has been much blunted in me. I labour much less to catch the suffrages of the public, than to obtain that inward approval which has always been the sweetest reward of my efforts. Without doubt, in moments of disgust and discouragement, I have often needed the spur of vanity to excite me to pursue my researches. But all the compliments I have received from Arago, De la Place, and Biot never gave me so much pleasure as the discovery of a theoretic truth, or the confirmation of a calculation by experiment.'

This, then, is the core of the whole matter as regards science. It must be cultivated for its own sake, for the pure love of truth, rather than for the applause or profit that it brings. And now my occupation in America is well-nigh gone. Still I will bespeak your tolerance for a few concluding remarks, in reference to the men who have bequeathed to us the vast body of knowledge of which I have sought to give you some faint idea in these lectures. What was the motive that spurred them on?

What urged them to those battles and those victories over reticent Nature, which have become the heritage of the human race? It is never to be forgotten that not one of those great investigators, from Aristotle down to Stokes and Kirchhoff, had any practical end in view, according to the ordinary definition of the word 'practical.' They did not propose to themselves money as an end, and knowledge as a means of obtaining it. For the most part, they nobly reversed this process, made knowledge their end, and such money as they possessed the means of obtaining it.

We see to-day the issues of their work in a thousand practical forms, and this may be thought sufficient to justify, if not ennoble their efforts. But they did not work for such issues; their reward was of a totally different kind. In what way different? We love clothes, we love luxuries, we love fine equipages, we love money, and any man who can point to these as the result of his efforts in life, justifies these results before all the world. In America and England, more especially, he is a 'practical' man. But I would appeal confidently to this assembly whether such things exhaust the demands of human nature? The very presence here for six inclement nights of this great audience, embodying so much of the mental force and refinement of this vast city,¹ is an answer to my question. I need not tell such an assembly that there are joys of the intellect as well as joys of the body, or that these pleasures of the spirit constituted the reward of our great investigators. Led on by the whisperings of natural truth, through pain

¹ New York: for more than a ~~decade~~ no such weather had been experienced. The snow was so deep that the ordinary means of locomotion were for a time suspended.

and self-denial, they often pursued their work. With the ruling passion strong in death, some of them, when no longer able to hold a pen, dictated to their friends the results of their labours, and then rested from them for ever.

Could we have seen these men at work, without any knowledge of the consequences of their work, what should we have thought of them? To the uninitiated, in their day, they might often appear as big children playing with soap-bubbles and other trifles. It is so to this hour. Could you watch the true investigator—your Henry or your Draper, for example—in his laboratory, unless animated by his spirit, you could hardly understand what keeps him there. Many of the objects which rivet his attention might appear to you utterly trivial; and, if you were to ask him what is the *use* of his work, the chances are that you would confound him. He might not be able to express the use of it in intelligible terms. He might not be able to assure you that it will put a dollar into the pocket of any human being, living or to come. That scientific discovery *may* put not only dollars into the pockets of individuals, but millions into the exchequers of nations, the history of science amply proves; but the hope of its doing so never was, and it never can be, the motive power of the investigator.

I know that some risk is run in speaking thus before practical men. I know what De Tocqueville says of you. ‘The man of the North,’ he says, ‘has not only experience, but knowledge. He, however, does not care for science as a pleasure, and only embraces it with avidity when it leads to useful applications.’ But what, I would ask, are the hopes of useful applications

which have caused you so many times to fill this place, in spite of snow-drifts and biting cold? What, I may ask, is the origin of that kindness which drew me from my work in London to address you here, and which, if I permitted it, would send me home a millionaire? Not because I had taught you to make a single cent by science am I here to-night, but because I tried to the best of my ability to present science to the world as an intellectual good. Surely no two terms were ever so distorted and misapplied with reference to man, in his higher relations, as these terms useful and practical. Let us expand our definitions until they embrace all the needs of man, his highest intellectual needs inclusive. It is specially on this ground of its administering to the higher needs of the intellect; it is mainly because I believe it to be wholesome, not only as a source of knowledge but as a means of discipline, that I urge the claims of science upon your attention.

But with reference to material needs and joys, surely pure science has also a word to say. People sometimes speak as if steam had not been studied before James Watt, or electricity before Wheatstone and Morse; whereas, in point of fact, Watt and Wheatstone and Morse, with all their practicality, were the mere outcome of antecedent forces, which acted without reference to practical ends. This also, I think, merits a moment's attention. You are delighted, and with good reason, with your electric telegraphs, proud of your steam-engines and your factories, and charmed with the productions of photography. You see daily, with just elation, the creation of new forms of industry—new powers of adding to the wealth and comfort of society. Industrial England is heaving with forces

tending to this end ; and the pulse of industry beats still stronger in the United States. And yet, when analyzed, what are industrial America and industrial England?

If you can tolerate freedom of speech on my part, I will answer this question by an illustration. Strip a strong arm, and regard the knotted muscles when the hand is clenched and the arm bent. Is this exhibition of energy the work of the muscle alone ? By no means. The muscle is the channel of an influence, without which it would be as powerless as a lump of plastic dough. It is the delicate unseen nerve that unlocks the power of the muscle. And without those filaments of genius, which have been shot like nerves through the body of society by the original discoverer, industrial America, and industrial England, would be very much in the condition of that plastic dough.

At the present time there is a cry in England for technical education, and it is a cry in which the most commonplace intellect can join, its necessity is so obvious. But there is no cry for original investigation. Still without this, as surely as the stream dwindles when the spring dies, so surely will ' technical education ' lose all force of growth, all power of reproduction. Our great investigators have given us sufficient work for a time ; but if their spirit die out, we shall find ourselves eventually in the condition of those Chinese mentioned by De Tocqueville, who, having forgotten the scientific origin of what they did, were at length compelled to copy without variation the inventions of an ancestry wiser than themselves, who had drawn their inspiration direct from Nature.

Both England and America have reason to bear those things in mind, for the largeness and nearness of material results are only too likely to cause both countries to forget the small spiritual beginnings of such results, in the mind of the scientific discoverer. You multiply, but he creates. And if you starve him, or otherwise kill him—nay, if you fail to secure for him free scope and encouragement—you not only lose the motive power of intellectual progress, but infallibly sever yourselves from the springs of industrial life.

What has been said of technical operations holds equally good for education, for here also the original investigator constitutes the fountain-head of knowledge. It belongs to the teacher to give this knowledge the requisite form; an honourable and often a difficult task. But it is a task which receives its final sanctification, when the teacher himself honestly tries to add a rill to the great stream of scientific discovery. Indeed, it may be doubted whether the real life of science can be fully felt and communicated by the man who has not himself been taught by direct communion with Nature. We may, it is true, have good and instructive lectures from men of ability, the whole of whose knowledge is second-hand, just as we may have good and instructive sermons from intellectually able and unregenerate men. But for that power of science, which corresponds to what the Puritan fathers would call experimental religion in the heart, you must ascend to the original investigator.

To keep society as regards science in healthy play, three classes of workers are necessary: Firstly, the investigator of natural truth, whose vocation it is to pursue that truth, and extend the field of discovery for the

truth's own sake, and without reference to practical ends. Secondly, the teacher of natural truth, whose vocation it is to give public diffusion to the knowledge already won by the discoverer. Thirdly, the applier of natural truth, whose vocation it is to make scientific knowledge available for the needs, comforts, and luxuries of civilized life. These three classes ought to co-exist and interact. Now, the popular notion of science, both in this country and in England, often relates not to science strictly so called, but to the applications of science. Such applications, especially on this continent, are so astounding—they spread themselves so largely and umbrageously before the public eye—that they often shut out from view those workers who are engaged in the quieter and profounder business of original investigation.

Take the electric telegraph as an example, which has been repeatedly forced upon my attention of late. I am not here to attenuate in the slightest degree the services of those who, in England and America, have given the telegraph a form so wonderfully fitted for public use. They earned a great reward, and they have received it. But I should be untrue to you and to myself if I failed to tell you that, however high in particular respects their claims and qualities may be, your practical men did not discover the electric telegraph. The discovery of the electric telegraph implies the discovery of electricity itself, and the development of its laws and phenomena. Such discoveries are not made by practical men, and they never will be made by them, because their minds are beset by ideas which, though of the highest value from one

point of view, are not those which stimulate the original discoverer.

The ancients discovered the electricity of amber; and Gilbert, in the year 1600, extended the discovery to other bodies. Then followed Boyle, Von Guericke, Gray, Canton, Du Fay, Kleist, Cunæus, and your own Franklin. But their form of electricity, though tried, did not come into use for telegraphic purposes. Then appeared the great Italian Volta, who discovered the source of electricity which bears his name, and applied the most profound insight, and the most delicate experimental skill, to its development. Then arose the man who added to the powers of his intellect all the graces of the human heart, Michael Faraday, the discoverer of the great domain of magneto-electricity. Ørsted discovered the deflection of the magnetic needle, and Arago and Sturgeon the magnetization of iron by the electric current. The voltaic circuit finally found its theoretic Newton in Ohm; while Henry, of Princeton, who had the sagacity to recognise the merits of Ohm while they were still decried in his own country, was at this time in the van of experimental inquiry.

In the works of these men you have all the materials employed at this hour, in all the forms of the electric telegraph. Nay, more; Gauss, the celebrated astronomer, and Weber, the celebrated natural philosopher, both professors in the University of Göttingen, wishing to establish a rapid mode of communication between the observatory and the physical cabinet of the university, did this by means of an electric telegraph. Thus, before your practical men appeared upon the scene, the force had been discovered, its laws investi-

gated and made sure, the most complete mastery of its phenomena had been attained—nay, its applicability to telegraphic purposes demonstrated—by men whose sole reward for their labours was the noble excitement of research, and the joy attendant on the discovery of natural truth.

Are we to ignore all this? We do so at our peril. For I say again that, behind all our practical applications, there is a region of intellectual action to which practical men have rarely contributed, but from which they draw all their supplies. Cut them off from this region, and they become eventually helpless. In no case is the adage truer, 'Other men laboured, but ye are entered into their labours,' than in the case of the discoverer and applier of natural truth. But now a word on the other side. While practical men are not the men to make the necessary antecedent discoveries, the cases are rare, though, in our day, not absent, in which the discoverer knows how to turn his labours to practical account. Different qualities of mind and habits of thought are usually needed in the two cases; and while I wish to give emphatic utterance to the claims of those whose position, owing to the simple fact of their intellectual elevation, is often misunderstood, I am not here to exalt the one class of workers at the expense of the other. They are the necessary complements of each other. But remember that one class is sure to be taken care of. All the material rewards of society are already within their reach, while that same society habitually ascribes to them intellectual achievements which were never theirs. This cannot but act to the detriment of those studies out of which, not only our knowledge of nature, but our present industrial arts themselves

have sprung, and from which the rising genius of the country is incessantly tempted away.

Pasteur, one of the most eminent members of the Institute of France, in accounting for the disastrous overthrow of his country and the predominance of Germany in the late war, expresses himself thus: 'Few persons comprehend the real origin of the marvels of industry and the wealth of nations. I need no further proof of this than the employment more and more frequent in official language, and in writing of all sorts, of the erroneous expression *applied science*. The abandonment of scientific careers by men capable of pursuing them with distinction, was recently deplored in the presence of a minister of the greatest talent. The statesman endeavoured to show that we ought not to be surprised at this result, because *in our day the reign of theoretic science yielded place to that of applied science*. Nothing could be more erroneous than this opinion, nothing, I venture to say, more dangerous, even to practical life, than the consequences which might flow from these words. They have rested in my mind as a proof of the imperious necessity of reform in our superior education. There exists no category of the sciences, to which the name of applied science could be rightly given. *We have science, and the applications of science*, which are united together as the tree and its fruit.'

And Cuvier, the great comparative anatomist, writes thus upon the same theme: 'These grand practical innovations are the mere applications of truths of a higher order, not sought with a practical intent, but pursued for their own sake, and solely through an ardour for knowledge. Those who applied them could

not have discovered them ; those who discovered them had no inclination to pursue them to a practical end. Engaged in the high regions whither their thoughts had carried them, they hardly perceived these practical issues, though born of their own deeds. These rising workshops, these peopled colonies, those ships which furrow the seas—this abundance, this luxury, this tumult—all this comes from discoverers in science, and it all remains strange to them. At the point where science merges into practice they abandon it ; it concerns them no more.'

When the Pilgrim Fathers landed at Plymouth Rock, and when Penn made his treaty with the Indians, the new-comers had to build their houses, to chasten the earth into cultivation, and to take care of their souls. In such a community science, in its more abstract forms, was not to be thought of. And at the present hour, when your hardy Western pioneers stand face to face with stubborn Nature, piercing the mountains and subduing the forest and the prairie, the pursuit of science, for its own sake, is not to be expected. The first need of man is food and shelter ; but a vast portion of this continent is already raised far beyond this need. The gentlemen of New York, Brooklyn, Boston, Philadelphia, Baltimore, and Washington, have already built their houses, and very beautiful they are : they have also secured their dinners, to the excellence of which I can also bear testimony. They have, in fact, reached that precise condition of well-being and independence when a culture, as high as humanity has yet reached, may be justly demanded at their hands. They have reached that maturity, as possessors of wealth and leisure, when the investigator of natural

truth, for the truth's own sake, ought to find among them promoters and protectors.

Among the many problems before them they have this to solve, whether a republic is able to foster the highest forms of genius. You are familiar with the writings of De Tocqueville, and must be aware of the intense sympathy which he felt for your institutions; and this sympathy is all the more valuable from the philosophic candour with which he points out not only your merits, but your defects and dangers. Now if I come here to speak of science in America in a critical and captious spirit, an invisible radiation from my words and manner will enable you to find me out, and will guide your treatment of me to-night. But if I in no unfriendly spirit—in a spirit, indeed, the reverse of unfriendly—venture to repeat before you what this great historian and analyst of democratic institutions said of America, I am persuaded that you will hear me out. He wrote some three and twenty years ago, and, perhaps, would not write the same to-day; but it will do nobody any harm to have his words repeated, and, if necessary, laid to heart.

In a work published in 1850, De Tocqueville says: 'It must be confessed that, among the civilized peoples of our age, there are few in which the highest sciences have made so little progress as in the United States.'¹ He declares his conviction that, had you been alone in the universe, you would soon have discovered that you cannot long make progress in practical science, without cultivating

¹ 'Il faut reconnaître que parmi les peuples civilisés de nos jours il en est peu chez qui les hautes sciences aient fait moins de progrès qu'aux États-Unis, ou qui aient fourni moins de grands artistes, de poètes illustres et de célèbres écrivains.' ('De la Démocratie en Amérique,' etc., tome ii. p. 36.)

theoretic science at the same time. But, according to De Tocqueville, you are not thus alone. He refuses to separate America from its ancestral home; and it is there, he contends, that you collect the treasures of the intellect, without taking the trouble to create them.

De Tocqueville evidently doubts the capacity of a democracy to foster genius as it was fostered in the ancient aristocracies. 'The future,' he says, 'will prove whether the passion for profound knowledge, so rare and so fruitful, can be born and developed so readily in democratic societies as in aristocracies. As for me,' he continues, 'I can hardly believe it.' He speaks of the unquiet feverishness of democratic communities, not in times of great excitement, for such times may give an extraordinary impetus to ideas, but in times of peace. There is then, he says, 'a small and uncomfortable agitation, a sort of incessant attrition of man against man, which troubles and distracts the mind without imparting to it either loftiness or animation.' It rests with you to prove whether these things are necessarily so—whether scientific genius cannot find, in the midst of you, a tranquil home.

I should be loth to gainsay so keen an observer and so profound a political writer, but, since my arrival in this country, I have been unable to see anything in the constitution of society, to prevent a student, with the root of the matter in him, from bestowing the most steadfast devotion on pure science. If great scientific results are not achieved in America, it is not to the small agitations of society that I should be disposed to ascribe the defect, but to the fact that the men among you who possess the endowments necessary for profound scientific inquiry, are laden with duties of administration, or

tuition, so heavy as to be utterly incompatible with the continuous and tranquil meditation which original investigation demands. It may well be asked whether Henry would have been transformed into an administrator, or whether Draper would have forsaken science to write history, if the original investigator had been honoured as he ought to be in this land. I hardly think they would. Still I do not imagine this state of things likely to last. In America there is a willingness on the part of individuals to devote their fortunes, in the matter of education, to the service of the commonwealth, which is probably without a parallel elsewhere: and this willingness requires but wise direction to enable you effectually to wipe away the reproach of De Tocqueville.

Your most difficult problem will be not to build institutions, but to discover men. You may erect laboratories and endow them; you may furnish them with all the appliances needed for enquiry; in so doing you are but creating opportunity for the exercise of powers which come from sources entirely beyond your reach. You cannot create genius by bidding for it. In biblical language, it is the gift of God; and the most you could do, were your wealth, and your willingness to apply it, a million-fold what they are, would be to make sure that this glorious plant shall have the freedom, light, and warmth necessary for its development. We see from time to time a noble tree dragged down by parasitic runners. These the gardener can remove, though the vital force of the tree itself may lie beyond him: and so, in many a case, you men of wealth can liberate genius from the hampering toils which the struggle for existence often casts around it.

Drawn by your kindness, I have come here to give

these lectures, and now that my visit to America has become almost a thing of the past, I look back upon it as a memory without a single stain. No lecturer was ever rewarded as I have been. From this vantage-ground, however, let me remind you that the work of the lecturer is not the highest work; that, in science, the lecturer is usually the distributor of intellectual wealth amassed by better men. And though lecturing and teaching, in moderation, will in general promote their moral health, it is not solely, or even chiefly, as lecturers, but as investigators, that your highest men ought to be employed. You have scientific genius amongst you – not sown broadcast, believe me, it is sown thus nowhere—but still scattered here and there. Take all unnecessary impediments out of its way. Keep your sympathetic eye upon the originator of knowledge. Give him the freedom necessary for his researches, not overloading him, either with the duties of tuition or of administration, not demanding from him so-called practical results—above all things, avoiding that question which ignorance so often addresses to genius, ‘What is the use of your work?’ Let him make truth his object, however unpractical for the time being it may appear. If you cast your bread thus upon the waters, then be assured it will return to you, though it may be after many days.

APPENDIX.

My work in the United States was wound up by a social meeting in New York, under the presidency of the Hon. W. M. Evarts, a name as familiar to English as to American ears. Of the able addresses delivered on that occasion, I here present three,¹ which have a special bearing upon scientific and educational questions. The first by Dr. Barnard, the learned President of Columbia College, New York; the second by Dr. Draper, so well and favourably known in England, both as a historian and man of science; and the third by Dr. White, President of Cornell University. To these I have ventured to add a few remarks of my own, made upon the same occasion.

PRESIDENT BARNARD'S ADDRESS.

I am expected to deal, this evening, with a theme which, under the actual circumstances, it is somewhat difficult to handle. The degree to which our systems of education tend to foster or discourage original investigation into the truths of Nature is a topic which might better befit an assembly more gravely disposed than the present. *Dulce est desipere in loco*—it is pleasant to put on the cap and bells when circumstances favour, says Horace, and he says quite truly; but he does not say, *difficile est sapere inter pocula*—it is hard to imitate the solemnity of Minerva's bird when champagne is on the board, as I think he ought to have said, and as he would, perhaps,

¹ With certain personal references omitted.

have said if prosody had allowed, and which would have been equally true. I shall not aim at such an imitation. I do not mean to be didactic if I can help it. If I am so, I trust you will be indulgent.

I say, then, that our long-established and time-honoured system of liberal education—and when I speak of the system I mean the whole system, embracing not only the colleges, but the tributary schools of lower grade as well—does not tend to form original investigators of Nature's truths; and the reason that it does not is, that it inverts the natural order of proceeding in the business of mental culture, and fails to stimulate in season the powers of observation. And when I say this, I must not be charged with treason to my craft—at least not with treason spoken for the first time here, for I have uttered the same sentiment more than once before in the solemn assemblies of the craft itself.

I suppose, Mr. President, that at a very early period of your life you may have devoted, like so many other juvenile citizens, a portion of your otherwise unemployed time to experiments in horticulture. In planting leguminous seeds you could not have failed to observe that the young plants come up with their cotyledons on their heads. If, in pondering this phenomenon, you arrived at the same conclusion that I did, you must have believed that Nature had made a mistake, and so have pulled up your plants and replanted them upside-down. Men and women are but children of a larger growth. They see the tender intellect shooting up in like manner, with the perceptive faculties all alive at top; and they, too, seem to think that Nature has made a mistake, and so they treat the mind as the child treats his bean-plant, and turn it upside-down to make it grow better. They bury the promising young buds deep in a musty mould formed of the decay of centuries, under the delusion that out of such *debris* they may gather some wholesome nourishment; when we know all that they want is the light and warmth of the sun to stimulate them and the free air of heaven in which

to unfold themselves. What heartless cruelty pursues the little child-martyr every day and all the day long, at home or at school alike; in this place bidden to mind his book and not to look out of the window—in that, told to hold his tongue and to remember that children must not ask questions! A lash from a whalebone switch upon the tender little fingers too eagerly outstretched could not sting more keenly, or be felt with a sharper sense of wrong, than such a rebuke coming across the no less eagerly extended tentacles of the dawning and inquiring intellect.

Now, a system of education founded on a principle like this is not going to fit men to engage successfully in that hazardous game of life, in which, in Prof. Huxley's beautiful simile, we are all of us represented as playing with an unseen antagonist, who enforces against us relentlessly every minutest rule of the game, whether known to us or not. Still less can it fit them to bring to light new rules of this difficult game, never yet detected by any human intelligence. Yet it is precisely of this kind of men that the world has present need. For grand as are the triumphs of scientific investigation already achieved, it is impossible to doubt that there are still grander yet behind to reward the zealous labourers of the time to come. I know that it sometimes seems to us otherwise. I know that the very grandeur of the achievements of the past makes us sometimes doubtful of the future; for it is generally true that the portals of Nature's secret chambers, yet unexplored, are only dimly discernible before they are unlocked.

I remember a time—it is now long gone by—when this sceptical feeling as to the possibilities of large scientific progress in the time to come was extremely prevalent, so prevalent that a learned professor of a neighbouring college thought it worth his while to combat, in an energetic public address, the discouraging notion that Nature has no longer any important secrets to yield. Subsequently history has magnificently corroborated his argument. For that was a time

when, as yet, no Faraday had drawn a living spark from the lifeless magnet; no Daniel, or Grove, or Bunsen, had given us an enduring source of electro-dynamic power; no Ohm had taught us how to measure such a power when obtained; no Bessell had detected the parallaxes of the fixed stars; no Adams or Leverrier had thrown his grapple into space, and felt the influence of an unseen planet trembling, to use the beautiful language of Herschël, along the delicate line of his analysis; no Draper, or Daguerre, or Talbot, had revealed the wonders of actinism; no Mayer or Joule had laid a sure foundation for the grand doctrine of the conservation of force; no Carpenter had unravelled the intricacies of nervous physiology, or analyzed the relations of mind and brain; no Agassiz had ridden down the Alps on the backs of the glaciers and proved their steady flow; no Darwin had lifted the veil from the mysteries of organic development; no Schiaparelli or Newton had put the harness of universal gravitation upon the wayward movements of the shooting-stars; no Mallet had presented an intelligible theory of volcanic flames and of the earth's convulsive tremors; no Kirchhoff had furnished a key to the intimate constitution of celestial bodies or a gauge of stellar drift; no Huggins, or Secchi, or Young, had applied the key thus presented to enter the secret chambers of the sun, the comets, the fixed stars, and the nebulæ; no Stokes had made the darkness visible which lies beyond the violet. In short, that period of presumed scientific omniscience seems now, as we look back to it, but the faint dawning of a day of glorious discovery, which we dare not, even yet, pronounce to be approaching its meridian.

How much of all this has been due to our systems of education? Among the great promoters of scientific progress before or since, how large is the number who may, in strict propriety, be said to have educated themselves? Take, for illustration, such familiar names as those of William Herschel, and Franklin, and Rumford, and Rittenhouse, and Davy, and Faraday, and Henry. Is it not evident that Nature herself,

to those who will follow her teachings, is a better guide to the study of her own phenomena than all the training of our schools? And is not this because Nature invariably begins with the training of the observing faculties? Is it not because the ample page which she spreads out before the learner is written all over, not with words, but with substantial realities? Is it not because her lessons reach beyond the simple understanding and impress the immediate intuition? That what she furnishes is something better than barren information passively received; it is positive knowledge actively gathered?

If, then, in the future we would fit man properly to cultivate Nature, and not leave scientific research, as, to a great extent, we have done heretofore, to the hazard of chance, we must cultivate her own processes. Our earliest teachings must be things, and not words. The objects first presented to the tender mind must be such as address the senses, and such as it can grasp. Store it first abundantly with the material of thought, and the process of thinking will be spontaneous and easy.

This is not to depreciate the value of other subjects or of other modes of culture. It is only to refer them to their proper place. Grammar, philology, logic, human history, *belles-lettres*, philosophy—all these things will be seized with avidity and pursued with pleasure by a mind judiciously prepared to receive them. On this point we shall do well to learn, and I believe we are beginning to learn something, from contemporary peoples upon the Continent of Europe. Object-teaching is beginning to be introduced, if only sparingly, into our primary schools. It should be so introduced universally. And in all our schools, but especially in those in which the foundation is laid of what is called a liberal education, the knowledge of visible things should be made to precede the study of the artificial structure of language, and the intricacies of grammatical rules and forms.

The knowledge of visible things—I repeat these words

that I may emphasize them, and, when I repeat them, observe that I mean *knowledge* of visible things, and not information about them—knowledge acquired by the learner's own conscious efforts, not crammed into his mind in set forms of words out of books. Our methods of education manifest a strong tendency in these modern times to degenerate in such a sort of cramming. Forty years ago, the printed helps to learning now supplied to the young men of our colleges in so lavish profusion were almost unknown; and teachers lent about as little aid, at least during the earlier years, as books. What the student learned then he learned for himself by positive hard labour. Now we have made the task so easy, we have built so many royal roads to learning in all its departments, that it may be well doubted if the young men of our day, with all their helps, acquire as much as those of that earlier period acquired without them.

The moral of this experience is, that mental culture is not secured by pouring information into passive recipients; it comes from stimulating the mind to gather knowledge for itself. When our systems of education shall have been remodelled from top to bottom, with due attention to this principle, then, if we have minds among us which are capable of pursuing Nature into her yet uncaptured strongholds, we shall find them out and set them at their work. Then neither 'mute, inglorious Miltons' on the one hand, nor on the other silent, unsuspected Keplers, nor Newtons 'guiltless' of universal gravitation, shall live unconscious of their powers, or die and make no sign. Then the progress of science will no longer be dependent, as in the past it has been to so great a degree, on the chance struggles of genius rebelling against circumstances, such as have given us a Herschel, a Franklin, a Hugh Miller, or a Henry; nor will the world be any more astonished to see the most brilliant of the triumphs of the intellect achieved by men who have cloven their own way to the forefront, in defiance of all its educational traditions.

PROFESSOR DRAPER'S ADDRESS.

When I was in London a year or two ago I passed some pleasant hours with my friend Prof. Tyndall. Among these, I think that, perhaps, the most pleasant were those of one afternoon that we spent together in the laboratory of the Royal Institution, where Davy discovered potassium and sodium, and decomposed the earths; where Young first announced the grand and fertile principle of interference, and placed on firm foundations the wave-theory of light; where Faraday made his great discoveries in electricity and magnetism. On that occasion Dr. Tyndall was showing me the action of ether-waves of short period upon gaseous matter, clouds formed by actinic decomposition. I saw the superb sky-blue light and verified its polarized condition. It was like the light of heaven.

Well, as I laid down the Nicol prism we had been using, I could not help thinking that there was an unseen Presence in the place—a *genius loci*—that inspired men to make such discoveries. Who was it that brought that genius there?

At the time of the American Revolution there resided in the town of Rumford, N. H., one Benjamin Thompson, who occupied himself in teaching a school. He embraced, as we Americans would say, the wrong side of the question on that occasion—he sided with the king's Government. He went to England, became a man of mark, and was knighted. Then he went on the Continent, again distinguished himself by his scientific attainments, again was titled, and this time, in memory of his American home, was called Count Rumford.

On his return to London, Count Rumford founded the Royal Institution, and thus to a native American the world owes that establishment which has been glorified by Davy, and Young, and Faraday. Had it not been for Rumford, Davy might have spent his life in filling gas-bags for Dr. Beddoes's patients, and Faraday might have been a book-binder

But if Benjamin Thompson, an American, founded the Royal Institution, James Smithson, an Englishman, shortly afterwards, founded that noble Institution in Washington which bears his name, and which, under the enlightened care of Prof. Henry, has so greatly ministered to the advancement and diffusion of science. You, sir, have called on me to respond to your toast, 'English and American Science,' and I think these facts show you how closely they have been associated.

Now Prof. Tyndall is on the point of leaving us. When he gets back to Albemarle Street, he will remember Broadway. I am sure that you will all join me in wishing him a pleasant voyage over the Atlantic. But I wish him something better than that, I will add—a safe return to America. There is a great deal for him to do here yet. He may tell his friends that he has been to America, but he must not tell them that he has seen the Americans. We who are living on the Atlantic verge of the continent are only modified Europeans—very slightly modified, indeed. One must go beyond the Alleghanies—yes, and over to the Pacific coast, before he can say he has seen what the American really is. I suppose that Dr. Tyndall has finished his glacier expeditions to Switzerland. Is there nothing here that can tempt him? He and other members of the Alpine Club need not go about the streets of London weeping like so many broken-hearted Alexanders that there are no more worlds to conquer. Let them take a look at the Rocky Mountains and tell us what they think of them. Dr. Tyndall is a lover of Nature. Well! we can show him all kinds of scenery, from where the half-frozen Mackenzie is lazily flowing through a waste of snows on its way toward the Arctic Ocean, to where oranges are growing on the Gulf. Or, if he is tired of inanimate Nature, and is in the mood of Dr. Johnson—you know the story. Boswell said to Johnson one day: 'See! What a beautiful afternoon; let us take a walk in the green fields.' 'No, I won't,' replied the grim and gruff lexicographer

'I've seen green fields; one green field is like another green field. They are all alike. No, sir! I'll walk down Cheapside. I like to look at men;'—if Dr. Tyndall is in that mood, can we not satisfy his curiosity? Another friend of mine, Mr. Froude, has set us all talking about Ireland. We can show Dr. Tyndall how we take the Irish immigrant, in his corduroy knee-breeches, his smashed-down hat, and his shillalah in his fist, and in a generation or so turn him into an ornament of professional life, make him a successful merchant, or familiarize him with all the amenities of elegant society. If that's not enough, we will show him how we take the German, and, wonderful to be said, make him half forget his fatherland and half his mother-tongue, and become an English-speaking American citizen. If that's not enough, we will show him how we have purged the African, the woolly-headed black man, of the paganism of his forefathers, and are now trying our hand at Darwinizing him into a respectable voter. If that's not enough, we will show him how, in the trans-Mississippi plains, we are improving the red Indian—alas, I fear my friend will say, improving him off the face of the earth! If that's not enough, we will show him where we have got tens of thousands of Chinese, with picks and shovels, digging Pacific railways. We are mixing European and Asiatic, red Indians and black Africans together, and I suppose certain English naturalists will tell us that the upshot of the thing will be a survival of the fittest. In San Francisco we can show Dr. Tyndall the church, the chapel, the joss-house, all in a row; and perhaps, considering his forlorn, celibate condition, he may be conscience-stricken when we display before his astonished eyes the much-married men of Mormondom.

Nowhere in the world are to be found more imposing political problems than those to be settled here; nowhere a greater need of scientific knowledge. I am not speaking of ourselves alone, but also of our Canadian friends on the other side of the St. Lawrence. We must join together in generous

emulation of the best that is done in Europe. In her Majesty's representative, Lord Dufferin, they will find an eager appreciation of all that they may do. Together we must try to refute what De Tocqueville has said about us, that communities such as ours can never have a love of pure science. But, whatever may be the glory of our future intellectual life, let us both never forget what we owe to England. Hers is the language that we speak, hers are all our ideas of liberty and law. To her literature as to a fountain of light we repair. The torch of science that is shining here was kindled at her midnight lamp.

PRESIDENT WHITE'S REMARKS.

There is a legend well known to most of us—and which has an advantage over most legends, in that it is substantially true—that a very distinguished man of science in this country was once approached by an eminent practical man, and urged to turn his great powers in scientific investigation and exposition to effect in making a fortune.

And to the great surprise of that man of business, the man of science responded, 'but, my dear sir, *I have no time to waste in making money.*'

Of all the recent great results of science, I think, sir, that those words have struck deepest and sped farthest in the average carnal mind on our side the Atlantic.

'No time to waste in making money!' I have stood, sir, in the presence of a very eminent man of affairs—one whose word is a power in the great marts of the world, and watched him as he heard for the first time this astonishing *dictum*. He stood silent—apparently in awe. The words seemed to reverberate among the convolutions of his brain, and to be re-echoed far away, back, from depth to depth among the deepest recesses of his consciousness—'No time to waste in making money!'

The toast, sir, to which you ask me to speak is, 'The Relation of Science to Political Progress.'

Now, sir, I maintain that the true spirit of scientific research, embracing as it does zeal in search for truth, devotion to duty which such a search imposes, faith in good as the normal and necessary result of such a search—that such a spirit is, at this moment, one of the most needed elements in the political progress of our country.

I might go on to show how usefully certain scientific methods might be brought to bear on the formation of political judgments, and in determining courses of political action. I might show how even a very moderate application of scientific principles would save us from what is constantly going on in municipal, State, or national legislation—the basing of important statutes, to-day, on the supposition that two and two make four, and to-morrow on the theory that two and two make forty; but the hour is late, and I spare you; I will confine myself simply to the value, in our political progress, of the spirit and example of some of the scientific workers of our day and generation.

What is the example which reveals that spirit? It is an example of *zeal*—zeal in search for the truth, *sought for truth's sake*—and not for the sake of material advantage; it is an example of *thoroughness*—of the truth sought in its wholeness, not in dilutions or adaptations, or suppressions, supposed to be healthy for this man's mind, or that man's soul; it is an example of *bravery*—the fearlessness that leads a truth-seeker to brave all outcry and menace; it is an example of *devotion to duty*; without which, for a steady force, as Prof. Tyndall just now observed, no worthy scientific work can be accomplished; and, finally, an example of *faith*—of a high and holy faith that the results of earnest truth-seeking cannot be other than good—faith that truth and goodness are inseparable—faith that there is a Power in the universe which forbids any honest truth-seeking to lead to lasting evil. A faith, this is, which has had its 'noble army of martyrs' from long before Roger Bacon down to this present—martyrs not less real than that devoted saint, from whom, as I

understand, our guest takes his name, who perished in the flames as a martyr to religious duty.

What I maintain, then, is, that this zeal for truth as truth, this faith in the good as for ever allied to the true, this devotion to duty, as the result of such faith and zeal, constitute probably the most needed element at this moment in the political regeneration of this country, and that, therefore, the example of our little army of true devotees of science has an exceeding preciousness.

Said a justly distinguished senator to me yesterday, in Washington: 'The true American idea of education is, to give all children a good and even start; then to hold up the prizes of life before them; then to say to them: "Go in and win; let the smartest have the prizes."' "

Who of the common herd shall dispute the conclusions of a senator beneath the great cast-iron dome at Washington?—But here, in this presence, I may venture to say that such a theory of education is one of the main causes of our greatest national danger and disgrace. No theory can be more false, or, in the long run, more fatal. Look at it for a moment:—

We are greatly stirred, at times, as this fraud or that scoundrel is dragged to light, and there rise cries and moans over the corruption of the times; but, my friends, these frauds and these scoundrels are not the 'corruption of the times.' They are the mere pustules which the body politic throws to the surface. Thank God, that there is vitality enough left to throw them to the surface! The disease is below all this; infinitely more wide-spread.

What is that disease? I believe that it is, first of all, *indifference*—indifference to truth as truth; next, *scepticism*, by which I do not mean inability to believe this or that dogma, but the scepticism which refuses to believe that there is any power in the universe strong enough, large enough, good enough, to make the thorough search for truth safe in every line of investigation; next, *infidelity*, by which I do not mean

want of fidelity to this or that dominant creed, but want of fidelity to that which underlies all creeds, the idea that the true and the good are one; and, finally, *materialism*, by which I do not mean this or that scientific theory of the universe, but that devotion to the mere husks and rinds of good, that struggle for place and pelf, that faith in mere material comfort and wealth which eats out of human hearts all patriotism, and which is the very opposite of the spirit that gives energy to scientific achievement.

The education which our senatorial friend approved leads naturally to just this array of curses.

On the other hand, I believe that the little army of scientific men furnish a very precious germ from which better ideas may spring.

And we should strengthen them. We have already multitudes of foundations and appliances for the dilution of truth—for the stunting of truth—for the promotion of half-truths—for the development of this or that side of truth.

We have no end of intellectual hot-house arrangements for the cultivation of the plausible rather than the true; and therefore it is that we ought to attach vast value to the men who with calmness and determination seek THE TRUTH, in its wholeness, on whatever line of investigation, not diluting it or masking it.

Their zeal, their devotion, their faith, furnish one of those very protests which are most needed against that low tone of political ideas which in its lower strata is political corruption. Their life gives that very example of a high spirit, aim, and work, which the time so greatly needs.

The reverence for scientific achievement, the revelation of the high honours which are in store for those who seek for truth in science—the inevitable comparison between a life devoted to that great pure search, on the one hand, and a life devoted to place-hunting or pelf-grasping on the other—all these shall come to the minds of thoughtful men in lonely

garrets of our cities, in remote cabins on our prairies, and thereby shall come strength and hope for higher endeavour.

And, Mr. Chairman, as this influence for good spreads and strengthens, I have faith that gratitude will bring in results for political good of yet another kind.

Many predecessors of our friend have, as literary men, strengthened the ties that bind together the old land and the new; and I trust that love, admiration, and gratitude, between men of science on both sides the Atlantic, may add new cords and give strength to old cords which unite the hearts of the two great English-speaking nations.

PROFESSOR TYNDALL'S REMARKS.

There is one point in your speech, Mr. President, which requires simple honesty and little wit on my part to respond to. That point is symbolized by those united flags of America and England which I now see before me. You spoke of the sympathy existing between the intellect of England and that of the United States, and of the smallness of our differences compared with the area of our coincidences. Coming from you, sir, these words had a peculiar weight and worth to me. I am persuaded that they are not the words of mere conventional compliment, but that they embody your convictions. And I am equally persuaded that they are the expression of a fact which will become more and more prominent as time rolls on, and as international knowledge is increased.

During my four months' residence in the United States I have not heard a single whisper hostile to England; and this accounts for a certain change of feeling on my part, accompanied by a corresponding change of expression in my lectures. At a time when the political relations of America and England were critical in the extreme, I received from the United States letters expressing the emphatic opinion that if men of science,

on both sides of the Atlantic, could be persuaded to interchange friendly visits, it would, as far as the United States were concerned, do more than diplomacy to soften the asperities arising out of political differences. I said something bearing upon this point in Boston; but of late nothing. And this, because I saw that any reference to it would have been out of place; resembling, as Mr. Emerson would say, the sound of a scythe in December, when there is nothing to mow. We are not angels on either side of the Atlantic, nor am I aware that we desire to be angels; but as men I believe there exists between us a strength of brotherhood competent to weld together the two kindred nations almost as closely as the various parts of your own vast community are welded to each other.

And now let us turn for a moment to science. The interest shown in the lectures to which you have so kindly referred is not, in my opinion, the creation of the hour. Every such display of public sympathy must have its prelude, during which men's minds are prepared, a desire for knowledge created, an intelligent curiosity aroused. Then in the nick of time comes a person, who, though but an accident, touches a spring which permits tendency to flow into fact, and public feeling to pass from the potential to the actual. In no other way can I account for my four months' experience in the United States. The soil had been prepared, and the good seed sown long before I came among you. And it is on the belief that the subject has a root deeper than the curiosity of the hour, that I found my hopes of its not passing rapidly from the public mind.

It would be a great thing for this land of incalculable destinies to supplement its achievements in the industrial arts by those higher investigations from which our mastery over Nature and over industrial art itself has been derived, and which, when applied in a true catholic spirit to man himself, will assuredly render him permanently healthier and nobler than he now is. To no other country is the cultivation of science, in its highest forms, of more importance than to yours.

In no other country would it exert a more benign and elevating influence. What, then, is to be done toward so desirable a consummation? Here, I think, you must take counsel of your leading scientific men. As regards physical science, I think, they are likely to assure you that it is not the statical element of *buildings* that you require, so much as the dynamical element of *brains*. Making use as far as possible of existing institutions, let chairs be founded, sufficiently, but not luxuriously endowed, which shall have original research for their main object and ambition. With such vital centres among you, all your establishments of education would feel their influence; without such centres, even your primary instruction will never flourish as it ought. I would by no means sever tuition from investigation; but, as in the institution to which I have the honour to belong, the one ought, in the cases now in view, to be made subservient to the other. The Royal Institution gives lectures—indeed, it lives in part by lectures, though mainly by the contributions of its members, and the bequests of its friends. But the chief feature of its existence—a feature never lost sight of by its wise and honourable Board of Managers—is that it should be a school of research and discovery. Though a by-law gives them the power to interfere, for the twenty years during which I have been there, no manager or member of the Institution has ever interfered with my researches. It is this wise freedom, accompanied by a never-failing sympathy, extended to the great men who preceded me, that has given to the Royal Institution its imperishable renown.

As to the source of the funds necessary for founding such chairs as those referred to, it is not for me to offer an opinion. Without raising the disputed question of State aid, it is possible in this country to do a great deal without it. The willingness of American citizens to throw their fortunes into the cause of public education is, as I have already stated, without a parallel in my experience. Hitherto their efforts

have been directed to the practical side of science ; and this is why I sought in my lectures to show the dependence of practice upon principles. On the ground, then, of mere practical, material utility, pure science ought to be cultivated. But assuredly among your men of wealth there are those willing to listen to an appeal on higher grounds. Into this plea I would pour all my strength. Not as a servant of Mammon do I ask you to take science to your hearts, but as the strengthener and enlightener of the mind of man.

Might I now address a word or two to those who in the ardour of youth feel themselves drawn towards science as a vocation. They must, I think, be prepared to suffer a little at times for the sake of scientific righteousness, not refusing, should occasion demand it, to live low and lie hard to achieve the object of their lives. I do not here urge upon my younger friends any thing that I should have been unwilling to do myself when young. A simple statement of my student-life on the Continent would prove this to demonstration. And it is with the view of giving others the chance that I then enjoyed, among my noble and disinterested German teachers, that I propose, after deducting, with strict accuracy, the sums which have been actually expended on my lectures, to devote every cent of the money which you have so generously poured in upon me, to the education of young American philosophers in Germany. I ought not, for their sake, to omit one additional motive which upheld me during my student life—a sense of duty. Every young man of high aims must, I think, have a spice of this principle within him. There are sure to be hours in his life when his outlook will be dark, his work difficult, and his intellectual future uncertain. Over such periods, when the stimulus of success is absent, he must be carried by his sense of duty. It may not be so quick an incentive as glory, but it is a nobler one, and gives a tone to character which the hope of glory cannot impart. That unflinching devotion to work, without which no real eminence in science is now attainable, implies the writing at

certain times of the stern resolve upon the student's character : 'I work, not because I love to work, but because I ought to work.' In science, however, love and duty are sure to be reconciled in the end.

And now, gentlemen, all is nearly over, and in a day or two I quit these shores. I read a day or two ago an article in the *Galaxy*, in which the writer, who had been in England, and who had had what you call 'a good time' in England, spoke nevertheless of the deep pleasure of reaching his own home. The words struck a sympathetic chord within me. And it is a curious psychical fact, that this home-yearning, in my case, is not only unopposed, but is actually aided by the feeling that since I came to this country America has been a home to me. It is not a case of two opposing attractions, but a case in which, one of the attractions being satisfied, I am left not only free to be acted on, but more ready to be acted on by the other. Were there any lingering doubt, as to my visit, at the bottom of my mind; did I feel that I had blundered—and with the best and purest intentions I might, through an error of judgment, have blundered—so as to cause you discontent, I should now be wishing to abolish the doubt or to repair the blunder. This would be so much withdrawn from the pleasurable thought of home. But there is no drawback of this kind; and, therefore, as I have said, the fulness of my content here, enhances the prospective pleasure of meeting my older friends. By some means or other the people of this country have begotten and fostered a strange confidence in me towards them. I feel as if I, a simple scientific student, who never taught the world to be a cent richer, who merely sought to present science to the world as an intellectual good, am leaving, not a group of friends merely, not merely a friendly city, but a friendly continent behind me. The very disappointment of the West I take as a measure of the West's goodwill. Tested and true friends are awaiting me at the other side, and, thinking of them and you, the pure cold intellect is for the

moment deposed, and the 'human heart' is master of the situation. But lest it, in the waywardness of strong emotion, should utter any thing which the re-enthroned intellect of to-morrow might condemn, I will pause here—hoping, not for the entire consummation, for that would be a hope too daring, but hoping, as the generations pass, that the attachment which binds me to America, on the one side, and 'the Old Country,' on the other, may be more and more approached and realized by the nations themselves.

MEASUREMENT OF THE WAVES OF LIGHT.

THE diffraction fringes described in Lecture II., instead of being formed on the retina, may be formed on a screen, or upon ground glass, when they can be looked at through a magnifying lens from behind, or they can be observed in the air when the ground glass is removed. Instead of permitting them to form on the retina, we will suppose them formed on a screen. This places us in a condition to understand, even without trigonometry, the solution of the important problem of measuring *the length* of a wave of light.

We will suppose the screen so distant that the rays falling upon it from the two margins of the slit are sensibly parallel. We have learned in Lecture II. that the first of the dark bands corresponds to a difference of marginal path of one undulation; the second dark band to a difference of path of two undulations; the third dark band to a difference of three undulations, and so on. Now the angular distance of the bands from the centre is capable of exact measurement; this distance depending, as already stated, on the width of the slit. With a slit 1.35¹ millimeters wide, Schwerd found the angular distance of the first dark band from the centre of the field to

¹ The millimeter is about $\frac{1}{25}$ th of an inch.

be $1' 38''$; the angular distances of the second, third, fourth dark band being twice, three times, four times this quantity.

Let $A B$, fig. 59, be the plate in which the slit is cut, and $C D$ the grossly exaggerated width of the slit, with the beam of red light proceeding from it at the obliquity corresponding to the first dark band. Let fall a perpendicular from one

FIG. 59.

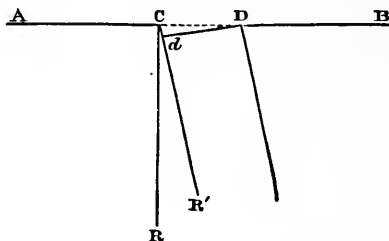

edge, D , of the slit on the marginal ray of the other edge at d . The distance, $C d$, between the foot of this perpendicular and the other edge is the length of a wave of the light. The angle $C D d$, moreover, being equal to $R C R'$, is, in the case now under consideration, $1' 38''$. From the centre D , with the width $D C$ as radius, describe a semicircle; its radius $D C$ being 1.35 millimeters, the length of this semicircle is found by an easy calculation to be 4.248 millimeters. The length $C d$ is so small that it sensibly coincides with the arc of the circle. Hence the length of the semicircle is to the length $C d$ of the wave as 180° to $1' 38''$, or, reducing all to seconds, as 648,000'' to 98''. Thus, we have the proportion—

$$648,000 : 98 :: 4.248 \text{ to the wave-length } C d.$$

Making the calculation, we find the wave-length for this particular kind of light to be 0.000643 of a millimeter, or 0.000026 of an inch.



PLUMES PRODUCED BY THE CRYSTALLIZATION OF WATER.

Photographed by Professor Lockett.

WATER CRYSTALLIZATION.

THE following letter from my excellent friend Professor Joseph Henry refers to a surprising case of crystallization here figured, and for which I am indebted to the kindness of Professor Lockett:—

‘Smithsonian Institution, Washington:

‘March 24, 1873.

‘MY DEAR PROFESSOR TYNDALL,—Accompanying this I send you a photograph, at the request of Professor S. H. Lockett, of the Louisiana State University, of which the following is his explanation:—

“In my drawing room I kept a wash-basin in which to rinse out the colour from my water-colour brushes. This colour gradually formed a uniform sediment of an indefinite tint over the bottom of the basin. On the night of the 26th of December last, which was an unusually cold one for this climate, the water in the basin froze. On the melting of the ice the next day, the beautiful figure you see on the photographs was left in the sediment. I carefully poured the water from the basin, let the sediment dry, and thus perfectly preserved the figure. It has been accurately photographed by an artist in this city. The negative is preserved, and if you would like to have any more copies they can readily be obtained.

“We are not much accustomed in this warm country of ours to the beautiful ‘forms of water,’ and this has struck me as a little remarkable, and worthy of being kept.”

‘The fact that the results have been produced by coloured sediment indicates a method of exhibiting the effects of crystallization in an interesting manner.

‘JOSEPH HENRY,

‘Secretary, Smithsonian Institution.’

ON THE SPECTRA OF POLARIZED LIGHT.

Mr. William Spottiswoode has recently introduced to the members of the Royal Institution, in a very striking form, a series of experiments on the spectra of polarized light. With his large Nicol's prisms he first repeated and explained the experiments of Foucault and Fizeau, and subsequently enriched the subject by very beautiful additions of his own. I here append a portion of the abstract of his discourse:—

‘It is well known that if a plate of selenite sufficiently thin be placed between two such Nicol's prisms, or, more technically speaking, between a polarizer and analyzer, colour will be produced. And the question proposed is, What is the nature of that colour? is it simply a pure colour of the spectrum, or is it a compound, and if so, what are its component parts? The answer given by the wave theory is in brief this: In its passage through the selenite plate the rays have been so separated in the direction of their vibrations and in the velocity of their transmission, that, when re-compounded by means of the analyzer, they have in some instances neutralized one another. If this be the case, the fact ought to be visible when the beam emerging from the analyzer is dispersed by the prism; for then we have the rays of all the different colours ranged side by side, and if any be wanting, their absence will be shown by the appearance of a dark band in their place in the spectrum. But not only so; the spectrum ought also to give an account of the other phenomena exhibited by the selenite when the analyzer is turned round, viz. that when the angle of turning amounts to 45° , all trace of colour disappears; and also that when the angle amounts to 90° , colour reappears, not, however, the original colour, but one complementary to it.

Handwritten note:
The answer given by the wave theory is in brief this:

‘ You see in the spectrum of the reddish light produced by the selenite a broad but dark band in the blue ; when the analyzer is turned round the band becomes less and less dark, until when the angle of turning amounts to 45° it has entirely disappeared. At this stage each part of the spectrum has its own proportional intensity, and the whole produces the colourless image seen without the spectroscope. Lastly, as the turning of the analyzer is continued, a dark band appears in the red, the part of the spectrum complementary to that occupied by the first band ; and the darkness is most complete when the turning amounts to 90° . Thus we have from the spectroscope a complete account of what has taken place to produce the original colour and its changes.

‘ It is further well known that the colour produced by a selenite, or other crystal plate, is dependent upon the thickness of the plate. And, in fact, if a series of plates be taken, giving different colours, their spectra are found to show bands arranged in different positions. The thinner plates show bands in the parts of the spectrum nearest to the violet, where the waves are shorter, and consequently give rise to redder colours ; while the thicker show bands nearer to the red, where the waves are longer and consequently supply bluer tints.

‘ When the thickness of the plate is continually increased, so that the colour produced has gone through the complete cycle of the spectrum, a further increase of thickness causes a reproduction of the colours in the same order ; but it will be noticed that at each recurrence of the cycle the tints become paler, until when a number of cycles have been performed, and the thickness of the plate is considerable, all trace of colour is lost. Let us now take a series of plates, the first two of which, as you see, give colours ; with the others which are successively of greater thickness the tints are so feeble that they can scarcely be distinguished. The spectrum of the first shows a single band ; that of the second, two ; showing that the second series of tints is not identical with the first, but

Miss G. Brewster

that it is produced by the extinction of two colours from the components of white light. The spectra of the others show series of bands more and more numerous in proportion to the thickness of the plate, an array which may be increased indefinitely. The total light, then, of which the spectrum is deprived by the thicker plates is taken from a greater number of its parts; or, in other words, the light which still remains is distributed more and more evenly over the spectrum; and in the same proportion the sum total of it approaches more and more nearly to white light.

‘ These experiments were made more than thirty years ago by the French philosophers, MM. Foucault and Fizeau.

‘ If instead of selenite, Iceland spar, or other ordinary crystals, we use plates of quartz cut perpendicularly to the axis, and turn the analyzer round as before, the light, instead of exhibiting only one colour and its complementary with an intermediate stage in which colour is absent, changes continuously in tint; and the order of the colour depends partly upon the direction in which the analyzer is turned, and partly upon the character of the crystal, *i.e.* whether it is right-handed or left-handed. If we examine the spectrum in this case we find that the dark band never disappears, but marches from one end of the spectrum to another, or *vice versâ*, precisely in such a direction as to give rise to the tints seen by direct projection.

‘ The kind of polarization effected by the quartz plates is called circular, while that effected by the other class of crystals is called plane, on account of the form of the vibrations executed by the molecules of æther; and this leads us to examine a little more closely the nature of the polarization of different parts of these spectra of polarized light.

‘ Now, two things are clear: first, that if the light be plane-polarized, that is, if all the vibrations throughout the entire ray are rectilinear and in one plane, they must in all their bearings have reference to a particular direction in space, so that they will be differently affected by different positions of the

analyzer. Secondly, that if the vibrations be circular, they will be affected in precisely the same way (whatever that may be) in all positions of the analyzer. This statement merely recapitulates a fundamental point in polarization. In fact, plane-polarized light is alternately transmitted and extinguished by the analyzer as it is turned through 90° ; while circularly-polarized light [if we could get a single ray] remains to all appearance unchanged. And if we examine carefully the spectrum of light which has passed through a selenite, or other ordinary crystal, we shall find that, commencing with two consecutive bands in position, the parts occupied by the bands and those midway between them are plane polarized, for they become alternately dark and bright; while the intermediate parts, *i.e.* the parts at one-fourth of the distance from one band to the next, remain permanently bright. These are, in fact, circularly polarized. But it would be incorrect to conclude from this experiment alone that such is really the case, because the same appearance would be seen if those parts were unpolarized, *i.e.* in the condition of ordinary lights. And on such a supposition we should conclude with equal justice that the parts on either side of the parts last mentioned (*e.g.* the parts separated by eighth parts of the interval between two bands) were partially polarized. But there is an instrument of very simple construction, called a "quarter-undulation plate," a plate usually of mica, whose thickness is an odd multiple of a quarter of a wave length, which enables us to discriminate between light unpolarized and circularly polarized. The exact mechanical effect produced upon the ray could hardly be explained in detail within our present limits of time; but suffice it for the present to say that when placed in a proper position, the plate transforms plane into circular and circular into plane polarization. That being so, the parts which were originally banded ought to remain bright, and those which originally remained bright ought to become banded during the rotation of the analyzer. The general effect to the eye will conse-

quently be a general shifting of the bands through one-fourth of the space which separates each pair.

‘Circular polarization, like circular motion generally, may of course be of two kinds, which differ only in the direction of the motion. And, in fact, to convert the circular polarization produced by this plate from one of these kinds to the other (say from right-handed to left-handed, or *vice versâ*), we have only to turn the plate round through 90° . Conversely right-handed circular polarization will be changed by the plate into plane polarization in one direction, while left-handed will be changed into plane at right angles to the first. Hence, if the plate be turned round through 90° we shall see that the bands are shifted in a direction opposite to that in which they were moved at first. In this therefore we have evidence not only that the polarization immediately on either side of a band is circular; but also that that immediately on the one side is right-handed, while that immediately on the other is left-handed.[¹]

‘If time permitted, I might enter still further into detail, and show that the polarization between the plane and the circular is elliptical, and even the positions of the longer and shorter axes and the direction of motion in each case. But sufficient has, perhaps, been said for our present purpose.

‘Before proceeding to the more varied forms of spectral bands, which I hope presently to bring under your notice, I should like to ask your attention for a few minutes to the peculiar phenomena exhibited when two plates of selenite giving complementary colours are used. The appearance of the spectrum varies with the relative position of the plates. If they are similarly placed—that is, as if they were one plate of crystal—they will behave as a single plate, whose thickness is the sum of the thicknesses of each, and will produce double

[¹ At these points the two rectangular vibrations into which the original polarized ray is resolved by the plates of gypsum act upon each other like the two rectangular impulses imparted to our pendulum in Lecture IV., one being given when the pendulum is at the limit of its swing. Vibration is thus converted into rotation.]

the number of bands which one alone would give ; and when the analyzer is turned, the bands will disappear and re-appear in their complementary positions, as usual in the case of plane-polarization. If one of them be turned round through 45° , a single band will be seen at a particular position in the spectrum. This breaks into two, which recede from one another towards the red and violet ends respectively, or advance towards one another according to the direction in which the analyzer is turned. If the plate be turned through 45° in the opposite direction, the effects will be reversed. The darkness of the bands is, however, not equally complete during their whole passage. Lastly, if one of the plates be turned through 90° , no bands will be seen, and the spectrum will be alternately bright and dark, as if no plates were used, except only that the polarization is itself turned through 90° .

‘If a wedge-shaped crystal be used, the bands, instead of being straight, will cross the spectrum diagonally, the direction of the diagonal (dexter or sinister) being determined by the position of the thicker end of the wedge. If two similar wedges be used with their thickest ends together, they will act as a wedge whose angle and whose thickness is double of the first. If they be placed in the reverse position they will act as a flat plate, and the bands will again cross the spectrum in straight lines at right angles to its length.

‘If a concave plate be used the bands will dispose themselves in a fanlike arrangement, their divergence depending upon the distance of the slit from the centre of concavity.

‘If two quartz wedges, one of which has the optic axis parallel to the edge of the refractory angle, and the other perpendicular to it, but in one of the planes containing the angle (Babinet’s Compensator), the appearances of the bands are very various.

‘The diagonal bands, beside sometimes doubling themselves as with ordinary wedges, sometimes combine so as to form longitudinal (instead of transverse) bands ; and sometimes cross one another so as to form a diaper pattern with bright

compartments in a dark framework, and *vice versâ*, according to the position of the plates.

‘The effects of different dispositions of the interposed crystals might be varied indefinitely; but enough has perhaps been said to show the delicacy of the method of spectrum analysis as applied to the examination of polarized light.’

The singular and beautiful effect obtained with a circular plate of selenite, thin at the centre, and gradually thickening towards the circumference, is easily connected with a similar effect obtained with Newton’s rings. Let a thin slice of light fall upon the glasses which show the rings, so as to cover a narrow central vertical zone passing through them all. The image of this zone upon the screen is crossed by portions of the iris rings. Subjecting the reflected beam to prismatic analysis, the resultant spectrum may be regarded as an indefinite number of images of the zone placed side by side. In the image before dispersion we have *iris-rings*, the extinction of the light being nowhere complete; but when the different colours are separated by dispersion, each colour is crossed transversely by its own system of dark interference bands, which become gradually closer with the increasing refrangibility of the light. The complete spectrum, therefore, appears furrowed by a system of continuous dark bands, crossing the colours transversely, and approaching each other as they pass from red to blue.

In the case of the plate of selenite, a slit is placed in front of the polarizer, and the film of selenite is held close to the slit, so that the light passes through the central zone of the film. As in the case of Newton’s rings, the image of the zone is crossed by iris-

coloured bands ; but when subjected to prismatic dispersion, the light of the zone yields a spectrum furrowed by bands of complete darkness exactly as in the case of Newton's rings, and for a similar reason. This is the beautiful effect described by Mr. Spottiswoode as the fanlike arrangement of the bands—the fan opening out at the red end of the spectrum.

PRÉFACE DU TRADUCTEUR FRANÇAIS.

LA LUMIÈRE de M. Tyndall ne ressemble à aucun des Traités qu'il m'a été donné d'étudier et d'analyser, en si grand nombre, dans mon 'Répertoire d'Optique moderne' et plus tard.

Ce n'est pas un Traité élémentaire, car il comprend les phénomènes les plus délicats, ceux même que nos programmes du baccalauréat écartent de l'enseignement classique ; et ce n'est pas non plus un Traité d'Optique supérieure, puisqu'il est la rédaction de Leçons faites devant un auditoire d'hommes et de femmes du monde.

Ce n'est pas un Traité d'Optique physique, car il donne la raison mécanique de chaque phénomène, et ce n'est pas un Traité d'Optique mathématique, car le calcul n'y joue aucun rôle.

Ce n'est pas un Traité d'Optique expérimentale, car le raisonnement domine tout, car l'analyse et la synthèse y prennent une part considérable ; et ce n'est pas un Traité d'Optique rationnelle, car il se résume tout entier dans la production des phénomènes sur la plus large échelle qu'on puisse imaginer, en les rendant visibles à un immense auditoire.

Qu'est-il donc et comment le caractériserons-nous ? En disant qu'il est tout à la fois, dans son unité merveilleuse, élémentaire et supérieur, physique et mathématique, expérimental et rationnel ; qu'il constitue un mode d'enseignement

sui generis, analytique et synthétique à la fois, vraiment nouveau et admirable en soi.

Singulière dans le fond, *la Lumière* est non moins singulière dans la forme. Au premier aspect, et parce qu'elle est en réalité la rédaction de Leçons improvisées, cette forme semble laisser beaucoup à désirer : on la dirait imparfaite ; mais, à mesure qu'on se l'assimile *la Lumière* étonne et ravit par sa vérité, sa précision, sa netteté, et l'on est forcé de reconnaître qu'elle est en son genre un modèle incomparable de perfection.

Ce qui la spécifie et lui donne une supériorité incontestable, c'est son mode d'exposition, d'une transparence en quelque sorte infinie. Elle donne la vision intuitive des faits et plus encore de la raison des faits ou du mécanisme des phénomènes. Je croyais savoir l'Optique, que j'ai étudiée et rédigée sous toutes ses formes depuis trente ans ; mais je suis forcé de reconnaître que je la sais incomparablement mieux depuis que j'ai traduit *la Lumière*. Les petites formules de M. Tyndall pénètrent beaucoup mieux au cœur des phénomènes que les plus savantes équations des Traités d'Optique mathématique.

Comme chefs-d'œuvre du genre je citerai la troisième Leçon, sur la polarité et la polarisation rectiligne, et la quatrième, sur la polarisation chromatique et les interférences. Jamais enseignement n'avait fait sur mon esprit un effet aussi extraordinaire. Non-seulement je voyais les phénomènes, mais je m'identifiais avec eux ; ils n'étaient plus que des modifications de mon intelligence, ma propre pensée. La sensation que j'éprouvais alors était vraiment délicieuse. La vue intuitive des phénomènes, de leurs causes, de leur mécanisme est en effet le triomphe suprême de l'enseignement. Et voilà surtout à quel point de vue je recommande *la Lumière* de M. Tyndall comme le seul livre qui, à ma connaissance, initie pleinement aux mystères de l'Optique. Je voudrais le voir dans les mains de tous les amis de la Science. Elle n'est pas aussi profonde, aussi savante, aussi encyclopédique que *la Chaleur* ; mais elle va bien plus directement au but et l'atteint

plus complètement. J'ai fait d'ailleurs tout ce que j'ai pu pour que, sans avoir une couleur trop anglaise, ma traduction rendit parfaitement le texte original.

Me sera-t-il permis de faire remarquer que, dans son exposé de l'analyse spectrale, M. Tyndall fait la part vraiment trop belle à M. Kirchhoff? S'il est vrai que le célèbre physicien de Heidelberg a fait, le premier, la chimie solaire, il n'est pas vrai au même degré qu'il ait fait le premier, par l'analyse spectrale, la chimie des substances terrestres. M. Tyndall parle bien de quelques précurseurs de M. Kirchhoff, mais il oublie les principaux, M. Plücker par exemple, qui apprit à MM. Kirchhoff et Bunsen à analyser par le prisme la lumière des flammes qu'ils s'efforçaient péniblement de résoudre dans ses principes constituants à l'aide de verres colorés ou absorbants. Le Mémoire de M. Kirchhoff a été lu à l'Académie de Berlin, le 27 octobre 1859; et neuf ans auparavant, comme sir William Thomson, le collègue et glorieux émule de M. Tyndall, a bien voulu le rappeler dans son discours inaugural de l'Association Britannique (Édimbourg, septembre 1871), je disais ('Répertoire d'Optique moderne,' publié en janvier 1860, t. III. p. 243): 'M. Foucault a publié une Note curieuse sur les spectres produits par les corps qui brûlent entre les deux pointes de charbon fixées aux pôles d'une forte pile. Nous avons répété ces belles expériences avec M. Soleil; nous pouvons même dire que nous leur avons donné un plus grand éclat en projetant ces spectres sur un écran, sans leur rien faire perdre de leur splendeur. Dans la combustion de l'argent et du cuivre, il y a une raie verte qui surpasse en intensité les rayons les plus illuminés du spectre solaire. Le spectre du cuivre était facilement reconnu par ses raies vertes, celui du zinc par ses merveilleuses raies violettes. Dans la flamme du laiton, composé de cuivre et de zinc, on admirait les raies vertes du cuivre et les raies violettes du zinc; le maillechort a présenté des apparences beaucoup plus splendides: l'œil ne se lassait pas de contempler toutes les raies lumineuses des métaux qui entrent dans la composition de cet alliage multiple. AVEC UN PEU D'EXPÉRIENCE ON ARRIVE À FAIRE,

PAR L'OBSERVATION DES RAIES, L'ANALYSE SINON QUANTITATIVE, DU MOINS QUALITATIVE des combinaisons les plus complexes de métaux très-dissemblables.'

Dans mon compte rendu d'une matinée scientifique donnée par M. Soleil et moi, dans les salons de M. Émile de Girardin, en 1849, j'avais décrit ces mêmes expériences et affirmé plus nettement que les spectres de radiation ou d'absorption de tous les corps de la nature avaient leurs raies sombres ou brillantes, caractéristiques et spécifiques de leur nature intime. Ma conviction à cet égard était si profonde, que je priai mon illustre maître A. Cauchy de formuler la théorie générale de ces raies. Il le fit dans une Note très-courte, mais très-explicite, publiée dans les 'Comptes rendus des séances de l'Académie des Sciences' et insérée en 1847 dans le second volume de mon 'Répertoire d'Optique,' p. 238 et 239. Qu'il me soit permis de reproduire ici les quelques lignes qui la terminaient et qui n'ont pas été assez remarquées : 'Observons encore que l'état initial d'un système de molécules ou plutôt d'une portion de ce système étant arbitraire, le système d'ondes planes qui représente cet état initial, et qui s'en déduit par une formule connue, peut varier à l'infini comme cet état lui-même. Il en résulte que, parmi les ondes planes correspondant aux diverses longueurs d'ondulations, les unes doivent être très-sensibles, tandis que les autres peuvent l'être beaucoup moins et disparaître presque entièrement. On ne devra donc pas être surpris de voir, dans la théorie de la lumière, les rayons doués de réfrangibilités diverses, lorsqu'on les dispersera par le moyen du prisme, offrir des intensités variables non-seulement avec les longueurs d'ondulations correspondantes, mais encore avec la nature des corps dont ils émanent ou qu'ils traversent, et l'on devrait s'étonner, au contraire, qu'il en fût autrement. Ainsi doivent être évidemment expliquées les raies brillantes et obscures découvertes dans le spectre solaire et dans ceux qui fournissent les autres corps lumineux. Les raies du spectre ne doivent pas nous surprendre : leur absence seule, dans le plus grand nombre des cas, serait inexplicable.' Voilà ce que nous écrivions en 1847. La

chimie spectrale était donc à cette époque une vérité essentielle et incontestable: M. Kirchhoff n'avait donc pas à la créer. Cette affirmation ne ressortira pas moins d'une autre citation que je tiens à faire ici: M. Adolphe Erman, dans un Mémoire adressé à l'Académie des Sciences de Paris, en octobre 1844, sur les raies d'absorption du chlore, de l'iode et du brome, disait en termes formels: ' Il est étonnant que la théorie des phénomènes d'absorption (les phénomènes solaires expliqués par Kirchhoff sont des phénomènes d'absorption) ait encore fait si peu de progrès, puisque la marche des recherches qui doivent y conduire était nettement indiquée d'avance. Il me semble, en effet, que ces recherches doivent se borner: 1° à décomposer, à l'aide du prisme, la lumière sur laquelle l'absorption a agi; 2° à caractériser les rayons qui ont été éteints par le seul moyen que l'Optique nous fournit pour cet effet, je veux dire par la mesure des longueurs d'ondes; et 3° à voir si les longueurs d'ondes des rayons observés sont liées par quelques lois qui expliquent leur disparition.' C'est là évidemment toute l'analyse spectrale, plus complète qu'on ne l'a faite jusqu'ici. En dehors de ces vues théoriques, il y avait à découvrir le fait qu'une flamme arrête les ondes qu'elle peut elle-même engendrer, et la gloire de cette découverte est essentiellement française: elle appartient à M. Léon Foucault; M. Kirchhoff n'a fait que la formuler mieux et la généraliser.¹

Il est dans *la Lumière* quelques passages hasardés que je ne puis laisser passer sans explications, précisément parce que, en les traduisant, j'en assume à un certain degré la responsabilité.

Page 9, ligne 11, M. Tyndall se fait l'écho d'une boutade humoristique d'une de ses plus grandes admirations, M. Helmholtz: ' On pourrait en réalité dresser contre l'œil une longue liste d'accusations: son opacité, son défaut de symétrie, son manque d'achromatisme, sa cécité absolue ou partielle. Toutes ces raisons prises ensemble amenèrent M. Helmholtz à dire,

¹ What M. Foucault and M. Kirchhoff respectively accomplished is stated in this volume. I have awarded to M. Kirchhoff nothing that can be justly denied to him.—J.T.

que, si un opticien lui livrait un instrument si plein de défauts il se croirait autorisé à le renvoyer avec les reproches les plus sévères.' Sous cette forme, l'appréciation de l'œil est vraiment impardonnable. L'œil n'est pas essentiellement ou absolument achromatique : cela est vrai, cela même est nécessairement vrai, puisque aucune œuvre finie ne peut être infiniment parfaite et que la perfection absolue est le propre de l'être infini. Mais, par cela même qu'aucun homme n'a conscience de ce défaut d'achromatisme, qu'il faut, pour le mettre en évidence, des expériences très-déliçates faites avec de puissants instruments ; qu'il ne modifie en rien pratiquement les couleurs des objets, l'œil est exactement ce qu'il doit être. On ne pourrait probablement faire disparaître ces imperfections inséparables de tout être créé et fini sans en faire naître d'autres beaucoup plus grandes. M. Helmholtz attribue le défaut d'achromatisme de l'œil au fait que la densité des milieux de l'œil ne surpasse guère la densité de l'eau. Or connaît-il assez la constitution de l'œil et les innombrables conditions qu'il doit remplir pour affirmer qu'une densité plus grande de ses milieux n'aurait pas des inconvénients très-graves, n'amènerait pas des épanchements ou des infiltrations ? Je remercie M. Tyndall d'avoir opposé à ce jugement inconsidéré cette conclusion très-sage (page 9) : ' Comme instrument pratique et en faisant entrer en ligne de compte les accommodements par lesquels ses défauts sont neutralisés, l'œil *n'en reste pas moins une merveille pour tout esprit capable de réflexion.*'

Page 132, M. Tyndall semble regarder comme fondée et insoluble l'objection faite à l'Église catholique, de prouver sa divinité ou son infaillibilité par l'authenticité de l'Écriture sainte, et d'affirmer l'authenticité et l'inspiration divine des saintes Écritures par l'autorité de l'Église infaillible, ce qui constituerait un cercle vicieux. On a prouvé, depuis bien longtemps, que ce cercle vicieux n'existe pas pour nous catholiques. En effet nous avons, indépendamment de toute citation des Écritures, par la tradition et la succession du ministère apostolique, la certitude de l'apostolicité de l'Église

romaine, et aussi du fait que les apôtres ont donné aux églises qu'ils ont fondées tels ou tels livres, et non d'autres, comme Écriture sainte et parole de Dieu ; en un mot nous prouvons, par la tradition non interrompue, l'authenticité et, par conséquent, l'inspiration des saintes Écritures, puis, par l'inspiration divine de l'Écriture, l'infailibilité de l'Église. Ce n'est pas là un cercle vicieux, c'est, au contraire, à l'égard des protestants, qui admettent la divinité de l'Écriture sainte, *à priori*, au point de récuser toute autre preuve, un argument personnel. Ce sont les protestants qui tombent, eux, dans un cercle vicieux, en prouvant la divinité de l'Écriture par une prétendue *persuasion intérieure* du Saint-Esprit, et se prétendent assurés de cette assistance par le témoignage des Écritures qui la leur promettent. Si M. Tyndall s'était interdit cette comparaison, je me serais de mon côté interdit cette observation que je regrette d'être forcé de consigner ici. *Non erat hic locus!*

Pages 112 et 113, M. Tyndall se hasarde à dire : ' C'est par cet acte de cristallisation que la Nature se révèle d'abord à nous comme architecte. Où s'arrêteront ses opérations ? continuera-t-elle, par le jeu des mêmes forces, à former des végétaux et des animaux ? Quelle que puisse être la réponse à ces questions, croyez-moi, les notions des générations à venir, sur cette chose mystérieuse que quelques-uns appellent la matière brute, seront très-différentes de celles des générations passées.' C'est le germe de cette confession étrange qui lui est échappée dans son discours d'inauguration de Belfast : ' Quand je prolonge ma vision en arrière, à travers les limites de l'évidence expérimentale, je discerne en cette matière, que, dans notre ignorance et sans le respect dû à son créateur, nous avons jusqu'ici couverte d'opprobres, *la promesse et la puissance d'engendrer toutes les formes et toutes les qualités de la vie.*' Nous avons expliqué cet écart d'un esprit très-élevé, par cette remarque bien simple, qu'après avoir perdu la notion du Dieu créateur, et fait la matière éternelle, il devait fatalement lui attribuer les propriétés et les facultés divines ; et que, sans s'en douter, il rendait hommage au Dieu

des Chrétiens, devenu pour lui le Dieu inconnu, *Ignoto Deo*.

Dans l'Appendice sur les rapports de la cristallisation avec la vie, M. Tyndall s'abandonne de nouveau à ses conceptions matérialistes, qui n'aboutissent, hélas ! qu'à faire mieux comprendre que la vie est restée, pour cet esprit éminent, un mystère impénétrable. Il se complaît à la représenter comme le résultat des attractions et des répulsions polaires, dont il dote les atomes et les molécules des corps à la façon des aimants. Mais, même dans la vie de son arbre, il y a autre chose que des directions moléculaires, effets de forces plutôt statiques que dynamiques : il y a mouvement et transport, qui supposent une force vive. J'aurais voulu qu'il eût placé le phénomène de la vie à côté des phénomènes de la sensation et de la pensée, dont il dit : 'Le cerveau de l'homme lui-même est assurément un assemblage de molécules arrangées suivant des lois physiques ; mais, si vous me demandez de déduire de cette assemblage le plus petit des phénomènes de la sensation ou de la pensée, je me prosterne dans la poussière, et je reconnais l'impuissance humaine. Cette fois la spéculation étendrait ses ailes bien au delà de la région où il n'est plus de milieu capable de soutenir son vol.'

Sur le terrain purement scientifique, nul plus que moi n'admire en M. Tyndall le penseur original et profond, le maître éminemment habile ; mais, avec son esprit si éclairé et si élevé, il comprendra qu'en le combattant sur le terrain de la religion et de la métaphysique, j'use d'un droit légitime, je remplis un devoir sacré.

F. MOIGNO.

INDEX.

ABS

- A**BSORPTION, principles of, 202
Addresses at Social Meeting in New York, 229
Airy, Sir George, severity and conclusiveness of his proofs, 212
Alhazen, his inquiry respecting light, 14, 210
Analyzer, polarizer and, 131, recom-
pounding of the two systems of
waves by the analyzer, 133
Angström, his paper on spectrum
analysis, 205
Arago, François, and Dr. Young, 52
— his discoveries respecting light,
211, 212
Atomic polarity, 98-101

- B**ACON, Roger, his inquiry re-
specting light, 14, 210
Barnard, President, his address at
Social Meeting in New York, 229
Bartholinus, Erasmus, on Iceland
spar, 114
Bérard on polarization of heat,
183
Blackness, meaning of, 32
Boyle, Robert, his observations on
colours, 68, 69
— his remarks on fluorescence,
166-168
Bradley, James, discovers the aber-
ration of light, 22, 23

CRY

- Brewster, Sir David, his chief objec-
tion to the undulatory theory of
light, 49
— his discovery in biaxal crystals,
212
Brougham, Mr. (afterwards Lord),
ridicules Dr. T. Young's specula-
tions, 51, 52
Browning, Mr., his prisms, 126
- C**ÆSIUM, discovery of, 196
Calorescence, 177
Clouds, actinic, 155-157
— polarization of, 158
Colours of thin plates, 67 -
— Boyle's observations on, 68, 69
— Hooke on the colours of thin
plates, 70
— of striated surfaces, 92, 93
Comet of 1680, Newton's estimate
of the temperature of, 171 *note*
Crookes, Mr., his discovery of thal-
lium, 196
Crystals, action of, upon light,
100
— built by polar force, 101
— illustrations of crystallization, 102
— architecture of, considered as an
introduction to their action upon
light, 101
— bearings of crystallization upon
optical phenomena, 109

CRY

- Crystals, rings surrounding the axes of, uniaxal and biaxal, 149
- Cuvier on ardour for knowledge, 223
- D**E TOCQUEVILLE, writings of, 218, 225, 226
- Descartes, his explanation of the rainbow, 24, 25
- his ideas respecting the transmission of light, 44
- his notion of light, 210
- Diamond, ignition of a, in oxygen, 172
- Diathermancy, 176
- Diffraction of light, phenomena of, 81
- bands, 81, 82
- explanation of, 83
- colours produced by, 92
- Dollond, his experiments on achromatism, 28
- Draper, Dr., his investigation on heat, 175; his address at Social Meeting in New York, 235
- Drummond light, spectrum of, 198

- E**ARTH, daily orbit of, 77
- Electric beam, heat of the, 169
- Electricity, discoveries in, 220, 221
- Emission theory of light, bases of the, 46
- Newton espouses the theory, and the results of this espousal, 79
- Ether, Huyghens and Euler advocate and defend the conception of an, 49, 59
- objected to by Newton; 59
- Euler espouses and defends the conception of an ether, 49, 59

GRA

- Eusebius on the natural philosophers of his time, 13
- Expansion by cold, 107
- Experiment, uses of, 3
- Eye, the, its imperfections, grown for ages towards perfection, 8
- imperfect achromatism of the, 30 *note*
- F**ARADAY, Michael, his discovery of magneto-electricity, 221
- 'Fits,' theory of, 76
- its explanation of Newton's rings, 77
- overthrow of the theory, 80
- Fizeau determines the velocity of light, 23
- Fluorescence, Stokes's discovery of 164
- the name, 176
- Forbes, Professor, polarizes and depolarizes heat, 184
- Foucault, determines the velocity of light, 23
- his experiments on absorption, 200, 201, 204
- Fraunhofer, his theoretical calculations respecting diffraction, 91
- his lines, 196
- — their explanation by Kirchhoff, 197
- Fresnel, and Dr. Young, 52
- his theoretical calculations respecting diffraction, 90
- his mathematical abilities and immortal name, 213
- G**OETHE, on fluorescence, 168
- Gravitation, origin of the notion of the attraction of, 96

GRA

- Gravitation, strength of the theory of, 150
 Grimaldi, his discovery with respect to light, 58
 — Young's generalizations of, 58

HAMILTON, Sir William, of Dublin, his discovery of conical refraction, 212

Heat, generation of, 6

— Dr. Draper's investigation respecting, 175

Helmholtz, his estimate of the genius of Young, 51

— on the imperfect achromatism of the eye, 30 *note*, 31

— reveals the cause of green in the case of pigments, 37

Henry, Professor Joseph, his invitation, 2

Herschel, Sir John, his theoretical calculations respecting diffraction, 90

— first notices and describes the fluorescence of sulphate of quinine, 168

— his experiments on spectra, 204

Herschel, Sir William, his experiments on the heat of the various colours of the solar spectrum, 174

Hooke, Robert, on the colours of thin plates, 70

— his remarks on the idea that light and heat are modes of motion, 71

Horse-chestnut bark, fluorescence of, 168

Huggins Dr., his labours, 208

Huyghens advocates the conception of ether, 43, 59

LAC

Huyghens, his celebrated principle, 86

— on the double refraction of Iceland spar, 114

ICELAND spar, 112

— double refraction caused by, 113

— this double refraction first treated by Erasmus Bartholinus, 114

— character of the beams emergent from, 117

— tested by tourmaline, 119

— Knoblauch's demonstration of the double refraction of, 188

Ice-lens, combustion through, 170

Imagination, scope of the, 43

— note by Maclaurin on this point, 44 *note*

JANSSEN, M., on the rose-coloured solar prominences, 207

Jupiter, Rømer's observations of the moons of, 20

Jupiter's distance from the sun, 20

KEPLER, his investigations on the refraction of light, 14, 210

Kirchhoff, Professor, his explanation of Fraunhofer's lines, 197

— his precursors, 204

— his claims, 206

Knoblauch, his demonstration of the double refraction of heat of Iceland spar, 188

LACTANTIUS, on the natural philosophers of his time, 13

LAM

- Lamy, M., isolates thallium in ingots, 196
- Lesley, Professor, his invitation, 2
- Light familiar to the ancients, 5
- generation of, 6, 7
 - spherical aberration of, 8
 - the rectilineal propagation of, and mode of producing it, 9
 - illustration showing that the angle of incidence is equal to the angle of reflection, 10, 11
 - sterility of the Middle Ages, 13
 - history of refraction, 14
 - demonstration of the fact of refraction, 15
 - partial and total reflection of, 17-20
 - velocity of, 21
 - Bradley's discovery of the aberration of light, 22, 23
 - principle of least action, 23
 - Descartes and the rainbow, 24
 - Newton's analysis of, 27
 - synthesis of white light, 30
 - complementary colours, 31
 - yellow and blue lights produce white by their mixture, 31
 - what is the meaning of blackness? 32
 - analysis of the action of pigments upon, 34
 - absorption, 35
 - mixture of pigments contrasted with mixture of lights, 37
 - Wünsch on three simple colours in white light, 41
 - Newton arrives at the emission theory, 46
 - Young's discovery of the undulatory theory, 50
 - illustrations of wave-motion, 52, 53
 - interference of sound-waves, 61

LIG

- Light, velocity of, 63
- principle of interference of waves of, 64
 - phenomena which first suggested the undulatory theory, 65-72
 - soap-bubbles and their colours, 65-73
 - Newton's rings, 73-79
 - his espousal of the emission theory, and the results of this espousal, 79, 80
 - transmitted light, 80
 - diffraction, 81, 92
 - origin of the notion of the attraction of gravitation, 96
 - polarity, how generated, 97
 - action of crystals upon, 101
 - refraction of, 110
 - elasticity and density, 111
 - double refraction, 112
 - chromatic phenomena produced by crystals in polarised, 124
 - the Nicol prism, 125
 - mechanism of, 129
 - vibrations, 129
 - composition and resolution of vibrations, 131
 - polarizer and analyzer, 131
 - recompounding the two systems of waves by the analyzer, 133
 - interference thus rendered possible, 134
 - chromatic phenomena produced by quartz, 142
 - magnetization of, 145
 - rings surrounding the axis of crystals, 146
 - colour and polarization of sky 150-60
 - range of vision incommensurate with range of radiation, 162
 - effect of thallene on the spectrum 165

LIG

- Light, fluorescence, 165
 — transparency, 171
 — the ultra-red rays, 174
 — part played by Nature by these rays, 178
 — conversion of heat-rays into light-rays, 179
 — identity of radiant heat and, 180
 — polarization of heat, 183
 — principles of spectrum analysis, 192
 — spectra of incandescent vapours, 193
 — Fraunhofer's lines, and Kirchhoff's explanation of them, 197
 — solar chemistry, 198-200
 — demonstration of analogy between sound and, 201, 202
 — Kirchhoff and his precursors, 204
 — rose-coloured solar prominences, 207
 — results obtained by various workers, 208
 — summary and conclusion, 209
 — measurement of the waves of, 247
 — polarised, the spectra of, 250
 Lignum Nephriticum, fluorescence of, 167
 Lloyd, Dr., on polarization of heat, 183, 212
 Lockyer, Mr., on the rose-coloured solar prominences, 208
 Lycopodium, diffraction effects caused by the spores of, 91

- M**AGNETIZATION of light, 145
 Malus, his discovery respecting reflected light through Iceland spar, 117
 — discovers the polarization of light by reflection, 211

NIC

- Masson, his essay on the bands of the induction spark, 205
 Melloni, on the polarization of heat, 184
 Metals, combustion of, 5, 6
 — spectrum analysis of, 193
 — spectrum bands proved by Bunsen and Kirchhoff to be characteristic of the vapour of, 195
 Mill, John Stuart, his scepticism regarding the undulatory theory, 152
 Miller, Dr., his drawings and descriptions of the spectra of various coloured flames, 204
 Morton, Professor, his discovery of thallene, 165
 Mother-of-pearl, colours of, 93

NATURE, a savage's interpretation of, 4

- New York, addresses at Social Meeting in, 229
 Newton, Sir Isaac, his experiments on the composition of solar light, 28
 — his spectrum, 28
 — dispersion, 28
 — arrives at the emission theory of light, 46
 — his objection to the conception of an ether espoused and defended by Huyghens and Euler, 59
 — his optical career, 73
 — his rings, 73-79
 — espouses the emission theory, 79
 — effects of this espousal, 80
 — his rings explained by the theory of 'fits,' 76
 — his idea of gravitation, 96
 — his errors, 211
 Nicol prism, the, 125

OCE

SEE

- O**CEAN, colour of the, 35
 Ørsted, discovers the deflection of a magnetic needle by an electric current, 178
 Optics, science of, 3
- P**ASTEUR referred to, 223
 Physical theories, origin of, 42-45
 Pigments, analysis of the action of, upon light, 34
 — mixture of, contrasted with mixture of lights, 37
 — Helmholtz reveals the cause of the green in the case of mixed blue and yellow pigments, 37
 — impurity of natural colours, 38
 Pitch of sound, 61
 Plücker, his drawings of spectra, 205
 Polariscopes, stained glass in the, 134, 135
 — unannealed glass in the, 139
 Polarity, notion of, how generated, 97
 — atomic, 98
 — structural arrangements due to, 100
 — polarization of light, 115
 — tested by tourmaline, 119
 — and by reflection and refraction, 121
 — depolarization, 123
 Polarization of light, 115
 — circular, 143
 — sky-light, 152, 158, 160
 — of artificial sky, 159
 — of radiant heat, 183
 Polarizer and analyzer, 131
 Poles of a magnet, 97
 Powell, Professor, on polarization of heat, 181
 Prism, the Nicol, 125

QUARTZ, chromatic phenomena produced by, 142

- R**ADIANT heat, 176
 — diathermancy, or perviousness to radiant heat, 176
 — conversion of heat-rays into light-rays, 177
 — formation of invisible heat-images, 183
 — polarization of, 183
 — double refraction, 185
 — magnetization of, 187
 Rainbow, Descartes' explanation of the, 24, 25
 Refraction, demonstration of, 15
 Refraction of light, 110
 — double, 112
 Reflection, partial and total, 17-20
 Respighi, results obtained by, 208
 Ritter, his discovery of the ultraviolet rays of the sun, 162
 Rømer, Olav, his observations of Jupiter's moons, 20
 — his determination of the velocity of light, 21
 Rubidium, discovery of, 195
 Rusting of iron, what it is, 5

- S**CHWEDT, his observations respecting diffraction, 91
 Science, growth of, 179, 206
 Schelling, his contempt for experimental knowledge, 14 *note*
 Scoresby, Dr., succeeds in exploding gunpowder by the sun's rays conveyed by large lenses of ice, 170
 Secchi, results obtained by, 208
 Seebeck, Thomas, discovers thermoelectricity, 179
 — discovers the polarization of light by tourmaline, 212

SEL

- Selenite, experiments with thick and thin plates of, 127
- Silver spectrum, analysis of, 193, 194
- Sky-light, colour and polarization of, 152, 157
- generation of artificial skies, 155
- Snell, Willebrord, his discovery, 15
- his law, 16, 24
- Soap-bubbles and their colours, 65, 66
- Sound, early notions of the ancients respecting, 52
- interference of waves of, 61
- pitch of, 61
- analogies of light and, 63
- demonstration of analogy between, and light, 201, 202
- Sonorous vibrations, action of, 137
- Spectrum analysis, principles of, 192
- Spectra of incandescent vapours, 193
- discontinuous, 194, 195
- of polarized light, 250
- Spectrum bands proved by Bunsen and Kirchhoff to be characteristic of the vapour, 195
- its capacity as an agent of discovery, 196
- analysis of the sun and stars, 196
- Spottiswoode, Mr. William, 126
- Stewart, Professor Balfour, 205
- Stokes, Professor, results of his examination of substances excited by the ultra-violet waves, 164
- his discovery of fluorescence, 165
- on fluorescence, 168
- nearly anticipates Kirchhoff's discovery, 201, 205
- Striated surfaces, colours of, 93
- Sulphate of quinine first noticed and described by Sir John Herschel, 168
- Sun, chemistry of the, 199
- Sun, rose-coloured solar prominences, 207

UND

- TALBOT, Mr., his experiment, 204
- Tartaric acid, irregular crystallization of, and its effects, 134
- Thallene, its effect on the spectrum, 165
- Thallium, spectrum analysis of, 193, 194
- discovery of, 196
- isolated in ingots by M. Lamy, 196
- Theory, relation of, to experience, 95
- Thermo-electric pile, 179
- Thermo-electricity, discovery of, 179
- Tombeline, Mont, inverted image of, 20
- Tourmaline, polarization of light by means of, 115
- Transmitted light, reason for, 80
- Transparency, remarks on, 170
- Tyndall, Professor, his remarks at Social Meeting in New York, 242
- ULTRA-VIOLET sun-rays, discovered by Ritter, 162
- — effects of, 163
- Ultra-red rays of the solar spectrum, 174
- — part played by the, 176
- Undulatory theory of light, bases of the, 48
- — Sir David Brewster's chief objection to the, 49
- — Young's foundation of the, 50
- — phenomena which first suggested the, 65, 72
- Undulatory theory of light, Mr. Mill's scepticism regarding the, 152
- — a demonstrated verity in the hands of Young, 213

VAS

VASSENIUS describes the rose-coloured solar prominences in 1733, 207

Vitellio, his skill and conscientiousness, 14

— his investigations respecting light, 210

Voltaic battery, use of, and its production of heat, 6, 7

WATER, crystallization of, 104, 249

— deportment of, considered and explained, 108, 109

Waves of water, 52

— length of a wave, 53

— interference of waves, 54-56

Wertheim, M., his instrument for the determination of strains and pressures by the colours of polarized light, 137

Wheatstone, Sir Charles, 166

— his analysis of the light of the electric spark, 205

Whirlpool Rapids, illustration of the principle of the interference of waves at the, 57

YOU

White, President, his remarks at Social Meeting in New York, 238

Willigen, Van der, his drawings of spectra, 205

Wollaston, Dr., 196

— discovers the rings of Iceland spar, 212

Woodbury, Mr., on the impurity of natural colours, 38

Wünsch, Christian Ernst, on the three simple colours in white lights, 41

— his experiments, 41

YOUNG, Dr. Thomas, his discovery of Egyptian hieroglyphics, 50; and the undulatory theory of light, 50

Young, Dr. Thomas, Helmholtz's estimate of him, 51

— ridiculed by Brongham in the 'Edinburgh Review,' 51

— generalizes Grimaldi's observation on light, 58

— photographs the ultra-violet rings of Newton, 163

JOHN TYNDALL'S WORKS.

Essays on the Floating Matter of the Air, in Relation to Putrefaction and Infection. 12mo, cloth, \$1.50.

On Forms of Water, in Clouds, Rivers, Ice, and Glaciers.
With 35 Illustrations. 12mo, cloth, \$1.50.

Heat as a Mode of Motion. New edition. 12mo, cloth, \$2.50.

On Sound: A Course of Eight Lectures delivered at the Royal Institution of Great Britain. Illustrated. 12mo. New edition. Cloth, \$2.00.

Fragments of Science for Unscientific People. 12mo. New revised and enlarged edition. Cloth, \$2.50.

Light and Electricity. 12mo, cloth, \$1.25.

Lessons in Electricity, 1875-'76. 12mo, cloth, \$1.00.

Hours of Exercise in the Alps. With Illustrations. 12mo, cloth, \$2.00.

Faraday as a Discoverer. A Memoir. 12mo, cloth, \$1.00.

Contributions to Molecular Physics in the Domain of Radiant Heat. \$5.00.

Six Lectures on Light. Delivered in America in 1872-'73. With an Appendix and numerous Illustrations. Cloth, \$1.50.

Farewell Banquet, given to Professor Tyndall, at Delmonico's, New York, February 4, 1873. Paper, 50 cents.

Address delivered before the British Association, assembled at Belfast. Revised, with Additions, by the author, since the Delivery. 12mo, paper, 50 cents.

Charles Darwin's Works.

Origin of Species by Means of Natural Selection, or the Preservation of Favored Races in the Struggle for Life. New and revised edition, with Additions. 12mo. Cloth, \$2.00.

Descent of Man, and Selection in Relation to Sex. With many Illustrations. A new edition. 12mo. Cloth, \$3.00.

Journal of Researches into the Natural History and Geology of the Countries visited during the Voyage of H. M. S. Beagle round the World. A new edition. 12mo. Cloth, \$2.00.

Emotional Expressions of Man and the Lower Animals. 12mo. Cloth, \$3.50.

The Variations of Animals and Plants under Domestication. With a Preface, by Professor ASA GRAY. 2 vols. Illustrated. Cloth, \$5.00.

Insectivorous Plants. 12mo. Cloth, \$2.00.

Movements and Habits of Climbing Plants. With Illustrations. 12mo. Cloth, \$1.25.

The Various Contrivances by which Orchids are Fertilized by Insects. Revised edition, with Illustrations. 12mo. Cloth, \$1.75.

The Effects of Cross and Self Fertilization in the Vegetable Kingdom. 12mo. Cloth, \$2.00.

Different Forms of Flowers on Plants of the same Species. With Illustrations. 12mo. Cloth, \$1.50.

The Power of Movement in Plants. By CHARLES DARWIN, LL. D., F. R. S., assisted by FRANCIS DARWIN. With Illustrations. 12mo. Cloth, \$2.00.

The Formation of Vegetable Mould, through the Action of Worms. With Observations on their Habits. With Illustrations. 12mo. Cloth, \$1.50.

For sale by all booksellers ; or sent by mail, post-paid, on receipt of price.

New York: D. APPLETON & CO., 1, 3, & 5 Bond Street.

Thomas H. Huxley's Works.

- Science and Culture, and other Essays.** 12mo.
Cloth, price, \$1.50.
- The Crayfish: An Introduction to the Study of Zoölogy.**
With 82 Illustrations. ("International Scientific Series.")
12mo. Cloth, \$1.75.
- Science Primers: Introductory.** 18mo. Flexible Cloth,
45 cents.
- Man's Place in Nature.** 12mo. Cloth, \$1.25.
- On the Origin of Species.** 12mo. Cloth, \$1.00.
- More Criticisms on Darwin, and Administrative
Nihilism.** 12mo. Limp cloth, 50 cents.
- Manual of the Anatomy of Vertebrated Animals.**
Illustrated. 12mo. Cloth, \$2.50.
- Manual of the Anatomy of Invertebrated Animals.**
12mo. \$2.50.
- Lay Sermons, Addresses, and Reviews.** 12mo.
Cloth, \$1.75.
- Critiques and Addresses.** 12mo. Cloth, \$1.50.
- American Addresses; with a Lecture on the Study of
Biology.** 12mo. Cloth, \$1.25.
- Physiography: An Introduction to the Study of Nature.**
With Illustrations and Colored Plates. 12mo. Cloth, \$2.50.
- Huxley and Youmans's Elements of Physiology
and Hygiene.** By T. H. HUXLEY and W. J. YOUMANS.
12mo. \$1.50.
-

For sale by all booksellers; or sent by mail, post-paid, on receipt of price.

D. APPLETON & CO., Publishers,

1. 3. & 5 BOND STREET, NEW YORK.

ERNST HAECKEL'S WORKS.

THE HISTORY OF CREATION;

Or, THE DEVELOPMENT OF THE EARTH AND ITS INHABITANTS BY THE ACTION OF NATURAL CAUSES. A Popular Exposition of the Doctrine of Evolution in general, and of that of Darwin, Goethe, and Lamarck in particular. From the German of ERNST HAECKEL, Professor in the University of Jena. The translation revised by Professor E. Ray Lankester, M. A., F. R. S., Fellow of Exeter College, Oxford. Illustrated with Lithographic Plates. In two vols., 12mo. Cloth, \$5.00.

THE EVOLUTION OF MAN.

A Popular Exposition of the Principal Points of Human Ontogeny and Phylogeny. From the German of ERNST HAECKEL, Professor in the University of Jena, author of "The History of Creation," etc. With numerous Illustrations. In two vols., 12mo. Cloth. Price, \$5.00.

"In this excellent translation of Professor Haeckel's work, the English reader has access to the latest doctrines of the Continental school of evolution, in its application to the history of man. It is in Germany, beyond any other European country, that the impulse given by Darwin twenty years ago to the theory of evolution has influenced the whole tenor of philosophical opinion. There may be, and are, differences in the degree to which the doctrine may be held capable of extension into the domain of mind and morals; but there is no denying, in scientific circles at least, that as regards the physical history of organic nature much has been done toward making good a continuous scheme of being."—*London Saturday Review*.

FREEDOM IN SCIENCE AND TEACHING.

From the German of ERNST HAECKEL. With a Prefatory Note by T. H. Huxley, F. R. S. 12mo. \$1.00.

For sale by all booksellers; or sent by mail, post-paid, on receipt of price.

New York: D. APPLETON & CO., 1, 3, & 5 Bond Street.

Works of Alexander Bain, LL.D.,

PROFESSOR OF LOGIC IN THE UNIVERSITY OF ABERDEEN.

I.

LOGIC,

DEDUCTIVE AND INDUCTIVE. New revised edition. 12mo.
Cloth, \$2.00.

II.

MENTAL SCIENCE:

A Compendium of Psychology and History of Philosophy. 12mo.
Cloth, \$1.50.

III.

MORAL SCIENCE:

A Compendium of Ethics. 12mo. Cloth, \$1.50.

IV.

MIND AND BODY.

The Theories of their Relations. (Forming a volume of "The
International Scientific Series.") 12mo. Cloth, \$1.50.

V.

THE SENSES AND THE INTELLECT.

New edition. 8vo. Cloth, \$5.00.

VI.

THE EMOTIONS AND THE WILL.

Third edition. 8vo. Cloth, \$5.00.

VII.

EDUCATION AS A SCIENCE.

(Forming a volume of "The International Scientific Series.")
12mo. Cloth, \$1.75.

"The work should become a text-book for teachers, not to be followed ser-
vilely or thoughtlessly, but used for its suggestiveness."—*Boston Gazette*.

"Professor Bain is not a novice in this field. His work is admirable in many
respects for teacher, parent, and pupil."—*Philadelphia North American*.

"A work of great value to all teachers who study it intelligently."—*Boston
Advertiser*.

D. APPLETON & CO., Publishers,

1. 3. & 5 BOND STREET, NEW YORK

WORKS OF H. ALLEYNE NICHOLSON, M. D.

I.

Text-Book of Zoology, for Schools and Colleges. 12mo. Half roan, \$1.50.

II.

Manual of Zoology, for the Use of Students, with a General Introduction to the Principles of Zoölogy. Second edition. Revised and enlarged, with 243 Woodcuts. 12mo. Cloth, \$2.50.

III.

Text-Book of Geology, for Schools and Colleges. 12mo. Half roan, \$1.30.

IV.

Introduction to the Study of Biology. Illustrated. 12mo. Cloth, 65 cents.

V.

The Ancient Life - History of the Earth. A Comprehensive Outline of the Principles and Leading Facts of Palæontological Science. 12mo. Cloth, \$2.00.

The Quarterly Journal of Science.

"A work by a master in the science who understands the significance of every phenomenon which he records, and knows how to make it reveal its lessons. As regards its value there can scarcely exist two opinions. As a text-book of the historical phase of palæontology it will be indispensable to students, whether specially pursuing geology or biology; and without it no man who aspires even to an outline knowledge of natural science can deem his library complete."

Athenæum.

"The Professor of Natural History in the University of St. Andrews has, by his previous works on zoölogy and palæontology, so fully established his claim to be an exact thinker and a close reasoner, that scarcely any recommendation of ours can add to the interest with which all students in natural history will receive the present volume. It is, as its second title expresses it, a comprehensive outline of the principles and leading facts of palæontological science. Numerous woodcut illustrations very delicately executed, a copious glossary, and an admirable index, add much to the value of this volume."

D. APPLETON & CO., Publishers, 1, 3, & 5 Bond Street, New York.

WORKS OF SIR JOHN LUBBOCK, BART.

THE ORIGIN OF CIVILIZATION AND THE PRIMITIVE CONDITION OF MAN, Men- tal and Social Condition of Savages.

Fourth edition, with numerous Additions. With Illustrations. 8vo.
Cloth, \$5.00.

"The first edition of this work was published in the year 1870. The work has been twice revised for the press in the interval, and now appears in its fourth edition enlarged to the extent of nearly two hundred pages, including a full index."

"This interesting work—for it is intensely so in its aim, scope, and the ability of its author—treats of what the scientists denominate *anthropology*, or the natural history of the human species; the complete science of man, body and soul, including sex, temperament, race, civilization, etc."—*Providence Press*.

PREHISTORIC TIMES, as illustrated by An- cient Remains and the Manners and Cus- toms of Modern Savages.

Illustrated. Entirely new revised edition. 8vo. Cloth, \$5.00.

The book ranks among the noblest works of the interesting and important class to which it belongs. As a *résumé* of our present knowledge of prehistoric man, it leaves nothing to be desired. It is not only a good book of reference, but the best on the subject.

"This is, perhaps, the best summary of evidence now in our possession concerning the general character of prehistoric times. The Bronze Age, The Stone Age, The Tumuli, The Lake Inhabitants of Switzerland, The Shell Mounds, The Cave Man, and The Antiquity of Man, are the titles of the most important chapters."—*Dr. C. K. Adams's Manual of Historical Literature*.

ANTS, BEES, AND WASPS.

A Record of Observations on the Habits of the Social Hymenoptera.
With Colored Plates. 12mo. Cloth, \$2.00.

"This volume contains the record of various experiments made with ants, bees, and wasps during the last ten years, with a view to test their mental condition and powers of sense. The principal point in which Sir John's mode of experiment differs from those of Huber, Forel, McCook, and others, is that he has carefully watched and marked particular insects, and has had their nests under observation for long periods—one of his ants' nests having been under constant inspection ever since 1874. His observations are made principally upon ants, because they show more power and flexibility of mind; and the value of his studies is that they belong to the department of original research."

"We have no hesitation in saying that the author has presented us with the most valuable series of observations on a special subject that has ever been produced, charmingly written, full of logical deductions, and, when we consider his multitudinous engagements, a remarkable illustration of economy of time. As a contribution to insect psychology, it will be long before this book finds a parallel."—*London Athenæum*.

New York: D. APPLETON & CO., 1, 3, & 5 Bond Street.

DARWINISM STATED BY DARWIN HIMSELF: CHARACTERISTIC PASSAGES FROM THE WRITINGS OF CHARLES DARWIN.

SELECTED AND ARRANGED BY PROFESSOR NATHAN SHEPPARD.

12mo. Cloth, \$1.50.

By means of a systematic selection of passages from the various writings of Charles Darwin, the reader of this volume is enabled to grasp readily the scope of Darwin's argument as to the origin and evolution of species.

"The general reader may well be thankful for this compilation, and the greatest physicist in the world is, after all, nothing more than a general reader in paleontology and the theory of groups."—*Science*.

"He has succeeded far better than many persons familiar with Darwin's works, would have thought possible. The book is, indeed, in all respects a notable example of clever and conscientious editing, for which the compiler is entitled to high praise."—*New York Commercial Advertiser*.

"Mr. Sheppard must be credited with exemplifying the spirit of impartial truth-seeking which inspired Darwin himself. From these condensed results of the hard labor of selection, excision, and arrangement applied to more than a dozen volumes it is impossible to draw any inference respecting the philosophical opinions of the compiler. With the exception of a brief preface there is not a word of comment, nor is there the faintest indication of an attempt to infuse into Darwin's text a meaning not patent there, by unwarranted sub-titles or headlines, by shrewd omission, unfair emphasis, or artful collocation. Mr. Sheppard has nowhere swerved from his purpose of showing in a clear, connected, and very compendious form, not what Darwin may have meant or has been charged with meaning, but what he actually said."—*The Sun*.

"That there is coming a time when Darwin's own Darwinism will be accepted as the world's every-day belief, from pulpit to hut, nobody who can read the signs of the times will deny. The editor quotes in the beginning some fourteen eminent religious authorities on the subject. Some of them accept his teachings outright, and find nothing in them opposed to religion. All speak of him in the highest terms. Darwinism, as popularly understood, however, is very different indeed from the real teachings of this marvelous man. Professor Sheppard has done well to here place in popular form the main points of the theory, in extracts from the author's own writings."—*The World*.

"This compilation has a twofold use, of which the one is to form an introduction to the study of Darwin's works, the other to serve as a memorandum for those who have read them. It is of uniform size and binding with the works of Darwin, and forms a useful digest, and in some sort an index of the twelve volumes by the great naturalist."—*The New York Times*.

"Mr. Sheppard's plan is a good one. He does not condense or translate the author's language. He gives us the language itself. It was a difficult task to perform. It required literary skill and good judgment. Mr. Sheppard has both, and by judicious selection and management he has given us the substance of Darwin's teaching."—*The New York Herald*.

"Those who are desirous of obtaining a general idea of Darwin's line of argument and research, and have not the means to obtain, or the time to read the numerous volumes in which they are fully stated, will find in this work an authentic and inexpensive summary of his scientific views, expressed in his own language."—*The Observer*.

New York: D. APPLETON & CO., 1, 3, & 5 Bond Street.



ET

—

RY

—



MAY 17 1983

**PLEASE DO NOT REMOVE
CARDS OR SLIPS FROM THIS POCKET**

UNIVERSITY OF TORONTO LIBRARY

U. T. L.
100 St. George St.

