



3 1761 06705940 2

628.7

UNIVERSITY OF TORONTO
DEPARTMENT OF CIVIL ENGINEERING
Municipal and Structural

CANADIAN
SOCIETY OF CIVIL
ENGINEERS



TORONTO
BRANCH

UNIVERSITY OF TORONTO
DEPARTMENT OF CIVIL ENGINEERING
TORONTO, CANADA
ENGINEERING

No.

UNIVERSITY OF TORONTO
DEPARTMENT OF CIVIL ENGINEERING
Municipal and Structural



Digitized by the Internet Archive
in 2007 with funding from
Microsoft Corporation

SMALL WATER SUPPLIES

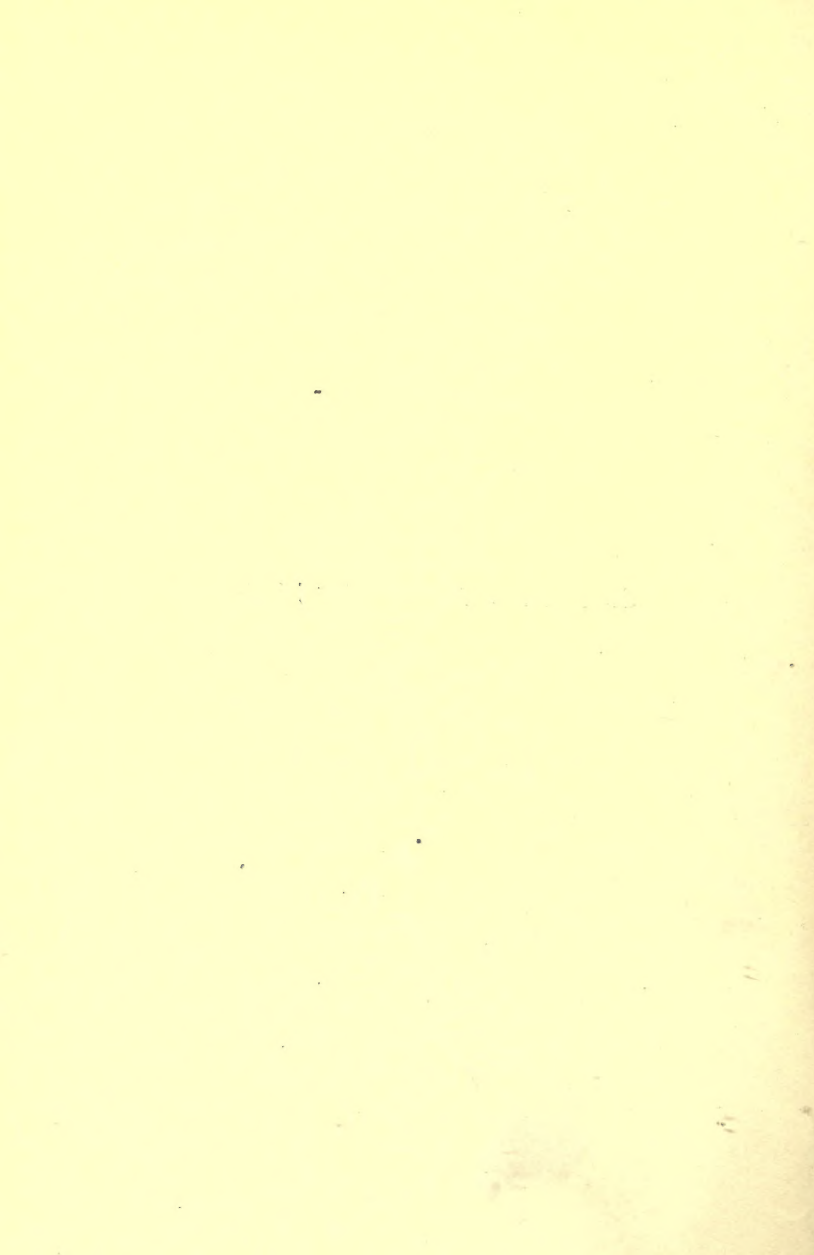

SMALL WATER SUPPLIES

BEING A PRACTICAL TREATISE ON THE METHODS
OF COLLECTING, STORING AND CONVEYING WATER
FOR DOMESTIC USE IN LARGE COUNTRY MAN-
SIONS, ESTATES AND SMALL VILLAGES AND FARMS

For the use of Engineers, Estate Agents,
and Owners of Country Property

BY

F. NOËL TAYLOR, C.E.

MEMBER OF THE INSTITUTE OF MUNICIPAL ENGINEERS
AUTHOR OF "A MANUAL OF CIVIL ENGINEERING PRACTICE"

WITH 126 ILLUSTRATIONS FROM
DRAWINGS AND PHOTOGRAPHS

LONDON

B. T. BATSFORD, 94 HIGH HOLBORN
NEW YORK

D. VAN NOSTRAND CO., 25 PARK PLACE

UNIVERSITY OF TORONTO
DEPARTMENT OF CIVIL ENGINEERING
Municipal and Structural

LIBRARY

758061

UNIVERSITY OF TORONTO

PREFACE

IN the following treatise the subject of water supplies to country houses and estates is discussed. Although there are at the present time numerous excellent treatises on the subject of "waterworks," yet these books almost without exception aim at discussing works of large magnitude such as are carried out every year at home and abroad for supplying large towns with water for domestic purposes, and to a lesser extent, water for power purposes. This class of work demands high engineering skill for its proper carrying out, and this skill is only obtained after years of devotion to and experience on similar works. Moreover, the subject of quite small supplies, which are essentially different than the larger ones, receive little or no consideration. It was this reason, together with the fact that the writer in his younger days felt the want of some sort of a guide to assist him in carrying out successfully several of the small water supply schemes on which he has been engaged from time to time, that induced him to put together in concise form a few of the most important details of this work. It is quite impossible to point out every conceivable form of difficulty which besets the engineer in work of this kind, or in fact any kind, and there are so many subjects which bear directly on that upon which this

book treats that it would be equally impossible to treat them all exhaustively. For instance, the important subject of hydraulics is a very wide one, and is freely discussed in separate books. The object of the writer, however, has been to go into each subject as far as it will under any ordinary circumstances concern the designer of small waterworks, so that the book, although it is hoped that the engineering profession will find it welcome, will permit of those whose experience in engineer's work is somewhat limited being able to form a good idea of how such work may be successfully done. Again, the chapter on storage treats of different kinds of dams and walls, and points out how each different variety may be economically designed, but no attempt is made to show WHY such constructions are used, because this subject would belong to books on engineering, design, and mechanics. The method of applying each theory is, however, fully explained to the best of the writer's ability in a practical manner, so that although the knowledge of the "why and wherefore" which should be in the possession of a fully qualified engineer is an advantage, yet those who have not this knowledge may with reasonable forethought follow the text.

Regarding the question of pumps, pump design belongs to the mechanical engineer, and although the purchaser rarely designs his pump, yet the chapter on this subject aims at pointing out the different circumstances under which pumping will be required, and advising the reader what class of engine is the best in *every* way for the particular purpose and then to describe briefly that engine. Of

course first-class firms will generally give the best of advice. At the same time, pump makers are only human, dividends have to be paid, and consequently the unwary run the risk of providing extra profit at their own expense.

Finally, it may be said that in the building of tanks and reservoirs a knowledge of building materials is essential and also the methods of using them. Information on this score belongs to books on materials and building construction. The subject of reinforced concrete is freely discussed, examples of practical works in this connexion are given, but for further information on a wide subject the reader must look elsewhere. The practice which the writer advises his readers to follow when dealing with reinforced concrete construction, is to make up his mind what form of tank or dam, etc., he will erect, and then submit this to a firm who manufacture the reinforcement. They will only be too pleased to advise how THEIR special stuff may be placed to its best advantage under the particular circumstances in question. It is hoped that many of the younger members of the profession will find the book useful, and that when the circumstances of any likely case have been fully considered the information as to the best way to proceed with the work will be readily found in the following pages.

F. NOËL TAYLOR.

12 WILLIAM STREET,
DUBLIN, *December, 1911.*

CONTENTS

	PAGE
PREFACE	V
CHAP.	
I. PROPERTIES OF WATER AND SOURCES OF SUPPLY	I
Impurities in Water — Pollution of Rivers— Dangers of Well-water.	
II. WELLS AND WELL SINKING	28
III. FLOW OF WATER IN CHANNELS AND PIPES	47
IV. PUMPING WATERS	66
V. STORAGE AND DISTRIBUTION	111
APPENDIX I. NOISES IN WATER PIPES AND THEIR CAUSES	159
,, II. FURTHER NOTES ON ABYSSIAN TUBE PIPES	161
INDEX	163

CHAPTER I

PROPERTIES OF WATER AND SOURCES OF SUPPLY

IMPURITIES IN WATER.

PURE water is as essential for our well-being as pure air. Therefore it would seem the most important duty of those who seek to obtain water for a purely domestic purpose to investigate first of all the purity of that water before any further time or money is put into the project. The services of an analyst are also very desirable, because he should be able to give better advice on the question of purity than the engineer whose business is to bring the supply to the consumer in ways which are going to be shown. A word may be said on the taking of samples to submit to the analyst, which is usually done by the engineer when he has finally decided that a certain supply is the most convenient to the situation, because there is a right and a wrong way of doing this. In the first place special bottles must be used, known as *Winchester Quart* bottles. They must have glass stoppers. When taking the sample they must be well rinsed out with the actual water in question. When filled the stopper must be immediately sealed and num-

bered, the number being referred to in the advice note with such information as date, time, place, temperature of water and atmosphere, and the name of the collector of the sample, etc.

A first-class chemist will not usually consider any samples which are not collected as advised. With river water single samples are insufficient; a series of samples must be collected over a considerable period, bearing in mind the condition under which they were taken, because flood waters and waters flowing after a long drought are often very different from the analyst's point of view, besides such items as agricultural operations, decay of plant life, etc., which often have a marked effect.

When a bacterial examination is to be made the bottle should be filled with hot water raised gradually to boiling-point. The water is then emptied and the bottle kept for half an hour in boiling water, the stopper being kept in the bottle.

Water has a great power as a solvent; in fact it has a greater combining tendency than any other compound, although as an oxide it is indifferent. It is very susceptible to pollution and will dissolve gases present in the atmosphere, and in towns bring down fine particles of carbon and dust from the air when falling as rain. In fact there are so many ways in which water apparently pure can be polluted, that the greatest care must be exercised in selecting any particular source of supply for domestic and internal use. For country houses river water is sometimes very handy. While the analyst is looking into the matter it is the duty of the engineer to examine the stream upwards for outward and visible

signs of pollution. These in the country usually consist of other houses along its banks which may discharge sewage, or farmyard refuse into it in a crude or only partially purified state. In other places manufactories may exist with trades' waste flowing into the river. There may be boat traffic on the river from which refuse will be sure to be pitched into it; surface and road drains, and ditches may fall into it, delivering polluted waters. Even sewage works may exist along its banks; in fact a hundred and one things may be present to render its use for drinking purposes a grave risk; when chemically examined the elements composing a water are revealed. Metals, for instance lead and copper, in and above certain quantities render the supply unfit. These are the inorganic substances and are easy of determination, but when we pass on to the organic matter the problem assumes a much more complex and uncertain problem to deal with, and in fact is far the most important question. Good water always contains oxygen solution, and its absence from water denotes pollution; to oxygen and carbonic acid the flavour of water is chiefly due, since distilled water is insipid and undesirable for drinking purposes. Ammonia and nitrogen, except as traces, are to be regarded with suspicion, as they generally denote some sort of organic pollution or other, as also do in a somewhat lesser degree sulphur¹ and chlorine. Mineral impregnations gained by the water during its passage along the natural strata, are not usually detrimental to a domestic supply, although for manufacturing purposes they are often very in-

¹ This does not apply to sulphurous medicinal springs.

jurious and demand expensive treatment in their extermination. As stated, the nitrogenous compounds are the most dangerous and the determination of their quantity is of paramount importance. They are generally present in the form of ammonia, albuminoid ammonia, nitrates and nitrites. The second named is the most dangerous. It bespeaks certain nitrogenous matter in an undecomposed state in solution, and must not be present in any supply in quantities over *one in ten million*.

Again, all waters will contain that constituent of common salt known as *Chlorine*. It may be regarded as the result of animal pollution. The estimation of what constitutes an abnormal quantity of chlorine is, however, a difficult matter. Again, organic impurities, although not perhaps likely to be directly dangerous to health, may be conducive to the development of organized growths with water. Again, a bacterial examination of a supply is often useful, especially if it is in any way suspected of being harmful. By this method the number and varieties of well-known microbes contained in the water are revealed. Again, we have what are known to the public as hard and soft waters. Spring water, well water, and water from streams flowing in limestone districts are liable to be hard. That is to say, although usually free from suspended matter, they contain dissolved mineral matter in considerable quantities, consisting usually of carbonates of lime, magnesia, calcium, manganese and iron. These are held in solution by an excess of CO_2 . In a lesser degree we have calcium sulphates, and chloride and magnesium sulphate or chloride. The presence

of CaCl_2 , CaSO_4 , MgCl_2 , MgSO_4 are not held in solution by CO_2 . Lime and magnesia are the most important, and exist in well water by reason of the CO_2 , which that class of water is known to possess. They would not exist in solution in water containing no CO_2 . Being held in solution by the CO_2 they are known to constitute what is known as *temporary* hardness, but calcium sulphate and magnesium sulphate constitute *permanent* hardness, being themselves soluble and difficult of eradication. For a domestic supply this hardness in water is not usually of any disadvantage, except that it entails a waste of soap, and renders its use in some degree unpleasant. Otherwise, from a dietetic point of view, medical men approve of it, especially for children, although to elderly people it may induce rheumatism. Hence we shall not discuss methods of softening which are principally applicable to water for steam users and other traders. Boiling water removes the temporary hardness; very soft water, on the other hand, will contain much CO_2 and dissolve lead pipes. A water which is fresh, limpid, and free from smell, and which will boil vegetables without discolouring them, and dissolve soap without leaving curds, will generally satisfy most requirements. The following tests may be applied by the engineer and are very useful.

1. To test for the hardness of water, dissolve pure white soap in alcohol and add the solution to hard water. The result is a milky-white solution.

2. To test for the presence of copper, add some sal ammoniac and iron filings to the water, and a blue colour will result.

3. To test for the presence of carbonic acid, add lime water (liquor calcis) to the supply, and a milky solution will result. The lime water may be made from slaked lime and water, the solution containing half a grain of oxide of lime (CaO) to the ounce.

4. To find out if sulphur is present, allow some mercury to stand in the water, when its presence will cause a dark surface to appear on the otherwise silvery mercury.

5. Lime in solution will cause a milky precipitate on the addition of oxalic acid.

6. Sulphate of lime. The addition of barium chloride causes a white precipitate.

7. The presence of alkalies (which will neutralize any acid present) will turn litmus paper blue if it has been reddened by dipping in an acid solution, such as vinegar, beforehand.

8. To test for the presence of iron, add a solution of potassium ferrocyanide to the water, which will cause the natural blue colour of the ferrocyanide to disappear.

9. The presence of lead will cause a black discolorization when ammonium sulphide solution is added to the water.

10. The presence of magnesia (which is of more importance in boiler-feed water than domestic supplies) is proved on boiling the water and adding ammonium carbonate and phosphate of sodium. The result will be a white precipitate of magnesia. It may here be stated that too much hardness in water, besides being a commercial disadvantage, is also very unpopular amongst domestic users. The principal cause is the presence of bicarbonate of lime. It is

removed more or less successfully by adding lime in solution. This will combine with the CO_2 and become chalk, which will settle.

For those engineers who have sufficient quantity of work in connexion with water supplies to warrant the outlay, a water tester is a very useful asset. The one which has been brought under the writer's notice as being especially useful in this direction, is the *Dionic* water tester, an invention of Messrs. Digby & Biggs, made by Messrs. Evershed & Vignoles. The principle upon which the apparatus acts is based

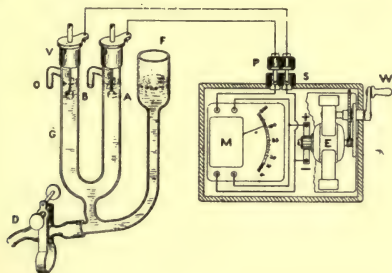

FIG. 1.

on the fact that the conductivity of pure water containing any electrolyte substances in solution is due almost entirely to the dissolved substances, and only to a very small extent to the water itself. This theory is established by Kohlrausch. The apparatus is described by the makers as follows.

The complete apparatus is shown in fig. 1, where G is a bent glass tube to contain the water under test, and the A and B are the electrodes for passing the electric current through the water. The electrodes are connected by wires to a direct-reading conductivity meter M, and a continuous-current

hand-driven dynamo E ; so that by turning the handle W of the dynamo, a current traverses the meter and the water in the conductivity tube G. The pointer of the meter is deflected, and comes to rest at some point upon the scale which directly indicates the conductivity of the water in the tube. The test is completed as soon as the pointer has come to rest, that is to say, in two or three seconds.

The tube G is made long enough, and the electrodes are given sufficient surface, to make the electric resistance in the paths of the current-path immediately surrounding the electrodes negligibly small, compared with that of the length of water in the tube. Hence gas bubbles may accumulate on the electrodes without making any observable difference in the measured conductivity. Moreover, gas bubbles liberated from the electrodes rise upwards and escape freely at the upper ends of the tube ; they can never diminish the conductivity by travelling downwards into the path of the electric current. The electrodes are short, hollow cylinders of platinum, so that they present a large surface, from every part of which gas bubbles are free to escape upwards.

Water derived from springs or wells in the chalk is inevitably a hard water. Where there is no sewage pollution the conductivity is an accurate measure of the hardness, and the new method takes the place of the "soap test," with all the advantages of rapidity, precision and simplicity. The hardness may be due either to carbonate of lime or carbonate of magnesia, or both ; and if it is necessary to discriminate, a chemical analysis must be made once for all. After that, periodic tests of conductivity

provide all the information required by a steam user. They indicate and measure any changes in hardness, and the corresponding alterations are easily made in the softening process or in the anti-fouling composition used in the boilers.

The measure of hardness in grains per gallon may be deduced from the conductivity by means of the curve given by the makers which shows the relation between quantity of chalk in solution and conductivity.

POLLUTION OF RIVERS.

The Dionic Tester can be usefully applied in cases of suspected sewage pollution in rivers. If two tests of the water are made, one above the outfall and the other below, the presence of sewage effluent will be immediately detected by the increased conductivity of the water below the outfall. The method has the advantage that an inspector can easily carry the apparatus with him and make his tests on the spot.

It will be concluded then that spring water is superior to river water for potable¹ purposes. In the geological strata through which it naturally has to pass it undergoes a high degree of filtration, usually unattainable by artificial means. It is bright and sparkling and contains certain natural gases which render it very palatable; these as desirable properties, however, are no indication of purity in themselves; surface flow often has the means of reducing impurities (organic and inorganic) in water

¹ The term *potable* in this book is used to denote water which will be used for drinking and cooking purposes and making up liquids for internal use.

to a harmless state, by oxidizing the organic matter and allowing deposition of part of the inorganic, and as stated allowing the escape of excessive volumes of CO_2 . Again, although a clear water supply is very desirable, it does not necessarily say that *turbid* waters are not fit for use after the turbidity has had time to settle, the settlement meanwhile having the effect of carrying down other forms of impurity whose specific gravity would not otherwise allow of their precipitation. It must, however, be made certain that the turbidity is pure clay, loam, or sand, as the case may be, and not the result of foul slime found in back waters, stagnant pools, etc., which are usually the breeding grounds of organisms of a very low state. Opposed to turbidity, which may not be an indication of impurity, is *opacity* in water, and it has been shown to indicate serious pollutions. No satisfactory explanation is offered by textbooks regarding this opacity; it suffices to say such water is to be regarded with much suspicion. The writer recalls a case of noticing this in the public supply of a town in the north of England,¹ but he said nothing and avoided the water. A few months later when cleaning the reservoir a human body was found in a very decomposed state lying over the bottom draw-off pipe. Water which is palatable is generally found on examination to be pure, although unpalatable water may be of very excellent quality. The writer does not consider the Vartry supply to Dublin at all good for drinking, yet it is considered one of the best in the world. Again, although not often noticeable, water may have an objectionable odour to those

¹ In deference to the authorities the name of the town is withheld.

with a specially acute sense of smell. This usually indicates the presence of H_2S , which is not desirable. It may, however, merely indicate stale or putrid water. It is not proposed to go into the methods whereby water is analysed. This is the business of a specialist whose services under most circumstances should be requisitioned by the engineer. The report when received should state clearly—

- | | | |
|------------------------------|---|-----------------------|
| (a) Total solids | } | in parts per million. |
| (b) Degree of total hardness | | |
| (c) Organic carbon | | |
| (d) Organic nitrogen | | |
| (e) Ammonia | | |
| (f) Nitrites and nitrates | | |
| (g) Chlorine | | |

No determination is usually made of the quantity of each constituent of saline matters either dissolved or suspended, except in cases where lead or arsenic may be suspected, nor is any notice usually taken of dissolved gases. The term "previous animal or sewage contamination" may be observed in a report. Its quantity is based on the ammonia and nitrates which as stated are usually supposed to bespeak sewage pollution. By this expression is represented the supposed original contamination per 1,000,000 parts and is reckoned up as follows. Let x = the ammonia and y the nitrates, while z is a constant employed, value .320. Then the amount of contamination per million parts is equal to

$$A = 10 (x + y - z) \dots \dots \dots (1)$$

Mention has been made of the effect of some waters on lead pipes which is very important, and waters of this kind usually are so destructive on iron that in

houses the hot-water boilers and cylinders have to be of copper instead of iron. This is the case with the Dublin water supply, users of which never install iron boilers or cylinders, and all supply piping which would otherwise be of lead has to be of a special alloy of lead and tin.¹ The water also is very destructive to street mains. This property of water of acting on lead and iron is generally attributed to small quantities of peat in it. Water holding CO_2 in solution, if free from oxygen, soon acts as an acid and rapidly attacks iron. The minute quantities of peaty matter in water undergo after a time a slow fermentation, which gives rise to an increased volume of CO_2 above the normal and to nitric acid. The introduction of soda into water of this sort has the effect of neutralizing the acidity, also about 3 grains of lime per gallon would have the same result. Crushed limestone in filter beds will also be of service, while stone filtration has been found to be of benefit provided it was slow. Further information on the subject will be found in a paper by Mr. Kaye-Parry, M.I.C.E., read before the Institute of Civil Engineers in Ireland, Vol. XXXV, 1909.

Having thus reviewed the properties of water, the sources of supply may be looked into.

The one which would appeal to the ordinary person first would be rain water. Country houses usually have a large roof surface. Smoke does not generally exist in the atmosphere, hence in most establishments of this kind we find rain-water butts. They are useful where the supply is limited, but it is

¹ Sir Charles Cameron, analyst to the city of Dublin, recommends for use in that city alloy pipe composed of $96\frac{1}{2}$ parts of lead and $3\frac{1}{2}$ of tin.

very much better to collect all this water into a tank and treat it properly. This will be treated in the chapter on storage. At the same time rain water is not palatable.

The second method of supply is that from rivers, the purity of which must be ascertained as advised before. Provided then that it is pronounced pure, we may see how it can be collected. Most towns are supplied from rivers, by impounding the water they bring down at the upper reaches where there are more or less mountain streams free from pollution. A river so far as it concerns water supply is formed by the rainfall of the district, preserving the level of the saturation surface above the natural hollow that forms its bed, and the erosion due to scour of the water therein; hence it will be observed that water will reach a river in different ways, viz., by surface flow and rain, percolation of land water and the natural tributaries of the river. On the whole the quality of river water for small domestic supplies is very much inferior to well water, being charged with animal, vegetable, and mineral impurities, and the size of the scheme does not usually warrant the laying down of expensive plant for its purification. The theory put forward that rivers during their course have a self-purifying property has been proved (so far as short rivers in Britain are concerned) to be a fallacy, even over a considerable series of falls, although this action will allow of the escape of CO_2 . Shallow well water is also usually of a quality much the same as river water, which is intercepted by these wells on its way along the saturation surface towards the rivers, but of course the pollution of the

river will not affect the water from the shallow well, provided this well is not so near the river as to allow of a percolation therefrom, which might be the case if excessive pumping of that well was going on. In fact the water is fairly good except in periods of long continued drought, when the water is very liable to contamination from surface drainage. To avoid this such wells are lined down to a point below the lowest level of the saturation surface. In passing it may be well to say exactly what the saturation surface is, as frequent use has been made of this term. Water falling on the earth seeks by the action of gravity lower levels, always along lines offering the least resistance. Through soil it is vertical, but at great depths it meets the natural body of subterranean water. Its path downwards is here checked and deflected at an angle, steep in compact rocks and flat in permeable rock and gravel; where these hydraulic laws cause the waters to have a definite surface slope there is the *surface of saturation*. A plane generally inclined towards the sea; over compact rocks, this surface is not very far below the surface of the ground. In fact it may at times be above it, and we have *water-logged* ground; or again the water may issue in the form of a hillside rivulet or rill, and the water so obtained is not always very good for domestic supply—except lias formation, where the water has only been able to penetrate a short distance vertically into the sub-soil and superficial strata.

So much then for river water. However important the question may be to town supplies, for domestic supplies river water takes a back place. Later it will be described how it may be obtained

and stored, but in the meantime it is necessary to pass on to the much more important question of well water and spring water. We have seen that of the rainfall part of it goes into the rivers. Some also evaporates in quantities which concern the engineer of large waterworks. A small quantity is absorbed by plant life, especially in early summer, while a large portion sinks through the soil and goes to form the great body of subterranean water which has been referred to, and from which our springs derive their supply. The proportion of the rainfall yielded by springs has attracted the attention of waterworks engineers for some time, a quantity varying with the geological



FIG. 2.

structure, clay being very impermeable and gravel permeable, the latter being conducive to the formation of springs, as is also a level tract of country in preference to a hilly district. First of all we have surface springs, where a tract of gravel of the shape of a flat dome lies on top of a bed of clay; all along the lower ridge of the gravel, where the clay comes to the surface (or outcrops), springs may be capable of formation owing to the water being prevented from passing through the clay. The idea is shown by fig. 2, and the basin-shaped mass of gravel lying on the clay will always be in a state of saturation. This is a very commonly occurring instance of a spring, but the water is not of as good a quality as that obtained from deep wells. Again, a fault in the

pervious stratum lying over a bed of clay will cause a spring, for instance in fig. 3. The underground water may be tapped at the fault. Again, take the case of fig. 4, which shows clearly the beds of permeable and impermeable strata in a state which often occurs in practice. Springs will issue at the points

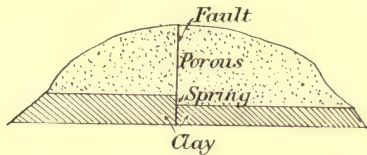

FIG. 3.

shown along the line of water level. It will also be seen that if a well is sunk at certain points a flow of water will result at the surface, while in others pumping will be required. The first instance constitutes an artesian well. In the foregoing cases we have assumed the saturation surface to be level. This is by no means always the case, especially where there is a river in the district. It will then be in-

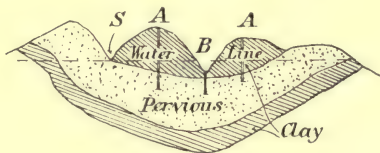

FIG. 4.

clined towards the river, and will be along a line joining the mean water level of that river and the top of the nearest outcrop of clay as shown by fig. 5. It must not be assumed, however, that the surface of saturation will be invariably a straight line. In fact in most cases it is depressed, while in extreme

cases of wet weather it may be in the form of a convex curve, the convexity being towards the surface, causing what are known as *intermittent* springs. In carboniferous limestone, which may be regarded as a permeous rock, boulders of clay and unpermeable strata are found. This will also give rise to a spring, because these boulders, occurring in fault in the limestone, constitute a barrage across the natural path of the subterranean water, which immediately rises up the side of the barrage and so to the surface, if sufficient pressure is present on the water behind. These faults are often in parallel lines across the



FIG. 5.

limestone right down to low levels, where, of course, owing to the greater pressure, most water is obtained.

By far the most important water-bearing strata in this direction, however, is *chalk*. Chalk has an extraordinary power of holding water,¹ and is to be found over the greater part of the south of England and in most other places. It usually lies below tertiary sands and clays. The inclination of the saturation surface in chalk varies, the variation being usually dependent on the angle at which the stratification dips. The average dip is about 12 ft. per mile, but may reach 100 ft. in places.

¹ One cubic foot of chalk can hold two gallons of water, or nearly one-third of its bulk. Some chalk rocks which have been subjected to igneous action, as is the case in Co. Antrim, hold but little water.

Now, besides being very absorptive, chalk is very retentive. It is intersected with fissures along which the water travels by capillary attraction, hence although from chalk when exposed water will rapidly evaporate, yet percolation is not the means by which a supply can be looked for. Again, when chalk is very low down below the surface it becomes subjected to a superincumbent load, which tends to close up these fissures, and the abstraction of water therefrom is rendered more difficult, and borings in chalk are generally made where (or near where) it outcrops at the surface. On chalk beds near the sea the capil-

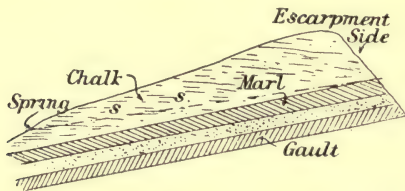

FIG. 6.

lary attraction of the chalk will even cause an inflow of salt water, and the supply from any wells in the district may be brackish. Chalk, however, generally lies in basins, the edge of which will be found to be intercepted by rivers and sometimes by the sea. A typical example is shown in fig. 6, in which the chalk is on the surface overlying a bed of marl superimposed on greensand and gault clay. The probable position of springs is shown. The surface of saturation slopes at about 1 in 400. In cases of this kind water obtained in this manner is usually of finer quality. The steep slope of the chalk shown in fig. 6 is known as the escarpment side. In fact, this is

a typical example of the way chalk beds are found. Many towns will be found to have arisen on the lower parts of the flat slope, by reason of there being water readily at hand here, and primitive man, not being usually a skilled engineer, founded his dwelling where water existed, in opposition to present-day methods of calling in the engineer to bring it from a distance. It will be noted, too, in fig. 6, that no water will be obtained on the escarpment side, because the impervious stratum of marl has a gradual slope in one direction, but if it has also a slope towards the escarpment side, which is sometimes found,

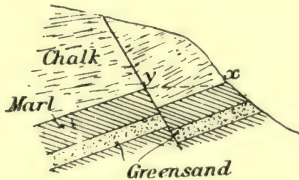

FIG. 7.

then, although the slope will be the shorter of the two, a small amount of water may be had there as well where the marl outcrops on the escarpment side. In the same way a fault, as shown by fig. 7, will cause a similar supply, but the line xy must slope in the direction yx to an extent enabling hydraulic laws to be fulfilled. Below xy the ground will be saturated. Generally it will be found that chalk springs occur in valleys much below the general level of the formation, and their overflow corresponding with the existence of some fissure above a harder and more retentive bed than the mass of chalk.

Almost as absorbent as chalk are the oolitic rocks.

They are, however, much more capable of percolation. On the whole they yield good water, but unfortunately are somewhat liable to pollution from the surface by their great capability of infiltration. The oolitic rocks, also called Jurassic rocks, comprise principally Portland stone, limestone, and calcareous grit, and from a stratigraphical¹ point of view consist of four great masses of calcareous or moderately permeable strata separated by thick deposits of clay. Thus we have alternative pervious and impervious strata which causes many springs, and a copious supply in wells sunk in the impervious, though if the clay has to be pierced great depths may be encountered before water is reached. Portland stone will only yield water in fissures, but the porous strata below, which in turn rests on a bed of clay, provides much water.

Then there is the Trias formation. It does not possess many fissures and yields a good supply of hard water, except in cases where it overlies what is known as Bunter² Sandstone, when it will contain gypsum and rock salt in solution and in sufficient quantities as to render it unfit for use. The Trias formation consists of red, blue, and white clay, resting on dense red clay and sandstone. It is classed together with the Permian formation and may rest on granite or limestone, and usually lies in horizontal beds. Regarding the water-bearing properties of the group, gravel will frequently be found lying on the stiff clays and marls of the upper new red sandstone, and wells sunk therein will supply a good

¹ Stratigraphy is the science of the geological arrangement of Strata.

² Tudsbery and Brightmore on Waterworks, 3rd ed., p. 124.

quality of water in small quantities. Medicinal springs exist in new red sandstone, especially brine springs. Red sandstone is almost equally permeable in every direction, which is evinced by quarry faces of this stone being quite dry, in the same way as chalk and sand, except in places where clay forms partings in it, and in this case well sinking would not be attended by much success. Liverpool, in its old waterworks, furnishes a good example of wells sunk in red sandstone.

We now come to consider what are termed the *Palæozoic Series*, which, however, are not as important from a water supply point of view as those previously mentioned. Palæozoic rocks consist of shale, grit, sandstone, with layers of coal and ironstone and millstone grit, and carboniferous limestone. Wells sunk near coal measures will yield a small quantity of water impregnated with iron and not of good quality. Millstone grit usually rests on impervious limestone shale. It is usually found in wild localities in very rugged form and intersected with ravines in which flow mountain torrents supplied with water finding its way through its pores. Practically the same remarks apply to carboniferous limestone. Springs will occur at faults filled with clay. In fact carboniferous limestone is a study in itself, so interesting are the rivers therein which disappear and reappear frequently along their course. The Peak of Derbyshire affords many instances, as also does Coole Park, Co. Galway, of which the writer has personal experience.

In this chapter, then, brief notice has been taken of the various sources of supply which will be at the disposal of the engineer. In conclusion, it will be

observed that, although river water may be very handy and admirable for rough use, it will not generally be very good for drinking. In many cases of country houses it will be found prudent to lay on a supply of river water where available for the house supply generally, and sinking a well for drinking water only. The combination of the two supplies will be usually ideal, because no fear will be entertained of the drinking water running short under ordinary circumstances, necessitating the very inconvenient practice of economizing water for washing purposes in hot weather. When this is the case the writer advises the water from the river to be raised by mechanical means, and the well water by a hand pump: no house connexion being made from this latter supply, and one tap and *one only* to be available for drawing off potable water placed in the most convenient position (the scullery usually). It is most essential to do this, because it is the only satisfactory way of making servants discern between the two supplies, and allowing of no confusion. The inmates of a house soon get to know that all potable water must be pumped by hand. Storage tanks for the drinking supply are quite unnecessary in most cases and very inadvisable. In cases however of small houses with only a hand-pumped supply from a well, then provision must be made for delivering into a store tank, but the pump should have a draw-off tap, clearly labelled DRINKING WATER.

In cases where the only supply is the river, that is where it would be impracticable for such a shallow well to intercept the water on its way to the river for a potable supply, there storage and filtration

must be provided for as will be shown. Spring water will have to be led to a storage reservoir and filtered if necessary. It may have to be raised to the point of consumption, in which case the potable water will have to be stored unless the spring is very near the house.

The remarks on water bearing strata refer to wells which are proposed to be sunk in districts overlying such. The remarks are brief as they refer to geology, a branch of science in itself of which the engineer certainly profits by a knowledge.

No attempt has been made to point out where and where not to sink a well, because each case must be considered on its merits, and no hard or fast rules can be laid down. The remarks given are only intended to give a guide as to what the prospective well seeker may expect when he has studied the geological map of the district. When doubt exists as to whether sinking will yield water, or when great depths may have to be sunk, the services of a water diviner are very useful. Water divining is a gift; only very few practice this art and some of those are not reliable. On the whole, however, much reliance can be placed on a first-class man.

To decide on the proper place to sink a well is not an easy matter, and naturally this position must be correctly determined before any work is commenced owing to the expense of such work. We cannot hope to place before the reader all the minor considerations which have to be gone into, and the services of a water expert are usually requisitioned before any actual engineering work is put in hand,

No doubt the most favourable position for a well is a large synclinal (viz., dipping in opposite directions towards a common line or plane) basin having a good rainfall, the outlying strata being pervious, while the underlying is impervious. Where there are intersecting dykes of igneous rock outcropping, if a boring is made on the side nearest the outcrop of the strata intercepted, we shall be fairly likely to produce a good yield of water. There is no certainty about any boring; we can only be guided by previous experience. Wells and boreholes sunk in oolitic strata seem to have been the most successful, one at Bourne, in Lincolnshire, being one of the most remarkable, yielding (at only 92 ft. deep) half a million gallons per day at the surface, and borings in this class of rock need only be small; but when we come to sandstone and other similar rocks, we have to make them larger, because of the slower rate of percolation. Even then it is well known that where pumping is resorted to the yield will gradually fall off for a certain time after it has been in use, and it is most essential to avoid too much pumping where possible.

DANGERS OF WELL WATER.

The impurities from the soil, from defective drains and cesspools, readily gain access to the well and foul the purer water. It is therefore not surprising to find that the majority of the wells to farmhouses and in villages yield water which—to make a plain statement—is always liable at any time to become the means of spreading disease.

It is astounding to listen to the ignorant speeches

and to witness the apathy of some farmers, especially should the water from their well be abundant in quantity. To them it is an excellent supply, quality being a secondary consideration.

These farmers, however, should they be dairy farmers, are occasionally alarmed by the visit of the sanitary officer or the medical officer of health from a neighbouring town. Then, when the question of a fresh-water supply is suggested, and afterwards demanded, these farmers, although indifferent and scornful at first, often prove loudest in their praises when a new and perfectly pure water supply has been obtained, thanks to the skill and energy of the sanitary engineer.

The water supply to many farms and villages is from shallow wells, and it has already been explained how the water in these ordinary surface wells is readily polluted; at least it is a difficult matter to sink surface wells in connexion with farmhouses, or the houses in many villages, without them becoming polluted. It therefore becomes necessary to sink wells of a greater depth, this depth depending on the geological formation of the ground.

The quality of water yielded by deep wells is usually good, having some of the good qualities of spring water. It is liable, however, to be hard.

Regarding the quantity of water to be provided for any country house or estate supply scheme, it is of course a great advantage when the supply is considerably more than the demand at all times; where however a desirable supply presents itself, but is at the same time limited in quantity, it is desirable to ascertain if the expense necessary to utilize it will

be repaid by calculating the minimum quantity of water which will supply all the demands likely to be made upon it, and to assist the reader in coming to a satisfactory decision on the point the following table, from Mr. Hurst's Surveyor's Pocket Book, is appended.

In temperate climates, for each man, woman and child allow for house per day	20 gals.
In tropical climates allow	25 „
Soldiers require for all purposes per man per day	15 „
Allow per day for each horse (food and drink $\frac{2}{3}$ and washing $\frac{1}{3}$)	15 „
An ox or cow will consume per day	8 „
Mule, donkey or pony	6 „
Sheep or pig	1 „

Cavalry horses are usually allowed 8 gallons of water and artillery horses 10 gallons per day, which include washing carriages and horses.

Allow per day for cleaning each two- wheeled carriage	8 gals.
„ four-wheeled cart or waggon	12 „
„ „ „ coach or carriage	20 „
A large bath requires from	40 to 50 „
A shower-bath requires from	3 to 6 „
A water-closet at each flushing	2 to 3 $\frac{1}{2}$ „

The available rainfall from roofs in England and Ireland varies according to the locality, being always more in western districts than eastern. It may, however, be roughly estimated for water supply at 18" per annum on an average. It must always be borne

in mind, however, that no matter how this water may be otherwise free from atmospheric pollution (this of course being the case in country districts), there is always an element of danger from a sanitary aspect of fouling of the water by excrement from birds, but except in houses near the sea whence sea-gulls may find their way inland, or houses surrounded by rookeries, this is hardly worthy of much consideration.

CHAPTER II

WELLS AND WELL SINKING

THE matter in the foregoing chapter is intended to give the reader some idea of the different means by which he will be able to obtain a supply of water for a country house or estate. For rivers and surface springs, dams, reservoirs, and pumps, either separately or conjointly, may have to be employed, and they will be considered later on. Meanwhile attention is directed to the methods of sinking wells, when the engineer's opinion or the advice of an expert demands such a procedure.

The choice of a proper place for sinking a well is a matter of extreme importance, because upon it will depend the success or failure of the whole venture. In order to decide upon it, it is necessary to take into consideration the geological features and the physical configuration of the district, together with the dip and strike of the strata, and the extent and direction of faults. Generally it is found that the most favourable position is in a large synclinal¹ basin in a place where porous strata overlies impervious. The presence of fissures or faults in chalk and limestone usually afford the best chances

¹ Inclined downwards from opposite directions.

of a good supply; in the same way as dykes of igneous rock in porous strata present a barrier in the course of the flow of water along its natural slope, and tend to force it upwards along the line of this barrier.

First of all let us consider wells of somewhat large diameter and shallow depths in comparatively soft earth. The practice generally consists of excavating the hole and lining it with brickwork, iron or concrete as the case may be, the latter process being technically known as *steining*, and is not required in hard rock and firm chalk. Those wells in soft earth are for obvious reasons nearly always circular, although the oval form seems to have found favour with some engineers.¹ The excavation in such cases is the same as any other engineering work, shoring and strutting being required on loose sand and soft wet clay and loam, and any water gaining access to the workings requiring removal, or the use of cast-iron segments to keep it out. Water of this description is especially liable to be met with in sand springs present in plastic clay. Boring will probably have to be resorted to in such cases. The simplest case of a well is that sunk into a bed of sand or gravel which rests on a bed of clay, and this constitutes a *shallow well*. Such wells generally reach a depth in the sand or gravel which is permanently in a state of saturation, and this level is generally above the clay. No estimation of the depth can be formed with accuracy; theoretically it corresponds with the level of the lowest natural

¹ The use of the oval well is usually confined to cases where extra width is required to place two pumps abreast.

point at which the water can escape over the edge of the natural clay basin in which the sand or gravel lies.

In other cases a well will be sunk through impervious material to a porous bed underlying it, and in such wells it is usual to have a permanent water level some feet higher than the level from which it rose, and where the level is above surface level no pumping is required, and the well is termed an *Artesian* well. These wells are bored and are very common in beds of chalk and near red sandstone. Steining is executed in various ways. Former practice, and to some extent modern practice, makes use of ordinary bricks for this purpose, hard, square, well-burnt stock bricks generally being employed. The very simplest way is to lay them dry $4\frac{1}{2}$ in. thick, with rings at intervals set in cement three courses thick, the interval varying in the discretion of the engineer.

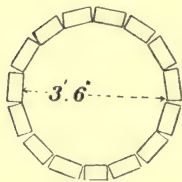

FIG. 8.

Owing to the shape of the ordinary brick (9 in. \times $4\frac{1}{2}$ in. \times 3 in.) this method has not much to commend it unless laid in cement the whole way as will be seen by fig. 8. The courses naturally break joint, and the brickwork is sometimes built as shown in fig. 9 on a wood (oak or elm) curb, laid at the bottom of

the excavation previously levelled to receive it. Two thickness of wood breaking joint are employed bolted together to a total thickness of about 3 in. The breadth is an inch or so greater than the brickwork. The shaft proceeds above the curb and the earth carefully rammed behind it. Subsequent ex-

cavation thus proceeds inside the curb, which will be supported by the props as shown and the process

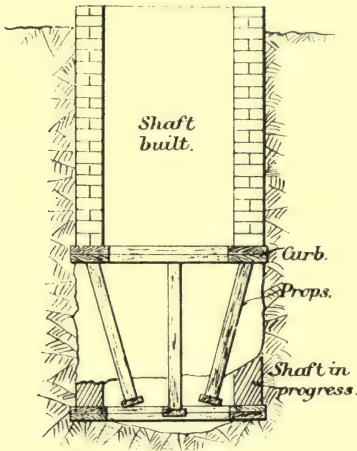

FIG. 9.

repeated. The props are inclined and spiked to the upper curb and rest on sole plates. Great care must be taken when the brickwork rises to the underside of the second curb in order to fill up the space very fully between the two sections with cement. It will very often occur when the bricks are laid as in fig. 8 that the earth will swell and bind them together, in which case the curb would be dispensed with, and bricks being added under the executed steining. For a 9 in. lining, laid as headers and stretchers as shown by fig. 10, the curb system is the best. In passing it may be said that

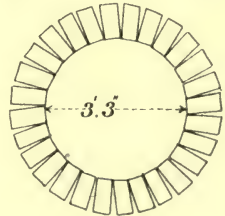

FIG. 10.

laying the bricks dry has not much to recommend it. Again, the use of ordinary 9 in. \times 4½ in. \times 3 in. brick is not at all commensurate with the best practice. Stock sizes of radiating bricks (viz., bricks of uniform thickness but tapering in width) are now made by brickmakers for use in sewer and chimney work, and make a much better job, which is out of proportion to their extra cost. The reason why old wells are

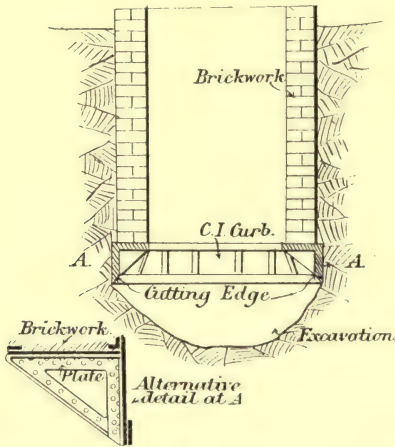

FIG. 11.

found built of rectangular bricks is that certain duties appear to have been levied on bricks other than this shape some years ago. Better perhaps than the wood curb system described, is the use of a cast-iron curb in sections with a cutting edge, as shown by fig. 11, as it can be used in loose and wet ground. The brickwork is built on this curb and the men excavate the earth inside it; meanwhile the curb slips (or should slip) gradually downwards, but the work of letting down the curb demands great

care so that it does not get the least degree out of the vertical. If it does it will bind and will not generally be set moving again without difficulty, more often than not it never will, when the process will have to be repeated below. The writer has found that a small charge of explosive let off at the base of the shaft will often remedy matters, or water poured in round the outside of the brickwork *may* effect the same object. In cases where the curb is not required to slip it may be hung up by the rods attached to cross timbers at the top of the well. This will be necessary when galleries are driven horizontally from the bottom of the well to add to the water supply therein. Many engineers prefer to lay 9 in. brickwork all as stretchers, as shown by fig. 12, the advantage being that $4\frac{1}{2}$ in. of lining can be laid at a time. Another form of lining wells in bad ground is that by cast-iron segments bolted together. They have internal flanges and are cast in segments about 5 ft. long, usually as shown by fig. 13, while in some cases the cylinders are steel riveted and stiffened by internal ribs of angle or tee iron.

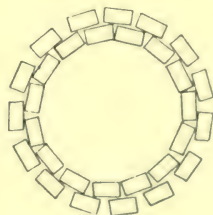

FIG. 12.

In both cases the writer is inclined to recommend the flushing up with cement of the internal faces of such iron and steel curbs, and finishing to a cylindrical hard surface, which certainly makes a very fine job. The latest practice, which is perhaps the best of all, is the use of reinforced concrete for the purpose.

The reader is referred to figs. 14, 15, 16. Concrete is more or less impervious to water and can if necessary be made absolutely so, and hence we can get rid once for all of the danger of contaminated top surface water. The concrete would only have to be about 6 in. thick, while vertical steel rods, $\frac{3}{8}$ in. diameter spaced 18 in. apart, running up vertically through the concrete, and circumferential rods, $\frac{1}{4}$ in.

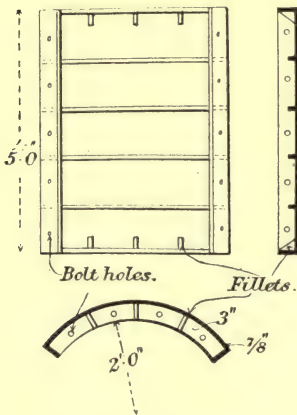

FIG. 13.

diameter and spaced 9 in. apart, would constitute the reinforcement, the two sets being bound with steel wire to each other. The circumferential rods would be placed within the vertical ones. The best concrete for the purpose would be composed of 1 part of best portland cement to $2\frac{1}{2}$ parts of sand and 4 parts of very small broken stone or gravel. It will be necessary to construct a circular collapsible frame

of wood, 12 in. smaller than the diameter of the well and about 4 ft. 6 in. long. This is set up vertically at the bottom of the excavation, and the concrete is placed between this frame and the side of the excavation, the frame being meanwhile covered with soft soap to prevent the concrete sticking to it. The two rings A and B are cut to a diameter equal

to that of the shaft, less twice the thickness of concrete and 4 in. = $2 \times 6 + 4 = 16$ in., and is made in two parts joined by iron plates C, C, and bolts. The frame can also be made collapsible by cutting away a taper piece of the ring at D, D, between the plates, and the four boards which form the outer circum-

FIG. 15.

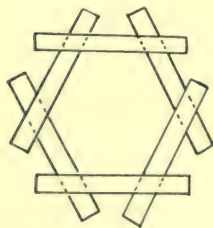
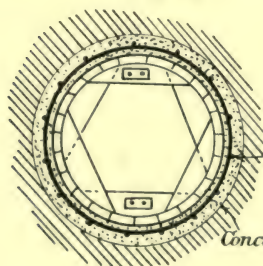

FIG. 16.

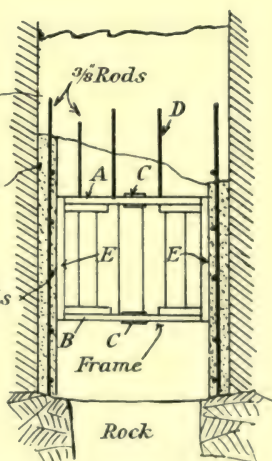

FIG. 14.

ference of the frame are left loose. The rings are made by drawing a circle the size of the frame laying the boards round its circumference (see fig. 16). The boards are then lightly tacked together and a circle of the same radius marked on three ends. After the boards are knocked apart they are sawn out along

the lines so worked and finally fastened together. At the points D, D, taper pieces of the ring are sawn out. Their size would be 6 in. wide at the inner circle and $5\frac{1}{2}$ in. at the outer. Finally around the circumference of the frame would be fastened the boards E, E, each 2 in. thick and 4 ft. long. The concrete lining rests on the rock at the bottom of the well, which has been previously levelled to receive it. Care must be taken to keep the rods in position while filling in the concrete, and also to cut the rock so that the frame will rest nicely upon it for the first "lift". It requires very careful ramming when placing the concrete, so as to properly consolidate it and cover the rods well, and a wet mixture is advisable for this particular class of work. The frame should be left in for 24 hours before it is raised for another lift. The lining would be plastered afterwards in neat cement if required. On the whole the latter method of steining wells is strongly to be advised.

We now pass on to another system of gaining water from subterranean sources, namely that of *Boring*. When a well has to be sunk of considerable depth in rock, it will be found cheaper to bore it than excavate it in the old way. Borings up to 15 ft. in diameter CAN be executed when a small hole, say 6 ft. in diameter, is driven first. It is an operation which demands skill, care, and specialized experience, besides special plant, and is best entrusted to specialists, although a system known as the Chinese system can be practised by any ordinary intelligent contractor. The tools consist of a boring head and a cutting chisel. The method is shown by fig. 17, in

which the cutting chisel is attached to the boring head and suspended by a hook from a rope.

The boring head, which is somewhat smaller in diameter than the hole, is made of cast iron and is usually 18 in. in length. There are two ways of using this tool. One is for use when it is not intended to subsequently line the hole with a tube, which can be done in very hard rock. In this case the loop is fixed in a central position, so that the chisel will strike plumb on the bottom of the boring. When, however, the hole has to admit of a tube, it must be larger

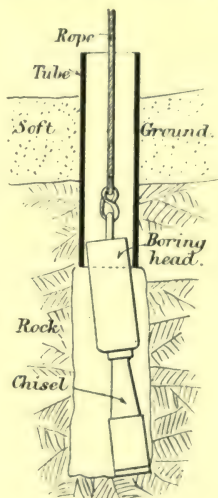

FIG. 17.

in diameter than otherwise, and to ensure this the head is slung so that it is eccentric to the central axis. This simple adjustment is effected by fixing the loop on the boring head on one side of the centre, and the chisel then strikes the bottom obliquely as shown by the figure, and so cuts a larger hole. When a hole has to be cut through clay or stiff earth another form of cutting tool is employed, as shown in fig. 18, consisting of a 2 in. diameter steel tube having a screw, where shown, to screw it into the boring head in place of the chisel.



FIG. 18.

The tube must have holes in it where shown to allow waste matter free egress. The method of using these

tools is as follows. A small hole is cut, say 3 ft. deep, for a start, in which a length of pipe of the largest size proposed to be used is inserted as a guide for the tool, the pipe being carefully set in its true position in a secure manner and truly vertical. Next, shear

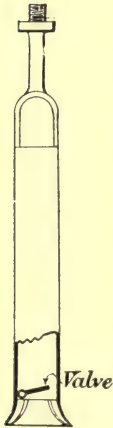

FIG. 19.

legs must be obtained, preferably of a light iron collapsible form, and a pulley slung vertically over the tube. Over this a rope passes, and to which the tools are attached. The working of the tools simply consists of moving the tools up and down by means of the rope. The chisel tool will then cut and break up the rock gradually, which has to be removed by an apparatus known as the shell pump. It is illustrated in fig. 19. This is a simple piece of apparatus, consisting of a steel tube having a rubber foot valve. By being raised and lowered into the rubbish a couple of times, it gets filled very much in the same manner as the

ordinary lift pump. It is then drawn up and emptied. A similar form of apparatus is shown in fig. 20 with a ball valve and seat. Notice should be taken of the small pin which limits the rise of the ball. Figs. 21, 22, and 23 show special varieties of chisels for specific purposes. Fig. 21 is for use in hard gravel and rock; fig. 22 for breaking up boulders of hard rock encountered in boring in clay, with the apparatus shown by fig. 18; while fig. 23 is a simple V-shaped chisel. They are made of tool steel. Fig. 22 is sometimes called a *plug drill*. Sometimes, unfortunately, tools break and their removal is occasionally difficult. In figs. 24 and 25 is illus-

trated a tool for attempting their removal. It is known as a crow's-foot. In fig. 26 is another variety of shell pump for removing soft mud. Water must in all cases be copiously applied to the tools. This combining with the broken rock, etc., causes the mud. As the boring proceeds, the tubes should be driven down. The above apparatus can of course be elaborated in many ways. A windlass may be added to the plant for working the rope, and a special snatch block arrangement, similar to those used on pile drivers, to

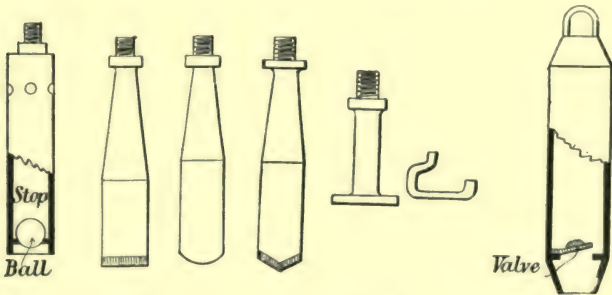

FIG. 20. FIGS. 21, 22, 23. FIGS. 24, 25. FIG. 26.

release the tool. On large installations a petrol engine will take the place of manual labour, but in most cases the principal features are the same. When starting a boring it is as well to give the tool a twist or so by means of the rope: as the work proceeds it will effect this motion of its own accord. Most bore-holes are lined, except those in very hard rock, and the hole must be cut large enough to receive the lining, and the boring and lining usually proceed simultaneously. Cast-iron tubes have been much employed and are used at the present day, but steel tubing is much more usual. In any case the bottom

tube should have a cutting edge of hard steel, and the lower pipes are perforated with small holes about $\frac{3}{4}$ in. in diameter, except in chalk or hard rock. Copper tubes have also been used to some extent, but they are naturally very expensive. The steel tubes are generally lap welded and screwed at each end.

These ends are then butted together and secured by a collar, as shown by fig. 27, which refers to

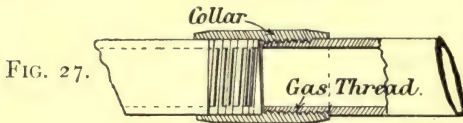

FIG. 27.

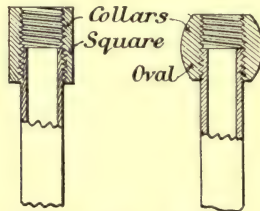

FIG. 28.

FIG. 29.

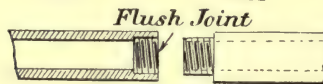

FIG. 30.

tubes of fairly large size, while smaller-sized tubes would be joined by collars of the form shown in figs. 28 and 29; while if the driving is likely to present any difficulties, the flush joint shown in fig. 30 is used. The most modern system is known as the Abyssian driven tube well, and it consists of a perforated steel-pointed tube as shown in fig. 31, which is driven down into the water-bearing strata when this is not very far below the surface. This

system is not suitable for very hard rocks, as the excessive driving required will damage the joints. The method which was described as the Chinese system is known as percussive boring, and it was stated that the action of raising and lowering the tools imparted the necessary rotary motion. So far as it goes, the system is useful for small bore-holes started at the surface, but for deeper and longer ones, and those which are started from the bottom of a well, as a continuation thereof, when the work has to be done from a staging as low down in the well as possible (which is usually a few feet above the supposed level to which water will rise), iron rods take the place of the rope. The staging is a plank flooring securely cross-braced, having a hole in the centre for the rods to pass through, but it must be small enough to prevent the passage of a special clamp attached to the top rod in use, which will form a rest for the apparatus while changing rods and guard against loss of the tools below the stage. Below this opening, and down to the bottom of the well, a temporary iron tube is placed to act as guide. The boring rods may be from 10 to 20 ft. long, and are generally made of wrought iron and sometimes of steel. The top rod is of the form shown by fig. 32, and has eye-holes for the turning bars (called "Tommy" bars) to pass through a hook, by means of which the drop motion is imparted. The rod joints are made like the one in fig. 33, in which the recess is shown for use with the clamp referred to above. This clamp

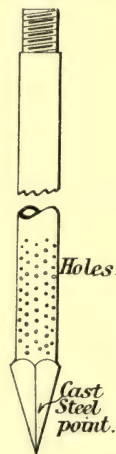

FIG. 31.

is a plank flooring securely cross-braced, having a hole in the centre for the rods to pass through, but it must be small enough to prevent the passage of a special clamp attached to the top rod in use, which will form a rest for the apparatus while changing rods and guard against loss of the tools below the stage. Below this opening, and down to the bottom of the well, a temporary iron tube is placed to act as guide. The boring rods may be from 10 to 20 ft. long, and are generally made of wrought iron and sometimes of steel. The top rod is of the form shown by fig. 32, and has eye-holes for the turning bars (called "Tommy" bars) to pass through a hook, by means of which the drop motion is imparted. The rod joints are made like the one in fig. 33, in which the recess is shown for use with the clamp referred to above. This clamp

is shown in fig. 34, and its method of use will now be obvious. With these rods, and the chisels, etc., previously described and illustrated, small borings can be done by hand. Larger ones must, of course, be executed by motive power. The up and down motion is, of course, simple enough, but the rotary motion is not quite so positive. It is usually effected

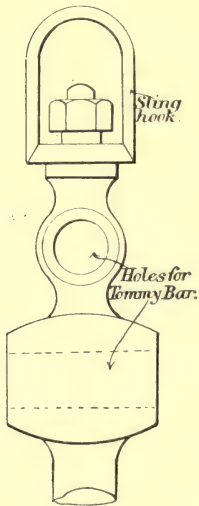

FIG. 32.

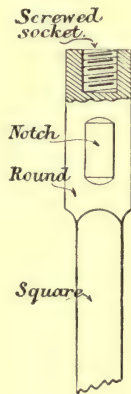

FIG. 33.

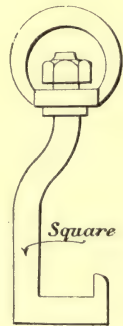

FIG. 34.

by two cast-iron collars fastened to the top bar by collars, one above the other, with a space between. The two edges closest to each other of the collars, viz., the top edge of the bottom collar and the bottom edge of the top one, are cut with teeth like a ratchet wheel, while a toothed bush works between them. These teeth, however, are specially cut, so that those which engage with the top collar are one half pitch in advance of those which engage with the lower

one. The sliding bar is attached to the rope, and consequently when the tool descends the top teeth will engage with the top collar, while when it is raised the bottom teeth engage with the bottom collar, and the rope will twist through an angle corresponding to the distance of half the pitch at each reversal of the motion.

Yet another form of rock-boring is that in which a diamond drill is employed, and which may be used for bore-holes up to 2 ft. in diameter. It has the advantage of cutting a solid core, which is both easy of removal in large sections and also serves to show the engineer the exact nature of the strata cut through. The motion is purely rotary, and the cutting is done by diamonds securely brazed into steel plugs, fitting into an apparatus called the crown, which revolves according to the hardness of the rock from 50 to 200 revolutions per minute. The advantage of rotary drilling is, of course, the solid cores produced, besides the reduced liability to breakdowns and failure; because with percussion boring in fairly large holes, and to great depths, the moving parts of the apparatus become very heavy, and vibration sets up in the rods which is difficult to prevent. This originally led to the adoption of wooden rods, iron-bound and with iron heads and feet, screwed with male and female threads in the usual way. Wood rods, however, are liable to break, due to the twisting action required; and to remedy this the hollow steel rod was introduced, which appears to have given fairly good results. With great depths, however, even with the use of tubular or wooden rods, the boring tool is always in danger

of being crushed unless some form of slide joint is introduced. A good form is shown by fig. 35, and it divides the rod into two sections. The upper portion is counterbalanced by a weighted lever, which allows of the lower section only acting by percussion. As will be seen from the figure the two parts slide over each other, and so as the top part is counter-



FIG. 35.

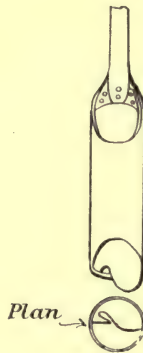

FIG. 36.

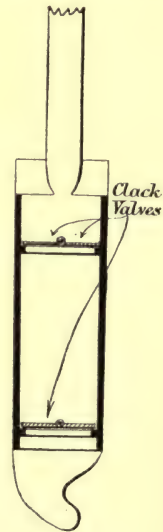

FIG. 37.

balanced it only drops slowly, while the bottom section, having the full force of gravity upon it, will do the striking hit only with a force equal to the weight of the lower section. The limit of travel of the slide is generally about 12 in., and the most satisfactory load for the bottom or striking section is 15 cwt. A slide joint is not required for rotary drilling. Percussion tools have already been illus-

trated and described. Tools employed for simple boring are however different, and they are of course confined to use in soft ground. For use in stiff clay the form shown by fig. 36 is generally employed, while for running sand, in order to prevent a return of the spoil, the type shown in fig. 37 must be used. It has two flap (or clack) valves as shown. The rods used for working these augers must have guides attached to them, being a loose running fit in the guide tubes.

It may have been mentioned that when an artesian well has been cut in rock, and water is found but only percolates slowly, a decided improvement can often be made by exploding a charge of nitro-glycerine in the bottom of it. This charge consists of a sort of torpedo made of tin and filled with the required quantity of nitro-glycerine, and having a detonator and fuse. The former consists of a copper capsule filled with fulminate of mercury, while the safety fuse is inserted into the open end of the detonator until it reaches the fulminate, and the copper casing pressed round the wire to close it up. The idea is shown by fig. 38. The whole detonator is then pushed home into the primer, and connected to an electro-magnetic machine or low tension battery at the surface, the top of the detonator having been made quite water-tight with beeswax beforehand. The wires for the electric current to travel along must of course be thoroughly well insulated and waterproofed. These detonators want great



FIG. 38.

care in handling, as a heavy blow *may* explode them at the wrong time, and no electrical connexion of any sort should be made before the whole affair is let down into the bore-hole ready for exploding. Nitro-glycerine for the purpose is bought in water-proof cartridges, which must be kept dry and cool, and above all away from frost. They are placed in the torpedo, and the topmost into which the detonator is pushed constitutes the *primer*. The whole may then be exploded, the water in the bore-hole being a sufficient *tamping*, as it is called, without further trouble. The number to be used for any particular rock will generally be stated by the firm who supply the explosive.

CHAPTER III

FLOW OF WATER IN CHANNELS AND PIPES

THE matter contained in this chapter is common to all books on hydraulics and waterworks, and most books on civil engineering. There is much current literature on the subject. In order however to understand what is to follow, and also to make certain calculations necessary in carrying out to a successful issue small water supplies, the engineer must be able to measure the flow of water in channels and to estimate the delivery through pipes in an accurate manner. Hence in the following pages will be discussed briefly, and put as far as it will concern the practical man, the question of steam gauging, and flow in and pressure and friction in pipes, and it is hoped that these remarks will serve as an apology for going over ground which has been covered by many writers before, bearing in mind however that many of the textbooks referred to deal with the matter in a very exhaustive and theoretical way, so much so in fact that the practical man has little time or inclination to wade through them.

A small river passing through an estate on which water is wanted may serve a variety of purposes, the most commonly occurring being—

1. Supplying a direct gravitational supply by means of a dam forming a small reservoir from which the water flows in a channel or pipe line.

2. Providing sufficient power to a hydraulic ram, raising either its own water or water from another source.

3. Providing power for a turbine which will drive pumps for raising water or for other purposes for which cheap reliable motive power is wanted.

4. Providing water which is raised by other forms of motive power.

In cases Nos. 2 and 3 the power given out by the flowing water will need to be ascertained, while in cases Nos. 1 and 4 it may be also required to find what quantity of water is flowing.

Now, in small streams the quantity of water flowing will vary greatly, and as the expense of a long series of elaborate observations will not usually be warranted by these small works in the same way as is the case with large waterworks, it is the practice of the writer wherever possible to make such gaugings at the time of lowest flow. Unfortunately this will only occur once a year, which may delay the work somewhat, but nevertheless the course is advised unless any reliable information as to the lowest level of the stream can be obtained, or the volume is likely to be far and away in excess of what will probably be wanted. The information so often vouched by gamekeepers, butlers, etc., on estates is usually most unreliable. For small streams a very handy way of gauging is by means of a small stone dam laid across the stream, and made watertight with clay on the inside. It is easily put up and removed ; a pipe is

inserted at such a level that it will run about half full when constituting the ONLY outlet for the imprisoned water. The enquirer can then form a tolerably reliable estimate of the flow by counting the number of bucketfulls of water collected, say in a minute, and knowing the capacity of the bucket. It is only applicable to very small flows; somewhat larger flows may be measured by allowing the pipe to run full force, and measuring the depth from still water level to the centre of the pipe. This constitutes the "head," and with the diameter of the pipe gives a means of calculating the probable discharge. We shall discuss flow in pipes later. It will nearly always be the case, however, for conditions 2 and 3 that a proper gauge will have to be erected across the stream, and the use and construction of such a gauge as the writer uses will now be described. It may be well to note, however, that where the stream is sluggish and is fairly deep and uniform in cross section, a tolerable estimate of flow can be made by ascertaining the velocities. For instance, take such a case as fig. 39, which might be a mill race or other artificial channel. A few experiments with a float will give the velocity at the centre between two known points. An orange or gutta-percha ball is recommended, or a rod float consisting of a light wooden rod loaded with lead at the bottom and with a piece of cork at top will be found very useful. They should be of such a length that the weighted portion is a few inches from the bottom. With this

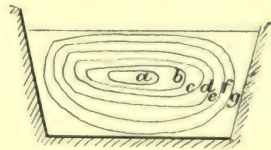

FIG. 39.

kind of float various velocities can be taken, and when the stream is divided into imaginary contours, as shown in the figure, accurate estimates of the flow can be made. For instance, say the velocity at A was 280 ft. per minute while that at B was 270.

The mean velocity between the two contours will therefore be $270 + 280 \div 2 = 275$ ft., and the quantity flowing in this section will be $275 \times 12.41^1 = 3412.75$ cub. ft. per minute. The mean velocity between B and C is 265 ft., and the corresponding quantity flowing will be 9757.3 cub. ft. per minute. Therefore the total quantity flowing will be found by calculating the velocity and quantity between each two contours, and adding together the quantities thus found.

Velocity at	Feet per Min.	Areas between	Sq. Ft.
A	280	AB	12.4
B	270	BC	36.81
C	260	CD	69.25
D	250	DE	95.42
E	230	EF	116.10
F	210	FG	135.50
G	190	GH	144.94

To return however to the question of the gauge. The most accurate results will be gained by the use of this piece of apparatus if properly constructed. It is not an expensive piece of apparatus and can be made and erected by an intelligent carpenter.

The size of the gauge is determined by the drainage area. It must pass the greatest floods. That is the reason that most gauges have two or three

¹ 12.41 is the area of this particular contour.

notches cut in them, so as the small flow may be accurately registered. The building of such a gauge to give good results requires a little care. In the first place, the water has to be altogether diverted by a temporary channel. If this is impracticable, coffer-dams must be formed taking half the stream at a time.

The conditions to be specially observed in construction are as follows:—

1. The ends must tail into the banks at least 3 ft., and puddled with clay.
2. The gauge must be set truly level, and well puddled at the bottom.

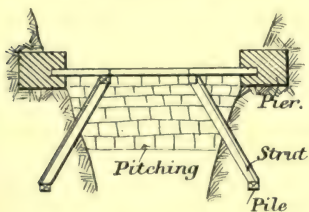

FIG. 40.



FIG. 41.

3. On the downstream side of the gauge there must be a stone apron of 18 in. of stones, set at least 6 in. below the lowest notch.

4. End walls of masonry are preferable to mere puddle.

5. It must be very strongly strutted.

6. In loose ground it should be founded upon piles, and sheet piles driven at the upstream side to prevent the puddling blowing out under pressure. The bearing piles would be 4 in. to 6 in. square.

Now bearing in mind the conditions set forth, a very suitable form of gauge is given in figs. 40, 41,

42. The planking should be 2 in. or 3 in., and all joints tongued and grooved. They may be square on the top, rounded, bevelled (on the outside), or the top may be a thin iron plate. The first thing to do when using such a gauge is to find the level of still water

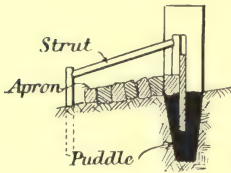

FIG. 42.

- above it. A suitable apparatus is shown in fig. 43, and consists of a round brass rod AB, having a hook of brass wire fixed to it and brought to a sharp point. The rod slides vertically in the tube, which is securely fixed to the support. It is split along one side and has a vernier cut upon it; on the rod AB is a scale of inches and tenths. In use the rod is adjusted so as the hook just causes a small pimple to appear on the water surface. The gauge should be placed some distance back from the gauge, and must be very carefully set so that *the top of the hook is exactly dead level with the sill of the gauge* when reading zero. The depth of water flowing

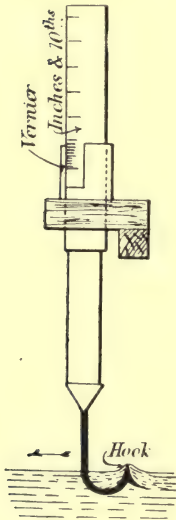

FIG. 43.

over the gauge which is ascertained by this apparatus effects the flow, inasmuch as the greater the depth the greater the quantity flowing, but also (as we before explained) the head due to the depth causes the velocity to be proportional to the square root of the head. Having set up the apparatus in a

truly accurate and satisfactory manner, it remains to calculate the flow by means of a satisfactory formula. We want to find the depth of water flowing over it = H and the breadth of the weir L .

There are various formulæ in general use. Those which are simplest, provided they give accurate results, are necessarily the most satisfactory.

Q = quantity in cub. ft. per second.

Then first we have Mr. James B. Francis' equation,

$$Q = 3.33 \left(L - \frac{H}{5} \right) H \sqrt{H} (2)$$

or if we can only measure the depth on the sill in inches conveniently = h ,

$$Q = .0801 \left(L - \frac{h}{60} \right) h \sqrt{h} (3)$$

These equations assume a double end contraction.

If there is none $Q = 3.33 LH \sqrt{H} (4)$

$$Q = .0801 Lh \sqrt{h} (5)$$

Again, there is Mr. Thomas Hawkesly's formula,

$$Q_g = \frac{1}{2} Lh^{\frac{3}{2}} (6)$$

In this case Q_g = gallons per second.

But we have only been dealing with rectangular notches. It is often convenient not to make them that shape, but to make them in the form of the Cippoletti weir, as fig. 44.

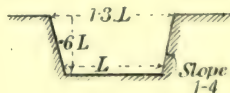

FIG. 44.

The formula to use is

$$Q = 3.367 LH \sqrt{H} (7)$$

$$Q = .081 Lh \sqrt{h} (8)$$

For very small flows the V notch is a very useful,

simple, and reliable piece of apparatus. There is considerable difference in the formulæ used to calculate the flow over V and rectangular notches. In the case of the former the stream, lines, and general shape of the set remain similar to one another under all heads, while in the rectangular notch a change of head produces dissimilar sets. The idea of using a triangular notch for gauging small flows of water is due to Prof. James Thomson, who has proved that the quantity flowing depends upon the $\frac{5}{2}$ th power of the head, and a coefficient has been deduced from experimental data thus :—

when Q = discharge in cubic feet per second,
 h = head of water over notch in *feet*,
 c = coefficient of discharge, in this case
 equal to 2.635,

$$Q = c(h)^{\frac{5}{2}}$$

The equation is quite simple to use, but the use of logarithms is necessary. The angle of the V should be 90° .

Now the foregoing method of construction would not be suitable to a greater head than about 4 ft., and when the depth would have to be greater a stronger form of construction must be resorted to. This might be the case when a wooden weir is erected across a river, not necessarily for gauging purposes but to dam back the water for a variety of purposes, in which a permanent brick, stone, or concrete weir, which are described in Chapter V, would be too expensive. A few calculations must be gone into referring to fig. 45. The greatest pressure likely to come on the bottom of the dam will be equal to wh , where h is the height to top water level as shown,

and $w = 62\frac{1}{2}$ lb. per cubic foot (= weight of water as taken in practice). Therefore the thrust $= p = wh = 9 \times 62.5 = 562.5$ lb. Say the distance between the posts is 10 ft., calculate the pressure at 8 ft. from top water level $= 8 \times 62.5 = 500$ lb., and on a layer of the bottom of the gauge 1 ft. deep we have a total pressure of

$$\frac{500 \times 562.5}{2 \times 112} \times 10 = 47.4 \text{ cwt.} = P$$

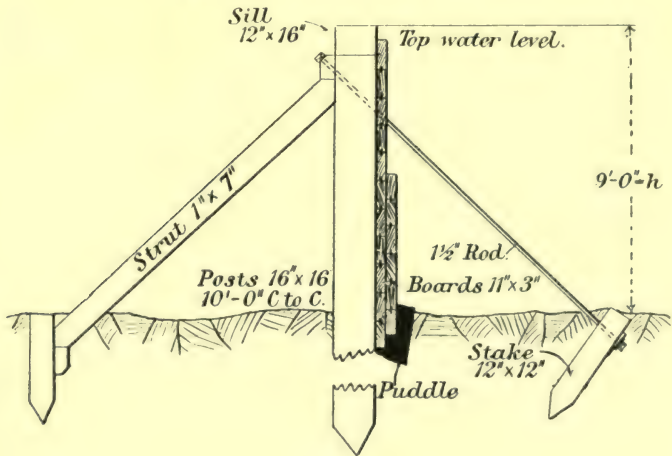

FIG. 45.

From this we require to find how thick the bottom boarding will have to be. This will be equal to

$$\sqrt{\frac{10 \times 47.4}{12}} = \sqrt{\frac{474}{12}} = \sqrt{39.5}$$

= say 6 in., which would be provided by two layers of 11 in. \times 3 in. stock size boarding, which need only be continued 4 ft. 6 in. upwards, a single thickness of the same boarding sufficing thereafter. The boards would be tongued and grooved. The iron tie

rod is an important member, as in case of the strut getting loose it may have to withstand the whole thrust of the water, and should be calculated accordingly. Say it is set at an angle of 45° .

The stress on the rod will be

$$\frac{.5 \times 10 + h^2 \times \frac{h}{3}}{9} \times \sqrt{2}$$

$$= \frac{.5 \times 62.5 \times 9 \times 9 \times \frac{9}{3}}{9} \times \sqrt{2}$$

$$= 843.75 \times 1.41 = 1189.6875. \quad c \times \frac{8}{20} = 4.75 \text{ tons.}$$

The iron rod will stand say 4 tons per sq. in.

$$\therefore \frac{4.75}{4} = 1.1875$$

= say a $1\frac{1}{2}$ in. diameter rod. The strut must bear the same stress, only in compression instead of tension, and a 7 in. \times 12 in. strut will do when tested by the Rankine Gordon formula with which every engineer would be acquainted, but which would be out of place discussed in this book. The gauge constructed on the above principles will be found to be capable of practically universal application, and is a very useful piece of apparatus and cheaply put up.

Now, it will sometimes be found necessary in works of this kind to which this book refers to convey water some distance by means of an open channel. This may be necessitated when a low fall turbine is being installed for pumping purposes, in which case the river or stream will be dammed in a more permanent form than the timber erection described, and the water conveyed to the turbine along an open channel which will be practically level, having only just enough fall to enable the water to

pass freely along it. Generally such an open channel will be cut through soft ground, although rock may be encountered. If the cutting is not watertight it must be made so with clay puddle, although if short a lining of concrete is much better. Channels cut through ordinary soft earth must have their sides cut to such a slope that no fear will be entertained of their collapse, and the velocity of flow in such channels must be limited to 3 ft. per second. The velocity in such a channel will be found by the formula

$$V = \frac{10}{11} \sqrt{HF} \quad . \quad . \quad . \quad . \quad (9)$$

where V is the velocity in lineal feet per second (which multiplied by the sectional area of the stream will give the discharge in cubic feet per second), F , *twice* the fall per mile in feet, while H is a quantity known as the *Hydraulic Mean Depth*, and its value is equal to the cross sectional area of the stream divided by the wetted perimeter, the former being in square feet and the latter in feet. The full explanation of the use of this term will be found in books on hydraulics. Take for example a channel 3 ft. wide, vertical sides, with 2 ft. of water in it, obviously the sectional area of the stream is $3 \times 2 = 6$, while the length of the wetted sides (perimeter) = $2 + 2 + 3 = 7 \therefore$ hydraulic mean depth = $\frac{6}{7} = .8571$. In a circular culvert full or half full this quantity is equal to $\frac{1}{2}$ radius. When such open channels are made of concrete, or pitched with rubble masonry, there is one form which gives the best result in practice. It is shown by fig. 46, the sides being all tangent to a semicircle whose diameter is the top

level of the water flowing therein under ordinary circumstances. The angle θ should be noted. To

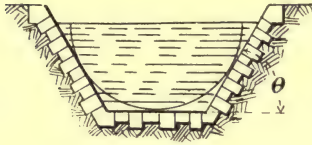

FIG. 46.

calculate the velocity in such a channel, let H be the same as before, i the hydraulic slope of the water surface, and N a

coefficient.

$$\text{Then } N = 4 \left(\operatorname{cosec} \theta + \frac{\tan \theta}{2} \right) \quad (10)$$

$$\text{and } V = \left\{ \frac{1.811}{N} + 41.6 + \frac{.00281}{\sin i} \right\} \times \sqrt{HS} \quad (11)$$

$$\left\{ 1 + \left(41.6 + \frac{.00281}{\sin i} \right) \frac{N}{\sqrt{H}} \right\}$$

S being the length in which the water surface falls one unit, that is to say if the fall is 5 ft. per mile, $S = 5280 \div 5 = 1056$, and so on. In order to avoid a repetition of the use of the above formulæ a list of velocities for given values of H , S , N , and i , etc., will be found in most engineers' pocket-books.

We now pass on to the flow of water in pipes which are under pressure, that is, they are full and there is a pressure on the upper surface of the interior due to the water. For working hydraulic rams, high fall turbines, pelton wheels for pumping purposes, and also conveying water from reservoirs, etc., pipes are used.

These pipes which we are going to consider are pipes for supply of water for domestic or power purposes; they will usually be made of cast iron or sometimes of welded or riveted steel, and are assumed to be running quite full under pressure. Now if we

have a pipe of diameter d ft., under a pressure or head h ft., its total length being L , also in feet, the velocity in that pipe in feet per second is

$$V = 50 \frac{\sqrt{dh}}{L} \quad . \quad . \quad . \quad (12)$$

Now the flow of water in a pipe is of course dependent upon the friction in that pipe, and the friction is proportional to—

1. Length of pipe.
2. Inversely as diameter.
3. The velocity squared.
4. The roughness.
5. Independent of pressure.

Now when the velocity V is found, and we know the sectional area, the discharge in cub. ft. is easily found. Multiply this by 6.25 and we have gallons. Then if we have

G = gallons discharge per minute,

L = length of pipe line in yards,

D = diameter of pipe in inches,

we can find the loss of head due to friction by the equation

$$H = \text{loss of head in ft.} = \frac{G^2 L}{(3D)^5} \quad . \quad . \quad . \quad (13)$$

Or if it is a pipe line for a power scheme, the loss of power would be a more important quantity.

Then if H_l = the loss of energy in foot-lbs. of every pound of water passing through the pipe, L = length, and D = diameter of pipe in feet, and V as already calculated,

$$H_l = \frac{.0007LV^2}{D} \quad . \quad . \quad . \quad (14)$$

and we know that there are 33,000 ft.-lbs. of energy in a horse-power. Now the resistance to flow in any pipe is, as we have pointed out, as the square of the velocity. So, presuming there is a pipe line carrying a certain quantity of water, and we are going to lay a branch to take, say, $\frac{1}{6}$ of the quantity. If D = diameter of the main, what will be the diameter of the branch? Its value—

$$= d = \sqrt{\frac{D^2}{6}} \quad (15)$$

D and d being in inches, but the main would continue, or reduced in size only, that is a 12-in. main would

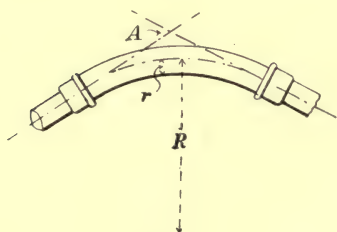

FIG. 47.

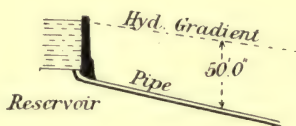

FIG. 48.

become a 10-in. one. A loss in pipe lines which would especially affect power questions is that due to bends, for which we have the following equation, giving the loss of head in feet.

$$= H = .0155 V^2 \left(\frac{A}{180} L \right) \quad (16)$$

V = velocity ft. per second.

A = angle shown in fig. 47, while L appears in the following table, when certain values of $\frac{r}{R}$ are considered, viz. the ratio of semi-diameter of the actual pipe to the radius of curvature,

$\frac{r}{R}$	·1	·2	·3	·4	·5	·6	·7	·8	·9	·10
L	·131	·138	·158	·206	·294	·44	·66	·98	1·4	2·0

Now all pipes must be laid with at least a certain gradient to provide power to overcome friction. Such a gradient is known as the hydraulic gradient, and the formula to find it is

$$\frac{2.3V^2}{d} \dots \dots \dots (17)$$

This will give us the required fall in feet per mile, which roughly pans out at 10 ft. per mile in ordinary cases, viz. a gradient of 1 in 528. Perhaps the hydraulic gradient would warrant a little further explanation. Say we have a reservoir and a pipe line from it. Say at any point on the pipe line the pressure recorded was 50 ft. Then if this line and the reservoir were plotted correctly on a section, *vide* fig. 48, the line joining the top water level of the reservoir and a point vertically 50 ft. above the pipe line at the point in question, would be the hydraulic gradient. This, of course, assumes the pipe to be running full, but full only; no pressure at the top of its circumference. So if a pipe has not a gradient equal to the hydraulic gradient, there would be a point on the pipe where we should have no pressure, and its distance in feet from the reservoir for any pipe would be

$$l = \frac{2500dH}{V^2} \dots \dots \dots (18)$$

d = diam. in ft.

But provide the pipe with the proper gradient and it will run on for ever!

Having regard to the weight of cast-iron pipes, tables for use in estimating are published, but if these were not handy we can find out the factor by means of a simple equation also. Given D = the outside and d = inside diameter in inches. W , the weight in lbs. per yd. of the pipe, is equal to

$$W = 7.35(D^2 - d^2) \quad . \quad . \quad . \quad (19)$$

while if we have flanges, 2 flanges = 1 ft. of pipe, or if the joints are spigot and faucet, 1 spigot and 1 faucet = 1 ft. of pipe also.

In water schemes one of the most essential calculations for mains of any importance is their size. Too small a pipe causes shortness of supply, while pipes too large, besides being useless expense, tend to contaminate the water by long standing. A little discretion is necessary.

Say we have to supply W cub. ft. of water per minute, the total length of pipe being L ft., its diameter = D ins., and the pressure = H ft.

Then
$$D = .531 \sqrt[5]{\frac{LW^2}{H}} \quad . \quad . \quad . \quad (20)$$

The fifth root of the equation will of course be solved by logarithms and by dividing by 5.

If, however, we have to distribute the quantity by means of a number of small pipes in preference to one large one, and their proposed diameter is d ins., the number to be provided will be equal to

$$N = \frac{\sqrt[5]{D^5}}{\sqrt[5]{d^5}} \quad . \quad . \quad . \quad (21)$$

The flow in gravitational mains, however, is not always as simple as it may appear, and mistakes can

be made in laying a water supply pipe unless the theory of flow in them is understood. Let us consider an example such as might occur in practice. Referring to fig. 49 we have a reservoir main which delivers the water into a tank as shown, following the contour of the ground as near as possible. Let a valve be placed where shown and let $V V V$, etc., be imaginary vertical pipes. Water will now stand in them to the same level as the water in the tank, as shown by the horizontal line. Open the valve, however, and the water level will sink in these pipes to

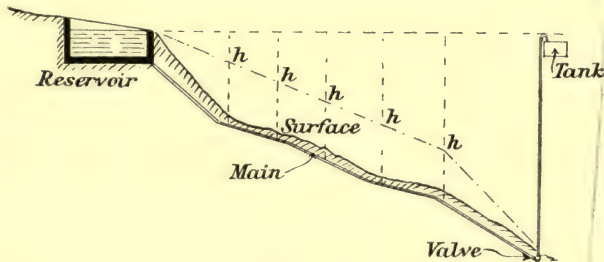

FIG. 49.

points which are always on the hydraulic gradient and marked $H H H$, etc. This position is however only true for a certain position of the valve. Open it more and the line $H H$ will drop, close it and it will rise; that is, the level of the hydraulic gradient will vary according to the draw off. Hence the water in the tank will *not* always rise at the other end of the pipe line to the same level as that of the reservoir, and hence it is very important that the highest point of the pipe line after it leaves the reservoir should be lower than the lowest level in that reservoir by an amount equal at *least* to the values found in equa-

tions 13, or 14 and 16 added together. The term "Head" is the way in which water pressure is denoted in place of pounds per sq. in. or other units. For instance, imagine a column of water 1 sq. ft. in sectional area and 20 ft. high; at the lowermost point of this column the pressure due to the water would be 20 ft. head, exerted equally in all directions, and as water weighs $62\frac{1}{2}$ lbs. per foot cube the total pressure on an area of 1 sq. foot at the bottom is equal to $20 \times 62\frac{1}{2} = 1250$. As to the intensity of pressure $\frac{1250}{144} = 8\cdot68$ lbs. per sq. in. In other words, divide

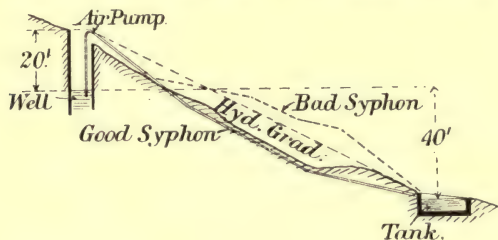

FIG. 50.

the head by a constant = 2·3 and the result will be the pressure in lbs. per sq. in.

Another point of interest in the use of gravitating water mains is the use of a syphon, and by means of which in certain cases a supply can be drawn from a well (not over 28 ft. in depth to lowest water level) *without* pumping or other mechanical means. Every advantage should, of course, be taken of cases of this sort. Referring to fig. 50, we have a well on a hillside, required to deliver into a tank as shown without pumping up from the well. Now everyone is well acquainted with the mercurial barometer, in which a column of mercury will stand in a vacuum

about 34 in. high. In precisely the same way water will stand in theory to about 34 ft., which in practice 28 ft. is considered the outside limit. Now in fig. 50 the vertical pipe in the well constitutes the short leg of the syphon and the rest of it the long leg. When the pipe is quite airtight and the end of the lower leg is somewhat lower than the level of water in the well, then if the short leg is immersed in water and air is exhausted from the pipe, water will flow right through it and continue to do so till the water falls below the bottom of the short leg, or air finds its way into the pipe, when the vacuum must be again started. The highest point of the pipe line must not be more than 28 ft. above the lowest water level, while the difference of level between the lower end of the pipe and the top water level must be at least equal in value to that found in equations 13 and 16 added together. For satisfactory working the long leg must fall gradually throughout its length, and its hydraulic gradient must be drawn, and it must not rise above this line at any point. In the figure the full line shows a properly constructed syphon, and the dotted one a syphon which would not work. At the very top point of the pipe line a valve should be placed from which water can be poured into the pipe. When this is done and the stop valve on the lower end closed, water will rise up to the filling point. This valve is then closed and will not be in use again till the apparatus fails from some cause or other, and when the lower valve is opened a continuous flow of water should result. The closing of the lower valve will not break the vacuum.

CHAPTER IV

PUMPING WATERS

IN cases of small water supplies it will very often be found necessary to raise the water from its source of supply to the point at which it is required to be used. This is nearly always the case with wells, except in the instance which was given in the last chapter, and in many cases river water will have to be pumped also, because the outlay available for the scheme will not usually warrant large reservoirs being formed at a higher level up stream, as is the case with large town water supply schemes.

Every one is well acquainted with the ordinary hand pump in use in many houses at the present day for raising water from a shallow well in the vicinity. They are usually of the form known as wall pumps, and as the name implies they are fixed to the wall, and motion imported to them by means of a long lever. They are very useful for drawing water from moderate depths (say up to 25 feet) in small quantities. When used for pumping into storage tanks the labour spent is sometimes heavy. In this class of pump the cheapest and best in the end is the best quality it is possible to buy. They should be made entirely of gun-metal, except the lever, etc., and frame, while the bearings should be bushed; all pins case-

hardened. The pump rod is best made of copper, while a copper air vessel and a draw-off cock complete the apparatus. As has already been stated, when the water so pumped is for drinking purposes only, this draw-off cock should be the only means of getting such water, but in small houses a supply has to be fed to the storage cistern, and in all cases it should go as directly as possible to the cistern laid inside the house in a wooden casing filled with saw-dust, and inside walls are preferable to outside ones for the purpose. It is always a wise precaution, when the pump does deliver into a tank, to open the draw-off cock before proceeding to pump potable water until it ceases to flow; this will show that the rising pipe is empty and that no stale water will be drawn off. Another form of pump which needs little or no description is the old-fashioned horse pump. This type of pump is not usually put down now, but briefly it consists of an ordinary two-cylinder well pump fixed in the ordinary manner, the motive power being imparted by a horse moving round in a circle of about 12 feet radius. At the centre of this circle is a pivot turning on a vertical axis and having attached to it a long pole to which the horse is harnessed, and a spur wheel which engages with a pinion on the horizontal shaft of the pump. The machine at the best is never very efficient, and usually meets with more abuse than other kinds of pumping machinery. Moreover, owners of horses have frequently informed the writer that this class of work is harmful to horses. Having thus described the two most usually found of the old types of pump, we proceed to investigate more modern and economical methods of raising water.

For the particular purpose we are at present concerned with, the hydraulic ram stands first and foremost in importance. It may here be remarked that it is strange how slow engineers and others are to adopt this old-established, simple, cheap and efficient piece of apparatus; when once properly installed a first-class hydraulic ram wants hardly any attention. There is no fuel, oil packing or labour for supervision required; practically no expenditure on upkeep; it

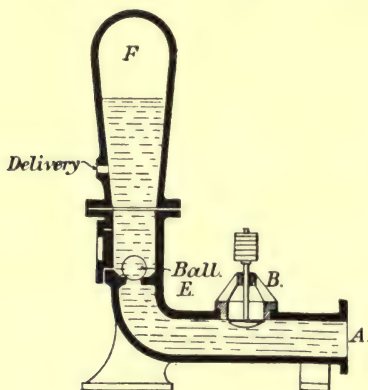

FIG. 51.

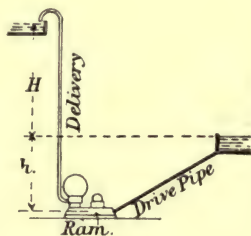

FIG. 52.

will work year in, year out, without attention and with practically no noise. The hydraulic ram is a machine which utilizes the momentum of a stream of water falling a small height to elevate a *portion* of that water to a greater height. For instance, 100 gallons of water falling 10 ft. height raises 10 gallons to a height of 80 ft., and so on; the efficiency of a good ram reaching 80 per cent, or in other words it will give out $\frac{8}{10}$ of the energy put into it. The following is a description of this simple piece of apparatus, referring to figs. 51 and 52.

At A is attached the supply pipe called the drive pipe, 10 to 20 ft. long. The bell F contains air to act as a cushion. There is a valve B, having a weight keeping the valve open normally. Suppose water starts to flow out of this valve it acquires velocity, increasing too so much as to overcome the weight and close the valve. Rushing onward, it gains considerable pressure, so much so that the ball valve lifts and the water flows up the supply pipe. Now the valve B falls again and the process is repeated. The action of the hydraulic ram illustrates the conversion of potential energy into kinetic energy, kinetic into pressure, and pressure, again, to potential (*vide* hydraulics). Now, referring to the line diagram, fig. 52, we have H = delivery head and h = supply head ; then the efficiency of the apparatus

$$= n = 1.12 - 0.2\sqrt{\frac{H}{h}} \quad \dots \quad (22)$$

The quantity of water which will run to waste by way of the dash valve B,

$$q = \frac{H}{nh} \quad \dots \quad (23)$$

n being as in equation 22.

The actual water delivered per stroke

$$= \frac{Qnh}{H} \quad \dots \quad (24)$$

The correct diameter of the drive pipe

$$= D = 2\sqrt{Q+q} \quad \dots \quad (25)$$

The correct diameter of the supply pipe

$$= d = \frac{D}{2} \quad \dots \quad (26)$$

The length of drive pipe required in feet

$$= H + 1.2 \left(\frac{H}{h} \right) \quad . \quad . \quad . \quad (27)$$

The capacity of the air vessels should be equal to

$$.0055 d^2 H \quad . \quad . \quad . \quad (28)$$

The diameter D and d being in inches. Of course it must not be supposed that a hydraulic ram can be used under all circumstances and any place instead of another kind of pump; but it is surprising how many different circumstances it is adaptable to. In the first place, a stream of flowing water, no matter how small, is essential. A small spring or brook will usually suffice. Other important considerations are the total height the water must be lifted and the length of piping through which it has to be forced.

Finally, the most important consideration, and usually that upon which the practicability of the scheme will depend, is the fall available for working the ram. In such cases as old mills, etc., there will usually be ample fall, while a swift mountain stream which never runs very low or dry in the summer will in most cases provide it; but when flat country and slow-moving rivers have to be considered the question is a little more complex, and accurate levels must be taken by an experienced surveyor. In most cases it will suffice to find the difference in level between the surface of the flowing water at points 500 yards apart, one of the two points being that at which the ram will be placed, or in the case of a surface spring, if there is a suitable place to discharge the exhaust from the ram within, say, 300 yards. Having ascertained these items the engineer may rest assured that a high-class firm can supply a ram

which will work under a fall of 5 ft. in 500 yards, provided the quantity of water is ample. In order to give the makers every chance of giving an estimate, unless the stream is a large one, in which the supply may be considered as unlimited, then a gauging should be made in the way pointed out in the

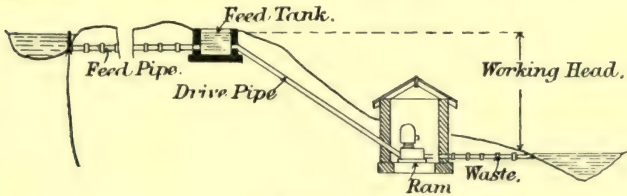

FIG. 53.

previous chapter, bearing in mind the fact that the greater the fall the less water will be required. Again, the greater the fall the less expensive will be the ram. On the other hand, it is quite possible where choice lies between bringing water from a distance in order to get a high fall, and using water near at hand with a low fall, that the more expensive

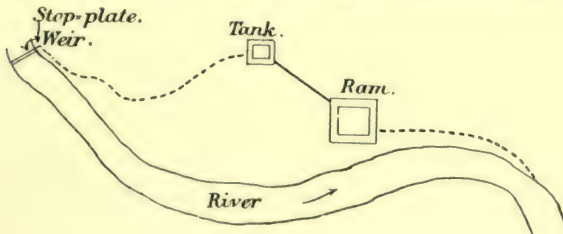

FIG. 54.

ram will be the cheapest in initial cost, the up-keep of all types being about the same.

The plan and section in figs. 53 and 54 show in diagrammatic form the usual arrangement for raising water by means of a hydraulic ram. A small weir

placed across the stream where shown, will be an advantage to working ; it need only be made of dry stone just to pond up the water so that it will enter the drive pipe easily. Water is led to the feed tank by means of ordinary stoneware or fireclay drain pipes laid on a concrete bed and cement jointed. The overflow (or exhaust) pipe from ram is made in a similar way, whilst the pipe from the feed tank to ram being under pressure would be ordinary cast-iron spigot and socket water main jointed with lead. A suitable house should be built for the ram with access for repairs or inspection, while the feed tank would be built of concrete. It serves to intercept foreign matter which would otherwise gain access to the ram and choke it. It should be cleaned out at intervals, for which purpose a small hand stop-plate is useful, where shown, set in concrete. Other modifications of the above example will of course present themselves to the reader who may have special cases to consider on their merits ; it is given as being typical of most installations.

Mention has been made of sinking shallow wells near a river to intercept the water finding its way to that river in hopes that it will be of better quality. This water will usually have to be raised to the source of supply. When this shallow well has a water level not more than 8 ft. below the surface, and a hydraulic ram is workable from the river at the surface of that well, it may be adapted to raising the water from it. Rams of this kind are made by Messrs. John Blake & Co., of Accrington, Lancs., and the idea is shown by fig. 55. The pure supply, of course, need not of necessity be drawn from a well,

it may be led by gravity from any other pure source, such as a spring or artesian well. In fact, every case wants its own special consideration. In many cases, also, two small rams will often prove more efficient for a particular scheme than a single large one. Some rams have a special arrangement of a snifting valve

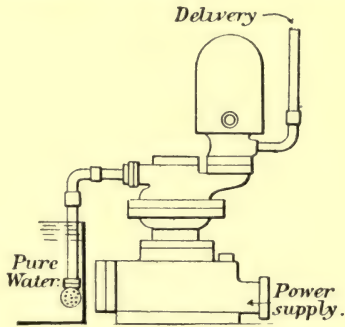

FIG. 55.

screwed into the ram casing immediately below the check valve. It usually consists of a brass plug with a very small hole drilled through its axis. Every time water passes through the check valve a small quantity will also pass through the small orifice in the snifter valve. Now when the check valve closes, the consequent reaction of the water is sufficient to cause a slight vacuum immediately under the check valve, which has the effect of drawing air through the snifter valve which is carried up into the air vessel on the next stroke, and will prevent the air in the air vessel being exhausted by the water, and consequently the working of the ram is much improved, bearing in mind that the air is usually compressed to about half its volume when a "head" of 70 ft. is the working pressure on the delivery pipe of the ram. A more modern type of ram than that in fig. 51 is shown in fig. 56, which includes a snifter valve. Another device found on some makes is that of a cylinder containing a piston acted on by a

spring, which is fitted to the injection pipe and con-

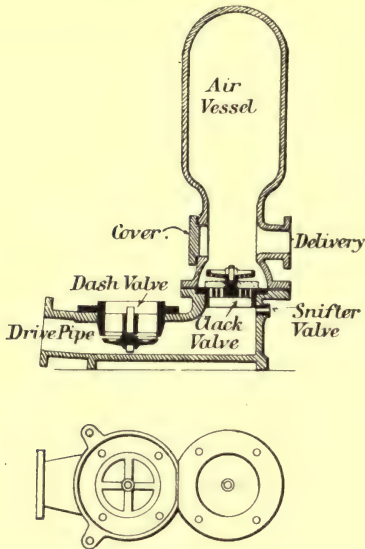

FIG. 56.

connected to the water chamber. When the water closes the waste valve by its momentum, it forces up the piston at the same time as it opens the delivery valve. This will assist in the recoil of the water. When purchasing a ram it is important to specify that all valves and moving parts should be of best gun-metal, and when fixing, all pipes should be at least 3 ft. below ground to protect them from frost. Suitable means must always be provided for conveying away the waste water as rapidly as possible. At the same time, the efficient working of a hydraulic ram remains unimpaired even if it is flooded. Rams will not usually work well when the delivery head is more than twenty-five times the working head, friction in the delivery pipe (as found by methods shown in the previous chapter) being taken into due consideration.

A ram may fail or lose efficiency by

- (a) Friction in the drive pipe.
- (b) Waste valve too heavily loaded.
- (c) Check valve too heavily loaded,

- (d) Badly fitting valves.
- (e) Friction in rising main.
- (f) Bends in the drive pipe causing friction and eddies in the flow.

The next class of pump which will be considered is the deep well pump. It has already been stated that when the suction of a pump is more than 25 ft. failure to work or impaired efficiency may result. It will sometimes be the case that the water level in a well may be considerably below 25 ft. from the surface, hence a pump at the surface is impossible and deep well pumps are resorted to. These are usually vertical barrel pumps, although other forms may be used under special circumstances. They are worked by rods actuated by suitable gearing, and driven by some form of motive power or other. Owing to the difficulty of fixing and repair such pumps must be on the very best construction, the bucket, head valves and seating should always be made of the best gun-metal, likewise the stuffing-box glands. It is also an advantage to have the pump barrels lined with gun-metal, but this is only usually found in very large and high-class pumps. The bucket rods should be made of copper, and if the buckets are fitted with gun-metal spring rings there is a decided advantage over the usual methods of leather packing. Single or double barrels are generally used for very large pumps; three barrels is a great advantage in providing a continuous delivery of water.

The pump is usually mounted on a strong platform built in the well; steel beams or cast-iron box girders are very much better than wood, while the

rods should be of wrought iron with tee butt joints. Where they are very long guide brackets have to be erected in the well shaft, at intervals of about 10 ft., and the guides are best made in the form of anti-friction rollers. The erection of these pumps demands the greatest care, so as to ensure that the pump and rods are in a truly vertical line. If this is not so the valves will get broken. The most efficient pump for this class of work is that which has a hollow working barrel, and the suction valves in that barrel, and the best known type in England of such a pump is perhaps that known as Ashley's pump, and made by Messrs. Glenfield & Kennedy, Ltd., Kilmarnock. It is illustrated and fully explained in figs. 57 and 58. It has the advantage of perfect accessibility; the bottom valve and the bucket which contains both the suction and delivery valves can be lifted, examined and replaced very quickly. The pump is admirably adapted to bore-holes, and it is made in sizes from 2 in. \times 6 in. to 23 in. \times 48 in.

Another form of pump used in wells is known as the plunger pump, and is very simple, and is illustrated in fig. 59. Here A is the plunger, in small pumps usually of gun-metal, and in larger sizes lined with the same working in an ordinary stuffing-box, packed with hemp soaked in tallow. B is the rising main, C the upper valve chest, D the lower valve chest, and E the suction pipe with a strainer at the bottom. It may here be remarked that all pumps should be placed as near the water as possible, and that the suction pipe should terminate in some sort of strainer to keep out large foreign bodies which might enter the pump and choke it, if not ruin it

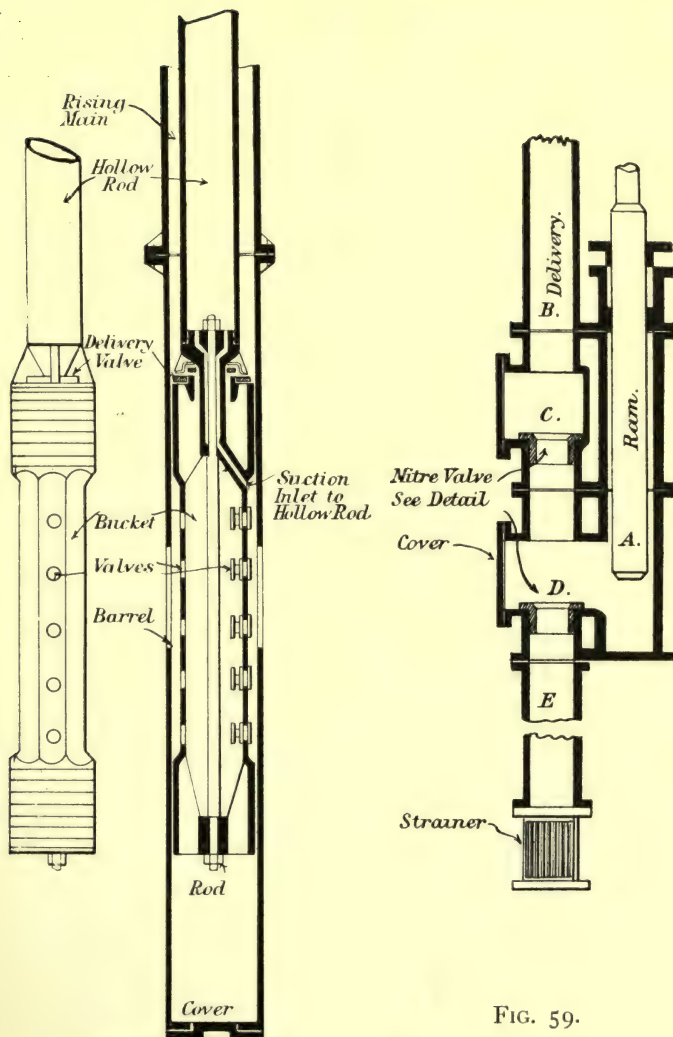

FIGS. 57, 58.

FIG. 59.

altogether. Some form of retaining, or foot valve, should also be included in the equipment, in order that the pump will never "suck wind," as it is termed. For ram pumps of all kinds, except high-speed pumps, to which reference will be made, the simplest and best form of valve is the mitre valve, as

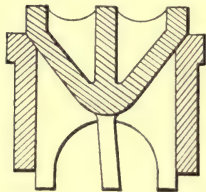

FIG. 60.

shown in fig. 60, made of gun-metal and having gun-metal seats fixed in the pump casing. They are usually bevelled to an angle of 45° and fitted with feathers to stop and guide the beat of the valve. They should be made as large as possible, in order to reduce

the amount of lift required and consequent wear.

Another class of pump having solid buckets is shown in fig. 61. In detail it is not so much used as those previously mentioned, but gives a very even flow of water. They want more attention than the other types, and consequently this will only render their use in large, shallow wells admissible.

The rings are a patent composition known as Woodite and are shown at A in fig. 61 A. The bucket is solid, and in order to fit the rings they must be heated in hot water for 15 minutes, and stretched over the bucket, which is then placed in position in the pump barrel. At B are shown holes $\frac{1}{16}$ in. in diameter. There are four to each ring. They serve to admit the water behind the rings to keep them tight. At C should be a working clearance between barrel and bucket.

We now pass on to a class of pump used in con-

nexion with estate water supply. In nearly every

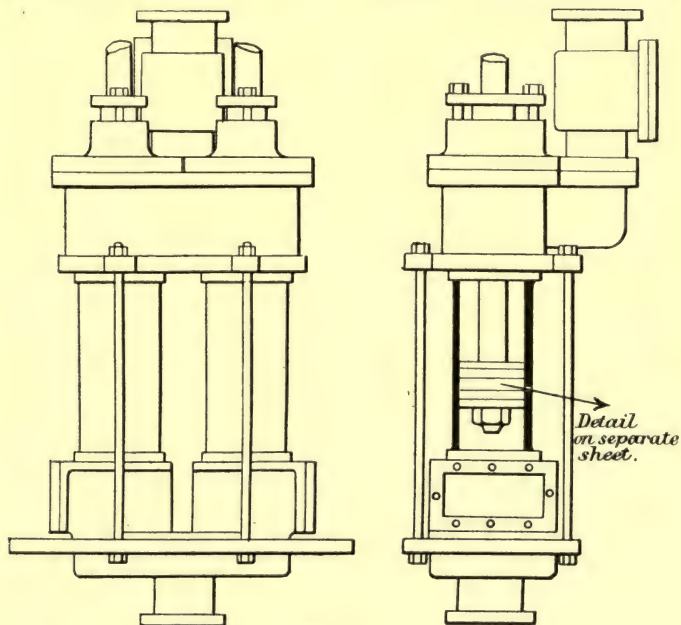

FIG. 61.

case it can be placed at the surface, and is known as the single, double, or treble ram pump as the case may be. It is certainly the most simple, efficient and convenient class of pump for the purpose. Single and double rams are used where the supply is only very small, but where possible it is advisable to use a treble ram pump, as the flow of water is much steadier and the pump lasts much longer. In any

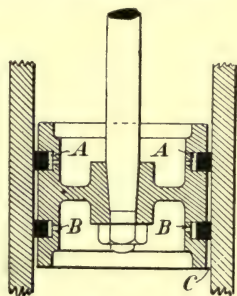

FIG. 61 A.

case a pump larger in size than is absolutely necessary, and working at a consequent lower rate of speed, is in all cases an advantage.

For the purpose of description a vertical treble ram pump has been chosen, as made by Messrs. Frank Pearn & Co., because it is typical of the class of engine, and a single or double ram pump has the same essential features. It is illustrated in figs. 62, 63 and 64, while a horizontal pump is shown in figs. 65 and 66, designed for an electric drive. The pump barrels are of close-grained cast iron, together with the valve chambers, and vacuum vessels are formed in one having a trough which collects leakage from the glands. The valves and seats are of gun-metal, and the type shown in fig. 60. The rams are of the trunk type in small sizes of gun-metal, and large sizes cast iron lined with gun-metal. They work through neck rings and cast-iron glands packed with hemp soaked in tallow. The crank shaft is of forged steel, and works in gun-metal bushes of the usual type. The connecting rods are of forged steel likewise; the air vessel is of cast iron. This class of pump is also commonly known as a three-throw pump. In order to give the reader a better idea of this class of machine, a similar type is shown in fig. 67, taken from a photograph. This class of pump may be driven in a variety of ways, discussed later on, but it must run slowly, and that is the reason of the pulleys, gearing, and counter shaft shown. There is now on the market a very good pump which has been designed to run at high speeds, and so avoid the wear, tear and noise of gearing and the necessity of belts, etc. It is made by Messrs. Daniells & Co.,

DEPARTMENT OF THE ARMY
HEADQUARTERS
WASHINGTON, D. C.

of Stroud, Gloucestershire, and is known as the "Excelsior" pump. Pumps with mitre valves must run fairly slowly, under 60 revolutions per minute being generally deemed advisable to allow the valves to close and to avoid wear and tear on them. The Excelsior pump, which is illustrated in figs. 68 and 69, has not the ordinary mitre valve but a special valve known as the Guttermuth valve, which has decided advantages over the ordinary type when

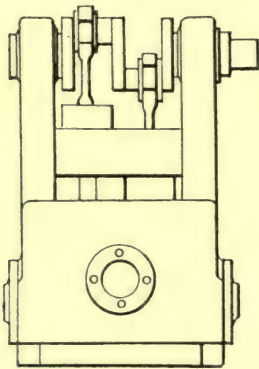

FIG. 68.

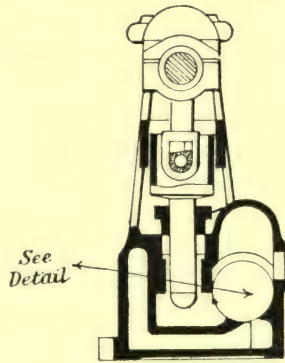

FIG. 69.

the pump has to run at a high speed. The valve consists of a strip of phosphor bronze, one end of which is coiled upon a spindle to form a spiral, leaving part of the sheet flat to form the valve flap proper. Referring to figs. 70 and 71, it will be seen that the entire opening of the port only entails a minimum coiling strain on the spiral, which increases its durability while yet allowing it to exact sufficient power to close the flap gently, directly the flow of water ceases. An illustration of a complete set of Guttermuth valves appears in fig. 72. These valves

do equally well on horizontal pumps as well as vertical.

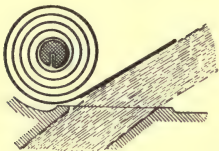

FIG. 70.

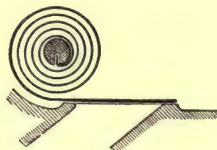

FIG. 71.

For general purposes there is a pump which satisfies a great many conditions and is worthy of notice.

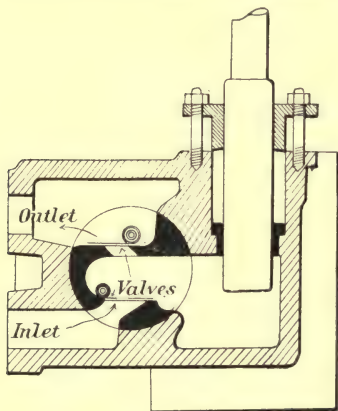

FIG. 72.

It is known as the "Hatfield" pump, and is made by Messrs. Merryweather & Co., Greenwich Road, London. It is a very novel adaptation of the three-throw pump, and is illustrated in figs. 73 and 74, from which it will be seen that there are three pump barrels arranged symmetrically round the shaft. They form part

of a single gun-metal casting, in which also are formed the valve chambers and passages. Each pump piston is of comparatively large diameter, but has a very short stroke. The advantage of this unique arrangement is that the pump may run at a high speed, if required up to 700 r.p.m. The valves are a special form, made of india-rubber, with a very large area and small lift. The pump is very well

adapted to electric driving, and a special arrangement of a bye-pass between suction and delivery pipes takes the place of a clutch. These pumps are also fitted with Merryweather's patent variable stroke mechanism, by means of which the quantity of water delivered and the pressure can be controlled, while the pump shaft is being driven at a constant speed.

Pumps fitted with this arrangement offer many advantages where a pump is required for domestic

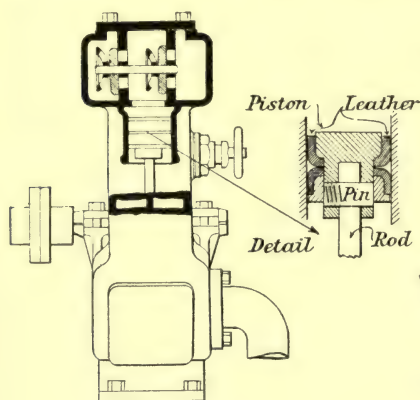

FIG. 73.

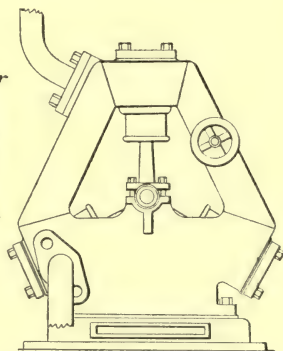

FIG. 74.

water supply and fire protective purposes. When running at a short stroke it is capable of forcing water through long lines of piping, and to great heights, for filling tanks, reservoirs, etc., and in the event of an outbreak of fire the pump can be run up to its full capacity, and large quantities of water thrown with great force on to the fire.

The variation in stroke is effected by means of a sliding eccentric, provided with internal gearing for adjusting the eccentric relative to the crank shaft,

thus altering the amount of stroke. A hand-wheel is provided for the purpose of adjusting the stroke, which can be done gradually, thus enabling any desired quantity or pressure to be obtained.

The main casting is entirely of gun-metal, fitted with three gun-metal plungers working through gun-metal packed glands directly in the valve chambers. Each plunger is fitted with a substantial gun-metal tail-rod, working through a gun-metal stuffing-box in the valve cover. The crank shaft is of steel, running in gun-metal adjustable bearings; the connecting rods of gun-metal coupled to the plungers with large ball and socket joints. Efficient lubricating arrangements are provided, and large wearing surfaces.

Another advantage of these pumps is that they work equally well when the shaft is vertical or horizontal. This latter position allows a great deal of latitude in erection, and is a condition which may save expense, as will be pointed out when motor power for driving pumps is considered.

In most cases of estate water supply, it will generally happen that the quantities of water to be raised are comparatively small, and the height to which it is pumped fairly great. Under these circumstances, then, the pumps which have been described will be generally found to satisfy most conditions, and pumps of any other kind, of a more or less fancy nature, are generally to be avoided. When, however, it occurs that a large quantity of water has to be raised to a very moderate height, say 20 ft. or so, there is an entirely different machine for the purpose known as the centrifugal pump. It is a rotary pump, and pos-

sesses the advantage of strength, and simplicity of construction, low first cost, simple foundations, and ease of erection and repair. A well-designed centrifugal pump will discharge more water for a given power than any other kind. Centrifugal pumps can be erected in very awkward places sometimes; they will work equally well with the shaft vertical or horizontal, but the suction should not be greater than 7 ft., and when placed below the water level it is an advantage. They are very useful for raising dirty water, as they have no valves. The arrangement essentially consists of a series of curved blades, mounted on a spindle and made to revolve in a cast-iron case. When so, a partial vacuum is created which provides the suction at the same time. Centrifugal force impels the water towards the outer circumference of the blades, where it accumulates pressure and is so raised to the desired height. All centrifugal pumps run at a high rate of speed. When two or more pumps are combined in one casting on the same shaft and bed-plate, the water passing from the first to the last, and finally to the delivery, the combination is known as a multi-stage pump, and such pumps deliver water to a greater height than would be possible with a single stage pump.

The subject of deep well pumps has already received attention. In many cases pumps of this kind are indispensable, although even the best are sometimes far from satisfactory, and many engineers prefer an entirely different system of raising water from wells. It is hardly likely that circumstances will be once for all in favour of such a device, because the dominating question is a supply of compressed

air, and this will rarely be found on estates installed for a particular and separate purpose. The method about to be discussed is known as the "air lift" pump. In principle and operation it is very simple. Air is injected by means of a nozzle placed below the working water level, and rising, carries up water along with it. The submerged parts are subject to no wear whatsoever, and except for corrosion, are practically indestructible, even when working in gritty water which is often fatal to deep well pump pistons. The air compressor and receiver, which are the only parts requiring attention, are, of course, at surface level. The Worthington Pump Co., who make air lift pumps, record the fact that the air lift pump has the advantage of increasing the yield of any deep well; whether this is the case or not with every well, the air certainly imparts sparkle and life to the water, which is certainly desirable. Of course an air compressor has to be erected and driven by some form of motive power. Some years ago an air compressor was a cumbersome and expensive piece of apparatus, but there are now on the market some good machines of small size which run at a high speed, such as those manufactured by Messrs. Alley & Maclelan, of Glasgow; Messrs. Reavel & Co., of Ipswich; The Worthington Pump Co., London. Where electricity is handy, an electrically driven air lift pipe may prove its advantage above other forms, but like all engineering questions each case has to be considered on its merits, and a knowledge of ascertaining these merits is not a subject which a writer can describe, but is the monopolized possession of the engineer possessing experience and common-sense. In cases

of deep well pumping, in which an existing supply of electricity is handy, the choice may be between

1. The air lift pump.
2. The centrifugal pump with vertical shaft driven by a motor on the same shaft without gearing.
3. A Hatfield pump under the same conditions.
4. Any of the other forms of well pump described.

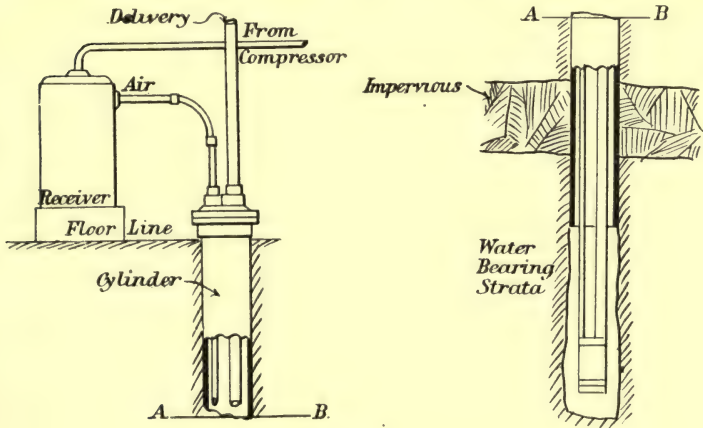

FIG. 75.

It will be seen, then, that the subject provides ample scope for one's wits.

The general arrangement of an air lift pump is shown by fig. 75, while a suitable small high-speed compressor is illustrated in fig. 76.

So much for the actual pumps.

The pipes through which the water is drawn and forced demand attention, more in fact than is usually bestowed on them. The suction pipes should be of ample size, as short and straight as possible, perfectly airtight, and any bends should be of a large radius

(see remarks in previous chapter on friction of bends); as before advised foot-valves on the suction are essential. The suction pipe should be twice as large (not twice the diameter, which means four times as large) as the delivery, and more on high-speed pumps if the makers recommend it. A strainer at the foot of the suction pipe usually completes it.

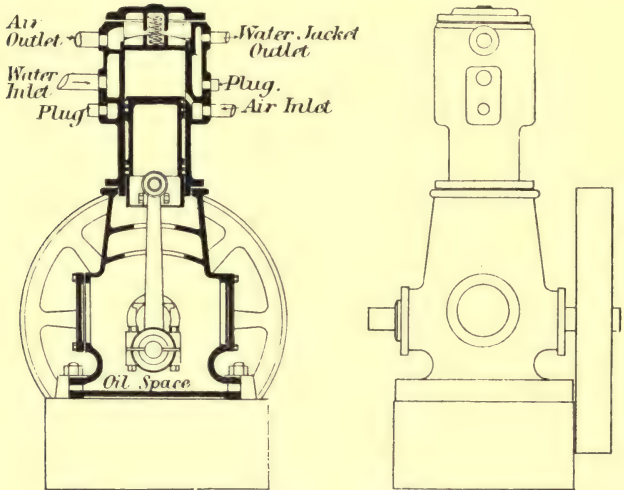

FIG. 76

Regarding the delivery pipes, it is essential to see that they are truly cylindrical. For small sizes where the water is not likely to unduly corrode them, wrought-iron pipe (gun-barrel) with screwed collar joints, etc., are used. They are, length for length, about 25 per cent lighter than cast-iron pipes of the same diameter, and they can be bent conveniently.

In most cases, however, it will be preferable to use cast-iron pipes, which are not so liable to corrosion,

but in the smaller sizes are liable to easy breakage and uneven thickness of casting. They should be vertically cast in dry sand.

Each pipe before fixing should be examined and struck gently with a hammer, to detect faults, and the bore should be even throughout. They should be laid with as few bends as possible and with as uniform a slope as the ground will permit of; a check valve near the pump is an advantage as it relieves pressure at starting. The size of a delivery pipe is usually stated by the makers of the pump; it should be about $\frac{1}{3}$ to a $\frac{1}{2}$ the area of the working barrel, and if very long should be increased in diameter to reduce friction according to the conditions laid down in the previous chapter.

The joints of these pipes may be simple flange joints, with four bolts having square nicks fitting in square holes in the flanges, the packing consisting of a lead ring. In high-class work the flanges are *drilled* to template and faced in the lathe, red lead being used to finish the joint. In most cases, however, the spigot and socket joint made with run-lead and caulked, or the turned and bored joint, will be found as good as any. They will be described in the next chapter.

Pipe lines from pump should be so designed that the speed in them will be less than 250 ft. per minute, because it must be borne in mind that fluid friction always varies as the square of the velocity.

It will be seen from the illustrations that a bottle-shaped casting appears on the delivery side of pumps. It is known as the air vessel, and is for equalizing the flow of water and cushioning it. It relieves the valves

of severe shock, and altogether improves the working of the pump. They are sometimes placed on the suction side, but only usually in large pumps. For the delivery side their cubic capacity is generally five times the total displacement of the ram or rams, as the case may be; those on the suction side have about half this capacity. The shape of an air vessel does not matter much, generally the cylindrical or inverted pear shape is found in practice. They must be smooth inside.

An important problem relating to pumps for estate water supply and other purposes is the power required to drive them. So many factors depend on this. For instance, knowing the required duty of the pump it might be necessary to ascertain if the power required to give this duty can be had in the form of water or other natural source, or if not, what size of engine will be wanted and its consequent capital cost and cost of running.

For instance, let us take the following example. A three-throw pump is to be installed to pump 3000 gallons per hour to a height of 300 ft. The size of the rams is 4 in. and the stroke 6 in. At each revolution of the pump the theoretical amount of water displaced will be equal to

$$\frac{3 \times 4 \times 4 \times .7854 \times 6}{1728} = \frac{7854}{6} = .1309$$

and $.1309 \times 6.25 = .818$ gallons per revolution

$$\therefore \frac{3000}{.818 \times 60} = \text{say } 60 \text{ revolutions per minute}$$

as a fair speed, but bearing in mind that the theoretical discharge will only be about 80 per cent of the actual, it will be well to provide for the pump running at

$\frac{60}{.80} = 75$ revolutions per minute, which would be quite fast enough for a small three-throw ram pump with ordinary mitre valves.

Now the horse-power required will be as follows : 3000 gallons per hour = 50 gallons per minute, and a gallon of water weighs 10 lb. The head, 300 ft., is assumed to include the actual vertical height of the delivery above the suction, *plus* friction in the pipe and friction due to bends, all calculated as already pointed out.

Now $50 \times 10 \times 3000 = 150,000$ foot-pounds of energy required. A horse-power is taken as equal to 33,000 foot-pounds, while the engine will probably give 80 per cent efficiency, the gearing, etc., 90, and the pump, as stated, 80. The combined efficiency of the whole will then be $.8 \times .9 \times .8 = .576$, say 60 per cent over all efficiency. Hence, as the water horse-power is equal to

$$\frac{150,000}{33,000} = 4.54$$

the actual horse-power required will be

$$\frac{4.54 \times 100}{60} = \frac{45.4}{6} = 7.566,$$

say 8 horse-power. If the engine was a gas engine this horse-power would have to be that which was developed by the engine during a Brake test. Of course the testing of such engines is quite out of the province of this book, but the prospective buyer of plant must be very careful upon what the makers mean by a horse-power. The term nominal horse-power is misleading, and should be strenuously avoided. With gas engines and oil engines only the

Brake horse-power should be considered, and the makers should be bound to provide an engine of that power under the circumstances under which it will work. The indicated horse-power, a quantity upon which steam-engine builders place much reliance, is quite unsuited to the rating of gas and oil engines, and is in all cases unreliable. Indicator diagrams are only taken for the purpose of ascertaining the working of the valves, etc.

We now proceed to investigate the ways in which small pumps are economically driven. For country work, where no electricity or gas supply is available, the oil engine or producer-gas engine at once provides a solution of the problem. Those made by first-class makers are reliable machines, and small oil engines will generally work well on ordinary lamp oil (Royal Daylight Brand), which can be obtained in most localities. For larger engines which use more oil, it may be prudent to lay down a plant capable of using cheap crude petroleum, which when bought in large consignments provides very cheap fuel.

Where continuous working will be the rule, one cannot do better than install a producer for the engine of the suction type, if anthracite coal can be obtained at a moderate price. Any ordinary intelligent working-man can look after the producer, which, when started (they take about half an hour to light up and start), will work for hours with only casual attention. Most makes of gas engine are similar to each other; it is hard to say which is the best maker. Each claims special advantages for his own engine. A typical example is given in fig. 77.

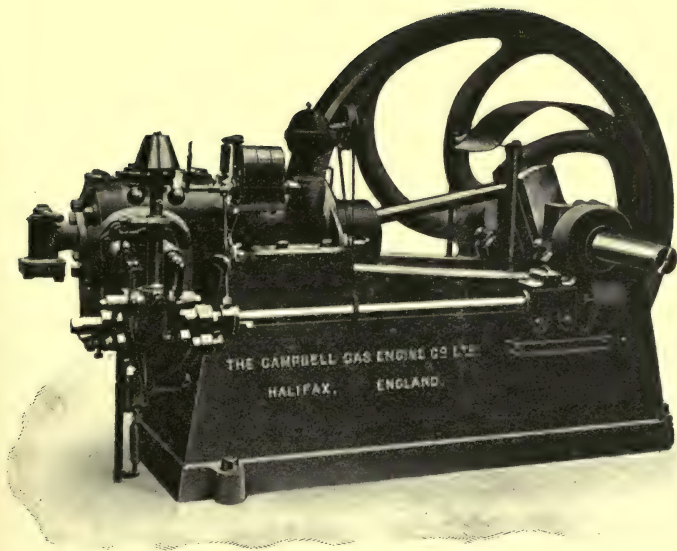

FIG. 77.—A TYPICAL GAS ENGINE.

For driving ordinary three-throw pumps a belt may be employed driving on to the counter shaft of the pump as shown in the illustrations. The engine must be started with the belt on the loose pulley, and when it speeds up and is firing every fourth stroke, the belt is shifted to the fast pulley, from which it should always be removed before closing down. A much better arrangement is, however, where the engine drives the pump by gearing. In this case the pinion on the engine shaft should be of raw hide to reduce noise and wear. A friction-clutch connects up the engine and pump when the latter is running normally. Such an arrangement, together with other details of a typical plant, is shown in fig. 78. Gas or oil engines may be vertical or horizontal; the writer is inclined to favour the vertical pattern when all other points are in its favour.

Oil engines are now made of the high-speed type, very similar to the motor-car engine, and appear to give satisfactory results.

The remarks on gearing, etc., only apply to those pumps which must run at a speed below that at which the engine can economically run. Daniells' pumps, the Hatfield pump, and centrifugal pumps do not want gearing, but the latter may have to run by belt at a much higher speed than the engine.

On estates the steam engine does not now usually exist, but, where a supply of steam is handy, the best type of small pumping engine is the direct acting type, either duplex, with positively-moved valves, or the simple, with steam-moved valves. Pumps of the "weir" type are very simple and economical. Where electric light exists on an estate, the power may be

used for pumping water by means of electric motor. This, however, is not generally a wise proceeding where no accumulators exist; it is generally prudent to make the pumping plant a separate unit. It must not be supposed from the foregoing remarks that the gas or oil engine provides at once the best way of raising water. These machines, however good, cost money in fuel and repairs, and before deciding on any form of motive power, the engineer should make quite sure that all *natural* sources of power have been investigated and found wanting. We have already discussed the hydraulic ram, but a flowing river provides another source of power in the shape of a turbine (water-wheels will not be discussed, they are heavy, cumbersome machines, of low efficiency and out of date). Say, however, a stream is gauged and found to provide at least 1000 gallons per minute and a fall of 10 feet can be obtained.

A gallon of water weighs 10 lb. $\therefore 10 \times 1000 \times 10 = 100,000$ foot-pounds per minute, which is equal to $\frac{100000}{33000}$, 3 horse-power, from which a good turbine would easily develop $2\frac{1}{2}$ horse-power. If the fall were 20 ft. this would be doubled, and so on. The matter in all cases demands attention, far more in fact than is usually given to it.

There are three ways in which water-power may be used. For falls up to 20 ft. with large quantities of water, the Jonval type of turbine is used; for falls from 20 to 150 ft. a Girard turbine is the best; while if the supply is small but the head is great, say 150 to 500 or over, a pelton wheel is a very serviceable motor. In Britain the most usually occurring instance is the first, and as the use of water-power is a comprehen-

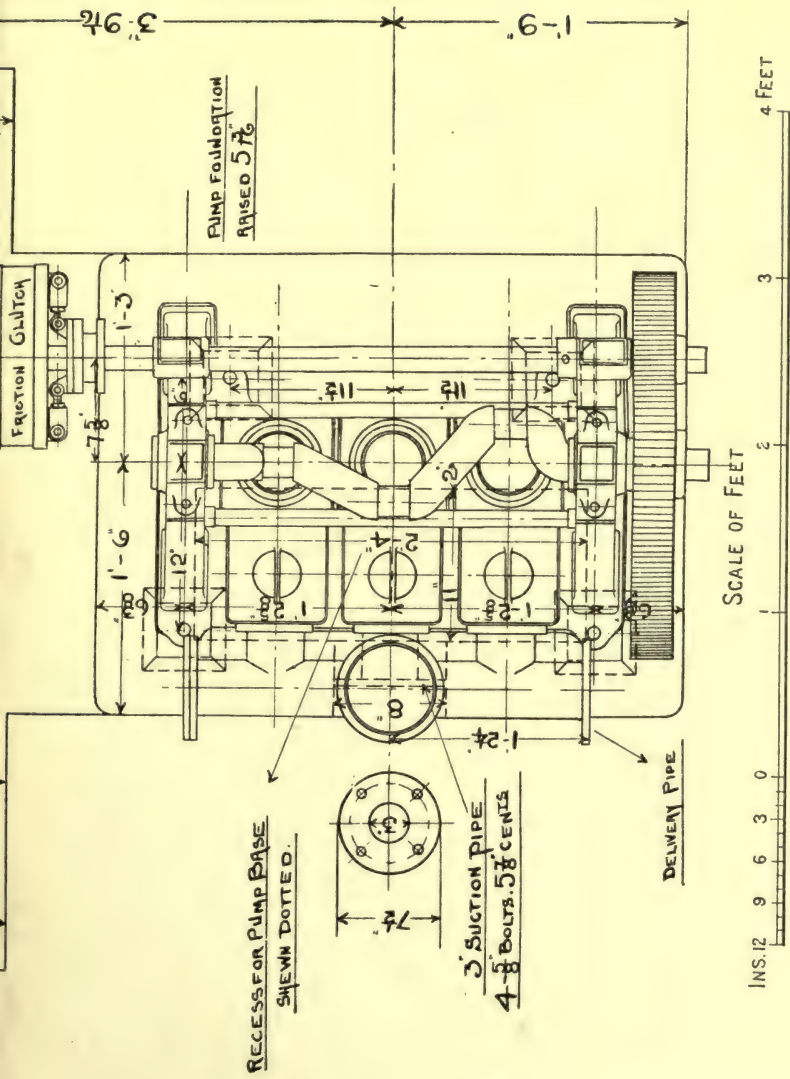

FIG. 78.—TYPICAL PLANT SHOWING COMBINED ENGINE AND PUMP CONNECTED BY

sive subject in itself, our remarks will be confined to giving an illustration of the means of utilizing power in this way. Referring to fig. 79, water is conducted along the head race to the wheel pit, passing through a grating to remove leaves, etc., and a penstock for shutting down for repairs.

The turbine works completely under water, or is "drowned," as it is termed, and has a vertical shaft. The water, after passing through the turbine, flows away by gravity along a suitable channel. Above the turbine is the house where the starting wheel is fixed. The sliding gate is never used for regulating purposes. The bevel gearing is, also in this house, and the shaft which drives the pump and other machinery as required.

The arrangement is very compact and typical. The

Girard turbine and the pelton wheel generally have horizontal shafts and the water laid on to them by pipes; the methods of connexion with the pump then become quite similar to any other prime mover.

Yet another source of power which must not be lost sight of is wind-power, which is very frequently employed for the purpose under discussion. It is

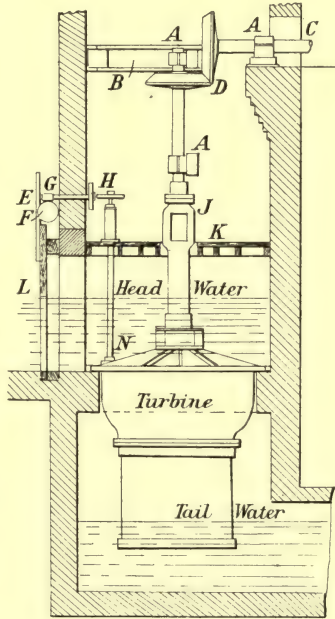

FIG. 79.

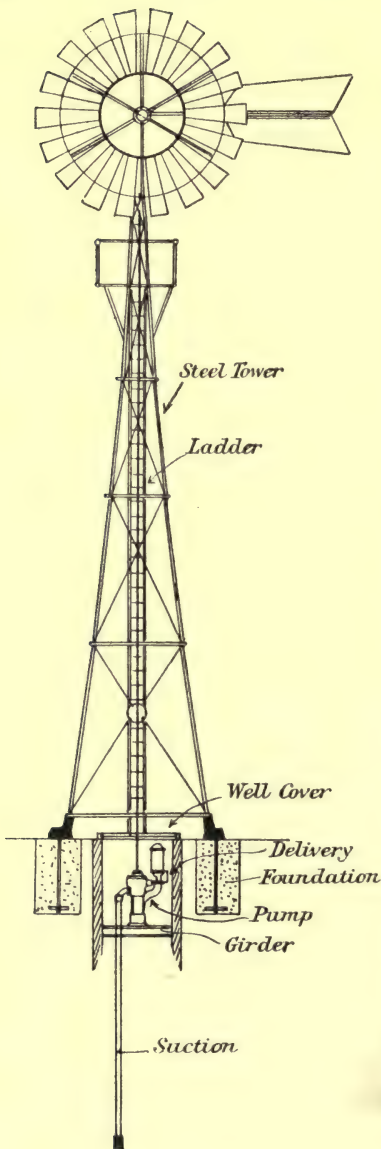

FIG. 80.

simple, free from running cost, and low in repairs, but has the one domineering disadvantage that in times of hot, dry weather, when water is wanted badly, a windmill has a habit of stopping work. This may, of course, be avoided to a great extent by putting down a plant in excess of what is actually required, and constructing a very large service reservoir, capable of holding a few weeks' supply, which will retain the excess water pumped in windy weather. A modern windmill is an entirely different machine from the old type of romantic days. A modern mill is an ingenious contrivance and remarkably efficient. Americans are years ahead of Britain in this respect. The general arrangement is shown in fig.

80. Erected directly over the well in which is placed the pump, the fan is supported on a light steel angle-iron frame, and to which access is gained by a light ladder. The pump is driven direct without gearing, and generally works at about 60 r.p.m., but the driving rod is not driven off the main shaft but usually from a counter shaft, which is driven by gear wheels from the main of a ratio of about $2\frac{1}{2}$ to 1. The up-and-down motion of the rod is then produced by an ordinary crank. The main shaft is not in the centre line but some few inches away from it. The tail vane, however, which serves to keep the fan "head on" to the wind, is exactly in the centre. This arrangement controls the working of the mill in very high winds, because the fan, by reason of its being not in the same straight line as the tail vane, will tend to turn away from the wind. In ordinary weather the tail vane will counteract this through the medium of levers and springs which are connected with the head of the machine; high winds, however, overcome the resistance of these springs in proportion to their intensity, and by turning the wheel to one side the speed is reduced. Another means by which windmills are governed is a side vane, which projects on the plane of rotation of the wheel. The wind pressure on this always has a tendency to turn the wheel edgewise to the wind, this force being counteracted by a weight which, however, is overcome by any abnormally strong wind.

Some mills have centrifugal governors. The blades of the mill are connected in sets of about six and fixed to a bar at the middle of their lengths. A rotating action to this bar closes up the blades,

umbrella fashion. A weight, however, prevents this action taking place till the governor is travelling at such a speed as to lift the weight. The mill may be stopped by closing up the blades, independently of the governor, by a chain gear at ground level, while in other forms a band brake fulfils the same purpose. On very large machines a small fan is fixed in a plane at right angles to the main fan. When high winds tend to drive the fan away from the wind, this small fan starts to rotate and closes up some of the blades.

To find the approximate horse-power of a mill—
 Let N be the number of blades,
 A the area of each blade in sq. ft.,
 V the velocity of the wind in feet per second.

$$\text{H.p.} = \frac{NAV^3}{1,660,000} \quad \dots \quad (29)$$

For instance, if $N = 50$, $A = 2.5$, and $V = 30$,

$$\text{H.p.} = \frac{50 \times 2.5 \times 30^3}{1,660,000} = \frac{337.5}{166} =$$

just over 2 horse-power.

A few words on the erection of pumps may be an advantage to the reader. While it is usual for the makers to build the pump and engine complete, and erect and test it at the works, and finally send one of their own fitters to erect it on the site, it is usual for the purchaser to have the foundations put in by an ordinary builder. For this purpose the engine builders will supply a plan of the foundations, which must be rigidly worked to according to the dimensions entered thereon. Where the ground is composed of sand, gravel, or hard clay, the load on the foundations *may* be $2\frac{1}{2}$ tons per sq. ft., although

circumstances will rarely demand this except in the case of very heavy machinery. When excavating to put in the concrete it may happen that a water level is found, and in that case it is advisable to continue the cutting somewhat further down than required, and fill up to the water surface with broken brick or stone well rammed. The actual composition of the concrete is usually 6-1 Portland cement and ballast, the latter being composed of 2-1 of $1\frac{1}{2}$ in. broken stone and sand. This is laid and rammed in 4-in. layers till it is raised to within 1 in. of the required height. It should then be covered with damp sacks and left for 30 hours at least to set. After this a rendering of 1 in. of sand and Portland cement in equal quantities is applied, and the whole brought to a hard, smooth surface and left for six or eight days. It is customary for the contractor to make a wooden template of the engine bed according to the drawings supplied and with the exact position of the foundation bolts marked on it. This is placed in position, and the masonry, brickwork, or concrete put in round it. The verticals are light trucks in which the foundation bolts are eventually placed. They have a shoe at the lower end, as shown in fig. 81, which is well embedded in the masonry or concrete. Gas pipe is frequently used in place of the wood tubes. Foundation bolts should not be cemented on.

Regarding the actual erection and fitting up of pumps, the suction pipe should always be full to the sizes specified by the makers, and if very long, somewhat larger. It should have as few bends as possible and these of a large sweep. The suction pipe if long must always be laid with an uniform fall to avoid

air pockets or summits, and this gradient should not

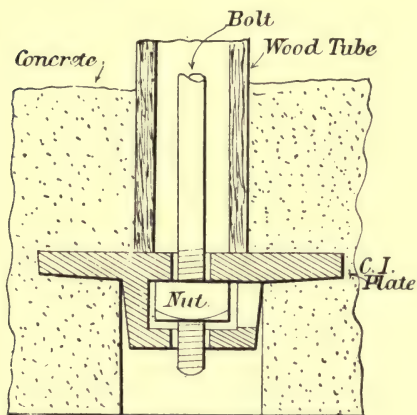

FIG. 81.

be less than 1-150. It is equally important to see that the pipe joints are quite tight, or else air will leak in and stop the pump working. It should always be tested to about 30 lb. per sq. in. before filling in the trench it is laid in. Cast-iron flange pipes are the best, or spigot and socket pipes laid downwards from the pump. Valves on either suction or delivery should be full-way gate valves, while the merits of the foot valve have already been discussed, but the strainer, which is usually combined with the foot valve, must always be specified to have openings to a total area at least four times that of the suction pipe so as to reduce friction. The strainer also should be frequently examined and cleaned if required, a precaution too often overlooked.

Finally, when the suction pipe is fitted the utmost care must be taken to see that there is no foreign matter in it of the smallest degree which would get into the pump and do certain damage. The discharge pipe would be laid in the same way as will be described in the next chapter, with the simple addition of a relief valve immediately next to the

pump. This would prevent damage to the pump in case it was started against a closed valve on the discharge, an occurrence of which, due to a careless workman, was witnessed by the writer to his physical discomfort.

As the subject of internal combustion engines is so important in the case of small water supply schemes, it may be well to say a few words on them for the benefit of those who have little or no experience in this connexion, and who would perhaps otherwise be at the mercy of the engine builders. Of course it pays to deal only with high-class firms, who would rather help and advise than take advantage of the inexperienced.

The bed of a gas engine (under which heading are included oil and spirit engines) similar to that shown in fig. 77 is of cast iron. The cylinder is a separate casting and is generally in one with the combustion chamber and exhaust valve box. Ample space should be provided for the circulation of cooling water around the walls and valve seats most exposed to the high temperature of the explosions. The cylinder should be fitted with a removable liner of very hard metal which can be easily replaced at any time. The crank shaft and connecting-rods are of mild steel. The former should be made from one forging with the throw slotted out and run in long, gun-metal adjustable bearings.

In oil engines the ignition may be effected by either an externally heated tube of nickel alloy heated by a wickless lamp adjusted in relation to the tube, or an internally heated tube of nickel alloy enclosed in a small chamber filled with non-conducting material.

The engine is started by an externally heated tube and run for a short time, when the internal tube gets sufficiently hot to run the engine without further attention, the external tube being put out of use. With producer-gas the magneto ignition is the most efficient.

The governing of all but the very smallest sizes (which employ an inertia governor) is effected by the usual centrifugal form of governor on the hit-and-miss principle. That is, when the engine exceeds the normal speed the governor causes it to make an idle stroke when otherwise it would make a power stroke.

As before stated, it is most important for the buyer to be quite clear on the point of "horse-power".

No other definition of the term should be considered than *the working Brake horse-power* which the engine will give off during an ordinary full day's work of ten hours.

Where it would not entail a long journey, a visit to the works to see the engine working on the test beds is very advisable, otherwise a test certificate should be applied for, and in all cases a trial run should be specified after the installation is fixed.

The approximate consumption of oil in a first-class engine should not exceed one pint per working Brake horse-power per hour under normal conditions when working at full load. In large engines this will be reduced, while at partial loads it will be increased for any engine. Hence the desirability of working the engine up to its full load. In all cases the brand of petroleum used should be that advised by the makers for the particular engine.

When town gas is used (of the standard quality of 630 B.T.U. net heat value) the consumption should not exceed 20 cub. ft. per Brake horse-power per hour at full load, and with suction gas-producers using anthracite the consumption of fuel should be about 1 lb. per Brake horse-power per hour in small engines and $\frac{3}{4}$ in very large ones. When gas coke is used 30 per cent more should be allowed. With these considerations in view then, the prospective buyer will be able to see what class of engine will be most suitable to his requirements. For instance, in one place anthracite may be very expensive and oil comparatively cheap, in another the saving on fuel in a producer may repay the cost of that producer in a few years. This is the case with engines over 10 horse-power which work continuously more or less.

The following advice should be laid to heart:—

Never select an engine which is just equal—or barely equal—to the required duty. Many vendors make a practice of this, involving their customers in certain disappointment and continued trouble. No engine should be subjected to overload, as overheating and (consequent) premature ignitions are thereby induced, involving the risk of sudden destructive strains on both cylinder and crank shaft.

Be careful to define the kind of work the engine is to perform, and how long it is to run without a stop. The usual day's run in most places is 9 to 10 hours, but there is no difficulty in providing for much longer periods of work if it is made known, when the engine is being ordered, what length of unbroken run is desired.

Continuous Running.—This expression is frequently made use of without qualification; or the engine is said to be required to run “day and night,” without any period being assigned, which is obviously absurd. When an engine is required for long runs be careful always to state how many hours it is to work without stopping, and how long the stop is to be.

Height above Sea-level.—A gas or oil engine gives off less power as its position is elevated, owing to the diminished atmospheric pressure and consequent lessened supply of oxygen. At moderate heights the loss is inappreciable, but at considerable altitudes it becomes serious. Roughly speaking, the loss of power may be taken as about 3 per cent for each thousand feet above sea-level. When, therefore, there is any question of placing an engine at any considerable elevation, the actual height should be stated, in order that the proper size be selected, and the necessary adjustments made.

Cleanliness.—A gas or oil engine invariably works better if kept clean—free from grit and dust. A clean engine and engine-room indicate that the engine is being properly cared for. A dirty engine implies neglect not only of cleaning but of most of the minor duties to which a caretaker ought to give his attention. A dirty, and therefore neglected, engine may involve trouble from hot bearings, premature ignition, and other causes. A close adherence to the “Instructions” issued with each engine will well repay the small trouble involved. In certain trades where a large quantity of dust cannot be avoided, the engine should be placed in a well-sealed

engine-room ; the shafting passing through as small an opening in the wall as can be done with.

The most suitable fuel to be employed in the "Suction" gas-producer is Welsh anthracite beans, which is recommended on account of its cleanliness in use and freedom from tarry matter ; the generator is designed for the use of this fuel, and the data given in catalogues as to consumption, etc., is based upon its use. There are, however, other fuels which may be utilized in the "Suction" gas-producer if suitable arrangements be provided for dealing with the same.

Among these may be mentioned Scotch anthracites, which, although containing a larger proportion of ashes and tarry matter, and requiring a little more attention in working, are obtainable at very reasonable prices, and give results which are remarkable in their economy. The producer is well adapted for the use of this poorer quality fuel, and provision is made for separating the tar before the gas enters the cylinder of the engine.

Gas coke may be utilized as fuel with satisfactory results, but it must be of a well-carbonized quality, washed, and broken into pieces of about $\frac{1}{2}$ in. to $1\frac{1}{4}$ in. diameter.

The "Suction" gas-producer may also be modified to use wood charcoal. This material yields gas equal to that from Welsh anthracite. The charcoal must be in pieces like twigs (about $\frac{1}{2}$ in. diameter and 2 to 3 in. long), thoroughly charred, so as to contain no tarry matter and be free from dust.

When the gas-producer is required for fuel other than best Welsh anthracite, this fact must be stated

when inquiring or ordering, and full particulars of the fuel should be given, together with an analysis if possible, as in many cases it is necessary to modify the generator, and provide a special scrubber arrangement, etc.

Much interest is at present being displayed at the time of writing in a pump which utilizes the direct pressure of an explosion of gas on the surface of a volume of water for pumping it. The pump acting on this principle is known as the Humphrey pump, and in a paper read by the inventor, Mr. H. A. Humphrey, before the Manchester Association of Engineers on 11 October, 1910, it was described as follows.

Figs. 81*a* and 81*b* show alternative arrangements of the top of the combustion chamber for a two-cycle pump. It will be observed that the combustion chamber has to be specially shaped, so that the incoming charge, which may be preceded by pure air, displaces the burnt products and mixes as little as possible with them. Thus, in fig. 81*a*, A is the admission valve at the top of the tall, narrow part of the chamber B, in which the full charge volume extends down to the level C C. A number of exhaust valves E lead to a common exhaust outlet O, which may be fitted with a non-return valve, or each exhaust valve may carry a light non-return valve on its spindle, as shown. The level at which expansion reaches atmospheric pressures is, say *f f*, but this level having been reached by the water, its further movement draws in fresh combustible mixture till it occupies the space down to C C, and the liquid level has fallen to *g g*. The column of liquid now returns

and drives the exhaust products through the valves *E*—which had opened by their own weight—until these valves are shut by the water. The kinetic energy acquired by the column is now spent in compressing the fresh charge, which is ignited to start a

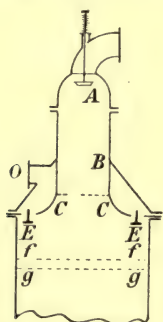

FIG. 81a.

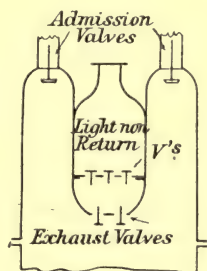

FIG. 81b.

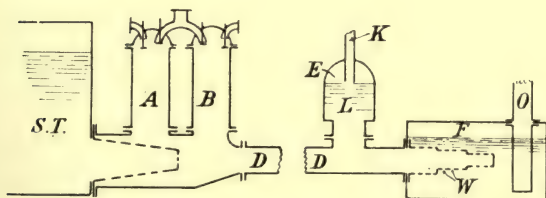

FIG. 81c.

new cycle. Thus, each outstroke is a working stroke, and no locking gear is required on the valves.

The same cycle applies to fig. 81b, but in this case there is a series of admission valves placed in a ring so as to allow the mixture to enter with a low velocity in order to prevent eddies and mixing with the exhaust products. The author pointed out that a higher

compression pressure was obtained with this pump than with the simple pump, and consequently higher efficiencies with the same lift.

The author then dealt with two-barrel and suction-lift pumps and high-lift pumps. He pointed out how any Humphrey pump could be converted into a high-lift pump by means of an air vessel fitted with valves and called an intensifier. Into this vessel air is drawn into and rejected at each cycle. Fig. 81c will help to make the operation of such a pump clear. A and B are the barrels of a two-barrel pump, and at the end of the splay pipe D there are two air vessels E and F, the latter being large enough to give a continuous flow at outlet O, and to maintain a practically uniform pressure. The smaller air vessel E is fitted with a downwardly projecting pipe K, open to the atmosphere at the top and carrying a valve L at its lower extremity arranged to close under the action of the rising water. The cycle starts with an explosion, all valves except L being shut and the water level, as shown. While the water level in E is rising to L, air is merely being discharged into the atmosphere, and, as no work is being done by the column of water, it gains speed until valve L is shut by impact. Imprisoned in E there is now a definite quantity of air, which suffers compression until its pressure reaches that at which the high-pressure water valves W can open and allow the remaining kinetic energy of the column to force water into F. Valves W close when the column comes to rest, but there remains enough energy in the compressed air in E to give, by expansion, the return flow, which causes exhaust in A and compression of the fresh charge in

B to start a fresh cycle. When the water level falls below valve L, this valve opens, and air is admitted into E for the rest of the return stroke.

The author pointed out that if the pipe K were made vertically adjustable with regard to E, the point of the cycle at which L shuts could be varied, and more or less air entrapped in E at will. But the amount of energy stored in this air would also vary with its quantity, for it is assumed that the degree of compression remains constant, and fixed by the pressure maintained in F. Consequently, the ratio of the total energy of the working stroke to the energy stored in the compressed air in E could be made anything desired, or, in other words, any compression pressure of the new charge in B could be obtained, and this independent of the water lift. Further, by manipulating the position of pipe K, a given pump could be made to meet any conditions as to height of lift, for if the lift increased K could be raised so that the energy stored in the air in E remained the same, there being less air but at a higher pressure. Now, at each cycle, air is drawn into and rejected from the vessel E, and if K were connected to a supply of combustible mixture instead of opening into the atmosphere, an automatic pump would be provided for taking in mixture and discharging it under pressure.

Similar pumps are now being installed at the Chingford Reservoir of the Metropolitan Water Board, under the direction of Mr. W. B. Bryan, M.I.C.E., the chief engineer.

If the discharge were made into a reservoir from which the combustion chambers A and B could be

supplied, a means of quickening the cycles is provided and the output increased. The author said it had been found convenient to replace the vessel E by two vessels, one for air and one for gas, so as to keep the constituent parts separate until they entered the combustion chambers. If the first portion of the outstroke of the water column were allowed to reject the surplus air and gas back to the sources of supply, then the action throughout the cycle was precisely that described when using the single vessel E, except that a larger portion of the total energy was absorbed in the compression of air and gas ; but the excess was given out during the expansion of the pre-compressed charge in either A or B. The chief advantage pointed out for this system was the more rapid working, as there was no longer any need to wait for the water level in A and B to fall under the action of gravity when the charge was being taken in. In fact, the appliance became practically independent of the water level on the supply side. The 1000 horse-power pump now being built in Germany will operate in the manner described, and the pump will require no more space than a 1000 horse-power tandem engine.

The drawings are merely explanatory diagrams and are not intended to give details.

CHAPTER V

STORAGE AND DISTRIBUTION

WE now come to consider works necessary in constructing reservoirs and tanks for the storage of water, either from a natural source or from pumping engines.

It will sometimes be found that a spring or river is at such an elevation that if a tank or reservoir be formed, water therefrom will flow to the source of supply and still have adequate pressure at that supply without pumping, which of course is a very desirable state of affairs. In other cases the river or stream may require damming back for the purpose of supplying a hydraulic ram or providing head water to a turbine, or even a supply for a pump to draw from. In any case, where water has to be pumped it is very desirable to store the pumped water in some form of tank or other in order to provide against breakdown of the machinery, and in the case of windmills, very calm weather, while the provision for fire must not be lost sight of; and as some water will want filtering, the construction of small filters will find consideration in this chapter also. Reference has already been made to a form of wooden dam which will be useful under many

circumstances, but at the best it can only be regarded as a more or less temporary expedient.

Let us consider the case of a flowing river which, being at such an altitude above the place at which the water will be wanted, that when due allowance has been made for friction in a main of fair size, say 6 in., and bends, etc., there will be sufficient pressure on the water to force it to the top of the highest building and with a few feet to spare. It is also well to bear in mind that a water main will get rusty inside as time goes on, and friction will consequently increase, and also the fact that for gravitational purposes small mains are not to be advised. The cost of laying a 6-in. main is very little more than a 2-in. main, the difference in cost being merely the cost of the pipes. The extra outlay is well spent, especially when there is not too much "head" to spare. In large reservoirs the construction of such a bank as is being considered is, of course, a work of great magnitude, and such work is not usually found in connexion with estate water supplies. The type of bank referred to is the puddle bank, consisting of a trench dug at right angles to the stream, across, and into the two sides of the valley. At the bottom and sides the trench should penetrate impervious stratum, clay or compact rock without faults. From the bottom of this trench is raised a wall of puddled clay to a height of about 4 ft. or so above top water level. On each side of this bank is tipped earth in layers. All the outer slope is 3 to 1 and the inner slope $2\frac{1}{2}$ to 1 or 2 to 1, as the case may be. The puddle wall is also covered with earth so that it will always retain its moisture, while the inner slope is pitched

with dry rubble stone and the outer slope sown with grass seed. Sometimes circumstances will prove favourable to such a method of construction, on, of course, a much smaller scale than large waterworks, although the method of construction is precisely the same in both cases. The most important part of the work is the trench. It must be carried down to a firm, hard, and impervious foundation, and it is the duty of the engineer to most rigidly inspect the work when it is opened up to the full depths specified, and to see that all bad places are cut out and filled with clay. The same remarks, of course, apply if the wall was to be of masonry or concrete, as will be described. Springs encountered must be led away down-stream to a suitable outlet by means of pipes. In firm ground the trench is opened up with sloping sides, but in soft ground the sides would be vertical and the trench timbered. The drawing of the timber when the clay is in demands great care. The clay used must be well worked and quite free from all foreign matter. The thickness of the puddle wall will vary ; no hard and fast rules are given by engineers ; the safest way is to make it at the base, that is, the top of the trench, $\frac{1}{3}$ the depth of the water impounded, the top width being about 3 ft. in small reservoirs, and 6 ft. in large ones, and battered accordingly. The clay used must be exposed to the elements as long as possible before use as it is much improved thereby, and the earth bank is carried up at the same time as the puddle wall, when it reaches ground level, while the whole bank should be raised simultaneously from end to end. An example of a clay embankment is given in fig. 85.

In works of large magnitude, it is usual to deal with the water during progress of the work by means of a canal cut along the side of the valley above the top level of the embankment and joining the stream farther down. It is called the "bye-wash". In small works such an expense would not be warranted. In such cases the best expedient is to divert the stream, which will probably only be small, to one side, and in its bed set a line of pipes on a very firm foundation of concrete. When finished and complete with a valve, the work on the bank may proceed on each side and above it. The culvert should be large

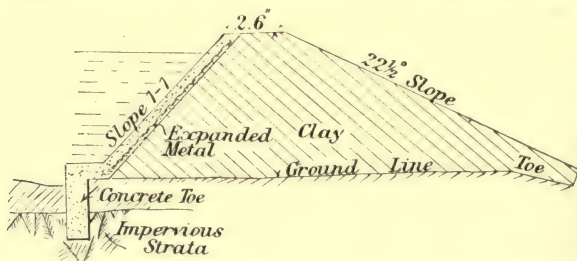

FIG. 82.

enough to pass the greatest floods, and must be so solidly constructed as to avoid any after settlement due to the load of the bank. This method of procedure is not employed in large banks, but may be safely used for banks sustaining less than 20 ft. of water, which in small works will usually be the maximum.

Another useful form of bank to impound moderate depths of water is a clay bank lined with concrete as shown in fig. 82, care being taken that the clay rests on a firm, and is carried down to an impervious, foundation. The concrete would be reinforced be-

cause the clay bank would not remain quiescent during settlement. It should be formed of one part of Portland cement, two parts of sand, and four parts of broken brick or stone, and should be reinforced through the centre of its thickness with expanded

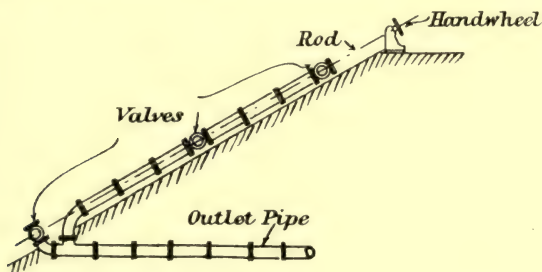

FIG. 83.

metal, while the concrete could be made waterproof by adding a 5 per cent solution of alum to the mixture, which is an advisable procedure in all cases of concrete retaining water. A suitable valve for the outlet culvert of this and the previous bank is shown in fig. 83, while it may be mentioned that it is a very wise precaution to use on the pipes, where they pass through the core, circular shields of cast iron, made in segments and bolted together, which will resist the tendency of any water to creep along the pipes, and so start a leak which will often resist all efforts to stop it. The plates, which are called puddle plates, are shown in fig. 84.

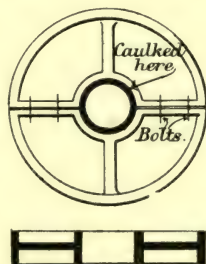

FIG. 84.

On all reservoirs there must be some provision for

discharging the flood waters, and that water which is not used for immediate consumption. Where the dam is of masonry or concrete, it is a simple matter to allow it to flow over the top in ways which will be discussed. With earthen banks, however, the provision of a waste weir is necessary to prevent the water accumulating to a dangerous height. It is usually constructed of heavy masonry set in cement, and the water being gradually let down to down-stream level by a channel made of similar masonry in a series of steps to break the fall, the rise of each step not being greater than 2 ft. under ordinary circumstances. The waste weir must not be formed in the bank itself but at one side or the other, and should be of the most solid construction. The method of drawing off the supply from such reservoirs demands attention. In masonry dams it is an easy matter to lead pipes through the dam at any desired point. With large reservoirs with clay banks the usual practice is to build a tower of masonry or cast iron which contains the valves and draw-off pipes, etc., which are then led through the bank in a masonry culvert which itself is dry and easy of access for repair. This is an expensive and elaborate construction which is quite unnecessary for small works, and for which purpose the one form of construction, which at the same time cuts down expense and saves more pipes than necessary running in the bank, is the syphon outlet. The action of the syphon in connexion with wells has already been fully discussed. The system for use in the case of a reservoir is precisely the same, the reservoir bank being the same as the side of the well, that is, the obstacle over which the water has to

be drawn. One or two feet difference in level will suffice to lift the water over the bank, whence it flows by gravity to the point at which it is required. The idea is shown by fig. 85, in which the pipe is laid along the inner slope and above the puddle wall and to a valve well at the foot of the outer slope, in which is placed a regulating valve and a scour valve. The only other necessary adjunct is a small hand air-pump, which is placed in a house erected on the top of the bank. This form of construction is greatly to be advised wherever water has to be drawn from such a reservoir, whether for direct supplies or for driving turbines or hydraulic rams. The purest water is drawn about $\frac{1}{3}$ the way down from top water level, but valves may be placed at any desired level actuated

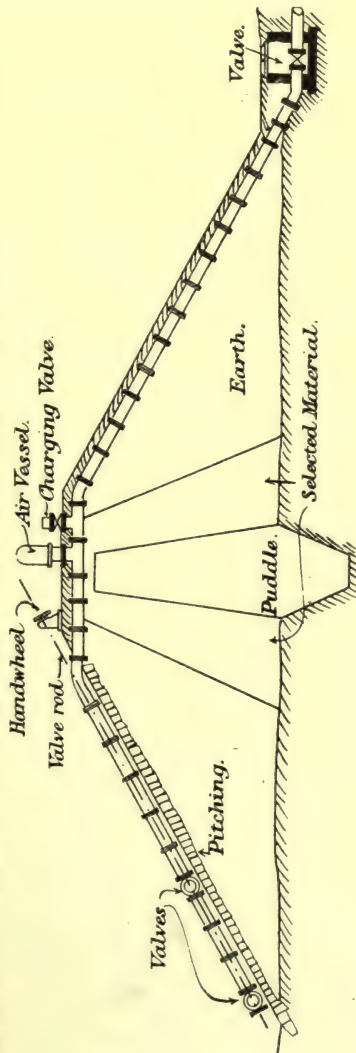

FIG. 85.

by rods as shown. If it is possible to lay on a supply (even very small) at a few feet above the top of the syphon pipe, a cistern may be erected in the house in place of an air-pump, and this connected with an automatic air-valve will serve to keep the syphon always in action. The subject of earthen dams has been discussed, because this chapter would be incomplete without it. At the same time it may be said that for small reservoirs it is not the best form of construction, and that in this connexion, unless in the opinion of the engineer circumstances particularly warrant the foregoing construction, some form of masonry or concrete dam is far superior. The design of such walls demands minute attention, because there are two conditions which have to be satisfied, one (essential), that the wall shall be proof against failure under ordinary circumstances, and the other (very desirable), that this stability and solidity shall be gained by the most economical method of construction; or in other words, it is the duty of the engineer to dispose of his materials in the most economical manner possible. Walls subject to water pressure on one side are known as retaining walls, and although this term is more often applied to walls, which hold up masses of earth in preference to water, yet the conditions of both are essentially the same, and when the case of water thrust is understood the subject of earth pressure is simply a modification.

Now the water retained by a wall or dam exerts a certain thrust along a horizontal plane on that wall which tends to overturn it. This thrust is known as the *overturning moment*. The masonry of which the wall is constructed exerts a force down-

wards due to gravity which constitutes the *resisting moment*. It then remains with the designer to make the resisting moment greater than the overturning moment. In the first place, let us investigate certain formulæ whereby the approximate thickness of a wall can be found, because when this is found a rough idea can be formed of the section of the wall which must fulfil the above conditions.

Let D = the depth of water to be retained in feet.

Let W = the weight of 1 cub. ft. of the wall, as per table.

STRENGTH AND WEIGHT OF MATERIALS.

Material.	Safe Dead Load. Tons per sq. ft.	Factor of Safety.	Weight, lb. per ft. cube.
Granite masonry	15 tons	20	160
Portland and hard limestone	15 "	15	140
Sandstone	12 "	10	130
Blue brick (in cement)	9 "	8	120
Stock brick (in cement)	6 "	5	115
" Lias mortar	5 "	4	112
" Grey mortar	3 "	4	112
Portland cement concrete	5 "	8	130
Lias lime concrete	3 "	8	120
Compact earth	2 "	—	112
Made ground	1 "	—	110

Let $w = 62.5$ lb. = weight of 1 cub. ft. of water.

Let T = *mean* thickness of wall in feet.

$$\text{Then } T = .7D \tan \frac{a}{2} \sqrt{\frac{w}{W}} \quad . \quad . \quad (30)$$

The term $\tan \frac{a}{2}$ demands attention. This is a quantity which is included in order to render the formula applicable to cases of walls which retain earth instead of water, and such cases will occur

from time to time in schemes of estate water supply as will be pointed out. "a" signifies the natural angle of slope of the particular earth in question, which will be found in pocket-books of engineering matter. Generally for ordinary earth the quantity $\tan \frac{a}{2}$ will be .414 and for stiff clay .767, while for water it is unity, and in the same way it will denote the weight of 1 cub. ft. of the earth in question.

Let us consider the case of a small masonry dam,

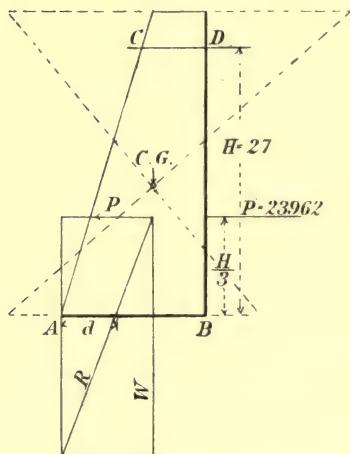

FIG. 86.

straight in plan, built of granite in cement mortar, and of the section shown in fig. 86. A B is assumed to be a single bed joint, the friction on which will prevent failure by sliding. It may here be remarked that a wall may fail by

1. Shearing.
2. Toppling over.
3. Crushing on the outer joints and consequent separation of the inner ones.

4. Sliding on the surface.

5. Sliding on the bed joints.

In fig. 86 C D is the water level. At the points A and B it will be necessary to find the pressure due to the water at A and tension at B. The masonry which is heavy would weigh 170 lb. per cubic foot. The area of the cross-section of the wall is as per

scale, $\frac{(5 + 15) \times 30}{2} = 300$ sq. ft., and the weight of the wall per foot run = $300 \times 170 = 51,000$ lb. The centre of gravity is found by setting out the dotted lines as shown, by extending the base a distance each side equal to the top thickness of the wall, and the top a distance each side likewise equal to the base thickness and joining the diagonals whose intersection will be the centre of gravity.

$$\text{Water thrust} = \frac{whl}{2} \quad \dots \quad (31)$$

$$= \frac{62.5 \times 27 \times 28.4}{2} = 23,962 \text{ lb.}$$

Acting as stated $\frac{1}{3}$ the way up from the base, this thrust always being perpendicular to the face of the wall. Plot the water thrust horizontally and the weight of the wall vertically, as shown, and complete the parallelogram and scale off the resultant. Also very carefully note the distance d .

Then the maximum pressure on the outer edge will be equal to

$$\frac{2}{3} \times \frac{W}{d} \quad \dots \quad (32)$$

W being the vertical component of the resultant. It is always wise to find out when the wall has been so designed, that the resultant falls within the middle third of the base (which it must do if the wall is to be safe), the exact amount of tension or compression on the inner or outer joints of the wall, as the case may be, so as to see if they are within safe limits. Of course, an ordinary mortar joint should not be subject to any tension. A concrete wall *may* with safety bear a small amount, while a reinforced concrete

wall will stand more according to the amount of reinforcement.

Let W = weight of wall in lbs., tons, etc., per foot run.

A = the area of base of wall 1 ft. wide.

$Z = \frac{1}{6} B D^2$ where B = the width and D the thickness of the wall (B is usually 1'0 as 1 ft. wide of the wall is taken), while a fourth quantity is required = M which is equal to $W \times d$.

Then a familiar equation

$$\frac{W}{A} \pm \frac{M}{Z} \quad \cdot \quad \cdot \quad \cdot \quad \cdot \quad (33)$$

will when worked out give the compression on the outer joints when the sum of the two quantities is taken and the tension on the inner ones when the difference is taken, the sign \pm denoting that either the sum or the difference is to be taken. The difference should for bed joints in masonry prove a negative quantity. The question will receive further consideration.

In the meantime, it may be said that in the case of a river in which the water is intended to be stored up for the purpose of providing water-power rather than a supply for domestic purposes, a different form of construction is employed for holding up the water for moderate depths. It is rather what is known as a weir than a dam, and is of a much greater thickness than is necessary to merely withstand the thrust of water, and is not subject to calculation but is intended rather to be capable of passing large quantities of water when required over its crest. The foundation should be firm, and if necessary a row of piles should be driven down at the foot of

the down-stream slope. The hearting may be of concrete or random rubble, but the crest and the apron, down which the water will flow, must be constructed of solid block in course masonry, and the

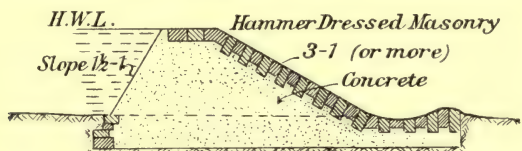

FIG. 87.

form is shown in fig. 87. Sluices should be provided to let off flood water.

It will often be found economical to make masonry dams thinner than has been described, providing for the thrust by means of buttresses, the inner face having a batter as well as the outer one.

The first thing to do is to settle the amount of batter to be given to the outer face.

Take, for instance, fig. 88. The value of x is required. Let T , t , T_1 , H and x be as shown, while let the ratio of the clear space between the buttresses to the thickness of those buttresses be denoted by r .

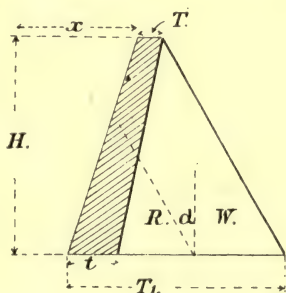

FIG. 88.

Then a general formula to find x will stand

$$x = \frac{T_1^3 + rT^3}{T_1^2 + rt^2} - S \left(\frac{T_1 + rt}{2(r-1)} + T \right). \quad (34)$$

S being the specific gravity of the masonry usually

from 2 to 2.5. The value of x so found is the minimum safe value. The values of Tt and r have to be provisionally settled by the designer, the most suitable being

$$T = .5 + \frac{H}{10} \quad . \quad . \quad . \quad (35)$$

$$t = T + \frac{H}{20} \quad . \quad . \quad . \quad (36)$$

$$r = \frac{50 - H}{10} \quad . \quad . \quad . \quad (37)$$

while the thickness B of the buttress may be taken as 2 in. for every 1 ft. in value of H . There is an equation for T_1 , but it is of a very complex nature, and its discussion would be out of place in a book of this sort, and certain values are tabulated as under:—

Value of H .	Value of T_1 .
5	5.90
6	6.80
7	7.90
8	9.00
9	10.00
10	11.40
11	12.50
12	13.55
13	14.70
14	15.90
15	17.00
16	18.25
17	18.75
18	20
19	22
20	23.25

Value of H.	Value of T_1 .
21	24'50
22	25'75
23	27'00
24	28'50
25	30'00
26	31'25
27	33'00
28	34'50
29	36'00
30	38'00

When the above values are ascertained for a given value of H, it will be necessary to ascertain if the resulting structure will have the maximum pressure at the toe within safe limits, and also that the resultant does not make an angle with the vertical greater than the angle of repose. Referring again to fig. 88, it is required to find the angle a and also the value of P, the maximum pressure, at the toe as follows:—

$$\cot a = \frac{(r+1)(x+ST) + S(T_1+rt)}{H(r+1)} \quad . \quad (38)$$

$$\text{and } P = \cdot 0280 H^2(r+1) \frac{T_1 \cot a \sec^2 a}{T_1^2 + rt^2} \quad . \quad (39)$$

and having found $\cot a$ we have another equation for x which may be used as a check :

$$\text{that is, } x = H \cot a - ST - \frac{S(T_1+rt)}{r+1} \quad . \quad (40)$$

If the value of a is limited to 35° , which is the angle recommended by Prof. Rankine, the value of x will increase, but the writer is inclined to believe that a may be as much as 42° and the wall quite safe. The tension in the dam between the buttresses can

be easily computed by assuming it as a loaded and supported beam (not fixed) between the buttresses which would be placed from 6 ft. to 8 ft. apart according to circumstances. No tension will exist if the inner face between the buttresses is slightly arched in plan.

Now having designed such a dam, it remains with the designer to calculate its cubic contents, and also the cubical contents of a solid dam to fulfil the same conditions. The saving is generally about 35 per cent, but it must remain to the judgment of the engineer to decide if the saving in actual cubic feet of masonry is going to counterbalance the extra cost entailed in building a wall of this more complicated description. The weight of the wall between the buttresses can be found as follows. Referring to fig. 89—



FIG. 89.

$$W_1 = Z \times \frac{T+t}{2} \times HS w \quad . \quad . \quad (41)$$

Z being as shown and $w = 62.5$ lb.

The overturning moment due to the water may be found as follows:—

$$M = \frac{H^3}{6} (r+1) B w \quad . \quad . \quad . \quad (42)$$

B being as shown in the figure.

The foregoing method of construction can be economically carried out in reinforced concrete. Solid masonry walls stand the water thrust by reason of their own weight, but reinforced concrete walls resist the load by means of a lever arm. The main

point in designing is to ensure that the steel bars are always in tension. In the illustration (fig. 90) a somewhat novel construction is employed. The circles show old wire haulage rope which was used for the reinforcement. When they are packed quite level a very good form of construction results. They must be pulled straight while ramming the concrete. The dotted lines show small wire binding twisted

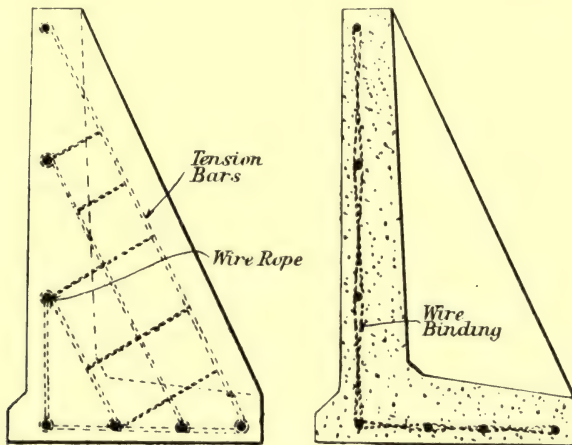

FIG. 90.

round each of the bars. In the view showing the counterfort in elevation is seen small wire binding placed at intervals of 18 in. round the continuous wire ropes. The wall was designed for a depth of water of 7 ft.

Another wall of a similar nature is discussed and illustrated in fig. 96.

In passing, it is necessary to find out what effect earth pressure has on retaining walls. In tanks

built of masonry in the ground for holding water, the sides will, of course, be subject to the thrust of that water. This will generally be greater than any earth pressure likely to come on them. Yet at the same time it might not be the case, especially when the surface of the ground rises rapidly from the wall. Hence the reason for discussing the question here. Referring to fig. 91, ED is equal to natural slope of ground, and EDF equal to the limiting angle

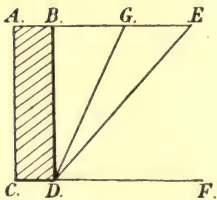

FIG. 91.

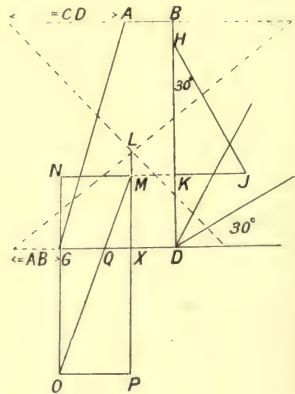

FIG. 92.

of resistance, ABCD equal to the wall. Now BG is made equal to half BE, and the pressure of the earth upon the wall, as we pointed out, is equal to half BG^2 multiplied by the weight of 1 cub. ft. of earth, say 110 lb.; this gives us what is known as the *active* pressure. It is now obvious to the reader that the earth which is behind the angle of repose does not affect the stability of the wall in the least, but the wedge in between is that which takes effect only. By bisecting the wedge we have what is termed *the line of*

rupture. In fig. 91 the angle of repose is taken as 30° , therefore GD bisecting it gives us the line of rupture, and BGD is the wedge of earth which we have to calculate upon. Calculate the weight of the earth and calculate the weight of the wall, assuming both to be 1 ft. wide (fig. 92). Make KD one-third the way up from the base, and to scale make KH equal to weight of the wall. Now make the angle KHJ equal to 30° (or the angle of repose), and produce it to meet the perpendicular from K. Now JK to scale is equal to the force acting on the wall in lbs. Now find the centre of gravity of the wall by any known method. A simple way is by means of the dotted lines, producing the top each side a distance equal to the base, and producing the base likewise a distance equal to the top as shown on the drawing. The centre of gravity will then be at the intersection of the two diagonals at L. Drop a perpendicular LP making MP equal to weight of wall, in this case = 3920 lb., complete the parallelogram. MO is then the all-important line, the line of resistance of the wall, which must pass through the *middle third* of the base if the wall is to be safe.

The above graphic construction is of the utmost value and importance to the engineer. It is simple, but must be very accurately drawn to a large scale. If this be done no failure of the wall from *natural* causes is likely to occur. Its neglect in design may mean complete failure, and if not extravagant use of material. When the ground has a sloping surface, such as occurs in what we termed surcharged revetments, the above graphic construction holds good, because it simply means calculating a larger wedge of earth.

We now come to the important case of a reservoir, on the side of a hill, to store spring water, as in fig. 93.

Our first calculation is that of the earth pressure on the right-hand wall, which in this case is surcharged, that is, the earth has a sloping surface upwards from the wall. Set up the line AB at the same angle from the vertical as the natural slope of the earth, and produce the slope of surcharge to meet it. Bisect AB and describe the semicircle. Draw *xy* perpendicular to AB, cutting the semicircle

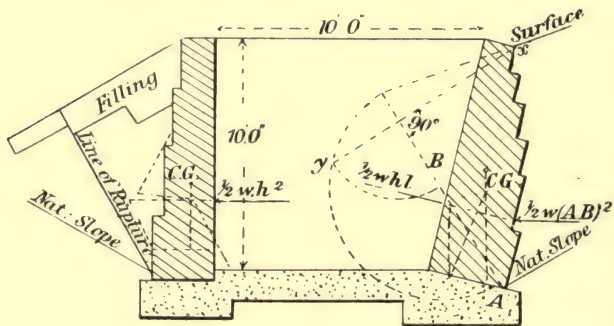

FIG. 93.

in *y*. Now the horizontal thrust at one-third the height of the wall will be

$$\frac{1}{2}w(AB)^2 \quad \dots \quad (43)$$

$$= \frac{1}{2} \times \frac{100}{112}(5.7)^2 = 14.5 \text{ cwt.}$$

The weight of the wall will be found to be 25 cwt. In the manner shown, this must be combined with the thrust, and the resultant drawn. The distance from the point where the resultant cuts the base of the wall from the centre must then be accurately measured, the diagram being done to a large scale, say it is .71 feet.

Using equation $\frac{W}{A} \pm \frac{M}{Z}$ as explained, we have

$$\frac{29}{3.375} \pm \frac{29 \times 0.71}{\frac{1}{8} \times 1 \times 3.375^2}$$

= 8.61 \pm 10.7, which will give compression .96 ton and tension .1 ton per sq. ft.

The pressure due to the water is equal to

$$\frac{1}{2}whl = \frac{1}{2} \times \frac{62.5}{112} \times 10 \times 10.3$$

= 1.43 tons. Combining this with the previous resultant we have a new resultant which cuts beyond the inner edge of the base, and consequently $\frac{W}{A} \pm \frac{M}{Z}$ will give the following results:—

$$\frac{32}{3.375} \pm \frac{32 + 2.4}{\frac{1}{8} \times 1 \times 3.375^2} = 9.5 \pm 40.5$$

= 2.5 tons compression and 1.55 tons tension.

In the same way, the left-hand wall may be considered, and it will be found that, as before, the values of compression and tension for earth and water pressure are within safe limits for concrete walls.

The illustration also shows the proper methods of construction. A reservoir of this description affords a good opportunity for the use of reinforced concrete, especially in the case of porous rock such as shale. The organic matter and surface soil should be cut away, and the hard bottom exposed and trimmed off level, and this space enclosed by a concrete wall. We will assume the ground falls away corner-wise, and that *two* sides of the tank are exposed, as shown in figs. 94 and 95.

The walls lying against the rock would be 6 in. thick at the bottom and 4 in. at the top, and rein-

forced by expanded metal. It may here be remarked that it is impossible to go into detail over the amount of reinforcement required. The reader is referred to the author's work on "Civil Engineering Practice" (C. Griffin), and to other standard works on the subject. But the best results are usually obtained when preliminary designs are got out by sending such drawings to the companies who make the reinforcement. They will always advise the most economical sections to use.

The exposed walls want buttresses and reinforcement. For the case in question, the buttresses would

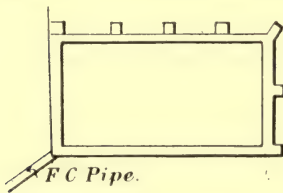

FIG. 94.

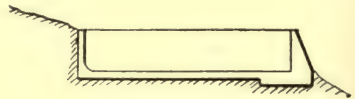

FIG. 95.

be well placed at 7 ft. centres, and the wall would be reinforced with $\frac{1}{4}$ round rods horizontally, as shown, the vertical ones being placed 1 ft. centre to centre. The rods are bound together by wire. Expanded metal is shown in its correct position. Regarding the buttresses, the best reinforcement would be two $\frac{1}{2}$ -in. round rods, and one $\frac{3}{8}$ -in. rod with stirrups of $\frac{3}{4}$ -in. hoop iron, as shown. The bottom is reinforced with expanded metal. The coping should be reinforced with $\frac{3}{8}$ -in. horizontal round bars bound with wire to the vertical ones. The erection of such work, of course, demands the usual skill and attention bestowed on engineering construction work. A detail drawing is given in fig 96.

When a tank is closed provision should always be made for the admission of air which will tend to keep the water pure. Simple holes may be left in the roof, and short lengths of fireclay pipe with galvanized gratings set in the sockets will suffice, provided they are a few inches above ground level, to prevent any dirt falling into the water. A current of air may be induced by the use of Boyle's patent air-pump ventilators, upcast and downcast heads being used, but

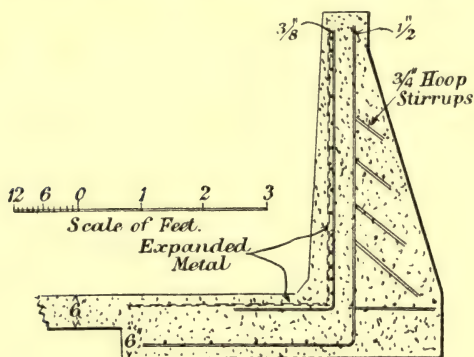

FIG. 96.

this, of course, is merely a refinement and not an absolute necessity (or see detail, fig. 112 *a*). Where circumstances allow of such a construction, a very convenient way of storing water which is pumped (the construction also is quite admissible for gravitation supplies) is by means of an elevated tank, which also forms the roof of the engine-house, and is supported on the walls of the same. Referring to figs. 97 and 98, we have a rectangular tank 15 ft. square, and holding water to a depth of 4 ft. 6 in. Its construction, by means of reinforced concrete, is

clearly shown by the drawings. In the walls there are vertical bars $\frac{1}{2}$ in. square (or $\frac{3}{8}$ in. round) which are spaced at 4 in. centre to centre. It is not necessary, however, to carry *all* the bars up to the top of the walls where the stresses set up by the water are less,

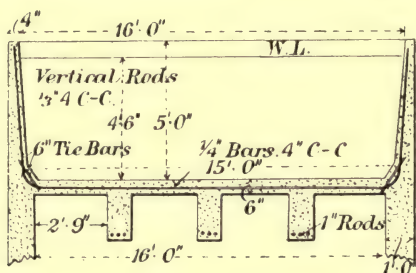

FIG. 97.

but every alternate bar is so carried up, while the others terminate about half-way up or a little over.

These bars are turned into the bottom of the tank and carried 4 ft. horizontally, while at the corners are fixed two bars placed at an angle of 45° to the horizontal, and of the same section as the others.

In the walls are also horizontal bars of the same

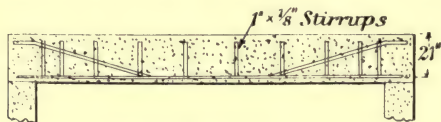

FIG. 98.

section but spaced 12 in. apart, while at the angles extra horizontal bars are introduced between the main ones. They would be 4 ft. long, and bent at the centre, extending 2 ft. each side of the angle. For the bottom of the tank, which would be 6 in.

thick, $\frac{1}{4}$ in. round bars placed at 4 in. centre would be the best reinforcement, laid longitudinally and transversely, although a heavy section of expanded metal would also be very suitable, set like the bars $4\frac{1}{2}$ in. below the upper surface. The tank is supported on cross beams extending from the side wall as shown in the drawings. They are reinforced by three horizontal bars placed 21 in. from the top of the beam. The middle bar is turned up at the ends, as shown, to take shear. The ends of all bars should be fish-tailed. To assist in taking up shear it is also necessary to introduce stirrups of 1 in. \times $\frac{1}{8}$ in. flat iron. They are bent into the shape of an elongated U, the sides of which would be 20 in. long. They would be placed on the outer bars only. It is important that bars where they cross should be tied to each other by soft wire, B.W.G. 18. The concrete would be composed of four of aggregate, two of sand, and one of cement. The tank in question was designed to hold 6750 gallons, weighing about 30 tons.

Regarding the water-holding power of concrete:—

Generous use of Portland cement will secure impervious concrete. Several structures, such as reinforced dams, standpipes, and tanks, have been successfully built with the concrete mixed in the ordinary manner in proportions about 1 : 2 : 4 or 1 : 2 : 3, without special care other than to secure a wet consistency. Tests, not here given, show that ordinary sand in mortar in proportions 1 : $2\frac{1}{2}$ or richer is impervious. Also, so-called sand or silica cements make a somewhat tighter mortar than Portland cements.

Whether it is cheaper to use the larger quantity

of cement or to grade the aggregate depends upon the relative local prices of cement and of aggregate, and the size of the work. These are the proved methods that are free from doubt as to enduring efficiency and strength, and are of reasonable cost.

It should be remembered that trowelling on a plaster coat of mortar and washing with thin grout are but modifications of use of rich proportions of Portland cement.

The use of finer sand than is usually accepted for ordinary concrete work may prove to be of special value. Its advantage, if successful, will consist simply in cheapening the process of grading ordinary materials to an ideal analysis. Its effect on reducing strength is well known, and its use will in some cases be limited by strength requirements.

Puzzolan and sand cement are superior to Portlands in securing impermeability, but they are somewhat inferior in strength. Colloidal clay as a substitute for 5 per cent or 10 per cent of the sand, or the substitution of 1 per cent or $2\frac{1}{2}$ per cent solutions of alum sulphate, or possibly other electrolytes for the mixing water, may prove cheap and effective processes.

The degree of imperviousness which may be expected from the methods described is such as to meet ordinary conditions, as the demand for dry basements, roofs, and walls, and the storage of water or its conveyance under moderate heads without objectionable loss or resulting damage from its escape.

Two questions of great importance, the solutions of which are being sought, are whether it is necessary to secure a greater degree of protection for rein-

forcing steel than can now be obtained, and whether it is practicable to construct in reinforced concrete to resist hydrostatic heads of 100 ft. to 300 ft., such as is demanded for great dams and pressure conduits.

One set of experiments with mixtures as lean as 1 : 4 : 14, intended to secure the highest possible degree of permeability to serve as drainage blocks through which seepage of water might be carried away, became so nearly impervious in twenty-four hours under a head of 20 in. as to make doubtful their use for the purpose intended. This was with the flow perpendicular to the bed of the blocks. With the blocks so placed that the flow was parallel to the bed, the flow was greatly increased.

The difficulties in securing perfect workmanship in mixing and placing the concrete, and avoiding the formation of bedding planes through the mass, are greater than are those resulting from lack of knowledge of what should be done.

For storing smaller quantities of water cast-iron or steel tanks are used. For estate water supply the cast-iron tank has much to recommend it, because the sections are cast and machined in the works, are small and comparatively light in weight, consequently transport to the country is rendered easy, while the fitting together does not demand skilled labour. Steel tanks which find much favour in very large sizes on important works are not at all well adapted to this particular purpose, because much of the work has to be done on the site and by skilled labour. These remarks, however, do not apply to very small galvanized steel tanks which find use in a variety of places. Cast-iron tanks can be erected to

almost any convenient size or shape from the same size plates, but the square is always the most economical in material for holding a given quantity of water. It is not our intention to discuss the design of such tanks, because this is left in the hands of the makers, who usually have on stock rectangular plates for the bottom and sides and curved plates for the horizontal and vertical angles.



FIG. 99.

The usual design of plate is shown in

fig. 99,

from which it will be seen how very convenient they are for shipment and transit. A detail of the joints employed is shown in fig. 100, which are put together with red-lead or thin strips of sheet-lead and bolted, while the tank would better be stayed by round bars laid from side to side crossing each other, flattened and drilled at the ends and bolted to the plates or by diagonal stays bolted to the flanges of the plates on the sides and bottom of the type shown in fig.

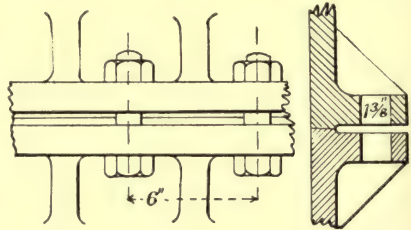

FIG. 100.

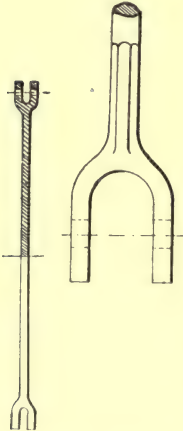

FIG. 101.

101. The tank would be supported in any usual

way, the most usual being on a brick or stone tower by means of cross joists of one section laid across it. It may simply rest on a flat roof, pro-

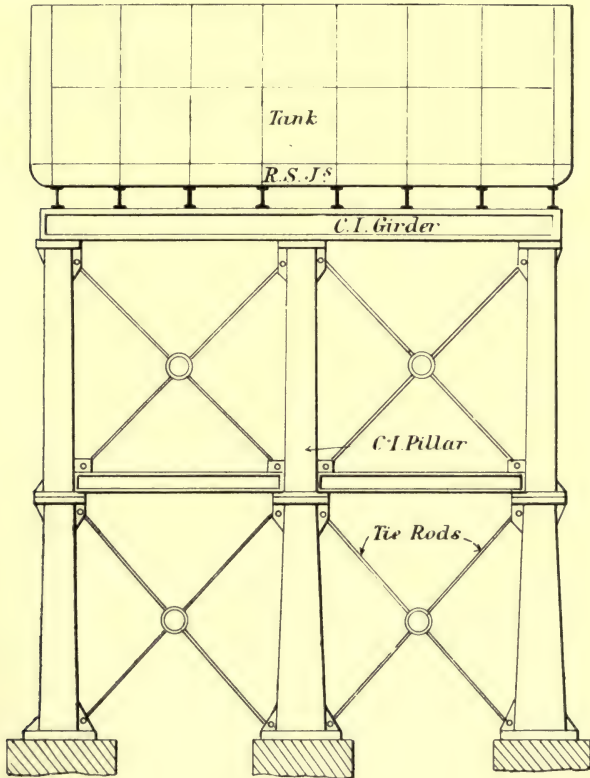

FIG. 102.

vided this is quite strong enough to carry the tank when full. In other cases a system of cast-iron pillars may be used, as shown by fig. 102.

The appurtenances of tanks are not numerous. They include the delivery pipe, which should always be turned over the side of the tank in an inverted U shape. The overflow should be $\frac{1}{2}$ in. larger in diameter than the delivery, while the draw-off pipes are screwed into the bottom and have copper straining-roses on them to keep out foreign bodies. An indicator board, of the type shown in fig. 103, completes the apparatus.

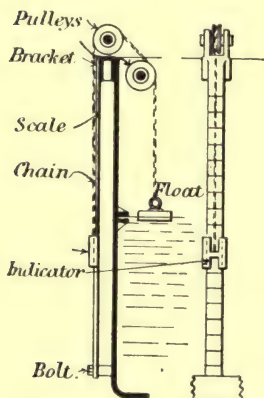

FIG. 103.

Cast-iron tanks are not usually made over 4 ft. deep. All tanks should be covered. This is a precaution too often neglected, with the result that the water gets very foul on top, and not usually being seen continues so for years. The writer speaks with some feeling on this point, as the filthy state of tanks in otherwise well-ordered households has astonished him. The

simplest way is by means of 3 in. \times 4 in. timbers bolted to the top flanges. These then will support rafters in the same way as wall plates in an ordinary house roof. The covering would be boarding treated with creosote, or covered with lead, and having manholes for admission to the tank. The whole should be capable of easy removal.

The filtering of water next demands attention. Water when collected in the condition in which it occurs in Nature, with the exception of spring and well water, must be subject to some form of filtration before it can be used for domestic use.

The impurities usually exist in the suspended form, although there are many impurities in solution, and these will be noted by the analyst who examines the water, who will state if any and what treatment they may require. Small water supplies will, of course, not warrant the laying down of elaborate plant of this description, but if the water is abnormally soft, small quantities (advised by a chemical expert) of powdered carbonate of lime may be added to remove some of the dissolved CO_2 .

In this connexion, however, the removal of suspended impurities by filtration is the most important question. A certain amount of settlement goes on during storage, and very heavy matter is intercepted by wire-gauze strainers attached to the draw-off valves in the reservoir. The usual filtering medium, however, is sand and gravel. The filter consists essentially of a brick or concrete tank, rendered water-tight and containing layers of filtering material graded in size, the water being admitted on top and drawn over from the bottom of the tank. A very simple form of filter is shown in fig. 104, and the drawing being self-explanatory needs no further description.¹

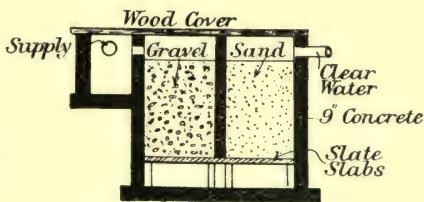

FIG. 104.

In the case of storage and use of rain-water a very suitable arrangement is shown in figs. 105 and 106. Rain-water, which used to be stored in butts, which were generally the receptacle for filth,

¹ The Slate Slabs are perforated freely.

is now usually conducted in proper cement-jointed fireclay pipes from the gullies to an underground chamber, either circular or rectangular in plan,

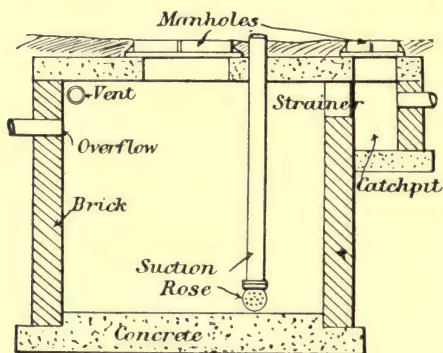

FIG. 105.

built of brick or concrete and waterproofed inside. The drawings show a rectangular one, and provided with a catch-pit and strainer, which are placed in an

accessible position. This will intercept and retain any foreign matter, and in addition to which is a gauze strainer, as shown. The tank is provided with an overflow, vent pipe, and a suction pipe for con-

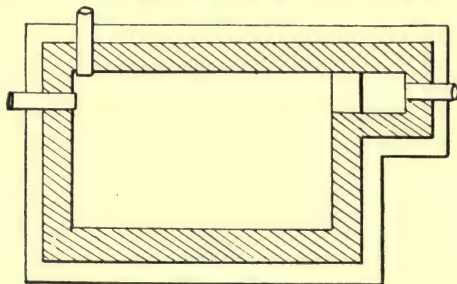

FIG. 106.

nexion to a pump. The actual size of the tank requires calculating according to the amount of roof surface which supplies water to it. If $8\frac{1}{4}$ cub. ft. of tank capacity is allowed for every 100 sq. ft. of roof

surface, it will be found that the tank will not be too large and yet not allow much to pass away unused, but it may be much increased if water is scarce and every available drop is required.

Another system is shown in fig. 107. It will be seen that the filter is not covered. This is advisable as light and air help to purify the water during filtration, while the fine sand on top will want periodically scraping, which is not easy to do in a closed tank unless the depth between roof and the top of the sand admits of a man standing up. After a time the sand will be found to get a jelly-like

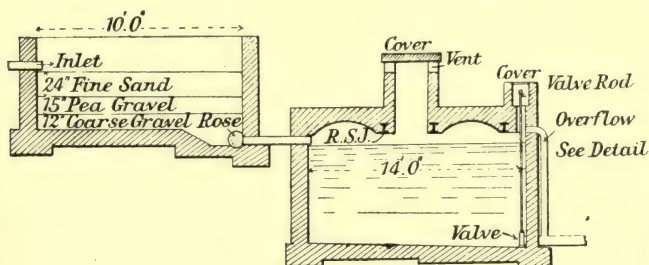

FIG. 107.

slime on the top, which impedes the working of the filter and requires removal. It has a certain value in the purification of water and is a matter to which waterworks engineers attach much importance, but its discussion would be out of place here, and the reader is referred to the larger works on water supply. The efficiency of such a filter depends largely upon the ratio of filtration, 3 in. per hour being quite fast enough. An overflow pipe connected from the top of the tank to a drain would pass away any surplus water that could not be dealt

with by the filters. The filters would be better if made in duplicate, because cleansing would not interfere with the supply.

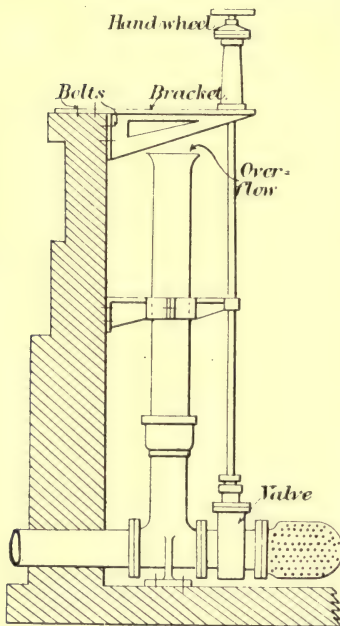

FIG. 108.

shown in fig. 110, in which the bell-mouth standpipe can be raised or lowered by the central screw and hand-wheel, and so the depth of water on the filter can be adjusted to give the desired rate of filtration. The deeper the water the greater the "head," and consequently the faster the flow in the filter. In the same way the distributing

The outlet pipe is connected to the clear-water tank, the top of which should be covered with about 18 in. of earth in order that the water shall be cool in hot weather, and should have an overflow pipe and wash-out, as shown in detail in fig. 108. The outlet from the filter may be simply a rose on the bell-mouth of the pipe (all outlets from tanks should be by means of a bell-mouth), but a much better arrangement, which is strongly advised, is

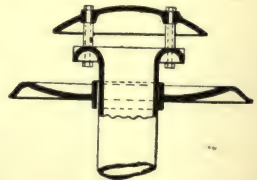

FIG. 109.

valve, shown in fig. 109, is a useful device for admitting the water evenly over the sand.

In figs. 111 and 112 details are given of a larger and more solid type of underground tank than has yet been discussed, for storing clear water from a filter-bed. It will be seen that the tank is partly in cutting only, and that when built the roof is covered with earth and a bank constructed all round.

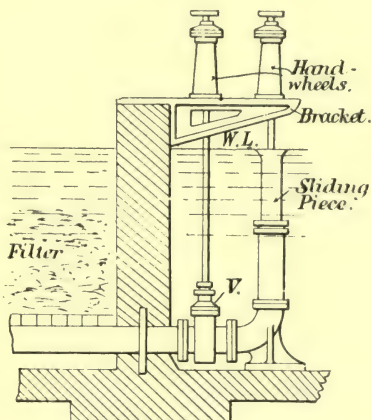

FIG. 110.

In addition to the side walls, which must withstand

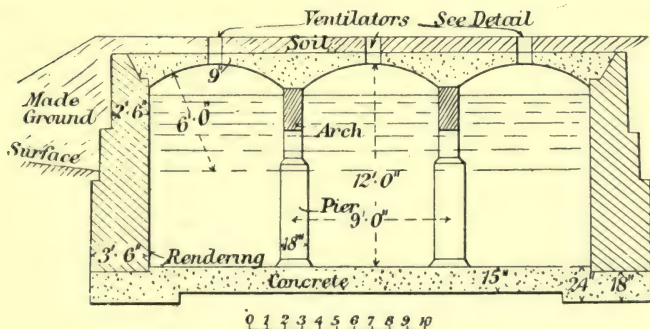

FIG. 111.

the water thrust and the thrust of the arched roof, there are a series of piers with arches turned

between them for supporting the roof. These may

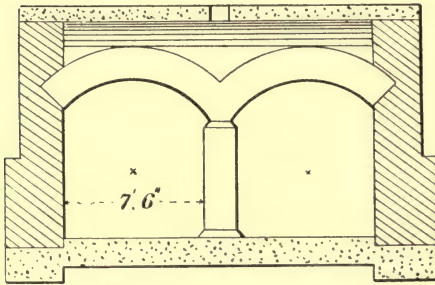

FIG. 112.

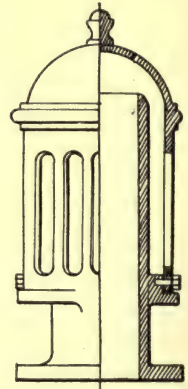

FIG. 112a.

be replaced, if so desired, by cast-iron pillars supporting rolled-

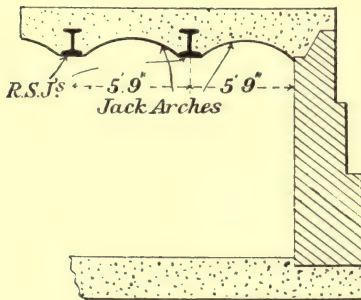

FIG. 113.

steel joists upon which jack arches are turned. In fig. 113 these jack arches are illustrated, but no intermediate pillars are required because the joists may safely be used over a span equal to the distance be-

tween the side walls. The more modern method of covering such tanks is by means of reinforced concrete beams and floor slabs, as shown in detail in figs. 114 and 115. No thrust is then introduced into the walls. Let the beam be 14 in. deep to the centre of reinforcement and 7 in. wide over all. Its span is shown as 7 ft. 6 in. and its weight will be

$$\frac{7}{12} \times \frac{14}{12} \times 7.5 \times \frac{150}{112}$$

equal, say, 7 cwt. If the external load is worked out it will be found to be about 110 cwt. on each beam.

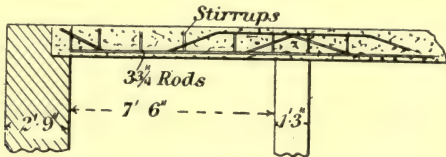

FIG. 114.

On the 7 in. \times 14 in. beams over the span in question, the safe load is found as follows:—

$$= W = (.37 p + .214) \frac{bd^2}{L} \quad . \quad . \quad (44)$$

$$= .37 \times 1.3 + .214 \left(\frac{7 \times 14 \times 14}{7.5} \right) = 128 \text{ cwt.},$$

which is ample; p being the safe stress intensity in lb. per sq. in. = 150 = 1.3 cwt.

The method of ascertaining the thrust on the walls due to the arch, and if such walls will withstand that thrust, is shown in fig. 116. Find the centre of gravity of the arch and the load above at A. Drop a perpendicular AB, and from the top of the middle third at the crown draw a horizontal line to cut AB in C. Join C to the bottom of the middle third at the abutment. Find the weight of the arch (at 150 lb. per ft. cube) and the load above (at 112 lb.) and set off from C, CB equal to that load. Complete the

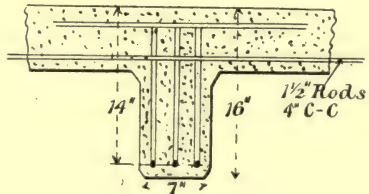

FIG. 115.

parallelogram DCEB. From the centre of gravity of the wall set up a perpendicular cutting CD in F, and from F set off FG equal to weight of wall and FH equal to thrust at skewback. Now complete the parallelogram FGJH. Combine this last resultant FJ with the earth thrust and we have the new parallelogram KLMN. Finally the resultant of this dia-

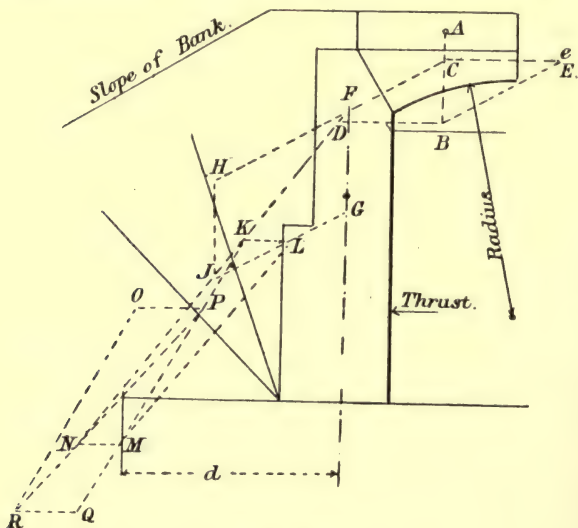

FIG. 116.

gram KM must be combined with the water thrust, giving the figure OPQR. If this drawing has been done accurately to a large scale, the distance d (explained before) may be measured with accuracy and the intensity of stress found in the usual way by the formula—

$$\frac{W}{A} \pm \frac{M}{Z}, \text{ etc.}$$

Having now discussed most of the forms of filters and tanks which would find place in a small water supply scheme for purifying and storing water, we proceed to investigate how the distribution to the various parts of the grounds and house is effected. Outside the house cast-iron pipes are invariably used. They may be had in various sizes. Those which principally concern the reader are 6, 5, 4, and 3 in. pipes. Two and $1\frac{1}{2}$ in. mains are made, but they are not really very satisfactory. The other sizes and larger can usually be had from good makers, cast vertically in dry sand, and a much sounder pipe will result. It pays to go to a reliable firm. The pipes are cast in 6 ft. or 9 ft. lengths, according to size, and must be coated with Angus Smith's solution inside and out. This solution is composed of coal-tar and pitch-oil in the proportion of one part of tar to three of oil. The mixture is heated to the boiling temperature of the oil and the castings are immersed in it and allowed to remain until the temperature is diffused throughout the mass. The pipes are then gently withdrawn, the naphtha and other volatile oils evaporating and drawing off the iron, so that while still very hot a firm hard coating of pitch is left which firmly adheres to the pipe. It requires care in doing however, because the heat of the mixture must be between 350° and 450° Fah. ; if it is too hot the pitch will scale off. The flange joint for pipes used in pump sections has been discussed. For distribution two forms of joint are employed.

The ordinary spigot and socket form is most usually employed, as shown in section in fig. 117. The pipes are fitted home, and into the intervening space be-

tween them in the socket is run molten lead. This is afterwards caulked with a proper tool, and a very sound lasting joint will result. Before running the lead a round or so of gasket is pushed into the space to keep the pipes central and prevent the lead getting into them. The use of lead wool is much to be recommended. No gasket or molten lead is then required. It becomes a solid mass when rammed home with a proper caulking tool.

In fig. 118 is a type of joint known as the turned and bored joint, these pipes being also sometimes termed "drive" pipes. A special projection is cast both on the spigot and socket, and these are faced up



FIG. 117.



FIG. 118.

in the lathe to a taper. When the spigot end is rammed into the socket end and gently tapped home, the two turned faces come together and make the joint. They should be wiped with red-lead before driving home. No hard and fast rule can be laid down for the sizes of mains in small works. Four in. mains will be found to give satisfaction in most cases. The extra expense over 2 and 3 in. mains is generally amply repaid by future freedom from trouble and a good supply for cases of fire or emergencies. The thickness of metal will vary according to the greatest "head" likely to come upon them. The makers should be informed of the head when ordering. The pipes may be laid following the inclinations of the surface, provided the laws of the hydraulic gradient are observed, but it is a mistake

to have too many rises and falls, where a little extra cutting would reduce them. The pipes should have about 2 ft. 6 in. of cover at least. They may be laid in the trench without concrete, but they must bear evenly on the bottom, and concentration of weight on the sockets rigidly avoided. Where a length of pipe has to be cut, the joint of two adjacent spigot ends is made by a collar, which constitutes a double-ended socket, as shown in fig. 119. It is run up with lead in the usual way. When crossing a hill pipes meet so \wedge , and at

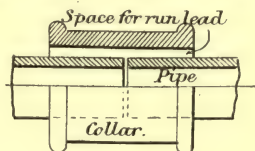
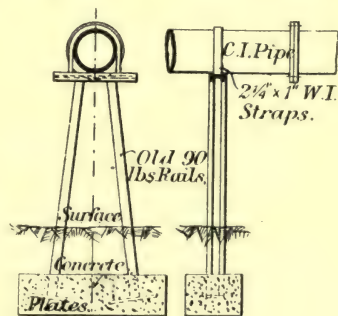

FIG. 119.

these points an air-valve is placed to let out air when the main is being filled after lying empty for any reason. These, together with stop-valves, hydrants, hatch-boxes for inspection, etc., constitute the usual fittings for distribution.

They are all fully illustrated and described in the catalogues of such makers as Messrs. Glenfield & Kennedy of Kilmarnock, etc., and it is unnecessary

to describe them in detail here, as they are always put up in stock patterns and sizes. When a small depression or ravine has to be crossed, it is sometimes inadvisable to carry the pipe down one side and up the other. A very useful construction, employed by the writer, which is simple and cheap, is shown in figs. 120 and 121,



FIGS. 120, 121.

shown in figs. 120 and 121,

For taking off small branches from mains lead pipe is used. The main is drilled and tapped and into it is screwed a brass ferrule having a union joint. On to one end of this union is soldered the lead pipe, by means of a wiped joint.

In fig. 122 an example is given of the distribution of water for various purposes in connexion with a large country house. It will be observed that an oil engine and pump delivers water from a shallow well into a large ferro-concrete tank at a sufficient elevation to allow of water flowing by gravity to the cast-iron tank on the main building. When water is in the concrete tank all the hydrants are under a pressure of about 50 ft. The house fittings are all supplied in the usual manner from the cast-iron tank, but there is a small slate tank in the kitchen fed by a $\frac{3}{4}$ -in. service pipe to supply water for drinking, etc. The hydrant at the stable is a wall pattern, and is used for carriage washing, etc.; the others are set in cast-iron surface boxes and are for fire use. The lodge has a $\frac{3}{4}$ -in. supply from the main tank. A by-pass in the engine-room allows of the engine pumping water into the mains at a pressure of 60 lb. per sq. in. when the valve at the foot of rising pipe to cast-iron tank is closed, a relief valve blowing off at this pressure being in the engine-room. This provision is in case of fire, but water at 50 ft. pressure is of course always available as long as the main tank is full. All the rain-water is led from the surface traps by 4 in. and 5 in. fireclay cement-jointed pipes into a large concrete tank in yard. The water is not filtered but merely strained. A pump in the yard serves to raise it for stable use, but may in dry

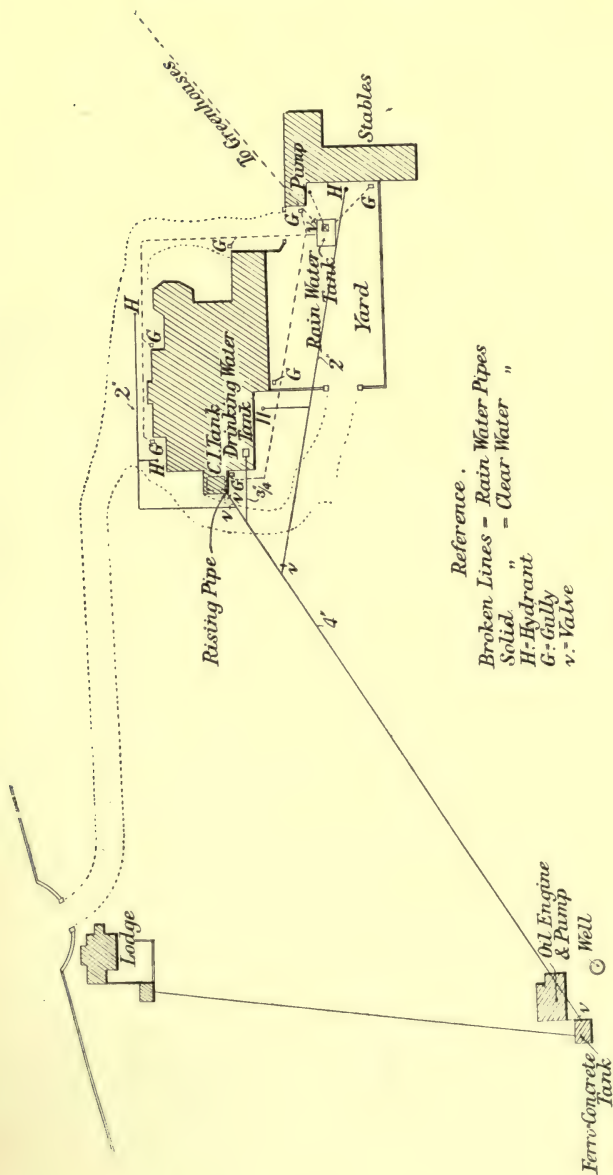

FIG. 122.

weather deliver into the cast-iron tank for house use. A 4-in. cast-iron pipe conveys the water from this tank to another at the greenhouses lower down, and the overflow also delivers into this pipe so that no water is wasted.

For the purpose of small supplies cast iron is practically universally used for pipes, except those inside the house of very small diameter. The metal is not usually as strong as that put into large machines and structural work, the ultimate tensile strength being not more than 6 tons per sq. in. on an average. Pipes are always tested at the works under pressure, and this pressure may be put on till the metal is stressed to half its breaking strength; but this will not usually do the pipe very much good, and in view of the fact that they should be struck with a hammer while under test, this stress should not exceed one-third the ultimate strength.

But between the time of proving and laying in the ground the pipes are subject to a variety of accidents which tend to produce defects, and where the pipe line is any way long or important it should be tested again when laid. The operation is somewhat troublesome and is consequently conspicuous by its absence. There should be a clause in the specification binding the contractor to locate and repair any leaks occurring when the full working pressure comes on, but this pressure is not usually sufficient to show up perhaps a very small leak. Where the ground is very undulating the mains are laid in sections, starting from the bottom of the valley on each pipe line and working up, socket end first, to the top of each hill. The pipes are here joined or as it is termed "married".

If the pipes were laid straight forward (as is the case when the gradients are slight) from the furthest point of supply to the reservoir, the lead would not flow properly into the joints on the down gradients and lead wool should be used in this case. For testing the far end has to be plugged. Screw plugs used for drain testing are quite unsuitable, and

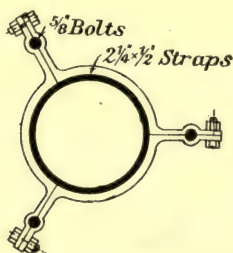

FIG. 123.

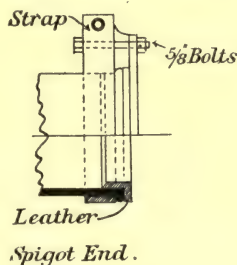

FIG. 124.

although a cap may be leaded on it must be properly strutted to prevent its blowing off, and in any case it is an awkward job to cut such plugs off, and consequently it is usual to resort to some form of removable cap for the purpose. Such a piece of apparatus is illustrated in figs. 123, 124, 125, the drawing being quite self-explanatory. Any firm who supply hydraulic machinery can provide the cup leathers, the rest of the apparatus being supplied by a local blacksmith. The apparatus is very useful to contractors who do much of this class of work, as a test is always a desirable thing. A small tap

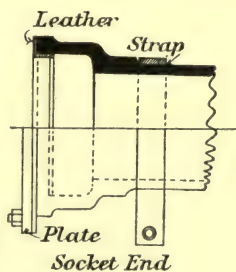

FIG. 125.

must be inserted in a stopper at the upper end to allow the air to escape while filling, when full the pressure is applied by a force-pump having a gauge to denote the pressure. While under pressure the pipe is subject to a radial pressure acting on the whole circumference of the pipe equally all round (except for the difference of head between the top and bottom of the pipe which is of course negligible). The component part of the force which tends to tear the metal asunder acts in a direction tangential to the circumference at all points and at right angles to the radius; consequently, although the pressure is radial, the circumference receives nearly an equal pressure all round. The force tending to burst the pipe, f is proportional to the radius, and if p is the pressure shown on the gauge,

$$f = pr \quad . \quad . \quad . \quad (45)$$

r being the radius.

Then if t = the thickness of metal, and s = strain per sq. in. of metal acted upon,

$$t = pr \quad . \quad . \quad . \quad (46)$$

Beyond the face, however, the metal is strained less and less according as the radius increases, because the portion of the metal acted upon by the force pr is indefinitely thin, the metal at the back of the pipe merely assisting the strength of that at the internal face. The metal resists the bursting pressure with a force inversely proportionate to the square of the radius at that part, because the magnitude of the bursting force is proportional to the internal radius, and its proportional stress at any part of its thickness is inversely as the distances at which it acts, the rate of extension being also inversely as the same distance;

APPENDIX I

NOISES IN WATER PIPES

It frequently happens that when all is complete and a water system is put into operation that noises appear in the pipes, which give rise to nuisance and are sometimes difficult to locate. Sometimes they take the form of loud cracking, which points to air in the service pipes, which accumulates in any raised parts in those underground, and which air is periodically driven through the cistern ball-valves. The remedy is to arrange the underground pipes so that no air can be pent up inside. Continuous noises are caused by water accelerating to and fro in each branch service pipe by which a vacuum is formed by each reflux motion inside, usually at the highest end or near to the cistern ball-valve. The water flows into this vacuum with such force as to knock against the inside of the pipe and cause a sound similar to that made by the stroke of a hammer. To remedy it a small air vessel should be placed on the service pipe as near to the highest ball-valve as may be convenient.

Humming noises are caused in a variety of ways :—

(a) By the valve washer not fitting true on the seat round the orifice inside the valve.

(b) By the edges of the washer being loose and

the water impinging against them, thus emitting a sound similar to the air impinging against the reed of an organ pipe.

To avoid this a hard material should be used for washers, such as vulcanized rubber. Ball-valves too light for the purpose may cause noise and should not be used. Heavy fittings of this kind are always best, having all burrs and sharp edges removed from the inside. In fact, attention should always be paid to the brass fittings of water supply schemes, and the best quality used. This is a matter which may escape attention in country work, town supplies being under regulation by the local authority as to class of fittings used.

The lead service pipes used should also be heavier than actually required. To calculate the strength of lead pipes the thickness and tearing strength must be known. This latter is 2160 lb. per sq. in. Consequently, if we know

t = thickness of pipe in inches,

$$s = \frac{2160}{6} = 360,$$

r = radius of pipe,

p = water press. lb. per sq. in.,

$$\text{then } p = \frac{t \times s}{r}.$$

In the case of 1 in. lead pipe,

$$p = \left(\frac{2 \times 360}{.5} \right) = 144 \text{ lb. per sq. in. ultimate,}$$

or a safe pressure of

$$\frac{144}{3} = 48 \text{ lb. per sq. in.}$$

APPENDIX II

FURTHER NOTES ON ABYSSINIAN TUBE PIPES

THIS kind of well forms a cheap and handy source of water supply. Some notes were made of it on page 40. This plant is cheap, and can be made by a local blacksmith, and the driving and fitting comparatively easy. A tube can be driven into drift deposits which are found over the whole of the older foundations. They vary in thickness, and consist of alternate layers of gravel and other material of a more or less porous nature, and clay which is considered as impervious. Water will usually be found in the porous material when the clay is pierced. Tubes can be driven through the clay for about 25 ft. if there is not any hard rock. In the case of rock or greater depths boring has to be resorted to. For driving a point, illustrated in fig. 31, lap-welded steam pipe and a pump are required; for small houses $1\frac{1}{2}$ in. tube will do. Stock lengths of 3 to 10 ft. can be obtained. (Gas pipe is quite unsuitable.) The sockets must be bevelled off to prevent undue resistance in driving.

The lower tube is bulbed up to a point, as shown in fig. 31. The holes should be $\frac{1}{8}$ in fine strata and $\frac{1}{4}$ in coarse. They should extend for about 18 in. and have a total area greater than that of the tube.

The class of pump supplied will vary with the class of dwelling supplied. For driving, a clamp as shown in fig. 126 is fixed to the tube with bolts and nuts. Over the tube above a block of wood is made to slide. It has a hole in it a little larger than the outside diameter of the tube, iron handles on each side, and iron rings at each end to prevent splitting.

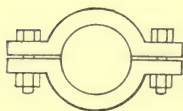

FIG. 126.

Over the tube above a block of wood is made to slide. It has a hole in it a little larger than the outside diameter of the tube, iron handles on each side, and iron rings at each end to prevent splitting. The up and down motion on to the clamp effects the driving. During driving the inside of the tube has to be cleaned by a steam shell-pump, like fig. 20, attached to $\frac{1}{2}$ in. tube. The ball would be a small lead one $\frac{5}{8}$ in. in diameter. If a general survey of the site seems to be in favour of finding water at any particular point, driving can be started by means of a small hole 24 in. deep, made with a pinch bar, but it must be made quite vertical as it is a base for subsequent operations, and when the point is placed in it, it must be accurately plumbed and re-drawn if not quite so. Two men work the block of wood which is called a "monkey," the clamp being removed as the work proceeds. The water will start to rise when the tube has gone down quite a short distance perhaps, but it must be driven several feet farther down to allow for its lowering the saturation surface, testing the tube for its perpendicularity in the meantime. Water poured down the tube will loosen the earth which has got in preparatory to removing it by the shell-pump, and as soon as a few feet of water rise in the tube the pump should be fixed. The first water will be muddy and scarce. More pumping, especially a few strokes at a time and then a pause, will so increase and clear it.

INDEX

A

	PAGE
Abyssinian tube well - - - - -	40
Accessories of tanks - - - - -	140
Advice to buyers of gas engines - - - - -	103
Air compressor - - - - -	86
— lift pump - - - - -	86
— valves on pipes - - - - -	151
— vessel on pumps - - - - -	89
Ammonia in water - - - - -	3, 11
Analyst's report - - - - -	11
Angus Smith's solution - - - - -	149
Artesian wells - - - - -	16-30
Ashley pump - - - - -	76

B

Bacterial examination - - - - -	2
Banks, concrete and clay - - - - -	114
— puddle - - - - -	112
Bends in pipes - - - - -	60
Bolts, foundation - - - - -	99
Borehole lining - - - - -	39
Boring - - - - -	36
— Chinese system of - - - - -	36
— chisels for - - - - -	38
— from bottom of well - - - - -	41
— in stiff clay - - - - -	45
— rods - - - - -	41

	PAGE
Boring, rotary motion for - - - - -	42
— tools for - - - - -	37-38
Bourne, well at - - - - -	24
Brake horse-power - - - - -	92
Branch pipes - - - - -	60
Branches, size of - - - - -	62
Brick lining of wells - - - - -	30
Bursting pressure in pipe - - - - -	156
Buttressed masonry dams - - - - -	123
Bye-wash - - - - -	114

C

Cast-iron tanks - - - - -	137
Cement, sand for - - - - -	136
— waterproofing - - - - -	135
Chalk-beds near sea - - - - -	18
— water from - - - - -	17
Channels, flow in - - - - -	57
— open, form of - - - - -	57
Chinese system of boring - - - - -	36
Chisels for boring - - - - -	38
Chlorine in water - - - - -	3-4
Clay, boring tool for - - - - -	45
— puddle - - - - -	113
CO ₂ in water - - - - -	13
Coal measures, effect of - - - - -	21
Comparison of pumps - - - - -	87
Compressor air - - - - -	86
Concrete and clay bank - - - - -	114
— dams - - - - -	126
— for steining - - - - -	33
— tank roof - - - - -	146
Constructing wells - - - - -	29
Consumption of gas - - - - -	103
— of oil - - - - -	102

	PAGE
Consumption of water - - - - -	26
Crow's-foot tool - - - - -	39
Curbs, cast-iron - - - - -	33
— timber - - - - -	31

D

Dams, buttressed masonry - - - - -	123
— masonry - - - - -	118-119
— reinforced concrete - - - - -	126
— timber - - - - -	54
— water thrust on - - - - -	121
Dangers of well water - - - - -	24
Daniells' pump - - - - -	80
Delivery of pumps - - - - -	87
Depth gauge - - - - -	140
— of wells - - - - -	29
Designing walls - - - - -	129
Detonator - - - - -	45
Diagram, stress - - - - -	129
Diamond drill - - - - -	43
Dionic water tester - - - - -	7
Distributing valve for filters - - - - -	144
Divining water - - - - -	23
Draw-off pipes - - - - -	117
Drinking water - - - - -	22
Dublin water - - - - -	10

E

Earth pressure on walls - - - - -	128
Efficiency of filtration - - - - -	143
Engines, gas - - - - -	92, 101
— horse-power - - - - -	92
— oil - - - - -	92, 101
Erection of foundations - - - - -	99

	PAGE
Erection of turbines - - - - -	94
— of well pumps - - - - -	76
Escarments - - - - -	18
Evaporation, loss by - - - - -	15
Examination, bacterial - - - - -	2
Explosives, use in wells - - - - -	45

F

Faults - - - - -	17
Filter, simple - - - - -	141
— size of - - - - -	142
Filtering media - - - - -	141
— water - - - - -	140
Filtration, efficiency of - - - - -	143
Filters, distributing valve - - - - -	144
— outlet from - - - - -	144
Flood waters - - - - -	116
Flow in channels - - - - -	58
— in pipes - - - - -	58-59, 89
— in streams - - - - -	48
— pipes - - - - -	59
Flow-over gauges - - - - -	52
Formulæ for gauges - - - - -	53
Foundations for pumps - - - - -	98
Francis' formula - - - - -	53
Friction formula - - - - -	59
Fuel for gas-producers - - - - -	105

G

Gas engines - - - - -	101
— — above sea-level - - - - -	104
— — buying - - - - -	103
— — fuel for - - - - -	105
— — governing - - - - -	102
— — horse-power - - - - -	92

	PAGE
Gas producers - - - - -	105
— pump - - - - -	106
Gauge depth - - - - -	140
— flow-over - - - - -	52
— formulæ for - - - - -	53
— for streams - - - - -	51
Gauging streams - - - - -	48
Good water, qualities of - - - - -	5
Gradient, hydraulic - - - - -	61
Gravel, water from - - - - -	20
Gravitating mains - - - - -	62
Guttermuth pump-valves - - - - -	81

H

Hand pump - - - - -	66
Hardness in water - - - - -	4-5
Hatfield pump - - - - -	82
Hawkesly's formula - - - - -	53
"Head" - - - - -	64
Hill-side reservoir - - - - -	130
Hook gauge - - - - -	52
Horse pump - - - - -	67
— power of gas engines - - - - -	92
House, water system for - - - - -	152
Humphrey pump - - - - -	106
Hydraulic gradient - - - - -	61
— mean depth - - - - -	57
— ram - - - - -	68
— — arrangement of - - - - -	72
— — formula for - - - - -	69
— — loss of efficiency - - - - -	74
— — power to work - - - - -	71
— — snifting valve - - - - -	73
Hydrogen sulphide in water - - - - -	11

	PAGE
I	
Impurities in water - - - - -	141
Intermittent springs - - - - -	17
J	
Joints of pipes - - - - -	150
Jurassic rocks - - - - -	20
K	
Kaye-Parry on Dublin water - - - - -	12
L	
Laying cast-iron pipes - - - - -	154
Lead pipes, water in - - - - -	11
— service pipes - - - - -	152
Limestone - - - - -	21
Line of rupture - - - - -	128
Lining for borehole - - - - -	39
— for wells - - - - -	30-33
Loss by evaporation - - - - -	15
— of head - - - - -	59
M	
Masonry dams - - - - -	118
— materials for - - - - -	119
Mean velocity of stream - - - - -	50
Media for filters - - - - -	141
Metal in water - - - - -	3
Millstone grit - - - - -	21
Mitre valves - - - - -	78
N	
Nitrogen in water - - - - -	3

	PAGE
Puddle trench, springs on	114
— thickness of	113
— plates	115
Pump, air lift	86
— Ashley	76
— centrifugal	84
— comparison of	87
— Daniells'	80
— deep well	75
— delivery pipes for	87-88
— erection of	76
— foundation	98-99
— hand	66
— Hatfield	82
— horse	67
— Humphrey	106
— mitre valves	78
— piston	82
— plunger	76
— ram	79
— shell	38
— steam	93
— suction pipes for	87-88
— three-throw	80
— water-power	94
— wind-power	95-96
Pumping water	66
Purity of water	I

Q

Quantity of water to provide for	25
----------------------------------	----

R

Ram, hydraulic	68
— arrangement of	72

	PAGE
Ram, hydraulic, formulæ - - - - -	69
— — — — — loss of efficiency - - - - -	74
— — — — — power to work - - - - -	71
— — — — — snifting valve - - - - -	73
— — — — — pumps - - - - -	79-80
Reinforced concrete dams - - - - -	126
— — — — — tank - - - - -	131-146
Reservoir on hill-side - - - - -	130
Reservoirs, draw-off pipes - - - - -	116
— — — — — flood water from - - - - -	116
— — — — — syphon outlet - - - - -	116
Rivers, pipes over - - - - -	151
— — — — — pollution of - - - - -	9
— — — — — weirs - - - - -	122
Rocks, Jurassic - - - - -	20
— — — — — oolitic - - - - -	20
Rods, boring - - - - -	41
Roof supplies - - - - -	12
Rupture, line of - - - - -	128

S

Sampling water - - - - -	1
Sand for use in cement - - - - -	136
Sandstone springs - - - - -	20-21
Saturation surface - - - - -	14
Sea, chalk-beds near - - - - -	18
Service pipes - - - - -	152
Shallow well water - - - - -	14
— — — — — wells - - - - -	25
Size of filters - - - - -	142
— — — — — of pipes - - - - -	62
Slide joint - - - - -	44
Smith's solution - - - - -	149
Spring water - - - - -	9, 29
Springs, intermittent - - - - -	17

	PAGE
Steam pump - - - - -	93
Steining wells - - - - -	30-33
Storage tanks - - - - -	22, 130-135, 144
Storing water - - - - -	III-143
Stream, flow in - - - - -	48
— gauge - - - - -	51
— gauging - - - - -	48
— use of - - - - -	48
Strength of pipes - - - - -	156
Stress, diagrams for walls - - - - -	129
Suction pipes - - - - -	87
Sulphur in water - - - - -	3-4
Supplies from rivers - - - - -	2-13
Surface springs - - - - -	15
Syphon - - - - -	64, 116

T

Tank appurtenances - - - - -	140
— cast-iron - - - - -	137
— reinforced concrete - - - - -	131
— roofs - - - - -	146-147
— underground - - - - -	145
— walls - - - - -	148
Tanks, storage - - - - -	22, 130-135, 144
Tester, dionic - - - - -	7
Testing cast-iron pipes - - - - -	155
— samples - - - - -	5
— water - - - - -	5-6
Thickness of cast-iron pipes - - - - -	156
— of dams - - - - -	119
Thrust on dams (water) - - - - -	121
— on earth - - - - -	128-130
Tools, boring - - - - -	37
Trench, puddle - - - - -	113
Trias, formation - - - - -	20

	PAGE
Tubes for boreholes - - - - -	40
Turbidity - - - - -	10
Turbine - - - - -	94

U

Underground tanks - - - - -	145
-----------------------------	-----

V

Vee notch - - - - -	54
Velocity of stream - - - - -	49

W

Walls, tank - - - - -	148
Waste weir - - - - -	116
Water, action on lead pipes - - - - -	11
— diviner - - - - -	23
— flood - - - - -	116
— from chalk - - - - -	17
— from gravel - - - - -	20
— from shallow wells - - - - -	14
— impurities in - - - - -	141
— logged ground - - - - -	14
— pipes - - - - -	149
— pollution of - - - - -	2
— power - - - - -	94
— purity of - - - - -	1
— qualities of good - - - - -	5
— storage - - - - -	111
Water thrust on dams - - - - -	121-128
Weight of pipes - - - - -	62
Weir, river - - - - -	122
Well pump - - - - -	75
Wells at Bourne - - - - -	24

	PAGE
Wells, brick lining - - - - -	30
— constructing - - - - -	29
— danger of water from - - - - -	24
— depth of - - - - -	29
— position of - - - - -	23-28
— shallow - - - - -	25
— steining - - - - -	29
— use of explosives in - - - - -	45
Wooden dam - - - - -	54

CITY OF TORONTO
DEPARTMENT OF CIVIL ENGINEERING
Municipal and Structural

UN
DEPA

DEPARTMENT OF CIVIL ENGINEERING
Municipal and Structural

PLEASE DO NOT REMOVE
CARDS OR SLIPS FROM THIS POCKET

UNIVERSITY OF TORONTO LIBRARY

S&M
A
491

