

2
SMITHSONIAN



MISCELLANEOUS COLLECTIONS

VOL. 81



"EVERY MAN IS A VALUABLE MEMBER OF SOCIETY WHO, BY HIS OBSERVATIONS, RESEARCHES,
AND EXPERIMENTS, PROCURES KNOWLEDGE FOR MEN"—SMITHSON

(PUBLICATION 3063)

CITY OF WASHINGTON
PUBLISHED BY THE SMITHSONIAN INSTITUTION

1930

The Lord Baltimore Press
BALTIMORE, MD., U. S. A.

ADVERTISEMENT

The present series, entitled "Smithsonian Miscellaneous Collections," is intended to embrace all the octavo publications of the Institution, except the Annual Report. Its scope is not limited, and the volumes thus far issued relate to nearly every branch of science. Among these various subjects zoology, bibliography, geology, mineralogy, anthropology, and astrophysics have predominated.

The Institution also publishes a quarto series entitled "Smithsonian Contributions to Knowledge." It consists of memoirs based on extended original investigations, which have resulted in important additions to knowledge.

C. G. ABBOT,
Secretary of the Smithsonian Institution.



CONTENTS

1. THÉRIOT, I. Mexican mosses collected by Brother Arsène Brouard—II. August 15, 1928. 26 pp., 9 text figs. (Publ. no. 2966.)
2. RESSER, CHARLES E. Cambrian fossils from the Mohave Desert. July 5, 1928. 14 pp., 3 pls. (Publ. no. 2970.)
3. SNODGRASS, R. E. Morphology and evolution of the insect head and its appendages. November 20, 1928. 158 pp., 57 text figs. (Publ. no. 2971.)
4. BUSHNELL, DAVID I., JR. Drawing by Jacques Lemoyne De Morgues of Saturioua, a Timucua chief in Florida, 1564. August 23, 1928. 9 pp., 1 pl., 1 text fig. (Publ. no. 2972.)
5. ABBOT, CHARLES G. The relations between the Smithsonian Institution and the Wright brothers. September 29, 1928. 27 pp. (Publ. no. 2977.)
6. ALDRICH, L. B. A study of body radiation. December 1, 1928. 54 pp., 9 text figs. (Publ. no. 2980.)
7. ROBERTS, FRANK H. H., JR. Recent archeological developments in the vicinity of El Paso, Texas. January 25, 1929. 14 pp., 5 pls., 8 text figs. (Publ. no. 3009.)
8. METCALF, MAYNARD M. Parasites and the aid they give in problems of taxonomy, geographical distribution, and paleogeography. February 28, 1929. 36 pp., 3 text figs. (Publ. no. 3010.)
9. MILLER, GERRIT S., JR. A second collection of mammals from caves near St. Michel, Haiti. March 30, 1929. 30 pp., 10 pls. (Publ. no. 3012.)
10. McINDOO, N. E. Tropisms and sense organs of Lepidoptera. April 4, 1929. 59 pp., 16 text figs. (Publ. no. 3013.)
11. FOWLE, FREDERICK E. Atmospheric ozone: Its relation to some solar and terrestrial phenomena. March 18, 1929. 27 pp., 13 text figs. (Publ. no. 3014.)
12. JEANÇON, J. A. Archeological investigations in the Taos Valley, New Mexico, during 1920. June 11, 1929. 29 pp., 15 pls., 14 text figs. (Publ. no. 3015.)
13. WETMORE, ALEXANDER. Descriptions of four new forms of birds from Hispaniola. May 15, 1929. 4 pp. (Publ. no. 3021.)
14. COLLINS, HENRY B., JR. Prehistoric art of the Alaskan Eskimo. November 14, 1929. 52 pp., 24 pls., 2 text figs. (Publ. no. 3023.)
15. HALL, MAURICE C. Arthropods as intermediate hosts of helminths. September 25, 1929. 77 pp. (Publ. no. 3024.)





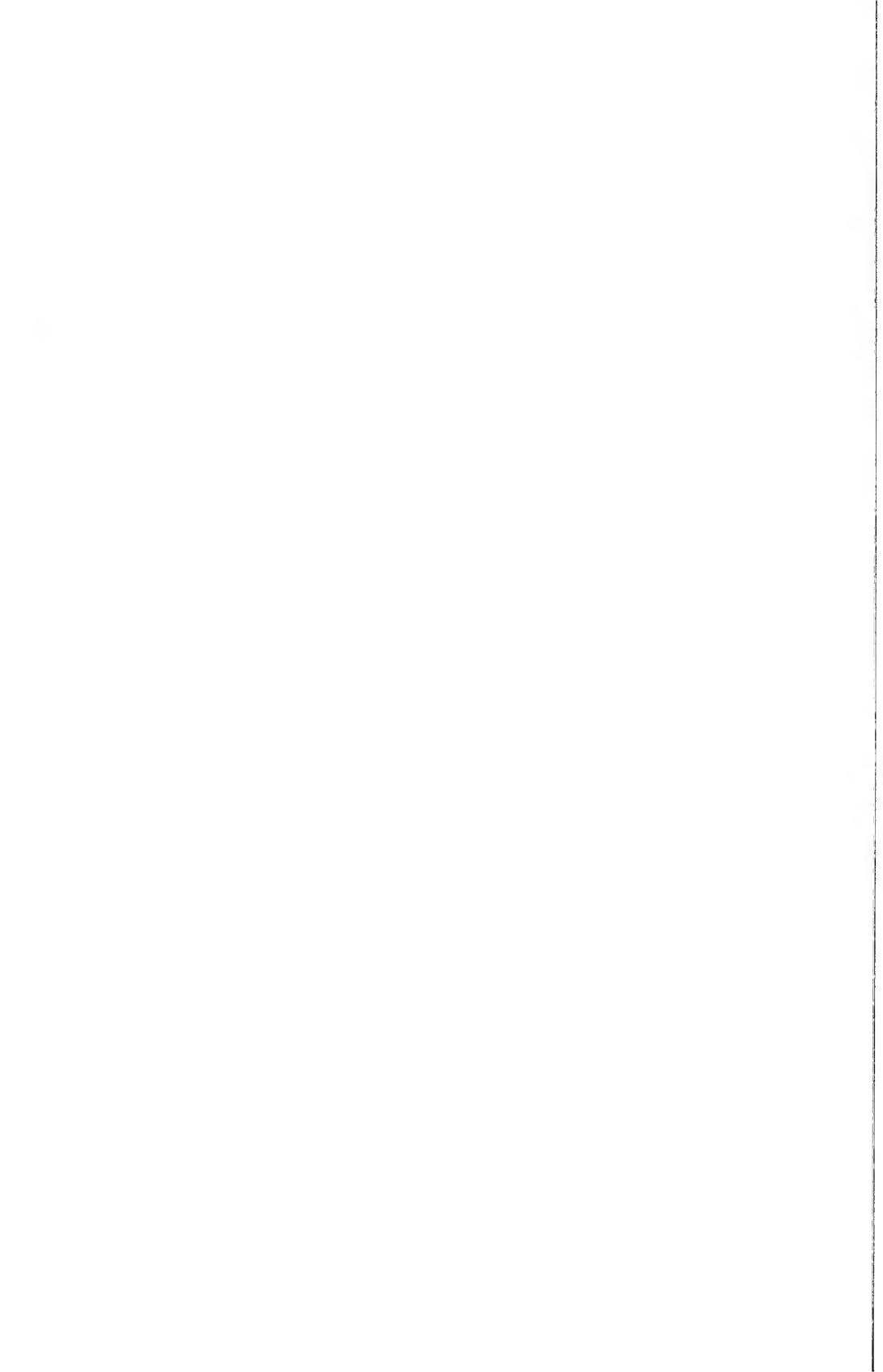

SMITHSONIAN MISCELLANEOUS COLLECTIONS
VOLUME 81, NUMBER 1

MEXICAN MOSSES COLLECTED BY
BROTHER ARSÈNE BROUARD II

BY
I. THÉRIOT
Fontaine la Mallet, France



(PUBLICATION 2966)

CITY OF WASHINGTON
PUBLISHED BY THE SMITHSONIAN INSTITUTION
AUGUST 15, 1928

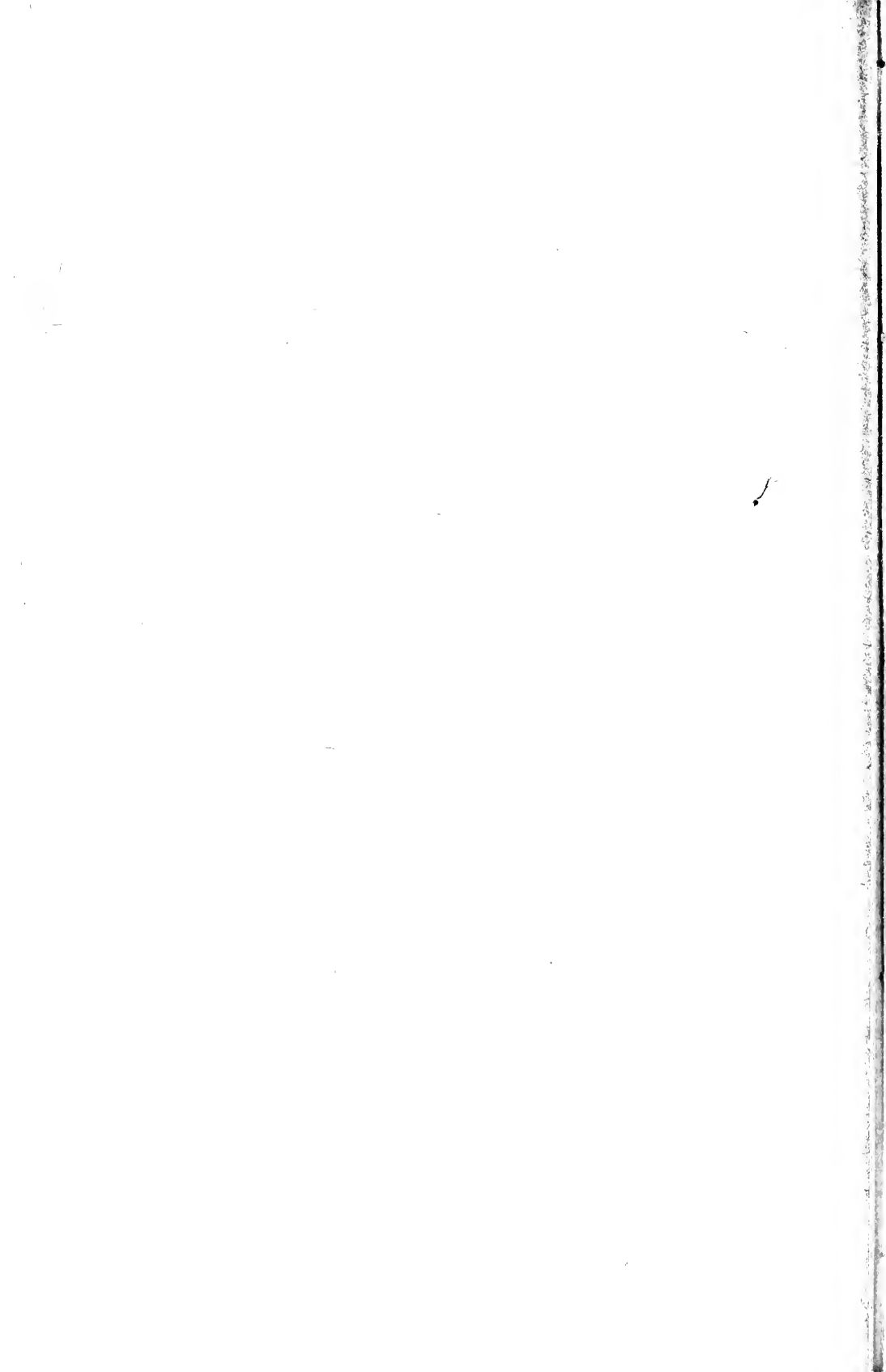

SMITHSONIAN MISCELLANEOUS COLLECTIONS
VOLUME 81, NUMBER 1

MEXICAN MOSSES COLLECTED BY
BROTHER ARSÈNE BROUARD—II

BY
I. THÉRIOT
Fontaine la Mallet, France



(PUBLICATION 2966)

CITY OF WASHINGTON
PUBLISHED BY THE SMITHSONIAN INSTITUTION
AUGUST 15, 1928

The Lord Baltimore Press
BALTIMORE, MD., U. S. A.

MEXICAN MOSSES COLLECTED BY BROTHER
ARSÈNE BROUARD—II¹

By I. THÉRIOT

FONTAINE LA MALLET, FRANCE

In the present paper I continue my report upon the important moss collections made by Brother G. Arsène, which the United States National Museum submitted to me for study. The species here considered belong chiefly to the families Grimmiaceae, Funariaceae, Bryaceae, Orthotrichaceae, Meteoriaceae, Neckeraceae, Leskeaceae, and Thuidiaceae. In a third paper, in preparation, I shall review the Pottiaceae, Amblystegiaceae, Brachytheciaceae, and Hypnaceae.

Through the good offices of Brother Arsène, I have entered into correspondence with a new and zealous collector of Mexican mosses, Brother Amable (F. S. C.), a teacher in Mexico City. Last year I received from him an important collection from the "Valley of Mexico," a classic locality often cited in the *Prodromus* of Bescherelle. The plants were gathered in localities whose altitudes vary from 2,100 to 3,400 meters. Brother Amable's mosses will be included in the present paper and in the following one. To distinguish them from those of Brother Arsène's collection they are accompanied by Brother Amable's name.

About two years have elapsed since the completion of the first paper, and meantime Mr. V. F. Brotherus has published the second edition of his *Genera*. Important modifications have taken place in the families and the genera, and in the known distribution of the species. The reader is advised that the present work follows the plan of the second edition, while the preceding paper was written in conformity with the first edition.

¹ Part I was published as Vol. 78, No. 2, Smithsonian Miscellaneous Collections, June 15, 1926, and to this the reader is referred for a list of special collecting localities with altitudes. The comments and critical notes of the present instalment have been translated from the French by Brother Arsène.

DITRICHACEAE (continuation)

CERATODON PURPUREUS (L.) Brid.

Valle de México: Desierto (*Bro. Amable*).

CERATODON STENOCARPUS Bry. Eur.

Valle de México: Desierto (*Bro. Amable* 1269).

DICRANACEAE (continuation)

AONGSTROEMIA BRITTONIAE Thér., nom. nov.

Aongstroemia pusilla Thér. Smithsonian Misc. Coll. 78²: 2. 1926.

I name this species after Mrs. E. G. Britton, who had the kindness to inform me that the name *pusilla* had already been used by Hampe.

METZLERELLA LEPTOCARPA (Schimp.) Card.

Valle de México: Desierto (*Bro. Amable* 1254 in part).

Mr. R. S. Williams has established (*N. Amer. Fl.* 15: 153. 1913) the synonymy of this species with *Dicranodontium costaricense* (C. M.) R. S. Williams. I agree with him, but, following Brotherus' example, I maintain the species in the genus *Metzlerella*. Thus the name becomes ***Metzlerella costaricensis*** (C. M.) Broth.

OREAS MEXICANA Thér., sp. nov.

(FIG. 1)

Morelia: Cerro Azul (4793).

Autoica, corticola, pusilla. Caulis vix 1-2 mm. altus. Folia sicca crispula, humida valde patula, lanceolato-lineararia, breviter et late acuminata, subobtusa, concava, canaliculata, marginibus planis, integris, 1.7-2.5 mm. longa, 0.25-0.35 mm. lata, costa basi 40 μ , dorso laevi, ante apicem evanescente, cellulis basilaribus hyalinis, rectangularibus, parietibus tenuibus, sequentibus quadratis vel breviter hexagonis, saepe transverse dilatatis, valde chlorophyllosis, tenuiter papillosis, parietibus tenuibus, 10 μ \times 6-8 μ . Pedicellus sicca suberectus, tortellus, humida superne cygnicollus, 1-2 mm. longus; capsula minuta, sicca suberecta, cylindrica, valde sulcata, humida subglobosa; peristomium simplex, dentes (8) bigeminati, irregulares, nunc breves, e basi late triangulari obtusi, 6-8-trabeculati, nunc elongati, 14-16-trabeculati (0.12 mm. alti), longitudinaliter striati, sporae 18-24 μ crassae. Caetera desunt (capsulae deoperculatae).

This is one of the finest discoveries made by Brother Arsène. The genus *Oreas* has been regarded as monotypic; besides it has not been known in America.

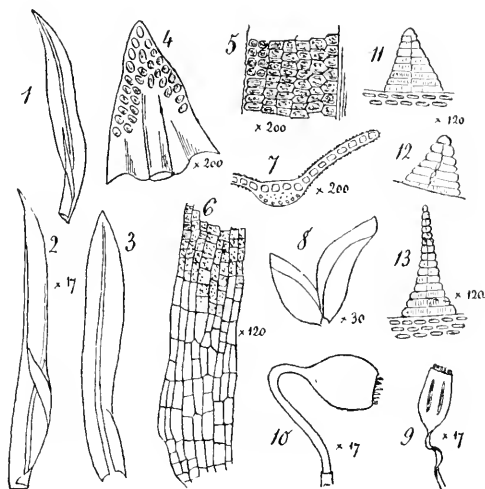

FIG. 1.—*Oreas mexicana* Thér. 1, 2, 3, leaves; 4, acumen; 5, margin and median cells; 6, basal areolation; 7, cross-section of a leaf toward the middle; 8, perigonal leaves; 9, dry capsule; 10, moist capsule; 11, 12, 13, teeth of peristome.

Oreas Martiana Hoppe & Hornsch. is more robust, with stems 2 to 6 cm. long; the leaves are very acute, partially revolute, and long-attenuate at the apex; the costa is excurrent, and the cells are strongly incrassate and completely smooth.

SYMBLEPHARIS HELICOPHYLLA Mont.

Valle de México: Desierto (*Bro. Anable* 1246, 1254 in part).

In these specimens the species appears under two distinct forms, which are, however, rather frequently combined in the same tuft. They are characterized as follows:

(a) Forma *normalis*. Pedicel 10 mm. long; deperculate capsule 2 mm.

(b) Forma *brevisetata*. Shorter pedicel (3-4 mm.); deperculate capsule 1.5 mm.

I am unable to discover any other differences between these two forms.

GRIMMIACEAE

COSCINODON ARSENEI Thér., sp. nov.

(FIG. 2)

Querétaro: Júrica, upon stones (11001).

Autoicus, pusillus, sat compactus. Caulis brevis, simplex, 3-5 mm. altus. Folia sicca imbricata, humida erecto-patula, obovata, breviter acuminata, longe pilifera, 1.5 mm. longa, 1 mm. lata, marginibus planis, integerrimis, costa valida, basi 80 μ , in pilum longum, hyalinum, integrum excedente, cellulis basilaribus quadratis, parce chlorophyl-

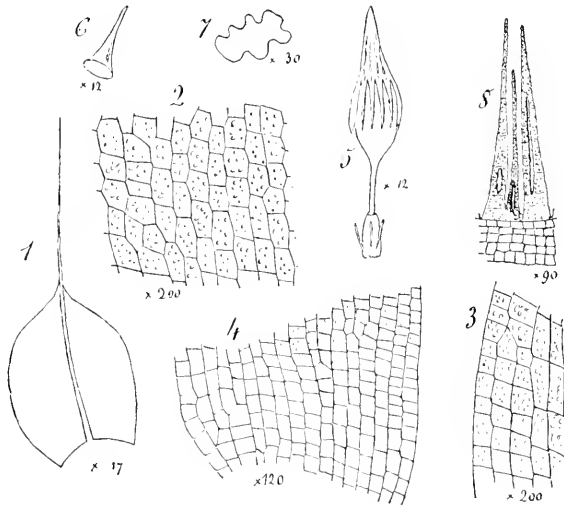

FIG. 2.—*Coscinodon Arseni* Thér. 1, leaf; 2, median cells; 3, marginal cells; 4, basal areolation; 5, capsule with calyptra; 6, operculum; 7, cross-section of calyptra; 8, teeth of peristome.

losis, sequentibus breviter rectangularibus vel hexagonis, laevibus, parietibus tenuibus, majusculis, 15-30 μ longis, 12-15 μ latis. Pedicellus erectus, circa 1 mm. longus; capsula subimmersa, minuta, ovata, sicca laevis; operculum conico-rostratum; annulus latus; peristomii dentes irregulares, nunc simplices, parum lacunosi, nunc fere ad basin fissi, papilloso, 0.35-0.40 mm. lati; sporae 12-15 μ crassae; calyptra mitraeformis, valde plicata, profunde laciniata, fere totam capsulam obtegens.

Close to *C. Wrightii* Sull., but very distinct; differing from it by the larger, entire leaves, thin-walled cells, the capsule borne upon a longer pedicel and consequently almost exserted, and, finally and chiefly, by the narrow, slightly lacunose teeth of the peristome.

GRIMMIA OVATA Web. & Mohr, forma dioica

Morelia: Cerro San Miguel (5070); Campanario (7449).

GRIMMIA ARSENEI Card. Rev. Bryol. 40: 37. 1913

Morelia: (7894, 7906).

Sterile plants. It would be interesting to know this plant in fruit, in order to be sure of its affinities. By its size and form and the direction and areolation of the leaves it appears very close to *G. californica* Sull.; nevertheless it may be distinguished by the areolation of the lamina, which is very opaque and formed throughout by two layers of cells, while in *G. californica* the cells are bistratose only on the margin (1 to 6 rows of cells).

GRIMMIA CALIFORNICA Sull.

Valle de México: Salazar, upon earth (*Bro. Amable* 1293).

I believe this species is new for Mexico.

FUNARIACEAE

FUNARIA SARTORII C. M.

Puebla: Hacienda Alamos (4724 in part); Rancho Posadas (4806).
Distrito Federal: Mixcoac (9472); Desierto (*Bro. Amable* 1206, 1217).

Determined from description. Brother Amable's specimens differ from Brother Arsène's in having shorter and slightly broader leaves, shorter peristome, and larger and more verrucose spores. They may represent a distinct species.

FUNARIA APICULATIPILOSA Card. Rev. Bryol. 40: 37. 1913

Puebla: Cerro Guadalupe (686, 687, 4613); Rancho Guadalupe (4590, 4592).

Nos. 686 and 687 have horizontal, larger capsules and a higher peristome; moreover, their leaves are more difficult to moisten.

FUNARIA EPIPEDOSTEGIA Card. Rev. Bryol. 36: 109. 1909

Morelia: Cerro San Miguel (5043, 5044, 5083); Campanario (7939a).

FUNARIA ORTHOPODA Thér., sp. nov.

(FIG. 3)

Puebla: Río San Francisco (919, 923).

Caulis brevissimus, 1-2 mm. altus, inferne denudatus, superne comosus. Folia sicca et humida erecta, difficile emollita, valde concava.

oblongo-acuminata, acuta, elimbata, marginibus planis, integris, 2 mm. longa, 0.7 mm. lata, costa tenui, percurrente; rete pellucido, cellulis vesiculosus, quadratis vel breviter hexagonis, superioribus longioribus. Pedicellus erectus, 15-25 mm. longus, capsula inclinata, oblonga, arcuata, asymmetrica, macrostoma, collo brevi attenuata, profunde sulcata; operculum plano-convexum; peristomium duplex, dentes papilloosi, haud striati, 0.5 mm. alti, processus papilloosi; sporae sublaeves, 20-24 μ crassae.

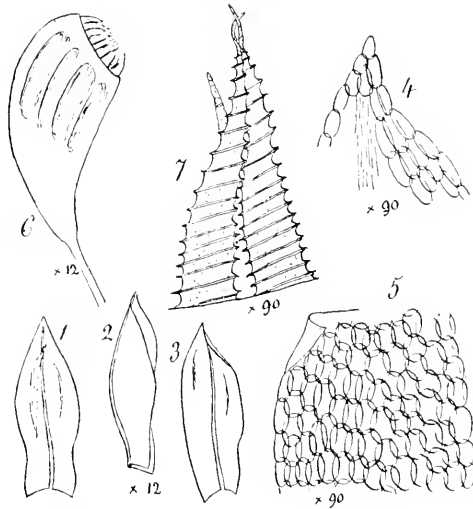

FIG. 3.—*Funaria orthopoda* Thér. 1, 2, 3, leaves; 4, apical cells; 5, basal areolation; 6, capsule; 7, fragment of peristome.

Belonging to the group of *F. hygrometrica* (L.) Sibth. Distinguished from that species and its numerous forms or subspecies by a straight not hygrosopic pedicel, a suberect capsule, and larger spores.

FUNARIA HYGROMETRICA (L.) Sibth. and var. CALVESCENS
(Schwaegr.) Bry. Eur.

Apparently very common in Mexico, as elsewhere. There are more than 25 numbers in the collection. I think it useless to enumerate them.

FUNARIA CONVOLUTA Hampe

Puebla: (7958). Morelia: Loma del Zapote (4638, 4639); Bosque San Pedro (4576).

The species is surely close to *F. hygrometrica* var. *calvescens*; nevertheless it may be recognized by the form of the capsule, the large size

of the spores, and, chiefly, by the perichaetium, the external leaves of which are spreading and the internal ones closely clasping the pedicel, all of them very concave, very shortly acuminate or subrounded, and acute or subobtusely.

A novelty for Mexico.

FUNARIA ANNULATA Besch. Prodr. Bryol. Mex. 48. 1871

Puebla: Road to Cholula (713).

Brotherus considers this moss very close to *F. calvescens* Schwaegr. I do not deny it, but I have not been able to examine enough specimens to appreciate the extent of the variations and to form a concrete opinion of its relative position.

BRYACEAE

WEBERA SPECTABILIS (C. M.) Jaeg.

Bryum spectabile C. M. Syn. 2: 583. 1851.

Morelia. Campanario (4772, 7535).

WEBERA CYLINDRICA Schimp. in Besch. Prodr. Bryol. Mex. 52. 1871

Morelia: Campanario (7549, 7932, 7952); Loma Santa María (5102).

I consider these two species very close. It would not be difficult, I think, to find some day transitional forms which will throw *W. cylindrica* into synonymy. Meanwhile I distinguish *W. cylindrica* by its broader leaves (0.5-0.7 mm., instead of 0.3-0.4 mm.), more frequently revolute, with a stronger costa (70-120 μ against 40-60 μ).

WEBERA DIDYMODONTIA (Mitt.) Broth. in Engl. & Prantl, Pflanzenfam. ed. 2, 1: 362. 1924

Bryum didymodontium Mitt. Musc. Austr. Amer. 289. 1869.

Morelia: Campanario (7547, 7555, 7556, 7640).

Determination doubtful. In the sterile state it seems to me impossible to distinguish with certainty this species from *W. commutata* Schimp. Only a single specimen (7556) is in fruit, and the capsules are very young. I recognized the species by the length of the pedicels (up to 4 cm.), and I give the same name to the sterile specimens because they are from the same place and look identical with no. 7556.

WEBERA ZACATECANANA (R. S. Williams) Thér., comb. nov.

Pohlia zacatecana R. S. Williams, Bryologist 26: 33. pl. 4. 1923.

Morelia: Andameo (4833).

MNIOBRYUM ALBICANS (Wahlenb.) Limpr. Laubm. Deutschl. 2: 277. 1895

Mnium albicans Wahlenb. Fl. Lapp. 353. 1812.

Puebla: Río San Francisco (5005). Morelia: Rincón (9436).
Distrito Federal: Tlalpam (9500).

EPIPTERYGIUM MEXICANUM (Besch.) Broth.

Valle de México: Desierto (*Bro. Amable*). Growing as isolated stems among other mosses.

BRACHYMENIUM BARBAE-MONTIS C. M.

Puebla: Tepoxúchitl (s. n.). Morelia: Andameo (4820). Tlaxcala: Acuitlalpilco (743 in part).

The last number differs from the others by its broader leaves, revolute for a longer distance, with a short apiculus. It is perhaps more than a form, but unfortunately the specimens are absolutely sterile.

BRACHYMENIUM EXIGUUM Card. Rev. Bryol. 38: 7. 1911

Puebla: San Antonio (*Bro. Nicolas* 6028); Cerro Guadalupe (660).

BRACHYMENIUM MURALE Schimp. in Besch. Prodr. Bryol. Mex. 51. 1871

Puebla: Rancho Posadas (4804). Veracruz: Córdoba (s. n.).

BRACHYMENIUM Sect. **LEPTOSTOMOPSIS**

I recognized in this section among Brother Arsène's mosses the following species: *B. capillare* Schimp., *B. luteolum* (C. M.) Jaeg., *B. imbricatum* Schimp., *B. Münchii* Broth., *B. chlorocarpum* Card., *B. Lozanoi* Card., *B. niveum* Besch., and *B. condensatum* R. S. Williams.

Among these numerous species, the last three are easy to distinguish: *B. Lozanoi* by its leaves distinctly and finely serrate near the apex; *B. niveum* and *B. condensatum* by their leaves widely marginate and finely dentate at the apex.

It is not the same for the others. The determination of the numerous specimens has been a laborious and delicate task, because, according to my observations, among the characters attributed to each one of these species few are constant. And yet I had before me, for every one of them, a fragment of the type or of some other plant

authentically named! But where a variable species is concerned, a single stem can not give an accurate and complete idea. This stem constitutes simply a form of the species, and its comparison with the others makes them appear, very often, as if they were distinct species.

Such are the reasons why my opinion about these debatable species is founded more on the mosses I had to identify than upon the small fragmentary authentic specimens at hand; hence it seems useful to say how I understand them.

BRACHYMENIUM CAPILLARE Schimp. in Besch. Prodr. Bryol. Mex. 50. 1871

Innovations not julaceous, rather laxly foliated; leaves oblong, obtuse, the margins plane or almost plane, the costa excurrent; stem and perichaetial leaves obtuse-lanceolate, strongly revolute. Capsule cylindrical.

Puebla: Esperanza (4508, 4659, 4668, 4669, 4682, 4992). Morelia: Campanario (7461, 7463).

No. 4992 is a form with larger leaves, and nos. 7461 and 7463 a form with a thicker capsule.

BRACHYMENIUM LUTEOLUM (C. M.) Jaeg.

Bryum lutecolum C. M. Linnaea 38: 625. 1874.

Close to the preceding species. Differs by julaceous innovations with densely imbricate leaves, which are oval-suborbicular.

Puebla: Hacienda Batán (s. n.). Morelia: Bosque San Pedro (4579).

BRACHYMENIUM IMBRICATUM Schimp.

Bryum imbricatifolium C. M. Syn. 2: 578. 1851.

As in *B. lutecolum*, with julaceous innovations; leaves strongly imbricate, but in both the stem and branch leaves the costa almost always disappearing below the apex.

Puebla: Hacienda Alamos (4718, 4721, 4759, 4865).

BRACHYMENIUM MÜNCHII Broth. in Card. Rev. Bryol. 38: 5. 1911

Julaceous innovations with oval or oblong leaves, narrower at the apex and almost acute. The stem and perichaetial leaves are subobtusely or acute, with a strong ($60\ \mu$) costa always excurrent.

Puebla: Esperanza (4943); Malinche (6004); Hacienda Batán (4973).

Judging by the exsiccatae I possess (Bryoth. Levier, leg. *Münch*; *Pringle* 15078), this species is very variable. The leaves of the innovations are more or less elongate and somewhat narrow-acute; the perichaetial leaves are more or less revolute, widened or not at the base; the capsule is oblong, but in Brother Arsène's specimens it is more often claviform.

BRACHYMENIUM CHLOROCARPUM Card. Rev. Bryol. 36: 111. 1909

This possesses a special habit, which, once seen, renders easy its recognition. Its affinities are with *B. imbricatum* and *B. Münchii*. It is distinguished from both species by the costa, which is excurrent in the leaves of the innovations and generally evanescent in the perichaetial ones; also "by the soft, pale, inclined or hanging capsule and by the strongly flexuous pedicel" (teste Cardot).

Puebla: (4624). Morelia: Andameo (4831).

BRACHYMENIUM LOZANOI Card. Rev. Bryol. 38: 5. 1911

Morelia: Cerro Azul (4558, 4560).

Near *B. systylium* (C. M.) Jaeg. by the size and the form of the leaves; but in *B. systylium* the entire or subentire leaves are difficult to moisten.

BRACHYMENIUM NIVEUM Besch. Journ. de Bot. 15: 383. 1901

Morelia: Andameo (4834).

BRACHYMENIUM CONDENSATUM R. S. Williams, Bryologist
26: 2. 1923

Morelia: Cerro San Miguel (5065).

Very close to the preceding species. I distinguish it by its leaves, with a wider margin toward the apex, a costa vanishing more often below the apex, and a shorter and less flexuous hyaline hair point. In *B. niveum* the hair point is very long and flexuous, giving the tufts the facies of some *Argyrobryum*, like *B. arachnoideum* for instance.

BRACHYMENIUM MEXICANUM Mont. Ann. Sci. Nat. II. Bot. 9: 54. 1838

Morelia: (7905); Cerro San Miguel (4871, 4874, 5061).

The leaves are exactly entire. That condition agrees well with Montagne's original description, "foliis integerrimis," and with C. Müller's. Mitten saw them differently: "Margine superne minute serrulata;" it was probably an exceptional case.

ANOMOBRYUM FILIFORME (Dicks.) Husn. var. **MEXICANUM** (Schimp.)
Par. Ind. Bryol. 182. 1894

Puebla: Hacienda Alamos (577, 4636). Morelia: (7889, 7902, 7911); Andameo (4821, 4836); Campanario (7445, 7513, 7548). Valle de México: Desierto (*Bro. Amable*).

ANOMOBRYUM PLICATUM Card. Rev. Bryol. 36: 112. 1909

Morelia: Wall of a garden (7966).

BRYUM LAXULUM Card. Rev. Bryol. 36: 113. 1909

Morelia: (7647, 7648, 7649, 7650, 7655, 7949); Jesús del Monte (7609); Bosque San Pedro (4585); Loma Santa María (7865, 7878, 7881, 7883). Valle de México: Desierto (*Bro. Amable*).

Some of these collections, chiefly nos. 7647, 7649, and 7650, have elongate and narrow leaves like *B. lanceolifolium* Card.; but the cuspid, the reflection of the edges, and the areolation are characters which connect them closely to *B. laxulum*.

BRYUM Sect. **ARGYROBRYUM**

The species of this section belonging to Brother Arsène's collection are cited or described in the first paper.

BRYUM ARGENTEUM L.

Valle de México: Portales (*Bro. Amable* 1258).

A form tending toward var. *brachycarpum* Card.

BRYUM ARGENTEUM L. var. **COSTARICENSE** Rev. & Card.

Valle de México: Salazar (*Bro. Amable* 1310); Colhuacán (1319).

BRYUM ARGENTEUM L. var. **CHLOROCARPUM** Card.

Valle de México: Desierto (*Bro. Amable* 1266); Contadero (1297 in part).

This is a very curious plant. The capsule, narrowly cylindrical and attenuate into a long neck, would make one believe it a good species if one did not find in the same cluster shorter capsules of a different outline, among which some insensibly approach the typical form of *B. argenteum*.

BRYUM LIEBMANNIANUM C. M. Syn. 2: 573. 1851

México: Upon a roof (*Bro. Amable*).

BRYUM SQUARRULOSUM (Card.) Thér.

Brachymenium squarrulosum Card. Rev. Bryol. 38: 7, 31. 1911.

(FIG. 4)

I have this moss under two different names in my collections: *Brachymenium squarrulosum* Card., *Barnes & Land* 486, *Pringle* 10580 in part, 15213; *Bryum subchryseum* Broth. & Par. in sched. (comm. Paris), *Bro. Arsène*. Although these names belong to different genera, the two plants are certainly identical.

I found this same species, abundantly and well fruited, in Brother Arsène's collection (see below). The capsules have an inner peristome made up of a basal membrane half the height of the teeth, the seg-

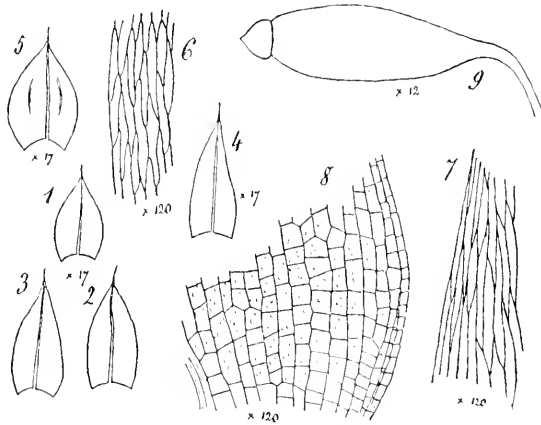

FIG. 4.—*Bryum squarrulosum* (Card.) Thér. 1, 2, 3, stem leaves; 4, perichaetial leaf; 5, leaf from the innovation; 6, median cells; 7, marginal cells; 8, basal areolation; 9, moist capsule.

ments widely split, oblong-lanceolate, equal to the teeth and provided with appendiculate cilia. The peristome of *Barnes & Land* 486 is in every way similar. This moss, which has the habit, leaves, and areolation of a *Brachymenium*, belongs, then, by its capsule, to the genus *Bryum*. It has a close affinity with *Bryum chryseum* Mitt., the same facies, size, and leaves. But the two species are essentially different in their sporophyte: *B. squarrulosum* has a short, thick, claviform capsule, and *B. chryseum* has an elongate, narrow capsule insensibly attenuate into a neck of the same length.

The name proposed by Brotherus and Paris was happily chosen, but it remains a *nomen nudum*; the one given by Cardot is the valid one.

Morelia: Loma del Zapote (7506); Andameo (4818, 4846); Punguato (4879, 5059); Campanario (7559); Jesús del Monte (7619). Distrito Federal: Mixcoac (9151, 9457). Tlaxcala: Acuitlalpilco (718).

No. 4846 presents a curious and rare mixture of two species, *Bryum squarrulosum* and *Erythrodontium densum* var. *brevifolium* Card., which have the same size, same habit, and same shade of color, and are indistinguishable to the untrained eye.

BRYUM MICROBALANUM Card. Rev. Bryol. 36: 112. 1909

Puebla: Rancho Posadas (4809).

BRYUM ROSULATUM C. M. Bot. Zeit. 14: 416. 1856

Morelia: Campanario (7529); Jesús del Monte (7963 in part).

BRYUM LATILIMBATUM Card. Rev. Bryol. 36: 114. 1909

Puebla: Cerro Guadalupe (794).

BRYUM EHRENBERGIANUM C. M. Syn. 1: 255. 1849

Puebla: (4991); Esperanza (4941). Tlaxcala: (606 in part). Valle de México: Desierto (*Bro. Amable* 1208).

BRYUM COMATUM Besch. Prodr. Bryol. Mex. 55. 1871

Morelia: Cerro San Miguel (5084); Punguato (5049); Campanario (7552 in part); Jesús del Monte (7607) Loma Santa María (7645). Valle de México: Contadero (*Bro. Amable* 1312).

BRYUM ANDICOLA Hook., forma

Puebla: Cerro Guadalupe (688). Morelia: Loma del Zapote, (7503); Calzada de México (7630a). Distrito Federal: Mixcoac (9452, 9463); Valle de México, Desierto (*Bro. Amable* 1203).

Looser areolation; cells 40-50 μ \times 20 μ .

BRYUM BOURGEANUM Card. Rev. Bryol. 36: 115. 1909

Valle de México: San Rafael (*Bro. Amable* 1278).

BRYUM SUBELIMBATUM Thér., sp. nov.

(FIG. 5)

Puebla: Fort Lorette, alt. 2,200 m. (657).

Caulis 2 cm. altus, laxe sed regulariter foliosus, interdum rosulatus. Folia sicca crispulo-contorta, elliptico-oblonga, breviter acuminata,

acuta, cuspidata, marginibus usque ad medium folii anguste revolutis, superne denticulatis, costa basi $120\ \mu$ lata, sensim attenuata, in cuspidem brevem excurrente, cellulis mediis hexagonis, $50\text{--}60\ \mu$ longis, $20\text{--}24\ \mu$ latis, parietibus tenuibus, basilaribus breviter rectangularibus, marginalibus (e 2-3-ser.) linearibus, concoloribus, haud incrassatis, limbum vix distinctum efformantibus. Caetera desunt.

In its size and the dimensions of the leaves this is to be compared with *B. andicola* Hook.; it may be distinguished from that species by the more acute-acuminate, longer-cuspidate leaves, the cells being twice as long and also wider, and above all by the hardly differentiated

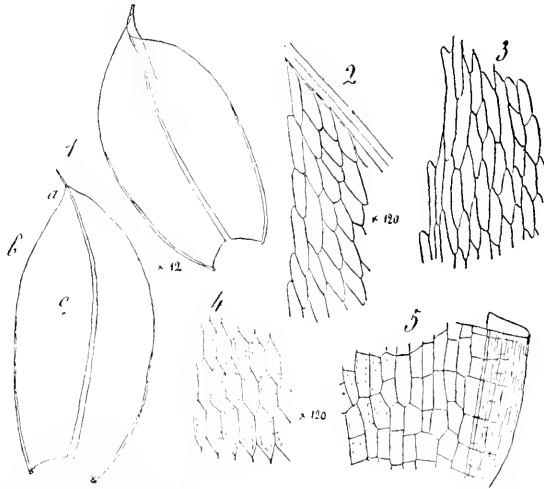

FIG. 5.—*Bryum sublimbatum* Thér. 1, leaves; 2, apical cells near point *a*; 3, marginal cells toward point *b*; 4, median cells at point *c*; 5, basal areolation.

border, composed toward the middle of the leaf of 2 or 3 linear cells with walls as thin as those of the adjacent cells and entirely disappearing toward the apex.

ORTHOTRICHACEAE

ZYGODON SPATULAEFOLIUS Besch. Prodr. Bryol. Mex. 43. 1871

Valle de México: Desierto (*Bro. Amable* 1252).

Mr. N. Malta considers this species identical with *Z. obtusifolius* Hook.

ZYGODON OLIGODONTUS Card. Rev. Bryol. 36: 107. 1909

Valle de México: Salazar, upon a tree (*Bro. Amable* 1235 in part).

ORTHOTRICHUM DIAPHANUM (Gmel.) Schrad. Spic. Fl. Germ. 69. 1794

Bryum diaphanum Gmel. Syst. Nat. 2 : 1335. 1791.

Valle de México: California (*Bro. Amable* 1273) ; Tlalpam (*Bro. Amable* 1236).

ORTHOTRICHUM MALACOPHYLLUM Card. Rev. Bryol. 38: 2. 1911

Valle de México: Contadero (*Bro. Amable* 1301 in part).

ORTHOTRICHUM PYCNOPHYLLUM Schimp.

Puebla: Esperanza (4680) ; Hacienda Batán (4966, 4967).
Morelia: Cerro Azul (4794, 4930). Valle de México: Salazar (*Bro. Amable* 1295).

Brother Amable's material is plentiful, with well-fruited specimens, consequently I was able to make interesting observations and more particularly to ascertain the wide variability of this species. For instance, in the same tuft some plants have immersed capsules and others show them more or less exserted ; sometimes the ripe capsules are entirely smooth and sometimes a little costate ; the segments of the inner peristome may be nearly entire or more or less erose ; finally, the leaves, when moist, are either spreading or strongly squarrose.

It seems that the individuals with exserted capsules and squarrose leaves should be called *O. recurvans* Schimp., and those with immersed capsules *O. Lozanoi* Card. ; but both have a densely villous calyptra, while in *O. recurvans* and *O. Lozanoi* the calyptra is only sparingly villous.

To what conclusion do these remarks lead if not that the names *O. pycnophyllum*, *O. recurvans*, and *O. Lozanoi* have been created for forms of a very variable species and that it is desirable, as Cardot suggested in 1909 (*Rev. Bryol.* 36: 107), to reunite them under a single name, the one which has priority (*O. pycnophyllum* Schimp.) ?

MACROMITRIUM GHIESBREGHTII Besch. Prodr. Bryol. Mex. 44. 1871

Puebla: Boca del Monte (4685) ; Esperanza (4671, 4676, 4681, 4687, 4688, 4756, 4801).

Nos. 4685, 4687, and 4688 represent forms with shorter branches, with leaves less appressed when dry and more spreading when moist, and with shorter pedicels.

I recall that Cardot (*Rev. Bryol.* 38: 101. 1911) considers *M. Ghiesbreghtii* and *M. Leiboldtii* Hampe as mere forms or varieties

of *M. mexicanum* Mitt., but I have not had an opportunity to form a personal opinion on this point.

MACROMITRIUM PYCNOPHYLLUM Card. Rev. Bryol. 36: 108. 1909;
37: 19. 1910

Morelia: Campanario (7568, 7635); Cerro Azul (4535, 4545, 4548, 4777); Cascade de Coincho (4717 in part).

Often found intermingled with the following species. Sometimes the association is so intimate and the stems so entangled that the separation of the two species is almost impossible.

MACROMITRIUM TORTUOSUM Schimp. in Besch. Prodr. Bryol. Mex. 45. 1871

Morelia: Cerro Azul (4557, 4777a, 4791, 4792); Cascade de Coincho (4712, 4717 in part); Campanario (7464, 7524, 7528, 7532, 7536, 7560, 7567, 7634a, 7636, 7638).

Determination only probable. I had the choice between *M. tortuosum* Schimp. and *M. Schimperii* Jaeg. (*M. flexuosum* Schimp.). Although not absolutely identical with *M. tortuosum*, the specimens do not differ enough to be separated. On the other hand, I do not know *M. Schimperii*, and the descriptions of the two species in Bescherelle's *Prodromus* are insufficient to permit distinguishing one from the other.

CRYPHAEACEAE

CRYPHAEA ORIZABAE Schimp. in Besch. Prodr. Bryol. Mex. 70. 1871

Veracruz: Córdoba (s. n.).

Determined from description. I distinguish this species from *C. filiformis* (Sw.) Brid. by the leaves, which are larger and very entire at the apex, and have larger cells.

CRYPHAEA APICULATA Schimp.

Puebla: Hacienda Batán (4970).

The leaves are entire, as described by Bescherelle, and not "sehr klein gezähnt," as described by Brotherus.

CRYPHAEA ATTENUATA Schimp. in Besch. Prodr. Bryol. Mex. 72. 1871

Morelia: Cerro Azul (4798); Valle de México: Desierto (*Bro. Amable* 1223, 1237).

CRYPHAEA PATENS Hornsch. var. **DECURRENS** (C. M.) Schimp. & Par.

Veracruz: Jalapa (8002). Puebla: Esperanza (7921, 7975).

According to my observations this variety differs from the type by the form of the leaves, which are gradually and insensibly narrowed, by their direction when moist (less spreading than in *C. patens*), and by the perichaetial leaves, which are enervate or nearly so.

CRYPHAEA SARTORII Schimp. in Besch. Prodr. Bryol. Mex. 72. 1871

Puebla: Núchitl, alt. 2,800 m. (7980).

Cardot (Rev. Bryol. 38: 102. 1911) thinks it is convenient to reunite this species with *C. patens*. I willingly adhere to his opinion, because the habit, the less dentate acumen, and the less incrassate areolation do not seem to be characters sufficiently important for the separation of *C. Sartorii*.

DENDROPOGONELLA RUFESCENS (Schimp.) E. G. Britton, Bryologist
9: 39. 1906

Puebla: Núchitl (7968); Esperanza (7955).

LEUCODONTACEAE (Continuation)

LEUCODON CRYPTOTHECA Hampe, Linnaea 12: 350. 1838

Valle de México: Desierto (*Bro. Amable* 1283, 1306).

PTEROBRYACEAE

RENAULDIA COCHLEARIFOLIA (Hornsch.) Broth.

Morelia: Cerro Azul (4559a).

PTEROBRYOPSIS MEXICANA (Schimp.) Fleisch. Hedwigia 45: 60. 1905

Morelia: Campanario (7460); Cerro Azul (4501, 4503, 4977, 4982, 7656); Cerro San Miguel (5080, 5086); Carindapaz (7956); Cascade de Coincho (4716).

Considering these specimens in the aggregate, I have observed some variability in the compression of the branches, the form of the leaf, the length of the cells and the thickening of their walls, the density of the chlorophyll, etc. Some of them would thus seem to show a tendency toward *P. Pringlei* Card., a species I do not know.

METEORACEAE

PILOTRICHELLA FLEXILIS (Sw.) Jaeg., forma

P. turgescens (C. M.) Jaeg.; *Neckera turgescens* C. M. Syn. 2: 131. 1850.

Puebla: Esperanza (4750, 4757). Morelia: Cerro Azul (4979, 4986). Veracruz: Jalapa (7993, 8003).

PAPILLARIA APPRESSA (Hornsch.) Jaeg.

Puebla: Xúchitl (7991). Veracruz: Córdoba (s. n.), forma *flagellifera*.

Mrs. E. G. Britton considers this species a synonym of *P. nigrescens* (Sw.) Jaeg.

PAPILLARIA HAHNII Besch.; Ren. & Card. Bull. Soc. Roy. Bot. Belg. 2: 127. 1899

Puebla: Xúchitl (7997). Veracruz: Jalapa (7999).

PAPILLARIA DEPPEI (Hornsch.) Jaeg.

Puebla: Boca del Monte (4689); Esperanza (4749, 4751).

No. 4751 has leaves ending in a very long and very fine acumen, like those of *P. subulifolia* Schimp., which, in my opinion, should not be kept specifically distinct from *P. Deppei*. I might add that the differences I have observed between *P. Deppei* and *P. Hahnii* are not of great systematic importance.

METEORIUM ILLECEBRUM (C. M.) Mitt. Musc. Austr. Amer. 437. 1869

Neckera illecebra C. M. Syn. 2: 137. 1850.

Puebla: Esperanza (4724, 4728, 4733, 4746); Xúchitl (8004). Morelia: Santa Clara, alt. 2,000 m. (4845); Campanario (7526, 7531, 7533, 7559, 7570, 7575). Veracruz: Jalapa (7969).

Variable in the form of the leaves, in the length of the hair point, and in the number of papillae (oftener 1, rarely 2 or 3) to each cell and their development.

METEORIUM ILLECEBRUM (C. M.) Mitt. var. TERETIFORME Card. Rev. Bryol. 38: 40. 1911

Morelia: Cascade de Coincho (4711).

The following numbers belong to forma *gracilis*: Puebla: Esperanza (4514, 4662, 4691); Hacienda Batán (4962). Morelia: Cerro Azul (4525); Zamora (7964).

NECKERACEAE

NECKERA HORNSCHUCHIANA C. M. Syn. 2: 51. 1850

Morelia: Cerro Azul (4526).

NECKERA CHLOROCAULIS C. M. and N. ORBIGNYANA Lor.

I have tried to differentiate these two species, with the help of the descriptions and the specimens of my collections, but have had little success. Indeed, it is rare to find a specimen which combines all the characters attributed to each species. As a matter of fact, if, among the mosses of Brothers Arsène and Amable enumerated below, I take at random three plants, I cannot find two of them identical. This seems to mean that I have before me transitional forms linking closely the extremes which have received the names *N. chlorocaulis* and *N. Orbignyana*. It is then more convenient, beyond a doubt, to combine these two species under the name *N. chlorocaulis* C. M., which has priority (1851) over Lorenz's species (1864).

Puebla: Esperanza (4744, 7977); Hacienda Batán (4964, 4965).
Morelia: Cerro Azul (4559, 4798). Veracruz: Jalapa (7996). Valle de México: Desierto (*Bro. Amable* 1213, 1224, 1239).

PILOTRICHACEAE

PILOTRICHUM MEXICANUM Thér., sp. nov.

(FIG. 6)

Morelia: Loma Santa María (4867, 4895, 7869).

Sterile. Caulis secundarius 4-5 cm. altus, erectus, irregulariter ramosus, ramis inaequalibus, saepe arcuatis, plerumque simplicibus.

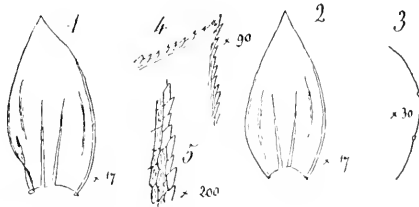

FIG. 6.—*Pilotrichum mexicanum* Thér. 1, stem leaf; 2, branch leaf; 3, cross-section of leaf; 4, apex of a stem leaf; 5, margin of leaf.

Folia caulis secundarii erecto-adpressa, late ovata, acuta, concava, longitudinaliter plicatula, 1.5 mm. longa, 0.8 mm. lata, marginibus inferne revolutis, sequentibus serrulatis, dentibus acutis hyalinis, costis

fere parallelis, attenuatis, ad medium evanidis, rete opaco, chlorophylloso, cellulis laevibus, hexagonis, parietibus tenuibus; folia ramea similia sed minora. Caetera desunt.

A curious plant, which is very different from all the species of the genus to which I could compare it, by the leaves dentate in the upper two-thirds, by its smooth obscure areolation formed by thin-walled cells, and by the insensibly attenuate costae not extending beyond the middle of the leaf. It has the habit of *P. fasciculatum* C. M., but the leaves of the latter are of a different form; moreover, the costa, which plainly contrasts with the areolation, stops abruptly, without attenuation, and projects beyond the lamina.

HOOKERIACEAE

CYCLODICTYON ALBICANS (Sw.) Broth.

Hypnum albicans Sw. Prodr. Veg. Ind. Occ. 140. 1788.

Morelia: Campanario (7721).

CYCLODICTYON ARSENEI Thér., sp. nov.

(Fig. 7)

Distrito Federal: Cuajimalpa, alt. 3,100 m. (9489).

C. albicans (Sw.) Broth. et *C. humectato* Card. proximum, sed differt rete densiore, cellulis magis chlorophyllosis, praesertim limbo latissimo e 3-4 seriebus cellularum formato.

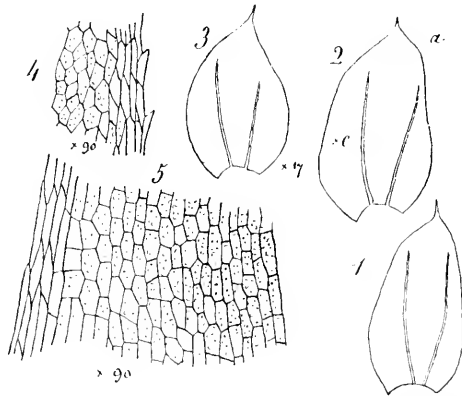

FIG. 7.—*Cyclodictyon Arseni* Thér. 1, 2, 3, dorsal and lateral leaves; 4, upper and marginal cells near point *a*; 5, median and marginal cells near point *c*.

Neither can our species be *C. Liebmanni* Schimp., for in describing the latter the author does not speak of a border; besides, he compares it with *C. albicans*, attributing to it more long-cuspidate and more strongly dentate leaves.

FABRONIACEAE (continuation)

FABRONIA PATENTIFOLIA Card.

Valle de México: Texcoco, upon trees (*Bro. Amable* 1288).

FABRONIA DENTATA Schimp. in *Besch. Prodr. Bryol. Mex.* 87. 1871

Valle de México: California (*Bro. Amable* 1275); Chapingo, upon tree (*Bro. Amable* 1286).

I see in this moss a species entirely independent from *F. flavinervis* C. M. It is easy to recognize by the smaller and more abruptly narrowed leaves, with almost entire margins, a slender costa scarcely reaching the middle, and shorter and wider cells.

I imagine the author was alluding to the perichaetial leaves when he named this species "*dentata*," but it will be agreed that for a moss whose stem and branch leaves are entire the name is rather badly chosen.

FABRONIA OCTOBLEPHARIS Schwaegr. *Suppl.* 1²: 338. pl. 99. 1816.

(Fig. 8, in part)

Valle de México: Contadero, upon the earth (*Bro. Amable* 1301, 1308 in part, 1316).

An exact match for the European moss. Cardot described (*Rev. Bryol.* 37: 50. 1910) a variety *americana* of this species, but the type had not, till now, been indicated in Mexico. It is worth remarking that the moss from Contadero grows upon the ground, a rather rare station for species of the genus *Fabronia*; yet the classical habitat of *F. octoblepharis* in Europe is precisely "earth upon walls."

FABRONIA OCTOBLEPHARIS Schwaeg. var. **MEXICANA** Thér., var. nov.

(Fig. 8, in part)

Querétaro: Júpica, alt. 1,850 m., on rocks (*Bro. Arsène* 11000 in part).

Differs from both the type and var. *americana* Card. by its squatty habit, its shorter, numerous, more densely leafed branches; by its oval and more abruptly acuminate leaves; by the oval, shortly apicu-

late, subentire perichaetial leaves; and, above all, by the slightly elevated (0.11 mm.) peristome, with obliquely striate and punctate teeth. Perhaps a distinct species.

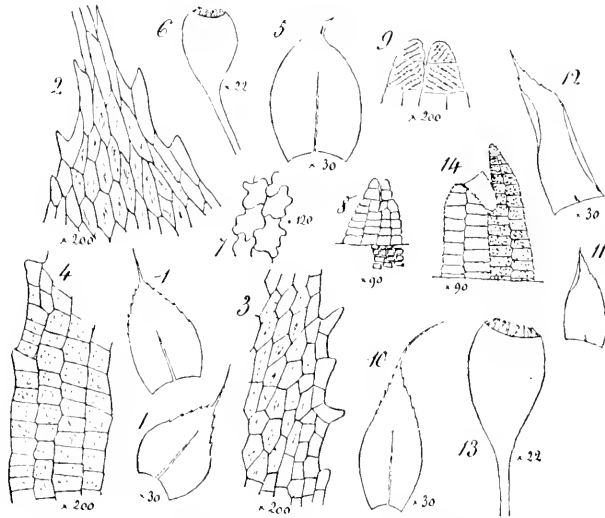

FIG. 8.—*Fabronia octoblepharis* Schwaegr. var. *mexicana* Thér. 1, leaves; 2, apical cells; 3, upper and marginal cells; 4, basal areolation; 5, perichaetial leaf; 6, moist capsule; 7, exothecal cells; 8, fragment of peristome; 9, apex of a tooth. *Fabronia octoblepharis* Schwaegr. (*Bro. Amable* 1316). 10, leaf; 11, 12, perichaetial leaves; 13, moist capsule; 14, fragment of peristome.

LESKEACEAE

RHEGMATODON FILIFORMIS Schimp. in Besch. Prodr. Bryol. Mex. 87. 1871

Morelia: Cerro Azul (4543).

LINDBERGIA MEXICANA (Besch.) Card. Rev. Bryol. 38: 51. 1911

Leskea mexicana Besch. Prodr. Bryol. Mex. 89. 1871.

This seems to be extremely common in Mexico, if one may judge by the following list: Puebla: (4511); Rancho Santa Bárbara (4517, 4518, 4597, 4601, 4810); Hacienda Alamos (4722, 4758, 4763, 4766); Cholula (4863); Molino de Huexotitla (4815). Morelia: Bosque San Pedro (4570, 4571, 4573, 4588). Tlaxcala: Acuitlalpilco (743, 744). Distrito Federal: Mixcoac (9450, 9455, 9474, 9484); Tlalpam (9496). Valle de México (*Bro. Amable*): Texcoco (1285, 1289, 1290); Desierto (1212); San Rafael (1284); Tlompantla (1234); El Peñon (1216).

No. 1216, from the Peñon, is a robust form. No. 1234 from Tlampangtla is another and more remarkable form. Its leaves are narrowed and long-acuminate as in var. *acuminata* Card., but by the size and the areolation it is connected with the normal forms.

LINDBERGIA MEXICANA var. **ACUMINATA**. Card. Rev. Bryol. 37: 51. 1910

Puebla: Huejotzingo (4615, 4857). Valle de México: San Rafael (*Bro. Amable* 1276).

LINDBERGIA OVATA Thér., sp. nov.

(FIG. 9)

Morelia: Cerro San Miguel (5078, 5079).

Autoica. Caulis tenellus, repens, dense caespitosus, ramis erectis vel circinatis. Folia densa, leviter imbricata, marginibus planis, inte-

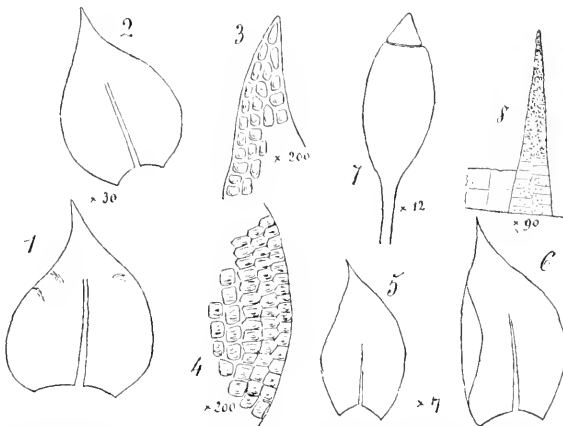

FIG. 9.—*Lindbergia ovata* Thér. 1, stem leaf; 2, branch leaf; 3, apical cells; 4, basal areolation; 5, 6, perichaetial leaves; 7, moist capsule; 8, fragment of peristome.

gerrimis, 0.8 mm. longa, 0.5-0.6 mm. lata, rete chlorophylloso, opaco, cellulis ovatis, laevibus, parum incrassatis, marginalibus transverse dilatatis, costa subaequalia circa $\frac{3}{4}$ folii evanescente. Folia perichaetialia similia, intima vaginantia; pedicellus erectus, 1 cm. longus; capsula oblonga, operculum conicum, peristomii dentes papilloso, opaci, 0.3 mm. alti, membrana pallida, vix papillosa, processus nulli; spora 30-36 μ crassae.

Differs from *L. mexicana* Besch. by the branches with less imbricate leaves, somewhat spreading when dry, by its oval leaves abruptly contracted into a short acumen, with the costa stopping much farther

from the apex, by the larger, wider, and more convolute inner perichaetial leaves, by the more inflated oblong capsule, with a higher operculum, and lastly by the longer and more densely papillose teeth of the peristome and the spores twice larger.

THUIDIACEAE

HERPETINEURON TOCCOAE (Sull.) Card. Bot. Centrabl. 19^o: 127. 1905

Anomodon Toccoae Sull. Musc. Bor. Amer. 58. 1856.

Morelia: (7907); Campanario (7454, 7465); Carindapaz (7951 in part).

HAPLOCLADIUM MICROPHYLLUM (Sw.) Broth.

Hypnum microphyllum Sw. Prodr. Veg. Ind. Occ. 142. 1788.

Puebla: Esperanza (4675). Morelia: Jesús del Monte (7608, 7613, 7625). Valle de México: Desierto (*Bro. Amable* 1241 in part, 1245 in part).

RAUIA SUBCATENULATA (Schimp.) Broth.

Pseudoleskea subcatenulata Schimp. in Besch. Prodr. Bryol. Mex. 90. 1871.

Morelia: Rincón (4566); Parc San Pedro (4580, 4586); Loma Santa María (4875, 4876, 4889, 4897, 4905, 4909, 4915, 4916, 5090, 7853); Campanario (7456); Jesús del Monte (7689).

THUIDIUM TUERCKHEIMII C. M. Bull. Herb. Boiss. 5: 219. 1897, forma

Morelia: Loma Santa María (4893).

In habit and areolation this form approaches var. *angustatum* Card.; but, disregarding the fact that one cannot compare the fruit (the plant being sterile), it differs in the dark green color of the tufts and in its longer rameal leaves. The apical cells of the secondary branch leaves are rather frequently acute.

THUIDIUM MEXICANUM Mitt. Musc. Austr. Amer. 577. 1869

Morelia: Cerro Azul (4552, 4553, 4984). Valle de México; San Rafael (*Bro. Amable* 1277, 1279, 1281, 1282).

This is the form named *T. orthocarpum* by Beschereille, and reunited by Cardot with Mitten's species.

THUIDIUM (EUTHUIDIUM)

The determination of the three following species, represented by sterile plants, is given with all reserve, especially in the case of *T. Schlumbergeri*.

THUIDIUM ROBUSTUM Card. *Rev. Bryol.* 37: 52. 1910

Puebla: (4944, 4955, 4958); Esperanza (4677). Distrito Federal: Cuajimalpa (9486).

THUIDIUM MIRADORICUM Jaeg.

Thuidium tamariscinum var. *mexicanum* Schimp. in Besch. Prodr. Bryol. Mex. 92. 1871.

Morelia: Cerro Azul (4540, 4987).

THUIDIUM SCHLUMBERGERI Schimp. in Besch. Prodr. Bryol. Mex. 92. 1871

Puebla: (4946, 4952); Esperanza (4564, 4658, 4665, 4684, 4739, 4753, 7981). Morelia: Cerro Azul (4529, 4785); Cerro San Miguel (5055, 5074, 7502, 7545); Campanario (7455, 7644, 7923, 7927, 7930, 7931, 7937). Mexico (9477).

ENTODONTACEAE (continuation)

ENTODON ERYTHROPUS Mitt. var. **MEXICANUS** Card., forma

Valle de México: (*Bro. Amable*); San Juanico (1260, 1261); Contadero (1304, 1309).

Pedicle short, 8 mm.; capsule elongate and narrow (4 mm. × 0.6 mm.). It is not var. *brevisetata* Card., since, according to the author, that is a depauperate form, and the above plants are as robust as the ordinary forms of the type. There is therefore no authority for separating them from the var. *mexicanus*. I consider them as a forma *brevisetata-stenocarpa*.

ENTODON ABBREVIATUS (Bry. Eur.) Jaeg.

Valle de México: (*Bro. Amable*); Desierto (1245); San Rafael (1280); Contadero (1302, 1305, 1308 in part).

ERYTHRODONTIUM TERES (C. M.) Par. *Ind. Bryol.* ed. 2, 159. 1904

Neckera teres C. M. *Syn.* 2: 98. 1851, in part.

Morelia: Cerro Azul (5081); Campanario (7466, 7633a).

ERYTHRODONTIUM LONGISETUM (Hook.) Par. Ind. Bryol. ed. 2, 158. 1904
Neckera longiseta Hook. Musc. Exot. pl. 43. 1818-20.

I refer with doubt to this species (which now includes *E. cylindricaule* C. M.) no. 7530, from El Campanario. This plant has the pedicel plainly yellow, but the teeth of the peristome are striate as in the species of the division A. Should not this last character have all the importance which is ordinarily given to it?

POLYTRICHACEAE (continuation)

ATRICHUM MÜLLERI Schimp. var. **CONTERMINUM** (Card.) Thér.
 Valle de México: Desierto (*Bro. Amable* 1267, 1271 in part).

POGONATUM ERICAEOFOLIUM Besch. var. **LOZANOI** (Card.) Card. Rev.
 Bryol. 37: 6. 1910; 38: 38. 1911
 Valle de México: Desierto (*Bro. Amable* 1272 in part).

POGONATUM CUSPIDATUM Besch. Prodr. Bryol. Mex. 62. 1871
 Valle de México: Desierto (*Bro. Amable* 1210, 1270).

POLYTRICHUM JUNIPERINUM Willd.

Valle de México: Mexico (*Bro. Amable* 1218).

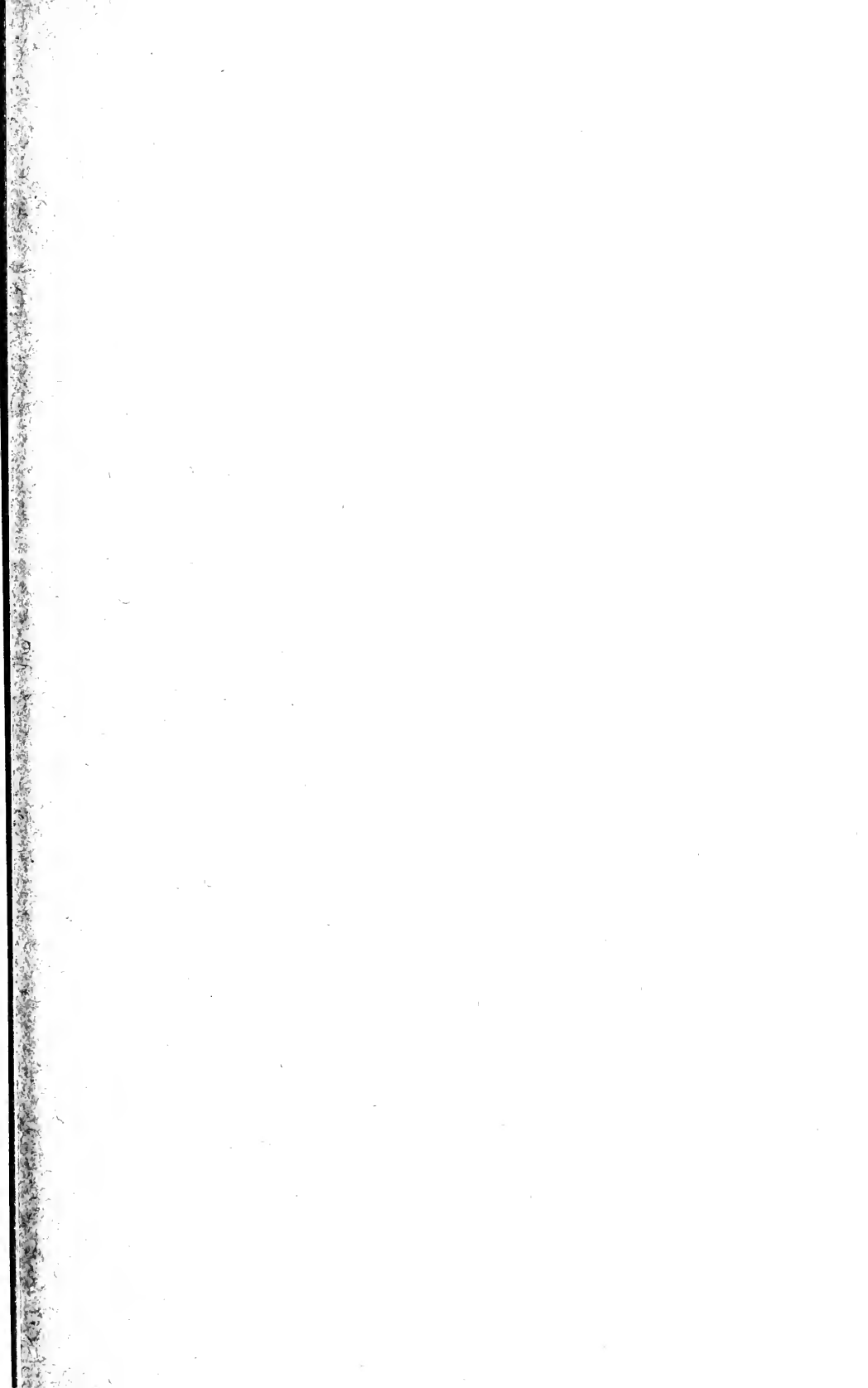



SMITHSONIAN MISCELLANEOUS COLLECTIONS
VOLUME 81, NUMBER 2

CAMBRIAN FOSSILS FROM THE MOHAVE DESERT

(WITH THREE PLATES)

BY

CHARLES E. RESSER

Associate Curator of Stratigraphic Paleontology,
United States National Museum



(PUBLICATION 2970)

CITY OF WASHINGTON
PUBLISHED BY THE SMITHSONIAN INSTITUTION
JULY 5, 1928

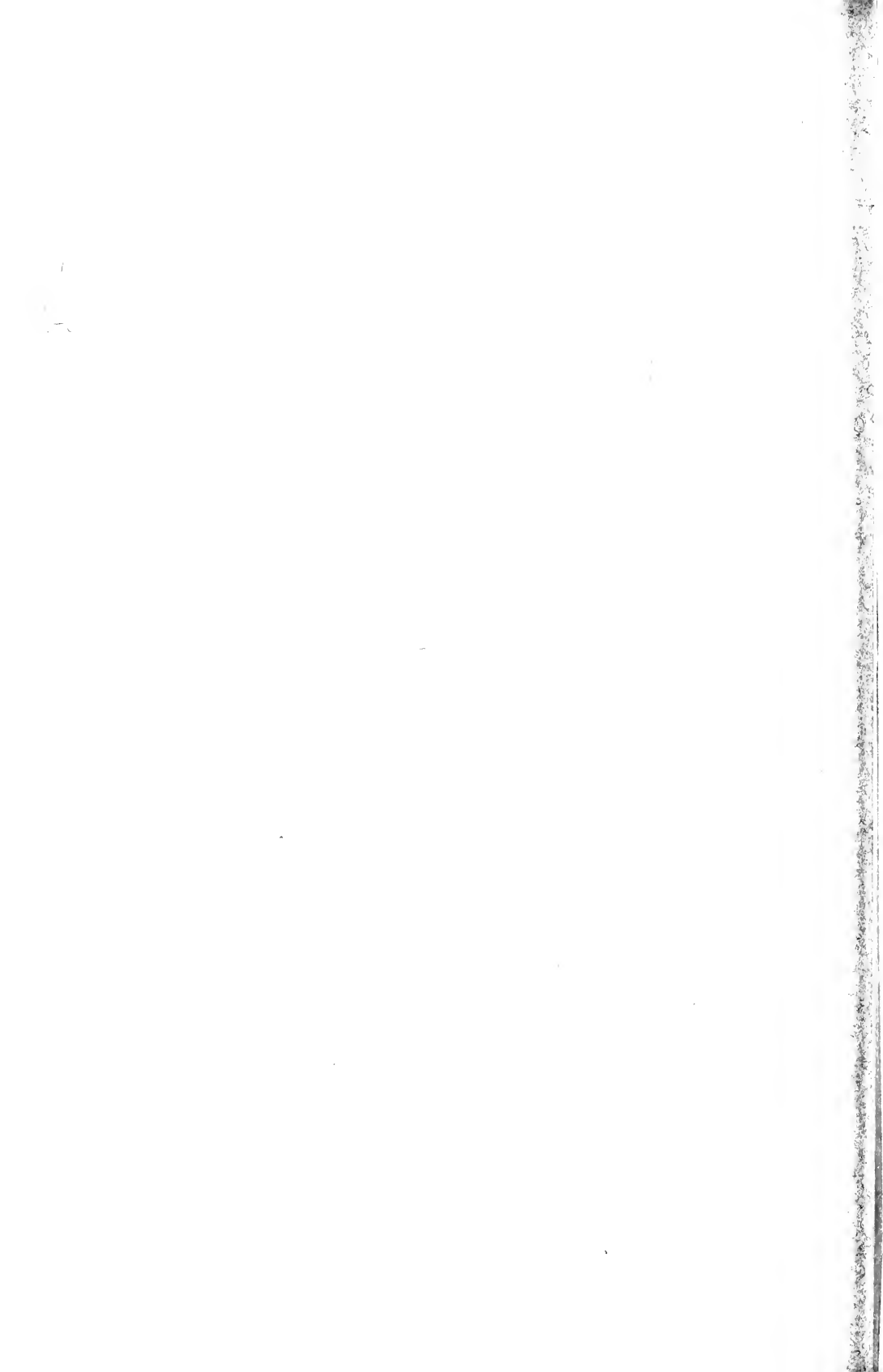

SMITHSONIAN MISCELLANEOUS COLLECTIONS
VOLUME 81, NUMBER 2

CAMBRIAN FOSSILS FROM THE MOHAVE DESERT

(WITH THREE PLATES)

BY
CHARLES E. RESSER
Associate Curator of Stratigraphic Paleontology,
United States National Museum



(PUBLICATION 2970)

CITY OF WASHINGTON
PUBLISHED BY THE SMITHSONIAN INSTITUTION
JULY 5, 1928

The Lord Baltimore Press
BALTIMORE, MD., U. S. A.

CAMBRIAN FOSSILS FROM THE MOHAVE DESERT

BY CHARLES E. RESSER

ASSOCIATE CURATOR OF STRATIGRAPHIC PALEONTOLOGY, UNITED STATES
NATIONAL MUSEUM

(WITH THREE PLATES)

INTRODUCTION

Twenty years ago Darton¹ first announced the finding of Cambrian rocks in Bristol Mountain (then called Iron Mountain), near Cadiz, California, on the Santa Fé Railroad, about 100 miles east of Barstow, a locality well south of any from which Cambrian fossils had previously been obtained. He pointed out the fact that these beds, which rest unconformably on an eroded granite surface, dip down the slope of the hills toward the east, mentioning, in his brief description of the section, that the few fossil fragments found both in the shale below the nodular blue limestone and in the limestone layers in the shale above it, were thought by Dr. Walcott to be possibly Middle Cambrian in age. A more thorough study of the region was made in 1921 by C. W. Clark, then a student at the University of California,² who published a detailed description of the section, listing fossils from two horizons. These lists, which had also been checked by Walcott, included one new name among the fossils from the lower shale and another for the single fossil found in the upper shale. Only the latter was described sufficiently to preserve the name. The name, *Wanneria ? cadizensis*, proposed for the new species in the lower shale becomes a *nomen nudum*. Clark's original collection, together with one obtained later under the direction of Dr. J. C. Merriam, is the basis for the following discussion of the contained faunas.

My attention was called particularly to the interesting features of these faunas while identifying the species prior to their return to the University of California, the officials of which have very kindly given their permission for the following descriptions. The types of the

¹ Darton, N. H., Discovery of Cambrian Rocks in Southeastern California. Journ. Geol., Vol. 15, 1907, p. 470.

² Clark, C. W., Lower and Middle Cambrian Formations of the Mohave Desert. Univ. of Calif. Publ., Dep. Geol., Vol. 13, No. 1, 1921, pp. 1-7.

specimens herein described remain in the National Museum, and a third set was set to Princeton University. These fossils are interesting in that they constitute the most southerly and westerly occurrence of Cambrian beds west of the Rocky Mountains, besides being sufficiently well preserved to show structural features, particularly of the Mesonacidae which are yet but poorly and incorrectly described.

GEOLOGICAL SECTION AND CORRELATIONS

The section in Bristol Mountain, as described by Clark, may be summarized as follows: about 470 feet (143.3 m.) of quartzites rest unconformably on an eroded granite surface. Above this bed occurs about 22 feet (6.7 m.) of fine-grained, arenaceous shale containing thin beds of sandstone. The Mesonacid fauna herein described occurs abundantly in the soft shale portion of this bed. Next above is 25 feet (7.6 m.) of blue to black, unfossiliferous, nodular limestone. This is in turn overlain by 120 feet (36.6 m.) of brown or black arenaceous shale from which, about 12 feet (3.7 m.) below the top, the two Middle Cambrian fossils were obtained. The Paleozoic section is terminated by Carboniferous limestones about 635 feet (193.5 m.) thick.

Owing to the presence of the Mesonacidae, the three lower beds were referred to the Lower Cambrian, and the overlying shale to the Middle Cambrian. No question can be raised as to the Middle Cambrian age of the fossils in the upper shale, but the final decision as to the Mesonacid fauna must await the results of studies now being made at many places in an attempt to settle the vexing question as to where the Lower-Middle Cambrian boundary must be drawn.

According to our present ideas, Bristol Mountain must be in the seaway through which various Cambrian seas are supposed to have invaded the continent from the Pacific. Both faunas here described would appear to be more or less closely related to those in formations elsewhere in the southwestern United States, all of which were deposited in shallow seas whose exact extent and connections are not yet fully known. The fossils in the lower shale find their nearest affinities in the Prospect Mountain formation far to the northeast in the Eureka District, Nevada, with some relationship also apparent in the intervening Silver Peak District. The seas in which these older beds in the three regions mentioned were deposited certainly had Arctic connections, whereas no faunas are at present known from beds deposited in strictly Pacific seas. Whether the occurrence of older Cambrian beds in Bristol Mountain indicates Pacific connections must remain undetermined for the present. However, it would appear

rather improbable that a strictly Arctic sea, narrow as it must have been and on a continental mass of such low relief as then prevailed, should approach so near the Pacific basin and not be connected with it. The Middle Cambrian fauna of Bristol Mountain apparently represents that usually characterized by the trilobite *Dolichometopus productus*, a fauna that is exceedingly widespread, extending from the southern Appalachians to Greenland and from British Columbia to Arizona, usually occupying a position somewhat below the middle of the Middle Cambrian. This fauna again is commonly regarded as Arctic rather than Pacific in origin. And so, while additional light is shed on paleogeography by the Bristol Mountain fossils, we cannot yet outline the exact boundaries of those early seas.

DISCUSSION OF SOME MESONACID GENERA

I do not propose at this time to undertake the much needed revision of the Mesonacidae, but shall simply deal with questions raised by the particular species under discussion.

MESONACIS Walcott 1885

Mesonacis Walcott, 1885, Amer. Journ. Sci., 3d ser., Vol. 29, p. 328. (Described as a new genus.)

Mesonacis Walcott, 1910, Smithsonian Misc. Coll., Vol. 53, No. 6, p. 261. (General treatise on the entire family.)

The distinctness of the genera *Mesonacis* and *Olenellus* has been questioned, because many species previously referred to *Olenellus* proved upon the discovery of additional specimens to have the extra segments posterior to the fifteenth, and hence were transferred to *Mesonacis*. Some of these transfers appear to be ill-founded since no account was taken of the other generic features.

At the present stage of the study I would suggest that both *Mesonacis* and *Olenellus* are good genera, although there is considerable difficulty in distinguishing the cephalon or even the cephalon and the first fifteen segments. Several differences may however be pointed out. In *Mesonacis* the eyes are shorter and do not reach the occipital ring; also the rim around the head is narrower, particularly near the genal angles. The main distinction, according to my present view, is to be found in the character of the so-called rudimentary segments that occur posterior to the fifteenth, with its large spine. Unfortunately these most important anatomical features are infrequently preserved, even though the percentage of entire shields to cephalon is considerably greater than in other trilobite groups. In *Mesonacis* all

these segments have pleurae, as illustrated in the figures of *M. vermontana* (see particularly Walcott, 1910, pl. 26). According to my present views, *Olenellus* had such segments, perhaps fewer in number, but *without* pleurae, *i. e.*, without dorsal furrows. These are illustrated in the specimen figured by Walcott in 1910, on plate 33, figure 1, as *Paedumias transitans*. It must be remembered that most of our ideas of *Olenellus* are based not on Hall's original figures of *O. thompsoni* but on the incorrect restoration, made from a very poorly preserved specimen, first published by Walcott in 1886 and subsequently widely copied. This figure, as Walcott stated in 1910, (description of pl. 35, fig. 1) is incorrect in representing the anterior lobe of the glabella as not reaching the rim. In this respect *Olenellus* and *Mesonacis* are identical.

The peculiar habit possessed by most of the Mesonacidae, that of the genal spines advancing forward, is not an individual characteristic, as is commonly assumed, but is specific. This is clearly indicated in the following specific grouping of the specimens from this locality. If the position of the genal spines were a matter of individuality, it would not be possible, as stated later in the descriptions, to assemble a dozen or more specimens into each of several species in which there is no variation in this respect.

PAEDUMIAS Walcott, 1910

Paedumias Walcott, 1910, Smithsonian Misc. Coll., Vol. 53, No. 6, p. 304.
(Described as a new genus.)

The original description of the single species referred to this genus in 1910 is based mainly on the specimens from York, Pennsylvania, but it is clearly stated that the type locality is in Vermont. The observations on which this original discussion were based were made on some specimens that cannot belong to the genus. The best example so used is the large, well preserved specimen illustrated by Walcott, 1910, as figure 1 on plate 33, which I now refer to *Olenellus*. Walcott states on page 308, "Nearly all the specimens of *Paedumias* found at York have the typical cephalon of *P. transitans*, as shown on pl. 34, figs. 2-4. In all of these the anterior lobe of the glabella is some distance from the frontal rim of the head, while in typical *Olenellus thompsoni* and *Mesonacis vermontana* from Vermont the anterior lobe touches the frontal rim." Thus it will be seen that he had in mind what he calls the "elongate form" as the typical form of *Paedumias*. Accordingly I have chosen the specimen figured on plate 34, figure 1 as the lectotype (U. S. Nat. Mus., Cat. No. 56808).

Pacdumias, as it is proposed to restrict it, possesses several definite generic characters. The glabella fails to reach the rim and is connected with it by a ridge that crosses the intervening space. The marginal sutures and rim are quite like the same features in *Mesonacis*. All the species strictly referable to *Pacdumias* thus far studied possess intergenal spines, a feature not present in the types of *Mesonacis* or *Olenellus*.

Except that intergenal spines have not been found in *Nevadia*, the cephalons of that genus and *Pacdumias* have a number of characters in common. In both, the glabella does not reach the rim and is connected medially with it by a ridge. In both genera the glabella tends to taper forward, a feature that has caused the placing of a number of species into *Callavia* that do not belong there (see p. 6).

SYNOPTICAL CHARACTERIZATION OF MESONACIS, OLENELLUS,
PAEDUMIAS, NEVADIA, AND CALLAVIA

The characteristics of the various genera studied in connection with this paper may be briefly summarized as follows:

Mesonacis.—Glabella touches the anterior rim and does not taper forward, but usually has more or less of an hour-glass shape. Rim narrow and striated. Marginal and epistomal plates separated by intramarginal and marginal sutures. Third thoracic segment large, and a strong spine occurs on the fifteenth. Rudimentary segments, with well developed pleurae, posterior to the fifteenth. Hypostoma without spines.

Olenellus.—Glabella as in *Mesonacis*. Rim perhaps a little wider and eyes somewhat longer. Thorax same as in *Mesonacis*, to fifteenth segment. Rudimentary segments posterior to the fifteenth without definite pleurae, *i. e.*, without dorsal furrows.

Pacdumias.—(Restricted) Glabella usually tapers forward, never extends forward to rim, with which it is connected by a median ridge. Rim, marginal and epistomal plates, and thorax to the fifteenth segment like *Mesonacis* and *Olenellus*. Intergenal spines present. Rudimentary segments posterior to the fifteenth *without* pleurae, as in *Olenellus*. Hypostoma with spines on posterior margin and connected with the rostral or epistomal plate by a stalk, which probably causes the median ridge on the upper surface of the cephalon.

Nevadia.—Cephalon most like *Pacdumias*. Glabella fails to reach the rim, with which it is connected by a median ridge. Rim and sutures possibly the same also, but none of the specimens is well enough preserved to be quite certain on these points. No intergenal

spines observed. Thorax distinct because of the loose arrangement of the segments. Hypostoma unknown.

Callavia.—Glabella fails to reach the rim, but there is no median ridge. Rim wide but poorly defined, in fact it may be said to be lacking. Intergenal spines very strong. Well developed occipital and thoracic spines. Third thoracic pleura not enlarged. No strong spine on the fifteenth segment. Hypostoma without posterior spines, attached directly to a broad sickle-shaped plate. This plate separates from the cephalon along a marginal suture (intramarginal) that corresponds to the one on the inner edge of the rim in *Mesonacis*, and it is divided into two similarly shaped pieces by the true marginal suture. Thus both the marginal and epistomal plates are situated on the under side. Since the combined width of the two plates is considerable they bridge the space between the anterior margin and the glabella, so that the hypostoma needs no stalk and hence there is no median ridge on the top side of the cephalon.

The other genera assigned to this family were not studied in this connection and will be discussed in a later revision.

FOSSILS FROM THE LOWER SHALE

The following six species all occur in association in a fine-grained, brown, somewhat calcareous shale, which is practically indistinguishable from the shales in both the eastern and western United States that carry the same genera of trilobites.

Since all the fossils come from one locality and occur in two beds only, no locality or horizon will be listed following the descriptions.

PATERINA PROSPECTENSIS Walcott

Plate 1, figs. 1, 2

Micromitra (Paterina) prospectensis Walcott, 1912, Monogr. U. S. Geol. Surv., No. 51, p. 352, pl. 2, fig. 4.

The few specimens of this brachiopod from Bristol Mountain are somewhat larger than the individuals from the type locality in Nevada, but otherwise seem to agree with them in all respects.

MESONACIS FREMONTI (Walcott), Restricted

Plate 1, figs. 3-9; plate 2, fig. 9; plate 3, fig. 8

Olenellus fremonti Walcott (pars), 1910, Smithsonian Misc. Coll., Vol. 53, No. 6, p. 320, pl. 37, figs. 1, 2.

A number of species are certainly included among Walcott's specimens grouped under this specific name. The form from southern

California here illustrated agrees in every respect with that from the type locality—Eureka District, Nevada (Loc. 52), to which the species is now restricted, and also with the specimens from Resting Springs, Inyo County, California (Loc. 14L). This is the most abundant species at Bristol Mountain, being represented by more than 50 specimens, of which only two show a portion of the thorax. The specimens vary in size from less than one cm. in width of cephalon to more than 12 cm., and the position of the genal spine is exactly the same in all.

The illustrations show the intramarginal suture that begins on the posterior margin of the cephalon, crosses over the genal angle, and then passes forward just inside the strongly striated rim, separating a marginal plate from the cheeks (see p. 5). This suture, as it passes forward, leaves the exact inner edge of the rim and runs along on it becoming less well defined, but does not reach the outer margin. A second suture appears to be present on the margin, thus forming a second detachable plate that lies under the first. This second plate, to which the hypostoma is probably attached, should, I think, be regarded as corresponding to the rostrum or epistoma of other trilobites. Just what the upper plate, which carries the upper half of the genal spines, may represent is not clear. Provisionally I shall call this plate the marginal plate. In some specimens the marginal plate is broken away (pl. 1, figs. 3, 4) exposing the underlying epistoma; in others both plates have been lost.

The facial suture, the position of which in the trilobites of this family has been a matter of much discussion, is quite clearly indicated in normal position posterior to and along the eyes, but its course anterior to them is not apparent.

MESONACIS BRISTOLENSIS, new species

Plate 2, figs. 5-8

None of the illustrated forms in the various species of the Mesonacidae with advanced genal spines has them in the position they occupy in this species. This species is represented in the collections by about 15 specimens in all of which the spines are in the same position, even though the cephalae vary from 2.5 cm. to more than 4 cm. in width, indicating again that within these limits neither size nor age of individuals causes variation in the position of the genal spines.

This species differs from *M. fremonti* first of all in the more advanced position of the long, slightly curved genal spines, which gives

the head a trapezoidal shape, making it shorter and wider. Again the facial suture shows plainly posterior to the eye but does not appear in front of it. The glabella of *M. bristolensis* extends farther forward so that it apparently overhangs the rim. It differs also from *M. fremonti* in having a greater constriction where the dorsal furrow is bent inward opposite the third pair of glabellar furrows, thus giving the glabella somewhat of an hour-glass shape. The occipital ring is wider than in *M. fremonti*, and the furrow, while also interrupted, differs in having the shallowing inner ends turn sharply backward before dying out completely. The third pair of glabellar furrows also does this, and the two lateral portions are parallel to the two portions of the occipital furrow. The second pair of glabellar furrows is represented by a continuous line, only slightly curved back in the center—less than in *M. fremonti*. The first pair of furrows is similar in direction and depth in both species.

The rim of *M. bristolensis* appears to narrow toward the center of the head, owing to the more forward extension of the glabella. It is striated as usual and the intramarginal suture running along the inner edge of the marginal plate is clearly marked. This suture occupies the usual relative position on the greatly shortened rim and across the genal angle. It continues sub-parallel to the posterior edge of the free cheek, the outer edge of which in this case occupies a vertical position, constituting the lateral margin of the cephalon, and terminates in the lower corners of the cephalon where the facial suture reaches the margin.

The palpebral lobes are relatively further forward, shorter, and perhaps a little more curved than in *M. fremonti*.

Mesonacis bristolensis has the usual striated surface, but the striae appear a little stronger than in the other species.

MESONACIS INSOLENS, new species

Plate 2, figs. 1-4

More than 20 cephalons of this species occur in the collections, and again none shows any variation in the point of origin and direction of the advanced genal spines. A poorly preserved, almost entire specimen indicates some of the characters of the thorax, which also will not fit any of the described forms with similarly advanced genal angles.

Compared with *M. bristolensis*, the most similar species in this fauna, several differences beside that of the position of the genal spine are readily noticeable. The shape of the cephalon is normal, being quite like that of *M. fremonti*. The posterior portion of the facial

suture is again well marked. The glabella is not quite so far forward, but is also considerably constricted in the center by the convergence of the dorsal furrow. The occipital furrow marks off a relatively wide occipital ring by means of two straight slits which are also directed slightly backward. The two parts of the third pair of glabellar furrows which have a shallow connection across the glabella, are peculiar in the manner of deepening and turning forward at their outer ends into the dorsal furrow. The second and first pairs are as in *M. bristolensis*, as are also the eyes.

The pleural portion of the third thoracic segment is more than ordinarily enlarged, even for a *Mesonacis*.

PAEDUMIAS NEVADENSIS (Walcott), Restricted

Plate 3, figs. 3-7

Callavia ? nevadensis Walcott, 1910 (pars), Smithsonian Misc. Coll., Vol. 53, No. 6, p. 285, pl. 38, fig. 12.

The specific name is here restricted to the incomplete specimen illustrated, and its congeners, cited from the type locality, Eureka District, Nevada (Loc. 52). The removal of this species from *Callavia* and its reference to *Paedumias* is demanded by the structure of the rim, as pointed out in the preceding generic discussion.

Since the specimens from Bristol Mountain seem to agree in all respects so far as the incomplete Nevada specimens of *P. nevadensis* permit comparison, they may be counted as representing a second species common to the two localities.

Owing to the tapering anterior glabellar lobe, coupled with its distance from the anterior margin, this species cannot well be confused with any other at the California locality, except its close ally *P. clarki*. Intergeneral spines are present.

PAEDUMIAS CLARKI, new species

Plate 3, figs. 1, 2

At first this species was referred to one of the forms included in *Mesonacis gilberti*, but closer comparison showed differences from all of them. It seems certain also that some of the specimens referred by authors to the species *Mesonacis gilberti* belong neither to that species nor even to *Mesonacis*, but are distinct species of *Paedumias*.

Compared with *P. nevadensis*, *P. clarki* is immediately distinguished by the fuller anterior lobe of the glabella and by the shorter distance between that and the frontal rim. The intergeneral spines in *P. clarki* are too weak to show in the photographs.

Unfortunately the specimen illustrated in plate 3, figure 1 fails to preserve the rear portion of the thorax so that its features cannot be determined.

FAUNA OF THE UPPER SHALE

Two species were found in the Middle Cambrian shale overlying the nodular limestone. They lie side by side on one small piece of rock.

DOLICHOMETOPUS ? LODENSIS (Clark)

Plate 3, fig. 9

Bathyriscus howelli lodensis Clark, 1921, Univ. Calif. Publ., Dep. Geol., Vol. 13, No. 1, p. 6.

The original description states simply that the thoracic segments number eight and that the pleurae of the fifth are much longer than the rest, particularly than the three succeeding ones.

This species is referred to *Dolichometopus* in spite of the fact that no other species now in the genus has the long fifth thoracic pleurae. Except for this and the sharper pleural spines, this species agrees quite closely with the adjacent specimen referred to *D. productus*.

DOLICHOMETOPUS PRODUCTUS (Hall and Whitfield)

Plate 3, fig. 9

Ogygia producta Hall and Whitfield, 1887, U. S. Geol. Expl. 40th Parall., Vol. 4, p. 244, pl. 2, figs. 31-35.

Dolichometopus productus Walcott, 1916, Smithsonian Misc. Coll., Vol. 64, No. 5, p. 369, pl. 53, figs. 2-4.

This single incomplete specimen appears to be the same as the common *D. productus*, a widespread Middle Cambrian species.



DESCRIPTION OF PLATE 1¹

	PAGE
<i>Paterina prospectensis</i> (Walcott).....	6
FIG. 1. (× 2.) Large dorsal valve. Plesiotype. U. S. Nat. Mus., Cat. No. 78377.	
2. (× 2.) Ventral and dorsal valves. Plesiotype. U. S. Nat. Mus., Cat. No. 78378.	
<i>Mesonacis fremonti</i> (Walcott).....	6
FIG. 3. Fairly well preserved cephalon. The course of the posterior facial suture, the marginal suture, the occipital and intergenal spines, and the general shape of the cranium, together with the slightly advanced position of the genal spines, are clearly shown. Plesiotype. U. S. Nat. Mus., Cat. No. 78379.	
4. Another cephalon in which the anterior margin on the left is disturbed by the peculiar slickensiding in the fossils from this locality. Size and position of the eyes and character of glabellar furrows are well shown. Plesiotype. U. S. Nat. Mus., Cat. No. 78380.	
5. A third, less complete cephalon, well preserved on the right side, showing particularly the posterior facial and intramarginal sutures as well as the striations on the rim. Plesiotype. U. S. Nat. Mus., Cat. No. 78381.	
6. Small cephalon with left eye practically complete. Plesiotype. U. S. Nat. Mus., Cat. No. 78382.	
7. Mould of portion of cephalon and thorax. Note extra width of third segment. Plesiotype. U. S. Nat. Mus., Cat. No. 78383.	
8. (× 4.) Enlargement of genal angle of specimen illustrated in preceding figures, showing striated rim and course of the intramarginal suture across the genal angle.	
9. The associated hypostoma, referred to the species. Plesiotype. U. S. Nat. Mus., Cat. No. 78384.	

¹All figures natural size unless otherwise stated.

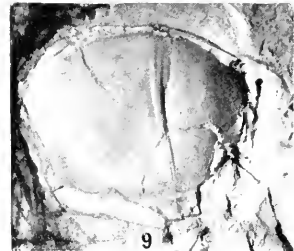
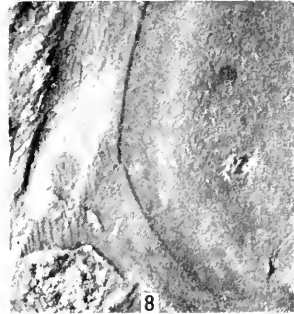
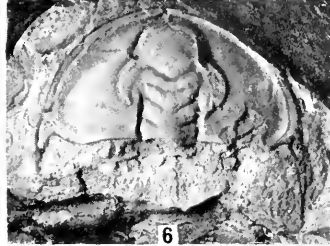
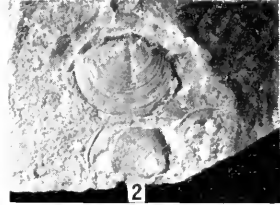
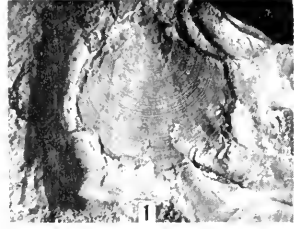
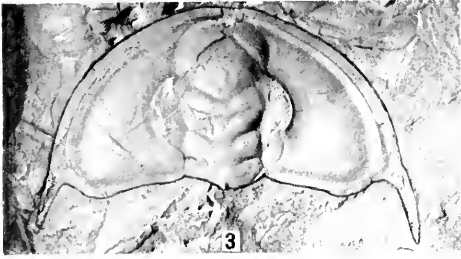

Cambrian Fossils from the Mohave Desert.

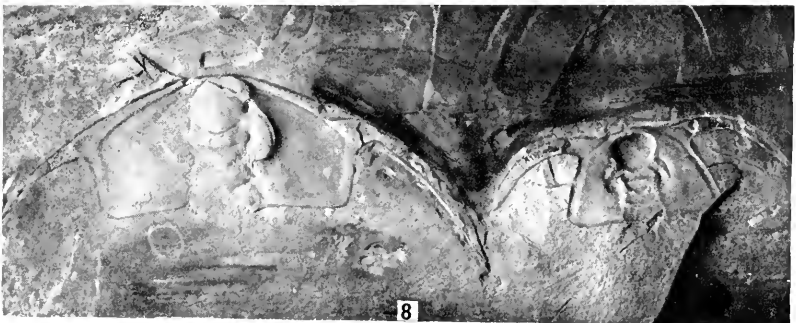
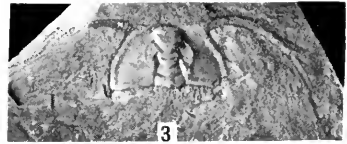
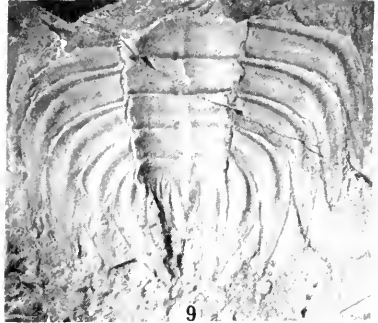
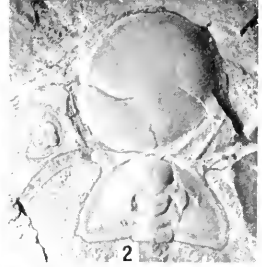
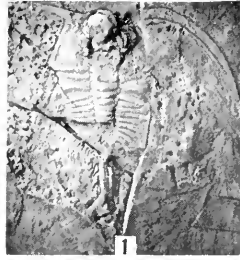

Cambrian Fossils from the Mohave Desert.

DESCRIPTION OF PLATE 2

	PAGE
<i>Mesonacis insolens</i> , new species.....	8
FIG. 1. Poorly preserved carapace giving some idea of the shape and general characteristics of the species. Cotype. U. S. Nat. Mus., Cat. No. 78386.	
2. Well preserved cephalon beside the hypostoma of <i>Mesonacis fremonti</i> . Cotype. U. S. Nat. Mus., Cat. No. 78387.	
3. Small cephalon illustrating the size and position of the eyes and the glabella. Note the occipital spine. Cotype. U. S. Nat. Mus., Cat. No. 78388.	
4. A larger head in which the full size of the advanced genal spines is shown. Cotype. U. S. Nat. Mus., Cat. No. 78389.	
<i>Mesonacis bristolensis</i> , new species.....	7
FIGS. 5, 6. Cephalon and enlarged ($\times 4$) view of the glabella showing the surface features. Cotype. U. S. Nat. Mus., Cat. No. 78390.	
7. Another cephalon with a fairly complete glabella. Cotype. U. S. Nat. Mus., Cat. No. 78391.	
8. Fairly complete cephalons of this species and of <i>M. insolens</i> , showing the different angles at which the genal spines arise. Cotype. U. S. Nat. Mus., Cat. No. 78392.	
<i>Mesonacis fremonti</i> (Walcott).....	6
FIG. 9. Portion of the thorax near the posterior end. Plesiotype. U. S. Nat. Mus., Cat. No. 78385.	

DESCRIPTION OF PLATE 3

	PAGE
<i>Paedumias clarki</i> , new species	9
FIG. 1. A specimen preserving the major portion of the thorax. Note the narrow rim and the median ridge between it and the glabella. Two other cephala occur on the same piece of rock. Cotype. U. S. Nat. Mus., Cat. No. 78393.	
2. Larger cephalon with eyes and glabella well preserved. Cotype. U. S. Nat. Mus., Cat. No. 78394.	
<i>Paedumias nevadensis</i> (Walcott)	9
FIG. 3. Small, but fairly complete cephalon. Plesiotype. U. S. Nat. Mus., Cat. No. 78395.	
4. Large cephalon showing the intergenal spines. Plesiotype. U. S. Nat. Mus., Cat. No. 78396.	
5. Another large cephalon, somewhat crushed, causing this specimen to resemble <i>P. clarki</i> . Plesiotype. U. S. Nat. Mus., Cat. No. 78397.	
6. Smaller cephalon with the glabella better preserved. Note the occipital spine. Plesiotype. U. S. Nat. Mus., Cat. No. 78398.	
7. Cephalon complete on the left side, showing position and size of the genal spine. Plesiotype. U. S. Nat. Mus., Cat. No. 78399.	
<i>Mesonacis fremonti</i> (Walcott)	6
FIG. 8. Enlargement ($\times 4$) of the left rear quadrant of the hypostoma shown on plate 1, figure 9. Plesiotype. U. S. Nat. Mus., Cat. No. 78384.	
<i>Dolichometopus</i> ? <i>lodensis</i> (Clark)	10
FIG. 9. The smaller shield shows the general characters of this species. The larger, less complete carapace is referred to <i>Dolichometopus productus</i> . Holotype. U. S. Nat. Mus., Cat. No. 78400.	

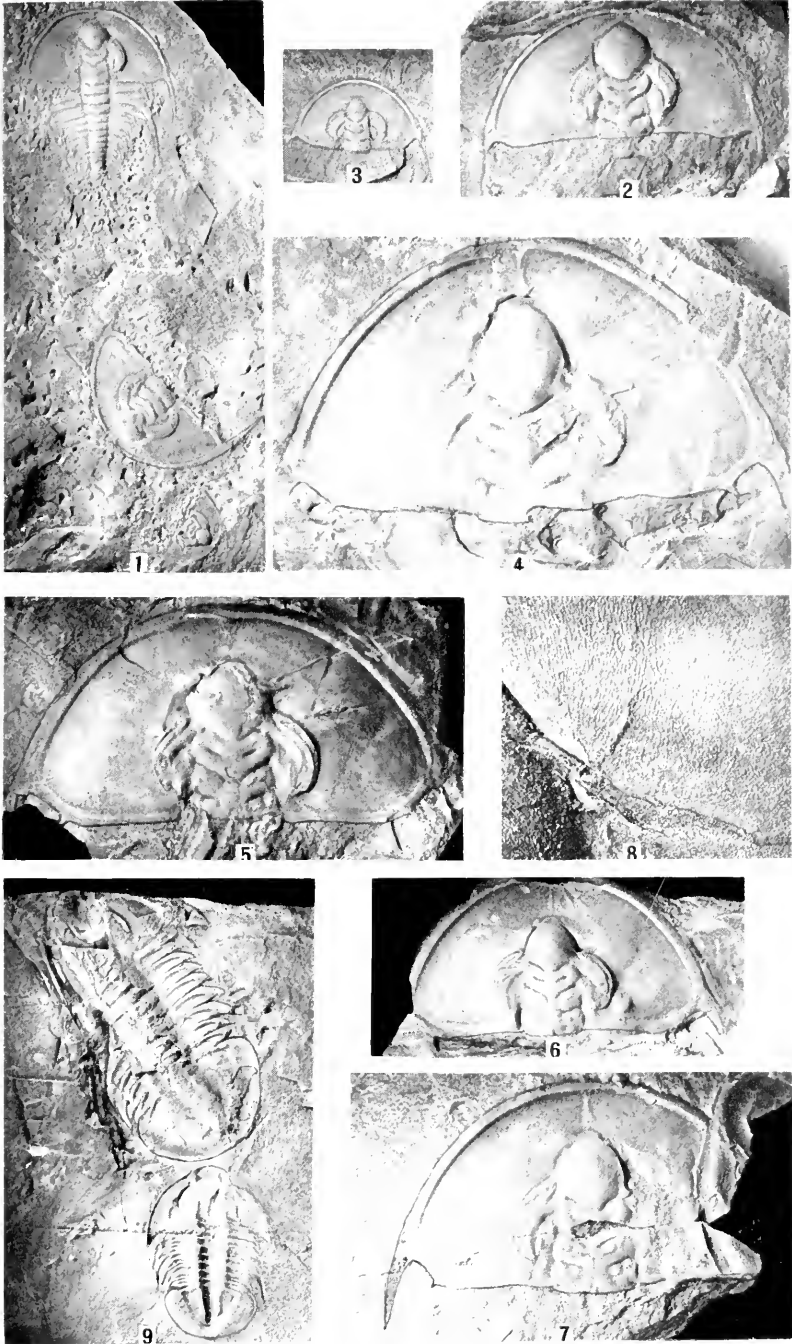

Cambrian Fossils from the Mohave Desert.

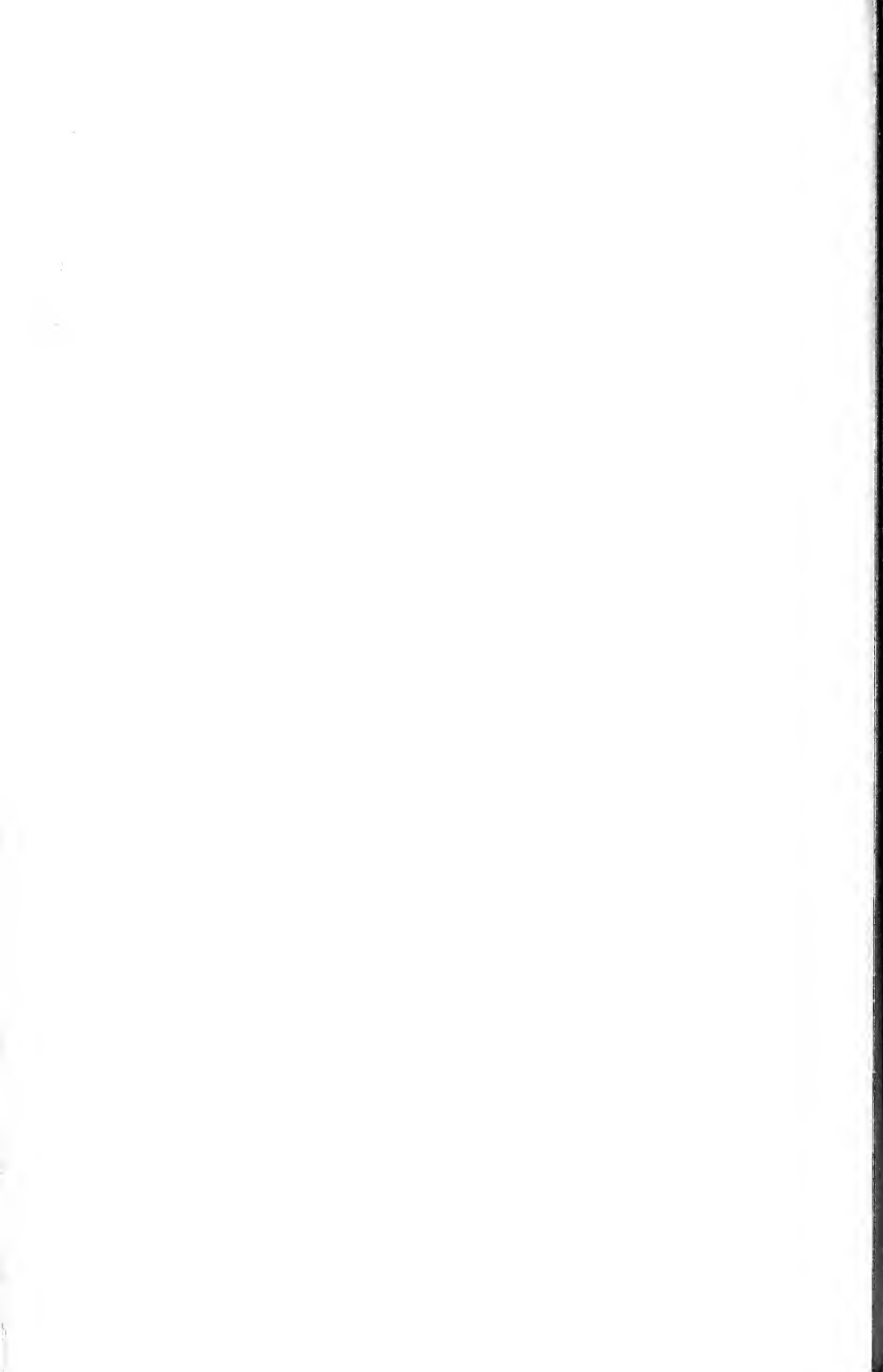

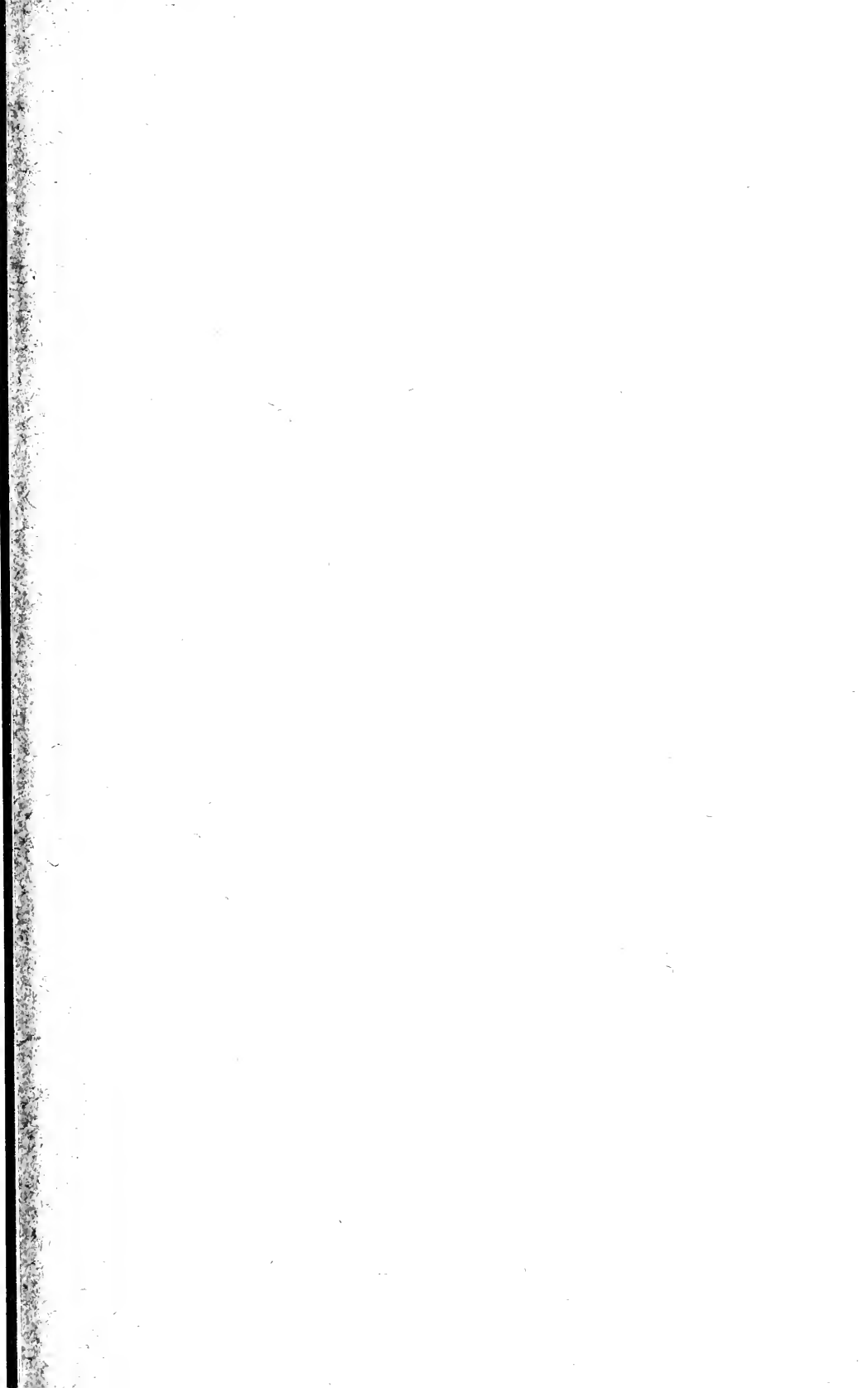



SMITHSONIAN MISCELLANEOUS COLLECTIONS

VOLUME 81, NUMBER 3

MORPHOLOGY AND EVOLUTION OF THE
INSECT HEAD AND ITS APPENDAGES

BY

R. E. SNODGRASS

Bureau of Entomology



(PUBLICATION 2971)

CITY OF WASHINGTON
PUBLISHED BY THE SMITHSONIAN INSTITUTION
NOVEMBER 20, 1928

SMITHSONIAN MISCELLANEOUS COLLECTIONS
VOLUME 81, NUMBER 3

MORPHOLOGY AND EVOLUTION OF THE
INSECT HEAD AND ITS APPENDAGES

BY
R. E. SNODGRASS
Bureau of Entomology



(PUBLICATION 2971)

CITY OF WASHINGTON
PUBLISHED BY THE SMITHSONIAN INSTITUTION
NOVEMBER 20, 1928

The Lord Baltimore Press
BALTIMORE, MD., U. S. A.

MORPHOLOGY AND EVOLUTION OF THE INSECT HEAD AND ITS APPENDAGES

By R. E. SNODGRASS

BUREAU OF ENTOMOLOGY

CONTENTS

	PAGE
Introduction	2
I. Evolution of the arthropod head.....	2
Cephalization	3
Development of the body in segmented animals.....	12
The protocephalon	19
The definitive arthropod head.....	27
II. General structure of the insect head.....	33
The head capsule.....	34
The labrum and epipharynx.....	41
The stomodeum	42
The hypopharynx	45
The tentorium	50
III. The head appendages.....	56
The antennae	57
The postantennal appendages.....	59
The gnathal appendages.....	60
The mandibles	62
The first maxillae.....	74
The second maxillae.....	77
Morphology of the gnathal appendages.....	79
IV. Summary of important points.....	90
V. The head of a grasshopper.....	94
Structure of the cranium.....	95
The antennae	99
The mandibles	100
The maxillae	102
The labium	106
The preoral cavity and the hypopharynx.....	107
The stomodeum	112
The mechanism for moving the head.....	118
VI. Special modifications in the structure of the head.....	120
Modifications in the fronto-clypeal region.....	120
Modifications in the posterior ventral region of the head.....	125
VII. The head of a caterpillar.....	131
Structure of the head capsule.....	132
The antennae	137
The mandibles	138
The maxillae and labium.....	139
The stomodeum	145
The musculature of back of head, and nature of insect neck.....	150
Abbreviations used on the figures.....	153
References	155

INTRODUCTION

It is regrettable that we must arrive at an understanding of things by way of the human mind. Lacking organs of visual retrospection, for example, we can only hold opinions or build theories as to the course of events that have preceded us upon the earth. Knowledge advances by what biologists call the method of trial and error, but the mind can not rest without conclusions. Most conclusions, therefore, are premature and consequently either wrong or partly wrong, and, once in every generation, or sometimes twice, reason back tracks and takes a new start at a different angle, which eventually leads to a new error. By a zigzag course, however, progress is slowly achieved. Error, then, is a byproduct of mental growth. It is not a misdemeanor in scientific research unless the erring one clings to his position when he should see its weakness. It is better to write beneath our most positive contentions that we reserve the right to change of opinion without notice. The reader, therefore, should not take it amiss if he finds certain conclusions drawn in this paper that do not fit with former statements by the writer, for no apology will be offered.

I. EVOLUTION OF THE ARTHROPOD HEAD

The head, as a differentiated region of an animal, is a more ancient structure than is any other specialized part of the body, and a proper understanding of the head structure involves an examination of the evidence of cephalic evolution from the very earliest period when evidence of head development can be found. Most of the Arthropoda have well developed heads, and that the arthropod head is a specialized body region, just as is the thorax or the abdomen in forms where these body regions are differentiated, is shown by the fact that in the embryo it consists of a series of body segments. In most cases, and particularly in insects, however, the head differs from the other body regions in that its component segments become so thoroughly consolidated in the adult as to leave little evidence of the primitive elements in the head structure. Even in the ontogenetic record the true history of the head development is so obscure in many respects, and so much deleted in the early passages, that, though all the facts of embryology were known, it is probable that the assembled information would still give but an incomplete account of the phylogenetic evolution of the head. It is only by a comparative study of the head structure and its development in the various arthropod groups, and by an effort to correlate the known facts of arthropod organization with what is known in other animals successively lower in the scale of evolution, that we

may arrive at a satisfactory conclusion as to the steps by which the complex head of an insect has been evolved—and even then we must allow much for errors of judgment.

CEPHALIZATION

It has been but little questioned that the numerous groups of meta-zoic animals are derived from a creature resembling the blastula of embryonic development (fig. 1 A). The embryonic blastula is exemplified, among living animals, in the early stage of the free-swimming larval planula of the Coelenterata (fig. 2 A). The planula develops

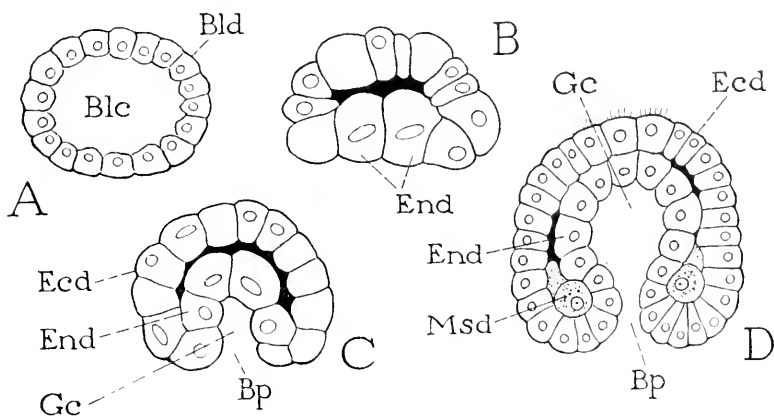

FIG. 1.—Typical early stages in general embryonic development.

A, blastula stage, diagrammatic, consisting of a blastoderm (*Bld*) surrounding a blastocoel cavity (*Blc*). B, C, D, stages in development of a chiton (from Kowalevsky, 1883): B, differentiation of cells in blastula; C, gastrulation, forming gastrocoel cavity (*Gc*), lined with endoderm (*End*), and opening through blastopore (*Bp*); D, later stage, showing origin of mesoderm layers (*Msd*) just within lips of blastopore.

directly from the coelenterate egg, and has the form of a hollow mass of cells, the outer surface of which is covered with vibratile cilia. The uniform motion of the cilia propels the animal through the water in the direction of one axis of the body (fig. 3), and thereby one end is distinguished as *anterior* and the opposite as *posterior*. The creature thus becomes uniaxial and bipolar, though as yet there may be no differentiation of body structure. The functional differences at the two poles of the body, however, determine the course of the subsequent development of physical characters. Structural differentiation of the end of the body that is forward in usual progression is called *cephalization*, a term meaning the process of evolving a head.

The body of the planula is usually larger at the anterior end (figs. 2, 3), and only in this does the planula attain cephalization in the strict sense. Its principal structural differentiation occurs at the posterior pole, where there takes place an ingrowth of cells (fig. 2 B-1) that soon fills the hollow of the body, and finally, by the appearance of a cavity within its mass, becomes the wall of the stomach of the mature animal. The process of forming a primitive stomach, or *archenteron*, as it takes place in the planula, is typified by that of gastrulation in ordinary embryonic development (fig. 1 A-D). The planula, of course, is a specialized larval form, and its manner of endoderm formation can not be taken as showing how the archenteron was evolved, but the free-swimming planula does show that the primitive mouth, or *blastopore* (fig. 1 C, D, *Bp*), was formed at the

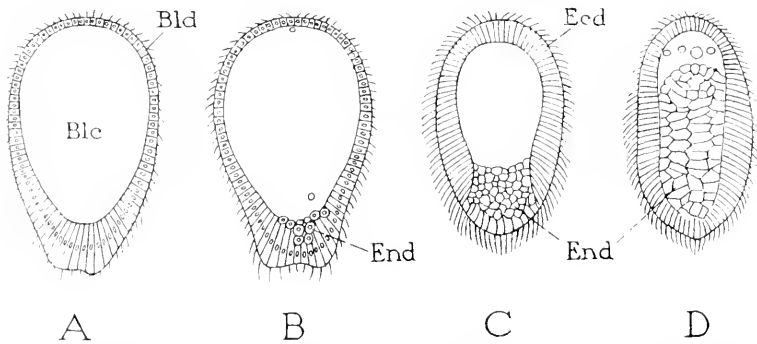

FIG. 2.—Formation of the endoderm in a coelenterate planula larva by proliferation of cells from posterior pole. (From Hatschek, 1888, after Claus.)

Blc, blastocoele; *Bld*, blastoderm; *Ecd*, ectoderm; *End*, endoderm.

posterior pole of the body, and not at the anterior pole. It is interesting to note, therefore, that the position of the mouth opening was not necessarily a primary determining factor of cephalization; the practical site for a mouth in a free-swimming, ciliate animal was determined by the direction of the animal's movement. Korschelt and Heider (1895) have stated, if a monaxial, heteropolar planula is allowed to swim through water containing particles of carmine, it can be seen that the particles are repulsed at the anterior and lateral parts of the body, but that they accumulate at the posterior pole. "Here accordingly," say Korschelt and Heider, "was a favorable place for the reception of particles of food, and by a flattening or shallow invagination of the posterior pole these favorable conditions were increased. The archenteron, therefore, in its earliest beginnings was a pit in which to catch particles of food."

This is a satisfactory explanation of the origin of the gastrula if not questioned too closely; but Bidder (1927) rather disturbs the idea with his statement that "the laws of viscous matter make it clear that the free-swimming gastrulae we observe as larvae could never earn their own living, since the stream-lines would carry every particle of food outside the cone of dead water which is dragged behind the gastrula mouth." On the other hand, Bidder admits, "creeping planulae or gastrulae might pick things up." A creeping animal, however, would never in the first place develop a mouth at the rear end of the body. What we want is an explanation of the original posterior position of the blastopore, and if none offered will suffice, we must be content with the fact.

The further history of the coelenterate larva has no bearing on the evolution of insects, for the creature soon becomes attached by its head end, and, probably as a result of the sedentary, plant-like habits

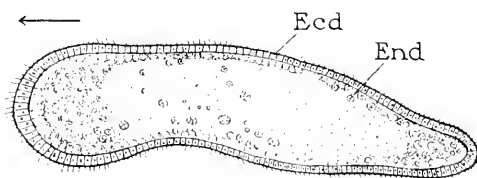

FIG. 3.—Free-swimming planula larva of a coelenterate, *Sympodium corralloides*, with ciliated ectoderm, and completely-formed endoderm. (From Kowalevsky and Marion, 1883.)

of its immediate ancestors, develops into a polype or jellyfish having a radiate, flower-like type of structure. Some writers have suggested that the worms and the arthropods may have been evolved from an elongate medusa, but it seems more probable that the Coelenterata, the Annelida, and the Arthropoda are all to be traced back to a free-swimming gastrula ancestor. The mature planula is a specialized gastrula, but it is of general interest in that it gives us a passing glimpse of a free-living animal in the blastula and gastrula stages at a time when cephalization was first established in the Metazoa.

The structure and development of the arthropods suggest that these creatures were developed from forms adapted to a creeping rather than a swimming mode of progression. Some planula larvae lack cilia and have creeping habits, and such forms, though they have nothing to do with the arthropod ancestors, show that a free-living creature in the blastula or gastrula stage may change its mode of progression. The creeping habit as an habitual mode of progression entails some fundamental structural adaptations. An animal that crawls

must keep one surface against the support, and thus it establishes a functional distinction between its upper surface and its lower surface, which has led to the structural differentiation of *dorsiventrality*; and from this, in combination with movement in one direction, finally, bilateral symmetry of organization necessarily follows.

Progression by crawling instead of by swimming alters the whole status of the relation between the animal and the environment. A mouth at the posterior end of the body now becomes quite impracticable, and embryonic history shows that crawling animals proceeded to rectify the defect, supposedly inherited from their free-swimming ciliate ancestors, by lengthening the mouth, or blastopore, in a forward direction on the under side of the body. In the young *Peripatus* embryo, for example (fig. 4 A, B), the blastopore is a long slit on the

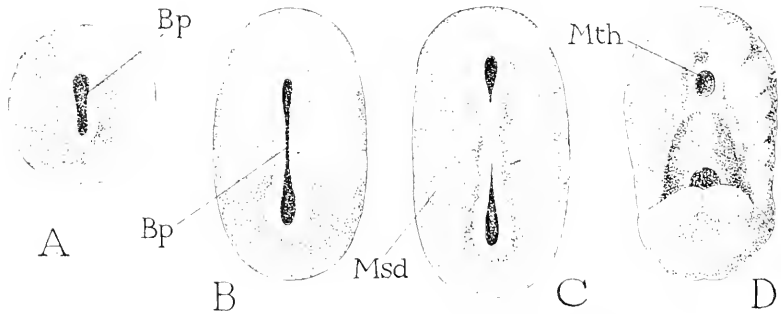

FIG. 4.—Early stages in the development of *Peripatus capensis*. (From Balfour, 1883.)

The blastopore (*Bp*) elongates on ventral surface of embryo, and then closes except at the two ends (*C*) where open extremities become mouth and anus. Segmentation appears as series of coelomic sacs in mesoderm (see fig. 6, *Msd*).

ventral surface of the blastoderm. Later, the edges of the slit come together (*C*) and unite except at the two ends, where openings remain into the archenteron that become the mouth and anus of the mature animal. In insects and other arthropods, the process of gastrulation in the embryo (fig. 5 A) is clearly a modification of that in *Peripatus*, by which many of the details have been omitted and the whole procedure greatly altered. In most insects (fig. 5 B), gastrulation resembles that of the planula (fig. 2) in so far as it takes place by an internal proliferation of cells from the blastoderm, but most of the gastrulation area gives rise to mesoderm, the true endoderm being formed only at the two extremities of the inner layer (fig. 5 C, *AMR*).

The mesoderm, and the associated mesenchyme, play an important part in the organization of all the higher Metazoa, since they form the internal organs that lie between the ectodermal covering of the body and the endodermal epithelium of the alimentary canal. The mesoderm is of particular importance in segmental animals because it is in this layer that metamerism originates. Mesoblastic tissue is produced in a gastrulated embryo in two ways: First, in the form of scattered cells proliferated from the inner surface of the invaginated endoderm; and second, in the form of cell layers. The scattered cells

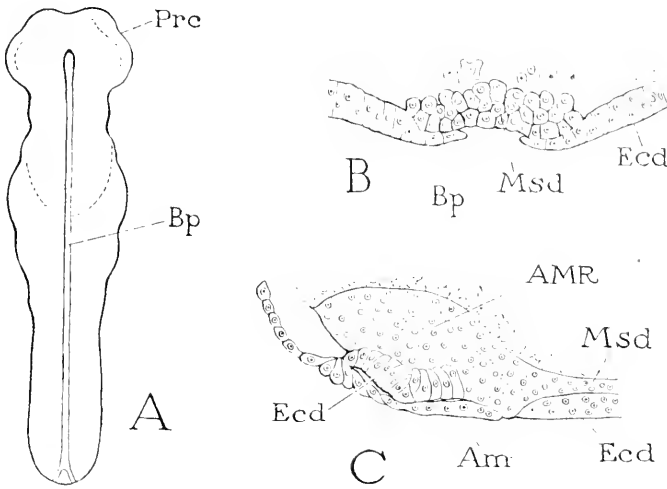

FIG. 5.—Gastrulation in insects.

A, embryo of *Leptinotarsa decimlineata* with long gastrulation groove, or blastopore (*Bp*), on ventral surface. (From Wheeler, 1889.)

B, cross section through blastopore of embryo of *Forficula*, showing mesoderm (*Msd*) formed by invagination of middle plate. (From Heymons, 1895.)

C, anterior mesenteron, or endodermic rudiment (*AMR*) formed at anterior end of mesoderm (*Msd*) in embryo of honeybee. (From Nelson, 1915.)

form a loosely coherent mesenchyme; the cell layers constitute the true mesoderm. The primitive mesoderm cells are given off from the endoderm near where the latter joins the ectoderm, that is, just within the lips of the blastopore (figs. 1 D, 6, *Msd*). In the young annelid larva, the mesoderm cells first form two lateral bands of tissue at the posterior end of the body (fig. 7 D, *Msd*). Later, the extended mesoderm tracts become excavated by a series of cavities, the coelomic sacs, which mark the beginning of segmentation. In *Pteripatus* (fig. 4), likewise, two rows of coelomic sacs (*Msd*) are formed as paired cavities in the mesoderm, which extends laterally between the ectoderm and the endoderm along the line of junction between these two

layers (fig. 6, *Msd*). In the annelids, the coelomic sacs form the entire segmented body cavity; in *Peripatus* and most of the arthropods, the greater part of the definitive body cavity is derived from a space between the ectoderm and the endoderm lined with mesenchymatic cells.

It is most important to bear in mind the intimate relation that exists between the mesoderm and the endoderm. In the arthropods, especially in insects, the process of gastrulation, as above noted, is greatly modified, and mesoderm tissue alone is proliferated along the greater part of the length of the blastopore area, which in only a few generalized forms appears as a true opening. At each end of the mesoderm, however, endodermal tissue is formed (fig. 5 C, *AMR*), and the two

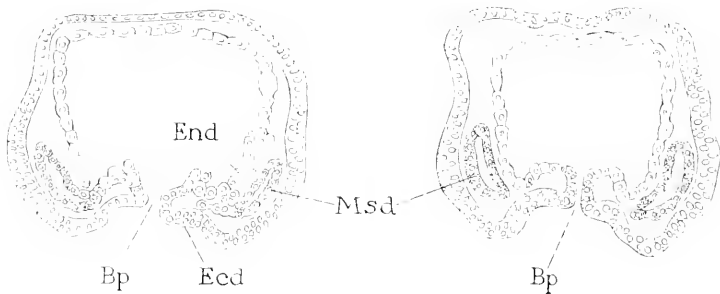

FIG. 6.—Formation of mesoderm in *Peripatus capensis*. (From Balfour, 1883.)

Cross sections of embryos through blastopore, showing formation of mesodermic coelomic sacs (*Msd*) from endoderm (*End*) just within lips of blastopore (*Bp*).

endoderm rudiments mark the anterior and the posterior limits of the mesoderm—consequently, they define the area of segmentation.

It is unnecessary to speculate as to the phylogenetic steps that may have led from the early creeping gastrula form of animal to the worm-like ancestor of the arthropods, but we must note the important advance in cephalization, and the possibilities of further head development that came with the establishment of a mouth at the anterior end of the body. Food, whether living or inert, had now to be recognized and seized on contact. Consequently, it became highly important to the animal to be able to determine its course according to favorable or unfavorable conditions of the surroundings. The ectoderm of the anterior end of the body developed a special sensitiveness to environmental changes, and, probably by means of ectodermal processes extending into the body, communicated the stimuli received from without to the internal tissues. Certain groups of the sensitive cells then

were withdrawn into the body where they became the rudiments of a central nervous system. Other sensory cells, remaining at the surface but sending processes inward to the buried cells, formed the peripheral sensory system. This anterior differentiation of sensory and conductive tissues opened still other possibilities of cephalization, which have led to the development of the brain and all the complex sense organs located on the head in higher animals.

It is difficult to establish, by concrete example, the contention that the change in the position of the mouth resulted from a change in the manner of locomotion, but it is indisputable that the ancestors of the worms and the arthropods must have assumed the crawling habit at some stage in their evolution. The chaetopod annelids, in their embryonic development, arrive at a first larval stage known as a *trochophore* (fig. 7 D), which is a free-swimming creature with well differentiated anterior and posterior poles, and a dorsal and a ventral surface, with the mouth situated anteriorly in the latter. If dorsiventrality is to be attributed to a creeping mode of locomotion, then there must be some stage omitted between that represented by the free-swimming planula, and that of the free-swimming trochophore, because there is no evident reason, otherwise, why two forms having the same mode of life should have an organization so different. The trochophore is without doubt a specialized larval form modified secondarily for a swimming habit. It can not, therefore, be taken to represent an ancestral form of the worms; but it is the only free-living creature that shows us the beginning of the worm organization, and its structure can certainly be traced into that of the arthropods.

The annelid trochophore is typically ovate in shape with the larger end forward (fig. 7 D), or rather, upward, since the creature floats upright in the water, but the side in which the mouth (*Mth*) is located is called the ventral surface because it becomes the under surface of the mature worm. The mouth lies a little below the middle of the body, and the anus (*An*) is situated at the posterior pole. The body is surrounded by several bands of vibratile cilia. The principal band (*b*), comprising usually two rows of cilia, is situated on the widest part of the body and just before the mouth. It divides the animal into a preoral, or *prostomial*, region (*Pst*), and into a postoral, or *metastomial*, region (*Mst*). A second band of cilia (*c*) is generally present a short distance behind the mouth, and sometimes there is a third, preanal band (*G, d*) near the posterior end, which sets off a terminal circumanal region, or *periproct* (*Ppt*). At the anterior end of the body there is a central tuft of tactile hairs (*G, a*), a pair of small lateral tentacles (*Tl*), and one or more simple eye spots (*O*).

The mouth of the trochophore (fig. 7 D, *Mth*) opens into an ectodermal *stomodaeum* (*Stom*), which leads into a large endodermal stomach, or *mesenteron* (*Ment*), of two parts, the second of which communicates with the exterior through a short ectodermal *procto-*

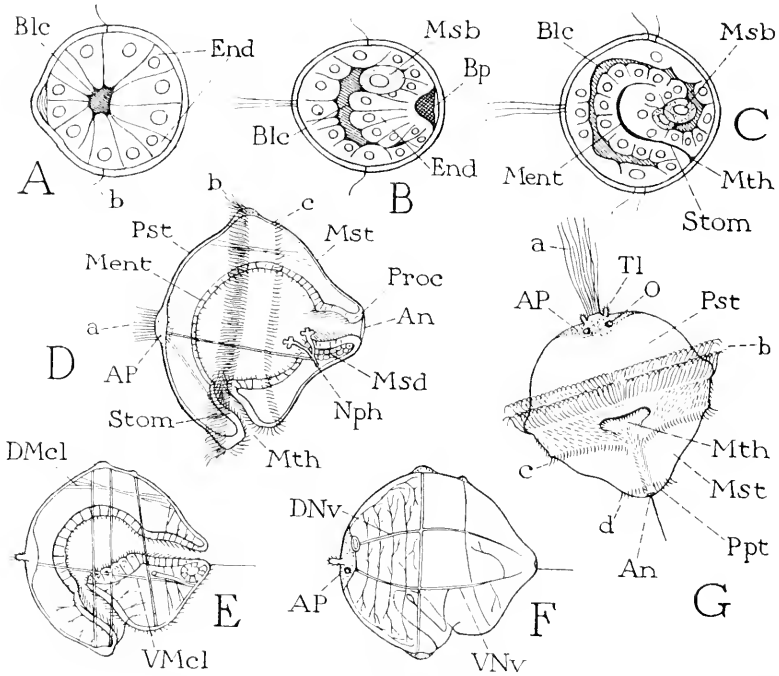

FIG. 7.—Structure and development of an annelid trochophore larva. (From Hatschek, 1888-91, but figures A to F turned in position of adult worm with mouth downward.)

A, blastula stage with endoderm cells (*End*) differentiated at posterior pole. B, gastrulation, showing a primitive mesoblast cell (*Msb*) of one side. C, gastrulation completed, mesenteron (*Ment*) detached from ectoderm at posterior end, its anterior end opening through stomodaeum (*Stom*) and mouth. D, full-grown trochophore larva of *Polygordius*. E, diagrammatic view of the muscle system. F, the nervous system. G, ventral surface of a trochophore.

a, apical tuft of cilia; *An*, anus; *AP*, apical plate; *b*, preoral band of cilia; *Blc*, blastocoel; *Bp*, blastopore; *c*, postoral band of cilia; *d*, circumanal band of cilia; *DMcl*, dorsal muscle; *DNv*, dorsal nerve; *End*, endoderm; *Ment*, mesenteron; *Msb*, primary mesoblast cells; *Msd*, mesoderm; *Mst*, metastomium; *Mth*, mouth; *Nph*, nephridium; *O*, eye spot; *Ppt*, periproct; *Proc*, proctodeum; *Pst*, prostomium; *Stom*, stomodaeum; *Tl*, tentacle; *VMcl*, ventral muscle; *VNv*, ventral nerve.

deum (*Proc*). In development, the endoderm is formed by invagination at the posterior end of the body (fig. 7 A, B, *End*), but the blastopore (*Bp*) soon shifts to the ventral surface (C) and elongates forward. The posterior part of the blastopore is then closed; the

anterior open extremity is carried inward by an ectodermal invagination which becomes the *stomodeum* (*C, Stom*), the external opening of which is the definitive mouth (*Mth*). The proctodeum and the anus are formed later by a posterior invagination of the ectoderm, and the proctodeum secondarily opens into the posterior end of the stomach. At the anterior end of the preoral region of the body, or prostomium, the ectoderm is thickened to form a sensory *apical plate* (*D, G, AP*) beneath the sensory organs here located, and from it ectodermal nerve tracts extend posteriorly in the body wall (*F*). Typically, there is a pair of dorso-lateral longitudinal nerves (*DNv*), and a pair of ventro-lateral nerves (*VNv*). The simple musculature of the trochophore (*E*) is developed from mesenchyme tissue; the epithelial mesoderm forms only the pair of mesoderm bands (*D, Msd*) and a pair of nephridia (*Nph*) in the posterior part of the body. This description of the trochophore is based mostly on that of Hatschek (1888-1891), from whose work the illustrations of figure 7 are taken.

The trochophore develops into the worm form of its parents by a metamorphosis involving an elongation of its posterior end (fig. 9), accompanied by a reduction of the cephalic swelling, until finally, in the adult, the only differentiation in the head region is an anterior, median prostomial lobe overhanging the mouth (fig. 10, *Pst*). The prostomium usually bears the principal sensory areas or organs of the worm, and a ganglionic nerve mass is differentiated from the inner surface of its ectoderm, which becomes the supraoesophageal ganglion, or *brain*, of the annelid. In the Polychaeta, the prostomium may bear one or more pairs of eyes, and several pairs of sensory tentacles (fig. 10). As the body of the young worm elongates, it becomes transversely segmented, the somites increasing in number posteriorly as the segmented area lengthens.

The young arthropod embryo, in its first definite form (fig. 8 A), consists of a large head region, the so-called cephalic lobes (*Prc*), and of a slender body (*Bdy*). The mouth (*B, Stom*) is situated on the ventral surface of the cephalic enlargement. The proctodeal invagination and the anus are formed, usually in a later stage, at the posterior end of the body.

The large-headed stage of the young arthropod embryo has a certain resemblance to the trochophore stage of the annelid larva; but it is probable that the similarity between the two forms has no genetic significance, and that the size of the cephalic lobes in the arthropod embryo is to be explained as an acceleration of development. Yet, it is evident that the cephalic region of the arthropod embryo cor-

responds with the prostomial and metastomial regions of the trochophore, and includes also the next following somite, for the first antennae, which are the appendages of the second somite of the arthropods, are developed on the cephalic lobes of the embryo (fig. 8 B, C, D, *Ant*). In the insect embryo, furthermore, the region of the rudimentary second antennal appendages, or the tritocerebral segment (fig. 8 C, *III*), is often incorporated into the cephalic lobes. It is probable, therefore, that the very early insect embryo represents a higher stage of cephalic evolution than does the annelid trochophore

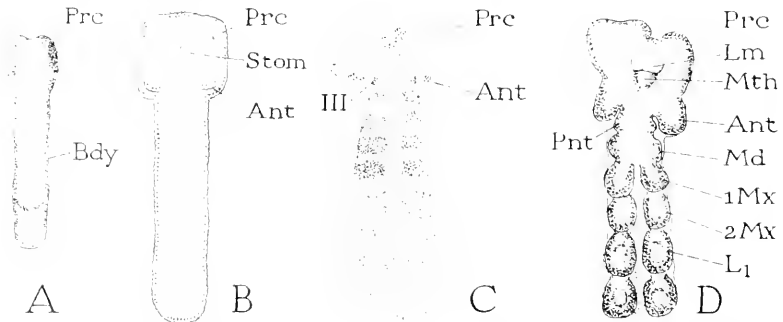

FIG. 8.—Young stages of insect embryos, showing cephalic lobes, beginning of segmentation, and formation of appendages.

A, germ band of *Blatella germanica* on seventh day, with cephalic lobes (*Prc*) indicated. (From Riley, 1904.)

B, embryo of same, about nine days old, with cephalic lobes developed into a distinct protocephalon (*Prc*), antennae (*Ant*) appearing, stomoderm (*Stom*) indicated as thickening of ectoderm. (From Riley, 1904.)

C, young embryo of *Lepisma*, with well-developed protocephalon (*Prc*), bearing stomoderm and rudiments of antennae, with tritocerebral segment (*III*) closely associated with its base. (From Heymons, 1897.)

D, embryo of *Blatella* late in tenth day, with labrum (*Lm*), mouth (*Mth*), and antennae (*Ant*) on protocephalon (*Prc*), followed by rudiments of post-antennal appendages (*Pnt*), mandibles (*Md*), first maxillae (*1Mx*), second maxillae (*2Mx*), and legs (*L₁*). (From Riley, 1904.)

larva, in as much as it has already progressed to a point where the head includes two or three of the body segments.

The definitive head of the arthropod may contain as many as six or seven of the body segments. Before going farther in the study of progressive cephalization, then, it will be necessary to understand something of the development and general organization of the body in segmented animals.

DEVELOPMENT OF THE BODY IN SEGMENTED ANIMALS

In the Annelida, the worm form is developed from that of the trochophore by an elongation of the posterior part of the larval body

(fig. 9), and by a decrease in the relative size of the cephalic enlargement. The young worm is a cylindrical creature with only a comparatively small prostomial lobe projecting before the mouth. With the elongation of the body, the alimentary canal and the mesoderm bands are correspondingly lengthened, and the trochophore muscles and nerves are continued into the new region. The external surface of the body of the trochophore is marked off into several areas by circular bands of cilia; the worm body, on the other hand, is constricted by transverse grooves into a series of segments, or somites. The segmentation of the adult worm *originates in the mesoderm bands* by the development in the latter of a series of paired coelomic sacs. Secondly, the mesodermic divisions become impressed upon

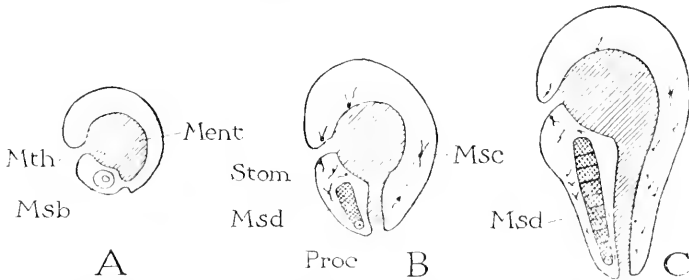

FIG. 9.—Diagrams of the development of an annelid trochophore larva, and early stage in its metamorphosis into a segmented worm. (From Hatschek, 1888-'91.)

A, early larval stage, showing a primary mesoblast cell (*Msb*) of one side. B, later stage in which the mesoblast has formed scattered mesenchyme cells (*Msc*), and a ventro-lateral band of mesoderm (*Msd*) in each side of the body. C, early stage of metamorphosis in which each mesoderm band has divided into a number of primary segments.

the body wall, and the segmentation expressed externally by a series of transverse, circular grooves on the intersegmental lines. In the worms, the segments increase in number from before backward by the differentiation of new segments between the last one formed and the periproct. The latter remains as an undifferentiated terminal piece of the body bearing the anus. The prostomial region of the trochophore becomes the prostomium of the adult worm; the metastomial region in the Archannelida constitutes the first body segment, or that immediately behind the mouth; but in the Polychaeta and Oligochaeta the metastomium is said to unite with the next somite to form a compound peristomial segment.

In the adult annelid (fig. 10), the body, as distinguished from the head, is all that part of the worm that lies posterior to the mouth (*A. Mth*), and the only differentiated head region is the prostomium

(*Pst*), though the peristomium (*Prst*) is sometimes called a part of the "head". The prostomium varies in size from a small lobe overhanging the mouth, to a large area extended posteriorly into the dorsal region of the peristomium (B). It bears the principal sensory organs, eyes and tentacles (*O*, *Tl*), of the anterior part of the worm. The alimentary canal extends entirely through the body from the mouth at the anterior ventral edge of the peristomium to the anus at the end of the periproct.

The nervous system of the adult annelid consists of a brain located before or above the oesophagus, derived from the ectodermal apical plate of the prostomium of the trochophore (fig. 7 F, *AP*), and of a ventral nerve cord of segmental ganglia and intervening connectives, formed from two nerve strands developed from the ectoderm

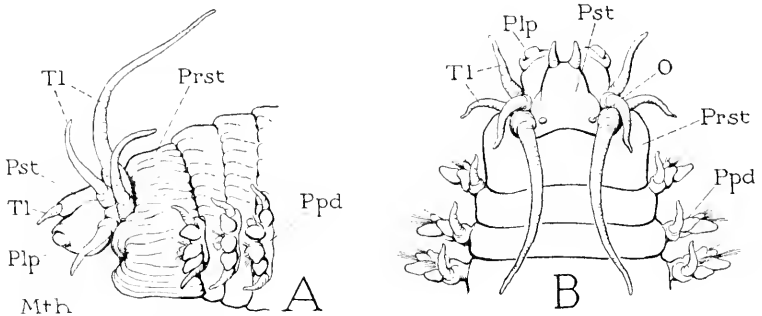

FIG. 10.—Anterior end of an adult polychaete annelid worm, *Nereis virens*.

A, lateral view. B, dorsal view.

Mth, mouth; *O*, ocellus; *Plp*, prostomial palpus; *Ppd*, parapodium; *Prst*, peristomium; *Pst*, prostomium; *Tl*, prostomial tentacles.

of the ventral body wall and prolonged from the ventro-lateral nerve strands of the trochophore. The ventral cord, therefore, is connected with the brain by a pair of connective nerve cords passing to the sides of the oesophagus. Usually, the two ventral nerve strands are united along the midline in adult worms, but in certain polychaete forms (*Serpulidae*) the two cords are said to remain separate, though connected by transverse, interganglionic commissures in each segment.

In the Arthropoda, body segmentation begins during an early embryonic stage, and the somites are added, in general, as in the annelids, from before backward by the differentiation of new segments behind the last one formed. In some of the arthropod groups, segmentation is completed in a postembryonic stage; in insects (except Protura), however, the somites are all defined before the creature leaves the egg, and the typical sequence of segmentation is not always followed.

The component segments of the cephalic lobes, or head of the arthropod embryo, are never distinct, but the subsequent development of the anterior nerve centers shows that the lobes comprise two segments at least, in addition to a prostomial region, and that usually a third segment is more or less included in their posterior part.

The way in which metamerism arose in the phylogenetic history of segmented animals is not known, and it is not necessary to believe that the method of segment formation in either the annelid larva or the arthropod embryo gives a picture of primitive segmentation in the course of evolution. The development of the trochophore into the worm is clearly a process of metamorphosis, that is, it is the return of a specialized, aberrant larva to the ancestral form represented more nearly in that of the adult; and it is well known that embryos do not keep closely to the phylogenetic path in the details of their development. Since so many other essential features in the body structure of animals are connected with the mode of locomotion, the writer holds as most probable the idea that segmentation also had its beginning as an adaptation to a specific kind of movement. The creeping, worm-like ancestors of the annelids and arthropods certainly at an early period must have developed a contractile tissue in their mesoderm bands—that they did so is attested by the early development of a central nervous system consisting of motor neurons, following the lines of the later established ventral longitudinal muscle bands. It is, then, clear that a breaking up of the contractile tissue into short lengths would give a greater efficiency of movement, with the possibility of more variety of action, and that, with the differentiation of true muscle fibers, the attachment of the ends of the fibers to the ectoderm would carry the metamerism into the body wall. The fact that embryonic segmentation begins anteriorly and progresses backward, in itself suggests that metamerism originated in a creeping animal; in a free-swimming form, the progress of segmentation should be the reverse, for the motile region of the animal would be the tail end. Organs developed at the time of metamerism or subsequent to it, such as nephridia, tracheae, and external appendages, are repeated in each segment, those antedating segmentation either remain unsegmented, as the alimentary canal, or take on a secondary segmentation, as do the body wall and the nervous system.

There are other theories of metamerism: Hatschek (1888-1891) enumerates five views that have been proposed to explain the origin of body segmentation, but none of them is based on the simple fact that in embryonic development, metamerism begins in the mesoderm

and secondarily spreads to other tissues. The older locomotion theory was defective in that it attributed the formation of segments to the mechanical stress of movement.

At the completion of metamerism, a segmented animal has attained a generalized structural stage in which it consists of a segmented body part coëxtensive with the length of the alimentary canal (fig. 11), and of a prostomial region (*Pst*) anterior to the mouth (*Mth*). Since the mouth in annelids and arthropods marks the site of the original anterior extremity of the blastopore on the ventral surface of the body (figs. 4 B, 5 A, *Bp*), it is evident that *mesodermal segments can not be formed morphologically anterior to the mouth*, and therefore, that *the preoral region is never truly segmented*. The common idea, then, that the arthropod mouth lies behind the first head segment, or, as proposed by some writers, behind the second or even the third seg-

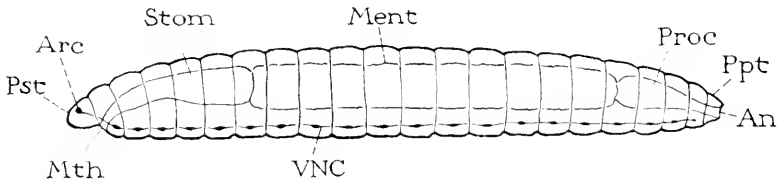

FIG. 11.—Diagram of the structure of a theoretically generalized segmented animal.

An, anus; *Arc*, archicerebrum; *Ment*, mesenteron; *Mth*, mouth; *Ppt*, periproct; *Proc*, proctodeum; *Pst*, prostomium; *Stom*, stomodeum; *VNC*, ventral nerve cord.

ment, disregards the fundamental relation between the endodermal and mesodermal layers. Segmentation can not exceed the extent of the mesoderm, and the primitive extent of this layer in the annelids and arthropods is defined by the positions of the mouth and the anus. The blastopore never extends quite to the true cephalic extremity. The stomodeal invagination, which gives rise to the definitive mouth, is thus preceded by an unsegmented prostomium. The closed posterior end of the blastopore, however, is at the posterior extremity of the body, where the blastopore and endoderm originated, and the later formed proctodeum, therefore, opens terminally in the periproct. In some arthropods a median lobe, or suranal plate, grows out over the anus from the periproct, and simulates the prostomial lobe at the anterior end of the body. Likewise, there may be lateral and subanal lobes of the periproct.

In as much as the most important evidence of the segmentation of the arthropod head is derived from a study of the cephalic nerve

masses, it will be necessary to understand next the essential features in the evolution of the central nervous system in segmented animals.

The annelids, as already noted, have a ganglionic nerve mass lying in the anterior part of the body, before or above the stomodeum, which takes its origin from the ectodermal apical plate of the prostomium (fig. 7 F, *Ap*). This, the most primitive brain of the annelid-

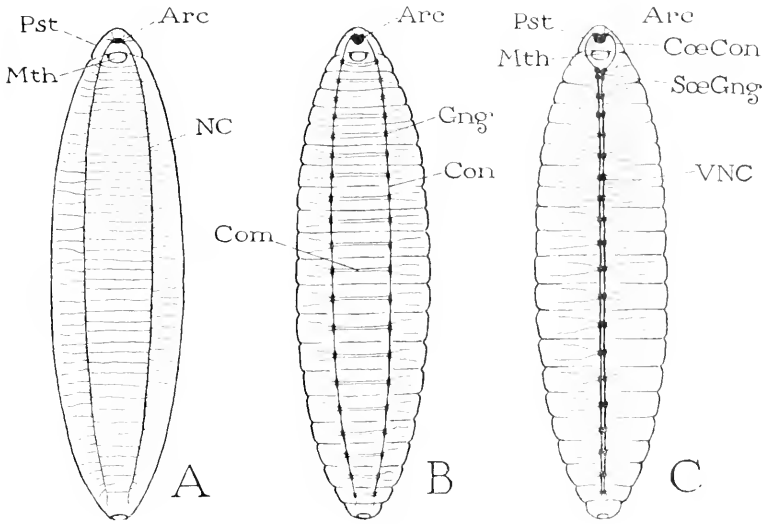

FIG. 12.—Diagrams suggesting the evolution of a central nervous system of annelid-arthropod type of structure.

A, theoretical structure of nervous system in an unsegmented pre-annelid form, consisting of a prostomial archicerebrum (*Arc*), and of two ventrolateral nerve cords (*NC*), connected medially by transverse nerves, and giving off nerves laterally to body wall and internal organs. Nerve cells diffused along the cords.

B, simple nervous system of the ladder type in a segmented animal. The nerve cells aggregated into segmental groups, or ganglia (*Gng*), along the cords; the intervening parts of cords converted into connectives (*Con*), and the transverse ventral nerves forming commissures (*Com*) between the ganglia.

C, the segmental pairs of ganglia united into compound ganglia of a median ventral nerve cord (*VNC*), in which the first, or suboesophageal, ganglion (*SocGng*) is postoral, and connected with archicerebrum of prostomium (*Arc*) by connectives (*CoeCon*) encircling the mouth (*Mth*).

arthropod series (fig. 12 A, *Arc*), has been named by Lankester (1881) the *archicerebrum* (a happy, though mismatched union of linguistic elements). In the trochophore, a pair of dorsal and a pair of ventral nerves (fig. 7 F, *DNv*, *VNv*) extend backward from the apical plate, but in the adult worm and in arthropods only the nerves of the ventral pair are retained. In the more primitive condition, the two ventral nerve strands have a latero-ventral position (fig. 12 A,

NC), and it seems reasonable to attribute the special development of these nerves in a creeping animal to the special development of sensitivity in the ectoderm along the edges of the body in contact with the supporting surface.

That the nerve strands were primarily unsegmented is shown by the fact that they are not ganglionated in the Archiannelida, and by their condition in *Peripatus* where the nerve cells are still distributed along the length of the cords, and segmental grouping of the cells is but slight. A concentration of the nerve cells of the cords in each segment is, then, only a simple adaptation to efficiency where metamerism becomes the established body structure. After the segregation of the nerve cells into pairs of segmental ganglia, the intervening fibrous tracts of the cords remain as connectives between the successive ganglia in each chain, while transverse ventral nerves, originally going from one cord to the other, become commissures uniting the ganglia of each segmental pair. In this way, apparently, a simple nervous system, formed primarily as two parallel strands of nerve tissue, became a segmented system of the ladder type (fig. 12 B). In the further course of evolution, the ganglia of each segment come together medially and combine into a single ganglionic mass, or segmental ganglion (C), which, in some arthropod groups, acquires an addition from a secondary median cord of nerve tissue developed from the ventral ectoderm along the midline of the body. The transverse commissures are now internal fibrous tracts of each double ganglion, but the lengthwise cords persist usually as paired interganglionic connectives. Each definite body ganglion, or pair of ganglia, innervates, in general, only the parts and organs of its own segment, but all the ganglia show a tendency to migrate along the cords, especially in a cephalic direction, and to unite with other ganglia to form composite ganglionic masses. Whatever may be the final position of any pair of ganglia, however, its nerves in most cases still go to the segment in which the ganglia originated. The nervous system, thus, often gives a key to the body segmentation where the latter is obscure or obliterated.

The next important stage of development is that, characteristic of the arthropods, in which are formed the external *segmental appendages*. The organs designated "appendages" in the limited sense are hollow, ventro-lateral outgrowths of the body wall (figs. 13, 14, 22), which become movable by muscles inserted on their bases, and flexible by a series of joints in their walls, also provided with muscles. Here again, we connect structural evolution with movement, for undoubtedly the segmental appendages in the first place were all organs of locomotion, giving a new power of movement supplanting the wriggling and

creeping of earlier ancestral forms. The question of whether the appendages were first used for propulsion through the water, or for progression on a solid support will not be discussed here, but, in the course of their evolution, the appendages have become specialized to serve a great variety of functions. Moreover, by the functional grouping of the appendages, the corresponding body segments have themselves become differentiated into groups forming often quite distinct body regions (fig. 13 B), of which the head of an insect is one of the most highly evolved.

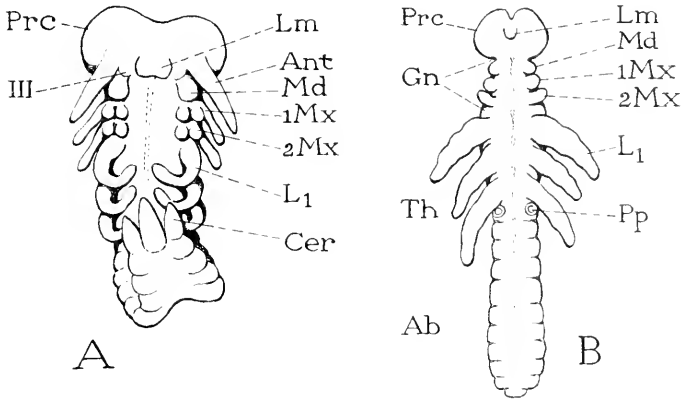

FIG. 13.—Young insect embryos at a stage when the thorax is already differentiated, but in which the gnathal segments are not yet added to the protocephalon to form the definitive head.

A, embryo of *Lepisma saccharina* (from Heymons, 1897). B, embryo of *Ranatra fusca* (from Hussey, 1926).

Ab, abdomen; Cer, cercus; Gn, gnathal segments; III, tritocerebral segment; L₁, first leg; Lm, labrum; Md, mandible; 1Mx, first maxilla; 2Mx, second maxilla; Pp, "pleuropodium"; Prc, protocephalon; Th, thorax.

THE PROTOCEPHALON

The arthropods differ from the annelids in the possession of a composite head, or *syncephalon*, formed by the union of several of the anterior segments with the prostomium.

In the embryonic development of most Arthropoda the head is first differentiated as a swelling of the anterior end of the body, forming the so-called cephalic lobes (fig. 8 A, B, Prc). On this region are developed the labrum (D, Lm), the eyes, the stomodeal invagination (B, Stom), or mouth (D, Mth), the antennae (Ant), and in some cases the postantennal appendages, when the last are present (fig. 22 A, 2Ant). The cephalic lobes soon become a very definite embryonic head (fig. 13 A, B, Prc), which either remains as the entire

adult head (certain crustaceans), or constitutes the basic structure to which other body segments are added later to form the definitive head. It is impossible, therefore, to escape the conclusion that the primary embryonic head represents an early phylogenetic stage of cephalization, which was characteristic of the ancestors of all the arthropods. This first arthropod head may be termed the *protocephalon* (procephalon, Patten, 1912) to distinguish it from the prostomial head of the annelids, which might fittingly be designated an *archicephalon*, though Crampton (1928a) has proposed this term to denote a later formed cephalic region composed of the protocephalon and the mandibular segment.

There has been some uncertainty as to the number of segments involved in the protocephalon, for the segmentation of the cephalic lobes is never clearly marked in the embryo, and the existence of primary head segments is usually indicated rather by the presence of the head appendages, and by the divisions of the cephalic nerve mass, than by the appearance of metamerism in the head itself. It appears most probable, however, for reasons to be given presently, that the protocephalon comprises a prostomial region and two or three primitive somatic segments. The adult arthropod brain is a syncerebrum, consisting always of two parts, the protocerebral and deutocerebral lobes, to which in most cases are added the ganglia of a following segment, which constitute then the tritocerebral brain lobes. The protocerebral lobes are the most complex part of the brain, and they are probably formed of elements derived from a primitive prostomial region and from the ganglia of a preantennal segment. The deutocerebral lobes are simple developments of the ganglia of the antennal segment. The postantennal ganglia do not always enter into the composition of the definitive brain, and their segment is often not a part of the protocephalic head of the embryo, as indicated by the position of its appendages (fig. 8 D, *Pnt.*, fig. 22 B, C, *Ch*; D, *Pnt*).

The segmental position of the mouth has been the subject of much difference of opinion. Most writers hold that the stomodeal invagination is situated in or before the first true head segment; others claim that it lies behind the second, or even the third segment (Comstock and Kochi, 1902; Holmgren, 1909, 1916; Henriksen, 1926). It was long ago pointed out by Lankester (1881) and by Goodrich (1898), however, that only on the assumption that *all* the true head segments of arthropods are *postoral* in position can the arthropod head segmentation be homologized with the anterior body segmentation of the annelids. Whatever part of the head is truly preoral, according to this view, belongs to the prostomium. Moreover, Lankester argued,

the arthropod brain must contain a median anterior rudiment derived from the prostomial ganglionic mass, or archicerebrum, in addition to the ganglia of the component segments. "In the Chaetopoda," Lankester says, "the prae-oesophageal ganglion appears always to remain a pure archicerebrum. But in the Crustacea (and possibly all other Arthropoda * * *) the prae-oesophageal ganglion is a syn-cerebrum consisting of the archicerebrum and of the ganglion masses appropriate to the first and second pair of appendages which were originally postoral, but which have assumed a praeoral position whilst carrying their ganglionic masses up to the archicerebrum to fuse with it."

According to Lankester's view, then, the arthropod head should comprise a prostomial region and several postoral segments, and the brain correspondingly should include the prostomial archicerebrum

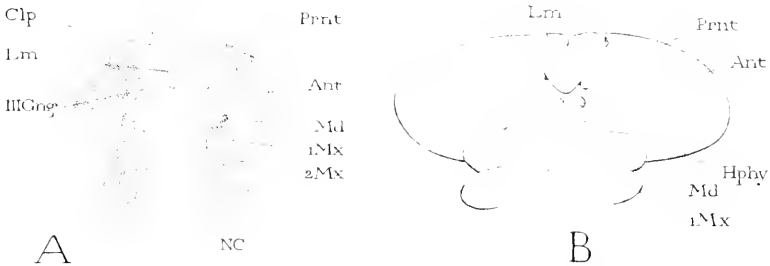

FIG. 14.—Young embryos of a chilopod and an insect showing rudiments of preantennal appendages.

A, anterior end of embryo of *Scolopendra* (from Heymons, 1901). B, same of a phasmid, *Carausius morosus* (from Wiesmann, 1926).

Ant, antenna; Clp, clypeus; Hphy, hypopharynx; III Gng, tritocerebral ganglion; Lm, labrum; Md, mandible; iMx, first maxilla; 2Mx, second maxilla; Prnt, preantenna.

and the paired postoral ganglia of the first two segments, with the ganglia of the third segment added in most cases. This idea, expressed theoretically by Lankester and by Goodrich, has been given substantial support by Heymons in his study of the development of *Scolopendra*, and more recently by Wiesmann from a study of the embryo of *Carausius*.

The head of *Scolopendra*, Heymons (1901) says, is formed during embryonic development by the union of an unsegmented preoral region and six postoral segments. The preoral part Heymons calls the "acron," taking this term from Janet (1899) in a slightly altered sense; it is the primary "Kopfstück," which clearly is the prostomium. The first true metamere, or postoral segment, is marked by a pair of small coelomic sacs in the mesoderm, and bears a pair of evanescent preantennal appendages (fig. 14, *Prnt*), which at an early

stage lie on a line posterior to the mouth. Later, this segment loses its identity, and it can not be traced in the composition of the adult head. The second metamere is the antennal segment, bearing the antennae of chilopods (fig. 14 A, *Ant*) and insects (fig. 13 A, *Ant*), or the corresponding first antennae (antennules) of Crustacea (fig. 22 A, *1Ant*). The third metamere is the so-called intercalary segment, marked by a pair of coelomic sacs and corresponding ganglia in *Scolopendra* (fig. 14 A, *III Gng*), bearing the highly developed second antennae of Crustacea (fig. 22 A, *2Ant*), the chelicerae of Arachnida (fig. 22, B, C, *Ch*), or the rudimentary post-antennal appendages of insects (fig. 22 D, *Pnt*). The fourth, fifth, and sixth metameres of the definitive chilopod head are the segments of the gnathal appendages (fig. 14 A, *Md*, *1Mr*, *2Mr*), which have united with the protocephalon.

The adult brain of *Scolopendra*, Heymons finds, is a composite of preoral and postoral ganglionic elements. The preoral parts are derived from the ectoderm of the prostomial region, the postoral parts are the paired ganglia of the first three head metameres. The prostomial elements include a median archicerebral rudiment that becomes the anterior part of the supraoesophageal commissure, and paired lateral rudiments, which form the dorsal cortical plate, the frontal lobes, and the optic lobes of the definitive brain. The ganglia of the first metamere, or preantennal segment, are a pair of small nerve masses which unite with the prostomial rudiments to form the protocerebral lobes of the adult brain. The ganglia of the antennal segment constitute the deutocerebrum; those of the postantennal segment become the tritocerebral lobes. The definitive location of the preantennal and antennal ganglia anterior to the mouth is a secondary one, and their union before or above the stomodeum, Heymons explains, comes about ontogenetically through the late development of the transverse commissures, which are not formed until the respective ganglia have acquired a preoral position. Wheeler (1893) had suggested that "the arthropod protocerebrum probably represents the annelid supraoesophageal ganglion, while the dento- and tritocerebral segments, originally postoral, have moved forward to join the primitive brain." This essentially is also Heymon's earlier view (1895), but the existence of a separate pair of preantennal segmental ganglia was not suspected at that time.

For many years Heymons' observations on the development of the head of *Scolopendra* have remained unverified. It is, therefore, of particular interest to find essentially the same structure now described for an insect. Wiesmann (1926), studying the development of a phasmid, *Carausius morosus*, reports that the head is composed of

a prostomial region and of six postoral metameres with paired coelomic sacs, of which the first metamere bears a pair of small, evanescent preantennal appendages (fig. 14 B, *Prnt*). Wiesmann, however, claims that the prostomium is a segment, because he finds in its mesoblastic tissue a pair of small cavities at the base of the paired rudiments of the labrum. The prostomial region of the adult arthropod contains a part of the body lumen, but from this it does not necessarily follow that its primitive mesoblastic cavities are homologous with the coelomic sacs of the true mesoderm, the extent of which should be limited by the length of the blastopore (see page 16). More likely, the mesoblast of the prostomium is a mesenchyme. In any case, however, it is only a matter of definition as to what we shall call a "segment."

The assumption of the presence of one or more preoral segments in addition to the prostomium disregards the fundamental relation between the embryonic germ layers. As already pointed out, the position of the mouth, or of the stomodeal invagination, marks the anterior end of the blastopore; the extent of the endoderm, except as it expands within the body, is determined by the length of the blastopore; the mesoderm is derived from the endoderm, and in the mesoderm metamerism originates. Therefore, in a bilateral animal, it seems clear, *true segments can not lie morphologically anterior to the mouth*. In the insect embryo, the anterior mesenteron rudiment actually defines the anterior limit of the mesoderm. Later formed segmental regions or appendages that appear to be preoral must, then, have acquired this position secondarily. In the figure of a *Peripatus* embryo (fig. 4 D) it is clearly seen how the anterior coelomic sacs may extend laterally before the mouth, and how corresponding appendages might come to have a preoral location topographically, though being morphologically postoral.

In the insect brain, there has never been noted a distinction between ganglionic rudiments of a preantennal segment and prostomial elements in the composition of the definitive protocerebral lobes, and the optic lobes are commonly referred to the first segment, though their independent origin is recognized. In the Crustacea, however, preantennal ganglia have been recorded, and Daiber (1921) says, "since ontogeny appears to give support to the view that the optic lobes are secondary structures, we must suppose that the segmental ganglia of the preantennal segment have been mostly suppressed, and that remains of them are represented in the ganglion cells of the roots of the oculomotor nerves. The ganglion pair found in the embryo of *Astacus* and *Iaera* between the ganglionic fundaments of the optic lobes and those

of the antennal ganglia, and which later fuse with the brain ganglia, are probably to be explained as the true segmental ganglia of the preantennal appendages."

It may be questioned if there is ever a true segmental separation between the ocular and antennal region of the insect head, since whatever division does occur between the two parts appears relatively late in development, and is, therefore, probably of a secondary nature. Holmgren (1916), from a comparative study of the histology of the brain of annelids and arthropods, concluded that the protocerebral and deutocerebral parts of the definitive arthropod brain are secondary subdivisions of one primitive nerve mass, which, moreover, Holmgren would identify with the archicerebrum of the annelids. This conclusion is scarcely tenable, because, interpreted literally in terms of annelid structure, it would assign the antennae to the prostomium, and because it disregards the evidence of the postoral position of both the preantennal and antennal rudiments in the embryo.

It is usually assumed that the compound eyes of crustaceans and insects belong to the preantennal segment, which, on this assumption, is designated the "ocular" segment. Heymons (1921), however, claims that in *Scolopendra* the eyes and the optic lobes are derived from the ectoderm of the prostomial region. It is perhaps not necessary to believe that the grouped ocelli of the Chilopoda, even the composite "pseudo-compound" eyes of *Scutigera*, are related to the true compound eyes of crustaceans and insects, since the details of structure in the two cases are quite different; but it would seem less probable that the optic lobes of the brain should have a separate origin in the different arthropod groups. In many of the Crustacea, the compound eyes are pedunculate, being situated on segmented stalks having an ample musculature innervated from the protocerebrum, and this fact gives strong support to the idea that the eye-stalks are appendages of the preantennal segment. Experiments have shown that if an eye-stalk is amputated, an antenna-like organ is often regenerated from the stump, on which an eye is not developed. These results recall the experiments of Schmitt-Jensen (1913, 1915) who cut off the antennae of a phasmid (*Carausius morosus*) and found that the appendages were regenerated in a form closely resembling the tarsi of the thoracic legs, each, in some cases, with a pair of terminal claws and a pulvillus.

It is difficult to evaluate these regeneration phenomena, for it seems highly improbable that the insect antenna ever had the specialized structure of the thoracic appendages of modern adult insects. Many

writers hold that the crustacean eye-stalks are secondary outgrowths; and, as for their innervation from the protocerebral lobes, it might be claimed that the roots of the oculo-motor nerves come from a part of the protocerebrum derived from the prostomial archicerebrum. A definite opinion on these matters must await the results of further research. Since, however, in the Annelida, the prostomium is the seat of primary sensory development, and of the principal sense organs

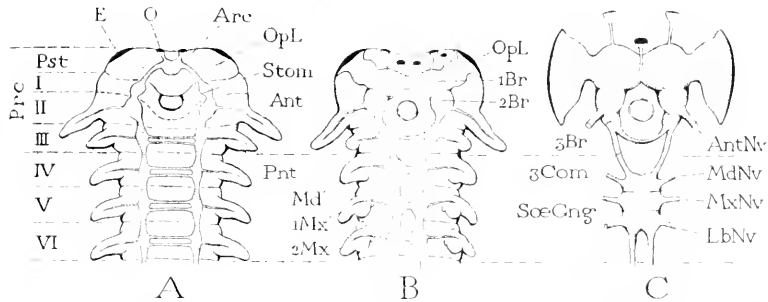

FIG. 15.—Evolution of the insect brain as it must be conceived *if* it includes an archicerebral rudiment, and *if* the compound eyes and the optic lobes are derived from the prostomial region, as claimed by Heymons.

A, theoretical generalized condition in which the ganglia of the prostomium (*Pst*), preantennal segment (*I*), antennal segment (*II*), and postantennal segment (*III*) are yet distinct, and in which the prostomial archicerebrum (*Arc*) is the brain.

B, the prostomium and the first three postoral segments united into a protocerebrum; the brain composed of protocerebral lobes (*1Br*) formed of the archicerebrum (*Arc*) and ganglia of preantennal segment (*I*), and of deutocerebral lobes (*2Br*) representing ganglia of antennal segment (*II*); ganglia of postantennal segment (*III*) distinct and connected by postoral commissure. This condition retained in some lower crustaceans.

C, the definitive condition in all insects: the ganglia of postantennal segment (*III*) are added to the brain to form the tritocerebral lobes (*3Br*) of the latter; the ganglia of the gnathal segments (*II*, *V*, *VI*) united in a compound suboesophageal ganglion (*SocGng*).

Ant, antenna; *AntNv*, antennal nerve; *Arc*, archicerebrum; *1Br*, protocerebrum; *2Br*, deutocerebrum; *3Br*, tritocerebrum; *3Com*, tritocerebral commissure; *E*, compound eye; *LbNv*, labial nerve; *Md*, mandible; *MdNv*, mandibular nerve; *1Mx*, first maxilla; *2Mx*, second maxilla; *MxNv*, maxillary nerve; *O*, ocellus, *OpL*, optic lobe; *Pnt*, postantennal appendage; *Prc*, protocephalon; *Pst*, prostomium; *SocGng*, suboesophageal ganglion; *Stom*, stomodaeum.

(fig. 10), it is at least in harmony with the assumed annelid ancestry of the Arthropoda to suppose that the arthropod eyes had their origin on the prostomial region of the head, and that their definitive posterior, dorsal location has resulted from the backward revolution of the anterior part of the head, a transformation that actually takes place in the growth of the embryo.

We may conclude, without going farther into matters of controversy, that the immediate ancestors of the arthropods possessed a

long, segmented body, at the anterior end of which was a specialized cephalic region, differing from the annelid head in that it comprised both the prostomium and the first two or three primitive body segments. In this early arthropod head, or protocephalon, the prostomium was still an important element; it perhaps carried the ocular organs, though tentacles were probably lacking, and it was extended dorsally on the facial aspect of the head between the bases of the antennae; on its ventral part, just before the mouth, there was a median lobe, the labrum. The first true head segment was much reduced, and its appendages were vestigial, or absent, unless they are represented in the eye-stalks of modern crustacea. The second head segment bore the antennae, simple, jointed appendages, which acquired a preoral position on the sides or front of the head by a secondary forward migration of their bases. These two segments and the prostomium became intimately fused, and in the ontogenetic development of present-day arthropods they appear as a unified, bilobed cephalic enlargement of the young embryo (figs. 8, 13, 16 A, B, C, 22 C, D, *Prc*). The brain at this stage was a syncerebrum, consisting of the archicerebrum and optic lobes fused with the ganglia of the preantennal and antennal segments, the two lateral nerve masses being united above the stomodaeum (fig. 15 B). The third postoral segment was probably more or less closely associated with the second, but, judging from embryonic evidence (fig. 8 D), it did not at first form an integral part of the protocephalon. Its ganglia (later the tritocerebral lobes of the brain) at this stage constituted the first ganglia of the ventral nerve cord.

There can be no question that the arthropods are to be divided into two principal groups, one represented by the modern mandibulate forms, the other by those in which the appendages of the fourth segment retained the more generalized structure of the pedipalps of modern arachnids and xiphosurans. The separation of the two groups must have taken place in the protocephalon stage, for, as will later be shown, the unity of structure in the mandibles of all the mandibulate forms is such as to leave no doubt that the mandible is a common inheritance from a primitive mandibulate ancestor. But, before the definitive gnathal segments were added to the head, it would seem that the postantennal, or tritocerebral, appendages must have assumed the principal gnathal function by means of basal endites that served as masticatory lobes. In the xiphosurans and arachnids, these appendages have become the chelicerae, if modern embryology is rightly interpreted; in the crustaceans they lost their gnathal function and were developed into the second antennae; in the land-inhabiting

myriapods and insects they have become reduced to rudiments, or to embryonic vestiges.

Insects were thoroughly modern in the later part of the Carboniferous period, when their remains are first known from the geological records. They must have been in the course of evolution during all the preceding extent of the Paleozoic era. Scorpions are found in the Silurian rocks, eurypterids in the Ordovician. Crustaceans, as represented by trilobites and other forms, were well developed in the Cambrian. The common arthropod ancestors in the protocephalic stage, long antedating the divergence of the several modern groups, must have existed, therefore, in remote ages of Pre-Cambrian time.

THE DEFINITIVE ARTHROPOD HEAD

In all modern arthropods, at least one pair, and usually several pairs of the segmental appendages following the protocephalon are modified to form organs of feeding, and they are crowded forward toward the mouth, those of the first pair coming to lie at the sides of the mouth opening. These appendages become the "mouth parts" of insects, and in general they may be termed the *gnathal appendages*. As a consequence of the forward transposition of the gnathal appendages, the postoral, sternal parts of the protocephalic segments are reduced and in most cases practically obliterated, their places being taken by the sterna of the gnathal segments. Early in the course of evolution, therefore, the gnathal segments themselves must have had a tendency to fuse with the protocephalon to form an enlarged head region; and nearly all the arthropods show in some degree the results of this tendency toward a more extensive cephalization of the anterior segments in the formation of a composite definitive head.

The condensation of the anterior segments has resulted in the formation of a definite cephalic structure in many of the arthropod groups. Among the Crustacea, however, there is much variation in the composition of the head. In the decapods, the protocephalon alone forms a distinct though immovable head piece—it is that part attached within the anterior end of the carapace, overhung by the rostrum, that bears the eyes, the antennules, the antennae, and the labrum, and which may be easily detached from the region covered by the carapace (fig. 17 B). The segments of the mandibles, the maxillae, the maxillipeds, and the legs are united dorsally in the wall of the carapace. The jaws of the decapods, therefore, are not attached to the primitive head, and though the protocephalon and carapace may be said to constitute a "cephalothorax," there appears to be no reason

for regarding the region of the carapace formed of the gnathal segments as a part of the head, since there is no evidence that the decapod head ever included more than the protocephalon.

The generalized malacostracan crustacean, *Anaspides*, also retains the protocephalon as an independent head piece attached within the projecting anterior rim of the mandibular segment. The large mandibular segment is likewise free from the following maxillary segment, but the two maxillary segments and the first maxilliped segment are

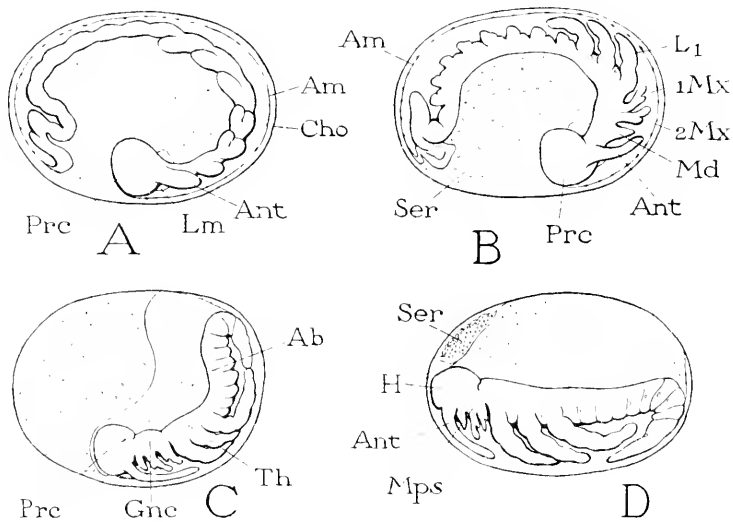

FIG. 16.—Four stages in the development of *Forficula*. (From Heymons, 1895.)

A, embryo differentiated into a protocephalic head, and a body. B, appendages of gnathal segments (*Md*, *1Mx*, *2Mx*) well developed. C, the gnathocephalic region (*Gnc*) compact, but still distinct from protocephalic region. D, protocephalic and gnathocephalic regions united in the definitive head (*H*).

Ab, abdomen; *Am*, amnion; *Ant*, antenna; *Cho*, chorion; *Gnc*, gnathocephalon; *H*, definitive head; *L1*, first leg; *Lm*, labrum; *Md*, mandible; *1Mx*, first maxilla; *2Mx*, second maxilla; *Prc*, protocephalon; *Ser*, serosa; *Th*, thorax.

fused into a composite region bearing the maxillae and the first maxillipeds.

In most of the other Crustacea, the head either is a unified cephalic structure consisting of the protocephalon and the three gnathal segments, in some forms with one or two of the maxilliped segments added, or it exhibits varying stages in the condensation of the gnathal and maxilliped segments with the protocephalon. A relatively primitive condition is shown by *Eubbranchipus* (Anostraca), in which the protocephalon itself is a distinct and well-developed head capsule (fig. 17 A, *Prc*) carrying the first and second antennae (*1Ant*, *2Ant*), the

eyes (*E*), and the labrum (*Lm*); but to it is attached the tergum of the mandibular segment (*IV*) bearing the large, jaw-like mandibles (*Md*). Following the mandibular segment, comes the region of the two maxillary segments (*I* + *II*) with the rudimentary first and second maxillae on its under surface. *Eubbranchipus* thus represents a stage in the evolution of the head almost equivalent to that in the embryonic development of insects shown in figure 16 C where the gnathal segments (*Gnc*), in process of being united with the protocephalon segments (*Prc*), still constitute a distinct body region. In *Limnadia* (Choncostraca), the structure of the head is essentially as in *Eubbranchipus*, but the gnathal segments are more intimately united with the protocephalon, and the second antennae are typical biramous appendages.

In *Apus* (Notostraca) the head is more highly evolved (fig. 17 D, E), and its lateral and posterior margins are produced into a large cephalic carapace (*Cp*). The protocephalon and the gnathal segments are united, but their respective areas are well defined dorsally (*D*). The protocephalon (*Prc*) is set off from the mandibular tergum (*IV*) by a sinuous transverse groove (*x*); on its upper surface it bears the group of head sense organs, including the compound eyes (*E*), and, on its lower surface (*E*), the antennae (*Ant*) and the labrum (*Lm*). The tergal region of the mandibular segment (*D, IV*) is distinctly limited posteriorly by a second suture (*y*) on the dorsal surface of the carapace, behind which is a narrow area representing the dorsal wall of the two maxillary segments (*I* + *II*), from the posterior edge of which is reflected the median part of the carapace. Back of the head, and partly covered by the carapace, is the long, flexible body of forty or more segments. Here is a condition quite different, therefore, from that of the decapods (fig. 17 B, C), in which latter the protocephalon has retained its individuality, while the gnathal segments have united with those of the maxillipeds and the ambulatory limbs to form the region of the carapace (*C, Cp*).

In the Amphipoda and the Isopoda, the head consists of the protocephalon, the three gnathal segments, and one or two of the maxilliped segments. In these groups, however, the head segments are fused into a cranium-like capsule (figs. 17 F, H, 28 A), in which little or no trace of the original head segmentation is to be discovered. In form and general appearance, the amphipod head (fig. 17 H) often curiously suggests the head of an insect, but both the amphipod and the isopod cranium appears to contain at least one more segment than is known to be included in either the insect or the myriapod head.

The head in the Chilopoda (fig. 17 G), Diplopoda (K), and Hexapoda (I), is a highly evolved cranial capsule composed of the protoce-

phalon and the gnathal segments, but so thoroughly fused are all the cephalic elements that the segmental composition of the head is no longer discernible in the head wall. The insect head is a well-standardized structure, which, though varying greatly with regard to form, is the same in fundamental construction throughout all the insect orders. The myriapod head, likewise, exhibits no modifications in its basic structure, and, from a study of the head alone, it is impossible to judge whether the cephalic structures of the myriapods and of the insects has had a common origin, or whether in each group the head has been evolved along a separate line of development. Considering the differences in the head appendages, and especially in the mandibles, as will be shown later, it appears probable, however, that the myriapods and insects are not as closely related as the form of the head might otherwise suggest. The insect head resembles also the head of the amphipods and isopods, as already pointed out, but it can be shown that the evolution of the head appendages has run parallel in the insects and the crustaceans, and here again, therefore, we must conclude that the similarities in the head structure are only equal results of the primary tendency toward a condensation of the gnathal segments with the protocephalon, in consequence of the drafting of the appendages of these segments into the service of the mouth.

Considering all the evidence, especially that which will be adduced from a study of the mandibles, it seems most probable that the several principal arthropod groups represent independent lines of descent from ancestors differentiated at an early stage in the evolution of the composite head structure. The early development of the thorax in the insect embryo, before the gnathal segments are added to the head (fig. 13), is evidence that the insects formed a distinct arthropod group long before the completion of the definitive head, unless the differentiation of the thorax in the young insect embryo is to be regarded as a precocious embryonic development, comparable with the early development of the head in the vertebrate embryo. It is scarcely necessary, however, to postulate, as suggested by Walton (1927), a separate origin of the insects from annelids.

In the Arachnida, the protocephalon constitutes a distinct head at an early embryonic period, but, as shown in Balfour's illustration (fig. 22 C, *Prc*), it does not include at this stage the tritocerebral segment (*III*) in its composition. At a later stage, however, the tritocerebral segment and the five following segments are usually added to the protocephalon to form a cephalothorax (fig. 17 J, *Cth*). The appendages of the cephalothorax of an adult arachnid are the chelicerae

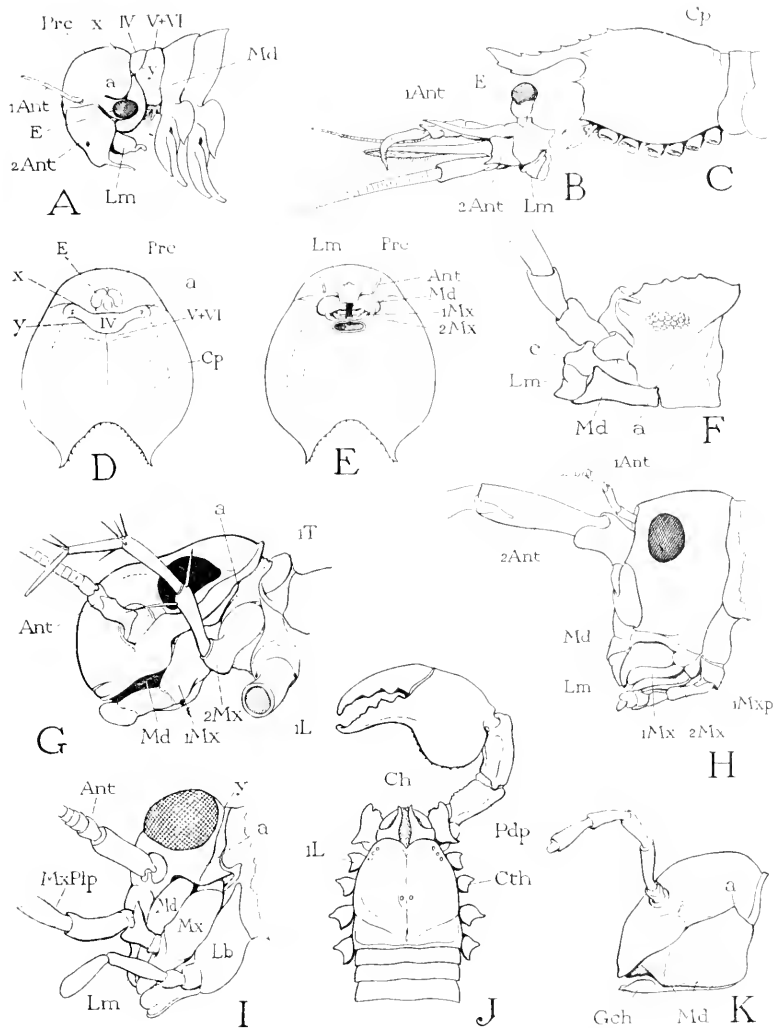

FIG. 17.—Head or head region of various arthropods.

A, head and anterior body region of *Eubranchipus vernalis* (Phyllopoda, Anostraca), with gnathal segments (*II*, *I*, *VI*) distinct from protocephalon. B, protocephalic head piece of *Spirontocaris polaris* (Decapoda) separated from the carapace. C, carapace of *Spirontocaris polaris* from which the protocephalon (B) has been detached. D, head and head carapace of *Apus longicaudata* (Phyllopoda, Concostraca), dorsal view, showing segments *IV*, *V*, *VI* added to protocephalon (*Pre*) and forming carapace. E, ventral view of same. F, head of *Porcellio* (Isopoda) with maxillae removed. G, head of *Scutigera forceps* (Chilopoda). H, head of *Orchestoidea californica* (Amphipoda). I, head of *Machilis* (apterygote insect). J, cephalothorax and anterior abdominal segments of a scorpion (Arachnida). K, head of *Euryurus erythrohygus* (Diplopoda).

a, dorsal (or posterior) articulation of mandible; *Ant*, antenna; *1Ant*, first antenna; *2Ant*, second antenna; *c*, anterior articulation of mandible; *Ch*, chelicera; *Cp*, carapace; *Cth*, cephalothorax; *E*, compound eye; *Gch*, gnathochilarium; *II*, mandibular segment; *iL*, first leg; *Lm*, labrum; *Md*, mandible; *iMx*, first maxilla; *2Mx*, second maxilla; *iMxp*, first maxilliped; *MxPlp*, maxillary palpus; *Pdp*, pedipalp; *Pre*, protocephalon; *iT*, first tergum; *V*, first maxillary segment; *VI*, second maxillary segment; *x*, suture between protocephalon and mandibular segment; *y*, suture between mandibular and first maxillary segments.

(*Ch*), or tritocerebral appendages, the pedipalps (*Pdp*), which are the mandibular appendages of other groups, and four pairs of legs (*L*), which are represented by the two maxillae and the first two pairs of maxillipeds in the Crustacea. Antennae are lacking in all adult arachnids, but some writers (Croneberg, 1880, Jaworowski, 1891) have reported the presence of antennal rudiments in the embryos of certain species (fig. 22 B, *Ant*). The comparative lack of specialization in the arachnid limbs suggests that the Arachnida are an ancient group of arthropods having little direct relationship to other forms, except to the Niphosura and possibly to the extinct eurypterids. In the Solpugida, the cephalothoracic region is divided into an anterior cephalic part carrying the eyes, the mouth, the chelicerae, the pedipalps, and the first pair of legs, and into a posterior thoracic part carrying the second, third, and fourth pairs of legs. The division between these two body parts, as compared with insects, falls between the first and second maxillary segments, and the parts, therefore, are in no way comparable with the insect head and thorax. In the ticks (Ixodoidea), the head-like structure known as the capitulum is said to bear only the chelicerae and the pedipalps. In its composition it is thus equivalent to the protocephalon with only the first gnathal segment added.

Cephalization in the Arthropoda, then, apparently has progressed from the prostomial stage (archicephalon) to the formation of a protocephalon, from a protocephalon to the usual definitive head, or telocephalon, and finally to the union of head and body regions in a cephalothorax. The archicephalic stage is to be inferred from the evident derivation of the arthropods from an annelid-like ancestor having the prostomium as the only defined head. The protocephalic stage is shown in the development of all arthropod embryos, and is retained in the decapods and related crustaceans, where the carapace is a gnatho-thoracic structure. The telocephalic stage exhibits a progressive evolution in phyllopods, amphipods, and isopods by the addition of one, two and three, four or five segments to the protocephalon; in insects and myriapods it has reached a standardized condition in which the head is composed of six segments and the prostomium. The cephalothoracic stage is characteristic of the Niphosura and Arachnida, in which the segments of all the fully developed appendages are united, and combined with the prostomium.

A study of the head alone does not furnish a sufficient basis for a discussion of the inter-relationships of the various arthropod groups, but it must be recognized that the facts here given, and others to be described in this paper have an important bearing on the subject.

and that their significance has not been fully taken into account by those who have formulated theories of arthropod relationships and descent.

II. GENERAL STRUCTURE OF THE INSECT HEAD

The almost complete suppression of the primitive intersegmental lines in the insect head makes a study of the head segmentation in insects a difficult matter, and investigators differ widely in their views as to the parts of the adult head that have been derived from the several head segments. Since the prostomial region and the three segments of the protocephalon are never distinct, even in the earliest embryonic stages, it seems fruitless to speculate as to what areas of the adult cranium are to be attributed to them individually, but the general protocephalic region must be at least the region of the clypeus and frons, the compound eyes, and the antennae. In as much as the muscles of the three pairs of gnathal appendages have their origins in the posterior parts of the head, it is reasonable to assume that the areas upon which these muscles arise represent the walls of the gnathal segments that have been added to the protocephalon.

According to Heymons (1895), who bases his conclusions on a study of the embryonic development of the head in *Periplancta* and *Anisolabis*, the entire cranium except the frons and the region of the compound eyes and the antennae is formed from the walls of the mandibular, maxillary, and labial segments. Janet (1899), taking the attachments of the muscles of the appendages on the head walls as criteria of the respective segmental limits, maps the cranium into areas that closely correspond with the segmental regions claimed by Heymons. From Riley (1904), on the other hand, we get a quite different conception of the definitive head structure. According to Riley's account of the development of the head of *Blatta*, the great cephalic lobes of the embryo form most of the adult head capsule. The dorsal and lateral walls of the gnathal segments, Riley says, are so reduced by the posterior growth of the cephalic lobes that little remains of them in the adult head—only the extreme posterior and postero-lateral parts of the cranial walls, and the postoral ventral region being referable to them. This view must assume that the muscles of the gnathal segments have moved forward to the protocephalic region as their own segments became reduced, and it would nullify the evidence of head segmentation based on muscle attachments. The writer is inclined to agree with Heymons and Janet that the muscle attachments on the lateral and dorsal walls of the cranium should be pretty closely indicative of the limits of the gnathal terga in the composition

of the head, but it must be admitted that muscle bases can undergo rather extensive migrations. That the gnathal segments contribute a considerable part to the cranial walls of the definitive insect head is clearly suggested by Heymons' figures of the development of Forficula (fig. 16), and, as already shown, there can be no doubt that these segments enter bodily into the head composition of Crustacea that have a well-defined composite head. With insects, it is a question of the degree of reduction that the gnathal segments have suffered after their union with the protocephalon.

By whatever phylogenetic course the cephalic region of the insect body has arrived at its definitive state, it acquired long ago a cranium-like form, and a definite structure that has since been modified only in superficial characters, adaptive to different modes of living and to different ways of feeding in the various groups of modern insects.

THE HEAD CAPSULE

The chitinous walls of the definitive head capsule constitute the *epicranium*. In an adult insect head preserving the typical embryonic position, with the facial aspect directed forward (fig. 18 B), the mouth parts are suspended from the ventro-lateral edges of the epicranium. A pair of *compound eyes* (*E*) typically have a lateral or dorso-lateral position, and three ocelli (*O*) occur between them on the dorsal or facial area of the head (*A*). The antennae (*Ant*) vary in their location from positions just above the bases of the mandibles (fig. 50 A, *Ant*) to a more median site on the dorsal part of the face (fig. 18 A, B). The top of the head, or *vertex* (fig. 18 A, B, *Vx*), is marked by a median *coronal suture* (*A, cs*) that turns downward on the face and divides into the *frontal sutures* (*fs*), which diverge ventrally to the anterior articulations of the mandibles (*c*). The coronal suture and the frontal sutures together constitute the *epicranial suture*. The lines of these sutures are marked internally by ridges, and the coronal ridge is sometimes developed into a plate supporting muscle attachments. The median facial region between and below the frontal sutures is the *frons* (*Fr*), ventral to which is the *clypeus* (*Clp*), with the *labrum* (*Lm*) suspended from the lower margin of the latter.

The posterior surface of the epicranium (fig. 18 C) is occupied by the opening (*For*) from the head cavity into the neck, usually a large aperture, properly termed the *foramen magnum* by analogy with vertebrate anatomy, but commonly called the "occipital foramen" by entomologists. The surface of the head surrounding the foramen

dorsally and laterally is the occipital area. Its anterior limit is defined in orthopteroid insects by the occipital suture (*ocs*). The occipital area is subdivided by a suture lying close to its posterior margin,

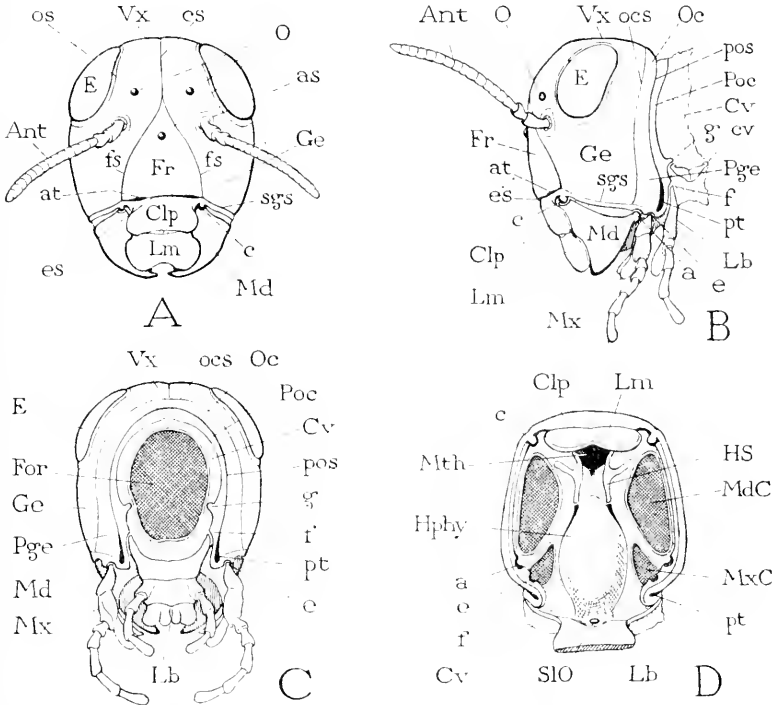

FIG. 18.—Generalized structure of the head of an adult pterygote insect, diagrammatic.

A, anterior view. B, lateral. C, posterior. D, ventral.
a, posterior articulation of mandible; *Ant*, antenna; *as*, antennal suture; *at*, anterior tentorial pit; *c*, anterior articulation of mandible with cranium; *Clp*, clypeus; *cs*, coronal suture; *Cv*, neck (cervix); *cv*, cervical sclerite; *E*, compound eye; *e*, articulation of maxilla with postgenal margin of cranium; *f*, articulation of labium with postoccipital rim (*Poc*) of epicranium; *For*, foramen magnum; *Fr*, frons; *fs*, frontal suture; *g*, postoccipital condyle for articulation of first cervical sclerite with head; *Ge*, gena; *Hphy*, hypopharynx; *HS*, suspensorium of hypopharynx; *Lb*, labium; *Lm*, labrum; *Md*, mandible; *MdC*, opening in head wall where mandible removed; *Mth*, mouth; *Mx*, maxilla; *MxC*, opening in head wall where maxilla removed; *O*, ocelli; *Oc*, occiput; *os*, ocular suture; *ocs*, occipital suture; *Pgc*, postgena; *Poc*, postocciput; *pos*, postoccipital suture; *pt*, posterior tentorial pit; *sgs*, subgenal suture; *SIO*, orifice of salivary duct; *Vr*, vertex.

here named the *postoccipital suture* (fig. 18 B, C, *pos*), which sets off a narrow marginal rim of the cranium, or *postocciput* (*Poc*), to which the neck membrane is directly attached. The postoccipital suture, though sometimes inconspicuous by reason of the reduction of the

postoccipital rim, is the most constant suture of the cranium. The dorsal part of the occipital area before it is termed the *occiput* (*Oc*), and the lateral ventral parts the *postgenae* (*Pgc*). Rarely the occiput and the postgenae are separated, as in *Melanoplus*, by a short suture on each side.

The lateral areas of the cranium, between the occipital suture and the frontal sutures, and separated dorsally by the coronal suture, have been appropriately termed by Crampton (1921) the *parictals*. The parietal area behind and below the compound eye is the *gena* (fig. 18 B, *Gc*), that between the eyes is the vertex. The lower marginal area of each lateral wall of the head is commonly marked by a submarginal suture (fig. 18 A, B, *sgs*), which forms an internal ridge strengthening the ventral lateral edge of the cranium (fig. 39 A, *SgR*). The suture has been termed the "mando-genal" suture (Yuasa, 1920, MacGillivray, 1923), but, for grammatical reasons, the writer would substitute the term *subgenal suture*, and call the corresponding ridge the *subgenal ridge*. The ridge is sometimes known as the "pleurostoma." When an epistomal ridge separates the clypeus from the frons, it unites the anterior ends of the subgenal ridges.

The true ventral wall of the head is the region between the bases of the mouth parts (fig. 18 D), the median area of which is produced into the variously modified lobe known as the *hypopharynx* (*Hphy*). Anterior to the base of the hypopharynx, and immediately behind the posterior, or epipharyngeal, surface of the labrum and clypeus is the *mouth* (*Mth*). The space inclosed by the labrum and the mouth parts is often called the "mouth cavity," but, since it lies entirely outside the body, it is more properly a *preoral cavity*.

The frons, clypeus, and labrum belong to the prostomial region of the head. The frons and clypeus are not always distinct, but when they are separated, the dividing fronto-clypeal groove, or *epistomal suture* (fig. 18 A, B, *es*), extends typically between the bases of the mandibles. That the more primitive division of the prostomium, however, is that between the labrum and the clypeal area is evidenced by the fact that the labral retractor muscles always extend from the base of the labrum to the frontal area (fig. 19, 2, 3). The clypeus, on the other hand, can not be regarded as a mere articular region between the labrum and the frons, secondarily developed into a chitinous plate, as some writers have suggested, because the most anterior of the dilator muscles of the stomodeum have their origins upon its inner surface (fig. 41, 33, 34). The external suture separating the clypeus from the frons appears to be incidental to the development of an internal *epistomal ridge* (fig. 39 A, B, C, *ER*) forming a brace be-

tween the anterior articulations of the mandibles. The typical position of the fronto-clypeal suture is on a line between the mandibular bases passing through the roots of the anterior arms of the tentorium; but the suture and its ridge are often arched upward, as in the Hymenoptera, Psocidae, and Homoptera (fig. 46 E, F, G, H), or bent dorsally in an acute angle, as in the caterpillars (fig. 50 A). The fronto-clypeal suture is to be identified by the origin of the anterior arms of the tentorium from its internal ridge; the frontal region above it is marked by the attachments of the labral retractor muscles, and the clypeal region below is distinguished by the origins of the first anterior stomodeal muscles on its inner surface. The value of these characters will be illustrated in succeeding parts of this paper. The clypeus may be secondarily divided into an *anteclypeus* and a *postclypeus*, the latter sometimes attaining a special development, as in Homoptera.

If the prostomial region of the adult head embraces only the labrum, clypeus, and frons, the frontal sutures must separate the prostomial area from the area derived from the segmental elements of the head, as maintained by Riley (1904); but, if the compound eyes and the optic lobes of the brain had also a prostomial origin, as claimed by Heymons (1895, 1901), then an area between and including the compound eyes must be regarded as a part of the general prostomial region. Following Heymons' interpretation, Berlese (1909) recognizes a "postfrons" embracing the ocular region, and a "prefrons," which is the ordinary frontal sclerite. Whatever the facts of the case may be, it will be most convenient to retain the name "frons" for the latter sclerite. In general, the frontal sutures mark the lines of cleavage in the facial cuticula at the time of a molt, but there are exceptions to this rule, for the cuticular splits, when extended from the end of the coronal suture, may diverge to the sides of the frons, and may even extend laterad of the bases of the antennae, as in Odonata (fig. 46 I).

The frontal sutures are often obscured or are lacking, and the frons then becomes confluent with the lateral epicranial walls. The anterior median ocellus, when present, is located upon the frons, or on the frontal region; the paired ocelli usually lie above or posterior to the upper ends of the frontal sutures, though in some cases they appear to be in the sutures. The antennae are usually situated on the facial aspect of the head, but they never truly arise upon the frons. In post-embryonic stages, the antennae occupy positions varying from points just above the mandibles, as in caterpillars, to points laterad of the upper end of the frons; they sometimes lie against the frontal

sutures, and by an approximation of their bases, they may constrict the frons between them. The reversed relative position of the antennae and the compound eyes, as between embryonic and adult stages, comes about through the posterior revolution of the ocular region and the forward migration of the antennae. The antennal socket is generally strengthened by an internal circular ridge on the cranial wall surrounding it (fig. 39 A, *AR*), and the compound eye is likewise encircled by an inflection of the cuticula close to its base (*OR*). These ridges and their external sutures set off the so-called ocular and antennal sclerites (fig. 18 A, B).

The posterior, or occipital, surface of the epicranium (fig. 18 C) is usually but a narrow area surrounding the foramen magnum (*For*) dorsally and laterally, the foramen being normally completed ventrally by the base of the labium (*Lb*), or by the neck membrane in which the labium is suspended. When the foramen is small, however, the occipital area often becomes a wide transverse surface on the back of the head, and its ventral, or postgenal, parts may form median processes that sometimes unite into a bridge beneath the foramen, in which case the latter becomes entirely surrounded by chitinous walls (fig. 48 B, C). The occipital suture (fig. 18 B, C, *ocs*), when present, is generally located about where the dorsal and lateral areas of the head wall are reflected upon the posterior surface. It does not seem probable that the occipital suture is a primitive intersegmental line of the head, for, though it lies approximately between the mandibular and maxillary regions, it does not consistently separate the bases of the mandibular and maxillary muscles, and the posterior articulation of the mandible is with the postgena *posterior* to the lower end of the suture (fig. 18 B, *a*). As is the case with most of the skeletal grooves, it is probable that the occipital suture has no significance in itself, and that it is merely incidental to its corresponding internal ridge, which strengthens the posterior part of the cranium along the line where the dorsal and lateral areas are reflected into the posterior surface.

In the Machilidae the posterior part of the epicranium is crossed by a prominent suture lying close behind the eyes dorsally (fig. 17 I, *y*) and extending downward on each side of the head to a point on the lateral margin of the cranium between the base of the mandible (*Md*) and the base of the maxilla (*Mr*). This suture, therefore, appears to separate the region of the mandibular segment from that of the maxillary segment in the cranial wall, and if it does so, it may be the homologue of the mandibulo-maxillary suture in the phyllopod crustaceans (fig. 17 A, D, *y*), and of the corresponding suture in the more generalized malacostracan forms, such as *Anaspides*. Crampton

(1928a) has called the mandibulo-maxillary suture the "archicephalic" suture, since he calls the region before it the "archicephalon," but the term thus applied denotes too much antiquity for a stage that is clearly subsequent to several others in the head evolution. A similarly-placed suture is present in the head of *Japyx* (fig. 30 B, *PcR*), but the relation of the suture here to the bases of the head appendages can not be determined. The occipital suture of the pterygote insect head, ending laterally *before* the posterior mandibular articulations, therefore, is probably not the mandibulo-maxillary suture of the simpler crustaceans, or the homologue of the posterior suture in the head of *Machilis*.

The postoccipital suture (fig. 18 B, C, *pos*) is a most important landmark of the head because it is invariably present, and because of its constant anatomical relations to other parts. The posterior tentorial pits (*pt*) are always located in its lower ends, and if the pits migrate in position, as in some of the Coleoptera and other insects, the lower ends of the suture are correspondingly lengthened (fig. 49 C, *pt*, *pt*). Frequently the suture is inconspicuous by reason of its closeness to the margin of the cranium, and for this reason, probably, it has not been given sufficient attention by entomologists. Comstock and Kochi (1902) believed that the suture is the groove between the pleurites of the maxillary segment; but Riley (1904) claimed, from a study of the developing head of *Blatta*, that the suture is the intersegmental groove between the maxillary and the labial segments, and that the postoccipital sclerite is a remnant of the wall of the labial segment, which segment is otherwise obliterated or represented in the anterior part of the neck membrane. This view is at least in harmony with certain anatomical relations in the adult head, and is tentatively adopted in this paper.

Internally, the postoccipital suture forms a postoccipital ridge (fig. 39 A, *PoR*) just within the foramen magnum, and upon this ridge are attached the anterior ends of the dorsal muscles of the prothorax (figs. 45 A, 57 A, B, C). The ridge, therefore, must be a primary intersegmental fold corresponding with the ridges or phragmata supporting the longitudinal muscles in the thorax and abdomen. If it does not represent the fold between the maxillary and labial segments, it should be that between the labial segment and the prothorax. If the first possibility is true, as claimed by Riley, there is an intersegmental line lost somewhere in the neck, and the muscles going from the first phragma of the thorax to the postoccipital ridge of the head must be regarded as extending through the region of two primary segments. If, on the other hand, the posterior ridge of the head is the

intersegmental fold between the labial and the prothoracic segments, the muscles in the neck are all muscles of the prothorax, and the neck itself is prothoracic. It is evident that much morphological significance hinges on this problem. The neck sclerites, for example, in the first case, might belong either to the labial segment or to the prothorax, or to both; in the second case, they could pertain only to the prothorax. The relation of the posterior arms of the tentorium to the postoccipital suture and ridge will be noted under the special description of the tentorium (page 50).

The labrum, the appendages of the gnathal segments, and the hypopharynx constitute the *mouath parts* of insects. The gnathal appendages are the mandibles, the first maxillae, and the second maxillae, which last are united in insects to form a labium. The morphology of these appendages will be discussed in a later section (pages 79-90), but it is important here to understand their relations to the cranial wall. The mandible in biting pterygote insects is typically suspended from the lower edge of the gena and postgena, and swings outward and inward on a longitudinal axis between anterior and posterior articulations with the head wall. The anterior articulation is with a condyle at the contingent angles of the gena and clypeus (fig. 18 A, B, D, *c*), the posterior with a shallow facet on the lower margin of the postgena (B, D, *a*).

The maxilla hangs from the lower edge of the postgena, upon which it is freely movable by a single articular point just before the lower end of the postoccipital suture (fig. 18 B, D, *e*). The labium, in generalized insects, is suspended from the neck membrane, but each lateral angle of its transverse base is closely attached to the postoccipital rim of the head (B, C, D, *f*). The positions of the maxillary and labial articulations relative to the postoccipital suture (*pos*) are in harmony with the idea that this suture is the intersegmental groove between the maxillary and the labial segments. In some insects, the labium is shifted forward between the ventral edges of the postgenae, and thus becomes removed from its primitive position. In such cases, as in caterpillars (fig. 53 A) and adult Hymenoptera (fig. 48 B, C), the ventral angles of the postgenae may approach each other medially, or even unite into a ventral bridge (hypostoma) behind the labium. In other insects, in which the posterior part of the head is lengthened, the base of the labium is elongated between the postgenae, forming the plate known as the *gula*. These modifications, however, will be discussed more fully in section VI of this paper.

The head is attached to the thorax by a cylindrical, membranous neck, or *cervix* (fig. 18 B, *c'*). In each lateral wall of the neck there

is typically a pair of lateral neck plates, or cervical sclerites, hinged to each other. The first is articulated anteriorly to a small process, the *odontoidca* (Yuasa, 1920), or the *occipital condyle* (Crampton, 1921), on the rear margin of the postoccipital rim of the head (B, C, *g*) just above the base of the labium. The posterior neck plate articulates with the anterior margin of the prothoracic episternum. Other cervical sclerites of less constant form are sometimes present in the ventral wall of the neck, and occasionally there are chitinizations also in the dorsal wall. The lateral neck sclerites are important elements in the mechanism for moving the head on the thorax. Upon them are inserted muscles from the postoccipital ridge of the head, and from the inner surface of the prothoracic tergum (fig. 45 A, B).

The uncertainty of the morphology of the insect neck, and consequently of the neck skeleton, furnishes a problem still to be solved. As already pointed out, the status of the neck and of its sclerites will depend upon that of the postoccipital rim of the head: if the latter is an anterior remnant of the labial segment, the neck sclerites may belong to the labial segment, or also to the prothorax; if, however, the postoccipital ridge of the head, upon which the anterior ends of the dorsal prothoracic muscles are attached, is the infolding between the head and the prothorax, then the neck can only be a part of the prothorax. The second assumption looks improbable in view of the position of the labial articulations in generalized insects (fig. 18 B *f*).

THE LABRUM AND EPIPHARYNX

The labrum is a characteristic feature of the arthropod head, and probably corresponds with the tip of the annelid prostomium. In the embryo (figs. 8 D, 13, 22 A, D, *Lm*), it appears at an early stage as a median ventral lobe of the prostomial region, lying just before the point where the stomodeal invagination will be formed. In the mature head the mouth opening (figs. 18 D, 19, *Mth*) is immediately behind the base of the labrum (*Lm*), and the posterior, or epipharyngeal, surface of the latter is continued directly into the dorsal wall of the pharynx (fig. 19, *Phy*). The adult labrum takes on various forms in different insects, but it is typically a broad flap freely suspended from the lower edge of the clypeus (fig. 18 A, *Lm*). When movable, the labrum is provided with muscles inserted on its base, having their origin on the inner surface of the frons. Typically, there are two pairs of these muscles, one pair (fig. 19, 2) inserted anteriorly on the labral base, the other (3) posteriorly on the chitinous bars of the inner face of the labrum known as the tormae (figs. 37 B, 42 A).

The points of origin of the labral muscles serve to identify the frontal sclerite, or the true frontal region when the frontal sutures are lacking. Frequently there is only one pair of labral muscles (fig. 50 E, G), and when the labrum is immovable on the clypeus, both pairs are lacking. The labro-frontal muscles are to be regarded as median muscles of the prostomium. On the posterior surface of the labrum there is often a median lobe, the *epipharynx* (fig. 19 *Ephy*), that fits between the bases of the closed mandibles, and obstructs the entrance to the mouth (*Mth*) when the labrum is closed upon the hypopharynx.

THE STOMODEUM

In the embryonic development of arthropods, the endodermal part of the alimentary canal, which becomes the true stomach, is formed within the body and has at first no opening to the exterior. The anterior and the posterior ectodermal parts, or *stomodeum* and *proctodeum*, of the definitive alimentary tube are ingrowths of the ectoderm at the two extremities of the blastopore. Their inner ends abut against the ends of the endodermal sac, and their final union with the latter takes place by an absorption of the adjacent walls. In some insects the proctodeum does not open into the ventriculus until the end of the larval stage.

If the ontogenetic development of the alimentary canal is to be translated literally into phylogenetic evolution, we should have to believe that the arthropod stomach was once a closed sac, and that the stomodeum and proctodeum are secondary means of communication with it. But, if insects have had a continuous line of free-living ancestors, this seems unlikely, and it is more probable that, in their actual history, the stomodeum and the proctodeum have been formed as open invagination of the primitive circumoral and circumanal regions, and that the discontinuous development of the three parts of the alimentary canal in ontogeny is an adaptation to embryonic or larval conditions.

It has been proposed by Janet (1899, 1911) that the stomodeum consists of the walls of three primitive segments that once formed the true anterior end of the body, but which have been inverted, as the primitive mouth, now the orifice from the stomodeum into the stomach, was retracted. This theory would give a plausible explanation of the presence of the stomodeal ganglia, but it must assume that these ganglia have been formed from paired ventral rudiments which have migrated dorsally and fused on the upper surface of the stomodeum. The known origin of these ganglia from the epithelium of the dorsal

wall of the stomodeum, however, is direct evidence that they do not belong to the system of the ventral nerve cord.

The stomodeum (fig. 19) is usually differentiated into several parts in the mature insect, which may include a *buccal cavity* (*BuC*), a *pharynx* (*Phy*), an *oesophagus* (*OE*), a *crop* (*Cr*), and a *proventriculus* (*Pvent*). The entire length of the tube, except the extreme anterior end, is surrounded by circular and longitudinal muscles. In general the circular muscles form an external layer, the longitudinals an internal layer, but the arrangement and relative development of

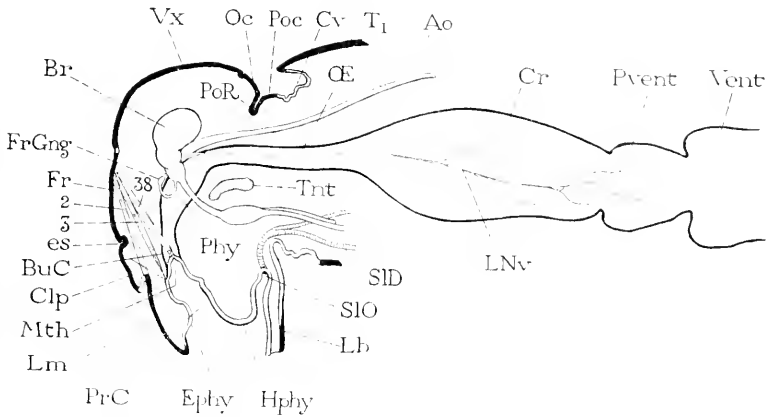

FIG. 19.—The stomodeum of an insect, and its relation to associated organs in the head, diagrammatic.

Ao, aorta; *Br*, brain; *BuC*, buccal cavity; *Clp*, clypeus; *Cr*, crop; *Ephy*, epipharynx; *es*, epistomal suture; *Fr*, frons; *FrGng*, frontal ganglion; *Hphy*, hypopharynx; *Lb*, labium; *Lm*, labrum; *LNv*, lateral stomodeal nerve; *Mth*, mouth; *Oc*, occiput; *OE*, oesophagus; *Phy*, pharynx; *Poc*, Postocciput; *PoR*, postoccipital ridge; *PrC*, preoral cavity; *Pvent*, proventriculus; *SID*, salivary duct; *SIO*, orifice of salivary duct; *T1*, tergum of prothorax; *Tnt*, body of tentorium; *Vent*, ventriculus; *Vx*, vertex; 2, anterior labral muscle; 3, posterior labral muscle; 38, retractor muscle of the mouth angle.

the two layers varies much in different insects, as will be illustrated in the grasshopper and the caterpillar (pages 115 and 145). The buccal cavity, the pharynx, the oesophagus, and the crop are provided with dilator, or "suspensory" muscles arising on the walls of the head, on the tentorium, and on the walls of the thorax (figs. 41, 44, 55).

The parts of the stomodeum can not be concisely defined, because they are functional adaptations of structure varying in different insects, rather than strictly morphological regions of the stomodeal tube. The buccal cavity is the anterior, or ventral, end of the stomodeum, including the region of the mouth opening (fig. 19, *BuC*). The dilator muscles of the stomodeum that have their insertion on the dorsal wall

of the buccal cavity arise upon the clypeus, and this relation between the region of the buccal cavity and the clypeus appears to be a constant one. In the cicada, the sucking pump is a mouth structure quite distinct from the true pharynx, and the origin of its dilator muscles upon the large striated facial sclerite of the head wall helps to identify this plate as the clypeus (fig. 46 H, *Clp*). In many insects, however, there is no structural distinction between the region of the buccal cavity and that of the pharynx. The retractor muscles of the mouth angles (fig. 19, 38) have their origin on the inner surface of the frons, and their points of attachment give another character, in addition to that furnished by the labral muscles, for the determination of the frons when the limits of this sclerite are obscured, or the identity of the plate otherwise doubtful. The mouth retractors are inserted upon chitinous processes that extend into the stomodeal walls at the mouth angles from the suspensorial rods of the hypopharynx (fig. 42 B, *y*). Usually these processes are short and inconspicuous, but in the bees they form long arms united at their bases in a chitinous plate in the floor of the buccal cavity.

The region of the pharynx is usually marked by a dilation of the stomodeum, and sometimes it forms an abrupt enlargement of the tube. The frontal ganglion is situated on its dorsal wall (fig. 19, *FrGng*), and the circumoesophageal connectives lie at its sides. The dorsal dilator muscles of the pharynx have their origin on the frons, on the parietals, on the dorsal arms of the tentorium, and rarely one or two pairs may encroach on the area of the clypeus (caterpillars). The pharynx of the Orthoptera is divided into an "anterior pharynx" and a "posterior pharynx" (Eidmann, 1925), but the part called the posterior pharynx, the dorsal dilator muscles of which arise on the posterior dorsal walls of the head, appears to correspond with the oesophageal region in some other insects.

The oesophagus, when there is a distinct oesophageal region, is a narrow tubular part of the stomodeum following the pharynx (fig. 19, *OE*), and varies much in length in different insects. Its posterior end enlarges into the crop (*Cr*), or the crop is sometimes a lateral diverticulum. The terminal part of the stomodeum in biting insects is usually a well-defined proventriculus (*Prvent*). The chitinous intima of all parts of the stomodeum may be provided with short hairs, spicules, or chitinous nodules, but the inner cuticular structures are best developed in the proventriculus, where they generally have the form of longitudinal ridges or plates, with deep grooves between them.

According to the views of the earlier students of the digestive organs of insects, the proventriculus constituted a gizzard; its inner chitinous fold, and its sheath of strong muscle fibers, it was pointed out, must serve to break up the larger or harder pieces of the food material not sufficiently crushed by the jaws. Experimental evidence of this function, however, is lacking, and Plateau (1874, 1876) argued that the proventriculus is merely an apparatus for passing the food from the crop into the stomach. More recently, Ramme (1913) has shown that the proventriculus, in Orthoptera and Coleoptera at least, has another important function in that the furrows between its chitinous ridges serve to conduct the digestive secretions of the ventriculus into the crop, where they attack the food material in advance of its entrance into the stomach. The channels between the proventricular folds, then, rather than the folds themselves, are to be regarded as having the primary functional importance. Otherwise, the proventriculus serves to conduct the food mass into the ventriculus. In *Dytiscus*, according to Ramme, the armature of the proventriculus retains the indigestible parts of the food, which are later ejected from the mouth; but in Orthoptera all the food matter passes through the alimentary canal.

THE HYPOPHARYNX

When the gnathal segments are added to the protocephalon during embryonic growth, their sternal parts lose their identities in the general postoral ventral wall of the definitive head. On this region there is developed a median lobe between the bases of the mouth parts known as the *hypopharynx* (fig. 18 D, *Hphy*). The name is poorly chosen, because the organ in question lies on an exterior surface of the head entirely outside the pharynx, but it is a heritage of earlier days in entomology and is now well established in entomological terminology.

There is a difference of opinion among embryologists as to how many of the gnathal sterna contribute to the formation of the hypopharynx. According to Heymons (1901), the hypopharynx is formed in insects on the sternal region of the mandibular and first maxillary segments, but in the chilopods it arises on the mandibular segment alone. The fusion of the bases of the second maxillae in insects, and the similar union of both pairs of maxillary appendages in the chilopods gives reasons for this view, but, as will be shown presently, the primitive adductor muscles of all the gnathal appendages have their origin on the hypopharyngeal region in the chilopods and in the apterygote insects—a condition which indicates that at least some part

of each gnathal sternum enters into the hypopharyngeal region. Riley (1904) describes the hypopharynx of *Blatella germanica* as formed in the embryo from the sterna of the mandibular, first maxillary, and second maxillary segments.

In the more generalized pterygote insects, the hypopharynx hangs like a tongue in the preoral cavity (fig. 19, *Hphy*) behind the mouth (*Mth*), shut in anteriorly by the labrum, laterally by the mandibles and maxillae, and posteriorly by the labium. Its base generally extends posteriorly to the labium (figs. 18 D, 19), and in the groove between

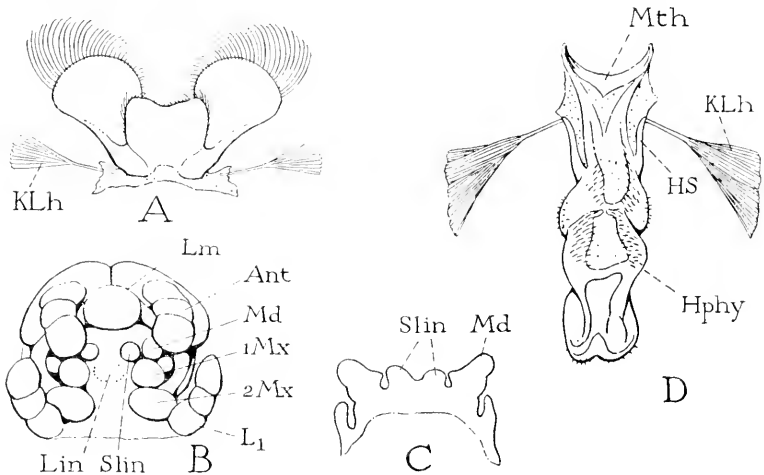

FIG. 20.—The hypopharynx.

A, three-lobed hypopharynx of an ephemerid nymph, with ventral adductor muscles of mandibles (*KLh*) attached to its base. B, head of embryo of *Anurida maritima* (from Folsom, 1900), ventral view, showing median lingua (*Lin*) and paired superlinguae (*Slin*) that combine to form hypopharynx of adult. C, transverse section through mandibles of embryo of *Tomocerus plumbeus* (from Hoffman, 1911), showing origin of superlinguae (*Slin*) from inner angles of mandibles. D, hypopharynx of *Microcentrum rhombifolium*, ventral, with rudiments of suspensorial arms (*HS*) on which ventral mandibular adductors (*KLh*) are attached.

the two organs is situated the orifice of the salivary duct (*SLO*). In general, therefore, the salivary orifice serves as a landmark for separating the hypopharynx from the labium, or for determining the hypopharyngeal region when a specific hypopharyngeal lobe is lacking, as in the honeybee; but the opening of the salivary duct may be at the apex of the hypopharynx, as in Homoptera, or, when the hypopharynx and labium are united, as in many insect larvae (fig. 54 A, D), it may lie at the tip of the combined labio-hypopharyngeal structure.

In some insects the hypopharynx consists of a median part and of two lateral lobes. In such cases it usually projects forward like a lower

lip beneath the mouth opening. The lateral lobes are best developed in the more generalized insects, both apterygote (fig. 21 D, *Hphy*) and pterygote (fig. 20 A), and in coleopteran larvae, but possible traces of them are to be found in many of the higher orders. The occurrence of the hypopharyngeal lobes has been well reviewed by Crampton (1921a) and by Evans (1921), and those of lepidopteran larvae have been described by de Gryse (1915). The median lobe of the hypopharynx is best distinguished as the *lingua*, though some writers call it the "glossa"; the lateral lobes have been termed "paraglossae" and "maxillulae," but Folsom (1900) has given them the more distinctive name of *superlinguae*, because the lateral lobes of the labium are commonly known as the paraglossae.

The nature of the superlingual lobes of the hypopharynx has been much discussed. Hansen (1893) proposed that they represent the first maxillae, or maxillulae, of Crustacea, and Folsom (1900) believed that their identity as such was established in the discovery of what he regarded as a corresponding pair of ganglia in the embryonic head of *Anurida*. Crampton (1921a), on the other hand, argued that the superlinguae of insects must be the homologues of the paragnatha of Crustacea, and it will be shown later in this paper that the identity in the relations of each of these organs to other structures of the head can leave little doubt of the truth of Crampton's contention. The superlinguae, then, are not the first maxillae of Crustacea; but if the superlinguae represent a segment in the insect head, the paragnatha have a like significance in the crustacean head. It now appears probable, however, that neither of these organs has a segmental value, since Folsom's claim of the presence of a pair of superlingual ganglia has not been verified by subsequent research, and Hoffmann (1911) appears to have demonstrated that in the collembolan, *Tomocerus plumbeus*, the superlinguae are derived during embryonic development from the inner basal angles of the mandibles (fig. 20 C, *Slin*).

In the Chilopoda and Diplopoda there is a single median hypopharyngeal lobe forming a projecting lip below the mouth opening (fig. 21 A, B, C, *Hphy*). In the Crustacea, the paragnaths usually lie to each side of the median line, and are associated with the first maxillae, but in some forms, as in *Gammarus*, they are united on a common median base, forming a bilobed structure very similar to the hypopharynx of the apterygote insect *Japyx* (fig. 21 D).

The base of the hypopharynx is supported anteriorly, in generalized insects, by a pair of chitinous plates or bars that extend laterally at each side of the mouth, and form a suspensorial apparatus for the

hypopharynx (fig. 18 D, *HS*). The plates appear to be chitinous remnants of the mandibular sternum. They are best developed in the myriapods. In *Lithobius* (fig. 21 A), *Scolopendra* (B), and *Scutigera* (C), each plate is a large, irregular sclerite (*HS*) attached laterally to the lower margin of the head wall at a point (*d*) before the base of the mandible, and ending mesally in the side of the hypopharynx. In some chilopods a process on the anterior free part of the mandible articulates against the hypopharyngeal plate of the same side.

Attems (1926) describes the suspensorial plates of the hypopharynx in the chilopods as a mandibular support ("kommandibular Gerüst"), but the homologous sclerites and their apodemal processes in the diplopods he calls the "tentorium." The writer has not observed corresponding structures in the Crustacea. In insects the hypopharyngeal supports are variously developed, but are usually reduced, and often rudimentary. In *Machilis* (fig. 21 E, *HS*) their outer ends are broadly fused with the basal angles of the clypeus (*Clp*); in *Japyx* (D) the plates are reduced and united in a W-shaped sclerite in the base of the hypopharynx; in *Dissosteira* (fig. 42 B, C, *HS*) they are slender bars extending outward to the bases of the adductor apodemes of the mandibles; in *Microcentrum* (fig. 20 D, *HS*) they are rudimentary prongs diverging from the base of the hypopharynx. In many cases a process extends from each hypopharyngeal bar into the lateral walls of the mouth, where it supports the insertion of the retractor muscle of the mouth angle (figs. 42 B, 44, 38), and may give rise to an extensive pharyngeal skeleton. In the bees these processes form the long rods bearing the protractor muscles of the pharynx, though the hypopharyngeal bars themselves are lacking.

In the chilopods and in the apterygote insects, an apodemal process arises from the inner end of each suspensorial plate of the hypopharynx, and extends posteriorly below the sides of the pharynx (fig. 21 A, C, D, *HA*). Upon these apodemes arise the retractor muscles of the hypopharynx, the ventral dilators of the pharynx, and ventral adductors of the mandibles, the first maxillae, and the second maxillae. These muscles are all properly *sternal* muscles, and their origin in the Chilopoda and Apterygota on the hypopharyngeal apodemes, which are sternal apophyses of the head, attests a primitive relation in these groups between the muscles of the gnathal appendages and the sternal parts of their segments. In some of the Crustacea, the corresponding muscles have their origins on a central endoskeletal structure that arises on the sternal region of the gnathal segments behind the mouth. In many Crustacea, however, and in the Diplopoda, the ventral

muscles of the gnathal appendages, especially those of the mandibles, show a highly specialized condition in that they are mostly separated from their sternal connections and united upon a common transverse

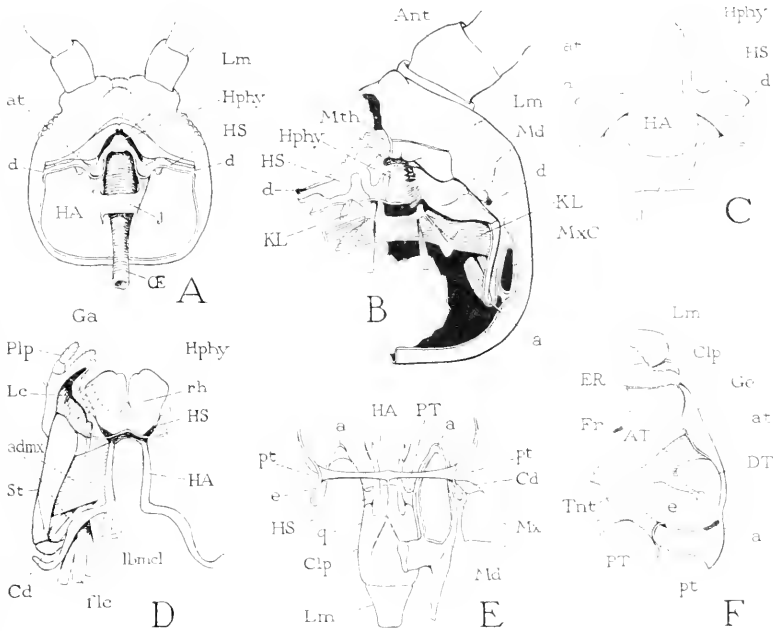

FIG. 21.—The hypopharyngeal apophyses and the tentorium.

A, under surface of head of *Lithobius*, mandibles and maxillae removed, showing suspensorial plates (*HS*) of hypopharynx suspended from points (*d*) on margins of head, and hypopharyngeal apophyses (*HA*) invaginated from their inner ends and connected by ligamentous bridge (*j*) beneath pharynx.

B, Head of *Scolopendra*, ventral, maxillae and right half of cranium removed, showing attachment of mandibular adductors (*KL, KL*) on ligament uniting the hypopharyngeal apodemes.

C, *Scutigera forceps*, ventral view of hypopharynx (*Hphy*), suspensorial plates (*HS*), their apodemes (*HA*) and uniting ligament (*j*).

D, *Heterojapyx gallardi*, ventral view of right maxilla, hypopharynx (*Hphy*), and hypopharyngeal apodemes (*HA*) upon which arise muscles of the maxilla (*adm*), the labium (*lbmcl*), and the mandibles (not shown).

E, *Nesomachilis mauricus*, posterior view of unconnected anterior and posterior arms of tentorium (*HA, PT*), part of the head wall with clypeus (*Clp*) and labrum (*Lm*), base of maxilla (*Mx*), and mandible (*Md*).

F, Ephemeroptera nymph, ventral view of tentorium and part of left side of head, showing anterior tentorial arms (*AT*) arising from ventral margin of gena (*Ge*).

ligament. In the pterygote insects the hypopharyngeal muscles, the ventral dilators of the pharynx, and most of the fibers of the ventral adductors of the mouth part appendages arise on the endoskeletal structure of the head known as the *tentorium*. Evidently, then, the

tentorium must have some relationship with the hypopharyngeal apophyses of the Apterygota and the Chilopoda, and with the sternal apodemes of the gnathal segments in the Crustacea. The nature of this relationship will be shown following the anatomical description of the tentorium.

THE TENTORIUM

The tentorium of orthopteroid insects is a horizontal, X-shaped brace between the lower edges of the cranial walls (fig. 39 B, *Tut*). It consists of a central *body* with a pair of divergent *anterior arms* (*AT*) and a pair of divergent *posterior arms* (*PT*). The arms are hollow invaginations of the head wall. The roots of the anterior arms appear as external pits, in most insects lying just before the anterior articulations of the mandibles (fig. 18 A, B, *at*) in the epistomal suture, when the latter is present; the roots of the posterior arms form depressions in the lower ends of the postoccipital suture (B, C, *pt*). Usually there is a pair of internal processes, or *dorsal arms* of the tentorium (fig. 39 A, C, *DT*), arising centrally at the junction of the anterior arms with the body, and extending dorsally and anteriorly to the facial wall of the head near the bases of the antennae. Sometimes these arms are fused with the cuticula of the cranial wall, but generally they are attached only to the hypodermis, and often their outer ends are weak and tendinous. Riley (1904) says that the dorsal arms of the tentorium of *Blatta* arise in the embryo as processes from the inner ends of the anterior arms. The tentorium undergoes many modifications of form in different insects, according as certain parts become more highly developed and others reduced, but its typical structure is seldom obscured.

In its typical form, the tentorium is a simple "tent," as its name implies, composed of the central plate, or body, suspended by the four stays, or arms, from the four ventral angles of the head. Yet, morphologists have always been suspicious of accepting the tentorial structure at its apparent face value. Some writers would homologize the arms with the apophyses of the thoracic pleura, others with the apophyses of the thoracic sterna. Either disposition suggests, then, that there should be a pair of such processes for each of the head segments. Wheeler (1889) thought that he found in the embryo of *Leptinotarsa* (*Doryphora*) five pairs of tentorial invaginations, representing each head segment but the last. Other investigators have not verified this, and most students of the development of the insect head report the presence of only the two pairs of invaginations that form the anterior and the posterior arms of the definitive structure.

Besides bracing the walls of the cranium, the tentorium gives attachment to muscles of the hypopharynx, of the mandibles (in some insects), of the maxillae, of the labium, of the pharynx, and, when dorsal arms are present, to muscles of the antennae. Such a comprehensive relation to the musculature of the head appendages, therefore, furnishes ample ground for the suspicion that the tentorium includes in its composition more than is evident in its adult structure. Janet (1899), after making a careful analysis of the muscles arising upon the tentorium in the head of an ant, concluded that the tentorium must be composed at least of three pairs of processes corresponding with the antennal, the maxillary, and the labial segments. The antennal processes, according to Janet's homology, are the anterior arms, the labial processes are the posterior arms; the maxillary processes are assumed to have lost their connection with the head wall, after their inner ends had united with those of the other processes in the formation of the central tentorial body. Janet's scheme, however, is not complete without the assumption of mandibular elements in the tentorium, for, in some of the lower insects, certain muscles of the mandibles are attached upon the tentorium. Since these muscles were not then known, Janet suggested that the homotypes of the mandibular tentorial processes are represented on the mandibular segment by the points where the corpora allata have their origin in the hypodermis. All the tentorial processes, both real and hypothetical, Janet regarded as homologous with the *furcal invaginations* of the thoracic sterna, because the tentorium of the adult insect supports the *adductor* muscles of the head appendages. This is sound reasoning, and the conclusion probably comes as close to the truth in the matter as the truth may be approached by induction from the facts presented by the higher insects; but a study of the Apterygota, the Myriapoda, and the Crustacea throws an entirely new light on the origin and evolution of the tentorium, and dispels the obscurity which has led to so many theories concerning the nature of this head structure.

The morphology of the tentorium, briefly summarized from facts later to be described, is as follows: The anterior arms and the part of the body of the tentorium on which the ventral adductor muscles of the mandibles, the maxillae, and the labium have their origin are identical with the hypopharyngeal apophyses of the Myriapoda and Apterygota, and have their prototypes in the ventral apodemes of the gnathal segments in Crustacea. From their positions just laterad of the hypopharynx, the bases of the apophyses have moved outward in the ventral wall of the head before the bases of the mandibles to the lateral ventral edges of the cranium, where they come to lie in the subgenal sutures.

Then, proceeding forward, they have migrated to the fronto-clypeal suture on the facial aspect of the head. The primitive condition is found in Chilopoda, Diplopoda, and Apterygota; intermediate conditions occur in the Ephemera and Odonata; the final condition is characteristic of all Pterygota, except the Ephemera and Odonata. The posterior tentorial arms are invaginations in the lower ends of the postoccipital suture of the cranium, which is probably the intersegmental groove between the first and second maxillary segments. These arms are absent in the Myriapoda and most Apterygota; they are present in *Machilis* and in some Crustacea, where their inner ends are united to form a transverse bar through the back of the head; they are present in all Pterygota, where the anterior arms are united with them to form the typical four-branched tentorium. The dorsal tentorial arms are processes of the anterior arms and may secondarily become attached to the dorsal or facial wall of the cranium.

The muscles of the tentorium, with the exception of the antennal muscles usually arising on the dorsal arms in pterygote insects, are all muscles that primitively have their origin on the *sterna of the gnathal segments*. They include two sets of median longitudinal ventral muscles, one set going anteriorly to the hypopharynx, and the other posteriorly to the sternum or sternal processes of the prothorax; they include also the transverse ventral adductors of the mandibles, the first maxillae, and the second maxillae, and the ventral dilators of the pharynx. In the Chilopoda and Apterygota, all these muscles arise from the hypopharyngeal apodemes, except some of the mandibular muscles which may become detached from the apophyses, or retain a direct connection with the base of the hypopharynx. The hypopharyngeal apodemes are, therefore, paired apophyses of the region of the gnathal sterna. There is no evidence that they are composite structures; each appears to be a single process invaginated from a chitinous remnant of the mandibular sternum (the suspensorial plate of the hypopharynx), but since it bears the sternal muscles of the three gnathal appendages, either the bases of these muscles have migrated forward, or each apophysis is a process of the three united sterna. When the two apophyses move to the positions on the front wall of the head characteristic of the orthopteroid branch of the Pterygota, they retain the muscle attachments, and when they unite with the posterior arms to form the typical tentorium, the head presents the aspect of having none of the ordinary sternal muscles of the appendages attached on its sternal region, except for the small mandibular adductors present in some of the lower Pterygota that have retained their origin directly on the base of the hypopharynx.

The antennal muscles that take their origin on the dorsal arms of the tentorium in most adult pterygote insects have evidently migrated secondarily to this position after the attachment of these arms to the dorsal wall of the cranium. In the crustaceans, myriapods, and many insect larvae, the antennal muscles have the primitive attachment on the walls of the head capsule (figs. 23 B, 50 B, C, E, F, 3).

Evidence fully supporting the above statements is easily adduced from a comparative study of the head structure and the gnathal musculature in the Myriapoda, Apterygota, Ephemera, Odonata, and orthopteroid Pterygota. Many of the facts have been described by other writers, but their significance appears to have been unrecognized.

In the Chilopoda, the hypopharyngeal apodemes are large chitinous processes (fig. 21 A, B, *HA*) that arise from the inner ends of the suspensorial plates of the hypopharynx (*HS*) close to the base of the hypopharynx (*Hphy*). Each projects posteriorly at the side of the pharynx, and the two are bridged below the pharynx by a sheet of ligamentous tissue (A, C, *j*). Upon the arms, or on processes of the arms, and on the uniting ligament arise the ventral adductor muscles of the mandibles (B, *KL*), and of the first and second maxillae. The relations here are the same as in the thorax of an insect where the ventral leg muscles arise from a pair of sternal apophyses. In the Diplopoda, a highly specialized condition has arisen through the separation of the inner ends of the muscles from the apodemes and their union across the median line by a tough transverse ligament (fig. 26 A, *k*). The large mandibular adductors (*KL*, *KL*) here pull against each other from the two ends of the ligament. The ligamentous bridge suggests, in a way, the body of a tentorium, but as will be seen it has no relation to the insect tentorium. A similar condition of the mandibular adductors exists in many of the Crustacea (fig. 27 A, B, *KL*), and in some of the fibers of these muscles in the apterygote insects (C, D, *KLk*), as will be described later in connection with the mandibles (page 62).

In the Apterygota, the hypopharyngeal apodemes are well developed and extend far back in the head. Those of *Japyx* (fig. 21 D, *HA*) are slender rods running parallel beneath the sides of the pharynx and then diverging outward and posteriorly to the head wall behind the cardines of the maxillae (*Cd*), but their ends appear to be free and not attached to the cuticula of the cranium. Upon these arms arise the hypopharyngeal retractor muscles, a set of mandibular adductors (fig. 27 C, *KLt*), the adductors of the maxillary stipes and cardo (fig. 21 D, *adm*), and muscles of the labium (*lbmcl*). The hypopharyngeal skeleton of *Japyx* was described first by Meinert (1867),

and later by von Stummer-Traufels (1891). The latter writer called it the "Stützgerüst," or supporting framework of the hypopharynx; he figured it in *Tetradontophora gigas* and in *Campodea staphylinus*, and he says it has essentially the same structure in *Japyx*, *Campodea*, and Collembola. Folsom (1899) described the hypopharyngeal skeleton of the collembolan, *Orchesella cincta*, as consisting of a thin median plate with paired anterior, dorsal, and posterior arms. The anterior arms, he says, are united with the lateral lobes of the hypopharynx, the others are attached to the cranial walls by fibrous strands. This structure of the collembolan head, upon which arise muscles of the pharynx, the mandibles, and the maxillae, Folsom points out is the true tentorium, homologous with that of the Orthoptera and other mandibulate insects. The failure to recognize this fact, he says, "has led students to assign an altogether undue importance to the 'Stützapparat' of the ligula (hypopharynx), which has erroneously been regarded as a sort of substitute for a tentorium." "Partly as a result of this error," he adds, "systematists have acquired an exaggerated opinion of the differences which separate Collembola and Thysanura from insects of other orders."

The tentorium of the Protura has been described by Berlese (1910) and by Prell (1913). The anterior arms of the structure are united in a median bar, but each arm itself is forked anteriorly, and the two forks are said by Prell to make connections with the base of the hypopharynx and with the fronto-clypeal ridge of the head. Both Berlese and Prell call this endoskeletal structure of the proturan head the "tentorium," but Prell observes that it has a close resemblance to the "Zungenapparat" of the Collembola and suggests a homology with this structure. It is now to be seen that the two structures are, indeed, identical, and that the hypopharyngeal apophyses of the Apterygota are the primary elements of the pterygote tentorium.

In *Machilis* (figs. 21 E, 27 D), the hypopharyngeal apodemes (*HA*) arise from suspensorial plates (fig. 21 E, *HS*) connected laterally with the cranial walls as in the chilopods, but their points of origin from these plates are at the basal angles of the clypeus (*Clp*). There is in *Machilis* also a well-developed posterior tentorial bar (*PT*) extending transversely through the back of the head from pits (*pt*) in the lower ends of the postoccipital suture. The maxillary cardines (*Cd*) are attached to the margin of the cranium just anterior to these posterior tentorial depressions. The inner ends of the hypopharyngeal apodemes (*HA*), or anterior tentorial arms, of *Machilis* become weak and fibrous, and in specimens cleaned in caustic they do not connect with the posterior tentorial bar. The tentorium of *Machilis*,

therefore, appears to be in an intermediate stage of development in which the anterior and posterior elements are still independent of each other. A two-branded fiber (*q*) extends downward in the head from the middle of the posterior bar. A similar tentorial bar is strongly developed in the crustacean, *Gammarus* (fig. 28 B, *PT*).

In all the pterygote insects the anterior and the posterior arms of the tentorium are united with each other, and typically the lateral elements are fused across the median line to form the central plate-like body of the tentorium (figs. 21 F, 39 B, *Tnt*). The median plate, however, is not developed in all cases; in the caterpillars the posterior arms form only a slender bar through the back of the head, to which the anterior arms are attached on each side (fig. 53 D, *Tnt*), and a similar condition exists in adults of the higher Hymenoptera, where the posterior bar appears as a slender yoke between the posterior ends of the large anterior arms. In all insects of the orthopteroid branch of the Pterygota, the roots of the anterior tentorial arms lie in the fronto-clypeal suture (figs. 18 A, B, 36 A, B, 46 A, B, D, F, *at*, *at*). So constantly do they have this position that they become diagnostic marks of the suture, or of the fronto-clypeal line when a suture is absent. In the Ephemera (*nymphs*), however, the roots of the broad anterior arms (fig. 21 F, *at*) lie at the edges of the inflected ventral areas of the genae (*Gc*), before the bases of the mandibles. Here, clearly, is a more primitive condition, differing from that of the Myriapoda and Apterygota only in that the bases of the hypopharyngeal apodemes have moved outward from the hypopharynx to the lateral walls of the cranium. In the Odonata the roots of the anterior tentorial arms lie on the sides of the head, above the bases of the mandibles, in the subgenal sutures. This is a second step toward the orthopteroid condition, in which finally the tentorial roots have migrated anteriorly into the fronto-clypeal suture on the facial aspect of the head.

The writer believes that the facts presented in the foregoing descriptions solve the riddle of the insect tentorium, and explain the seeming anomalies of the gnathal musculature, though he has not shown the mode of union between the anterior and the posterior arms in forming the characteristic tentorium of pterygote insects, and though the method of the change in the connections of the anterior arms from the base of the hypopharynx to the facial aspect of the head may still be held as not exactly determined. The origin of the anterior tentorial arms as *apophyses of the sternal region of the gnathal segments*, however, shows that the adductor muscles of the gnathal appendages, which arise on the tentorium in pterygote insects,

are the true sternal muscles of the head appendages, and this relation brings the musculature of these appendages directly in line with that of the thoracic legs, which are moved by sets of muscles arising on the tergum and the sternum in each segment. In the Pterygota, it will further be shown, the mandibles lose their primitive sternal adductors, and, by a change in the nature of the mandibular articulation with the head, the primitive tergal promotor and remotor muscles of the jaw become the functional abductors and adductors.

III. THE HEAD APPENDAGES

The segmental appendages of the head in an adult insect are the antennae, the mandibles, the maxillae, and the labium. The antennae

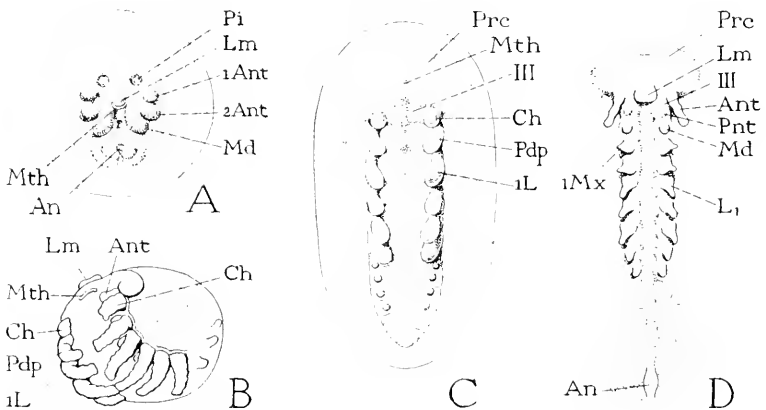

FIG. 22.—Arthropod embryos showing relative development of the tritocerebral appendages.

A, embryo of a crayfish, *Astacus (Potamobius) astacus* (from Reichenbach, 1877). B, embryo of a spider, *Trochosa singoriensis* (from Jaworowski, 1891). C, embryo of a spider, *Angelena labyrinthica* (from Balfour, 1880). D, embryo of an apterygote insect, *Anurida maritima* (from Wheeler, 1893).

An, anus; Ant, antenna; 1Ant, first antenna; 2Ant, second antenna; Ch, chelicera; III, tritocerebral segment; 1L, first leg; L1, prothoracic leg; Lm, labrum; Md, mandible; Mth, mouth; Pdp, pedipalp; Pi, pit on head region; Pnt, postantennal appendage; Prec, protocephalon.

belong to the second, or deutocerebral, segment of the protocephalon, the other appendages to the gnathal segments. In many insect embryos there is present a pair of small lobes on the third protocephalic segment, which lobes are unquestionably rudiments of the tritocerebral appendages. Preantennal appendages have been reported in Scolopendra and in the phasmid insect, *Caranusius* (fig. 14 A, B Prnt). As already pointed out, there is some reason for regarding the crustacean eye stalks as being the appendages of the preantennal segment, though the true status of these organs has not yet been demonstrated.

The eye stalks of the decapod crustaceans arise from the ends of a transverse ridge on the top of the protocephalon, and project laterally from under the base of the rostrum, the latter being a process of the anterior edge of the carapace, and, therefore, from the tergum of the mandibular segment. Each eye stalk (fig. 17 B) consists of two movable segments, a narrow basal one forming a short peduncle, and a large terminal one capped by the hemispherical compound eye. Schmidt (1915) enumerates ten individual muscles for each eye stalk in the crayfish, the basal segment being provided with muscles arising on the head walls that move the appendage as a whole, while muscles from the basal segment move the terminal eye-bearing segment. The eye muscles are innervated by an oculo-motor nerve arising from the brain near the base of the sensory optic nerve.

THE ANTENNAE

The insect antenna is typically a many-jointed filament. Usually the first two basal segments are differentiated from the rest of the

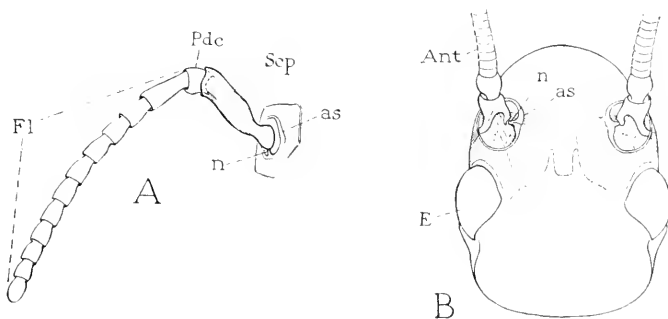

FIG. 23.—The antenna.

A, diagram of typical segmentation and articulation of an insect antenna. B, head of a chilopod, *Scutigera forceps*, dorsal, showing dorsal articulation of antennae, and origin of antennal muscles on walls of cranium.

Ant, antenna; *as*, antennal suture; *E*, eye; *n*, articular pivot of antenna; *Pdc*, pedicel; *Scp*, scape; *Fl*, flagellum.

shaft (fig. 23 A). The first segment serves to attach the antenna to the head, and, being often thicker and longer than the others, forms a basal stalk, or *scape* (*Scp*), of the appendage. The second segment, or *pedicel* (*Pdc*), is short, and in nearly all insects contains a special sensory apparatus known as the organ of Johnston. The part of the antenna beyond the pedicel is termed the *flagellum* or *clavola* (*Fl*). The flagellum may be long and tapering and made up of many small segments, or it may be abbreviated, and reduced even to a single segment. The scape is set upon a small membranous area of the head wall, sometimes depressed to form a cavity, or *antennal socket*.

The head wall surrounding the antennal base is strengthened by an internal ridge, the line of which is marked externally by a suture (fig. 23, *as*), setting off a circular, marginal rim known as the antennal sclerite. Usually a pivot-like process (*n*) from the rim of the sclerite forms a special support and articular point for the base of the scape, and allows the antenna a free motion in all directions. In its single point of articulation with the head wall, the antenna resembles the maxilla, or the mandible of those apterygote insects in which the jaw does not have a double hinge with the cranium. In most pterygote insects the antennal pivot is ventral or postero-ventral in position, relative to the base of the antenna (fig. 23 A), while the single mandibular or maxillary articulations are dorsal. The ventral position of the antennal articulation might be supposed to have shifted during the forward and upward migration of the appendage from its primitive ventral and postoral situation; but in *Japyx* the antennal pivot is dorsal, as it is also in the Chilopoda (fig. 23 B, *n*).

Each antenna is moved by muscles inserted upon the base of the scape. The origin of the antennal muscles in adult pterygote insects is commonly on the dorsal, or dorsal and anterior arms of the tentorium (fig. 38 D, *DT*, *AT*), but in the caterpillars (fig. 50 B, C, E, F) and in some coleopteran larvae, the antennal muscles arise upon the walls of the epicranium. The cranial origin of the muscles is probably the primitive condition, for, as already shown, the tentorium belongs to the gnathal segments only. The attachment of the antennal muscles on the tentorium, therefore, appears to be a secondary condition that has resulted from the migration of the muscle bases to the dorsal tentorial arms when the latter make contact with the dorsal wall of the head. In Crustacea and Chilopoda the antennal muscles have their origin on the head wall. In *Scutigera* (fig. 23 B) a dorsal set to each antenna arises on the dorsal wall of the cranium mesad and posterior to the antennal base, and a ventral set arises on the lateral walls below the antenna, and below the eyes. The insertion points of these muscles, distributed on three sides of the articular pivot (*n*), allow the muscles to act as levators, depressors, and rotators of the appendage. The part of the insect antenna distal to the scape is moved by muscles arising within the scape and inserted on the base of the pedicel (fig. 23 A). The segments of the flagellum in insects, however, so far as known to the writer, are never provided with muscles, and their lack of muscles suggests that the flagellum is a single segment secondarily subsegmented, corresponding with the flagellum of a crustacean antenna (fig. 24 B, *Fl*), which is a many-jointed dactylopodite. In the Myriapoda, however, all the antennal segments may

be individually provided with muscles (*Scolopendra*, *Spirobolus*). The first antenna, or antennule, of the crayfish, according to Schmidt (1915), has paired antagonistic muscles for each of its first three proximal segments, and the third segment contains a single reductor inserted on the base of the dorsal branch of the flagellum, but otherwise none of the flagellar segments is provided with muscles.

The Arachnida and Niphosura lack antennal appendages in the adult stage. Croneberg (1880) describes a pair of head lobes in the arachnid embryo, which he says fuse into a median rostrum in the mites and in the higher arachnids, and which he believes represent the antennal appendages. Jaworoski (1891) likewise describes in the embryo of a spider, *Trochosa singoriensis*, a pair of lobes situated before the chelicerae, which he claims are rudiments of the antennae (fig. 22 B, *Ant*), but he says the lobes disappear during later development.

THE POSTANTENNAL APPENDAGES

The pair of postantennal appendages on the tritocerebral segment of the head, known also as the antennae (Crustacea), second antennae, premandibular appendages, and intercalary appendages, are at best rudimentary in all insects. According to Uzel (1897), two small lobes in the adult head of *Campodca*, lying between the labrum and the maxillae, in the space left free by the retracted mandibles, are the tritocerebral appendages; the writer has found a pair of small papillae in *Dissosteira* between the bases of the mandibles and the angles of the mouth (fig. 42 B, *Put*) that might be vestiges of these organs. Otherwise tritocerebral appendages are known in insects only as evanescent rudiments in the embryo (fig. 22 D, *Put*). In the Myriapoda, likewise, the postantennal appendages are lacking, or possibly are present as temporary premandibular lobes on the head of the embryo ("rudiments of lower lip" in *Geophilus*, Zograf, 1883). In the Crustacea, on the other hand, the appendages of the tritocerebral segment, though sometimes reduced or lacking, are commonly highly developed, biramous organs, the second antennae, or "the antennae" according to the terms of carcinology. In the decapods each appendage consists of a two-segmented base (fig. 24 B, *Prtp*), of a large, one-segmented exopodite (*Exp*), and of a long, slender endopodite (*Endp*), of which the terminal segment is the many-jointed flagellum (*Fl*). The exopodite is independently movable by abductor and adductor muscles arising in the second segment of the base.

In Niphosura and Arachnida, the chelicerae (fig. 24 A) are generally regarded as the appendages of the tritocerebral segment. Their

rudiments in the embryo of a spider (fig. 22 C, *Ch*) bear a relationship to the head so similar to that of the tritocerebral rudiments in the insect embryo (D, *Pnt*), that the identity of the two sets of organs can scarcely be questioned. Holmgren (1916), furthermore, claims that the histology of the arachnid brain shows that the chelicerae are innervated from the tritocerebral region of the brain. If this homology is correct, there is no reason for calling the tritocerebral appendages "second antennae" except in the Crustacea. The arachnid chelicera is a uniramous organ, that of a scorpion (fig. 24 A) having three well-developed segments.

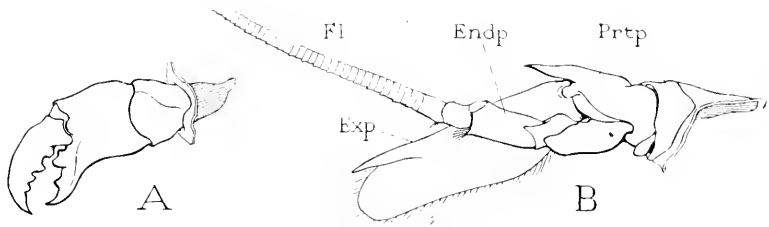

FIG. 24.—Postantennal appendage of adult arthropods.

A, chelicera of a scorpion, left, ventral view, showing uniramous structure and three segments. B, second antenna of a decapod crustacean (*Spirontocaris groenlandicus*), left, ventral view, showing biramous structure, consisting of two-segmented base (*Prtp*) bearing an exopodite (*Exp*) and an endopodite (*Endp*).

THE GNATHAL APPENDAGES

There can be no doubt that the gnathal organs—the mandibles, the first maxillae, and the second maxillae—constitute a distinct group of appendages in the eugnathate arthropods. The mandibles are the most highly modified of the gnathal appendages, and, in most cases, their structure has lost all resemblance to that of the more generalized insect maxillae. A maxillary appendage, therefore, should be studied first as affording a better example of the basic structure of the gnathal organs, and, in insects, the first maxilla preserves most nearly the primitive structure, since the second maxillary appendages are united to form the labium.

The first maxilla of an insect with typical biting mouth parts, of which the roach offers a good example (fig. 25 A), consists of a basal stalk, two terminal lobes, and a palpus. The base is divided into a proximal *cardo* (*Cd*), suspended from the head by a single point of articulation (*c*), and a distal *stipes* (*St*). The cardo and stipes are freely flexible on each other by a broad hinge line, and their planes may form an abrupt angle at the union, but neither has an inner wall,

the two being merely strongly convex sclerites set upon the membranous lateral wall of the head, and their cavities are a part of the general head cavity. Only the terminal maxillary lobes and the palpus are free parts of the appendage. The lobes arise from the distal end of the stipes, one, the *lacinia* (*Lc*), being internal, the other, the *galea* (*Ga*) external. The galea is also anterior to the lacinia (or dorsal to it in insects with the head flattened and held horizontal). The

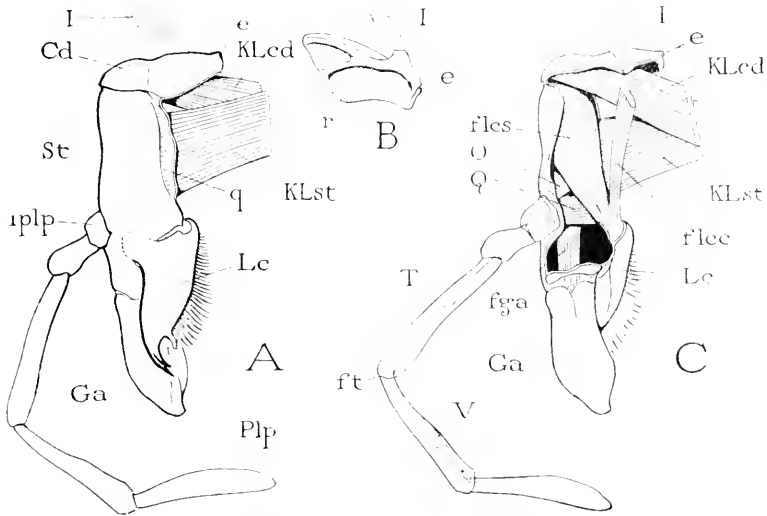

FIG. 25.—Maxilla of *Periplaneta*.

A, left maxilla, posterior (ventral) surface. B, internal surface of crado. C, right maxilla, anterior (dorsal) view, showing muscles.

Cd, crado; *e*, articulation of crado with cranium; *fga*, flexor of galea; *fles*, cranial flexor of lacinia; *fles*, stipital flexor of lacinia; *ft*, femoro-tibial joint of palpus; *Ga*, galea; *I*, promotor of crado; *KLcd*, adductor of crado (origin on tentorium); *KLst*, adductor of stipes (origin on tentorium); *Lc*, lacinia; *O*, levator of palpus; *Plp*, palpus; *iplp*, first segment of palpus; *Q*, depressor of palpus; *q*, submarginal suture (and internal ridge) near inner margin of stipes; *r*, internal ridge of crado; *St*, stipes; *T*, depressor of fourth segment (tibia) of palpus; *T*, depressor of fifth segment (tarsus) of palpus.

galea is usually a soft lobe; the lacinia is more strongly chitinized, and ends in a strong incisor point provided with one or more apical teeth curved inward. Both lobes are movable on the end of the stipes: the galea can be deflexed, and the lacinia can be flexed inward. The palpus (*Plp*) arises from the lateral surface of the stipes, a short distance proximal to the base of the galea. The palpus of the roach is five-segmented.

The musculature of the maxilla (fig. 25 C) comprises muscles that move the appendage as a whole, and muscles that move the terminal

lobes and the palpus. The first group includes a tergal muscle (*T*) arising on the posterior dorsal wall of the head, and two sets of sternal muscles (*KLcd*, *KLst*) arising on the tentorium in most insects, or on the homologous hypopharyngeal apodemes in some apterygote insects (fig. 30 B, *HA*). The single tergal muscle (fig. 25 C, *T*) is inserted on the proximal end of the cardo just before the articulation of the latter with the head (*c*): it is probably a promotor, serving to swing the appendage forward. The sternal muscles (i. e., the tentorial or hypopharyngeal muscles) consist of two large flat bundles of fibers, one group (*KLcd*) inserted on the inner face of the cardo, the other (*KLst*) on an internal ridge of the stipes near the mesal border of the posterior face of the latter (*A, q*). These muscles are the adductors of the maxilla; the fibers of the cardo muscle arise anterior (or dorsal) to those of the stipes muscle and cross them obliquely.

The muscles of the movable parts of the maxilla include muscles of the galea, the lacinia, and the palpus. The galea has a single muscle (fig. 25 C, *fga*) arising on the posterior wall of the stipes and inserted on the posterior rim of the base of the galea; it is a reductor in as much as it serves to flex the galea posteriorly (or ventrally). The lacinia has a large flexor (*flcs*) arising in the base of the stipes, and a second muscle (*flcc*) arising on the posterior dorsal wall of the cranium. In the roach these two muscles are inserted by a common broad tendinous base on the inner proximal angle of the lacinia; in other insects they usually have separate insertions (fig. 30 B, *flcs* and *flcc*, fig. 40 B, *I4, I5*). The palpus is provided with two muscles (fig. 25 C, *O, Q*), both of which arise within the stipes and are inserted on the base of the first segment of the palpus (*A, Iplp*). The two palpus muscles are more distinct in most other insects than in the roach (fig. 31 A, B, C, E), and since one is dorsal and the other ventral, relative to the morphologically vertical axis of the maxilla, they are clearly a levator and a depressor, or abductor (*O*) and adductor (*Q*), of the palpus. The muscles within the palpus vary somewhat in different insects. In the palpus of the roach, a levator of the second segment arises in the first, where also a long depressor of the fourth segment (*T*) has its origin. A depressor of the terminal segment (*I'*) arises ventrally in the penultimate segment.

THE MANDIBLES

The most generalized mandibular appendage in the arthropods, i. e., one corresponding most closely in structure and musculature with a typical maxilla, is to be found, not in the insects or crustaceans, but in the myriapods, and best developed in the Diplopoda.

The diplopod mandible consists of a large basal plate, which appears to form an extensive part of the lateral head wall (fig. 17 K, *Md*), and of a movable terminal lobe mostly concealed in the normal condition by the gnathochilarium (*Gch*). The basal plate is subdivided into several regions, but particularly there is a proximal piece (fig. 26 A, *Cd*) and a distal piece (*St*), separated by a line of flexibility. The proximal piece is loosely articulated to the head wall by a single point on its dorsal posterior angle (*a*). The entire mandibular base is slightly movable by its membranous union with the head, but it is not of the nature of a free appendicular structure, since it has no inner wall—it is merely a convex plate in the lateral wall of the head, but

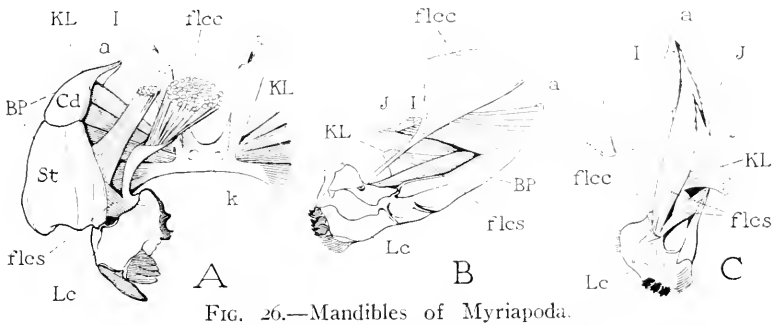

FIG. 26.—Mandibles of Myriapoda.

A, right mandible of a diplopod, *Thyropygus* (*Spirostreptus*), dorsal, showing large dumb-bell adductors (*KL, KL*) from opposite mandibles, united by median tendon (*k*). B, left mandible of a chilopod, *Scutigera forceps*, lateral view. C, right mandible of *Scutigera*, dorsal, somewhat diagrammatic.

a, articulation of mandible with cranium; *BP*, basal plate of mandible; *Cd*, "cardo" of mandible; *flec*, cranial flexor of lacinia; *fles*, stipital flexor of lacinia; *I*, promotor of mandible; *J*, remotor of mandible; *k*, median tendon of diplopod (*A, k*) to form dumb-bell muscle; *Lc*, lacinia; *St*, "stipes" of mandible.

separated from the cranium by a membranous suture. The free terminal lobe of the mandible is a strongly chitinized, jaw-like structure with a proximal molar area and terminal incisor point (fig. 26 A, *Lc*). It is hinged by a dorsal articulation at its base with the end of the basal plate.

So closely do the parts of the diplopod mandible (fig. 26 A) resemble the cardo, the stipes, and the lacinia of an insect maxilla (fig. 25 A), that the imagination at once sees in the diplopod jaw an appendage similar to the maxilla, lacking only a galea and a palpus. That the fancied resemblance is real is easily demonstrated by a study of the musculature.

The musculature of the diplopod mandible consists of muscles that move the appendage as a whole, and of muscles that move the lacinial

lobe. As in the insect maxilla, the muscles that move the entire organ include a tergal promotor and a group of ventral adductors. The promotor (fig. 26 A, *I*) arises on the wall of the cranium dorsal and posterior to the articulation of the basal plate with the head. It is inserted on the dorsal (anterior) margin of the distal division (*St*) of the basal plate, and in its point of insertion alone does this muscle differ from the promotor of the insect maxilla, which is inserted on the edge of the cardo (fig. 25 C, *I*). Functionally, however, the two muscles are the same, and a shift in the point of attachment is not a morphological difference.

The adductor muscles of the diplopod mandible consist principally of a great mass of fibers (fig. 26 A, *KL*) filling the cavity of both divisions of the basal plate (*Cd* and *St*). These muscles are clearly the homologues of the adductors of the cardo and the stipes in the insect maxilla (fig. 25, *KLcd*, *KLst*), which have their origins on the tentorium, or on the hypopharyngeal apodemes. In the diplopod mandibles, however, the fibers of the adductor muscles converge medially from each jaw upon a large, tough, transverse ligament (fig. 26 A, *k*), and the two conical fiber masses, together with the connecting ligament, form a great dumb-bell-shaped muscle uniting the two mandibles. The two sets of fibers pull against each other to close the jaws. Clearly, the inner ends of these muscles have become detached from the hypopharyngeal apodemes, and the fibers from opposite sides have been united across the middle of the head by means of a transverse ligament. There is also, however, a small group of adductor fibers to each mandible (not seen in the figure) that still retains a connection with the corresponding apodeme of the hypopharynx. Besides the mandibular muscles, other muscles have their origin on the transverse ligament, including muscles to the gnathochilarium, which is either the united second maxillae, or the combined first and second maxillary appendages. In the Diplopoda, therefore, the ventral adductors of all the gnathal appendages have lost their sternal connections by their detachment from the hypopharyngeal apodemes. This is a specialized condition, and the ligamentous bridge on which the muscles arise has no relation to the insect tentorium.

The muscles of the free terminal lobe of the diplopod mandible (fig. 26 A, *Lc*) include a muscle inserted directly on the base of the lobe (*flcs*) arising within the stipes (*St*), and a large cranial muscle (*flcc*) arising on the dorsal wall of the head and inserted by a strong, chitinous apodeme on the inner basal angle of the lobe. These muscles correspond exactly with the lacinal flexors of the insect maxilla, one of which (fig. 25 C, *flcs*) arises within the stipes, the other (*flcc*) on the

dorsal wall of the cranium. In most insects the second muscle is inserted, as in the diplopod, on a chitinous apodeme from the inner angle of the lacinia (fig. 30 B, *lcc*). There can be little question, therefore, that the single lobe (*Lc*) of the diplopod mandible is the lacinia, and that the jaw of the Diplopoda has a structure identical with that of the insect maxilla, except for the lack of a galea and a palpus.

The mandible of the Chilopoda is more specialized in structure than is that of the diplopods, but in its musculature it is in some respects more generalized. In *Scolopendra*, *Lithobius*, *Scutigera*, the jaw is slender and greatly elongate. In *Scutigera* (fig. 17 G, *Md*) its tapering base is exposed on the side of the head where it is articulated to the cranial margin (*a*), but in *Scolopendra* (fig. 21 B) the end of the mandible is buried in a pocket of the head wall lying mesad of the base of the maxilla (*MxC*). The long basal plate of the chilopod jaw is undivided (fig. 26 B, *BP*), and is articulated to the head wall by its apical point (*a*). In some chilopods there is an anterior articulation between the mandible and the suspensorial plate of the hypopharynx, but this articulation is a mere contact between external surfaces. As in the diplopods, the basal plate has no inner wall. The distal part of the mandible is a free lobe (*Lc*) movable on the base, but not so definitely hinged to the latter as is that of the diplopod mandible.

The musculature of the chilopod mandible is practically alike in both the Pleurostigma and the Notostigma, and is essentially the same as in the diplopods, though the muscles differ in relative size. The basal plate is provided with both tergal and sternal muscles. Of the former, there are two sets of fibers, one inserted on the dorsal (anterior) edge of the proximal part of the plate (fig. 26 B, C, *I*), the other (*J*) on the ventral (posterior) edge; both have their origins on the dorsal wall of the cranium. These muscles apparently serve to rotate the mandible on its long axis, and they probably act as protractors where the mandible is capable of a longitudinal movement; but clearly the first would be a promotor, and the second a remotor in an appendage with primitive relations to the head. The sternal muscles of the mandible consist of a conical mass of adductor fibers (fig. 26 B, C, *KL*) spreading upon the inner wall of the basal plate from their median origin (fig. 21 B, *KL*), which is on the ligamentous bridge uniting the two apodemes of the hypopharynx (fig. 21 A, C, *j*). The adductors of the chilopod mandibles are unquestionably homologues of the dumb-bell muscle of the diplopods. The condition of the mandibular adductors, therefore, is more primitive in the Chilopoda, for here the muscles retain their connections with the sternal, hypopharyngeal apodemes.

The movable terminal lobe of the chilopod mandible (fig. 26 B, C, *Lc*) is provided with the same muscles as is the corresponding lobe of the diplopod mandible (A, *Lc*) and the lacinia of the insect maxilla (figs. 25 C, 30 B, *Lc*). The muscle from the lobe to the basal plate in the chilopod jaw is very large (fig. 26 B, C, *fics*), suggesting that of *Japyx* (fig. 30 B, *fics*), and is composed of two groups of fibers. The cranial muscle (*ficc*) arises by a broad base on the dorsal wall of the head, and is inserted on a slender apodeme from the inner angle of the lobe. In the chilopod mandible, therefore, there is a basal plate (fig. 26 B, *BP*) corresponding with the cardo and stipes of the insect maxilla, but not divided as in the diplopods, and a free terminal lobe (*Lc*) which represents the lacinia. In retaining the connection of the adductor muscles with the hypopharyngeal apodemes, the chilopod mandible preserves the primitive condition shown by the maxilla of *Japyx* (fig. 30 B).

In the Crustacea and Hexapoda, the mandible, or the jaw part of the mandibular appendage, which may bear a palpus, consists of a single piece. Whatever may be the primitive elements that have entered into its composition, these elements are fused into a solid gnathal organ. There are, hence, never muscles entirely within the mandible, except those that pertain to the palpus, when a palpus is present. The mandibular musculature consists exclusively of the muscles that move the appendage as a whole, and these muscles correspond with the muscles of the basal plate of the myriapod mandible, or with those of the cardo and stipes of the insect maxilla.

In the phyllopod crustacean *Apus*, the large mandibles (fig. 27 A, *Md*) hang vertically from the wall of the mandibular segment (*IV*). Each is a strongly convex, elongate oval structure, attached to the lateral membranous wall of the head by most of its inner margins, leaving only a ventral masticatory part projecting below as a free lobe. A single, dorsal point of suspension (*a*) allows the base of the mandible to turn on its vertical axis, or to swing inward and outward as far as the membranous lateral head wall will permit. The musculature is correspondingly simple: two dorsal muscles from the tergum of the mandibular segment (*IV*) are inserted on the base of the jaw, one (*I*) on the anterior margin, the other (*J*) on the posterior margin; the hollow of the mandible is filled with a great mass of fibers (*KL*) which converge upon a median transverse ligament (*k*) that receives likewise the muscles from the opposite jaw. Here, then, is a ventral dumb-bell adductor, as in the diplopods, and two dorsal muscles, which may function either as protractors and reductors, or as anterior and posterior rotators. It is not clear as to what constitutes the mechanism

of abduction in appendages with this type of articulation and musculature.

The *Apus* type of mandible is probably characteristic of most of the more generalized Crustacea; it is present also in some of the

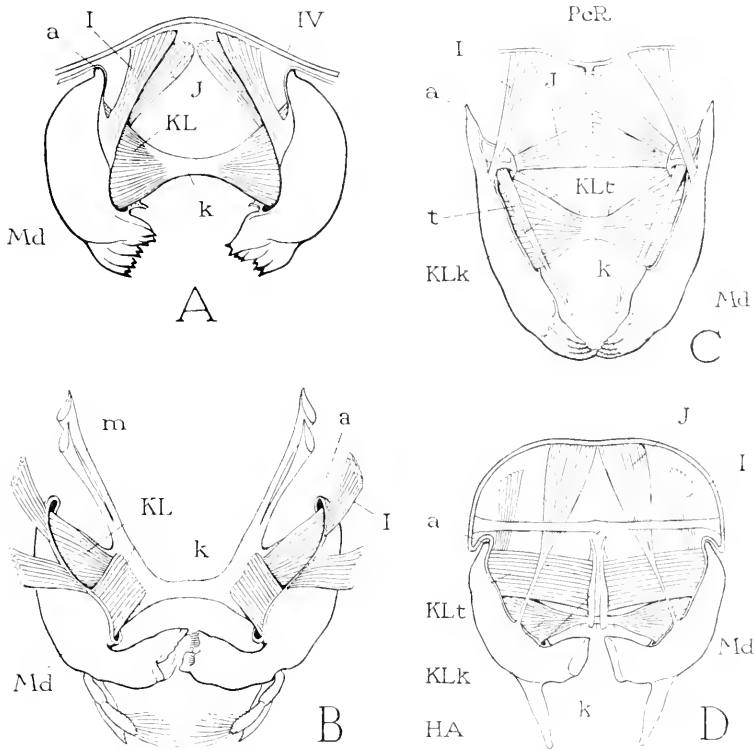

FIG. 27.—Mandibles of Crustacea and Apterygota.

A, mandibles of *Apus longicaudata* (phyllopod), anterior. B, mandibles of *Spirontocaris groenlandicus* (decapod), anterior. C, mandibles of *Heterojapyx gallardi* (apterygote insect), anterior (dorsal). D, mandibles of *Nesomachilis mauricus* (apterygote insect), posterior.

a, articulation of mandible with cranium, or with wall of mandibular segment (*IV*); *HA*, hypopharyngeal apophysis; *I*, promotor of mandible; *J*, remotor of mandible; *k*, median tendon of mandibular adductors of dumb-bell muscle (*KL* or *KLk*); *KLk*, fibers of mandibular adductors united by tendon (*k*); *KLt*, fibers of mandibular adductors retaining origin on hypopharyngeal apophyses (D, *HA*); *m*, suspensory tendons of mandibular adductors; *Md*, mandible; *PcR.*, posterior cranial ridge; *t*, branch of labral muscle attached on mandible.

decapods (*Virbius*, *Spirontocaris*). In *Spirontocaris* (fig. 27 B), the median ligament (*k*) of the dumb-bell adductors (*KL*) is connected with the hypodermis of the dorsal wall of the body by a branched arm (*m*) on each side. As before pointed out, however, the adductor liga-

ment is in no sense to be homologized with the tentorium as developed in some of the higher crustacea and in the pterygote insects. Each mandible of *Spirontocaris* is provided with two dorsal producer muscles (*I*), but a reductor was not observed. *Spirontocaris* preserves the primitive single dorsal point of articulation of the mandible (*a*) with the wall of its segment. In higher decapods, the amphipods, and the isopods, where the mandible may have a double hinge with the wall of the head, the musculature of the organ is modified in a manner to be described later.

The simple mechanism of the mandible of the higher pterygote insects is well understood; the complicated musculature of the mandible in Apterygota has been given scant attention, and the derivation of the pterygote jaw mechanism from that of the Apterygota has been almost ignored. Börner (1909) has given the first comparative account of the mandibular musculature in the more generalized insects, and has pointed out certain points of similarity with the musculature of higher crustaceans. He did not, however, carry his comparisons to the myriapods, and thereby missed some fundamental relations.

The mandibles of the Machilidae will serve best as an example of the more generalized apterygote jaw. The mandible of *Machilis* or of *Nesomachilis* (fig. 27 D, *Md*) is surprisingly similar in form to that of the crustacean *Apus* (*A*), except that it has a long incisor point in addition to a broad molar lobe. In this latter character the machilid jaw resembles the mandibles of some of the decapod crustaceans, such as *Spirontocaris* and *Virbius*, as has been pointed out by Crampton (1921b). The mandible of *Machilis* is suspended by a single dorsal point of articulation (*a*) against the lateral wall of the head. The cavity of the elongate base of each organ is filled by a mass of muscle fibers (*KLk*), and these fibers from the two mandibles converge upon the ends of a common transverse tendon (*k*) that passes through the base of the hypopharynx. Here, in an insect, therefore, we find the same type of dumb-bell adductor uniting the two mandibles as occurs in the Diplopoda and in lower Crustacea. In *Machilis*, however, there is a second and larger set of adductor fibers (*KLt*) which has its origin on the hypopharyngeal apodemes (*HLA*). *Machilis*, therefore, in the possession of two differentiated sets of mandibular adductor fibers, combines the primitive condition of the chilopods with the specialized condition of the diplopods and lower crustaceans. The tergal musculature of the mandible in *Machilis* is simple, consisting of an anterior promotor (*I*) and a posterior remotor (*J*). The two muscles are disposed exactly as in *Apus* (*A*), and are in entire

conformity with the tergal musculature of the basal plate of the jaw of *Scutigera* (fig. 26 B, C, I, J) and other chilopods.

The machilid type of mandibular musculature appears to be characteristic of most apterygote insects except the Lepismatidae. In *Japyx* and *Campodea*, the bases of the elongate mandibles and maxillae are deeply retracted into the head above the labium, and the edges of the labium are fused to the postgenal margins of the head, so that the distal edge of the labium appears as the ventral lip of a pouch containing the other gnathal appendages and the hypopharynx.

The mandibles of *Heterojapyx* (fig. 27 C, *Md*) are simple, slender organs, each consisting of a long, hollow basal piece, and of a more strongly chitinized free terminal lobe with a toothed incisor edge. The proximal tapering end of each jaw is set off from the rest by a thick internal ridge, superficially suggesting the division of the maxillary base into cardo and stipes; but the "division" in the *Japyx* mandible gives rigidity instead of flexibility. The two mandibles of *Heterojapyx* are connected by a large dumb-bell adductor muscle (*KLk*), the spreading fibers of which fill the basal cavities of the organs. Besides this muscle there are also sets of ventral fibers (*KLt*) to the mandible that arises on the hypopharyngeal apophyses. The tergal muscles of the mandibles are large: they include for each jaw an anterior muscle (*I*) arising against a dorsal cranial ridge (*PcR*), and a wide fan of posterior fibers (*J*) arising along a median coronal ridge. Because of the retraction of the mouth appendages, the hypopharyngeal muscles of the mandibles (*KLt*) would appear to function as protractors, and the tergal muscles as retractors; but the former are clearly the hypopharyngeal adductors of *Machilis* (D, *KLt*), and the latter the tergal promoters (*I*) and remoters (*J*). A peculiarity noted in *Heterojapyx*, if the writer observed correctly, is the attachment of a branch of the retractor of the labrum (*t*) on the base of the mandible.

In the Collembola, which also have retracted mandibles and maxillae, the mandibular musculature would appear, from Folsom's (1899) account of *Orchesella cincta*, to be of the same essential nature as that of *Japyx*. Folsom enumerates ten muscles for each mandible of *Orchesella*, but they all fall into three groups according to their origins, namely, muscles arising on the walls of the head, muscles arising on the "tentorium" (hypopharyngeal apodemes), and fibers from one mandible to the other. The second and third groups constitute the adductors of the jaw; their fibers are inserted, Folsom says, on the inside of the lateral wall of the mandible, and most of them have their origin on the "tentorium," but a few of the

fibers, he adds, "pass under the tentorium and become continuous with similar fibers from the opposite mandible." Folsom, it will be noticed, says the adductor fibers connecting the mandibles pass *beneath* the tentorial arms. In *Japyx* the tendon of the dumb-bell muscle distinctly lies dorsal to the hypopharyngeal apodemes. In *Machilis* the apodemes are so loosely connected with the base of the hypopharynx and so strongly united with the lateral inflections of the head wall, that in dissections their hypopharyngeal connections are easily lost, and the impression is given that the tendon of the dumb-bell

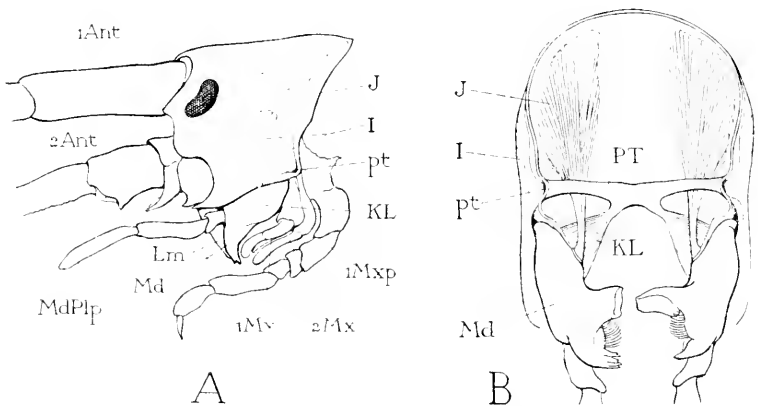

FIG. 28.—Head of *Gammarus locusta* (amphipod crustacean).

A, lateral view of head, showing tergal abductors (*I*) and adductors (*J*) of left mandible, and base of ventral adductor (*KL*). B, postero-ventral view of back of head, showing origin of ventral adductors (*KL*) on posterior tentorial bar (*PT*).

1Ant, first antenna; *2Ant*, second antenna; *I*, abductor of mandible; *J*, dorsal adductor of mandible; *KL*, ventral adductor of mandible; *Lm*, labrum; *Md*, mandible; *MdPlp*, mandibular palpus; *1Mx*, first maxilla; *2Mx*, second maxilla; *1Mxp*, first maxilliped; *pt*, posterior tentorial pit; *PT*, transverse posterior tentorial bar.

adductor lies ventral to the apodemes. It does lie ventral to the suspensorial plates uniting the apodemes with the lateral walls of the head, but it passes anterior, *i. e.*, dorsal, to the ends of the apodemes themselves. Folsom's statement, therefore, should be verified, for a discrepancy in the relations of the parts in question seems hardly permissible if we are dealing with homologous structures.

The mandibles of the Protura, as described by Berlese (1909), are provided each with retractors and protractors that have their origins on the head wall, and with a protractor arising on the tentorial apodeme. Berlese, however, does not mention a muscle continuous between the two mandibles. The muscles present clearly represent the usual tergal muscles, and the hypopharyngeal adductor.

In all the apterygote forms thus far described, the mandible has a free attachment to the head, being implanted by most of its length in the ventro-lateral membranous part of the head wall, and articulated to the margin of the chitinous cranium by only a single dorsal point of contact. In the Lepismatidae, a new condition is established in the mandible through the elongation of its dorsal base line forward and ventrally to the anterior end of the lower genal margin of the epicranium. The jaw thus becomes hinged to the head on a long basal axis extending from the primitive dorsal articulation, which is now *posterior*, to the angle between the genal margin of the head and the clypeus. At the latter point a secondary, *anterior* articulation is established between the mandible and the cranium. Börner (1909) describes the articulation of the mandible of *Lepisma*, but he does not observe that its type of structure is characteristic of the Lepismatidae only, not of the Apterygota in general. The alteration in the mandibular articulation involves a change in the entire mechanism of the jaw, and initiates the series of modifications that have led to the evolution of the pterygote type of mandibular musculature from that of *Machilis*, *Japyx*, and the Collembola.

The musculature of the mandible of *Lepisma*, as described by Börner (1909), is apparently almost the same as that of *Machilis*. The adductor muscles inserted within the body of the mandible consist of a large dorsal set of fibers (fig. 29 B, *KLt*) from the tentorium representing the fibers that arise on the hypopharyngeal apodeme of *Machilis* (figs. 27 D, 29 A, *KLt*), and of a small ventral set (*KLh*) arising directly from the hypopharynx. The tergal muscles comprise a pair of abductors (*I*) inserted on the outer margin of the mandibular base between the two articular points (*a*, *c*), and a large dorsal adductor (*J*) inserted on the inner margin mesad of the posterior articulation. The tergal abductors and adductor, however, are clearly the promotor and the remotor of the mandible of *Machilis* (fig. 29 A, *I*, *J*) and of all other generalized forms, which have assumed a new function by reason of the change in the nature of the mandibular articulation.

The structure and musculature of the mandible in nymphs of Ephemera is essentially the same as in *Lepisma*. Börner describes and figures the nymph of *Cloëon dipterum*, showing the presence of a large tentorial adductor and a very small hypopharyngeal adductor, in addition to the dorsal abductors and adductors; the writer has verified the existence of all these muscles in another ephemera species. In a dragonfly nymph, *Aeschna*, a small hypopharyngeal adductor was found, but no tentorial fibers were observed. In the

orthopteron, *Locusta*, Börner shows two small tentorial adductors of the mandible (fig. 29 C, *KLt*), and a small hypopharyngeal adductor (*KLh*). The same muscles the writer has found in *Microcentrum*, the hypopharyngeal fibers being attached medially on the tips of the rudimentary suspensorial arms of the hypopharynx (fig. 20 D, *KLh*); but no trace of either set could be discovered in the acridid, *Dissosteira*. Mangan (1908) described in the roach, *Periplancta australasiac*, both a tentorial adductor and a hypopharyngeal adductor. The first

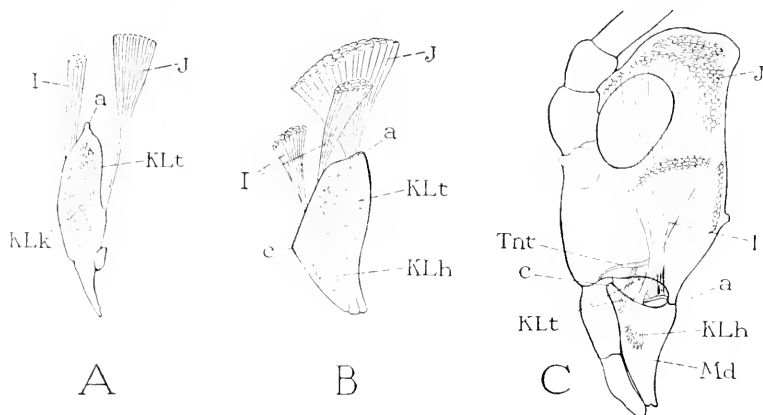

FIG. 20.—Three stages in the evolution of the mandibular mechanism in biting insects.

A, mandible of *Machilis*, outer surface, with single dorsal point of articulation (*a*) with cranium; the jaw moved by tergal promotor (*I*) and remotor (*J*), and by ventral adductors (*KLk*, *KLt*, see fig. 27 D).

B, mandible of *Lepisma* (from Börner, 1909), articulated with cranium on long basal hinge inclined downward anteriorly from dorsal articulation (*a*) to anterior articulation (*c*); the promotors (*I*) here become abductors, and the remotor (*J*) becomes a tergal adductor; ventral adductor (*KLh*, *KLt*) retained.

C, head of *Locusta* (from Börner, 1909), showing common type of mandibular articulation in pterygote insects, with hinge line inclined downward posteriorly from anterior articulation (*c*) to posterior articulation (*a*); tergal abductors and adductors (*I*, *J*) highly developed, ventral adductors (*KLh*, *KLt*) rudimentary. In higher Pterygota the ventral adductors disappear.

mention of either of these muscles is by Basch (1865), who found the tentorial adductor in the mandible of *Termes flavipes*.

The adductor fibers arising directly from the base of the hypopharynx are evidently remnants of the primitive sternal adductors that have retained their original connections. In the insects, therefore, the primary, sternal adductor muscles (*KL*) of the mandibles have become differentiated into three groups of fibers, the fibers of one group (*KLh*) retaining the primitive sternal connection, those of the second (*KLt*) being carried inward upon the sternal (hypopharyngeal) apophyses, those of the third (*KLk*), after having united medially

with the corresponding set from the opposite mandible, having been detached from all connections except their points of insertion on the mandibles. With the change in the mandibular articulation from a single dorsal suspensory point to a long basal hinge, the primary adductors have lost their importance, and the function of adduction has been secondarily taken over by the primary tergal remotor, while the original tergal promotor becomes the abductor. Remnants of the primary adductors in insects having a hinged mandible persist in the Lepismatidae, Ephemera, Orthoptera, and Isoptera, but in the higher orders they have disappeared.

A still further evolution in the mandibular base has reversed the tilt of the hinge line. Instead of sloping from the posterior articulation downward and forward, as it does in *Lepisma* and in some ephemerid nymphs, the base of the jaw in all higher insects is inclined from the anterior articulation downward and posteriorly (fig. 20 C). This change in the slope of the axis of the hinge causes the apex of the jaw to swing inward and posteriorly during adduction, instead of inward and anteriorly as in the first condition.

In the higher decapod crustaceans, and in the amphipods and isopods, the mandible has undergone an evolution parallel to that which has taken place in insects. Börner (1909) has described the mandible and mandibular musculature of *Gammarus*, an amphipod, and has shown the structural similarity with the mandible of *Lepisma*. In *Gammarus locusta* (fig. 28 A) the mandible is hinged to the cranium by its long base, which slopes downward and forward from the posterior point of articulation. The primitive tergal promotor muscle (*I*) has then become an abductor, and the remotor (*J*) has become a dorsal adductor. The primitive ventral adductor (*KL*) has its origin on a well-developed transverse tentorial bar (B, *PT*) passing through the back of the head; a hypopharyngeal branch of the adductor is lacking. In the crayfish (*Astacus*), Schmidt (1915) describes an anterior ventral adductor of the mandible arising on the anterior end of the ventral head apodeme. In the isopods the mandible attains a stage almost exactly comparable with that of the higher pterygote insects (fig. 17 F)—the basal hinge line of the jaw slopes posteriorly and downward, and the only muscles present, so far as the writer could find, are the tergal abductors and adductors.

The homologues of the mandibles in Niphosura and Arachnida, the so-called pedipalps (fig. 17 J, *Pdp*), scarcely need consideration here. The pedipalps never attain a jaw-like form, but retain always the structure of a jointed limb, though the basal segment may develop a strong gnathal lobe.

THE FIRST MAXILLAE

The leading features of the first maxilla have been sufficiently noted in the description of a generalized gnathal appendage (page 60) based on the maxilla of *Periplaneta* (fig. 25). In none of the other arthropods are the maxillary appendages so highly developed as in the insects, but, in all the arthropods, it appears that the mandible has been evolved from an appendage that was originally very similar

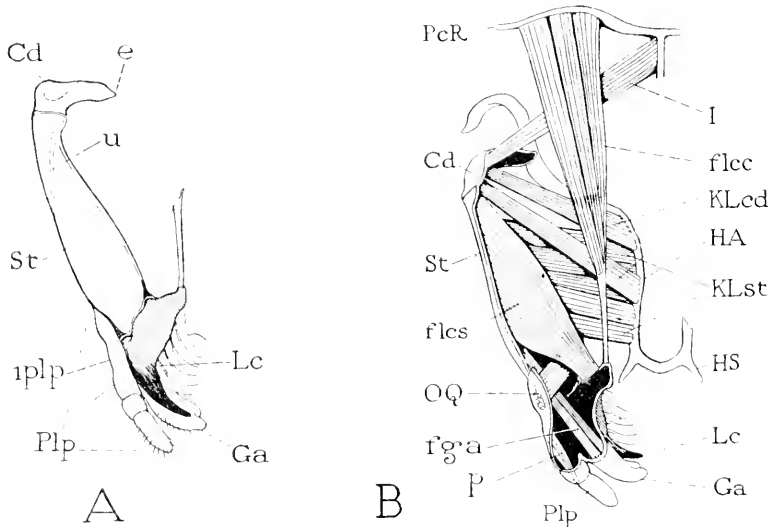

FIG. 30.—Maxilla of *Heterojapyx gallardi*.

A, left maxilla, posterior (ventral) surface. B, right maxilla and muscles, anterior (dorsal) view.

Cd, cardo; *e*, articulation of cardo with cranium; *f_{ga}*, flexor of galea; *flec*, cranial flexor of lacinia; *flec*, stipital flexor of lacinia; *Ga*, galea; *HA*, hypopharyngeal apophysis; *HS*, rudiment of suspensorial arm of hypopharynx; *I*, promotor of cardo; *KLcd*, adductors of cardo; *KLst*, adductors of stipes; *Lc*, lacinia; *OQ*, muscle of base of palpus; *p*, muscle of terminal segment of palpus; *PcR*, posterior cranial ridge; *Plp*, palpus; *lplp*, first segment of palpus; *St*, stipes; *u*, line of internal ridge of stipes.

to the generalized insect maxilla. In many of the higher insects the maxillae, too, have become specialized, always in adaptation to special modes of feeding, but a description of the modifications involved is beyond the scope of the present paper. The musculature of the organ is essentially the same in all groups of biting insects, except as it suffers a reduction where the appendages become reduced or united with the labium.

The maxilla of *Japyx* (fig. 30) presents a more generalized condition in its relation to the head than does the maxilla of the roach,

in that the head apophyses (B, *HA*) upon which the adductor muscles of the appendages arise are still connected with the hypopharynx, whereas in *Periplaneta* the corresponding endoskeletal arms have lost their primitive sternal connections and have become a part of the tentorium. The adductors of the cardo in *Heterojapyx* (fig. 30 B, *KLcd*) are well differentiated from those of the stipes (*KLst*), and cross obliquely the inner ends of the latter. The promotor of the cardo (*I*) arises against a median ridge of the dorsal wall of the cranium. The lacinia (*Lc*), which is mostly covered dorsally by the galea, has a broad flexor arising within the stipes (*flcs*), and a large cranial muscle (*flcc*) arising against the dorsal cranial ridge (*PcR*) on the top of the head, and going dorsal to the other muscles of the appendage to be inserted on a slender apodeme from the inner angle of the lacinial base. The galea (*Ga*) is provided with a single long flexor (figs. 30 B, 31 D, *fga*) arising within the stipes, which splits into two bundles of fibers toward its insertion on the ventral wall of the base of the galea. The palpus (*Plp*) is reduced and otherwise modified as compared with that of the roach (fig. 25), consisting of only three segments, of which the basal one (figs. 30 A, 31 D, *1plp*) is much elongate and is united with the outer wall of the base of the galea (*Ga*). There might be some question as to the homology of this basal region of the palpus of *Japyx*, but the insertion upon its base of the muscle (*OQ*) from the stipes, evidently representing the usual pair of palpal muscles, and the origin within it of a muscle (*p*) going to the distal segment of the palpus identify the part in question as the true basal segment of the palpus.

The cardo and the stipes of many insects appear externally to be divided into sub-sclerites, but in most such cases it is found that the so-called "sutures" are but the external lines of inflections that have formed internal ridges, the ridges being developed either for giving strength to the sclerite, or to furnish special surfaces for muscle attachment. The cardo of *Periplaneta*, for example (fig. 25 A, *Cd*), has a "divided" appearance externally, but when examined from within (B) it is seen that the regions apparent on the surface result from the presence of a strong Y-shaped ridge (*r*) on the inner wall, which extends distally from the base to reinforce with its diverging arms the extremities of the hinge line with the stipes. This structure of the cardo is characteristic of other orthopteroid insects. Crampton (1916) distinguishes the area of the cardo between the arms of the ridge as the "veracardo," and calls the rest of the sclerite the "juxta-cardo." The terms may have a descriptive convenience, but they are misleading if taken to signify a division of the cardo into two parts.

The stipes is usually marked by a prominent groove parallel to its inner edge (fig. 25 A, *q*), setting off a narrow marginal strip. The groove is here likewise but the external line of an internal ridge or plate upon which are inserted the adductor muscles of the stipes (B, *KLst*). Crampton designates the area of the stipes external to the ridge as the "verastipes," and that mesad to it as the "juxta-stipes." In *Heterojapyx* the basal part of the stipes is strengthened by an internal ridge (fig. 30 A, *u*) that forks proximally to the ends of the hinge line with the cardo.

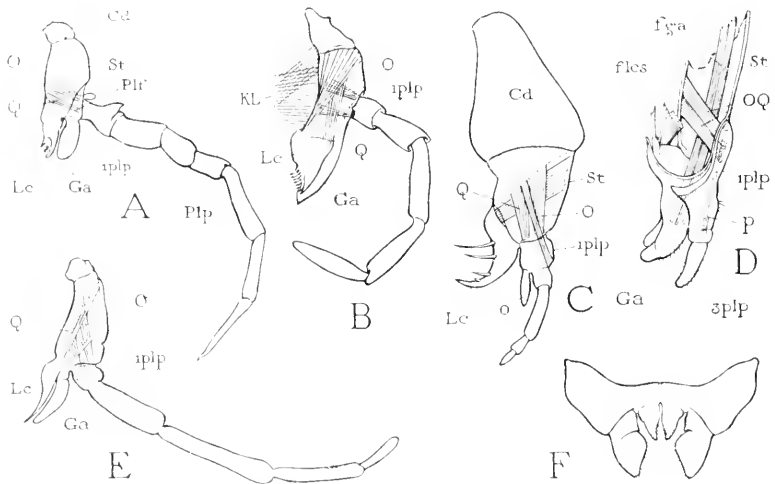

FIG. 31.—Maxillae of insects and of a chilopod.

A, maxilla of *Nesonmachilis*. B, maxilla of *Thermobia* (Lepisuatidae). C, maxilla of larva of *Sialis*. D, terminal part of maxilla of *Heterojapyx*. E, maxilla of an adult stonefly (*Pteronarcys*). F, first maxillae of a chilopod (*Lithobius*).

Base of palpus to be identified by insertions of levator and depressor muscles (*O*, *Q*); the palpifer (*Pfp*) has no muscles, and appears as a mere subdivision of stipes; in *Sialis* larva (C), lobe *o* is not the galea, but an endite of first segment of palpus (*1pip*), the latter identified by its muscles (*O*, *Q*).

The ventral, or distal, end of the stipes bears the lacinia and galea, and to its lateral surface is attached the palpus. The lacinia and galea are movable lobes, each being provided with muscles having their origin in the stipes, by which they can be flexed posteriorly (or ventrally if the mouth appendages are horizontal). The lacinia, in addition, has a muscle from the cranial wall inserted on the inner angle of its base, which gives it a mesal flexion, or adduction. The base of the galea commonly overlaps anteriorly the base of the lacinia.

The maxillary palpus arises from the outer wall of the stipes, usually only a short distance proximal to the base of the galea. The

area supporting the palpus is frequently differentiated from the rest of the stipes, and is then distinguished as the palpifer (fig. 31 A. *Plf*). When the delimiting suture of the palpifer region extends to the galea, the palpifer appears to support both the galea and the palpus. *That the palpifer is not a segment of the appendage is shown by the fact that muscles neither arise within it nor are inserted upon it.* The muscles that move the palpus as a whole have their origins within the main part of the stipes, and always pass through the palpifer, if the latter is present, to be inserted on the proximal segment of the palpus (figs. 25 C, 31 A-E. *O*, *Q*). The palpus muscles, then, may be taken as identification marks of the true basal segment of the palpus. Since they are typically inserted one dorsally and the other ventrally, relative to the vertical axis of the appendage, they are evidently a levator (*O*) and a depressor (*Q*) of the palpus. The number of segments in the maxillary palpus varies much in different insects. *Machilis* perhaps presents the maximum number of seven (fig. 31 A): the palpus of the roach with five segments is more typical (fig. 25). Evidence will later be given indicating that the palpus is the telopodite of the maxillary appendage, and that its basal articulation with the stipes, or palpifer, is the coxo-trochanteral joint of a more generalized limb (fig. 35 A, B, C, *ct*). A joint near the middle of the palpus (figs. 25 C, 35 A, B. *ft*) often suggests the femero-tibial flexure.

THE SECOND MAXILLAE

The second maxillae of insects are unquestionably united in the labium. The correspondence in external relations between the parts of each half of a typical labial appendage and those of an entire maxilla is so close that most entomologists have not hesitated to assume an homology of the submentum (figs. 32 A, 40 D, *Smt*) with the cardines, of the mentum (*Mt*) with the stipites, of the glossae (*Gl*) with the laciniae, and of the paraglossal (*Pgl*) with the galeae. Some writers, however, have contended that the submentum, or both the submentum and the mentum represent the sternum of the labial segment. Thus, Crampton in a recent paper (1928) adopts the idea of Holmgren (1909) that the submentum and mentum are derived from the sternum of the labial segment.

In an orthopteroid labium (fig. 40 D), the muscles of the palpi (28, 29), and the muscles of the terminal lobes (25) arise in the mentum (*Mt*), and this relation, together with the presence of muscles from the mentum to the tentorium (23, 24), must certainly identify the region of the mentum in the labium with that of the stipes in a

first maxilla (fig. 40 B, *St*). The wall of the mental region, however, may not be entirely or continuously chitinized (fig. 32 A), and, hence, a distinction must be drawn between the entire region of the mentum, and the area occupied by one or more mental sclerites. The labium may contain muscles not represented in the maxillae, such as the muscles associated with the orifice of the salivary duct in the grasshopper (fig. 40 D, 26, 27), or with the silk press in the caterpillar (figs. 53 C, D, 54, A, B, C, 17, 18, 19).

The submentum corresponds functionally at least with the cardines of the maxillae, since it serves to attach the labial appendage to the walls of the head. The lateral articulation of its basal angles to the

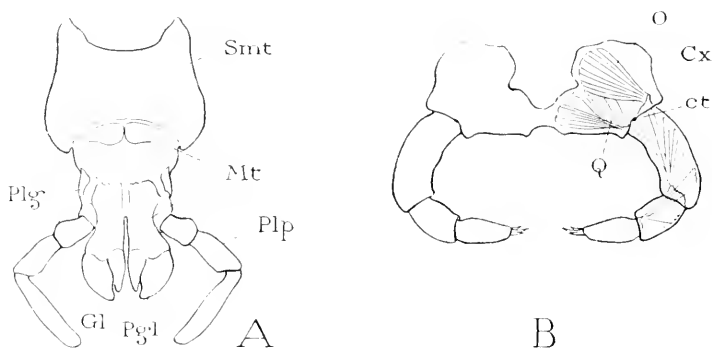

FIG. 32.—Second maxillae.

A, typical second maxillae of an insect (*Periplaneta*) united to form the labium. B, second maxillae of a chilopod (*Lithobius*) united by inner angles of coxae.

ct, coxo-trochanteral joint; Cx, coxa; Gl, glossa; Mt, mentum; O, levator muscle of telopodite (palpus); Pgl, paraglossa; Plg, palpiger; Plp, palpus; Q, depressor muscle of telopodite (palpus); Smt, submentum.

margins of the cranium in orthopteroid insects (figs. 18 B, C, 36 C, f) suggests, moreover, that the points of attachment are the true basal articulations of the second maxillae with the cranium, corresponding with the articulations of the cardines (*e*) in the first maxillae. It is possible, of course, that a median part of the labial sternum has been incorporated into the submentum. To accept the proposal, however, that the entire submentum is the sternum of the labial segment, is to assume that the sternum itself has become articulated laterally to the tergum of its segment, and that it alone bears the segmental appendages. Such assumed relations violate the basic principles of segmental morphology, and thus throw suspicion on the evidence given in their support.

It will be shown in the next section of this paper that the *cardines* of the maxillae are not true proximal segments of the maxillary appendages, but are secondary subdivisions of the bases of these appendages. It appears probable, therefore, that the submentum represents likewise proximal subdivisions of the bases of the second maxillae, retaining the lateral articulations with the margins of the cranium in generalized insects (fig. 36 C, f), and perhaps including between them a median part of the labial sternum.

If the insect labium (figs. 32 A, 40 D) is compared with the second maxillae of a chilopod (fig. 32 B), it will be seen that the united basal segments of the latter (*Cx*), containing the origins of the palpal muscles (*O*, *Q*), correspond at least with the mentum of the labium. The large proximal segments of the chilopod maxillae are clearly the bases of a generalized limb, the coxae, according to Heymons (1901), and the limb base, or a subcoxal division of it, bears the primitive dorsal articulation of the appendage with the body. The mentum, and at least the lateral parts of the submentum, therefore, appear to be subdivisions of the primary bases of the second maxillary appendages, corresponding with the stipites and cardines of the first maxillae in insects, and with the similar subdivisions of the bases of the mandibles in the diplopods (fig. 26 A, *Cd*, *St*).

The median, terminal duct of the labial, or "salivary," glands opens anterior to the labium, and, in typical forms, at the base of the mentum (figs. 18 D, 19, *SIO*). The position of the orifice, anterior to the submentum, however, does not argue that the latter is entirely the sternum of the labial segment, but rather the reverse, for it is likely that the orifice of the duct has not left the sternal region of its segment, and that it has been crowded forward in the latter by the median approach of the labial cardines. The common duct of the labial glands results during embryonic development from the union of the two primary ducts of paired lateral glands of the labial segment.

MORPHOLOGY OF THE GNATHAL APPENDAGES

It has often been assumed that the segmental appendages of all arthropods are derived from a primitive limb having a biramous type of structure. A two-branched limb, however, occurs actually only in the Crustacea, and there is no certain evidence of a biramous limb structure ever having prevailed in other arthropod groups. In all forms, including the Crustacea, the segmental appendages first appear in the embryo as simple protuberances of the body wall, and some zoologists now believe that the exopodite branch, when present, is

merely a specially developed exite lobe of a single shaft. Borradaile (1917) expresses the opinion that "probably the primitive crustacean appendage resembled that of the Branchiopoda in being uniramous." Movable lobes individually provided with muscles, however, may be developed along both the outer and the inner margin of the limb, and an excessive development of one of the outer lobes might give rise to

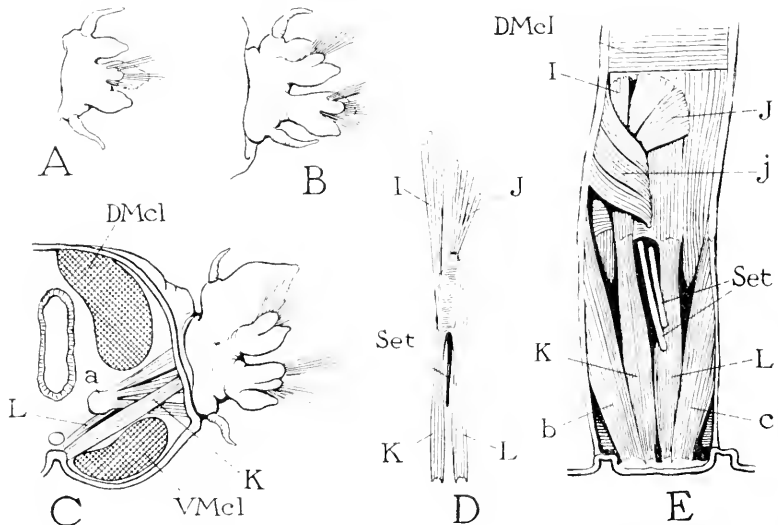

FIG. 33.—Parapodium and parapodial musculature of an annelid worm (*Nereis virens*).

A, B, first and third parapodia, left, anterior surfaces.

C, cross section of left half of a segment from middle of body, cut anterior to base of parapodium, showing muscles of setae inserted on end of setal pouch (*a*), and ventral promotor (*K*) and remotor (*L*) muscles of parapodium. *DMcl*, *VMcl*, dorsal and ventral bands of longitudinal body muscles.

D, musculature of third parapodium, right, inner view, showing tergal promotor (*I*) and remotor (*J*), and sternal promotor (*K*) and remotor (*L*).

E, musculature of right side of a segment from middle of body, internal view, lateral oblique muscles and setal muscles removed: *b*, *c*, anterior and posterior pleuro-sternal muscles; *DMcl*, part of dorsal longitudinal muscles; *I*, tergal promotor of parapodium; *J*, tergal remotor; *j*, accessory remotor arising anteriorly from intersegmental fold; *K*, sternal promotor; *L*, sternal remotor; *Set*, bases of setae.

a secondary biramous structure of the appendage. Hansen (1925) recognizes the definitive two-branched structure of the typical crustacean appendage, but he says it seems "impossible to deny the possibility that the exopod may be analogous with the epipod, and if so the primitive appendage is uniramous."

The segmental appendages, or parapodia, of the polychaete annelids are in some cases simple lobes; in others they are of a two-branched

structure owing to the presence of two groups of setae on each (fig. 33 B, C). In *Nereis virens*, though most of the parapodia are distinctly cleft, those of the first and second segments do not have the double structure (fig. 33 A). Whatever relations, however, may be traced, or assumed to exist, between the annelids and the arthropods, the relationship must be presumed to have come through a remote worm-like ancestor common to both groups, for none of the highly organized modern annelids can be taken to represent the ancestral form of the arthropods.

A comparative study of the legs of mandibulate arthropods will show that in each group there is a maximum of seven limb segments, beyond a subcoxal base, that are individually provided with muscles. The relative size and form of the segments, the character of the articulations, and the nature of the musculature present many variations, and it is not to be assumed that segments are to be homologized in all cases by their numerical order beyond the base of the limb.

The gnathal appendages undoubtedly constitute a group of organs that are individually homologous in arthropod groups, whether their segments are united with the protocephalon to form a larger head, or with the body segments following. The similarity of the structure of the mandible in all the eugnathate arthropods, and the common plan of its musculature, allowing for modifications of which the evolution can easily be followed, leave no doubt concerning the identity of the jaw in the various groups, or that the jaw attained its basic structure in some very remote common ancestor. The primitive structure of the mandible is not entirely preserved in any arthropod: in the Diplopoda and Chilopoda the movable lacinia is retained, but the palpus has been lost; in the Crustacea and Hexapoda, the lacinia has lost its independent mobility and has become solidly fused with the base of the appendage, but in many crustaceans a mandibular palpus persists.

The first maxilla of the Hexapoda has the structure of a generalized mandible, *i. e.*, it consists of a base supporting a palpus and at least one movable lobe, the lacinia, though generally there is present a second lobe, the galea. The insect labium consists of a pair of appendages that probably once had the structure of the first maxillae. In the Chilopoda the maxillary appendages appear to have undergone but little modification of structure, and those of the second pair still retain a form similar to that of the body appendages. The corresponding appendages of the Diplopoda are now so highly specialized that it is useless to speculate as to their earlier form. In the Crustacea both pairs of maxillae have been reduced in size and modified

in structure to serve as organs accessory to the mandibles, but they have not attained the highly specialized form of the corresponding appendages of insects.

We may conclude, therefore, that in the common ancestor of the several groups of modern eugnathate arthropods, the mandible alone had attained a gnathal function, and that in form and structure it resembled the maxilla of a present day insect, though perhaps lacking a galea, or outer endite lobe of the base. The two maxillae at this period were more or less modified to serve as organs accessory to the mandibles.

When the modern groups of arthropods were differentiated, the mandible, in the Diplopoda and Chilopoda, retained the movable lacinia, but lost the palpus; in the Crustacea and Hexapoda, the lacinia fused with the base of the appendage to form a solid jaw, while the palpus was preserved by the crustaceans, and lost by the insects. The two maxillary appendages retained the leg-like form in the Chilopoda; in the Diplopoda they became highly specialized in a manner peculiar to the diplopod group; in the Crustacea and Hexapoda they were modified for an accessory gnathal function, but in the insects they acquired a form almost identical with that of a primitive mandible. Finally, in the insects, the second maxillae united basally to form the labium. While the insect maxilla appears to be a highly specialized appendage, it will be shown that its basic structure is not far removed from that of a thoracic leg.

While the status of the gnathal appendages relative to one another in the various groups of the eugnathate arthropods seems fairly clear, it is a more difficult matter to homologize their parts with the segments of the ambulatory appendages. The structure of the first and second maxillae of a chilopod, or of the first maxilla of an insect, suggests that the gnathal appendages have been derived from an appendage of the ambulatory type—the insect maxilla is certainly more like the leg of an insect, a chilopod, or a decapod than it is like one of the body appendages of *Apus* (fig. 35 C), or of any other of the lower crustaceans in which the appendages are used for swimming. This condition suggests, therefore, that the ambulatory leg more nearly represents the primitive type of arthropod limb than does an appendage, such as that of *Apus*, clearly modified for purposes of purely aquatic locomotion. If we consider, furthermore, that the appendages of the chelicerate arthropods (Xiphosura and Arachnida) are also of the ambulatory type, the evidence becomes all the more convincing that the primitive arthropod limb was a walking leg and not a swimming organ. If this deduction is acceptable, we must conclude that

the Crustacea represent a group of arthropods that have secondarily adopted an aquatic life, and that, while certain forms have become thoroughly adapted to a free life in the water, others have retained, with but little modification, some of the organs that were developed primarily for terrestrial locomotion. This view, perhaps, is contrary to generally accepted ideas concerning the evolution of the arthropods, but it is clearly futile to attempt to derive the appendages of arthropods in general from the swimming appendages of Crustacea.

If the ambulatory limb be taken as more nearly representative of the basic structure of an arthropod appendage than is the natatory

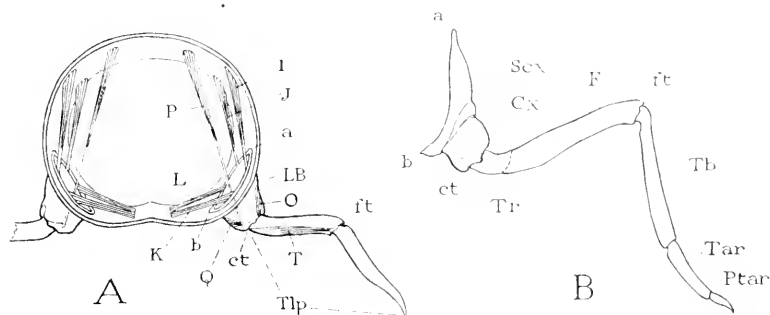

FIG. 34.—Generalized segmentation and musculature of an insect leg, diagrammatic.

A, theoretical segmentation and musculature of a primitive arthropod leg, anterior view: the appendage, consisting of a *limb base* (LB), and a *telopodite* (Tlp) of two segments, moved forward and backward on vertical basal axis (*a-b*) by tergal and sternal promotors (*I, K*), and tergal and sternal remotors (*J, L*).

D, definitive segmentation of an insect leg by division of limb base (*A, LB*) into subcoxa (*Scx*) and coxa (*Cx*), and by subsegmentation of first part of telopodite into trochanter and femur, and of second part into tibia, tarsus, and praetarsus.

a-b, basal axis of limb base; *ct*, coxo-trochanteral joint; *Cx*, coxa; *F*, femur; *ft*, femoro-tibial joint; *I*, tergal promotor; *J*, tergal remotor; *K*, sternal promotor; *L*, sternal remotor; *O*, levator of telopodite; *P*, tergal depressor of telopodite (characteristic of insects); *Ptar*, praetarsus; *Q*, depressor of telopodite; *Scx*, subcoxa; *T*, depressor of distal segment of telopodite; *Tar*, tarsus; *Tb*, tibia.

limb, we have only to inquire as to what was its probable form in the ancestors of terrestrial arthropods. The primitive appendage undoubtedly turned forward and backward on a vertical axis through its base (fig. 34 A, *a, b*), as does the parapodium of a modern polychaete annelid (fig. 33 A, B, C). For walking purposes, however, the limb must have acquired joints, and, as Börner (1921) has shown, the simplest practical condition would demand at least *two* joints with vertical movements (fig. 34 A), one near the union of the leg with the body (*ct*), dividing the limb into a *basal piece* (LB) and a *telopodite*

(*Tlp*), and one (*ft*) near the middle of the telopodite. These primary joints persist, evidently, as the coxo-trochanteral joint (*B, ct*) and the femero-tibial joint (*ft*) of the leg (*Hüftgelenk* and *Kniefelenk*, according to Börner). The type of leg-segmentation resulting from two joints so placed applies at least to the Chilopoda, Diplopoda, Hexapoda, and Crustacea; in the Xiphosura and Arachnida, however, it is possible that the mechanism of the leg is given by three primary joints, the second and third setting off a horizontal middle section of the leg (patella).

The further segmentation of the limb has been produced by the subdivision of the principal parts of the telopodite. In the mandibulate arthropods (fig. 34 B), one or two small segments cut off from the basal end of the proximal piece of the telopodite form the trochanters (*Tr*), while the rest of this part becomes the femur (*F*); the distal section beyond the knee joint (*ft*) subsegments into the tibia (*Tb*), tarsus (*Tar*), and praetarsus (*Ptar*). This type of segmentation is clearly shown also in the maxillipeds or in any of the anterior body appendages of *Apus*. In the third maxilliped (fig. 35 C) there are two principal flexures, one (*ct*) between the limb base (*LB*) and the telopodite (*Tlp*), the other (*ft*) beyond the middle of the latter. The part between the two points of flexure is the femur (*F*) with two indistinctly separated trochanters (*Tr*); that beyond consists of two shortened segments, and the terminal praetarsus, or dactylopodite. The limb base of *Apus* is entire, but in some arthropods the basis appears to have become subdivided into a coxa (fig. 34 B, *Cx*) and a subcoxa (*Scx*). The coxa may then become the free functional base of the appendage, since the subcoxa usually forms a chitinization in the pleural or the sternal wall of the segment.

The primitive musculature of the limb base was such as to swing the appendage forward and backward; it must have comprised, therefore, promotor and remotor muscles. Probably there was a tergal promotor (fig. 34 A, *I*) and a tergal remotor (*J*), and a sternal promotor (*K*) and a sternal remotor (*L*). In a thoracic leg of an insect, the base of the telopodite is provided with a depressor muscle (*P*) having its origin on the tergum of the segment, which greatly increases the lifting power of the appendage, but this muscle is not to be considered as a primitive element of the limb musculature. The usual levator and depressor muscles of the telopodite (*O, Q*) have their origin within the limb base.

The simple type of musculature shown in figure 34 A, and here assumed to be the primitive musculature of an arthropod limb base, is actually present in typical form in the simpler anterior parapodia

of the annelid, *Nereis virens* (fig. 33 D). Here a dorsal promotor and a remotor (*I, J*) arise on the tergal wall of the segment, and a ventral promotor and a remotor (*K, L*) on the midline of the sternal wall. The ventral muscles are repeated regularly in all the segments of the worm (*C, E, K, L*), but in the more posterior segments the dorsal muscles, though present (*E, I, J*), are less symmetrical in arrangement, and the primary remotor (*J*) is subordinated to a large oblique remotor (*j*) that arises on the anterior margin of the segment. This last muscle is described by Börner (1921) as being the typical dorsal remotor of the parapodium, but by comparison with the simpler anterior appendages (*D*) it appears to be a secondary acquisition, for the muscle (*E, J*) dipping beneath it has the same insertion on the parapodial base as that of the tergal promotor of the anterior parapodium (*D, J*). Börner's claim, however, that this simple type of limb musculature presented by *Nereis* must represent the primitive motor mechanism of an appendage turning forward and backward on a vertical axis through its base is scarcely to be questioned.

The basal muscles of an appendage do not necessarily retain their original functions, nor their primitive simplicity, for an alteration in the basal articulation of the appendage may change the fundamental movements of the limb, and thereby give quite a different action to the muscles, which, in turn, may shift in position, or become split up into segregated groups of fibers, thus multiplying the number of individual muscles actually present.

Returning now to a further consideration of the muscles of the gnathal appendages of the arthropods, it is not difficult to draw a parallel between the musculature of a mandible, or of an insect maxilla, and that of the annelid parapodium (fig. 33 D, E), or with the hypothetically primitive musculature of an arthropod limb base as expressed in figure 34 A. In the mandible of *Scutigera* (fig. 26 B, C), *Apus* (fig. 27 A), *Heterojapyx* (fig. 27 C), *Nesomachilis* (fig. 27 D), a tergal promotor (*I*) and a remotor (*J*) have the typical relation to the appendage. In some forms the tergal remotor appears to be lacking (Diplopoda, fig. 26 A; *Spirontocaris*, fig. 27 B). The cranial flexor of the mandibular lacinia in diplopods and chilopods (fig. 26 A, B, C, *flcc*) is probably derived from the tergal promotor, since it arises on the dorsal wall of the head and goes dorsal (anterior) to the ventral muscles. The sternal promotor and remotor, which are distinct muscles in the annelid parapodium (fig. 33 C, D, E, *K, L*), are united in the gnathal appendages of the arthropods, where they become ventral adductors (*KL*) as a result of the free movement

of the base of the appendage on a single dorsal point of articulation (*a*).

The adductor fibers of the mandible may all retain their connection with the sternal, or hypopharyngeal, apophyses (Chilopoda, fig. 21 B), or they may become detached from the apophyses and united with the fibers from the opposite jaw to form a transverse dumb-bell muscle (Diplopoda, fig. 26, A, *KL*; some Crustacea, fig. 27 A, B; most Apterygota, fig. 27 C, D, *KLk*), though at the same time some of the fibers may retain their connections with the apophyses, or with the tentorium (Apterygota, fig. 27 C, D, *KLt*; Orthoptera, fig. 29 C, *KLt*) or with the base of the hypopharynx (*Lepisma*, fig. 29 B, *KLh*; *Locusta*, fig. 29 C, *KLh*; *Microcentrum*, fig. 20 D, *KLh*; ephemerid nymph, fig. 20 A, *KLh*). The evolution of the mandibular muscles in the higher insects has been detailed in an earlier paragraph, wherein it was shown that the ventral adductors are reduced and finally obliterated after the jaw has acquired a double hinge with the edge of the cranium, and that the tergal promotor and remotor muscles then become respectively the functional abductors and adductors.

The basal musculature of the insect maxilla, as already shown, coincides almost exactly with the basal musculature of the mandible of a diplopod or a chilopod, and may be derived from the simple plan of the musculature of the annelid parapodium. The tergal promotor is evidently separated into two groups of fibers inserted on the dorsal and ventral extremities of the anterior rim of the appendage base, the upper set being the muscle of the cardo (figs. 25 C, 30 B, *I*), the lower set the cranial flexor of the lacinia (*flcc*). A tergal remotor is lacking in the insect maxilla, but so it appears to be also in the diplopod mandible (fig. 26 A). The sternal promotor and remotor muscles (figs. 33 D, E, 35 B, *K*, *L*) are united, as in the mandible, to form a ventral adductor (*KL*), the fibers of which almost always retain their origin on the hypopharyngeal apophyses, or on the corresponding part of the tentorium, and are distributed to both the cardo and the stipes (figs. 25 C, 30 B, *KLcd*, *KLst*). In *Machilis* the maxillary adductors from opposite appendages are united with each other medially, and appear to be detached from the ventral apophyses.

The margin of the basal cavity of the maxilla (fig. 35 A) includes the region of the cardo, the stipes, and the lacinia: and the tergal and sternal muscles (*I*, *J*, *KL*) of the appendage are distributed to these three parts. *The entire base of the maxilla, therefore, has the fundamental character of a single segment, and there can be no doubt that this segment is the true primitive base of the appendage (fig. 34 A, LB).* The base of a leg appendage may be divided into a coxa

and a subcoxa (fig. 34 B, *Cx*, *Scx*), and Börner (1909, 1921) would identify the cardo of the maxilla with the subcoxa of a leg. The suture separating the cardo from the stipes, however, terminates at both ends in the marginal rim of the maxillary base (fig. 35 A) instead of running parallel with it; *the cardo, therefore, does not have the relation of a true segment to the rest of the appendage.* It is perhaps,



FIG. 35.—The relation of a maxilla to a generalized limb.

A, theoretical generalized structure of a gnathal appendage, consisting of a limb base (*LB*), bearing a divided basendite (*Lc*, *Ga*), and a six-segmented telopodite, or palpus (*Plp*), with the principal downward flexure at the femoro-tibial joint (*ft*). The limb base provided with tergal promotor and remotor muscles (*I*, *J*), and sternal adductors (*KL*).

B, showing basal musculature of a gnathal appendage analysed into the functional elements of the musculature of an annelid parapodium (fig. 33 D).

C, third maxilliped of *Apus longicaudata*, left, anterior surface, showing division into a limb base (*LB*) and a telopodite (*Tlp*); the base movable on a transverse axis (*a-b*), the telopodite with a principal flexure (*ft*) between its third and fourth segments.

a-b, basal axis of limb base; *Bc*, basendite; *ct*, coxo-trochanteral joint; *F*, femur; *fga*, flexor of galea; *flcc*, cranial flexor of lacinia; *fics*, stipital flexor of lacinia; *ft*, femoro-tibial joint; *Ga*, galea; *I*, tergal promotor; *J*, tergal remotor; *K*, sternal promotor; *KL*, ventral adductors (*K* and *L* united); *L*, sternal remotor; *LB*, limb basis; *Lc*, lacinia; *O*, levator of telopodite; *Plp*, palpus (telopodite); *Q*, depressor of telopodite; *Tlp*, telopodite; *Tr*, trochanters.

though, to be questioned if the subcoxal chitinization, the pleuron, at the base of a thoracic leg is not also a mere subdivision of the basal limb segment similar to the cardo, rather than the remains of a true independent segment. If the cardo does, in any sense, represent the thoracic subcoxa, it is to be noted that the hinge line between it and the stipes has a horizontal position with reference to the axis of the appendage, and this, the writer has argued (1927), must have been the primitive position of the subcoxo-coxal hinge in a thoracic leg.

Though the homology of the cardo must be left in question, the writer would agree with Börner (1909, 1921) that the part of the maxilla bearing the lacinia, galea, and palpus represents the coxal region of the leg base, and that the basal segment of the palpus is a trochanter (fig. 35 A, *Tr*). The lacinia and galea, then, are *coxal endites*, and, as Börner proposes, *the stipes and palpifer are corresponding secondary subdivisions of the coxa*, or of the coxal region of the maxillary base. In the maxillae and maxillipeds of the Crustacea, Börner claims, the segments bearing the lobes homologous with the insect lacinia and galea are also subdivisions of the coxa. By this interpretation, the palpus (fig. 35 A, *Plp*) becomes the telopodite of the maxillary appendage (B); its basal union with the stipes or palpifer is the coxo-trochanteral joint (*ct*), and its principal distal articulation having a ventral flexure is the femoro-tibial joint (*ft*).

Other writers have held somewhat divergent views concerning the homologies of the maxillary segments. Göldi (1913) interpreted the cardo as the coxopodite, the stipes as the basipodite, to which he assigned the lacinia and galea as endite lobes, and the basal segment of the palpus as the ischiopodite. Crampton (1922) gave a modification of this view in that he proposed that the palpifer represents a segment, the ischiopodite, and that the galea is an endite of this segment. Uzel (1897) appears to give confirmation to this view in his description of the development of the maxilla of *Campodea*; the maxillary rudiment, he says, is first divided into an outer and an inner lobe, and then the outer lobe splits into two parts, one of which becomes the palpus, the other the galea. If the maxilla of *Campodea* resembles that of *Japyx* (fig. 30 A), however, it is easy to believe that the structure in the embryo might be misinterpreted, in as much as the adult structure is misleading until the muscle relations are taken into consideration (fig. 31 D); then it is seen that the basal region of the palpus, which is united with the base of the galea, is the true basal segment of the palp, and not the palpifer—clearly a secondary modification.

It has already been pointed out that the entire lack of muscle connections in the palpifer is a condition that disavows the segmental nature of the palpifer region. Crampton's best example among insects of a structure corresponding with his idea of the segmentation of a maxillary appendage is the maxilla of the larva of *Sialis* (fig. 31 C), in which there is a small lobe (*o*) borne on the apparent first segment of the palpus. This lobe Crampton would identify as the galea, making the supporting segment the palpifer. The muscles (*O*, *Q*) inserted on the base of this segment, however, clearly demonstrate that it

is the true base of the palpus (*Iplp*)—therefore, not the palpifer, which lacks muscles—and that the lobe in question is not the galea, as also the absence of a muscle to it would indicate. The maxilla of the *Sialis* larva, then, is not a generalized appendage in the sense that Crampton would infer, since it lacks a true galea and is provided with an accessory lobe on the first segment of the palpus. Similar lobes of the palpus segments occur in other insects, particularly in larvae of Coleoptera; they have a suggestion of the endite lobes of the telopodite in such crustaceans as *Apus* (fig. 35 C).

In the thoracic legs the limb is always flexible at the union between the basis and the telopodite, *i. e.*, at the coxo-trochanteral joint, and in no appendage, where the facts can be clearly demonstrated, is there a union between the coxa and the trochanter. It does not seem reasonable, therefore, to suppose that the proximal segment of the telopodite (the trochanter) should have been incorporated into the limb base in the case of a maxillary appendage. Especially is such a supposition unreasonable in the face of much specific evidence to the contrary. The whole body of evidence bearing on the limb mechanism points to a primitive uniformity of flexure in all the appendages, whereby the limb is divided into a *basis* and a *telopodite*, and indicates that the articulation between these two parts is preserved in the entire series of appendages, except, of course, where the telopodite is lost.

The maxillipeds and the anterior body appendages of *Apus* bear each five endite lobes. The first lobe (fig. 35 C, *Be*) is a basendite, the second is carried by the proximal division of the trochanter, the third by the femur, the fourth by the tibia, and the fifth by the tarsus. Each endite is independently movable by muscles inserted upon or within its base. The maxillae of *Apus* are reduced to single lobes, but the first maxilla appears to represent the rudimentary limb base with the large basendite, since it falls exactly in line with the series of basal endites on the following appendages. The basal endites of arthropod limbs in general, including the "gnathobases" of the trilobite appendages, the gnathal lobes of the pedipalps in Niphosura and Arachnida, and the "styli" of the legs of *Scolopendrella*, are almost certainly analogous lobes in all cases, and they must be represented by the laciniae (at least) of the insect maxillae, by the laciniae of the mandibles of diplopods and chilopods, and by the incisor and molar lobes of the mandibles in all arthropods. It is a question, therefore, whether the galea of the insect maxilla is an accessory lobe of the limb base, or a subdivision of the primary basendite (fig. 35 B, C, *Be*). The latter seems probable, since, in the more generalized insects, the

lacinia and galea overlap each other basally, and both are flexed by the muscles inserted upon their bases that have their origin in the stipes.

It is impossible at present to arrive at final conclusions on the many problems connected with the morphology of arthropod appendages, and the most that the writer would claim for the present attempt at advancing the subject is that the material here presented gives at least a substantial enlargement to the foundation of known facts from which future work must proceed. There is no question that students of arthropods have given far too little attention to the relationship between skeletal structure and musculature. The more the subject is looked into, the more it will be seen that the characters of the arthropod skeleton are in large part adaptations to the strain of muscle tension, and that they are to be correctly interpreted only through an understanding of the entire mechanism of which they are a part. The sclerites of the insect cuticula, in particular, have been studied as if they were skeletal elements deftly fitted together in such a manner as to cover the outside of the animal, and we entomologists have played with them, as we might with the sections of a picture puzzle, without looking for their significance in the mechanics of the insect. The arthropod skeleton, it is true, has been formed from a few major centers of increased chitinization, but the minor "divisions" are in almost all cases adaptations to flexion, or the opposite, namely, the strengthening of the skeleton by the development of internal ridges. The scientific study of the comparative anatomy of insects must look for its advance in the future to a wider knowledge of muscles and mechanism.

IV. SUMMARY OF IMPORTANT POINTS

1. The arthropods have been derived from creeping animals, not from forms specially modified for swimming; their immediate progenitors were annelid-like in structure.

2. The stomodeum marks the anterior end of the blastopore. There are, therefore, no true mesodermal segments anterior to the mouth. The unsegmented preoral part of the animal is the prostomium, and constitutes the most primitive head, or *archicephalon*, of segmented animals, since it contains the first nerve center, or "archicerebrum," and bears the primitive sense organs.

3. The first stage in the development of a composite head in the arthropods, as represented in the embryo, comprises the prostomium and the first two or three postoral segments. The head in this stage may be termed the *protocephalon*; it is represented by the cephalic lobes of the embryo, which may or may not include the third segment.

4. The protocephalon carried the labrum, the mouth, the eyes, the preantennae, and the antennae, also the postantennae when it included the third body segment.

5. During the protocephalic stage of insects, as shown by the embryo, the thorax was differentiated as a locomotor center of the body, and the region between the head and the thorax, consisting of the fourth, fifth, and sixth body segments, became a distinct gnathal region.

6. The gnathal region was eventually added to the protocephalon to form the definitive head, or *teloccephalon*. In the Crustacea, in which there was no thoracic region corresponding with that of the insects, the gnathal region was not definitely limited posteriorly, and the definitive head in this group may include as many as five segments following the protocephalon. In some of the crustaceans the gnathal segments have united with segments following to form a gnathothorax, leaving the protocephalon as a separate anterior head piece. In the Arachnida the protocephalon included the prostomium and two postoral metameres, and it has combined with the following six segments to form the cephalothorax.

7. In the definitive insect head, the prostomium, according to some embryologists, contributes the clypeus and frons and the region of the compound eyes; according to others it forms the clypeus and frons only. The labrum is a median preoral lobe of the prostomium.

8. The arthropod brain probably always includes the median prostomial ganglion, combined with the ganglia of the preantennal segment to form the protocerebral lobes. It may still be questioned whether the optic lobes are derived from the prostomium or from the preantennal segment. The ganglia of the antennal segment form the deutocerebrum. The commissures of the protocerebrum and the deutocerebrum are formed above the stomodeum, and unite with the archicerebral rudiment to form the median part of the brain. The ganglia of the postantennal segment, when united to the preceding ganglia, become the tritocerebral brain lobes, but they remain separate from the brain in some crustaceans, and their uniting commissure always preserves its sub-stomodaeal position.

9. The prostomial region of the adult arthropod is innervated from the postantennal ganglia, but this is probably a secondary condition owing to the loss of the true prostomial nerves.

10. The appendages of the definitive insect and myriapod head are the preantennae, the antennae, the postantennae, the mandibles, the first maxillae, and the second maxillae. Rudimentary, evanescent preantennae have been reported only in the embryo of *Scelopendra*

(Heymons) and in the embryo of *Carausius* (Wiesmann). Postantennae are commonly present in insect embryos, but their rudiments persist in only one or two doubtful cases in the adult. The postantennal appendages are the second antennae of Crustacea, and probably the chelicerae of Arachnida and Xiphosura. Endites of their bases may have been the functional jaws of the insectan and myriapodan ancestors in the protocephalic stage.

11. The gnathal appendages have been derived from organs having the structure of uniramous ambulatory legs. All the primitive arthropod appendages were probably uniramous ambulatory limbs. Biramous and natatory appendages are characteristic of the Crustacea only, and are probably secondary adaptations to an aquatic life.

12. The mandible is a common inheritance from an early ancestor of the eugnathate group of arthropods. Its primitive structure resembled that of the first maxilla of modern insects, and is best preserved in the Myriapoda.

13. The diplopod mandible consists of a base subdivided into cardo and stipes, bearing a large movable lacinia, but lacking a galea and a palpus. In the typical chilopod mandible, the division between cardo and stipes has been lost, and the lacinia is less free. The musculature of the chilopod mandible is more primitive than that of the diplopod mandible. In the crustaceans and insects the mandibular lacinia is either lost, or is fused with the base to form a solid jaw. The mandibular palpus is retained in many Crustacea. The mandible is represented by the pedipalp in Arachnida.

14. The first maxillary appendage is best developed in the insects, and probably here preserves the primitive structure of the mandible. Its musculature is exactly duplicated in the musculature of the mandibles in the diplopods and chilopods. Neither the first nor the second maxillae of the chilopods gives any evidence of ever having attained the special structure of the primitive mandibles and the insect maxillae.

15. A primitive gnathal appendage had the structure of a generalized ambulatory appendage, consisting of a *limb basis* and a *telopodite*. The basis represents the coxa and subcoxa of a thoracic leg, but its division into cardo and stipes is not a true segmentation. The galea and lacinia are movable endites of the basis, with the origin of their muscles in the stipital region of the latter. The telopodite becomes the palpus of the gnathal appendage, and its basal articulation is the homologue of the coxo-trochanteral joint in the leg. The palpifer is not a segment of the limb, but a subdivision of the stipes

bearing the palpus and the galea (as claimed by Börner); the muscles of the palpus and the galea pass through the palpifer, but never arise within it.

16. The primitive appendage was implanted in the soft lateral wall of its segment, and turned forward and backward on a vertical axis through its base, as does an annelid parapodium. The first joint set off the telopodite, and gave the latter a mobility in a vertical plane.

17. The primitive muscles inserted on the base of a generalized limb, as on an annelid parapodium, consisted of a dorsal promotor and a remotor, and of a ventral promotor and a remotor. When tergal plates were developed, the gnathal appendages of the arthropods became attached to their lateral margins, each by *single* point of articulation. The ventral muscles of the appendages then became sternal adductors.

18. The points of origin of the ventral adductors of the gnathal appendages in myriapods and insects were probably crowded together when the gnathal segments were added to the protocephalon. They have since become supported on a pair of apophyses arising at first from the base of the hypopharynx. In the myriapods and in most of the apterygote insects, the apophyses still maintain their hypopharyngeal connections; but in the pterygote insects their bases have migrated laterally to the margins of the cranium, and in all but some of the lower forms have finally moved to a facial position in the epistomal suture. Their posterior ends have united with the transverse tentorial bar developed in the back part of the head. The hypopharyngeal apophyses of the Myriapoda and Apterygota have thus come to be the anterior arms of the pterygote tentorium.

19. The adductor muscles of the insect maxillae, arising on the tentorium, are the sternal adductors of the appendages, corresponding with the sternal adductors or rotators of the thoracic legs, and are derived from the primitive ventral promotors and remotors of the limb.

20. The ventral adductors of the mandibles in the Chilopoda retain their connections with the sternal, or hypopharyngeal, apophyses. In the Diplopoda, Crustacea, and Apterygota, groups of the adductor fibers from the mandibles have lost their sternal connections and have united with each other by a median ligament to form a dumb-bell muscle between the two jaws. Other groups of fibers may retain their connections with the apophyses, or direct with the base of the hypopharynx. In the Pterygota, the ventral adductors of the mandibles have been lost, except for a few rudiments in some of the lower orders.

21. The mandible of *Lepisma* and of pterygote insects is hinged to the head on a long base line with anterior and posterior articulations.

The posterior articulation is the primitive one, the anterior a secondary one. By this change in the articulation and movement of the jaw, the primitive tergal promotor muscle becomes an abductor, and the primitive tergal remotor becomes an adductor. The base line of the mandible slopes downward and forward in *Lepisma* and in a few of the lower pterygotes; in all others its slope is reversed, allowing the tip of the jaw to swing inward and posteriorly during adduction. A similar evolution of the mandible has taken place in the Crustacea.

22. The ridge of the base of the insect cranium, on which the prothoracic and neck muscles are inserted, is probably a chitinization of the intersegmental fold between the maxillary and labial segments. The posterior tentorial arms arise from its ventro-lateral ends by invaginations in the external suture. The neck of the insect, therefore, may be unchitinized parts of both the labial and the prothoracic segments.

V. THE HEAD OF A GRASSHOPPER

After laying down the general principles worked out in the preceding sections, it will be well to test them with a few specific examples. The head of a grasshopper is a good subject for an elementary study of the structure of the pterygote insect head, because it preserves the generalized orientation in having the face directed forward and the mouth appendages hanging downward. Terms of direction, therefore, do not have to be qualified—*ventral* is downward, *dorsal* is upward, and *anterior* is forward. The descriptions here given are based on the Carolina locust (*Dissosteira carolina*), a fairly large grasshopper to be obtained in almost any part of the United States.

The muscles are designated numerically for convenience of reference only, and the same numbers do not refer to corresponding muscles in the grasshopper and in the caterpillar (Section VII). The myology of insects is as yet too little advanced to furnish a satisfactory general nomenclature for insect muscles, and no attempt is made here to use a set of names for the muscles of the grasshopper that could in all cases be applied to the muscles of other insects. The usual method of naming muscles according to their function, or their supposed function, gives terms fitting for the species described; but in many cases, by a change in the articulation between the skeletal parts involved, muscles that are clearly homologous have their functions completely altered. Again, it is impossible to name muscles consistently according to their points of origin and insertion, for either end of a muscle may shift and may migrate into a territory quite foreign to its original

connections. A third feature disturbing to a uniform muscle nomenclature is the fact that any muscle may break up into groups of fibers, or, at least, a single muscle in one species may be represented functionally by several muscles in another. Finally, there are muscles that are evidently new acquisitions developed in connection with special mechanisms. The importance of the study of musculature for the understanding of the insect skeleton, however, can not much longer be ignored.

STRUCTURE OF THE CRANIUM

The walls of the head in the grasshopper are continuously chitinized on the anterior, dorsal, and lateral surfaces (fig. 36 A, B), and the

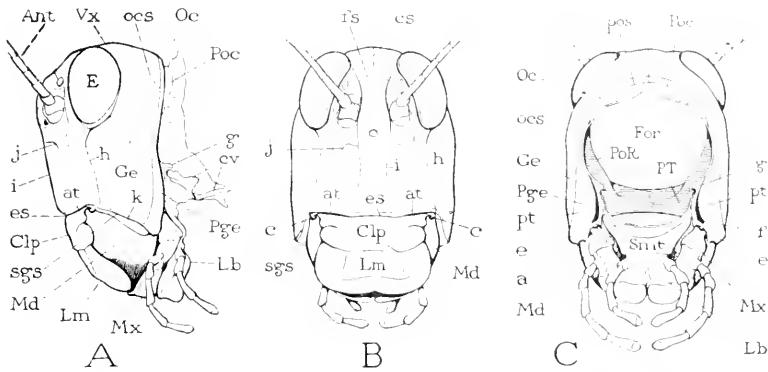

FIG. 36.—Head of a grasshopper, *Dissosteira carolina*.

A, lateral. B, anterior. C, posterior.

a, posterior articulation of mandible; *Ant*, antenna; *at*, anterior tentorial pit; *c*, anterior articulation of mandible; *Clp*, clypeus; *cs*, coronal suture; *cv*, cervical sclerites; *E*, compound eye; *e*, articulation of maxilla with cranium; *es*, epistomal suture; *f*, articulation of labium with cranium; *For*, foramen magnum; *fs*, frontal suture; *g*, condyle of postocciput for articulation with cervical sclerite; *Ge*, gena; *h*, subocular ridge; *i*, frontal carina; *j*, subantennal suture; *k*, flexible area between lower edge of gena and base of mandible; *Lb*, labium; *Lm*, labrum; *Md*, mandible; *Mx*, maxilla; *O*, ocellus; *Oc*, occiput; *ocs*, occipital suture; *Pgc*, postgena; *Poc*, postocciput; *PoR*, postoccipital ridge; *pos*, postoccipital suture; *PT*, posterior arm of tentorium; *pt*, posterior tentorial pit; *sgs*, subgenal suture; *Vx*, vertex.

dorsal and lateral walls are reflected upon the posterior surface (C) to form a narrow occipito-postgenal area surrounding the foramen magnum (*For*). The foramen is closed below by the neck membrane, in which is suspended the base of the labium (*Lb*). The ventral wall of the head, between the bases of the gnathal appendages, is occupied mostly by the large median hypopharynx, it being otherwise reduced to the narrow membranous areas between the lateral margins of the hypopharynx and the bases of the mandibles and maxillae.

The facial aspect of the cranium is distinctly separated by the epistomal suture (fig. 36 A, B, *es*) from the clypeus, but there is no demarked frontal sclerite. The apex of the frons, however, is defined in *Dissosteira* by two short remnants of the frontal sutures (B, *fs*) diverging from the end of the coronal suture (*cs*). The facial area of the head is limited on each side by an impressed line (*h*) extending from the lower angle of the eye to the anterior articulation of the mandible. The median part of this area forms a broad *frontal costa*, margined laterally by a pair of sinuous carinae (*i*) reaching from the top of the head to the lower part of the face. A short, transverse *subantennal suture* (*j*) lies on each side of the frontal costa just below the level of the median ocellus. The inner ridges of these subantennal sutures have a close relation to the attachments of the more important muscles of the frons (fig. 38 D, *j*). The true frontal area of the grasshopper, therefore, must include the region of these sutures and extend dorsal to them between the bases of the antennae into the angle between the short remnants of the frontal sutures.

The lateral areas of the head (fig. 36 A) have no special characteristics. The subgenal suture (*sgs*) on each side is continuous anteriorly with the epistomal suture (*es*). The compound eye is surrounded by a distinct suture forming a high ridge internally (fig. 39 A, *OR*), and setting off a narrow rim, or ocular sclerite, around the base of the eye (fig. 36, A, B, C).

On the posterior surface of the head (fig. 36 C), the occipito-postgenal area (*Oc, Pgc*) is included between the well-marked occipital suture (*ocs*) and the postoccipital suture (*pos*). In *Dissosteira* the occiput and postgenae are continuous; in *Melanoplus* the occipital arch is separated from the postgenae by a short groove on each side on a level with the lower angles of the compound eyes. Posterior to the postoccipital suture is the postoccipital rim of the head (*Poc*), widened above and below on each side, to which the membrane of the neck is attached. The postoccipital suture forms internally the ridge on which the muscles of the neck and prothorax that move the head are inserted (fig. 45 A, *PoR*). Laterally the postoccipital ridge is elevated as a high plate (fig. 36 C, *PoR*), from the ventral ends of which the posterior arms of the tentorium (*PT*) proceed inward. The roots of the tentorial arms appear externally as long open slits in the lower ends of the postoccipital suture (*pt, pt*).

The clypeus and labrum form together a broad free flap (fig. 36 A, B, *Clp, Lm*) hanging before the mandibles from the lower edge of the frontal region. The fronto-clypeal, or epistomal, suture (*es*) is a deep groove forming internally a strong epistomal ridge (fig. 39 A,

B, C, *ER*), from the lateral parts of which arise the anterior tentorial arms (*AT*). The roots of these arms appear externally as lateral slits in the epistomal suture (figs. 36 B, 37 A, *at*, *at*), just mesad to the anterior articulations of the mandibles (*c*, *c*). The clypeus of *Dissosteira* is partially divided by transverse lateral grooves into auteclypeal and posteclypeal areas. The labrum is a broad oval plate, notched at the middle of its ventral margin, freely movable on the lower edge of the clypeus. A median quadrate area on its basal half is limited below by a sinuous transverse groove (fig. 37 A) that forms a low ridge on the inner surface of the anterior wall (B, *L*). On the

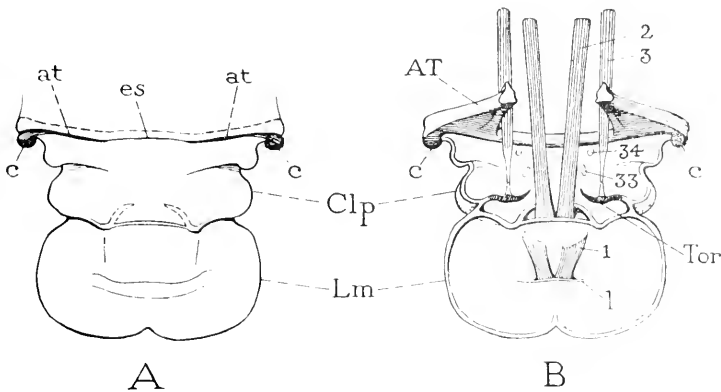

FIG. 37.—Clypeus and labrum of *Dissosteira carolina*.

A, anterior surface. B, posterior surface of anterior wall, showing muscle attachments, and bases of anterior tentorial arms.

AT, anterior arm of tentorium; *at*, anterior tentorial pit; *c*, anterior articulation of mandible; *Clp*, clypeus; *es*, epistomal suture; *L*, ridge of anterior labral wall; *Lm*, labrum; *Tor*, tormæ; *1*, labral compressors; *2*, anterior retractors of labrum; *3*, posterior retractors of labrum; *34*, *35*, points of origin of anterior dilators of buccal cavity (figs. 41, 44).

posterior surface of the clypeo-labral lobe, the area of the clypeus is separated from that of the labrum by two small chitinous bars, the *tormæ* (figs. 37 B, 42 A, *Tor*). A median Y-shaped thickening (fig. 42 A, *m*) of the cuticula of the labrum makes a ridge on the inner surface of the posterior labral wall.

The clypeus has no muscles for its own movement, but the first two pairs of anterior dilators of the buccal cavity (figs. 41, 44, *33*, *34*) are inserted on the inner surface of its anterior wall (fig. 37 B, *33*, *34*). The labrum is provided with three sets of muscles, as follows:

1.—*Compressors of the labrum* (fig. 37 B).—A pair of short muscles arising medially on transverse ridge of anterior labral wall (*L*); diverging to arms of Y-shaped ridge in posterior wall (fig. 42 A, *m*).

2.—*Anterior retractors of the labrum* (fig. 37 B).—A pair of long muscles arising on subantennal ridges of frons (fig. 38 D, *j*); converging downward to insertions on base of anterior wall of labrum (fig. 37 B).

3.—*Posterior retractors of the labrum* (fig. 37 B).—A pair of long muscles arising on subantennal ridges of frons, each laterad of *z* (fig. 38 D); inserted on dorsal processes of tormae at base of posterior wall of labrum (figs. 37 B, 42 A).

The articulations of the gnathal appendages occupy typical positions along the lower lateral margins of the cranium. The mandible articulates anteriorly with a condyle (fig. 39 A, *c*) supported at the junction of the epistomal and subgenal ridges (*ER*, *SgR*), but projecting on the external surface of the head. Posteriorly the jaw articulates with a facet on the ventral edge of the postgena (figs. 36 C, 39 A, C, *a*). This articulation as the first is outside the membranous connection of the mandible with the head. The axis of the mandible slopes strongly downward and posteriorly between the articular points. The lateral edge of the mandibular base is separated from the margin of the gena by a narrow, flexible strip of weakly chitinized articular membrane (fig. 36 A, *k*), at the ventral margin of which arises the abductor apodeme of the mandible (fig. 39 D, *8 Ap*).

The maxilla articulates by a single point on the base of the cardo with a shallow facet on the edge of the postgena (figs. 36 C, 40 C, *c*) almost directly below the posterior tentorial pit (*pt*). The maxillary articulation is thus crowded unusually far posteriorly in the grasshopper. In most generalized insects it lies well before the line of the postoccipital suture, as in a roach or a termite, and is often much farther forward.

The labium is loosely articulated by the elongate basal angles of the submentum with the posterior margin of the postoccipt at points a short distance above the posterior lower angles of the latter (figs. 36 C, 40 C, *f*).

The tentorium of the grasshopper has the form of an X-shaped brace between the lower angles of the cranial wall (fig. 39 B). The anterior arms (*AT*) arise from the lateral parts of the epistomal ridge (*ER*), their broad bases extending from points above the mandibular articulations half way to the median line of the face. In this respect *Dissosteira* shows an advance over *Periplaneta*, in which the bases of the anterior tentorial arms arise from the subgenal ridges and extend only a short distance mesad of the mandibular articulations. The posterior tentorial arms of *Dissosteira* (fig. 39 B, *PT*) arise from the lower ends of the postoccipital ridge (fig. 45 A, *PoR*). The median

body of the tentorium is concave below (fig. 39 B, C, *Tnt*). A thin, flat dorsal arm of the tentorium (fig. 39 C, *DT*) arises from the base of the inner end of each anterior arm and extends upward and anteriorly to the wall of the cranium just before the lower angle of the compound eye. The dorsal tentorial arms are attached to the hypodermis of the head wall, but make no connection with the cuticula in *Dissosteira*.

THE ANTENNAE

Each antenna consists of two larger basal segments, and of a long slender flagellum broken up into about 24 small subsegments. In

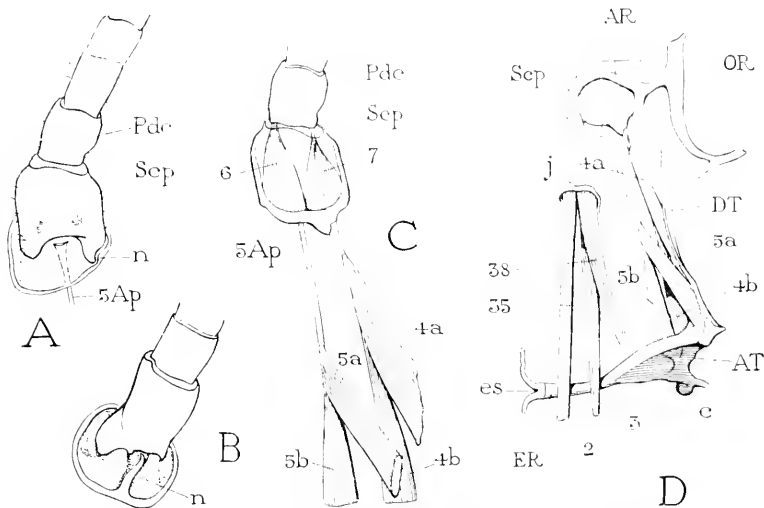

FIG. 38.—Antenna of *Dissosteira carolina* and of *Periplaneta*.

A, base of left antenna of *Dissosteira*, ventral surface. B, the same of *Periplaneta*. C, base of right antenna and antennal muscles of *Dissosteira*, dorsal view. D, base of right antenna, antennal muscles, anterior tentorial arm, muscles arising on frons, and associated structures of *Dissosteira*, interior view.

5Ap, apodeme of depressor muscles of antenna; AR, antennal ridge; At, anterior arm of tentorium; c, anterior articulation of mandible; DT, dorsal arm of tentorium; ER, epistomal ridge; es, epistomal suture; j, subantennal ridge; n, pivot of antenna; OR, ocular ridge; Pdc, pedicel; Scp, scape.

Dissosteira the antenna of the male is a little longer than that of the female. Of the two basal segments, the proximal one, or scape (fig. 38 A, *Scp*), is the larger. It is articulated to the rim of the antennal socket by a small process on the lateral ventral angle of its base that touches upon the margin of the socket (*n*). The motion of the scape on the head, however, is that of a hinge joint moving in a vertical plane on a transverse axis. The base of the scape is provided

with levator and depressor muscles (C, D). In other insects the antenna is more commonly pivoted on a ventral point of articulation with the rim of the socket, as in *Periplaneta* (fig. 38 B, *n*), and thus has greater freedom of movement. As already noted, however, the articular point may be dorsal, as in *Japyx*, and in the Chilopoda (fig. 23 B, *n*). The thickened rim of the antennal socket (fig. 38 D, *AR*) is braced by a short arm against the anterior margin of the heavy circumocular ridge (*OR*). A crescentic area of the head wall just above and mesad to the antennal socket is depressed externally, and the inflection tilts the place of the antennal socket somewhat dorsally, giving the antenna a more upward play than it otherwise would have.

The second basal segment of the antenna, the pedicel (fig. 38 A, B, *Pdc*), is movable in a horizontal plane on the end of the scape by means of muscles arising within the scape. The other segments of the antenna are flexible but have no muscles.

The muscles of the antenna comprise muscles inserted on the base of the scape that move the antenna as a whole, and the muscles of the pedicel that move the pedicel and flagellum. They are as follows:

4.—*Levators of the antenna* (fig. 38 C, D).—Two muscles arising on tentorium, one (D, *4a*) on dorsal arm, the other (*4b*) on anterior arm; both inserted by a short tendon on a lobe of dorsal side of base of scape (C, D).

5.—*Depressors of the antenna* (fig. 38 C, D).—Two muscles arising on dorsal arm of tentorium (D, *5a*) and on anterior arm (*5b*); both inserted on a long slender tendon arising near ventral margin of scape (A, *5Ap*) in articular membrane of antenna.

6.—*Extensor of the flagellum* (fig. 38 C).—Arises dorsally and medially in base of scape; inserted medially on base of pedicel.

7.—*Flexor of the flagellum* (fig. 38 C).—Arises dorsally and laterally in base of scape; inserted laterally on base of pedicel.

THE MANDIBLES

The mandible of the grasshopper is a strongly chitinous jaw—a short, hollow appendage with triangular base, thinning down to the cutting margin. The anterior and the posterior angles of the lateral base line carry the articular points with the head, and the apodeme of the adductor muscles arise at the median angle.

The distal edge of each mandible presents an incisor and a molar area. The first (fig. 39 D, *o*) forms the compressed and toothed apical part of the jaw, the second (*p*) forms a broad grinding surface on the anterior median face closer to the base of the mandible. The incisor and molar areas are not exactly alike on the two jaws, each being

best developed on the right. The molar area of the right mandible consists of strong, heavy ridges forming a projecting surface; the ridges of the left jaw are low and their area does not project. The two molar surfaces, therefore, fit one upon the other without interference when the jaws are closed. The incisor lobes of the mandibles close upon the ventral end of the hypopharynx, the molar surfaces over its base, and the anterior contour of the hypopharynx is modeled

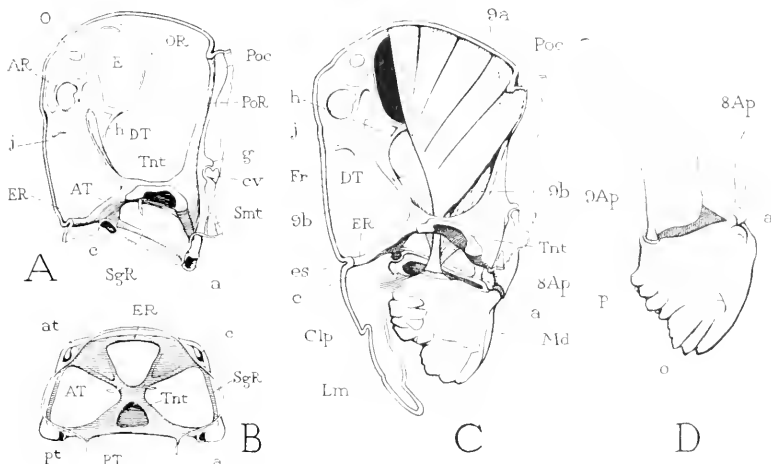

FIG. 39.—Internal structure of the head of *Dissosteira carolina*, and the mandible and its muscles.

A, inner surface of right half of epicranium. B, tentorium and lower margin of epicranium, ventral view. C, inner view of right half of head, with right mandible and its muscles in place. D, right mandible, postero-mesal view.

a, posterior articulation of mandible; *8Ap*, abductor apodeme of mandible; *9Ap*, adductor apodeme of mandible; *AR*, antennal ridge; *AT*, anterior tentorial arm; *at*, anterior tentorial pit; *c*, anterior articulation of mandible; *Clp*, clypeus; *cv*, cervical sclerite; *DT*, dorsal tentorial arm; *E*, compound eye; *ER*, epistomal ridge; *es*, epistomal suture; *Fr*, frons; *g*, condyle of articulation of cervical sclerite; *h*, subocular ridge; *j*, subantennal ridge; *Lm*, labrum; *Md*, mandible; *O*, ocellus; *o*, incisor lobe of mandible; *p*, molar area of mandible; *Poc*, post-occiput; *PoR*, postoccipital ridge; *PT*, posterior tentorial arm; *pt*, posterior tentorial pit; *SgR*, subgenal ridge; *Smt*, submentum; *Tnt*, body of tentorium.

according to the irregularities of the mandibular surfaces. The posterior slope of the mandibular hinge lines cause the points of the jaws to turn inward, upward, and posteriorly during adduction. At the base of each molar area of the mandibles a flat brush of hairs (fig. 39 C, D) projects inward, and the two brushes come together anterior to the mouth opening when the mandibles are closed, serving thus evidently to prevent the escape of masticated food material from between the jaws. The anterior surfaces of the mandibles are overlapped by the epipharyngeal surface of the clypeus and labrum, and the

asymmetry of the mandibular surfaces and contours is reflected in that of the epipharyngeal surface (fig. 42 A).

The mandibles of *Dissosteira* are moved, so far as the writer could discover, only by tergal abductor and adductor muscles, which, as already explained, are the primitive tergal promotors and remotors transformed in function by the change from a monocondylic to a dicondylic articulation in the mandible (fig. 29 A, B, C). Small ventral adductors of the mandibles arising on the hypopharynx and on the tentorium persist in some of the Tettigoniidae (figs. 20 D, *KLh*, 29 C, *KLh*, *KLt*), but these muscles appear to be lost in the Acrididae, as they are in all higher pterygote insects. The fibers of the functional abductors and adductors arise on the walls of the cranium and are inserted on flat apodemal plates of the jaws. The abductor apodeme is a small plate (fig. 39 D, *8Ap*) arising from the articular membrane close to the outer margin of the mandibular base and near the posterior articulation (*a*). The adductor apodeme (*9Ap*) consists of two large thin plates borne upon a common stalk, which arises from the articular membrane at the inner angle of the mandibular base, and lies in the lateral angle between the anterior and posterior arms of the tentorium (C). One plate extends dorsally in a longitudinal plane, the other, which is smaller, lies in a transverse plane. Each mandibular apodeme is a chitinous invagination from the articular membrane close to the base of the jaw. The muscles of the mandible correspond with the apodemes. They are as follows:

8.—*Abductor of the mandible*.—A small fan of fibers, arising on ventral part of postgena and on extreme posterior part of ventral half of gena; inserted on abductor apodeme of the mandible.

9.—*Adductors of the mandible* (fig. 39 C).—Two sets of fibers corresponding with the two divisions of the adductor apodeme. The fibers of one set (*9a*) arise on dorsal wall of cranium, from a point between compound eyes to occiput, with one bundle attached on post-occiput (*Poc*); inserted on both sides and on posterior margin of the median apodemal plate. Those of the other set (*9b*), inserted on the transverse plate of the apodeme, arise on lateral walls of cranium from subocular ridge (*h*) to postgena, and some of the posterior fibers encroach upon outer end of posterior tentorial arm.

THE MAXILLAE

The maxilla of the grasshopper (fig. 40 A) is so similar to that of the roach (fig. 25 A), already described, that its major features will need no special description. It consists of a triangular cardo (fig. 40 A, *Cd*), a quadrate stipes (*St*), with a well-developed palpifer

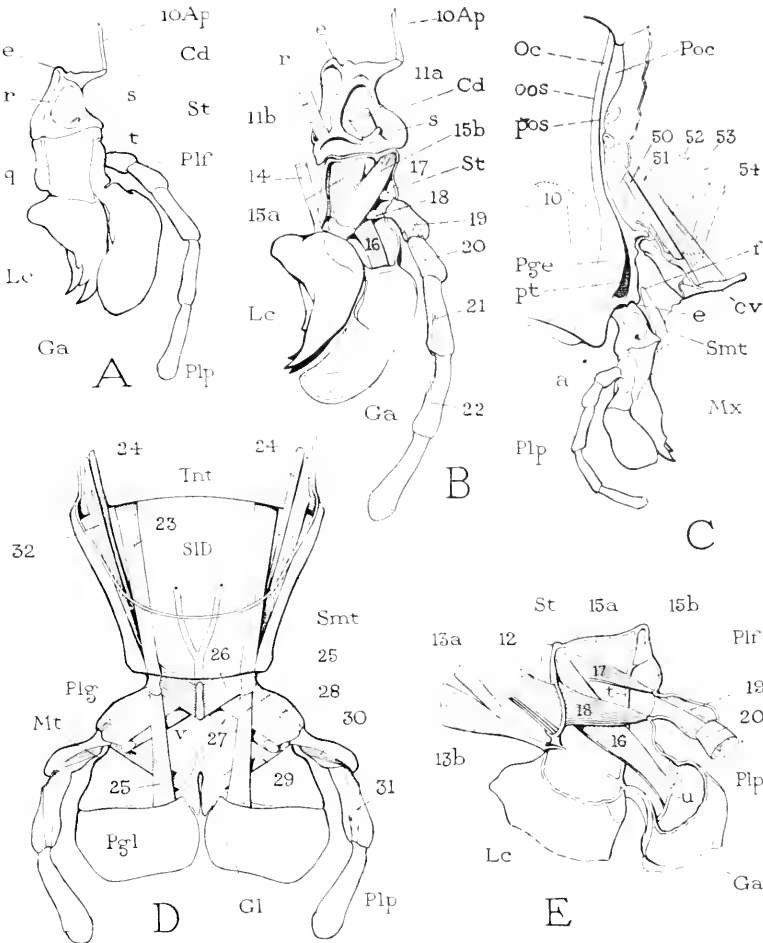

FIG. 40.—Maxilla and labium of *Dissosteira carolina*.

A, right maxilla, posterior surface. B, left maxilla, anterior view, exposing muscles of cardo and stipes. C, posterior region of cranium, with cervical sclerites and maxilla, left side. D, labium and its muscles, posterior view. E, stipes and palpifer with bases of palpus, galea and lacinia, lacinal muscles removed, anterior view.

a, posterior articulation of mandible; *10Ap*, apodeme of promotor of cardo; *Cd*, cardo; *cv*, cervical sclerite; *e*, articulation of maxilla with cranium; *f*, articulation of labium with cranium; *Ga*, galea; *G1*, glossa; *Lc*, lacinia; *Mt*, mentum; *Mx*, maxilla; *Oc*, occiput; *ocs*, occipital suture; *Pgc*, postgena; *Plf*, palpifer; *Plg*, palpiger; *Plp*, palpus; *Poc*, postocciput; *pos*, postoccipital suture; *pt*, posterior tentorial pit; *q*, suture and internal ridge near inner margin of stipes; *r*, internal ridge of cardo; *s*, apophysis of cardo for muscle insertion; *SID*, salivary duct; *Smt*, submentum; *St*, stipes; *t*, suture and internal ridge separating palpifer from stipes; *Tnt*, body of tentorium; *u*, inner ridge at base of posterior wall of galea; *v*, keel of salivary cup.

(*Plf*), and two terminal lobes, lacinia (*Lc*) and galea (*Ga*), and a five-segmented palpus (*Plp*).

The cardo presents an irregular topography on its external surface, and is marked into several areas by the lines of a strong branching ridge on its internal surface (fig. 40 B, *r*). Crampton (1916) calls the part proximal and posterior to the ridge the *juxtacardo* and the rest of the sclerite the *veracardo*, but the inference that these areas are "divisions" of the cardo is scarcely warranted, since the ridge is clearly a mere strengthening device. The articular point (*e*) of the cardo with the cranial margin is a knob on the posterior angle of its base, anterior to which is a long arm to which is attached the apodeme (*10, ip*) of the promotor muscle (*C, 10*). A pit in the distal part of the external surface of the cardo (*A, s*) marks the site of an internal process on which one of the adductor muscles is inserted (*B, 11a*). The distal margin of the cardo is articulated by a long, flexible hinge line with the base of the stipes, but there are no muscles extending between the cardo and stipes.

The quadrate stipes (fig. 40 A, *St*) has a strong plate-like ridge on its internal surface near the inner margin (*q*), on which is inserted one of the adductor muscles (*E, 12*). Crampton distinguishes the body of the stipes as the *verastipes*, and the flange mesad of the muscle-bearing ridge as the *juxtastipes*. The region of the palpifer (*A, Plf*) is well separated from that of the stipes by an internal ridge (*E, 1*), but the muscles of the palpus (*17, 18*), as well as the muscle of the galea (*10*), have their origin in the stipes, suggesting that the palpifer is a subdivision of the stipes, and not a basal segment of the palpus.

The lacinia (fig. 40 A, B, *Lc*) is borne by the distal end of the stipes, and is capable of flexion anteriorly and posteriorly on an oblique axis with the latter. Distally it tapers and ends in two claws turned inward. The lacinia is flexed by a pair of strong muscles arising within the stipes (*B, 15a, 15b*), and by a slender muscle (*11*) having its origin on the wall of the cranium.

The galea (fig. 40 A, *Ga*) is carried by a distal subdivision of the palpifer, which Crampton (1916) calls the *basigalea*. In form, the galea (*A, B, C, Ga*) is an oval, flattened lobe; its walls are but weakly chitinized. Its inner margin lies against the lacinia, and its outer surface is modeled to fit the outer part of the posterior surface of the mandible, against which it can be tightly closed. The base of the galea is marked on the posterior wall by an internal ridge (*E, u*), upon which is inserted its single flexor muscle (*10*).

The maxillary palpus consists of five segments (fig. 40 A, B, C, *Plp*). The basal segment is provided with levator and depressor muscles (B, E, 17, 18) arising within the stipes; each of the other segments has a single muscle arising in the first or second segment proximal to it.

The muscles of a maxilla are as follows:

10.—*Promotor of the cardo* (fig. 40 C).—A small fan of fibers arising on lower posterior part of postgena, external and anterior to the mandibular abductor; inserted on slender apodeme of basal arm of cardo.

11.—*Adductors of the cardo* (fig. 40 B).—Two muscles arising on posterior end of anterior arm of tentorium, extending ventrally, posteriorly, and outward; one (*11a*) inserted on process (*s*) of inner face of cardo, the other (*11b*) mesad to distal end of ridge (*r*) of cardo.

12.—*Proximal adductor of the stipes* (fig. 40 E).—Arising on extreme posterior end of anterior arm of tentorium; inserted on ridge of inner margin of stipes.

13.—*Distal adductors of the stipes* (fig. 40 E).—Two muscles arising on tentorium, the first (*13a*) a slender muscle arising, along with *11a*, *11b*, and *12*, on posterior end of anterior arm of tentorium, the second (*13b*) a large, thick, digastric muscle arising laterally on concave ventral surface of body of tentorium; both muscles inserted on a slender apodeme attached to inner distal angle of stipes.

Muscles *11*, *12*, and *13* correspond with the adductors of the cardo and stipes that in Apterygota arise on the hypopharyngeal apodemes (fig. 30 B, *KLcd*, *KLst*), representing the sternal adductors, or sternal promotor and remotor, of a primitive appendage (fig. 35 B, *K*, *L*).

14.—*Cranial flexor of the lacinia* (fig. 40 B).—Arises on gena just before upper end of promotor of cardo (C, 10); inserted on inner angle of base of lacinia. This muscle is the homologue of the cranial flexor of the maxillary lacinia in Apterygota (fig. 30 B, *flec*), and of the corresponding flexor of the mandibular lacinia in Myriapoda (fig. 26 A, B, C, *flec*).

15.—*Stipital flexor of the lacinia* (fig. 40 B).—A large two-branched muscle arising in base of stipes, one branch (*15a*) medially, the other (*15b*) in outer basal angle; both inserted on anterior margin of base of lacinia. These muscles flex the lacinia forward. Berlese (1909) describes the posterior branch of this muscle in *Acridium* as attached to the posterior wall of the lacinia, and as being an antagonist to the anterior branch, but in no insect has the writer observed an antagonist to the lacinial flexor.

16.—*Flexor of the galea* (fig. 40 B, E).—A large muscle arising mesally in base of stipes, external to lacinial muscles and depressor of palpus; inserted posteriorly on ridge (E, *u*) at base of galea. This muscle probably flexes the galea forward and inward, the point of flexion being at the base of the subgalea.

17.—*Levator of the maxillary palpus* (fig. 40 B, E).—Origin in median basal part of stipes; insertion on dorsal margin of basal segment of palpus.

18.—*Depressor of the maxillary palpus* (fig. 40 B, E).—Origin on inner edge of stipes; crosses anterior to muscle of galea (16) to insertion on ventral margin of basal segment of palpus.

If the basal segment of the palpus (fig. 35 A) corresponds with the trochanter of the leg (fig. 34 B, *Tr*), then muscles 17 and 18 represent the levator and depressor of the telopodite (fig. 34 A, *O*, *Q*) arising in the coxal region of the leg base (*LB*).

19, 20, 21, 22.—*Muscles of the maxillary palpus* (fig. 40 B).—A single muscle for each segment, the first (19) a levator of second segment, the second (20) a protractor of third segment, the third (21) a depressor (adductor) of fourth segment, the fourth (22) a reductor of terminal segment.

The joint between the third and fourth segments of the palpus apparently represents the femero-tibial flexure of a leg (figs. 34, 35 A, *ft*), the two small basal segments of the palpus being trochanters.

THE LABIUM

The labium of the grasshopper (fig. 40 D) is simple in construction, and typical of the labium of biting insects, except in the reduction of the glossæ. It consists of a large submentum (*Smt*) with the elongate basal angles loosely attached to the posterior margin of the cranium behind the roots of the posterior tentorial arms (*C*, *f*). The mentum (*D*, *Mt*) is broad, with imperfectly differentiated palpus-bearing lobes, or palpigers (*Plg*), at the sides of its base. On its ventral margin the mentum bears a pair of large flat lobes, the paraglossæ (*Pgl*), with a pair of rudimentary glossæ (*Gl*) between them. Each palpus is three-jointed.

At the base of the anterior surface of the mentum, where the wall of the mentum is reflected into that of the hypopharynx (fig. 41), there is a small, median, oval, cup-shaped depression into which opens the duct from the salivary glands (*SID*). A small prominence on the base of the hypopharynx fits into the salivary cup and apparently closes the latter when the labium is pressed against the hypopharynx.

The walls of the salivary cup are chitinous, and its posterior inner surface bears a strong chitinous keel (figs. 40 D, 41 *v*) projecting into the interior of the labium in the base of the mentum. Two pairs of muscles (figs. 40 D, 26, 27) are attached upon the keel and the walls of the salivary cup.

The musculature of the labium is in general similar to that of the maxillae. It includes the following muscles:

23.—*Proximal retractors of the mentum* (fig. 40 D).—A pair of muscles arising on ventral surfaces of posterior tentorial arms; inserted on lateral basal angles of mentum.

24.—*Distal retractors of the mentum* (fig. 40 D).—A pair of muscles arising on posterior surfaces of posterior tentorial arms; extending through submentum and mentum to be inserted on anterior wall of labium at inner basal angles of the glossae. The distal parts of these muscles are not seen in figure 40 D, being covered posteriorly by muscles 23 and 25. The labial muscles 23 and 24 evidently correspond with the tentorial adductors of the maxillae (E, 12, 13).

25.—*Flexors of the paraglossae* (fig. 40 D).—A pair of large muscles arising in lateral basal angles of mentum; inserted on bases of paraglossae, to posterior walls, near inner ends. Each of these muscles corresponds with the flexor of the galea in the maxilla (E, 16).

The small labial glossae of *Dissosteira* have no muscles.

26, 27.—*Muscles of the salivary cup* (fig. 40 D).—Two pairs of muscles: one pair (26) arising on basal angles of mentum, converging to insertions on keel of salivary cup; the other pair (27) arising on posterior wall of mentum near bases of palpi, converging proximally to insertions on sides of salivary cup. These muscles apparently have no homologues in the maxillae; perhaps they are special labial muscles having something to do with the regulation of the flow of saliva from the salivary duct.

28.—*Levator of the labial palpus* (fig. 40 D).—Origin in lateral basal angle of mentum; insertion on dorsal rim of base of palpus.

29.—*Depressor of the labial palpus* (fig. 40 D).—Origin in distal median angle of mentum; insertion on ventral rim of base of palpus.

30, 31.—*Muscles in the labial palpus* (fig. 40 D).—The first (30) a levator of second segment; second (31) a depressor (adductor) of third segment.

THE PREORAL CAVITY AND THE HYPOPHARYNX

The intergnathal space, or preoral cavity, of the grasshopper (fig. 41, *PrC*) is of large size, but it is mostly filled by the thick, tongue-like hypopharynx suspended from its roof (*Hphy*). Its anterior wall

is the posterior surface of the clypeus and labrum (*Clp*, *Lm*), which in the grasshopper is not produced into a specially developed lobe, or epipharynx. The lateral walls are the inner faces of the mandibles and maxillae; the posterior wall is the anterior surface of the labium (*Lb*). The dorsal wall of the cavity represents the true sternal region of the head, sloping downward and posteriorly from the mouth opening to the base of the labium. It is mostly produced into the large,

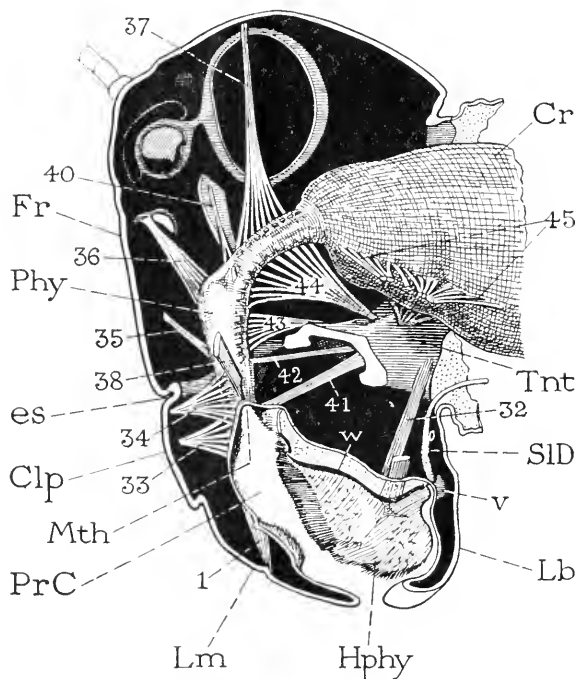

FIG. 41.—Stomodeum, and its dilator muscles in right half of head of *Dissosteira carolina*.

Clp, clypeus; *Cr*, crop; *es*, epistomal suture; *Fr*, frons; *Hphy*, hypopharynx; *Lb*, labium; *Lm*, labrum; *Mth*, mouth; *Phy*, pharynx; *PrC*, preoral cavity; *SID*, salivary duct; *Tnt*, tentorium; *v*, salivary cup.

median hypopharynx (*Hphy*), leaving otherwise only a narrow membranous area on each side between the base of the hypopharynx and the bases of the mandible and maxilla.

The anterior or epipharyngeal wall of the preoral cavity presents a number of features of special interest (fig. 42 A). The lateral parts of the labral region of this wall are concave and fit closely over the smooth, rounded, anterior surfaces of the mandibles. The bands of hairs directed inward on the labral surface guard the exits from

between the mandibles, and the asymmetrical forms of the hair-covered areas here correspond with the different shapes of the two mandibles. Minute sense organs are scattered over this labral surface, especially on the bare lateral regions. A special group of similar but somewhat larger sense organs lies at each side of the notch in the ventral border of the labrum. The median area of the basal half of the labral surface forms a low elevation, the sides of which are thickly covered with long spine-like hairs curved inward and upward. This elevation projects between the inner edges of the closed mandibles, and its irregular contours fit with the lines of the opposing jaws. Its median surface is depressed and embraces the region of the internal Y-shaped ridge (*m*). The elevation is continued upward on the clypeal region, above the spreading arms of the Y-shaped ridge, and between the inner recurved ends of the tormae (*Tor*), and then into the mouth (*Mth*) and upon the anterior wall of the buccal cavity. A sinuous groove begins upon the elevation ventrally between the tormae, which extends dorsally and enlarges into a deep, median channel continued into the anterior wall of the mouth and pharynx. At the sides of the lower end of the channel, between the slender arms of the tormae, are four asymmetrically placed, oval groups of small peg-like sense organs with large circular bases, partly covered from the sides by fringes of long recumbent hairs.

The hypopharynx is a large median lobe suspended, as already noted, from the ventral wall of the head between the mouth and the base of the labium (fig. 41, *Hph*). Its posterior end is closely covered by the paraglossal lobes, and its sides are concealed by the mandibles and maxillae. In form, as seen from below (fig. 42 C), the hypopharynx is somewhat ovate, with the smaller end anterior, but its posterior end is set off as a narrowed lobe by lateral constrictions. The lateral surfaces of the anterior division fit into the posterior concavities of the mandibles, those of the posterior lobe are embraced by the concave inner faces of the laciniae. The posterior, basal extremity of the hypopharynx projects as a small median process into the salivary cup on the base of the labium (fig. 41). The lateral line of the hypopharyngeal base is marked by a slender, sinuous, chitinous bar on each side (*æ*). The arrangement of the hairs clothing the hypopharynx is sufficiently shown in the figures (figs. 41, 42 C). On its sides and at the posterior end near the salivary cup are a few small sense organs similar to those of the labrum.

Dorsal to the anterior end of the hypopharynx is an area that leads directly upward into the floor of the mouth. It possibly represents the sternal region of the protocephalic segments of the head. On its

median surface (fig. 42 B, C) is a ridge, bordered by long hairs directed inward and upward, that continues dorsally from the narrowed end of the hypopharynx, and which is excavated by a median channel where it enters the mouth. At each side of this channel is an oval group of sense organs. Flanking the ridge are two chitinous bars (*HS*), the ventral ends of which articulate with the anterior extremities of the lateral basal rods of the hypopharynx (ω). Dorsally each bar forks into two arms, of which one (x) goes posteriorly to

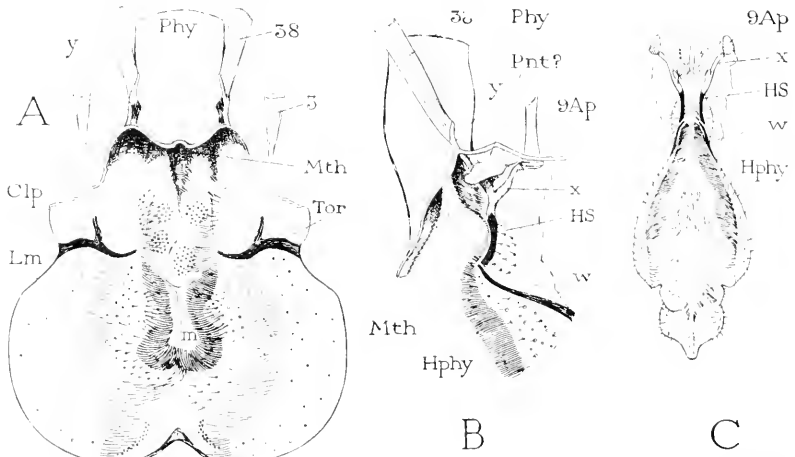

FIG. 42.—The epipharyngeal surface, and the hypopharynx of *Dissosteira carolina*.

A, epipharyngeal surface of clypeus and labrum, and ventral extremity of pharynx. B, lateral view of mouth opening, and of suspensorial apparatus of hypopharynx. C, antero-ventral view of hypopharynx and its suspensory rods.

9Ap, apodeme of adductor muscle of mandible; *Clp*, clypeus; *Hphy*, hypopharynx; *HS*, suspensorial bar of hypopharynx; *Lm*, labrum; *m*, Y-shaped ridge in epipharyngeal wall of labrum; *Mth*, mouth; *Phy*, pharynx; *Pnt*, small lobe behind angle of mouth, possibly rudiment of tritocerebral appendage; *Tor*, torus; ω , lateral basal bar of hypopharynx; x , mandibular branch of suspensorial bar (*HS*) of hypopharynx; y , oral branch of same.

the base of the adductor apodeme of the mandible (*9Ap*), and the other (y) goes anteriorly, laterally, and dorsally into the angle of the mouth, where it forms a support for the insertion of the retractor muscle of the mouth angle (A, B, 38).

The two lateral bars (fig. 42 B, *HS*) in the space between the hypopharynx and the mouth, with their posterior dorsal arms (x) braced against the bases of the mandibular apodemes, and their ventral ends articulated with the basal rods (ω) of the hypopharynx, constitute a movable suspensorial apparatus of the hypopharynx. It is evident that a contraction of the mouth angle muscles (38) inserted

on the anterior dorsal arms (*y*) of the bars must effect a movement of the hypopharynx, and that the latter would be lifted and swung forward beneath the mouth opening. The pull of the mouth muscles, however, also retracts the mouth angles, and there is probably thus accomplished a closing of the mouth upon the food mass accumulated in the preoral space above the anterior end of the hypopharynx. In the grasshopper, the mouth is closed also by the opening of the jaws, but, so far as can be observed in a dead specimen, the closing of the mouth in this case results mechanically from the transverse stretching of the oral aperture between the separating bases of the adductor apodemes of the mandibles.

Posteriorly the hypopharynx is fixed to the base of the labium, where its wall is reflected into that of the latter (fig. 41). The hypopharynx, therefore, can swing forward only in unison with the labium, but otherwise it is free to move to the extent permitted by the membranous areas laterad of its base. The only muscles properly belonging to the hypopharynx are the following:

32.—*Retractors of the hypopharynx* (figs. 40 D, 41)—A pair of muscles arising posteriorly on extreme lateral ends of anterior arms of tentorium (fig. 40 D); inserted on posterior parts of basal rods of hypopharynx (fig. 41).

The contraction of these muscles probably retracts the hypopharynx, and pulls the hypopharynx and labium posteriorly. The mouth aperture is opened by the contraction of the dilator muscles inserted on its anterior and posterior walls (figs. 41, 44, 33, 34, 41).

The rods (*HS*) of the suspensory apparatus of the hypopharynx in the grasshopper are evidently remnants of the much larger suspensory plates of the hypopharynx in Apterygota and Myriapoda (fig. 21 A, B, C, E, *HS*). In *Microcentrum*, as already shown (fig. 20 D), a small hypopharyngeal adductor muscle of the mandible is attached to the end of each rod. In the roach (*Periplaneta*) the chitinous parts of the hypopharyngeal suspensorium are more strongly developed than in the grasshopper, and their action can be more clearly demonstrated. In the bees, though the hypopharynx itself may be lacking, the oral arms of the suspensory bars are prolonged as slender rods into the lateral walls of the pharynx, and their basal ends are bridged by a wide plate on the pharyngeal floor.

In *Dissosteira* there is at each side of the mouth, in the angle between the dorsal arms of the suspensory bar of the hypopharynx, a very small but distinct membranous lobe of a definite form (fig. 42 B, *Pnt*), but having no apparent function, and bearing neither hairs nor sense

organs. The position of these lobes between the mouth and the adductor apodemes of the mandibles strongly suggests that they are rudiments of the postantennal appendages of the tritocerebral segment, which have otherwise not been observed in the adult of any pterygote insect.

THE STOMODEUM

At the upper end of the preoral cavity (fig. 41, *PrC*), anterior to the base of the hypopharynx, and immediately behind the base of the clypeus is the true mouth (*Mth*), or external opening of the stomodeum. The mouth of *Dissosteira* is a transverse aperture having acute lateral angles, but without definite "lips," for the epipharyngeal

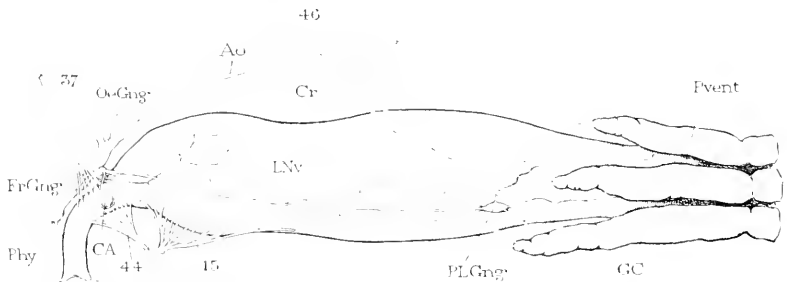

FIG. 43.—Pharynx, crop, anterior gastric caeca, and associated organs of *Dissosteira carolina*.

Ao, aorta; *CA*, corpus allatum (?); *Cr*, crop; *FrGng*, frontal ganglion; *GC*, gastric caecum; *LNv*, lateral stomodeal nerve; *OeGng*, posterior median or oesophageal ganglion; *Phy*, pharynx; *PLGng*, posterior lateral stomodeal ganglion; *Pvent*, proventriculus.

and the supra-hypopharyngeal walls are directly continued into the anterior and posterior walls of the buccal cavity and pharynx.

The stomodeum of the grasshopper extends from the mouth upward in the anterior part of the head (fig. 41), then turns posteriorly above the tentorium, and continues rearward through the head and thorax into the base of the abdomen (fig. 43). By differences in its diameter and in the character of its walls, the stomodeum is differentiated into several parts, but only three parts are well defined in the grasshopper; these are the *pharynx*, the *crop*, and the *proventriculus*.

The pharynx, or first division of the stomodeum, is a narrow, muscular-walled tube bent downward to the mouth between the anterior arms of the tentorium (figs. 41, 43, 44, *Phy*). The region of the mouth, including the upper end of the preoral cavity (fig. 41, *PrC*) and the part of the stomodeum just within the oral aperture, may be distinguished as the *buccal cavity* because the muscles inserted on it

(figs. 41, 44, 33, 34, 38, 41) function in connection with the mouth. The dorsal dilators (33, 34) arise upon the clypeus (fig. 41, *Clp*).

The true pharyngeal region of the stomodaeum of the grasshopper is differentiated into an *anterior pharynx* and a *posterior pharynx*, the two parts being thus named by Eidmann (1925) in the roach. The principal differences between the two parts of the pharynx, however, are in the conformations of the cuticular lining, though the posterior end of the anterior pharynx is marked externally by a slight bulging of the lateral walls. The circumoesophageal connectives (fig. 44, *CocCon*) lie approximately between the two pharyngeal sections.

The crop (fig. 43, *Cr*) is a large, rather stiff-walled sack, representing probably both oesophagus and crop in insects with a long oesophageal tube, though the posterior section of the pharynx in the grasshopper appears to be the oesophageal region in the caterpillar (fig. 55). The anterior end of the crop in *Dissosteira* lies in the back of the head where it rests upon the bridge of the tentorium (fig. 41); the ventral surface of the thoracic part of the organ is supported by the spreading apophyses of the thoracic sterna. The anterior third of the crop (fig. 43) is somewhat set off from the rest by a slight narrowing of the walls; the posterior part tapers between the large anterior caecal pouches of the ventriculus, and ends in the proventriculus (*Pvent*). The proventriculus is a small, cup-shaped enlargement of the posterior end of the stomodaeum, mostly concealed between the bases of the ventricular pouches (*GC*).

The frontal ganglion of the stomodeal (stomatogastric) nervous system (fig. 43, *FrGng*) rests against the anterior wall of the pharynx, and the posterior median oesophageal ganglion (*OcGng*) lies over the posterior end between the spreading bases of the last pair of dorsal dilator muscles of the pharynx (37). From this second median ganglion a long lateral nerve (*LNv*) goes posteriorly on each side of the crop, ending on the rear part of the latter in a posterior lateral ganglion (*PLGng*). A pair of short anterior lateral nerves from the oesophageal ganglion go laterally to a pair of globular bodies, possibly the corpora allata (*CA*), lying at the sides of the posterior pharynx. The anterior dilated end of the aorta (*Ao*) rests upon the oesophageal ganglion, and its open, trough-like lower lip is extended forward beneath the brain.

The Inner Wall of the Stomodaeum.—The surface of the intima, or cuticular lining, of the pharynx, crop, and proventriculus is diversified by various folds and ridges, most of which are clothed with hairs or are armed with small chitinous teeth.

The channels on the walls of the preoral cavity that lead into the mouth are continued upon the inner walls of the anterior pharynx. The median epipharyngeal groove proceeds upward on the anterior pharyngeal wall between two converging ridges, but it soon ends in a thick median fold which follows the midline of the roof of the posterior pharynx to the end of the latter. Likewise, the median channel leading upward from the base of the hypopharynx is continued on the rear wall of the anterior pharynx, between two converging ridges, and ends in a median ventral fold on the floor of the posterior pharynx. From the lateral angles of the mouth, wide channels go dorsally in the side walls of the anterior pharynx, but these again end each in a lateral fold of the posterior pharynx. Thus the relative positions of the principal ridges and grooves in the walls of the two parts of the pharynx are reversed. In the posterior pharynx there is a slenderer intermediate fold between each two of the major dorsal, lateral, and ventral folds. These eight folds of the posterior pharynx end at the entrance of the crop, giving the aperture a stellate appearance when seen from the lumen of the crop. All the pharyngeal folds, except the midventral fold of the posterior pharynx, are clothed with hairs directed backward.

In the crop, a wide dorsal channel proceeds from the pharyngeal opening posteriorly on the anterior third of the upper wall between converging folds of the intima. A narrower ventral channel follows the midline of the floor between a pair of folds that diverge posteriorly and are lost beyond the middle of the organ. The lateral walls of the anterior half of the crop are closely corrugated by obliquely transverse ridges, which bear rows of small, slightly curved, sharp-pointed, chitinous teeth projecting backward. The anterior three or four transverse ridges on each side are particularly conspicuous by reason of their greater width, and because they are thickly beset with similar but slightly larger teeth than those of the other ridges. In the posterior, narrowed part of the crop the transverse ridges are replaced by fine, parallel, lengthwise folds, following the lines of the longitudinal muscle fibers. Numerous teeth are present here also, but they are smaller and blunter than those of the anterior region, and are mostly arranged in small groups, usually two or three together, on elevations of the intima along the folds. The interior characters of the crop are better developed and the teeth are more numerous in the larger organ of the female grasshopper than in that of the male. They can be studied best on pieces of the intima stripped from the tough muscular sheath of the crop.

The walls of the short proventriculus are produced into six flat, triangular elevations having their bases contingent anteriorly, and their apices directed backward, where they all end on the rim of the wide, round orifice into the ventriculus. The proventricular ridges are not mere folds of the intima, for each is formed by a thick mass of the underlying epithelial cells. The surface of the intima in the proventriculus is smooth, except for a few very small teeth on the edges of the triangular ridges, and areas of minute granulations on the distal halves of the latter. The posterior margin of the proventricular wall is reflected outward upon itself to form a short circular fold projecting into the anterior end of the ventriculus, reaching just past the openings of gastric caeca. The intima covers the outer surface of the fold, but terminates at the base of this surface. The line of the latter, therefore, marks the end of the stomodeal or anterior ectodermal section of the alimentary canal.

The Muscular Sheath of the Stomodeum.—The stomodeal walls are everywhere covered with flat bands of muscles, which in general take a transverse and a longitudinal direction, the transverse bands being external and the longitudinal internal; but the distribution of the two sets is not such as to form a regular net-pattern on all parts of the stomodeum. On the posterior two-thirds of the crop, the external transverse fibers have the form of continuous rings encircling the organ, and the longitudinals run with its length. On the anterior third, however, the ring muscles are interrupted laterally and dorsally, and their layer is continued only on the ventral surface as a series of ventral arcs; but the fibers of a latero-ventral tract of the posterior longitudinal muscles on each side curve upward on the lateral wall of the crop where the circular bands are interrupted, and are continuous with those from the opposite side over the dorsal surface as an external layer of obliquely transverse fibers reaching to the base of the pharynx. On the pharyngeal tube the muscles again take the pattern of regularly arranged external circular and internal longitudinal fibers. The circular fibers of the pharynx may belong to the interrupted set of circular fibers of the crop, but the longitudinal fibers are continued irregularly into the walls of the crop on the inner surface of the anterior circular fibers of the latter, and they do not, therefore, belong to the same layer as the posterior longitudinal crop muscles. A close study of the stomodeal musculature of the grasshopper would show some complexity of detail in the arrangement and relationship of the muscle fibers, but nothing approaching the intricacy of the fiber connections in the muscular layers on the pharynx and crop of the caterpillar, to be described later.

The Dilator Muscles of the Stomodeum.—Thirteen paired sets of muscle fibers and one median unpaired muscle arising on the skeletal parts of the head or thorax are inserted on the stomodeal walls in *Dissosteira* (figs. 41, 43, 44). These muscles may be classed as *dorsal*, *lateral*, and *ventral* according to their insertions, though because of the downward flexure of the pharynx, the first “dorsal” and “ventral” muscles are anterior and posterior. The dilator muscles of the stomodeum, sometimes called also suspensory muscles, enumerated from 33 to 46 inclusive, are as follows:

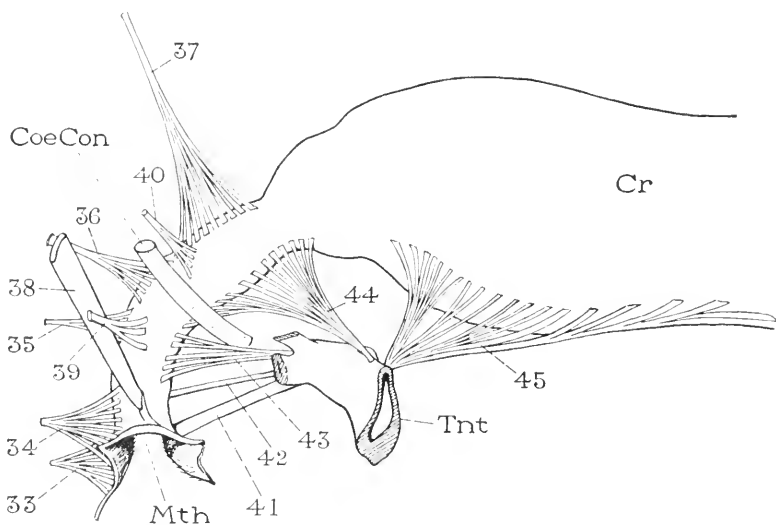

FIG. 44.—Dilator muscles of the buccal region, pharynx, and crop of *Dissosteira carolina*.

CoeCon, circumoesophageal connective; *Cr*, crop; *Mth*, mouth; *Tnt*, tentorium.

33.—*First anterior dilators of the buccal cavity* (figs. 41, 44).—A pair of fan-shaped muscles arising on inner wall of clypeus (fig. 37 B), the fibers spreading to their insertion on anterior wall of buccal cavity (fig. 44) mostly distal to oral aperture.

34.—*Second anterior dilators of the buccal cavity* (figs. 41, 44).—A pair of fan-shaped muscles similar to 33, arising on clypeus near epistomal ridge (fig. 37 B); inserted laterad of 33 and mostly proximal to oral aperture.

35.—*First dorsal dilators of the pharynx* (figs. 41, 44).—A pair of slender muscles arising on frontal area of head wall, each attached between labral retractors of same side (fig. 38 D); inserted on anterior wall of pharynx.

36.—*Second dorsal dilators of the pharynx* (figs. 41, 44).—Each arises by a slender stalk on subantennal ridge of frons (fig. 41); inserted by spreading base on upper end of anterior pharynx.

37.—*Third dorsal dilators of the pharynx* (figs. 41, 43, 44).—Each arises by slender stalk on vertex near inner rim of compound eye just anterior to first dorsal fibers of mandibular adductor; inserted by widely spreading base on dorsal wall of posterior pharynx.

38.—*Retractors of the mouth angles* (figs. 41, 44).—These, the largest muscles of the stomodeum, and the first of the lateral series, arise on the subantennal ridges of the frons (fig. 38 D), and extend downward and posteriorly to their insertions on the oral arms of the hypopharyngeal suspensorial rods (figs. 42 A, B, 44) in the lateral angles of the mouth.

39.—*First lateral dilators of the pharynx* (fig. 44).—A pair of slender muscles arising laterally on frontal region; inserted on sides of anterior pharynx.

40.—*Second lateral dilators of the pharynx* (figs. 41, 44).—A slender muscle on each side, arising on posterior face of distal end of dorsal arm of tentorium (fig. 41); inserted by spreading base on upper end of anterior pharynx (fig. 44).

41.—*Ventral dilator of the buccal cavity* (figs. 41, 44).—A median, unpaired, strap-like muscle arising on ventral face of body of tentorium; inserted on median groove of posterior wall of mouth.

42.—*First ventral dilators of the pharynx* (figs. 41, 44).—A pair of fibers arising on ventral surface of tentorium; going anteriorly to insertions medially on lower end of posterior wall of anterior pharynx.

43.—*Second ventral dilators of the pharynx* (figs. 41, 44).—A group of diverging fibers on each side, arising on anterior edge of tentorium; inserted latero-ventrally on anterior pharynx.

44.—*Third ventral dilators of the pharynx* (figs. 41, 43, 44).—A large fan of fibers on each side, arising on dorsal edge of posterior arm of tentorium; the spreading fibers inserted ventro-laterally along entire length of posterior pharynx.

45.—*Anterior dilators or protractors of the crop* (figs. 41, 43, 44).—A large group of fibers arising on each posterior tentorial arm, behind origin of 44; spreading posteriorly to insertions ventro-laterally along anterior third of crop. These are the last of the stomodeal muscles that have their origin in the head.

46.—*Posterior protractors of the crop and gastric caeca* (fig. 43).—A pair of long, branched muscles, each arising by a slender stalk on inner surface of prothoracic tergum, just anterior to base of trochantal muscle; branching downward and posteriorly, one branch in-

serted on lateral wall of crop just above posterior lateral stomodeal ganglion (*PLGng*), the others on tips of the gastric caeca (*GC*) of same side.

THE MECHANISM FOR MOVING THE HEAD

The head of the grasshopper is freely attached to the prothorax by a membranous neck, but its movements are somewhat limited by the overlapping anterior edges of the protergum, and by the pair of cervical sclerites on each side (fig. 45 B, *1cv*, *2cv*) which link the head with the concealed episternal plate of the prothorax (*Eps₁*).

The cervical sclerites, however, constitute an important part of the mechanism for moving the head. The two plates of each pair are articulated end to end, and ordinarily they are bent downward at an angle to each other (fig. 36 A, *cv*). The first is articulated anteriorly to the posterior margin of the postoccipital rim of the head (fig. 45, *g*), the second posteriorly to the anterior edge of the prothoracic episternum (*Eps₁*). The neck plates thus constitute a fulcrum on each side between the head and the thorax, giving a leverage to the dorsal and ventral muscles extending from the postoccipital ridge and tentorium to the prothorax and the first thoracic phragma. Moreover, upon each plate are inserted strong levator muscles (fig. 45 B) arising on the back of the head and on the prothoracic tergum, and the contraction of these muscles, with the consequent straightening of the angle between the two plates of each pair, must cause the protraction of the head. From each anterior plate a horizontal muscle extends to the prosternal apophysis of the opposite side (fig. 45 A, B, *54*). Besides the muscles that connect the skeletal parts of the head, neck, and prothorax, there are two muscles on each side inserted directly upon the neck membrane (A, *56*, *57*).

It is difficult to give names signifying function to the neck muscles, for it is evident that the function will depend on whether the two muscles of any pair act in unison, or as antagonists. The neck muscles of *Dissosteira* are as follows, on each side:

47.—*First protergal muscle of the head* (fig. 45 A).—A slender muscle arising dorsally on prothoracic tergum; inserted dorso-laterally on postoccipital ridge of head (*PoR*).

48.—*Second protergal muscle of the head* (fig. 45 A).—A larger muscle arising on principal ridge of protergum (*c*); inserted with 47 on postoccipital ridge of head.

49.—*Longitudinal dorsal muscle of the prothorax* (fig. 45 A).—Extends from first thoracic phragma (*1Ph*) to postoccipital ridge (*PoR*) just below 48.

50, 51.—*Cephalic muscles of the cervical plates* (fig. 45 A, B).—Origin on postoccipital ridge below 49; both extend ventrally and posteriorly, the first (50) inserted on first cervical plate, the second (51) on second plate.

52, 53.—*Protergal muscles of the cervical plates* (fig. 45 B).—Origin dorso-laterally on prothoracic tergum; both extend ventrally and anteriorly, crossing internal to 50 and 51, to be inserted on first

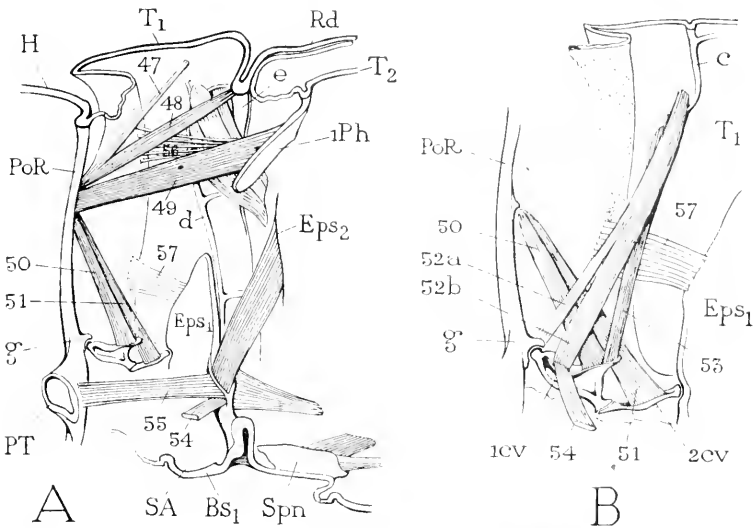

FIG. 45.—Muscles of the neck of *Dissosteira carolina*, right side, internal view.

A, muscles extending between head and prothorax, omitting 52, 53 and 54, inserted on cervical sclerites (B). B, head and prothoracic muscles of cervical sclerites.

*BS*₁, basisternum of prothorax; *c*, first ridge of protergum; *1cv*, first cervical plate; *2cv*, second cervical plate; *d*, second ridge of protergum; *e*, third ridge of protergum; *Eps*₁, episternum of prothorax; *Eps*₂, episternum of mesothorax; *g*, process of head articulating with first cervical sclerite; *H*, head; *iPh*, first thoracic phragma; *PoR*, postoccipital ridge; *PT*, base of posterior arm of tentorium; *Rd*, posterior fold of protergum; *SA*, apophysis of prothoracic sternum; *Spn*, spina; *T*₁, tergum of prothorax.

cervical plate, the first (52*b*) with a branch (52*a*) to articular process (*g*) of postoccipital ridge.

54.—*Prosternal muscle of the first cervical plate* (fig. 45 A, B).—A diagonal, horizontal muscle arising on apophysis of prothoracic sternum (A, *SA*), crossing its fellow to insertion on inner edge of first cervical plate of opposite side (B).

55.—*Longitudinal ventral muscle of the prothorax* (fig. 45 A).—A broad, flat muscle from prosternal apophysis (*SA*) to base of posterior arm of tentorium (*PT*).

56.—*Dorsal lateral neck muscle* (fig. 45 A).—A band of slender fibers from first phragma (*1Pl*), inserted on base of neck membrane.

57.—*Ventral lateral neck muscle* (fig. 45 A, B).—A short, flat muscle from anterior edge of prothoracic episternum (*Eps*₁), inserted on base of neck membrane.

VI. SPECIAL MODIFICATIONS IN THE STRUCTURE OF THE HEAD

The important structural variations in the head of biting insects affect principally the fronto-clypeal area, and the posterior lateral and ventral regions. Modifications of the facial plates are often to be correlated with variations in the relative size of the buccal and pharyngeal parts of the stomodeum, or with a special development of the mouth cavity. Modifications in the posterior ventral parts of the head are correlated with a flattening and elongation of the cranial capsule, usually resulting from an upward tilting of the head on the neck by which the mouth parts become directed forward, and, in certain orders, are accompanied by an elongation of the submentum anteriorly, with a differentiation of this plate into a posterior gular sclerite and a secondary anterior submental sclerite.

MODIFICATIONS IN THE FRONTO-CLYPEAL REGION

The prostomial part of the insect head includes the frons, the clypeus, and the labrum. Whether or not it comprises also the region of the compound eyes may be regarded as an open question, and one for the embryologists to settle. If the compound eyes belong to the first true segment of the head, it is probable that the frontal sutures define the posterior limit of the prostomium; otherwise the sutures must be secondary formations within the area of the prostomium. The frontal sutures do not always mark the lines of cleavage in the head cuticula at the time of a molt. In an odonate nymph, for example (fig. 46 1), the facial clefts (*t*) of the molting cuticula extend from the coronal suture outward and downward on each side between the eyes and the bases of the antennae, far outside the possible limits of the frons (*Fr*).

The part of the postembryonic head that may be defined as the *frons* is the area included between the frontal sutures, where these sutures are fully developed (fig. 46 B, *Fr*). The frontal sutures (*fs*) extend typically from the coronal suture (*cs*) to the neighborhood of the anterior articulations of the mandibles (*c*, *c*). The true frontal region, therefore, can not include the bases of the antennae, which

organs belong to the second head segment behind the prostomium, and acquire their facial positions secondarily by a forward and upward migration. Ventrally the frons is limited, and separated from the

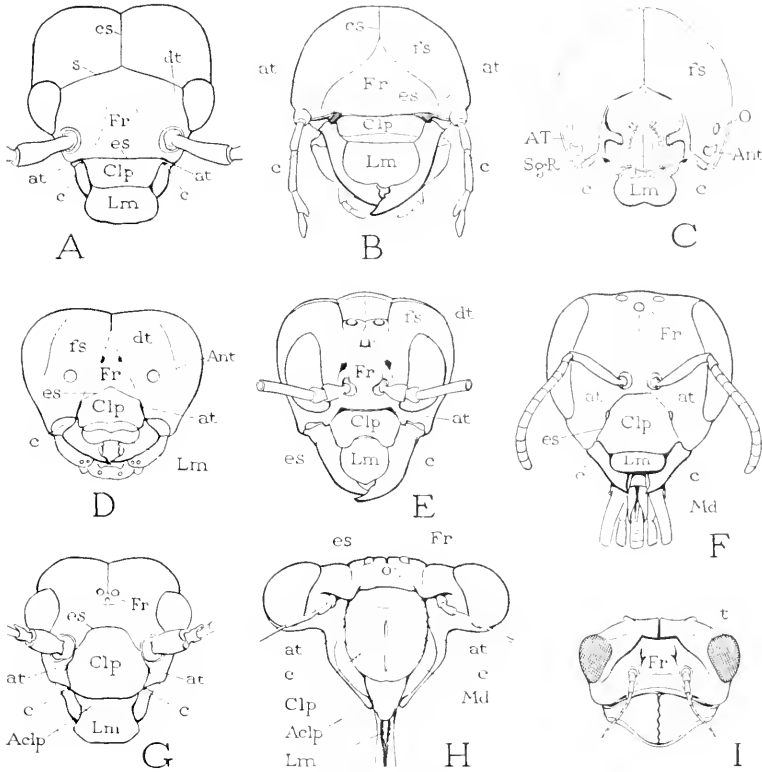

FIG. 46.—Modifications in the facial structure of the insect head.

A, *Forficula auricularia*. B, *Popillia japonica*, larva. C, *Pteronidea ribesi*, larva, inner surface of front of head. D, *Vespa maculata*, well-chitinized larva. E, *Pteronidea ribesi*, adult. F, *Apis mellifica*. G, *Psocus venosus*. H, *Magicicada septendecim*. I, molted skin of an *Aeschna* larva.

Aclp, anteclypeus; *Ant*, antenna; *AT*, anterior arm of tentorium; *at*, anterior tentorial pit; *c*, anterior articulation of mandible; *Clp*, clypeus; *dt*, attachment of dorsal tentorial arm to head wall; *es*, epistomal suture; *Fr*, frons; *fr*, "adfrontal"; *Lm*, labrum; *O*, ocellus; *s*, suture of *Forficula* diverging from end of coronal suture; *SgR*, subgenal ridge; *t*, molting split in *Aeschna* larva diverging from end of coronal suture, but is not frontal suture.

clypeus, by the epistomal suture (fig. 46 B, *es*), except when this suture is lacking. If a median ocellus is present, it is situated in the upper angle of the frons (figs. 46 E, 47 B). The muscles of the labrum, some of the dilator muscles of the pharynx, and the retractors of the mouth angles, when present, have their origins on the frons. By

these characters, especially the position of the median ocellus and the origin of the labral muscles, the true frontal region is to be identified when the frontal sutures are imperfect or obsolete (fig. 46 E, F, *Fr*).

As was shown in the study of the grasshopper (fig. 36 B), the frontal region of the face may present a number of secondary lines formed by ridges of the inner surface. In the Dermaptera two sutures (fig. 46 A, *s*) diverge widely from the end of the coronal suture (*cs*) and extend outward to the compound eyes. It appears doubtful that these are the frontal sutures, for the true frontal region should be the smaller triangular area indistinctly defined on the median part of the face.

The *clypeus* (fig. 46 B, *Clp*) is a distinct area of the prostomial region, and is to be identified by the origin of the dilator muscles of the mouth and buccal cavity on its inner wall. It is almost always in biting insects separated from the labrum by a flexible suture, and it is demarked from the frons whenever the epistomal suture is present. The clypeus is sometimes divided into an anteclypeus and a postclypeus by a partial or complete transverse suture; but often the term "anteclypeus" is given to a more or less membranous area between the clypeus and the labrum (fig. 46 G, *Aclp*), and it is likely that regions named "anteclypeus" are not equivalent in all cases.

The *labrum* (fig. 46 B, *Lm*) hangs as a free flap before the mouth. It is a preoral lobe of the prostomium characteristic of insects, myriapods, and crustaceans. The insect labrum is usually movable, and is provided with one or two pairs of muscles (though both may be absent), which, as above noted, have their origin on the frons. The labral muscles, therefore, are strictly muscles of the prostomium.

The principal departure from the typical structure in the prostomial sclerites arises from variations in the development or in the position of the epistomal suture, and from a partial or complete suppression of the frontal sutures.

The epistomal suture is the external groove formed incidentally to the development of an internal transverse ridge across the prostomial area. Since this ridge in generalized insects lies approximately between the anterior articulations of the mandibles, its primitive position suggests that it was developed to strengthen the lower edge of the face between the mandibular bases. The epistomal ridge itself is a continuation of the subgenal ridges, and the epistomal suture is, therefore, continuous with the subgenal sutures. In the Ephemera and Odonata, as we have seen, the anterior arms of the tentorium arise in the subgenal sutures laterad of the bases of the mandibles. In some of the Orthoptera, as in the roach, and in larvae of Coleoptera,

the tentorial arms have moved forward to a position above the mandibular articulations, and their external openings, the anterior tentorial pits, appear in these positions (fig. 46 B, *at, at*).

In some of the more generalized insects, the epistomal ridge and its suture are lacking, as in the roach, and there is then present only a single fronto-clypeal sclerite (fig. 47 A, *Fr-Clp*). In such cases, the tentorial pits (*at*) lie in the anterior extremities of the subgenal sutures (*sgs*), above the anterior articulations (*c*) of the mandibles. Where an epistomal ridge unites the subgenal ridges across the face, separating the clypeus from the frons, the tentorial pits may retain

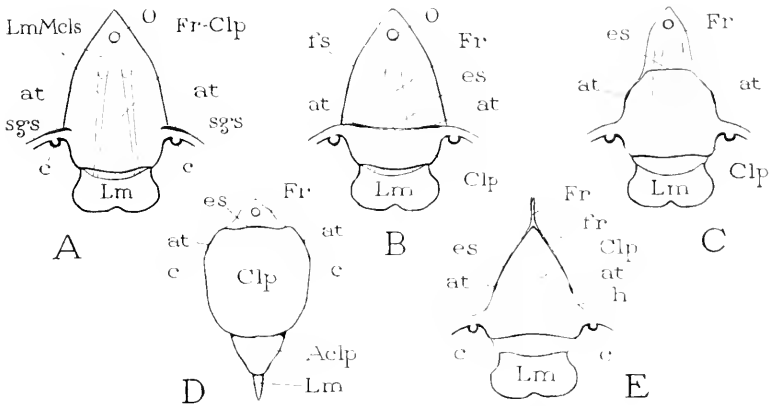

FIG. 47.—Diagrams showing variations in the position of the epistomal suture (*es*), and the relations of the frons and the clypeus.

Aclp, anteclypeus; *at*, anterior tentorial pit; *c*, anterior articulation of mandible; *Clp*, clypeus; *es*, epistomal suture; *Fr*, frons; *fr*, "adfrontal"; *Fr-Clp*, fronto-clypeus; *fs*, frontal suture; *h*, line of secondary ridge across lower part of clypeus; *Lm*, labrum; *LmMcls*, labral muscles, with origin always on frons; *O*, median ocellus.

their positions above the mandibular articulations (fig. 46 A, B, *at, at*); but more commonly they move into the epistomal suture (fig. 47 B). In any case, the tentorial pits identify the epistomal suture, when this suture is present. The mandibular articulations (*c, c*) are carried by the ventral margin of the epicranium and are not true landmarks of the epistomal suture, as has been pointed out by Yuasa (1920), and by Crampton (1925).

As long as the epistomal suture maintains its direct course across the face, no complications arise; but the suture is frequently arched upward, and this shift in the position of the suture extends the clypeus into the facial region above the bases of the mandibles, and reduces the area of the frons (fig. 47 C). A modification of this kind

has taken place in the Hymenoptera. In the larval head of *Vespa* (fig. 46 D) the clypeus has clearly encroached upon the area of the frons by a dorsal arching of the epistomal suture (*cs*). In an adult tenthredinid (E), the same condition is observed, but the lower parts of the frontal sutures (*fs*) are lost, and the bases of the antennae have approached each other mesally, and have constricted the frontal area between them. In the adult of *Apis* (F) the condition is more exaggerated—the epistomal suture (*cs*), identified by the tentorial pits (*at, at*), is arched upward almost to the bases of the antennae, and the frontal sutures are obsolete. The frontal area (*Fr*), however, is to be identified by the position of the median ocellus, and the points of origin of the labral muscles between and just above the antennal bases. The head of a larval tenthredinid (fig. 46 C) presents a specialized condition, for the single large facial plate is here clearly a fronto-clypeus, as shown by the origin of the labral muscles on its upper parts, and by the origin of the tentorial arms (*AT*) from the ridges at its sides. Evidently, the median part of the epistomal ridge and its suture has been suppressed. A similar condition is to be observed in some trichopteran larvae.

A still greater degree in the upward extension of the clypeus is shown on the face of a psocid (fig. 46 G). Here the epistomal suture (*cs*) is arched high above the tentorial pits (*at, at*), and the clypeus (*Clp*) becomes the large, prominent, shield-shaped plate of the face between the bases of the antennae. The frontal sutures are lacking, but the frontal area (*Fr*) is that between the bifid end of the coronal suture and the clypeus, on which is located the median ocellus. A weakly chitinized area below the clypeus is sometimes called the anteclypeus (*Aclp*), but it appears to be only a chitinization of the connecting membrane between the clypeus and the labrum.

The clypeus, finally, attains its greatest development at the expense of the frons in the Homoptera (fig. 47 D). In the cicada (fig. 46 H), the clypeus is the great bulging, striated plate of the face upon which arise the dilator muscles of the mouth pump. The dorsal arch of the epistomal suture (*cs*) lies on a level with the antennal bases, and the anterior tentorial pits (*at, at*) are in its upper lateral parts, just above the dorsal extremities (*c, c*) of the mandibular plates (*Md*). The frons is a small, indistinctly defined triangular area (*Fr*) bearing the median ocellus in the adult. It is more strongly marked in the nymph, and is cut out by the opening of the frontal sutures at the time of the molt. The plate below the principal clypeal sclerite is probably an anteclypeus (*Aclp*), because in some Hemiptera it is not distinctly separated from the area above it, but it is questionable if

it is homologous with the preclypeal area of the psocid (fig. 46 G, *AcIp*). The terminal piece in the cicada (H, *Lm*) that closes the groove in the upper part of the labium would appear to be the labrum by comparison with Heteroptera. The "mandibular plates" (*Md*) on the sides of the head must be the true bases of the mandibles. Their upper ends (*c*, *c*) have the same relations to the surrounding parts that the anterior mandibular articulations have in biting insects. The mandibular bristles are chitinous outgrowths from the ventral posterior angles of the plates, and the protractor apparatus of each bristle in the adult is differentiated from the posterior margin of the mandibular plate, as the writer has elsewhere shown (1927).

In the larvae of Lepidoptera, a somewhat different type of modification has produced an unusual distortion in the relation between the frons and the clypeus. The caterpillar head shows no essential variation within the order, but the homologies of the facial structures are clear if interpreted by the characters which serve as identification marks in the other orders. The triangular facial plate (fig. 50 A) thus becomes the clypeus, because the suture (*cs*) bounding it is identified as the epistomal suture by the origin of the anterior tentorial arms from its lateral parts (fig. 50 I, *AT*). Upon this plate arise the muscles of the buccal region of the stomodeum. The median part of the frons is invaginated and forms the thick internal ridge (*Fr*) dorsal to the apex of the clypeus, which is to be identified as the frons by the origin of the labral muscles upon it. The so-called "adfrontals" (*A*, *fr*) are probably lateral remnants of the frons at the sides of the clypeus, and the "adfrontal" sutures are the true frontal sutures (*fs*). That the relations of the plates of the caterpillar's head, as thus established, are identical with those in other insects is made clear in the diagram given at E of figure 47. The clypeus (*Clp*) has simply extended into the area of the frons, and the median part of the latter plate (*Fr*), bearing the origins of the labral muscles, has been inflected, while its distal parts, the so-called "adfrontals" (*fr*), maintain the original lateral ground of the primitive frontal area. The lower part of the clypeus is sometimes strengthened between the bases of the jaws by a secondary thickening forming a submarginal ridge (*h*) on its inner surface.

MODIFICATIONS IN THE POSTERIOR VENTRAL REGION OF THE HEAD

The structural changes in the posterior parts of the head described here are associated with an elongation of the postgenal regions, resulting in the production of a long interval between the foramen

magnum and the posterior articulations of the mandibles. Two different types of structure follow from this style of modification, one shown in adult Hymenoptera and in the larvae of Lepidoptera, the other in those orders in which a gular plate is developed.

The morphology of the posterior surface of the hymenopteran head is comparatively easy to understand, for, in the larval stages, the rear aspect of the head presents the same structure as does that of an adult orthopteron (fig. 36 C). In the head of the larva of *Vespa*, for example (fig. 48 A), the details of the structure are exactly as in the grasshopper. There is a distinct postoccipital suture (*pos*) ending below in the invaginations of the posterior arms of the tentorium (*pt, pt*). The postocciput (*Poc*) is very narrow, but it forms the marginal lip of the head capsule behind the postoccipital suture.

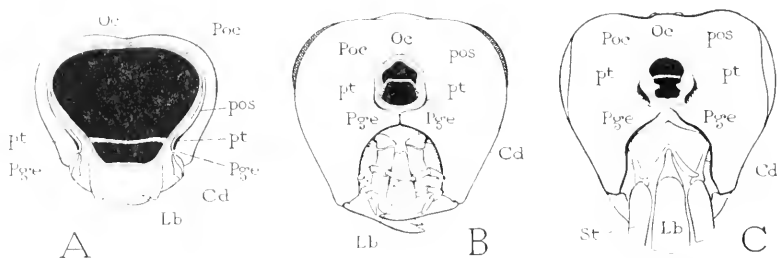

FIG. 48.—Development of the posterior head region in Hymenoptera.

A, posterior surface of head of larva of *Vespa maculata*. C, same of the adult. D, corresponding view of head of adult *Apis mellifica*.

Cd, cardo; *Lb*, labium; *Oc*, occiput; *Pge*, postgena; *Poc*, postocciput; *pos*, postoccipital suture; *pt, pt*, posterior tentorial pit; *St*, stipes.

The labium (*Lb*) is suspended from the ventral neck membrane, and the cardines of the maxillae (*Cd*) are articulated to the ventral cranial margins just anterior to the tentorial pits.

In the adult wasp (fig. 48 B) the back of the head presents a quite different appearance from that of the larva. The foramen magnum is greatly contracted and is reduced to a small aperture in the center of a broad occipito-postgenal field. It is surrounded by a wide postoccipital collar (*Poc*) set off by the postoccipital suture (*pos*), in which suture are located the posterior tentorial pits (*pt, pt*). The labium (*Lb*) is detached from the neck and displaced anteriorly (ventrally), and the space between its base and the neck is closed by mesal extensions of the inner angles of the postgenae (*Pge, Pge*). The articulations of the cardines (*Cd*) are also far removed from the tentorial pits (*pt, pt*), and are separated from them by the intervening bridge of the postgenae. In the wasp the postgenal bridge pre-

serves a median suture, but in the honeybee (C) the line of union between the postgenal lobes is obliterated, and the bridge presents a continuous surface in the space between the foramen magnum and the fossa containing the bases of the labium and maxillae. In an adult tenthredinid (*Pteronidea*), on the other hand, the foramen magnum, though greatly reduced in size by the development of a wide occipito-postgenal area, is still "open" below, that is, it is closed by a narrow remnant of the neck membrane between the approximated angles of the postgenae. The labium, however, is displaced ventrally and united with the bases of the maxillae.

In the Hymenoptera, then, there can be little question as to the line of evolution that has produced the structure of the back of the head in the higher forms. The resulting condition has been correctly observed by Stickney (1923), who says: "In many Hymenoptera the mesal margins of the postgenae are fused between the occipital foramen and the articulation of the labium." A very similar modification of the head has taken place in the caterpillars, as will be shown later, in which the parts constituting the "hypostoma" (fig. 51 A, *Hst*) correspond with the postgenal bridge of adult Hymenoptera. In either case, an unusual thing has happened in that the labium, after being moved forward to unite with the maxillae, has been separated from its own segment by the intervention of parts of the first maxillary segment. If the postgenae are lateral tergal elements of the head wall, their ventral union finds a parallel in the prothorax of the honeybee, which is completely encircled behind the bases of the legs by the prothoracic tergum.

The modifications in the posterior ventral parts of the head in those orders in which a "gula" is developed are difficult to explain if studied only in the higher phases of their evolution, but they can be understood if traced from forms that show the simpler earlier stages of departure from the normal.

In the Blattidae, the cranium is much flattened, but the essential head structure has not been altered, its posterior parts retaining the same form as in the less movable head of the grasshoppers. In many insects, especially in the Neuroptera and Coleoptera, however, the flattened head is not only turned upward on the neck, causing the true anterior surface to become dorsal and the mouth parts to be directed forward, but the ventral surface of the head has been elongated to preserve the vertical plane of the foramen magnum. In such insects the bases of the mouth parts become separated from the foramen magnum by a wide space, and in this space there appears a median

plate called the "gula." The nature of the gula has long been a puzzle to entomologists, but Crampton (1921, 1928) has given reasons for believing that it is a differentiation of the base of the labium, and a few examples taken from the Coleoptera will amply substantiate this view.

In a scolytid or scarabaeid beetle larva the structure of the head does not differ essentially from that of the grasshopper. The face is directed forward, the mouth parts hang downward, and the under surface of the head is short. In the scarabaeid larva (fig. 49 A) the occipital and postgenal regions terminate in a postoccipital suture (*pos*), in the ventral ends of which are situated the large invaginations (*pt*, *pt*) of the posterior arms of the tentorium. Beyond the suture is a narrow postoccipital rim of the cranium (*Poc*), best developed ventrally, where the lateral cervical sclerites (*cv*) are articulated to it. The postoccipital ridge is developed on each side of the foramen magnum into a broad apodemal plate (*PoR*), the two plates constricting the foramen laterally, and uniting ventrally in the broad tentorial bridge, which is concealed in the figure by the ventral part of the neck membrane (*NMb*). The labium, the maxillae, and the mandibles of the scarabaeid larva are suspended from the ventral edges of the cranium exactly as in the grasshopper (fig. 36 C), but the two forms differ by the elongation in the beetle (fig. 49 A) of the postgenal margins of the head between the articulations of the cardines (*c*) and the posterior articulations of the mandibles (*a*).

The basal part of the submental region of the labium in the scarabaeid larva, *Popillia japonica* (fig. 49 A), is chitinized to form a triangular plate (*Smt*). This plate is attached to the mesal points of the postgenae (*Pgc*), and has its extreme basal angles prolonged behind the tentorial pits to points (*f*, *f*) corresponding with the basal articulations of the submentum with the postocciput in an orthopteron (fig. 36 C, *f*). There can be no doubt that this plate in the beetle head is the submentum, or a chitinized basal part of the submentum. It is marked by a transverse groove between the tentorial pits (*pt*, *pt*).

In a silphid larva (fig. 49 B) the general structure of the head is similar to that in the scarabaeid larva, but the ventral postgenal margins between the articulations of the cardines (*c*, *c*) and the mandibles (*a*) are much longer, and the posterior tentorial pits (*pt*, *pt*) are approximated in the mesally prolonged basal angles of the postgenae. The submentum (*Smt*) is large; its base is narrowly constricted between the tentorial pits, which here almost cut off a small but distinct proximal area (*Gu*). The lateral angles of this extreme basal area of the submentum are prolonged behind the tentorial pits and become cou-

tinuous with the postoccipital rim of the cranium (*Poc*), which is set off by the postoccipital suture (*pos*) ending ventrally in the tentorial pits (*pt, pt*).

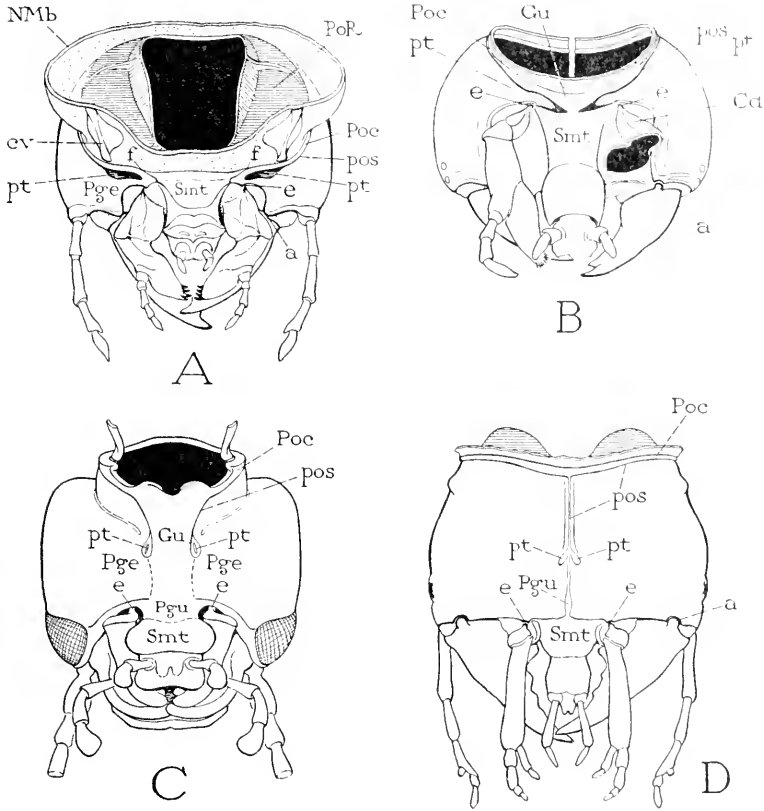

FIG. 49.—Evolution of the "gula" in Coleoptera.

A, Postero-ventral view of the head of a scarabaeid larva, *Popillia japonica*. B, same of a silphid larva, *Silpha obscura*. C, ventral surface of an adult meloid, *Epicauta pennsylvanica*. D, same of a carabid larva, *Scarites*.

a, posterior articulation of mandible; *Cd*, cardo; *cv*, cervical sclerite; *e*, anterior articulation of mandible; *Gu*, gula; *Pgc*, postgena; *Poc*, postocciput; *PoR*, postoccipital ridge; *pos*, postoccipital suture; *pt*, posterior tentorial pit; *Smt*, submentum.

The characteristic structure of an adult coleopteran head is well illustrated in the head of a meloid beetle (fig. 49 C). The form of the cranial capsule here differs principally from that of the scarabaeid or silphid larva in the lengthening of the postgenal regions between the foramen magnum and the articulations of the cardines (*e, e*).

The extension of the ventral surface of the cranial wall accommodates the head to its horizontal position, and has involved a great elongation in that part of the submentum which lies between the posterior tentorial pits (*pt*, *pt*) and extends forward to the articulations of the cardines (*c*, *c*). This region of the submentum is known as the *gula*. In *Epicauta* (fig. 49 C) the tentorial pits lie at about the middle of the lateral margins of the gula, and the ventral ends of the postoccipital suture (*pos*) are, consequently, turned anteriorly and lengthened in the same direction behind the pits. The ventral parts of the postoccipital suture, terminating in the tentorial pits, now become the so-called "gular sutures." It is evident that the large gular region in the adult meloid head (fig. 49 C) lying posterior to the tentorial pits and continuous basally with the postoccipital rim of the cranium (*Poc*) is produced from the small but corresponding area in the larval silphid head (B, *Gu*), and that this area, in turn, is merely the basal strip of the submentum in the scarabaeid larva (A, *Smt*), attached to the postocciput by its lateral extremities (*f*, *f*).

In adult Coleoptera the distal end of the gula may be differentiated as a "pregula" or "gular bar" (C, *Pgu*). It supports the terminal part of the original submental plate (*Smt*), which lies between the bases of the maxillae, and which, in a restricted sense, is usually called "the submentum" by coleopterists. The pregular region may fuse laterally with the "hypostomal" regions of the postgenae, and in other ways the more primitive structure may become so obscured that the relations of the parts are difficult to determine except by studying them in a gradient series of simpler forms. The comparative studies made by Crampton (1921, 1928) on the gula in various orders show fully its numerous variations, and demonstrate its origin from the proximal part of the primitive submental plate. Stickney (1923) also has well illustrated the structure of the gula and associated parts in a large number of coleopteran forms. Stickney fails to recognize, however, that the "gular sutures" are direct continuations of the ventral ends of the postoccipital suture, and that, therefore, the gular plate between them must be the basal part of the submentum. He would explain the gular bridge in the Coleoptera as a product of the ventral fusion of the edges of the postgenae, and the gular sclerite as a plate cut out of this newly-formed region by the anterior extension of the "gular sutures." As we have seen, the ventral bridge of the cranial walls is formed in this manner in the Hymenoptera (fig. 48), as Stickney has pointed out, but in the Hymenoptera the tentorial pits have remained at the sides of the foramen magnum, and the labium has lost its original connection with the postoccipital region.

The facts are quite otherwise in the Coleoptera, for here the labium retains its postoccipital connections, and its base has been drawn out between the lengthened postgenal margins to form the gula.

In certain Coleoptera the postgenal margins do become closely approximated (fig. 49 D), but, in such cases, the gula is compressed between the postgenae, and sometimes almost obliterated. The gular sutures may then be partially or wholly united into a median gular suture, with which are closely associated the two tentorial pits (*pt*, *pt*). Intermediate stages of this condition are well shown in some of the Rhyncophora, in which the head is drawn out into a "snout."

In the Neuroptera, both larvae and adults, and in larval Trichoptera, a gular plate is developed showing essentially the same structure and variations of form as in the Coleoptera. The gular structure has been described in various members of these orders and others in addition to the Coleoptera by Crampton (1921, 1928). In the Termitidae, Crampton shows, the gular region of the submentum may be very much elongated, and in the soldier of *Termopsis* its margins become united with the lengthened edges of the postgenae to form a typical gular plate.

The question of the derivation of the gula, the answer to which is, that the gula is a part of the submental region of the labium, is not to be confused with the question as to the origin of the submentum itself. The various views concerning the nature of the submentum have been already discussed in an earlier section of this paper (page 77), and the writer will reiterate here only his own personal opinion that, since the submentum in generalized insects is attached laterally to the postoccipital tergal region of the head, it comprises the basal parts of the second maxillary appendages, to which, however, there may be added a median field of the sternum of the corresponding segment. If the submentum is regarded as entirely the labial sternum, then the sternum becomes suspended directly from the tergum of its segment, and bears the appendages—a condition so at variance with ordinary morphological relations as to discredit the premises from which it is deduced.

VII. THE HEAD OF A CATERPILLAR

The caterpillars are remarkable for their standardization of structure. In none of the other larger groups of insects is there such uniformity in fundamental organization as in the larvae of the Lepidoptera. Some species are superficially specialized, but apparently there is no "generalized" caterpillar. Ontogenetically, the caterpillars probably represent a stage below that of the larvae of Neuroptera, and of

the larvae of the more generalized adult Coleoptera (Adephaga), since the young of these insects are closer in form to that of a typical adult insect. The caterpillars show primitive conditions in the origin of the antennal muscles on the walls of the cranium, in the musculature of the thoracic legs, in the monocondylic leg joints, in the dactylopodite-like end segments of the legs, and in the retention of the abdominal "legs," if these organs are remnants of true abdominal appendages, as they appear to be. The general form of the alimentary canal, of the tracheal system, and of the nervous system are fairly generalized, though the brain is specialized by an extreme condensation of its ganglia. On the other hand, the head, the maxillary appendages, the muscle sheath of the alimentary canal, and the body musculature are all highly specialized. While the form of the caterpillar's body is worm-like, it is not to be supposed that it represents a worm stage or even a primitive stage in the insect ancestry, for the structure of the head shows that the caterpillar belongs to the highly evolved stage of the pterygote insects. The caterpillar's form is merely one that adapts the insect to a wide feeding environment. The extremely complicated body musculature must be regarded as acquired through an excessive multiplication of the segmental muscles to give unlimited mobility to a soft-bodied animal. The fly maggot likewise has an intricate body musculature, but of quite a different pattern from that of the caterpillar.

STRUCTURE OF THE HEAD CAPSULE

The caterpillar head is an example of the type of head structure in which the lower genal and postgenal regions of the cranium (fig. 51 E) are lengthened to give a long ventro-lateral area on each side between the foramen magnum and the posterior articulation of the mandible. The facial aspect of the head (fig. 50 A) is characterized by the extension of the clypeus into the area of the frons, and by the invagination of the median part of the frons dorsal to the clypeus.

The prominent triangular plate so characteristic of the facial aspect of a caterpillar's head is unquestionably the clypeus (fig. 50 A, B, C, F, H, *Clp*), though it has usually been called the "frons." Its margins are defined internally by a strong V-shaped ridge (E, I, *ER*), the inverted apex of which is continued into a thick median ridge of the dorsal wall of the cranium. From the arms of the V-ridge arise the anterior tentorial apophyses (*AT*), and the latter identify the V-ridge as the epistomal ridge (*ER*). The space between the diverging arms, therefore, is the true clypeus (*Clp*). It has already been shown that the clypeus in other orders of insects may be extended into the facial region dorsal to the mandibular articulations (figs. 46 D, F, G, 47 C).

Further evidence that the area thus designated the clypeus in the lepidopteran larva is the true clypeal area, and not the frons, is given

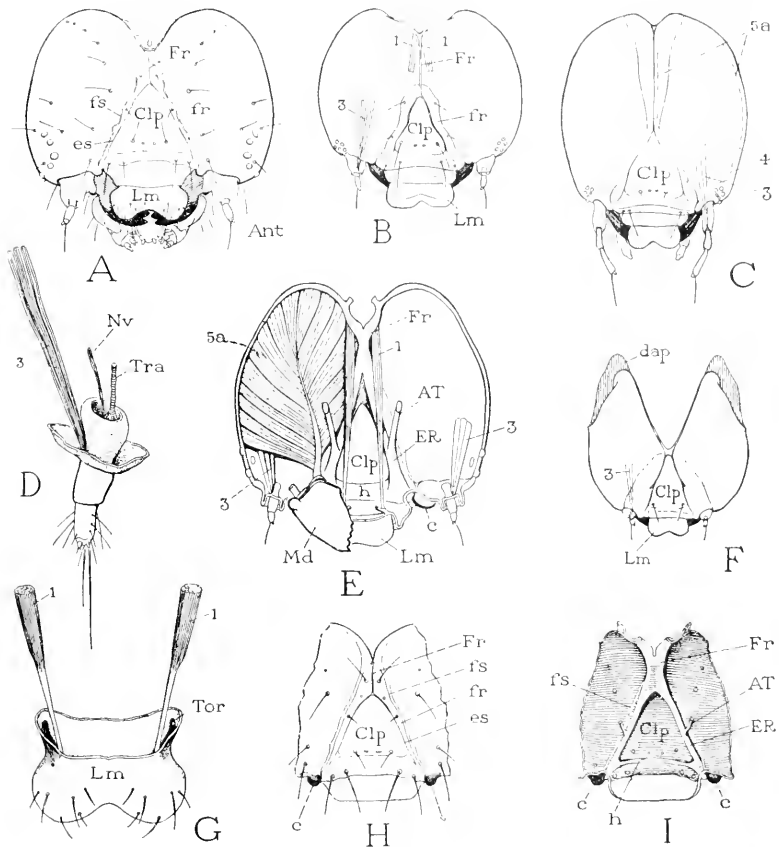

FIG. 50.—Head structure of caterpillars: anterior cranial wall, labrum, antenna, and mandibular muscles.

A, anterior surface of head of *Lycophotia (Peridroma) margaritosa*. B, same of *Thrydopteryx ephemeraeformis*. C, same of *Sibene stimulea*, showing areas of origin of mandibular muscles (*j. 5a*). D, antenna of *Malacosoma americana*, left, anterior view. E, interior view of anterior wall of head of *Prionoxystus robiniae* (Cossidae), with labral muscles and adductor of left mandible in place. F, anterior surface of head of *Mnemonica aurocyanea*. G, labrum of *Lycophotia margaritosa*, anterior view, showing muscle insertions. H, fronto-clypeal area of same. I, inner view of same.

AT, anterior arm of tentorium; c, anterior articulation of mandible; Clp, clypeus; ER, epistomal ridge; es, epistomal suture; Fr, frons; fr, "adifrontal"; fs, frontal suture; h, submarginal thickening of clypeus; Lm, labrum; Md, mandible; Nv, antennal nerve; Tra, antennal trachea.

by the origin of the clypeal dilator muscles of the stomodeum upon it (fig. 55, 20, 21). Finally, it is to be observed, the muscles of the labrum, which, in all cases where the identity of the facial plates is clear,

arise on the frons, are never attached to the triangular plate of the caterpillar face, but take their origin from the median ridge dorsal to it (fig. 50 B, E, *r*). In many caterpillars the lower part of the clypeus is strengthened by an internal submarginal thickening (E, I, *h*) forming a bracing ridge between the articulations of the mandibles (c, *c*).

The frontal area of the head, as has been shown, is to be identified by the origin of the labral retractor muscles upon its inner surface (fig. 47 B, C). In the caterpillar the labral muscles arise either upon the median internal ridge of the cranium that extends between the apex of the posterior emargination of the vertex and the apex of the clypeus, or upon the dorsal bifurcations of this ridge that are continued into the margins of the vertical emargination (fig. 50 B, E, 53 E, *r*). This ridge, then, is at least a part of the frons. It is formed by a deep inflection of the median line of the cranium dorsal to the apex of the clypeus, which appears externally as a median suture (fig. 50 A, B, C, H, *Fr*). In a softened specimen this frontal invagination can often be widely opened, when it is seen that its inflected surfaces are continuous with the so-called "adfrontal" strips lying laterad of the clypeus and extending ventrally to the bases of the mandibles. The sutures, or membranous lines, along the outer margins of the "adfrontals" thus become the true frontal sutures (fig. 50 A, H, I, *fs*).

The frontal region of the caterpillar, therefore, includes the invaginated frontal groove (fig. 50 A, E, *Fr*), the "adfrontals" (*fr*), and perhaps the apical margins of the vertical emargination. When the mature caterpillar sheds its skin at the pupal molt, the head cuticula splits along two lines, which, beginning at the notch of the vertex, follow the external lips of the median frontal invagination and then diverge along the "adfrontal" sutures to the bases of the mandibles. An elongate piece is thus cut out which includes the median frontal inflection, the "adfrontals" and the clypeus. In some caterpillars the molting cleft follows only one of the adfrontal sutures, the other remaining closed.

The median part of the vertex in the caterpillar's head is obliterated by the dorsal emargination, and the angle of the emargination usually extends into the frontal invagination (fig. 50 I); in some cases the notch is so deep that the latter is reduced to a very small area dorsal to the apex of the clypeus (F).

The labrum of the caterpillar (fig. 50 A, B, *Lm*) is commonly separated from the lower edge of the clypeus by a wide, flexible membranous area. Some writers, having mistakenly identified the true clypeus as the frons, have regarded this membranous area as the clypeus,

but the error of this interpretation is shown by the fact that none of the stomodeal muscles arise upon the membrane, the clypeal dilators having their origin on the triangular plate above. The caterpillar labrum has but a single pair of muscles:

1.—*Retractor muscles of the labrum* (figs. 50 E, G, 53 E).—A pair of long slender muscles arising on the inflected frons (figs. 50 E, 53 E, *Fr*); inserted by long tendons on bases of tormae (figs. 50 G, 53 E)

The ventral surface of a caterpillar's head presents a number of secondary modifications that, at first sight, somewhat obscure the basic structure; but, when the general head "landmarks" are once recognized, it is not difficult to see that the fundamental structure is no different from that in an orthopteroid head.

As we have noted, the caterpillar head is characterized by an elongation of the postgenal regions between the foramen magnum, or the end of the neck membrane (fig. 51 E, *NMb*), and the posterior articulations of the mandibles (*a*). On each side, a posterior median part of the postgena (*A, E, Hst*) is separated from the more lateral postgenal region (*Pge*) by a suture (*j*).

The median area thus set off is called the *hypostoma* (*Hst*), and the inner angles of the two hypostomal areas are approximated and sometimes united on the median line behind the base of the labium, which is thus separated from its usual basal connection with the neck membrane, or with the postoccipital rim of the cranium. In this manner a condition has been evolved which is almost a replica of that in the head of adult Hymenoptera (fig. 48 B, C), except that in the latter the hypostomal areas are not separated from the rest of the postgenal regions.

In some caterpillars a well-developed subgenal ridge (fig. 51 D, *SgR*) follows the outer margin of the membranous area of the antennal base from the anterior articulation of the mandible (*c*) to the posterior (*a*), and is then continued along the anterior mesal margin of the hypostoma (*Hst*). Some entomologists distinguish the part of the subgenal ridge that skirts the mandibular area as the "pleurostomal ridge," or "pleurostoma," and that part which follows the hypostomal margin as the "hypostomal ridge." The external suture that defines the hypostomal area on each side (*E, j*) forms internally a strong ridge (*D, j*) extending from the subgenal ridge at the posterior mandibular articulation (*a*) to the postoccipital ridge (*PoR*). The subgenal ridge, especially its hypostomal part, is lacking or but weakly developed in some caterpillars (*C*), but the ridge of the hypostomal suture (*j*) is always well developed, and apparently serves to brace the genal area between the mandible and the posterior rim

of the head. The maxillae are suspended in the usual manner by the articulations of the cardines against the margins of the hypostomal areas of the postgenae (C, *Cd*, E, *c*).

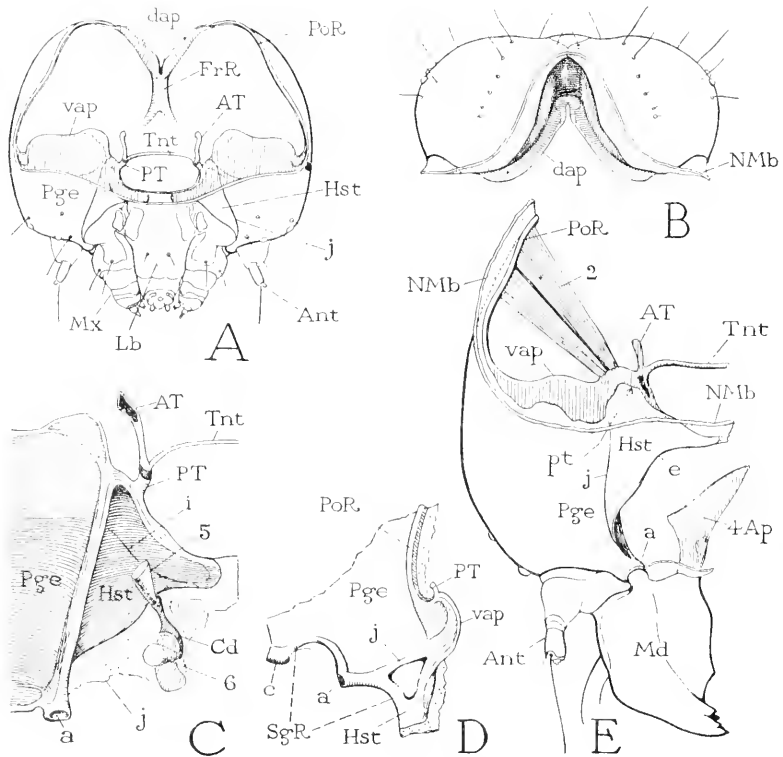

FIG. 51.—Structure of the posterior and ventral parts of the head of a caterpillar.

A, postero-ventral view of head of a noctuid (*Lycophotia margaritosa*). B, dorsal view of same. C, interior view of postgenal and hypostomal regions, showing posterior arm of tentorium (*PT*), and articulation of cardo (*Cd*). D, inner face of same region in *Malacosoma americana*. E, ventral view of right half of cranium, with mandible and antenna, of *Estigmene acrea*.

a, posterior articulation of mandible; *Ant*, antenna; *4Ap*, base of adductor apodeme of mandible; *AT*, anterior arm of tentorium; *c*, anterior articulation of mandible; *Cd*, cardo; *dap*, dorsal apodemal plate of postoccipital ridge; *e*, articulation of cardo to cranium; *FrR*, frontal ridge; *Hst*, hypostoma; *i*, line of base of neck membrane; *j*, hypostomal suture, hypostomal ridge; *Lb*, labrum; *Md*, mandible; *Mx*, maxilla; *NMb*, neck membrane; *Pge*, postgena; *PoR*, postoccipital ridge; *PT*, posterior arm of tentorium; *Tnt*, transverse bar of tentorium; *vap*, ventral apodemal plate of postoccipital ridge.

The foramen magnum is extraordinarily large in the caterpillar, being almost as wide as the cranium, and is extended forward dorsally in the median notch of the vertex (fig. 51 A). The postoccipital ridge (*PoR*) is inflected from the rear margin of the cranial walls, there

being no perceptible chitinization beyond it to form a postoccipital rim in the neck region. The postoccipital ridge gives origin to plate-like apodemes that constrict the actual opening of the head cavity into that of the neck. Usually there is a pair of dorsal apodemes (A, B, *dap*) in the notch of the vertex, and a pair of larger ventral apodemes (A, D, E, *vap*) arising from the postgenal and hypostomal parts of the postoccipital ridge. The apodemes vary much in size and shape in different species, but those of the ventral pair are usually the larger and the more constantly developed. The apodemes furnish surfaces of attachment for the anterior ends of prothoracic muscles inserted on the back of the head (fig. 57 A, C). In the caterpillars the foramen magnum is crossed laterally by oblique foraminal muscles, which are the following:

2.—*Muscles of the foramen magnum* (figs. 51 E, 57 A).—Attached below on each side to ventral postoccipital apodeme (fig. 51 E, *vap*) laterad of posterior root of tentorium; spreading dorsally and laterally, sometimes as a broad fan (fig. 57 A), to the dorso-lateral parts of postoccipital ridge. The foraminal muscles are of the nature of the transverse muscles of the intersegmental folds in the body of the caterpillar. From their position it would appear that they must produce a tension on the hypostomal regions of the head wall. Foraminal muscles are not present in insects generally.

The tentorium of the caterpillar is a simple structure consisting of two slender longitudinal bars, and of a delicate transverse posterior bridge. The longitudinal bars, which represent the anterior arms of the tentorium (fig. 53 D, E, *AT*), arise from the lateral parts of the epistomal ridge at the sides of the clypeus (fig. 50 E, I, *AT*). They extend horizontally through the head (fig. 53 E), and are united posteriorly with the ends of the posterior bridge (figs. 51 A, C, E, 53 D, *Tnt*). The bridge represents the united median parts of the posterior tentorial arms (fig. 51 A, C, *PT*), the origins of which (E, *pt*) are at the posterior angles of the hypostomal plates in the deep inflections that form the inner ends of the ventral postoccipital apodemes (*vap*). The positions of all the tentorial roots in the caterpillar, thus, are identical with those of the tentorial roots in an orthopteroid head, notwithstanding the considerable alterations which the surrounding parts have suffered.

THE ANTENNAE

The antennae are much reduced in all caterpillars, being so small by comparison with the adult organs that the latter are forced to develop by recession, and during the propupal stage their tips only lie within the antennae of the larva. The antennae of the caterpillar are

situated on membranous areas just laterad of the bases of the mandibles, while the antennae of the adult arise from the facial region above the compound eyes. The ventro-lateral position of the larval antennae, therefore, appears to be a primitive character in the caterpillars.

Each antenna of the caterpillar consists of three segments, of which the middle one is usually the largest, the proximal segment being often reduced to a mere basal ring (fig. 51 E, *Ant*), and the terminal one appearing as a minute apical papilla of the second. The membrane of the antennal base may form a large mound with the antenna retractile into it, or sometimes a long cylindrical projection simulating a basal segment (fig. 50 C). A hypodermal fold projects inward from the base of the antenna (fig. 50 D) which receives the antennal nerve and trachea. Each antenna is moved by a single set of muscle fibers, which are:

3.—*The retractor muscles of the antenna* (fig. 50 B—F).—A group of slender fibers arising on the parietal walls of the cranium laterad of adfrontal area; inserted on anterior inner angle of base of proximal antennal segment. Extension of the antennae is probably effected by blood pressure from within the head.

THE MANDIBLES

The mandibles of the caterpillar are typical insect jaws suspended from the lower margins of the cranium by a hinge line sloping downward posteriorly, with well-developed anterior and posterior articulations. The anterior articulation of each mandible consists of a condyle on the cranial margin placed just laterad of the clypeus (fig. 52 A, *c*), received into a socket on the base of the jaw; the posterior articulation (*a*) is the reverse, consisting of a socket on the cranial margin receiving a condyle of the mandible. As in all insects, the articular points of the jaw lie *outside* the membrane that connects the base of the mandible with the head. A line between the two articulations divides the base of the jaw unequally (fig. 52 B), the larger part being mesad to the axis.

The muscles of the mandibles are inserted on large but weakly chitinized apodemal inflexions arising at the outer and inner margins of each jaw. The muscles take their origin on the walls of the cranium and on the ventral apodemes of the postoccipital ridge. Their fibers occupy most of the cavity of the head, and the cranial hemispheres appear to model their form on that of the bases of the great adductor muscles of the jaws.

4.—*The abductor muscles of the mandible* (figs. 50 C, 52 B).—A group of fibers, small by comparison with the adductor group, arising on lower lateral and posterior walls of cranium, and on ventral apodeme of postoccipital ridge laterad of posterior root of tentorium; fibers converging ventrally, anteriorly, and mesally to insertion on abductor apodeme of mandible.

5.—*The adductor muscles of the mandible* (figs. 50 C, E, 52 B, 53 E).—An enormous mass of fibers disposed in two sets (figs. 52 B, 53 E, 5a, 5b). The fibers of one group arise from almost entire dorsal, anterior, lateral, and posterior walls of corresponding half of epi-cranium above the ocelli (figs. 50 C, E, 53 E, 5a); they converge downward upon both surfaces of the broad adductor apodeme of mandible. The fibers of the other group (figs. 52 B, 53 E, 5b) arise on ventral apodeme of postoccipital ridge (fig. 53 E, *tap*) mesad of bases of

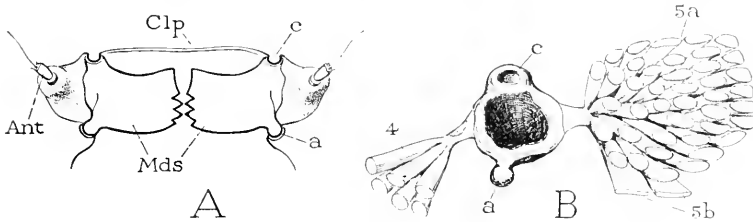

FIG. 52.—Mandibles of a caterpillar.

A, mandibles and antennae of *Estigmene acrea*, ventral view. B, left mandible of a noctuid, with bases of muscles, dorsal view.

a, posterior articulation of mandible; *Ant*, antenna; c, anterior articulation of mandible; *Clp*, edge of clypeus; *Mds*, mandibles; 4, abductor muscle of mandible; 5a, fibers of adductor arising on wall of cranium; 5b, adductor muscles arising on ventral apodeme of postoccipital ridge (see fig. 53 E).

abductor fibers, and extend horizontally to posterior edge of adductor apodeme of mandible.

The obliquity of the mandibular axes causes the points of the jaws to turn upward and somewhat posteriorly during adduction. When the mandibles are closed, the teeth on the cutting edges of the two jaws are opposed to each other (fig. 52 A), not interlocked; but usually one mandible closes first and its toothed edge passes inside that of the other. Live caterpillars examined by the writer always closed the right mandible over the left, and species of several families preserved in alcohol were found to have the jaws in the same position.

THE MAXILLAE AND LABIUM

The basal parts of the maxillae and labium are united, and their chitinous areas are reduced or variously broken up into small plates (figs. 51 A, 53 A), which may differ much in different species. With

the anterior wall of the labium, apparently, is united also the hypopharynx (fig. 54 D, *Hphy*), and the duct of the silk gland opens through a hollow spine, the spinneret, at the tip of the labium.

Each maxilla includes a cardinal area (fig. 53 A, *Cd*), a stipital area (*St*), both united with the basal part of the labium, and a free terminal lobe (*Lc*), which appears to be the lacinia. A maxillary palpus is lacking. The area of the cardo includes one principal sclerite (fig. 53 A, B, E, F, *Cd*), and generally one or two accessory plates (A, E, F, *k, k*). The principal sclerite is always articulated to the hypostomal margin at a point (*c*) corresponding with the articulation of the cardo to the cranium in orthopteroid insects. The area of the stipes (*St*) is variously chitinized, or unchitinized, but it always preserves the ridge (*q*) of its inner margin, upon which are attached all the stipital muscles. The homology of the terminal lobe of the maxilla is difficult to determine.

The musculature of the maxilla of a caterpillar comprises muscles pertaining to its three parts, most of which are comparable to the maxillary muscles of the grasshopper or other generalized insects, though there is little similarity in the general appearance of the structure in the two cases. The cardo, in the caterpillar, is provided with two or three muscles (fig. 53 B, E, F, 6, 7, 8), all of which arise on the anterior arm of the tentorium (D, E), and, therefore, represent the tentorial adductors of the cardo in orthopteroid insects. The usual cranial muscle of the cardo (fig. 25, *I*, fig. 40 C, *10*) is lacking in the caterpillar. The stipes is provided likewise with tentorial adductors (fig. 53 B, D, E, F, 9, 10, 11) inserted on its mesal chitinous ridge (*q*). The terminal maxillary lobe is moved by muscles that arise within the stipes (B, F, 12, 13), and also by a long muscle (B, 14) having its origin in the posterior angle of the hypostomal plate (*Hst*) of the epicranium. These three muscles are inserted upon a basal sclerite in the ventral wall of the maxillary lobe (A, B, *l*). The first two suggest the ordinary stipital muscles of the lacinia, but the third (*14*) appears to have no homologue in more generalized insects, since the usual cranial flexor of the lacinia (fig. 30 B, *flcc*) is inserted on the median angle of the latter. The insertion of the three muscles on a single sclerite in the base of the maxillary lobe leaves no evidence to indicate the presence of a galea, and suggests that the lobe is the lacinia alone, complicated in form by the development of large sensory papillae. Certainly, the musculature of the lobe shows that none of the papillae can be a palpal rudiment.

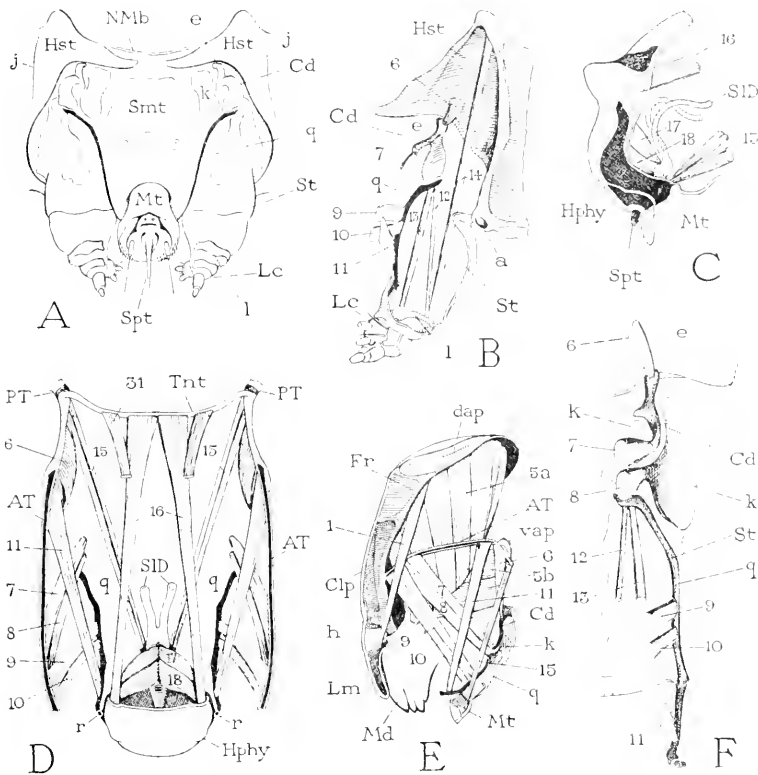

FIG. 53.—Maxilla, labium, and silk press of a caterpillar.

A, *Estigmene aceraca*, maxillae and labium, with hypostomal plates of head, posterior (ventral) view. B, internal view of left maxilla and hypostomal region of same, showing muscles. C, *Malacosoma americana*, distal part of labium and hypopharynx, lateral view, showing silk press and muscles. D, *Lycophotia margaritosa*, muscles of maxillae, labium, and hypopharynx, internal (dorsal) view. E, the same, right side of head, internal view, showing muscles of labrum, mandible, maxilla, and labium. F, cardo and lateral parts of stipes of right maxilla, showing bases of muscles, dorsal (anterior) view. (Compare with E.)

a, anterior articulation of mandible; AT, anterior arm of tentorium; Cd, cardo; Clp, clypeus; dap, dorsal apodeme of postoccipital ridge; e, articulation of cardo with cranium; Fr, frons; h, submarginal ridge of clypeus; Hphy, hypopharynx; Hst, hypostoma; j, hypostomal suture; k, accessory plates of cardo; l, basal sclerite of lacinia; Lc, lacinia; Lm, labrum; Md, mandible; Mt, mentum; NMb, neck membrane; PT, posterior tentorial arm; pt, posterior tentorial pit; q, ridge on inner edge of stipes; r, articular nodule between end of stipital ridge (q) and mentum; SID, silk gland ducts; Smt, submentum; Spt, spinneret; St, stipes; Tnt, transverse bar of tentorium; vap, ventral apodeme of postoccipital ridge.

The muscles of the maxilla may be enumerated as follows, and they will probably be found to differ but little in different species of caterpillars:

6.—*First adductor of the cardo* (fig. 53 B, D, E, F).—Origin on posterior end of anterior arm of tentorium (*AT*); goes ventrally to insertion on base of cardo.

7.—*Second adductor of the cardo* (fig. 53 B, D, E, F).—Origin anteriorly on tentorial arm (D, E); insertion on distal end of cardo.

8.—*Third adductor of the cardo* (fig. 53 D, E, F).—This muscle found in noctuid larvae, perhaps a subdivision of 7. Origin anterior to 7 on tentorial arm (D, E); insertion on accessory plate (E, F, *k*) mesad to the articulating sclerite of cardo (*Cd*).

9.—*First adductor of the stipes* (fig. 53 B, D, E, F).—Arises near anterior end of anterior tentorial arm (D, E); goes obliquely ventrally and posteriorly to insertion on marginal ridge (B, D, E, F, *q*) of stipes.

10.—*Second adductor of the stipes* (fig. 53 B, D, E, F).—Origin at anterior end of tentorial arm, just before *o* (D, E); insertion on stipital ridge (D, E, F, *q*) anterior to *o*.

11.—*Third adductor of the stipes* (fig. 53 B, D, E, F).—Arises posteriorly on anterior tentorial arm, just before first adductor of cardo (*6*); goes obliquely ventrally and anteriorly (D, E), internal to 7, 8, 9, and 10, to insertion on anterior end of stipital ridge (B, D, E, F, *q*).

12.—*External retractor of the lobe* (fig. 53 B, F).—Origin on base of stipital ridge (*q*); insertion laterally on basal plate (A, B, *l*) of terminal lobe of maxilla.

13.—*Internal retractor of the lobe* (fig. 53 B, F).—Origin on base of stipital ridge (*q*); insertion mesally on basal plate (A, B, *l*) of terminal lobe of maxilla.

14.—*Cranial abductor of the lobe* (fig. 53 B).—Origin in basal angle of hypostomal plate of epicranium (*Hst*); insertion on outer end of basal plate (*l*) of terminal lobe of maxilla. A corresponding muscle is not present in orthopteroid insects.

The labium of the caterpillar (fig. 53 A) lies between the maxillae. The broad membranous surface of its large submental region is united on each side with the marginal ridges (*q*) of the stipites, and its basal part is continuous laterally with the membrane of the cardinal areas. Proximally the labium may be continuous with the neck membrane (*NMb*) between the approximated ends of the hypostomal plates (*Hst*), but, when the latter are united, the labium becomes

separated from the neck. A large submental plate occupies the median basal part of the submental region in some species (*A. Smt*).

The distal, free lobe of the labium probably represents the mentum and ligula of other biting insects, combined with the hypopharynx, which forms its anterior surface (fig. 54 A). Evidence of this interpretation is found in the fact that the labial and hypopharyngeal

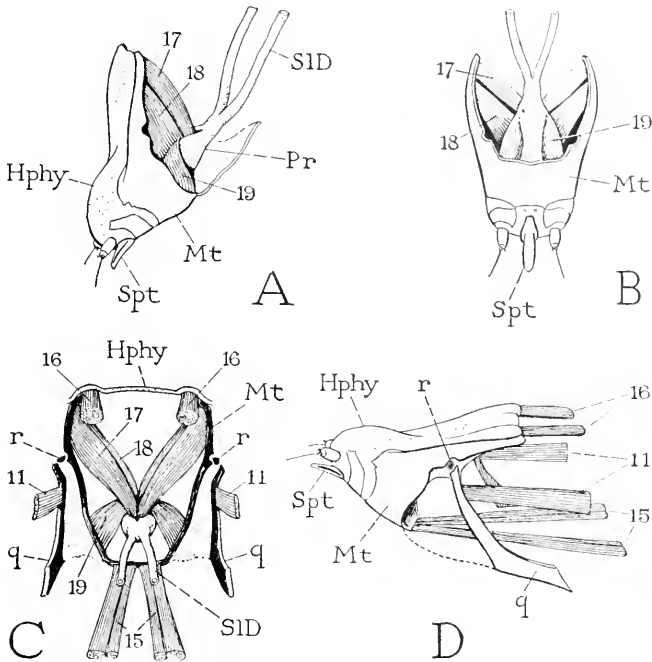

FIG. 54.—Distal part of labium, hypopharynx, and silk press of a noctuid caterpillar.

A, mentum and hypopharynx, with silk press partly exposed, lateral view. B, the same, dorsal view. C, the same, posterior view, showing support on arms of stipites (*q, q*). D, lateral view, showing muscle attachments.

Hphy, hypopharynx; *Mt*, mentum; *Pr*, silk press; *q, q*, ridges of stipes; *r, r*, articular nodules between stipital arms and mentum; *SID*, silk duct; *Spt*, spinneret.

muscles are inserted on the base of the lobe (figs. 53 C, D, 54 C, D, 15, 16), and in the position of the spinneret (fig. 54 A, D, *Spt*), which contains the opening of the silk duct (salivary duct), the latter being normally situated between the labium and the hypopharynx (fig. 18 D, *SIO*).

The mental region of the mento-hypopharyngeal lobe appears to be that occupied by the large proximal plate (fig. 53 A, *Mt*) that em-

braces the base of the lobe ventrally and laterally, but which is not continued across the hypopharyngeal surface (figs. 53 C, 54 A, C, D, *Mt*). This plate is supported upon the distal ends of the ridges of the stipites (fig. 54 C, D, *q, q*), which are turned forward and articulated with the dorsal arms of the mentum (*Mt*) by small, chitinous nodules (*r, r*). By this mechanism, the mentum-hypopharynx, which carries the spinning apparatus, is freely movable on a transverse axis between the ends of the supporting stipital ridges. The motion in a vertical plane is the only movement that can be given to the spinning apparatus, except by the action of the entire head; but the head of the caterpillar is highly mobile by reason of the great number of muscles inserted upon its posterior margin (fig. 57). The musculature of the mentum-hypopharynx, or spinning organ, is as simple as its mechanism, consisting of two pairs of muscles, as follows:

15.—*Reductors of the spinning organ* (figs. 53 C, D, E, 54 C, D).—A pair of double muscles arising at posterior ends of tentorial arms (fig. 53 D, E); converging ventrally and anteriorly to insertions on ventral edge of mentum (figs. 53 C, E, 54 C, D, *Mt*). These muscles probably represent the mento-tentorial muscles of orthopteroid insects (fig. 40 D, 23), which are primitive adductors of the second maxillae.

16.—*Producers of the spinning organ* (figs. 53 C, D, 54 C, D).—A pair of broad muscles arising medially on transverse bridge of tentorium (fig. 53 D, *Tnt*), diverging ventrally and anteriorly to base of hypopharynx (figs. 53 C, D, 54 C, D, *Hphy*). These muscles are probably the retractors of the hypopharynx in orthopteroid insects (fig. 41, 32).

The silk press of the caterpillar is a special development of the common duct of the labial glands (here, the silk glands). The deeply invaginated dorsal wall of the organ exerts a pressure on the silk material, which is regulated by two sets of opposing muscles that, probably acting together, effect a dilation of the lumen of the press by elevating the invaginated roof. The muscles of the press arise within the mentum, and the two sets may be distinguished as follows:

17, 18.—*Dorsal muscles of the silk press* (fig. 54 A, B, C).—Two lateral series of muscles, the number on each side varying in different species of caterpillars, arising on dorsal arms of mentum; converging to insertions on chitinous raphe in dorsal (anterior) wall of press.

19.—*Ventral muscles of the silk press* (fig. 54 A, B, C).—Origin in ventrolateral parts of mentum; insertion on dorso-lateral edges of silk press. These muscles are antagonists to the dorsal muscles, since the fibers of the two sets oppose each other in the crossed lines of an X

(fig. 54 C); but in function the ventral muscles are probably accessory to the dorsals by counteracting the pull of the latter on the press.

It is difficult to discover a parallelism between the muscles of the silk press in the caterpillar and muscles of the labium in other insects. However, it may be possible that the two sets of muscles in the labium of the grasshopper (fig. 40 D, 26, 27) inserted on the salivary cup (*v*) are the prototypes of the silk press muscles, though their insertion points are ventral instead of dorsal.

THE STOMODEUM

The stomodeum of the caterpillar (fig. 55) is differentiated into four parts. The first part is a bucco-pharyngeal region (*BuC*, *Phy*);

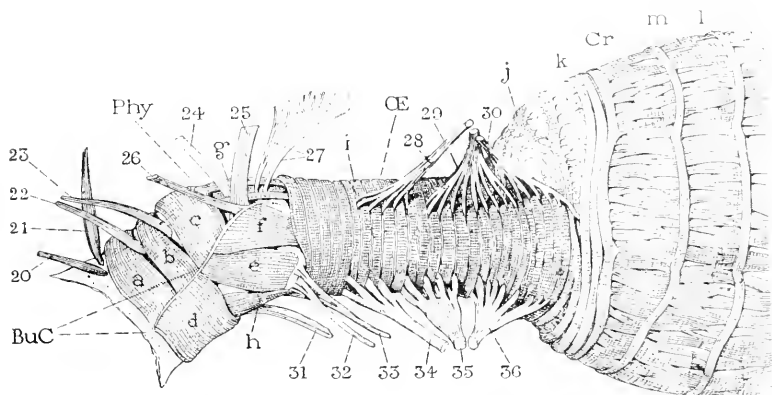

FIG. 55.—Anterior part of the stomodeum of a noctuid caterpillar, showing muscles of the stomodeal wall, and the dilator muscles arising in the head.

a-m, muscles of stomodeal wall; *BuC*, buccal cavity; *Cr*, crop; *OE*, oesophagus; *Phy*, pharynx; 20-23, muscles of buccal region, arising on clypeus; 24-27, dorsal dilators of anterior pharyngeal region; 28-30, dorsal dilators of oesophagus (posterior pharyngeal region); 31-36, ventral dilators.

the second, a cylindrical tube with strong transverse muscle rings, constitutes an oesophagus (*OE*) in the caterpillars, but it evidently corresponds with the posterior section of the pharynx in Orthoptera; the third part is the large sack-like crop (*Cr*); the fourth is the constricted posterior region of the stomodeum (fig. 56 F, *Pvent*), which may be termed the proventriculus, though it has no special development of the lining intima, such as usually distinguishes the proventricular region in other insects.

The muscular sheath of the entire alimentary canal of the caterpillar is strongly developed, and in some parts becomes highly complicated in structure. The alimentary muscles are particularly strong in the noctuids, and the following descriptions are based mostly on *Lycophotia margaritosa*.

The lateral walls of the bucco-pharyngeal region are marked on each side by an oblique ridge (fig. 55), formed by a specially chitinized groove of the intima, which gives a firm line of insertion for the external muscles. The latter consist of thick, broad bands of strongly fibrillated muscle tissue, for the most part lying in one plane, though varying in position from transverse to longitudinal. The anterior-most muscles consist of two dorsal arcs (*a*, *b*), and of a corresponding wide ventral arc (*d*), their ends inserted laterally on the oblique ridges. This part of the stomodeum may be defined as the buccal region because its dilator muscles (20-23) have their origins on the clypeus. The anterior end of the pharyngeal region following is covered dorsally by a broad transverse muscle (*c*) attached laterally on the oblique ridges. The frontal ganglion lies over the posterior border of this muscle. Each side of the pharynx presents two muscle plaques (*e*, *f*) attached to the ventral margins of the upper half of the oblique ridge, but extending posteriorly to the oesophagus. The posterior dorsal wall of the pharynx is covered with several longitudinal muscles, the most prominent of which is a wide, median, external band of fibrils (*g*) deflected from the posterior part of the broad anterior transverse muscle (*c*). Concealed by this muscle are two longitudinals of a deeper set, arising anteriorly on the buccal region beneath the first transverse muscle (*a*) and extending posteriorly to the anterior end of the oesophagus. Several superficial longitudinal fibers lie more laterally.

The buccal region of the stomodeum is thus distinguished by its strong circular musculature, which evidently gives it a powerful constrictor action. The pharynx is provided principally with longitudinal muscles, and its action, except for that produced by the anterior dorsal transverse muscle, must be one of lengthwise contraction.

The entire length of the oesophageal tube is sheathed in a close series of strong circular fibers (*i*) which are complete rings, except a few of the most posterior interrupted dorsally at the anterior end of the crop.

The inner walls of the pharynx and oesophagus form four longitudinal folds—one dorsal, one ventral, and two lateral. The dorsal fold is broad, flat, and straight-edged. It arises at the base of the labrum, where its margins begin at the tormae, and continues to the posterior end of the oesophagus, where it is lost with the sudden widening of the stomodeal tube in the crop. Between the pharynx and the oesophagus, the continuity of the dorsal fold is interrupted by a transverse fold. The ventral and lateral folds are less definite, rounded

inflections of the stomodeal wall, continuous from the pharynx into the oesophagus. In *Lycophotia margaritosa* each of these folds ends at the opening of the crop in a prominent fleshy papilla covered with small chitinous points. Between the folds are four deep channels extending from the mouth to the crop, two dorso-lateral, and two latero-ventral. Possibly it is through these channels that the alimentary liquid, which caterpillars frequently eject from the mouth when irritated, is conveyed forward from the crop.

The muscles of the crop (fig. 55, *Cr*) are arranged longitudinally and circularly. The circular muscles (*l*), except for a few closely placed anterior bands (*k*), are widely spaced, external circular fibers. They all completely surround the crop like the hoops of a barrel. At the junction of the crop with the oesophagus, there are several short transverse fibers (*j*) confined to the dorsal surface. All the muscles of the crop are strongly fibrillated (fig. 56 A, B, C, D). The circular bands have distinct nuclei, but nuclei were not observed in the longitudinal muscles of noctuid species examined.

The longitudinal muscles of the crop (fig. 55, *m*) have their origin in single fibrillae (fig. 56 A) or small bundles of fibrillae (B) given off from the posterior margins of the circular fibers. They are, therefore, of the nature of branches of the circular fibers, and this fact may account for their lack of nuclei. Moreover, the longitudinal muscles are not continuous, individual bands, but are everywhere branched and intimately united by intercrossing bundles of fibrillae in such a manner that the entire layer becomes a plexus of muscle tissue (fig. 56 C). Most of the fibrillae of this layer spring from the anterior circular fibers, but probably all the circular fibers contribute at least a few elements to the longitudinal plexus. On the anterior end of the crop, the longitudinal fibrillae appear as simple connectives between the transverse fibers (fig. 55, *j*). On the posterior end of the crop (fig. 56 F), the longitudinal muscles again break up into smaller fibril bundles, and at last into fine strands that reunite with the external circular fibers of the crop or the proventriculus.

The proventricular region (fig. 56 F, *Provent*) resembles the oesophagus in being surrounded by a close series of strong circular muscle fibers (*n*). There is no distinct inner muscular sheath here, but the circular fibers are all connected by small bundles of fibrillae going from one to another (G), some to the first neighboring fibers, others to the second, third, or fourth removed in either direction. The proventriculus has a special feature in the presence of an external layer of fine, widely-spaced, longitudinal muscles, stretched freely between its two ends (fig. 56 F, *o*). These threadlike strands arise anteriorly

from branches that spring from the posterior ends of the longitudinal crop muscles, and from the anterior circular fibers of the proventriculus. Posteriorly they again break up into branches that are lost in a plexus of fibers at the junction of the proventriculus with the ventriculus (*Vent*).

A study of the stomodeal muscle sheath of the caterpillar thus shows that the usual brief statement that the insect stomodeum is surrounded by an external layer of circular fibers and an internal layer of longitudinal fibers must be considerably modified and amplified to fit conditions in the caterpillar. The proctodeal muscles of the caterpillar are even more complicated than are those of the stomodeum. The high degree of development in the alimentary musculature of the caterpillars accords with the general specialization of the caterpillar as an animal most efficient in feeding, and the extreme development of the somatic musculature is only another adaptation to the same end.

The dilator muscles of the stomodeum are inserted dorsally and ventrally on the stomodeal walls. The dorsal muscles are grouped into three sets corresponding with the buccal, pharyngeal, and oesophageal regions of the stomodeum. The dilator muscles of the dorsal and central series, enumerated according to the order of their insertions, are as follows:

20.—*First dorsal dilators of the buccal cavity* (fig. 55).—A pair of slender muscles arising on submarginal ridge of clypeus (fig. 50 1, *h*); extending posteriorly to insertions laterally on roof of mouth cavity just before first band of circular stomodeal muscles.

21.—*Second dorsal dilators of the buccal cavity* (fig. 55).—Origins on clypeus, above middle and close to lateral margins; insertions medially on dorsal wall of mouth cavity between insertions of 20.

22, 23.—*Third and fourth dorsal dilators of the buccal cavity* (fig. 55).—Two pairs of slender muscles: those of each side arising together in ventral angles of clypeal triangle just above ends of submarginal ridge; inserted dorso-laterally on buccal region, 22 before second band of transverse muscles (*b*), 23 behind it.

A wide space occupied by the third transverse muscle band (*c*) intervenes between the dilators of the buccal region and those of the true pharyngeal region.

24.—*First dorsal dilators of the pharynx* (fig. 55).—Origin on upper part of clypeus just internal to epistomal ridge; insertion medially on dorsal wall of pharynx laterad of frontal ganglion. These are clearly true pharyngeal muscles; their points of origin have evidently crossed the epistomal ridges to the clypeus.

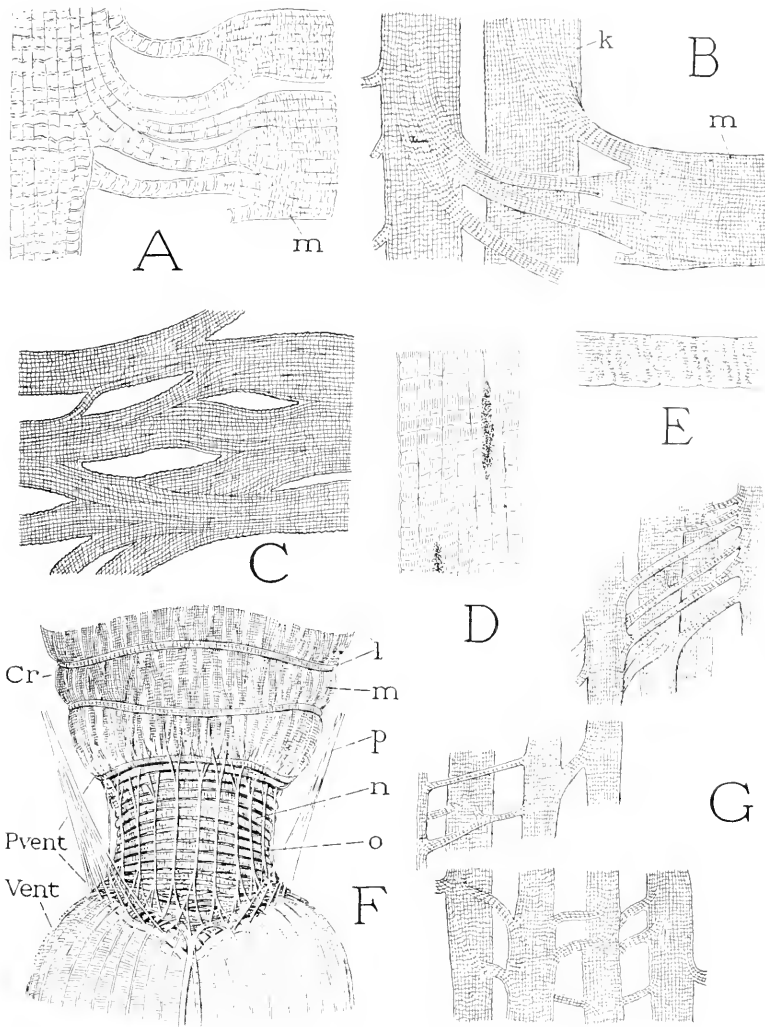

FIG. 56.—Muscles of the stomodeum of a noctuid caterpillar.

A, B, origin of longitudinal muscles (*m*), of crop (see fig. 55) from fibrils deflected from the anterior circular muscles (*j*, *k*). C, plexus of longitudinal muscles, anterior part of crop. D, piece of circular fiber from anterior part of crop. E, a connecting fiber between circular and longitudinal muscles. F, posterior end of crop (*Cr*), proventriculus (*Pvent*), and anterior end of ventriculus (*Vent*): *l*, *m*, circular and longitudinal muscles of crop; *n*, circular muscles of proventriculus; *o*, external longitudinal fibers of proventriculus; *p*, first suspensory muscles of ventriculus. G, parts of seven consecutive circular fibers of proventriculus, showing bundles of uniting fibrils, external.

25.—*Second dorsal dilators of the pharynx* (fig. 55).—Origins on epistomal ridges near union with frontal ridge; insertions dorso-laterally on pharynx.

26.—*Third dorsal dilators of the pharynx* (fig. 55).—Each arises on cranial wall laterad of origins of antennal muscles; extends medially, posteriorly, and downward to insertion on pharynx just laterad of 25.

The insertions of muscles 24, 25, and 26 all lie posterior to the frontal ganglion connective.

27.—*Fourth dorsal dilators of the pharynx* (fig. 55).—A group of fibers on each side, arising on outer surface of lower end of frontal ridge; converging to one or two stalks inserted on dorsal wall of pharynx just before brain.

The following dorsal muscles are inserted behind the brain and on the region of the stomodeum that may be distinguished in the caterpillar as the oesophagus, but which is the so-called posterior pharynx in Orthoptera.

28, 29, 30.—*Dorsal dilators of the oesophagus* (fig. 55).—Three fans of muscles arising on posterior margin of cranial walls on each side of vertical emargination; the spreading fibers inserted dorso-laterally on oesophagus from brain to crop.

31.—*First ventral dilators of the pharynx* (fig. 55).—A pair of long slender muscles arising on transverse bar of tentorium (fig. 53 D, *Tnt*), converging to ventral wall of pharynx where inserted just behind first ventral transverse muscle (*d*).

32, 33.—*Second and third ventral dilators of the pharynx* (fig. 55).—A pair of small muscles on each side arising on extreme outer ends of transverse tentorial bar; fibers spreading at insertion ventro-laterally on pharynx just before anterior circular muscles of oesophagus.

34, 35, 36.—*Ventral dilators of the oesophagus* (fig. 55).—Three large fans of fibers arising on postoccipital apodemes on each side laterad of posterior roots of tentorium; the spreading fibers inserted ventro-laterally on oesophagus from circum-oesophageal nerve connective to crop.

THE MUSCULATURE OF BACK OF HEAD, AND NATURE OF THE INSECT NECK

The head of the caterpillar is remarkably mobile. It is provided with a wonderful system of muscles, the fibers of which arise mostly in the prothorax and are distributed at their insertions upon the post-occipital ridge of the head in such a manner as to enable the caterpillar to make all possible head movements of which it conceivably might have need (fig. 57 A, B, C).

The muscles of the prothorax of the American tent caterpillar, *Malacosoma americana*, are illustrated in figure 57. At A are shown the lateral and ventral muscles as seen from a posterior dorsal view, with the head turned somewhat downward on the neck; B shows the dorsal muscles as seen from below; C presents an inner view of all

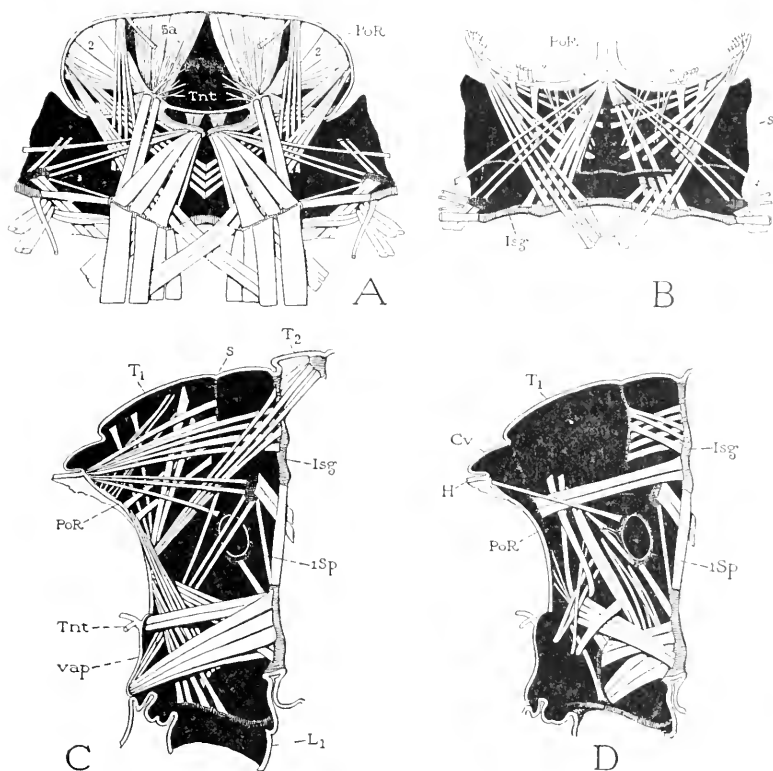

FIG. 57.—Muscles of the prothorax of a caterpillar, *Malacosoma americana*.

A, prothoracic muscles inserted on lateral and ventral parts of back of head, and ventral muscles of mesothorax, posterior view. B, dorsal muscles of prothorax and mesothorax inserted on dorsal half of back of head, seen from below. C, innermost layers of muscles of right half of prothorax, internal view. D, external muscles of right half of prothorax.

Isg, intersegmental fold; *L₁*, base of prothoracic leg; *PoR*, postoccipital ridge of head; *s*, edge of tergal plate of prothorax; *Isp*, first spiracle; *Tnt*, transverse bar of tentorium; *vap*, ventral apodermal plate of postoccipital ridge.

the muscles in the right half of the prothorax inserted on the head; and D gives the muscles of the same side that lie external to those shown in C, except the single fiber arising just dorsal to the spiracle, which is shown in both figures.

The various fibers of the head muscles are mostly arranged in groups, and it is easiest to trace them from their points of insertion on the back of the head. Inserted in the median notch of the vertex there is a dorsalmost group of long fibers that diverge posteriorly to the dorsal wall of the prothorax (B, C), the middle fibers of each group going to the posterior margin of the segment. External to these muscles, a group of short fibers, inserted serially on each side, extends posteriorly and dorsally to the tergal plate of the prothorax. Laterally there are inserted on the postoccipital ridge several fibers that spread to their origins on the tergal plate, and a group of four long fibers going dorsally and medially to the intersegmental fold (*Isg*), with the two median fibers crossing the latter to the dorsum of the mesothorax. Three lateral groups of fibers (A, C) go ventrally and posteriorly from their head insertions, one to the sternal intersegmental fold, another to the region just before the base of the prothoracic leg, and the third to the median longitudinal fold between the legs. Ventrally there are inserted on the ventral apodeme of the hypostomal region (C, *vap*) the anterior ends of the ventral longitudinal muscles of the prothorax (A, C), and a group of four long fibers on each side that arise on the region above the spiracle.

It is of particular interest to observe that, in the caterpillar, the ventral longitudinal muscles of the prothorax are *not* inserted on the tentorium (fig. 57 A, C) as they are in orthopteroid insects, and furthermore, that all the principal longitudinal ventral muscles of the thorax have their origin on the *intersegmental* folds, and not on intrasegmental apophyses. The primitive anterior insertion of these muscles in the prothorax, therefore, should be on a ventral intersegmental fold between the prothorax and the last head segment. We have already seen that there is evidence of the loss of the true labio-prothoracic intersegmental fold, since the postoccipital ridge, which bears the anterior attachments of the prothoracic muscles in all known insects, appears to be the fold between the maxillary and the labial segments. If so, the original attachments have been lost and the muscles now extend through the length of two primary segments.

Furthermore, the attachment of the ventral muscles of the caterpillar on the hypostomal regions of the head must signify a migration of the muscles from their primitive sternal insertions, for the hypostomal lobes clearly belong to the postgenae, and are, therefore, ventral extensions of the tergal area of the head wall. In any case, an attachment of the ventral muscles on the bridge of the tentorium certainly represents a farther displacement of the muscle insertions by a final

migration from the tergal postoccipital ridge to the posterior tentorial apophyses.

The question of the morphology of the cervical region of the insect must yet remain a puzzle; but the musculature gives no evidence of the existence of a neck segment. On the other hand, the fold in the integument of the caterpillar between the neck (fig. 57 D, *Cv*) and the prothoracic tergum (T_2) is suggestive of being the true intersegmental line between the labial segment and the prothoracic segment, and several muscles of the prothorax have their anterior attachments upon it (D). If the primitive insect is conceived as a continuously segmented, vermiform animal, the neck, or any other secondary intersegmental area, must be a part of a primary segmental region. From the evidence at hand it seems more probable that the region of the insect neck belongs to the labial segment, than to an anterior part of the prothoracic segment.

ABBREVIATIONS USED ON THE FIGURES

- | | |
|--|--|
| <i>Ab</i> , abdomen. | <i>Ch</i> , chelicera. |
| <i>abplp</i> , abductor of palpus. | <i>Cho</i> , chorion. |
| <i>adplp</i> , adductor of palpus. | <i>Clp</i> , clypeus. |
| <i>Am</i> , amnion. | <i>CocCon</i> , circumoesophageal connective. |
| <i>AMR</i> , anterior mesenteron rudiment. | <i>Com</i> , commissure. |
| <i>An</i> , anus. | β <i>Com</i> , commissure of tritocerebral lobes. |
| <i>Ant</i> , antenna. | <i>Con</i> , connective. |
| <i>AntNv</i> , antennal nerve. | <i>cs</i> , coronal suture. |
| <i>Ao</i> , aorta. | <i>ct</i> , coxo-trochanteral joint. |
| <i>AP</i> , apical plate. | <i>Cth</i> , cephalothorax. |
| <i>AR</i> , antennal ridge. | <i>Cv</i> , neck, cervix. |
| <i>Arc</i> , archicerebrum. | <i>cv</i> , cervical sclerite. |
| <i>as</i> , antennal suture. | <i>Cx</i> , coxa. |
| <i>AT</i> , anterior arm of tentorium. | |
| <i>at</i> , anterior tentorial pit. | <i>dap</i> , dorsal apodemal plate of postoccipital ridge. |
| <i>BC</i> , body cavity. | <i>DMcl</i> , dorsal longitudinal body muscle. |
| <i>Bdy</i> , body. | <i>DNv</i> , dorsal longitudinal nerve. |
| <i>Blc</i> , blastocoele. | <i>DT</i> , dorsal arm of tentorium. |
| <i>Bld</i> , blastoderm. | <i>dt</i> , attachment of dorsal tentorial arm to wall of cranium. |
| <i>Bp</i> , blastopore. | |
| <i>1Br</i> , protocerebrum. | <i>E</i> , compound eye. |
| <i>2Br</i> , deutocerebrum. | <i>Ecd</i> , ectoderm. |
| <i>3Br</i> , tritocerebrum. | <i>End</i> , endoderm. |
| <i>Bs</i> , basisternum. | <i>Endp</i> , endopodite. |
| <i>BuC</i> , buccal cavity. | <i>Ephy</i> , epipharynx, epipharyngeal surface. |
| <i>CA</i> , corpus allatum. | <i>Eps</i> , episternum. |
| <i>Cd</i> , cardo. | |
| <i>Cer</i> , cercus. | |

ER, epistomal ridge.
es, epistomal suture.
Exp, exopodite.

F, femur.
fga, flexor of galea.
Fl, flagellum.
flc, flexor of lacinia.
flcc, cranial flexor of lacinia.
flcs, stipital flexor of lacinia.
For, foramen magnum, or "occipital" foramen.
Fr, frons.
fr, "adfrontal"
FrGng, frontal ganglion.
fs, frontal suture.
ft, femoro-tibial joint.

Ga, galea.
GC, gastric caecum.
Gc, gastrocoele, archenteron.
Gch, gnathochilarium.
Ge, gena.
Gl, glossa.
Gn, gnathal segments.
Gnc, gnathocephalon.
Gng, ganglion.
Gu, gula.

H, head.
Hphy, hypopharynx.
Hst, hypostoma.

I, tergal promotor muscle of an appendage.
I-II, segments of the head.
Isq, intersegmental fold.

J, tergal remotor muscle of an appendage.

K, sternal promotor muscle of an appendage.
KL, ventral adductor muscles.
KLh, ventral adductors arising on hypopharynx.
KLk, ventral adductors united by ligament (*k*) forming "dumb-bell muscle."

KLt, ventral adductors arising on tentorium, or hypopharyngeal apodemes.

L, leg. *1L*, first leg. *L₁*, prothoracic leg.
 sternal remotor muscle of an appendage.
LB, primitive limb base (coxa and subcoxa).

Lb, labium.
LbNv, labial nerve.
lbmcl, labial muscles.
Lc, lacinia.
Lm, labrum.
LNv, lateral stomodeal nerve.

Md, mabdible.
MdC, mandible cavity.
MdNv, mandibular nerve.
Ment, mesenteron.
Mps, mouth parts.
Msb, primary mesoblast.
Msc, mesenchyme.
Msd, mesoderm.
Mst, metastomium.
Mt, mentum.
Mth, mouth.
Mr, maxilla.
1Mr, first maxilla.
2Mr, second maxilla.
MrC, maxilla cavity.
MrNv, maxillary nerve.

NC, nerve cord.
NMb, neck membrane.
Nph, nephridium.

O, ocellus.
 levator muscle of palpus, or of trochanter.

Oc, occiput.
OcR, occipital ridge.
ocs, occipital suture.
OE, oesophagus.
OcGng, oesophageal, or posterior median stomodeal ganglion.
OpL, optic lobe.
OR, ocular ridge.
os, ocular suture.

- P*, thoracic depressor muscle of trochanter.
PcR, posterior cranial ridge.
Pdc, pedicel.
Pdp, pedipalp.
Pge, postgena.
Pgl, paraglossa.
Ph, phragma.
Phy, pharynx.
PLGng, posterior lateral stomodeal ganglion.
Plp, palpus
Pnt, postantennal appendage.
Poc, postocciput, postoccipital rim of foramen magnum.
PoR, postoccipital ridge.
pos, postoccipital suture.
Pp, "pleuropodium," specialized appendage of first abdominal segment.
Ppd, parapodium.
Ppt, periproct.
PrC, preoral cavity.
Prc, protocephalon.
Pmnt, preantennal appendage.
Proc, proctodeum.
Prst, peristomium.
Prtp, protopodite.
Pst, prostomium.
PT, posterior arm of tentorium.
pt, posterior tentorial pit.
Ptar, praetarsus.

Q, depressor muscle of palpus, or of trochanter.
Rd, posterior fold of tergum.

rh, retractor of hypopharynx.
RNv, recurrent nerve.

S.A., sternal apophysis.
Scp, scape.
Scr, subcoxa.
Ser, serosa.
Sct, seta, setae.
SgR, subgenal ridge.
sgs, subgenal suture.
SID, salivary duct, silk gland duct.
SIO, opening of salivary duct.
Smt, submentum.
ScoGng, suboesophageal ganglion.
Sp, spiracle, *tSp*, first thoracic spiracle.
Spn, spina.
Spt, spinneret.
St, stipes.
Stom, stomodeum.

T, tergum.
 depressor muscle of tibia.
Tar, tarsus.
Tb, tibia.
Th, thorax.
Tl, tentacle.
Tlp, telopodite.
Tnt, tentorium.
Tor, torma.
Tr, trochanter.

V, fifth head segment.
vap, ventral apodemal plate of postoccipital ridge.
VI, sixth head segment.
Vlcl, ventral longitudinal body muscle.
VNC, ventral nerve cord.
VNv, ventral longitudinal nerve.
Vx, vertex.

REFERENCES

- ATTEMS, C. (1926). Myriapoda. Krumbach's *Handbuch der Zoologie*, 4. Berlin, Leipzig.
 BALFOUR, F. M. (1880). Notes on the development of the Araneina. *Quart. Journ. Micr. Sci.*, n. s., 20: 1-23, pls. 19-21.
 — (1883). The anatomy and development of *Peripatus capensis*. *Quart. Journ. Micr. Sci.*, n. s., 23: 213-259, pls. 13-20.
 BASCH, S. (1865). Untersuchungen über das Skelet und die Muskeln des Kopfes von *Termes flavipes* (Kollar). *Zeit. wiss. Zool.*, 15: 56-75, pl. 5.

- BERLESE, A. (1909). Gli Insetti, **1**. Milan.
- (1910). Monografia dei Myrientomata. *Redia*, **6**: 1-182, pls. 1-17.
- BIDDER, G. P. (1927). The ancient history of sponges and animals. *Rep. British Assoc. Adv. Sci.*, **1927**: 58-71.
- BÖRNER, C. (1909). Neue Homologien zwischen Crustaceen und Hexopoden. Die Beissmandibel der Insekten und ihre phylogenetische Bedeutung. *Zool. Anz.*, **34**: 100-125, 9 figs.
- (1921). Die Gleidmassen der Arthropoden. Lang's *Handbuch der wirbellosen Tiere*, **4**: 649-694, 57 figs. Jena.
- BORRADAILE, L. A. (1917). On the structure and functions of the mouth-parts of the palaemonid prawns. *Proc. Zool. Soc. London*, **1917**: 37-71, 51 figs.
- COMSTOCK, J. H., and KOCH, C. (1902). The skeleton of the head of insects. *Amer. Nat.*, **36**: 13-45, 29 figs.
- CRAMPTON, G. C. (1916). A comparative study of the maxillae of the Acridiidae (Oedipodinae and Tettiginacae), Phasmidae and Phylliidae. *Psyche*, **23**: 83-87, pl. 11.
- (1921). The sclerites of the head, and the mouth parts of certain immature and adult insects. *Ann. Ent. Soc. Amer.*, **14**: 65-103, pls. 2-8.
- (1921a). The origin and homologies of the so-called "superlinguae" or "paraglossae" (paraguaths) of insects and related arthropods. *Psyche*, **28**: 84-92, pl. 5.
- (1921b). The phylogenetic origin of the mandibles of insects and their arthropodan relatives. A contribution to the study of the evolution of Arthropoda. *Journ. New York Ent. Soc.*, **29**: 63-100, pls. 6-8.
- (1922). A comparison of the first maxillae of apterygotan insects and Crustacea from the standpoint of phylogeny. *Proc. Ent. Soc. Washington*, **24**: 65-82, pls. 8, 9.
- (1925). The external anatomy of the head and abdomen of the roach, *Periplaneta americana*. *Psyché*, **32**: 195-220, pls. 5-7.
- (1928). The eulabium, mentum, submentum and gular region of insects. *Journ. Ent. and Zool.*, **21**: 1-15, 3 pls.
- (1928a). The evolution of insects, chilopods, diplopods, Crustacea and other arthropods indicated by a study of the head capsule. *Canad. Ent.*, **60**: 129-141, pls. 8-12.
- CRONEBERG, A. (1880). Ueber die Mundtheile der Arachniden. *Arch. Naturgesch.*, **46** (1): 285-300, pls. 14-16.
- DAIBER, MARIE (1921). Crustacea. Lang's *Handbuch der Morphologie der wirbellosen Tiere*, **4**: 9-252. Jena.
- EIDMANN, H. (1925). Vergleichend-anatomische Studien über die Pharynxmusculation der Insekten. *Zool. Anz.*, **62**: 49-64.
- EVANS, A. M. (1921). On the structure and occurrence of maxillulae in the orders of insects. *Journ. Linn. Soc. Zool.*, **34**: 429-456, pl. 31.
- FOLSOM, J. W. (1899). The anatomy and physiology of the mouth-parts of the collembolan, *Orchesella cincta*. *Bull. Mus. Comp. Zool.*, **35**: 7-39, pls. 1-4.
- (1900). The development of the mouth-parts of *Anurida maritima* Guer. *Bull. Mus. Comp. Zool.*, **36**: 87-157, pls. 1-8.

- GÖLDI, E. A. (1913). Die bisherige Anschauung bezüglich der Homologie der Insekten-Mundteile mit der Derivaten des Spaltfusses der Crustaceen und eine notwendig gewordene Modification. *Mitt. Schweiz. Entom. Gesells.*, **12**: 146-151, 1 fig.
- GOODRICH, E. S. (1898). On the relation of the arthropod head to the annelid prostomium. *Quart. Journ. Micr. Sci.*, n. s., **40**: 247-268, 12 figs.
- DE GRUYSE, J. J. (1915). Some modifications of the hypopharynx in lepidopterous larvae. *Proc. Ent. Soc. Washington*, **17**: 173-178, pls. 17-19.
- HANSEN, H. J. (1893). Zur Morphologie der Gliedmassen und Mundtheile bei Crustaceen und Insekten. *Zool. Anz.*, **16**: 193-198, 201-212.
- HATSCHKE, B. (1888-'91). Lehrbuch der Zoologie (first to third parts). Jena.
- HENRIKSEN, K. L. (1926). The segmentation of the trilobite's head. *Saert. Medd. Dansk. geolog. For.*, **7**: 1-32, 27 figs.
- HEYMONS, R. (1895). Die Embryonalentwicklung von Dermapteren und Orthopteren. 136 pp., 12 pls. Jena.
- (1897). Entwicklungsgeschichtliche Untersuchungen an *Lepisma saccharina* L. *Zeit. wiss. Zool.*, **62**: 581-631, pls. 29, 30.
- (1901). Die Entwicklungsgeschichte der Scolopender. *Zoologica. Orig.-Abhandl. Gesamt. Zool.*, **33**, 244 pp., 8 pls.
- HOFFMANN, R. W. (1911). Zur Kenntnis der Entwicklungsgeschichte der Collembolen. (Die Entwicklung der Mundwerkzeuge von *Tomocerus plumbeus* L.) *Zool. Anz.*, **37**: 353-377, 7 figs.
- HOLMGREN, N. (1909). Termitenstudien. I. Anatomische Untersuchungen. *Kungl. Svenska Vetenskapsakad. Handl.*, **44**, No. 3, 215 pp., 3 pls.
- (1916). Zur vergleichenden Anatomie des Gehirns von Polychaeten, Onychophoren, Ziphosuren, Arachniden, Crustaceen, Myriopoden, und Insekten. *Kungl. Svenska Vetenskapsakad. Handl.*, **56**, No. 1, 303 pp., 12 pls.
- HUSSEY, PRISCILLA B. (1926). Studies on the pleuropodia of *Belostoma flumineum* Say and *Ranatra fusca* Palisot de Beauvais. *Entomologica Americana*, **7**: 1-59, pls. I-II.
- JANET, C. (1899). Essai sur la constitution morphologique de la tête de l'insecte. 74 pp., 7 pls. Paris.
- (1911). Constitution morphologique de la bouche de l'insecte. 35 pp., 2 pls. Limoges.
- JAWOROWSKI, A. (1891). Ueber die Extremitäten bei den Embryonen der Arachniden und Insecten. *Zool. Anz.*, **14**: 164-169, 173-176, 4 figs.
- KORSCHULT, E. and HEIDER, K. (1895). Text-book of embryology of invertebrates. English transl., Vol. I.
- KOWALEVSKY, A. (1883). Embryogénie du *Chiton polii* (Philippi). *Ann. Mus. Hist. Nat. Marseille. Zool.*, **1**, 46 pp., 8 pls.
- KOWALEVSKY, A. and MARION, A. F. (1883). Documents pour l'histoire embryogénique des Alcyonaires. *Ann. Mus. Hist. Nat. Marseille. Zool.*, **1**, 50 pp., 5 pls.
- LANKESTER, E. R. (1881). Observations and reflections on the appendages and on the nervous system of *Apus cancriformis*. *Quart. Journ. Micr. Sci.*, n. s., **21**: 343-376, 3 figs.
- MACGILLIVRAY, A. D. (1923). External insect-anatomy. Urbana, Ill.
- MANGAN, J. (1908). On the mouth-parts of some Blattidae. *Proc. R. Irish Acad.*, **27**, B: 1-10, pls. 1-3.

- MEINERT, F. (1867). On the Campodeae, a family of Thysanura. English transl., *Ann. Mag. Nat. Hist.*, ser. 3, **20**: 361-378, 3 figs.
- PATTEN, W. (1912). The evolution of the vertebrates and their kin. Philadelphia.
- PRELL, H. (1913). Das Chitinskelett von Eosentomon. *Zoologica Orig.-Abhandl. Gesammt. Zool.*, **25**, 58 pp., 6 pls.
- RAMME, W. (1913). Die Bedeutung des Proventriculus bei Coleopteren und Orthopteren. *Zool. Jahrb., Anat.*, **35**: 419-456, pls. 22-24.
- REICHENBACH, H. (1877). Die Embryonalanlage und erste Entwicklung des Flusskrebse. *Zeit. wiss. Zool.*, **29**: 123-196, pls. 10-12.
- RILEY, W. A. (1904). The embryological development of the skeleton of the head of Blatta. *Amer. Nat.*, **38**: 777-810, 12 figs.
- SCHMIT-JENSEN, H. O. (1913). Homeotisk Regeneration af Antennen hos en Phasmide, Carausius (Dixippus) morosus. *Vidensk. Med. Dansk. naturh. Foren.*, **65**: 113-134. English transl., *Ann. Rep. Smithsonian Inst.* for 1914: 523-536, 7 figs.
- SCHMIDT, W. (1915). Die Muskulature von Astacus fluviatilis (Potamobius astacus L.) *Zeit. wiss. Zool.*, **113**: 165-251, 26 figs.
- SNODGRASS, R. E. (1927). The head and mouth parts of the cicada. *Proc. Ent. Soc. Wash.*, **29**: 1-16, pl. 1.
- (1927a). Morphology and mechanism of the insect thorax. *Smithsonian Misc. Coll.*, **80**, No. 1, 108 pp., 44 figs.
- STICKNEY, F. S. (1923). The head-capsule of Coleoptera. *Illinois Biol. Monographs*, **8**, No. 1, 51 pp., 26 pls.
- VON STUMMER-TRAUNFELS, R. (1891). Vergleichende Untersuchungen über die Mundwerkzeuge der Thysanuren und Collembolen. *Sitz. Kaiserl. Akad. Wiss. Wien.*, math.-natur., **100**, Abth. I: 216-235, 2 pls.
- UZEL, H. (1897). Vorläufige Mitteilung über die Entwicklung der Thysanuren. *Zool. Anz.*, **20**: 125-132.
- (1897a). Beiträge zur Entwicklungsgeschichte von Campodea staphylinus Westw. *Zool. Anz.*, **20**: 232-237.
- WALTON, L. B. (1927). The polychaete ancestry of the insects. I. The external structure. *Amer. Nat.*, **61**: 226-250, 11 figs.
- WHEELER, W. M. (1889). The embryology of Blatta germanica and Doryphora decimlineata. *Journ. Morph.*, **3**: 291-386, pls. 15-21.
- (1893). A contribution to insect embryology. *Journ. Morph.*, **8**: 1-160, pls. 1-6.
- WIESMANN, R. (1926). Zur Kenntnis der Anatomie und Entwicklungsgeschichte der Stabheuschrecke Carausius morosus Br. III. Entwicklung und Organogenese der Cölomblasen, pp. 123-328, 86 figs. Published by Zool.-vergl. anat. Inst. Univ. Zürich.
- YUASA, H. (1920). The anatomy of the head and mouth-parts of Orthoptera and Euplexoptera. *Journ. Morph.*, **33**: 251-290, 9 pls.
- ZOGRAF, N. (1883). Contributions to a knowledge of the embryological development of Geophilus ferrugineus L. K. and Geophilus proximus L. K. (in Russian). *Studies Lab. Zool. Mus. Moscow Univ.*, **2**, pt. 1, 77 pp., 108 figs.

SMITHSONIAN MISCELLANEOUS COLLECTIONS

VOLUME 81, NUMBER 4

DRAWING BY
JACQUES LEMOYNE DE MORGUES OF
SATURIOUA, A TIMUCUA CHIEF
IN FLORIDA, 1564

(WITH ONE PLATE)

BY

DAVID I. BUSHNELL, Jr



(PUBLICATION 2972)

CITY OF WASHINGTON
PUBLISHED BY THE SMITHSONIAN INSTITUTION
AUGUST 23, 1928



SMITHSONIAN MISCELLANEOUS COLLECTIONS
VOLUME 81, NUMBER 4

DRAWING BY
JACQUES LEMOYNE DE MORGUES OF
SATURIOUA, A TIMUCUA CHIEF
IN FLORIDA, 1564

(WITH ONE PLATE)

BY
DAVID I. BUSHNELL, Jr



(PUBLICATION 2972)

CITY OF WASHINGTON
PUBLISHED BY THE SMITHSONIAN INSTITUTION
AUGUST 23, 1928

The Lord Baltimore Press
BALTIMORE, MD., U. S. A.

DRAWING BY JACQUES LEMOYNE DE MORGUES OF
SATURIOUA, A TIMUCUA CHIEF IN
FLORIDA, 1564

BY DAVID I. BUSHNELL, JR.
(WITH ONE PLATE)

When it became known in Europe that a new continent had been discovered beyond the sea, that the lands reached by Columbus and his companions did not form part of Asia but were a new and distinct region, wonder was aroused as to the sort of people who were to be found in the strange and unknown country. So great was the interest thus manifested that many narratives of early voyages contain accounts of the natives encountered along the coasts and some refer, all too briefly, to the manners and customs of the *Indians*, a term erroneously applied to the inhabitants of the New World. Many records are preserved of natives having been taken to Europe by the explorers. It is written that when the Cabots—first to reach the continent of North America—returned to England in the year 1497, they carried three of the strange people from the newly discovered lands, and that four years later Cortereal compelled others to return with him to Europe. Likewise when Jacques Cartier reached France in 1535, after exploring the great River St. Lawrence, he had on board his small vessel a native chief taken in the wilderness. This tends to prove that many were eager to learn about the people who lived in the mysterious region far to the westward, beyond the sea. With this evidence of interest in the people of the New World it is difficult to believe that pictures were not made of them; sketches or paintings to portray their peculiar customs, strange ornaments and dress, and frail habitations. But no drawings are known to have been made during the voyages of the Cabots, of Ponce de Leon, Varrazano, Narvaez, de Soto, or Cartier. No proof that any pictures of Indians of North America were made during the first half of the sixteenth century has been discovered. And although the account of the voyages of Cartier, as presented by Ramusio, is accompanied by several crude illustrations, there is no evidence to indicate that the drawings were made by a person who had visited Canada. Thus it would appear that not until the year 1564, when the French expedition led by Laudonnière set

sail from Havre de Grace for the Land of Florida, did an artist accompany an expedition for the definite purpose of making drawings to be taken back to Europe. Consequently Jacques Lemoine de Morgues, artist, who accompanied Laudonnière, made the earliest known pictures of Indians of North America. Many sketches were undoubtedly made by the artist during the eventful year he remained in Florida but only one original example of his work can now be traced, this being a drawing of the great chief Saturioua who claimed the land on which the French erected Fort Carolina.

JACQUES LEMOINE DE MORGUES

Very little is known of the life and career of the artist who accompanied Laudonnière to Florida. He appears to have been a man of culture and learning. He was a Huguenot and seems to have been known personally by Charles IX. He prepared a brief Narrative of events in Florida which was printed by Theodoro de Bry, in the year 1591, as the second part of *Grand Voyages*. Together with this text were the engraved reproductions of 42 drawings made by Lemoine revealing scenes in Florida, the natives, their habitations, and events of interest.¹ To quote from the English translation of Lemoine:

"Charles IX, King of France, having been notified by the Admiral de Chatillon that there was too much delay in sending forward the re-enforcements needed by the small body of French whom Jean Ribaud had left to maintain the French dominion in Florida, gave orders to the admiral to fit out such a fleet as was required for the purpose. The admiral, in the mean while, recommended to the king a nobleman of the name of Renaud de Laudonnière; a person well known at court, and of varied abilities, though experienced not so much in military as in naval affairs. The king accordingly appointed him his own lieutenant, and appropriated for the expedition the sum of a hundred thousand francs." The Narrative continues: "I also received orders to join the expedition, and to report to M. de Laudonnière . . . I asked for some positive statements of his own views, and of the particular object which the king desired to obtain in com-

¹Two works have been quoted in preparing these notes:

- a. History of the First Attempt of the French to Colonize the Newly Discovered Country of Florida. By Rene Laudonnière. In Historical Collections of Louisiana and Florida. By B. F. French. New York, 1869.
- b. Narrative of Le Moyne, an Artist who accompanied the French Expedition to Florida under Laudonnière, 1564. Translated from the Latin of De Bry. Boston, 1875.

manding my services. Upon this he promised that no services except honorable ones should be required of me; and he informed me that my special duty, when we should reach the Indies, would be to map the seacoast, and lay down the position of towns, the depth and course of rivers, and the harbors; and to represent also the dwellings of the natives, and whatever in the province might seem worthy of observation: all of which I performed to the best of my ability, as I showed his majesty, when, after having escaped from the remarkable perfidies and atrocious cruelties of the Spaniards, I returned to France."

The three vessels of the expedition sailed from Havre de Grace April 20, 1564. Their first stop was at the Canaries, thence they sailed to the West Indies. At one island, "called Dominica, we watered. Making sail again, we reached the coast of Florida, or New France as it is called, on Thursday, June 22." They had arrived off the mouth of the River of May, the present St. Johns. Soon ascending the stream a few miles they selected a site where Fort Carolina was erected.

Lemoynes was in Fort Carolina September 20, 1565, when it was attacked and taken by the Spaniards. He fled and wandered through the swamps several days before meeting Laudonnière and some fifteen others who had escaped the massacre. Later they reached the mouth of the river, boarded one of the small ships and made sail for France, "ill manned and ill provisioned. But God, however, gave us so fortunate a voyage, although attended with a good deal of suffering, that we made the land in that arm of the sea bordering on England which is called St. George's Channel."

Now to quote from Laudonnière's record.

The first of the three ships to return to France departed from Florida July 28, 1564. About November 10, 1564 "Captain Bourdet determined to leave me, and to return to France." During the summer of 1565 the French were visited by the English Admiral Hawkins.

Laudonnière, with his small party including the artist Lemoynes, sailed from Florida September 25, 1565. "About the 25th of October, in the morning, at the break of day, we descried the *Isle of Flores*, and one of the *Azores*, where, immediately upon our approaching to the land, we had a mighty gust of wind, which came from the north-east, which caused us to bear against it four days; afterwards, the wind came south and south-east, and was always variable. In all the time of our passage, we had none other food saving biscuit and water." About November 10, 1565, they reached the coast of Wales and landed, having been carried out of their course and thus failed to reach France. They had landed at Swansea. Laudonnière then wrote:

"For mine own part I purposed, with my men, to pass by land; and, after I had taken leave of my mariners, I departed from *Swansea*, and came, that night, with my company, to a place called *Morgan*, where the lord of the place, understanding what I was, staid me with him for the space of six or seven days; and, at my departure, moved with pity to see me go on foot, especially being so weak as I was, gave me a little hackney.

"Thus I passed on my journey—first to *Bristol*, and then to *London*, where I went to do my duty to M. de Foix, which, for the present, was the King's ambassador, and helped me with money in my necessity. From thence I passed to *Calais*, afterward to *Paris*, where I was informed that the king was gone to *Moulins*, to sojourn there; incontinently, and with all the haste I could possibly make, I got me thither, with part of my company."

Lemoyne was probably one of the company, and it may have been at this time that he revealed to the king the work he had done in Florida.

How long Lemoyne continued to live in France is not known but later he crossed the channel and resided in London. He was a Huguenot and for that reason may have sought safety in flight. During 1587 Lemoyne was in London, in the service of Sir Walter Raleigh, when he was visited by De Bry in the endeavor to purchase his papers relating to the expedition to Florida, but as has been written: "Lemoyne resisted all persuasions to part with his papers. After Lemoyne's death De Bry bought them of his widow (1588), and published them in 1591."

What became of Lemoyne's drawings is not known. Possibly those secured by De Bry were taken to Frankfort and there copied by the engravers, later to be lost or scattered. No example of the artist's work is in the British Museum, London; the Louvre, Paris; or the Galleria degli Uffizi, Florence.

It may be suggested that Lemoyne's connection with Sir Walter Raleigh influenced the latter in sending the English artist John White to Virginia, in 1585. White's instructions were quite similar to those received by Lemoyne some twenty years before. Their work was of the same nature.

SATURIOUA RE DELLA FLORIDA

Saturioua was a Timucua chief whose tribe claimed and occupied territory on both sides of the St. John River, from its mouth inland for some distance as well as up and down the coast.

During the summer of 1564, while Fort Carolina was being constructed by Laudonnière, "several chiefs visited our commander, and signified to him that they were under the authority of a certain king named Saturioua, within the limit of whose dominions we were, whose dwelling was near us, and who could muster a force of some thousands of men."

Saturioua soon desired to see the work being done by the French and visited the site chosen for the fort. "He sent forward, however, some two hours in advance of his own appearance, an officer with a company of a hundred and twenty able-bodied men, armed with bows, arrows, clubs, and darts, and adorned, after the Indian manner, with their riches; such as feathers of different kinds, necklaces of a select sort of shells, bracelets of fishes' teeth, girdles of silver-colored balls, some round and some oblong; and having many pearls fastened on their legs. Many of them had also hanging to their legs round flat plates of gold, silver, or brass, so that in walking they tinkled like little bells. This officer, having made his announcement, proceeded to cause shelter to be erected on a small height near by of branches of palms, laurels, mastics, and other odoriferous trees, for the accommodation of the king." And soon the great chief arrived, "accompanied by seven or eight hundred men, handsome, strong, well-made, and active fellows, the best-trained and swiftest of his force, all under arms as if on a military expedition." The meeting proved one of great interest to both French and Indian. Laudonnière made known to Saturioua that he had been "sent by a most powerful king, called the King of France, to offer a treaty by which he should become a friend to the king here, and to his allies, and an enemy to their enemies; an announcement which the chief received with much pleasure. Gifts were then exchanged in pledge of perpetual friendship and alliance." The Indians soon departed, but the French hastened with greater energy the completion of the fort.

Some days passed and the time arrived when Saturioua desired to test the sincerity of the French. "The chief sent messengers to M. de Laudonnière, not only to confirm the league which had been made, but also to procure the performance of its conditions, namely, that the latter was to be the friend of the king's friends, and the enemy of his enemies; as he was now organizing an expedition against them." A vague, ambiguous reply was received by the messengers and by them carried to Saturioua. The great chief then visited the fort, accompanied by a large number of men. He attempted to have the French go with him on his expedition against his enemies farther up the river but they declined. "Failing, however, to obtain what he

wished, he set out on his expedition with his own men. While these affairs were in progress, M. de Laudonnière sent his second ship, commanded by Pierre Capitaine, to France."

Saturioua, surrounded by his chiefs and warriors, preparing to start on the expedition, was the subject of a drawing by Lemoyné, one engraved by De Bry, but the description of the picture as given by the artist is really more complete than the reference just quoted.

The description of the engraving, given by De Bry, was evidently prepared by Lemoyné himself. The English translation is now quoted :



FIG. 1.—Ceremonies performed by Saturioua before going on an expedition against the enemy. From De Bry, 1591.

"It is mentioned in the account of the second voyage that the French made a treaty of friendship with a powerful chief of the vicinity, named Saturioua, with agreement that they were to erect a fort in his territory, and were to be friends to his friends, and enemies to his enemies; and, further, that on occasion they should furnish him some arquebusiers. About three months afterwards, he sent messengers to Laudonnière to ask for the arquebusiers according to the treaty, as he was about to make war upon his enemies. Laudonnière, however, sent to him Capt. La Caille with some men, to inform him courteously that he could not just then supply any soldiers, for the reason that he hoped

to be able to make peace between the parties. But the chief was indignant at this reply, as he could not now put off his expedition, having got his provisions ready, and summoned the neighboring chiefs to his aid; and he therefore prepared to set out at once. He assembled his men, decorated, after the Indian manner, with feathers and other things, in a level place, the soldiers of Laudonnière being present; and the force sat down in a circle, the chief being in the middle. A fire was then lighted on his left, and two great vessels full of water set on his right. Then the chief, after rolling his eyes as if excited by anger, uttering some sounds deep down in his throat, and making various gestures, all at once raised a horrid yell; and all his soldiers repeated this yell, striking their hips, and rattling their weapons. Then the chief, taking a wooden platter of water, turned toward the sun, and worshipped it; praying to it for a victory over the enemy, and that, as he should now scatter the water that he had dipped up in the wooden platter, so might their blood be poured out. Then he flung the water with a great cast up into the air; and, as it fell down upon his men, he added, 'As I have done with this water, so I pray that you may do with the blood of your enemies.' Then he poured the water in the other vase upon the fire, and said, 'So may you be able to extinguish your enemies, and bring back their scalps.' Then they all arose, and set off by land up the river, upon their expedition."

Laudonnière wrote regarding these happenings: "About two months after our arrival in Florida, the *Paracoussy* Saturioua sent certain Indians unto me to know whether I would stand to my promise, which I had made him at my first arrival in that country: which was, that I would show myself friend to his friends, and enemy unto his enemies; and, also, to accompany him with a good number of harquebuses, when he should see it expedient, and should find a fit occasion to go to war." Laudonnière declined to join his forces with those of Saturioua and the latter departed on the war-like expedition without the promised aid of the French. Laudonnière then continued his narrative: "The ceremony which this savage used, before he embarked his army, deserveth not to be forgotten; for, when he was sitting down by the river's side, being compassed about with ten other *paracoussies*, he commanded water to be brought him speedily. This done, looking up into heaven, he fell to discourse of divers things, with gestures that showed him to be in exceeding great choler, which made him one while shake his head hither and thither; and, by and by, with, I wot not what fury, to turn his face towards the country of his enemies, and to threaten to kill them. He oftentimes looked upon the sun, praying him to grant him a glorious victory of his enemies; which, when he

had done, by the space of half an hour, he sprinkled, with his hand, a little of the water, which he held in a vessel, upon the heads of the *paracoussies*, and cast the rest, as it were, in a rage and despite, into a fire, which was there prepared for the purpose. This done, he cried out, thrice, *He Thimogoa!* and was followed with five hundred Indians, at the least, which were there assembled, which cried, all with one voice, *He Thimogoa!*”

These events transpired during the latter part of August, 1564.

SATURIOUA—DRAWING BY LEMOYNE

The original drawing now reproduced for the first time, is in crayon—black and sanguine. It bears a legend in Italian which reads: *Saturioua Re della Florida nell' America Settertionale in atto di andare alla Guerra*. Translated it is: “Saturioua King of Florida in North America in the act of going to war.” This evidently shows the chief immediately after the completion of the ceremony mentioned on preceding pages. He has grasped his spear but continues to hold the wooden bowl containing water.

Details are revealed in the drawing with great clearness. Several of these may be explained by quoting from Lemoyne's notes attached to various sketches reproduced by De Bry. Describing the peculiar ear ornament represented as being worn by Saturioua, Lemoyne wrote: “All the men and women have the ends of their ears pierced, and pass through them small oblong fish-bladders, which when inflated shine like pearls, and which, being dyed red, look like a light-colored carbuncle.” Tattooing was practiced extensively and “all these chiefs and their wives ornament their skins with punctures arranged so as to make certain designs. . . . Doing this sometimes makes them sick for seven or eight days. They rub the punctured places with a certain herb, which leaves an indelible color.” But the strangest of their customs, “For the sake of further ornament and magnificence, they let the nails of their fingers and toes grow, scraping them down at the sides with a certain shell, so that they are left very sharp. They are also in the habit of painting the skin around their mouths of a blue color.” Elsewhere Lemoyne wrote: “They let their nails grow long both on fingers and toes, cutting the former away, however, at the sides, so as to leave them very sharp, the men especially; and, when they take one of the enemy, they sink their nails deep in his forehead, and tear down the skin, so as to wound and blind him.”

Such were some of the strange and curious customs of the people of Florida more than three and one-half centuries ago.



Size 10 by 7 inches

SATURIOUA

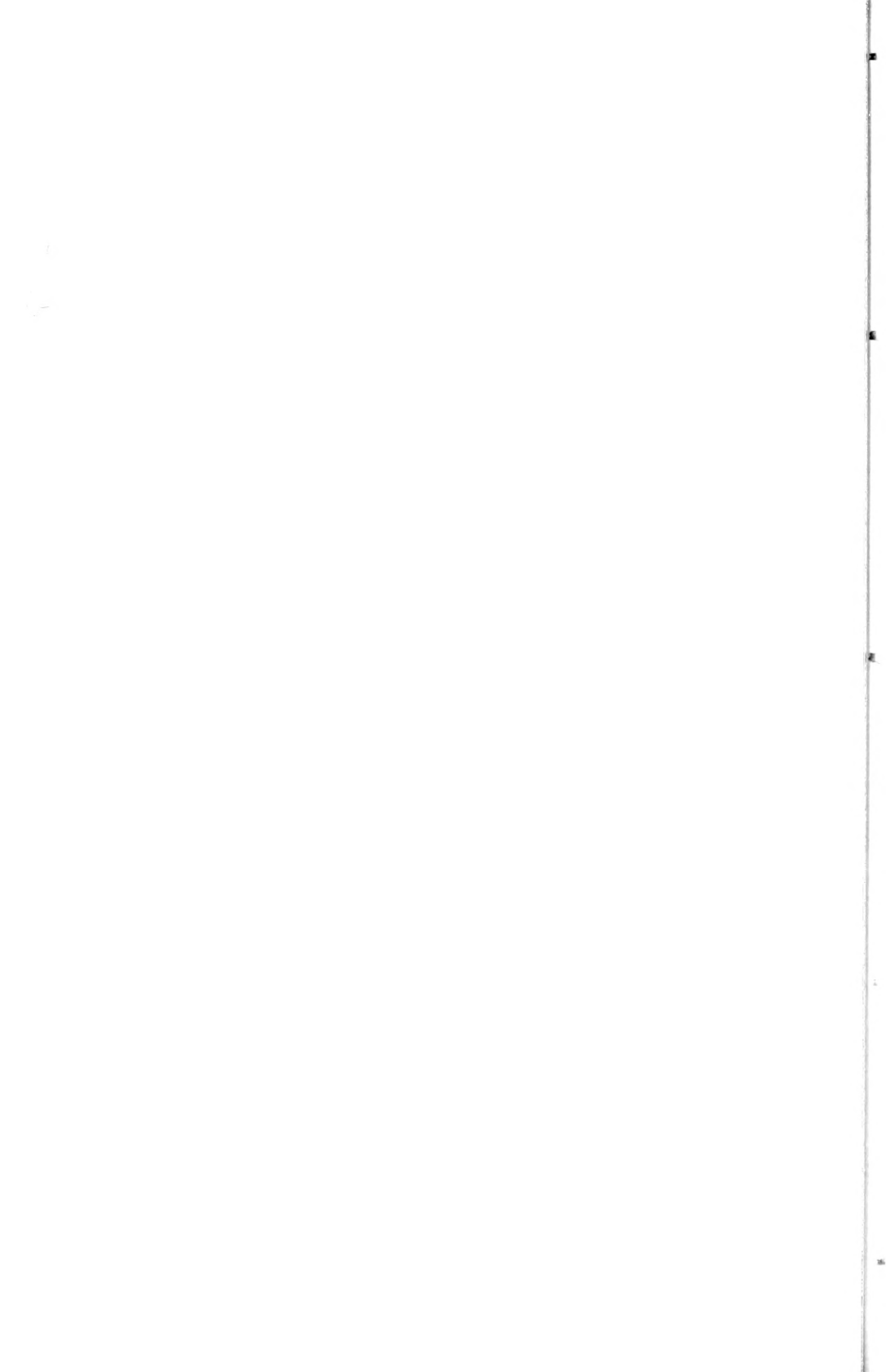

Unfortunately the history of this very interesting drawing, now in the author's collection, is not known; however, it is possible to reach certain conclusions regarding its origin. The legend is in Italian and this offers a clue as to the time the picture was actually made.

The youthful Charles IX was King of France in 1564, the year of the French expedition under Laudonnière to Florida, but all were dominated by the Queen-mother, Catherine de' Medici, surrounded as she was by groups of Italians who had accompanied or followed her to France. Italian was spoken at the French Court.

Lemoynes had accompanied the expedition to Florida for the purpose of preparing a series of drawings and sketches, these, as he himself wrote: "I showed his majesty, when, after having escaped from the remarkable perfidies and atrocious cruelties of the Spaniards, I returned to France." And it may be assumed that all such work, when exhibited at Court, bore legends written in Italian. The drawing of *Saturioua Re della Florida*, may have been one of the sketches thus displayed.

It is not possible to determine exactly when the drawing was made. Knowing the manner in which the artist escaped from Fort Carolina the night it was taken by the Spaniards there is no reason to believe he was able to save any drawings. All his possessions appear to have been abandoned and lost.

The event of *Saturioua* starting for war, the subject of the drawing now reproduced, occurred late in August, 1564. Little more than two months later, early in November, the second of the French vessels returned to France. Undoubtedly it carried dispatches and various papers relating to the progress of affairs in the Colony, and quite likely sketches and drawings by the artist of the expedition, Lemoynes, were included with the official reports. The drawing of the chief with whom the French were then in contact, and who claimed the region in which they had settled, may have been sent to France at that time. Again it is suggested that the picture may have been made after Laudonnière and his small party, including Lemoynes, had returned to Europe but before they had reached Moulins and met the king.

The fact that the legend on the drawing is in Italian, not French, would seem to prove beyond doubt that it was so written for the benefit of Charles IX, the Queen-mother, and their Italian followers and associates.

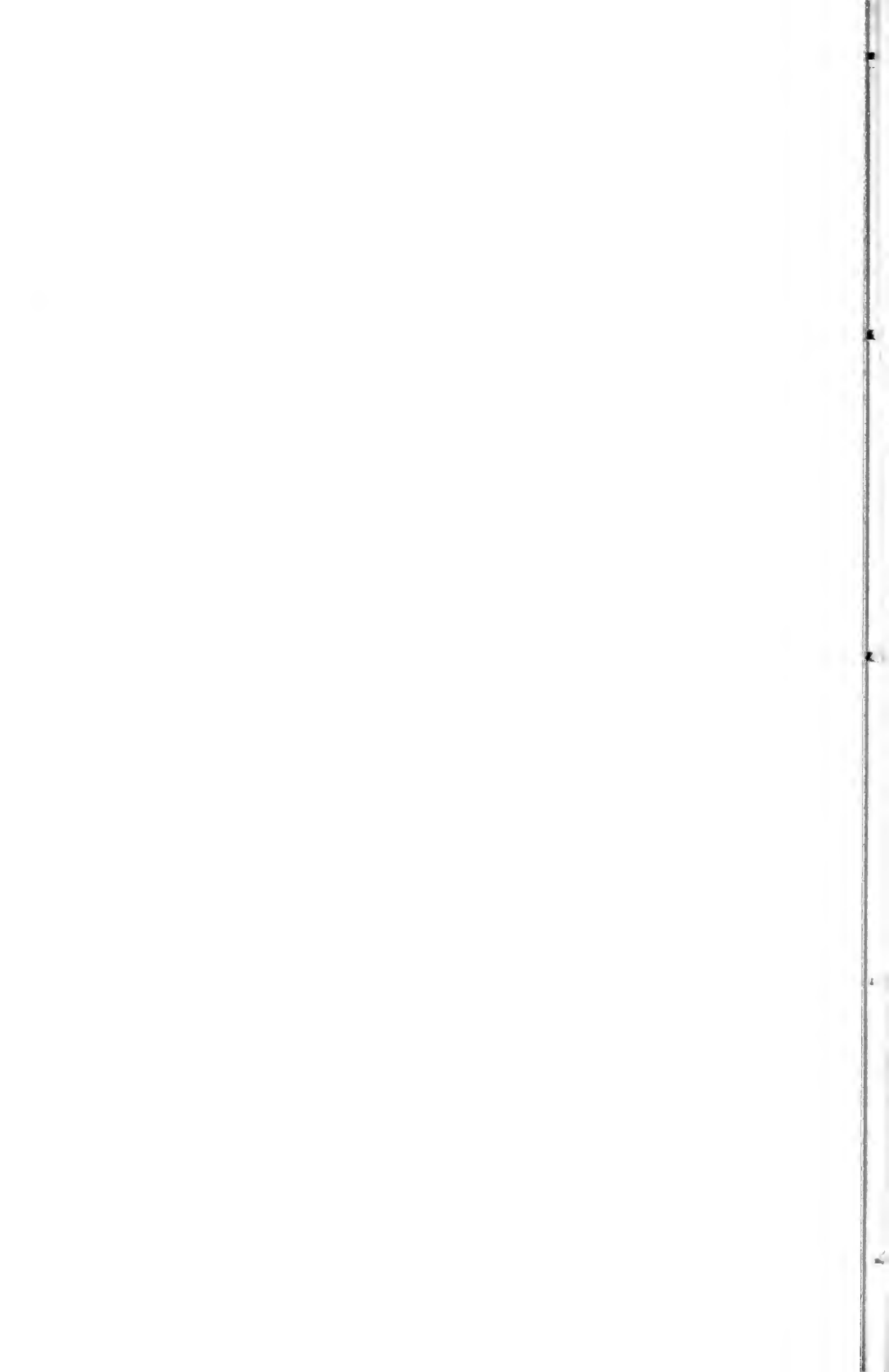

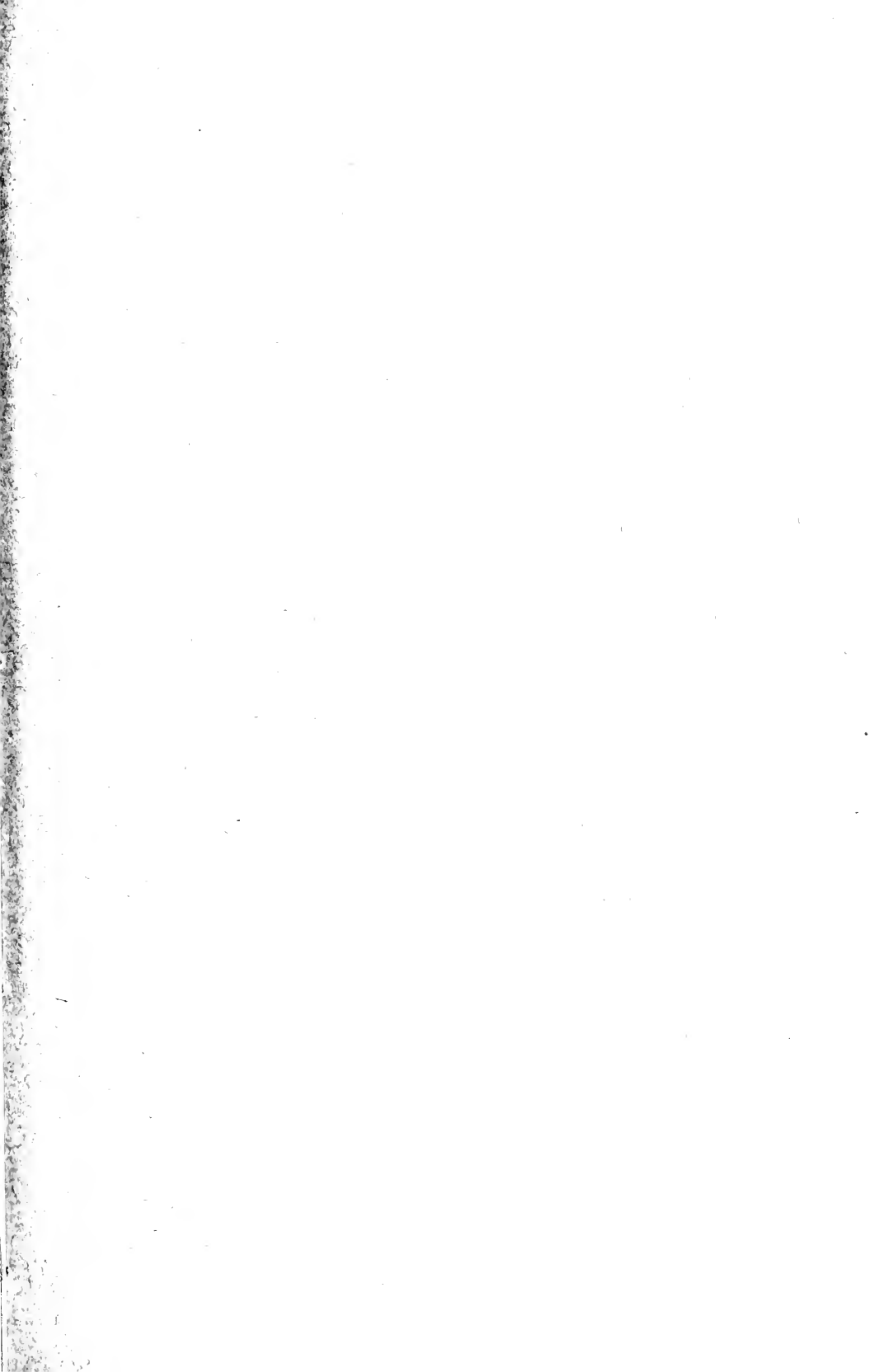



SMITHSONIAN MISCELLANEOUS COLLECTIONS
VOLUME 81, NUMBER 5

THE RELATIONS BETWEEN THE
SMITHSONIAN INSTITUTION AND
THE WRIGHT BROTHERS

BY
CHARLES G. ABBOT
Secretary, Smithsonian Institution



(PUBLICATION 2977)

CITY OF WASHINGTON
PUBLISHED BY THE SMITHSONIAN INSTITUTION
SEPTEMBER 29, 1928

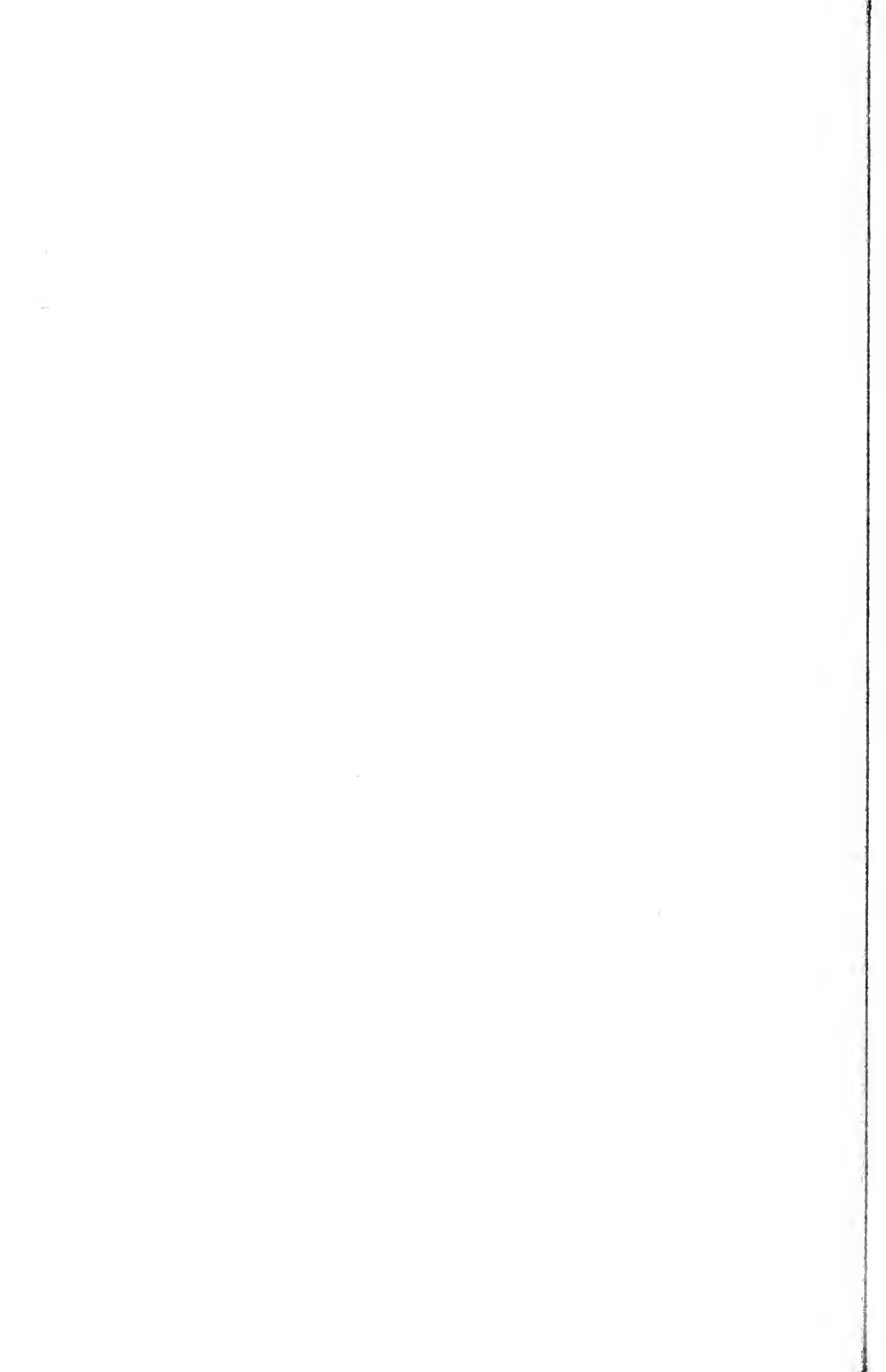

SMITHSONIAN MISCELLANEOUS COLLECTIONS
VOLUME 81, NUMBER 5

THE RELATIONS BETWEEN THE
SMITHSONIAN INSTITUTION AND
THE WRIGHT BROTHERS

BY
CHARLES G. ABBOT
Secretary, Smithsonian Institution



(PUBLICATION 2977)

CITY OF WASHINGTON
PUBLISHED BY THE SMITHSONIAN INSTITUTION
SEPTEMBER 29, 1928

The Lord Baltimore Press
BALTIMORE, MD., U. S. A.

PREFATORY NOTE

This statement represents an attempt on the part of the Smithsonian Institution to clarify an unfortunate controversy, and to correct errors where errors have been made, in order to do justice alike to three great pioneers of human flight—Wilbur and Orville Wright, and Samuel Pierpont Langley—as well as to the Smithsonian Institution.

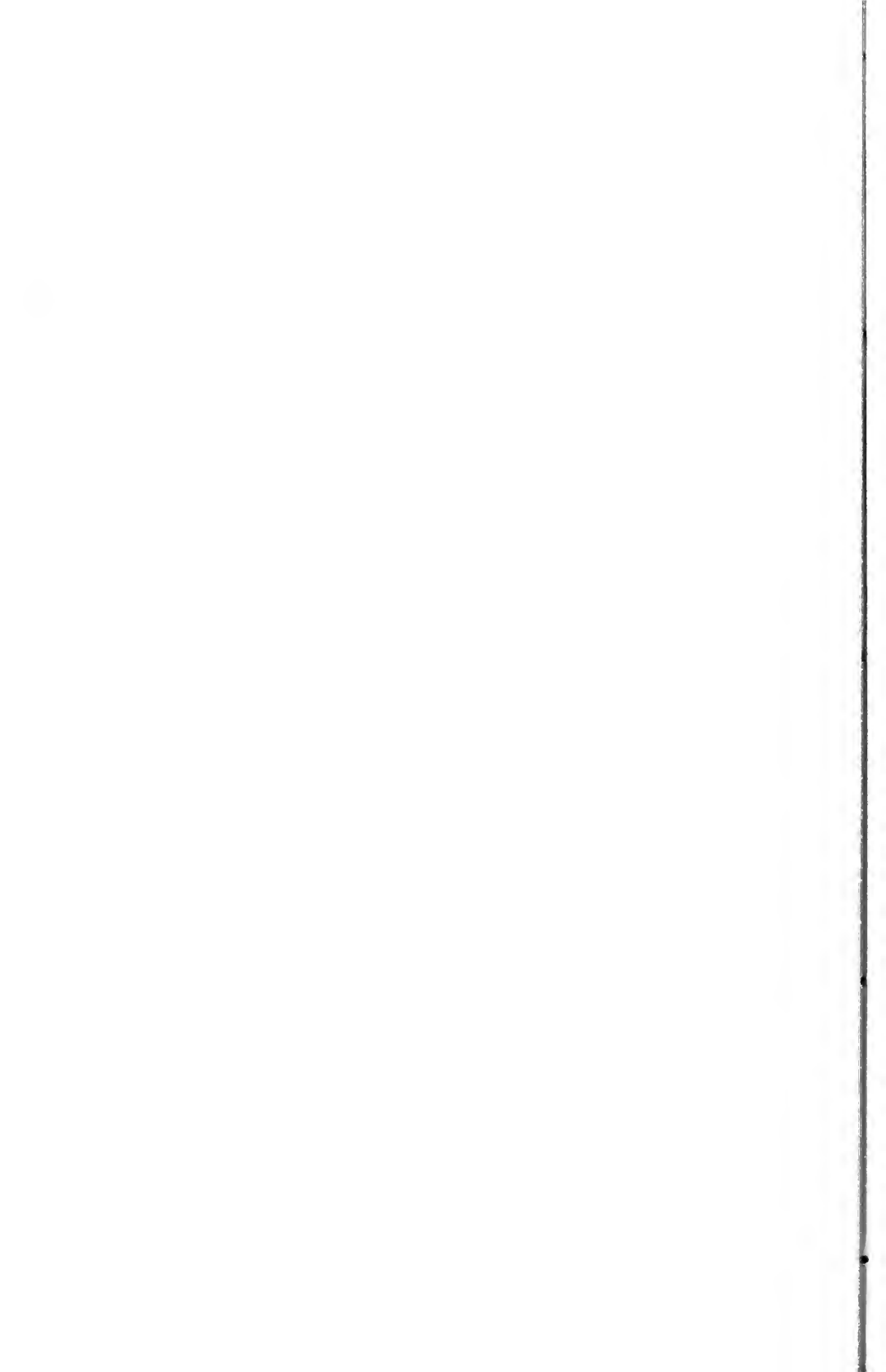

THE RELATIONS BETWEEN THE SMITHSONIAN INSTITUTION AND THE WRIGHT BROTHERS

BY CHARLES G. ABBOT

SECRETARY, SMITHSONIAN INSTITUTION

For several months past, beginning February 13, 1928, when I first addressed Mr. Orville Wright, a month after my election as Secretary, I have sought to end the so-called Langley-Wright controversy. In a friendly, personal conference with Mr. Orville Wright on April 19, he explained to me the points regarding which he feels that the Smithsonian Institution has dealt unjustly with the Wright brothers, and stated that what he termed a "correction of history" by the Smithsonian was essential.

So far as I am aware, all men agree that on December 17, 1903, at Kitty Hawk, North Carolina, Orville and Wilbur Wright, alternately piloting their plane, made the first sustained human flights in a power propelled heavier-than-air machine.

These successful flights by the Wright brothers came as the culmination of: (1) Their extensive laboratory experiments to determine the behavior of plane and curved surfaces in air. (2) Their numerous gliding flights during several years at Kitty Hawk and elsewhere. (3) Their original design and construction of their flying machine and of the engine and propellers.

The Smithsonian Institution has recognized these achievements in the following manner:

1. By printing articles by Wilbur and Orville Wright in the Smithsonian Annual Reports. (See Smithsonian Annual Reports, 1902, pp. 133-148; 1914, pp. 209-216.)

2. By printing other articles descriptive of their achievements. (See Smithsonian Annual Reports, 1903, pp. 179-180; 1908, p. 133; 1910, pp. 147-151, 160-161.)

3. By making the first award of the Langley gold medal for aeronautics to Wilbur and Orville Wright. This award was made on February 10, 1909, and the medal was formally presented on February 10, 1910. (See Smithsonian Annual Reports, 1909, pp. 22, 107, 111; 1910, pp. 22-23, 104-110.)

4. By formal vote of the Board of Regents, March 15, 1928, as follows:

WHEREAS, To correct any erroneous impression derived from published statements that the Smithsonian Institution has denied to the Wright brothers due credit for making the first successful human flight in power-propelled heavier-than-air craft;

Resolved, That it is the sense of the Board of Regents of the Smithsonian Institution that to the Wrights belongs the credit of making the first successful flight with a power-propelled heavier-than-air machine carrying a man.

5. By requesting the Wright brothers to furnish for exhibit in the National Museum the originals or models of any planes made by the Wrights up to 1910, the selection to be at their discretion. (The request specifically included the Kitty Hawk plane. See pages 5 and 6 following, for letters of Secretary Walcott to Wilbur Wright of March 7, 1910, and April 11, 1910.)

6. By exhibiting in the National Museum the plane flown at Fort Myer in 1908 by Orville Wright, which is the first airplane bought for military purposes by any government.

7. By exhibiting since 1922 in the National Museum twelve double-sided frames containing forty-nine photographs showing the circumstances of the Kitty Hawk and Fort Myer flights.

Mr. Wright feels, however, that the Smithsonian Institution has appeared to be engaged in propaganda with the

object of exalting Langley at the expense of himself and his brother as follows:

1. By predominant mention of the achievements of Langley in the addresses at the time of the first presentation of the Langley medal.
2. By a misleading account of the exercises of February 10, 1910, printed in the Smithsonian Annual Report of 1910.
3. By what he regarded as the lack of cordiality in an invitation by Secretary Walcott in April, 1910, to the Wright brothers to deposit the Kitty Hawk or other planes in the U. S. National Museum.
4. By the contract, in 1914, for experiments with the Langley machine made with Mr. Glenn Curtiss, at that time a defendant in a patent suit brought by the Wright brothers.
5. By claims of priority in capacity to fly, for the Langley machine, based on the experiments of 1914, and repeated in Smithsonian publications as well as on labels in the National Museum.
6. By failure to recognize properly the abilities of the Wrights as research men.

I propose to take up these points seriatim:

1. Mr. Wright's feeling that predominant mention of the achievements of Langley was made at the presentation of Langley medals to him and his brother.

The main address on February 10, 1910,¹ was by the late Dr. Alexander Graham Bell, a friend of Langley, a close observer of his experiments for a period of ten years, and a Regent of the Smithsonian Institution. The occasion was the first award of a gold medal bearing Langley's name, which had been established at the suggestion of Dr. Bell to perpetuate Langley's place in aeronautics. Responding to a feeling then prevalent that Langley, on account of the

¹ See Smithsonian Annual Report, 1910, pp. 104-108.

ill success of his experiments of 1903, had met with unjust ridicule, and doubtless inspired also by the partiality of a friend, it cannot be denied that Dr. Bell made less prominent in comparison with Langley's achievements the successful pioneer work of the Wrights than he might well have done appropriately on that occasion. But Dr. Bell was not lacking in appreciation of the Wrights. In the following letter recommending establishment of the Langley medal he suggests the fitness of awarding it to the Wright brothers:

Beinn Bhreagh,
Near Baddeck,
Nova Scotia,

December 5, 1908.

Hon. C. D. Walcott,
Secretary, Smithsonian Institution,
Washington, D. C.

Dear Secretary Walcott:

The Wright brothers are being deservedly honored in Europe. Can not America do anything for them? Why should not the Smithsonian Institution give a Langley medal to encourage aviation?

Yours, sincerely,

ALEXANDER GRAHAM BELL.

(See Smithsonian Annual Report, 1909, p. 107.) By reference to the same Report¹ it will be seen also how strongly Senator Lodge felt in regard to the merits of the Wright brothers.

2. Mr. Wright's feeling that the summary of the exercises of February 10, 1910, printed in the Smithsonian Annual Report of 1910 was misleading.

I acknowledge with regret that the summary of the proceedings given at an earlier page of the Smithsonian Annual Report for 1910 (pp. 22-23) is misleading. The summary quotes the following words from Mr. Wilbur Wright:

¹ Smithsonian Annual Report, 1909, p. 111.

“The knowledge that the head of the most prominent scientific institution of America believed in the possibility of human flight was one of the influences that led us to undertake the preliminary investigation that preceded our active work. He recommended to us the books which enabled us to form sane ideas at the outset. It was a helping hand at a critical time, and we shall always be grateful.”

From the context it would appear that Mr. Wright made this statement at the ceremony. This was not the case. Actually the statement was quoted by Dr. Bell in his speech from an extract of a private letter from the Wright brothers which Dr. Octave Chanute had quoted at the Langley Memorial meeting, December 3, 1906.¹ The full statement made by Wilbur Wright at the ceremony is given as approved by him at pages 109-110 of the same Smithsonian Annual Report, that for 1910.

Mr. Orville Wright assures me that though he and his brother both drew encouragement from the fact that so celebrated a scientific man as Dr. Langley had adventured his reputation in the field of heavier-than-air aviation, the Wrights did not rely on Langley's experimental data or conclusions, but made laboratory researches of their own, on which their constructions were based exclusively. I fully accept this assurance as a true statement of historical fact.

3. Mr. Wright's feeling that Secretary Walcott's invitations to deposit the Kitty Hawk and other planes in the National Museum lacked cordiality.

The letters referred to are as follows:

Smithsonian Institution,
Washington, U. S. A.,
March 7, 1910.

My dear Mr. Wright:

The National Museum is endeavoring to enlarge its collections illustrating the progress of aviation and, in this connection, it has

¹ See Smithsonian Miscellaneous Collections, Vol. XLIX, Art. IV, Publ. No. 1720, p. 32.

been suggested that you might be willing to deposit one of your machines, or a model thereof, for exhibition purposes.

The great public interest manifested in this science and the numerous inquiries from visitors for the Wright machine make it manifest that if one were placed on exhibition here it would form one of the most interesting specimens in the national collections. It is sincerely hoped that you may find it possible to accede to this request.

With kindest regards, I am

Very truly yours,

CHARLES D. WALCOTT,

Secretary.

MR. WILBUR WRIGHT,
Dayton, Ohio.

Dayton, Ohio,

March 26, 1910.

Mr. Charles D. Walcott,
Washington, D. C.

My dear Dr. Walcott:

Your letter of the 7th of this month has been received. If you will inform us just what your preference would be in the matter of a flier for the National Museum we will see what would be possible in the way of meeting your wishes. At present nothing is in condition for such use. But there are three possibilities. We might construct a small model showing the general construction of the airplane, but with a dummy power plant. Or we can reconstruct the 1903 machine with which the first flights were made at Kitty Hawk. Most of the parts are still in existence. This machine would occupy a space 40 feet by 20 feet by 8 feet. Or a model showing the general design of the latter machine could be constructed.

Yours truly,

WILBUR WRIGHT.

Smithsonian Institution,

Washington, U. S. A.,

April 11, 1910.

Dear Mr. Wright:

Yours of March 26th came duly to hand, and the matter of the representation of the Wright airplane has been very carefully considered by Mr. George C. Maynard, who has charge of the Division of Technology in the National Museum. I told him to indicate what he would like for the exhibit, in order that the matter might

be placed clearly before you and your brother. In his report he says:

The following objects illustrating the Wright inventions would make a very valuable addition to the aeronautical exhibits in the Museum:

1. A quarter-size model of the airplane used by Orville Wright at Fort Myer, Virginia, in September, 1908. Such a model equipped with a dummy power plant, as suggested by the Wrights, would be quite suitable.

2. If there are any radical differences between the machine referred to and the one used at Kitty Hawk, a second model of the latter machine would be very appropriate.

3. A full-size Wright airplane. Inasmuch as the machine used at Fort Myer has attracted such world-wide interest, that machine, if it can be repaired or reconstructed, would seem most suitable. If, however, the Wright brothers think the Kitty Hawk machine would answer the purpose better, their judgment might decide the question.

4. If the Wright brothers have an engine of an early type used by them which could be placed in a floor case for close inspection that will be desirable.

The engine of the Langley Aerodrome is now on exhibition in a glass case and the original full-size machine is soon to be hung in one of the large halls. The three Langley quarter-size models are on exhibition. The natural plan would be to install the different Wright machines along with the Langley machines, making the exhibit illustrate two very important steps in the history of the aeronautical art.

The request of Mr. Maynard is rather a large one, but we will have to leave it to your discretion as to what you think it is practicable for you to do.

Sincerely yours,

CHARLES D. WALCOTT,

Secretary.

MR. WILBUR WRIGHT,
1127 West Third Street,
Dayton, Ohio.

I cannot but feel that Mr. Wright has erred in ascribing to Dr. Walcott any but a sincere invitation to the Wrights to make their own selection of whatever they thought best suited and most available to deposit in the National Museum for the purpose of illustrating their achievements. It is to be recalled, too, that in 1910 the world was ringing with the triumphant demonstrations of the Wrights at Fort Myer and in France of ability to make long-continued air flights. At that moment the Fort Myer plane was far more cele-

brated than the Kitty Hawk plane. Now, of course, all is changed. We have the Fort Myer plane. But it is profoundly regretted by patriotic Americans that the Kitty Hawk plane is not in a place of honor in the United States National Museum.

4. Mr. Wright's feeling that the contract to test the Langley plane in 1914 with Mr. Glenn Curtiss, then a defendant in a suit with the Wrights, was unfriendly to them.

I concede to Mr. Wright that it lacked of consideration to put the tests of the Langley plane into the hands of his opponent, Mr. Curtiss. As early as 1908 Dr. Walcott had had correspondence with Mr. Manly and with Dr. Chanute on the desirability of further experiments with the Langley Aerodrome under Manly's direction. Lack of means, from which the Smithsonian then as now suffered, doubtless stood in the way. Without having been familiar myself with all the circumstances at that time, I believe it was owing to the fact that Mr. Curtiss had the available plant and Manly had not, so that the former could make the tests at smaller expense than the latter, that Dr. Walcott determined to place the machine in Curtiss' hands for trial. The Smithsonian paid Mr. Curtiss \$2,000 to make the experiments. Yet the fact that the results of these tests might prove valuable to Mr. Curtiss in his defense against Mr. Wright's suit, and the unfavorable aspect in which that might put the Smithsonian Institution, if foreseen, might well have deterred from the course of action adopted. The appointment of Dr. A. F. Zahm to represent the Smithsonian as official observer at the Hammondsport tests has been criticized. At that time Dr. Zahm, a recognized aeronautic authority, was the official recorder of the Langley Aeronautical Laboratory of the Smithsonian Institution, a position he had held since May, 1913, so that his appointment as indicated was natural.

As to the propriety of testing Langley's machine in 1914, some have objected on the ground that it was a precious specimen, taken from the National Museum to be wantonly subjected to destruction. This is not true. The machine, excepting its engine, was never on public exhibition until 1918. In 1904 it was specifically placed by the War Department¹ at the disposal of the Smithsonian for further tests. It had been kept continuously in the shops where it was made from the winter of 1903 until it was taken to Hammondsport.

In 1914 airplane construction had not reached the comparatively standardized stage of the present day. It was then thought possible that the tandem, dragon-fly type of the Langley Aerodrome had merits which should be developed. There was also the thought that a decisive success might rescue from unmerited ridicule Langley's fame. These, I submit, were circumstances very properly inviting the making of the tests. But I feel that it was a pity that Manly, Dr. Langley's colleague, could not have been the man chosen to make them.

5. Mr. Wright's feeling that claims in priority of capacity to fly for the Langley machine based on 1914 experiments were unjustified and prejudicial to the Wright brothers.

The claims published by the Smithsonian relating to the 1914 experiments at Hammondsport were sweeping. In the Report of the U. S. National Museum for 1914, page 47,²

¹ It is frequently erroneously stated that the Congress appropriated \$100,000 to Langley for his experiments. The sum of \$50,000 allotted to him by the Board of Ordnance and Fortifications of the War Department was all the public money that he ever had for the purpose. There was no direct Congressional appropriation whatever.

² See also Smithsonian Annual Report, 1914, pp. 9-10 and 217-222; also the label of the full-sized Langley machine as first installed in 1918 in the National Museum, hereafter quoted.

we read: "Owing to a defect in the launching apparatus, the two attempts to fly the large machine during Dr. Langley's life proved futile, but in June last, without modification, successful flights were made at Hammondsport, N. Y." Certainly this was not literally true, but Assistant Secretary Rathbun, who wrote the statement given above, I am certain believed this to be true. There were, however, many differences. (I refer only to the first tests when the original Langley-Manly engine was used.) Mr. Wright claims that essential changes tending to improve the chances of success were made on the basis of knowledge gained subsequent to 1903.

Some of the differences were favorable, some unfavorable, to success. Just what effects, favorable or unfavorable, the sum total of these changes produced can never be precisely known. In the opinion of some experts, the tests demonstrated that Langley's machine of 1903 could have flown, and in the opinion of others, these tests did not demonstrate it. It must ever be a matter of opinion.

In 1918, the Langley plane, reconstructed as nearly as possible as of 1903, using all available original parts, by Mr. R. L. Reed, the foreman who had most to do with it in Langley's time, was exhibited in the U. S. National Museum with this label:

THE ORIGINAL, FULL-SIZE,
LANGLEY FLYING MACHINE, 1903

Later this label was amplified to read as follows:

ORIGINAL LANGLEY
FLYING MACHINE, 1903

THE FIRST MAN-CARRYING AEROPLANE IN THE HISTORY OF THE WORLD CAPABLE OF SUSTAINED FREE FLIGHT. INVENTED, BUILT, AND TESTED OVER THE POTOMAC RIVER BY SAMUEL PIERPONT LANGLEY IN 1903. SUCCESSFULLY FLOWN AT HAMMONDSPORT, N. Y., JUNE 2, 1914. DIMENSIONS: 55 FEET LONG, 48 FEET WIDE; SUSTAINING WING SURFACE, 1,040 SQUARE FEET.

Vigorous criticism of the statements made by the Smithsonian relative to the test of 1914, and the capability of flight of Langley's machine having appeared, Dr. Walcott in 1925 asked Dr. J. S. Ames and Admiral David W. Taylor, members and now Chairman and Vice-Chairman, respectively, of the National Advisory Committee for Aeronautics, to examine the circumstances and report. Their conclusions were summarized in the following letter, supported by several appendices which are printed herein, the whole of which was given to the press by Dr. Walcott on June 9, 1925.

Washington, D. C.,
June 3, 1925.

Dr. Charles D. Walcott,
Secretary, Smithsonian Institution,
Washington, D. C.

Dear Doctor Walcott :

The announcement that Mr. Orville Wright had arranged to have the first Wright airplane deposited in a British museum having aroused considerable controversy as to the accuracy of the label attached to the Langley flying machine now on exhibition in the Smithsonian Institution, you have asked us to examine the Langley machine, look into its history, and advise you whether we consider it desirable to modify the present label.

We have made a careful study, not only of the history of the Langley machine itself, but also of all the circumstances connected with its tests. We append to this letter (Appendix I) a suggested modified label, and a statement of our views and conclusions (Appendix II), upon which our recommendation is based.

There is no question but that the Wrights were the first to navigate the air, thus reaching the goal long sought by many, but in our opinion, when Langley's 1903 machine was wrecked in launching, he too, after years of effort, following a different road, was in sight of the same goal. He was like the prophet of old who, after forty years of wandering in the wilderness, was permitted to view the promised land upon which he never set his foot. Langley's accomplishments in aeronautics were notable, and he is entitled to full credit for them. We believe that the Langley machine of 1903 was capable of sustained flight had it been successfully launched, and it is naturally fitting that the Smithsonian Institution should

perpetuate with pride, by exhibiting his models and flying machine, suitably labeled, the aeronautical achievements of its distinguished secretary.

It is unfortunate that in the past the situation has been beclouded by patent litigation, in which the Smithsonian Institution had no part, involving temptation for one side to exaggerate and distort favorably Langley's work, and for the other side to belittle and deny it. While bitterness thus engendered survives, it cannot be expected that any label can be placed upon Langley's machine that will be fully acceptable to everyone. The appended suggested label departs from the customary brief title in two respects. In the first place, it is much longer and goes more into the history of the exhibit than is customary. In the second place, in view of the facts that the exhibit deals with the border line between success and failure of man's effort to fly, and that the original Wright machine, a purely American product and the first to fly, is destined to a museum in another country, we have suggested that the label on the Langley machine, also a purely American product and capable of flight but not successfully flown, contain an explicit and definite statement, which would be unnecessary under other circumstances, giving to the Wrights the credit due them as the first to fly, on December 17, 1903.

It is our earnest hope that this proposed restatement of the label will prove satisfactory both to yourself and to Mr. Orville Wright, with both of whom we have had such friendly relations on the National Advisory Committee for Aeronautics and in whose judgment and fairness of mind we have such implicit confidence.

Respectfully yours,

(Signed) JOSEPH S. AMES

Professor of Physics,

Johns Hopkins University.

(Signed) D. W. TAYLOR

Rear Admiral (C. C.) U. S. N., Retired.

APPENDIX I

(Ames-Taylor Report)

LABEL

LANGLEY FLYING MACHINE

THE ORIGINAL LANGLEY FLYING MACHINE OF 1903, RESTORED. IN THE OPINION OF MANY COMPETENT TO JUDGE, THIS MACHINE WAS THE FIRST HEAVIER-THAN-AIR CRAFT IN THE HISTORY OF THE WORLD CAPABLE OF SUSTAINED FREE FLIGHT UNDER ITS OWN POWER, CARRYING A MAN.

THIS MACHINE SLIGHTLY ANTEDATED THE WRIGHT MACHINE DESIGNED AND BUILT BY WILBUR AND ORVILLE WRIGHT, WHICH, ON DECEMBER 17, 1903, WAS THE FIRST IN THE HISTORY OF THE WORLD TO MAKE A SUSTAINED FREE FLIGHT UNDER ITS OWN POWER, CARRYING A MAN.

Langley's machine was designed by Samuel Pierpont Langley, Secretary of the Smithsonian Institution, and completed in 1903. The original machine was never successfully launched into the air: attempts at launching with a catapult on October 7 and December 8, 1903, were failures owing to defects in the operation of the catapult launching device, and the machine was damaged severely. In 1914, using all available parts remaining, the machine was reconstructed, with certain modifications, and with hydroplane floats attached for the purpose of enabling it to rise from the water instead of being launched by a catapult. In that condition, and carrying a man, it was successfully flown with the original power plant, at Hammondsport, New York, June 2, 1914, and photographed in flight. With a modified and more powerful power plant, it was subsequently flown repeatedly. These tests indicated that the original airplane would have flown if successfully launched in the tests of 1903. After the Hammondsport flights the pontoons were removed and the airplane was restored in accordance with original drawings and data to its original condition, and is constructed in the main of the original parts.

Washington, D. C.,

June 3, 1925.

APPENDIX II

(*Ames-Taylor Report*)

THE LANGLEY FLYING MACHINE.

Memorandum for Dr. Charles D. Walcott,
Secretary, Smithsonian Institution.

1. In connection with our letter to you of even date, concerning the label on the Langley Flying Machine in the National Museum, we beg to add the following remarks of an historical nature, and our views and conclusions in some detail.

2. Professor S. P. Langley became actively interested and engaged in the study of aeronautics in 1887, and was assiduous in the theoretical and experimental study of the subject till his death in 1906. The more important of his results were finally published in Volume 27 of "Smithsonian Contributions to Knowledge," Part 1, issued in 1891, entitled "Experiments in Aerodynamics"; Part 2, the "Internal Work of the Wind," 1893; and Part 3, the "Langley Memoir on Mechanical Flight," 1911. In the course of his study he became convinced of the possibility of "mechanical flight," *i. e.*, of constructing a heavier-than-air machine, to be driven by an engine, and sufficiently powerful and stable to carry a man. To this end he constructed certain models about 12 feet wide by 15 feet long, weighing approximately 30 pounds, each driven by a $1\frac{1}{2}$ horsepower steam engine which with its boiler weighed not over 7 pounds per horsepower. These models actually did fly, in one case as long as 1 minute and 49 seconds and for a distance of 4,300 feet. These two machines made successful flights on May 6, 1896, in the presence of Dr. A. Graham Bell, and on November 28, 1896, in the presence of Mr. Frank G. Carpenter. The model machines numbered 5 and 6 were placed on exhibition in the National Museum on April 21, 1905. Finally, by the aid of a grant of \$50,000 made by the Board of Ordnance and Fortification of the War Department in December, 1898, which was later supplemented by funds to the amount of \$20,000 from the Smithsonian Institution, he constructed in the years from 1898 to 1903 a full-size flying machine (which he called an "aerodrome"), a reproduction on a scale approximately 4:1 of these steam models which had previously flown in 1896. The engine of this final machine was a radial 5 cylinder, water cooled, gasoline type, 5 inch bore by $5\frac{1}{2}$ inch stroke, developing 52.4 horsepower at 950 r. p. m., and

weighing 125 pounds, or 2.2 pounds per horsepower. This engine was designed and built by Mr. Charles M. Manly at the Smithsonian shops. Two tests were attempted with this flying machine, Mr. Manly being the pilot in both cases.

3. The machine was designed to obtain its initial impetus by means of a spring-catapult propelling it along a pair of rails on top of a house boat. The first test was conducted in the middle of the Potomac River, opposite Widewater, Virginia; and suitable provision was made for the flotation of the machine upon its landing on the surface of the river as it was intended to do. The second test was made on December 8, 1903, off the Arsenal Point in the Potomac River at the junction of the Georgetown Channel and the Eastern Branch. A full description of the machine and the tests is given in "Langley Memoir on Mechanical Flight," published in 1911. Both attempts to launch the machine failed. The first on October 7, 1903, failed because a lug on a pin projecting from the bottom of the lower front guy post hung in its slot on a support on the launching car or catapult, causing the front wings to be badly twisted from a positive angle of lift to a negative angle of depression, thus forcing the front end of the machine downwards instead of supporting it, and resulting in the machine striking the water about 150 feet in front of the house boat from which it was launched. The front wings and propellers were broken by the impact and the rear wings and control surfaces were destroyed by towing the machine through the water. The second test on December 8, 1903, failed for reasons which were never absolutely determined. Photographs of the operation show clearly, however, that the immediate cause was the collapse of the rear part of the machine. This was probably due to a sudden gust of wind striking it and throwing it against a stanchion as it passed down the launching track, while it was still in contact with the catapult. Thus, no evidence was obtained of the aerodynamic or other features of the machine itself. Further study at the time was not possible because funds were exhausted and the public prejudice against the work made it impossible for Dr. Langley to raise either public or private funds.

4. The machine was drawn from the water in its damaged condition the night of December 8, 1903. A few days later it was removed to the shops of the Smithsonian Institution where the frame was repaired and the engine, which had not been injured, was stored for further use till such time as additional funds might become available to build new wings and to defray the expenses of

further tests. Official disposition of that part of the machine belonging to the War Department was made on March 23, 1904, when by formal letter of the Board of Ordnance and Fortification, signed by Major General G. S. Gillespie, President of the Board, and addressed to Dr. Langley, the Board stated that ". . . all of the material procured for experiments with the aerodrome from allotments of this Board will be left in your possession, in order that it may be available for any future work which you may be able to carry on in the solution of the problem of mechanical flight; unless, of course, the Board of Ordnance and Fortification shall otherwise direct, but until such action be taken there will be no necessity for a separation or distribution of the property so far as the Board is concerned."

5. It would seem from the above that at that time there was expectation that further tests would be made with the machine.

6. The machine had in the meantime been cleaned and restored to its original condition, except for the necessary wings and control surfaces. The ribs and cloth covering on the original wings and control surfaces had been so damaged as to require replacement, but the metal fittings were all saved for rebuilding the wings when it might become possible.

7. The engine was shipped to New York in 1906 and exhibited at the first aeronautical show which was held at the Grand Central Palace by the Aero Club of America. It was then returned to Washington and placed on temporary exhibition in the National Museum, but the rest of the machine remained in the Smithsonian shops and was not then placed on exhibition in the National Museum.

8. It appears that as early as 1908 the Smithsonian Institution contemplated making further tests with the Langley Flying Machine. This is evident from a memorandum of September 14, 1908, signed by Cyrus Adler, addressed to Mr. Rathbun, at the Smithsonian Institution, which reads as follows:

"September 14, 1908.

"For Mr. Rathbun:

"I had a talk today with Mr. Chanute, the gist of which I should like to put on record.

"He spoke of Mr. Manly's desire to fly Mr. Langley's flying machine just as it was constructed in order to demonstrate that it could have flown. Mr. Chanute said that in his opinion Mr. Langley's machine could fly just as it was constructed, and this had been

demonstrated by the fact that a Frenchman has built a machine exactly like Mr. Langley's which has flown, but he believed further that the machine would be wrecked in alighting.

"I thought you might care to have this because it is more than likely that before very long, through the War Department or in some other way, the question of trying the machine will be forcibly brought up.

Very truly yours,

CYRUS ADLER."

This is further evidenced by the following correspondence between Dr. Walcott and Dr. Octave Chanute, one of the pioneers in flying experiments:

"November 16, 1908.

"Dear Dr. Chanute:

"In a letter received during the summer while I was away from the city, Mr. Charles M. Manly says:

The Langley machine is today capable of more than any other machine yet built, and is apt to remain so for some time. The engine is now seven years old and still is the peer of the world.

"Mr. Manly has suggested that he be permitted to make trial tests of the Langley machine at some future time. I write to ask whether in your judgment it would be wise to have an attempt made to fly with it.

Sincerely yours,

CHAS. D. WALCOTT."

"Chicago, Illinois,

November 20, 1908.

"Mr. Chas. Walcott,
Secy., Smithsonian Instn.,
Washington, D. C.

"Dear Sir:

"I have your letter of the 16th, asking whether in my judgment, it would be wise to make an attempt to fly with the Langley machine.

"I have never seen this machine but I suppose that I understand it fairly well from descriptions.

"My judgment is that it would probably be broken when alighting on hard ground and possibly when alighting on the water, although the operator might not be hurt in either case.

"If the Institution does not mind taking this risk and suitable arrangements can be made about the expense. I believe that it

would be desirable to make the test, in order to demonstrate that the Langley machine was competent to fly and might have put our government in possession of a type of flying machine, which, although inferior to that of the Wrights, might have been evolved into an effective scouting instrument.

Yours truly,

O. CHANUTE."

" November 27, 1908.

" Dear Sir:

" I wish to thank you for your letter of November 21, in relation to the Langley machine. I will talk the matter over with Mr. Manly the next time I see him.

Very truly yours,

CHAS. D. WALCOTT."

" DOCTOR OCTAVE CHANUTE,

61 Cedar Street,

Chicago, Illinois."

9. In 1910, the Smithsonian Institution made an effort to secure the original Wright machine of 1903, or a model thereof for exhibition in the National Museum. This is evidenced by the following correspondence between Dr. Walcott and Mr. Wilbur Wright:

" Smithsonian Institution,

Washington, U. S. A.,

March 7, 1910.

" My dear Mr. Wright:

" The National Museum is endeavoring to enlarge its collections illustrating the progress of aviation and, in this connection, it has been suggested that you might be willing to deposit one of your machines, or a model thereof, for exhibition purposes.

" The great public interest manifested in this science and the numerous inquiries from visitors for the Wright machine make it manifest that if one were placed on exhibition here it would form one of the most interesting specimens in the national collections. It is sincerely hoped that you may find it possible to accede to this request.

" With kindest regards, I am

Very truly yours,

CHARLES D. WALCOTT,

Secretary."

" MR. WILBUR WRIGHT,
Dayton, Ohio."

" Dayton, Ohio,
March 26, 1910.

" Mr. Charles D. Walcott,
Washington, D. C.

" My dear Dr. Walcott:

" Your letter of the 7th of this month has been received. If you will inform us just what your preference would be in the matter of a flier for the National Museum we will see what would be possible in the way of meeting your wishes. At present nothing is in condition for such use. But there are three possibilities. We might construct a small model showing the general construction of the airplane, but with a dummy power plant. Or we can reconstruct the 1903 machine with which the first flights were made at Kitty Hawk. Most of the parts are still in existence. This machine would occupy a space 40 feet by 20 feet by 8 feet. Or a model showing the general design of the latter machine could be constructed.

Yours truly,

WILBUR WRIGHT."

" Smithsonian Institution,
Washington, U. S. A.,
April 11, 1910.

" Dear Mr. Wright:

" Yours of March 26th came duly to hand, and the matter of the representation of the Wright airplane has been very carefully considered by Mr. George C. Maynard, who has charge of the Division of Technology in the National Museum. I told him to indicate what he would like for the exhibit, in order that the matter might be placed clearly before you and your brother. In his report he says:

The following objects illustrating the Wright inventions would make a very valuable addition to the aeronautical exhibits in the Museum:

1. A quarter-size model of the airplane used by Orville Wright at Fort Myer, Virginia, in September, 1908. Such a model equipped with a dummy power plant, as suggested by the Wrights, would be quite suitable.
2. If there are any radical differences between the machine referred to and the one used at Kitty Hawk, a second model of the latter machine would be very appropriate.
3. A full-size Wright airplane. Inasmuch as the machine used at Fort Myer has attracted such world-wide interest, that machine, if it can be repaired or reconstructed, would seem most suitable. If, however, the Wright brothers think the Kitty Hawk machine would answer the purpose better, their judgment might decide the question.

4. If the Wright brothers have an engine of an early type used by them which could be placed in a floor case for close inspection that will be desirable.

"The engine of the Langley Aerodrome is now on exhibition in a glass case and the original full-size machine is soon to be hung in one of the large halls. The three Langley quarter-size models are on exhibition. The natural plan would be to install the different Wright machines along with the Langley machines, making the exhibit illustrate two very important steps in the history of the aeronautical art.

"The request of Mr. Maynard is rather a large one, but we will have to leave it to your discretion as to what you think it is practicable for you to do.

Sincerely yours,

CHARLES D. WALCOTT,

Secretary."

"MR. WILBUR WRIGHT,
1127 West Third Street,
Dayton, Ohio."

10. Apparently, nothing developed from the above correspondence. Dr. Walcott's last letter quoted above was never replied to. It is a matter of grave regret that at that time the Wright brothers did not see their way to reconstruct and deposit in the National Museum their original full-size airplane, the first machine ever to fly successfully with a man, because then, in 1910, it would have been the only full-size flying machine on exhibition in the National Museum, the Langley machine being still in the shops of the Smithsonian Institution awaiting further tests.

11. In September, 1911, the Smithsonian Institution secured and placed on exhibition in the National Museum the original Wright airplane that was tested at Fort Myer in 1908, and purchased by the War Department, being the first military airplane purchased by the Government.

12. In January, 1914, the late Lincoln Beachey, one of the pioneer aviators, and others, again suggested that it would be of interest to determine by actual test whether the essential features of Professor Langley's aerodynamic theory, as illustrated in his 1903 machine, were correct. Finally, at the initiative of the Smithsonian Institution, the Curtiss Aeroplane Company was invited to submit a bid to refit the machine and to make tests. The formal letter to the Curtiss Aeroplane Company was dated March 31, 1914, and the reply offering to undertake the work for a price of \$2,000, was

written by Mr. G. H. Curtiss on April 1, 1914. The machine was thereupon sent to the shops of the Curtiss Aeroplane Company at Hammondsport, New York, on April 2, 1914, and the engine was shipped on April 13, 1914.

13. In preparing the machine for flight with the original engine, certain modifications and additions were made. These were due, in the main, to the fact that, whereas the original machine was fitted for use with a catapult, these new tests were to be made from the surface of a lake, using hydroplaning floats. Therefore, certain changes were necessary to attach these floats to the machine and to properly inter-brace them and the supporting surfaces together.

14. It is perfectly clear from the correspondence between the Smithsonian Institution and the Curtiss Aeroplane Company that no emphasis was placed upon the use of the original machine, as such, but that what was desired was knowledge concerning certain features of the Langley design, which was expressed in Dr. Walcott's letter of March 31, 1914, previously referred to, in the following terms:

"In connection with the reopening and development of work under the Langley Aerodynamical Laboratory, it seems desirable to make a thorough test of the principles involved in the construction of the Langley heavier-than-air man carrying flying machine, especially the question as to the tandem arrangement of the planes, and general stability, especially longitudinal stability."

15. A brief interesting account of the Hammondsport tests is contained in the Annual Report of the Smithsonian Institution for 1914, pages 217 to 222.

16. After the flights were discontinued in November, 1915, the machine was returned to the Smithsonian shops on June 26, 1916. There it was completely overhauled. New wings and control surfaces were built to the same form and size (with solid instead of hollow ribs to save the expense of the latter) so as to refit the machine for exhibition purposes in the National Museum and restore it as nearly as possible to its original condition as it was in 1903. As much of the original material was used as possible. When this overhaul was completed, it was placed on exhibition in the National Museum on January 15, 1918.

17. It is seen that up to 1915 the Langley machine was used solely and properly for the purposes intended by Professor Langley himself, for which it was originally turned over by the Board of Ordnance and Fortification which had defrayed the major portion of its cost. When all had been done to this end that was possible,

the machine became properly an exhibit in the National Museum. It was never an exhibit until 1918.

18. Previous to this date, there had been placed on exhibit in the Museum the two Langley steam-driven models which had successfully flown in 1896, and the quarter-size model of the large machine equipped with its 3 horsepower radial gasoline engine. The first two of these are approximately, and the latter exactly, one-fourth the linear dimensions of the full-size machine. It is thus clear that, when in the letters from the Smithsonian Institution to Messrs. Wilbur and Orville Wright, of March 7 and April 11, 1910, the request was made for models of their successful machines, it was the hope to have both Langley and the Wright brothers represented in the Museum by exhibits of the same character.

19. The question whether the original Langley machine of 1903 was capable of flight under its own power and carrying a pilot has been a controversial one since, subsequent to the Hammondspport trials of 1914, there was litigation to which the Smithsonian Institution was in no way a party, involving infringement, or alleged infringement of the Wright patents by other manufacturers, and since, in 1921, the English patent attorney for the Wrights published a violent attack, with allegations of fraud, etc., in connection with the Hammondspport trials.

20. There are just three questions involved, which must be answered before it is possible to determine the capability of flight of the original Langley machine. These questions are: First, was the power plant adequate? Second, did the machine embody the proper aerodynamic principles to enable it to balance and maintain itself in the air? Third, was it sufficiently strong structurally to carry its weight and the stresses due to flying?

21. As regards the power plant, there seems no question that, in the Hammondspport trials the original Manly engine never developed the power of which it was demonstrated to be capable in 1903. Furthermore, during the Hammondspport trials with the original engine, the weight lifted into the air, including the pontoons, was 40 per cent greater than that of the machine as of 1903 with a pilot. Moreover, the bracing and supports to the pontoons and the pontoons themselves must have added materially to the resistance of the machine. If under these circumstances, the Langley machine was capable of arising from the water, which was demonstrated, there is no question in our mind that the 1903 machine had an adequate power plant.

22. With reference to the second question, although there were some changes in the supporting and guiding surfaces in the Hammondsport machine as compared with those of the 1903 machine, they were not, in our judgment, material, either as regards the Hammondsport machine when fitted with the original Manly engine, or subsequently when modified by a more powerful engine with a tractor screw. Moreover, the machine as it stood was virtually an exact copy of a quarter-size model which had shown itself aerodynamically quite satisfactory. We conclude, accordingly, that the answer to the second of the fundamental questions above is also in the affirmative.

23. When it comes to the question of strength, the case is not so clear. There is no question that the changes made in 1914 provided additional strength. Additional strength was obviously needed if 40 per cent additional weight was to be carried. However, the fact that additional strength was provided renders it impossible to remove the third question from the realm of controversy. This is a question for technical experts. A complete wing, one-quarter of the sustaining area, showed, by sand load test, ability to carry a total weight of 260 pounds without damage, while one-quarter of the weight of the original machine and pilot was $207\frac{1}{2}$ pounds, only. Subsequently, the Hammondsport machine with a much more powerful engine (a Curtiss 80 horsepower engine) and with only a moderate increase in strength, showed itself capable of flight carrying 1,520 pounds, or 85 per cent more weight than the original machine of 1903. These facts, in our opinion, establish a strong presumption in favor of the adequacy of the structural strength of the original machine. However, we have asked the disinterested head of the Design Section of the Bureau of Aeronautics of the Navy Department, to study with his experts the original machine and give us their opinion as to the adequacy of the original structure. They are of the opinion that structurally the original Langley flying machine was capable of level and controlled flight.

24. It should not be thought that the original Langley machine was, in any sense, a finished product. Langley himself regarded his machine as only a beginning; numerous problems had occurred to him which needed solution before aviation could be considered practicable. Since Langley and the Wright brothers looked at the subject from such different angles it would have been an inestimable advantage to the science and the art of aviation if Langley had been able to continue his work.

25. In conclusion, we beg to call attention to the fact that a careful examination of the Langley machine now on exhibition in the National Museum shows that there are four minor inaccuracies as compared to the original machine of 1903, which should be remedied, namely:

- (a) The safety flotation tanks should be installed;
- (b) The fin forward of the dihedral rudder should be removed;
- (c) The vertical surface at the rear of the dihedral rudder should be removed; and
- (d) The catapult lugs should be fitted to the king post.

Respectfully submitted,

JOSEPH S. AMES,

Professor of Physics,

Johns Hopkins University.

D. W. TAYLOR,

Rear Admiral (C. C.) U. S. N., Retired."

In October, 1925, Dr. Walcott directed that the label of the large Langley machine of 1903 should be altered to read as follows:

LANGLEY AERODROME

THE ORIGINAL LANGLEY FLYING MACHINE OF 1903, RESTORED

IN THE OPINION OF MANY COMPETENT TO JUDGE, THIS WAS THE FIRST HEAVIER-THAN-AIR CRAFT IN THE HISTORY OF THE WORLD CAPABLE OF SUSTAINED FREE FLIGHT UNDER ITS OWN POWER, CARRYING A MAN.

THIS AIRCRAFT SLIGHTLY ANTEDATED THE MACHINE DESIGNED AND BUILT BY WILBUR AND ORVILLE WRIGHT, WHICH, ON DECEMBER 17, 1903, WAS THE FIRST IN THE HISTORY OF THE WORLD TO ACCOMPLISH SUSTAINED FREE FLIGHT UNDER ITS OWN POWER, CARRYING A MAN.

The aeronautical work of Samuel Pierpont Langley, third Secretary of the Smithsonian Institution, was begun in 1887. By fundamental scientific research he discovered facts, the publication of which largely laid the foundation for modern aviation. Langley designed large model aeroplanes which repeatedly flew in 1896 with automatic stability for long distances. The U. S. War Department, impressed by his success, authorized him to construct a man-carrying machine which was completed in the Smithsonian shops in the spring of 1903. Attempts made to launch it on October

7 and December 8, 1903, failed owing to imperfect operation of the catapult launching device. In these trials the wings and control surfaces were badly damaged and lack of funds prevented other tests at that time. The aeroplane was left by the War Department with the Smithsonian Institution for further experiments. In 1914 (following the foundation by the Institution of the Langley Aerodynamical Laboratory) the experiments were resumed, using all available parts of the original machine. The frame and engine were the same as in the first trials; the reconstructed wings were used without the leading edge extension; the control surfaces were reconstructed; and launching pontoons with necessary trussing were substituted for the original catapult. Thus equipped, and weighing over 40 per cent more than in 1903, with Glenn H. Curtiss as the pilot, it was successfully flown at Hammondsport, N. Y., June 2, 1914. With a more powerful engine and tractor propeller it was subsequently flown repeatedly. These tests indicated that the original machine would have flown in 1903 had it been successfully launched. After the Hammondsport flights the machine was restored in accordance with the original drawings and data under the supervision of one of the original mechanics, using all original parts available. In 1918 the machine thus restored was deposited in the National Museum for permanent exhibition. (Its 52-horse-power gasoline engine was designed by Charles M. Manly, who superintended the construction of the machine and piloted it in 1903.)

THE MODEL AERODROMES DESIGNED BY LANGLEY, THE LANGLEY-MANLY ENGINE, AND PHOTOGRAPHS OF THE MACHINES IN FLIGHT ARE SHOWN NEARBY.

6. As regards the sixth point as given on page 3 I do not know the basis for Mr. Wright's feeling that the Smithsonian has failed to recognize properly the abilities of himself and his brother as research men.

The Institution has published two articles, one by Wilbur Wright on "Some Aeronautical Experiments" and the other by Orville Wright on "Stability of Aeroplanes" (see Smithsonian Annual Reports, 1902, pp. 133-148, and 1914, pp. 209-216). Such publication by the Smithsonian Insti-

tution is in itself definite recognition of the status of the Wrights as discoverers of new truths.

The Smithsonian Institution has borne charges in which have occurred the words "hostile," "insidious," "false propaganda," in consequence of the events I have described. In order to show that the Institution's officers have not been insincere I quote the following passage from a letter which I sent to the Editor of the Journal of the Royal Aeronautical Society, April 27, 1928:

1. Langley himself said after the two unsuccessful launchings in 1903: "Failure in the aerodrome itself or its engines there has been none; and it is believed that it is at the moment of success, and when the engineering problems have been solved, that a lack of means has prevented a continuance of the work." He died in the same belief.

2. Manly twice risked his life in this faith, and eagerly wished to risk it thus again. From conversation I had with him in 1925, I am certain that he also died in the same belief.

3. Chanute on several occasions stated that "he had no doubt" that Langley's machine "would have flown if it had been well launched into the air."

Such, then, in brief review are statements that have been made. In concluding this account, I express, on behalf of the Smithsonian Institution, regret:

1. That any loose or inaccurate statements should have been promulgated by it which might be interpreted to Mr. Wright's disadvantage.

2. That it should have contributed by the quotation on page 23 of the Smithsonian Annual Report of 1910 to the impression that the success of the Wright brothers was due to anything but their own research, genius, sacrifice, and perseverance.

3. That the experiments of 1914 should have been conducted and described in a way to give offense to Mr. Orville Wright and his friends.

I renew to Mr. Wright on behalf of the Smithsonian Institution, my invitation of March 4, 1928, to deposit for

perpetual preservation in the United States National Museum the Kitty Hawk plane with which he and his brother were the first in history to make successful sustained human flight in a power propelled heavier-than-air machine. Finally, as a further gesture of good-will, I am willing to let Langley's fame rest on its merits, and have directed that the labels on the Langley Aerodrome shall be so modified as to tell nothing but facts, without additions of opinion as to the accomplishments of Langley. This label now reads as follows:

LANGLEY AERODROME
THE ORIGINAL SAMUEL PIERPONT LANGLEY
FLYING MACHINE OF 1903, RESTORED.

DEPOSITED BY
THE SMITHSONIAN INSTITUTION

301,613

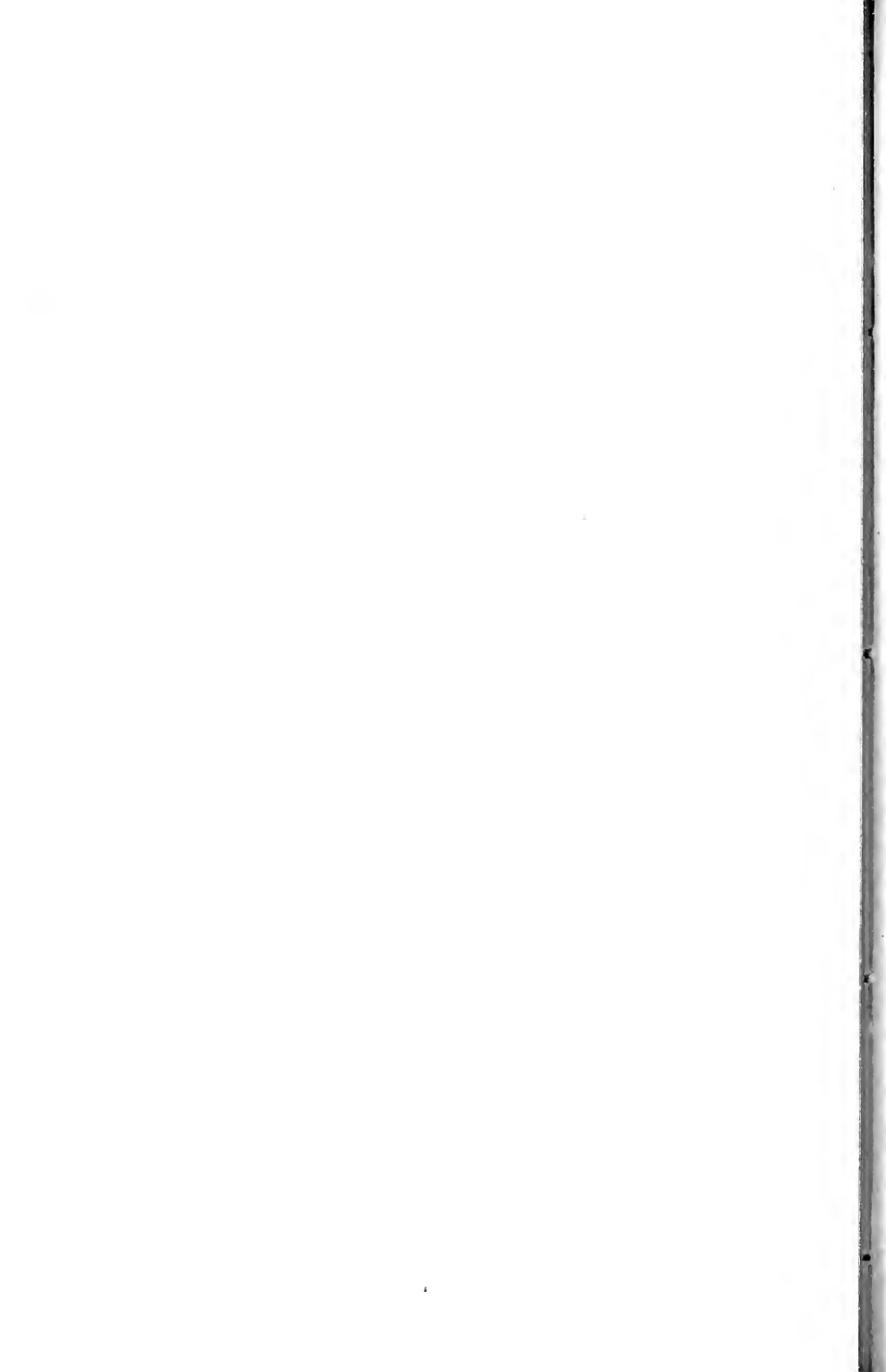



SMITHSONIAN MISCELLANEOUS COLLECTIONS
VOLUME 81, NUMBER 6

A STUDY OF BODY RADIATION

BY
L. B. ALDRICH



(PUBLICATION 2980)

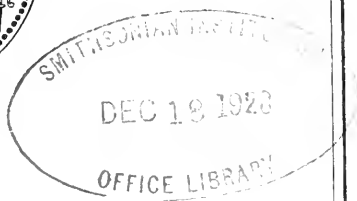

CITY OF WASHINGTON
PUBLISHED BY THE SMITHSONIAN INSTITUTION
DECEMBER 1, 1928



SMITHSONIAN MISCELLANEOUS COLLECTIONS
VOLUME 81, NUMBER 6

A STUDY OF BODY RADIATION

BY
L. B. ALDRICH



(PUBLICATION 2980)

CITY OF WASHINGTON
PUBLISHED BY THE SMITHSONIAN INSTITUTION
DECEMBER 1, 1928

The Ford Baltimore Press
BALTIMORE, MD., U. S. A.

A STUDY OF BODY RADIATION

By L. B. ALDRICH

CONTENTS

	PAGE
Introduction	2
Dr. Abbot's experiments in 1921.....	3
Preliminary experiments in still air.....	7
Preliminary calorimeter experiments.....	14
Calorimeter tests with cloth walls.....	16
Relationship between melikeron and thermolement results.....	17
Experiments on ten subjects in still and in moving air.....	19
General discussion	20
Summary of results.....	24
Notes on tables.....	26

LIST OF TABLES

TABLE	PAGE
A. Abbot-Benedict observations in 1921.....	27
B1-10. Observations and results of preliminary experiments on ten subjects.....	29
C. Observations and results of preliminary calorimeter tests.....	39
D. Observations and results of calorimeter tests with cloth walls.....	40
E1-10. Observations and results of experiments on ten subjects in still and in moving air	41
F. Summary of cloth-covered calorimeter tests.....	51
G. Summary comparing thermolement and melikeron.....	51
H. Summary of table E, varying air velocities.....	52
J. Summary of table E, still air.....	53
K. Summary of changes in skin and clothing temperatures in moving air..	54
L. Condensed summary of tables B and E.....	54

LIST OF TEXT FIGURES

FIGURE	PAGE
1. Melikeron and mounting.....	4
2. Thermolement device	8
3. Thermolement electrical connections.....	8
4. Bath for constant temperature junction.....	9
5. Calibrating bath	10
6. Thermolement calibration curve.....	11
7. Sketch showing body position numbers.....	12
8. Vertical and horizontal calorimeters.....	15
9. Diagram for computing solid angle exposed to melikeron.....	16

INTRODUCTION

The following is a report submitted to the New York Commission on Ventilation, covering experiments conducted by the Smithsonian Institution under a grant of \$1000 from the Commission.

The *raison d'être* of the experiments here described is explained in the following quotation from A Preliminary Note on Radiant Body-heat and the School Ventilation Problem, by T. J. Duffield, Executive Secretary, New York Commission on Ventilation:

Satisfactory temperature conditions in the classroom can be established and maintained only when the loss of body heat from each pupil is not interfered with by similar processes of his neighbors or other bodies. In the classroom, the pupil loses heat by evaporation, convection (including conduction), and radiation. It is only through thorough consideration of each of these types of body heat loss that we can hope to determine logical standards of floor and air space per pupil for classrooms.

The heat required to evaporate the moisture both in the lungs and from the body surface is a real loss as far as the pupil is concerned, but the heat-loss by evaporation does not enter into the problem of ventilation, because the heat has disappeared in the form of *latent heat of vaporization*. Modern ventilation—using that term in the strict sense—can cope successfully with the problem of removing the *convected* heat, which, under normal conditions of school-room construction and occupancy, is transferred by *conduction* to the air which surrounds the body. The air, thus heated, expands, rises and may be readily removed and replaced by cooler air. In these ways, two of the three forms of body heat loss are accomplished, but concerning the third form—*radiation*—very little experimental work appears to have been done. . . .

. . . . The heat loss by radiation can be cared for only if artificial sources of radiant heat in the classroom are properly shielded, and if adequate floor space per pupil in the seating section is provided.

Just what the area of this space should be is a matter requiring further study, but, by reason of the different factors affected, it is evident that the provision of additional air space by making ceilings higher cannot compensate for inadequate floor space. The amount of body heat loss by radiation and the thermal gradients for pupils of different average ages must be investigated before standards of floor space in classroom design can be established scientifically and logically.

After a conference with Dr. C. G. Abbot, Secretary of the Smithsonian Institution, the New York Commission on Ventilation in June, 1927, made a grant of \$1000 to the Institution to carry out a study of body heat loss by radiation. The prosecution of this study was delegated by Dr. Abbot to the writer. In a letter dated July 20, 1927, Mr. Duffield, Executive Secretary of the New York Commission on Ventilation, says:

Our problems, as we appreciate them are two:

(1) We want to know the amount of body heat loss by radiation and its relation to the total under various conditions of air temperature, and if they

would have any influence under varying conditions of humidity and air motion as well. Of course we are primarily interested in this as it affects the normally clothed school child, but I feel that this study should be extended to include adults as well, in order that we may make a definite contribution to our knowledge concerning the relative importance of the different types of heat loss under varying external conditions.

(2) We are greatly interested in the thermal heat gradients about pupils normally clothed under conditions prevailing in the school rooms where the average pupil is surrounded by his radiant neighbors, distance from him 20 to 24 inches. This matter should be studied at various temperatures ranging from 60° to 70° F. and if the findings of the first study warrant it, under various conditions of humidity and rates of air change as well.

As a preliminary, in order to discover what criteria govern the spacing of children in classrooms, the following letter, signed by the Acting Secretary of the Smithsonian Institution, was sent in August, 1927, to the superintendents of schools in ten of the larger cities of the United States:

At the suggestion of the New York Commission on Ventilation, the Smithsonian Institution is conducting a research concerning the amount of body heat loss by radiation, particularly as it affects children in the classroom.

As an aid to this research, the Institution would greatly appreciate your kindness in replying to the following three queries:

(1) In the schools under your supervision, what considerations were factors in establishing the space allotted to each individual in the classrooms?

(2) In particular, was any consideration given to the loss of heat by radiation from the individual pupils?

(3) Are the radiators or other artificial heat sources in classrooms shielded to prevent direct radiation to the pupils?

Your coöperation is earnestly hoped for.

Seven replies were received. To question (1), all seven answered that the classrooms were of certain standard sizes, determined generally by state law. To question (2), all seven replied no. To question (3), six answered no and one yes. This correspondence makes it evident that as yet the question of radiation exchange between pupils and surrounding objects has been given practically no consideration in designing classrooms.

DR. ABBOT'S EXPERIMENTS IN 1921

In the spring of 1921, Dr. Abbot conducted a series of experiments on the radiation from the nude body. This work was carried out at the invitation of Dr. F. G. Benedict in the Nutrition Laboratory of the Carnegie Institution in Boston. A description of this work and summary of Dr. Abbot's results, since they have not been previously published, are with his permission incorporated here.

In 1920 the Smithsonian Astrophysical Observatory designed and built a new instrument for the measurement of radiation called the "melikeron." It is essentially different from the ordinary type of radiation instrument such as the pyranometer, pyrgeometer, bolometer, etc., in that radiation is absorbed not upon a flat surface but by a device shaped like a honeycomb. This makes the melikeron, by virtue of its form, approximately a "black body," capable of absorbing practically all radiation falling upon it. A detailed description of the instrument and tests made upon it are given in Smithsonian Miscel-

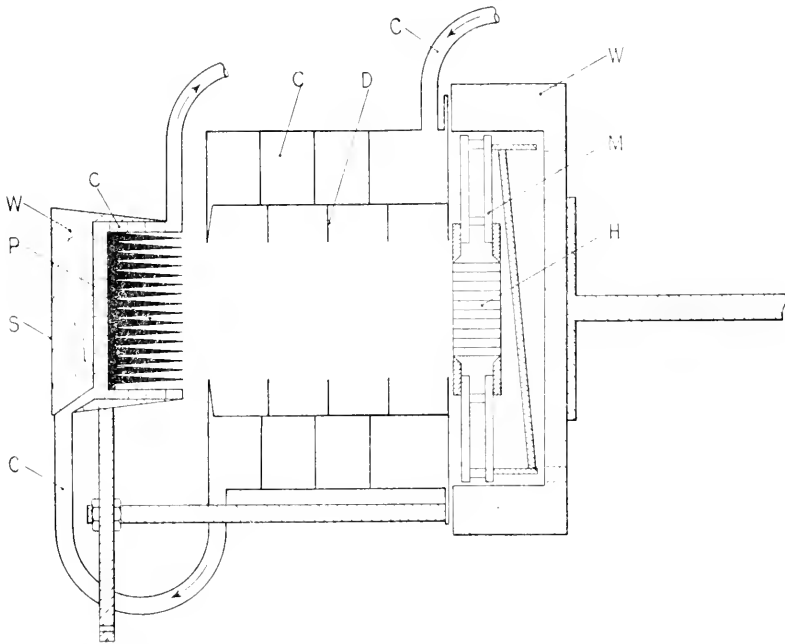

FIG. 1.—Melikeron and mounting, showing special water-circulating vestibule and water-circulating, "pin-cushion" shutter.

W—Wooden insulator.

M—Melikeron.

S—Shutter.

H—Honeycomb absorber.

D—Metal diaphragms.

C—Circulating water.

P—Blackened metal points.

aneous Collections, Vol. 72, No. 13. Being well adapted to the measurement of long wave radiation such as is emitted by bodies at low temperature, Melikeron No. 1 was chosen by Dr. Abbot for his measurements on the radiation from a nude subject in Dr. Benedict's laboratory. A special mounting was made, with the melikeron enclosed in a wooden case to keep air currents away. The front was provided with a diaphragmed vestibule through which water circu-

lated. The diaphragms helped to prevent convection currents from reaching the honeycomb and also limited the radiation received to a known solid angle. A water circulating shutter completed the mounting. The side of the shutter exposed to the melikeron consisted of a large number of projecting metallic points and resembled a "pin-cushion." This made the shutter as well as the melikeron an approximately "black body" by virtue of its form. The vestibule and shutter are shown in cross-section in figure 1.

The melikeron and mounting were securely clamped to the round of a chair back. Observations were made upon the nude subject standing or sitting before the instrument so that the skin was about 15 mm. from the shutter. Direct skin temperature measurements were made at the same positions and as nearly as possible at the same time by Dr. Benedict, using his rubber-backed thermoelement device described in his paper, "The temperature of the human skin" (Asher-Spiro's *Ergebnisse der Physiologie*, Supplement-Band, 1925).

To abstract from Dr. Abbot's notes—

Suppose the temperature of the "pin-cushion" shutter is $T_0 = 273 + t_0$. Its radiation is $\sigma T_0^4 = 8.20 \times 10^{-11} \times (273 + t_0)^4$ in small calories per sq. cm. per minute (Stefan-Boltzmann formula, see Smithsonian Physical Tables, p. 247). This applies to radiation to a whole hemisphere. The jacket surrounding the melikeron limits the radiation to a circular opening 3.66 cm. in diameter and 7.03 cm. from the absorbing surface of the melikeron. It is necessary to determine what part of the total radiation from a whole hemisphere enters through this opening. See figure 9.

Let O be the center of the absorbing surface of the melikeron, and AB the opening in the jacket. Then the area of the opening AB will be

$$\int_{\theta=0}^{\theta=\theta} (2\pi\rho \sin \theta) \rho d\theta$$

and the radiation received on the horizontal surface at O will be proportional to

$$\begin{aligned} & \int_{\theta=0}^{\theta=\theta} 2\pi\rho \sin \theta \rho d\theta \cos \theta \\ &= 2\pi\rho^2 \int_0^{\theta} \sin \theta \cos \theta d\theta = \pi\rho^2 \sin^2 \theta \end{aligned}$$

For the whole hemisphere this becomes $\pi\rho^2$

The part of the total radiation entering the vestibule is the ratio

$$\frac{\pi\rho^2 \sin^2 \theta}{\pi\rho^2} = \sin^2 \theta$$

For diameter 3.66 cm. and $\rho' = 7.03$ cm.,

$$\sin^2 \theta = \frac{(1.83)^2}{(1.83)^2 + (7.03)^2} = .06347$$

NOTE.—In certain experiments on the hand (see Table A) a smaller opening was used having diameter 2.42 cm. For this, $\sin^2 \theta = .02877$.

The paper referred to above (Smithsonian Misc. Coll., Vol. 72, No. 13) gives the constant of melikeron No. 1 as 2.45. That is, by multiplying 2.45 by the square of the current, in amperes, required to compensate, we obtain, in calories per sq. cm. per minute, the difference in radiation between the shutter and whatever object is exposed on removing the shutter. The difference in radiation between the "pin-cushion" shutter and the skin would be

$$R = 2.45 \frac{C^2}{\sin^2 \theta}$$

A shunted voltmeter of 49.3 ohms resistance was used to measure the current, hence

$$R = \frac{2.45}{(49.3)^2} \frac{V^2}{\sin^2 \theta} = \frac{.001008 I^2}{\sin^2 \theta}$$

where I = voltmeter reading in volts.

The shutter being a black body at temperature t_0 C., radiates

$$8.20 + 10^{-11}(273 + t_0)^4$$

Then the skin radiates

$$8.20 \times 10^{-11}(273 + t_0)^4 + .001008 \frac{V^2}{\sin^2 \theta}$$

if we neglect the radiation which appears to arise in the skin, but really is reflected by the skin into the instrument and was emitted by the walls of the room, the vestibule of the melikeron, and so forth. If the skin was a perfect radiator or "black body" this reflection correction would be zero.

We may get a line on this by computing the temperature of the skin, assuming it "black" and comparing with observed temperatures taken directly.

If T_1 = absolute temperature of skin

T_0 = absolute temperature of pin-cushion shutter,

Skin radiation = σT_1^4

Shutter radiation = σT_0^4

$$\text{Then } R = .001008 \frac{V^2}{\sin^2 \theta} = \sigma(T_1^4 - T_0^4)$$

$$T_1^4 = T_0^4 + .001008 \frac{V^2}{\sigma \sin^2 \theta} = T_0^4 + 1.939 V^2 \times 10^8$$

for the large aperture and,

$$= T_0^4 + 4.27T^2 \times 10^8$$

for the small aperture.

The observations and computed temperatures are recorded in table A. The part of the body exposed to the melikeron is shown in the table by the position number. Interpretation of these numbers is given in figure 7.

As explained on page 8 of the paper on the melikeron, a check on the ability of Melikeron No. 1 to absorb completely low temperature radiation was made. The mean result of the test yielded a value for the constant

$$\sigma = 8.49 \times 10^{-11}$$

Again in April, 1921, after returning from the Boston work, Dr. Abbot made a similar test. The mean of 3 values gave

$$\sigma = 8.58 \times 10^{-11}$$

These values would tend to show that the constant 2.45 for Melikeron No. 1 is perhaps a little too high.

PRELIMINARY EXPERIMENTS IN STILL AIR

In the preceding we have described experiments by Drs. Abbot and Benedict in Boston in 1921. All the subsequent experiments described in this report were performed by the writer at the Smithsonian Institution in Washington. The first series of experiments was more or less preliminary in nature. They were carried out in the large laboratory room of the Astrophysical Observatory under somewhat unsatisfactory conditions as regards the control of wall and room temperatures.

As in the Abbot-Benedict work, two instruments, one for the direct measurement of radiation, and one for measurement of surface temperatures were used. Melikeron No. 2 replaced No. 1 previously used, but the same water circulating vestibule and "pin-cushion" shutter were retained. On November 28, 1927, a test of Melikeron No. 2 was made, as had been done for No. 1, by exposing to a black body at a known low temperature. Five determinations gave the following values for σ

$$\begin{array}{r} 8.10 \times 10^{-11} \\ 8.23 \\ 8.23 \\ 8.42 \\ 8.84 \end{array}$$

$$\text{Mean } 8.36 \times 10^{-11}$$

The melikeron was clamped in a vertical position at a convenient height (about 1 m.) and remained unchanged throughout the work. The subject stood or sat in front of the instrument so that the part of skin or clothing exposed was about 5 to 10 cm. from the shutter. In the first trials, water directly from the tap was circulated through vestibule and shutter. The difference in temperature, however, between the surrounding air and the shutter and vestibule produced a

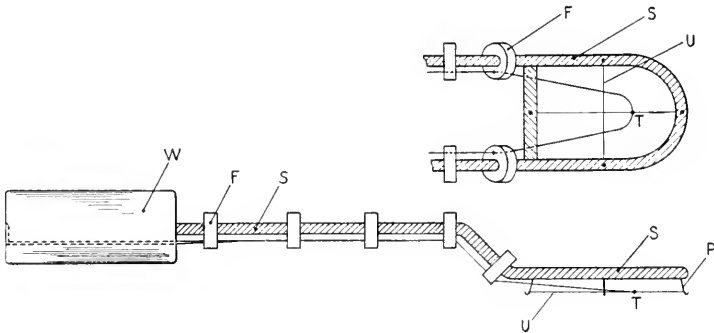

FIG. 2.—Thermoelement device for measuring surface temperatures.

F—Fibre rings. *P*—Spring steel projection
S—German silver frame. *U*—Silk thread.
W—Wooden handle. *T*—Thermoelement.

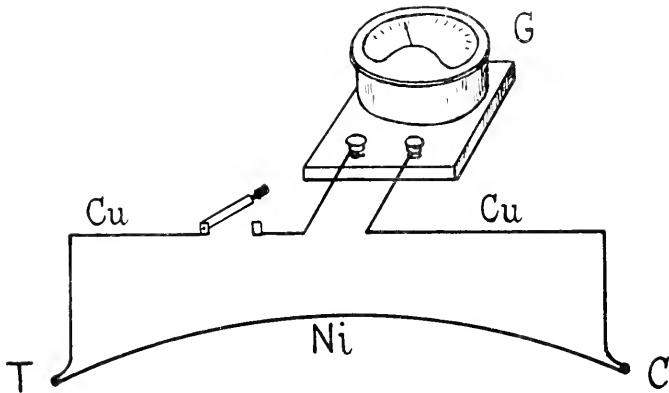

FIG. 3.—Diagram of electrical connections of copper-nickel thermoelement.

G—Galvanometer.
T—Thermoelement junction.
C—Constant temperature junction.

convection effect which altered as the shutter opened and closed and introduced an error resulting in too large values. Fifty feet of block tin pipe was then coiled and placed in a tank of water kept at room temperature. The tap water passed through this just before entering the instrument. Mercury thermometers measured the temperature of

the circulating water before entering the vestibule and after leaving the shutter. The mean was used as the shutter temperature.

For the direct measurement of skin and clothing temperatures, a special device was prepared with the help of Mr. Kramer, the Observatory mechanic, and embodying Dr. Abbot's suggestions. The device is shown in figure 2. It consists of a specially mounted copper-nickel thermoelement of fine drawn wire. A frame of German silver is bent as shown in the figure and fastened in a wooden handle, *H'*. Two silk threads are stretched to form a cross between the four spring-wire posts, *p*. The thermoelement wires are fastened sym-

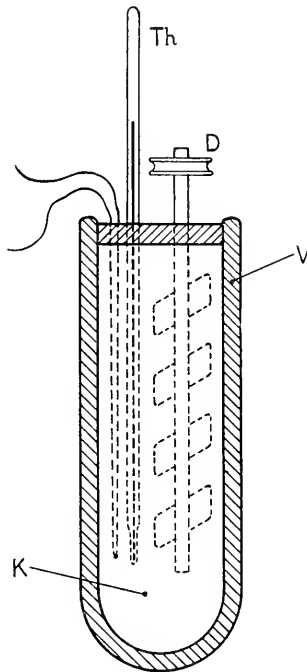

FIG. 4.—Bath for constant temperature junction.

Th—Thermometer.
D—Stirring device.
K—Kerosene bath.
V—Vacuum flask.

metrically to these silk threads with the junction straddling the length-wise thread. The wires lead out through fibre rings, *F*, and through the wooden handle. The copper wire (see fig. 3) leads through a switch to a sensitive type Leeds and Northrup D'Arsonval galvanometer and thence to the constant temperature junction in a stirred kerosene bath as shown in figure 4. The Cu-Ni wires are sufficiently

long so that all desired positions can be reached without moving the constant temperature bath. Holding the device by the wooden handle, one presses lightly the four prongs of spring wire *p* upon the surface whose temperature is desired. This places the junction in excellent contact with the surface. There is no backing to the junction save a single silk thread, and thus no possibility of heat piling up and causing too high temperatures. For about $\frac{1}{2}$ cm. on each side of the junc-

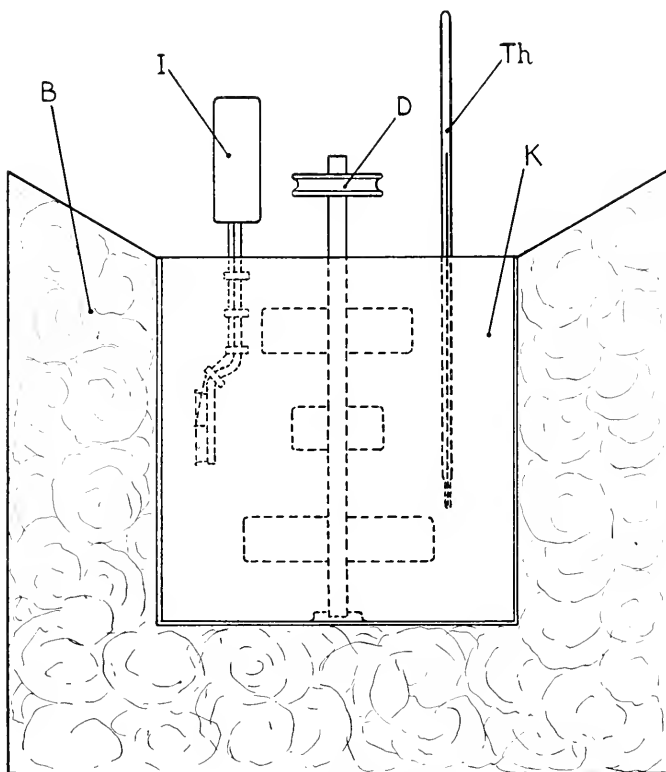

FIG. 5.—Calibrating bath.

I—Thermoelement device.

B—Insulation of cotton batting.

tion, the wire also touches the surface and assumes the surface temperature, thus eliminating error due to cooling of the junction by conduction along the wires.

Instead of a potentiometer for measuring microvolts, the thermoelement was calibrated by plotting galvanometer deflections directly against temperature differences between the two junctions. A kerosene bath (fig. 5) was prepared in which the thermoelement device

was immersed. By a series of changes of the temperatures of both baths a plot (fig. 6) of the relationship between galvanometer deflection and temperature difference was made. By carefully keeping the whole set-up—galvanometer, scale distance, electrical resistance and

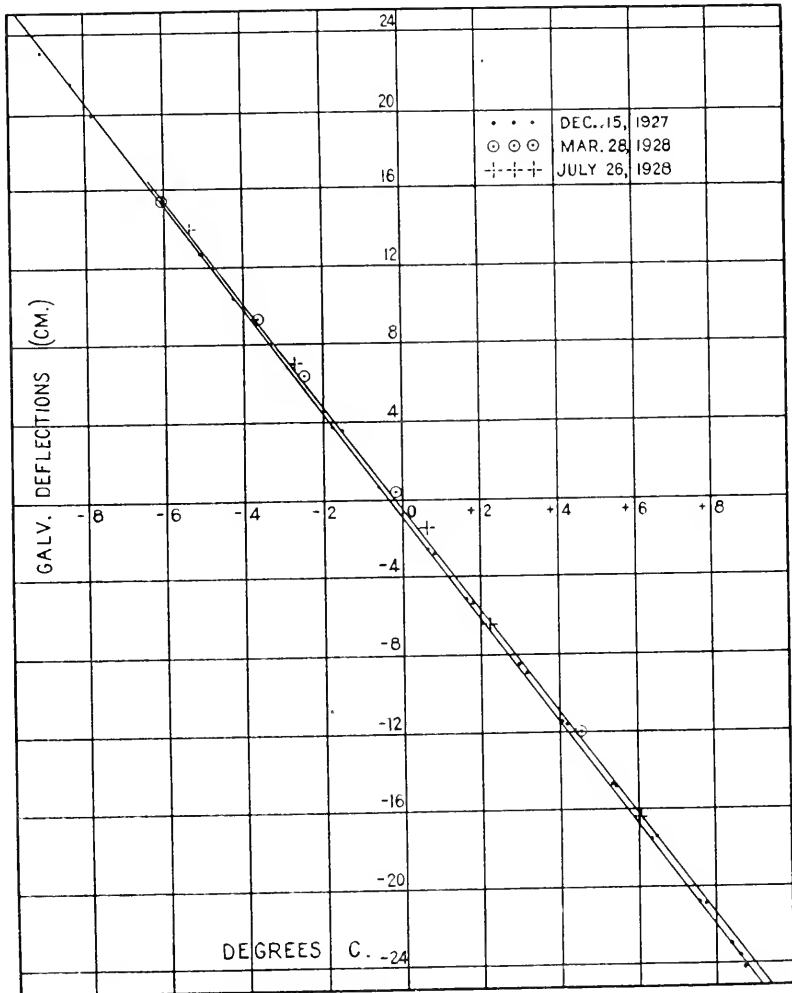

FIG. 6.—Thermolement calibration curve.

contacts, etc.—unchanged, negligible change was found in the calibration curves made at the beginning, during and at the end of the experiments. It is probable that the calibration curve is accurate to $0^{\circ}.1$ C. To avoid error from lack of uniformity of the galvanometer

scale, the zero of the galvanometer was always kept exactly at the middle of the scale.

Ten subjects were chosen, 3 adults and 7 children. Each subject wore ordinary clothing. No attempt was made to minimize metabolism, either by rest or diet before the measurements. The subject stood or sat, exposing to the melikeron in succession some 10 different places

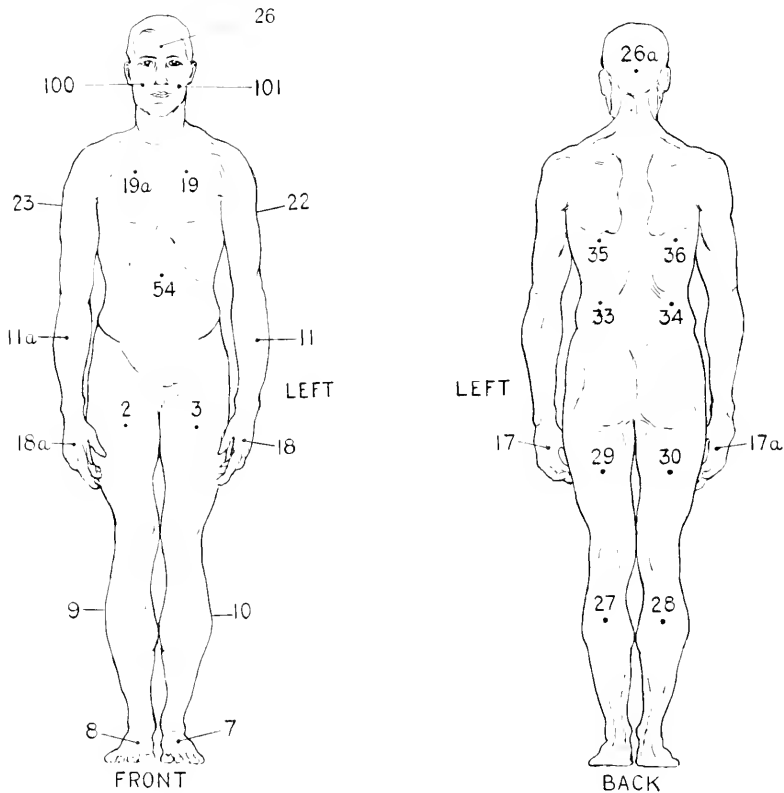

FIG. 7.—Sketch showing body position numbers.

on the body, usually 3 places on the exposed skin, 1 on the hair, 1 on the shoes, and 5 on the clothed parts. Figure 7, adapted from a similar figure kindly furnished by Dr. Benedict, gives a series of numbers corresponding to definite places measured. A single melikeron measurement required from 5 to 10 minutes, for the instrument is sluggish and requires careful adjustment of the compensating current. Immediately following each melikeron measurement the skin temperature was determined with the thermoelement device upon

the same part of the skin or clothing. Usually 3 independent measurements of the temperature were made, since each required less than $\frac{1}{2}$ minute, and the mean used.

The observations are summarized in table B. The application of the Stefan formula to obtain the computed temperatures was the same as described under the Abbot-Benedict experiments, except that for Melikeron No. 2 the constants are altered.

Thus (see fig. 9, also pages 5 to 6),

$$R = \sigma(T_1^4 - T_0^4) \sin^2 \theta$$

where

$$\begin{aligned} R &= (\text{constant Melik. No. 2}) \times C^2 \\ &= 4.0 \times (\text{current in amperes})^2 \\ \sigma &= 8.20 \times 10^{-11} \end{aligned}$$

T_1 = absolute temperature of radiator

T_0 = absolute temperature of melikeron shutter

$$\sin^2 \theta = \frac{r^2}{\rho^2} = \frac{r^2}{r^2 + \rho^2} = \frac{(1.83)^2}{(1.83)^2 + (7.2)^2} = .0606$$

$$\text{Then } T_1^4 = T_0^4 + \frac{4.0 \times C^2}{8.20 \times .0606 \times 10^{-11}} = T_0^4 + 8.05 C^2 \times 10^{11}$$

From this equation, the value of T_1 , the absolute temperature of the surface measured, is determined.

In examining tables A and B, we find that the 4th power formula applied to the measurements on either skin or clothing yields values as great or slightly greater than the observed temperatures. This is evidence that the skin and clothing radiate as a black body at the low temperatures measured. Cobet and Bramigk (Ueber Messung der Wärmestrahlung der menschlichen Haut und ihre klinische Bedeutung, Deutsches Archiv für klinische Medizin, Vol. 144, p. 45 to 60) confirm this result on the skin, and Leonard Hill (The Science of Ventilation and Open Air Treatment, British Govt. Report, 1919, Medical Research Commission) finds both skin and clothing nearly black body radiators for low temperature radiation.

In table B, the values in the *Radiation Summary* were obtained by the application of Stefan's formula to the mean temperatures given under *Temp. Summary*. For example, in table B1, we have given

$$\begin{aligned} \text{Estimated wall temp.} &= 21^\circ\text{C} \\ \text{Mean skin temp.} &= 33.7^\circ\text{C} \end{aligned}$$

Then

$$\begin{aligned} R &= \sigma(T_1^4 - T_0^4) \\ &= 8.20 \times 10^{-11} [(273 + 33.7)^4 - (273 + 21.0)^4] \\ &= .1131 \text{ calories per sq. cm. per minute.} \end{aligned}$$

The value of the *Total Radiation* of the subject is obtained somewhat empirically as follows: The total surface area (see Notes on Tables, p. 26) is divided into sections

skin area, girls 8%, boys 7%

hair 5%

clothing, girls 78%, boys 79%

shoes 9% (if boots, 10% and clothing 78%)

The average skin radiation per sq. cm., as just determined, is multiplied by the corresponding number of centimeters of exposed skin, and similarly for clothing, hair, and shoe areas, and the sum taken. Since part of this total is ineffective, due to the area between the legs and under the arms not radiating to a full hemisphere of wall, this total radiation is reduced 8%. Dividing this result by the number of sq. m. surface area gives the value recorded under *Total Radiation*.

PRELIMINARY CALORIMETER EXPERIMENTS

The total radiation values of table B appeared much too large when compared with the basal metabolism values. The total energy production or metabolism must at all times equal the total energy loss. Exclusive of a small loss through urine and faeces and the warming of air and food taken in, there are three ways in which the body loses heat, namely, by radiation, by convection (including conduction), and by evaporation of water from lungs and skin. Du Bois states (*Basal Metabolism in Health and Disease*, ed. 1927, p. 400) that for a room temperature 22° to 25° C. and relative humidity 30 to 50%, the loss by vaporization of water from lungs and skin is about 24% of the total loss. By analogy with work done on the cooling of wires and blackened spheres we would expect the body convection loss to be at least as great as the radiation loss. For example, on p. 251, *Smithsonian Physical Tables*, 7th Ed., McFarlane finds the total loss of least as great as the radiation loss. For example, on p. 251, Smith- to a blackened enclosure at 14° is .00266 gram calories per second, or .1596 calories per minute. On page 247 the difference in radiation between a black body at 24° C. and one at 14° is 918-801=117 gram cal. per sq. cm. per 24 hours or .0813 calories per sq. cm. per minute.

Then the per cent of radiation loss of the blackened sphere (which, to be sure, at these low temperatures radiates decidedly less than the "black body") is

$$\frac{.0813}{.1596} = 51\%, \text{ convection loss} = 49\%$$

It is of course true that the actual energy production of each of the ten subjects was materially greater than that shown by the basal

metabolism values. Yet even when adequate allowance is made for this, the radiation loss seemed to be an unexpectedly large proportion of the total energy production.

After conference with Dr. Abbot and several members of the New York Commission on Ventilation, a series of experiments was started with the hope of shedding some light on the amount of body convection loss. These experiments proved that convection was, indeed, less than had been anticipated, but the close approach of total radiation to basal metabolism remains surprising.

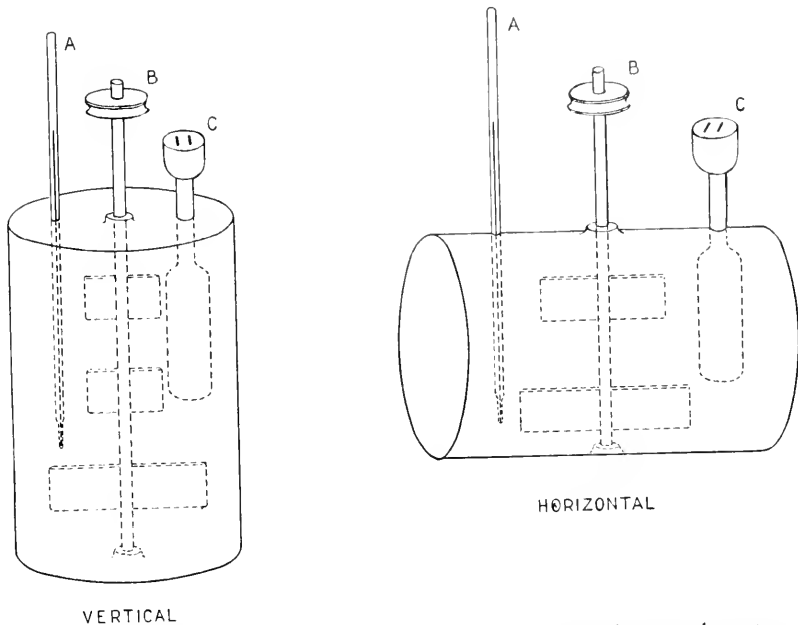

FIG. 8.—Cylindrical copper calorimeters, each 38 cm. long and 30.5 cm. diameter, filled with water and completely covered with tight fitting jackets consisting of one thickness of brown canton-flannel cloth.

- A—Thermometer.
 B—Stirring device.
 C—Electrical heating element.

Two calorimeters were prepared of thin sheet copper, cylindrical in shape, each 38 cm. long by 30.5 cm. in diameter. One was mounted vertically and the other horizontally, each supported on four rubber blocks on the top of four metal rods. This permitted free convection and radiation on all sides but the rate of cooling of the vertical calorimeter might well be less than that of the horizontal because the warm convection currents rising from below would more closely bathe the sides in the vertical form. Appropriate stirring and heating devices were inserted as shown in figure 8. Each was filled with a known amount of water, and the

outside completely covered with a tight fitting jacket consisting of a single thickness of brown canton-flannel cloth. The purpose of the shape and covering of the calorimeters was to simulate the clothed human body. Heat was lost from the calorimeter only by radiation and convection, and the total loss of heat per hour could be accurately determined from the rate of change in temperature of the water and the water equivalent of the calorimeter. A series of tests was made with each calorimeter, and in each test the radiation loss was determined with the melikeron and with the thermoelement, following exactly the method described above as applied to human subjects.

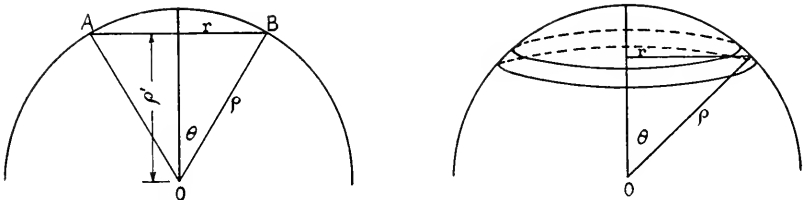

FIG. 9.—Diagram for computing solid angle exposed to melikeron.

The results of the preliminary tests are given in table C. Several interesting points appear. First, the radiation loss of the horizontal calorimeter is 6 or 7% less than in the vertical. This indicates that the shape of the calorimeter is important in determining the amount of the convection and helps to account for the difference in convection between the sphere 50% and the cylinders 70 to 80%. As noted above, however, this discrepancy is also in part due to the less perfect radiating properties of lamp-black than of porous cloth. Second, in the test of March 3, with air motion of about 300 feet per minute the radiation is only 47% and the convection increased to 53%. Third, with no cloth cover, the test of March 26 shows only 34% radiated from the copper surface in still air. This is an indication of the low emissivity of the metal surface as compared with the cloth.

CALORIMETER TESTS WITH CLOTH WALLS

A weakness in the experiments thus far has been the impossibility of accurately knowing the mean temperature of the walls to which the subjects or calorimeters are radiating. A very helpful letter from Prof. Phelps of the New York Commission dated March 27, 1928, suggested the possibility of standardizing the wall conditions by surrounding the subject with cloth draperies whose temperature, closely that of the air in the room, could be determined with the same thermo-

element used on the subject. This suggestion seemed especially feasible since our results indicate that cloth radiates nearly as a black body. Accordingly, brown canton-flannel cloth was hung forming a curtained room $2\frac{1}{2}$ meters high and $1\frac{1}{2}$ by 2 meters in area, enclosing the calorimeter and with the melikeron mounting projecting through the curtain. The same cloth also formed the ceiling and floor. For part of the tests a current of air of known velocity from an electric fan outside the curtain was admitted through a hole in the cloth. The air velocity at the calorimeter was measured with a Katathermometer, an instrument invented by Prof. Leonard Hill, of England (see *The Science of Ventilation and Open Air Treatment*, British Govt. Report, 1919), and serving admirably for this purpose. The motor of the electric fan was run on storage batteries to insure a more constant air current. The Katathermometer was kindly furnished by Mr. Duffield, of the New York Commission.

The results of these tests are found in table D. Table F is a condensed summary of both tables C and D. From these tables a number of conclusions can be drawn:

(1) The amount radiated from the horizontal cylindrical calorimeter is about 7% less than from the vertical cylindrical calorimeter.

(2) The estimated wall temperatures in the preliminary calorimeter experiments are too low. From this cause the amount radiated should probably be lowered at least 10%. Much more weight can be placed in the measured wall temperatures of the cloth walls.

(3) For air motions greater than 75 feet per minute, the melikeron is unsatisfactory for use. An irregular drift of the galvanometer zero due probably to small fluctuating convection currents makes the instrument unreliable.

(4) In the preliminary experiments the melikeron gives appreciably higher results than the thermolement, and in the second set of experiments this discrepancy disappears. The cause of this is explained in the following section.

RELATIONSHIP BETWEEN MELIKERON AND THERMO- ELEMENT RESULTS

In the preceding experiments, recorded in tables B, C, D and E, we have 265 comparisons of temperatures determined directly by thermolement and computed from the radiation as measured with the melikeron, and including skin, clothing, hair, shoes, wall, and cloth-covered calorimeter temperatures. By a study of these comparisons we can determine their relationship, with a view to using only the thermolement in a new series of experiments. The thermo-

element is much quicker and easier to use than the melikeron. Also it offers no difficulty in air currents where the melikeron becomes unusable.

Table G is a summary of this kind. The first trials with the water jacketed melikeron indicated a minus correction (see page 8) when the water jacket temperature was less than room temperature. The water jacket temperatures are therefore given in all the tables and the differences Room Temperature minus Water Jacket Temperature are recorded in table G. Examination discloses a rough equality between the differences Melikeron minus Thermolement and Room Temperature minus Water Jacket Temperature. In the wall temperatures no difference is noted between melikeron and thermolement—which is as we might expect since the wall is always close to room temperature, and the melikeron reading is very small. In the measurements at air velocities greater than 130 feet per minute there is decided disagreement—which we know is due to the unsatisfactory performance of the melikeron in air currents. Of the remaining observations, the difference Melikeron minus Thermolement on the skin is much larger than in any other group. For comparison, all the other groups, viz., clothing, hair, shoes, and calorimeter, are united in one group at the bottom. From the algebraic mean of Room T. minus Water J. T. in this group,

when Room T. minus Water J. T. = $^{\circ}82$, Melik. minus Therm. = $^{\circ}80$ that is, the melikeron calculated temperature is in error by as much as the water jacket differs in temperature from the wall. Hence we may conclude that on the skin, when Room T.—Water J. T. = 0,

$$\text{Melik.—Therm.} = 1^{\circ}91 - 0^{\circ}67 = 1^{\circ}24.$$

Again from the arithmetical mean of Room T.—Water J. T.,

$$\text{when Room T.—Water J. T.} = 1^{\circ}14, \text{ Melik.—Therm.} = ^{\circ}80$$

from which on the skin, when Room T.—Water J. T. = 0,

$$\text{Melik.—Therm.} = 1^{\circ}91 - \frac{1.31}{1.14} \times ^{\circ}80 = 1^{\circ}00$$

A mean of all clothing, hair, shoes, and calorimeter (Melik.—Therm.) differences whose (Room T.—Water J. T.) differences are less than $1^{\circ}0$ gives

No. of observations	Melik.—therm. difference	Room T.—water J. T. difference (algebraic)
30	$^{\circ}51$	$^{\circ}39$

Calorimeter tests alone give

8

.20

.24

These results confirm the preceding conclusion that the melikeron computed temperatures are in error by just as much as the water jacket differs in temperature from the wall. Summarizing the above evidence, it appears that when the Room T. minus the Water J. T. is zero, the Melikeron and Thermolement temperatures on clothing, hair, shoes, and calorimeter agree with each other within $^{\circ}1$. On the skin, however, when the Room T. minus the Water J. T. is zero the melikeron computed temperatures are approximately $1^{\circ}1$ greater than the thermolement temperatures. Dr. Abbot's skin measurements of 1921 at Boston (see table A) give evidence of the same thing—that on the skin the melikeron computed temperatures are higher than those measured directly with the thermolement. A mean of 53 of his values in table A gives

$$\text{Melikeron minus Thermolement} = 1^{\circ}9$$

As an explanation for the persistently larger melikeron temperatures on the skin, Dr. Abbot suggests that since the skin is porous and the internal temperature of the body is higher than that of the surface, the melikeron sees into a deeper layer than that reached by the thermolement.

EXPERIMENTS ON TEN SUBJECTS IN STILL AND IN MOVING AIR

A second series of experiments on human subjects was begun on May 30, 1928. It included 8 children of school age and 2 adults. Three similar sets of observations were taken on each subject, first in still air, second with moderate air motion, and third with faster air motion. As before, the air motion was produced by an electric fan three meters away, the motor of which ran on storage batteries. Air velocities were again measured with the Hill Katathermometer. Each subject was placed inside the same curtained room described under the calorimeter experiments. Skin, clothing and wall temperatures were measured with the thermolement device. Exactly the same body and wall positions were measured on each subject. A complete set included 7 observations on the exposed skin, 15 on the clothing, 1 on the hair, 2 on the shoes, and 10 on the walls. The skin temperatures were then corrected to the melikeron scale by increasing the thermolement skin temperatures $1^{\circ}1$ as explained in the previous section. The observations were grouped and summarized as shown in table E. Following exactly the method described on page 13, Stefan's 4th power formula was applied to the various groups and values of the total radiation determined as given in table F.

Unlike the first series of experiments on 10 subjects (see table B), this second series was carried out in midsummer. Fortunately the room was equipped with refrigerating pipes so that the room temperatures were kept fairly normal and comfortable. These pipes were entirely outside of the curtained room where experiments were made.

Attention is called to the summaries of table E data contained in tables H, J and K. Table H divides the air velocities into four groups and shows how, with the room and wall temperatures remaining nearly constant, the calories of radiation loss progressively decrease as the air motion increases. Table J gives for each subject, in calories per sq. m. of body surface, the basal metabolism and the loss of heat by radiation; also the ratios between these two quantities. These ratios are also arranged according to increasing room temperatures. A marked decrease in the ratio occurs with increasing room (and with it the wall) temperatures. Table K is a summary showing the changes in skin and clothing temperatures with varying air velocities, dividing the changes into three groups, namely, temperature changes on the side of the subject toward the fan, perpendicular to it, and away from it. A drop in temperature occurs in all three groups, with the greatest drop on the side toward the fan. In the other two groups the drop is only about one half as great. On the side towards the fan the clothing temperature drop is about one third greater than the skin temperature drop.

GENERAL DISCUSSION

We have presented the results of three series of experiments on the radiation loss of human subjects, and a fourth series on the radiation loss from specially prepared calorimeters. The first series gave the results of Drs. Abbot and Benedict on the radiation and skin temperatures of a nude subject when the room temperature was held at 15° and again when it was held at 26° . It is interesting to note the change in radiation loss in these two different cases. On March 31, when the room temperature was 15° , the thermoelement skin temperature (mean of 87 values, many of which are not included in table A) was $27^{\circ}.2$, and on April 1, when the room temperature was $26^{\circ}.0$ (mean of 40 values), was $30^{\circ}.8$. The black body temperatures, computed from the melikeron values and the Stefan formula, were March 31 (mean of 20 values) $28^{\circ}.2$, and on April 1 (mean of 12 values) $33^{\circ}.4$. Dr. Benedict estimated the wall temperature on April 1 to be 26° , and it is probable that on March 31 the wall temperature was at least as low as 15° . (Outside temperature was $8^{\circ}.6$.) Assuming these wall

temperatures we can compute from the Stefan formula the average radiation per sq. cm. per minute from the body. It results as follows:

March 31, from thermoelement, .1003 cal., from melikeron, .1109 cal.

April 1, from thermoelement, .0432 cal., from melikeron, .0673 cal.

Thus the body actually radiated in the order of twice as much when the walls were at 15° as when the walls were at 26° . The best work in basal metabolism indicates that an individual's metabolism remains practically unchanged through this range of room temperature. A very considerable readjustment, perhaps of water vapor loss, must take place to compensate for the large change in radiation.

Let us compare the two series of experiments on human subjects recorded in tables B and E. Each series included 10 individual subjects, composed of adults and children of school age, of both sexes and all normally clothed. The first series was performed in midwinter, the second series in midsummer. During the first, the mean relative humidity was 43% and during the second 62%. In each series determinations were made on each subject of the total loss of heat by radiation in still air. The second of the two series deserves greater weight for two reasons:

(1) Cloth walls were used and the mean wall temperature determined from actual measurements with the thermoelement.

(2) A greater number of skin and clothing temperatures were measured since only the thermoelement was used.

In the first series the subject radiated to the walls, windows, and furniture of the room. Their mean temperature was estimated from the room temperature, after a study, on a typical day, of the relationship between the room temperature and that of the walls, windows, and furniture. From this study it was concluded that the mean wall temperature was probably $.5^{\circ}$ below room temperature. This arbitrary correction was adopted for all the preliminary 10 subjects and also for the preliminary calorimeter experiments (see table C). It is remarked on page 17 under (2) that the estimated wall temperatures in the table C data are probably too low. The reason for this can be seen from the fact that the table C data were obtained in the spring, whereas the table B data were taken in midwinter. The mean outside temperature was 11.0° for table C, and 3.5° for table B. It is evident that with a warmer temperature outside, the $.5^{\circ}$ difference between room and wall temperature was too great. On the other hand, on examining the data of the typical day from which the arbitrary $.5^{\circ}$ correction was determined, I find that the outside temperature was 2° and that the mean wall temperature was in reality 1.0° below room temperature. The arbitrary correction was made $.5^{\circ}$

because I erroneously thought the mean outside temperature was considerably above 2° . It is probable then that since the mean outside temperature was actually only 1.5° above that of the measured day, the wall temperatures of table B should have been several tenths degree lower. As explained on pages 18 to 19, there is also another correction to be made in table B, due to the difference Room Temp.—Water Jacket Temp. This correction requires a lowering of the skin and clothing temperatures of about the same magnitude as the wall temperature correction just mentioned. It is a fortunate accident that the difference in temperature between the body surface and the walls thus remains nearly the same and the mean radiation values in table B remain unchanged.

Table L compares the means of the two series, tables B and E. The total radiation is greater in the first series due to the lower mean room temperature. The adult basal metabolism (determined from Du Bois' chart) is higher in the first series because the 3 adults were two male and one female, average age 31, whereas in the second series the adults were both female and average age 43. The work of many investigators agrees in placing the basal metabolism per sq. m. of body surface of adults considerably lower than that of children. Yet the radiation losses in tables B and E show no such change as between adults and children. In table L the ratios

$$\frac{\text{Radiation loss}}{\text{Basal metabolism}}$$

are in each case higher for adults than children. This is difficult to explain.

At normal indoor temperatures, in still air and with the subject normally clothed and at rest, the major heat losses would be distributed as follows: The loss by evaporation of water from lungs and skin (as stated by Du Bois, see page 14) is 24% of the total. The convection loss, assuming it is similar to that of the cloth-covered vertical calorimeter, is $\frac{2}{3}$ of the radiation loss. Or,

$$\begin{aligned} \text{Water vapor loss} &= 24\% \text{ of the total} \\ \text{Radiation loss} &= 46\% \text{ of the total} \\ \text{Convection loss} &= 30\% \text{ of the total} \end{aligned}$$

It is interesting to compare this with a statement by Rubner (see page 20, Leonard Hill, *The Science of Ventilation and Open Air Treatment*) that "for an average man, in still air, the loss of heat is distributed as follows: Warming of inspired air, 35; warming the food, 42; evaporation of water, 558; convection loss, 823; radiation, 1181; total loss, 2700 kg. calories."

In considering the method by which the total radiation values are obtained in these experiments, there will perhaps be question concerning the correctness of the empirical division of the body surface into skin, clothing, shoe, and hair areas, as well as the 8% reduction for ineffective radiation between legs and under arms. Yet these factors may be altered through a considerable range and not materially alter the final result. The radiation loss will still be nearly the same magnitude.

It has been a matter of surprise to the writer that the literature covering calorimetry experiments on the total energy consumption of human subjects makes so little mention of the surrounding temperatures to which the subject radiates; also that in the comparisons between direct and indirect calorimetry the temperatures used are nearly the same throughout. It was my privilege on March 21, 1928, accompanied by Prof. Phelps, of the New York Commission, to visit the Bellevue Hospital laboratory of Dr. Du Bois, to talk with him and see the operation of the Sage calorimeter which, under the skilful manipulation of Dr. Du Bois and his assistants, has added a new chapter to our knowledge of metabolism in health and disease. The visit was of especial interest in that Dr. Stefansson, the explorer, was present for a metabolism test to determine the effect of an exclusively meat diet. Dr. Du Bois explained that the reason all his experiments had been carried out at nearly the same temperature was because of the intricacy of the apparatus and the difficulty of redetermining all the constants for each set of temperatures. He agreed that it was important to compare direct and indirect calorimetry at other temperatures and indicated that he hoped to find opportunity to do so.

Incidentally in the course of these experiments, rough tests were made with the thermolement device to see how rapidly its temperature falls off as the thermolement recedes from the skin or clothing. The thermolement has a bright metal surface and consequently its temperature is but little affected by absorption of radiation. The tests show that, in moving the device horizontally away from the body, as soon as actual contact is broken between thermolement and skin or clothing, the thermolement temperature falls rapidly almost to room temperature and then gradually declines to room temperature as the thermolement recedes. At 30 cm. distance no effect of the presence of the body could be detected in still air. There would be a marked effect of course if the thermolement were held over the body instead of at the side, or if the thermolement had a better emissivity so that its temperature would be raised by a larger absorption of radiation.

SUMMARY OF RESULTS.

The concrete results of these experiments are briefly summarized:

(1) The radiation from the skin and clothing is approximately that of a "black body" or perfect radiator.

(2) Skin temperatures computed from melikeron radiation measurements are about 1° C. higher than skin temperatures measured directly with the thermoelement. This is not true on clothing or calorimeters. Apparently the melikeron sees deeper into the pores of the skin.

(3) A cloth-covered, vertical, cylindrical calorimeter at body temperature loses in still air 60% by radiation, 40% by convection. A similar horizontal calorimeter loses 54% by radiation, 46% by convection. The human body convection loss is probably similar to this, that is, the convection loss is roughly one third less than the radiation loss, in still air and normal room temperatures.

(4) Increasing air motion rapidly decreases the percentage radiation loss and increases the convectional. With the vertical calorimeter:

Air motion	% radiation loss
0	60
75 ft. per min.	41
130 ft. per min.	35
190 ft. per min.	25

(5) Total body radiation similarly decreases with air motion:

Air motion	Radiation loss (mean for 10 subjects)
0 to 50 ft. per min.	30.7 large cal. per sq. m. per hour
50 to 100	29.3
100 to 150	25.7
180 to 250	23.2

(6) Increase in room temperature (which also means increase in wall temperature) produces a progressive lowering of radiation loss. The ratio

$$\frac{\text{Radiation loss}}{\text{Basal metabolism}}$$

decreases with increase of room and wall temperature:

	Room temp.	$\frac{\text{Radiation loss}}{\text{Basal metabolism}}$
Table L.....	{ 21.3	.80 (mean of 10 subjects)
	{ 24.1	.75 (mean of 10 subjects)
Table J.....	{ 22.1	.84 (mean of 3 subjects)
	{ 24.5	.74 (mean of 4 subjects)
	{ 25.6	.66 (mean of 3 subjects)

(7) Keeping room and wall temperatures unchanged, the temperature of skin and clothing decreases with increasing air motion,

the decrease being greatest on the side facing the wind and about one half as great on the side away from the wind. The clothing temperature drop on the side towards the wind is about one third greater than the corresponding skin temperature drop. Summary of 10 subjects:

Air motion (ft. per min.)	Skin temp. drop—		Clothing temp. drop—		
	Away from wind	Towards wind	Away from wind	Towards wind	Perpendicular to wind
0 to 100	-.4	-.8	-.6	-1.3	-.5
100 to 250	-.7	-1.2	-.4	-1.7	-.5

(8) At normal indoor temperature, in still air and with the subject normally clothed and at rest, body heat losses are distributed as follows:

Evaporation of water.....	24%
Radiation	46%
Convection	30%

(9) Tests with the thermoelement show that the air temperature falls to room temperature very rapidly as the distance from the body increases. That is, there is a steep temperature gradient in the first centimeter or so from the body surface. With the thermoelement 30 cm. away no effect of the presence of the body could be detected.

(10) The Abbot-Benedict work (table A) indicates that the radiation loss from a nude subject is about twice as great for a room temperature of 15° as it is for a room temperature of 26°. This evidence does not entirely support the "suit of clothes" theory referred to by Du Bois. In explanation of this theory, he says (p. 385, 1927 ed. "Basal Metabolism"): "A constriction of the peripheral blood vessels (occurs) and the amount of heat carried to the surface is relatively small in proportion to the heat produced. . . . The patient really changes his integument into a suit of clothes and withdraws the zone where the blood is cooled from the skin to a level some distance below the surface."

(11) Normal fluctuations in humidity indoors produce negligible effect upon the radiation loss. This is to be expected. Our bodies, about 300° Absolute, radiate almost wholly between the wavelengths 4μ and 50μ with a maximum at 10μ. Water vapor absorption is so strong for much of this range and so nearly negligible near the maximum, 10μ, that its possible effect is nearly fully produced even by the humidity of an ordinary room. Thus the effect of changes of quantity of water vapor in the ordinary room is small. Were the air of the room exceedingly dry, changes might be noticeable.

Interesting and important questions concerning the comfort and welfare of children in classrooms are inadequately answered today. It is hoped that this report may in some degree help towards a better understanding of these problems.

NOTES ON TABLES

Temperatures are given in centigrade degrees.

Air velocities are in feet per minute.

Surface areas are determined from Du Bois' height-weight chart (*Archives of Internal Medicine*, Vol. 17, p. 865, 1916).

Basal metabolism values are taken from Du Bois' "Basal Metabolism in Health and Disease," edition 1927, p. 145.

In table E, Wall *A*, *B*, *C*, *D*, *E*, refer to definite places on the canton-flannel curtains hung around the subject and forming the walls to which the subject is radiating. Places *A*, *B*, and *D* are on the sides, *C* on the ceiling and *E* on the floor. Position numbers followed by an asterisk are taken on the skin because of short sleeves or low socks.

In table E also, skin temperatures in the three columns on the right are just as read from the thermoelement device. In the summary on the left they have been corrected to the melikeron scale by the addition of 1° F as explained in the text.

TABLE A.—*Abbot-Benedict Observations*

SUBJECT: Miss W, nude

March 30, 1921

Time	Pos.	Temp. Water Jacket	Observed Temp. (thermo- element)	Temp. Computed from Radiation	Remarks
1 33	19	21.1	32.8	34.1	Pos. 14 cm. below 19.
38	..	20.8	33.0	33.0	
45	19a	19.8	31.6	31.8	Pos. 14 cm. below 19a.
2 05	55	19.3	32.7	40.7	
10	..	19.1	32.5	36.8	
18	..	19.1	31.9	39.6	
29	54	19.1	33.0	34.2	Pos. 10 cm. to left of 54.
35	32.7	34.2	
45	55	19.5	31.2	36.6	
58	54	19.7	32.2	33.3	Pos. 10 cm. to left of 54.
3 21	32	20.0	27.8	28.4	Standing facing window, holding iron
27	31	19.7	27.2	29.3	post to steady herself.
38	30	19.2	27.7	30.6	Pos. 2 cm. below 30.
..	34	18.9	30.3	33.7	Pos. 6 cm. above 34.
53	45	18.7	27.6	30.2	
4 01	46	18.4	27.7	29.9	
12	14	18.7	32.1	34.6	
20	28	18.8	26.6	26.4	

March 31, 1921. Room Temp. 15.0 C. Outside Temp. 8.6 C.

.....	..	17.6	30.9	32.2	Dr. B.'s hand.
.....	..	20.8	15.2	29.9	Floor.
.....	..	19.4	..	28.7	45 toward wall and ceiling.
10 23	14	17.7	32.0	33.4	Miss W., subject.
34	46	17.4	26.7	29.8	
39	46	17.2	26.0	27.0	
45	14	17.2	29.6	32.5	
53	46	17.2	25.1	26.5	
56	14	17.1	29.5	31.7	
11 02	46	17.2	25.4	26.8	
10	..	17.3	..	21.5	Toward ceiling.
17	14	17.3	29.2	31.4	
23	46	17.3	24.0	25.2	
30	32	17.4	22.6	23.9	
34	30	17.4	24.5	26.1	
39	3	17.4	24.2	26.1	
42	28	17.6	22.9	24.5	
47	34	17.6	27.1	29.1	
57	53	17.8	29.0	31.8	

TABLE A (continued)
 March 31, 1921 (continued)

Time	Pos.	Temp. Water Jacket	Observed Temp. (thermo- element)	Temp. Computed from Radiation	Remarks
12 02	54	17.9	26.5	28.4	
10	55	17.9	25.3	26.1	
21	55	18.2	25.6	26.8	Subject lying down, melikeron held over her.
27	54	18.3	25.7	28.0	
30	53	18.3	28.9	29.8	
2 00	..	20.8	35.4	39.3	Dr. M., subject, Rt. hand is made into a tube resting in left.
					Hands taken apart for skin temp., so that both palms were exposed.
.....	..	20.8	35.5	37.7	Palms not exposed, position held.
April 1, 1921. SUBJECT: Miss W. Room Temp. held at 26.0 Outside 4.2					
9 56	14	25.3	33.7	35.0	Sitting.
10 01	46	24.6	29.8	31.7	Standing.
10	14	23.9	33.3	35.9	Sitting.
17	46	23.2	29.7	31.7	Standing.
24	34	22.9	31.9	33.7	
30	2	22.6	30.2	31.9	Standing on stool.
36	29	22.4	30.0	31.8	
40	32	22.2	28.1	30.0	
53	53	21.9	32.5	34.7	
11 05	54	21.6	31.2	35.3	
12	54	21.3	31.4	34.9	
21	53	20.9	31.9	34.5	
2 55	..	24.5	34.4	34.7	Dr. M, subject, Rt. hand made into a tube resting in left. Melikeron opposite hole made by hand. Thermolement with rubber back inserted in hole made by hand.
.....	36.1	Opened hands and clapped them together again with thermolement between.
3 01	..	23.4	33.3	Hands in position of tube.
03	..	22.9	33.3	Hands in position of tube.
06	34.5	No rubber back. Mean of 13 values.
12	..	21.6	34.2	
14	35.7	No rubber back. Mean of 10 values.
41	..	20.1	35.0	35.7	Hands made into tube.
50	..	20.0	35.2	35.6	

TABLE B.—Observations and Results of Preliminary Experiments on Ten Subjects

TABLE B1

DATE: Jan. 18, 1928.
 SUBJECT: S. A.
 SEX: Male.
 AGE: 7 yrs.
 WEIGHT: 25.5 kg.
 HEIGHT: 124 cm.
 SURFACE AREA: .95 sq. m.
 CLOTHING: Green, wool suit, cotton stockings.
 Air temperature outdoors, 10°.
 Relative humidity indoors, 40%.
 Room temperature, 21° .5.

TEMPERATURE SUMMARY

Kind	No. Values	Temp. computed from Stefan formula
Skin.....	3	33.7
Clothing.....	5	28.5
Hair.....	1	29.9
Shoes.....	(est.)	25.6
Wall.....	(est.)	21.0

RADIATION SUMMARY

	Calories per sq. cm. per min.
Skin.....	.1131
Clothing.....	.0653
Hair.....	.0779
Shoes.....	.0396

Place	Water Jacket Temp.	Temp. by Thermo-Element	Temp. computed from Stefan Formula
	o	o	o
18a.....	19.5	32.0	34.0
26a.....	19.5	27.3	29.9
100.....	19.6	30.4	33.2
54.....	19.6	23.8	28.6
11.....	19.5	27.4	28.9
int. wall.....	19.5	21.2	21.2
34.....	19.5	25.0	27.7
30.....	19.5	23.8	27.2
10.....	19.4	27.7	30.3
int. wall.....	19.4	21.1	20.9
101.....	19.4	31.0	34.0

TOTAL RADIATION

36.9 large calories per sq. meter per hour.

BASAL METABOLISM

43 large calories per sq. meter per hour.

TABLE 132

DATE: Jan. 21, 1928.

SUBJECT: M. W.

SEX: Female

AGE: 11 yrs.

WEIGHT: 28.1 kg.

HEIGHT: 140 cm.

SURFACE AREA: 1.07 sq. m.

CLOTHING: Red, wool dress, cotton stockings.

Air temperature outdoors, -2° . 8.Relative humidity indoors 32% .Room temperature 22° . 1.

Place	Water Jacket Temp.	Temp. by Thermo-Element	Temp. computed from Stefan Formula
	o	o	o
int. wall.....	20.7	21.9	21.7
18a.....	20.7	32.3	33.4
26a.....	20.7	30.1	28.4
100.....	20.7	31.9	32.9
54.....	20.7	24.6	26.0
11.....	20.7	25.7	26.7
int. wall.....	20.7	21.9	21.7
34.....	20.7	26.0	26.3
9.....	20.7	27.7	28.6
18a.....	20.7	31.4	32.2
26a.....	20.7	27.0	26.4
int. wall.....	20.7	21.9	21.7
100.....	20.8	31.2	33.6
54.....	20.8	24.7	26.1

TEMPERATURE SUMMARY		
Kind	No. Values	Temp. computed from Stefan formula
Skin.....	4	33.0
Clothing.....	5	26.7
Hair.....	2	27.4
Shoes.....	(est.)	24.0
Wall.....	(est.)	21.6

RADIATION SUMMARY	
	Calories per sq. cm. per min.
Skin.....	.1012
Clothing.....	.0440
Hair.....	.0502
Shoes.....	.0207

TOTAL RADIATION	
25.8 large calories per sq. meter per hour.	

BASAL METABOLISM	
44 large calories per sq. meter per hour.	

TABLE B3

DATE: Jan. 28, 1928.
 SUBJECT: J. S.
 SEX: Male
 AGE: 12 yrs.
 WEIGHT: 46.2 kg.
 HEIGHT: 158 cm.
 SURFACE AREA: 1.44 sq. m.
 CLOTHING: Cotton waist, corduroy trousers, high, red rubber boots. (Snow storm outside)
 Air temperature outdoors -4° .4.
 Relative humidity indoors 37% .
 Room temperature 19° .7.

TEMPERATURE SUMMARY		
Kind	No. Values	Temp. computed from Stefan formula
Skin.....	4	32.2
Clothing.....	5	26.8
Hair.....	1	29.4
Shoes.....	2	24.2
Wall.....	(est.)	19.2

RADIATION SUMMARY	
	Calories per sq. cm. per min.
Skin.....	.1135
Clothing.....	.0642
Hair.....	.0878
Shoes.....	.0420

Place	Water Jacket Temp.	Temp. by Thermo-Element	Temp. computed from Stefan Formula
	o	o	o
18a.....	19.2	30.8	32.5
100.....	19.2	30.4	32.3
26a.....	19.2	24.1	29.4
11.....	19.1	28.6	25.4
54.....	19.1	30.1	29.0
33.....	19.2	25.2	27.0
2.....	19.1	24.7	25.7
29.....	19.1	25.1	26.7
int. wall.....	19.1	19.4	19.5
10.....	19.2	22.4	23.7
8.....	19.2	23.7	24.8
int. wall.....	19.2	19.3	19.6
18a.....	19.1	29.5	31.5
100.....	19.1	29.7	32.4

TOTAL RADIATION
 36.7 large calories per sq. meter per hour.

BASAL METABOLISM
 44 large calories per sq. meter per hour.

TABLE B4

DATE: Jan. 31, 1928.				
SUBJECT: S. W.				
SEX: Male.				
AGE: 6 yrs.				
WEIGHT: 18.2 kg.				
HEIGHT: 111 cm.				
SURFACE AREA: .76 sq. m.				
CLOTHING: Cotton waist, wool trousers, cotton stockings.				
Air temperature outdoors 0°.				
Relative humidity indoors 46%.				
Room temperature 21° 8.				
TEMPERATURE SUMMARY				
Kind	No. Values	Temp. computed from Stefan formula		
Skin.....	3	34.0		
Clothing.....	6	27.7		
Hair.....	1	32.0		
Shoes.....	1	25.6		
Wall..... (est.)		21.3		
RADIATION SUMMARY				
		Calories per sq. cm. per min.		
Skin.....		.1134		
Clothing.....		.0562		
Hair.....		.0950		
Shoes.....		.0372		
Place	Water Jacket Temp.	Temp. by Thermo-Element	Temp. computed from Stefan Formula	
black velvet.	19.8	21.0	20.5	
18a.....	19.9	32.3	33.6	
100.....	19.9	30.6	33.6	
26a.....	19.9	30.6	32.0	
54.....	19.9	27.2	28.7	
11.....	19.9	28.2	28.7	
33.....	19.9	25.6	27.2	
int. wall.....	19.9	21.3	21.6	
2.....	19.9	25.8	25.2	
29.....	19.9	25.7	26.8	
10.....	20.0	29.2	29.8	
7.....	20.0	23.0	25.6	
18a.....	20.0	32.0	34.8	
int. wall.....	19.9	21.2	21.3	
TOTAL RADIATION				
33.3 large calories per sq. meter per hour.				
BASAL METABOLISM				
44 large calories per sq. meter per hour.				

TABLE B5

DATE: Feb. 4, 1928.
 SUBJECT: E. L.
 SEX: Female.
 AGE: 8 yrs.
 WEIGHT: 24 kg.
 HEIGHT: 127 cm.
 SURFACE AREA: .93 sq. m.
 CLOTHING: Cotton dress and stockings.
 Air temperature outdoors 13°.4.
 Relative humidity indoors 46%.
 Room temperature 22°.4.

TEMPERATURE SUMMARY		
Kind	No. Values	Temp. computed from Stefan formula
Skin.....	4	34.7
Clothing.....	5	28.6
Hair.....	1	28.7
Shoes.....	1	28.6
Wall.....	(est.)	21.9

RADIATION SUMMARY	
	Calories per sq. cm. per min.
Skin.....	.1152
Clothing.....	.0592
Hair.....	.0598
Shoes.....	.0592

Place	Water Jacket Temp.	Temp. by Thermo-Element	Temp. computed from Stefan Formula
	o	o	o
18.....	20.9	32.1	35.1
100.....	20.9	31.5	34.3
26a.....	20.9	27.9	28.7
54.....	20.9	28.6	30.3
11.....	20.9	29.2	29.0
33.....	20.9	25.0	27.0
2.....	20.9	25.0	25.4
10.....	20.9	29.4	31.5
8.....	20.9	27.1	28.6
int. wall.....	20.9	22.4	21.7
18.....	20.9	32.2	35.7
101.....	20.9	31.5	33.7

TOTAL RADIATION
 35.2 large calories per sq. meter per hour.

BASAL METABOLISM
 42 large calories per sq. meter per hour.

TABLE B6

DATE: Feb. 4, 1928.
 SUBJECT: R. S.
 SEX: Male.
 AGE: 10 yrs.
 WEIGHT: 31.8 kg.
 HEIGHT: 138 cm.
 SURFACE AREA: 1.10 sq. m.
 CLOTHING: Cotton waist, grey, wool trousers, stockings.
 Air temperature outdoors 8° 3.
 Relative humidity indoors 46%
 Room temperature 21° 4.

TEMPERATURE SUMMARY

Kind	No. Values	Temp. computed from Stefan formula
Skin.....	3	34.4
Clothing.....	6	27.5
Hair.....	1	28.4
Shoes.....	1	25.7
Wall.....	(est.)	20.9

RADIATION SUMMARY

	Calories per sq. cm. per min.
Skin.....	.1203
Clothing.....	.0566
Hair.....	.0652
Shoes.....	.0420

TOTAL RADIATION
 33.1 large calories
 per sq. meter per hour

Place	Water Jacket Temp.	Temp. by Thermo-Element	Temp. computed from Stefan Formula
18.....	20.6	33.0	35.1
100.....	20.5	30.8	35.1
26a.....	20.4	27.6	28.4
54.....	20.6	25.9	28.6
11.....	20.8	28.0	27.7
33.....	20.9	27.5	27.2
int. wall.....	20.9	21.2	21.3
29.....	20.9	25.3	26.5
2.....	20.9	25.7	25.8
10.....	20.9	28.0	29.5
8.....	20.9	23.4	25.7
101.....	20.9	30.5	33.3
int. wall.....	20.8	21.6	21.5

BASAL METABOLISM

42 large calories per sq. meter per hour.

TABLE B7

DATE: Feb. 11, 1928.

SUBJECT: P. L.

SEX: Female.

AGE: 8 yrs.

WEIGHT: 25.9 kg.

HEIGHT: 129 cm.

SURFACE AREA: .96 sq. m.

CLOTHING: Cotton dress, short sleeves,
cotton stockings.

Air temperature outdoors 6°.

Relative humidity indoors 46%.

Room temperature 21°.9.

TEMPERATURE SUMMARY

Kind	No. Values	Temp. computed from Stefan formula
Skin.....	2	34.8
Clothing.....	6	26.8
Hair.....	1	27.7
Shoes.....	1	25.1
Wall.....	(est.)	21.4

RADIATION SUMMARY

	Calories per sq. cm. per min.
Skin.....	.1204
Clothing.....	.0465
Hair.....	.0555
Shoes.....	.0315

Place	Water Jacket Temp.	Temp. by Thermo-Element	Temp. computed from Stefan Formula
	o	o	o
101.....	20.9	29.7(?)	35.2
18.....	20.9	32.8	34.5
26a.....	20.9	27.9	27.7
54.....	20.9	25.6	26.7
22.....	20.9	27.4	29.0
34.....	20.9	25.3	25.1
2.....	20.9	24.0	25.1
29.....	20.9	25.1	24.8
10.....	20.9	29.1	30.3
7.....	20.9	25.1	25.1

TOTAL RADIATION

28.1 large calories per sq. meter per hour.

BASAL METABOLISM

42 large calories per sq. meter per hour.

TABLE B8

DATE: Dec. 13, 1927.

SUBJECT: M. M.

SEX: Female.

AGE: 27 yrs.

WEIGHT: 61.3 kg.

HEIGHT: 165 cm.

SURFACE AREA: 1.67 sq. m.

CLOTHING: Dark silk dress, silk stockings.

Air temperature outdoors ———

Relative humidity indoors 59%.

Room temperature 22°.6.

Place	Water Jacket Temp.	Temp. by Thermo-Element	Temp. computed from Stefan Formula
18.....	19.9	31.0	31.4
26a.....	19.9	26.3	26.6
100.....	19.9	34.4
54.....	19.9	28.8	31.6
11.....	19.9	29.7	31.9
34.....	19.9	27.7	28.2
30.....	19.9	26.0	27.4

TEMPERATURE SUMMARY

Kind	No. Values	Temp. computed from Stefan formula
Skin.....	2	31.4
Clothing.....	4	29.8
Hair.....	1	26.6
Shoes.....	(est.)	27.0
Wall.....	(est.)	22.1

RADIATION SUMMARY

	Calories per sq. cm. per min.
Skin.....	.0830
Clothing.....	.0676
Hair.....	.0390
Shoes.....	.0426

TOTAL RADIATION

35.9 large calories per sq. meter per hour.

BASAL METABOLISM

37 large calories per sq. meter per hour.

TABLE B9

DATE: Dec. 9, 1927.
 SUBJECT: K. B.
 SEX: Male.
 AGE: 21 yrs.
 WEIGHT: 61.3 kg.
 HEIGHT: 173 cm.
 SURFACE AREA: 1.73 sq. m.
 CLOTHING: Woolen shirt and trousers,
 thick leather boots.
 Air temperature outdoors, $-2^{\circ}.8$.
 Relative humidity indoors 38% .
 Room temperature 18.4 .

Place	Water Jacket Temp.	Temp. by Thermo-Element	Temp. computed from Stefan Formula
	o	o	o
101.....	20.4	29.5	31.4
18.....	20.3	27.1	29.7
19.....	20.4	25.2	27.5
11.....	20.4	25.9	25.5
3.....	20.4	24.6	25.0
10.....	20.5	23.1	23.6
101.....	20.5	30.6	33.0
18.....	20.5	25.9	25.7
10.....	22.6	24.3	26.1
18.....	22.6	32.5	33.8

TEMPERATURE SUMMARY

Kind	No. Values	Temp. computed from Stefan formula
		o
Skin.....	5	30.5
Clothing.....	4	26.0
Hair.....	(est.)	27.0
Shoes.....	1	23.6
Wall.....	(est.)	17.9

TOTAL RADIATION

38.2 large calories per sq. meter per hour.

BASAL METABOLISM

39.7 large calories per sq. meter per hour.

RADIATION SUMMARY

	Calories per sq. cm. per min.
Skin.....	.1077
Clothing.....	.0681
Hair.....	.0766
Shoes.....	.0473

TABLE BIO

DATE: Dec. 21, 1927.

SUBJECT: L. A.

SEX: Male.

AGE: 45 yrs.

WEIGHT: 74.6 kg.

HEIGHT: 179 cm.

SURFACE AREA: 1.93 sq. m.

CLOTHING: Dark wool suit.

Air temperature outdoors ..

Relative humidity indoors 37%.

Room temperature 21°.3.

Place	Water Jacket Temp. °	Temp. by Thermo-Element °	Temp. computed from Stefan Formula °
18a.....	19.3	33.9	31.6
26a.....	19.3	31.7	29.4
11a.....	19.3	25.0	27.2

TOTAL RADIATION

31.4 large calories per sq. meter per hour.

TEMPERATURE SUMMARY

Kind	No. Values	Temp. computed from Stefan formula °
Skin.....	1	31.6
Clothing.....	1	27.2
Hair.....	1	29.4
Shoes.....	(est.)	24.5
Wall.....	(est.)	20.8

BASAL METABOLISM

39.7 large calories per sq. meter per hour.

RADIATION SUMMARY

	Calories per sq. cm. per min.
Skin.....	.0950
Clothing.....	.0552
Hair.....	.0752
Shoes.....	.0317

TABLE C.—*Preliminary Tests of Cylindrical Copper Calorimeters, Cloth-covered*

		Vertical		Horizontal			
Amount of copper.....		2.91 kg.		2.60 kg.			
Amount of brass.....		1.50		.50			
Amount of water.....		26.70		27.20			
Total water equivalent.....		27.05 kg.		27.48 kg.			
Area of calorimeter.....		5103 sq. cm.		5103 sq. cm.			
Date 1928	Calor- imeter	Room Temp.	Outside Temp.	Air Velocity (feet per min.)	Mean Temp. Cal. Water	Melik. Water Jacket Temp.	Loss of Heat in calories per hour (large cal.)
Feb. 29	Vert.	21.9	11.7	0	30.4	20.8	21.36
Mar. 1	Vert.	23.7	8.9	0	32.1	22.2	19.57
Mar. 3	Vert.	22.9	6.7	about 300	32.0	20.4	38.42
Mar. 15	Horiz.	24.5	14.4	0	32.0	24.3	19.63
Mar. 16	Horiz.	22.0	3.3	0	32.4	22.7	27.75
Mar. 26	Horiz.	25.5	17.2	0	32.5	22.6	12.86 (no cloth cover)
Apr. 21	Vert.	24.1	8.3	0	37.5	22.7	
Apr. 25	Vert.	22.8	13.9	0	31.7	19.0	
Apr. 25	Vert.	23.5	15.0	0	31.7	22.6	

Date 1928	Esti- mated Wall Temp.	No. Values	Mean Temp. Cal. Surface (Thermo- element)	No. Values	Mean Temp. Cal. Surface (computed from Melik.)	Loss by Radiation (in large cal. per hour)	% Rad- iated
Feb. 29	21.4	11	27.0	5	28.2	17.07	80.
Mar. 1	23.2	12	29.0	4	29.1	15.83	81.
Mar. 3	22.4	17	25.6	6	29.2	18.25	47.
Mar. 15	24.1	18	29.0	6	29.3	14.00	71.
Mar. 16	21.5	18	28.4	6	29.5	21.45	77.
Mar. 26	25.1	18	30.7	4	26.7	4.41	34.
Apr. 21	28	32.2	4	32.7
Apr. 25	27	28.1	4	30.2
Apr. 25	27	28.6	4	29.4

TABLE D.—Tests of Vertical Calorimeter, Cloth-covered, Surrounded by Cloth Walls

Date 1928	Room Temp.	Out-side Temp.	Air Vel. (feet per min.)	Mean Temp. Cal. Water	Melik. Water Jacket Temp.	Loss of Heat in large cal. per hour	Mean Wall Temp.	No. of places wall temp. measured
Apr. 27	21.6	9.4	0	34.2	21.3	31.80	22.0	19
Apr. 27	21.4	9.4	0	32.0	21.4	24.70	22.2	16
Apr. 28	22.4	8.9	0	30.9	22.5	21.95	22.9	18
May 1	23.9	20.6	0	34.5	23.1	25.40	24.7	13
May 1	23.9	20.6	130	33.9	23.2	33.50	24.6	11
May 3	24.7	27.2	0	31.2	24.2	15.70	26.0	10
May 3	25.0	27.2	75	30.9	24.2	16.75	25.9	9
May 5	28.5	33.9	75	39.5	28.5	34.05	29.9	12
May 5	28.8	33.9	130	38.8	28.5	35.15	29.7	12
May 7	24.4	20.0	190	36.4	25.6	47.60	25.0	12
May 7	24.4	20.0	190	35.6	25.4	43.80	25.0	12

Date 1928	Mean Temp. Cal. Surface (Thermoelement)	No. of places measured	Mean Temp. Cal. Surface (computed from Melik.)	No. of places measured	Loss by Radiation in large cal. per hour		% Radiated	
					Melik.	Thermoelement	Melik.	Thermoelement
Apr. 27	29.5	26	29.1	4	18.95	20.06	59.5	63.2
Apr. 27	28.1	24	28.1	4	15.70	15.70	63.5	63.5
Apr. 28	27.9	22	28.2	4	14.13	13.40	64.4	61.2
May 1	30.5	16	30.6	4	16.07	15.64	63.3	61.6
May 1	29.2	22	30.6	4	16.43	12.54	49.0	37.4
May 3	28.9	8	29.3	4	8.88	7.93	56.5	50.5
May 3	28.5	9	28.2	4	6.17	6.94	36.8	41.5
May 5	34.7	16	34.7	4	13.84	13.84	40.7	40.7
May 5	33.7	16	33.8	4	11.55	11.30	32.8	32.2
May 7	29.1	16	31.4	3	17.70	11.04	37.2	23.2
May 7	29.2	16	31.7	3	18.50	11.42	42.2	26.1

TABLE E.—*Observations and Results of Experiments on Ten Subjects in Still and in Moving Air*

TABLE E1

DATE: May 30, 1928.
 SUBJECT: S. A.
 SEX: Male.
 AGE: 7 yrs. 5 mos.
 WEIGHT: 24 kg.
 HEIGHT: 127 cm.
 SURFACE AREA: .93 sq. m.
 CLOTHING: Woolen sweater, cotton trousers, socks.
 Air temperature outdoors, 21°.1.
 Relative humidity indoors, 56%.

TEMPERATURE SUMMARY

Kind	No. Values	Temp. at air vel.		
		0	130	180
Skin.....	7	34.1	32.3	31.1
Clothing....	15	28.4	27.3	26.3
Hair.....	1	33.8	34.2	32.4
Shoes.....	2	26.2	27.4	25.2
Wall.....	10	21.1	22.0	21.3
Room.....	2	19.8	21.3	20.9

RADIATION SUMMARY

	Calories per sq. cm. per min. at air vel.		
	0	130	180
Skin.....	.1157	.0915	.0865
Clothing.....	.0641	.0457	.0433
Hair.....	.1131	.1094	.0990
Shoes.....	.0444	.0468	.0337

TOTAL RADIATION

Air vel.	Calories per hour per sq. meter
0	38.6
130	29.4
180	27.2

Place	Temperatures at Air Velocity		
	0	130	180
room.....	19.7	21.1	20.9
wall A.....	19.0	21.4	21.0
B.....	20.8	21.3	21.2
C.....	21.7	23.4	21.9
D.....	20.8	21.6	21.1
E.....	19.4	20.6	19.4
26.....	34.6	35.0	33.6
100.....	30.8	30.2	30.1
101.....	32.3	29.7	29.5
19a.....	27.8	26.7	24.1
19.....	28.3	24.8	23.6
54.....	28.0	25.1	23.6
2.....	29.5	28.5	23.5
3.....	28.8	27.7	27.0
23.....	29.5	28.5	27.0
22.....	27.6	27.3	27.9
18.....	33.1	30.2	30.0
18a.....	32.5	30.8	29.9
17.....	33.4	31.7	30.5
17a.....	34.1	30.5	29.7
9.....	26.9	27.9	27.7
10.....	26.9	26.3	24.8
8.....	26.9	27.4	25.0
7.....	25.6	27.5	25.5
26a.....	33.8	34.2	32.4
35.....	29.1	27.3	26.7
36.....	28.6	27.3	27.5
29.....	30.4	30.0	29.3
30.....	30.5	27.2	27.5
27.....	27.4	27.3	26.8
28.....	27.3	27.8	26.4
wall A.....	22.1	22.5	21.3
B.....	22.1	22.9	20.4
C.....	23.6	24.4
D.....	21.7	22.8	21.6
E.....	19.8	21.1	20.9
room.....	19.9	21.5	21.0

TABLE E2

DATE: July 12, 1928.				Place	Temperatures at Air Velocity			
SUBJECT: S. W.					0	15	50	
SEX: Male.					room	24.9	23.2	23.0
AGE: 6 yrs. 6 mos.					wall A	25.7	23.9	23.7
WEIGHT: 18 kg.					B	25.7	23.8	23.3
HEIGHT: 116 cm.					C	26.0	24.3	23.7
SURFACE AREA: .78 sq. m.					D	25.6	24.0	23.4
CLOTHING: Tan cotton suit, socks.					E	25.1	23.9	23.5
Air temperature outdoors, 27°0.				26	35.6	35.5	35.0	
Relative humidity indoors, 68%.				100	32.0	31.7	31.9	
				101	33.1	33.3	32.3	
				19a	33.2	33.2	32.3	
				19	32.6	32.9	31.7	
				54	30.2	31.7	32.1	
				2	29.5	30.7	28.8	
				3	32.0	30.0	28.7	
				23	32.5	31.8	31.2	
				22	32.6	32.1	31.7	
				18	34.8	34.4	33.8	
				18a	33.9	33.8	33.3	
				17	35.1	33.3	34.6	
				17a	34.3	33.3	33.6	
				9*	32.4	30.3	31.6	
				10*	32.4	31.5	31.0	
				8	28.7	29.0	28.3	
				7	28.2	27.4	27.9	
				26a	35.1	33.6	32.7	
				35	33.1	32.0	29.3	
				36	32.0	32.2	30.5	
				29	29.9	29.0	27.9	
				30	31.9	30.0	27.8	
				27*	31.6	30.9	31.0	
				28*	31.3	32.1	30.5	
				wall A	26.6	25.4	24.7	
				B	26.6	25.1	24.1	
				C	26.7	25.7	24.9	
				D	26.2	24.3	23.9	
				E	25.8	24.3	24.1	
				room	25.3	23.3	23.1	

TEMPERATURE SUMMARY				
Kind	No. Values	Temp. at air vel.		
		0	15	50
Skin	11	34.4	33.8	33.7
Clothing	11	31.8	31.4	30.2
Hair	1	35.1	33.6	32.7
Shoes	2	28.4	28.2	28.1
Wall	10	26.0	24.5	23.9
Room	2	25.1	23.3	23.1

RADIATION SUMMARY				
		Calories per sq. cm. per min. at air vel.		
		0	15	50
Skin0766	.0838	.0878	
Hair0835	.0818	.0785	
Clothing0521	.0619	.0552	
Shoes0215	.0327	.0362	

TOTAL RADIATION	
Air Vel.	Calories per hour per sq. meter
0	29.3
15	34.4
50	32.1

TABLE E₃

DATE: July 12, 1928.
 SUBJECT: M. W.
 SEX: Female.
 AGE: 11 yrs. 5 mos.
 WEIGHT: 27.5 kg.
 HEIGHT: 143 cm.
 SURFACE AREA: 1.07 sq. m.
 CLOTHING: Light cotton dress, socks.
 Air temperature outdoors, 27.0.
 Relative humidity indoors, 68%.

TEMPERATURE SUMMARY				
Kind	No. Values	Temp. at air vel.		
		0	15	50
Skin	7	35.0	35.1	34.0
Clothing	15	31.6	31.1	30.2
Hair	1	33.8	33.4	31.8
Shoes	2	31.3	29.6	27.6
Wall	10	25.7	24.5	24.2
Room	2	24.5	23.2	23.2

RADIATION SUMMARY			
	Calories per sq. cm. per min. at air vel.		
	0	15	50
Skin	.0851	.0965	.0882
Clothing	.0525	.0587	.0528
Hair	.0730	.0803	.0677
Shoes	.0498	.0447	.0296

TOTAL RADIATION	
Air Vel.	Calories per hour per sq. meter
0	31.0
15	34.2
50	30.2

Place	Temperatures at Air Velocity		
	0	15	50
room	25.0	23.3	23.2
wall A	25.7	24.3	24.0
B	25.5	23.9	23.7
C	26.1	24.8	24.6
D	25.6	24.0	23.6
E	25.3	24.0	23.9
26	34.9	34.6	34.5
100	33.7	33.5	32.8
101	32.6	32.5	32.0
19a	32.6	33.0	33.0
19	33.1	32.6	31.9
54	33.9	33.4	33.9
2	31.6	28.4	28.2
3	31.3	28.9	28.1
23	31.9	31.4	31.0
22	31.9	31.8	31.1
18	33.6	33.6	32.7
18a	34.2	33.8	32.6
17	34.4	35.0	32.5
17a	34.2	35.2	32.9
9	31.7	30.7	31.5
10	31.9	32.2	31.0
8	31.1	30.0	27.6
7	31.6	29.2	27.6
26a	33.8	33.4	31.8
35	33.4	32.7	30.5
36	30.0	33.0	31.5
29	29.8	29.1	27.6
30	29.0	29.2	25.9
27	30.8	29.5	29.2
28	31.7	30.6	29.7
wall A	26.3	25.2	24.6
B	25.7	25.0	24.2
C	26.1	25.3	25.1
D	25.3	24.3	24.1
E	25.2	24.3	23.9
room	24.0	23.0	23.2

TABLE E4

DATE: July 14, 1928.
 SUBJECT: T. L.
 SEX: Male.
 AGE: 14 yrs. 3 mos.
 WEIGHT: 43.5 kg.
 HEIGHT: 152 cm.
 SURFACE AREA: 1.36 sq. m.
 CLOTHING: Cotton waist, black woolen trousers, canvas shoes, high socks.
 Air temperature outdoors, 27°.8.
 Relative humidity indoors, 68%.

Place	Temperatures at Air Velocity		
	0	84	136
room.....	22.4	22.6	22.8
wall A.....	23.8	23.4	23.1
B.....	23.2	22.8	22.8
C.....	23.8	23.3	23.3
D.....	23.3	22.9	22.8
E.....	23.4	23.3	22.9
26.....	33.9	32.6	33.0
100.....	31.2	30.7	29.8
101.....	31.7	31.1	30.0
19a.....	31.2	30.5	31.0
19.....	31.1	30.6	30.5
54.....	29.2	30.1	29.4
2.....	28.7	28.2	28.7
3.....	27.7	26.9	28.6
23.....	31.1	30.8	29.6
22.....	31.6	30.1	31.1
18.....	33.2	33.1	31.1
18a.....	33.3	32.5	30.8
17.....	34.7	33.7	32.0
17a.....	34.6	32.7	30.1
9.....	30.8	30.5	30.5
10.....	31.7	31.0	30.7
8.....	28.2	29.1	28.2
7.....	28.6	29.1	27.7
26a.....	31.1	31.4	29.6
35.....	30.3	28.1	28.1
36.....	31.2	29.6	28.1
29.....	28.7	27.5	26.2
30.....	29.9	27.5	27.3
27.....	30.3	29.4	29.2
28.....	30.5	30.1	28.7
wall A.....	24.6	23.4	23.7
B.....	23.9	23.7	22.3
C.....	24.6	24.0	23.7
D.....	23.9	23.5	23.1
E.....	24.0	24.3	24.6
room.....	22.6	22.9	22.8

TEMPERATURE SUMMARY

Kind	No. Values	Temp. at air vel.		
		0	84	136
Skin.....	7	34.3	33.4	32.1
Clothing....	15	30.3	29.3	29.2
Hair.....	1	31.1	31.4	29.6
Shoes.....	2	28.4	29.1	27.9
Wall.....	10	23.8	23.5	23.2
Room.....	2	22.5	22.7	22.8

RADIATION SUMMARY

	Calories per sq. cm. per min. at air vel.		
	0	84	136
Skin.....	.0943	.0892	.0790
Clothing....	.0569	.0509	.0527
Hair.....	.0647	.0708	.0558
Shoes.....	.0405	.0491	.0414

TOTAL RADIATION

Air vel.	Calories per hour per sq. meter
0	32.5
84	30.2
136	29.7

TABLE E5

DATE: July 18, 1928 SUBJECT: P. L. SEX: Female AGE: 8 yrs. 5 mos. WEIGHT: 26 kg. HEIGHT: 131 cm. SURFACE AREA: .98 sq. m. CLOTHING: Light, cotton dress, high socks. Air temperature outdoors, 28° to 33°. Relative humidity indoors, 61%.				Place	Temperatures at Air Velocity		
					0	97	235
				room	24.2	24.1	24.5
				wall A	25.0	24.6	24.7
				B	24.9	24.5	25.0
				C	25.9	25.5	26.2
				D	24.7	24.5	25.5
				E	24.4	24.4	25.3
				26	34.5	34.6	34.4
				100	31.5	31.7	31.1
				101	31.6	31.3	31.1
				19a	32.0	29.9	29.5
				19	31.5	31.4	31.2
				54	30.8	30.6	31.2
				2	28.9	30.2	30.5
				3	29.8	31.4	29.0
				23	31.7	31.1	31.0
				22	32.0	30.9	30.1
				18	33.0	33.4	32.1
				18a	32.6	33.8	32.9
				17	34.9	33.8	33.3
				17a	33.5	34.6	32.6
				9	29.8	30.5	30.0
				10	31.1	30.5	31.2
				8	29.4	29.2	28.2
				7	29.4	29.2	28.0
				26a	32.5	32.2	31.4
				35	31.9	30.0	29.8
				36	32.7	30.4	31.8
				29	30.0	29.6	26.6
				30	29.4	27.9	26.9
				27	30.0	29.6	29.2
				28	30.1	29.8	29.8
				wall A	26.0	25.6	25.4
				B	25.3	25.3	25.5
				C	26.3	26.4	26.6
				D	25.1	25.0	25.3
				E	24.6	24.9	25.4
				room	24.0	24.5	24.8

TEMPERATURE SUMMARY				
Kind	No. Values	Temp. at air vel.		
		0	97	235
Skin	7	34.2	34.4	33.6
Clothing	15	30.8	30.3	29.9
Hair	1	32.5	32.2	31.4
Shoes	2	29.4	29.2	28.1
Wall	10	25.2	25.1	25.5
Room	2	24.1	24.3	24.6

RADIATION SUMMARY				
		Calories per sq. cm. per min. at air vel.		
		0	97	235
Skin	.0818	.0850	.0734	
Clothing	.0502	.0463	.0359	
Hair	.0658	.0643	.0536	
Shoes	.0374	.0368	.0231	

TOTAL RADIATION	
Air vel.	Calories per hour per sq. meter
0	29.0
97	27.4
235	21.4

TABLE E6

DATE: July 18, 1928.	Place	Temperatures at Air Velocity		
SUBJECT: M. A.		0	97	235
SEX: Female.		°	°	°
AGE: 55 yrs.	room	24.0	24.1	24.5
WEIGHT: 64.5 kg.	wall A	24.9	24.6	24.7
HEIGHT: 167 cm.	B	25.0	25.0	25.0
SURFACE AREA: 1.73 sq. m.	C	26.1	26.2	26.5
CLOTHING: Light, cotton dress, black stockings.	D	24.7	24.6	24.9
Air temperature outdoors, 28° to 33°.	E	24.1	24.3	24.3
Relative humidity indoors, 61%.	26	33.8	33.3	33.2
	100	32.3	32.2	32.0
	101	32.4	31.9	31.6
	19a	30.4	29.9	30.1
	19	30.7	30.2	30.7
	54	31.3	30.9	31.6
	2	29.1	30.1	31.1
	3	30.0	30.4	32.0
	23	31.3	31.3	30.6
	22	30.9	30.3	30.1
	18	34.7	33.7	33.1
	18a	33.6	33.0	33.1
	17	35.8	35.5	34.1
	17a	35.5	34.6	34.5
	9	31.2	31.3	31.7
	10	31.4	31.5	30.7
	8	29.2	29.5	27.5
	7	29.1	29.2	29.2
	26a	28.4	26.7	27.5
	35	32.0	30.4	29.2
	36	31.7	31.0	29.6
	29	31.8	30.6	29.9
	30	31.8	30.6	29.3
	27	31.1	31.3	30.7
	28	31.2	31.2	30.4
	wall A	28.1	25.7	25.2
	B	26.0	25.8	25.9
	C	26.7	26.8	27.0
	D	25.1	25.3	25.2
	E	24.5	24.9	24.6
	room	24.0	24.4	24.7

TEMPERATURE SUMMARY				
Kind	No. Values	Temp. at air vel.		
		0	97	235
		°	°	°
Skin	7	35.1	34.6	34.2
Clothing	15	31.1	30.7	30.5
Hair	1	28.4	26.7	27.5
Shoes	2	29.2	29.3	28.3
Wall	10	25.5	25.3	25.3
Room	2	24.0	24.2	24.6

RADIATION SUMMARY				
	Calories per sq. cm. per min. at air vel.			
		0	97	235
Skin0883	.0853	.0812	
Clothing0504	.0490	.0464	
Hair0262	.0126	.0194	
Shoes0332	.0356	.0268	

TOTAL RADIATION		
Air vel.	Calories per hour per sq. meter	
	0	97
	28.0	26.8
235	25.2	

TABLE E7

DATE: July 19, 1928.
 SUBJECT: M. B.
 SEX: Female.
 AGE: 4 yrs. 8 mos.
 WEIGHT: 15 kg.
 HEIGHT: 100 cm.
 SURFACE AREA: .65 sq. m.
 CLOTHING: Light, cotton dress, no sleeves, high socks.
 Air temperature outdoors, 29° to 33°.
 Relative humidity indoors, 58%.

TEMPERATURE SUMMARY				
Kind	No. Values	Temp. at air vel.		
		0	140	235
Skin	9	33.7	34.2	34.4
Clothing	13	31.2	30.7	30.4
Hair	1	32.0	29.7	29.0
Shoes	2	29.0	29.2	28.9
Wall	10	25.6	25.8	25.9
Room	2	24.6	24.9	25.2

RADIATION SUMMARY			
	Calories per sq. cm. per min. at air vel.		
	0	140	235
Skin	.0696	.0764	.0772
Clothing	.0505	.0442	.0398
Hair	.0578	.0346	.0272
Shoes	.0302	.0302	.0265

TOTAL RADIATION	
Air vel.	Calories per hour per sq. meter
0	28.1
140	25.2
235	23.1

Place	Temperatures at Air Velocity		
	0	140	235
room	24.5	24.4	24.9
wall A	25.3	25.2	25.3
B	25.1	25.2	25.8
C	26.1	26.3	26.6
D	25.1	25.2	25.4
E	24.8	25.0	25.1
26	32.2	33.7	33.8
100	32.0	32.6	32.6
101	32.4	32.7	32.9
19a	32.0	30.7	30.6
19	31.2	30.1	30.7
54	30.9	32.5	32.3
2	31.6	30.1	31.7
3	30.8	29.9	31.1
23*	32.0	32.1	32.5
22*	32.0	32.0	32.6
18	32.4	32.8	33.6
18a	32.4	33.1	33.6
17	34.1	33.9	34.4
17a	33.9	34.7	33.7
9	31.0	31.3	30.3
10	32.1	31.9	31.1
8	28.4	28.9	29.8
7	29.7	29.6	28.0
26a	32.0	29.7	29.0
35	30.7	29.8	28.8
36	31.8	32.1	31.5
29	31.2	29.2	28.3
30	30.2	29.8	28.6
27	31.1	31.1	29.8
28	31.2	30.5	30.3
wall A	26.1	26.2	26.1
B	26.1	26.3	26.3
C	26.8	27.0	27.0
D	25.6	25.8	25.9
E	25.2	25.6	25.3
room	24.7	25.4	25.6

TABLE E8

DATE: July 19, 1928.
 SUBJECT: G. B.
 SEX: Female.
 AGE: 30 yrs.
 WEIGHT: 59 kg.
 HEIGHT: 157 cm.
 SURFACE AREA: 1.59 sq. m.
 CLOTHING: Light, cotton dress, short sleeves, tan stockings.
 Air temperature outdoors, 29° to 33°.
 Relative humidity indoors, 58%.

TEMPERATURE SUMMARY				
Kind	No. Values	Temp. at air vel.		
		0	140	235
Skin.....	7	34.9	34.1	33.5
Clothing.....	15	31.6	30.8	30.3
Hair.....	1	31.9	31.1	30.4
Shoes.....	2	30.6	29.8	30.5
Wall.....	10	26.0	25.9	26.0
Room.....	2	24.8	25.1	25.4

RADIATION SUMMARY			
		Calories per sq. cm. per min. at air vel.	
		0	140 235
Skin.....	.0821	.0738	.0680
Clothing.....	.0502	.0437	.0380
Hair.....	.0534	.0463	.0392
Shoes.....	.0412	.0341	.0398

TOTAL RADIATION	
Air vel.	Calories per hour per sq. meter
0	28.9
140	25.2
235	22.6

Place	Temperatures at Air Velocity		
	0	140	235
room.....	25.0	24.9	25.1
wall A.....	25.6	25.3	25.4
B.....	25.7	25.4	25.5
C.....	26.8	26.6	26.8
D.....	25.6	25.4	25.6
E.....	25.2	24.9	25.1
26.....	33.8	33.5	33.5
100.....	33.4	32.6	32.9
101.....	33.2	32.4	32.5
19a.....	32.0	32.7	32.3
19.....	32.0	32.0	32.1
54.....	30.9	31.0	30.7
2.....	30.9	31.0	28.8
3.....	31.2	29.3	29.4
23.....	32.9	31.8	31.3
22.....	32.8	32.3	31.2
18.....	33.5	33.1	32.2
18a.....	33.0	32.8	32.0
17.....	34.8	33.5	31.9
17a.....	34.7	32.8	31.9
9.....	31.5	31.0	30.7
10.....	32.2	31.5	31.2
8.....	30.6	29.8	30.3
7.....	30.6	29.8	30.8
26a.....	31.9	31.1	30.4
35.....	32.6	31.5	31.0
36.....	32.7	31.8	31.5
29.....	30.1	26.5	26.9
30.....	29.8	27.8	27.4
27.....	31.3	30.5	29.9
28.....	31.2	31.2	30.3
wall A.....	26.6	26.5	26.1
B.....	26.5	26.6	26.3
C.....	27.1	27.1	27.2
D.....	25.8	26.0	26.1
E.....	25.4	25.4	25.7
room.....	24.6	25.3	25.7

TABLE E_g

DATE: July 20, 1928. SUBJECT: E. L. SEX: Female. AGE: 8 yrs. 5 mos. WEIGHT: 24 kg. HEIGHT: 129 cm. SURFACE AREA: .94 sq. m. CLOTHING: Light, cotton dress, no sleeves, high socks. Air temperature outdoors, 32° to 35° 6. Relative humidity indoors, 60%.				Place Temperatures at Air Velocity 0 145 245 ° ° °		
TEMPERATURE SUMMARY				room 25.7 25.9 26.2 wall A 26.6 26.4 26.6 B 27.1 26.5 26.9 C 28.4 27.4 27.8 D 26.8 26.4 26.8 E 26.5 26.2 26.6 26 35.1 34.6 34.7 100 33.0 32.3 33.0 101 33.1 32.5 33.0 19a 30.8 30.0 30.2 19 31.6 30.7 31.4 54 33.0 32.4 32.5 2 31.6 30.8 30.3 3 30.4 29.9 30.7 23* 32.5 32.2 32.5 22* 32.6 32.1 33.0 18 34.1 33.4 34.1 18a 34.4 34.2 34.0 17 34.8 33.7 33.8 17a 35.0 33.8 33.6 9 32.5 32.5 31.4 10 32.6 32.3 31.6 8 31.9 29.3 30.3 7 31.6 31.8 30.9 26a 33.3 30.2 30.9 35 31.8 31.1 30.3 36 31.8 30.7 31.3 29 32.6 27.7 28.0 30 31.1 28.5 29.2 27 31.9 31.3 31.4 28 32.1 32.1 31.3 wall A 27.3 27.1 27.2 B 27.0 27.1 27.5 C 27.9 28.0 28.3 D 26.8 26.9 27.0 E 26.5 26.6 27.3 room 26.3 26.4 26.6		
RADIATION SUMMARY Calories per sq. cm. per min. at air vel. 0 145 245				Skin0729 .0673 .0583 Clothing0430 .0352 .0320 Hair0567 .0294 .0340 Shoes0430 .0319 .0307		
TOTAL RADIATION Calories per hour per sq. meter				Air vel. 0 25.8 145 20.8 245 19.0		

TABLE E10

DATE: July 20, 1928.
 SUBJECT: J. C.
 SEX: Male.
 AGE: 10 yrs. 11 mos.
 WEIGHT: 35 kg.
 HEIGHT: 135 cm.
 SURFACE AREA: 1.14 sq. m.
 CLOTHING: Cotton waist, golf knickers,
 high socks.
 Air temperature outdoors, 32° to 35° 6.
 Relative humidity indoors, 60%.

Place	Temperatures at Air Velocity		
	0	145	245
room.....	25.6	26.1	26.5
wall A.....	26.6	26.7	26.9
B.....	26.4	26.8	27.2
C.....	27.4	27.9	28.0
D.....	26.5	26.7	27.0
E.....	26.3	26.5	26.9
26.....	34.5	34.0	33.9
100.....	34.0	33.4	33.5
101.....	33.4	33.2	33.4
19a.....	33.7	33.6	33.1
19.....	33.3	33.0	33.3
54.....	33.4	33.3	34.0
2.....	32.2	32.0	30.8
3.....	31.9	31.2	32.2
23.....	33.1	32.7	32.8
22.....	32.9	32.8	32.5
18.....	34.2	33.8	33.1
18a.....	34.0	34.4	32.7
17.....	34.1	33.3	33.6
17a.....	34.8	33.9	33.7
9.....	32.0	30.8	31.0
10.....	32.3	32.2	31.7
8.....	32.1	32.0	31.8
7.....	31.9	31.8	32.7
26a.....	34.0	34.1	32.3
35.....	34.1	31.9	32.8
36.....	34.5	33.1	32.0
29.....	32.1	31.4	30.2
30.....	32.7	31.5	30.1
27.....	31.4	31.5	30.9
28.....	31.9	32.1	31.4
wall A.....	27.3	27.4	27.2
B.....	27.0	27.4	27.5
C.....	27.8	28.6	28.1
D.....	26.8	27.2	27.1
E.....	26.7	26.9	27.1
room.....	26.0	26.6	27.0

TEMPERATURE SUMMARY

Kind	No. Values	Temp. at air vel.		
		0	145	245
Skin.....	7	35.2	34.8	34.5
Clothing.....	15	32.8	32.2	31.9
Hair.....	1	34.0	34.1	32.3
Shoes.....	2	32.0	31.9	32.2
Wall.....	10	26.9	27.2	27.3
Room.....	2	25.8	26.3	26.7

RADIATION SUMMARY

	Calories per sq. cm. per min. at air vel.		
	0	145	245
Skin.....	.0768	.0703	.0664
Clothing.....	.0533	.0457	.0425
Hair.....	.0647	.0629	.0458
Shoes.....	.0462	.0431	.0451

TOTAL RADIATION

Air vel.	Calories per hour per sq. meter
0	30.0
145	26.3
245	24.4

TABLE F.—*Summary of Cloth-covered Calorimeter Tests*

Calorimeter	Wall Temp.	Air Vel.	Per cent Radiated by		No. of Tests
			Melik.	Thermoclement	
Preliminary tests—					
Vertical	Estimated	0	80	72	5
Horizontal	Estimated	0	74	65	2
Final tests with cloth walls—					
Vertical	Measured	0	61	60	5
Vertical	Measured	75	39	41	2
Vertical	Measured	130	41	35	2
Vertical	Measured	190	40	25	2

TABLE G.—*Summary Comparing all Thermoclement Temperatures with Corresponding Temperatures Computed from Melikeron Values Given in Tables B, C and D*

Place	No. of Observations	Average difference Melik.—Thermo.	Average difference Room temp.—Water Jacket temp.	
			Algebraic Mean	Arithmetic Mean
Skin	37	1.91	.67	1.31
Clothing	49	1.12	1.16	1.45
Hair	9	.30	1.61	1.61
Shoes	8	1.39	.43	1.20
Wall	15	.03	1.37	1.37
Cloth-covered				
Cal. in still air	52	.56	.82	.95
moving air				
< 130 ft.	16	.37	-.4	.7
> 190 ft.	12	2.8	.2	1.6
Clothing }	67	1.10	1.12	1.40
Hair				
Shoes				
{ Clothing Hair Shoes Cal. < 130 ft.)	135	.80	.82	1.14

TABLE II.—*Summary Taken from Observations Recorded in Table E*

Subject	Room Temp.	Wall Temp.	Radiation Loss large calories per hour per sq. meter	Air Vel.	No. of Determinations	MEANS—		Radiation Loss, large cal. per hr. per sq. m.
						Room Temp.	Wall Temp.	
In still air—								
S. A.	19.8	21.1	38.6			°	°	
S. W.	25.1	26.0	29.3	< 50	12	23.9	25.2	30.7
M. W.	24.5	25.7	31.0	50 to				
T. L.	22.5	23.8	32.5	100	5	23.5	24.4	29.3
P. L.	24.1	25.2	29.0	100 to				
M. A.	24.0	25.5	28.0	150	6	24.4	25.2	25.7
M. B.	24.6	25.6	28.1	180 to				
G. B.	24.8	26.0	28.9	250	7	24.8	25.5	23.2
E. L.	26.0	27.1	25.8					
J. C.	25.8	26.9	30.0					
Air vel. <50 ft.—								
S. W.	23.3	24.5	34.4					
M. W.	23.2	24.5	34.2					
Air vel. 50 to 100 ft.—								
S. W.	23.1	23.9	32.1					
M. W.	23.2	24.2	30.2					
T. L.	22.7	23.5	30.2					
P. L.	24.3	25.1	27.4					
M. A.	24.2	25.3	26.8					
Air vel. 100 to 150 ft.—								
S. A.	21.3	22.4	29.4					
T. L.	22.8	23.2	29.7					
M. B.	24.9	25.8	25.2					
G. B.	25.1	25.9	25.2					
E. L.	26.1	26.9	20.8					
J. C.	26.3	27.2	26.3					
Air vel. 180 to 250 ft.—								
S. A.	20.9	21.3	27.2					
P. L.	24.6	25.5	21.4					
M. A.	24.6	25.3	25.2					
M. B.	25.2	25.9	23.1					
G. B.	25.4	26.0	22.6					
E. L.	26.4	27.2	19.0					
J. C.	26.7	27.3	24.4					

TABLE J.—*Summary from Observations Given in Table E, for Still Air*

1928	Subject	Age	Sex	Room Temp.	Basal Metab.	Loss by Radiation	Rad. Loss Basal Met.
					(large cal. per sq. m. per hour)		
May 30	S. A.	7	M	19.8	43	38.6	.90
July 12	S. W.	6	M	25.1	44	29.3	.67
July 12	M. W.	11	F	24.5	40	31.0	.77
July 14	T. L.	14	M	22.5	41	32.5	.79
July 18	P. L.	8	F	24.1	41	29.0	.71
July 18	M. A.	55	F	24.0	34	28.0	.82
July 19	M. B.	5	F	24.6	42	28.1	.67
July 19	G. B.	30	F	24.8	35	28.9	.83
July 20	E. L.	8	F	26.0	42	25.8	.61
July 20	J. C.	11	M	25.8	42	30.0	.71

Arranged according to increasing room temperatures:

Subject	Room Temp.	Radiation Loss Basal Metabolism
S. A.	19.8	.90
T. L.	22.5	.79
M. A.	24.0	.82
P. L.	24.1	.71
M. W.	24.5	.77
M. B.	24.6	.67
G. B.	24.8	.83
S. W.	25.1	.67
J. C.	25.8	.71
E. L.	26.0	.61

TABLE K.—*Summary of Drop in Temperature of Skin and Clothing due to Increased Air Motion, from Observations Given in Table E*
(Each number is the mean of from 3 to 6 values)

Subject	Air Vel. (Feet per min.)	Skin			Clothing		
		Away from fan °	Towards fan °	Side °	Away from fan °	Towards fan °	Side °
S. A.	100 to 150	-1.7	-1.5	-1.1	-1.9	+ .3
	180 to 250	-2.9	-2.1	-1.5	-3.9	-.9
S. W.	0 to 50	-.2	-.9	-1.5	+ .2	-.9	0
	50 to 100	-.6	-1.0	-2.2	-.8	-2.8	-.3
M. W.	0 to 50	-.2	+ .4	-1.2	-.1	-.8
	50 to 100	-.9	-1.8	-1.6	-1.7	-1.7
T. L.	50 to 100	-.7	-.9	-.3	-1.4	-.2
	100 to 150	-1.8	-2.9	0	-2.2	-.7
P. L.	50 to 100	+ .4	-.1	+ .1	-1.2	-.4
	180 to 250	-.3	-1.2	-.3	-1.7	-.9
M. A.	50 to 100	-.6	-1.0	0	-.8	0
	180 to 250	-.8	-1.2	+ .8	-1.8	-.5
M. B.	100 to 150	+ .7	-.6	0	-.6	-.6	+ .1
	180 to 250	+1.0	+ .3	+ .5	0	-1.5	-.5
G. B.	100 to 150	-.5	-1.3	-.2	-1.4	-.8
	180 to 250	-.8	-2.4	-.7	-1.8	-.9
E. L.	100 to 150	-.5	-1.8	-.4	-.7	-1.7	-.6
	180 to 250	-.1	-1.6	+ .2	-.5	-1.7	-1.1
J. C.	100 to 150	-.2	-.5	-.3	-.9	-.4
	180 to 250	-.7	-1.1	-.2	-1.6	-.3
MEANS—							
	0 to 50	-.2	-.2	-.5	-.5	-.4
	50 to 100	-.5	-1.0	-.6	-1.6	-.5
	100 to 150	-.7	-1.4	-.5	-1.5	-.4
	180 to 250	-.7	-1.3	-.3	-2.0	-.7
	0 to 100	-.4	-.8	-.6	-1.3	-.5
	100 to 250	-.7	-1.2	-.4	-1.7	-.5

From Table H, Mean change in Room Temp. from still air to air motion = +°.2.
Mean change in Wall Temp. from still air to air motion = -°.2.

TABLE L.—*Summary of the Two Series of Ten Subjects (Tables B and E)*

Series	Dates	Range of Room T.	Mean of Room T.	Range of Relative Humidity	Mean	Kind	Total Radiation	Basal Metabolism	Radiation
									Bas. Met.
First	Dec. 9	18.4	21.3	32%	43%	Adult	35.2	39	.90
	to	to	Children	32.7	43	.76
	Feb. 11	22.6	59%	All	33.5	42	.80
Second	May 30	19.8	24.1	56%	62%	Adult	28.4	34.5	.82
	to	to	Children	30.5	42	.73
	July 20	26.0	68%	All	30.1	40.5	.75

Radiation and basal metabolism values are given in large calories per hour per sq. meter of body surface.

SMITHSONIAN MISCELLANEOUS COLLECTIONS
VOLUME 81, NUMBER 7

RECENT ARCHEOLOGICAL DEVELOP-
MENTS IN THE VICINITY OF
EL PASO, TEXAS

(WITH FIVE PLATES)

BY
FRANK H. H. ROBERTS, JR.
Bureau of American Ethnology



(PUBLICATION 3009)

CITY OF WASHINGTON
PUBLISHED BY THE SMITHSONIAN INSTITUTION
JANUARY 25, 1929

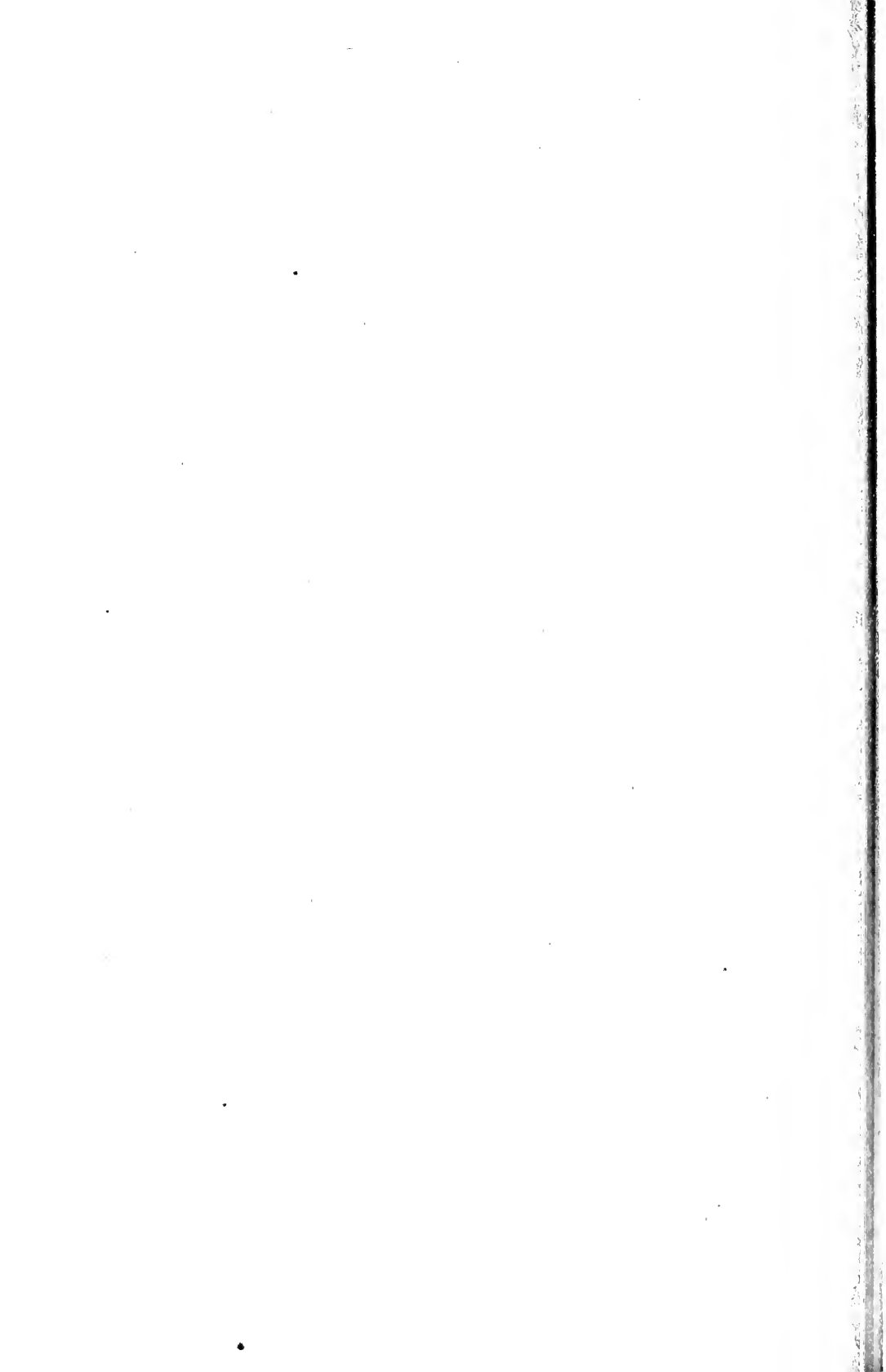

SMITHSONIAN MISCELLANEOUS COLLECTIONS
VOLUME 81, NUMBER 7

RECENT ARCHEOLOGICAL DEVELOP-
MENTS IN THE VICINITY OF
EL PASO, TEXAS

(WITH FIVE PLATES)

BY
FRANK H. H. ROBERTS, JR.,
Bureau of American Ethnology



(PUBLICATION 3009)

CITY OF WASHINGTON
PUBLISHED BY THE SMITHSONIAN INSTITUTION
JANUARY 25, 1929

The Lord Baltimore Press
BALTIMORE, MD., U. S. A.





Openings to some of the caves in mountains northeast of El Paso, Texas.
Photograph by courtesy of J. A. Alexander.

RECENT ARCHEOLOGICAL DEVELOPMENTS IN THE VICINITY OF EL PASO, TEXAS

BY FRANK H. H. ROBERTS, JR.

BUREAU OF AMERICAN ETHNOLOGY

(WITH FIVE PLATES)

In the winter of 1921 the writer visited a number of caves approximately 20 miles northeast of El Paso, Texas, for the purpose of examining a series of pictographs which were painted on their walls. The mountains in which the caves are located lie between El Paso and the far famed Hueco Tanks, in the range bearing the same name, which played so prominent a part in the early history of that section of the Southwest. These water holes formed the oasis for many a wandering band of Apaches, and have long been the rendezvous of cattlemen and a resting place for travellers in that semi-desert region. There is a much greater variety and number of pictographs in the vicinity of the tanks than in the immediate neighborhood of the caves mentioned above, but the drawings in the latter are of greater interest, not for what they represent but because their presence led to the discovery that the caves were once occupied and that many objects of the material culture of a people not yet definitely identified were buried beneath the sand which covered the floors and filled the back portions of the recesses.

At the time of his first visit to the region the writer was impressed with the possibility of finding traces of occupation in the caves, but he was unable to make the necessary investigations because of lack of time and equipment. In the following years there was no opportunity to return to the region, and consequently no definite steps could be taken towards a careful examination of the caves. In the meantime others became cognizant of their existence, through the reports that paintings were to be seen on the rocks of the neighborhood, and it was soon discovered that interesting "curios" could be dug out of their sandy floors. No extensive finds were made, however, until the spring of 1927 when Mr. Robert P. Anderson, then president of the El Paso Archaeological Society, and Mr. R. W. Stafford began a systematic exploration of the caverns and secured a large amount of material.

The specimens collected during the investigations of the two El Paso men include fragments from headdresses, a number of sandals, curved clubs, digging sticks, spear shafts, spear heads, foreshafts for spears, netting, a cord skirt, shell pendants, beads, parts of mosaic combs, and a large basketry armlet covered with a turquoise mosaic. News of the discoveries was published in El Paso papers and was reported to the National Museum by Mr. Anderson. The writer was just leaving for field-work in northwestern New Mexico when this information was received, and fortunately was able to include El Paso in his trip west. At the latter place he had an opportunity of examining the objects gathered by Mr. Stafford and Mr. Anderson and of revisiting the caves where they were found.

There are 28 of these natural recesses in the faces of the limestone cliffs. In some cases they are just above the tops of the steep talus slopes, about two-thirds of the way up the side of the mountain, and in many instances have a narrow ledge of rock running along in front of them (pl. 1). Others are located just below the tops of the cliffs along the upper ledges. In general they open to the northwest or west, and most of them contain evidence of Indian visitors. In many these traces take the form of pictographs painted on the walls in red pigment, while others furnish objects from the material culture of the people. The best examples of the rock paintings were not found in the caves where objects were obtained, but in a large shallow recess about a mile away. Some of the caves have small alcoves, opening off from the main room, which give evidence of having been blocked up at some time or other with loose rock walls.

In three of the caves, smoke-blackened ceilings and débris-covered floors gave definite indications of at least temporary occupation. It was in the layers of refuse, ash, and sand that the specimens left by the people who occupied them were found. One cave in particular had proved quite rich in such objects. At the time when it was visited it had been rather thoroughly examined and a great many objects removed. By digging in the few undisturbed portions of the floor at the back of the cave, however, there were uncovered 12 sandals, a number of spear shafts, a fragment of netting, several portions of curved clubs, a few beads, and some potsherds.

The pictographs in this district consist of realistic and conventionalized life-forms and geometric designs. Inasmuch as a careful study of the drawings and paintings on the rocks of the region is being made by Col. M. L. Crimmins, U. S. A., retired, only a few examples will be given. The writer feels that a great majority of them are to be attributed to the various groups of Apache who were in that section

of the Southwest in fairly large numbers, but a few of them suggest at least slight Pueblo influence. The latter seem to be of greater age and in some instances are partially covered by portions of those of more recent date. Whether they have any relation to the objects found in the caves is a problem still to be solved.

Three figures which probably were intended to represent masked heads were found on the walls of one of the caves (fig. 1). In two examples the persons represented seem to have been wearing a tablet-like headdress, a feature quite common in the Southwest since early historic times. Thus far no evidence has been obtained to show that the ceremonial mask was in use in prehistoric times, although certain investigators are inclined to believe that its development may have begun, as the result of influences from the Mexican cultures to the

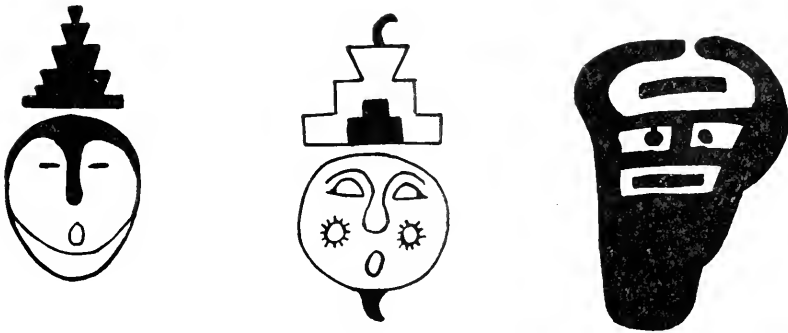

FIG. 1.—Representations of masked heads painted on walls of one of the caves.

south, in the period just following the great era of the Pueblo peoples and immediately preceding the advent of the Spanish explorers. The use of the ceremonial headdress has been markedly widespread in recent times, however, not only among the Pueblos and Navajos but also among the Apaches in certain of their observances. Among the majority of the groups using the mask and headdress there is considerable use of thin strips cut from the flowering stem of the yucca or Spanish bayonet in building up the framework. Fragments of frames made from this sort of material were found in several of the caves, and it seems quite probable that the pictures represent such objects. Their stepped or terraced shape is comparable to some of the Pueblo forms. The third figure possibly represents the mask worn by a participant in a buffalo or similar dance and is certainly decidedly suggestive, in its character and the manner in which it was drawn, of the work of the nomadic Indians.

Among the realistic forms are a number of birds which are not readily identifiable. Two examples are illustrated in figure 2, *a*, *b*. There are also many representations of snakes. In some instances, as figure 2, *c*, they are very realistic, while in others they are more conventionalized and show a combination of the geometric and realistic types. The horned or plumed serpent illustrated in figure 2, *d*, is an example. The plumed serpent has long played a prominent part in Southwestern cultures and representations of it are found in many places. It occurs in the decorations on pottery and in pictographs and petroglyphs, and is used in effigy forms in certain ceremonies of the Zuni and Hopi Indians. Its prominence in the art and ceremonies of the Mexican cultures to the south is so well known that it needs no

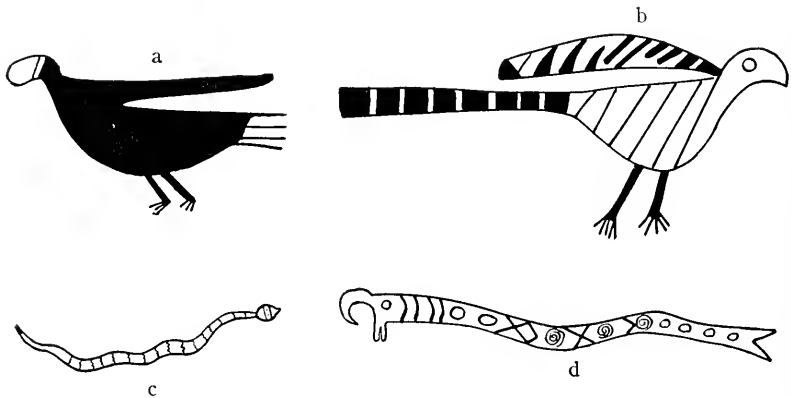

FIG. 2.—Bird and serpent pictographs found on cave walls.

discussion. The example from this cave suggests similar forms on pottery from Casas Grandes in the Chihuahua district of Old Mexico and also some of those occurring on bowls from the Mimbres Valley in southern New Mexico.

Figure 3 shows the best example of a highly conventionalized geometric form. It is impossible to say just what it was intended to represent, but it is quite reminiscent of some of the square-shouldered figures of the Pueblo country to the north and west. A closer parallel to this figure is to be found, however, in some of the geometric designs on pottery from Casas Grandes in northern Mexico.

Only a few illustrations of the kind of pictographs to be seen in this section have been given, but they are sufficient to indicate the general character of the paintings; an extended discussion would be beyond the requirements of this paper.

Mention has been made of headdresses fashioned from the split stems of the yucca. Several triangular shaped objects were found in some of the caves by Mr. Stafford and Mr. Anderson which may well have been the framework for such headdresses. They were constructed from two long pieces and a series of short ones placed cross-wise (fig. 4). The short cross pieces were fastened to the longer ones by means of cord made from tightly twisted yucca fiber. The holes through which the cord passed were drilled. In some cases the material was painted red on one side and the other side was covered with pitch, possibly

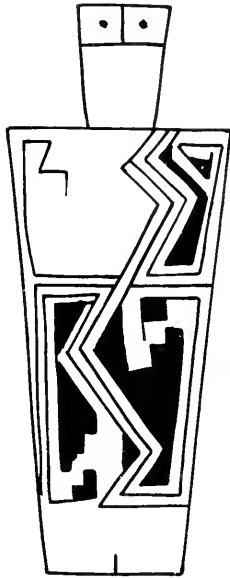

FIG. 3.—Conventionalized geometric figure painted on the wall of a cave.

for the attachment of down or feathers; other examples show that the red pigment was applied to both sides. Some of these triangular frames measured 8 inches wide and 18 inches long while others were as much as 2 feet wide at the base and 3 feet long. They would have served admirably, because of their extremely light weight, as a base for a pyramidal or fan-shaped headdress.

Two kinds of sandals appear in the collections from these caves. The predominant style is not common in the better known portions of the Southwest, whereas the other form is fairly well represented in collections from various sites (pl. 2). Both were made from the ever-useful yucca leaves woven in a wickerwork technique. The

narrow leaf variety of the plant seems to have furnished the best material as it was the most frequently used.

The characteristic form of sandal has a long oval outline, and seems to have been shaped for use on either foot. It was made of a wicker-work of whole leaves woven over a warp of two bundles formed from several of the leaves, four to eight being the normal number. The warp was generally tied at both ends, although occasional examples show a single bundle bent at the middle and tied at the heel end. The latter are generally rather square toed. The projecting ends of the warp leaves were frequently shredded at the heel to form a pad, and at the toe, several of them were tied to make a fastening loop and the remainder were allowed to protrude to form a slight fringe. The weft strands or cross-elements were started on the lower surface

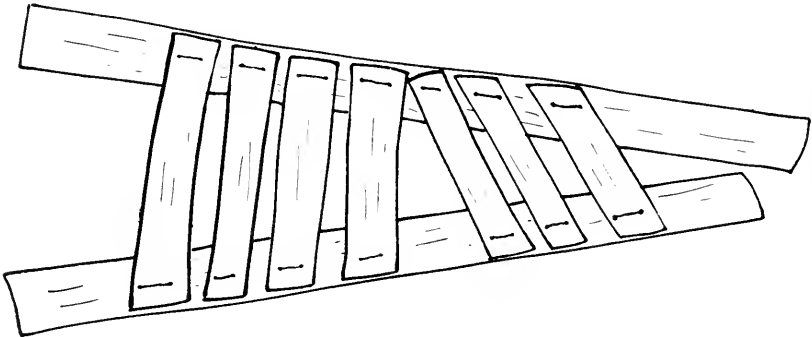
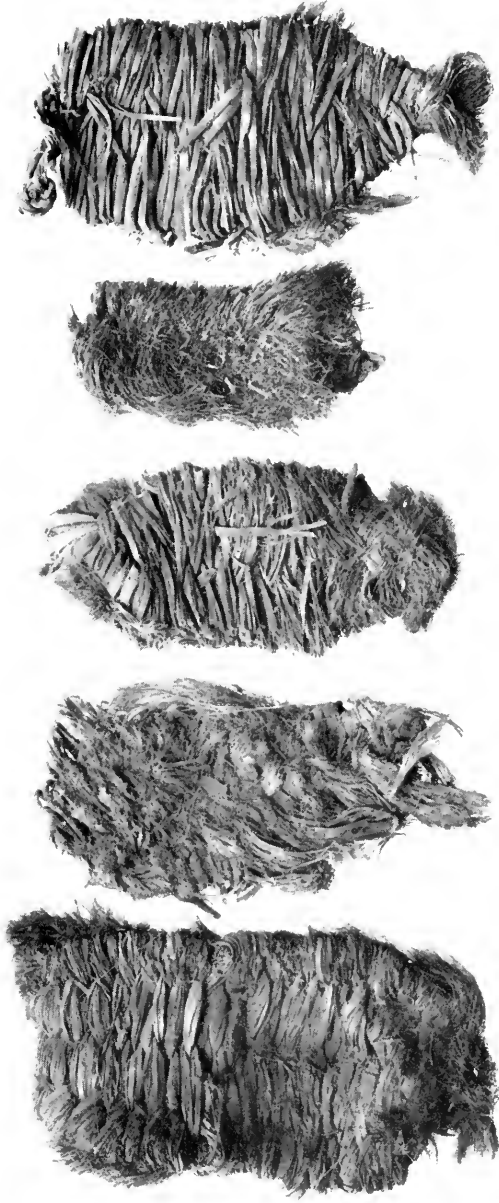

Fig. 4.—Characteristic form in which headdress frames were made from yucca stalks.

of the sandal (fig. 5). The small ends meet in the middle along the top; the strands pass under one warp and back over it; then under and over the other, the ends being drawn down through the sole where they were cut off and shredded to form a pad on the bottom. This is one form of the figure 8 type of weaving.

Two methods of fastening the foot strings at the toe end are indicated by the specimens. The loop fashioned from projecting ends of the warp leaves has already been mentioned. Another form shows a separate loop passed through the warp. In some of the sandals, strings of twisted fiber were fastened to these loops and passed back over the foot where they were attached to the warp, one string just back of the instep and the other just below the ankle. The loops in both forms were small and the strings probably passed between the first and second and third and fourth toes. On most of the specimens found by the writer, and those examined in other collections, there



Examples of sandals found in caves. U. S. National Museum Catalogue Nos. 215428, 340796.

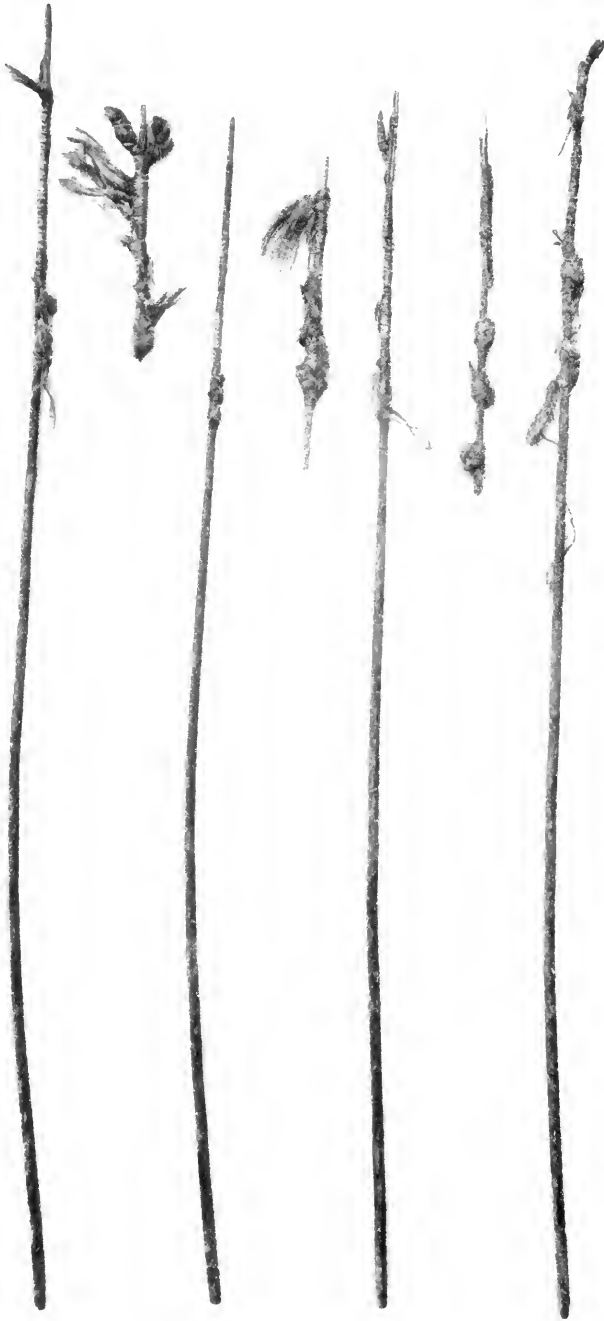

Spear shafts showing fiber embellishment. U. S. National Museum
Catalogue No. 340790.



FIG. 1.—Cord skirt made from twisted apocynum fiber. Photograph by J. A. Alexander.



FIG. 2.—Fragment of netting found in one of the caves.

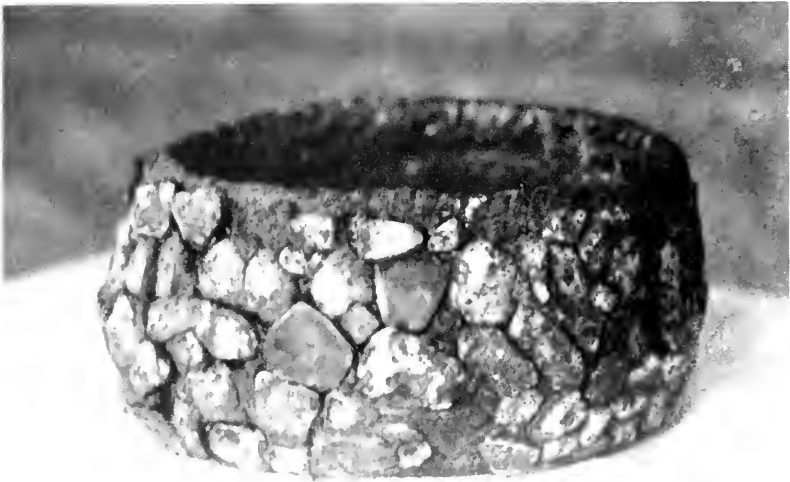

FIG. 1.—Basketry armband with turquoise mosaic.



FIG. 2.—Shell pendants and fragments from mosaic combs.
Photographs by J. A. Alexander.

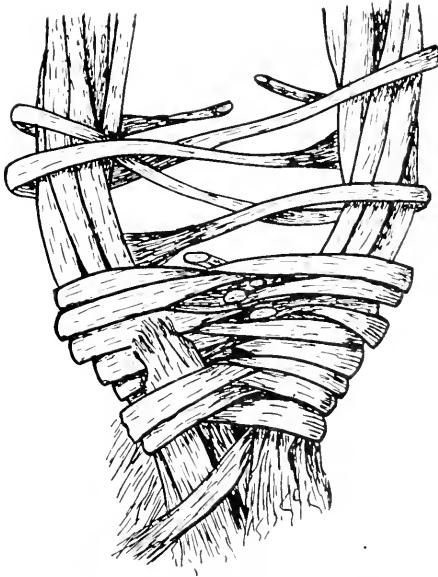

FIG. 5.—Technique of sandal weaving.

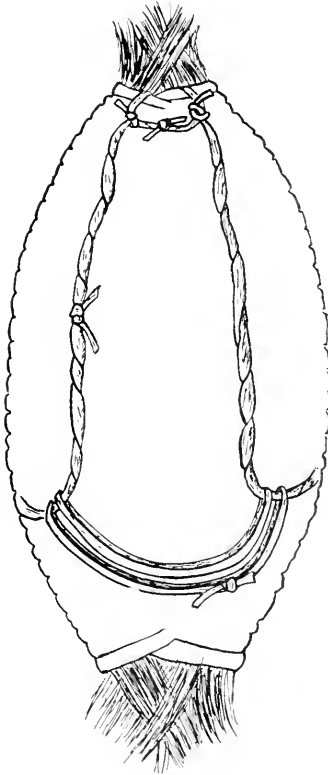

FIG. 6.—Attachment cords on sandals.

are no indications of heel cords, but in a few instances they are present. Where this is the case, the heel cords consist of several loops of shredded leaves which pass around the back of the heel of the wearer and connect the side strings (fig. 6).

In general it may be said that this form of sandal is one which belongs in that section of the Southwest. Similar specimens have been reported from Silver City,¹ New Mexico; the writer has seen a number in various collections from caves in the vicinity of Van Horn, Texas, some distance east of El Paso; and two of the same type, in the collections of the National Museum,² were found in a cave near Lava, New Mexico, in 1902 and presented to the museum shortly afterwards. Dr. Walter Hough found a specimen in 1905, during the course of his investigations at Tularosa Cave in western New Mexico, which is comparable to those from El Paso, although the yucca leaves in the former were partially shredded.³ Another of the same type is figured by Lumholtz in his *Unknown Mexico*. This specimen was obtained during the course of investigations carried on in Cave Valley, northwestern Chihuahua.⁴ Only one example of the type has been noted in collections coming from regions farther north in the Pueblo area. The latter is in the private collection of Mr. J. A. Jeancon at Nateso Pueblo, Indian Hills, Colorado. Mr. Jeancon found it in a cave in southeastern Utah in 1908, when he was conducting explorations in the Montezuma Creek section. A type very suggestive of the El Paso form but varying somewhat in the technique of its manufacture was found in northeastern Arizona by Kidder and Guernsey during their earlier explorations. They found a number of sandals in a small cliff house on Laguna Creek which have the general appearance of the ones from El Paso but which differ from them in that they did not have the figure 8 weave in the weft and that they had only a single leaf in the warp.⁵

The second form of sandal had four warp strands of single leaves. The warps were tied at the heel and toe, and the weft leaves were

¹ Mason, O. T., *Primitive Travel and Transportation*. Rep. U. S. Nat. Mus. 1894, Washington, 1896, p. 358, pl. 7, No. 3. U. S. Nat. Mus. Cat. No. 45610.

² U. S. Nat. Mus. Cat. No. 215428.

³ Hough, W., *Culture of the Ancient Pueblos of the Upper Gila River region, New Mexico and Arizona*, Bull. 87, U. S. Nat. Mus., Washington, 1914, p. 84, fig. 173, a. U. S. Nat. Mus. Cat. No. 246688.

⁴ Lumholtz, Carl, *Unknown Mexico*, Scribners, 1902, Vol. 1, pp. 68-69.

⁵ Kidder, A. V., and Guernsey, S. J., *Archeological Explorations in North-eastern Arizona*. Bull. 65, Bur. Amer. Ethnol., Washington, 1919, p. 103, fig. 37.

woven back and forth in the usual wickerwork technique. The large ends of the weft leaves were brought out on the under side where they were shredded as in the case of the other sandal. There was also the same tendency to permit the shredded ends of the warp leaves to protrude in a sort of fringe at the toe. No specimens from this region have been found with foot attachments still in place, and it is therefore impossible to tell how these may have functioned. Similar sandals have been found at other sites in the Southwest. Kidder and Guernsey describe the form in their Arizona paper,¹ and the collection obtained from Bat Cave, 125 miles north of El Paso, by Mr. DeMeir contains an example of the form.²

The spear shafts are very interesting (pl. 3). They were made from the flower stalks of the agave, which, although light, is very strong and suitable for such purposes. Their average length varies between 5 feet 3 inches and 5 feet 9 inches. The distal ends of these shafts are the heaviest. They have an average diameter of one-half inch and taper gradually towards the butt ends. The latter average a little less than a quarter of an inch in diameter. In the heavy ends a cone-shaped hole was drilled for the purpose of inserting a short foreshaft in which a stone point had been mounted. They were not always equipped with stone points, however, as some of the specimens in the collection of Mr. Stafford had hard, sharp wooden points. In every case the proximal or butt end shows a slight cup-shaped depression, which suggests that the shafts were for use with a spear-thrower or atlatl. The latter object has a small hook at one end which would fit into such a cup-like hole and aid materially in hurling the projectile. The ends of the shafts were bound with sinew wrappings which have disappeared from most of the specimens, although the markings which they left are plainly discernible. These wrappings were probably used to prevent the shaft from splitting as a result of the drilling of the hole in its end.

One rather curious feature about the spears is that they were decorated with streamers, balls, and braids of agave fiber (*Agave lecheguilla* Torr).³ These decorations must have been attached for ceremonial purposes, as the spears could not have been of great usefulness with so much cumbersome material fastened to them (pl. 3). It is possible that they may have been used as wands in the ob-

¹ *Ibid.*, p. 158.

² U. S. Nat. Mus. Cat. No. 215428.

³ Mr. L. H. Dewey of the U. S. Department of Agriculture kindly identified the material for the writer.

servance of some ceremony, or they may be analogous to the long prayer pahos of the Pueblos. Certain features about the cave in which they were found suggested that it might have been one of the sacred places of the people rather than a mere dwelling site. The great numbers of spear shafts scattered through the débris give at least some grounds for such a supposition.

Closely associated with the twisted fiber on the shafts, in a number of cases, was a small bundle of three or more sticks which had been carefully smoothed, sharpened at one end, and rounded off at the other (fig. 7). They were bound together by strips of sinew and then fastened to the shaft with some of the twisted fiber. They were so placed that their rounded ends projected several inches beyond the butt of the shaft. What their purpose may have been or what significance may be attached to them is not known at the present time. Kidder and Guernsey found similar bundles of small sticks in their



FIG. 7.—Method of attaching bundle of small sticks to end of spear shaft.

Basket Maker caves which they identified as material for the making of hair ornaments.¹ They did not find any attached to spear shafts.

A dull red pigment was applied to the spear shafts in some cases, and this is especially noticeable where they have been protected by fiber wrappings. The shafts as a group are very much like those found with the remains of the Basket Maker cultures in the region farther west and north. Their chief difference is in the agave fiber embellishments.

Foreshafts for the spears were made from sticks of harder material. They were tapered at one end to fit the socket in the shaft, while the other end was notched for the insertion of a stone point. The latter was held in position by the use of pitch and a wrapping of sinew. Without the heads the foreshafts range from $6\frac{1}{2}$ to 7 inches in length. The stone points, from 1 to 2 inches in length, are of the elongated triangular shape with good barbs and a tang. The majority of them were made from a gray chert.

¹ Guernsey, S. J., and Kidder, A. V., *Basket-Maker Caves of Northeastern Arizona*. Papers of the Peabody Museum, Vol. VIII, No. 2, Cambridge, 1921, p. 52, pl. 18, c.

The piece of netting obtained from the cave¹ is too small to permit the determination of what it may have been used for, but because of the many similar fragments which were dug out by various specimen hunters it is possible that it may have been a small section from a rabbit net such as the peoples in the Pueblo area farther north and west used.² It is different from the latter in its weave, however, and is quite suggestive in a general way of the technique used in the manufacture of the foundations for the fur and feather cloth blankets. In the latter the weaving was much finer than that of the El Paso specimens, which give no indication of the attachment of either fur or feathers. The fragment may possibly be from a carrying net.

The netting was simply made, although two kinds of material were used in its manufacture. Double warp threads of tightly twisted, two-ply apocynum cord are in marked contrast to the weft of loosely twisted agave fiber. The weft was held in place by a double twist of the warp between each weft cord (pl. 4, fig. 2). The weft was looped back at the edge and carried along until its end was reached, when a new cord was spliced on. The warp strings were placed at an average of every two inches. The double twist which held the weft in place made an average space of one-fourth inch between the strands of the latter. The width of the fragment obtained by the writer is 20 inches but its original length cannot be determined. Netting of the same type was found in caves near Carlsbad, New Mexico, and a portion of it presented to the National Museum.³

Twisted apocynum fiber was used for other purposes than making netting and cords for sandal ties. One of the specimens from the large cave was a cord apron consisting of a waist string to which a series of short cords had been attached (pl. 4, fig. 1). The latter hung down in front in a kind of fringe. Kidder and Guernsey, as well as many other investigators, have found large numbers of similar aprons and have determined that they were a woman's garment. Many have been found on female mummies but none has been observed on a male.

Curved clubs from the caves are comparable to those from the Basket Maker caves of northeastern Arizona and to some of those found in southeastern Utah by Mr. N. M. Judd.⁴ They were fashioned

¹ U. S. Nat. Mus. Cat. No. 340797.

² Guernsey and Kidder, *loc. cit.*, p. 77, pl. 31, c.

³ U. S. Nat. Mus. Cat. No. 330643.

⁴ Guernsey and Kidder, *loc. cit.*, p. 88, pl. 36.

Judd, N. M., *Archeological Observations North of the Rio Colorado*. Bull. 82, Bur. Amer. Ethnol., Washington, 1926, p. 147, pl. 51.

from a hard wood and are slightly oval in cross-section. The sides are fairly flat but the edges are well rounded. The long way of the stick is not straight. They are either slightly crescentic like a boomerang or tend towards an S-shape (fig. 8). Down the center on each side, running from end to end, are four deep parallel grooves. These are not always continuous and may be broken at one or two places. Possibly this is due to the fact that at intervals of varying distance most of the clubs have, or did have, encircling wrappings of sinew, probably so placed to prevent the object from cracking. The makers occasionally went so far as to make a groove around the stick where these wrappings were placed. Some have a deeper groove or notch at one end which may have been for the purpose of attaching a wrist cord. Practically all show traces of a pitch bumper at the opposite end from the cord notch.

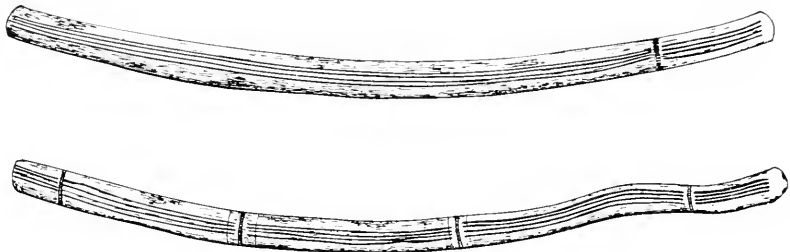

FIG. 8.—Two forms of grooved clubs found in the caves. (About $\frac{1}{2}$ natural size.)

Such clubs are frequently referred to as rabbit sticks, because of their apparent likeness to clubs used by some of the modern southwestern Indians in hunting rabbits, but in certain specific features they are not comparable to them. Inasmuch as this subject has been discussed at some length elsewhere,¹ it will not be necessary to consider it in detail here. Guernsey and Kidder have pointed out the relation between clubs of this sort and the atlatl in the Basket Maker cultures, and also as noted in some of the sculptures of Yucatan, in which figures are depicted holding such an implement as well as bundles of spears and spear-throwers. It is in this connection that the suggestion was made that they may have been used as a weapon of defense in warding off spears. They would also have made a fairly good offensive weapon at close quarters for delivering a bruising or crushing blow.

Clubs of the same kind have been found at other localities in the El Paso area. An almost identical one was recovered from a cave near Carlsbad, New Mexico, in 1924 by Dr. Willis T. Lee and is at

¹ Guernsey and Kidder, *loc. cit.*, pp. 88-89.

present in the U. S. National Museum.¹ It was collected at the same time as the netting mentioned in a previous paragraph. Another fine specimen is that figured by Dr. Hough in his Upper Gila paper.² Mr. De Meir of Las Cruces found it at the same time as the sandals already described. Still another example was found in New Mexico, in an old shrine near Laguna pueblo, by Dr. Elsie Clews Parsons.³ It probably was never used at Laguna, but likely was found in some cave and because of the fact that it belonged to the "old" people, was deposited in the war god shrine as an offering of considerable significance.

The few planting sticks found in the caves are very simple in form. They consist of a long, straight stick of hard wood slightly flattened and pointed at one end. There is nothing unusual in this type of implement and its only interest here lies in showing that the people were at least partially agriculturists.

One of the most attractive specimens in Mr. Stafford's collection⁴ is the basketry armlet. The base was made of basketry upon which was placed a rather crude mosaic of turquoise chips (pl. 5, fig. 1). Several of the latter had been used as pendants, or at least intended for such a purpose, as they were perforated at one end for suspension. The pieces of turquoise were held in place by a thick layer of pitch, possibly piñon gum.

The abalone shell pendants and fragments from two combs with shell mosaic ornamentation are illustrated in plate 5, figure 2. The combs were made from wood, and as in the case of the armlet, the mosaic pieces were held in position by some pitchy substance.

Beads from the locality are of several kinds. Some were made from turquoise, a few from bone, others from shell, olivella, abalone and clam; a few were made from seeds, and quite a number from a fairly hard, fine-grained white stone suggestive of the southwestern form of alabaster. Most of the beads, excepting of course the olivella shells, are of the flat cylindrical shape but an occasional one is found which has an elongated oval form with the perforation at one end. The latter might even be classed as small pendants.

¹ U. S. Nat. Mus. Cat. No. 330644.

² Hough, W., Culture of the Ancient Pueblos of the upper Gila River Region, New Mexico and Arizona. Bull. 87, U. S. Nat. Mus., Washington, 1914, p. 19, fig. 21.

U. S. Nat. Mus. Cat. No. 215429.

³ Parsons, E. C., War God Shrines of Laguna and Zuñi. Amer. Anthrop., N. S., Vol. 20, No. 4, Lancaster, 1918, p. 385, fig. 39.

⁴ The collection has since been sold to Mr. and Mrs. R. B. Alves, El Paso, Texas.

The few fragments of pottery picked up were interesting because they are from a type of vessel which seems to center, more or less, in the El Paso area. It is a very sandy, dark red ware with a dull black painted decoration. The writer has found fragments from vessels of the same kind at many sites in the neighborhood of El Paso, and has seen sherds and vessels of the same type from the Mimbres Valley in southwestern New Mexico. There seems to be no question but that it is prehistoric pottery and that it belongs in the period of the great era in Pueblo development, but its extent—the area of its distribution—is a problem still to be worked out.

This brief description of the caves and the objects from them is not intended to be in any sense an exhaustive or complete report on a new archeological phase in the Southwest, but is presented purely as an announcement of recent developments in the area. There are puzzling problems which can be solved only by additional work in the region. Many features indicate a culture comparable to that of the Basket Makers, the predecessors of the Pueblo-Cliff-Dweller peoples of the San Juan region. This is especially marked in the spear shafts, curved clubs, sandals, and netting. Other factors point toward a later period and a possible connection with some of the nomadic groups of the region. Unquestionably there is some mixture of early and late material in these sites but unfortunately the stratigraphic evidence was lost during the excavations. From what could be learned of the positions in which the objects were buried, it seems fairly certain that the potsherds and triangular-shaped frames which are thought to have been used in the making of ceremonial headdresses do not belong with the other objects but represent a later horizon. Of this we cannot be sure, however, until further investigations bring more evidence to light.

On the present meager evidence the writer is inclined to suggest that there is in this section of the Southwest the northern fringes of a culture analogous to the Basket Makers of the San Juan, but which had its fullest development in the northern Mexico region; a culture closely related to that represented by the material from the Coahuila caves. The sites as a whole open up a new and interesting field for future investigation, one which should be carefully worked, not only that a thorough knowledge of the remains of the region may be obtained, but that the relationships existing between the peoples of this area and those to the north and south may be determined.

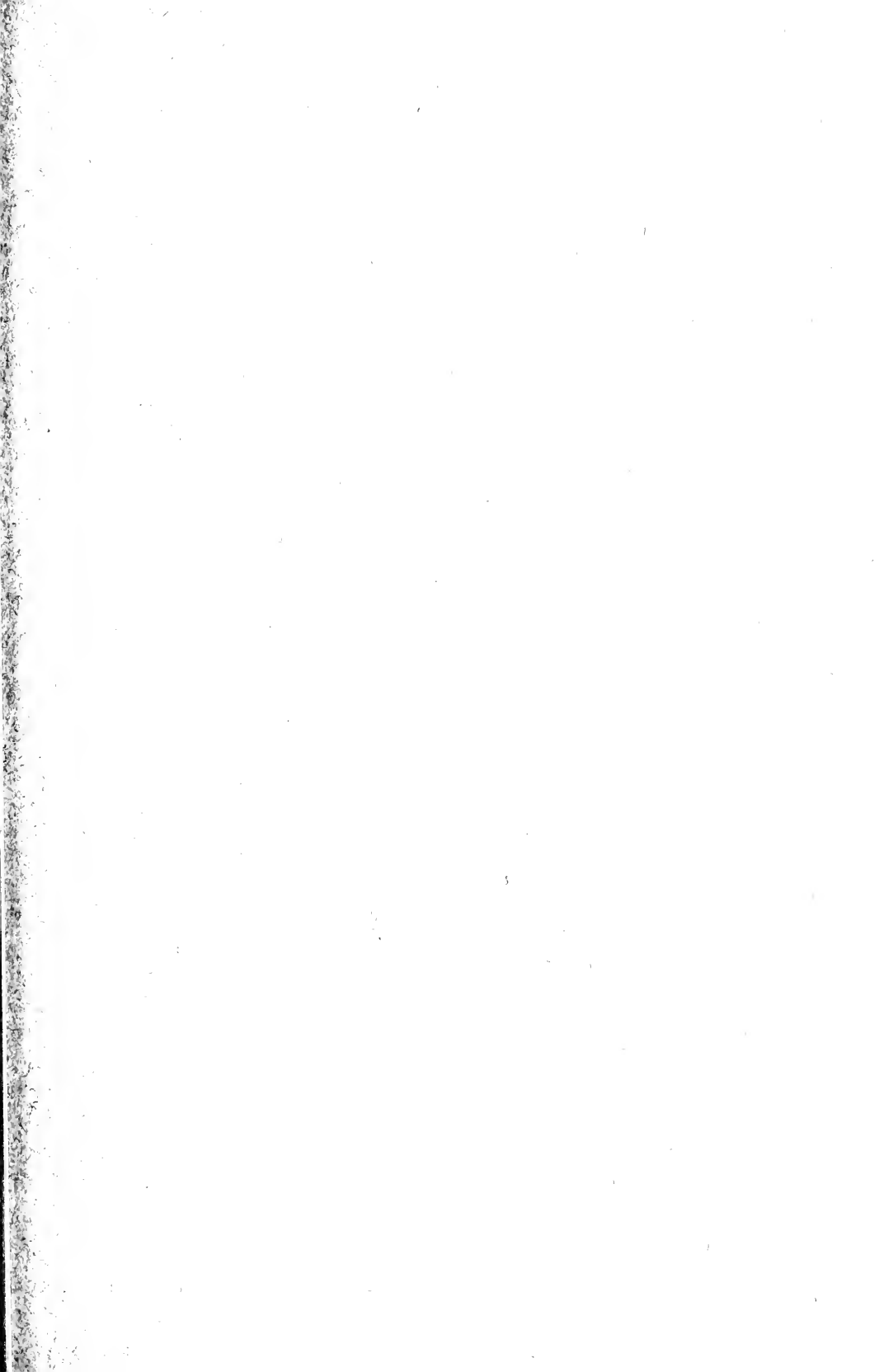



SMITHSONIAN MISCELLANEOUS COLLECTIONS

VOLUME 81, NUMBER 8

PARASITES AND THE AID THEY GIVE IN
PROBLEMS OF TAXONOMY, GEO-
GRAPHICAL DISTRIBUTION,
AND PALEOGEOGRAPHY

BY

MAYNARD M. METCALF

The Johns Hopkins University

5
1929
OFFICE LIBRARY



(PUBLICATION 3010)

CITY OF WASHINGTON
PUBLISHED BY THE SMITHSONIAN INSTITUTION
FEBRUARY 28, 1929

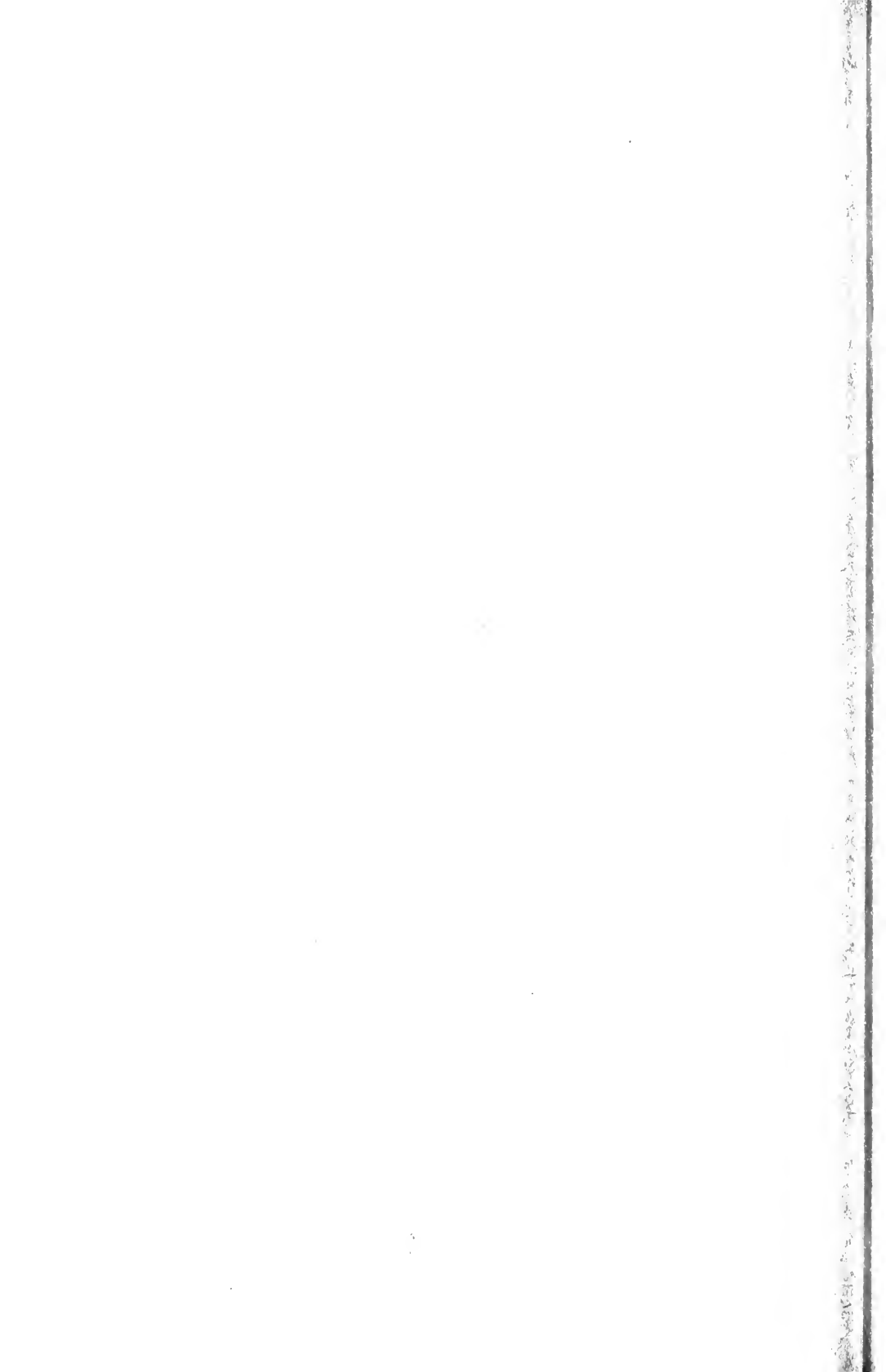

SMITHSONIAN MISCELLANEOUS COLLECTIONS
VOLUME 81, NUMBER 8

PARASITES AND THE AID THEY GIVE IN
PROBLEMS OF TAXONOMY, GEO-
GRAPHICAL DISTRIBUTION,
AND PALEOGEOGRAPHY

BY
MAYNARD M. METGALF
The Johns Hopkins University



(PUBLICATION 3010)

CITY OF WASHINGTON
PUBLISHED BY THE SMITHSONIAN INSTITUTION
FEBRUARY 28, 1929

The Lord Baltimore Press
BALTIMORE, MD., U. S. A.

PARASITES AND THE AID THEY GIVE IN PROBLEMS
OF TAXONOMY, GEOGRAPHICAL DISTRIBUTION,
AND PALEOGEOGRAPHY

BY MAYNARD M. METCALF
THE JOHNS HOPKINS UNIVERSITY

A new method of approach to problems of wide interest is a most welcome thing if it gives assistance in reaching reliable conclusions. The concomitant study of parasites and their hosts is proving of importance in the revealing light it is throwing upon questions of genetic relationships among organisms, upon problems* of their places and times of origin, of their routes of dispersal, and thus also upon problems of former geographical conditions, including not only land connections for the dispersal of land animals and plants but also inter-sea connections for the wandering of marine organisms. Host-parasite data cast light also upon problems of former climates, whether warm or cold, wet or arid; and they assist in questions of the whole character of the habitat of former animals and plants. The method is of such crucial import that it seems well to review briefly such use as has thus far been made of it, and especially to point out possible extensions in its use.

In only a few instances have host-parasite data been used in connection with these broad taxonomic, geographic and paleogeographic problems, and an historical review of the use of the method can be brief. On the other hand, it is no simple task to illustrate adequately the method and to show at all fully the extent of its application, for it enters into and illuminates some very complex problems. In these complex problems host-parasite evidence must be interwoven with data from taxonomy, paleontology, geology, geography, biogeography and paleogeography. Like most classes of data of major significance it has wide interconnections.

A single instance of the use of host-parasite data may well be given in introduction, to make the subject more concrete. Frogs of the genus *Rana* are wanting in South America and in Australia, except for *R. palmipes* along the northern coasts of the former continent and *R. papua*¹ at the northern tip of Australia, both of these being

¹Harrison (1928) refers to four Anura, other than leptodactylids and hylids, as recent immigrants into North Queensland. I have not found first-hand reference to these forms.

recent immigrants from the north. The place of the true frogs in these southern lands is taken by the Leptodactylidae, a dominant group which we might call the "southern frogs." This family is found in South America, Central America, the Antilles and along the southern coast of North America (many American genera and species); in Tasmania, Australia, Papua and adjacent islands, the New Hebrides Islands,¹ and the Bismarck Archipelago (numerous Australasian genera and species); also in South Africa (one genus, three species).

This remarkable distribution, in widely separated Southern Hemisphere lands, has caused much discussion. Most zoogeographers have seen in this dispersal evidence of a southern land connection between Australia and South America. The discovery of southern frogs in Africa was so recent that the African occurrence has been but little discussed.² Some students, though fewer recently than formerly, have vigorously disputed any such intercontinental connection, claiming either that the American southern frogs are not close relatives of those in Australasia (Gadow's earlier opinion, Eigenmann's later view), or that the southern frogs originally belonged in the whole Northern Hemisphere and that the South American and Australian representatives all came from the old common northern stock, and that more recently the northern members of the family have become extinct (Matthew 1915, Noble 1922, Dunn 1923). This seems a most unlikely suggestion in view of present knowledge. To be sure, the origin of the mammalia seems to have been in the northern land mass. The occurrence of mammals to-day in southern lands is due in considerable part to their having spread southward in the past, although some groups of major importance have evolved in the south, and one other, the marsupials, seem to have used east-west dispersal routes in both the Northern and the Southern Hemispheres. It is one of the leading mammalian paleontologists, Matthew, who has recently most vigorously upheld this hypothesis of northern origin and southward dispersal and who has most extensively developed it. He has extended it even to the point of claiming the probable northern origin of all [?] groups of terrestrial animals [and plants?] which arose during the Tertiary and probably also the Mesozoic periods, holding that the present Southern Hemisphere representatives of these groups are archaic forms crowded out from northern lands by the competition

¹One report only, and this very doubtful, apparently erroneous.

²I shall describe soon a *Protoopalina* parasitic in the South African leptodactylid *Helcophryne*, and discuss the significance of the presence of these forms in South Africa.

of more recently developed and more efficient relatives in the north.¹ He rejects all idea of east and west land connections in the Southern Hemisphere between the continents.

Let us apply evidence from host-parasite data to the two concepts (1) of parallel evolution as explaining discontinuous distribution and (2) of only northern centers of origin and radiation for all Tertiary and Mesozoic forms, and let us in our illustration confine ourselves to the Leptodactylidae, and some of their parasites.

In the recta of Australian and American southern frogs occurs a characteristic ciliate protozoan, *Zelleriella*, one of the Opalinidae, and some of these Australian and South American ciliates are almost if not quite specifically identical. This genus of ciliates is absent from

¹Matthew postulates a northern source of origin for each group, which is like an ebullient spring with wave after wave overflowing, each successive wave pushing the previous wave outward in all directions in which conditions allow dispersal. Like the "age and area" hypothesis of Willis, this is too geometrical and too little biological. The recent tendency to attempt to express all biological conditions in geometrical figures and in formulae seems likely to prove but transient. To each of these hypotheses there is both theoretical and factual objection. It would indeed be strange if, as Matthew thinks, the animals [and plants?] dispersing in radiating streams should all leave behind them their ability themselves to become centers, springs, of further evolution on a large scale. There seems no theoretical ground of any sort for this corollary implied in Matthews' hypothesis. But, and this is more important, the facts do not seem to agree with Matthews' theory of one center of origin, with newer and newer forms continually appearing here and pushing the more archaic ones to the "ends of the earth." It seems rather to be the most vigorous, most dominant forms which spread to great distances, not the most ancient. It seems that these dominant animals and plants spread by their own vigor rather than that the less vigorous, archaic forms are pushed out to the far places of the earth by the vigorous competition of more dominant species.

Note the conditions among the Anura. The genus *Bufo* arose probably in late Cretaceous times in northwestern South America or more probably in southeastern Asia (Metcalf, 1923, 1923a) and it has spread to all temperate and tropical lands except such as have been isolated and inaccessible (Australasia, Madagascar). The genus *Hyla* arose apparently in tropical South America in mid-Tertiary times and its spread to North America was after the middle Pliocene, when the Isthmus of Panama was formed; yet, in the comparatively short time since the mid-Pliocene one species of *Hyla* has spread throughout eastern and northeastern Asia, over Europe and on into northern Africa. The true frogs, *Rana*, probably the most modern of the Anura, have spread to all accessible portions of the world except that since they entered South America in the later Pliocene they have not spread beyond the Amazon river. No, it is not the more archaic forms but the more dominant forms that seem to be the wide wanderers. When a decadent group like the bell toads (*Discoglossidae*) has representatives in distant lands, it indicates, apparently, that once they were vigorous and have now become decadent (Metcalf 1928, 1928a).

the Old World (except Australasia) and in the New World is southern, having spread only as far north as the Gulf Coast of the United States (Metcalf 1923a). The parasites of the southern frogs indicate seemingly beyond question that the Australian and American southern frogs are related and also that they arose in the Southern Hemisphere and passed by some southern route from one to the other of their southern habitats. It might be possible, however unlikely, that the southern frogs of Australia evolved from very ancient ancestors¹ in a way parallel to that of the South American southern frogs, though almost always in cases of parallel evolution there are found some criteria to distinguish such resemblance from that due to genetic relationship. But no one can for a moment believe that, along with the parallel evolution of the American and Australian hosts, there was also a parallel evolution of their opaliuids, parallel to such a degree that almost or quite identical species of parasites are found in these frogs in South America and in Australia. The old hypothesis of parallel evolution, put forward by Gadow (1909) and others before the evidence from the parasites was known, could not now be seriously entertained and Gadow himself gave up the hypothesis.

If then the southern frogs of Australia are close relatives of those of South America, how can we account for the present dispersal of this family? Nearly all zoogeographers, because of evidence from the Anura and from many other groups, both vertebrates and invertebrates, believe in a former land connection between South America and Australia by way of an Antarctic continent, and a number of the more prominent students of the subject have emphasized also, in this connection, the former existence of large connected areas of land in the Pacific, especially the Southern Pacific, Ocean. Phytogeographers also have added much important evidence. The evidence from plants is, however, less convincing, since many seeds and spores may often be carried great distances by winds and by ocean currents.

On the other hand a few students of dispersal have accepted (Noble 1922, 1925; Dunn 1923) or been favorably inclined toward (Schenck 1905, 1905a, 1907; Cheesman 1906, 1909) the hypothesis of origin in a northern land mass, Arctogeia, and a southward dispersal via the Isthmus of Panama to South America, via Malaysia to Papua.

¹ Probably archaic toads, for archaic genera of Bufonidae are still found in Australia as well as in South America. Noble (1922, 1925) calls these forms leptodactylids. Archaic bufonids and archaic leptodactylids were probably very similar. Herpetologists in general class these ancient genera in Australia, Africa and South America as bufonids. From one of them in South America the leptodactylids apparently arose.

Australia and New Zealand, and also by way of the Isthmus of Suez to Africa. Here again the parasites of the southern frogs furnish evidence to be used in connection with other considerations.

No southern frogs are known, either recent or fossil, from Euro-Asia, Malaysia or North America, except two species from the Texas coast. The opalinid *Zelleriella* is found in the southern frogs of South and Central America and in Tasmania and Australia and it probably will be found in Papuan representatives of this anuran family. If the southern frogs were ever in Arctogea with their *Zelleriella* parasites, both have completely disappeared. Why has not *Zelleriella*, at least, remained even if the frogs are gone? If *Zelleriella* ever was in southern frogs in Arctogea it should still be in some of the other Anura of these lands. Other families of Anura in South and Central America have adopted *Zelleriella*, for example the toads (*Bufo*), the tree frogs (Hylidae), the Dendrobatinae, the spade-foot toads, the Gastrophrynidae, and even the ranids (*Phyllobates*, *Prostherapis*, and one Californian *Rana*). The absence of *Zelleriella* from Arctogea thus emphasizes the absence of the southern frogs as indicating that neither ever were at home in the North.

There remains the possible hypothesis that the southern frogs were once in the North but that their parasitic *Zelleriellas* did not evolve until their hosts had spread to the Southern Hemisphere. But this wholly gratuitous hypothesis does not help us, for we would still have to account for the discontinuous southern dispersal of the *Zelleriellae* as due either to parallel evolution in South America and in Australasia, a wholly improbable conception, or to a southern land connection between these two now separated regions. The hypothesis of northern origin and southward dispersal of the southern frogs becomes grotesque in view of the evidence furnished by *Zelleriella*, and we shall see later that the evidence from the southern frogs and *Zelleriella* is reinforced by that from the southern crayfishes and their parasites as well as by much other evidence.

In our illustration we have seen host-parasite data used to indicate: (1) Genetic relationship between hosts; (2) places of origin and routes of dispersal of both hosts and parasites; (3) ancient land connections between now distinct and widely separated land masses.

Taken in connection with generally accepted paleogeographical conceptions, similar host-parasite data can be used to indicate times as well as places of origin of host groups and parasite groups. For example both the southern frogs and their *Zelleriella* parasites are far more abundant and are more diversified in America than in

Australasia. Origin in America seems indicated. If so, their spread to Australia must have been before the toads (*Bufo*) with their very different opalinid parasites (*Cepedea*),¹ had reached the South American home of southern frogs. There is much evidence of the presence of an effective barrier, perhaps a shallow sea, across what is now the region in South America south of the East Brazilian highlands, separating them from Argentina, Chile and Patagonia. If the southern frogs and *Zelleriella* arose in the southern part of South America and if *Bufo* and its *Cepedea* parasites were of northern origin, as seems on many indications to be true, the origin of the southern frogs and *Zelleriella* and also the time of their spread to Australia must have been before the obliteration of this South Brazilian barrier (sea?) stretching from the Atlantic to the Pacific Ocean, or else *Bufo*, carrying *Cepedea* would have spread with the southern frogs to Australia. But this it did not do, for *Bufo* and *Cepedea* are unknown from Australasia. Patagonia united with Brazil during the middle Tertiary, perhaps about the middle of the Miocene period. The southern frogs and *Zelleriella* apparently evolved before that time in southern South America or Antarctica and had reached Australia before Australia separated from Antarctica.

In a similar way the present occurrence of the Hylidae (tree-frogs), interpreted in the light of their parasites, indicates a southern origin and a southern dispersal. But we are interested, at this point of our discussion, merely in illustrating the value and method of using data from both hosts and parasites together and not in establishing particular hypotheses, so we will not here enter on a discussion of the further evidence from the Hylidae.

Having in mind this illustration of the host-parasite method, let us review briefly the use thus far made of the method and a few of the conclusions and hypotheses as to which it has given evidence. Then we will briefly consider possible extensions of the use of the method to other groups of hosts and parasites.

Only a few students have used host-parasite data for evidence as to genetic relationships of hosts, their origin and their migration routes, or as to paleogeographic problems, or as to all three.

¹ *Opalina* does not occur in South America in toads or in any other hosts, though a number of species of *Bufo* in Central and North America carry *Opalina*. The toads of South America probably came from Asia in the Cretaceous, before the genus *Opalina* had evolved, and came by a route that did not include the continent of North America as at present formed. *Opalina* probably evolved in southeastern Asia in the early Tertiary (cf. Metcalf 1923).

Von Ihering, in 1891, in discussing ancient land connection between southern South America and Australasia, points out that once Patagonia and Chile, on the south, were separated by sea from the Ecuadorean highlands and from the ancient plateau in eastern Brazil. Adducing evidence that southern Brazil was then united to Chile and Patagonia rather than to the Brazilian highlands, he writes: "*Aeglea lacvis* [a freshwater decopod crustacean] occurs in Rio Grande do Sul [southern Brazil] and in Chile and in both places with the parasite *Tcmnocephala chilensis*¹ [an ectoparasitic flatworm].² This, so far as I can learn, is the earliest instance of using evidence from parasites to reinforce evidence from their hosts in discussion of problems of dispersal.

In 1902 von Ihering made extensive use of parasite data in determining the place of origin of different South American vertebrates, especially mammals, discussing whether they evolved in South America or arose north of the Isthmus of Panama and spread to the southern continent. The data he used were from parasitic worms: Acanthocephala, Trematoda (flukes), Cestoda (tapeworms) and Nematoda (pinworms, etc.). In his discussion he makes the following points:

Two species of hosts are of common descent if they are parasitized by the same species or by nearly related species of parasites.

North America and South America were not united as now until Pliocene times.

There are two classes of elements in the neotropical fauna, one class autochthonous, a second class heterotochthonous, having been derived from North America and having entered South America since the beginning of the Pliocene period.

The long isolation of the autochthonous South American mammals during the Tertiary period should have developed in them species of worms different from those in the heterotochthonous mammals, the parasites of the latter showing resemblance to those of holarctic mammals.

The facts exactly agree with these theoretical considerations. Only the autochthonous South American hosts carry peculiar species of

¹ Italics mine.

² I have distinct memory of reading years ago mention by von Ihering of the genetic divergence between the freshwater mussels of southern and northern South America and his saying that those of the Argentine and of southernmost Brazil are like those of Southern Chile west of the Andes, and that they have the same parasites, but search of those of von Ihering's papers now accessible to me has failed to yield this reference.

Acanthocephala, while the heterotochthonous hosts carry both peculiar species and species common to both northern hosts and southern hosts. He carries the study further to include host-parasite conditions among mammals, birds, reptiles, amphibia, and freshwater fish. In conclusion he says, "The worms prove a valuable aid in analytical study of zoogeography and paleogeography."

There could hardly be a clearer example of the use of parasite data in study of these broad problems. It seems natural therefore to use the phrase "*the von Ihering method*" of utilizing host-parasite data.

Five years later than von Ihering's earlier paper, but six years earlier than the paper last cited, Vernon Kellogg (1896) discussed the biting lice of birds as giving evidence of genetic relationships between their hosts. In a later paper (1913) he notes the following instances of species of these mallophagan parasites being common to American and European birds not of the same species: The American and the European avocets do not meet, yet they have two mallophagan species in common; American and European coots similarly do not meet, yet have five mallophagan species in common; American and European bitterns are infected by the same mallophagan parasite. Other examples are American and Old World water-ousels; one American and one Old World kinglet; one mallophagan species common to two Old World and two New World crows. He writes (1896, p. 51):

The occurrence of a parasitic species common to European and American birds, which is not an infrequent matter, must have another explanation than any yet suggested. This explanation I believe is, for many of the instances, that the parasitic species has persisted unchanged from the common ancestor of the two or more now distinct but closely allied bird-species.

Kellogg repeatedly emphasized this idea of the interpretative value in bird-taxonomy of evidence from their parasites. In 1902, in a report by himself and Kuwana upon the Mallophaga of Galapagos Islands birds we find the paragraph:

It was hoped that the character of the parasites found on the strictly Galapagos Island bird hosts might throw some light on the relationships of these birds to continental genera and species, but our knowledge of the distribution of the Mallophaga is yet far too meager to give much value to suggestions and especially as we have no data at all regarding the Mallophaga of birds from the west coast of South America. . . .

The authors, however, found that of the 44 mallophagan species collected on the expedition 19 were identical with those Kellogg had previously studied from North American and Central American birds.

In 1905 Kellogg writes:

From this fact of near relationship of hosts in all the cases of parasite species common to several host-species it seems almost certain that this common occurrence, under circumstances not admitting of migration of the parasites from host to host, is due to the persistence of the parasite species unchanged from the time of the common ancestor of the two or more now distinct but closely allied bird-species. In ancient times geographical races arose within the limits of the ancestral host-species; these races or varieties have now come to be distinct species, distinguished by superficial differences in color and markings of plumage, etc. But the parasites of the ancient hosts have remained unchanged; the plumage as food, the temperature of the body, practically the whole environment of the insect, have remained the same; there has been no external factor at work tending to modify the parasite species, and it exists to-day in its ancient form, common to the newly arisen descendants of the ancient host.

Again in 1913 and in 1914 Kellogg cited the same data, and also other similar conditions for the Mallophaga and Anopleura (sucking lice) of mammals and urged further collection and compilation of host-parasite data for these hosts and parasites.

Kellogg writes (1913):

From the three Acarinate or Ratitian bird orders the Rheiformes, or South American rheas, the Casuariiformes or Australian cassowaries, and the Struthioniformes or African ostriches, only five species of Mallophaga have so far been recorded. On the rheas occur three species of *Lipeurus*, one being found on each of two host species and the other two on a third. On one species of Australian cassowary are found two Mallophagan kinds, one of which is the same species as that found on two of the South American rheas, while from the African ostrich, *Struthia camelus*, are recorded two parasite species, one of which is the same as that found on the third rhea.

It is clear that Kellogg, like von Ihering, saw the value of evidence from parasites as to genetic relationships between hosts, and as to recent and ancient dispersal of the hosts. The importance of such evidence in paleogeographical studies was not mentioned by Kellogg, but was implicit if not expressed. Since he makes no reference to von Ihering's studies, Kellogg seems to have reached independently a realization of the important aid parasites give in the study of genetic relationships and of zoogeography.

In 1909 Williams published a paper on the great epidemic among the Indians of New England in the years 1616-1620. The following quotation shows that he had a view of the bearing of parasitic disease upon questions of the origin and dispersal of human races and he paralleled Kellogg's conception of community of parasites among birds indicating common ancestors:

From this point of view [of geographical origin and distribution] it is of interest to study the relation of the American race to infectious diseases. Any

communicable disease occurring at the time of the discovery of America on either the eastern or the western continent exclusively probably originated on that continent. Any communicable disease belonging at that date equally to both halves of the world may probably be referred to a time at least as remote as that when the American race separated from the rest of mankind.

At least two other students came independently to the same realization of the importance of host-parasite data, Launcelot Harrison being the next. In 1911 he discussed genetic relationships of hosts on the basis of their parasites, and strangely enough it was the birds and their Mallophaga which first brought to him, as to Kellogg, this conception of the use of parasite data. I have not had access to the original record of this first discussion by Harrison, but he later refers to it as follows:

My personal connection with this subject dates from 1911, when, after about a year's study of Mallophaga, I read a paper before the Sydney University Science Society upon the possible value of these parasites in determining bird affinities. The manuscript of this paper has been lost, but an abstract was published in the annual report of the Society for 1911-12, which I quote to show that I had already arrived at some definite conclusions in advance of,¹ and independently of, Kellogg:

Wednesday, 16th August (1911).—Held in the Geology Theatre, the President in the chair. L. Harrison read a paper, illustrated with lantern-slides, on "The Taxonomic Value of Certain Parasites". The parasites referred to are the biting lice (Mallophaga) found upon birds or mammals. Owing to both environment and food remaining unchanged through the centuries, these insects have not differentiated as fast as their hosts, and afford indications of original relationship between birds that have diverged widely from parent stock. Though birds can be divided into good natural groups, the relationships between these groups have not, and cannot, be satisfactorily determined on anatomy alone. So any line of investigation that is likely to aid the solution of bird phylogeny deserves consideration. Some evidence is afforded confirming parts of existing classifications. Among other results, a study of the Mallophaga would suggest the inclusion of the penguins with the fowls, pigeons, and tinamous, a relationship that has never before been suggested. Such results could, of course, only be put forward as suggestions to the morphologist. A preliminary examination, however, of this group of parasites, certainly suggests that more complete knowledge will afford valuable clues towards the solution of bird taxonomy.

Between 1914 and 1922 Harrison published seven more papers discussing Mallophaga of birds and bird relationships. In 1924, he discussed at some length the former connections of Antarctica with other southern lands, quoted my own work on evidence from the Anura and their opalinid parasites and came to its support with biogeographic evidence and also with further host-parasite data from

¹ Kellogg antedated Harrison in this use of parasite data to determine bird relationships, but the realization of the importance of such data came to Harrison independently. Later he saw that much wider groups of problems are approachable through the host-parasite method, and his papers since 1924 discuss some paleogeographical questions connected with Australia, using host-parasite data.

flukes (Trematoda) and tapeworms (Cestoda) of mammals, birds and frogs (quoted from S. J. Johnston 1913, 1914, 1916), from biting lice (Mallophaga) of Australian and South American mammals, from fresh water Crustacea and their worm parasites (*Temnocephala*).

Biting lice belonging to three different groups, and which Harrison suggested (1922) might well constitute a distinct family, occur upon Australian and South American marsupials and South American porcupines.¹ Harrison says:

There is no evidence that these parasites have ever existed on other mammals in more northerly lands, and it seems most probable that they would have left residuals here and there if such had been the case. So here again the greater probability lies with Antarctic connection between South America and Australia.

As to the freshwater crayfishes and their geographical distribution (Australia, New Zealand, Madagascar, South America, with one "northward wanderer" in California), Harrison writes:

This is a case in which parasites can be used to aid us. The four southern groups of crayfishes² all carry ectoparasitic temnocephaloids, a group generally associated with the monogenetic trematodes [flukes], though differing from these in certain important features. They are confined to fresh water, and are parasitic on the following hosts other than crayfish: tortoises (Brazil), shrimps (Argentina), molluscs (Brazil), crab (Matto Grosso); shrimps and an isopod (Australia); Crustacea (Java to Philippines). In addition, one species has apparently succeeded in reaching the northern crayfishes at their southern limit. *Temnocephala mexicana* being recorded from *Cambarus digniti* of Mexico.

From the greater variety of hosts upon which they are found in South America, it would seem that the Temnocephaloidea were evolved there, becoming parasitic upon the ancestors of *Parastacus*, and were carried with the migrating Crustacea to Antarctica, New Zealand, Australia, and Madagascar (perhaps by way of the Mollucas and Seychelles, as has been suggested for many other animals).

If crayfish had ever existed in Africa, they must have had temnocephaloid parasites, since the Malagasy genus *Astacoides* has them, if it be presumed that the latter were derived from the former. It would follow that the Holarctic crayfish must have had these parasites. If so, where are they now? It is too much to ask us to believe that they have become extinct in the northern temperate zone when we find them so widely spread and holding their own in the southern. There is no evidence that crayfish have ever existed in the tropical belt, and the fact that their place is filled there by other creatures, such as fresh-water crabs, and giant prawns, seems to indicate positively their non-existence at any time.

In 1926 Harrison again discusses Antarctica as a center of radiation for plants and animals, using host-parasite data as "crucial evidence."

¹The porcupines are a peculiar group whose relationships to other rodents are not understood. It would be especially interesting to know what, if any, Mallophaga are found on African porcupines.

²Geographical, not taxonomic, groups, in the four lands named above.

One quotation, showing his effective use of hosts and parasites together as sources of evidence, may well be given here. After discussing again the Crayfish and their external parasites, the temnocephaloids, he writes:

The acceptance of Matthew's hypothesis of four separate dispersal streams of crayfishes from the northern hemisphere potamobiids [northern crayfish] into Madagascar (through Africa), Australasia, New Zealand and South America implies:

The presence in the past of temnocephaloids upon northern potamobiids, for which there is no evidence.

The extinction of both crayfishes and temnocephaloids in Africa, where there is no evidence that either ever existed and no obvious or plausible reason . . . why either or both should have become extinct.

The general distribution in the past of both crayfish and their parasites in the tropical belt, for which again there is not positive evidence. Moreover, since opportunity has been afforded for the southern crayfish to migrate into the tropical belt, and since they have not done so to any marked degree, it would seem that the tropics do not afford a congenial environment for crayfishes.

The extinction of temnocephaloids upon Asiatic and North American potamobiids, for which there is no evidence, and which should not, I think, be assumed without some justification or explanation.

These considerations seem to me to rule out Matthew's hypothesis completely. If the parastacids [southern crayfish] have been derived from potamobiids, the only possibility seems to be that such derivation took place in America, and that the parastacids, as such, first appeared in South America, and must have reached the other southern land masses by a southern route of dispersal, carrying their temnocephaloid parasites with them.

In 1928 two more papers by Harrison appeared. One (1928) presents important additional evidence as to antarctic zoogeography. A genus of lowly segmented worms, *Stratiodrillus* (one of the Histriobdellidae) occurs on fresh water crayfish in Tasmania, in New South Wales, and in Uruguay, and in this paper Harrison describes a fourth species on a crayfish from Madagascar. He discusses the family Histriobdellidae and its three genera and he prophesies that one or more species of the southern genus *Stratiodrillus* will be discovered on the gills of other South American crayfish (*Parastacus*) and of New Zealand crayfish (*Paranephros*).

The second of Harrison's papers in this year (1928) is an excellent general review of the whole host-parasite method. He had not learned of von Ihering's thorough-going use of this method of illuminating problems of genetic relationships of hosts, of geographical distribution of both hosts and parasites, and of former intercontinental connections. Also he failed to realize the extent of Kellogg's appreciation of the wide applicability of the host-parasite method. Harrison's own realization of the broad value of such data apparently came from reading two of my papers and from correspondence with me in the year 1921, a correspondence which, though brief, was very valuable

to me. But his grasp of the importance of parasites as indicating relationships of hosts was reached independently of von Ihering and Kellogg and much antedated my own. The following quotation shows Harrison's grasp of the wide extent of the usefulness of the host-parasite method:

The ostriches of Africa and the rheas or nandus of South America are commonly supposed by ornithologists to have arisen from quite distinct stocks. But their lice are so similar, and so different from all other bird-lice, that these must have evolved from a common ancestor, and so also must the birds themselves. Evidence derived from lice is confirmed by the cestode and nematode parasites of the two groups of birds. Thus a phylogenetic relationship may be established by means of parasites. Equally, a supposed relationship may be refuted. Their lice prove that the penguins are in no way related to any northern group of aquatic birds, but belong in an ancient complex which includes the tinamous, fowls and pigeons: that the kiwis of New Zealand are modified rails, and not struthious birds at all; that the tropic-birds are not steganopodes but terns, and so on. A third use is to refute suggestions of convergent resemblance, which are often very lightly made, and which are so exasperating to the zoogeographer since they are usually incapable of either proof or disproof. Leptodactylid frogs are found in South America and Australia. Did they evolve separately, or are they derived from common ancestors? The herpetologist cannot say with any certainty, but the parasitologist discovers that they share a genus, *Zelleriella*, of ciliate protozoan parasites, and must have had common origin. This same example will serve to illustrate a fourth use for the host-parasite relation. The genus *Zelleriella* can, and does, infest frogs other than Leptodactylids. It is not found, however, anywhere except in Australia, South and Central America, so that its distribution affords strong presumptive evidence that South America and Australia have been joined in past time in some way which excluded the northern land masses.

These examples indicate the nature of the host-parasite relation, and its possible usefulness.

In 1926 Harrison discussed before the Australian Association for the Advancement of Science "The Composition and Origins of the Australian Fauna, with Special Reference to the Wegener Hypothesis." This paper, in press but still unpublished in 1928, I have, of course, not seen.

S. J. Johnston, of Sydney, Australia, had heard Harrison present before the Sydney University Science Society his first discussion of the biting lice (Mallophaga) of birds as furnishing evidence of the genetic relationships of their hosts (Harrison 1911) and two years later Johnston (1913) wrote of the frog trematodes of Europe, America, Australia and Asia and their bearing upon possible former connections between these now separate lands. He concluded that the trematodes of Australian frogs find their nearest relatives in those of Asiatic frogs, and Grobbelaar, writing in 1922 upon African frogs

and their trematodes, accepted this judgment of Johnston's. Harrison questions this conclusion and predicts "with the utmost confidence" that future additions to the then very scant knowledge of Asiatic frog trematodes (six species) and the Trematoda of Australian frogs will show "that . . . the closest affinities of Australian frog trematodes . . . lie with those of South American frogs." In this 1913 paper Johnston refers to trematodes of Australian sea eagles, sea gulls and herons and he points out also that two flukes of the genus *Harmostomum* found in two Australian marsupials are so closely related to another *Harmostomum* from a South American opossum that they "must be considered as derived from common ancestors." Johnston must have had in mind the bearing of these parasite data upon problems of former connection of Australia with Asia and with South America, but neither in this nor in two subsequent papers (1914, 1916) upon Australian trematodes and cestodes in general did he bring out clearly the paleogeographic importance of his data. He emphasized chiefly their bearing upon the genetic relationships between the hosts.

Metcalf, the author of the present paper, was the fourth student of parasites to come independently to a realization of the important aid which parasites may give in solving problems outside the field of parasitology proper, and he used the host-parasite method in his earlier papers¹ much more extensively than it had been used before; but really he added nothing essential to the conception of this method which von Ihering had in 1891 and 1902. Kellogg too seems to have realized the applicability of the host-parasite method to other problems than genetic relationships of hosts, though he made but scant, if any, application of it to them. Harrison carried Kellogg's work upon bird relationships further and also in his papers subsequent to 1924 used parasite data extensively in problems of zoogeography and paleogeography. Priority is of very little interest, but, for what it is worth in this matter, the priority is clearly von Ihering's.

Metcalf in his chief paper (1923) purposely overemphasized his data, endeavoring to bring out even slight suggestions which could not be established without corroboration from other sources.² His desire

¹ Seven papers from 1920 to 1924; also one in 1928.

² "The endeavor will rather be to present the known data from the Anura and the Opalimidae and note their implications. Even very scant data, insufficient to have any real weight as they stand, will be stated and their implications noted, with the thought that even very minor items, of slight moment by themselves, may sometime be correlated with other data and then be of interest. The endeavor is, therefore, to have the treatment of this theme inclusive rather than critical." (From Metcalf, 1923.)

was not so much to prove certain particular taxonomic, zoogeographical and paleogeographical propositions as to illustrate and emphasize the method of using parasite data in the study of such problems. That, indeed, is the chief purpose of the present paper also.

Metcalfe studied the opalinid parasites found in the preserved Anura (frogs and toads) in the United States National Museum, including species from all parts of the world. He was already familiar with those occurring in Europe. Other species were obtained from the Indian Museum at Calcutta and a few more from South America. Assuming the general correctness of a set of Mesozoic and Tertiary maps compiled by himself, chiefly from Arldt, von Ihering, Scharff and Schuchert, and based upon geological and biogeographical evidence, not including parasites, he studied conjointly the taxonomy and distribution of the Anura and their opalinid parasites and applied these data from biogeography, paleogeography and from the host-parasite studies, to problems of the place and time of origin of different hosts and groups of hosts, of different parasites and groups of parasites, to the routes, times and directions of dispersal of both hosts and parasites, and in the discussion pointed out evidence bearing on the correctness of the maps used, and upon problems of ancient climates.

Before applying the data from the study of the opalinid parasites he tabulated the available data from both hosts and parasites under six items as follows: "Species of opalinid; Host species; Family or subfamily of host; Known geographical occurrence of opalinid in the species of host named; Known occurrence of host; Known occurrence of genus of host." This tabulation, used in connection with maps of the present day oceans and of the continents in the several geologic periods, was of great aid in studying present and former distribution of both hosts and parasites, places and times of origin of each and routes and directions of dispersal. *The publication of similar tables may properly be urged upon those who undertake comprehensive studies of any group of parasites. They will make the author's data most easily available to other students and so should extend the general use of host-parasite data. Where data from fossils of either hosts or parasites are known and are sufficiently extensive they should be tabulated, say under such items as these: Geographic locality of fossils of the host family; Geologic period of such fossils; and, if fossil remains of the parasites are known, similar data as to them should be tabulated. Of course preservation of parasites as fossils will be rare, but their spoor may be found and may be quite specific, as, for example, in the case of the Peridermiums of pines,*

rusts which produce swellings of possibly specific character. Other examples would be bone lesions of recognizable cause.

Let me here merely list a few of the things that seemed to be indicated with a greater or less degree of probability by these earlier studies of Metcalf.

Having assumed paleogeographical maps showing certain intercontinental connections, he applied to them the data from Anura and their opalinid parasites and found they fitted in such a way as to be in general confirmatory.

Protoopalina, the most ancient genus of the opalinids, was present in Equatoria (Australia plus Africa and South America) as early as the Triassic period, and its most archaic subgeneric group of species have persisted in these three continents, with only slight modification, until the present day.

Other subgeneric groups of species of *Protoopalina* arose as follows:

Group II in Australia at a time not indicated by the data.

Group III before the separation of Australia from Asia in Jurassic or early Cretaceous times, in Australia or southeastern Asia, spreading to Europe during the Cretaceous or early Tertiary by a route north of the Himalayas, and to Africa in the late Tertiary, entering from the northeast.

Group IV, in the Jurassic period, in Australia or southeastern Asia.

Group V, in Cretaceous times in Australasia, their presence in Australia and Java but not in Sumatra indicating that Java retained connection with Australia longer than did Sumatra. The absence of members of this group from South America is one of several bits of evidence indicating that migration between South America and Australia was chiefly westward.

Group VI, in the Jurassic period in Australia.

Group VII, in Precretaceous or Cretaceous times¹ in South Atlantis which united Patagonia to South Africa.

Group VIII, during the Tertiary period in western North America.

Group IX, in Jurassic times in Lemuria (the Indian Ocean land connecting Madagascar and India, see fig. 3), with a Tertiary dispersal to eastern Asia, Formosa and Java.

The opalinids of the earliest Anura were apparently of the genus *Protoopalina*, as evidenced by structure, life history and distribution, since *Protoopalinae* occur in all families of Anura whose habits permit infection with opalinids.

¹Later studies tend to place this South Africa-Patagonia union somewhat later, in the early Tertiary.

The genus *Zelleriella* arose in Patagonia, before the separation of Patagonia from Antarctica. This separation occurred probably in the middle Miocene. *Zelleriella* did not arise until Patagonia had lost its African connection, for the genus does not occur in Africa. In the early or middle Tertiary it spread to Australia; in the late Tertiary to Tropical America. Its original hosts were southern frogs (leptodactylids). Its presence in South America and Australia, and its absence from Euro-Asia is, when carefully studied, as already noted, evidence of former southern land connection between these continents.

To continue merely listing the things indicated by Metcalf's host-parasite data from Anura and their opalinids would be wearisome, so we will omit reference to the genera *Cepedea* and *Opalina* and their subgenera, whose times and places of origin and times and routes of dispersal were discussed, and will note further only some of the types of conclusions suggested.

Evidence was found as to the places and times of origin of the several families of frogs and toads, and the routes by which, and the times at which, they spread to the lands they now occupy. There are similar indications as to a number of genera of the hosts, *Bufo*, *Polydectes* and *Rana*, for example.

Spread of true frogs (*Raninae*) from the north into South America has not occurred, except for one species, and there are no indications of any southward wandering of Anura across the Isthmus of Panama since its formation in the Middle Pliocene. On the other hand, there has been extensive spread of Anura northward across this Isthmus.

The Sonoran desert of northern Mexico and the southwestern United States has been a hindrance to northward wandering of southern frogs since the middle Pliocene, but has not held back the tree frogs (Hylidae).

Negative as well as positive evidence is often given. For example, the absence of *Zelleriella*—the characteristic opalinid of the southern frogs—from Euro-Asia indicates that southern frogs were never in Euro-Asia. The absence of the genus *Opalina* from South America, though it is present in the toads (*Bufo*) in Central America, shows that toads have not passed south across the Isthmus of Panama since *Opalina*, a Tertiary immigrant from Asia, reached Central America. Again the only Euro-Asian species of tree frog (*Hyla arborea*) with its several subspecies is not endemic in Euro-Asia, but is an immigrant from North America, for it carries a North American *Opalina*.

This recital of a few of the indications from Metcalf's studies is sufficient to emphasize the point here in view, namely, that host-

parasite data may be applied to a great range of problems. This, which we might well name the *von Ihering method*, gives decisive results in many cases, while in other instances it furnishes merely corroborative evidence or evidence to be joined with that from other sources.

Metcalf subsequently published several papers discussing the host-parasite method or host-parasite data, as noted in the appended bibliography.

Darling (1921, 1925) used data from the hookworms of man to indicate human origins and migrations. Before the publication of this earlier paper Darling had very likely not read the papers of von Ihering, Kellogg, Harrison, Johnston and Metcalf, which had made somewhat similar use of parasite data, for he does not refer to these authors. It seems probable, therefore, that Darling may have been another independent discoverer of the broad significance of such data from parasites. The following quotation will show Darling's suggestions:

. . . . man of the Holarctic regions [is] parasitized exclusively or almost exclusively by *Ancylostoma duodenale*, while man of the Oriental and Ethiopian regions [is] parasitized exclusively or almost exclusively by *Necator americanus*. This suggests the possibility of there having been two primitive races of man, each one originally parasitized by a particular species of worm. Certain it is that *N. americanus* is found more exclusively among black and brown-skinned races, while *A. duodenale* is found exclusively or greatly predominates at the present time among Caucasian and Mongoloid stocks.

It may be that a Eurasiatic race of men, possibly the *Pithecanthropus* of Trinil, Java, became split off and furnished the stock from which man of oriental and Ethiopian regions sprung. *Proliopithecus* emerging from Holarctic Africa may have been not only the parent form of man, gibbon, chimpanzee, gorilla and the orang-outang, but he may have harbored the parent form from which have arisen the different hookworm species found in the various species of anthropoids of today. Possibly the ancestral tree of the primates can be revised after a study of the host relationships of their respective obligate nematode parasites. At any rate we can say that it seems likely from the present distribution of *A. duodenale* and *N. americanus* as determined in surveys recently made of selected groups that there were originally races of man parasitized exclusively by *A. duodenale* and inhabiting the Holarctic region, that is Europe, Asia, north of the Oriental region, and northern Africa; and that there were other races of man parasitized exclusively by *N. americanus* and inhabiting the Oriental region, that is the southern peninsulas of Asia and Indoasia or the Malay Archipelago; and also the Ethiopian region, that is, Africa south of the Sahara Desert.

Ewing (1924) in a study of biting lice of the family Gyropidae discusses the significance of their geographical and host distribution arguing in favor of a crossing over between rodent hosts and primate

and ungulate hosts rather than descent from common ancestors. In a second paper (1924a) Ewing discussed the host-parasite relations of human and louse races and the hybridization of both and he includes in this discussion prehistoric races of men and of their head lice, and he mentions again the probability that the tropical American spider monkeys (*Ateles*) acquired their head lice (*Pediculus*) "originally from man but not from recent man." Two years later the same author (Ewing, 1926) discusses further the significance of the geographical and host distribution of the genus *Pediculus*. Four paragraphs of his summary may well be quoted:

1. In America two distinct groups of *Pediculus* exist, one of them confined to man and one to monkeys.

2. The forms infesting man are apparently largely hybrid races of head lice, the pure strains of which were originally found on the white, black, red, and yellow races of man living in their original geographic range.

6. The monkey-infesting pediculids of America, so far as known fall into distinct species according to the hosts they infest, thus indicating, to a certain degree at least, a parallel host and parasite phylogeny.

7. If these monkey hosts (*Ateles*, species) procured their lice from man it was not from recent man but from human hosts that lived tens of thousands of years ago—long enough to allow a species differentiation to develop among the monkey hosts.

Ward (1926), in a presidential address before the American Society of Parasitologists, has mentioned the importance of such uses of data from parasites and refers in this connection to some of the work reviewed in the present paper.

Hegner (1928) discusses the protozoan parasites of monkeys and man and concludes with the following statement:

. . . . the protozoan parasites of monkeys and man belong for the most part to the same species or are so similar in their structure, life-cycle and host-parasite relations as to be practically indistinguishable. This situation is particularly striking when the protozoa of monkeys are compared with those of other animals associated with man. If the proposition that close relationships of parasites indicate a common ancestry of their hosts is valid, then the facts available regarding the protozoan parasites of monkeys and man furnish evidence of importance in favor of the hypothesis that monkeys and man are of common descent.

This shows Hegner's recognition of the importance of host-parasite data in studies of phylogeny.

Some few students have attempted to minimize the importance of parasite data in problems of biogeography (Noble, 1922, 1925; Dunn, 1925). Harrison (1924, 1926) has sufficiently answered their criticisms. Noble's criticisms are based largely upon his new classification of the Anura, a classification not as yet accepted by herpetologists.

The present writer thinks improbable Noble's idea that the southern frogs of Australia and those of South America evolved independently from the archaic toads, and developed along parallel lines.

So far as I can learn, the papers mentioned cover the use thus far made of data from parasites in connection with the three classes of problems here considered. So little has been done in this field and so little has that little been known that each successive student has thought himself a discoverer and a pioneer. It has been probably a unique incident in biological and geographical science. There have been instances of double or triple discovery—mutation, for example—but sixfold independent discovery of a concept with wide significance and capable of important application in further research has probably not before occurred.

We have described in outline the use that has been made of this "von Ihering method." It seems well before closing this paper to suggest possible further applications of the method, using other groups of parasites, and to mention some specific problems needing study by this method. Harrison (1928) has reviewed from this point of view different groups of animal parasites considering their availability for host-parasite studies. Let us include plants as well.

Protozoa—There are, of course, many groups of Protozoa part or all of whose members are parasites or commensals, having at any rate an obligatory association with definite animals or plants. Among the *Sarcodina* are many parasitic Amoebae and a few Heliozoa are internal parasites. I know of no use of data from these forms in studying such general problems as we have had in mind. Our knowledge of the taxonomy of these parasites, of their host-occurrence and of the geographical distribution of both parasites and hosts is inadequate, but the material for such host-parasite studies in these groups seems to be available. There is a considerable degree of specificity in the host relations of the *Endamoebae* and they are found in many groups of animals.

Multitudes of the flagellates are parasitic and probably no other group presents more advantageous material for host-parasite studies. Some flagellates are parasitic in plants. Although knowledge of flagellate parasites is extensive, it is very fragmentary, being almost nil for many regions of the earth and far from complete for most regions and for most hosts. In some groups we have enough records to begin tabulating the host occurrence and geographical occurrence and scrutinizing the tables for what they may indicate. Probably the finest groups for host-parasite studies are the termites (white ants) and the

flagellates living in their intestines. Approximately fifteen hundred species of termites are known and from all tropical and many temperate parts of the world. They have a highly elaborate taxonomy with four families, subfamilies, genera, subgenera, species and subspecies, and the genetic relationships and the phylogeny seem capable of successful study. Forty-six genera comprised in 12 families of termite flagellates have been described from less than 40 species of termites, this being but a meager beginning of the taxonomic and phylogenetic study needed for this truly vast number of mostly undescribed species. It seems unlikely that any other organisms will lend themselves so favorably to host-parasite studies as will the termites and their flagellates. Every individual termite is richly infected. The wealth of species of these hosts and of their Protozoa is so great as to be somewhat awesome. "There are probably more flagellate Protozoa in the intestines of termites than in all other animals combined."¹ It is a bold student who attacks these groups with the idea of employing them by the von Ihering method, but the one who does so should reap a rich reward.

The termites are a peculiarly favorable group for such studies because, in addition to their varied internal fauna of flagellate parasites, they harbor, either customarily or occasionally, representatives of every other group of parasitic Protozoa (Amoebae, Ciliates, Sporozoa) so that one studying them through their flagellates would often be able to check up results from some of their other parasites.

The Chlamydozoa are but little understood. It seems not unlikely that when better known, especially if they prove to be associated with mosaic and other filtrable virus diseases, they may prove of much interest.

The Sporozoa offer much fine material for host-parasite studies, all being parasitic. Most species of terrestrial and fresh water animals harbor representatives of one or more of the numerous groups of Sporozoa, and they infect also very many marine animals. Many Sporozoa, perhaps most of them, show a high degree of specificity in their selection of hosts, being confined each to one species of host or to one taxonomic group of hosts. This renders their evidence in some instances peculiarly convincing.

Among ciliate Infusoria are numerous parasitic species. *Balantidium* and *Nyctotherus*, parasites of man and other mammals, should be valuable for host-parasite studies. The "Astomata," which include several perhaps unrelated families, should also furnish favorable ma-

¹ Cleveland, L. R., quoted from a letter.

terial. But best of all ciliates for such studies seem to be the archaic group, the prociliates,¹ including only the Opalinidae, the basis of Metcalf's studies, to which reference has already been made.

The inability of their hosts, the frogs and toads, to endure salt water makes their evidence as to land routes of dispersal peculiarly cogent. Opalinids have remarkably clearly indicated phylogenetic relationships (Metcalf, 1926), probably more clearly indicated than in any other group of Protozoa. These two groups, the Anura and their opalinids, are thus peculiarly favorable for studies by the host-parasite method, especially studies of the phylogeny of the Anura and of their geographic dispersal.

The Ophryoscolecidae, a group of ciliates which live in the stomachs or intestines of ungulates, anthropoid apes and some South American rodents, have a highly diversified taxonomy, with relationships well indicated, are almost world-wide in distribution and seem, from our present inadequate knowledge, to be specific as to their hosts. They and their hosts should furnish important host-parasite data. No animals are better represented in fossil records than are the Ungulata.

Among the flatworms the Temnocephaloidea, with the crayfish on whose gills they are parasitic, have been used very effectively in host-parasite studies by von Ihering and Harrison, as already noted. Von Ihering and Johnston have made similar use of data from the flukes (trematodes), the tapeworms (cestodes), and some of their hosts. But the important results already obtained by aid of evidence from the flatworms are but a very minor fraction of the harvest that may be reaped by adequate study of this group.

Darling's studies of the origin and spread of human races in the light of their hookworm parasites are an example of the use of data from round worms (Nematoda). Among the Nematoda there are innumerable free-living forms, and great numbers of parasitic species infesting almost all kinds of animals and very many kinds of plants. A parasitic nematode is even known from a ciliate infusorian—a metazoan parasite in a protozoon. There is in the parasitic members of this group and their hosts a wealth of material which should prove an inexhaustible mine for working by von Ihering's method. The nematodes rival the trichonymphs of the termites as a source of data for such use, indeed because of their universal abundance and the huge number of their species they must surpass the trichonymphs in the number and variety of problems their evidence will help solve.

¹ Using Wenyon's (1926) modification of Metcalf's name "prociliates".

Harrison, as already described, has made use of parasite data from *Stratioidrilus*, a genus of archaic annelids, to indicate intimate relation between Australasia, Madagascar and South America. The annelids as a class, however, are poor in parasitic species.

Among the Crustacea the parasitic copepods may perhaps give light upon some interesting problems, though their host relations and especially the specificity of these relations need further study. The parasitic species of copepods are apparently chiefly ancient and reached for the most part their adaptation to parasitism long ago, having undergone little modification in later geologic periods. Others, however, seem to have adopted parasitism more recently. A thorough analysis of the parasitic copepods from this point of view would be worth while for its own sake and would give added significance to their host-distribution and geographical distribution.

Among the Arachnoidea (spiders, mites, ticks, etc.) several groups are parasitic, but the parasites are not confined each to one individual host or even to one species of host. They are free to pass from one host to another. This makes them far less useful for host-parasite studies than are more restricted parasites, but, in some instances at least, they present usable data.

The true insects include many groups among whose members parasitism is more or less well developed. Examples of insect parasites of terrestrial vertebrates and of insect parasites of insects at once come to mind, but with these insects, as with the mites and ticks, specificity of host-infection is in general not highly developed, though there are numerous exceptions in which there is constant relation between kind of host and kind of insect parasite, as, for example, some moths parasitic in bee colonies and some beetles restricted to ant nests.

Many insects parasitic upon plants have closely specific host limitations, being confined each to a single host species or to a related group of species, however freely they may pass from host individual to host individual. One thinks at once of the plant lice (Aphides), but many even of the larger insects have similarly restricted plant prey—*e. g.*, the potato beetle, the squash bug, the plum curculio, the hessian fly, the cotton boll weevil, grape Phylloxera, some butterflies, some moths, many gall-flies, etc.

Molluscs, echinoderms, vertebrates and other chordates, show few examples of parasitism, commensalism or obligate association of any kind. It is doubtful if the few cases known (shark-Remora, fish living among the tentacles of jelly-fish, fish living within sea cucumbers, fish

living in the mantle cavity of molluscs, and some others) will prove of much interest from the point of view of the present paper.

Parasitic plants have never been used, so far as I can learn, in such studies as those in which we are here interested, though they present a great mass of usable host-parasite data, but in all the groups which



FIG. 1.—The Atlantic Ocean and the adjacent land areas. The dotted lines indicate 2000 fathoms depth. (Modified from a map by W. & A. K. Johnston.)

furnish these data much further study is needed. A good degree of specificity between host and parasite is a desideratum and this we find in a good many cases.

The rusts are very favorable in some regards. Most of them are restricted in their hosts, many cause lesions which can readily be recognized, as, for example, the *Peridermiums* of pines and the branch "nests" of cedars. Many of the rusts of the conifers produce distortions in the hosts which could be identified in fossils. The two hosts,

intermediate and definitive, necessary for each species of rust, present a most interesting condition for distributional studies. The necessity for two hosts in the life cycle of a rust, presents a complication, but one which makes the evidence from the rusts and their hosts more than doubly significant. On the other hand the rusts lack one ad-



FIG. 2.—The Pacific Ocean and the adjacent land areas. The dotted lines indicate 2000 fathoms depth. (Modified from a map by W. & A. K. Johnston.)

vantage—their taxonomy is not well understood. This disadvantage is only partly compensated by their large number of forms and their numerous and diverse hosts. When the rusts are more widely and more thoroughly known they will present data of peculiar value in host-parasite studies.

The smuts of grasses, especially of uncultivated grasses, might furnish data; so also the powdery mildews (*Erisiphaceae*) and the downy mildews (*Peranosporaceae*), especially those infesting uncultivated species.

Mycorrhizae, commensal root fungi, of pines and many other groups might be of especial interest, first because the data they furnish might be compared with those from rusts and other fungi, and, second, because they produce lesions which possibly might be recognizable in fossils.



FIG. 3.—The Indian Ocean and the adjacent land areas. The dotted lines indicate 2000 fathoms depth. (Modified from a map by W. & A. K. Johnston.)

The fungi in general should be scrutinized for groups fitted for such studies. Fungus diseases of plants are being more and more studied and new data are thus being offered.

Plants and their parasites, when studied by the von Ihering method, will surely give very important results, but such study must be accompanied by further and laborious study of the structure, life history and taxonomy of the parasites.

Fossil records of the hosts are of especial interest in biogeographical problems and if these can be joined with fossil records of the parasites

also it is still more fortunate. This cannot be expected in many cases, but there is prospect of some success in such study of bones of Vertebrata and their lesions (Moodie, 1923; Rupper, 1921), of conifers and their distortions caused by Peridermiums and Mycorrhizae, of some other plants and their scars from fungus diseases, of many plants and their insect galls and probably of still other groups of animals and of plants showing fossil records of parasites.

This paper may well close by suggesting as samples one or two special problems favorable for attack by the host-parasite method. We have already noted crucial data presented by parasites of several groups as to the problem of east and west routes of dispersal in the Southern Hemisphere. The parasites of both plants and animals which show families, genera, and especially species, common to different southern lands, and southern lands only, may well be studied further. Such studies should finally determine not only the question of the former existence of such east and west migration routes, but also their position, their connections and their geologic time. On the other hand, if in some groups the dispersal was southward from northern lands, this fact will be demonstrated beyond dispute. Let us note here a partial list of species, genera, and families of southern occurrence whose parasites of all kinds should be studied (*cf.* figs. 1, 2 and 3).

Mammalia

The marsupials of Australia and of America (mostly tropical America).

Their biting lice (Mallophaga) have been somewhat studied, so also their flukes (Trematoda) and tapeworms (Cestoda).

The porcupines (Hystricomorpha) of America (mostly tropical America) and of Africa.

Edentata (sloths and anteaters) in South America, South Africa, southern India, Malaysia.

Birds

Struthionidae (ostrich family) with species—2 in New Zealand, 2 in Australia, 1 in Papua, 2 in South America, 1 in Madagascar.

Trogonidae (the quetzal and its relatives) in South America, Central America, Africa, and southern India.

Chionidae (sheathbills) Antarctic Islands

Psittacomorphae (parrots) in the Southern Hemisphere, with "stragglers" in North America and some in India.

Paristeropodes (a group of fowls) in Australia and South America.

The Ocydromine Rallidae (rails) 3 in Australia, *Heterochloa* in New Zealand and also in Madagascar.

Avocets and stilts in Australia, New Zealand, South America and Africa.

Penguins in Australasia (including New Zealand and its Antarctic islands), South America, Africa, Antarctica, Antarctic islands in general, including St. Paul in the Indian Ocean. It is interesting to note

that six species of fossil penguins were found in Graham Land by the Swedish Antarctic Expedition. In this connection note also that fossil Spheniscidae are known from New Zealand and Patagonia.

Reptiles

Giant tortoises in Galapagos Islands and in Malaysia.

Amphibia

Anura

Leptodactylidae (southern frogs) in South America, Central America, West Indies, Australia, Tasmania, Papua, South Africa.

Hylidae (tree frogs) in America (mostly tropical America), Australia, Tasmania, Papua, 1 species with several subspecies in Euro-Asia.

Pipidae (Surinam toad, etc.) in Guiana and South Africa.

Archaic Bufonidae, of other genera than *Bufo*, in Australia, northwestern South America, Central America, tropical Africa, southern India, Ceylon, Malaysia.

Gastrophrynidae, in Papua, tropical America, Africa, Madagascar, southern India, Ceylon, Siam.¹

Dendrobatinae in northwestern South America, southern Central America, western Africa, Madagascar.

Urodeles

Coccolidae (blindworms) in tropical America, tropical Africa, southern India, Ceylon, western Malaysia.

Freshwater fishes

Cichlidae in tropical South America, Central America, Cuba, Africa, Madagascar, southern India, Ceylon.

Characinae in tropical America and tropical Africa.

Galaxiidae in New Zealand, Australia, South America, the Falkland Islands, southern Africa. The genus *Galaxias* occurs in New Zealand, Tasmania, southern Australia, the southern extremity of South America, the Falkland Islands.

Osteoglossidae in South America and South Africa.

Haplochromidae in South America and South Africa.

Dipnoi (lung fishes) in South America, tropical Africa, Australia.

Molluscs

Tertiary fossil species common to New Zealand and South America are named by Chilton (1909) as follows: *Epitonium rugulosum lyratum*, *Crepidula gregaria*, *Turitella ambulacrum*, *Cucullaea alta*, *Venericardia patagonica*, *Brachydontes magellanica*. This community of species is of much interest and suggests a review of modern littoral mollusca and their parasites from the two regions.

Arthropods

Insects

Ants—*Notomyrmes* in New Zealand and Chili, *Prolasius* in New Zealand and its close relatives, *Acanthoponera* and *Lasiophares*, in South America. The following annotation from Emery (1895) is worth noting:

Chili is, however, an isolated country, which we may call "a continental island," although it is not surrounded by water. If we should take the Chilean fauna as a standard for the primitive fauna of

¹The report of a gastrophrynid from Samoa is questioned.

von Ihering's Archiplata, that should have been a very poor one, like the fauna of New Zealand, with which it offers a striking resemblance. The most characteristic feature of the Chilean ant fauna is the occurrence of peculiar species of *Monomosium*, like those inhabiting Australia and New Zealand, and of the genus *Melophorus* found only in Australia and New Zealand. These facts corroborate the hypothesis of a Cretaceous or Eocene connection between South America and Australia.

New Zealand appears as a bit of old Australia, quite free from later Papuan or Indian intrusions, like Madagascar, which as an isolated part of old Africa, had received but a few immigrants, when, at the Pliocene epoch, a stream of Indian life entered into the Ethiopian continent. Probably Chili may be considered as a part of ancient Archiplata, secured from Guyanean and Brazilian immigrants by the heights of the Cordillera, but having preserved only an incomplete set of the original Archiplatean fauna.

Beetles—*Longicornia* in Australia, New Zealand, South America;
Buprestidae in Australia, New Zealand, South America.

Flies—*Zaluscoidea* in the Auckland Islands; the closely related genus *Zalusca* in Kerguelen.

Peripatus—in Australia, South and Central America, South Africa,
Peripatus (sensu stricto) in South America and South Africa.

Arachnoidea (spiders, etc.)

Myro (a spider) with species—2 in the Antarctic Islands of New Zealand, 1 on Kerguelen Island, 1 at the Cape of Good Hope.

Rubrius (a spider) Antarctic Islands of New Zealand, Tasmania, South America.

Pacificana cockayni (a spider) in the Antarctic islands of New Zealand; a related species in Tasmania and a closely related species at Cape Horn.

Cryptostemma westernmanni (?) in tropical America and tropical Africa.

Cercoponius (a scorpion) in Australia, South America.

Crustacea—Land and freshwater forms:

Parastacid crayfishes in Australia, New Zealand, South America (with one "wanderer" in California), Madagascar. Their gill flukes have been studied by Harrison, so also their Histriobdellidae.

Trichoniscus, a subantarctic genus. One species occurs in the subantarctic islands of New Zealand, Fuegia, Falkland Islands.

Deto in Australia, New Zealand, Chatham Islands, Auckland Islands, Chili, Cape of Good Hope, St. Paul Island. The species *D. aucklandiae* occurs in New Zealand and Chili.

Idotoca lacustris in New Zealand, Campbell Island, the Straits of Magellan.

Annelid worms. Many of the commonest New Zealand polychaetous annelids are identical with those of Magellan Strait, Fuegia and Chili. A comprehensive study of these worms and their parasites from these regions should prove of much value. Chilton (1909) says "of 13 species in the subantarctic islands of New Zealand only 2 are endemic in New Zealand, 8 are found in South America or the Falkland Islands, and 2 extend to Kerguelen".

Plants have not been studied through their parasites by the von Thuring method. On the chance of possibly interesting some botanists it may be worth while to list a few plants of interest in connection with southern dispersal. The forms listed seem to indicate: some a dispersal from northerly lands southward, but many more a dispersal eastward or westward between southern lands, some by way of Antarctica. Omitting less conspicuous forms, note the following ferns and flowering plants:

Ferns

- Polytrichum vestitum*—Australasia, South America, islands of southern Pacific Ocean.
P. richardi—Australasia, Southern Pacific islands.
Asplenium flaccidum—Australasia, South America, Africa.
Blechnum penamarina—Australasia, South America.
B. capense—Australasia, South America, Africa.
Hestcopteris incisa—cosmopolitan in the tropics.
Pteridium esculentum—Australasia, South America.
Polypodium billardieri—Australasia, Malaysia, South America, Africa.
Hymenophyllum ferrugineum—Australasia, South America.
H. tunbridgense—Australasia, South America, Africa.
Dryopteris punctata—Australasia, South America, islands off South Africa.
Polystichum adiantiformae—Australasia, South America, southern Pacific islands.
Asplenium adiantoides—Australasia, Africa, islands of southern Pacific.
Poesia scaberula—Australasia, Africa.

Flowering plants

- Cypresses: *Callitris* in Africa, Madagascar, Australasia; *Fitzroya* in Chile, Tasmania.
Hierochloa redolens (grass), Australasia, South America, southern Pacific islands.
 Monimiaceae: Tasmania, New Caledonia, New Zealand, Madagascar.
 Saxifragaceae—35 genera in Australasia, Madagascar, South Africa and South America, only 2 of which cross the equator.
 Proteaceae: 48 genera, 950 species in South America; 32 genera, 250 species in South Africa.
 Verbenas: *Petraca* in South America, Timor, Java; *Petracoviter*, (a close relative) in Bouru and Amboina.

Species common to Australasia and South America:

Sedges as follows: *Scirpus inundatus* (extending to islands of the south Pacific), *Carex darwinii*, and its subspecies *wrolepsis*, *C. trifida*; *Luzula racemosa*; *Luzuriaga parviflora* (Liliaceae); *Colobanthus quitensis*; *Crassula moschata*; *Geum parviflorum*; *Sophora tetraptera* (the kowhai tree); *Oxalis magellanica*; *Geranium sessiflorum*; *Pelargonium australe*, (New Zealand, Australia, Tristan da Cunha); *Coriaria ruscifolia*, *C. thymifolia*; *Epilobium conjugens*; *Veronica elliptica*.

Genera common to Australasia and South America:

Drimys (3 species in New Zealand, 1 in Tasmania, 1 in Fuegia, 1 Tertiary fossil, *D. antarctica*, in Graham Land); *Araucaria* (1 Australasian, 2 South American, Norfolk Island 1, New Caledonia several, 1 fossil, *A. imponentis*, in Antarctica, also 2 related fossils *Araucaritis* and *Dadoxylon*); *Lomatia* (6 species in Australia and Tasmania, 3 in Chili, also 4 Tertiary fossil species in Antarctica); *Embothryum* (1 Australian, 4 South American); *Prionites* (1 each Tasmania and Fuegia); *Eucryphis* (1 Tasmania, 1 Australia, 2 Chili); and others—*Leptocarpus*, *Orites*, *Aristolochia*, *Drapetes*, *Terpniatia*, *Myosotis*, *Phyllaceus*, *Lagenophora*, *Leptinella*, *Enargea*, *Luzuriaga*, *Geranium*, *Azarella*; *Orcomyrrhis*, *Pernettia*, *Plantago* (subgenus *Plantaginella*), *Orcobolus*, *Carpha*, *Uncinia*, *Gaimarcia*, *Marsippospermum*, *Rostkovia*, *Libertia*, *Nothophagus* (Tertiary fossils, 4 species in Antarctica), *Caltha* (*Psychrophila*), *Drosera* (one subgenus), *Eucryphia*, *Gunnera*, *Prionotes*, *Tetrachondra*, *Pratia*, *Donatia*, *Abrolanella*.

Genera common to New Zealand and South America:

Griselinia (4 species in Chili, 2 in New Zealand); *Ourisia* (19 in South America, 8 in New Zealand); *Discaria* (18 in temperate South America, 1 in New Zealand, 1 in Australia); *Gaya* (10 in South America, 1 in New Zealand); *Fuchsia* (60 American from Mexico to Fuegia, 3 in New Zealand); *Jovellana* (2 in Chili and Peru, 2 in New Zealand); *Phrygilanthus* (20 in South America, 2 in New Zealand, 4 in Australia); *Muchlenbeckia* (10 in South America, 4 in New Zealand, 7 in Australia, one of them extending to New Zealand, 1 in the Solomon Islands); *Laurelia* (2 in southern Chili, 1 in New Zealand, 1 fossil in Graham Land, Antarctica); *Dacrydium* (many in New Zealand, 1 in Chili); *Pseudopanax* (5 in New Zealand, 2 in southern Chili).

Two paragraphs from Cheesman (1909) might be quoted:

Of 37 species of flowering plants and ferns known from the Kerguelen-South Georgia region, 20 are found also in the subantarctic islands of New Zealand while 27 are found in Fuegia and the Falkland Islands. The total number of Fuegian plants found in the subantarctic islands of New Zealand is 29, 14 of these extending also to the Kerguelen and South Georgia groups of islands. These figures deal only with the specific identity; if we consider the genera, we find that, out of 88 genera found in the subantarctic islands of New Zealand, there are no less than 56 with representatives in Fuegia.

Eleven species of plants found in the subantarctic islands of New Zealand are found either in the Tristan da Cunha group in the South Atlantic or in the Amsterdam Island group in the Indian Ocean, the flora of these two groups possessing many points of agreement notwithstanding their wide separation and showing also undoubted traces of affinity with those of Fuegia and Kerguelen. Two of these 11 species, however, do not occur in Fuegia or the Kerguelen-South Georgia group of islands.

What parasites, if any, can best be studied to test and extend the significance of the distribution of these and other southern hemisphere plants? Will they be some group or groups of fungi? Will predatory

insects of restricted food habits help? Will gall-forming insects give some light? How about nematodes? Will plant-feeding snails help?

The last few pages have noted a few sources of data for but one set of problems connected with the biogeography of the Southern Hemisphere. There are many other problems and groups of problems. Let us mention only one other.

It is thought that in Cretaceous times there was a strip of land running north from Japan, Korea and Kamchatka, crossing the

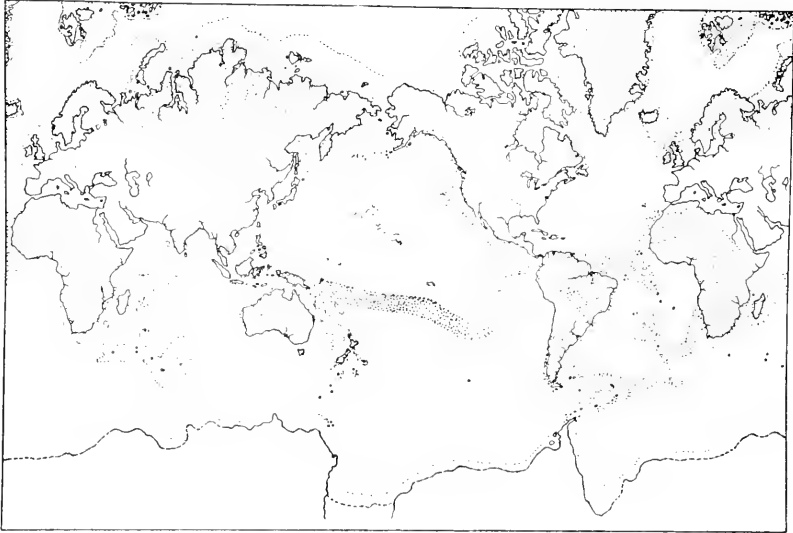

FIG. 4.—Hypothetical composite map of the Pacific Ocean and adjacent lands during Cretaceous times, showing the land-strip bounding this ocean on the north and east and extending westerly from South America across the southern Pacific to Papua and Australia. Not all parts of this land-strip were in existence at any one time, the northern portions being mostly earlier, the South-Pacific bridge being later, perhaps early Tertiary. (Compiled from several authors, chiefly Arldt.)

northern Pacific Ocean and running down the west coast of America to Ecuador and the Galapagos Islands (fig. 4). This circumpacific land strip may have connected at its southwestern end with the northern Malayan region (*cf.* fig. 2). It is thought to have connected with Eastern Asia in perhaps numerous places. It may have included the Aleutian Islands or may have lain mostly to the south of them. The mountainous islands of western Alaska, Vancouver Island, the Olympic mountains and the Siskiyou mountains of Northern California were probably included; so also may have been Mount Tamalpais, the Presidio Hill, the southern California islands, the tip of Lower California

and the middle portion of Central America where the mountain ranges have an east and west trend. Upon the American portion of this circumpacific land strip is a very interesting relict fauna and flora including, to name but a very few, the bell-toad *Ascaphus* (an immigrant from Euro-Asia who brought with him his characteristic Euro-Asian bell-toad parasite, *Protoopalina*, of an ancient subgenus) and a number of plants, conspicuous among which are several pines—the Monterey Pine, the Torrey Pine, *Pinus jeffreyi*. Study of these western relict pines and their rust and other parasites and comparison with East Asian pines and their parasites might prove of much importance. We should remember, too, that the Peridermiums of pines produce lesions which should be recognizable if preserved as fossils.

LITERATURE CITED

- ANDREWS, JUSTIN M. 1927. Host-parasite specificity in the Coccidia of mammals. Journ. Parasitology, Vol. 13, No. 3, March.
- CHEESMAN, T. F. 1906. Manual of the New Zealand flora.
- 1909. Systematic botany of the islands south of New Zealand. The Subantarctic Islands of New Zealand, Vol. I, Wellington, N. Z., John Murray, Govt. Printer.
- CHILTON, CHARLES. 1909. The biological relations of the subantarctic islands of New Zealand. (Summary of results). The Subantarctic Islands of New Zealand, Vol. II, Wellington, N. Z., John Murray, Govt. Printer.
- COCKAYNE, L. 1907. Report on a botanical survey of Kapiti Island. Dept. of Lands, New Zealand Govt.
- 1908. Report on a botanical survey of the Tongariro National Park. New Zealand Dept. of Lands.
- 1908a. Report on a botanical survey of the Waipoua Kauri Forest. New Zealand Dept. of Lands.
- 1910. New Zealand plants and their story. N. Z. Board of Science and Art, Manual No. 1, Wellington. John Murray, Govt. Printer. This edition is preferable to the later one.
- 1921. The vegetation of New Zealand. W. Engelmann, Leipzig.
- DARLING, S. J. 1921. The distribution of hookworms in the zoological regions. Science, Vol. 53, April 8.
- 1925. Comparative helminthology as an aid in the solution of ethnological problems. Amer. Journ. Trop. Med., Vol. 5.
- DUNN, E. R. 1925. The host-parasite method and the distribution of frogs. The American Naturalist, Vol. 59, No. 663, July-August.
- EMERY, C. 1895. On the origin of European and North American ants. Nature, Vol. 52, Aug. 22.
- EWING, H. E. 1924. On the taxonomy, biology and distribution of the biting lice of the family Gyropidae. Proc. U. S. Nat. Mus. Vol. 63, Mch. 4.
- 1924a. Lice from human mummies. Science, Vol. LX, No. 1556.
- 1926. A Revision of the American lice of the genus *Pediculus*, together with a consideration of the significance of their geographical and host distribution. Proc. U. S. Nat. Mus., Vol. 68, June 10.

- FORBES, H. O. 1893. The Chatham Islands. Their relation to a former southern continent. Abstract in Nat. Sci. Vol. 3.
- GADOW, HANS. 1909. Amphibia and Reptilia. Cambridge Natural History.
- HARRISON, LAUNCELOT. 1911. The taxonomic value of certain parasites. Abstract in Ann. Rep. Sydney Univ. Sci. Soc., 1911-1912.
- 1914. The Mallophaga as a possible clue to bird phylogeny. Austral. Zoologist, Vol. 1, No. 1.
- 1915. Mallophaga from Apteryx, and their significance. Parasitology, Vol. 7, No. 1.
- 1915a. The relation of the phylogeny of the parasite to that of the host. Abstract in Rep. Brit. Assoc. Adv. Sci., 1915.
- 1916. Bird-parasites and bird-phylogeny. Ibis, April, 1916. Abstract and discussion in Bull. CCXII. Brit. Ornith. Club.
- 1922. On the Mallophagan family Trimenoponidae, with a description of a new genus and species from an American marsupial. Austral. Zoologist, Vol. 2, No. 4.
- 1924. The migration route of the Australian marsupial fauna. Austral. Zoologist, Vol. 3, No. 7.
- 1926. Crucial evidence for antarctic radiation. Amer. Naturalist, Vol. 60.
- 1928. On the genus *Stratioidrilus*. Records Austral. Mus., Vol. 16.
- 1928a. Host and parasite. Presidential address. Proc. Linn. Soc. New South Wales. 1928, No. 1.
- "in press" in 1928. The composition and origins of the Australian fauna, with special reference to the Wegener hypothesis. Rep. Austral. Assoc. Adv. Sci., Perth, 1926.
- HEGNER, R. W. 1928. The evolutionary significance of the protozoan parasites of monkeys and man. Quat. Rev. Biol., Vol. 3, No. 2, June.
- IHERING, H. VON. 1891. On the ancient relations between New Zealand and South America. Trans. & Proc. New Zea. Inst., Vol. 24.
- 1902. Die Helminthen als Hilfsmittel der zoogeographischen Forschung. Zool. Anzeig., Vol. 26, Oct. 27.
- JOHNSTON, S. J. 1913. Trematode parasites and the relationships and distribution of their hosts. Rep. Austral. Assoc. Adv. Sci., Melbourne.
- 1914. Australian trematodes and cestodes; a study in zoogeography. Med. Journ. Austral., Sept. 12. Abstract in Proc. Brit. Assoc. Adv. Sci., Australia.
- 1916. On the trematodes of Australian birds. Proc. Roy. Soc. N. S. Wales, Vol. 1.
- KELLOGG, VERNON L. 1896. New Mallophaga, I. Proc. Calif. Acad. Sci., Vol. 6.
- 1905. Insects. New York, Henry Holt.
- 1913. Distribution and species-forming of Ectoparasites. Amer. Naturalist, Vol. 47.
- 1913a. Ectoparasites of the monkeys, apes and man. Science, N. S., Vol. 38.
- 1914. Ectoparasites of mammals. Amer. Naturalist, Vol. 48, May, 1914.
- KELLOGG & KUWANA. Mallophaga from birds. Proc. Wash. Acad. Sci., Vol. 4, Sept. 30.
- LONGMAN. 1924. The zoogeography of marsupials. Mem. of Queensland Mus., Vol. 8, No. 1, Jan. 30.

- MATHEW, W. D. 1915. Climate and evolution. *Ann. N. Y. Acad. Sci.*, Vol. 24, Feb. 18.
- METCALF, M. M. 1920. Upon an important method of studying problems of relationship and of geographical distribution. *Proc. Nat. Acad. Sci.*, Vol. 6, No. 7, July.
- 1922. The host-parasite method of investigation and some problems to which it gives approach. Abstract in *Anat. Record*, Vol. 23, No. 1, January.
- 1922. Animal distribution and ancient distribution routes. Lectures upon evolution and animal distribution, *Univ. Buffalo Studies*, Vol. 2, No. 4, Dec.
- 1923. The opalinid ciliate infusorians. *Bull. 120, U. S. Nat. Mus.*, June 15.
- 1923a. The origin and distribution of the Anura. *Amer. Naturalist*, Vol. 57, Sept.-Oct.
- 1923b. The host-parasite method and problems in which it is useful. Abstract in *Anat. Record*, Vol. 26, No. 5, Dec. 20.
- 1924. The opalinid parasites and the geographical distribution of the bell-toads (*Discoglossidae*), with a criticism of the age and area hypothesis. Abstract in *Anat. Record*, Vol. 29, No. 2, Dec. 28.
- 1926. Larval stages in a protozoan. *Proc. Nat. Acad. Sci.*, Vol. 12, No. 12, Dec.
- 1928. The bell-toads and their opalinid parasites. *Amer. Naturalist*, Vol. 62, Jan.-Feb.
- 1928a. Trends in evolution. A discussion of data bearing upon "orthogenesis." *Journ. Morphol. & Physiol.*, Vol. 45, No. 1, March 5.
- MOODIE, R. L. 1923. *Paleopathology*. Univ. Chicago Press.
- NOBLE, G. K. 1922. The phylogeny of the Salientia. *Bull. Amer. Mus. Nat. Hist.*, Vol. 46.
- 1925. The evolution and dispersal of frogs. *Amer. Naturalist*, Vol. 59, May-June.
- OLIVER, W. R. B. 1925. Biogeographical relations of the New Zealand region. *Journ. Linn. Soc.*, Vol. 47, No. 313, Sept. 16.
- ORTMANN, A. E. 1896-1899. *Tertiary invertebrates*. Rep. Princeton Univ. Expedition to Patagonia.
- 1901. Theories of origin of Antarctic fauna and flora. *Amer. Naturalist*, Vol. 35.
- 1902. The geographical distribution of freshwater decapods and its bearing upon ancient geography. *Proc. Amer. Philos. Soc.*, Vol. 41, No. 171, April-Dec.
- RUFFER, M. A. 1921. *Paleopathology of Egypt*. Univ. Chicago Press.
- SCHENCK, H. 1905. Ueber Flora und Vegetation von St. Paul und Neu Amsterdam. *Wiss. Ergeb. Deutch. Tiefsee-Expedition*, Vol. 2, T. 1, Lief 1.
- 1905a. Vergleichende Darstellung der Pflanzengeographie der subantarktischen Inseln insbesondere ueber Flora und Vegetation von Kerguelen. Same reference as Schenck (1905).
- 1907. Beiträge zur Kenntniss der Vegetation der Canarischen Inseln. Lief. 2, of same publication as Schenck (1905).
- SKOTTSBERG, CARL. 1915. Notes on the relations between the floras of subantarctic America and New Zealand. *Plant World*, Vol. 18, No. 5, May.

- WARD, H. B. 1926. The needs and opportunities in parasitology. *Science*, Vol. 64, No. 1654. Sept. 10.
- WENYON, C. M. 1926. *Protozoology*. London, Bailliere, Tindall & Cox.
- WHEELER, W. M. 1927. The ants of Lord Howe Island and Norfolk Island. *Proc. Am. Acad. Arts & Sci.*, Vol. 62, No. 4. May.
- WILLIAMS, H. U. 1909. The epidemic of the Indians of New England, 1616-1620, with remarks on native American infections. *Johns Hopkins Hospital Bull.*, Vol. XX, Nov.
- ZSCHOKKE, F. 1899. Neue Studien an Cestoden aplacentaler Säugetiere. *Zeitsch. f. w. Zool.* Bd. 65, Heft 3, Feb. 14.
- 1907. *Monezia diaphana* n. sp. Ein weiterer Beitrag zur Kenntniss der Cestoden aplacentaler Säugetiere. *Central bl. f. Bakt.*, Vol. 44.

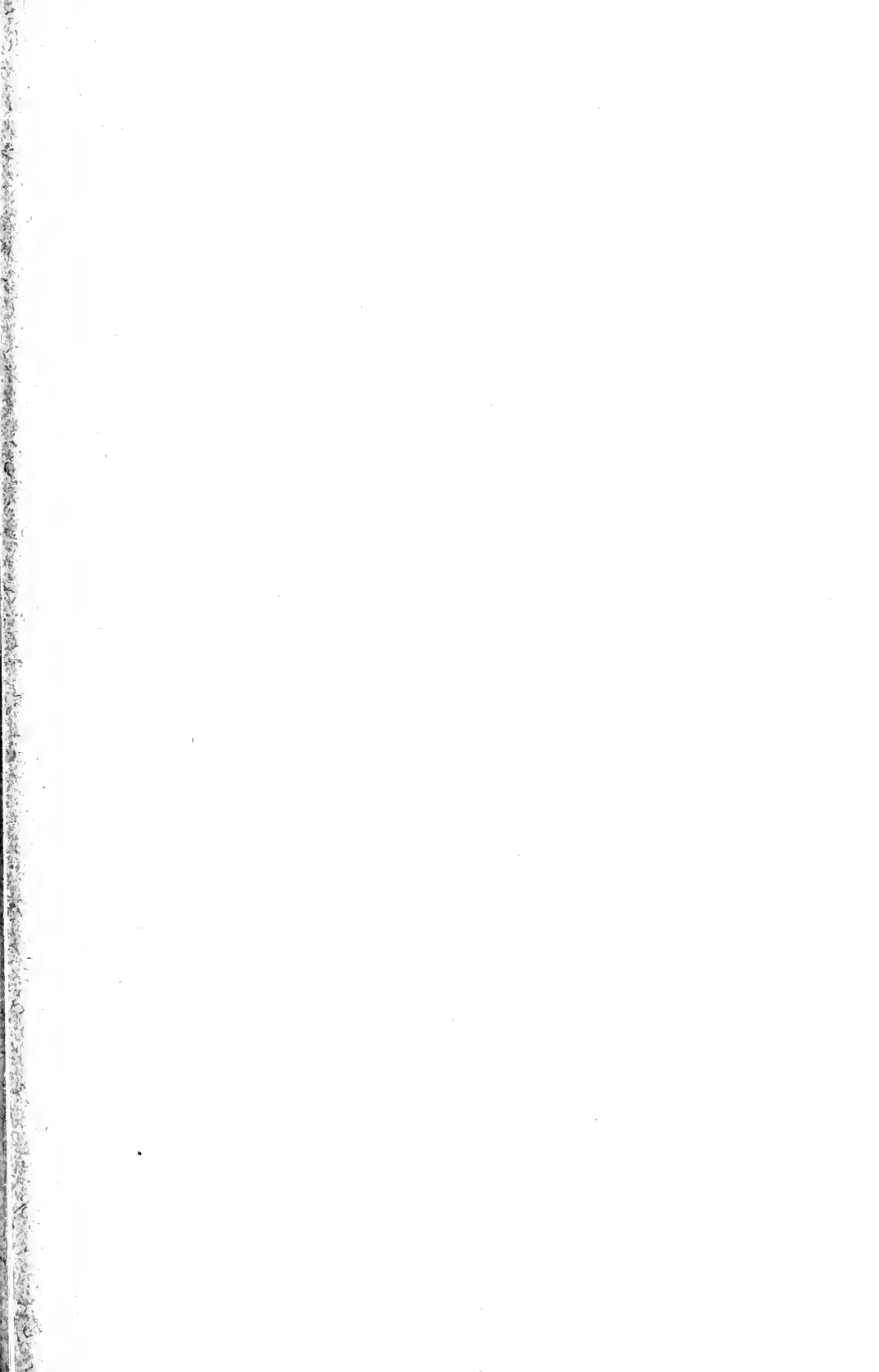



SMITHSONIAN MISCELLANEOUS COLLECTIONS

VOLUME 81, NUMBER 9

A SECOND COLLECTION OF MAMMALS
FROM CAVES NEAR ST. MICHEL, HAITI

(WITH TEN PLATES)

BY

GERRIT S. MILLER, JR.

Curator, Division of Mammals, U. S. National Museum



(PUBLICATION 3012)

CITY OF WASHINGTON

PUBLISHED BY THE SMITHSONIAN INSTITUTION

MARCH 30, 1929

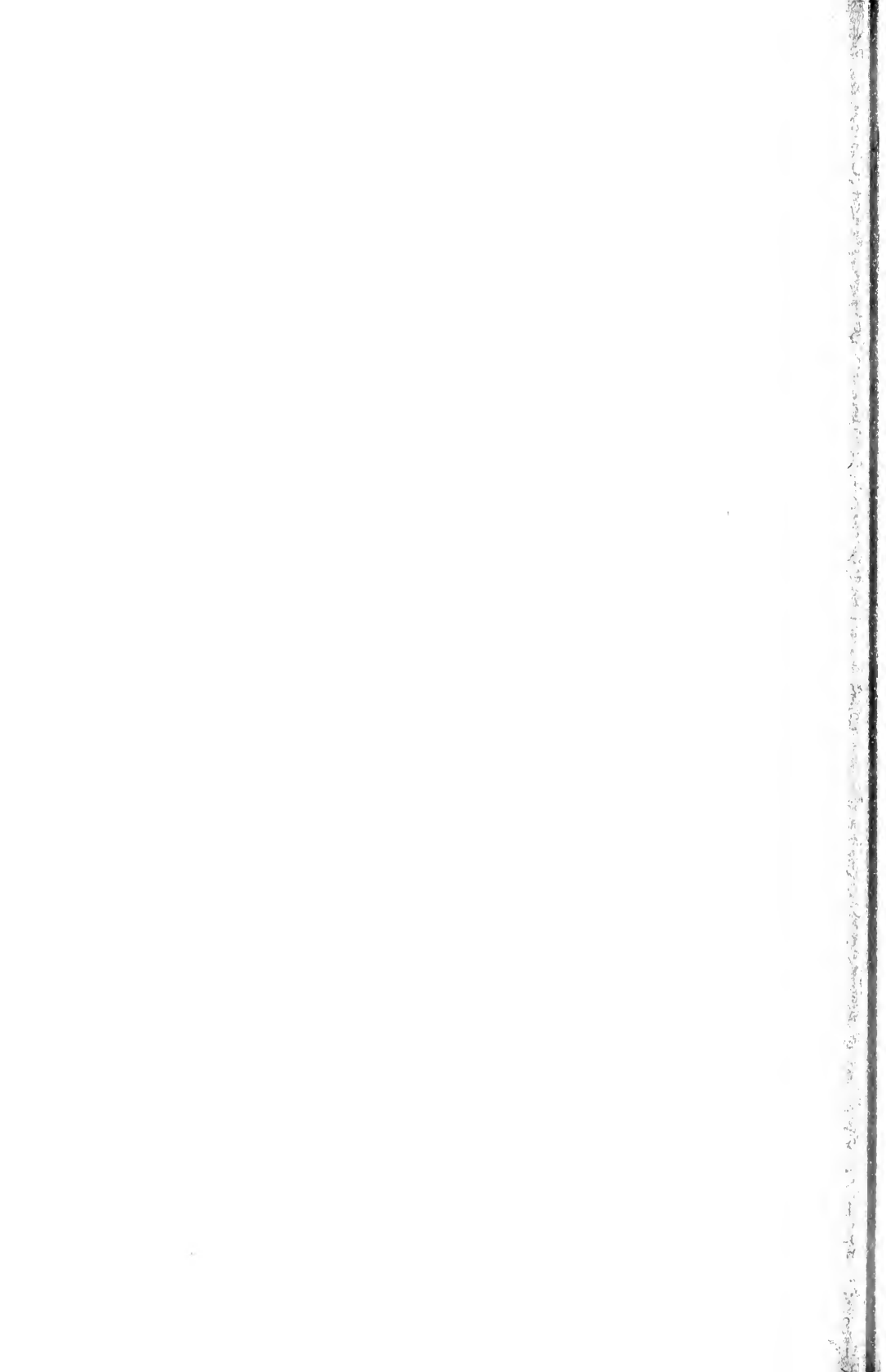

SMITHSONIAN MISCELLANEOUS COLLECTIONS
VOLUME 81, NUMBER 9

A SECOND COLLECTION OF MAMMALS FROM CAVES NEAR ST. MICHEL, HAITI

(WITH TEN PLATES)

BY

GERRIT S. MILLER, JR.

Curator, Division of Mammals, U. S. National Museum



(PUBLICATION 3012)

CITY OF WASHINGTON
PUBLISHED BY THE SMITHSONIAN INSTITUTION
MARCH 30, 1929

The Lord Baltimore Press
BALTIMORE, MD., U. S. A.

A SECOND COLLECTION OF MAMMALS FROM CAVES NEAR ST. MICHEL, HAITI

By GERRIT S. MILLER, JR.

CURATOR, DIVISION OF MAMMALS, U. S. NATIONAL MUSEUM

(WITH 10 PLATES)

Six years ago I published a short account of some bones of mammals from the floor material of two caves situated near St. Michel, north-central¹ Haiti (Smithsonian Misc. Coll., Vol. 74, No. 3, pp. 1-8, October 16, 1922). The small collection on which that paper was based had been made in 1921 by Mr. J. S. Brown and Mr. W. S. Burbank with the object of determining whether the caves contained deposits sufficiently rich in the remains of extinct vertebrates to justify a special expedition for their careful study. The few specimens brought home proved to be of so much interest that I visited Haiti in the spring of 1925, spending about four weeks at the plantation of l'Atalaye near St. Michel. A general account of this field-work appeared in Smithsonian Miscellaneous Collections, Vol. 78, No. 1, pp. 36-40, April 8, 1926. The following pages contain descriptions of the remains of mammals which I collected.

Concerning the caves themselves there is nothing important to add to the notes made by Mr. Brown and Mr. Burbank. Two smaller caves were found close to the large cavern near the town of St. Michel. One of these has the entire roof fallen in so that very little of the original floor material could be investigated. The other was in good condition for working, and the deposits which it contained proved to be exceptionally rich. Locally the region in which this group of caves is situated is known as St. Francisque. The cave in the dry valley north of the Atalaye plantation had been completely worked out for guano since it was examined by Mr. Brown and Mr. Burbank. Thus the interesting bone deposit which it contained had been almost totally destroyed. Nevertheless I succeeded in finding a few specimens scattered among the sifted limestone fragments with which the

¹Not "at the northwest end" of the republic as I wrongly stated in my general account of the region.

floor is now covered to a depth of nearly 10 feet. On the top of the ridge bounding the west side of this valley are situated at least three caves which had not been previously examined. One of these has no opening other than a hole in the roof about 6 x 10 feet in diameter. The chamber beneath this hole appeared to extend downward more than 20 feet. Its lateral extent could not be determined, and I made no attempt to explore it. One of the other caves is unusually deep, while the third is of more normal form, but rather narrow and crooked. In both I found abundant remains of extinct mammals.

In all of these caves the deposits began at or near the surface and continued downward to a depth of about four feet. The bones then ceased, and further digging proved so fruitless that it was nowhere continued to rock bottom. Wherever bones occurred the deposit could be discovered in a few minutes' work with shovel or trowel; and at any spot where the first few minutes' digging revealed nothing the result of further excavation to a depth of six feet was fruitless. Mr. Brown and Mr. Burbank had previously found this to be the case.

Before going to St. Michel I spent a day working in a cave at Diquini, near Port-au-Prince. The conditions there appeared to be exactly the same as in the large cave at St. Francisque, but no bones were found other than a few remains of domestic goat and pig in the most superficial layers, and recent bats and introduced rodents in fresh owl pellets. Why this cave should have been barren of the extinct fauna which occurs so abundantly in those near St. Michel is a question to which I cannot suggest an answer.

Since this paper was written the St. Michel caves have been again visited in the interests of the National Museum. The generosity of Dr. W. L. Abbott enabled Mr. Arthur J. Poole, Scientific Aid, Division of Mammals, to spend the period from December 15, 1927, to March 15, 1928, in carrying on excavations which have probably resulted in exhausting the bone deposits. Inspection of the very rich material which he brought back to Washington shows that, in general, these new collections confirm the conclusions which I had reached after study of the specimens that I obtained myself. Such additional facts as they bring to light pertain chiefly to details concerning some of the new forms which I had already described in manuscript. I have therefore concluded to publish this paper as it was originally written, except for the account of the ground sloths, animals for whose understanding my material proves to have been so inadequate as to have led to conclusions which I now believe to have been wrong.

INSECTIVORA

Insectivores of the genus *Nesophontes* are abundantly represented in the Haitian caves. They have not previously been recorded from the island of Hispaniola. In the superficial layer of the cave floors the bones of these animals occur in undisturbed material along with remains of *Epinys rattus* and *Mus musculus*. This association is so intimate that there appears to be no reason to doubt the simultaneous occurrence of the insectivores and the introduced rodents. Some of the jaws of *Nesophontes* are more fresh in appearance than some of the jaws of *Rattus* near which they were found. Whether or not *Nesophontes* now exists alive is a question which for the present cannot be answered. No bones of insectivores have been found in any of the numerous fresh owl pellets which I have examined. It seems not improbable, however, that if any part of the island remains uninvaded by the roof rat, the native animal might now be found to exist there.

It is a noteworthy fact that up to the present time no remains of *Solenodon* have been found in any of the caves. This animal is so much larger than *Nesophontes* that its absence from deposits which are mostly owl-made might at first be thought to be due to this circumstance. Its size, however, is no greater than that of several of the rodents which were freely eaten by the extinct giant barn owl, of whose refuse the bone deposits chiefly consist. While it is therefore impossible to suggest any reasonable explanation of the absence of *Solenodon* bones, the fact of this absence is an important one because of its bearing on the question of the completeness of the faunal record preserved in the caves.

NESOPHONTES PARAMICRUS sp. nov.

Plate I, fig. 1

Type.—Skull, lacking postero-inferior portion of occiput; the following teeth in place: pm^2 , pm^1 , m^1 and m^2 of right side, m^1 and m^2 of left side. No. 253063, U. S. Nat. Mus. Collected at front of large cave near St. Michel, Haiti, March, 1925, by Gerrit S. Miller, Jr.

Diagnosis.—Size and general characters of skull and teeth as in the Cuban *Nesophontes micrus* G. M. Allen. Upper molars without the well-defined sulcus which, in *N. micrus*, lies between the base of metacone and posterior commissure of protocone; lower molars with metaconid and entoconid obviously less nearly terete than in the Cuban animal.

Skull.—The skull appears to be similar to that of *Nesophontes micrus*.

Teeth.—As compared with those of *Nesophontes micrus* the larger maxillary teeth are more robust in general form, a character resulting from the less rapid narrowing of the base of the protocone toward the lingual side of the tooth crown. This peculiarity is especially evident in m^1 and m^2 , but it is also visible in pm^1 . This general tendency toward robustness of the cusps appears to be responsible for the main dental peculiarity by which the Haitian and Cuban members of the genus are distinguished from each other. In *Nesophontes micrus* there is always present, up to the time when this portion of the crown is destroyed by wear, a distinct and often wide notch at the point where the posterior margin of the protocone joins the base of the metacone. In *N. paramicrus* the bases of the two cusps are so large and well filled-out that they come together directly and smoothly or with at most a faintly developed intervening transverse crease. The same general features are present in the mandibular teeth, where the cusps show a uniform tendency to be heavier and less nearly terete than in the Cuban animal, characters best appreciated on comparison of the mataconid and entoconid of the two species. The heels of the lower molars are quadrangular (longer than broad) rather than squarish in outline and the bottoms of the central convexities tend to be rather broadly rounded instead of narrowly infundibuliform.

Measurements.—Type: greatest length, $32.4 \pm$; palatal length, 15.0; glenoid breadth, 12.4; interorbital breadth, 7.4; palatal breadth including molars, 9.2; front of canine to back of m^3 , 12.2; four molariform teeth (alveoli), 7.2.

Specimens examined.—Skulls, 2; left maxilla, 1; mandibles, 18; humeri, 9; femora, 10; innominate, 1.

Remarks.—This species is sharply differentiated from the Porto Rican *N. edithae* by its much smaller size, and from the Cuban *N. micrus* by the peculiarities of its teeth.

NESOPHONTES HYPOMICRUS sp. nov.

Plate 1, fig. 2

Type.—Nearly perfect skull (lacking auditory parts, incisors, canines and right median premolar) No. 253077, U. S. Nat. Mus. Collected in the deep cave near the Atalaye plantation, Haiti, March, 1925, by Gerrit S. Miller, Jr.

Characters.—Like *Nesophontes paramicrus* but constantly smaller (see pl. 1 and detailed comparisons under “remarks”); triangular outline of m^1 and m^2 in palatal aspect narrower; heels of mandibular molars shorter, their concavities narrowly funnel-shaped at base as in *N. micrus*.

Skull.—Except for its smaller size the skull appears to be essentially similar to that of *N. paramicrus*.

Teeth.—The upper teeth in four individuals differ constantly from the two specimens of *N. paramicrus* in the narrower triangular outline of the crowns of m^1 and m^2 . In the mandibular teeth the heel of each molar is shorter, though this character is usually more pronounced in m_1 and m_2 than in m_3 .

Measurements.—Type: greatest length, 27.6; condylobasal length, 26.8; palatal length, 12.8; glenoid breadth, 10.6; interorbital breadth, 5.8; palatal breadth including molars, 7.2; depth of braincase (median), 6.4; fronto-palatal depth behind molars, 5.2; front of canine to back of m^2 , 9.8; four molariform teeth (alveoli), 6.0.

Specimens examined.—Skulls, 4; left maxilla, 1; mandibles, 24; humerus, 1; femora, 6; innominates, 3.

Remarks.—That the original series of *Nesophontes* skulls from Porto Rico presents a range of variation in size which is unprecedented among other dilambdodont insectivores is well known. This fact has been attributed to sexual dimorphism and as such has been made a part of the diagnosis of the family *Nesophontidae* (see Anthony, Mem. Amer. Mus. Nat. Hist., n. s., Vol. 2, p. 365 “June” = October 12, 1918; Bull. Amer. Mus. Nat. Hist., Vol. 41, pp. 633, 635, December 30, 1919). The same conditions, though less well marked, were noticed by Anthony in a series of 33 skulls and 150 mandibles of the Cuban *Nesophontes micrus* (Bull. Amer. Mus. Nat. Hist., Vol. 41, p. 633, December 30, 1919). Through Mr. Anthony's kindness I have had the opportunity to examine the entire series of *Nesophontes* jaws in the American Museum of Natural History, and as the result of this examination I am convinced that the differences in size shown by the Cuban and Porto Rican series are probably not due to the same causes as those which have produced the analogous differences that occur in the Haitian material.

Among 26 jaws of the Porto Rican *Nesophontes edithæ* in sufficiently good state of preservation to give the two most important measurements, namely, distance from articular process to anterior face of first molar, and depth through coronoid process, these vary from 16.2 to 22.2 mm. and from 9.0 to 13.2 mm. respectively. This

is an unusually wide range of variation, but the steps by which it is accomplished are so small and the numbers of individuals are so evenly spaced along the series that the measurements present no features which suggest the inclusion of two species. The same is true of 48 jaws of the Cuban *Nesophontes micrus*. Here the range of variation in length from articular process to front of m_1 is from 12.2 to 14.6 mm. and that in coronoid depth is from 6.0 to 8.8 mm. One individual (teeth slightly worn) appears to be abnormally small, with the measurements 11.0 and 5.8 respectively; but apart from this exception the variations are remarkably uniform, and again there is nothing to suggest anything else than purely individual variation.

The series of 42 jaws from Haiti, in striking contrast, is readily separable into two lots on the basis of either one of three different measurements:¹ (a) distance from articular process to front of m_1 , larger form (13 specimens), 13.2-14.0, smaller form (18 specimens), 10.0-11.6; (b) depth through coronoid process, larger form (15 specimens), 7.6-8.8, smaller form (17 specimens), 6.0-7.0; (c) combined length of m_1 and m_2 , larger form (12 specimens), 4.50-4.85, smaller form (20 specimens), 3.70-3.85. The teeth in the smaller form are definitely reduced in size as compared with those of the larger individuals, a character which is immediately appreciable on comparison of specimens. In the Cuban and Porto Rican series the teeth tend to remain more constant throughout the series. Therefore in those smaller Cuban jaws which approach in size the maximum of the smaller Haitian form the teeth are obviously larger than in the latter. Finally there is no difference in the structure of the heel in the teeth carried by the large and small Porto Rican or Cuban jaws, while in the Haitian specimens an obvious difference is present.² Turning now to the skull and the maxillary dentition we find that the contrasts in size between the extremes of specimens from Cuba is about the same as that seen in those from Haiti. The teeth from Cuba, however, are alike in form from the largest to the smallest of 13 specimens, while in those from Haiti there is an obvious difference in the form of the triangular crown outline in the two largest as compared with five others. A final interpretation of these facts must await the

¹ Owing to the fact that some of the mandibles are imperfect it is impossible to obtain all three measurements from every individual.

² This is so constant that I made only one error in identifying, by this character alone, 26 jaws (18 *hypomicrus* and 8 *paramicrus*) submitted to me one at a time by an assistant. The specimens were examined under a magnifying power with which I was unfamiliar, this having the effect of destroying all sense of relative size.

accumulation of much more abundant material; but it now appears obvious that the variation in Haitian *Nesophontes* is different in character from that which is presented by the members of the genus occurring in Porto Rico and Cuba, and that the course which does least violence to probability may be followed by recognizing two species among the larger Haitian specimens, separated from each other by absolute differences in size and by easily appreciable structural characters of both maxillary and mandibular molar teeth, a condition which is not known to be due to sexual dimorphism in any insectivore.

NESOPHONTES ZAMICRUS sp. nov.

Plate 1, fig. 3

Type.—Anterior part of skull with complete palate (teeth lacking except pm^2 left and the molariform teeth of both sides) No. 253090. U. S. Nat. Mus. Collected in large cave near St. Michel, Haiti, March, 1925, by Gerrit S. Miller, Jr.

Characters.—Size much less than in any hitherto known member of the genus; palatal length, 10.6; four largest maxillary teeth, 5.0; four largest mandibular teeth, 5.6.

Skull.—Except for their smaller size the two imperfect skulls of this animal do not show any appreciable characters by which they can be distinguished from those of *Nesophontes hypomicrus*. The type gives the impression of greater slenderness, but this may be due to its small actual size. The ratio of palatal width to palatal length in the type is 54.7 and of palatal depth (at posterior margin) to palatal length is 37.7. In both of the two skulls of *M. hypomicrus* these ratios are 55.4 and 40 respectively, a difference which appears to be within the limits of reasonably looked-for individual variation. A greater difference is seen in the ratio of length from hamular process to depth including hamular process: 39.3 in *N. zamicrus*, 42.7 in *N. hypomicrus*. Still greater is that between the ratio of rostral width at level of canine to palatal length: 24.5 in *N. zamicrus*, 30.7 in *N. paramicrus*. Whether or not these peculiarities are anything more than individual is a question which must for the present remain open.

Teeth.—The teeth, except for their smaller size, resemble those of *Nesophontes hypomicrus* in all the characters which distinguish this animal from *N. paramicrus*.

Measurements.—Type: palatal length, 11.0; glenoid breadth, 7.8; interorbital breadth, 5.0; palatal breadth including molars, 5.8; front of canine to back of m^3 , 8.2; four molariform teeth (alveoli), 5.0.

Two mandibles: articular process to front of m_1 , 9.0 and 8.8; depth through coronoid process, 4.8 and 4.6; four molariform teeth (alveoli), 5.2 and 5.2.

Specimens examined.—Anterior portion of skull, 1 (type); median portion of skull (rostrum broken away at level of pm^1), 1; mandibles, 2; humerus, 1.

Remarks.—In their extremely small size the specimens which I refer to *Nesophontes zamircus* are sharply set off from all the other material which I have examined. In the type and one mandible the teeth are just beginning to wear; in the second skull and second jaw the process is distinctly more advanced. The series of *N. hypomicrus* includes individuals representing exactly the same stages but showing no approach to the diminutive size of the smallest animal.

CHIROPTERA

Many bones of bats occur in the deposits. While some of these must have come from individuals which inhabited the caves and died there, most of them were probably dropped in owl pellets. The species are all, with one exception, known to be present inhabitants of the island. The one exception is a local form of a genus not hitherto found living elsewhere than in Cuba. There is no reason to suppose that it is extinct in Hispaniola.

CHILONYCTERIS PARNELLII PUSILLUS G. M. Allen

One skull from owl pellets in the cave at Diquini.

MORMOOPS BLAINVILLII CINNAMOMEA (Gundlach)

Three skulls from the larger cave near St. Michel. All in superficial deposit, one of them in a fresh owl pellet.

MACROTUS WATERHOUSII WATERHOUSII Gray

Three skulls and five mandibles from the large cave near St. Michel. One mandible from the small cave. All in superficial deposits. Four skulls from owl pellets in the cave at Diquini.

MONOPHYLLUS CUBANUS FERREUS Miller

A skull, lacking all the teeth except m^1 right and pm^1 and m^1 left, was found among the owl pellet material from the cave at Diquini.

This specimen is unique among the many skulls of *Monophyllus* which I have examined in possessing the well-developed alveolus of a

simple premolar immediately behind the alveolus of the canine. The cavity is closely crowded between the alveolus of the canine and that of the anterior root of the normal anterior premolar. Its diameter is about .25 mm. In other respects the skull does not differ appreciably from those collected by Dr. W. L. Abbott at Jérémie.

Measurements.—Greatest length, 21.4; condylobasal length, 20.0; zygomatic breadth, 9.0; breadth of braincase, 8.8; postorbital constriction, 4.0; breadth of rostrum across alveoli of canines, 3.8.

BRACHYPHYLLA PUMILA Miller

One skull from the steep cave near the Atalaye plantation. Its measurements are as follows: greatest length, 28.0; condylobasal length, 26.8; zygomatic breadth, 15.8; lacrimal breadth, 9.0; postorbital constriction, 6.2; breadth of braincase, 12.2; depth of braincase at middle, 9.6; mandible 19.0; maxillary toothrow (alveoli), 9.2; greatest width of palate including molars, 10.4; mandibular toothrow (alveoli), 10.2. This specimen and the two originally collected by Dr. W. L. Abbott near Port-de-Paix shows that the Haitian *Brachyphylla* is readily distinguishable from the large form inhabiting Porto Rico. From the small Cuban *B. nana* it appears to differ in slightly less reduced size, broader rostrum and palate, and larger molars.

ARTIBEUS JAMAICENSIS JAMAICENSIS Leach

Seven mandibles from the large cave near St. Michel, six skulls and nine mandibles from the deep cave near the Atalaye plantation and three skulls from owl pellets in the cave at Diquini.

A large colony occupied the crooked cave in the group near the Atalaye plantation. When disturbed by the noise made by workmen digging in the cave floor the bats soon took refuge in small holes in the roof, where they remained almost completely hidden. On one occasion a half-grown young, unable to fly, fell from a roof cavity to the ground near where we were excavating. As it lay helpless it uttered chirping, bird-like cries. Immediately the air was filled with dozens of plunging and rising adult bats behaving in the manner of a flock of terns hovering over a wounded companion. Not one of them actually touched the young animal, and the confusion soon subsided, the adults retiring again to their holes.

PHYLLOPS HAITIENSIS (J. A. Allen)

Ten skulls, one left maxilla, 7 mandibles from the large cave near St. Michel; one skull from the deep cave and one mandible from the

crooked cave near the Atalaye plantation. One skull from owl pellets in the cave at Diquimi. The skulls were found at all levels from the surface downward to a depth of about two feet.

EROPHYLLA SANTACRISTOBALENSIS (Elliot)

One skull and two mandibles from the large cave near St. Michel; two skulls and three mandibles from the deep cave near the Atalaye plantation. The skulls exactly resemble three collected in a cave near Port-de-Paix by Dr. W. L. Abbott.

In cranial characters this species resembles *Erophylla bombifrons* of Porto Rico and differs notably from the Cuban *E. sczekorni* and its relatives *E. syops* of Jamaica and *E. planifrons* of the Bahamas. The close correspondence in size between the skulls of *E. santacristobalensis* and *E. bombifrons* is shown by the following measurements of the three best Haitian specimens (a) compared with those of three skulls from Porto Rico (b): greatest length, (a) 24.0, 23.4, 23.4, (b) 24.0, 24.2, 24.4; condylobasal length, (a) 22.2, 22.0, 22.0, (b) 22.2, 22.4, 22.4; breadth of braincase, (a) 9.6, 10.0, 10.0, (b) 10.0, 10.4, 10.0; postorbital constriction, (a) 4.6, 4.4, 4.6, (b) 4.4, 4.6, 4.6; breadth of rostrum at base of canines, (a) 5.0, 5.0, 4.8, (b) 5.0, 5.2, 5.0; median depth of braincase, (a) 8.4, 8.0, 8.0, (b) 8.0, 8.2, 8.2. Comparison of specimens shows that the rostrum in the Haitian animal is smaller relatively to the braincase than it is in *Erophylla bombifrons*, and further material will undoubtedly demonstrate the specific distinctness of the two animals.

PHYLLONYCTERIS OBTUSA sp. nov.

Type.—Imperfect skull No. 253095, U. S. Nat. Mus. Collected in the crooked cave near the Atalaye plantation, about four miles east of St. Michel, Haiti, March, 1925, by Gerrit S. Miller, Jr.

Characters.—Like the Cuban *Phyllonycteris pocyi* but incisive foramina smaller and anterior border of premaxillaries as viewed in palatine aspect less narrowly curved.

Skull and teeth.—The size of the skull is essentially as in *Phyllonycteris pocyi*, though the average may prove to be above that in the Cuban animal when it is possible to compare adequate series of specimens. The structure of the anterior part of the palate is alike in the three specimens examined, and is not duplicated by any among the large number of Cuban skulls with which I have compared them. Taking the width of the palate between the incisors and canines as

100, the length of this region from front of premaxilla to posterior border of foramina averages about 82 in *Phyllonycteris pocyi*, while in the three specimens of *P. obtusa* it is only 56.6, 58, and 59.5, respectively. The curve of the anterior premaxillary border of the palate forms part of a circle which, if completed posteriorly, would pass close behind the foramina in *P. pocyi*, but in *P. obtusa* it would be so much larger that the hinder edge of the foramina would scarcely extend beyond its center. The mandible and the molars, both maxillary and mandibular, do not differ appreciably from those of *P. pocyi*. Other teeth lost.

Measurements.—Type and specimen from Diquini (No. 253006): greatest length, —, 22.2; palatal length, 10.0, 10.2; back of glenoid process to front of premaxillary, 17.2, 16.8; breadth of braincase, —, 10.2; postorbital constriction, 5.6, 5.4, width of palate including molars, 7.2, 7.0; mandible, —, 15.4; maxillary toothrow (alveoli), 7.0, 7.2; mandibular toothrow (alveoli), —, 8.0.

Specimens examined.—A skull and mandible from the crooked cave near the Atalaye plantation, a skull from a cave near Port-de-Paix (Dr. W. L. Abbott), and a skull from owl pellets found in the cave at Diquini.

Remarks.—Unlike its relative *Erophylla* the Haitian *Phyllonycteris* is not particularly like the Porto Rican member of its genus. As Anthony figures (Mem. Amer. Mus. Nat. Hist., n. s., Vol. 2, pl. 60, fig. 12) and describes the Porto Rican *P. major* it is a larger animal with relatively small teeth; palatal length ranging from 10.6 to 11.1, but with a toothrow of only 6.7 to 6.8.

EPTESICUS HISPANIOLÆ Miller

TADARIDA MURINA (Gray)

One mandible of each of these small bats was collected in the large cave near St. Michel.

RODENTIA

Bones of native rodents representing six genera, only one of which is known to have a living species, form the great mass—probably more than 95 per cent—of all the deposits. Mingled with them are the remains of the large owl, *Tyto ostologa*, which brought them to the caves. It is easy to realize that the existence of a bird of this type might depend so entirely on an abundant rodent food supply that, with the gradual disappearance of the large indigenous rodents, the owl must also have become extinct, leaving the caves to the small

Tyto glaucops capable of subsisting on introduced rats and mice, and on the native bats, lizards and small birds. Beneath a ledge in one of the caves near St. Michel I found pellets of the small owl on the surface, and, at a depth of from eighteen inches to two feet, compactly moulded masses of extinct rodent bones, evidently parts of the pellets of the extinct bird which once used this same resting place.

BROTOMYS VORATUS Miller

Plate 2, fig. 1

Two imperfect skulls and 52 mandibles. These specimens represent all the caves worked in with the exception of the deep cave near the Atalaye plantation.

The skulls essentially agree with the type, from the Dominican Republic. The mandibles, when compared with specimens of *Boromys offela* and *B. torrei* collected in Cuba by William Palmer in 1917 show no striking peculiarities. In both species of *Boromys*, however, the masseter ridge on the outer side of the mandible is so developed that, in the region beneath m_2 , its upper surface projects almost at a right angle to the outer surface of the mandible above it, while its extreme edge in some specimens is slightly turned upward. In *Brotomys* the upper surface of the ridge slopes obliquely downward and the margin is not upturned.

The three genera *Brotomys*, the Cuban *Boromys*, and the Porto Rican *Heteropsomys* are at once distinguishable from the other native Antillean rodents by their relatively low crowned, long rooted, subterete cheekteeth. All three are intimately related and it may eventually be found expedient to unite them under one name. For the present, however, it seems preferable to regard them as distinct from each other. The additional material now at hand makes it possible to define their differences as follows:

- Posterior termination of incisor root visible behind anterior base of zygoma when skull is viewed from below; antorbital foramen relatively small, its height much less than length of toothrow. *Heteropsomys*.
 Posterior termination of incisor root not visible behind anterior base of zygoma when skull is viewed from below; antorbital foramen relatively large, its height nearly equal to length of toothrow.
 A deep neural channel on floor of antorbital foramen; posterior termination of incisor root marked by an obvious swelling. . . . *Boromys*.
 No definite neural channel on floor of antorbital foramen; posterior termination of incisor root not marked by an obvious swelling *Brotomys*.

BROTOMYS (?) CONTRACTUS sp. nov.

Plate 2, fig. 2

Type.—Anterior portion of skull, lacking zygomata, nasals and teeth, No. 253100, U. S. Nat. Mus. Collected in small cave near St. Michel, Haiti, March, 1925, by Gerrit S. Miller, Jr.

Characters.—Resembling *Brotomys voratus*, but size slightly less, rostrum relatively shorter, interorbital region narrower in proportion to frontopalatal depth and more arched transversely; teeth broader than in *Brotomys voratus*, and palate noticeably constricted, its interalveolar width at middle conspicuously less than transverse diameter of the adjoining alveoli.

Skull.—While resembling in a general way that of *Brotomys voratus* the skull of *B. (?) contractus*, even in the imperfect condition of the only known specimen, shows well marked differential characters. Most conspicuous among these is the narrowness of the bony palate as compared with the very wide alveoli of the anterior cheekteeth. In three specimens of *B. voratus* (the type from the Dominican Republic and two from Haiti) the width of the palate between the alveoli of the second cheekteeth is 2.55, 3.0 and 3.0, respectively, and the width of the first alveolus is 2.25, 2.25 and 2.30. In the type of *B. (?) contractus* the width of the palate at the same level is only 1.65, while that of the first alveolus is 3.60. The narrowing of the skull shown by the palate is also evident when the interorbital breadth is compared with the fronto-palatal depth. In the type of *Brotomys (?) contractus* the ratio of this breadth (15.6) to depth (13.0) is only 83.3, while in the three specimens of *B. voratus* it is 92.5, 90.0 and 92.6. The greater transverse convexity of the interorbital roof is a character which cannot be expressed by measurements; it is immediately obvious when specimens are compared in posterior view. Because of the imperfect condition of the skull a comparison of the length of the rostrum with anything but the length of the palate is difficult; hence the apparent shortening of the rostrum may be due in part to an actual lengthening of the palate to accommodate the enlarged teeth. In *Brotomys (?) contractus* the length of the palate (9.4) measured from posterior border to level of anterior margin of alveolus of pm^1 is essentially equal to the distance from the latter level to alveolus of incisor (9.8); in *B. (?) contractus* it is barely more than the distance from alveolar level to front of incisive foramina (that is, about 5 mm. less than the distance to alveolus of incisor). The alveolar length of the toothrow in the type of *B. (?) contractus* cannot be exactly measured (the alveolus of m^3 is entirely

missing on one side and is incomplete on the other) but it must have been essentially equal to the diastema (10.8 mm.). In the three skulls of *B. voratus* it is 9.8, 10.0 and 9.6, while the diastema in the same specimens is 13.6, 12.6 and 12.8, respectively.

Specimens examined.—One, the type.

Remarks.—The disproportion between the alveoli and palate in this species as compared with *Brotomys voratus* is so great as to suggest that, when more completely known, the animal will prove to represent a distinct genus. In all of the other related members of the group from the large *Heteropsomys* (and *Homopsomys* if distinct) of Porto Rico to the small *Brotomys torrei* of Cuba the proportionate width of palate and alveoli does not greatly vary; the palate, at the m^1 level is always at least equal to the width of the largest alveolus. The narrowing of the palate to less than half the width of this alveolus in *B. (?) contractus* may therefore easily be a character of more than specific weight.

ISOLOBODON LEVIR (Miller)

Plate 2, figs. 3, 3a

1922 *Isolobodon portoricensis* Miller, Smithsonian Misc. Coll., Vol. 74, No. 3, p. 3, October 16, 1922.

1922 *Ithydontia levir* Miller, Smithsonian Misc. Coll., Vol. 74, No. 3, p. 5, October 16, 1922.

Thirty palates and fragmentary skulls, more than 600 mandibles.

This is the most abundantly represented of the vertebrates found in the bone bearing deposits. Its flesh seems to have been the chief article of food of the giant barn owl, *Tyto ostolaga*; many of the skulls and jaws were found in masses of bones which had the structure characteristic of owl pellets.

The original collection from the large cave near St. Michel included two isolated upper premolars of *Isolobodon*. Wrongly determining them as lower teeth I made these specimens the basis of a new genus and species, *Ithydontia levir*, selecting as type what I supposed to be "a right mandibular tooth, probably pm_4 or m_1 ," but actually, as the rich material now at hand clearly shows, pm^4 left. So far as the generic name *Ithydontia* is concerned there can be no doubt—it is a synonym of *Isolobodon*. But the proper disposition of the specific name is less easily determined. For the present it seems necessary to retain *Isolobodon levir* as the designation of the Haitian member of the genus. Although the absence of good skulls from the St. Michel series makes a satisfactory comparison with *Isolobodon portoricensis*

impossible, the smaller size of the Haitian specimens is so constant as compared with material from Porto Rico and the Virgin Islands that the existence of two members of the genus appears to be established. The circumstance must not be overlooked that the Haitian food refuse was accumulated by owls, while that formed elsewhere was chiefly if not entirely deposited by men. It is possible therefore that the difference in size may be partly due to selection of the rodents used as food—the owls tending to capture smaller, more easily devoured individuals, the men preferring the larger ones. That the owls were able to eat animals as large as the largest Porto Rican *Isolobodon* is shown by the frequent presence in the deposits of *Aphatreus* jaws of equally large size. Whatever bearing the possibility of selection may have, the facts are as follows:

Among more than 600 Haitian mandibles the eight largest have tooththrows of the following lengths, 16.2, 16.2, 16.2, 16.4, 16.6, 17.0, 17.2 and 17.2 mm., while the extremes of Anthony's measurements of individuals selected from a series of 200 Porto Rican specimens are 17.6 and 19.2 mm. The three longest maxillary tooththrows among the Haitian specimens selected for large size are 16.2, 16.2 and 17.0 mm.; Anthony gives 17.2 to 19.3 mm. as the range of variation among adults in his series of 17 skulls. The interorbital breadth can be measured accurately or approximately in seven of the Haitian skulls. It ranges from 15 mm. to about 18 mm.; Anthony's extremes are 19.8 and 23.5 mm. in six skulls from Porto Rico. In two Haitian specimens the length of the frontal bone along the median suture is 18.6 mm. and 20.0 mm.; the extremes of eight from Porto Rico are given as 22 mm. and 30 mm., with only three specimens less than 24.5 mm. The breadth of rostrum at premaxillary suture does not exceed 11 mm. in any of 15 Haitian specimens (some of them obviously immature), while in seven from Porto Rico it ranges from 13 mm. to 14.5 mm. Under these circumstances it seems necessary to recognize the Haitian *Isolobodon* as a distinct form.

The status of the *Isolobodon* whose bones have been found in kitchen middens in the Dominican Republic is a matter of special interest now that it becomes impossible to regard the Haitian member of the genus as identical with *I. portoricensis*. I once said that there appears to be no way to distinguish between Dominican, Porto Rican and Virgin Island specimens;¹ and after going over the ground again in the present connection I am of the same opinion. A palate from San Pedro de Macoris, Dominican Republic, is broken in such a

¹ Proc. U. S. Nat. Mus., Vol. 54, p. 508, October 15, 1918.

manner that the toothrow cannot be measured, but the alveolar length must have been at least 18 mm.; enough of the base of the rostrum is preserved to show that the breadth at premaxillary suture was more than 13 mm. In three mandibles from the same locality the toothrow measures 17.6, 18.6 and 18.6 in contrast to the maximum of 17.2 for the entire series of over 600 jaws from the Haitian caves. Of two mandibles collected by Gabb at San Lorenzo Bay one has a toothrow 18.8 mm. in length, while in the other, an obviously younger individual, it is 16.8, only a little below the maximum for the Haitian specimens.

APHÆTREUS MONTANUS Miller

Plate 2, figs. 4, 4a, 4b

Seventeen imperfect skulls and palates, 208 jaws.

In both groups of caves the remains of this animal were common, the frequency of their occurrence coming next after that of *Isolobodon levir*.

The material at hand makes it possible to define the genus more completely than I was able to do in the original paper. It is now evident that the genera *Aphætreus*, *Isolobodon* and *Plagiodontia* form a rather compact group, the members of which are more nearly related to each other than any one of them is to *Capromys* and its allies. In all three the enamel pattern of the upper molars is tetramerous; in *Plagiodontia* the upper premolar has reached the same stage of simplification, but in *Aphætreus* and *Isolobodon* this tooth retains a small fifth element. The maxillary teeth of *Capromys* and *Geocapromys* are all pentamerous. In the *Isolobodon* group the direction of the inner reentrant fold is diagonally forward in the upper teeth, backward in the lower teeth; the reverse is the case in *Capromys*. The general structure of the crowns in the *Capromys* group parallels that which has been developed by the voles; this is not true with regard to *Isolobodon* and its allies. The characters of the three genera may be tabulated as follows:

Curve of upper incisor short, the root of the tooth lying at anterior margin of zygomatic process of maxillary; lower incisor terminating beneath m_1 ; pm^4 with one outer reentrant angle, its enamel pattern exactly similar to that of the molars; reentrant folds in upper teeth very oblique, their slant 45° or less as referred to corresponding alveolar line; reentrant folds on inner side of the lower teeth extending less than halfway across crowns; frontal sinus sufficiently inflated to produce an obvious swelling over anterior zygomatic root, to encroach on area of antorbital foramen, and to a less degree on that of orbit; posterior margin of zygomatic process of maxillary lying about in line with anterior alveolar border.....*Plagiodontia*.

Curve of upper incisor long, the root of the tooth lying in antorbital foramen; lower incisor terminating beneath m_2 ; pm^4 with two outer reentrant angles, its enamel pattern obviously different from that of the molars; reentrant folds in upper teeth not very oblique, their slant more than 45° as referred to corresponding alveolar line; reentrant folds on inner side of lower teeth extending more than halfway across crowns; frontal sinus not sufficiently inflated to produce an obvious swelling over anterior zygomatic root or to encroach on area of antorbital foramen or of orbit; posterior margin of zygomatic process of maxillary lying at or behind level of middle of alveolus of pm^4 .

Opposed inner and outer reentrant angles of all teeth remaining distinct throughout life, the enamel pattern of each tooth entire; crowns and alveoli of both upper and lower molars nearly as long as wide.....*Isolobodon*.

Opposed inner and outer reentrant angles of all teeth becoming confluent in adults, the enamel pattern of each tooth then divided into two sections; crowns and alveoli of both upper and lower molars conspicuously wider than long.....*Aphatrecus*.

The series of mandibles includes about 30 specimens in which the breaking through of the opposed enamel folds has not yet taken place. Unfortunately there are no sets of upper teeth representing the same stage. In these immature individuals the enamel pattern of the mandibular teeth contains exactly the same elements that are present in the corresponding teeth of *Isolobodon*. The characteristic peculiarities of crown outline are, however, evident at a very early stage, and, though less pronounced than in the adults, they are sufficient to be diagnostic. In harmony with the shorter tooth crowns of *Aphatrecus* the enamel folds are narrow as compared with those of *Isolobodon*, and the reentrants are more completely filled with cement. The crowns consequently tend to have a solid, squarish aspect, while in *Isolobodon* they are oblong and always with conspicuous angular emarginations. From the mandibular teeth of *Plagiodontia* those of *Aphatrecus* are readily distinguished by the less oblique direction of all the enamel folds, and by the greater length of the outer reentrant, which fold invariably extends more than halfway across the crown, while in *Plagiodontia* it never reaches the middle of the crown.

The maxillary teeth have not hitherto been known. Like the mandibular teeth they contain the same elements that are present in *Isolobodon*, but these elements are compressed in the axis of the toothrow, and the opposed reentrant folds are confluent in adults, thus splitting the enamel pattern into two sections. The region of breaking through in the maxillary teeth is clearly indicated by irregularities in the enamel outline; hence it seems probable that in young individuals it will be found that the pattern is not split.

Two toothless mandibles, not improbably pertaining to one individual, dug from the small available area of original floor material in the caved-in chamber near St. Michel, are unique, among the octodont rodents which I have examined, in the presence of a well developed fifth alveolus behind the normal fourth (pl. 2, fig. 4*b*).

PLAGIODONTIA ÆDIUM F. Cuvier

Seven mandibles (five from the group of caves near St. Michel, the others from the crooked cave near l'Atalaye) are referable to the species represented by the large specimen from San Pedro de Macoris, Dominican Republic, which I have identified (Proc. U. S. Nat. Mus., Vol. 72, Art. 16, pp. 5-6, September 30, 1927) as an individual of the species originally described by F. Cuvier. Only one of the Haitian specimens is fully adult, and in this the coronoid and angular regions are broken off and all the teeth have been lost. Its size must have been almost exactly the same as that of the Macoris jaw. In each the length of the symphysis menti is 27.6 mm. and the distance from the posterior angle of the symphysis to anterior margin of alveolus of pm_4 is 20.4. Among 13 jaws of the recently described Dominican *Plagiodontia hylæum* Miller the maxima for these two measurements are only 25.4 and 19.0, while the usual dimensions in adults are decidedly less, about 24 and 17. The length of the toothrow in the adult Haitian *P. ædium*, 23.4, is only 0.6 mm. less than that in the Macoris specimen; the maximum in the series of *P. hylæum* is 20.6. In two of the younger Haitian individuals, both of them broken off immediately behind the toothrow, the second molar is not yet fully in place. They are, however, distinctly larger and more robust than in two jaws of immature Dominican *P. hylæum*, one with m_2 worn flat but m_3 not in place, the other with all the crowns worn flat. In the five Haitian specimens with teeth the enamel pattern presents the characters which distinguish *Plagiodontia ædium* from *P. hylæum* (see Miller, Proc. U. S. Nat. Mus., Vol. 72, art. 16, p. 4, and pl. 1, figs. 1*c* and 2, September 30, 1927).

PLAGIODONTIA SPELÆUM sp. nov.

Type.—Right mandible of young adult, No. 253160, U. S. Nat. Mus. Collected in the crooked cave near the Atalaye plantation, Haiti, March, 1925, by Gerrit S. Miller, Jr.

Characters.—Resembling *Plagiodontia hylæum* Miller from eastern Dominican Republic but noticeably smaller; length of mandible measured from articular process probably not much exceeding 40 mm.

instead of ranging from about 48 to 54 mm.; mandibular tooththrow usually less than 18 mm. instead of ranging from about 18.5 to 20.5 mm. Portion of mandible in front of cheekteeth relatively shorter and more abruptly curved than in *P. hylæum*.

Measurements.—From five jaws which may be regarded as adult I am able to obtain the following measurements: length of mandible from articular process, 39.6, 39±, —, —, —, length of symphysis, 18.0, 18±, 17±, 17.6, —; diastema, 9.0, 9.4, 9±, 8.8, 9.2; depth from alveolar margin to lowermost point of symphysis, 11.2, 11.2, 11.2, 10.8, 11.6; mandibular tooththrow (alveoli), 16.2, 16.0, 15.8, 16.0, 15.6; transverse diameter of m_1 (grinding surface), 4.5, 4.5, 4.5, 4.2, 4.4. The same measurements in a mandible of *P. hylæum* which appears to be of exactly corresponding age (No. 239886): length from articular process, 48; symphysis, 21.6; diastema, 11.4; depth 13.0; tooththrow, 18.6; width of m_1 , 5.3.

Specimens examined.—Fifteen mandibles, all imperfect. Four of these came from the group of caves near St. Michel, the others were found in the crooked cave near the Atalaye plantation.

Remarks.—The small *Plagiodontia* from the St. Michel caves differs conspicuously from the associated large *P. adium* in size and in the longitudinally compressed cheekteeth. Its affinities are obviously with *P. hylæum* of the Samaná Bay region, the only member of the genus known to be now living. At first sight the jaws of *Plagiodontia spelæum* might be mistaken for immature specimens of *P. hylæum*, but when comparison is made between individuals in corresponding stages of development (as indicated in immature individuals by the eruption of the second and third molars, and in young adults by the gradual disappearing of porousness and surface wrinkling of the bone on the lower side of the jaw beneath the roots of these teeth) the differences between the two species become obvious.

HEXOLOBODON gen. nov.

Plate 3, figs. 1, 1a, 1b

Type.—*Hexolobodon phenax* sp. nov.

Characters.—So far as known most like *Geocapromys*, but differing as follows: cheekteeth with roots becoming closed at or soon after the stage when the crowns are worn flat; root of lower incisor passing beneath root of m_3 and terminating, in fully adult individuals, on outer side of tooththrow beneath the floor of the groove which separates the alveolus of m_3 from the base of the coronoid process; pm_4 (pl. 3, fig. 1a) with only two reentrant angles on inner side (as in *Capromys*);

all of the maxillary teeth with two about equally developed reentrant angles on each side, these imparting to the crowns an evenly six-lobed structure (pl. 3, fig. 1).

Remarks.—In the general structure of the palate and the relationship of the incisor roots to those of the premolars this genus is practically identical with *Geocapromys*. The roots of the premolars come close together in the median line, where they are overgrown by the maxillary exactly as in *Geocapromys*. The roots of the premolars with their covering of bone fill up the lower part of the nasal channel in the region between the incisor roots (pl. 3, fig. 1*b*). A broken palate without teeth could be distinguished by this character alone from a similar fragment of a *Capromys* or *Plagiodontia* skull, in both of which the anterior part of the nasal channel is widely open between the roots of the premolars (pl. 3, fig. 2), but might be confused with a similar fragment pertaining to a member of the genera *Geocapromys*, *Isolobodon*, or *Aphetrens*.

In *Geocapromys* and *Capromys* (pl. 3, fig. 2) the roots of all four cheekteeth, when exposed by cutting or breaking away their bony covering, are seen to be about evenly spaced in the tooththrow—at most the septum between the roots of pm^4 and m^1 is slightly thicker than the septa between the molars. In *Hexolobodon*, on the contrary (pl. 3, fig. 1*b*), the root of the premolar is thrown conspicuously forward away from that of the first molar.

The less specialized condition of the roots of the cheekteeth and the extension of the lower incisor root to the outer side of the mandibular tooththrow are characters which, like the enamel pattern of the upper teeth, sharply differentiate this genus from its Antillean relatives *Capromys*, *Geocapromys*, *Plagiodontia*, *Aphetrens*, and *Isolobodon*.

HEXOLOBODON PHENAX sp. nov.

Plate 3, figs. 1, 1*a*, 1*b*

Type.—Palate with complete dentition of immature individual (m_3 with only anterior half of crown worn flat), No. 253118, U. S. Nat. Mus. Collected in the small cave near St. Michel, March, 1925, by Gerrit S. Miller, Jr.

Characters.—An animal about the size of *Capromys pilorides*, but skull probably differing from that of all species of *Capromys* and *Geocapromys* in shorter rostrum and generally more robust form. With regard to features which are not obviously generic, such exact comparisons with *Capromys pilorides* as the fragmentary remains of

the extinct animal will permit, are as follows: palate in region between pm^4 and maxillo-premaxillary suture much smaller relatively to grinding area of toothrow (about 10×14 mm. as compared with 13×18 mm. in a specimen of *C. pilorides* with grinding area of toothrow of essentially the same length and breadth as that of the type), its upward slope more abrupt; no obvious pit for attachment of the maxillo-nasolabialis muscle in region between pm_4 and incisive foramen (these pits are visible in all the living species of *Capromys* and *Geocapromys*; they are not developed in *Isolobodon*, *Aphactreus* or *Plagiodontia*); posterior emargination of palate extending forward slightly beyond level of posterior border of m^2 instead of about to middle of m^2 ; narrow inferior maxillary zygomatic root, its width through middle of specialized muscle-insertion area considerably less than width of grinding surface of molars instead of distinctly greater than width of this surface. The upper toothrows are more convergent than in *Capromys pilorides*, so that the bony palate becomes reduced anteriorly to a width only about one-fifth that of the adjoining alveolus or of its own width posteriorly. In *C. pilorides* the anterior width of palate is considerably more than half that of alveolus and almost exactly half of its own posterior width. Posterior emargination of palate extending slightly beyond level of septum between alveoli of m^3 and m^2 . All of the mandibles are broken immediately behind the toothrows. In the portion which remains there are several obvious peculiarities as compared with the corresponding region in *Capromys pilorides*. The diastema is short and more abruptly concave when viewed from the side. The symphysis is conspicuously shorter than in *C. pilorides* and its long axis is set at a higher angle to the plane of the grinding surface of the molars; about 50° instead of about 35° . The anterior portion of the ridge which extends forward along the outer side of the mandible from the angular process is heavier and more evenly rounded than in the Cuban animal. The enamel pattern of the mandibular teeth appears to be not positively distinguishable from that of *Capromys pilorides*.

Measurements.—Type: distance from posterior surface of m^3 to anterior border of maxillary directly in front of toothrow, 30.0 (35.0);¹ distance from posterior margin of incisive foramen to posterior margin of palate, 24.6 (26.2); distance from alveolus of pm^4 to anterior edge of maxillary, 9.4 (13.2); width of bony palate through

¹ Measurements in parenthesis are those of a similarly broken palate of a slightly older individual of *Capromys pilorides* from Sierra La Guira, Pinar del Rio, Cuba (No. 253232, U. S. Nat. Mus.).

anterior edge of posterior emargination, 5.6 (8.2); least width of palate between toothrows, 1.2 (4.0); maxillary toothrow (alveoli) 22.0 (22.4); alveolar width of pm^4 , 5.8 (5.2); height of m^1 from grinding surface to root, 15.0 (14.0). Mandible of an individual with teeth in same stage of wear as those of type: distance in alveolar line from posterior margin of m_3 to anterior margin of incisor, 36.0; distance from tip of incisor to posterior edge of grinding surface of m_3 , 38.0; diastema, 10.0; distance from tip of incisor to anterior margin of crown of pm_4 , 15.8; depth from inner margin of alveolus of pm_4 to posterior point of symphysis, 14.4; length of symphysis, 22.4; length of toothrow, grinding surface, 22.2, alveoli, 24.0; alveolar width of pm_4 , 5.8. Mandible of an individual with crown of m_3 entirely worn flat: distance in alveolar line from posterior margin of m_3 to anterior margin of incisor, $37 \pm (46.6)$;¹ diastema, $11 \pm (18.8)$; depth from inner margin of alveolus of pm_4 to posterior point of symphysis, $17 \pm (19.0)$; length of symphysis, $23 \pm (23.0)$; length of toothrow, grinding surface, 24.2 (22.0); alveoli, 25.0 (22.4); alveolar width of pm_4 , 5.4 (5.0).

Specimens examined.—One palate, six mandibles and four isolated cheekteeth. A mandible and two of the isolated teeth were found in the caves near l'Atalaye, the rest of the material came from the large and small caves near St. Michel.

QUEMISIA gen. nov.

Plate 4, figs. 2, 2a

Type.—*Quemisia gravis* sp. nov.

Characters.—Size and general features probably as in the Porto Rican *Elasmodontomys*. Enamel pattern of mandibular cheekteeth (pl. 4, fig. 2a) like that of *Elasmodontomys* (pl. 4, fig. 1a) but reentrant folds less transverse to the axis of the toothrow, the axis of the folds slanting forward at an angle of only 21° instead of about 50° . Mandibular symphysis extending backward beyond level of middle of m_1 instead of barely to middle of pm_4 ; shaft of lower incisor not extending behind symphysis, its base lying beneath anterior half of m_1 (in *Elasmodontomys* the shaft of the incisor extends far beyond the symphysis to terminate beneath middle of m_2); shaft of femur more flattened than in *Elasmodontomys*.

¹ Measurements in parenthesis are those of an adult *Capromys pilorides* (No. 143150).

Remarks.—The genus *Quemisia* is a member of the group which is represented by *Elasmodontomys* in Porto Rico and *Amblyrhiza* in Anguilla. The cheekteeth in all three of these genera are very hypsodont but not ever-growing. The enamel pattern is pentamerous with the inner reentrant fold of the upper teeth (in *Amblyrhiza* and *Elasmodontomys*, at least) and the outer fold of the lower teeth passing behind the posterior outer reentrant. All of the reentrant folds penetrate nearly or quite across to the opposite side of the crown, thus producing a grinding surface which consists of a series of essentially parallel transverse enamel ridges.

The most striking known peculiarities of *Quemisia* are the long mandibular symphysis, short lower incisor, and the very unusual forwardly-directed enamel folds in the lower teeth. I have chosen the name because of my belief that the animal is probably the "Quemi" of Oviedo (*Hist. Gen. et Nat. de las Indias*, Madrid, 1851, p. 389).

QUEMISIA GRAVIS sp. nov.

Plate 4, figs. 2, 2a

Type.—Mandible of immature individual (m_3 with crown not yet in place), No. 253175, U. S. Nat. Mus. Collected in the crooked cave near the Atalaye plantation, March, 1925, by Gerrit S. Miller, Jr.

Characters.—As compared with a mandible of *Elasmodontomys obliquus* in corresponding stage of tooth growth the type specimen of *Quemisia gravis* shows many peculiarities in addition to those which have already been described. The depth of the horizontal ramus at middle of m_1 is greater in proportion to the length of the toothrow (21.5:33 instead of 18:34); the maximum width through the symphysis is greater (17.5 instead of 11) a difference occasioned partly but not wholly by the more posterior point of termination of the symphysis in the Haitian animal. The anterior base of the angular process is laterally compressed in *Quemisia*, so that it forms about one-third of the transverse diameter of the mandible; in *Elasmodontomys* it is so thick that it forms considerably more than half of the entire transverse diameter. The roots of the third and fourth cheekteeth extend down into this thickened area in *Elasmodontomys*. In *Quemisia* the roots of the three molars form a broadly curved ridge extending backward and upward from the symphysis and separated from the base of the angular process by a shallow groove; this ridge has, at first sight, something the appearance of the ridge which marks the course of the incisor root in *Elasmodontomys*.

The cheekteeth are open at the base, as in *Elasmodontomys* of the same age; whether or not they eventually become closed as in adult *Elasmodontomys* cannot now be determined. The enamel pattern is fundamentally the same as in *Elasmodontomys*, that is, a pentamerous pattern in which all the reentrant folds have been extended nearly or quite across the crown (the outer fold passing behind the second inner fold). The posterior limb of each fold has been thickened to form a conspicuous enamel plate and the anterior limb of each fold except the first has been reduced to the vanishing stage. As compared with that of the Porto Rican animal the pattern in *Quemisia* shows a mixture of excessive peculiarity and less high specialization. The forward turning of the enamel folds so that the anterior portion of each fold is approximately parallel with the main axis of the toothrow is a specialization of high degree and very peculiar kind. In *Elasmodontomys* there is an indication of this tendency at the front of the premolar, but the direction of the folds in the molars is normal and not essentially different from that seen in *Plagiodontia*, *Isolobodon* or *Aphatrens*. On the other hand the process of plate specialization has not progressed so far in *Quemisia* as it has in *Elasmodontomys*. While the external reentrant fold has extended completely across the crown in all three of the used cheekteeth neither of the two internal folds has quite reached the enamel of the opposite side in pm_4 , and only the first has penetrated so deeply in m_1 and m_2 . In each of the molars there is, therefore, one incomplete enamel plate, the second, while in the premolar there are two, the first and second. In *Elasmodontomys* all the folds have crossed the crown in all the teeth, and there are, consequently, no incomplete plates. The peculiar twisting of the enamel pattern almost into the axis of the toothrow in *Quemisia* throws the anterior loop of each tooth over on to the inner side of the crown out of contact with the tooth in front of it. The free face of each of these loops carries a fully developed enamel wall. In *Elasmodontomys* such an enamel wall occurs on the first loop of the premolar only.

A fragment of incisor (apparently an upper tooth) 19 mm. in length has a width of 5 mm. and an antero-posterior diameter of 4.2 mm. at level immediately proximal to the terminal worn area. The anterior face is longitudinally fluted by six obscurely developed ridges and the faint intervening concavities.

A broken femur which I refer without much doubt to this species differs from the corresponding bone in *Elasmodontomys obliquus* in the conspicuous flattening of its shaft. The greatest and least diameters

of the shaft in its narrowest region are 12.2 and 8.2, while in one specimen from Porto Rico they are 10.8 and 8.8, and in another 13.0 and 9.8.

Specimens examined.—Mandible and piece of an incisor from the crooked cave near the Atalaye plantation; broken femur from the small cave of the same group.

XENARTHRA

The occurrence of ground sloths in Hispaniola was not known before the discovery of a few bones in the St. Michel caves by Mr. Brown and Mr. Burbank. On the basis of this scanty material—four vertebrae, three of them imperfect, a piece of a limb bone of a young animal, and a fragment of a rib—I was unable to refer the species to any genus, and, at Doctor Matthew's suggestion, I recorded it¹ as *Megalocnus* ? sp. ?

On visiting the caves myself I secured teeth and a femur resembling the corresponding parts of the Porto Rican *Acratocnus* and also a calcaneum so unlike that of *Acratocnus* as to suggest the existence of two sloths differing generically from each other. The material collected by Mr. Poole now makes the definite separation of these animals possible. One is slender limbed, resembling *Acratocnus* in size and general features; the other is more heavy, its general build probably somewhat as in *Nothrotherium shastense*. Its bulk, however, though considerably exceeding that of *Acratocnus*, is not likely to have been much more than one-fourth that of the Californian animal.

That one or both of these sloths continued to exist on the island until after the advent of man I have no doubt. The facts which have led me to this conclusion are as follows: (a) In the two caves near St. Michel most of the sloth remains were found within two feet of the surface; and human bones and pottery occurred to the same depth without any indication that they had been dug in. (b) Near the entrance to the smaller of the two main caves bones of ground sloths (certainly two and perhaps more individuals) were inextricably mixed with bones of man (adult and infant) and domestic pig. The remains were scattered among the small fragments of limestone which made up the greater part of the floor material, and I was unable to determine any definite level-relationship among them. (c) Near the entrance to the large cave I unearthed with a trowel, in fine, soft, undisturbed material at the bottom of a trench two feet deep, the femur

¹ Smithsonian Misc. Coll., Vol. 74, No. 3, p. 6, October 16, 1922.

of a ground sloth, and, about 18 inches from it, a fragment of coarse dark pottery. There was no evidence of previous digging that I could discover; and the bone and pottery had every appearance of having been deposited on the former surface of the cave floor and subsequently covered by the gradual accumulation of detritus. (d) Both of these caves are situated on the side of a high ridge where the material composing their floors is entirely removed from the action of streams. (e) In general the ground sloth bones were associated with the human remains in exactly the same manner as the bones of *Isolobodon* and *Plagiodontia*, rodents which are positively known to have been contemporary with man.

ACRATOCNUS (?) COMES sp. nov.

Plate 5, fig. 2; plate 6, fig. 2; plate 8, fig. 1; plate 10, fig. 1

Type.—Right femur (lacking distal extremity) of adult, No. 253178, U. S. Nat. Mus. Collected in large cave near St. Michel, Haiti, March, 1925, by Gerrit S. Miller, Jr.

Characters.—A small ground sloth agreeing in general size with the Porto Rican *Acratocnus odontrigonus* Anthony; its weight probably not exceeding 50 pounds. Femur resembling that of the Porto Rican sloth, and, like it, with a well developed lesser trochanter and without noticeable antero-posterior compression of the shaft, but modified for more directly perpendicular weight-bearing.

Femur.—The femur differs from the corresponding bone of *Acratocnus odontrigonus* in at least two features which are important enough to indicate specific or, possibly, generic distinctness. (1) The intertrochanteric ridge is similar in position and development to the corresponding structure in *A. odontrigonus*, but it is supplemented by a large and conspicuous tubercle situated at the middle of the shaft at a level slightly below that of the lesser trochanter. This tubercle, of which no obvious trace exists in the numerous Porto Rican femora with which I have compared the Haitian specimen, forms the culminating point of a general thickening of the bone which imparts to the upper fourth of the shaft, as viewed from the side, a strongly angular-convex profile very different from the flat or slightly concave profile of the same region in *A. odontrigonus* (see pl. 6). (2) The neck is shorter than in *Acratocnus odontrigonus* and is less bent outward and forward from the axis of the upper half of the shaft; as a result, the head is set so as to diverge less noticeably from the general contour of the shaft. The differences in this respect between the Porto Rican and Haitian animals are of the same kind

as those which exist in greater degree between the femora of *Choloepus* and *Bradypus*. The less anterior directing of the neck in the Haitian femur is perhaps most readily made apparent by applying the proximal extremity of the bone to a flat surface in such a way that it is supported by the tripod formed by the posterior surfaces of the head and the two trochanters. The shaft of the bone in *Acratocnus* (?) *comes* then takes a position essentially parallel with the flat surface. When the femur of *A. odontrigonus* is similarly placed the shaft rises above the flat surface at an angle ranging from about 18° to about 23° . The same difference may be observed by tracing the direction of the low but usually evident ridge which crosses the neck from the head to the lesser trochanter. In *Acratocnus odontrigonus* this ridge extends so obliquely to the inner surface of the femur that its line, when continued downward, passes beyond the contour of the bone at a point situated near the mid portion of the head of the trochanter; in the Haitian specimen it passes out nearly 10 mm. farther down the shaft. The lesser inward bend of the neck is best appreciated by "sighting" down the anterior or posterior surface of the shaft of the bone; it then becomes obvious that the head lies nearer to the main axis in the Haitian specimen than in any of those from Porto Rico.

Remarks.—The femur on which this species is based resembles in all its general characters the corresponding bone of the Porto Rican ground sloths and of the Miocene South American *Hapalops*. The peculiarities which I have described as distinguishing it from the femur of *Acratocnus odontrigonus* separate it equally from the corresponding bone of *Hapalops*, at least so far as can be determined from Scott's figures of three species (*longiceps*, pl. 32. *elongatus*, pl. 41, and *ruefimeyeri*, pl. 42).

Other remains which I refer without much hesitation to *Acratocnus* (?) *comes* are as follows: (a) the proximal two-thirds of a right tibia (pl. 8, fig. 1) not certainly distinguishable from the corresponding part of the tibia of a Porto Rican ground sloth (No. 17711, Amer. Mus. Nat. Hist.); (b) an almost perfect atlas (pl. 10, fig. 1) of the proper size to fit a skull of *Acratocnus odontrigonus*; several caniniform teeth, both upper and lower, agreeing in a general way with those of the same animal; (c) foot bones and ungual phalanges resembling those of the Porto Rican species.

On the basis of the femur and of the parts which appear to be almost certainly associated with it I do not now feel justified in separating the small Haitian ground sloth more than specifically from *Acratoc-*

nus odontrigonus. It would cause no surprise, however, if further material should indicate that the animals were generically distinct.

The name *comes* alludes to the circumstance that the type specimen was found so closely associated with fragments of pottery as to lend strong support to the belief that the animal existed in Haiti as a contemporary of man.

PAROCNUS gen. nov.

Plate 7; plate 8, fig. 2; plate 9; plate 10, figs. 2, 3

Type.—*Parocnus scrus* sp. nov.

Characters.—Femur differing from that of *Acratocnus* in the absence of the lesser trochanter; in the conspicuous widening and flattening of the upper half of the shaft; and in the more nearly vertical set of the head (as indicated by the line of the epiphyseal suture in an immature individual), a condition which appears to agree essentially with that present in *Nothrotherium* as shown on plate 12 of Stock's Gravigrade Cenozoic Edentates of Western North America.

Remarks.—The genus *Parocnus* is readily distinguishable from *Acratocnus* by the structure of the femur alone. If I have correctly assembled the other parts which I believe to be associated with it there are many important differential characters. These parts are as follows: (a) a right humerus (pl. 9), 200 mm. in greatest length, resembling that of *Nothrotherium shastense* as figured by Stock (Cenozoic Gravigrade Edentates of Western North America, pl. 8, fig. 1, 1925) in general form but less heavily built, with relatively broader proximal extremity and without the entepicondylar foramen present in this sloth and in *Acratocnus*; (b) the proximal third of a left tibia (pl. 8, fig. 2) and an entire left fibula probably of the same individual; (c) a right astragalus (pl. 9, fig. 3) very different from that of *Hapalops* as figured by Scott (Rep. Princeton Exped. Patagonia, Pal., Vol. 2, pl. 33, fig. 4) and *Acratocnus* as figured by Anthony (Mem. Amer. Mus. Nat. Hist., n. s., Vol. 2, pl. 73, fig. 7, 1918) but resembling in a general way, particularly in its calcaneal aspect, the very much larger calcaneum of *Megalonyx* figured by Stock (p. 87, fig. 31, *A, B, C, D*); (d) three calcanea (2 left, 1 right) of a form (pl. 9, fig. 2) conspicuously different from that seen in *Hapalops* and *Acratocnus* but essentially similar in plantar and astragalus views to the calcaneum of *Mylodon* as figured by Stock

(p. 175, fig. 96); (e) a fragment of an atlas much larger than the corresponding part in *Acratocnus odontrigonus* or *O. (?) comes*. The area of the superior articular process in this atlas is nearly four times as great as that of another specimen from the same cave (the large cave near St. Michel) which I refer without much hesitation to *O. (?) comes* (pl. 10, fig. 1); (f) several foot bones and ungual phalanges of more robust structure than any known in the Porto Rican Sloth.

PAROCNUS SERUS sp. nov.

Plate 7; plate 8, fig. 2; plate 9; plate 10, figs. 2, 3

Type.—Right femur (lacking epiphyses) of immature individual, No. 253228, U. S. Nat. Mus. Collected in large cave near St. Michel, Haiti, January, 1928, by Arthur J. Poole.

Characters.—An animal considerably larger and more heavily built than *Acratocnus odontrigonus* or *A. (?) comes*, its weight as roughly estimated by comparison of limb bones with those of pigs, probably 150 lbs. or more.

Femur.—As compared with that of *Acratocnus odontrigonus* the femur of *Parocnus serus* (pl. 7) is immediately distinguishable by the absence of the lesser trochanter, as well as by its greater size and the much more noticeable antero-posterior flattening of the upper portion of the shaft. In a large femur of *Acratocnus* (No. 17716, Amer. Mus. Nat. Hist.) the two diameters of the shaft at middle of its upper half, lateral and antero-posterior, are respectively, 26 mm. and 17 mm.; in the type of *Parocnus tardus* they are 38 mm. and 14.5 mm. The ratio of antero-posterior to lateral diameters is therefore about 65 in *Acratocnus* and only about 38 in *Parocnus*. At middle of shaft the discrepancy is slightly less: ratio of antero-posterior to lateral diameter about 61 in *Acratocnus*, about 45 in *Parocnus*. Below the middle of the shaft the diameters in the two femurs are essentially alike, with ratios of 58 and 59, a difference which is too slight to have any special significance.

In addition to this striking peculiarity of general form the femur of *Parocnus serus* is further distinguished from that of the known species of *Acratocnus* by the absence of a lesser trochanter and the presence of a low ridge about 35 mm. in length extending obliquely downward and backward from the middle of the neck across the narrow inner aspect of the bone to its posterior margin; by the more thickened gluteal ridge; and by the presence of a noticeable con-

cavity on the posterior face of the shaft at the base of the great trochanter.

Unfortunately no perfect skulls of ground sloths have yet been found in the Haitian caves. One specimen from the small cave near St. Michel includes the interorbital region and anterior part of the braincase. It is about the size of the corresponding part of the skull in a large *Acratocnus odontrigonus*, but is conspicuously different in form, owing to the absence of the deep postorbital constriction which is such a noticeable feature in the skull of *Acratocnus*. Whether this fragment pertains to a skull of *Parocnus* or of *Acratocnus* (?) *comes* is a question which cannot be answered. A fragment of a palate from the same cave appears to have come from a skull of much the same size. It indicates a palate twice as wide in proportion to the length of the toothrow as that of *Acratocnus odontrigonus*, and it further differs from the palate of the Porto Rican sloth in the presence of a median longitudinal ridge supplemented, on each side, by a shallow but well-defined longitudinal furrow. The toothrow in this individual was probably of almost exactly the same length as that of the Porto Rican specimen figured by Anthony on plate 69 (fig. 1c).

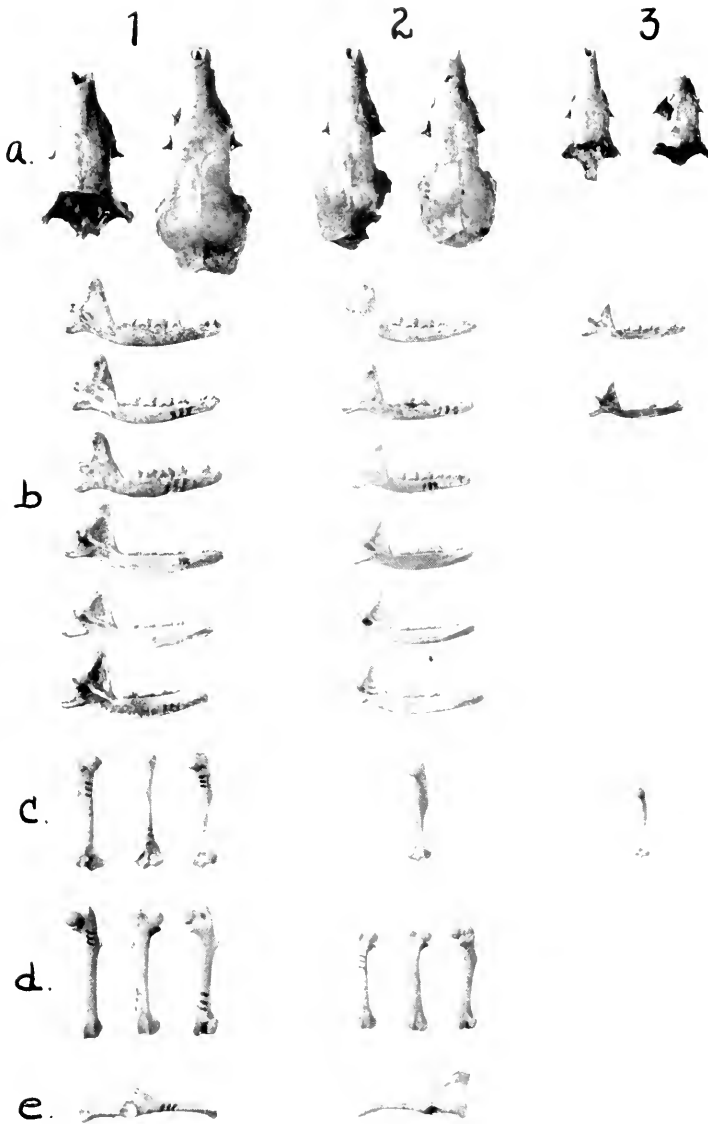

(All figures natural size)

1. *Nesophontes paramicrus* Miller. Nos. 253062-253076, U. S. Nat. Mus. a, 2 skulls (the type at right); b, 6 mandibles; c, three humeri; d, 3 femora; e, innominate.
2. *Nesophontes hypomicrus* Miller. Nos. 253077-253080, U. S. Nat. Mus. Letters as in fig. 1. Type skull at right.
3. *Nesophontes zamianus* Miller. Nos. 253000-253094, U. S. Nat. Mus. Letters as in fig. 1. Type skull at left.



1



2



3



4



3a



4a



4b

(All figures natural size)

1. *Brotomys voratus* Miller. No. 253097, U. S. Nat. Mus.
2. *Brotomys* (?) *contractus* Miller. Type.
3. *Isolobodon levir* (Miller). No. 253117, U. S. Nat. Mus.
- 3a. *Isolobodon levir* Miller. No. 253102, U. S. Nat. Mus.
4. *Aphetrus montanus* Miller. No. 253133, U. S. Nat. Mus.
- 4a. *Aphetrus montanus* Miller. No. 253145, U. S. Nat. Mus.
- 4b. *Aphetrus montanus* Miller. No. 253151, U. S. Nat. Mus.

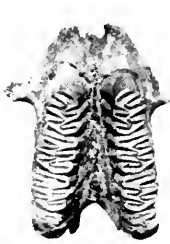

1



1a



1b



2

(All figures natural size)

1. *Hexolobodon phenax* Miller. Type specimen. Crowns of maxillary teeth.
- 1a. *Hexolobodon phenax* Miller. No. 253125, U. S. Nat. Mus. Crowns of mandibular teeth.
- 1b. *Hexolobodon phenax* Miller. Type specimen, showing alveolus of left incisor, roots of maxillary teeth and intervening floor of nasal passage.
2. *Capromys pilorides* Desmarest. No. 253232, U. S. Nat. Mus. Palate broken away from rest of skull in the same manner as the type of *Hexolobodon* to show corresponding structures.



1



2



1a



2a

(All figures natural size)

1. *Elasmodontomys obliquus* Anthony. Immature, with third molar not yet above level of alveolar rim. No. 17137 h. Amer. Mus. Nat. Hist.
2. *Quecuisia gravis* Miller. Type. Same stage of growth as fig. 1. In both specimens the alveolus of the incisor has been tapped at its base and a black thread passed through the tube.

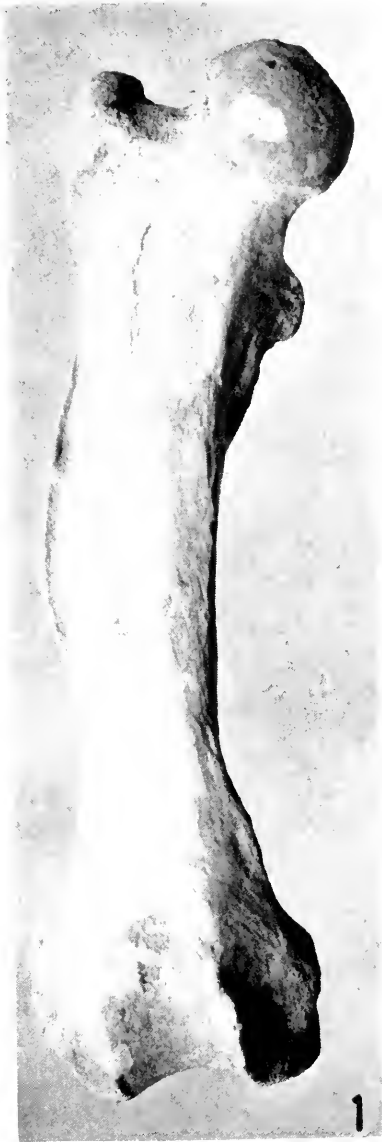

(Both figures natural size)

1. Right femur of *Acratocnus odontrigonus* Anthony, anterior aspect. No. 17711, Amer. Mus. Nat. Hist.
2. Right femur of *Acratocnus* (?) *comes* Miller, anterior aspect. Type.



(Both figures natural size)

1. Right femur of *Acratocnus odontrignonus* Anthony, outer aspect. No. 17711, Amer. Mus. Nat. Hist.
2. Right femur of *Acratocnus* (?) *comes* Miller, outer aspect. Type.

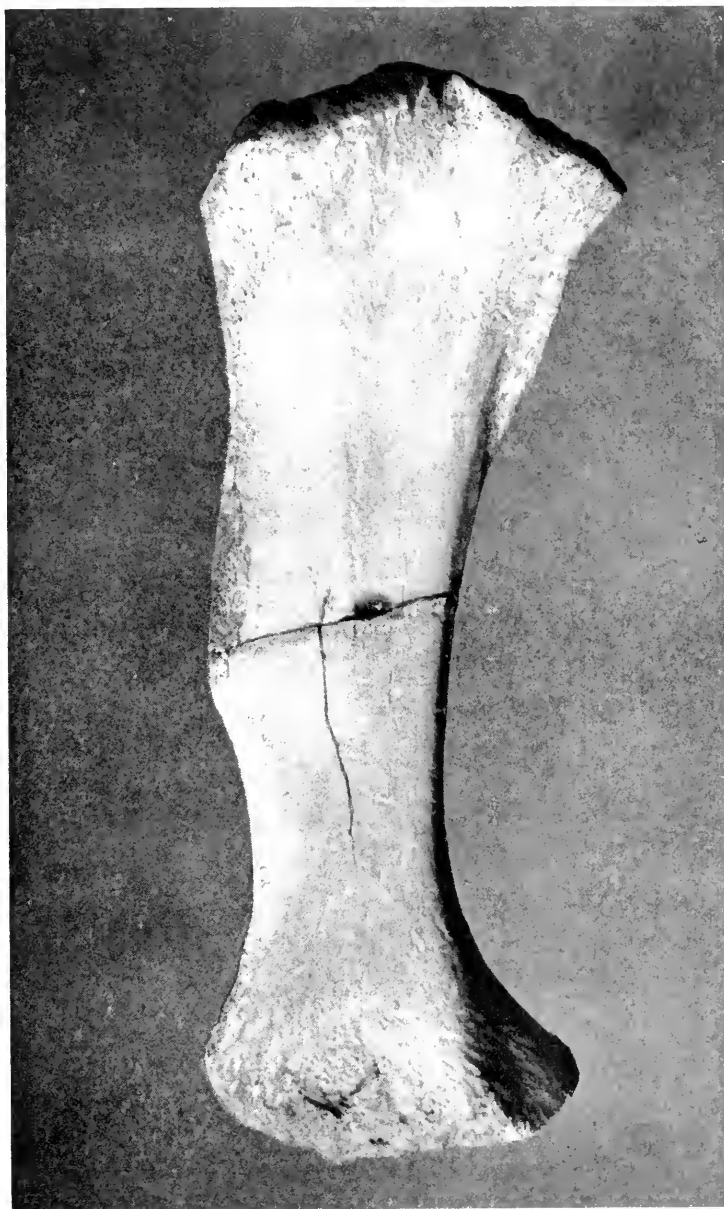

(Natural size)

Right femur of *Parocnus serus* Miller, anterior aspect. Type.

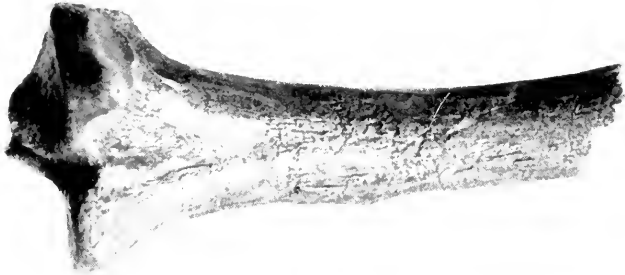

1



2

(Both figures natural size)

1. Right tibia of *Acratocnus* (?) *comes*. No. 253179, U. S. Nat. Mus.
2. Left tibia of *Parocnus serus*. No. 253230, U. S. Nat. Mus.

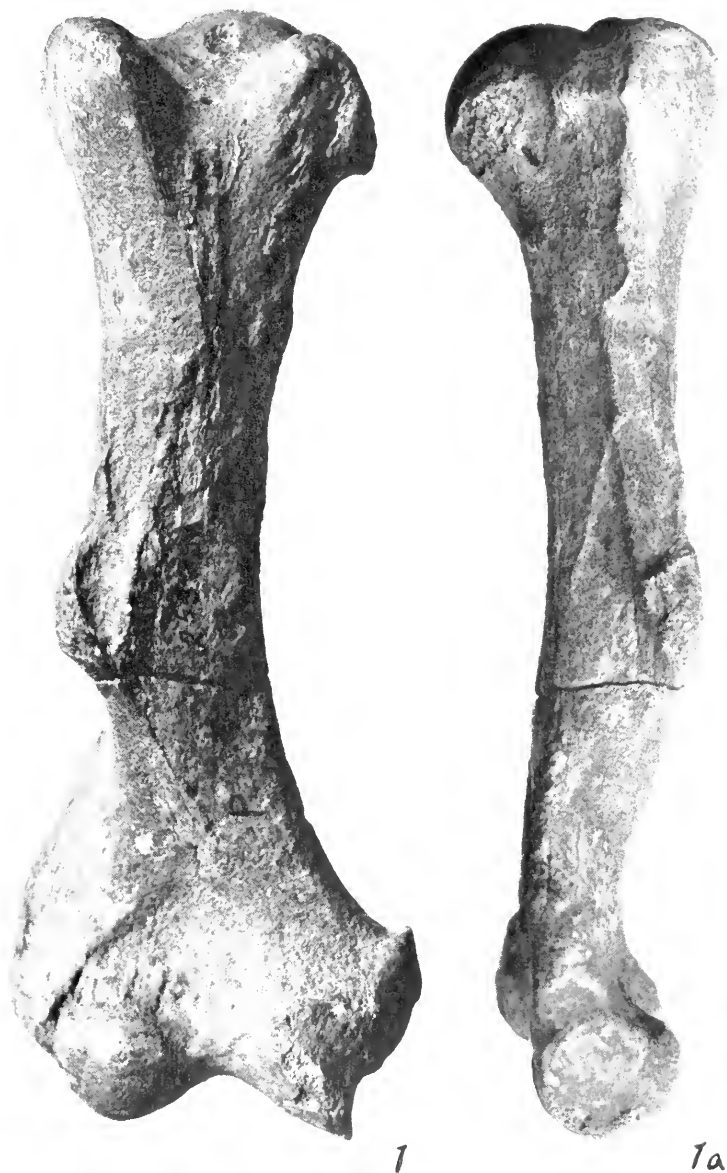

(Both figures $\frac{3}{4}$ natural size)

1. Right humerus of *Parocnus serus* Miller, anterior aspect. No. 253231.
U. S. Nat. Mus.
- 1a. Right humerus of *Parocnus serus* Miller, outer aspect. No. 253231.
U. S. Nat. Mus.

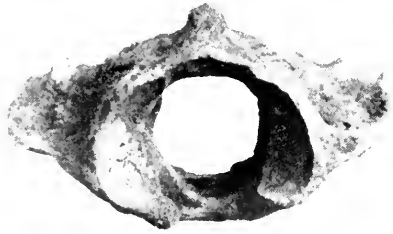

1

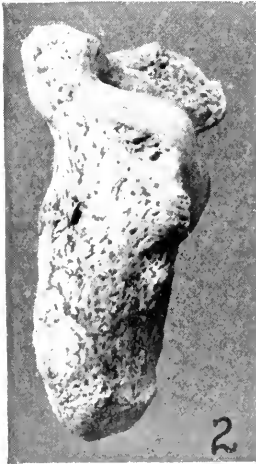

2



2a

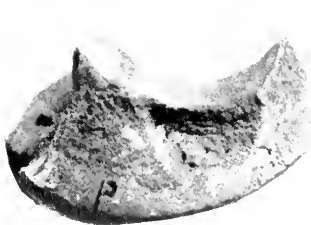

3



3a

(All figures natural size)

1. Atlas of *Acrotocnus* (?) *comes* Miller, anterior aspect. No. 253181, U. S. Nat. Mus.
2. Left calcaneum of *Parocnus serus*? outer aspect. No. 253220, U. S. Nat. Mus.
- 2a. Left calcaneum of *Parocnus serus*? dorsal aspect. No. 253220, U. S. Nat. Mus.
3. Right astragalus of *Parocnus serus*? outer aspect. No. 253220, U. S. Nat. Mus.
- 3a. Right astragalus of *Parocnus serus*? inferior aspect. No. 253220, U. S. Nat. Mus.

SMITHSONIAN MISCELLANEOUS COLLECTIONS

VOLUME 81, NUMBER 10

TROPISMS AND SENSE ORGANS OF LEPIDOPTERA

BY

N. E. McINDOO

Senior Entomologist, Deciduous-Fruit Insect Investigations,
Bureau of Entomology, U. S. Department of Agriculture



(PUBLICATION 3013)

CITY OF WASHINGTON
PUBLISHED BY THE SMITHSONIAN INSTITUTION
APRIL 4, 1929

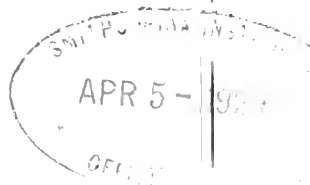

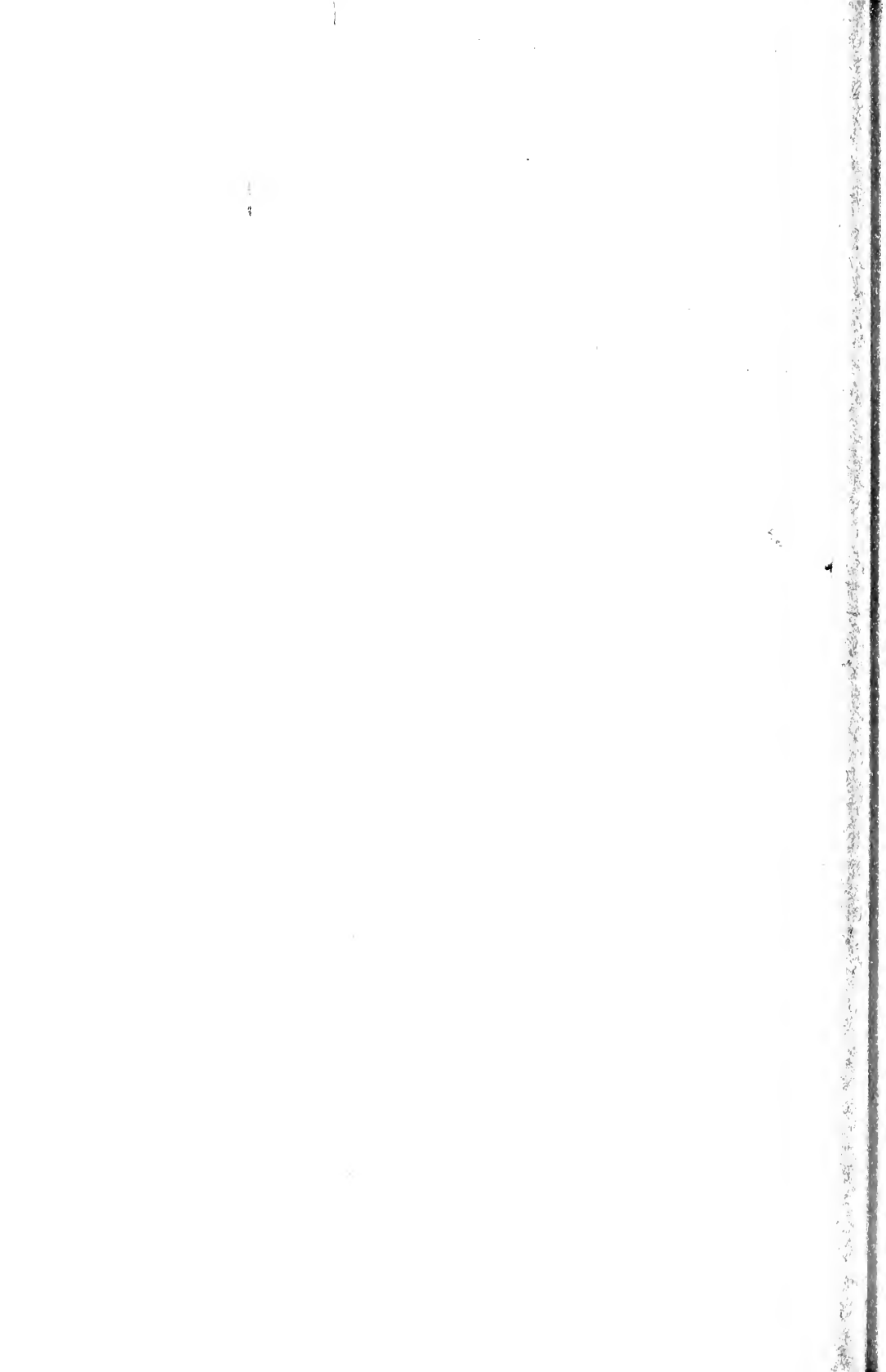

SMITHSONIAN MISCELLANEOUS COLLECTIONS
VOLUME 51, NUMBER 10

TROPISMS AND SENSE ORGANS OF LEPIDOPTERA

BY

N. E. McINDOO

Senior Entomologist, Deciduous-Fruit Insect Investigations,
Bureau of Entomology, U. S. Department of Agriculture



(PUBLICATION 3013)

CITY OF WASHINGTON
PUBLISHED BY THE SMITHSONIAN INSTITUTION
APRIL 4, 1929

The Lord Baltimore Press
BALTIMORE, MD., U. S. A.

TROPISMS AND SENSE ORGANS OF LEPIDOPTERA

By N. E. McINDOO

SENIOR ENTOMOLOGIST, DECIDUOUS-FRUIT INSECT INVESTIGATIONS, BUREAU OF
ENTOMOLOGY, U. S. DEPARTMENT OF AGRICULTURE

CONTENTS

	PAGE
Introduction	2
A. Tropisms	2
I. Phototaxis	3
1. Review of literature.....	3
(a) Definitions and problems in the study of light reactions...	3
(b) Are light reactions adaptive?.....	4
(c) Is orientation accomplished by selection of trial movements?	5
(d) How do light rays bring about orientation?.....	5
(e) Do circus movements support Loeb's theory?.....	5
(f) What wave lengths stimulate insects most?.....	6
(g) Light traps are not yet considered successful.....	9
2. Phototactic experiments on codling-moth larvae.....	10
II. Chemotaxis	14
1. Review of literature.....	14
2. Chemotactic experiments on codling-moth larvae.....	17
III. Geotaxis	19
1. Review of literature.....	19
2. Geotactic experiments on codling-moth larvae.....	20
IV. Thigmotaxis	21
1. Review of literature.....	21
2. Thigmotactic experiments on codling-moth larvae.....	22
B. Tropic receptors	22
I. Photoreceptors	23
II. Chemoreceptors	24
1. So-called olfactory organs.....	24
(a) Antennal organs	24
(b) Olfactory pores	27
2. So-called taste organs.....	35
III. Audireceptors	39
1. Tympanic organs	41
2. Chordotonal organs	41
3. Johnston organs	42
4. Auditory hairs	44
IV. Thigmoreceptors	45
1. Tactile organs	45
V. Georeceptors	46
1. Balancing organs	46
VI. Other receptors	47
C. Scent-producing organs	48
Summary and discussion.....	51
Literature cited	53

INTRODUCTION

Entomologists know considerable about the behavior of insects, but are still unable to explain many of their activities. Since insects are cold-blooded animals and their anatomical organization is entirely different from that of higher animals, their responses to environmental conditions are different. For this reason their activities are not so easily understood. Most of their reactions are tropic responses to external stimuli. We know considerable about some of our own external stimuli, such as light, sound, and heat, and how they affect us; but we know very little about the external stimuli which cause responses in insects, and we know still less about the sensory impressions which are produced in them by these stimuli.

When it is desired to control an insect, the first step is to study its life history, which is largely a study of its behavior, and in turn behavior is largely a result of tropic responses. A study of tropisms is, therefore, a basic one, but economic entomologists in their haste to obtain practical results usually overlook this fact. The late Jacques Loeb was our greatest advocate of the study of tropisms, and as a result of his indefatigable efforts there has arisen a much broader and more important subject—general physiology. If entomologists would study tropisms more seriously, using the best equipment obtainable, they would certainly obtain much information which could be used in insect control.

The object of this paper is to bring together the available information on the tropisms and sense organs of Lepidoptera, hoping that this information will encourage a more serious study of tropic responses. At the suggestion of Dr. A. L. Quaintance, Associate Chief of the Bureau of Entomology, the writer began a series of studies dealing with the tropisms of various insects, particularly those of the codling moth. The results herein discussed include those obtained by the writer in his studies on Lepidoptera and a review of the literature, most of which pertains only to butterflies and moths.

A. TROPISMS

The term tropism comes from the Greek word meaning "turn." According to Mast (56, p. 53) it was first used in 1832 by DeCandolle, who called the bending of plants toward light heliotropism. Later the word heliotropism came to signify both the bending and the explanation of the process. Verworn and Loeb, in 1886 and 1887, as cited by Mast, using tropisms as a basis for investigation, were the first to study animal behavior from the physico-chemical point of

view. Loeb attempted to show that the behavior in plants and animals is practically alike, and concluded that the behavior in animals is largely controlled by external agents, and is influenced by internal factors. He and his followers described reactions in animals in terms of tropisms.

There has been a controversy among various classes of scientists in regard to the proper terminology to be used in connection with tropic responses. Couch (6) proposes that the generic name, tropism, be retained for all the classes, but that biologists and biochemists use the words phototaxis, geotaxis, chemotaxis, etc., leaving the "isms" to be used by chemists and physicists, and particularly the word phototropism by the photochemist.

Mast (57) informs us that the term tropism has been defined in some 20 different senses. Since there is so much confusion about its meaning, he proposes that we cease using it altogether, using instead terms with more precise meanings as (p. 261): "negative or positive orientation or reaction to light, gravity, etc.; photo-, geo-, etc., negative or positive; or merely negative or positive reactions to light, gravity, chemicals, etc." In the following discussions these suggestions will be frequently followed, and instead of saying that an insect is negatively or positively phototropic or phototactic, it will be said to respond or react negatively or positively to light, or to be photonegative or photopositive.

I. PHOTOTAXIS

I. REVIEW OF LITERATURE

(a) *Definitions and problems in the study of light reactions.*—The terms heliotropism and phototropism have been generally used by both botanists and zoologists, but as already mentioned, Couch proposes that biologists use the word phototaxis, leaving the former terms for the photochemist. Botanists still insist on using them, but recommend that zoologists should say phototaxis and phototactic. According to Mast (56, p. 253) the botanists are correct, because

Organisms which orient and move toward or from a source of light are usually termed phototactic, those which orient but do not move as phototropic, and those which do not orient but still react have been termed photopathic.

Loeb, discussing both plants and animals, used the word heliotropism in his original German publications, in their English translations, and even in his latest papers. For our purpose here Loeb's definition of phototaxis will suffice. He says (43, pp. 135, 139):

Heliotropism covers only those cases where the turning to the light is compulsory and irresistible, and is brought about automatically or mechanically by

the light itself. . . . If the current curves of radiating energy, *e. g.*, light rays, strike an animal on one side only, or on one side more strongly than on the symmetrical side, the velocity or the kind of chemical reactions in the symmetrical photosensitive points of both sides of the body will be different. The consequence will be in a positively heliotropic animal a stronger tension or tendency to contract in the muscles connected with the photosensitive points of the one side of the body than in those connected with the opposite side.

Mast (56, pp. 57, 58) points out several problems in the study of light reactions which entomologists should carefully consider. They are discussed with others as follows:

(b) *Are light reactions adaptive?*—No, according to Loeb's definition. He says that animals go toward light neither because it is useful for them to do so nor because they enjoy it, but because they are photopositive. Mast strongly refutes this explanation by saying (56, pp. 298, 237):

Reactions to light are in general adaptive. There are, however, certain reactions which are clearly injurious and often fatal; as, for example, the flying of insects into a flame and the positive reactions of organisms which live in darkness. But the positive reactions of insects are ordinarily advantageous. It is only under artificial conditions that they prove fatal, and the ancestors of many animals which now live in darkness lived in the light. Positive reactions were probably advantageous to them, and the power to respond thus was probably inherited by the offspring, in which it is useless. . . . Negative response to light tends to keep these creatures [blowfly larvae] buried in cadavers where they find food. It is ordinarily only under artificial conditions that the reactions of organisms to light prove fatal. Positive reactions to candle, lamp and lighthouse destroy untold numbers of moths and flies and bees and beetles and birds, but who has seen such fatalities under natural conditions? Under such conditions the responses to light direct these animals to the advantage of their well-being.

Loeb's (43, p. 160) explanation of the origin of adaptive light reactions follows:

The fact that cases of tropism occur even where they are of no use, shows how the play of the blind forces of nature can result in purposeful mechanisms. There is only one way by which such purposeful mechanisms can originate in nature: namely, by the existence in excess of the elements that must meet in order to bring them about.

Mast (56, p. 368) adds that light reactions are variable, modifiable, and in general adaptive, and that regulation constitutes perhaps the greatest problem of life. Loeb (43, p. 125) believes there is a phototactic difference between the sexes of Lepidoptera, for male moths are more apt to fly into candle flames than are the females. It is well known, however, that both sexes are attracted to strong electric lights. It was assumed long ago that moths fly into flames because they are fond of light, but Loeb assures us that this is a purely mechanical

response, comparable to the turning of a plant toward light. In reply to the question as to why moths fly toward a candle at night and not toward the moon, Mast (p. 227) replies that in moonlight there are large illuminated areas all about, whereas in candle light the objects are so faintly lighted that moths do not react to light reflected from them. In reply as to why mourning-cloak butterflies fly toward a large illuminated patch of flowers rather than toward the sun which is much brighter, Parker (69) says it is because the patch of flowers makes a larger "spot on the retina." All of these responses Mast considers adaptive regardless of the explanations given.

(c) *Is orientation accomplished by selection of trial movements?*—Loeb (42, p. 57) exposed blowfly larvae in front of a window. He found them to be photonegative and to crawl with mathematical precision. Other investigators have repeated these tests, but they failed to find that blowfly larvae, or in fact any other insects, respond to light with mathematical precision. Mast (56, p. 196) says that blowfly larvae are excellent examples of animals which are guided fairly directly on their courses by successive trial movements.

Loeb (42, p. 24) tested caterpillars of *Euproctis* (*Porthesia chrysorrhoea*) and he found them to be strongly photopositive, creeping in a straight line toward the light. Lammert (40) in 1925 tested three other species of caterpillars which were also photopositive, but crawled in wavy lines. The present writer's results (p. 13) with codling-moth larvae agree with those of Lammert.

(d) *How do light rays bring about orientation?*—Loeb in 1888, according to Mast (56, pp. 54, 57, 228-235), claimed that orientation in animals is controlled by the direction in which the rays pass through the tissue. In 1889 he further said that symmetrically located points on the photosensitive surface must be struck by light at the same angle. Later he abandoned the idea of the importance of the angle between the sensitive surface and the light rays and substituted the view that orientation is brought about by absolute difference of intensity of the light on symmetrically located points on the sensitive surface. Jennings, Mast, and others claim that orientation is accomplished by changes of intensity on the sensitive surface. Loeb believed that light acted constantly as a directive stimulation similar to the action of a constant current of electricity, while Jennings and Mast believe that it acts only when the animal turns out of its course so as to produce changes of intensity.

(e) *Do circus movements support Loeb's theory?*—Mast (56, pp. 215-218) states that several workers have found that if one of

two symmetrically located sense organs has been prevented from functioning, the animal no longer orients but turns toward one side when stimulated. Certain flies with one eye blackened turned toward the functioning eye. Parker (69) obtained similar results with a butterfly (*Vanessa antiopa*). Loeb (44, pp. 52-61) cites the results of several writers, who conducted similar tests on insects, as giving "direct proof of the muscle tension theory of heliotropism in motile animals." Dolley (10) experimented with *Vanessa antiopa* and concluded that his results contradicted Loeb's "continuous action theory." According to this view the tension of the muscles of the appendages on both sides of the body is controlled through direct reflex arcs by the photochemical changes produced by light in the two retinas. Dolley says that these butterflies with one eye blackened can orient and can turn under certain conditions toward either side, all of which indicates that orientation in them is not wholly dependent upon the relative intensity of light on the two eyes. The same author (11) determined that *Vanessa antiopa* moves faster in weak light than in strong light. This behavior is not in accord with the above theory. Dolley also determined that these butterflies move faster in intermittent light than in continuous light, which indicates that orientation in them is "due to the time rate of change of intensity."

(f) *What wave lengths stimulate insects most?*—The determining of this is perhaps the most difficult of all the problems encountered in a study of tropisms, and much confusion has arisen while trying to solve it. Many erroneous conclusions have been derived; first, because the investigators, as a rule, have had a poor knowledge of the physics of color; and second, because in most cases they have not been properly equipped with apparatus to study the effects of various wave lengths on insects.

Loeb (42, p. 18) remarks that all authors who have studied the behavior of plants behind screens have usually concluded that only the more refrangible rays are heliotropically active. Using two colored screens (red and blue), he concluded that the more refrangible rays of the visible spectrum are more effective than the less refrangible rays in causing orientation in animals (p. 82). He tested the caterpillars of *Euproctis chrysorrhoea* (pp. 29-31) with these screens, which had been examined spectroscopically, and determined that they reacted most decidedly to the shorter wave lengths.

Mast (56, pp. 302-365) in 1911 reviewed the entire subject of wave lengths or colors and discussed insects in particular (pp. 343-355). He reviewed Loeb's work on animals and fails to understand how the

latter could have made such positive statements since only two colors were used. It is easy to ascertain that animals can distinguish wave lengths that we call colors, but it is difficult and perhaps impossible to determine whether the responses are brought about by the quality or quantity of the wave lengths, that is, by actual color or by brightness. Our only recourse is to test them and to judge their responses from the human point of view, which proves little or nothing in regard to insects. On this point Mast (p. 362) says:

Bees and fishes can undoubtedly distinguish different regions in the spectrum. They can be trained to select any of the primary colors of the spectrum by associating these colors with food. That is, they are positive to (or select) one color at one time and another at a different time. Just what mechanism is involved in this power of selection is unknown. Whether it is on the basis of brightness or on the basis of color vision or neither is a matter concerning which experimental evidence does not warrant a definite conclusion. Many organisms react to ultra-violet much as they do to visible rays. This is in harmony with the following quotation from Schäfer referring to man (1898, p. 1055): "The invisibility of the infra-red rays is probably due to insensitiveness of the retina, while the ultra-violet rays fail to be seen, partly, at any rate, owing to absorption by the ocular media."

Washburn (90, pp. 144-159) discusses the problem of visual qualities in invertebrates. Certain authors believe that vision as far as color is concerned in the lower animals, particularly insects, is similar to that in totally color-blind people. On this point Washburn (pp. 145, 147, 148, 157) says:

It is therefore of some importance to the problem of color vision in the lower animals to find *how strongly* the light rays of various wave-lengths affect them. But we must bear in mind that for the lower animals it is impossible to conclude color-blindness from the fact that the brightness values, that is, the effective intensities, of the different colors are what they would be for a color-blind human being. Just this unsafe inference is, however, drawn by certain authorities. . . . It is thus clear that when an animal discriminates between rays of different colors, the discrimination may be based merely on the intensity of the rays, either in themselves or in the effect which they have on the organism, rather than on their wave-length or color. . . . He [Hess] found that the yellow and green rays produce much more effect than the red and violet rays. Since this is true also of the color-blind human eye, he argues that the animals tested are totally color-blind. He holds, in fact, that all invertebrate animals are totally color-blind, on the same evidence. . . . But again we may remind ourselves that it does not follow that because a human being who finds the yellow-green, rather than the yellow, the brightest spectral region, is totally color-blind, therefore an animal, especially an invertebrate animal, the chemical substances in whose eye may have no resemblance to those in the human eye, is color-blind if it shows these reactions to the different regions of the spectrum.

Mayer and Soule (59) in 1906 determined that the caterpillars of the milkweed butterfly are photopositive to ultraviolet rays, but barely respond to the rays which man sees in the spectrum.

Lutz (46) in 1924 used colored filters as windows in a box and determined that insects can readily distinguish ultraviolet rays. Certain individuals, particularly Lepidoptera, stubbornly refused to respond to any condition of illumination, even clear sunshine, when they were placed in the box. Certain others responded only when urged to do so by jarring the box, but then their reactions were definite. The skipper *Epargyreus tityrus*, when put in the box "went to sleep," but when touched it went to the ultraviolet filter and tried to get out.

Other recent workers, whose apparatus and procedure are recommended to research students, have obtained results showing that insects respond to the color of certain wave lengths. Thus Abbott (1) determined that a certain ant responds most readily to yellow, and Bertholf (3) ascertained that red does not stimulate honeybees as much as it does humans, but that violet stimulates them more.

Besides consulting the references already cited students are advised to consult others, particularly Parsons (71) and Luckiesh (45).

One of the most recent papers on this subject is by Peterson and Haeussler (74), who studied the responses of the oriental fruit moth (*Laspeyresia molesta* Busck) and the codling moth (*Carpocapsa pomponella* L.) in 1925, 1926, and 1927. Several thousand individuals of each species were tested after dusk at Riverton, N. J., where an abundance of material could be secured. Two types of apparatus were used, but the most satisfactory one is what they call a "four-way light apparatus." The colored screens and lights used were submitted to Dr. P. A. van der Muelen of Rutgers University, who examined them spectroscopically. Their summary in part is as follows: Oriental fruit moths and codling moths seek the light side of containers in which they are placed. This indicates that they are photopositive under ordinary conditions. When tested under laboratory conditions in the four-way light apparatus, with the four compartments equally lighted with white lights, practically the same number of moths went into each compartment. When the compartments were unequally lighted, the largest number of moths went to the strongest light. When the moths were given the choice of lights varying in color from red to violet and the ratios of relative intensities of the colored lights were approximately equal, practically all of the moths went to blue and violet lights. Few or none were attracted to the red light. Orange and yellow lights, when compared to bluish ones, were also unattractive. Green light, possessing no blue rays, was likewise unattractive. Violet light was preferred to blue, and ultraviolet wave lengths appeared to be more attractive than violet. Ultraviolet light

was probably perceived by oriental fruit moths and they were probably attracted by it. Codling moths seemed to be more strongly photopositive to blue and violet lights than were oriental fruit moths. The responses of males and females of both species to colored lights appeared to be similar. Experiments in which ordinary electric lights were installed in a peach orchard were unsuccessful, only a few of the oriental fruit moths being caught in traps. Codling moths were not tested in orchards.

There is considerable difference of opinion regarding the apparatus to be used in light experiments. Yerkes and Watson (91, p. 3) say that simpler and more conveniently manipulated apparatus may be used in preliminary work, but emphatically recommend that such apparatus be abandoned as soon as possible. They recommend a very complicated piece of apparatus for thoroughgoing, intensive, and quantitative work.

(g) *Light traps are not yet considered successful.*—Dewitz (9) in 1912 briefly discussed the practical side of phototaxis as applied in economic entomology, but regretted that this subject had never been seriously studied from a scientific point of view. To his knowledge only one investigator spectroscopically examined the various lights used. This man projected a large spectrum on a screen in a dark room and then observed certain moths collect on the different colors of the spectrum. He found that the less refractive colors (red to green) exercised by far the strongest attraction. It is also stated that experiments were conducted in vineyards in Germany in which lamps provided with glass covers of various colors were used. The lamps with green glass attracted the largest number of moths.

According to Dewitz, artificial light as a control measure was first used in 1787 for attracting vine moths to lighted candles on window sills and to wood fires in vineyards. Since that date light traps have been gradually developed and improved until to-day there are many types and varieties of kerosene, acetylene, and electric lamps used for this purpose. It seems that none, however, has given complete satisfaction as a control measure. The present writer does not know of a single authentic report that this method has been successful on a large scale, although he has a recent newspaper report stating that along the German-Polish frontier powerful searchlight traps have been used successfully against a nocturnal moth whose larvae ravage the pine forests. Millions of moths are said to have been cremated by being attracted to flames near the searchlights.

At last an investigation on a large scale, in which up-to-date scientific methods are being used, has been started by the New York (Geneva) State Agricultural Experiment Station and the Empire State Gas and Electric Association. So far only a progress report of this work has been presented by Parrott (70), who regards a study of tropic responses of insects as one of the most promising fields of entomological inquiry, and who believes that when the more important facts about light attraction for insects are known we may, perhaps, be able to change some of our present practices on insect control. Experiments in orchards in which various kinds and colors of electric light bulbs were used gave a total catch of 65,000 insects, of which 29.6 per cent were Lepidoptera and 52.5 per cent were Diptera. All of the Lepidoptera, most of the Coleoptera and Hemiptera, and a smaller percentage of the Diptera and Hymenoptera caught were injurious species. Among the Lepidoptera were the codling moth, fruit-tree leaf-roller, cutworm moths, and several other species. This method was also found useful for trapping codling moths and other injurious insects in cold storage houses. In a dairy barn clear and white frosted bulbs attracted more flies than did the other colors, and red attracted the least of all. Tests in which colored glass filters were used with several species of moths including codling moths and European corn-borer moths showed that these insects did not respond to the red end of the visible spectrum, but the light yellow, light blue-green or daylight, red-purple, and blue-purple filters proved the most attractive.

2. PHOTOTACTIC EXPERIMENTS ON CODLING-MOTH LARVAE

The writer, like other observers, has found the adult codling moth an unfavorable insect on which to experiment in the laboratory. These moths are extremely erratic in behavior. They are very quiet and usually non-responsive during the daytime, but at dusk and later they are more active and readily respond the first time, although thereafter their responses are irregular and not fully reliable. Since the same individuals cannot be repeatedly tested with satisfaction and as the writer's supply of them was limited, he was not able to conduct the experiments as originally planned.

Having failed to obtain definite results by testing a small number of the adults, the writer spent much time in 1927 on the larvae, which proved to be more favorable material for tropic tests. In all 154 larvae, belonging to the two broods at Silver Spring, Md., were tested in the laboratory under various conditions. Most of them had been reared from eggs in the laboratory. The wormy apples

were kept in battery jars and drinking glasses, and an accurate record of the age, size, color, and behavior of the infesting larvae was recorded. The instars were determined by use of Dyar's (14) method of head measurements, the live larvae being rendered inactive by laying them upon a piece of ice on the microscope stage. Temperature and humidity records were obtained from centigrade thermometers and a hygrothermograph. Notes pertaining to the date, time of day, character of sky and wind, degree of brightness of sunshine, and rainfall were recorded, but unfortunately it was difficult and sometimes impossible to correlate climatic conditions with the tropic responses obtained. For this type of work more refined methods and apparatus are badly needed.

Since it was not possible to carry on phototactic tests among the trees in orchards in the natural environment of these insects, the next best condition was to use daylight in the laboratory. Daylight, however, was unsatisfactory because the intensity varied daily and even from hour to hour, so that comparative quantitative results were impossible. Artificial light with a 100-watt "daylite" bulb was tried. The larvae usually responded to it only after being touched and then very feebly. For these experiments a simple and quick method for determining daylight intensities was badly needed, but none seemed available.

Relative to ecological photometry and means of measuring light, Klugh (39) presents a critical review of the entire subject and then describes a new instrument, called an ecological photometer. There are already three kinds of instruments of high precision for measuring radiation. Two of them, the pyrhelimeter and spectrobolometer, are used by the astrophysicist and the third, the spectrophotometer, is employed by the physicist. The new instrument is said to meet the needs of the ecologist, but in order to operate it one should be considerably experienced in photography. Using the new instrument Klugh obtained very interesting results. As an example to show the great variations in daylight intensity, he selected an open habitat on a bright clear day, July 26. Letting the intensity at noon equal 100 per cent, he then determined the following percentages of intensities: At 9 a. m., 90 per cent; at 5 p. m., 83 per cent; at 6 p. m., 66 per cent; and at 7.45 p. m., 5.2 per cent. On another bright sunny day he found the intensity to be only 2 per cent in a woods while in the open it was 100 per cent, but on a cloudy day it was 10 per cent in the same woods as compared to 100 per cent in the open. The intensities on clear and cloudy days vary greatly. Filmy clouds over the sun

reduce the intensity, whereas white clouds in the sky but not over the sun increase it by reflection from 10 to 40 per cent over that of a cloudless day.

In view of the varying light values and other conditions involved in phototactic experiments, the reader can appreciate the experimenter's difficulties and can understand why it is so difficult to interpret the results correctly.

In bright light, although not direct sunshine, codling-moth larvae of the first instar were found to be weakly photopositive, and their reactions agreed in general principles with those described by other investigators. None was found, however, to orient and to move with mathematical precision as was stated by Loeb for certain insects.

Larvae of the first instar, confined in an uncovered box in which most of the light was reflected from the ceiling, moved in all directions. Recently hatched larvae placed on a table by a south window and six feet from an east window, instead of moving directly toward the south window, deviated toward the left (fig. 1, A). This reaction agrees with those described by other writers, for example Dolley (12), when two sources of light at right angles are employed.

In order to eliminate side lights a box, 18 inches long, 12 inches wide, 12 inches high, and lined with a dead-black cloth, was constructed. One end and the top were left open. The open end faced the south window while the experimenter, from above, traced the tracks of the insect with a pencil. Since there was apparently no difference between white paper and black paper as to effects of reflected light on the insect, all tracings were made on white paper. The pencil was moved gently a few millimeters behind the insect and this usually did not affect the behavior of the larva, although in tracing the path of photonegative insects care had to be exercised not to allow shadows from the pencil to fall upon the insect. Recently hatched larvae, when put in this phototactic box on either bright sunny days or on cloudy days, oriented themselves and tended to move toward the direct rays of light as illustrated in figure 1, B, in which those tested before noon deviated toward the left (No. 96) while those tested after noon deviated toward the right (Nos. 98, 99). Many exceptions to this tendency, which the writer cannot explain, were recorded, so no definite rules can be stated. In order to be reasonably certain about the light reactions of all the larvae tested, it was necessary to test each one two or more times before drawing conclusions.

Larvae of the second, third, and fourth instars were found to be weakly photopositive to weak light (fig. 1, C, Nos. 112a, 113a, 124a), but indifferent to strong light (Nos. 112b, 113b, 124b).

Larvae of the fifth instar sometimes acted indifferently to light (fig. 1, D, No. 108) but generally were weakly photonegative (Nos. 102, 118, 126, 129). Larvae of the sixth instar were either weakly (fig. 1, E, No. 100) or strongly photonegative (Nos. 54, 68, 72, 73, 78), the degree depending on their age. In all cases they oriented quickly and moved hurriedly from the light as illustrated in figure 1, E.

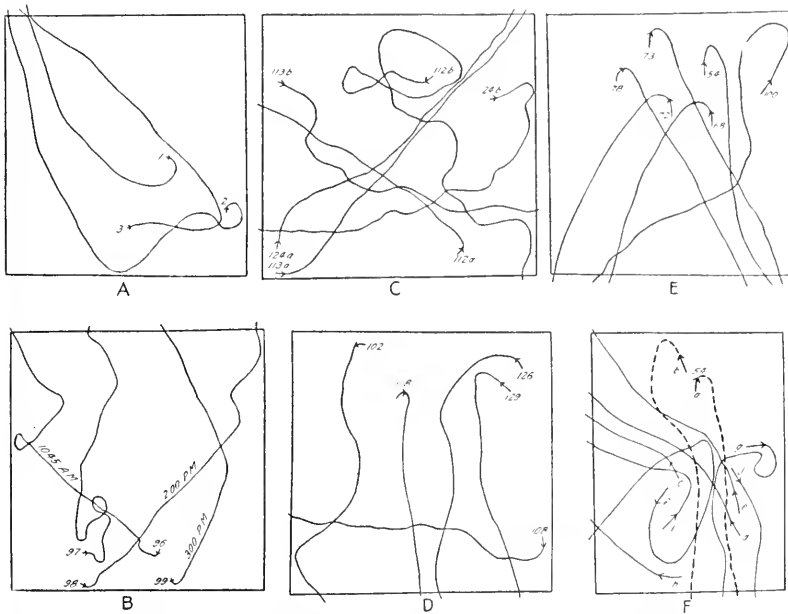

FIG. 1.—Tracings of phototactic responses of codling-moth larvae (see p. 12 for further explanation). A, Movements of recently hatched larvae of first brood tested on table between an east and a south window at 3.45 P. M. B, Recently hatched larvae of second brood tested in phototactic box. C, Larvae of second brood; Nos. 112 *a* and *b*, fourth instar; Nos. 113 *a* and *b*, third instar; and Nos. 124 *a* and *b*, second instar. D, Larvae of second brood, fifth instar. E, Larvae of second brood, sixth instar, fully grown. F, Fully grown larva, No. 154, ready to spin; *a* and *b*, normal; *c* to *j*, ocelli blackened.

Normal larvae of the sixth instar, ready to spin cocoons, were strongly photonegative (fig. 1, F, No. 154*a* and *b*), but when their ocelli were covered with a mixture of glue and lamp black they became indifferent to light as illustrated in figure 1, F, *c* to *j*.

One of Loeb's early observations indicated to him that lepidopterous larvae do not generally react to geotaxis, but that this tropism is replaced by phototaxis. According to Lammert (40), Schmitt-Auracher, after finding a migration of pigment in the ocelli of insects, supported this view and then assumed that the ocelli were capable of

two adaptive conditions, which are distinguished morphologically by different pigment deposits and that phototaxis depends on these deposits; that is, a dark deposit of pigment causes a dark adaptation and negative phototaxis, while a light deposit brings about a light adaptation and positive phototaxis. Lammert does not support this hypothesis because he failed to find a migration of pigment in the ocelli of certain insects, but his tests in which the ocelli were blackened caused him to believe that lepidopterous larvae have two kinds of photoreceptors—the ocelli and others lying in the body integument. He believes, therefore, that these larvae have a skin sensitive to light. The present writer's few experiments on this subject do not indicate that codling-moth larvae have photoreceptors in their integument, and these larvae do not appear to be suitable material in which to search for a migration of pigment in their ocelli.

II. CHEMOTAXIS

I. REVIEW OF LITERATURE

Much was learned about chemotaxis long before the term chemotropism was first applied to it. Among the earliest publications are those of Fabre (20, pp. 179-216) and Forel (21, p. 76), who established the fact that male moths are attracted from long distances to their mates apparently by means of odors emitted by the females. Mayer (58) in 1900 carried on tests with *Promethes* moths and established the fact beyond doubt that the males are attracted by emanations from scent-producing organs of the females. Later Mayer and Soule (59), Kellogg (37), Freiling (23), and others corroborated the view that the emanations are emitted from scent-producing organs. Prüffer (75, 76) more recently has supported this view in regard to the gipsy moth. He assures us that the attraction between the sexes is accomplished by means of aromatic substances which are secreted by the females and the odors of which are perceived by the males. To determine whether or not the attraction is similar to the radiation from radioactive material, he confined the females in a lead cylinder which would reduce the supposed radiation to a minimum and then allowed the emanations from the cylinder to escape by means of a specially constructed column of mercury. Using this apparatus he soon determined that the females thus confined attracted the males in the same manner as do the females in the open air, but that the males were not attracted when the females were confined in a hermetically sealed glass container. Dead females were also able to attract males, but to a lesser degree. Prüffer furthermore tells us that the radiation from a

living insect, which when laid upon a photographic plate leaves an impression, plays no part in this attraction.

Loeb (43, p. 155) in 1889 seems to have been the first one to use the term chemotropism in connection with the responses of Lepidoptera that have just been discussed and with the attractiveness which meat has for blowflies and their larvae.

As the writer (54, 55) has recently reviewed the literature dealing with chemotaxis in economic entomology, only a short discussion need be given here.

Chemotaxis, like the other tropisms, has two divisions. Attractants, usually called "attractants," induce positive chemotaxis and repellents induce negative chemotaxis. For our purpose here Trägårdh's (85) definition will suffice. He says (p. 113):

By the term "chemotropism" is meant, as well known, the automatic orientation of the animals to any olfactory sensation in such a manner that both sides of the body are struck by the lines of diffusion at the same angle. Theoretically, when a substance diffuses an odour, fine particles are ejected in straight lines, but in reality the air currents cause the lines to deviate from their straight track.

In the control of Lepidoptera many practical applications of chemotaxis have been made. Attractive poisoned bran baits are used as control measures against armyworms and cutworms. As early as 1896 baited traps were used by collectors to catch large numbers of fertilized, egg-laying female moths. Many years ago the common control method against grapevine moths in Europe was the use of attractive baits; but more recently the use of insecticides has supplanted this method as a control measure, so that now it seems to be used only as an indicator of the approximate number of moths present. With this information the grower knows when to apply the insecticides.

A molasses-yeast bait was placed by Peterson (72) in a peach orchard in New Jersey, and it was observed that large numbers of the oriental fruit moth came to the bait pans. This observation was a stimulus for more extended work with attractive baits, but this particular bait when fermenting proved to be the most attractive one tested. Frost (24) used weak acids, volatile oils or their constituents, sugars, and molasses as attractants. The fermenting sugar baits attracted the most moths. Peterson (73) tested about 250 aromatic chemicals as possible attractants for the oriental fruit moth. Terpeneol and several essential oils were somewhat attractive, but not so attractive as several fermenting sugar-producing products. Fermenting fruits (dried fruit in water), particularly prunes, pears, and apricots, attracted large numbers of moths. By using dried fruits, sugars, and

sirups in Maryland peach orchards in 1926, Siegler and Brown obtained results similar to those of Peterson. Apricots were the most attractive of the dried fruits used. A late report about baits for the oriental fruit moth is by Frost (25), who discusses comparative tests with various baits, factors affecting the catches of moths, and the value of bait pails as a means of control. He believes that this method may find a definite place in the control of this moth. The latest report consulted on this subject is by Stear (83), who says that bait pans offer little hope in practical control.

Supposing that the codling moth was attracted to fruit trees by odors, Yetter (92) conducted a large series of experiments in Colorado, using 35 aromatic chemicals. Of these only five attracted moths in sufficient numbers to give promising results. These five are isobutylphenyl acetate, diphenyl oxide, bromo styrol, benzyl benzoate, and safrol. He firmly believed that, if trapping were systematically carried out by all the growers in the Grand Valley and for the entire season, much could be accomplished in checking the damage done by this pest.

Yetter and Yothers each seem to have begun testing baits in 1923, but the latter did not publish his results until 1927. Yothers' (93) summary follows in part: Cooked, fermented apple juice, containing some of the apple pulp, proved more attractive than did vinegar or cider. A molasses ferment proved much more effective than did apple ferment, honey ferment, or any one of two dozen essential oils. Of the essential oils only three—clove, citronella, and sassafras—proved attractive to codling moths. About 55 or 60 per cent of the moths caught were females, and 95 per cent of these were gravid. The baits gave a good indication of the beginning and end of the codling-moth season, the appearance of each brood, and the maximum abundance of each. This information may be used to advantage in arranging spray dates for moth control. In bait tests final counts of fruit showed an increase of from 12 to 16 per cent of fruit over similar plots without traps. Yothers believes that an attractive bait may yet be discovered which will be so attractive that this method may then be recommended as a satisfactory supplementary control measure.

Yetter's first report encouraged others to try this supplementary control measure. Spuler (82) found codling moths to be attracted in large numbers to a fermented bait consisting of one gallon of apple cider, one-half pound of brown sugar, and one yeast cake. Approximately 60 per cent of the moths caught were females. It was concluded that the bait traps will reduce the number of moths in an orchard, thus serving as an important supplement to spraying, and will furnish infor-

mation as to the time of appearance of the moths. Other similar reports on this subject are by Headlee (30) and by List and Yetter (41). According to Fowler (22), baits are also being used in South Australia as an aid in codling-moth control. This writer says that large numbers of moths can be caught in suitable traps properly baited, and that it is profitable to put out a number of traps from the last week in October until the end of November, and again from the end of January to the middle of February, which intervals cover the periods of maximum emergence and give the best results. Baits are likewise being used in South Africa.

After experimenting with a large number of aromatic substances for several years at Clarksville, Tenn., Morgan and Lyon (67) have recently reported that amyl salicylate incites a decided feeding response in tobacco hornworm moths (*Phlegthontius carolina*), inducing an attraction to artificial flowers. Sixteen species of Sphingidae were caught in traps baited with the chemical besides the two species frequenting tobacco. In field experiments a number of female moths sufficient to have deposited 8.1 eggs per tobacco plant were caught in traps. Amyl benzoate was also found very attractive.

Attractants and repellents have been used in control measures against other species of moths, and a further discussion is perhaps not necessary to convince the reader that this new line of research merits further serious consideration.

2. CHEMOTACTIC EXPERIMENTS ON CODLING-MOTH LARVAE

The preliminary results which follow were obtained by testing codling-moth larvae with attractants and repellents. As an example of the procedure in the tests, a recently hatched larva was put in the phototactic box described on page 12 to be sure that it responded normally to light. After tracing its tracks (fig. 2, A, a) a sheet of white paper was laid on the table by the south window. Twelve cubes of green apple, each 4 or 5 millimeters in size, were placed an inch or more apart on the paper inside a circle having a diameter of 5 inches (fig. 2, A). The larva was then placed inside the circle and allowed to search for the pieces of apple while slowly moving toward the light. It was given 10 chances and each time it touched a piece of apple or the circle that particular chance ended. Pieces of cork of the same size as those of the apple and squares equally large, drawn with a pencil inside the circle, were used as controls.

Several larvae recently hatched went to the pieces of apple, on an average, in 65 per cent of the chances offered to them; several larvae

of the second instar in 50 per cent; one larva of the third instar in 60 per cent; and one larva of the sixth instar in 85 per cent. Several recently hatched larvae went to the pieces of cork in 40 per cent of the chances offered to them and others passed over the squares in 30 per cent of the chances.

These results indicate that smell and sight aid in locating objects, the former being the more important in perceiving odorous objects. Therefore, since larvae of the first instar have photopositive eyes, they remain in the open on apple-tree foliage and search freely for food, apparently not being aided by their senses until within a few millimeters of the food, because in these tests they wandered about

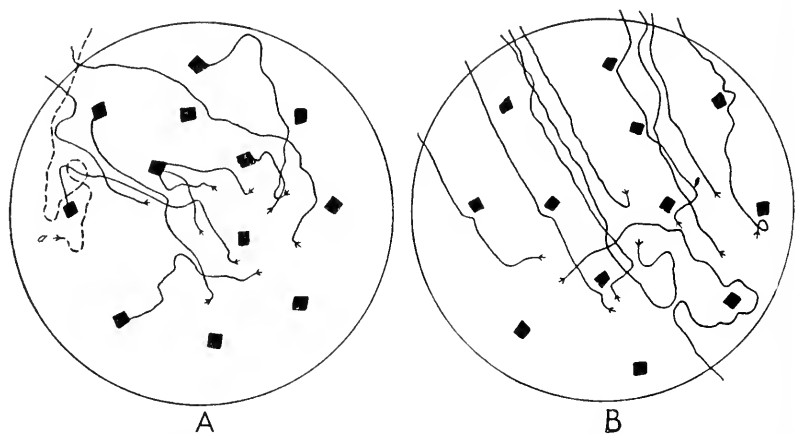

FIG. 2.—Tracings of chemotactic responses of recently hatched codling-moth larvae (see p. 17 for further explanation). A, Positive responses to small cubes of green apple; B, negative responses to synthetic apple oil on small cubes of cork.

aimlessly and did not perceive the pieces of apple and cork until near them, when they often turned and went directly to them.

Two tests were conducted with a repellent. Pieces of cork, after being dipped into concentrated synthetic apple oil, were laid inside the circle, and within a few moments the oil had spread on the paper around the cork. A recently hatched larva was given 10 chances to touch the cork, but not once was it touched. When approaching a piece of cork the larva often circled around the margin of oil on the paper. The following day the same pieces of cork were tested with another recently hatched larva. To the writer the cork was highly scented, but it did not wet the paper. In 10 chances this larva was turned 12 times from its course by the repellent odor (fig. 2, B).

III. GEOTAXIS

I. REVIEW OF LITERATURE

Frank in 1870, according to Mast (56, p. 12), invented the term geotropism to designate the reactions of parts of plants to gravity. Loeb (42, p. 85; 43, p. 125) in 1888 claims to be the first to call attention to the influence of gravity on the orientation of animals. Caterpillars of *Bombyx neustria* were found to be geonegative, for, when confined in a wooden vessel with the opening at the bottom, they crept upward. Loeb says that "geotropism," like "heliotropism," is evident only at certain epochs in the life of an animal, for the result of the geotactic tests were not at all times consistent in the same animals. Loeb (42, pp. 33, 44) confined caterpillars of *Euproctis chrysorrhoea* in test tubes in a dark room and found them to be geonegative. He remarks that strongly negative geotaxis is no isolated phenomenon in insects at the hatching time and immediately after the adults have emerged from the pupa cases. Caterpillars of butterflies, like freshly emerged moths, are also geonegative, though not so markedly. Immediately after emerging geotaxis is much stronger than phototaxis in the butterfly, but later these reactions are usually reversed.

Mayer and Soule (59) found three species of caterpillars to be geonegative. Geonegative and photopositive reactions serve to maintain the caterpillars of the milkweed butterfly near the upper part of their food and to lessen the risk of their wandering down the stem and starving before being able to find another milkweed. Two species of moth caterpillars were geonegative when about to pupate, but they always pupated head downward.

Dewitz (9) remarks that geotaxis may frequently combine with phototaxis, thereby forcing the animals to locate themselves on the extreme ends of tree branches and on the crowns of trees (negative geotaxis), or to descend into the soil (positive geotaxis).

Lammert (40) used an electric light beneath a special apparatus and found all the caterpillars tested to be geonegative with the light turned off. When the stimuli from light and gravity were simultaneously tested the light stimuli were the stronger.

The latest paper known to the writer which deals with geotaxis in insects is by Crozier and Stier (7). Their tests were conducted in a ventilated dark room the temperature of which ranged from 21° to 24° C. A weak nondirective red light was used and the observer's breathing currents were excluded by a screen. Tent caterpillars (*Malacosoma americana*) were tested and each was caused to creep diagonally across an inclined plane, which rested on a horizontal one.

They call the acute angle between the two planes a and the acute one between the track of the caterpillar and the horizontal plane θ . The angle a was changed for each series of tests, and in order to have an average angle θ a caterpillar was repeatedly tested, first with one side and then the other side downward. The results obtained are quantitatively described in terms of trigonometry. The summary in part is about as follows: The geotactic orientation of tent caterpillars while creeping upon a surface inclined at angle a to the horizontal is such that the path makes an average angle θ upward on the plane, of a magnitude proportional to $\log \sin a$. This is attributed to the fluctuation of the pull of the head region upon the lateral musculature of the upper side during the side-to-side swinging brought about in creeping.

A review of the literature by Crozier and Stier (7) shows that neither the mechanical theory nor the statolith theory is sufficient to explain geotaxis, because neither accounts "for the quantitative relationships between gravitational pull and the amplitude of orientation. There is left the appeal to the proprioceptive results of muscle tensions, already suggested to account for certain features of geotropism among insects and molluscs."

2. GEOTACTIC EXPERIMENTS ON CODLING-MOTH LARVAE

Recently hatched codling-moth larvae do not seem to be influenced by gravity either in the laboratory or on the foliage of apple trees. They avoid bright sunshine as much as possible, and if there are no interfering factors they crawl in all directions, as if hunting for food. Seventy-five larvae belonging to the fourth, fifth, and sixth instars were subjected to phototactic and geotactic tests in the laboratory. A branch of an apple tree, 30 inches long and bearing leaves, a small apple, and small twigs, was suspended from a chandelier. At the extreme top and bottom of the branch twine was wound loosely around the twigs to furnish a cocooning place for the larvae being tested. After receiving the phototactic test a larva was laid horizontally in one of the forks of the branch, and in such a position the light was not an interfering factor. The results obtained follow.

The light reactions were found to be a crude index for judging the responses to gravity. Those individuals which were weakly photonegative or were indifferent to light were generally not yet ready to make cocoons and consequently were not geopositive; but when ready to spin, or later, they were nearly always strongly photonegative and geopositive. When larvae ready to spin were put on the branch, they

wandered up and down, but finally went as a rule to the bottom where many made cocoons in the twine, while a few dropped by threads to the floor. This shows that larvae of the sixth instar at cocooning time are strongly geopositive, but shortly before this they were usually indifferent to gravity. The younger instars were either indifferent or geonegative. Therefore, at cocooning time negative phototaxis and positive geotaxis are closely correlated, and when one is known the other can be correctly assumed. In a case of this kind why assume the presence of geotaxis? Instead, why not say: "They go up owing to a hunger urge, and down because of a cocooning urge?" To the writer it seems that they "know" up from down at all times.

While ascending the branch a few of the larvae seemed to perceive the small apple when within an inch of it. They stopped crawling and reached as far as possible in the direction of the apple. These and others after finally reaching it ceased to wander farther.

IV. THIGMOTAXIS

I. REVIEW OF LITERATURE

Dewitz in 1885, according to Loeb (42, p. 23; 43, p. 156), first called attention to a contact-irritability exhibited by spermatozoa of a cockroach. Three years later Loeb noticed the same tropism in Infusoria and gave the name "stereotropism" to the peculiarity, which some animals have of orienting their bodies in a definite way toward the surfaces of solid bodies. Since this tropism in those animals having tactile organs is brought about through the sense of touch, the term thigmotaxis (touch arranging) seems to be more appropriate.

Loeb (43, p. 158; 44, p. 167) believes that positive thigmotaxis is second to chemotaxis in bringing about the union of the sexes. The holding of the female during mating is evidently a thigmotactic sense, and since only males and females of the same species mate, he believes that thigmotaxis plays a part in the selection of the proper species. The same author (42, pp. 22, 110) found certain moths (*Amphipyra*) to be thigmotactic because in tests they crept into crevices and in nature they remain in clefts in the bark of trees. He was able to show that light in such cases was not a factor, for the insects were forced to bring as much of their bodies as possible in contact with solid bodies. The friction and pressure produced by the solid bodies are considered by him to be the cause.

Dewitz (9) says that thigmotaxis is widely distributed among the lower animals and that the mode of living and conduct of many species can be traced back to it. Insects fasten their bodies tightly to promi-

ment objects or squeeze themselves between layers of folded dry goods. On these facts is based the employment of bands around fruit trees to catch codling-moth larvae and the caterpillars of the Tortricidae of the vine; likewise the use of stones and boards in gardens for collecting beneath them earwigs and slugs, which can then be destroyed wholesale. Female grape-moths (*Clysia ambiquella*), when laying eggs, are guided by the highly sensitive extremity of the abdomen, and this sensitive part aids the females of many insects to lay eggs in fissures and folds of plants, soil, and elsewhere. Dewitz also believes that thigmotaxis is the chief means by which caterpillars and certain other insects are able to live gregarious lives.

McCracken (47), while testing female silkworm moths, determined that eggs might be obtained by touching the sense hairs on the ovipositor with a pencil or fibers of cotton. She says that each contact brings forth an egg, and under natural conditions the stimulus is brought about by means of the ovipositor coming in contact with the surface upon which the insect rests.

2. THIGMOTACTIC EXPERIMENTS ON CODLING-MOTH LARVAE

All instars of the codling moth seem to have a well-developed sense of touch, but the thigmotactic sense is most pronounced in the fully developed larvae at cocooning time. When ready to spin, these larvae prefer a tight and dark place in which to crawl, but if a dark one is not at hand they do not hesitate to spin in a well-lighted place. Years ago economic entomologists took advantage of this habit by placing "codling-moth sticks" in the rearing jars. The larvae readily spin in these sticks, which later may be transferred to other containers.

Another practical application of the thigmopositive and photonegative reactions of these larvae has been utilized for many years. When bands are placed around the trunks of apple trees to serve as a supplementary control method we are merely taking advantage of nature's laws. It therefore seems that so far as tropic responses are concerned the vulnerable period in the life history of codling-moth larvae is brought about by a change in tropisms.

B. TROPIC RECEPTORS

In discussions of tropisms, sensory receptors are usually implied as being the organs which receive the tropic stimuli, but in plants and the lowest invertebrates specific sense organs apparently do not exist. However, in the higher invertebrates and vertebrates specific sense organs do exist, but with regard to certain sense organs in insects we are still guessing at their functions and consequently cannot accurately connect them with any known tropism.

The following discussions pertain to what is generally described under sense organs and the senses, but no attempt is made to give all phases of this subject, and most of the information pertains to Lepidoptera.

I. PHOTORECEPTORS

The photoreceptors are the compound eyes and ocelli and there is no difficulty in connecting the compound eyes of adult moths and butterflies and the ocelli of their larvae with the phototactic responses obtained experimentally. The usual number of ocelli on an adult insect is three, but the sexes of the codling moth have only two each. Judging from sections through the eyes of both adult and larva of this moth, the photoreceptors seem to be normally developed, but since so much work already has been done on the morphology of insect eyes no special study was made on this subject. The reader is referred to the reviews by Schröder (80), Snodgrass (81), and Hering (32).

So far as is known to the writer the only new idea on this subject is advanced by Lammert (40), who believes that lepidopterous larvae have two kinds of photoreceptors—the ocelli and others (probably pigment specks) in the body integument. Therefore, he believes that these larvae have a skin sensitive to light, which might be compared to that in the earthworm and other animals having photopigment widely distributed in the body wall.

The results obtained by Dürken (13) bear indirectly on the subject of body pigment used to direct the movements of larvae. He experimented five years to determine the effects of colored lights on the developing stages of the cabbage butterfly. Glass panes of vivaria were painted white and the effect of reflected light from green food-stuffs on the caterpillars was observed. Darkness produced some reduction of black pigment, while orange or red light produced much reduction of black and white pigments. Blue light caused a slight shifting in the direction of weaker pigmentation. Reaction to light occurred immediately before pupation. There was no effect previous to that time on the pigmentation of pupae. Pigmentation of imagoes was entirely unaffected by darkness or light, being absolutely independent of that of the pupae.

In regard to whether sight or smell plays the greater rôle among flower-visiting insects, Clements and Long (5) present the best recent reviews of the literature. They conclude that phototaxis is more important than chemotaxis. Odors attract from a distance while sight attracts from nearby. Form and size of objects play a lesser part in attraction.

II. CHEMORECEPTORS

Chemoreceptors include both olfactory and gustatory organs. Judging from the anatomy and function of these organs in man and the higher animals, we are not absolutely sure that insects have true chemoreceptors, although their organs certainly belong to the same category.

I. SO-CALLED OLFACTORY ORGANS

(a) *Antennal Organs*.—Several investigators have studied the morphology of the antennal organs, but since Schenk's (79) paper is one of the latest and perhaps best, it will suffice for our purpose here. Schenk carefully studied the various types of antennal hairs in both sexes of the following moths: One geometrid (*Fidonia piniaria*), two bombycids (*Orgyia antiqua* and *Psyche unicolor*), and one zygænid (*Ino pruni*). He found five types of sense hairs as follows (see fig. 3 of codling moth): (1) Pit pegs (Sensilla coeloconica), (2) end pegs (S. styloconica), (3) sense bristles (S. chaetica), (4) sense hairs (S. trichodea), and (5) pegs (S. basiconica). Relative to the last named only five were found and these on a female of *Fidonia*. These five types of sense hairs were found on the pectinate or feathered antennae of males and on the filiform or non-feathered ones of the females, and not only on the shafts of both types of antennae but also on all the barbs of the male antennae. The total number of sense hairs found by Schenk in various species is included in table 2, which also gives the tabulated results of the present writer's observations on other species.

TABLE 1.—Number of so-called olfactory organs on codling-moth antennae

Individual No.	Number on male antennae						Number on female antennae								
	Left antenna		Right antenna		Total		Individual No.	Left antenna		Right antenna		Total			
	Styles*	Pit pegs	Styles	Pit pegs	Styles	Pit pegs		Styles	Pit pegs	Styles	Pit pegs	Styles	Pit pegs		
1	36	308	41	319	77	627	1	46	331	35	345	81	676		
2	38	268	36	277	74	545	2	40	330	40	360	80	690		
3	36	366	33	373	69	739	3	36	386	35	368	71	754		
4	37	296	34	294	71	590	4	35	354	35	347	70	701		
5	36	284	31	244	67	528	5	47	257	43	260	90	517		
Average for male antennae.....						72	606	Average for female antennae.....						78	668

* A few styles on each antennae do not bear end pegs.

TABLE 2.—Comparative number of sense organs on antennae of adult *Lepidoptera*

Family	Number and name of species	Kind and number of sense organs					
		Pit pegs (S. cocconica)	End pegs (S. stylocornica)	Styles	Sense bristles (S. chaetica)	Sense hairs (S. trichodea)	Johnston organs
Sphingidae....	1. <i>Phlegethontius quinquemaculata</i> ...	0	0	few	few	very many
	2. <i>Ceratomia catalpae</i>	0	0	"	0	"
	3. Unidentified species.....	0	0	"	0	"	present
Arctiidae.....	4. <i>Apantesis</i> sp.....	few	few	"	many	many
	5. <i>Hyphantria cunea</i> ♀.....	many	"	"	"	"
	6. " " ♂.....	very many	"	"	"	very many
Noctuidae.....	7. <i>Prodenia arnthogalli</i>	few	0	"	"	"
	8. <i>Agrotis unicolor</i>	very many	few	"	"	"
	9. <i>Cirphis unipuncta</i>	very many	few	"	"	"
Liparidae.....	10. <i>Hemerocampa leucostigma</i> ♀.....	0	"	"	few	few
	11. <i>Malacosoma americana</i>	very many	"	"	many	very many
	12. <i>Bombyx mori</i> ♂.....	"	"	"	"	"
Bombycidae...	13. " " ♀.....	"	"	"	"	"
	14. <i>Orgyia antiqua</i> ♂.....	600	50	80	"
	15. " " ♀.....	75	30	42	few
Saturniidae...	16. <i>Psyche unicolor</i> ♂.....	very many	0	present	very many
	17. " " ♀.....	0	0	few	0	0
	18. <i>Samia cecropia</i> ♀.....	0	0	very many	present
Geometridae...	19. <i>Alsophila pometaria</i> ♂.....	0	few	"	very many	very many
	20. " " ♀.....	0	"	0
	21. <i>Fidonia piniaria</i>	350	22	117
Psychidae.....	22. " " ♀.....	100	16	105	few
	23. <i>Thyridopteryx ephemeriformis</i> ♀.....	0	0	0	very many	"
	24. <i>Sanninoidea exitiosa</i> ♂.....	0	0	few	"	"
Pyralidae.....	25. <i>Achroia grisella</i>	0	few	"	"	very many
	26. <i>Carpocapsa pomonella</i> ♀.....	many	"	"	few	"	present
	27. " " ♀.....	few	"	"	many	"	"
Yponomeutidae...	28. <i>Atteva aurea</i>	very many	0	120	"
	29. <i>Ino pruni</i> ♂.....	"	0	120	few
	30. " " ♀.....	many	0	0	0	many	present
Nymphalidae...	31. <i>Argynnis cybele</i>	very many	0	0	0	"
	32. <i>Vanessa antiopa</i>	very many	0	0	0	"
	33. <i>Pontia rapae</i>	few	0	0	0	"	"
Papilionidae...	34. <i>Papilio troilus</i>	very many	0	0	0	"	"

The antennal organs of five male and five female codling moths were carefully examined by the present writer. Little or no sexual differences were observed in the antennae or their organs. The antennae of both male and female are filiform and bear the same kinds and practically the same number of organs (tables 1 and 2). The number of segments in the antennae of males ranges from 55 to 61 with 58 as an average; those in the antennae of females from 59 to 63 with 62 as an average. Each antenna bears one Johnston organ

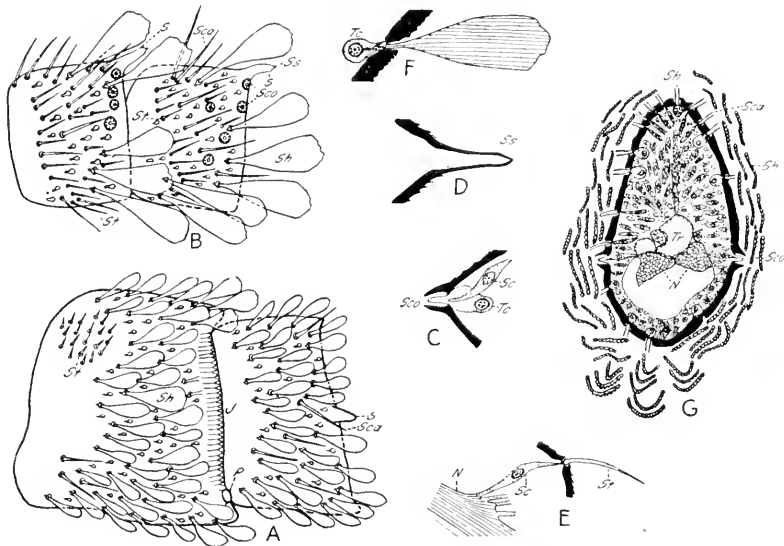

FIG. 3.—Antennal organs of female codling moth, No. 3. A and B, External views, $\times 125$. C to G, Sections; C to F, $\times 500$; G, $\times 320$. A, Second and third antennal segments; B, two segments from middle of antenna; C, pit peg; D, style and end peg; E, sense hair and its innervation; F, non-innervated scalelike hair; and G, cross section through distal end of segment near middle of antenna.

Abbreviations: *J*, Johnston organ; *N*, nerve; *P*, olfactory pore; *S*, style; *Sc*, sense cell; *Sca*, sense bristles (Sensilla ciliaetica); *Sco*, pit peg (*S. coelonica*); *Sh*, non-innervated scalelike hair; *Ss*, end pegs (*S. styloconica*); *St*, sense hairs (*S. trichodea*); *Tc*, trichogenous cell; and *Tr*, trachea.

(fig. 3, A, *J*), 2 or 3 olfactory pores (*P*), numerous pit pegs (fig. 3, B, *Sco*), end pegs (*Ss*) on styles (*S*), sense bristles (*Sca*), sense hairs (*St*), and scalelike hairs (*Sh*). Each of these, except the last named, is supposed to be a sense organ, and Freiling (23) has even pictured a slender scalelike hair of another moth as connected with a sense cell. Of these seven structures only the olfactory pores, pit pegs, and end pegs are supposed to be olfactory in function.

Pit pegs may be found on all segments, except the first, second, and the last one or two, of codling-moth antennae. If odors can pass

quickly through chitinous structures, pit pegs (fig. 3, C, *Sco*) would be excellent olfactory organs. Styles, usually terminating in end pegs, may be found on all segments except the first and second. A style (fig. 3, B, *S*) is nothing more than a prolongation of the distal outer edge of the segment and it is supposed to be innervated, but in codling-moth antennae it (fig. 3, D) has no nerve and consequently cannot be a sense organ. The writer has failed to find a drawing by any author showing a nerve connected with this structure.

The antennae of 21 other species (table 2) examined by the writer varied much in respect to barbs, from typical filiform antennae to fully feathered ones. The sense organs, as a rule, were widely distributed on both the shaft and barbs. In *Argynnis cybele* the pit pegs lie only on the club part of the antenna. Some of them are large and irregular in shape, and perhaps a pit bears more than one peg. In 11 of the specimens pit pegs were totally absent and in 12 no end pegs were observed on the comparatively few styles, and even styles were absent in one moth (No. 23) and in all the butterflies (Nos. 31 to 34) examined.

From the preceding it is evident that pore plates (*S. placodea*), common to three orders of insects (aphids, beetles, and bees and wasps), are totally absent in Lepidoptera, while the pegs (*S. basiconica*) are practically wanting. These two types are the ones generally considered as olfactory receptors in most insects. It is said that the end pegs and pit pegs of Lepidoptera replace the pegs and pore plates of other orders, but there is no proof whatever for this assumption, and furthermore it is doubtful whether the end pegs are ever innervated.

Granting that the pit pegs and end pegs are the only olfactory organs of Lepidoptera and drawing conclusions from the observations of Schenk and the present writer, eight individuals (table 2, nos. 1 to 4, 17, 18, 23, 24) of the 34 specimens examined cannot smell at all, while four other individuals (nos. 10, 19, 20, 25) have comparatively few end pegs as olfactory receptors.

(b) *Olfactory pores*.—At the suggestion of his reviewers the writer (48) in 1914 called the sense organs herein discussed "olfactory pores." Guenther (27) in 1901 seems to have been the first to describe the internal structure of these organs in Lepidoptera. He called those in the wings "Sinneskuppeln" and found their structure to be similar to that described by the present writer, although he did not see the pore aperture passing to the exterior. Vogel (88) made a more extended study of them in the wings of many Lepidoptera. He con-

sidered them as chordotonal organs. The present writer (50, 51) made a thorough study of the disposition and structure of them in many Lepidoptera and their larvae. Prüffer (77) has most recently described these pores on the wings of certain moths in connection with the antennal organs.

The olfactory pores on five male and five female codling moths were counted. Female no. 3 was examined most carefully and consequently the greatest number of pores was found on it. In figures 4 and 5 they are represented by black dots. The groups are numbered from 1 to 12. The isolated pores which are constant in position are designated by *a* to *e*, the others not being thus marked. Groups 1 to 6 and pores *a* and *b* lie on the wings (fig. 4); groups 7 to 11 and

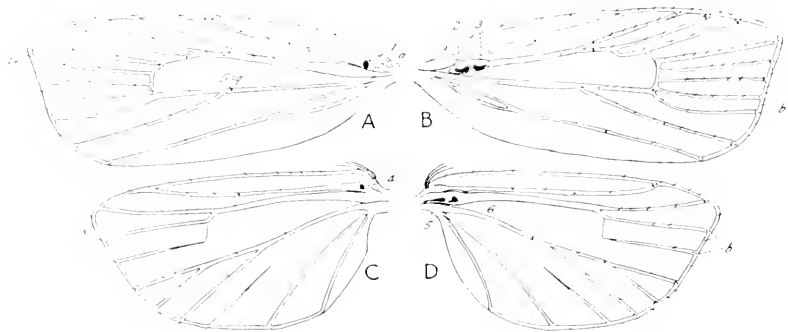

FIG. 4.—Semidiagrammatic drawings of wings of female codling moth, No. 3, showing location of olfactory pores (1 to 6, *a* and *b*, and other dots), sense scales (*Ss*), and sense hairs (*St*), $\times 5$. A, Dorsal side, and B, ventral side of front wing; and C, dorsal side, and D, ventral side of hind wing. Vogel (88) shows "Sinneskuppeln" or olfactory pores similarly located on wings of *Scorcia lineata*.

pores *c* and *d* on the legs (fig. 5, A); group 12 on the base of the labial palpus (fig. 5, E); and pores *c* (fig. 5, D) on the maxilla (one-half of proboscis). The number of pores in the groups follows: No. 1, 91; No. 2, 70; No. 3, 52; No. 4, 12; No. 5, 129; No. 6, 52; No. 7, 4; No. 8, 4; No. 9, 5; No. 10, 4; No. 11, 7; and No. 12, 8. The total number counted on female No. 3 follows: Legs, 191; front wings, 462; hind wings, 417; proboscis, 28; labial palpi, 16; and second segments of antennae, 4; making 1,118 in all. The total number of pores on males range from 933 to 1,049, with 986 as an average; and on females from 960 to 1,118, with 1,029 as an average.

Figures 6 to 8 represent the internal structure and innervation of the pores and sense hairs, and also the internal anatomy of the wings and legs where the pores are found on them.

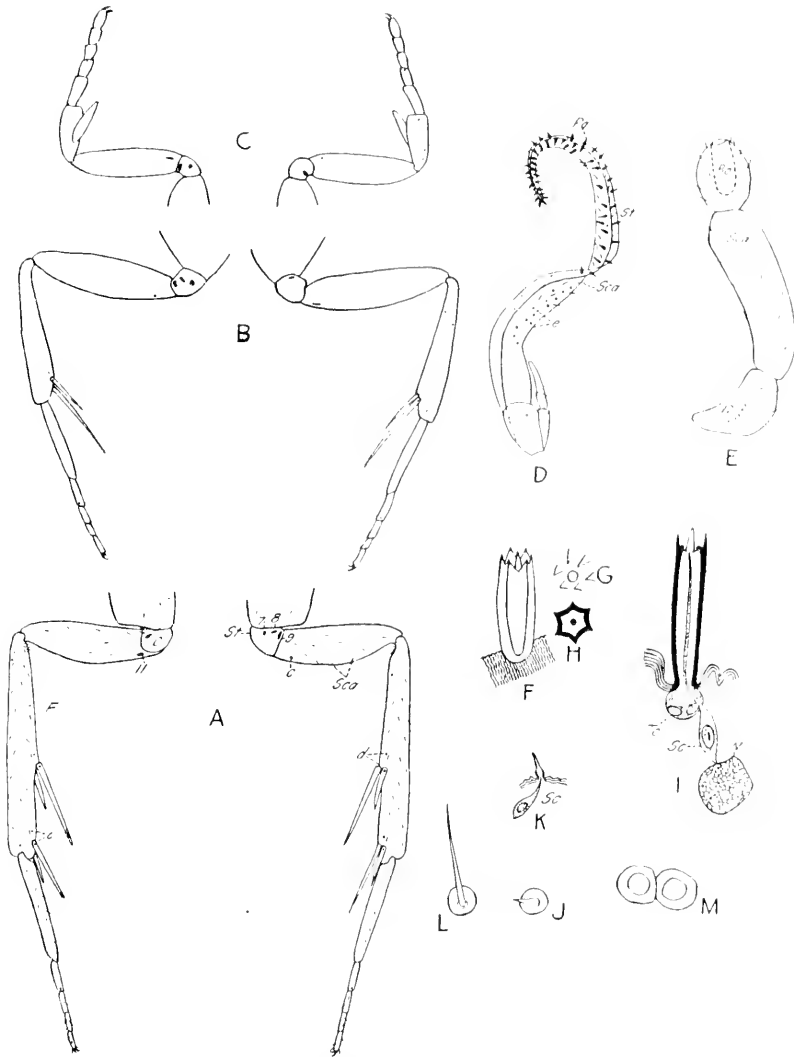

FIG. 5.—Legs, maxilla, and labial palpus of female codling moth, No. 3, showing location and structure of sense organs on these appendages. A, Inner and outer surfaces of hind leg; B, same of middle leg; and C, same of front leg, showing location of olfactory pores (7 to 11, *c* and *d*, and other dots), sense bristles (*Sca*), and sense hairs (*St*); $\times 5$. D, Maxilla or one-half of proboscis, and E, labial palpus, showing location of olfactory pores (*c* and *l2*), pegs (*Pg*), sense bristles (*Sca*), sense hairs (*St*), and labial-palpus organ (*Bo*); $\times 32$. F to M, Structure and comparative sizes of sense organs on proboscis; $\times 500$. F, External view of peg; G, looking down on its tip end; H, cross section of peg; and I, longitudinal section of peg, showing trichogenous cell (*Tc*), sense cell (*Sc*), and nerve (*N*). J and K, External and internal structure of smallest sense hair. L, External view of sense bristle. M, External view of two olfactory pores.

Lepidopterous larvae can smell, but they do not have the so-called olfactory organs such as pegs, pore plates, pit pegs, or end pegs like or even similar to those of adult insects. Therefore, it is only reason-

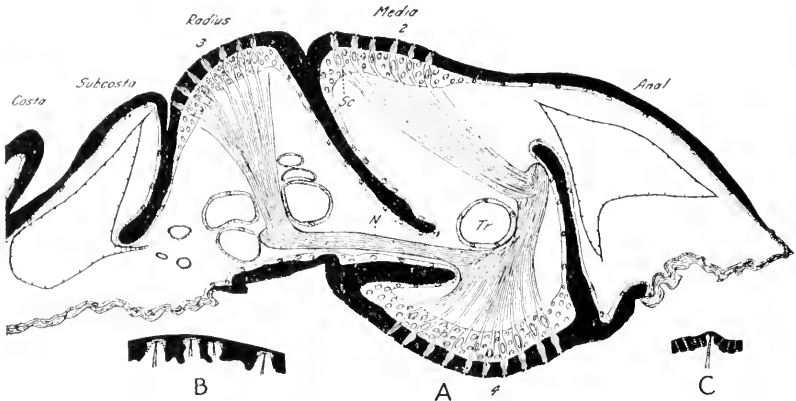

FIG. 6.—Cross sections of wings and proboscis of Lepidoptera, showing internal anatomy of wings and olfactory pores. A, Semidiagrammatic drawing from an oblique section through front wing of cabbage butterfly, showing groups 2, 3, and 1, of pores, sense cells (*Sc*), nerve (*N*), and trachea (*Tr*); $\times 100$. B, Pores from wing of codling moth; $\times 500$. C, A pore from proboscis of codling moth; $\times 500$.

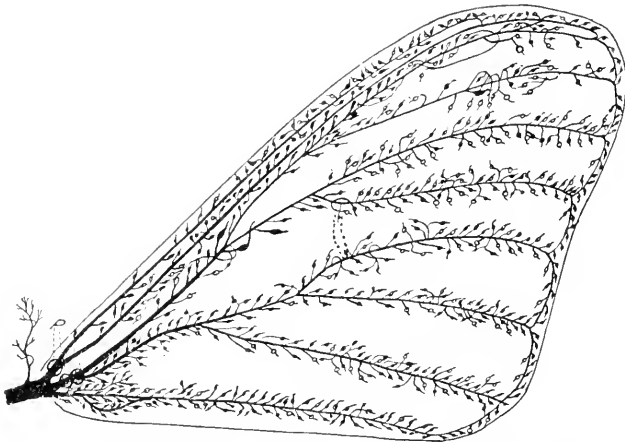

FIG. 7.—Schematic drawing of wing of a male *Saturnia pyri* L., showing innervation of olfactory pores (*P*) and other sense organs, including scattered pores and various types of sense hairs. The black dots represent those on the dorsal surface, and the circles, those on the ventral side. (Copied from Prüffer (77).)

able to suppose that the pores, called olfactory by the writer, act as smelling organs.

The olfactory pores of five specimens of each larval instar were counted. Little or no difference in position and number of the pores

was observed in the six instars. They are found widely distributed (figs. 9 and 10) as isolated pores or "punctures" on the following parts: Head capsule, 24; maxillae, 16; mandibles, 4; labrum, 2; labium, 6; antennae, 2; legs, 30; first thoracic segment, 4; and anal prolegs, 4; making 92 in all. Some of those on the head capsule were incorrectly named in 1919 by the writer (51), but in figure 9 they are correctly named according to Heinrich's (31) first paper and later ones on this subject.

In regard to experimental results concerning olfactory receptors, two papers will be briefly reviewed. The first and most important

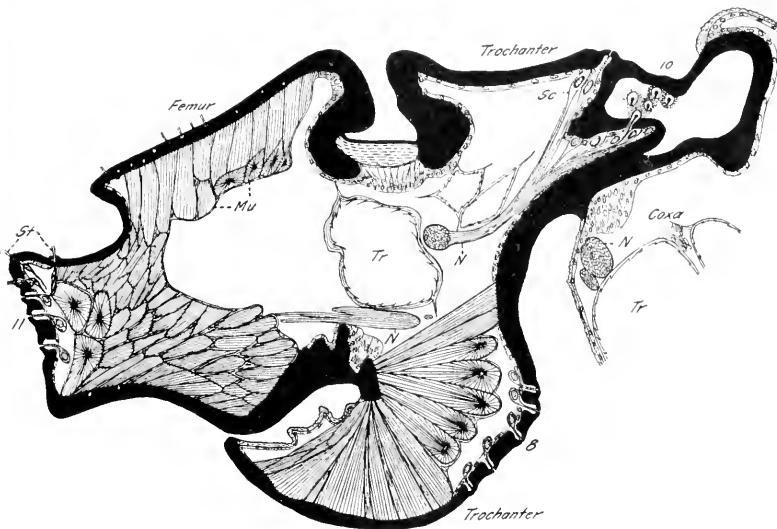

FIG. 8.—Semidiagrammatic drawing of an oblique section through femur, trochanter, and coxa of a silkworm moth, showing muscles (*Mu*), trachea (*Tr*), nerves (*N*), sense cells (*Sc*), sense hairs (*St*), and groups 8, 10, and 11 of olfactory pores, No. 10 being shown partially from a superficial view; $\times 100$.

experimental work to decide the function of the olfactory pores was done by the writer (48) on honeybees. Of the six sources of odors used three were essential oils. The writer's critics have apparently overlooked the fact that the results obtained by using the other three odors are reported in such a manner that they can easily be considered alone. Since the odors from the oils might have been irritant, let us consider the other results, which, when expressed in percentages, clearly show how closely the percentage of pores supposed to function corresponds to the percentage of response obtained. On the average, a worker honeybee has about 2,800 olfactory pores. On the bases of the four wings lie 54 per cent of them; the legs possess 23 per cent;

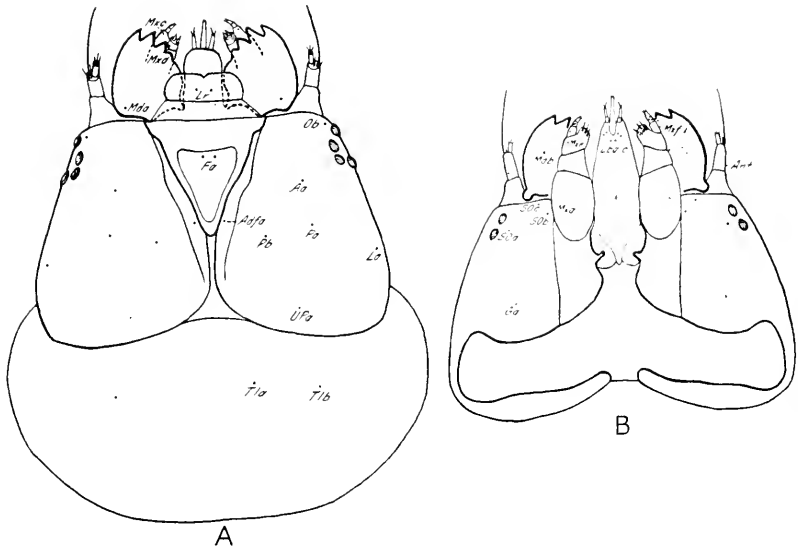

FIG. 9.—Disposition of olfactory pores or punctures on head and first thoracic segment of a fully grown codling-moth larva, $\times 20$; A, dorsal view; and B, ventral view.

Abbreviations: Frontal pore (*Fa*); adfrontal pore (*Adfa*); ocellar pore (*Ob*); anterior pore (*Aa*); posterior pores *a* (*Pa*) and *b* (*Pb*); lateral pore (*La*); ultraposterior pore (*UPa*); subcellar pores *a* (*SOa*), *b* (*SOb*), and *c* (*SOc*); genal pore (*Ga*); mandibular pores *a* (*Mda*) and *b* (*Mdb*); maxillary pores *a* (*Mxa*), *c* (*Mxc*), *d* (*Mxd*), *e* (*Mxe*), and *f* to *i* (*Mxf-i*); labial pores *a* to *c* (*Lba-c*); labral pore (*Lr*); antennal pore (*Ant*); and thoracic pores *a* (*T1a*) and *b* (*T1b*).

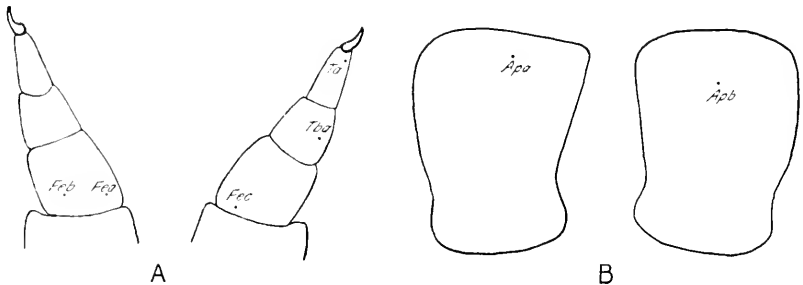

FIG. 10.—Disposition of olfactory pores or punctures on legs of fully grown codling-moth larva, $\times 30$. A, Anterior and posterior surfaces of prothoracic leg, and B, dorsal and ventral surfaces of anal proleg.

Abbreviations: Femoral pores *a* (*Fca*), *b* (*Fcb*), and *c* (*Fcc*); tibial pore (*Tba*); tarsal pore (*Ta*); and anal-proleg pores *a* (*A1pa*) and *b* (*A1pb*).

while the others lie on the sting, head, and head appendages. The individuals were allowed 60 seconds in which to respond. All of the pores on 31 unmutated bees responded to the odors from honey, pollen, and leaves of pennyroyal in four seconds (48, pp. 283, 284); that is, in one-fifteenth of the entire maximum time allowed for the response. Twenty bees with their legs covered with a mixture of beeswax and vaseline, leaving supposedly 77 per cent of the pores elsewhere to

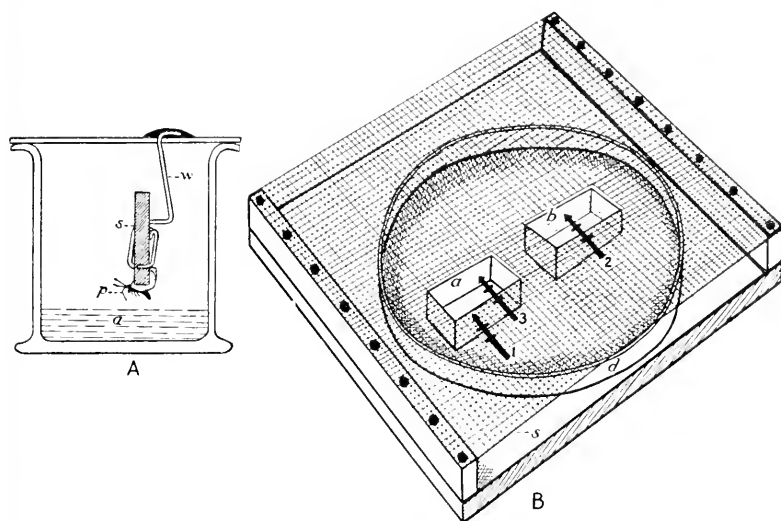

FIG. 11.—Diagrams of Minnich's apparatus used in testing insects to olfactory and gustatory stimuli. A, Section of an odor chamber made of a rectangular museum jar, showing a butterfly, held by a wire (*w*) and a spring clothes pin (*s*), responding with extended proboscis (*p*) to apple juice (*a*). (After Minnich.) B, Perspective view of apparatus used to show that butterflies "taste" with their tarsi; *a* and *b*, two small rectangular tin pans, *a* containing a cheese-cloth pack wet with apple juice and *b* containing a similar cloth wet with distilled water; and *d*, a Petri dish nearly full of apple juice in which stand the tin pans just beneath two openings in a wire screen (*s*). The arrows, 1, 2, and 3, represent the positions in which the butterflies were tested, the position of the walking legs being indicated by the cross-bars. (Redrawn from Minnich's two figures.)

function, responded 2.5 times more slowly (p. 336) or gave a response of 83.3 per cent. Twenty-eight bees with their wings pulled off, leaving 46 per cent of the pores elsewhere to function, responded eight times more slowly (p. 335) or gave a response of 46.7 per cent. And finally, 20 bees with their legs covered with the beeswax-vaseline mixture and their wings pulled off, leaving supposedly only 23 per cent of the pores located elsewhere to function, responded 11 times more slowly (p. 337) or gave a response of 26.7 per cent.

Cabbage butterflies (*Pontia (Pieris) rapæ* L.) were confined by Minnich (63) in an odor chamber (fig. 11, A). Since they are fond of apple juice its odor was used to stimulate the smelling organs, and the responses to it were then measured by the extent to which the proboscis was uncoiled for the purpose of partaking of the apple juice, although the insects could not reach it. The antennae were mutilated in three ways: (1) Covered with vaseline; (2) covered with a mixture of paraffin and vaseline; and (3) cut off at the base with fine scissors. When the organs on only one antenna were prevented from functioning, the olfactory response was reduced only 6 per cent; when those on both antennae were eliminated or prevented from functioning, the response was reduced 58 per cent. Thus according to these results nearly half of the olfactory receptors must be located elsewhere than on the antennae. In his own words Minnich (p. 354) says:

After the antennae are eliminated the animals were still 42 per cent responsive. Considering the variety of methods employed and the similarity of results obtained, this figure is much too large to be attributed to a failure to eliminate the antennal organs completely. It must, therefore, mean that there are olfactory organs on other parts of the body as well as on the antennae. . . . I cannot, therefore, concur with McIndoo in the view that the antennae of adult insects in general lack olfactory organs. Certainly, such is not the case with *Pieris*. Nor can I agree with the opposing viewpoint, that the olfactory organs of adult insects in general are confined to the antennae. In this respect the results on *Pieris* differ from those obtained by v. Frisch in his ingenious experiments on bees. The results of the present experiments show that a viewpoint intermediate between these two is correct for *Pieris*, and that while the antennae constitute a very important, probably the most important, olfactory region of the body, they do not constitute the sole olfactory region.

Regardless of the results obtained by testing insects with mutilated antennae, it has never seemed reasonable to the writer to suppose that odorous air can pass quickly through the hard and dry chitin covering the antennal organs. If it can, why not grant the same privilege to all sense organs covered with thin chitin, including all kinds of sense hairs and even the olfactory pores whose sense fibers, according to other authors, are separated from the outside air by a thin layer of chitin? In the higher animals the olfactory organs (fig. 12) are separated from the outside air by only a thin watery layer of mucus, and the latest results show that the free ends of the olfactory cilia actually come in contact with the air. Eidmann (18) erroneously supposed that the chitinous intima of insect intestines is similar to the coverings of the so-called olfactory and taste organs of insects. He proved chemically that aqueous solutions can pass slowly

through the intima when the latter is wet on both sides. From this result he concluded that the olfactory organs of insects need no openings through which the nerve endings can come in contact with the odorous air outside. The present writer cannot see any connection between his findings and the chemical sense receptors of insects.

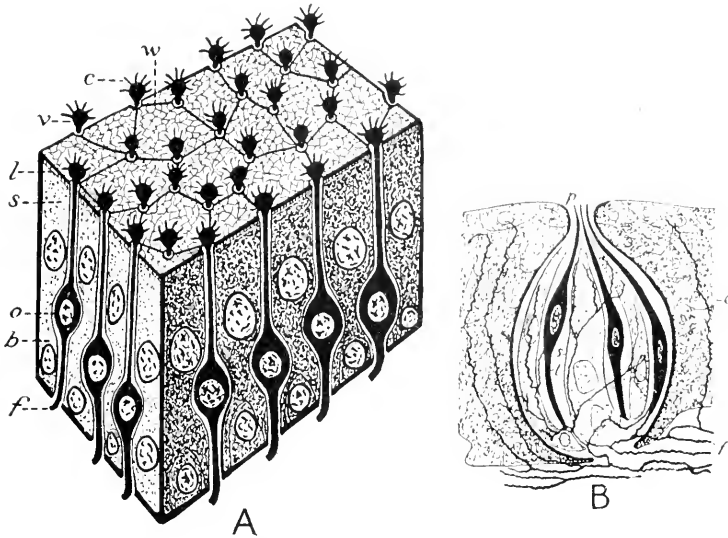

FIG. 12.—Olfactory and gustatory organs of higher animals. A, Diagram of a block from olfactory mucous membrane of a kitten, showing in section and perspective the following: Basal cells (*b*), olfactory cilia (*c*), nerve fibers (*f*), limiting membrane (*l*), olfactory cells (*o*), supporting cells (*s*), olfactory vesicles (*v*), and walls (*w*) of the five- and six-sided supporting cells from a surface view. The olfactory vesicles and cilia, which are embedded in and supported by an outer semifluid (not shown in drawing), are the true receptors of smell. (Redrawn from van der Stricht's (84) photomicrographs and figure 36, the latter in Herrick's book (33).) B, A single taste-bud from human tongue, showing nerve fibers (*f*) indirectly innervating the surrounding epithelium (*e*), supporting cells (*s*), and taste cells (*t*), whose outer ends project into and sometimes beyond the pore (*p*). (From Herrick (33), after Markel-Henle.)

2. SO-CALLED TASTE ORGANS

The so-called taste organs of Lepidoptera, according to Deegener's review (see Schröder (80) p. 149), consist of two round groups of sense hairs on the under side of the pharynx. The proboscides of Rhopalocera, Noctuidae, Geometridae, and Bombycidae bear at their tips more or less numerous peg-shaped structures of varied lengths and shapes in different species. In Sphingidae and Zygaenidae these pegs are distributed over the entire proboscides. These peculiar

structures have been considered both tactile and gustatory in function. Lepidopterous larvae bear on their antennae and mouth parts variously shaped sense hairs, some of which have been called taste organs, some touch organs, and others smelling organs.

Each maxilla on the codling moth bears about 50 pegs or about 100 for the entire proboscis. Female No. 3 had 93 of them (fig. 5, D, *Pg*). They are always found on the distal half of the maxilla and are usually six-sided (fig. 5, F to H) but a few are five-sided. Each one (fig. 5, I) arises from the proboscis as a fluted column and terminates in five or six sharp pinnacles, which surround the innervated hair. If aqueous liquids, or odors, in order to stimulate the nerves inside the hairs, can pass quickly through the chitinous walls, we can then safely call them taste organs, or smelling organs; if such a condition is not true, they are certainly nothing more than touch receptors. The writer has repeatedly objected to the chemical-sense assumption, but believes that smell and taste in insects are inseparable and that the olfactory pores are their only receptors. Figure 12 shows the similarity of olfactory and gustatory organs in the higher animals and that the stimuli do not pass through any membrane in order to reach the nerves.

Let us now consider the chemoreceptors found by Minnich on the tarsi of butterflies and flies. The two species of butterflies used by Minnich (60) may often be seen to alight on injured tree trunks or on decaying fruit in orchards, apparently for the purpose of feeding on the exuding sap of the tree or on the juice of the fallen fruit. In the presence of food it was further observed that the proboscis would uncoil and then coil up again in a definite manner. Minnich called this reaction of the proboscis a proboscis response, and later made use of it solely in measuring or weighing the responses of butterflies to various liquids. In order to determine the responses of the tarsal chemoreceptors, and at the same time to control the olfactory responses, many experiments with butterflies in confinement were conducted by using an ingenious and specially constructed apparatus. Briefly stated, the apparatus consisted of a shallow dish (fig. 11, B, *d*) covered with wire screen (*s*), in the center of which are two small rectangular openings, which lie just above two small rectangular tin pans (*a* and *b*) inside the dish, each containing several layers of cheesecloth. The cheesecloth in one pan (*a*) was wet with apple juice and that in the other pan (*b*) with distilled water; and the shallow dish was also full of apple juice. A butterfly to be tested was held by the wings with a spring clothes-pin in position *t*; that is,

with the four feet of the middle and hind legs touching the wire screen and with the antennae extending directly over the cheesecloth wet with apple juice. Since the front legs are rudimentary and not used for walking, they were not considered in these tests. If the insect responded at all in this position, the response was a truly olfactory one. The butterfly was next held in position 2; that is, with the head and antennae just above the cheesecloth wet with distilled water and with the feet of the middle legs resting on this wet cloth. If the insect responded at all in this position, the response was either an olfactory one or one brought about by contact with the feet on the cloth, or the response was a combination of both olfactory and contact stimuli. The butterfly was finally held in position 3; that is, exactly like position 2 except over the cheesecloth wet with apple juice. In this position the insect always responded, and the responses were of the same kind but differed in degree from those in position 2. As an average for all the responses obtained in the three positions, position 1 gave 29 per cent; position 2, 17 per cent; and position 3, 100 per cent; clearly showing that these butterflies can distinguish apple juice from distilled water merely by bringing their feet in contact with these liquids.

In other series of tests Minnich used solutions of common sugar, table salt, hydrochloric acid, quinine, and distilled water. In order to compare closely the results obtained, the first four substances were used on the basis of their molecular weights. Butterflies were able, by means of their feet alone, to distinguish the sugar solution from those of the hydrochloric acid and quinine, or from distilled water; and the salt solution from either sugar solution or distilled water.

Now the question naturally arises: Are there special sense organs in the tarsi of butterflies, which act as contact chemoreceptors? Minnich gives us definite information about their function, but leaves us in the dark concerning their exact location and structure. Experimentally he located them on the four tarsi of the middle and hind legs. Each tarsus is five-jointed, the first joint being about as long as the other four combined. Minnich believes that these organs lie in the distal end of the first joint, and particularly in the other four joints. He further believes that they are not temperature organs, touch organs, or organs to register the penetrating powers of liquids, but are chemical sense organs, perhaps somewhat similar to taste organs in man.

Excepting tactile hairs, there are no other known sense organs in the tarsi of butterflies, although no one apparently has looked for other sense organs at this place. In 1917 the present writer (50) reported finding olfactory pores on the legs of butterflies, but found

none on the tarsi. Recently he has more carefully examined the tarsi of six species of butterflies. No chemoreceptors were seen on the dark and hairy tarsi of three species, but on most of the light colored ones of *Pontia rapa*, *Papilio polyxenes*, and *P. troilus* a row of supposedly olfactory pores were observed on each tarsus. They are very plain on the tarsi of the cabbage butterfly (*Pontia*). A few pores were also seen on the tarsi of the codling moth (fig. 5). If these pores are the only chemoreceptors on the tarsi, it is not conceivable how they can detect differences between liquids except by the odors which might be emitted. If the tarsi of butterflies, which are covered with a thick and hard chitin, contain contact chemoreceptors, the mouth parts of insects in general should be provided with such receptors.

In other series of tests Minnich (61) repeated his former ones and obtained similar results. According to his scheme of measurement, the total response of all the butterflies tested was 100 per cent to the sugar solution used, 84.7 per cent to the quinine solution, and 51.6 per cent to the salt solution.

In his third report on this subject Minnich (62) says that the tarsal sensitivity of the butterflies tested to sugar solution may be as much as 256 times that of the human tongue. It is scarcely conceivable, although his carefully planned and admirably controlled experiments firmly convinced him that the feet of butterflies contain sense organs, which, when properly stimulated, are 256 times as sensitive as are the taste organs in our mouths.

A fourth paper on this subject by Minnich (65) deals with three species of flies. It was similarly determined that these flies can distinguish water from paraffin oil, or from sugar solution, by use of the chemoreceptors in the tarsi. Chemical sense organs were also located in parts of the proboscis. These organs are more sensitive than those in the tarsi to sugar solution. Minnich believes that all of these receptors serve as taste organs. Thus, according to these results, taste organs, at last, seem to have been located on the mouth parts of insects.

In regard to the so-called taste organs of insects, the writer has repeatedly stated that no one has demonstrated that they actually receive taste stimuli. Minnich (66) says that the proboscis of a certain blowfly is clothed with hairs, some of which are long and curved, and that these have been proven to be taste organs by the following test: A fly, abundantly supplied with water but otherwise starved, does not extend its proboscis when these hairs are touched with a tiny brush wet with distilled water; but when they are touched

with another brush wet with sugar solution the proboscis is quickly extended. These hairs are so sensitive that a single one, when touched, may produce the response. According to the accepted definition of taste, these hairs are true taste organs provided the sugar solution must actually touch them; if only a close proximity is required, then the sense of smell is involved. When asked this question, Minnich was not sure that he had totally eliminated smell. If these hairs are true taste organs, the present writer cannot understand how an aqueous solution can pass instantaneously through their walls in order to stimulate the nerves inside.

III. AUDIRECEPTORS

The common belief that insects can hear is based on three facts: (1) Many of the experimental results obtained indicate that they can perceive sound stimuli, although perhaps they do not hear as we do; (2) many have special sound-producing organs; and (3) many have so-called auditory organs.

The first report on the auditory sense of Lepidoptera was probably made in 1876. Since that date much has been published, but critics are still inclined to doubt whether any insect can really hear. Turner (86) and Turner and Schwarz (87) in 1914 produced good experimental evidence to show that *Catocala* and giant silkworm moths really hear. They used an adjustable organ pipe, an adjustable pitch pipe, and a Galton whistle. Their field experiments demonstrated that most of the moths tested can hear high-pitched notes, but usually low-pitched ones did not produce responses. They believe that responses of moths to sounds are expressions of emotion and that a response depends upon whether the sound has a life significance to the insect tested.

For many years it has been known that both adult and larval Lepidoptera are able to produce sounds and some of the sound-producing organs have been described. For example, the death's-head moths (*Acherontia*) make shrill chirping sounds, probably by forcing air through certain parts of the anatomy. Their larvae produce "crackling" notes. A hissing noise is made by several species of *Vanessa* and more pronounced sounds are produced by other Lepidoptera. Stridulating organs on the wings have been described by several, including Hampson (28) and Jordan (35). In certain Agaristidae and Geometridae the sound is made by pressing the tarsi against the ribbed areas on the wings. This subject is reviewed by Schröder (80, pp. 61-74) and Hering (32, pp. 190-193).

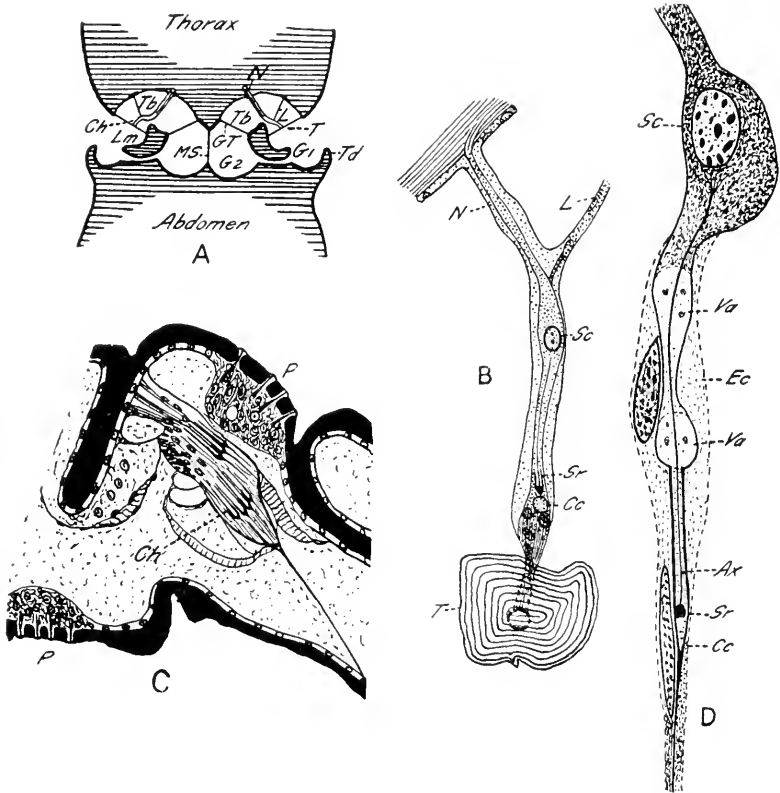

FIG. 13.—So-called auditory organs of Lepidoptera. A, Diagram from longitudinal section through portions of thorax and abdomen of a noctuid moth, showing following parts of tympanic organ: G_1 , Tympanic pit at whose base is found the drum head (T) and G_2 , tympanic cavity with drum head (GT). The two tympanic cavities are very deep, dorsolateral invaginations of the integument which touch one another at the median line where they form a common division wall (MS). In *Catocala* they do not touch one another. Tb , Tympanic nerve; Ch , chordotonal bundle; L , ligament of same; Td , tympanic cover; and Lm , chitinous lamella, separating the true drum head (T) from the other drum head (GT) and serving for the insertion of the chordotonal bundle (after Egger (17)). B, Chordotonal bundle of a notodontid (*Phalera bucephala* L.), showing drum head (T), ligament (L) of chordotonal bundle, tympanic nerve (N), sense cell (Sc), sense rod or "Stift" (Sr), and cap cell (Cc), (after Egger (15)). C, Portion of drawing from longitudinal section through base of front wing of *Lycaena icarus*, showing chordotonal organ (Ch) and "Sinneskuppeln" (P) or olfactory pores. D, Single chordotonal element from front wing of *Chimabacche fag*, showing sense cell (Sc), vacuole (Va), enveloping cell (Ec), axial fiber (Ax), sense rod (Sr), and cap cell (Cc). C and D after Vogel (89).

1. TYMPANIC ORGANS

According to Eltringham's (19) review, tympanic organs in Lepidoptera were first recorded in 1880 in Uraniidae. Since that date several other writers have described these sense organs in Lepidoptera, which are similar in structure and probably in function to those in Orthoptera. As Eggers (15) has presented the most comprehensive paper on this subject, his results are here briefly summarized. In all he examined 150 species of moths and 5 species of butterflies, representing over 40 families. No tympanic organs were found in 39 species of moths and in the five species of butterflies. They were found, however, in various stages of development in the thorax of 95 species and in the abdomen of 16 species of the moths. Thus 71.6 per cent of all had tympanic organs. Judging from this study butterflies and many moths, including Sphingidae, Saturniidae, and Bombycidae, apparently have no tympanic organs, and none was found in the codling moth by the present writer. The location and structure of the organs found by Eggers are represented by figure 13, A and B.

Eggers (17) next determined that the tympanic organs in noctuid moths are auditory in function. Noctuids, when in an excited condition, reacted to different sounds by flying or by raising the wings. They were tested under glass funnels to loud, sharp sounds such as those made by hand clapping, and to soft ones, as the twisting of a glass stopper in a bottle. When the drum heads (fig. 13, A, *T*) of both of the tympanic organs were destroyed the moths no longer reacted to sounds. When the drum head in one organ was destroyed the moths reacted to sounds in seven-tenths of the cases by flying. Moths with intact tympanic organs but with wings removed reacted to sounds in one-half the cases by running; in the other cases, by quick movements of the leg or antennae. Moths with intact tympanic organs but with antennae removed, reacted to sounds by flying. He concluded that these organs are sound receptors, analogous to the ears of mammals.

2. CHORDOTONAL ORGANS

The name chordotonal means a chord, or string, which is sensitive to tones. Graber (26) in 1882 presented the first comprehensive paper on the chordotonal organs, and much of our present information on this subject is based solely on his report. He apparently found these organs in a wide range of adult and larval insects, but he evidently included other sense organs too. Excluding the olfactory pores on insect wings, he did not find chordotonal organs in adult Lepidoptera,

but found them in the larvae of the codling moth and of *Tortrix scrophulariana*.

According to the review by Turner and Schwarz (87), chordotonal organs are not found in Myriapoda and Arachnida. They are found, however, in some insects which do not need a sense of hearing. They are well developed in caterpillars, even in those of Tortricidae, which spend their entire larval period inside of fruit. Eggers (16) remarks that chordotonal organs have been found in the first antennal segment (scape) of Apterygota, Orthoptera, and Hemiptera; in the second antennal segment (pedicel) of Neuroptera; and in the third antennal segment (first segment of funiculus) of Orthoptera. Some of these are called the Johnston organs, which are discussed later.

In the bases of lepidopterous wings Vogel (89) distinguished two types of sense receptors—chordotonal organs (fig. 13, C, *Ch*) and "Sinneskuppeln" (P) or olfactory pores. The former (fig. 13, D) seem to be true chordotonal organs, but the present writer did not see them in codling-moth wings or in those of other Lepidoptera.

Nothing definite is known about the function of the chordotonal organs, but they are usually considered as sound receptors. Since most of the movements of insects result in rhythms, as pointed out by Eggers, Snodgrass (81) suggests that these organs be regarded as rhythmometers.

3. JOHNSTON ORGANS

Tympanic organs, chordotonal organs, and Johnston organs are all chordotonal organs, because each sense element is chordlike in shape and has a sense rod, scolopala, or "Stift" according to the Germans. A tympanic organ is quite different from the other two types owing to the presence of a drum head or tympanum. A chordotonal organ and a Johnston organ usually differ little; if found in the pedicel, it is generally considered the latter; if found elsewhere, it is called the former; but in many insects both occur in the pedicel. A good review on this subject is by Snodgrass (81). The paper by Eggers (16) is the most comprehensive on this subject. He studied the Johnston organs in the pedicels of most of the insect orders and concluded that they are true "Stift" organs and are common to all insects, including Apterygota. In regard to the antennae of larvae he found them in hemimetabolous forms, but absent in holometabolous ones. Therefore, caterpillars do not have the Johnston organs.

In both sexes of the codling moth the present writer found the Johnston organs (fig. 14) to be highly developed, and the sense rod

or "Stift" (*Sr*) is only slightly different from that pictured in the Lepidoptera examined by Eggers. The writer also saw external marks of these organs in many other Lepidoptera.

Eggers informs us that their structure is not correlated with that of the tympanic organs. Formerly they were assumed to be auditory in function, but more recently they have been called muscular receptors

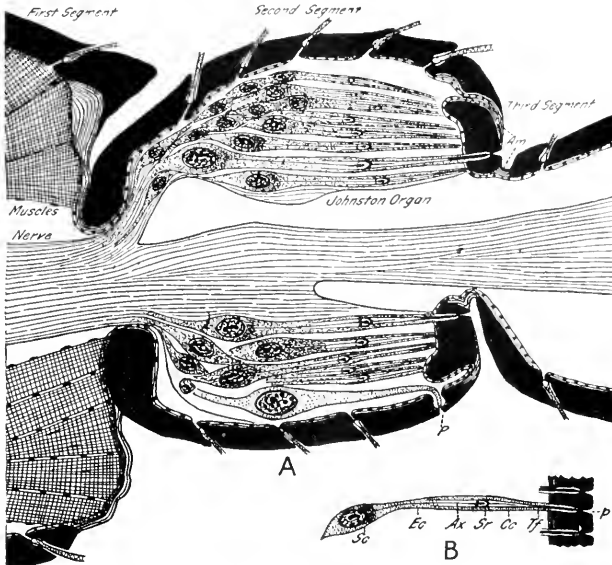

FIG. 14.—Johnston organs of codling moth, $\times 500$. A, Semidiagrammatic drawing, showing one olfactory pore (*P*) and Johnston organ whose distal end is attached to articular membrane (*Am*). This membrane consists of three concentric bands of chitin; two thin and flexible ones (represented by lines) and a thick, rigid, and much wider one (solid black) between them. Therefore, it slightly resembles a drum head and apparently may be vibrated by jars or by movements of the flagellum. B, Detailed structure of a single chordotonal element drawn from two sections. All parts, except the nuclei of the enveloping cell (*Ec*) and cap cell (*Cc*), were distinctly seen. Other authors have seen these nuclei in other Lepidoptera. The terminal fiber (*Tf*) of each element is fastened at the bottom of a pit (*p*) which usually lies in the rigid and thick band of the articular membrane. The other abbreviations are the same as those in figure 13, D.

or statical-dynamic organs to register the movements of the antennae. Eggers believes that they probably perceive the movements of the articular membrane to which they were attached. These movements are caused by the antennae being used as tactile organs, or by the wind vibrating these appendages. In the males of Culicidae and Chironomidae, however, they may be special auditory organs. The present writer (52) in 1922 studied the Johnston organs in the honey-bee in

which the articular membrane, to which the sense fibers are attached, resembles the head of a drum. It was then suggested that these organs might receive stimuli from gusts of wind, weak air currents, or from jars, but the most reasonable function considered was that they registered the movements of the flagellum.

4. AUDITORY HAIRS

Years ago there was a controversy as to whether spiders possessed auditory hairs. When a dead spider was put under a microscope and certain musical tones were produced, some of the hairs on the spider were seen to vibrate. This observation alone is no more proof for an auditory sense in spiders than to say that one stringed musical instrument can hear another if a certain cord of the first vibrates when a cord of the second is struck. Recently Minnich (64) has revived the subject of auditory hairs and shows definitely that certain hairs are the sound receptors in larvae of the mourning-cloak butterfly. When a test such as was given with a dead spider was repeated, no hairs on a freshly killed larva were seen to respond to the same tones to which larvae normally react.

Minnich's review shows that certain caterpillars in all instars react to a variety of sounds, including those made by slamming a door, clapping the hands, the human voice, a violin, and a shrill whistle, but the earlier observers did not locate the sound receptors. Minnich used sounds produced by the human voice, piano, organ, violin, dish pan, Galton whistle, tone modulator, and tuning forks. The larvae responded to all of these, except the whistle and modulator, usually by throwing the anterior third of the body dorsally or dorsolaterally. The extent of the response to sounds varied with the intensity of the tone. For full-grown larvae the upper limit of response was probably not far from C''' (1,024 complete vibrations per second). Responses were obtained from 32 to 1,024 vibrations per second. Responses to sounds increased greatly with age, being least in the first and greatest in the last two instars. The responsiveness was correlated with the number of body hairs, which were fewest on the first instar and most abundant on the last instar. Responses to ordinary mechanical stimulation decreased with age, being greatest in the first and least in the last instar. Headless larvae and fragments of bodies responded to sounds, but the auditory hairs were found to lie chiefly on the anterior two-thirds of the insect. These hairs are probably some of the ordinary tactile ones (*Sensilla trichodea*) studied by Hilton (34), who claimed that most of the body hairs of caterpillars are innervated. Minnich believes that the

body hairs act as sound receptors for three reasons: (1) Singeing the hairs greatly reduced or abolished the responses; (2) hairs bearing water droplets or flour did not respond; and (3) during the molting periods when the hairs were disconnected with their nerves there was little or no response.

Abbott (2) observed that normal *Datana* larvae gave definite responses to air currents and sudden jars, but to only two notes—C" (512 vibrations) and F sharp (728 vibrations)—by elevating the anterior and posterior parts of the body. These notes were made by using a closed pipe with a movable plunger, a piano, and a mandolin. He assured us that he believed the normal larvae actually responded to the foregoing musical instruments for four reasons: (1) They were protected from air currents when tested; (2) they were several feet from the instruments; (3) vibrations from the substratum were eliminated; and (4) no responses were observed when the body hairs were covered with water or shellac, or when the body surface was anaesthetized with a 2 per cent solution of procain. Since these caterpillars responded to only two notes, which are not experienced in nature, Abbott believed that these responses were not adaptive, but perhaps secondary, resulting from an "adaptation of certain organs to more significant stimuli."

IV. THIGMORECEPTORS

I. TACTILE ORGANS

It seems that no one has made a thorough study of the tactile organs of Lepidoptera, but those in certain beetles have been carefully studied. The writer (53) found tactile hairs on the cotton boll weevil as follows: Sense hairs (*Sensilla trichodea*), on the head capsule, antennae, mouth parts, thorax, legs, wings, and abdomen; sense bristles (*S. chaetica*), on nearly the same parts; and sense pegs (*S. basi-conica*), on the head capsule, mouth parts, and genitalia. Besides these three types Lepidoptera have a fourth, the sense scales (*S. squamiformia*); however, it seems that only the small, narrow scales are innervated, while the large, broad ones (fig. 3, B, *Sh*) have no nerve connection. If the end pegs (*S. styloconica*) are really innervated, we should add a fifth type of tactile organs.

Sense scales on the wings of Lepidoptera have been described by Guenther (27), Freiling (23), Vogel (88), and Prüffer (77). Vogel states that innervated scales are found on the wings of all Lepidoptera, occurring on both sides, mostly on the veins and particularly on the marginal ones, but they may be found also on the basal parts of the

wings. Quenther believes that the sense scales are wind tactile organs, used in orientation. With the aid of them Freiling believes that night-flying Lepidoptera in their rapid movements are able to avoid obstacles.

In regard to tactile hairs on the codling moth, all parts of the integument were not searched for them and in most cases where found they were identified from external appearances. Most of the tactile hairs on the wings seem to be ordinary sense hairs (fig. 4, A, *St*), but a few sense scales (*Ssq*) were seen. On the legs, maxillae, and labial palpi sense hairs (fig. 5, A and D, *St*) and sense bristles (*Sca*) are more or less numerous. On the antennae are found numerous sense hairs (fig. 3, *St*), sense bristles (*Sca*), and end pegs (*Ss*). The large non-innervated scales (fig. 3, G, *Sh*) overlap one another like shingles on a roof and on some segments they cover nearly all the sense organs. The peculiarly shaped pegs found on the maxillae (fig. 5, D, *Pg* and *I*) are also to be classified as tactile organs. Some of the tactile hairs on the antennae and mouth parts of codling-moth larvae are shown in figures 9 and 10.

V. GEORECEPTORS

I. BALANCING ORGANS

When an animal responds to gravity a special static or balancing organ is not necessarily involved, but such organs are known in four Phyla—Coelenterata, Mollusca, Arthropoda, and Vertebrata. Semicircular canals occur in the vertebrates, while otocysts or statocysts are found in certain medusae, molluscs, and crustaceans. A statocyst may be an open or closed cavity, lined with sense hairs. In the center of the cavity may be one or more concretions of carbonate or phosphate of lime, called otoliths or statoliths. In the shrimp a statocyst is found in a segment of the claw. It is an open sac in which the shrimp places grains of sand. As the animal moves about in all directions, the grains of sand fall against the sense hairs thus enabling the shrimp to keep its equilibrium. A statocyst, therefore, is nothing more than a special touch organ, and the same may be said about the semicircular canals in which the liquid in them takes the place of the statoliths. A good review on this subject is by Dahlgren and Kepner (8, pp. 207-215).

Insects so far as we know do not have organs similar in function to the semicircular canals and statocysts; nevertheless, they certainly have great balancing powers. The only case in which such organs have been surmised is in the Diptera. The so-called balancers or halteres were formerly considered organs of equilibrium, but flies can fly just as well without them.

Vom Rath (78) first described a flask-shaped structure in the distal segment of the labial palpus of the cabbage butterfly. The structure is lined with innervated hairs which he considered olfactory in function. He imagined this structure to be a special olfactory organ for detecting the presence of food. This structure, whose shape varies considerably, seems to be common to all Lepidoptera. It was seen in practically all of the specimens examined by the present writer. It is present in the labial palpi (fig. 5, E, *Bo*) of both sexes of the codling moth, in which it is sac-shaped, opening to the exterior by a wide mouth (fig. 15, A). The innervated hairs (fig. 15, B, *Hr*), instead of being narrow and hollow as figured by vom Rath, are wide, heavy, and club-

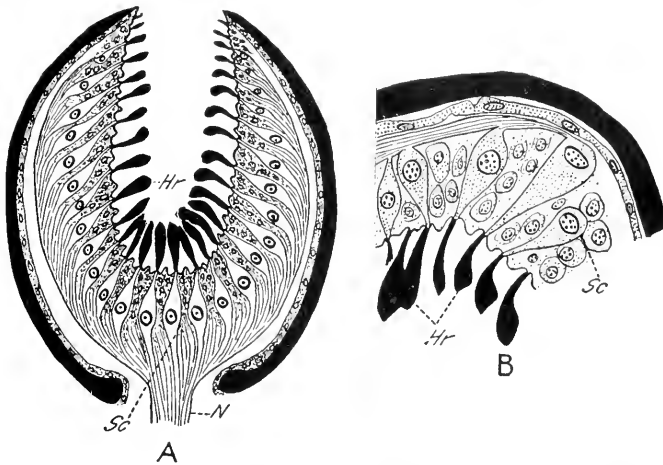

FIG. 15.—Sense organ in labial palpus of codling moth. It is probably a static or balancing receptor. A, Diagram of a longitudinal section through terminal segment, showing organ made up of sense hairs (*Hr*), sense cells (*Sc*), and a large nerve (*N*); B, drawing from an oblique section, showing same parts, $\times 750$.

shaped. They certainly cannot be olfactory in function. Since their slender bases arise from very delicate chitin, their clubbed ends probably swing in various directions as the insect moves about. This organ reminds the writer of the statocysts, especially those of the shrimp and crayfish, and it probably has a similar function. If it does not contain statoliths, the hairs may operate sufficiently without the use of them.

VI. OTHER RECEPTORS

Among the general sensations of Lepidoptera might be mentioned those of temperature, humidity, direction, hunger, fear, and pain, but they are probably not connected with special sense receptors.

Much experimental work on various temperatures, particularly as control measures, has been done on Lepidoptera, but little or none of it can be discussed from the tropic point of view. The sense of temperature is probably well developed, although in insects, as in ourselves, there are probably no special thermoreceptors. The subhypodermal nerve plexus, if present in adult Lepidoptera as found in caterpillars by Hilton (34), could easily perform this function. Humidity, which is closely related to temperature, also has much to do with the behavior of Lepidoptera. Hering (32, p. 201) remarked that butterflies have a barometric sense, because sultriness and low barometric pressure have a characteristic effect on both the adults and larvae. He imagined that some of the antennal organs are the receptors. Guenther (27) hazarded the opinion that the "Sinneskuppeln" (olfactory pores) were barometric receptors.

Prüffer (77) states that his results and those of Patijaud demonstrate that female moths cannot lure the males from long distances, in spite of evidence shown years ago by Forel, Fabre, and others. He says that the females of *Saturnia pyri* L., as an example, can attract the males from a distance of not over 50 meters. Noel (68) concluded that neither sight nor smell is sufficient to explain the attraction from long distances. As a hypothesis, he suggested that certain insects emit special waves or rays, resembling X-rays, or the Hertzian waves, or even the N-rays of Dr. Blondlot. He firmly believed that these rays, which have not yet been isolated or verified, really exist and that they are used in distant communication. It has also been suggested that the bushy antennae of certain moths support this theory.

C. SCENT-PRODUCING ORGANS

The study of scent-producing organs follows as a corollary to that of tropisms and tropic receptors. Since chemotaxis is such an important means of communication among insects, it is probably true that all insects have structures for producing odors. In fact these structures have already been described in numerous species belonging to most of the insect orders.

Several years ago the writer (49) reviewed the literature on this subject. A brief summary of that review concerning Lepidoptera follows: Scent scales on the wings constitute the almost universal type of scent-producing organs in male butterflies. Clark (4) has recently reviewed this subject and added much new information. A pair of invaginated sacs located at the ventro-posterior end of the abdomen has been found in certain male butterflies. These sacs are

partially lined with scent hairs at the bases of which lie unicellular glands. In a certain female butterfly the same organ is present, but there is also a circle of scalelike scent hairs around the anus. In another female butterfly there is a single invaginated sac, similarly located. In the females of the maracujá butterflies, a pair of styled knobs at the posterior end of the abdomen serves as a scent-producing organ.

The most common type of scent organ in male moths is a tuft of scent hairs on the tibiae of the third pair of legs. Occasionally there are also tufts of hair on the tibiae of the first and second pairs of legs. Another common type in certain male moths is a pair of tufts of scalelike scent hairs at the base of the abdomen. In the males of other moths a pair of invaginated sacs, lined with scent hairs, lies in the ventro-posterior end of the abdomen. In the females of certain moths a paired tuft of scent hairs lies near the anus. The scent-producing organ of the female silkworm moth (*Bombyx mori*) is the most highly developed of any found in a female lepidopteron. This organ is a pair of invaginated and greatly folded sacs in the posterior end of the abdomen. The female attracts the male by evaginating and turning these sacs inside out, thus fully exposing the inside which is moist with an aromatic substance. In all cases where scent hairs are present, each hair is connected with a unicellular gland.

The only scent-producing organ found by the writer in codling moths is a pair of invaginated sacs (fig. 16, A) in the ventro-posterior end of the abdomens of males. The mouth of the sac seems to be a long slit along the ventral median line. Muscles (*Mu*), which nearly surround the sac, apparently change the slit into a wide opening, forcing the 90 scent hairs (*H*) to the exterior between two abdominal segments. Each hair (fig. 16, B) is long and its base is connected with a single gland cell (*Gc*) at the anterior end of the sac. In cross section (fig. 16, C) the hairs are round or oblong, are transparent, and have a spongy texture. The outer wall is rough and a pore (*p*) can occasionally be seen in it. When greatly magnified the gland cells (fig. 16, D) are large and typical for scent-producing organs. Judging from this structure alone male codling moths attract the females by means of emitting odors from an aromatic substance which passes through pores in the scent hairs to the exterior.

No one seems to have described a scent-producing organ like the one in the codling moth, but Freiling (23) has described a similar one in a male butterfly (*Danaüs septentrionalis*). In this case the mouths of the paired sacs lie on either side of the anus. Most of the

scent hairs are attached to the anterior portion of the sac. When the sac is evaginated and the tuft of hair is expanded, this organ resembles a cylindrical fan whose contents are turned inside out to form the circular part of the fan. The scent hairs are filled with a matrix substance and the secretion passes through tiny pores in the walls of the hairs to the exterior.

Jordan (36) discovered in a number of Notodontidae a flap, which he called a cteniophore. It is movable and partly covers a cavity in

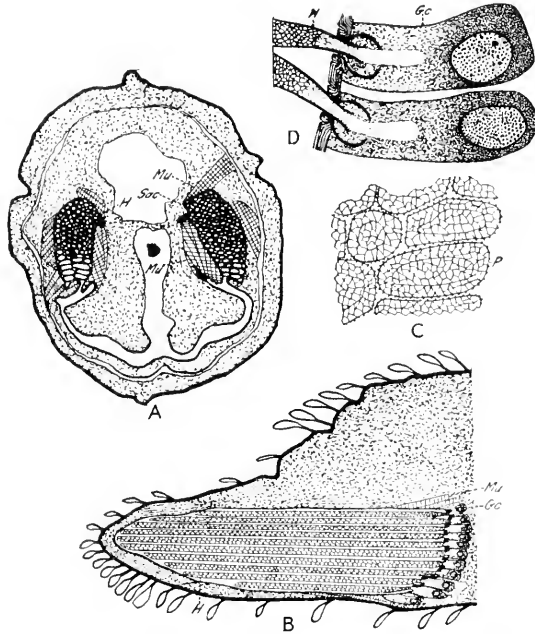

FIG. 16.—Scent-producing organ of a male codling moth. A, Cross section through tip end of abdomen, showing location of a pair of invaginated sacs, which are evaginated by muscles (*Mu*) thereby exposing the hairs (*H*) to the exterior, $\times 53$; B, longitudinal section through tip end of abdomen, showing muscles (*Mu*) attached to invaginated sac filled with scent hairs (*H*) to which are attached unicellular scent glands (*Gc*), $\times 53$; C, cross section of scent hairs, showing their spongy texture and pores (*p*) in outer wall, $\times 500$; D, longitudinal section through bases of two scent hairs (*H*) and their gland cells (*Gc*), $\times 500$.

the pleurum of the fourth abdominal segment. It is a special male apparatus developed in connection with scent organs. He believed that the hind tibia and hind wing were rubbed across the cteniophore to receive an odorous substance, probably from glands in the cavity. A remarkable combination of tympanic organ and cteniophore was earlier discovered by Jordan and more recently pictured by Hering (32, p. 195). In codling moths, a projection, probably a cteniophore, lies on either side of the abdomen of the males, but no cavity is present.

SUMMARY AND DISCUSSION

In order to throw light on the biology of the codling moth, a thorough investigation of the tropisms of this insect was begun in the spring of 1927. Definite results were obtained only by using the larvae. In all 154 larvae, belonging to the two broods at Silver Spring, Md., were tested individually in the laboratory under various conditions. In bright light, although not direct sunshine, larvae of the first instar were weakly photopositive. Certain tests indicated that objects are perceived and located by the senses of smell and sight, and by mere chance. Chance alone seemed to be only 30 per cent efficient; sight and chance combined, 40 per cent efficient; whereas smell, sight, and chance combined were 65 per cent effective. Therefore, since larvae of the first instar have photopositive eyes, they remain in the open on apple-tree foliage and search freely for food, apparently not being aided by their senses until within a few millimeters of the food. The larvae were found to be easily repelled by odorous substances, but attracted with difficulty.

Larvae of the second, third, and fourth instars were weakly photopositive to weak light, but indifferent to strong light. Larvae of the fifth instar sometimes acted indifferently to light but generally were weakly photonegative. Larvae of the sixth instar were either weakly or strongly photonegative, the degree depending on their age; and those with blackened ocelli did not respond to light. At cocooning time the larvae were strongly photonegative, geopositive, and thigmopositive, whereas during their earlier instars they either behaved indifferently to light, gravity, and touch, or were photopositive, geonegative, and thigmonegative. Consequently, when the larvae are ready to spin cocoons they avoid bright light as much as possible, usually move toward the ground and hunt for dark and tight places in which to pupate. When bands are placed around the trunks of apple trees to serve as a supplementary control method, we are merely taking advantage of nature's laws. It therefore seems that so far as tropic responses are concerned the vulnerable period in the life history of codling-moth larvae is brought about by a change in tropisms.

It is well known that certain varieties of apples are more susceptible to codling moth injury than are other varieties; why, no one knows, but several factors, including thickness, toughness, and waxiness of apple peel, and the odorousness and acidity of apples, might be considered. Owing to one or more of these factors the larvae probably gain entrance to the more susceptible varieties with less difficulty; or the female moths perhaps distinguish differences between apple trees.

and if so, they probably lay more eggs on the preferred varieties. No attempt was made in the present investigation to determine which was true, but it is certain that the larvae can distinguish apples by smell and touch, and the moths are certainly guided by tropic stimuli to the proper places for depositing eggs. A study of this kind raises more questions than it answers, yet there is no other way to make progress. Not being able to throw light on this question, a thorough study of the morphology of the sense organs of the codling moth and its larvae was made, hoping that a little light might finally be had.

Since the moths are nocturnal fliers, their eyes cannot be their chief sensory receptors for locating the proper host plant. As already stated, the eyes of the larvae change slowly from photopositive ones in the first instar to strongly photonegative eyes in the last instar. This change may be caused by a migration of pigment, as found in certain other larvae, and it seems to be in harmony with the habits of these larvae, which spend most of their time inside of fruit. Before entering apples, photopositive eyes are needed; but after emerging for the purpose of pupating, photonegative eyes are required.

Two kinds of smelling organs—certain hairs on the antennae, and the pores, called olfactory by the writer—are fully described. It seems doubtful whether these hairs, called pit pegs and end pegs, can serve as olfactory organs owing to their hard covering of chitin. Granting that these hairs are the only olfactory receptors of Lepidoptera, eight of the 34 individuals discussed in table 2 cannot smell at all, while four others can smell only slightly. The codling moth, however, has a good supply of them. Larvae do not have these so-called olfactory organs, yet they can smell. The olfactory pores are common to both adult Lepidoptera and their larvae. In the adult they are found on the wings, legs, mouth parts, and second segment of the antennae. In the larvae they occur on the head, mouth parts, antennae, legs, first thoracic segment, and anal prolegs.

There are supposedly two types of taste organs. The first type consists of certain hairs on the mouth parts, but since these are covered with hard chitin the writer does not believe that aqueous liquids can pass quickly through them in order to stimulate the nerves inside. The second type is Minnich's tarsal chemoreceptors, which, when properly stimulated, are 256 times as sensitive as are the taste organs in the human mouth. We know nothing about the structure of these receptors, and the present writer so far has found only two kinds of sense organs—sense hairs and olfactory pores—in the tarsi of insects.

We now have good evidence that both adult Lepidoptera and their larvae can hear, although probably not as we do. Four kinds of so-called auditory organs have been described. They are tympanic organs, chordotonal organs, Johnston organs, and auditory hairs. The first three have been found in adult Lepidoptera, while the second and fourth occur in caterpillars. Of these four the writer found only the Johnston organs in the adult codling moth, but Graber in 1882 saw chordotonal organs in the codling-moth larva. It has been shown experimentally that tympanic organs and auditory hairs are affected by sound waves, but we know nothing definite about the functions of the chordotonal and Johnston organs.

Other special sensory receptors of the codling moth include certain innervated hairs serviceable as tactile organs and a well-developed structure in the labial palpus. The latter might function as a balancing organ. The general senses to temperature, humidity, etc., are not supposedly connected with special sense organs, although these senses seem to be well developed in Lepidoptera. In connection with the olfactory organs the scent-producing organs were studied. The only one found in the codling moth is a pair of invaginated sacs in the abdomen of males; thus it seems that the males attract the females and not the reverse.

In conclusion it has been shown that considerable information is now available on the tropisms and sense organs of Lepidoptera, but there is much yet to be learned, and the problem should be attacked from all angles, using the best equipment obtainable. A recent review by Kennedy (38) helps to clarify certain phases of insect behavior. He remarks that while sensitivity is a function of the nervous system, it is conditioned by other structural features, such as small size and chitinous exoskeleton. Hase (29) has recently described his physiological laboratory and equipment at Berlin-Dahlem, which should be emulated by other scientists doing similar work. Much of his apparatus is used for testing the tropisms of insects.

LITERATURE CITED

- (1) ABBOTT, C. E.
1927. The effect of monochromatic light on *Formica dakotensis specularis* (Emery). *Ann. Ent. Soc. Amer.* **20**:117-122, 2 figs.
- (2) ———
1927. The reaction of *Datana* larvae to sounds. *Psyche* **34**:129-133.
- (3) BERTHOLF, L. M.
1927. The relative sensitivity of honeybees to light of different wavelengths. Abstract: *Journ. Econ. Ent.* **20**:521.

- (4) CLARK, A. H.
1927. Fragrant butterflies. Ann. Rep. Smithsonian Inst. for 1926, 421-446, 13 pls.
- (5) CLEMENTS, F. E., AND LONG, F. L.
1923. Experimental pollination; An outline of the ecology of flowers and insects. Carnegie Inst. of Washington, Publ. No. 336, 274 pp., 17 pls.
- (6) COUCH, J. F.
1922. The evolution of chemical terminology. II. Phototropism. Organotropism. Amer. Journ. Pharm. **94**:343-347.
- (7) CROZIER, W. J., AND STIER, T. J. B.
1928. Geotropic orientation in Arthropods. I. Malacosoma larvae. Journ. Gen. Physiol. **11**:803-821, 10 figs.
- (8) DAHLGREN, U., AND KEPNER, W. A.
1908. A text-book of the principles of animal histology. New York, 515 pp., illus.
- (9) DEWITZ, J.
1912. The bearing of physiology on economic entomology. Bull. Ent. Research **3**:343-354.
- (10) DOLLEY, W. L., JR. .
1916. Reactions to light in *Vanessa antiopa*, with special reference to circus movements. Journ. Exp. Zool. **20**:357-420, 21 figs.
- (11) ———
1917. The rate of locomotion in *Vanessa antiopa* in intermittent light and in continuous light of different illuminations, and its bearing on the "continuous action theory" of orientation. Journ. Exp. Zool. **23**:507-518.
- (12) ———
1920. The relative stimulating efficiency of continuous and intermittent light in *Vanessa antiopa*. Psychobiol. **2**:137-179.
- (13) DÜRKEN, B.
1923. Ueber die Wirkung farbigen Lichtes auf die Puppen des Kohlweisslings (*Pieris brassicae*) und das Verhalten der Nachkommen. Ein Beitrag zur Frage der somatischen Induktion. Arch. Mik. Anat. Entwicklungsmechanik **99**:222-389, 9 figs.
- (14) DYAR, H. G.
1890. The number of molts of Lepidoptera larvae. Psyche **5**:420-422.
- (15) EGGERS, F.
1919. Das thoracale bitympanale Organ einer Gruppe der Lepidoptera Heterocera. Zool. Jahrb. Abt. Anat. Ont. **41**:272-276, 5 pls., 6 figs.
- (16) ———
1924. Zur Kenntnis der Antennalen Stiftführenden Sinnesorgane der Insekten. Zeitschr. Wiss. Biol., Abt. A, Morph. Ökol Tiere **2**:259-349, 38 figs.
- (17) ———
1925. Versuche über das Gehör der Noctuiden. Zeitschr. Verg. Physiologie **2**:297-314, 1 fig.
- (18) EIDMANN, H.
1922. Die Durchlässigkeit des Chitins bei osmotischen Vorgängen. Biol. Zentrbl. **42**:429-435, 1 fig.

- (19) ELTRINGHAM, H.
1923. On the tympanic organ in *Chrysidia ripheus* Dru. Trans. Ent. Soc. London, pts. 3-4, 443-458, 3 pls., 2 figs.
- (20) FABRE, J. H.
[1922]. Social life in the insect world. Trans. (1911) by B. Miall. London.
- (21) FOREL, A.
[1908]. The senses of insects. Trans. by M. Yearsley. London.
- (22) FOWLER, R.
1927. Further investigations into codling-moth control. Second report on experiments carried out at Blackwood Experiment Orchard. Journ. Dept. Agr. So. Aust. **31**:480-492.
- (23) FREILING, H. H.
1909. Duftorgane der weiblichen Schmetterlinge nebst Beiträgen zur Kenntnis der Sinnesorgane auf dem Schmetterlingsflügel und der Duftpinsel der Männchen von *Danais* und *Euplecta*. Zeitschr. Wiss. Zool. **92**:210-290, 17 figs., 6 pls.
- (24) FROST, S. W.
1927. Further studies of baits for oriental fruit moth control. Journ. Econ. Ent. **20**:167-174, 2 figs.
- (25) ———
1928. Continued studies of baits for oriental fruit moth. Journ. Econ. Ent. **21**:339-348, 1 fig.
- (26) GRABER, V.
1882. Die chordotonalen Sinnesorgane und das Gehör der Insecten. Archiv. mikr. Anat. **20**:506-640, 6 figs., 6 pls.
- (27) GUENTHER, K.
1901. Ueber Nervenendigungen auf dem Schmetterlingsflügel. Zool. Jahrb. Anat. Ont. **14**:551-572, 1 pl.
- (28) HAMPSON, G. F.
1892. On stridulation in certain Lepidoptera, and on the distortion of the hind wings in the males of certain *Ommatophorinae*. Proc. Zool. Soc. London, 188-193, 6 figs.
- (29) HASE, A.
1927. Aufgaben und Einrichtung des Laboratoriums für physiologische Zoologie an der Biologischen Reichsanstalt für Land- und Forstwirtschaft zu Berlin-Dahlem nebst Beschreibung einiger neuer, daselbst gebauter Apparate. Zool. Anz. **73**:151-183, 13 figs.
- (30) HEADLEE, T. H.
1927. Orchard insect investigations. Codling moth. N. J. Agr. Exp. Sta., Rept. Dept. Ent., 175-184.
- (31) HEINRICH, C.
1916. On the taxonomic value of some larval characters in the Lepidoptera. Proc. Ent. Soc. Wash. **18**:154-164, 2 figs., 1 pl.
- (32) HERING, M.
1926. Biologie der Schmetterlinge. Berlin, 480 pp., 82 figs., 13 pls.
- (33) HERRICK, C. J.
1922. An introduction to neurology. 3d ed., Philadelphia and London, 395 pp., 140 figs.

- (34) HILTON, W. A.
1902. The body sense hairs of lepidopterous larvae. *Amer. Nat.* **36**: 561-578, illus.
- (35) JORDAN, K.
1905. Note on the peculiar secondary sexual character found among Geometridae at the sensory organ situated at the base of the abdomen. *Novit. Zool.* **12**: 506-507, 1 fig.
- (36) ———
1923. On the comb-bearing flap present on the fourth abdominal segment in the males of certain Notodontidae. *Novit. Zool.*, **30**: 153-154, 1 pl.
- (37) KELLOGG, V. L.
1907. Some silkworm moth reflexes. *Biol. Bull.* **12**: 152-154.
- (38) KENNEDY, C. H.
1927. Some non-nervous factors that condition the sensitivity of insects to moisture, temperature, light and odors. *Ann. Ent. Soc. Amer.* **20**: 87-106.
- (39) KLUGH, A. B.
1925. Ecological photometry and a new instrument for measuring light. *Ecology* **6**: 203-237, 5 figs., 1 pl.
- (40) LAMMERT, A.
1925. Ueber Pigmentwanderung im Punktauge der Insecten sowie über Licht- und Schwerkraftreaktionen von Schmetterlingsraupen. *Zeitschr. Wiss. Biol. Abt. C. (Zeitschr. Vergleich. Physiol.)* **3**: 225-278, 18 figs.
- (41) LIST, G. M., AND YETTER, W. P., JR.
1927. Codling moth in the Grand Valley of Colorado. *Col. Sta. Bull.* **322**, 46 pp., 9 figs.
- (42) LOEB, J.
1905. *Studies in general physiology.* Chicago, 423 pp., illus.
- (43) ———
1906. *The dynamics of living matter.* New York, 233 pp., illus.
- (44) ———
1918. *Forced movements, tropisms, and animal conduct.* Philadelphia and London, 209 pp., illus.
- (45) LUCKIESH, M.
1921. *Color and its applications.* 2d ed., New York, 419 pp., illus.
- (46) LUTZ, F. E.
1924. Apparently non-selective characters and combinations of characters, including a study of ultraviolet in relation to the flower-visiting habits of insects. *Ann. N. Y. Acad. Sci.* **29**: 181-283, 48 figs., 7 pls.
- (47) MCCRACKEN, ISABEL.
1907. The egg-laying apparatus in the silkworm (*Bombyx mori*) as a reflex apparatus. *Journ. Comp. Neur. and Psychol.* **17**: 262-285 1 fig.
- (48) MCINDOO, N. E.
1914. The olfactory sense of the honey-bee. *Journ. Exp. Zool.* **16**: 265-346, 24 figs.

- (49) McINDOO, N. E.
1917. Recognition among insects. *Smithsonian Misc. Coll.* **68** (2): 1-78.
- (50) ———
1917. The olfactory organs of Lepidoptera. *Journ. Morph.* **29**:33-54
10 figs.
- (51) ———
1919. The olfactory sense of lepidopterous larvae. *Ann. Ent. Soc. Amer.* **12**:65-84, 53 figs.
- (52) ———
1922. The auditory sense of the honey-bee. *Journ. Comp. Neur.* **34**:
173-199, 26 figs.
- (53) ———
1926. Senses of the cotton boll weevil—An attempt to explain how
plants attract insects by smell. *Journ. Agr. Research* **33**:
1095-1141, 16 figs.
- (54) ———
1927. Smell and taste and their applications. *Sci. Monthly*, Dec. 25:481-
503, 14 figs.
- (55) ———
1928. Responses of insects to smell and taste and their value in control
Journ. Econ. Ent. **21**:903-913.
- (56) MAST, S. O.
1911. Light and the behavior of organisms. New York, 410 pp., illus.
- (57) ———
1915. What are tropisms? *Arch. f. Entw. Mech. der Organismen* **41**:
251-263.
- (58) MAVER, A. G.
1900. On the mating instinct in moths. *Psyche* **9**:15-20.
- (59) ——— AND SOULE, C. G.
1906. Some reactions of caterpillars and moths. *Journ. Exp. Zool.* **3**:
415-433.
- (60) MINNICH, D. E.
1921. An experimental study of the tarsal chemoreceptors of two
nymphalid butterflies. *Journ. Exp. Zool.* **33**:173-203, 6 figs.
- (61) ———
1922. The chemical sensitivity of the tarsi of the red admiral butterfly,
Pyramis atalanta Linn. *Journ. Exp. Zool.* **35**:57-81, 3 figs.
- (62) ———
1922. A quantitative study of tarsal sensitivity to solutions of sac-
charose, in the red admiral butterfly, *Pyramis atalanta* Linn.
Journ. Exp. Zool. **36**:445-457, 1 fig.
- (63) ———
1924. The olfactory sense of the cabbage butterfly, *Pieris rapae* Linn.,
an experimental study. *Journ. Exp. Zool.* **39**:339-356, 1 fig.
- (64) ———
1925. The reactions of the larvae of *Vanessa antiopa* Linn. to sounds.
Journ. Exp. Zool. **42**:443-469, 2 figs.
- (65) ———
1926. The chemical sensitivity of the tarsi of certain muscid flies. *Biol.*
Bull. Mar. Biol. Lab. Woods Hole **51**:166-178, 2 figs.

- (66) MINNICH, D. E.
1926. The organs of taste on the proboscis of the blowfly, *Phormia regina* Meigen. Anat. Record **34**:126.
- (67) MORGAN, A. C., AND LYON, S. C.
1928. Notes on amyl salicylate as an attractant to the tobacco hornworm moth. Journ. Econ. Ent. **21**:189-191.
- (68) NOEL, P.
1915. L'attrance des mâles par les femelles. Bull. Trim. Lab. Ent. Agr., Seine-Inférieure, Rouen, 16 pp.
- (69) PARKER, G. H.
1903. The phototropism of the mourning-cloak butterfly, *Vanessa antiopa* Linn. Mark Anniversary Volume, 453-469, 1 pl.
- (70) PARROTT, P. J.
1927. Progress report on light traps for insect control. N. Y. Agr. Exp. Sta. paper presented at Ann. Convention of Empire State Gas and Electric Assoc. Oct. 7, 1927.
- (71) PARSONS, J. H.
1924. An introduction to the study of colour vision. 2d ed., Cambridge Univ. Press, illus.
- (72) PETERSON, A.
1925. A bait which attracts the oriental peach moth (*Laspeyresia molesta* Busck). Journ. Econ. Ent. **18**:181-190, 2 figs.
- (73) ———
1927. Some baits more attractive to the oriental peach moth than black-strap molasses. Journ. Econ. Ent. **20**:174-185.
- (74) ——— AND HAEUSSLER, G. J.
1928. Response of the oriental peach moth and codling moth to colored lights. Ann. Ent. Soc. Amer. **21**:353-379, 4 pls.
- (75) PRÜFFER, J.
1923. Observations et expériences sur les phénomènes de la vie sexuelle de *Lymantria dispar* L. Bull. Acad. Polonaise Sci. et Lettres, Série B. Extrait, 1-9.
- (76) ———
1924. La phénomène d'allechement des mâles par les femelles chez la *Lymantria dispar* L. Trav. Soc. Sci. et Lettres de Vilno **1** (5) : 1-12, 2 figs., 1 pl. (In Polish.)
- (77) ———
1927. On sense organs and the innervation of the antennae and the wings of *Saturnia pyri* L. and their relation to the phenomenon of the luring of males by females. Trav. Soc. Sci. et Lettres de Vilno **3** (8) : 1-84, 7 pls. (In Polish with title and summary in English.)
- (78) RATH, O. VOM
1888. Ueber die Hautsinnesorgane der Insekten. Zeitschr. Wiss. Zool. **46**:413-454, 2 pls.
- (79) SCHENK, O.
1903. Die antennalen Hautsinnesorgane einiger Lepidopteren und Hymenopteren mit besonderer Berücksichtigung der sexuellen Unterschiede. Zool. Jahrb. Anat. **17**:373-618, 4 figs., 2 pls.

- (80) SCHRÖDER, CHR.
1912. Handbuch der Entomologie. Jena.
- (81) SNODGRASS, R. E.
1926. The morphology of insect sense organs and the sensory nervous system. Smithsonian Misc. Coll. **77** (8) : 1-80, 32 figs.
- (82) SPULER, A.
1927. Codling moth traps. Wash. Coll. Sta. Bull. **214**, 12 pp., 4 figs.
- (83) STEAR, J. R.
1928. Some results with bait pans against the oriental moth, *L. molesta*, Busck. Journ. Econ. Ent. **21**:565-571.
- (84) STRICHT, O. VAN DER
1909. Le neuro-épithélium olfactif et sa membrane limitante interne. Mem. Acad. Roy. de Med. de Belgique **20** (2) : 1-45, 2 pls.
- (85) TRÄGÅRDH, I.
1913. On the chemotropism of insects and its significance for economic entomology. Bull. Ent. Research **4**:113-117.
- (86) TURNER, C. H.
1914. An experimental study of the auditory powers of the giant silkworm moths (Saturniidae). Biol. Bull. Mar. Biol. Lab. Woods Hole **27**:325-332.
- (87) ——— AND SCHWARZ, E.
1914. Auditory powers of the *Catocala* moths; an experimental field study. Biol. Bull. Mar. Biol. Lab. Woods Hole **27**:275-293.
- (88) VOGEL, R.
1911. Ueber die Innervierung der Schmetterlingsflügel und über den Bau die Verbreitung der Sinnesorgane auf denselben. Zeitschr. Wiss. Zool. **98**:68-134, 14 figs., 3 pls.
- (89) ———
1912. Ueber die Chordotonalorgane in der Wurzel der Schmetterlingsflügel. II Zeitschr. Wiss. Zool. **100**:210-244, 8 figs., 2 pls.
- (90) WASHBURN, M. F.
[1923]. The animal mind. New York. 386 pp., illus.
- (91) YERKES, R. M., AND WATSON, J. B.
1911. Methods of studying vision in animals. The Behavior Monographs **1** (2) : IV + 90, 13 figs.
- (92) YETTER, W. P., JR.
1925. Codling moth work in Mesa County. 16th Ann. Rep. Coll. Sta. for 1924, Circ. **47**:32-40.
- (93) YOTHERS, M. A.
1927. Summary of three years' tests of trap baits for capturing the codling moth. Journ. Econ. Ent. **20**:567-575, 1 fig.



SMITHSONIAN MISCELLANEOUS COLLECTIONS
VOLUME 51, NUMBER 11

Hodgkins Fund

ATMOSPHERIC OZONE: ITS RELATION TO SOME SOLAR AND TERRESTRIAL PHENOMENA

BY
FREDERICK E. FOWLE



(PUBLICATION 3014)

CITY OF WASHINGTON
PUBLISHED BY THE SMITHSONIAN INSTITUTION
MARCH 18, 1929



SMITHSONIAN MISCELLANEOUS COLLECTIONS

VOLUME 51, NUMBER 11

Hodgkins Fund

ATMOSPHERIC OZONE: ITS RELATION TO SOME SOLAR AND TERRESTRIAL PHENOMENA

BY

FREDERICK E. FOWLE



(PUBLICATION 3014)

CITY OF WASHINGTON
PUBLISHED BY THE SMITHSONIAN INSTITUTION
MARCH 18, 1929

The Lord Baltimore Press
BALTIMORE, MD., U. S. A.

Hodgkins Fund

ATMOSPHERIC OZONE: ITS RELATION TO SOME SOLAR AND TERRESTRIAL PHENOMENA

BY FREDERICK E. FOWLE¹

The reduction of the measurements of the output of radiation from the sun obtained at the Smithsonian station on Table Mountain, California (altitude 2,300 m.), encountered some difficulty which did not seem to be present at the station at Montezuma, Chile (altitude 2,900 m.), in the southern hemisphere. Preliminary reductions showed the presence of a direct relationship between the values obtained at Table Mountain for the radiation from the sun and the amount of ozone above that station. A yearly march present in the Table Mountain solar results, together with other irregularities, were eliminated when proper allowance was made for the amount of ozone above that station.

That ozone plays an important part in the interception of radiation coming to us from the sun, especially at the violet end of the spectrum, has been known for some time. It exerts absorption in the following places in the spectrum:²

(1) A very strong band in the ultra-violet, 0.2300 to 0.3100 μ , with its maximum at 0.2550 μ (the Hartley band).

(2) A complicated group, extending roughly from 0.3100 to 0.3500 μ (the Huggins band).

(3) A group in the yellow and red, 0.4500 to 0.6500 μ (the Chappuis band).

(4) A band in the infra-red between 9 and 11 μ .

¹ A preliminary report of this research was read at the 9th annual meeting of the American Geophysical Union, April, 1928 (*Ozone in the Northern and Southern Hemispheres*, *Journ. Terr. Magn. and Atm. Electr.* **33**, 151, 1928).

² Adapted, with alterations in the wave-lengths of the infra-red band, from "The absorption of radiation in the upper atmosphere," C. Fabry, *Proc. Phys. Soc.* **39**, 1, 1926.

The longer wave-length portion of the Hartley band (1) has been used by Fabry and Buisson¹ and others to measure the amount of ozone in the atmosphere. On June 7, 1920, they found an equivalent layer of a little more than 3 mm. at normal temperature and pressure (ntp). They estimated that at 0.2800μ the ozone absorption would reduce the incident solar energy to 10^{-16} of its entering value. Ozone, therefore, by its absorption in this band, limits the solar spectrum at its violet end as observable at the surface of the earth. Dr. Dobson² uses this band for measures both of the amount and the

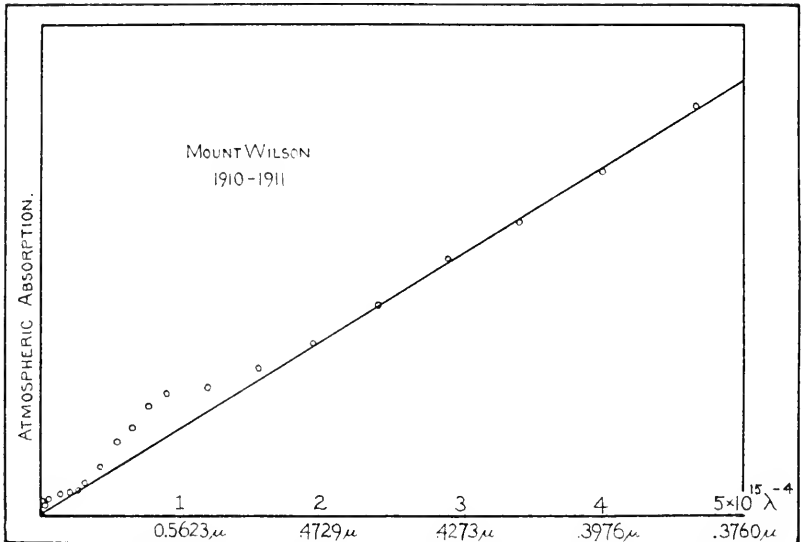

FIG. 1.—Atmospheric absorption coefficients showing ozone band (Fowle).

height of atmospheric ozone. He found a height of 30 to 40 km. above sea-level.

The Huggins band (2) was used by Cabannes and Dufay³ for measures of the altitude of the ozone layer by light reflected from the zenith at the time of the setting sun. They found an altitude of 40 to 50 km. above the earth's surface.

The Chappuis band (3) is used in the present research. The band in the infra-red (4) is of importance because of its location at a wave-length where otherwise the atmosphere would be nearly trans-

¹ Journ. de Phys. **2**, 107, 1921.

² Proc. Roy. Soc. **110A**, 660, 1926; **120A**, 251, 1928.

³ Journ. de Phys. et le Rad. **8**, 125, 1927.

parent to radiation out-going from the earth. It was observed in the laboratory by Ladenburg and Lehman,¹ and by the writer in the solar spectrum.²

A set of atmospheric transmission coefficients, freed as carefully as was possible from the effects of non-selective absorptions due to water vapor, dry dust, and particles associated with water vapor and called wet dust, was published by the writer in earlier papers.³ The observations are shown in figure 1, redrawn from Fabry's article (*loc. cit.*). Cabannes and Dufay⁴ used this data to show that the

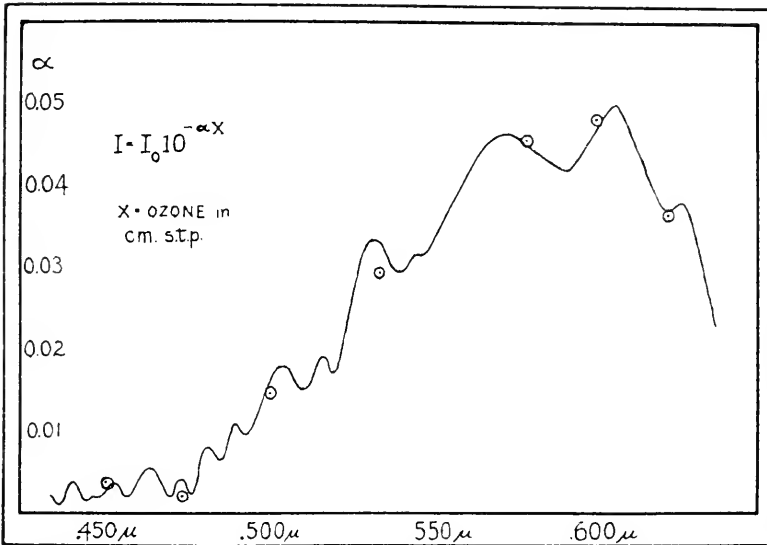

FIG. 2.—Atmospheric absorption in Chappuis yellow ozone band (Colange).

departures from the straight line of the points at wave-lengths greater than 0.4729μ were caused by ozone present in the atmosphere. Making the assumption that the atmospheric ozone amounts to 0.32 cm. ntp., they used the differences of ordinates between the observed points and the straight line, in the region of figure 1, just indicated, to calculate values of the absorption coefficients of ozone for a standard depth of 1 cm. ntp. Figure 2 shows the 7 resulting values plotted as circles and also a curve showing transmission coefficients

¹ Ann. d. Phys. **21**, 305, 1906.

² Smithsonian Misc. Coll. **68**, 1, 1917.

³ Astrophys. Journ. **38**, 392, 1913; **40**, 435, 1914.

⁴ Journ. de Phys. et le Rad. Sept. 1926.

for 1 cm. ozone as obtained in the laboratory by Colange.¹ The agreement is remarkable. The layer of ozone used by Colange was 18 cm. ntp., and from this the above curve was computed for 1 cm. ntp., by Bouguer's formula.

The same authors,² using a somewhat similar process, later utilized published observations, made by Smithsonian observers at their various stations, for further determinations of the ozone above these stations. These data had not been corrected for water vapor; also the values were taken from somewhat smoothed curves drawn through the plotted observed points. Further, because of gradually progressive changes in the transparency of the sky, comparatively few days furnish observations which are good enough for the above treatment. On these several accounts the investigation just cited is not fully satisfactory. In the following discussion only the original observations are used and they are treated by a method probably nearly independent of sky changes.

The results presently to be considered are to a considerable extent a by-product of spectro-bolometric observations originally made for the determination of the radiation emitted from the sun. Values from about 1,000 days have been utilized. In the ordinary reductions of this work, the ordinates of the solar energy curves (generally 6 curves per day) obtained with a 60° u. v. glass prism had already been read for about half of the days used. It has been the custom to read them on our plates at abscissae, among others, of 18, 20, 22, 24, 26, 28, and 30 cm. towards the violet from the infra-red band, ω_1 , at 2μ . These places correspond to wave-lengths of 0.764, 0.686, 0.624, 0.574, 0.535, 0.503, and 0.475 μ , respectively. This spectrum region includes the yellow Chappuis band due to ozone.

A preliminary futile attempt was made to use these ordinates to determine directly the depth of the ozone band. The band is masked by the numerous solar lines in that part of the spectrum. Indeed Fabry says: "The Chappuis bands have never been observed directly in the solar spectrum. I have often looked for them in the spectrum of the setting sun, but have never found them."

However, if the several observations of any day, made at each place in the spectrum at different zenith distances, are used to determine atmospheric transmission coefficients, and the resulting values are plotted against the corresponding deviations, the band is strongly

¹ Journ. de Phys. et le Rad. **8**, 257, 1927.

² Journ. de Phys. et le Rad. **7**, 257, 1926; **8**, 353, 1927.

brought out as may be noted in figure 3. This figure shows results for days of great, medium, and negligible absorption in this band. The abscissae are prismatic deviations, the ordinates, atmospheric transmission coefficients for zenith sun. As the quantity of atmospheric ozone may be correlated to the amount of energy cut out by this band from the radiation coming to us from the sun, the area of

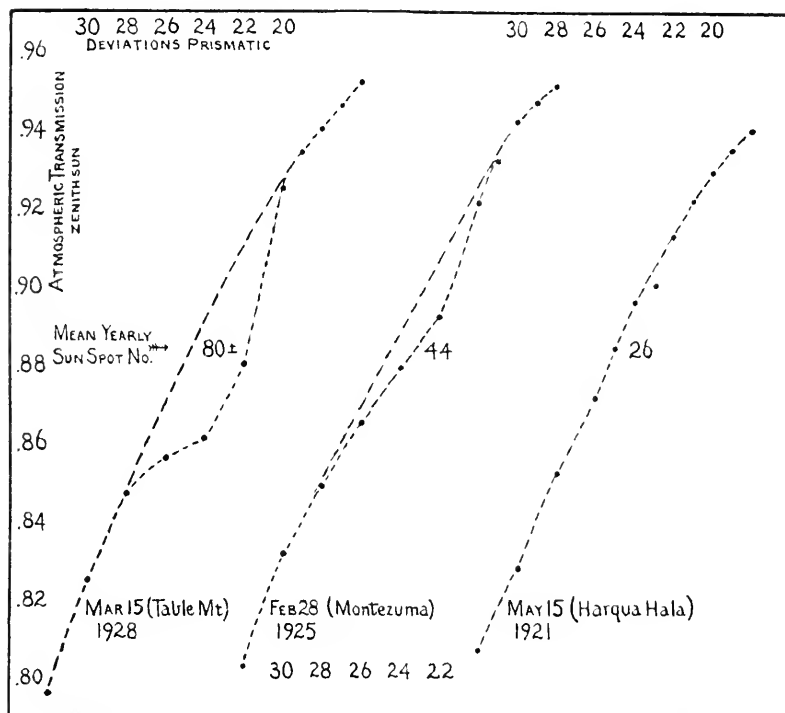

FIG. 3.—The Chappuis yellow ozone band.

this band, reduced to the proper energy units, has been utilized as a measure of the amount of ozone in the atmosphere.

A smooth curve is first drawn over the top of the band as indicated in figure 3. At any particular abscissa, let a_a represent the ordinate on the smooth curve drawn across the band, or, in other words, the transmission of the air for zenith sun with no ozone present; a_o is the corresponding transmission coefficient for ozone, and a the observed transmission. Then

$$a = a_o a_o \text{ OR } a_o = a / a_a.$$

Calling e the corresponding energy at the selected place in the sun's spectrum, it may be assumed that approximately the amount of energy absorbed from the sun's rays by ozone is

$$\left(\frac{a}{a_u} \cdot e\right) \text{ summed for spectrum places 22, 24, and 26.}$$

The accuracy of these measurements, depending, at the greatest, on differences of the order of (0.890-0.860), cannot exceed 1 part in 30, assuming no accidental errors. Farther, the measurements extend over times of from one to three hours. It is presumptuous to assume always a negligible change in the amount of ozone during such considerable times. Any change in the general transparency of the sky is probably negligible, since it would affect both the numerator and the denominator of the above expression. It takes only 30 seconds for the run through the part of the spectrum used, so that the time is short to produce differential errors within this band.

Because the results presently to be given differ so considerably in magnitude and range from the values of Dr. Dobson and those associated with him, it has been thought advisable to devote considerable time and study to the indications of the Chappuis band.

Is the discrepancy due to the presence of other atmospheric lines within the Chappuis ozone band? A count of the number of atmospheric lines, designated as such in St. John's recent revision of Rowland's Solar Spectrum Table,¹ leads to the following table:

Spectrum range	Wave-length range	Number of lines		
		atm ^c	H ₂ O	O ₂
27-29	0.490-.520 μ	0	0	0
25-27	0.520-.555	16	1	0
23-25	0.555-.600	311	244	43
21-23	0.600-.653	81	104	42

In figure 4 the area of that part of the ozone band under trial corresponding to the region of the first three lines of the above table is plotted against the corresponding precipitable water vapor in the atmosphere; in figure 5, is similarly plotted that corresponding to the lower line. No connection with water vapor can be certainly inferred from these two plots. What little dependence there seems to be is in the wrong direction; that is, the greater the water vapor, the smaller, on the average, seems to be the area of the band. This apparently inverse effect probably results because the season of greatest water

¹ Carnegie Institution Publications, 306, 1928.

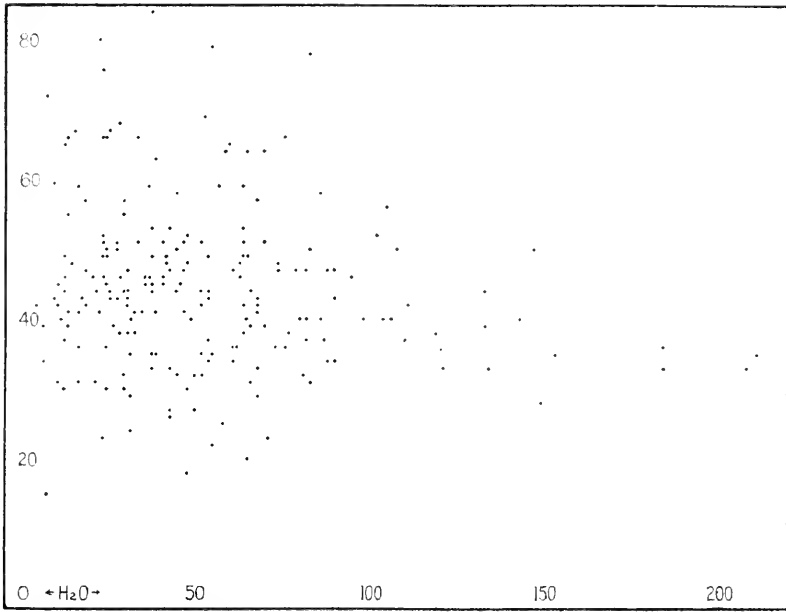

FIG. 4.—Abscissae, ppt. H₂O; ordinates O₃; 0.47 to 0.60 μ .

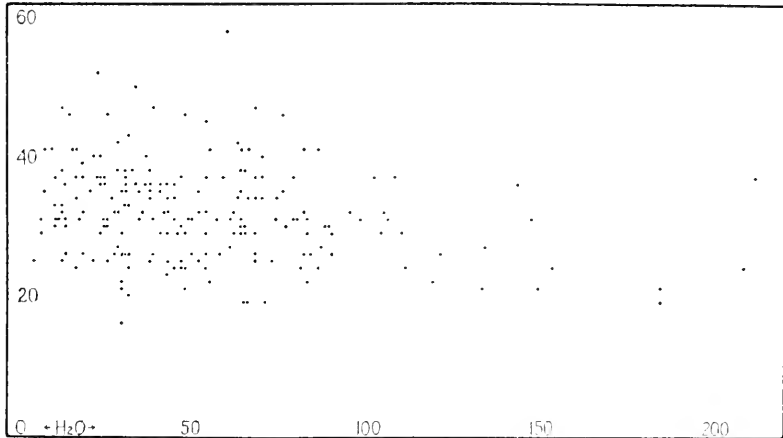

FIG. 5.—Abscissae, ppt. H₂O; ordinates O₃; 0.60 to 0.66 μ .

vapor comes considerably later in the year than that for the area-maximum of the band, yet before the time for its maximum.

A far more detailed study of the transmission coefficients in the region of this band has been made than was possible with the somewhat separated measurements in the spectrum made for the solar-radiation work. Plates for two days were reread and coefficients determined for each maximum and each minimum of the solar lines visible in the observed energy curves (fig. 6, curve *a*). Unfortunately, between deviations 20 and 22, and 27 and 28, such a process was impossible because of instrumental contingencies. The resulting coefficients determined independently for the two days of observations are plotted in curves *b* and *c*. This is a useful transformation, resulting, as it does, in a spectrum, *b* or *c*, showing only atmospheric lines, from an energy curve like *a* where the solar lines are dominant practically to the exclusion of any indication of atmospheric absorptions.

Assuming for the time being the validity of Bouguer's formula, a further step was taken. Entering figure 2 for the corresponding wavelength with the transmission coefficient determined at place 24 from the curve *c* of figure 6, the amount of ozone was determined. With this amount of ozone, and the transmission coefficients at *all* the maxima and minima of the curve in figure 2, an ozone band was computed, using the line across the top of the band in curve *c* of figure 6 as the basis. The result is plotted in curve *d* of figure 6. The agreement between *c* and *d* is better than could be expected and is indeed remarkable. Apparently because the writer is using a purer spectrum than Colange, the deflections in curves *b* and *c* are more marked than in curve *d*, but the agreement in position is satisfactory. Between deviations 26 and 30, the coefficients are too small to expect any accuracy. It seems therefore highly probable that practically all of this band as observed is due to ozone.

The writer, as already stated, prefers to express the results which follow in terms of a quantity fairly directly coming from the observations, namely, the amount of energy cut out from the incoming solar energy by this yellow Chappuis band. These results may be approximately reduced to amounts of ozone (ntp.) by using Bouguer's formula with the constant determined by Colange (*loc. cit.*) as indicated by the following table:

Band area	30	40	50	60	70	80	90	100	cal. $\times 10^4$
Ozone	0.00	.160	.200	.230	.260	.290	.320	.350	cm. ntp.

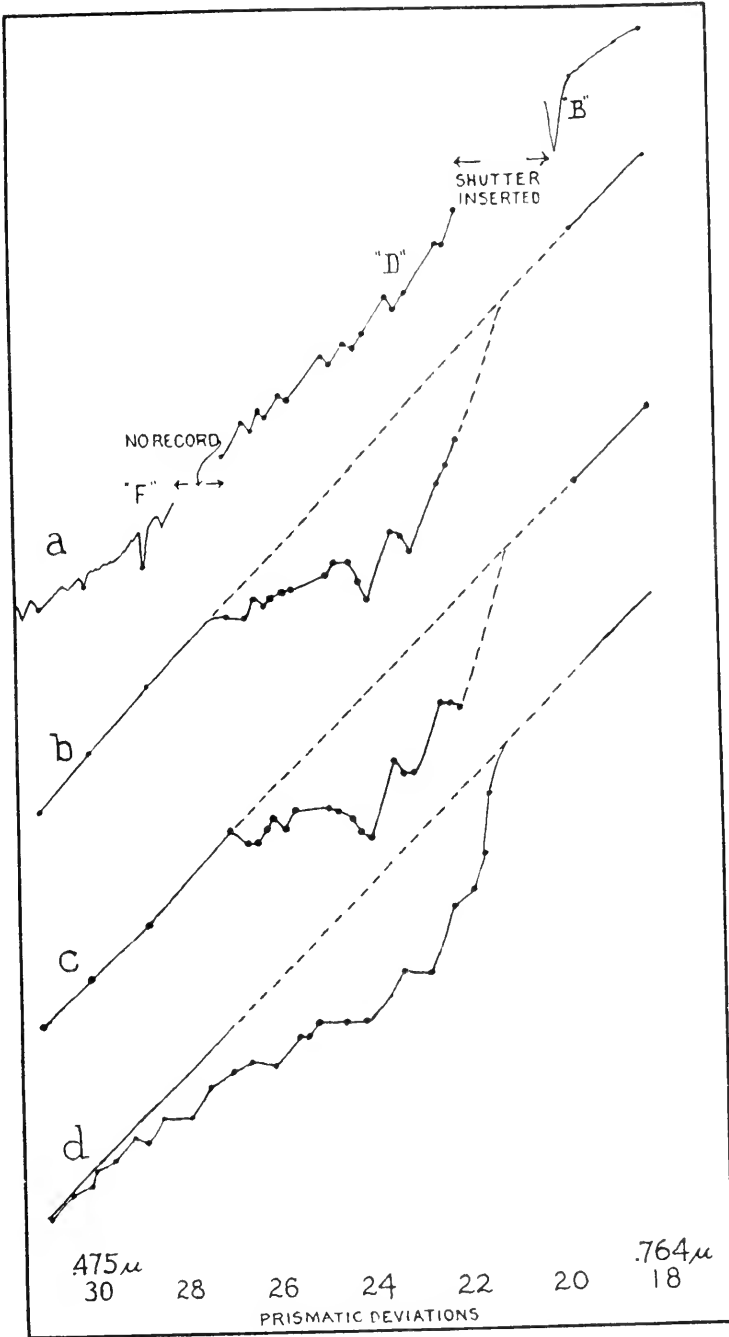

FIG. 6.

The use of Bouguer's formula is unsafe for banded absorptions, except possibly for a very pure spectrum, and as an interpolation formula. Langley¹ long ago showed its inapplicability in a region where quite different coefficients of absorption occur, and his logic is even more applicable in the present case where these occur in close juxtaposition, and in banded spectra where the resolving power is comparatively poor. Safer substitutes for Bouguer's formula may be employed. For instance, in estimating atmospheric precipitable water the writer always uses an absorption curve calibrated as far as possible in the laboratory. A curve approximately of the shape

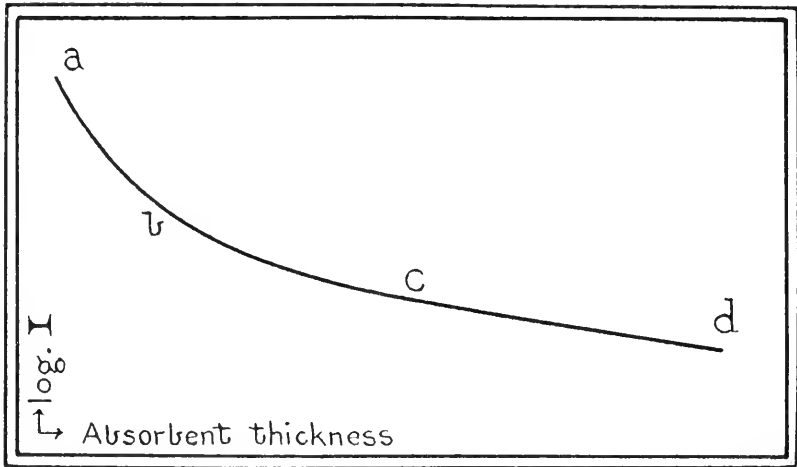

FIG. 7.

indicated in figure 7 would be expected. Where lines of strong absorption occur alternately with those of high transmission, the curve of figure 7 does not tend to approach a zero value of I with increasing absorbent, but to become horizontal for a finite value of I . Assuming Bouguer's formula to hold we should have a straight line, tangent to some portion of this curve. In view of the state of affairs indicated in figure 7, we should hesitate to use Bouguer's formula for computing the amounts of ozone, unless for data requiring very little extrapolation from the amounts of ozone used in the laboratory to determine the constant of the formula. It may be that these considerations explain certain discrepancies between Dr. Dobson's results

¹ Ann. Astrophys. Observ. Smithsonian Inst. 2, 16, 1908.

and mine at the same stations. He is working at a spectrum place where the coefficient a in the formula,

$$I = I_0 10^{-ar}$$

is very large, ranging from about 1 to 4. He is therefore probably working far down on the nearly horizontal portion of a curve such as is indicated in figure 7 where a large change in ozone makes a comparatively small change in the observed spectrum intensity values. On the other hand, in the Chappuis band used by the writer, the coefficient a is so small, about 0.04, that the band is very difficult to observe visually. Therefore we may assume that the writer is measuring in a band where a small change in ozone produces a great change in the observed quantity. In other words, for the amount of ozone present in the atmosphere, the Chappuis band is a more sensitive indicator of changes in atmospheric ozone than that employed by Dr. Dobson.

With these preliminary remarks, attention may be drawn to figure 8, in which recent observations made at Table Mountain with Dobson's apparatus, and reduced by him to cm. ozone ntp. are compared with the writer's results as expressed in areas of the Chappuis band. The average amount of ozone for this interval of time as computed by the preceding table from the writer's results is about 0.23 cm. ntp., while Dobson finds about 0.22 cm. The range of the variation found by the writer much exceeds that found by Dobson, but nevertheless a marked correlation exists between the two series.

The writer cannot leave Dr. Dobson's work without one further remark about his method. He states,¹ "It has been shown that there is a close connection between the amount of ozone in the upper atmosphere and the pressure conditions in the upper part of the troposphere and the lower part of the atmosphere," and states that, "it is remarkable that the ozone situated at so great a height" (40 to 50 km., as indicated by the results of Cabannes and Dufay, 30 to 40 km. by Dobson himself) should be so closely connected with variations of pressure much lower down."

Dr. Dobson² uses two methods in his evaluation of the amount of atmospheric ozone. In the first he takes as the general atmospheric transmission coefficient

¹ Proc. Roy. Soc. **120A**, 251, 1928.

² *Mö. Not. R. A. S.* **86**, 259, 1926. Proc. Roy. Soc. **110A**, 660, 1926.

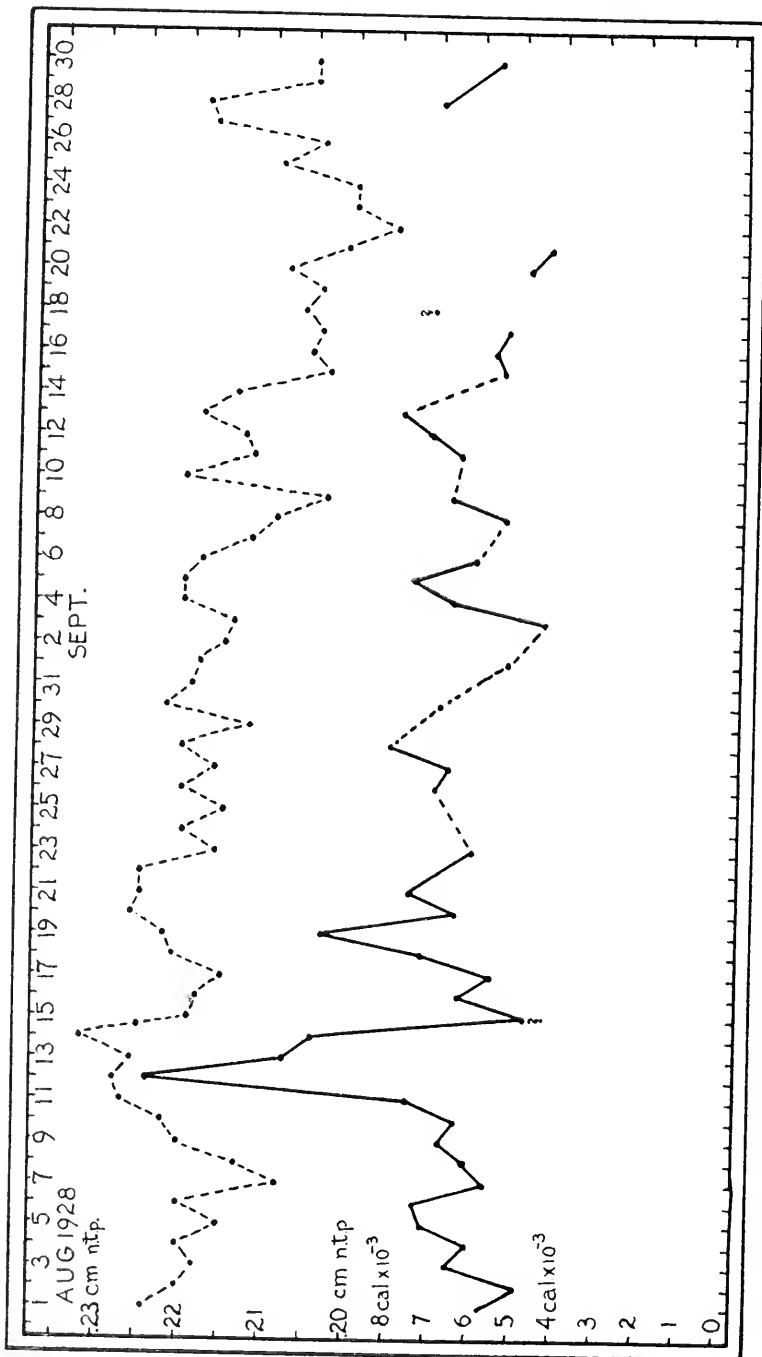

Fig. 8.—Upper dotted curve, Dr. Dobson's values for Table Mountain. Lower curve, the writer's values for Table Mountain.

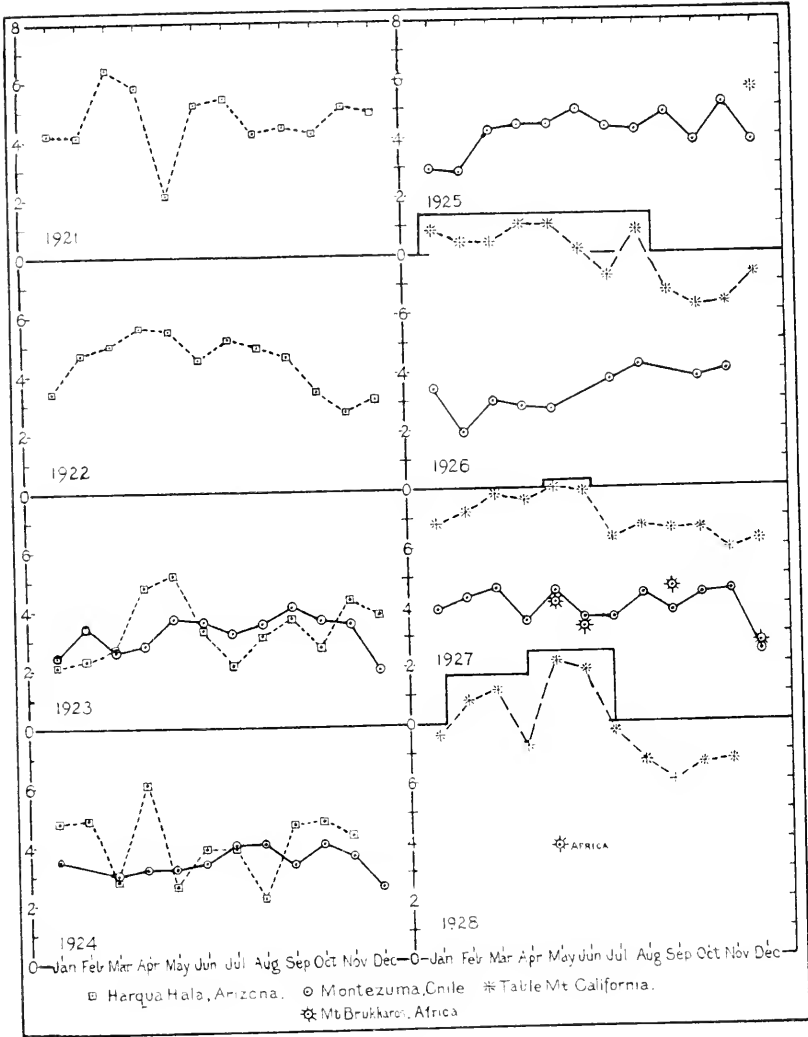

FIG. 9.

where

$$K = \beta + \delta + ax$$

β is the absorption coefficient due to small particles,

δ is the absorption coefficient due to large particles,

a is the absorption coefficient due to 1 cm. ozone ntp.,

x is the thickness of ozone atmospheric in cm. ntp.

Now it seems to the writer that the very variations with atmospheric pressure which Dr. Dobson throws into x , belong fully as

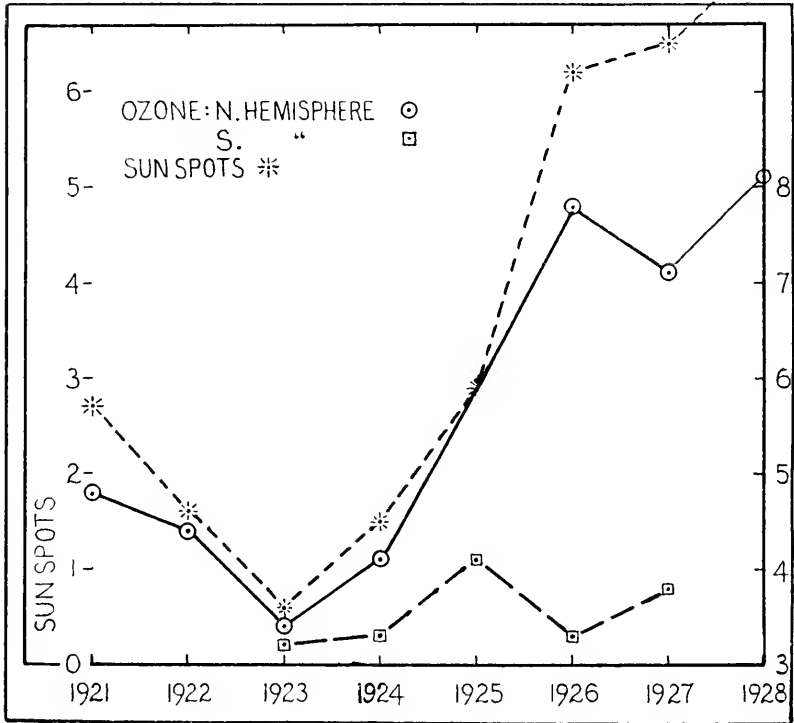

FIG. 10.

legitimately, and very probably, to both β and δ . All this relates to what Dr. Dobson calls his "long method," dependent upon several observations during the day. In his second or "short method" he uses the expression

$$x = \frac{(\log I_o - \log I'_o) - (\log I - \log I') - (\beta - \beta') \sec z}{(a - a') \sec z}$$

In the determinations by this "short method" he assumes that δ does not vary with λ and uses a value for β obtained from the formula

of Rayleigh. Although both these assumptions may be allowable up to a certain accuracy it seems likely that from either of them a variation dependent upon the atmospheric pressure or water vapor may have been introduced.

Let us now turn to the results of observations made at Harqua Hala (altitude 1,770 m.) and Table Mountain (2,300 m.) in the United States of America, Montezuma (2,900 m.) in Chile, and Mt. Brukkaros (1,600 m.) in Africa, embodied in the following table and figures 9, 10, and 11. The table gives only the monthly and

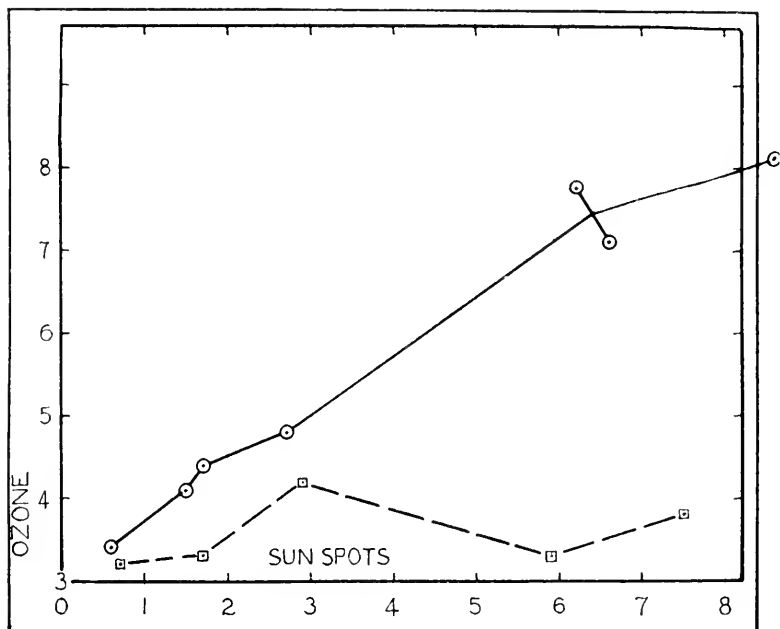

FIG. 11.

yearly means; hence the plotted points, especially in the plots of yearly means, figures 10 and 11, depend upon a considerable number of day's observations but not always every successive day. The Wolfer spot numbers and the magnetic character values here given are computed employing only the days of radiation observations. In my preliminary paper, already referred to, the plots related to daily values, and even with the few values there utilized from the 1926 and 1927 observations at Table Mountain, showed a distinct correlation between the ozone, the spot numbers, the magnetic character and the flocculi for the corresponding days.

THE OBSERVATIONS

Harqua Hala, 1921					Harqua Hala, 1922				
Month	No. obs.	Ozone area	Wolfer spots	Magn. ch.	Month	No. obs.	Ozone area	Wolfer spots	Magn. ch.
Jan.	9	42	27	0.6	Jan.	8	34	11	0.7
Feb.	14	41	31	.4	Feb.	5	47	23	1.0
Mar.	11	64	51	.8	Mar.	5	50	81	.9
Apr.	7	58	16	1.0	Apr.	5	56	15	1.0
May	3	34	45	1.1	May	7	55	8	.7
June	7	52	27	.4	June	7	45	4	.7
July	1	54	100	.5	July	4	52	18	.4
Aug.	4	42	20	.9	Aug.	2	49	11	.2
Sept.	13	44	18	.3	Sept.	3	46	6	.8
Oct.	11	42	17	.7	Oct.	4	34	4	.8
Nov.	5	51	18	.6	Nov.	3	27	4	.1
Dec.	4	49	14	.3	Dec.	4	31	10	.2
Year	89	48	27	0.6	Year	57	44	17	0.7

Harqua Hala, 1923					Montezuma, 1923				
Month	No. obs.	Ozone area	Wolfer spots	Magn. ch.	Month	No. obs.	Ozone area	Wolfer spots	Magn. ch.
Jan.	6	21	5	0.4	Jan.	2	24	10	0.9
Feb.	3	23	2	.3	Feb.	4	34	2	.6
Mar.	4	27	8	.7	Mar.	10	26	3	.4
Apr.	4	48	7	.6	Apr.	12	28	7	.4
May	5	52	2	.5	May	7	37	3	.5
June	3	33	10	.8	June	14	36	13	.4
July	1	21	0	1.4	July	6	32	2	.4
Aug.	3	31	3	.5	Aug.	4	35	2	.4
Sept.	2	37	10	.8	Sept.	5	41	10	.4
Oct.	3	27	12	.4	Oct.	4	36	8	.5
Nov.	1	43	7	.7	Nov.	3	35	9	.8
Dec.	2	38	0	.1	Dec.	2	19	0	.6
Year	37	34	6	0.5	Year	73	32	7	0.6

Harqua Hala, 1924					Montezuma, 1924				
Month	No. obs.	Ozone area	Wolfer spots	Magn. ch.	Month	No. obs.	Ozone area	Wolfer spots	Magn. ch.
Jan.	4	48	2	0.9	Jan.	4	35	0	0.5
Feb.	3	49	7	.2	Feb.
Mar.	2	28	0	.5	Mar.	4	30	0	.8
Apr.	1	61	0	.2	Apr.	4	32	10	.3
May	3	20	14	.8	May	4	32	22	.7
June	7	39	18	.7	June	4	34	22	.4
July	4	39	9	.8	July	4	40	25	.6
Aug.	1	22	11	.1	Aug.	5	40	11	.1
Sept.	3	47	19	.6	Sept.	4	33	22	.5
Oct.	5	48	25	.6	Oct.	4	40	26	.6
Nov.	3	33	31	.7	Nov.	5	20	22	.6
Dec.	Dec.	14	25	21	.4
Year	36	41	15	0.6	Year	56	33	17	0.5

Montezuma, 1925					Table Mountain, 1926				
Month	No. obs.	Ozone area	Wolfer spots	Magn. ch.	Month	No. obs.	Ozone area	Wolfer spots	Magn. ch.
Jan.	10	29	6	0.5	Jan.	16	88	69	0.9
Feb.	3	28	15	.5	Feb.	11	84	68	.6
Mar.	17	42	22	.4	Mar.	15	84	50	.8
Apr.	13	44	29	.5	Apr.	14	90	38	.8
May	13	44	38	.4	May	24	90	68	.6
June	14	49	24	.8	June	18	81	74	.5
July	7	43	37	.3	July	23	72	57	.5
Aug.	2	42	19	.8	Aug.	22	88	62	.5
Sept.	4	48	63	.0	Sept.	28	67	62	.7
Oct.	3	38	43	.7	Oct.	24	62	66	.6
Nov.	2	51	54	.8	Nov.	9	63	50	.5
Dec.	2	38	76	.4	Dec.	7	73	80	.4
Year	90	42	29	0.5	Year	211	78	62	0.7

Montezuma, 1926					Table Mountain, 1927				
Month	No. obs.	Ozone area	Wolfer spots	Magn. ch.	Month	No. obs.	Ozone area	Magn. ch.	Wolfer spots
Jan.	1	34	84	0.7	Jan.	2	68	72	0.4
Feb.	1	19	162	1.2	Feb.	4	72	86	.8
Mar.	2	30	38	.9	Mar.	4	78	87	.5
Apr.	4	28	43	.9	Apr.	5	76	87	.8
May	2	27	38	.6	May	5	80	79	.4
June	June	4	79	65	.3
July	3	37	34	.6	July	3	63	40	.1
Aug.	2	42	61	.4	Aug.	12	67	51	.8
Sept.	Sept.	6	66	60	.8
Oct.	3	37	82	1.2	Oct.	5	66	60	.7
Nov.	2	40	73	.5	Nov.	6	59	66	.4
Dec.	Dec.	2	62	36	1.0
Year	20	33	59	0.8	Year	58	69	65	0.6

Montezuma, 1927					Table Mountain, 1928				
Month	No. obs.	Ozone area	Wolfer spots	Magn. ch.	Month	No. obs.	Ozone area	Wolfer spots	Magn. ch.
Jan.	1	39	77	1.5	Jan.	16	76	70	..
Feb.	1	43	82	1.0	Feb.	11	87	79	..
Mar.	1	46	131	.2	Mar.	19	92	93	..
Apr.	4	35	86	1.2	Apr.	12	72	83	..
May	3	45	93	.2	May	20	101	73	..
June	3	36	86	.1	June	25	98	93	..
July	3	36	52	.3	July	20	77	102	..
Aug.	3	44	44	.8	Aug.	31	67	83	..
Sept.	2	38	90	.0	Sept.	18	60	79	..
Oct.	2	44	68	2.0	Oct.	18	66
Nov.	3	45	61	.1	Nov.	14	67
Dec.	2	24	65	.7	Dec.
Year	28	38	75	0.7	Year	204	81	85	..

From the data of the preceding table and the corresponding figures several phenomena are notable :

(1) There is a very decided yearly march, as has been noted by other observers.

(a) In the northern hemisphere we may take the maximum and minimum of this march as follows :

Maximum	Minimum
1921 March ¹	Sept.
1922 March	Nov.
1923 April-May	Aug. ?
1924 April	Aug. ?
1925 (April, Dobson)	(Oct., Dobson)
1926 April-May	Oct.
1927 April-May (April, Buisson)	Nov. (Nov., Buisson) ²
1928 May	Sept.

(b) and in the southern hemisphere as follows :

Maximum	Minimum
1923 Sept.	March
1924 Aug.-Sept.	March
1925 ?	Feb.
1926 Aug.	April ?
1927 not definite	not definite.

whence :

(2) In the yearly march the maxima and minima occur at nearly the same seasons of the year in the northern and southern hemispheres, though of course not in months of the same name. The maxima occur between April and May, the minima between August and November in the northern hemisphere and vice versa approximately in the southern.

(3) A marked correlation exists between the ozone and the Wolfer sun-spot numbers for the observations of the northern-hemisphere stations, as indicated in figures 10 and 11. The range of the yearly means for the area of the yellow band is from 20 to 100 (see fig. 9).

¹The writer is inclined to discount the appearance of the low value in May, 1921, as abnormal, possibly due to erroneous observing, and to consider the general march of the curve as indicating the minimum in September. Somewhat similar judgments occur later in the table.

²C. R. 186, 1229, 1918.

(4) In the southern hemisphere no such strong correlation is apparent between the spot numbers and the ozone. The corresponding range is only from 20 to 30. However the errors of the readings of the area when this is small are comparatively great; indeed the observations do hint a slight relationship.

The writer suggests that the following considerations point to a fifth deduction from the observations.

The ozone present in the upper air has been generally considered as formed from the oxygen there present by the action of ultra-violet light from the sun. Radiation of very short wave-length (less than 0.1850μ) acts upon oxygen, transforming it into ozone. It is not improbable that radiation of this wave-length reaches the earth from the sun. If so, it must produce ozone in the earth's atmosphere, but only in the *highest* levels, because it cannot reach the lower strata. Radiation of wave-length 0.1850μ is completely absorbed by 10 m. of air at ntp., and could scarcely penetrate lower than a stratum 40 km. above the earth. On the other hand, radiation lying between 0.2000 and 0.3000μ decomposes ozone, and between these two opposite actions a state of equilibrium would be established. Since the ozone-destroying wave lengths penetrate deeper into the atmosphere, this naturally limits the ozone layer to a high altitude.

It is possible though that another agency than ultra-violet light works to produce ozone. The investigations of Milne¹ and Pike² indicate the great probability that electrified particles gain such velocities on the sun that they are projected outwards into space from that body. Mme. Curie³ has shown that the α -particles emitted from radium salts ozonize oxygen. Electrons with a velocity of 1.80×10^8 cm./sec.⁴ are capable of producing ozone from oxygen. It is also produced by the silent electrical discharge.

Suppose then that there are two causes at work producing the ozone of the earth's atmosphere: One portion may then be due to the ultra-violet light from the sun, and present over both hemispheres; the other, caused by particles emitted from the sun of such a polarity that, when they reach the earth's field, they drift towards the northern hemisphere, above which alone would the ozone due to this last cause be abundantly present. The particles would then necessarily have a positive charge, *e. g.*, α -particles.

¹ Mo. Not. R. A. S. **86**, 259, 1926.

² Mo. Not. R. A. S. **88**, 3, 1927.

³ C. R. **183**.

⁴ Franck and Hertz, Verh. Deutsch. Phys. Ges. **15**, 34, 1913.

With the assumption of these two sources for the origin of the atmospheric ozone, several of the phenomena shown by the observations of this paper fall in line, and our fifth conclusion will be:

- (5) (a) Due to the ultra-violet light from the sun, there is a layer of ozone, varying apparently very little with the sun-spot period, and situated over both the northern and southern hemispheres and showing an annual march having its maximum in the spring of both hemispheres and its corresponding minimum in the autumn.
- (b) There is another layer formed under the bombardment of electrical particles (probably positive ions) emitted from the sun and showing strongly a dependence upon solar activity as indicated by Wolfer's sun-spot numbers. At the only minimum of spots observed this layer appeared practically absent, the measurements indicating the presence of the (a) layer alone.

Though the corresponding marches during the year of the ozone (which the writer proposes to attribute to the first of the above causes) occur in different months in the two hemispheres, the seasons of maximum and minimum are the same, namely, spring and autumn. One might be led to suppose that these variations are due to some dependence upon the annual and reciprocal marches in the two hemispheres of the air-masses through which the sun's rays could penetrate for the formation of ozone. Further at the tropical station at Montezuma the sun is more nearly overhead and the air-mass change smaller, which might perhaps account for the smaller annual range there. However the maxima and minima do not occur at times when the sun is farthest from or nearest to the zenith, when there would be the greatest and least air-masses.

Another circumstance might lead to an explanation of the annual march and its reciprocal effect in the two hemispheres so far as concerns the times of occurrence of the maxima and minima. Annually, as viewed from the earth, the sun's equator reaches its greatest southern displacement (7.25°) about March 7, and its greatest northern displacement about September 8. The aspect of the sun's disk as seen from the earth at these epochs is shown in figure 12. Since the earth subtends only about $30'$, as seen from the sun, under either circumstance, the sun would have practically the same aspect as viewed by ultra-violet light from either the northern or southern hemispheres of the earth. However, the ultra-violet light would probably be strongly scattered by the particles of the solar corona, and this annual shift of the far more extensive and considerably

more oblate corona might have a differential effect on the intensity of the ultra-violet light reaching the separate hemispheres.

Returning again to Dr. Dobson's results, he finds much the same values in both hemispheres. He now has an observer in New Zealand (1928).¹ He states² that he finds very little connection of his observations with the sun-spot cycle, and that little apparently in a reverse sense from that *clearly* indicated by the writer's results. He obtains an altitude for his ozone layer from the Hartley band at 30 to 40 km., whereas Cabannes and Dufay get an altitude from the

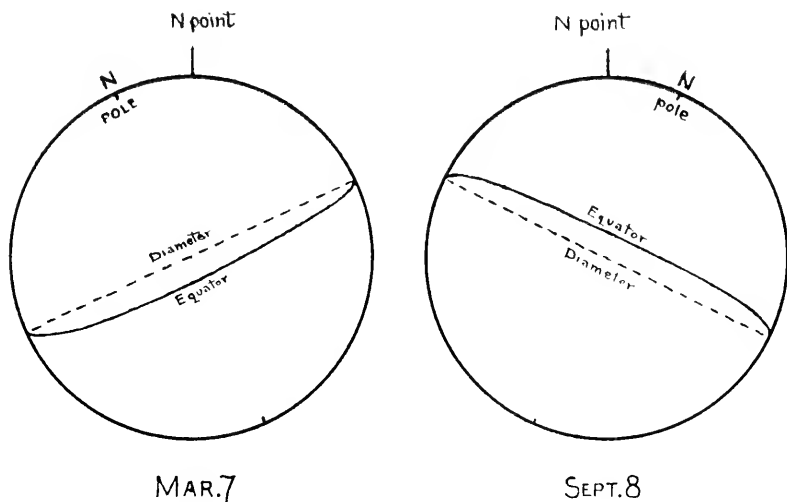

FIG. 12.

Huggin's band of 40 to 50 km. One might hazard the suggestion that it is not beyond possibility that the band used by Dr. Dobson corresponds to such a state of the molecule that only ozone formed by ultra-violet light is in the proper molecular state to effect absorption; whereas the band in the yellow is due to a molecular state which measures absorption due to ozone formed by either process. It will presently be seen how such supposition as to two layers of ozone is in line with the conclusions drawn from magnetic data relating to two separate strata, the lower of which is assumed to be due to ultra-violet light.

¹ Observatory, 51, 381, 1928.

² Proc. Roy. Soc. 114A, 532, 1927.

Turning to the literature of Terrestrial Magnetism, the writer was both surprised and pleased to find decided support lent by the phenomena of terrestrial magnetism to this hypothesis of two quantities of ozone formed by two separate agencies. Furthermore, these two layers were not only ascribed to the same two agencies as already stated, but assumed to be probably separate layers.

If we consider magnetically quiet days, we find a similar yearly march in the magnetic elements, the maxima and minima, however, occurring somewhat later, namely, in June and December at Greenwich; and further a regular march with the sun-spot period. This march is so regular as to lead to the inference that it is due to a general change in the whole solar disk accompanying the sun-spot period. Further there occur disturbed days which seem to be connected with specially disturbed conditions localized on the sun's disk, for they show a definite tendency to recur at successive rotations of the sun's disk.¹

"There are few facts of greater significance," writes Dr. Chapman, "with respect to the relation between magnetic changes and the sun, than the tendency shown by the earth's magnetic activity to return to its condition at any particular time, after the lapse of one or more periods of synodic rotation of the sun."

There are discordances between the succession of events with the ozone phenomena and those that are magnetic, so that the events may be confused with complications not due to the same cause, but the following discussion by Dr. Chapman (*loc. cit.*) seemed of special interest:

"These conclusions regarding the 'disturbance' solar agent have a direct bearing on the 'general' solar agent which affects the regular diurnal magnetic variations over the sunlit hemisphere. If the former consists of electrical corpuscles, the latter cannot do so—no mere difference of mass or sign of charge would account for the complete difference of distribution of the two agents reaching the earth. On the other hand, the apparently sole alternative among possible ionizing agents, viz., ultra-violet light, seems to accord with all the properties which the 'general' solar agent has been shown to possess: for the latter affects the sun-lit hemisphere almost exclusively, it arises from the sun's surface as a whole, and its intensity varies only gradually, from time to time, in correspondence with the general activity of the sun."

¹ Dr. Chapman, Trans. Cambridge Phil. Soc. **22**, 341, 1919.

And he later continues, "The facts hitherto reviewed may next be considered in their bearing upon atmospheric questions. One such question is, Are the layers affected by the two kinds of solar emissions the same or different, and if different, what is their relative situation?"

"Even, *a priori*, it would be expected that two such different emissions as corpuscles and ether waves will have different powers of penetration into the atmosphere, though it would not be possible, on such grounds alone, to decide whether the 'absorbing' layers were wholly distinct or not. The magnetic phenomena, however, give a fairly clear indication that they are practically distinct without overlapping * * *," and he reaches the conclusion "that the magnetic disturbance layer is situated at a higher level than the diurnal variation layer." He infers from this that the magnetic disturbance layer (due to ions from the sun) is situated between 90 and 120 km. and the diurnal variation layer (due to ultra-violet light), between 10 and 90 km.

Dr. Chapman has added a note dated July, 1919: "In a paper read (on May 22, 1919) before the Institution of Electrical Engineers, and shortly to be published, I have suggested that the ultra-violet radiation * * * may be some type of gamma-radiation, and that the corpuscles are (as Vegard has urged) alpha-particles. If both these processes originate from radio-active processes on the sun, the gamma-rays would be expected to penetrate more deeply into our atmosphere than the alpha-particles." All of which falls in with the observations and suggestions of the present paper.

Lord Rayleigh¹ has recently published observations which relate to a phenomenon possibly allied to that of ozone. These observations are measurements of the intensity of the auroral green line in the light of the night sky together with similar measurements of the intensity in the spectrum of the night sky on each side of this line. McLennan² has shown that this green line owes its existence to a metastable state of the oxygen atom. Whereas the green line is always present in the light of the night sky, the negative bands of nitrogen

¹ Proc. Roy. Soc. **119A**, 11, 1928.

² Nature, **122**, 38, 1928.

which are an important feature of the auroral spectrum, are not usually present.

Rayleigh's observations (fig. 13) apparently indicate an annual march in the intensity of this green line with two maxima—the smaller maximum occurring nearly contemporaneously with the single maximum in the ozone march, the larger with the ozone minimum. In the southern hemisphere, as with ozone, the months of the occurrence of these maxima are reversed but, of course, not the season.

Omitting observations made at Claremont which Rayleigh considers faulty, together with those for some stations with only few observa-

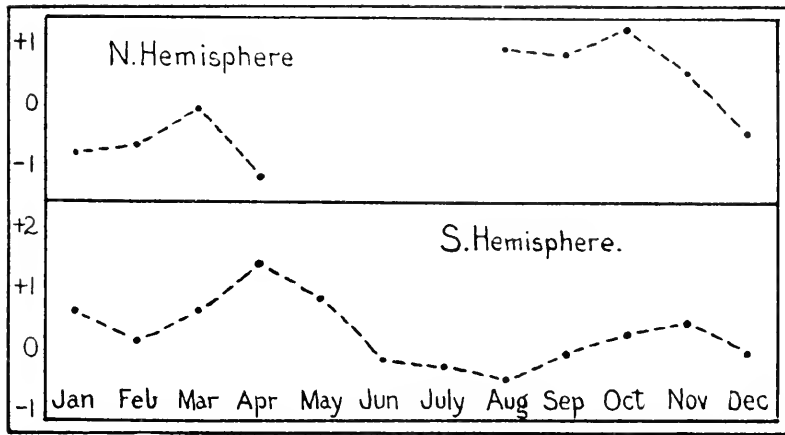

FIG. 13.—Lord Rayleigh's observation on Aurora green line. The gap in the northern hemisphere results is due to the impossibility of observations during these months in England because of twilight.

tions the following table was formed. The values given relate to a comparison of night sky observations with a standard source of light. For details the reader is referred to Lord Rayleigh's article. The scale units are such that in passing up one unit the intensity is multiplied by the anti-logarithm of 0.1 or 1.259; three steps on the scale are equivalent to a factor $(1.259)^3$ or approximately a doubled intensity. The presentation is different from that of Rayleigh so as to separate the stations of the northern and southern hemispheres. It indicates that the auroral line averages of greater intensity in the northern hemisphere while the parts of the spectrum on either side show no such difference.

Place, latitude longitude	No. obs.	Time range	Mean intensity		
			Red	Auroral green	Blue
Lerwick +60° 1° W	86	Sept. '25-Apr. '27	-2.8	+0.6	+5.7
England 52 1 E	81	Nov. '25-Oct. '26	-2.5	+0.5	+6.4
Kingston 44 77 W	6	Apr. '26-May '26	+0.1	+2.3	+9.5
Victoria 40 123 W	168	Sept. '25-Mar. '27	-3.2	+0.8	+6.3
Mt. Wilson 34 117 W	83	Sept. '25-Feb. '27	-2.0	+1.1	+6.8
Hawaii 19 150 W	116	Oct. '25-Nov. '26	-3.2	+0.3	+6.5
Kodaikanal 10 77 E	54	Oct. '25-Jan. '27	-2.8	-0.1	+6.2
Gilgil 0 37 E	5	Sept. '25	-2.7	+1.5	+6.6
Northern mean			2.5	+0.9	+6.7
Cape -34° 18' E	199	Nov. '25-Nov. '26	-2.7	+0.7	+7.1
Arequipa 16 71 W	31	Apr. '26-Nov. '26	-3.1	-0.3	+6.5
Canberra 35 149 E	149	Mar. '25-Oct. '26	-3.2	+0.4	+6.5
Christ Church 44 73 E	56	Feb. '26-Feb. '27	-1.0	+0.4	+7.0
Southern mean			-2.5	+0.3	+6.8

Before summarizing the results of this paper, the writer wishes to express his appreciation of the criticisms of Dr. Abbot, and the aid furnished by Miss Margaret Marsden and Mr. Hugh Freeman in the many computations, as well as his indebtedness to the workers in the field whose observations made possible this discussion.

SUMMARY

The amount of energy absorbed from the incoming solar radiation by the yellow ozone band has been used to measure the variations in the amount of atmospheric ozone during the years from 1921 to 1928. These observations have been made in both the northern and the southern hemispheres.

The resulting values show a distinct yearly march in both hemispheres. In the northern hemisphere the maxima of this march occur between April and May, the minima between August and November; in the southern hemisphere the maxima occur between August and September, the minima between April and May. In other words in both hemispheres the maxima occur in the spring, the minima in the autumn.

In the northern hemisphere a marked relationship exists between the ozone and the Wolfersun-spot numbers. The range in the monthly mean values for the ozone numbers is great and between 20×10^{-4} and 100×10^{-4} calories absorbed per cm^2 per minute from the incoming solar energy.

In the southern hemisphere no such marked relationship is noted, although one may be masked by the small range and corresponding inaccuracy in the values. The range is only from 20×10^4 to 50×10^4 calories.

It is suggested—and such a suggestion is strengthened by magnetic data—that we are dealing with two layers of ozone. The first is due to ultra-violet light coming from the sun and hence existing over all the stations. The second is assumed to be due to positively electrified particles emitted from definitely disturbed areas of the sun. This second effect reasonably shows a strong correlation with the Wolfer sun-spot numbers. Probably because these positive particles are deflected towards the earth's north pole this layer of ozone is found over the northern hemisphere stations only. At sun-spot minimum it is negligible so far as the present measurements indicate.

All the results of the present paper are based on monthly and yearly means. A consideration of the daily values would be another story. The plot published in the preliminary paper was based on daily values for only two years at Table Mountain. The short study then made of the daily values would indicate that what may be said of the connection between many magnetic values and solar disturbances may be said of ozone; that although with monthly and yearly averages, solar spottedness, for example, goes hand in hand with the amount of ozone, yet a day of many spots may pass with no increase of ozone and vice versa.





SMITHSONIAN MISCELLANEOUS COLLECTIONS
VOLUME 81, NUMBER 12

ARCHEOLOGICAL INVESTIGATIONS IN THE
TAOS VALLEY, NEW MEXICO, DURING 1920

(WITH 15 PLATES)

BY
J. A. JEANÇON



(PUBLICATION 3015)



CITY OF WASHINGTON
PUBLISHED BY THE SMITHSONIAN INSTITUTION
JUNE 11, 1929



SMITHSONIAN MISCELLANEOUS COLLECTIONS
VOLUME 81, NUMBER 12

ARCHEOLOGICAL INVESTIGATIONS IN THE
TAOS VALLEY, NEW MEXICO, DURING 1920

(WITH 15 PLATES)

BY
J. A. JEANÇON



(PUBLICATION 3015)

CITY OF WASHINGTON
PUBLISHED BY THE SMITHSONIAN INSTITUTION
JUNE 11, 1929

The Lord Baltimore Press
BALTIMORE, MD., U. S. A.

ARCHEOLOGICAL INVESTIGATIONS IN THE TAOS VALLEY, NEW MEXICO, DURING 1920

By J. A. JEANÇON

(WITH 15 PLATES)

INTRODUCTION

Although it had been known that there were prehistoric ruins in the Taos Valley in northern New Mexico, they had never been considered of sufficient importance to warrant excavating. The number of sites and the extent of their distribution had never been determined and it remained for the writer to make a survey of what appears to be a very important area of the pre-Spanish Southwest. As far as it has been possible to ascertain, the chronicles of the early Spanish explorers make no reference to any ruins in this region, although they write about the Pueblo of Taos. The first mention is found in the Castañeda report of the Coronado expedition¹ and in the *Relacion del Suceso*. In these records the village is called Braba, Valladolid and other names. It was visited by Alvarado in 1540 and by Barriónuevo in 1541. In the Castañeda report Taos is spoken of as a large and powerful village with a river flowing through the middle of it.² According to Bandelier, the present buildings are not the same as those of the 16th century Braba, but they still preserve the same appearance and occupy the same position relative to the river and valley as did the old village.³

Comparatively little ethnological work has been done at Taos and consequently the origin of the present people is still very much in doubt. The genesis myths of the Taos and of the Jicarilla Apaches, who occupy an adjacent portion of the State, have many points in common, and according to Mr. James Mooney⁴ the friendship between

¹ Winship, G. P., *The Coronado Expedition, 1540-1542*. 14th Ann. Rep. Bur. Amer. Ethnol., pp. 329-613.

² Winship, G. P., *loc. cit.*, p. 511.

³ Bandelier, A., *Final Report, Pt. II, Papers of the Archaeological Institute of America, American Series, IV*, University Press, Cambridge, 1892, p. 31.

⁴ Mooney, J., *The Jicarilla Genesis*. Amer. Anthropol. o. s. Vol. XI, No. 7, p. 200, Washington, 1898.

these peoples was so great that they formed an alliance and intermarried. Without doubt there is a strong strain of Jicarilla blood in the present population of Taos.

The Taos Valley is bordered on the east by one of the most picturesque parts of the Santa Fe range, by lofty timber-covered hills at whose feet nestles a plain of surpassing beauty. Criss-crossed by many creeks and streams, some of which attain almost the dignity of small rivers, this well-watered country must have presented to the prehistoric dwellers an environment which could not be duplicated in most of the region with which they were familiar. The climate now is most equable, and there is no reason to suppose that at the coming of the first Indians it was very different. The summers are hot enough to ripen corn and other grains, and the winters are only occasionally extremely cold, despite the statements of the early Spaniards to the contrary.¹

On the west the valley is bounded by the deep canyon of the Rio Grande, and the stream itself is practically impassable for many miles along its course. This no doubt presented a barrier to a large part of the country from the west, although access to the valley is easy from the northwest and the southeast.

The inhabitants of this region were fortunate in that the mountains furnished an abundance of timber for all purposes. The raw material was in close proximity to the villages so that it was not necessary for the people to carry their house beams and heavy logs for other purposes great distances. This was an item of considerable importance when it is remembered that the only means of transportation was man power.

The staple article of the people's food supply was corn, supplemented to some extent by wild seeds, roots, and fruit. Excellent wheat is now raised in the valley, but as it was unknown prior to the coming of the Spaniards it played no part in the life of the early Pueblos. They were not restricted to a vegetal diet, however, as game must have been quite abundant during the early occupation. Even at the present time deer and wild turkeys are fairly numerous in the Santa Fe range, and grouse, rabbits, and squirrels are plentiful. Many investigators have held that the turkey was not eaten by the Pueblo peoples, but kept for its feathers alone. Information given the writer suggests that some of the Rio Grande people used the bird for food as well as a source of feathers. During late prehistoric times the Indians even made forays into the plains area for buffalo

¹ Winship, G. P., *loc. cit.*, p. 511.

meat, and at the time when the Spaniards arrived they were found wearing clothing made from the hides of that animal and of deer.

Although the streams abounded in fish, there is some question whether they were used as food. Some of the Pueblos are very much averse to eating fish because of certain superstitious beliefs; others have no such feeling and eat them as freely as does the white man.

SITES IN THE TAOS VALLEY REGION

The general area covered under the name of Taos Valley is somewhat larger than the valley proper.

Ruins have been reported as far north as the state lines of New Mexico and Colorado including two large sites, one at a place called "The Lobo," the other at the Hondo crossing of the Rio Grande. Owing to lack of time the writer was not able to visit these sites.

Starting at a point four miles north of Fernandez de Taos, the American village three miles southwest of the Taos pueblo, and running east to the foothills (between two and one-half and three miles) are many series of tower remains; also long lines of broken ditches. In many places the mounds have been disturbed or almost wholly obliterated by agriculture. The "tower sites" are only tentatively so named, as their exact character could not be determined without excavation. The mounds are all low, none being over three feet in height, while most of them fail to attain even that elevation above the surrounding land. All are circular, slightly higher at the center than at the periphery, and are composed of river boulders. They vary from three to twenty feet in diameter. No traces of mortar or adobe plastering were observed on any of the stones. None of the mounds appear to bear any special relation, with regard to position, to any other; they are scattered at random all over the area. As far as the writer observed they were all on the north side of the remains of a large ditch which begins in the foothills close to the present Pueblo of Taos and runs out over the valley for more than four miles. At present there are not many potsherds scattered over the area. No information could be obtained from the Indians as to the meaning of these remains.

One and one-half miles east of Fernandez de Taos is a low mound from which project corners of a wall constructed of river boulders laid up in adobe. There is also a small burial mound. Although the whole area has been more or less cut up by farming activities, a series of small house remains is still in evidence extending for one-fourth of a mile west. All of these sites are covered with a great number of

potsherds and stone artifacts. Several years ago Mr. Randall, owner of the land upon which the sites occur, built a reservoir at the eastern end of his property, and he stated that a small pueblo ruin of eight or ten rooms was completely destroyed during the construction. A few skeletons and one perfect piece of pottery were found, but he did not know what had become of them.

East of the Randall Ranch, at the bottom of the foothills, were found a few sites covered with potsherds but showing no indications of walls. Small greatly eroded house sites occur along the bottom of the foothills for a distance of five miles to the south.

One-half mile north and a little to the west of the Randall place is a bench running from the foothills west to the town of Fernandez de Taos. At a point three-fourths of a mile northwest of Randall is a rather extensive site on the sides and top of the bench. There are two ash heaps, outcropping of walls, and what might prove upon excavation to be a burial mound. The whole area has been more or less washed out and beaten down and it is impossible to plat the outlines of the ruins in their present form. Some very handsome black and white sherds, many arrow heads, and one complete black cooking pot have been taken from this site, and there still remain some very good deeply grooved metates on the surface. Judging from the few wall remains discernible most of the buildings were built on the small tongues of land which jut out from the main bench. The whole site embraces a scant two acres of ground, but is one which in the writer's opinion would warrant excavating.

One-fourth mile from this site, a little above a Penitente churchyard, is the beginning of a series of natural mounds, on the top of most of which are nearly obliterated house remains. The sites are covered with quantities of potsherds, broken stone artifacts, and other minor antiquities. No walls are indicated, and in the present condition no outlines could be established. From this point north to the Pueblo of Taos are many other similar sites, almost all of them closer to the foothills. There were no wall indications at any of them.

About three miles west of Fernandez de Taos, the writer was told, is a fair sized ruin, but unfortunately time was not available to visit this site.

According to Bandelier there are several ruin sites in and about Ranchos de Taos, which is four miles below Fernandez de Taos. The writer was unable to obtain any information with regard to these ruins except the one at Llano, one and one-half miles east from the

Plaza at Ranchos. This is where the excavation was carried on, and the site will be described in the part of this paper devoted to the excavation.

South of the town of Llano, on the mesa, are many low mounds but no wall indications. Very little pottery is scattered over the surface. There are many circular depressions which at first appeared to be *kivas* but were afterwards found to be pits from which adobe was taken to build walls. Again it was impossible to determine accurately outlines of even the mounds, as these are so badly washed out and so nearly obliterated that no boundaries could be established.

BAGLEY RANCH RUIN

About nine miles from Fernandez de Taos and five miles from Llano, on the Bagley Ranch, are two of the most interesting sites in the whole Taos region. A little less than one-half mile from the ranch houses, on the sides of a tongue-shaped projection from the main mesa, is one which is extremely puzzling. Running along the base and the sides of the projection for more than one-half mile is an area covered with thousands of potsherds, broken metates, manos, and other minor antiquities. In some places the sherd-strewn areas extend almost to the top of the hill. There are three distinct benches, each one having a definite platform running back to the next rise. These platforms are covered with what appears to be disintegrated adobe walls and ashes, mixed with a vast amount of pottery and stone artifacts. At no place in the whole area are even the faintest traces of walls apparent. The writer dug in many places where a line of stones seemed to indicate walls, but none was found. The present covering of the ground is certainly not the native soil, as its appearance is very different from that of the soil a few feet away from the borders of the ruin. Adobe and ashes are in evidence everywhere on the site, while the native soil is covered with a sandy, small-pebbled layer similar to that on the bed of a stream. If once a pueblo stood here, it must have been a very large one, although now completely obliterated. If not, what was the source of all the pottery and other artifacts? It is very difficult to conceive that even an adobe village could be so completely wiped out. The whole area is much too great in extent to suppose that it is a refuse or burial mound. No fragments of human bones were found on the surface, as would be expected had there been burials in a refuse heap showing so many signs of erosion.

POT CREEK RUIN

The ruin to which this name has been given is one of the largest adobe-walled remains that the writer has seen in the Southwest. It is situated on the north bank of Pot Creek not more than one-fourth mile from the Bagley ranch houses and about the same distance from the main road running through the ranch. The mound covers many acres in area, rivalling in size that of Yucca House in the Montezuma Valley, southwestern Colorado. The mounds are very massive and attain a height of from 15 to 20 feet, suggesting that the village was two or more stories high. At no place are the mounds less than 15 feet wide, and in many places they are much wider.

The general ground plan of the buildings as indicated by mounds is a capital letter E with the three arms equal in length. In the middle of the site is an immense circular mound which is bisected by the central arm of the E. At the southwestern corner of the group is a compact mass of buildings almost surrounding a kiva. The other kivas are not embraced in the mass of rooms but are out in the open plaza. In many places there are indications of walls on the tops of the mounds. The whole surface of the ground is covered with innumerable potsherds and broken stone artifacts. It is possible that excavation would reveal many of the lower or ground floor rooms with ceilings intact.

Not over 500 feet east of this large mound is a smaller one. This suggests a compact mass of rooms and does not appear to have been a kiva.

Scattered over an area almost a mile square are potsherds, arrow heads and broken stone materials of all kinds. A lot of this has washed down from the large ruin, although possibly there were other small houses that have disappeared.

HOT SPRINGS

At no great distance from a hot spring called the John Dunn, near the Hondo, is a ruin which is described as one of the largest in the Taos region. The writer was not able to visit the site, however. There are many other hot springs in the valley to which the present Indians attribute medicinal properties, but the Dunne spring is the only one with which archeological remains are associated.

CEREMONIAL CAVE

About seven and one-half miles north of Fernandez de Taos, at the foot of a mountain called "Water Fall" or "Cascade," is a cave to which tradition ascribes ceremonial usage. Whether it was actually used for ceremonies cannot be verified at this time, as the Indians at Taos refuse even to mention it. Its situation at the foot of the mountain would be ideal for ceremonial purposes. The opening is heavily screened with trees and shrubs and would be difficult for anyone, not knowing its location, to find. The cave is not over 75 feet in depth and is about 30 feet high at the entrance. The ceiling attains a greater height inside, however. At about the middle of the back wall a trail leads to a formation which is suggestive of a seat and pulpit. The formation is between 35 and 40 feet above the floor. The trail is

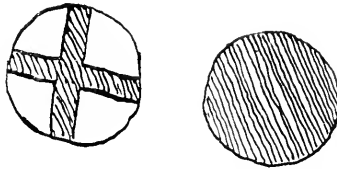

FIG. 1.—Circles painted on the roof of the ceremonial cave.

very smooth and highly polished, showing that many feet have passed over it. In front of and above the pulpit are two paintings, crudely done in white paint, possibly intended for sun symbols. Both are circular, one being filled in almost completely, while the other has a cross marked in the circle (fig. 1).

Falling from the rock, in front of the cave, is a thin trickle of water which forms a lovely little pool. The pebbly bottom of the latter was searched for offerings but none was found.

Americans who have lived at Fernandez de Taos for a long time state that the cave was actually used in comparatively recent years in connection with the August dances and other ceremonies, but no information as to their nature could be obtained. One informant said that the use of the cave was discontinued because the Mexican village of Seco was built too near to it.

THE EXCAVATIONS AT LLANO

Beginning at a point a half-mile south of the plaza at Ranchos de Taos and extending a mile east from there is the village of Llano. The ruin excavated is just beyond the last house at the extreme

eastern end of the village. The owner of the property, Mr. J. D. Martinez, stated that when his father built his corrals and stables, a burial mound was removed to make room for one of the corrals, and that many skeletons were exhumed and reburied a short distance away.

SMALL MOUND

At a point about 100 feet from the corrals is located the small mound (pl. 1, *A*) which was the first to be excavated by the writer. There were very few surface indications of a building, and the walls, after excavation, stood only a little over two feet in height. The ruin contained only seven rooms and had no kiva in connection with it. (Pl. 1, *B*.) Most of the rooms are unusually large. In room 7 was found a quantity of charred and decayed roof material of the usual type. The walls were exceedingly well mixed and laid up, and the thickness of the plaster indicated long occupancy. The following description of the building of a wall as given in the Castañeda Report of the Coronado Expedition¹ applies to the construction of the walls at Llano:

Tiguex. The women being engaged in making the mixture and the walls. . . . They had no lime but made a mixture of ashes, coals, and dirt, which is almost as good as mortar. . . . They gather a great pile of twigs of thyme and sedge grass and set it afire, and when it is half coals and ashes they throw a quantity of dirt and water on it and mix it all together. They make round balls of this which they use instead of stones after they are dry, fixing them with the same mixture which comes to be like a stiff clay.

In the Taos mixture, small pebbles are added. After seeing walls built in the modern pueblos the writer observed that the present method differs from that described by Castañeda with respect to placing the balls of adobe after they were dry. In cases observed at Santa Clara and other Rio Grande pueblos the balls were put in position before they had dried.²

Another difference noted at Taos was that the checking of the walls, after they had dried, occurred in irregular masses. In the Chama ruins, and in modern walls, the checking was in more or less regular rectangular masses of different sizes, the cracks running horizontally and perpendicularly in the walls. At Taos the cracks in the masses were of all shapes and sizes and did not occur with any

¹ Winship, Castañeda Report of the Coronado Expedition. 14th Ann. Rep. Bur. Amer. Ethnol., p. 520.

² Jeançon, J. A. Excavations in the Chama Valley, New Mexico, Bull. 81, Bur. Amer. Ethnol., p. 11, Washington, 1923.

degree of regularity. Even after the many years that the walls have been buried, the mixture of which they are made becomes very hard when exposed to the air for a few days. The average thickness of walls in the ruins was twelve inches. It is impossible at this time even to approximate the height.

LARGE MOUND

The large mound (pl. 2, *A*), located about 300 feet approximately east of the smaller one, gave the appearance before excavation of having been a two- or possibly three-storied building. This was found, however, not to be the case, the height of the mound being due to the fact that the ruin excavated had been a secondary structure built on the débris of an earlier one. No attempt was made to establish the outlines of the first occupation, except at five or six places where they were accidentally encountered. The whole mound was covered with a thin deposit of very black loam containing many quartzite pebbles, and supporting a very heavy growth of sage-brush which had to be cleared before the work of excavating could be commenced. The mound was entered from the south central end; the dirt was thrown out by hand and afterwards moved to the base of the mound by a scraper drawn by two horses. The whole surface of the mound was scraped until the walls appeared, at a depth varying from six to eighteen inches. Very little wind-blown sand from the mesas or valleys appeared in the dirt, and most of the débris removed was from decayed wall material. Even near the floors there was almost no wind-blown sand, indicating that the ruin did not stand empty long before it collapsed. The noticeable absence in many places of roof material, either charred or semi-decayed, gave rise to a supposition that possibly the second building was never completed and had not been roofed over. In some places, however, there was a lot of charred material and it is possible that where such was not found, the roof had been completely destroyed by fire and the remaining ashes had become so thoroughly mixed with deteriorated wall material that they could not be distinguished. In some rooms there were the charred remains of upright poles which indicated, despite the absence of roof material in any form, that the room had actually been finished and covered over. These upright poles were located in the center of the room, the only exception occurring in room 6 where the post was in the south-east corner. In the kiva were the remains of two upright cedar posts, and two openings in the floor where others had stood. The existence of the latter was shown in the adobe lining of the holes where decayed

bits of cedar adhered to the plaster. This use of a central upright post for a ceiling support is, as far as the writer knows, the only example thus far encountered on the Jemez Plateau and adjacent country.

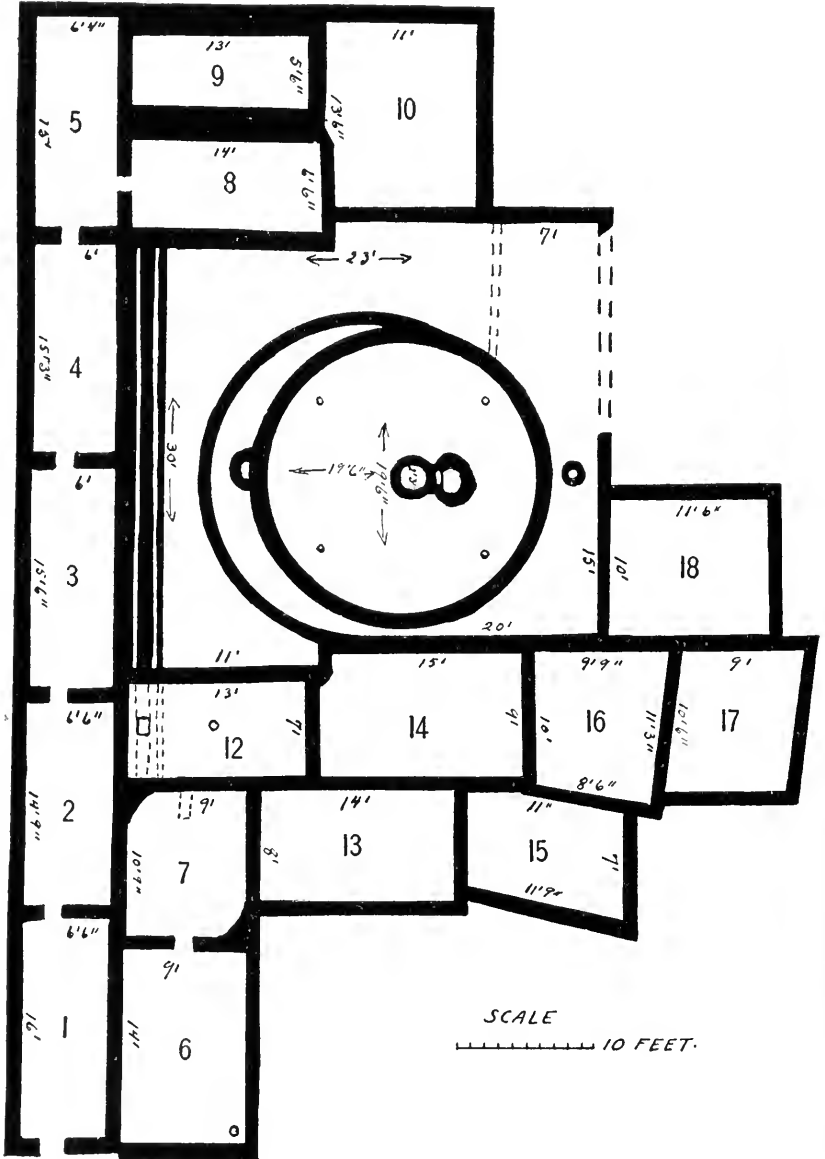

FIG. 2.—Map of large ruin at Llano.

Judging from present appearances there were no openings in the outside lower walls, not even ventilators, such as have been observed in other places on the Jemez Plateau. It is more than probable that the lower outside rooms were supplied with air and light entirely through hatches in the roof.

As far as could be determined by the excavation, the old walls did not serve as foundations for the secondary ones. There is practically no difference in the width of the walls of the buildings of the first and second occupations. All of them, old and new, are very irregular, and average from eight to twelve inches in thickness. Where the first walls were established, they ran under and on different lines from the newer ones. This was especially evident on the west side of the kiva plaza, where the original wall extended across the whole west side of the plaza and new ones were built on either side of the old one, the later ones rising from the present ground level while the older one extended for some distance below it. When these walls were

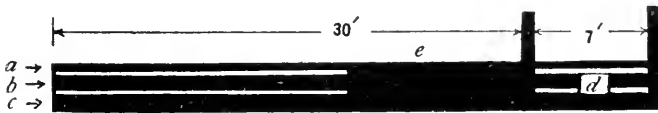

FIG. 3.—*a*, new wall; *b*, old wall; *c*, new wall; *d*, cache between walls; *e*, showing how spaces between walls were filled to make banquette.

completely excavated and swept it was found that the eastern one formed a banquette which had been plastered over the top and outer side (pl. 3, *A*). There was an open space between it and the central wall, which was built against the western one. The newer walls were not as well mixed and firm as the central one, which extended south below the room next to the plaza (fig. 3).

With the exception of room 7 all of the corners were square. In room 7 the southeast and northwest corners had been rounded off by the building of short walls across the corners. The northwest corner appeared to have been used as a fireplace, as the wall was smoke-stained from the floor to the top of the standing wall. There was no evidence of a chimney or even a hood such as the Zuñi and Hopi use. The southeast corner was not filled in solid, and the curving front wall, with the rectangular corner behind it, formed a sort of cupboard which was divided into an upper and lower shelf by a huge, flat, river boulder. The cupboard opening was circular and about one foot above the floor. There were no objects of any kind inside it, nor any smoke stains to suggest its use as a fireplace.

The walls of the large mound were built in the same manner as in the smaller mound, the only difference being their marked variation in thickness.

ROOMS

The rooms varied widely in size (pl. 2, *B*, *C*). No complete outlines of the first occupation were determined, but all of the second occupation rooms were uncovered and their dimensions are given in the following list:

No. 1.—16 ft. x 6 ft. 6 ins.	No. 10.—13 ft. 6 ins. x 11 ft.
2.—14 ft. 9 ins. x 6 ft. 6 ins.	12.—13 ft. x 7 ft.
3.—15 ft. 6 ins. x 6 ft.	13.—14 ft. x 8 ft.
4.—15 ft. 3 ins. x 6 ft.	14.—15 ft. x 9 ft.
5.—15 ft. x 6 ft. 4 ins.	15.—11 ft. x 7 ft. x 11 ft. 9 ins.
6.—9 ft. x 14 ft.	16.—10 ft. x 9 ft. 9 ins. x 11 ft. 3 ins. x 8 ft. 6 ins.
7.—10 ft. 9 ins. x 9 ft.	17.—10 ft. 6 ins. x 9 ft.
8.—14 ft. x 6 ft. 6 ins.	18.—11 ft. 6 ins. x 10 ft.
9.—13 ft. x 5 ft. 6 ins.	

The kiva plaza was roughly 30 ft. square.

The following measurements made in 1864 by Mr. John Ward at the present pueblo of Taos are interesting as showing the increase in size of the rooms more recently constructed:

Several rooms on the ground floor were measured by Mr. Ward and found to be in feet: 14 x 18; 20 x 22; 24 x 27; with a high ceiling averaging 7 to 8 feet.

In the second story they measured in feet: 14 x 23; 12 x 20; and 15 x 20; with a height of ceiling varying from 7 to 7½ feet.

The rooms in the third, fourth and fifth stories were found to diminish in size with each story.¹

It would be extremely interesting to have an opportunity of excavating and measuring rooms in the ruin of old Taos Pueblo, which lies a short distance east of the present village. Perhaps the gradual growth in size of the rooms over the period between the Llano houses and the modern Pueblo, could be obtained in these rooms. However, it would be next to impossible to obtain permission to excavate in the Old Pueblo as the Indians will not even permit the mounds to be measured, much less excavated.

STORAGE ROOM

One of the most interesting rooms in the group was one which had every appearance of having been used for storage purposes. It is situated just south of the kiva, and is called room 12 (pl. 3, *B*). A raised bench occupied almost three-fourths of the floor space. In

¹ Morgan, L. H., *Houses and House Life of the American Aborigines*. Contributions to North American Ethnology, Vol. 4, p. 145, Washington, 1881.

the south and east ends were buried seven pots, four on the south side and three on the east side (fig. 4).

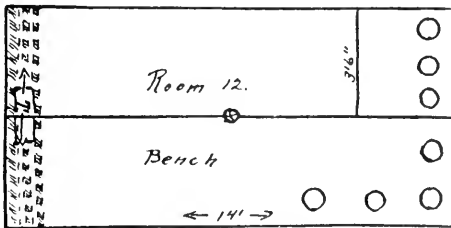

FIG. 4.—Ground plan of room 12, showing arrangement of storage jars below the bench level.

The tops of these pots came to within two or three inches of the floor; they may have been used for storing meal. At the western end was a sort of cupboard running under the wall, with an entrance about one foot square and one foot deep projecting into the room. In

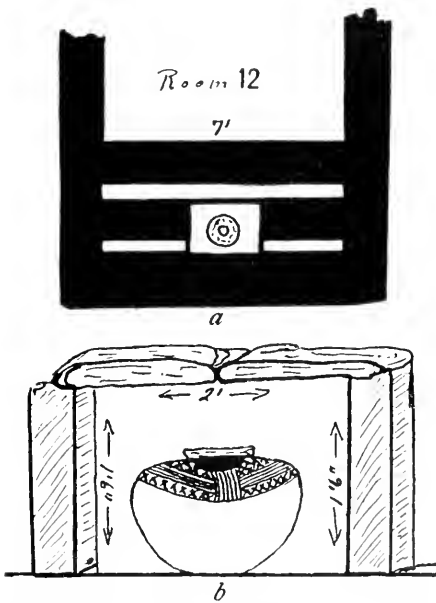

FIG. 5.—a, showing position of cupboard; b, cupboard with jar in place.

this cupboard was found a very handsome black and white heart-shaped jar (pl. 13, d), accompanied by a lid of micaceous schist and two small manos with flattened ends; also a fine buckhorn chisel, a large piece of buckhorn, a good bone awl, and several black and white sherds. A sketch of the cupboard is given in figure 5. Standing erect

in about the center of the room were the remains of a post approximately ten inches in diameter which was probably intended to support the roof.

KITCHEN

Another room in the eastern part of the group was probably used as a kitchen or cooking room. There were several poorly defined fireplaces in the floor, and a shallow trench ran along the entire south-

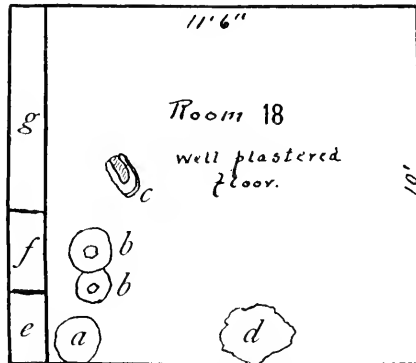

FIG. 6.—*a*, firepit containing ashes; *b*, pot rest with flat stone in bottom; *c*, metate; *d*, ash pile; *e*, *f*, storage boxes, 10 inches deep; *g*, shallow trench well plastered.

ern wall. This room was in such bad condition that it was almost impossible to get a definite idea of its original equipment of pots, etc. The few indications were enough, however, to establish its character (fig. 6).

KIVA

One of the most remarkable features of the ruin is the location of the kiva. Instead of being in an open plaza, detached from the main ruin, it is located almost in the center of a compact mass of rooms and is surrounded on all sides, thus completely cutting it off from the outside. The northeastern corner is enclosed by a wall which was in such bad condition that it was impossible to establish whether there had been rooms there or only an enclosing wall. The mound at this point is badly washed out, and although a thorough exploration was made, nothing definite could be established.

When the plaza, in which the kiva is located, was first cleaned off, it appeared that the area was used for dance purposes only. There

was a good hard stamped floor, with only a large river boulder in about the center to break it. After the floor was cleared, the writer decided to raise the boulder to see if there might be something below it, as it seemed out of place in the plaza. When the stone was raised a section of curved wall was disclosed, which led to the excavation of the kiva.

The one prominent problem of the kiva is the double wall on the west side (pl. 4). It was impossible from the excavation to determine why the two walls were used. At times it seemed to suggest two occupations; again this impression was destroyed by other indications which seemed to point to a single occupation. Both walls are alike in material and construction. The outside wall runs around about one half of the inner one. Starting at a point almost due north it runs around the western side and terminates almost due south. There is no outer wall on the eastern side. The ventilators are on the inner walls only, one east and one west (pl. 5, *A*). Both of these are barrel-shaped. The fill between the walls was composed of soft dirt, débris of roof material, river boulders, bits of pottery, and a few artifacts in bad condition, although a very handsome pipe was found in the trash. A curious feature occurring only in the kiva is the horizontal lines running around the inside of the walls. At first it would appear that these walls were laid up in regular courses, but an examination of shattered fragments shows that the wall was built in the same manner as all the others in the group, and that the horizontal lines do not indicate the use of moulds as would be suggested by their appearance. The walls still rise seven feet in height from the floor. They are about nine inches thick, and are very well made and hard.

The floor was formed of packed adobe, probably mixed with blood and ash as was the custom formerly. Three feet above the floor, in the débris which filled the chamber, was a deposit of two and one-half feet of drift sand, and between the sand and the floor were the remains of the roof beams, but these were in such bad condition that nothing could be learned of the roof construction.

There were two erect cedar posts at points shown on the map of the kiva, and in related positions were two holes in the floor, where additional supports had stood. These four uprights served to support the roof and show an interesting method of roof construction, one which was continued in later structures in the region.

The Castañeda Report refers to the supporting pillars as follows:

The young men live in the estufas, which are in the yards of the village. They are underground, square or round, with pine pillars. Some were seen with twelve pillars and with four in the center as large as two men could stretch around. They usually had three or four pillars.¹

And again:

At this village they saw the largest and finest hot rooms or estufas that there were in the entire country, for they had a dozen pillars, each one of which was twice as large around as one could reach and twice as tall as a man.²

The feature has been found in other prehistoric ruins, however, for to quote from Judd:

fragments of curved adobe walls remained on the eastern side and these, if continued, would have circled a central fireplace about which four large pillars [posts?] formerly stood. . . . kivas with roofs supported by uprights were noted, also, during preceding expeditions.³

The fallen roof masses on the floor were not in condition to give further information concerning the construction. Scattered all through the débris were fragments of human and animal bones, as well as a few pottery sherds. There were no indications of burials in the kiva.

The fireplace (pl. 5, *B*), in about the center of the floor, was unusually fine. When first found it was full to the top with wood ashes.

Its inside diameter was two feet three inches. To the east of the fireplace stood a flat river boulder about one foot wide and one and one-half feet high; next to this (east) was a small pit, oval in form and measuring one foot nine inches by one foot six inches, with a depth of nine inches. The use of this pit is not known. Four feet east of this, in the wall, was a doorway measuring two feet in height and one foot in width from which a passage, roofed over with poles four inches in diameter, led through the wall for a distance of four feet. Here it ended abruptly against another wall. The east ventilator was directly above this, but was not connected with the passage. The only entrance to it appeared to be from the kiva.

No ceremonial objects of any kind were found in the kiva proper.

¹ Winship, Translation of the Castañeda Report. 14th Ann. Rep. Bur. Amer. Ethnol., page 518.

² Idem, page 511.

³ Judd, Neil M., Archeological Investigations at Paragonah, Utah. Smithsonian Misc. Coll., Vol. 70, No. 3, p. 15.

MINOR ANTIQUITIES

STONE ARTIFACTS

Most of the stone artifacts were of the usual character. Manos and metates were of several forms, the unusual depth of the latter indicating a long period of use (pl. 6, *b*). Maul heads of the usual type presented no new features (pl. 7, *d*). No axe heads were found. Several small cylindrical stones of unknown use were found. While they were not of any definite character, they showed plainly the marks of having been used for some purpose, probably polishing (pl. 7, *b*).

Pot lids and other articles of micaceous schist were rather plentiful (pl. 6). The writer has never before heard of the use of this material for stone artifacts. Several larger slabs of it had evidently been used as baking stones, as one surface was smoked and the other covered with a heavy deposit of grease.

Eccentric forms.—This group includes a troughlike stone which was possibly used for smoothing arrow shafts (pl. 7, *a*). It measured two inches long by one inch wide, the trough being $\frac{5}{16}$ inch deep and $\frac{11}{16}$ inch wide at the top. It showed marks of rubbing in the trough and on the top, bottom, and sides.

Another was a triangular shaped stone, with indentation, which also was probably an arrow or javelin shaft smoother (pl. 7, *c*). It was found with a fine red pipe, a banded stone, and a fossil (*Turwillana*).

Chipped implements.—Rather ordinary forms and workmanship were presented in the chipped implements (pls. 8 and 9), the only exception being the object shown in the upper left corner of plate 8, an unusual knife blade of especially fine chalcedony. The cutting edge is well chipped, and the top forms an excellent handle.

The material used for chipped and crude cutting edges, arrow heads, javelin heads, drill points, etc., included chalcedony, agatized wood, slate, moss agate, obsidian, and a sort of hard shale. One especially fine javelin head measured $2\frac{1}{4}$ inches across the broadest part by $3\frac{1}{2}$ inches in length (pl. 8, lower left-hand figure).

BONE ARTIFACTS

Among the bone artifacts, also, only a few examples were out of the ordinary. Elk or deer horn was represented by flakers and chisels (pl. 10, *b*). Three pieces of rib bones (pl. 10, *c*) were interesting; the longest of these is 11 inches, the shortest $2\frac{3}{4}$ inches in length, although the latter was probably longer originally, as one end of it is broken. All three of these specimens are notched, two with

teeth or notches on both sides and one with the teeth only on one side. Their use is unknown, although they suggest the notched stick which is used by many of the southwestern Indians to accentuate the rhythm of a song. The notched stick is placed with one end resting on a drum head or the bottom of an inverted basket, and another stick is rubbed across the notches; the noise thus produced falling upon the regular beat of the measure serves to accentuate the rhythm.

Only a few of the best bone articles are shown in the illustrations. These artifacts were in great abundance.

PIPES

Although only one whole pipe was found, fragments from several others are sufficient to indicate that the ordinary form was that of the tubular pipe or cloudblower. All were made of pottery clay. The best specimen (pl. 11, *a*), found between the double walls of the kiva and about two feet from the floor, is $2\frac{1}{2}$ inches long, $\frac{5}{8}$ inch in diameter at the large end and $\frac{3}{8}$ inch at the mouth piece; it is red in color and was decorated by a series of striations beginning $\frac{1}{2}$ inch from the mouth and running to the edge of the bowl. The clay of which it was made is so hard that it was thought at first to be made of stone.

The fragment shown on plate 11, *b*, is from a cloudblower made of the black cooking-pot paste. It is 2 inches long, $\frac{5}{8}$ inch wide at the top, and $\frac{6}{16}$ inch at the mouth, and is decorated with an incised snake design.

The indented fragment (pl. 11, *c*) has a grayish black soft paste, and measures $2\frac{3}{16}$ inches long, $\frac{3}{4}$ inch wide at the top of the fragment, and $\frac{3}{8}$ inch at the mouth.

Plate 11, *d*, shows a fragment from a pipe made of soft black paste, with line and dot incised decoration. It is of the cloudblower shape, and is $1\frac{1}{4}$ inches long and $\frac{5}{8}$ inch in greatest diameter.

The last fragment shown (pl. 11, *e*) has a gray paste and is decorated with 7 incised horizontal lines which do not show in the illustration. It measured $\frac{3}{4}$ inch in greatest diameter and $1\frac{3}{4}$ inches in length.

FETISH OBJECTS

The prehistoric Indians in the Southwest had a tendency to collect curious fossils, concretions, brightly colored stones, and other natural objects, and it seems quite probable that they were used as fetishes or medicine stones. The people at Llano were no exceptions to the rule, and a number of fossils and odd-shaped stones suggesting such usage were found. Among the fossils are two which are interesting because

they bear the same name, in the Taos dialect, as a clan which formerly existed at Taos but is now extinct, the Turwillana clan.¹ The fossils are of the cylindrical variety marked with rings. It is possible that their presence in the ruin may indicate that such a clan had lived there.

Another of these objects was a handsomely polished banded piece of ribbon agate (pl. 11, *h*) probably used as a medicine stone, found in room 8. The colors are white, cream, gray, light brown, and black in irregular bands. It measures $2\frac{1}{4}$ inches in length and $\frac{1}{2}$ inch in greatest diameter.

INDICATIONS OF BASKETRY

While no baskets or fragments of basketry were found, many potsherds with basket impressions on them (pl. 11, *i*) were picked up during the summer, and these may be considered as a good indication that the people did have baskets. Judging from the impressions on the pottery fragments, the sticks of all the baskets used in the village were about the same size. In one case only does it appear that a larger bundle or rod had been used. On one fragment of pottery, there are what appear to be textile impressions or smears; these can be seen only under a magnifying glass; how they occurred it is at present impossible to tell.

The presence of basket impressions on pottery, which are more common in this region than at any other place where the writer has worked, has been explained by Dr. A. V. Kidder in a discussion of similar markings found on vessels from the Jemez Plateau. Dr. Kidder writes:

An extraordinarily high percentage of basket marked sherds is found at the small house ruins. Such sherds occur, it is true, in most other Black-and-White groups, but they are of greatest rarity. Here, however, they can be picked up at almost any site. The impressions show that bowls and lower parts of ollas were often formed in baskets. In these cases the clay was apparently coated on the inside of the basket and pressed down hard enough to render the marks of the weave sharp and clear. The upper parts of the ollas were probably constructed by the regular coiling method. Some bowls, however, seem to have been molded or cast entire in basket forms, as the impression of the weave runs to the rim. The baskets themselves were of the coiled variety, tray or bowl shaped; the coils measure 4 to 5 mm. in breadth and there are about six sticks to the centimeter.²

¹ Handbook of the American Indians, Bull. 30, Bur. Amer. Ethnol., Pt. 2, p. 690.

² Kidder, A. V., Pottery of the Pajarito Plateau and some of the Adjacent Regions of New Mexico. Mem. Amer. Anthropol. Assoc., Vol. II, pt. 6, p. 414.

POTTERY

The pottery from Llano may be classed in three groups, the black cooking vessels; the black on white bowls, ollas, and jars; and the black on red pottery.

There were no examples of the indented or corrugated pottery in the ruin at Llano, but on the surface there was an abundance of such sherds. The large jars from the ruin appear to have been made in the usual coil technique but the coils were obliterated, by wiping the surface with a corncob or some other object with a rough surface, as work on the vessel progressed. After the completion of the pot, decorations were incised around its upper part. On many the lower portions show traces of the coils which were not completely obliterated by the rubbing process.

The following quotation from Kidder gives a good impression of the general appearance of the ware:

The latest black ware so far identified is the striated; there is, of course, no sign of the coil, but the surface is scored with a series of fine and more or less parallel scratchings, criss-crossing over each other in all directions. These were produced evidently, by some finishing tool used while the clay was moist. Experiment shows that a corncob with the kernels removed most nearly duplicates these marks.¹

Although the coiling is still slightly apparent in places on the Llano vessels, the striations described by Kidder are also in evidence. As a matter of fact, the Llano forms seem to represent a combination of Kidder's black corrugated and striated forms.

The incised designs are of the simplest character consisting usually of horizontal lines, although on one pot (pl. 12, *a*) there has been an attempt to establish three zones of decoration, the middle zone different from the upper and lower ones. The short dashes of the middle zone appear to have been made with a long thumb nail.

The writer encountered a somewhat similar ware in an investigation of La Jara Cañon, New Mexico, situated at the southern end of the Jicarilla Apache reservation. However, there was considerable difference in the pastes of the two areas, that of Llano being much softer and without a great amount of temper, while that of La Jara Cañon was composed of materials that burned almost to a vitrified brick. The vessel marked *C* on plate 12 shows unobliterated coils on the neck beginning just above the shoulder. Below the coils are incised lines. The bottom has the usual obscured coils observed on practically all of the pots.

¹ Kidder, A. V., Notes on the Pottery of Pecos. Amer. Anthropol. n. s., Vol. 19, p. 339, Lancaster, 1917.

As will be seen from the illustrations the incisions on the various vessels were not all made with the same sort of an implement. Most of them are sharply cut, but in those shown on plate 12, *d, e, f*, a blunt broad implement was used.

All of the pots are more or less asymmetric, but so slight is the irregularity that it is rather pleasing than otherwise. The balance in form is also uneven; taking the vessel as a whole and noting the line of greatest diameter, we find that there is no set rule as to where it occurred in the vessel. Sometimes the greater part of the jar was above this line, and sometimes below it.

Plate 13, *b*, illustrates a water jar of beautiful form, grayish in color and showing only partially obscured coils in places. The paste of this vessel is much finer than that of the ordinary cooking or storage pot; it seems to fall between the black ware and the black on white decorated ware.

All of the forms are strikingly reminiscent of the earlier Apache forms, especially of the Apache water bottle.

Basket markings on the bottom of pottery vessels are so common as to give the impression that a large majority of the pots were started in the manner described by Dr. Kidder on page 19. Some of the crude black pots have excellent prints all over the bottom and often rising as much as two inches up the sides. In plate 13, *c*, a black on white piece, there may still be seen basket imprints just below the shoulder where the white slip has more or less disappeared. The prints on the bottom of this vessel are very plain. A number of interesting sherds are shown in plate 11, *i*.

Basket impressions have been recorded from many places. Dr. Kidder¹ speaks of them in the San Juan drainage as follows:

“Pottery vessels, on the other hand, were scarce and crude, and usually bore on their bottoms the imprint of the baskets in which they had been formed.”

Black on white ware.—Black on white ware was well represented at Llano and appears to be related to the Rio Grande black on white ware as well as to the southwestern Colorado wares. In the Taos region fully one-third of the sherds are very good white with excellent jet black decorations. One feature is very noticeable, namely, that the crackling or crazing of the white slip appears to have been done more by exposure to the elements than in the original baking of the ware.

¹ Prehistoric cultures of the San Juan drainage. Proc. 10th Internat. Cong. Americanists, p. 108. 1917.

On the sherds that are buried the white slip is not crazed, but where the sherds have been lying exposed on the ground, there appears to have been a deterioration and crazing has taken place in varying degree, depending probably on the length of time they have been exposed and on weather conditions.

No hard and fast rule seems to have been followed as to the zones of decoration. In the bowls the percentage of decoration on the exterior is practically the same as on the interior. This of course applies only to bowls; ollas are decorated only on the outside.

As far as could be determined from the rim fragments found, the rims were so thin that they could not be decorated. No dots, ticks, or zigzag lines were found on the rims; in many cases the exterior as well as the interior decorations extended to the rim. No out-turned rims were found.

Decorations of banded lines occur, but are not common. The usual arrangement of such designs is a broad band at the top and bottom.



FIG. 7.—Animal figure on pottery.

with three or four thinner lines between these. The paste of the black on white ware is usually hard and homogeneous. Little variation in color can be noted in the cross section of a sherd.

The following quotation from Dr. Kidder's notes on the black on white ware of Pecos is interesting for comparison:

Slip-color ranges from light to dark gray, very rarely purely white [good white about 33% per cent at Taos]; it is applied to the interior of the bowls in a relatively heavy coat; to the exterior usually as a thin wash, occasionally as a heavy coat, rarely omitted altogether. Slip often cracked, particularly when it is applied heavily on the exterior. Finish of the interior even but never glossy; of exterior much rougher. No specimen with corrugated or basket marked exterior observed. [Note difference in Taos basket marks.]

Ornamentation-pigment dull black, usually of slaty cast. Zones, interior of bowls exceedingly rare. [Note difference from Taos pottery.] Straight bowl rims usually plain, occasionally dotted; out-curved rims bear ticks or more commonly zigzag lines. The main ornament appears to have been in the form of a broad band encircling the interior of the bowl and leaving small blank spaces in the bottom. Bands framed above and below by single heavy lines "X" Plate VII, Figure 7; less commonly by one heavy line with a series

of lighter ones between it and the band ("N" Plate VII, Figure 8). Line breakers in framers rare. "All over" decorations apparently fairly common, particularly on small bowls. Design preponderatingly geometric and rectilinear, life and curvilinear forms practically absent. [At Taos, a few sherds with curves, one life figure.] Elements of design most commonly observed; coarse hatching and cross-hatching; plain and dotted checker-board series of plain triangular figures; dotted lines and edges; large stepped figures in opposed pairs. Brushwork normally crude and uncertain, lines coarse.

Paste composition—Paste, fine, very hard and homogeneous; color ranges from pure white (rare) through light gray to dark gray (rare). Many sherds of even color from surface to surface, but in the majority the center is darker than the edges. Gross tempering (sand or pounded rock) apparently absent.¹

No true biscuit ware was found, unless some of the vessels might be considered to come under the classification given by Nelson in the following quotation:

There seem to be two kinds of biscuit ware, the most common being of a dull white or light gray color, the other of a yellowish tone. This latter has its probable forerunner in a more or less distinguishable variety of black on white ware, but the prototype of the former has not been found so far.²

Although biscuit ware is found in the region, the writer is inclined to believe that the Llano black on white ware does not represent a form of biscuit ware, but a true black on white.

To quote again from Nelson:

The pottery actually figuring in the table is a local variety of the black on white ceramic identified with the general sub-stratum of Southwestern Pueblo culture. Bandelier generally associated the ware with "small houses," *i. e.*, with what might be called a pre-pueblo stage of sedentary life; but the data now at hand enable us to state that the large quadrangular form of village typical of the Rio Grande valley in later times was fully developed before the black on white pottery went out of style. The ware as a whole is perhaps not quite so fine [not the case at Taos] as that of Mesa Verde and Chaco regions on the one hand or of the Upper Gila and Mimbres regions on the other. It is particularly lacking in variety of form. In decorative symbolism it approaches the abandoned northwestern Pueblo area rather more than the southwestern, and is little, if at all inferior to it.³

As far as could be determined there were no pre-pueblo houses in the Taos region. The small ruins were apparently of the same period as the larger ones. No differences were noted between the pottery and other artifacts from the large and small sites.

¹ Kidder, A. V., *loc. cit.*, pp. 327-328.

² Nelson, N. C., *Chronology of the Taos Ruins, New Mexico*. Amer. Anthropol. n. s., Vol. 18, p. 169, Lancaster, 1916.

³ *Idem*, page 171.

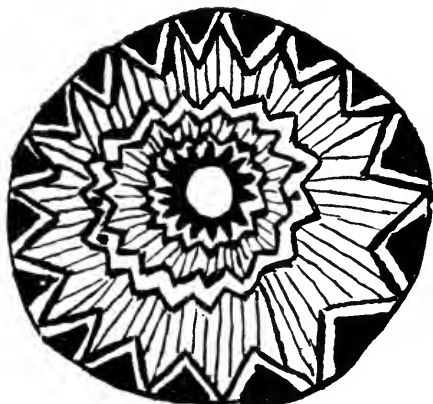

FIG. 8.—Design on black on white ware.

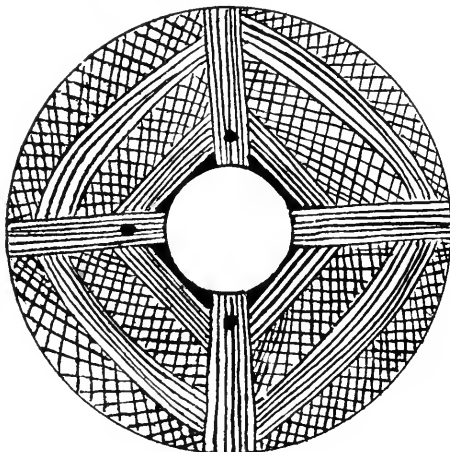

FIG. 9.—Design on black on white ware.

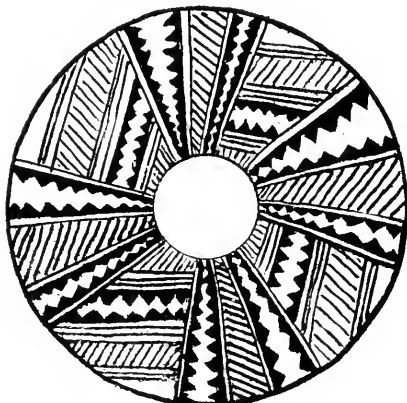

FIG. 10.—Design on black on white ware.

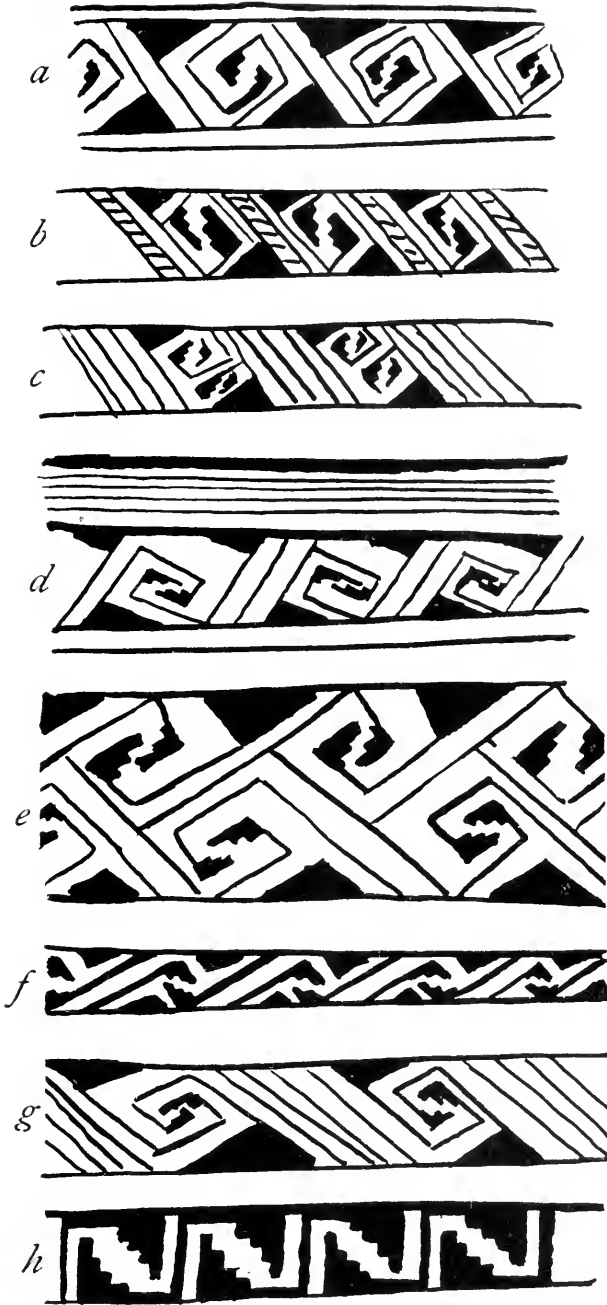

FIG. 11.—*a, b, c, d*, interlocking fret, Taos. *e, f, g, h*, interlocking fret, Aztec.

As may be seen from the figures drawn from sherds, no curvilinear designs at all were found, all being strictly rectilinear; only one life form was noted (fig. 7).

The black on white ware was mostly in the form of ollas and bowls. The small heart-shaped jars are particularly handsome (pl. 13, *c, d*). Two of these were found, one whole and the other in such condition that it could be restored. The designs are shown in plate 13, *c, d*, and figures 8, 9. Figure 10 is a reconstructed design from the top of a water jar. Enough fragments of this were found to reconstruct about five-eighths of it.

The interlocking fret design shown in a number of cases on the Taos black on white ware is almost identical with that found in the Aztec ruin

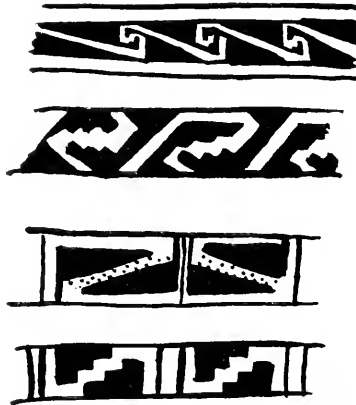

FIG. 12.—Interlocking fret design. From Oak Tree House, Mesa Verde National Park, Southwestern Colorado.

(fig. 11), and figured by Earl Morris in the *American Anthropologist*, Vol. 17, 1915, p. 676, and also on sherds found by the writer when acting as assistant to Dr. J. W. Fewkes, at Oak Tree House, on the Mesa Verde, in 1921 (fig. 12).

The dividing of the top of an olla as shown in figures 8 and 9 is common to most parts of the southwestern prehistoric Pueblo culture area. Figure 13 was taken from the paper cited above on the Aztec Ruin by Earl Morris.

The varied designs of the Taos region include zigzags, triangles, checkerboard and many other forms (fig. 14, and pl. 14).

Black on red ware.—Only a few sherds from vessels belonging to this group were found and these are not enough to give any definite opinion as to the general characteristics of the type in the Taos region.

The sherds obtained indicate that the ware was very pleasing in color and finish and that the decorations were chiefly of the geometric rectilinear form. The small percentage of black on red ware mixed with the black on white is a feature which is characteristic of other sections in the Southwest as well. This is notably true of the Chaco Canyon and the Mesa Verde ruins.

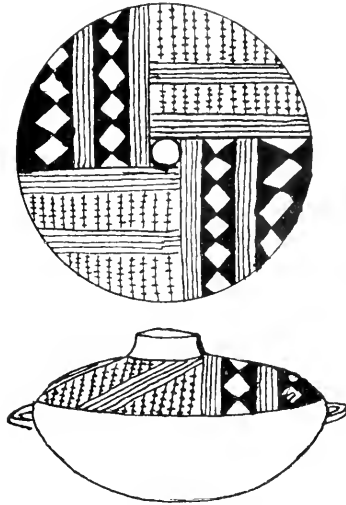

FIG. 13.—Jar from Aztec, New Mexico.

SUMMARY

During 1920 a brief survey was made of the distribution and location of ruins in the Taos Valley. The results showed that there were many sites, including a number of extensive adobe ruins, which are worthy of investigation.

Two mounds were excavated at Llano and the ruins of adobe buildings uncovered. The smallest structure constituted the remains of a 7 room pueblo which gave indication of a long period of occupancy. Considerable information on the methods of wall construction was obtained from this ruin.

The second and larger mound contained the remains of two levels of occupation. The building belonging to the second or later period was excavated. It had been an 18 room pueblo with a kiva. The building gave evidence of having been destroyed by fire and no information could be obtained with respect to the method of roof construction beyond the fact that the secular rooms had had a single

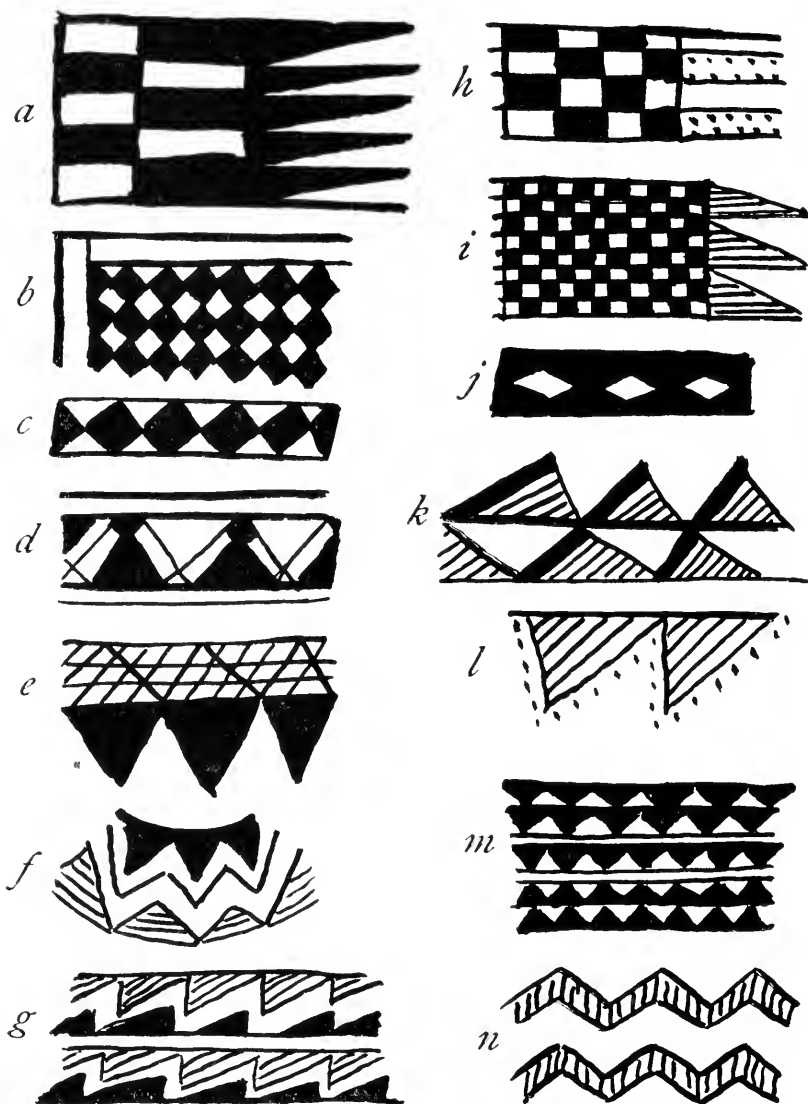

FIG. 14.—Designs on black on white ware, Taos region. *a*, interior, bowl, Bagley Ranch; *b*, exterior, shoulder, Llano; *c*, neck, Llano; *d*, interior, rim, small bowl, Llano; *e*, rim, Llano; *f*, neck of olla, Llano; *g*, interior, red ware bowl, Llano; *h*, interior, bowl, Bagley Ranch; *i*, interior, bowl, Bagley Ranch; *j*, neck, Llano; *k*, interior, small bowl, Llano; *l*, rim, Llano; *m*, shoulder, Llano; *n*, shoulder and neck, Llano.

central ceiling support and the kiva covering had rested on four upright posts. The kiva was found to have been placed in the center of a compact mass of rooms instead of in an open plaza detached from the main building.

The pottery gave evidence of a relationship to that of southwestern Colorado and the Rio Grande wares of the late black on white period. Nothing unusual in the way of stone or bone implements was found. All appear to be of the general type associated with such ruins. The chief interest in stone objects was in the absence of grooved axes and the use of large pieces of micaceous schist for cooking slabs.

The sites in general may be considered as representing a late phase of the black on white period, perhaps just preceding the beginning of the glazed wares in the Rio Grande.





A. Small mound at Llano before excavation.



B. Small mound at Llano after excavation.



A. Large mound at Llano before excavation.



B. Excavated rooms in large mound.



C. Excavated rooms in large mound.



A. Banquette.



B. Storage room.



A. Double wall of kiva.



B. Double wall of kiva.



A. West ventilator.



B. Fireplace.

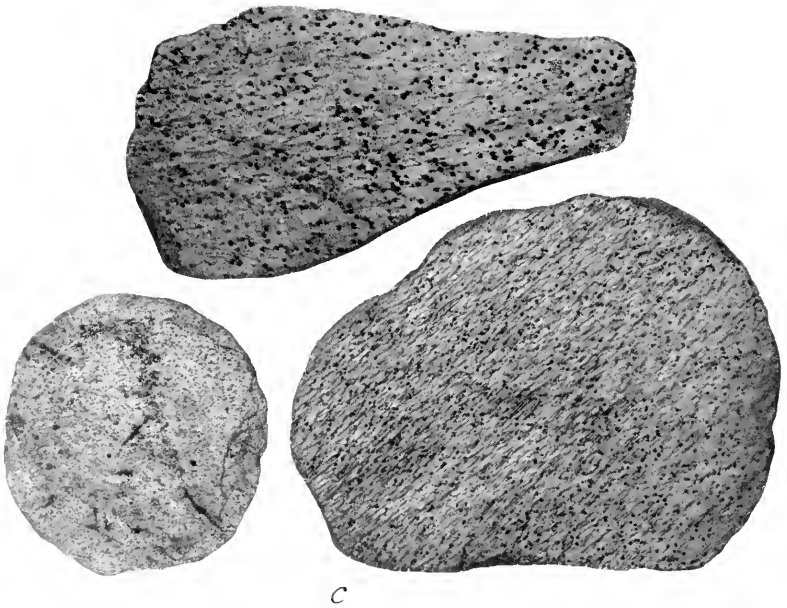
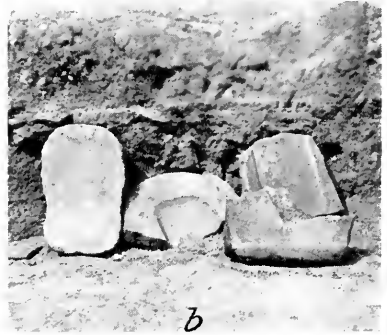

a, b, c. Metates and objects of micaceous schist.

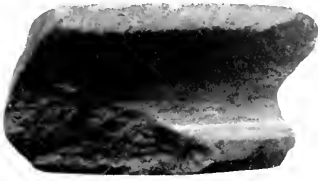

a

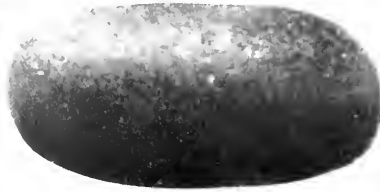

b

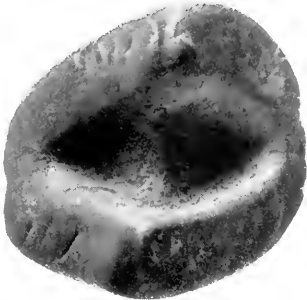

c



d



d



d

a, Arrow-shaft polisher; *b*, cylindrical stone; *c*, stone of unknown use; *d*, maul heads.



Chipped stone objects.

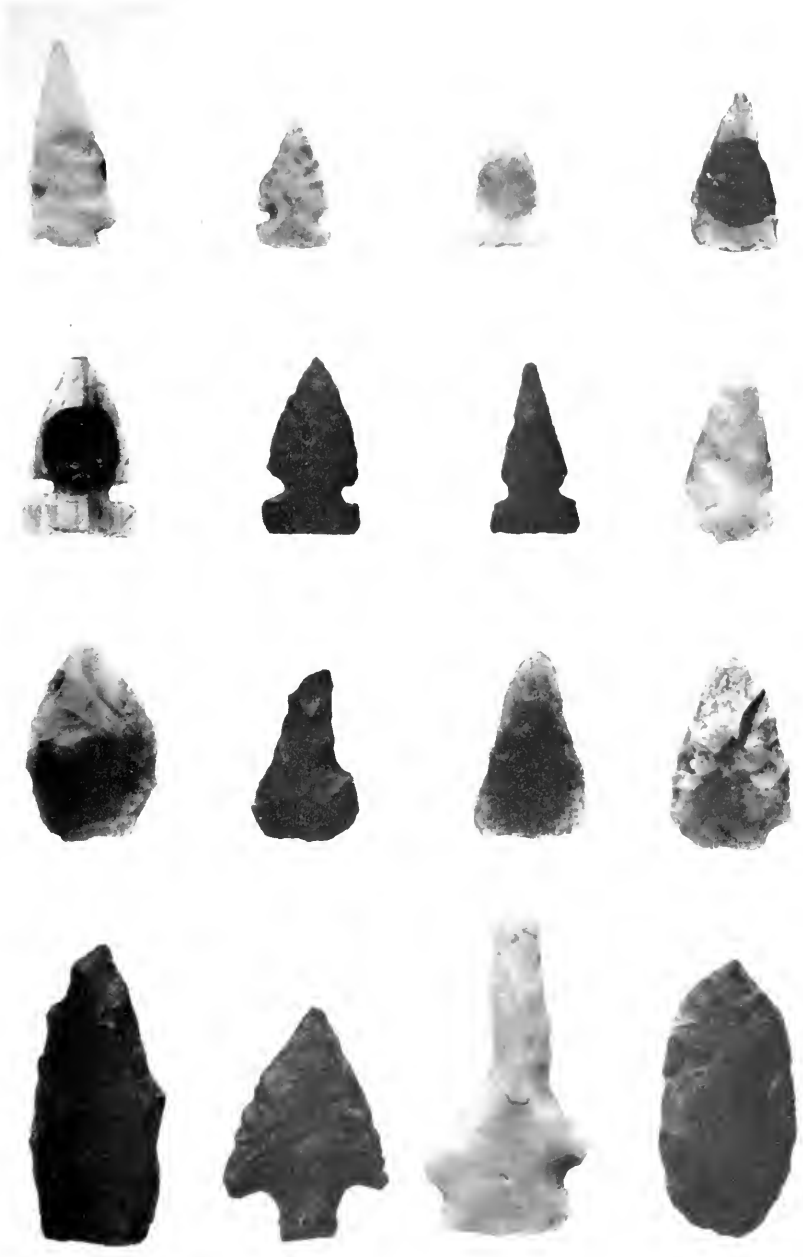

Chipped stone objects.

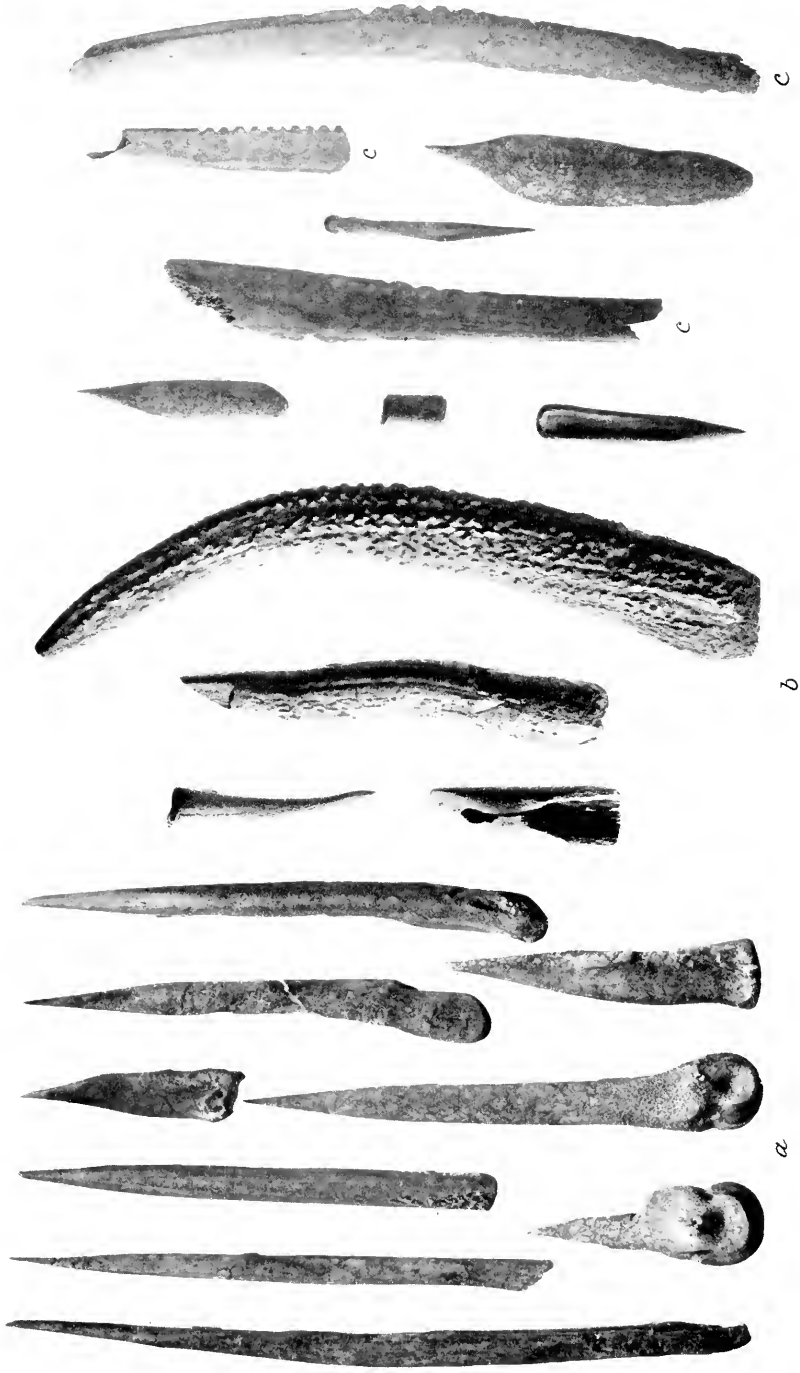

Bone implements.

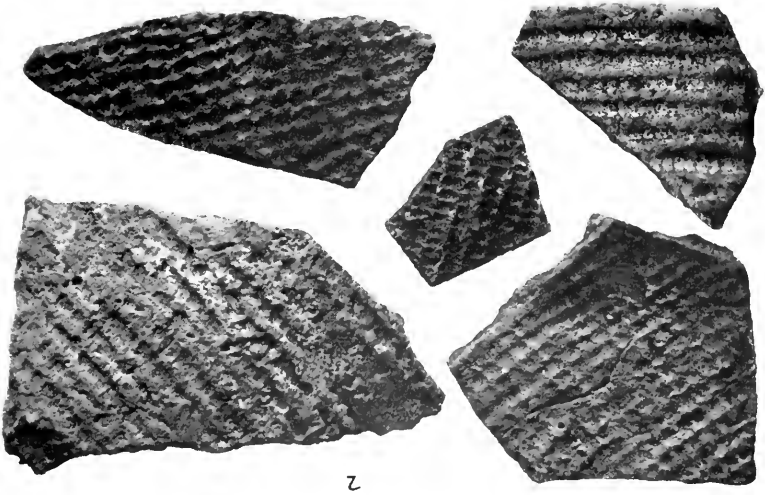
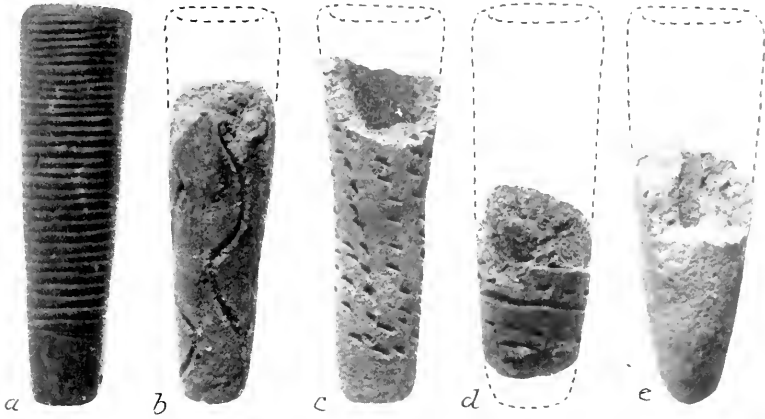

a, b, c, d, e. Pipes; *f, g,* fossils; *h,* agatized wood; *i,* basket impressions.



a



b



c



d



e



f

Culinary and storage jars.



a



b



c

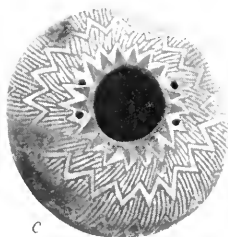

c



d



d

a, Culinary jar; *b*, water jar; *c*, *d*, black on white ware.

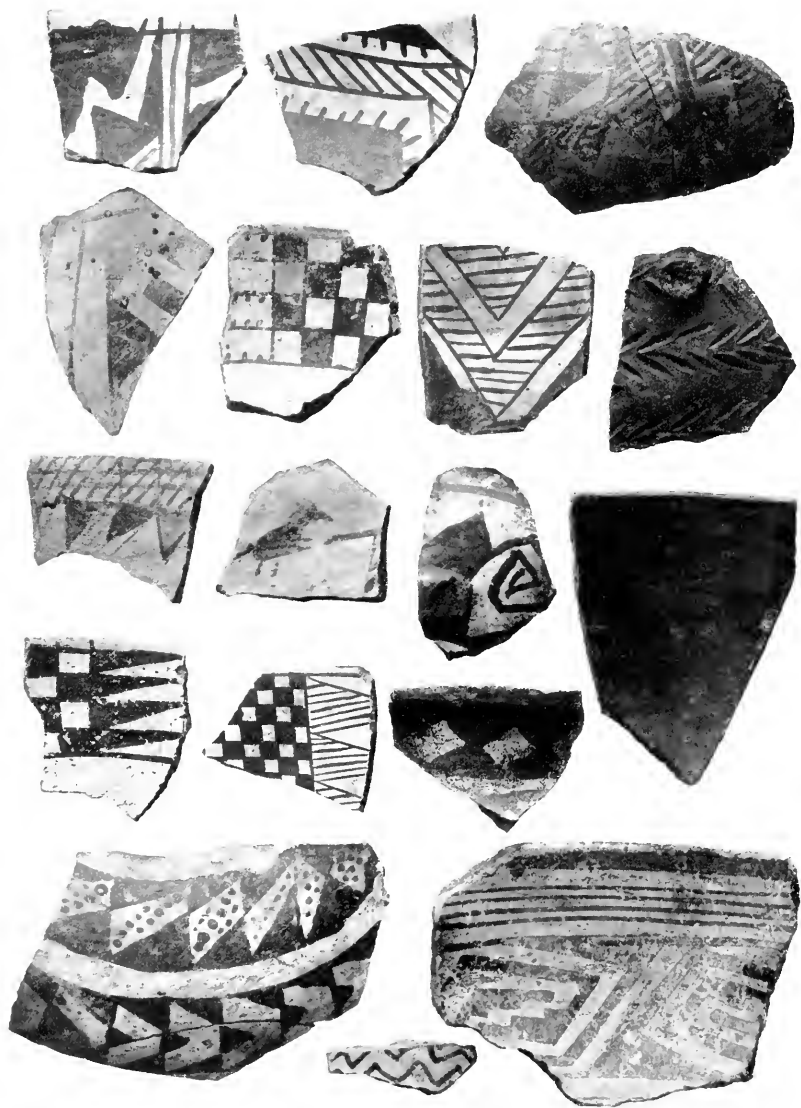

Types of pottery designs.

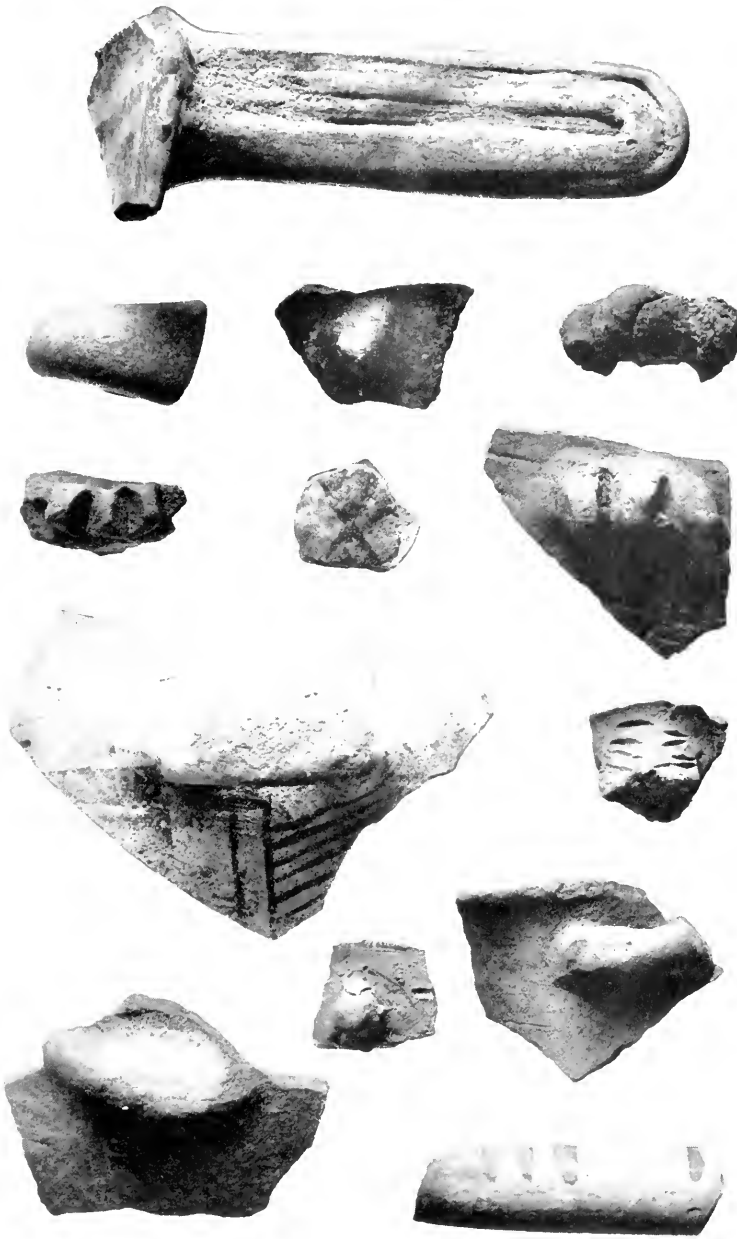

Types of pottery handles.

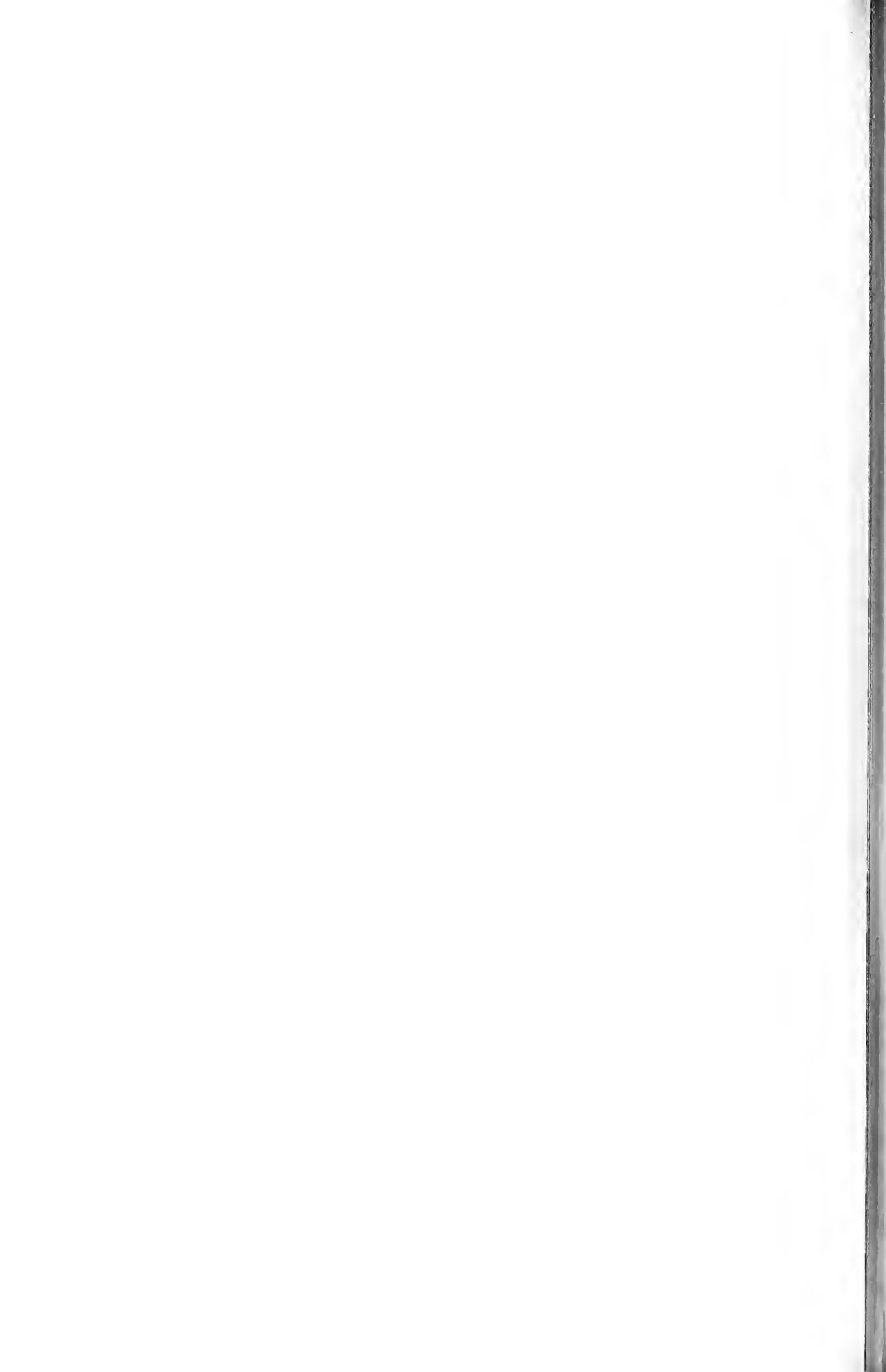

SMITHSONIAN MISCELLANEOUS COLLECTIONS

VOLUME 81, NUMBER 13

DESCRIPTIONS OF FOUR NEW FORMS OF
BIRDS FROM HISPANIOLA

BY

ALEXANDER WETMORE



(PUBLICATION 3021)

CITY OF WASHINGTON
PUBLISHED BY THE SMITHSONIAN INSTITUTION
MAY 15, 1929

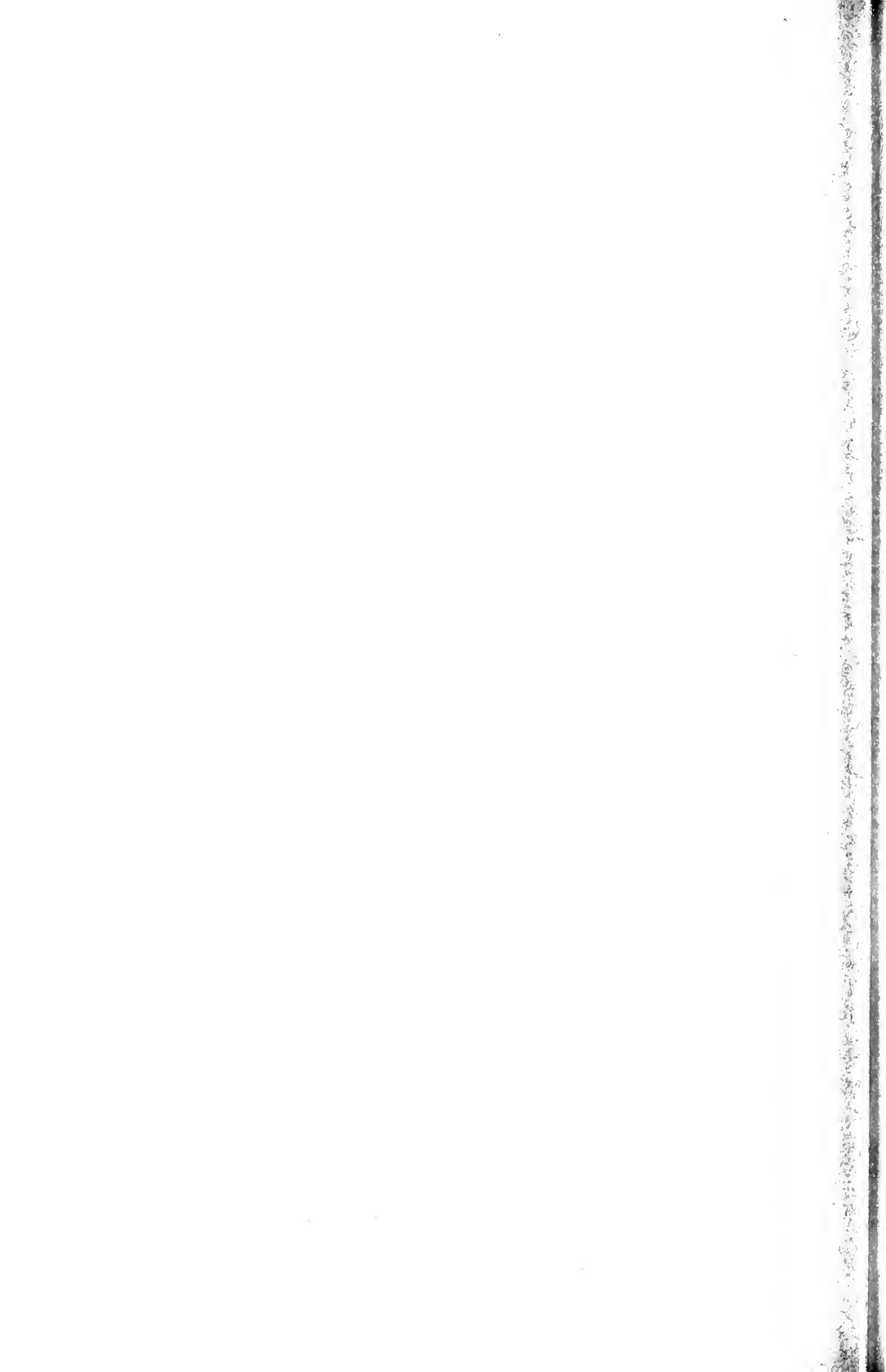

SMITHSONIAN MISCELLANEOUS COLLECTIONS

VOLUME 81, NUMBER 13

DESCRIPTIONS OF FOUR NEW FORMS OF
BIRDS FROM HISPANIOLA

BY

ALEXANDER WETMORE



(PUBLICATION 3021)

CITY OF WASHINGTON
PUBLISHED BY THE SMITHSONIAN INSTITUTION
MAY 15, 1929

The Lord Baltimore Press
BALTIMORE, MD., U. S. A.

DESCRIPTIONS OF FOUR NEW FORMS OF BIRDS
FROM HISPANIOLA

By ALEXANDER WETMORE

Continued studies of birds from Haiti and the Dominican Republic in the National Museum have brought to attention three geographic races found on small islands off the coast that differ sufficiently from the groups inhabiting the main island to merit subspecific distinction. In addition there has been found in the American Museum of Natural History a very distinct species of the peculiar genus *Calyptophilus* which is described here through the courtesy of Dr. Frank M. Chapman.

Family MNIOTILTIDAE

DENDROICA PETECHIA SOLARIS, subsp. nov.

Characters.—Similar to *Dendroica petechia albicollis* (Gmelin)¹ but lighter in color; averaging slightly larger.

Description.—Type, U. S. Nat. Mus. No. 278,738, male, collected at Z'Etroits, Gonave Island, Haiti, March 18, 1920, by Dr. W. L. Abbott. Upper surface slightly brighter than pyrite yellow, rump brighter yellow; anterior portion of crown somewhat brighter than sulphine yellow, with concealed portions of feathers sudan brown; wings dusky, the feathers margined externally with sulphine yellow; wing-coverts pyrite yellow, edged with lemon chrome; rectrices dusky, lightly edged externally with sulphine yellow, with inner webs extensively lemon yellow; under surface between light cadmium and lemon chrome, with breast and sides streaked with sudan brown. Maxilla dusky neutral gray, mandible deep neutral gray, tarsus and toes dull brown (from dried skin).

Measurements (in millimeters).—Ten males, wing 64.2-68.0 (65.9), tail 50.0-57.0 (52.1), culmen from base 12.3-13.1 (12.8),² tarsus 20.5-21.5 (21.3).

Seven females, wing 61.3-63.2 (62.2), tail 48.1-51.0 (48.9), culmen from base 11.5-12.9 (12.2), tarsus 21.2-22.0 (21.4).

Type, male, wing 67.0, tail 57.0, culmen from base 12.5, tarsus 21.5.

¹ *Motacilla albicollis* Gmelin, Syst. Nat., vol. 1, pt. 2, 1789, p. 983. ("S. Dominici" = Hispaniola.)

² Average of nine.

Range.—Confined to Gonave Island, Haiti.

Remarks.—The present form shows approach to *Dendroica petechia* *coa* of Jamaica in size and in brighter coloration, but is less golden yellow, with the dark coloration of the anterior part of the crown rufescent rather than orange brown. Its differences from *albicollis*, easily apparent in series, are more plainly evident in females than in males.

Following are measurements of *Dendroica p. albicollis* for comparison:

Eighteen males, wing 59.3-64.5 (62.5), tail 47.3-53.0 (50.5), culmen from base 11.0-13.3 (12.6), tarsus 19.9-22.0 (21.0) mm.

Five females, wing 57.8-63.0 (60.3), tail 47.8-50.2 (49.2), culmen from base 11.2-13.2 (12.4), tarsus 19.8-21.0 (20.6) mm.

Family THRAUPIDAE

CALYPTOPHILUS TERTIUS, subsp. nov.

Characters.—Similar to *Calyptophilus frugivorus frugivorus* Cory¹ but decidedly larger, with heavier bill; much darker in color; feathers encircling eyelids dark, instead of yellow; wings and tail rufescent.

Description.—American Museum of Natural History No. 166,421, male, from higher slopes of Morne La Hotte, Haiti, taken June 22, 1917, by R. H. Beck. Crown feathers centrally chaetura black, margined with grayish olive; sides of head chaetura drab; a spot of primuline yellow on lores, separated from eye by an area of dull black; hindneck, back and scapulars between deep and dark olive, shading back across rump to the bister of the upper tail-coverts; rectrices somewhat darker and more rufescent than warm sepia; remiges dusky brown, secondaries and inner primaries with external webs bister, outer primaries with external webs olive brown, and wing-coverts clove brown; edge of wing, with a wash of reed yellow; under wing-coverts mixed whitish and deep mouse gray; throat and center of breast white (more or less soiled); abdomen smoke gray; sides washed with deep mouse gray; flanks brownish olive; under tail-coverts bister. "Iris brown, bill black, horn below" (from collector's label); tarsi and feet bister (from dried skin).

Measurements (in millimeters).—Five males, wing 92.5-104.0 (98.9), tail 96.5-108.0 (101.2), culmen from base 23.7-27.4 (24.9), tarsus 32.5-35.0 (33.4).

¹*Phoenicophilus frugivorus* Cory, Quart. Journ. Boston Zool. Soc., October, 1883, p. 45. ("Santo Domingo" = Rivas, D. R.)

Two females, wing 84.4-91.5 (88.0), tail 83.9-89.0 (86.5), culmen from base 22.8-23.6 (23.2), tarsus 30.8-31.1 (31.0).

Type, male, wing 100.0, tail 100.2, culmen from base 24.5, tarsus 32.8.

Range.—Known only from the higher slopes of Morne La Hotte, Haiti.

Remarks.—The series of seven *Calyptophilus* in the American Museum of Natural History, collected by R. H. Beck from June 20 to July 4, 1917, back of Les Anglais on the higher ridges that lead up to the peak of Morne La Hotte, are so distinct in larger size and darker coloration from *Calyptophilus frugivorus* of the rest of the island that there is no question in assigning them specific rank. The new form seemingly is confined to the higher slopes of the mountain range of La Hotte, since during extensive collecting elsewhere it has not been found. It is another of the peculiar mountain forms of Hispaniola whose presence has been wholly unexpected.

This new species is described here through the kind permission of Dr. Frank M. Chapman of the American Museum of Natural History.

PHAENICOPHILUS PALMARUM EUROUS, subsp. nov.

Characters.—Similar to *Phaenicophilus palmarum palmarum* (Linnaeus)¹ but lighter in color; above brighter green, with gray of hind-neck lighter, becoming nearly white on sides of neck anteriorly; below with white more extended.

Description.—Type, U. S. Nat. Mus. No. 252,843, male, taken on Saona Island, Dominican Republic, September 13, 1919, by Dr. W. L. Abbott (in somewhat worn plumage). Crown and entire sides of head jet black, except for a spot on either side of the forehead, one above either eye, and the lower eyelid, which are white; hindneck, and sides a little paler than gray no. 7, the former becoming white at posterior border of black covering the ear-coverts; upper surface, including exposed portions of wing and tail feathers, between pyrite yellow and warbler green; concealed portions of remiges dusky; median underparts including the under tail-coverts extensively white; under wing-coverts smoke gray edged with white. Bill black, base of lower mandible dark dull grayish; tarsus dusky neutral gray (from dried skin).

Measurements (in millimeters).—Type specimen, male, wing, 90.0, tail, 67.5, culmen from base, 20.7, tarsus, 22.5.

¹*Turdus palmarum* Linnaeus, Syst. Nat., ed. 12, vol. 1, 1766, p. 295. ("Habitat in Cayennae Palmis" = Hispaniola.)

Range.—Restricted to Saona Island, Dominican Republic.

Remarks.—Though occasional birds in a considerable series of the palm tanager from the main island of Hispaniola approach in coloration the single skin at hand from Saona, none is quite so extensively white below, or so bright and light a green above, so that it seems permissible to name a Saona form on the basis of this scanty material.

Family FRINGILLIDAE

LOXIGILLA VIOLACEA MAURELLA, subsp. nov.

Characters.—Generally similar to *Loxigilla violacea affinis* (Ridgway)¹ but larger, with heavier bill.

Description.—Type, U. S. Nat. Mus. No. 250,456, Tortue Island, Haiti, collected February 2, 1917, by Dr. W. L. Abbott. Throat, short line above eye, and under tail-coverts somewhat darker than burnt sienna; axillars and under wing-coverts partly burnt sienna and white mixed; plumage otherwise deep black. Bill, feet, and tarsi black (from dried skin).

Measurements (in millimeters).—Three males, wing 82.4-84.3 (83.4), tail 70.2-71.9 (71.2), culmen from base 16.2-16.8 (16.4), depth of bill at base 12.9-13.8 (13.3), tarsus 22.1-22.8 (22.4).

One female, wing 77.7, tail 65.8, culmen from base 15.5, depth of bill at base 11.9, tarsus 22.9.

Type, male, wing 82.4, tail 71.9, culmen from base 16.8, depth of bill at base 13.8, tarsus 22.8.

Range.—Known only from Tortue Island, Haiti.

Remarks.—The greater size of the present form is more plainly evident on direct comparison of skins from Tortue with those from Hispaniola proper than from examination of the measurement tables, *maurella* being very appreciably larger and more robust. The only female seen is blacker than the majority of *affinis*. The new form is represented by three males and one female, all collected by Dr. W. L. Abbott, February 1 and 2, 1917.

Following are measurements of *L. v. affinis* for comparison:

Sixteen males, wing 71.9-79.2 (76.7), tail 61.7-69.3 (65.3), culmen from base 14.2-16.5 (15.2), depth of bill at base 11.0-12.9 (12.3), tarsus 19.2-23.4 (21.1) mm.

Nine females, wing 67.2-75.8 (71.2), tail 59.8-67.0 (63.5), culmen from base 12.6-14.3 (13.6)² depth of bill at base 10.4-11.8 (10.9), tarsus 19.7-22.3 (21.0) mm.

¹ *Pyhrrulagra affinis* "(Baird)" Ridgway, Auk, 1898, p. 322. (Port-au-Prince, Haiti.)

² Average of eight.

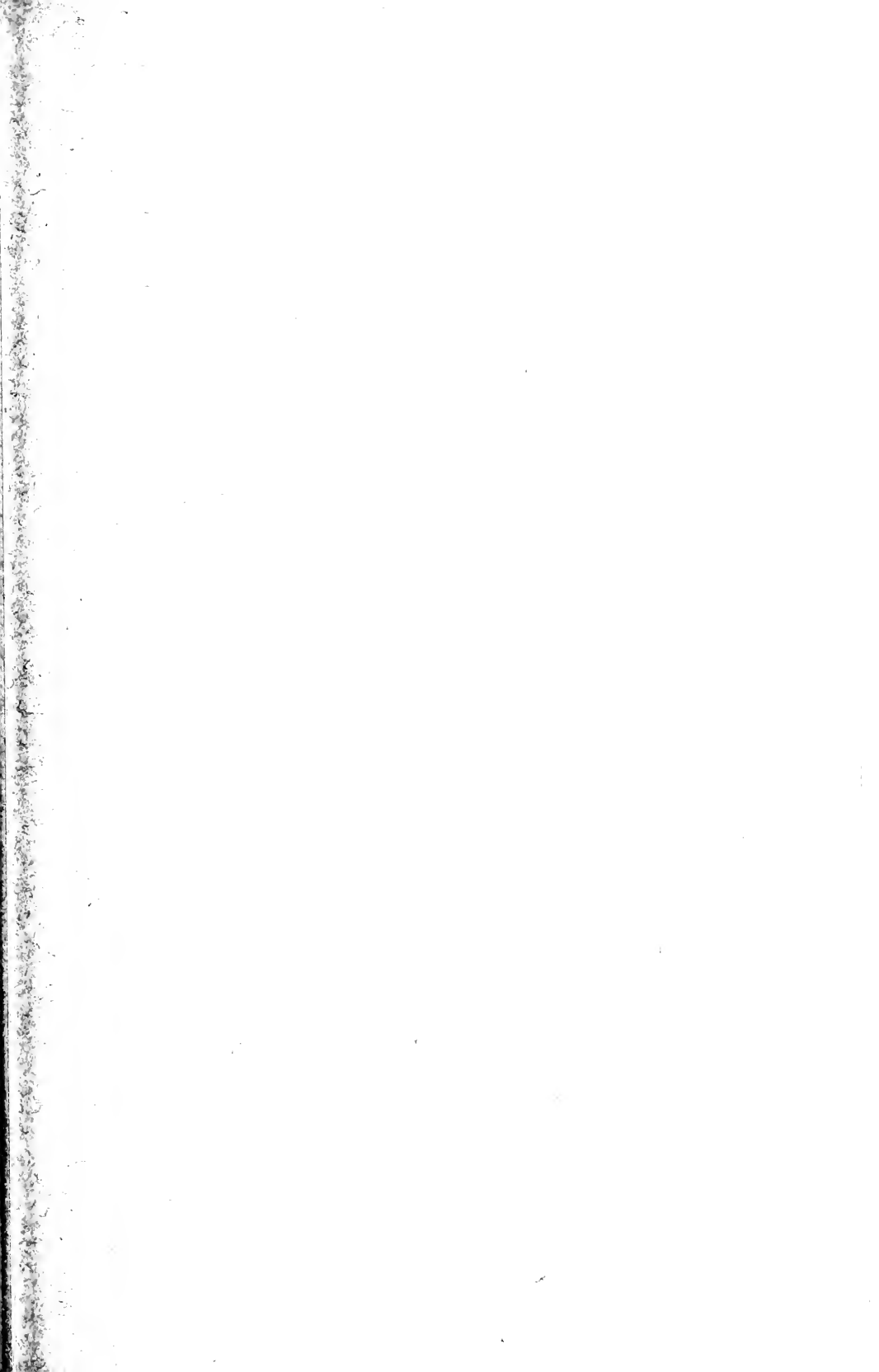



SMITHSONIAN MISCELLANEOUS COLLECTIONS
VOLUME 81, NUMBER 14

PREHISTORIC ART OF THE ALASKAN ESKIMO

(WITH 24 PLATES)

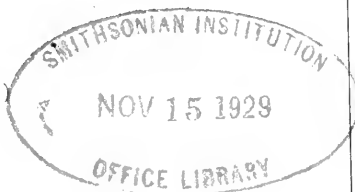

BY

HENRY B. COLLINS, JR.

Assistant Curator, Division of Ethnology, U. S. National Museum



(PUBLICATION 3023)

CITY OF WASHINGTON
PUBLISHED BY THE SMITHSONIAN INSTITUTION
NOVEMBER 14, 1929

SMITHSONIAN MISCELLANEOUS COLLECTIONS
VOLUME 81, NUMBER 14

PREHISTORIC ART OF THE ALASKAN ESKIMO

(WITH 24 PLATES)

BY

HENRY B. COLLINS, JR.

Assistant Curator, Division of Ethnology, U. S. National Museum



(PUBLICATION 3023)

CITY OF WASHINGTON
PUBLISHED BY THE SMITHSONIAN INSTITUTION
NOVEMBER 14, 1929

The Lord Baltimore Press
BALTIMORE, MD., U. S. A.

PREHISTORIC ART OF THE ALASKAN ESKIMO

BY HENRY B. COLLINS, JR.,

ASSISTANT CURATOR, DIVISION OF ETHNOLOGY, U. S. NATIONAL MUSEUM

(WITH 24 PLATES)

INTRODUCTION

Until very recently information on the archeology of the American Arctic was limited practically to the descriptions by Wissler¹ and Boas² of a relatively small number of specimens collected by Stefansson, Comer, and others from northern Alaska, the Hudson Bay region, and northwest Greenland. The first systematic excavations in the eastern regions were those made in Baffin Land, Melville Peninsula, and northwest Greenland by Therkel Mathiassen for the Fifth Thule Expedition from 1922 to 1924. The publication in 1927 of the results of these important investigations afforded for the first time an adequate view of the archeology of a large section of Arctic America.³ This work verified the conclusions of Boas and Wissler that in earlier times there had been a closer similarity between the Eskimo cultures of Alaska and the eastern regions than exists at present. Mathiassen, however, with a much larger mass of material systematically excavated at a number of widely scattered sites, was able to go further and show that the similarities were so numerous and striking that the Thule culture, the name he gave to the ancient eastern culture, must have had its origin in Alaska.

In 1926 Dr. Aleš Hrdlička made an anthropological survey of the Alaskan Coast from Norton Sound to Point Barrow⁴ and in the same year Mr. Diamond Jenness inaugurated archeological work in the Bering Sea region by excavating at Cape Prince of Wales and on the

¹Wissler, Clark, Harpoons and Darts in the Stefansson Collection. *Anthrop. Papers Amer. Mus. Nat. Hist.*, Vol. XIV, Part II, 1916.

Wissler, Clark, Archeology of the Polar Eskimo. *Anthrop. Papers Amer. Mus. Nat. Hist.*, Vol. XXII, Part III, 1918.

²Boas, Franz, The Eskimo of Baffin Land and Hudson Bay. *Bull. Amer. Mus. Nat. Hist.*, Vol. XV, Part I, 1901; Part II, 1907.

³Archeology of the Central Eskimos. Report of the Fifth Thule Expedition, 1921-24. The Danish Expedition to Arctic North America in Charge of Knud Rasmussen, Ph.D., Vol. IV, Parts 1 and 2, Copenhagen, 1927.

⁴Anthropological Work in Alaska. *Smithsonian Misc. Coll.*, Vol. 78, No. 7, pp. 137-158, 1927.

Little Diomedé Island.¹ As a result of these investigations it was shown that underlying the existing Eskimo culture of northern and northwestern Alaska there had been an earlier and in general more advanced culture which was marked especially by elaborately carved and ornamented objects of old ivory. The ancient style of art revealed by Hrdlička and Jenness was distinct and new, although some of the harpoon heads and foreshafts corresponded with the Thule types of the east.

In 1927 I conducted anthropological work in southwest and west Alaska with Mr. T. Dale Stewart of the United States National Museum, examining sections of the coast and islands from the Alaska Peninsula northward to the mouth of the Yukon.² This work consisted mainly of measuring the Eskimos and making collections of skeletal and cultural material. Although many old graves, village sites, and some few refuse piles were examined, no trace was found of the newly discovered ancient culture above referred to, which seems according to the present evidence not to have extended as a type south of St. Lawrence Island.

In 1928 I returned for a second season's work, and excavated on St. Lawrence and the small nearby Punuk Island, and later at Metlatavik on the Arctic coast just above Bering Strait.³ This work resulted in the collection of a large number of specimens that appear to be of particular interest as showing successive stages of art development in the newly revealed ancient Bering Sea culture. The detailed description of all this material will necessarily be somewhat delayed, but in order that the more important results may be made available as soon as possible it seems desirable to present in advance a brief description dealing with the art of St. Lawrence and Punuk Islands, together with a description of such additional examples of the old art from other Bering Sea and northern Alaskan sites as I have been able to obtain or have photographed.

¹ Archeological Investigations in Bering Strait. Bull. 50, Ann. Rep. for 1926, Nat. Mus. Canada, pp. 71-81, Ottawa, 1928.

Ethnological Problems of Arctic America. Amer. Geogr. Soc., Special Publ. No. 7, Problems of Polar Research, pp. 167-175, New York, 1928.

² The Eskimo of Western Alaska, Explorations and Field-Work of the Smithsonian Institution in 1927, pp. 149-156, 1928.

³ The Ancient Eskimo Culture of Northwestern Alaska. Explorations and Field-Work of the Smithsonian Institution in 1928, pp. 141-150, 1929.

The expense of the expedition was borne by Mrs. Mary Vaux Walcott, the Bureau of American Ethnology, and the American Association for the Advancement of Science.

Jenness has described some of the archeological material which he collected at Cape Prince of Wales and on the Little Diomedé as representative of what he has called the Bering Sea culture, and this designation will be followed in the present paper. Hrdlička, in a publication now in press, has also described the specimens he obtained in 1926. In addition, Mathiassen has recently published a description of several examples of the Bering Sea art which were in the collections of the Museum of the American Indian and in the National Museum at Copenhagen.¹ To Dr. George G. MacCurdy, however, belongs the credit for first calling attention to this unique style of Eskimo art some years before any archeological work had been done around Bering Strait and when there was no material with which to compare the single specimen that he found in the American Museum of Natural History.² This was an ivory object, identified as a whip handle,³ and bearing a decoration so different from anything known to the Eskimo that Dr. MacCurdy published a brief description of it in the *American Anthropologist*. In all, probably 30 objects showing the old Bering Sea decoration have been illustrated and described. Other examples of it are in various museums and private collections, and some of these will be described in the following pages.

OBJECTS REPRESENTATIVE OF THE OLD BERING SEA CULTURE

It will be understood that all of the objects to be described are of walrus ivory unless otherwise stated. In color they range from cream, through buff and brown, to a dark green or even black. This discoloration has resulted from the ivory having remained buried in the frozen ground for many years. An occasional artifact was shaped from a piece of mammoth ivory or old walrus tusk that had been washed up by the waves, but most of them were carved from the fresh walrus ivory and have since taken on their rich coloring.

On plate I are shown four harpoon heads embodying the features which may be regarded as typical of the most highly developed and apparently the oldest phase of the ancient Bering Sea art.

Plate I, *a-b*, is an exceptionally fine harpoon head owned by Messrs. Wilfred and Albert Berry of Seattle. Its provenience is not known except that it came from northern Alaska.

¹ Mathiassen, Therkel, *Some Specimens from the Bering Sea Culture*. *Indian Notes*, Museum of the American Indian, Heye Foundation, Vol. 6, No. 1, pp. 33-56, January, 1929.

² *An Example of Eskimo Art*, *Amer. Anthropol.*, Vol. 23, No. 3, pp. 384-385, 1921.

³ This appears, however, to be an adz handle. Cf. Mathiassen, 1929, p. 41.

The two heads, *c* and *e-f*, are also from northern Alaska, the exact locality unknown. They are in the Washington State Museum and I am indebted to Mr. F. S. Hall, Director of the Museum, and to the Messrs. Berry for the kind permission to figure their specimens. The heads are all of the closed socket type, with the line hole at right angles to the blade slit. The basis of the design consists of pairs of circles, at times somewhat elliptical, drawn free hand and surmounting low rounded elevations in such a manner as to suggest eyes on the head of a bird or mammal. There are two of these "heads," one at the terminal barb and another just above and in part overlapping it. In *c* there is a suggestion of a third "head" above the line hole. Plate 1, *e-f*, differs from the others in having a groove for a lateral blade on each side above the line hole. These harpoon heads are of the same form and style of ornamentation as one described by Mathiassen.¹ Besides the circles, which form the central motive, there is a graceful arrangement of lines, some deeply and some lightly incised, straight and curved, solid and broken or dotted. Small spurs are also attached to some of the lines and circles.

In plate 1, *d*, is shown an unusual harpoon head which I bought from an Eskimo on St. Lawrence Island. It was excavated from the old village at Sevuokok (Gambell) on the northwestern end of the island. Its ornamentation is of the same nature as the other three, although the careless scratching and unfinished appearance of the upper end distinguish it from most of the objects similarly decorated. There are also deep dots at the centers of the circles. In form, however, this harpoon head presents a number of anomalous features. The line hole, instead of being at the center, is placed at one side. The open socket is rounded instead of rectangular, and in position is more like what would be expected in a closed-socket type. Finally, the grooved band opposite the socket was cut after the decoration had been applied. These facts make it appear that the harpoon head was intended to have, and may originally have had, a closed socket, but that either in the drilling or subsequently while in use, a part broke away, leaving the socket exposed. In order that it might still be utilized the groove was then cut around the side and the foreshaft lashed on.

Figure 1 is a very interesting closed socket harpoon head from Plover Bay, Northeastern Siberia. It is of fossil mammoth ivory and is creamy gray in color in contrast to the usual brown of the old walrus ivory; it is badly pitted on the opposite side but enough of the ornamentation remains to show that the design was identical on both

¹ Indian Notes, Vol. 6, No. 1, fig. 13, *a*.

sides. In ornamentation it differs from those shown on plate 1 (except *d*) in having a dot within the elevated circles and in having two small cross-hatched areas on the terminal barb. The lines connected with the circles are also somewhat more finely incised and are applied with more precision. It differs from the first four specimens in having three barbs at the base instead of one, in this respect being similar to another type of the old Bering Sea harpoon head, examples of which are shown on plate 2.

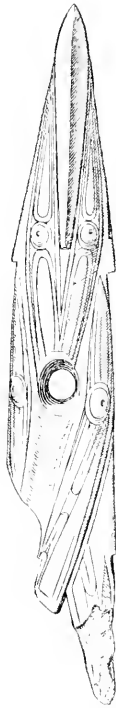

FIG. 1.—Closed socket harpoon head of fossil mammoth ivory from Plover Bay, Northeastern Siberia.

Plate 2, *e*, was collected by Mr. T. S. Scupholm from the deserted village of Kukuliak on the north side of St. Lawrence Island. It has an open socket for the foreshaft and rectangular slots for lashing. The line hole is parallel with the blade slit. On the terminal barb has been left a rectangular projection which gives it an appearance somewhat similar to figure 1. The central barb and two smaller ornamental remnants of barbs below it are features around which the decoration centers, and are to be compared with similar slight projections along the sides of *a*, *c*, and *e*, plate 1. The decoration consists of straight and curved lines, including very lightly incised broken lines. There

are no circles, but instead two (originally four) small eye-shaped designs at the center.

Plate 2, *a-b*, and *f*, are from the Washington State Museum; the exact localities from which they came are not known. The first is very similar in shape to *e*, the only difference being the more irregular outline of the terminal barb. The ornamentation is reduced to only a few simple lines.

Plate 2, *f*, is a small harpoon head of a peculiar type, of which four examples have been described previously: one by Wissler,¹ from Cape Smythe near Point Barrow; two by Jenness² from the Diomed Islands, and one by Mathiassen³ from Banks Island. The features common to harpoon heads of this type are three terminal barbs, the central one being the longest; a long open socket that reaches to about the center; small side blades of stone, either parallel or at right angles to the shaft socket; and most striking of all, where the slots for the lashing come to the surface on the upper side, a deep sunken area at either end of which is a circular perforation also for lashing. In the present specimen the upper perforation has been started from both sides but has not been drilled through. The decoration, which is very similar to the other specimens of the type described, consists of nucleated concentric circles and finely incised lines.

The decoration on *c-d*, also from the Washington State Museum, consists of straight and curved lines and concentric circles, but no dotted lines. It differs from the other two in having a rectangular sunken area around one side to hold the lashing in place, instead of a second slot through which it usually passed. There is also a smaller barb, undecorated, opposite the larger one.

In *g* and *h* are shown two undecorated heads from St. Lawrence Island owned by Mr. C. L. Andrews of Seattle. They have open sockets, no slit for an end blade, two and three terminal barbs, and on each side just above the line hole a deep groove for holding a side blade.

Plate 3, *b*, is a box handle, Washington State Museum collection, from northern Alaska. It is ornamented with four pairs of raised elliptical "eyes" with small holes sunk deep into the centers. They are separated and encircled by flowing lines.

Plate 3, *a*, is a similarly decorated box handle that I bought at Gambell, St. Lawrence Island, where it had been excavated. This

¹ Anthropol. Papers Amer. Mus. Nat. Hist. Vol. XIV, Pt. II, p. 410, 1916.

² Ann. Rep. for 1926, Nat. Mus. Canada, pl. XIII, *a*; and Amer. Geogr. Soc., Special Pub. No. 7, fig. 3, *c*.

³ Indian Notes, Vol. 6, No. 1, fig. 13, *b*. Probably not from Banks Island. See footnote, p. 36.

specimen is of bone and the five pairs of circular and elliptical "eyes" are not raised to the same extent as those on the smaller ivory handle but the elevations can be plainly felt by running the fingers over the surface.

Plate 4, *a*, is an object of unknown use from the Washington State Museum collection, reported to have come from Nelson Island. A similar specimen, from the Diomedes, is figured by Jenness.¹ The Washington specimen is of beautifully stained, creamy brown ivory and bears a comparatively simple ornamentation of circles, dots and straight lines, with a small unconnected figure made up of curved lines toward the end. The centers of the circles are small cylinders of ivory surrounded by rings of baleen. Two baleen discs were inserted above these on the upper side of the object. The two pairs of large circles and appended lines, together with the contour of the surface to which they are applied, produce an effect strongly suggestive of seal heads. There are two perforations on the lower side, and between these a deep, rounded notch, indicating that the object was intended to be lashed to something. The two heavy lines extending upward from the basal notch are deeply cut, leaving the lower edges of the seal heads slightly overhanging. The decoration on the opposite side is identical except that instead of the detached curved figure on the wing there are three concentric arcs.

Plate 4, *b*, is a similar, though cruder, object from St. Lawrence Island. It is owned by Messrs. Albert and Wilfred Berry of Seattle. It has no features suggestive of life forms like the preceding specimen, but like it has a deeply cut groove beginning at the notch. A single large circle near the center on each side, and a few small circles and slightly curved lines are the only ornamentation.

The specimen shown on plate 5 is the property of Rev. C. K. Malmin of Ketchikan, Alaska. It was found at Imaruk Basin, east of Teller, Seward Peninsula. The front end is carved to represent an animal's head, the long sharp canines indicating a carnivore. The ivory is mottled in rich shades of brown, cream, and gray. The principal design is placed at the center between the two large holes. This is divided into two parts by a deep, curving groove. The front design, ranging about the forward perforation, consists of rather deeply incised lines with occasional spurs and a curved petaloid figure within which is a small circle from which descend two short converging lines. This figure resembles the flat ivory hat ornaments, sometimes representing gulls' heads, used to decorate the wooden hunting

¹ Ann. Rep. for 1926, Nat. Mus. Canada, pl. XIII, *b*.

hats in Southwest Alaska. On the other side of the deep groove the design is continued by more lightly incised lines and a central ovoid figure outlined by small spurs and enclosing a small circle set between two pairs of short converging lines. The decoration is the same on the opposite side.

On the upper surface are two drilled holes 5 mm. deep representing the nostrils and further back two representing the eyes. There is a fifth hole near the end and two very shallow ones just back of the eyes. Beneath the nostrils and on the edge of the lower lip are a few slanting lines and spurs.

At the rear the upper part of the head is set off by a rounded curving ridge or lip, immediately above which is a deep groove. Above this are a few short lines and spurs, and below it on the curving handle-like rear portion is a simple pattern consisting of straight and curved lines, spurs and small circles at the inner angles of converging lines.

Of all the objects that have been described from the old Bering Sea culture this one is the most suggestive of the Northwest Pacific coast. It is also similar to the animal heads found so frequently in the Kuskokwim region of southwest Alaska (see pl. 21).

On plate 6 are shown two views of a remarkable object of unknown use, from Point Hope, collected in 1880 by Capt. E. P. Herendeen. This belongs with the class of objects described by Gordon¹ and Mathiassen.² It has two symmetrical, beautifully carved wings and a central section, in the base of which is a square excavation 15 mm. deep, probably for receiving a handle. The front or flat surface is the more elaborately decorated. Both wings are divided into three sections by deeply cut oblique lines, within which are placed nucleated concentric circles, four to each wing. The circles are slightly elevated with small round holes about 3 mm. deep at the centers. Tangent to each circle are two pairs of finely incised parallel or converging lines, while between these, on the outer arc of each circle, are three equidistant spurs. The design is completed by additional straight and curved lines, so placed as to accentuate and utilize to best advantage the angles and curves that give to the object its peculiarly graceful outline. The designs on the two wings are as nearly identical as is possible. The artist has achieved a pleasing effect by applying, even to the most minute detail, a perfect bilateral symmetry of form and

¹Gordon, G. B., *The Double Axe and Some Other Symbols*. The Museum Journal, Univ. of Penn., Vol. VII, No. 1, 1916, figs. 99, 100, 105, 106.

²Indian Notes, Vol. 6, No. 1, pp. 43-46.

design. In the top of the central wedge-shaped section between the wings is a narrow triangular incision 5 mm. deep. The circle at the center is the only one that is not raised.

Some of the more finely incised lines have been almost obliterated by wear, and at several places, especially at the end of one wing, the grain was defective and has chipped off, marring to some extent the design.

On the reverse the central portion is raised, or rather, the wings are cut down from it but at a sufficient distance so as to leave two flanges or shorter wings; through both of these are drilled oblique circular perforations 7 mm. in diameter. The ornamentation consists of lines and circles of the same general character as those on the opposite side, but they are much more worn down.

This masterpiece of Eskimo art could hardly have had a practical use; it was no doubt employed in some ceremony, probably connected with whaling, as Gordon suggested, or perhaps as a charm used by the boat captain to bring success in the hunt. I do not think it likely, however, that there is any genetic connection between this class of objects, found only in Alaska, and the well known prehistoric banner stones from the eastern part of the United States. It is true that this particular specimen and those figured by Gordon are somewhat similar to certain of the banner-stones, but, as will be seen later, this is only one of several forms that occur in Alaska, the others assuming shapes quite unlike anything known from the United States. Furthermore, the enormous area between Northwestern Alaska and the Great Lakes where no such objects are found makes it seem extremely improbable that the two classes of objects are related in origin.

On plate 7, *a-b*, are shown two views of a broken object of the type just described, with both wings missing. This was purchased in Seattle and the locality in Alaska from which it came is not known. It is very similar to the specimens from Point Barrow and East Cape described by Mathiassen.¹ The centers of the circles are 4 mm. in diameter and from 6 to 9 mm. deep, and may originally have had insets of some other material as in the object shown on plate 4, *a*. There are also five small nucleated circles, each set at the inner angle of two straight lines, to some of which are attached small spurs. The lines are closely applied, covering practically the entire surface. The decoration as a whole, with its combination of straight and curved lines, spurs, and circles, is of the same type as that shown on the three harpoon heads on plate 2, *c-d*, *e*, and *f*.

¹ Indian Notes, Vol. 6, No. 1, pp. 43.

In the base is an oval slot 21 mm. long and 15 mm. deep, which appears to have been cut rather than drilled. Slots of about the same diameter extend up through each flange and are connected near the center by a small circular perforation. At the top of the central projection is a long shallow notch which is a characteristic feature of these objects.

The broken harpoon socket piece shown on plate 7, *c*, was excavated at Gambell by Mr. Otto W. Geist, for the Alaska School of Mines. The decoration consists of nucleated circles connected by lines, the pattern being enclosed within a field set off by a deeply cut line. There was evidently a somewhat similar design on the other side of the shallow sunken band which encircles the object. The space between the two design elements at the bottom has been cut away, leaving the rounded ends in low relief, as was seen also on the harpoon heads shown on plate 1.

Plate 8, *a-b*, is an object of unknown use, collected at Point Hope by Henry D. Woolfe in 1885. It is of dark greenish-brown ivory and is carved to represent a seal. There is a slot at the back end 20 mm. long which continues on the underside for an additional 25 mm. This suggests a slot for a blade, but the central perforation, with grooves leading down to a flattened base, is evidently intended for attachment, in which case it is difficult to see how the object could have served as a knife or other cutting implement. The object is of particular interest, however, for the reason that, despite the absence of any etched designs, certain features of the outline are sufficient, quite apart from the patination, to show that it is a product of the old Bering Sea culture. Extending from below the neck to the middle of the back are two wide and deep grooves, the edges of which are bordered by lightly incised lines. The incision through the head is bordered in a similar manner. Around the ends of the grooves on the back is a somewhat deeply incised curving line bordered on one side by a ridge or lip. Such ridges, although more pronounced, may be seen on plate 5 and on plate 8, *c*. The eye is formed by a circular excavation 5 mm. in diameter set at the center of a large slightly sunken circular area. Freshly cut discs of wood and small black glass beads have been recently inserted in these cavities.

The broken object shown on plate 8, *c*, was purchased in Seattle; its provenience is not known. It is evidently part of a harpoon socket piece of the type illustrated by Mathiassen¹ from Point Hope and Kotzebue Sound. A round hole 6 mm. in diameter is drilled trans-

¹ Indian Notes, Vol. 6, No. 1, p. 39.

versely through the object, emerging at both sides immediately below the rounded projections at the somewhat constricted center. Cut into the sides and leading down from this perforation are two very narrow grooves similar to the groove in one of the specimens from Kotzebue Sound figured by Mathiassen. The rounded lip-like projection at the center may be compared with the raised border on the preceding specimen and the others first mentioned. The lightly incised lines forming the decoration have been almost entirely effaced on the two flat surfaces but still are faintly visible along the sides, though not in the photograph. The pattern consists of concentric circles with small cylindrical holes at the center 5 mm. deep. About these are continuous and broken lines and small spurs.

The objects shown on the preceding plates illustrate the various known forms of the ancient Bering Sea art. The features characteristic of this art may be outlined as follows: (1) nucleated circles and ellipses, usually concentric and often surmounting low rounded elevations; (2) the arrangement of these on certain objects so as to suggest the eyes of an animal; (3) deeply excavated centers to some of the circles, sometimes inset with discs of baleen or other material; (4) small circles at the inner angle of two converging lines; (5) spurs attached to the circles and lines; (6) straight and curved lines, singly or in bands, serving usually to accentuate the circles and fill in the vacant spaces; (7) finely incised broken or dotted lines; (8) an occasional checked or hachured area; (9) raised borders to grooves and rounded lip-like projections.

When we turn to consider the shapes and the surface elevations and depressions of the objects it is seen that they also form an important part of the decorative scheme. The notches in the wings of the specimen on plate 6, for example, are the beginning of the sections or panels into which the wings are divided and within which the lines and circles are so gracefully arranged. Similarly, the entire rounded end of the wing is set off by a curving line enclosing and unifying the design. The circles on the terminal barbs of the harpoon heads, such as those shown on plate 1, are placed in relation to the shape of the barb itself to suggest eyes, and the effect is repeated in the pair immediately above when a small triangular area is cut away, leaving a rounded and slightly elevated "nose." The same principle may be seen in the specimens on plate 4, *a*, and plate 7, *c*. In short, it may be said that the old Bering Sea art is marked by a profuse but extremely graceful application of lines, curves, and circles in such a way as to realize to the utmost, within the limits of the accepted patterns, the artistic possibilities of the surfaces to be covered.

The ivory specimens bearing ornamentation typical of the old Bering Sea culture are quite uniformly patinated and discolored.

It is natural to inquire as to the affinities of this new and distinctive type or phase of Eskimo art, which is apparently so different from that of the modern Eskimo. It has been suggested that it may be related to the art of the Northwest Coast Indians or the Amur tribes of north-eastern Asia. These are the two areas of highly developed art nearest the Bering Sea region and might naturally, therefore, be looked to as bearing some possible relationship to it. As Jenness has pointed out, however, the closest resemblance seems to be to Melanesia, with which there is no reason whatever to assume any relationship. I would suggest further that the resemblances here are more apparent than real. The old Alaskan pieces that most closely approach the Melanesian are those in which a series of circles or ellipses are separated and bordered by curving lines, giving to them a semblance of scroll work. It is important to note, however, that the circles are always complete and that the lines likewise are completely attached and never left with a free curving end.

With the two other regions in question, namely, the Amur and the Northwest Coast of America, I can again see no real resemblances. The art of the Amur tribes, with its ornate and highly conventionalized animal and floral forms, abounding in intricate spirals and panels of continuous curving figures in maze-like patterns, appears to me to be totally unlike the ancient art of the Bering Sea.

In the same way we will search in vain for any real resemblance to the peculiar art of the Northwest Coast. The Bering Sea art consists essentially of circles and lines, and the designs show no internal evidence of ever having been associated with realistic patterns, although carved representations of animals are not lacking (see pls. 5 and 8). The Northwest Coast art, on the other hand, is more solid and compact and, inextricably linked with totemic and other cultural concepts, is marked by symbolic and conventionalized representations of animal forms. The Bering Sea art is graceful and comparatively simple; the Northwest Coast art is heavy and complex. The only characteristic elements of Northwest Coast decoration that might be compared directly are the eye motives and the cross-hatched surfaces, for occasional oval figures with spurs attached, suggestive of eyes do occur in the old Eskimo art, and, infrequently, very small cross-hatched areas. The eye, however, is only a natural variant of the prevailing simple circle or ellipse, having resulted from the combination of this with another typical feature, the spur; while in the Northwest Coast the eye effect is produced by a continuous line enclosing a solid figure.

Boas regards the Northwest Coast eye as a development of the circle, and here arises an important theoretical point; for if it should be true that this highly important element in Northwest Indian art arose from a design which forms an even more important part of the old Eskimo art, we would have valid ground for considering that the art of the two regions was historically connected. But, assuming such a connection to have existed, there would still be no more reason for considering that the cultural impetus had been exerted from south to north than from the opposite direction. It must be remembered that the Eskimo culture under consideration is ancient; just how ancient, it is yet too early to say, but at any rate it is the oldest culture that has come to light in the extreme Northwest. It is, furthermore, closely related, apparently ancestral, to the very wide-spread Thule culture which, in early times, extended across north central Canada into Greenland, and which has been so thoroughly revealed through the recent researches of Mathiassen. On the other hand, there is no good reason for assigning an equal antiquity to the peculiarly local and highly developed art of the present tribes of the Northwest Pacific Coast.

It seems fairly evident, viewed solely from the ethnological standpoint, that certain culture traits now in the possession of the Alaskan Eskimo were derived from the Alaskan Indians. But this, along with a possibly similar condition in regard to physical type, may well have been of a secondary nature. At any rate, it does not seem possible at the present stage of our knowledge to point to any particular aspect of the *earlier* Eskimo culture that might be said, with any degree of certainty, to have been similarly derived.

In spite of the absence of any important specific resemblances between the art of the two areas, there still remains a vague, general similarity which may lead to the expectation that future archeological work may reveal an earlier stage of Northwest Coast culture closer to the ancient Eskimo culture of Bering Sea, or even, somewhere, a culture that may have been ancestral to both the Northwest Coast and Eskimo cultures. In this connection there is also the possibility that very important results might come from investigation of ancient sites in Southwest Alaska, or around Prince William Sound where Eskimo territory impinged on that of the Tlingit.

While it is difficult to trace true relationships of the newly found ancient Bering Sea culture with Indian tribes of America or tribes of northeastern Asia, it is plainly evident that there is an unbroken line of succession where such would be most expected, namely, in the Eskimo

territory of Alaska. With all its relative richness and undoubted superiority over the present Eskimo art there can be no doubt that the old art was the direct forerunner of the modern. At first glance there may appear to be little resemblance between the artistic and flowing ornamentation of the old Bering Sea culture and the familiar and much simpler designs employed by the modern Eskimo. But there are sufficient links to bridge the gap.

It would be possible, I believe, to trace the development of the old Bering Sea art into the modern if we had no more than the objects shown on plates 1 to 8, and those described by Jenness, Mathiassen, and Hrdlička. The transition would be somewhat sudden, it is true, and some of the designs might appear to be but little related. Fortunately, however, we now have additional data that throw light on a secondary stage of art development within the old Bering Sea culture. This new evidence makes it appear that the old Bering Sea art did not come to a sudden end, to be succeeded immediately by that of the modern Alaskan Eskimo, but that, on St. Lawrence Island at least, it entered upon a period of transition during which the designs became simpler, definitely foreshadowing the later Alaskan Eskimo art. Some of this material will be described in the following pages, and the conditions under which it was found, on Penuk and St. Lawrence Islands, will be briefly outlined.

THE PUNUK ISLAND AND CAPE KIALEGAK VILLAGE SITES

The three small Penuk Islands lie four miles off the southeast end of St. Lawrence Island. The largest island, on which the old village site is located, is slightly less than a half mile long and only a few hundred yards across at its widest point. The greater part of the island is covered with the usual tundra vegetation and is relatively flat, except for two rocky hillocks that rise suddenly from the southern side. To the west the island narrows and the tundra is replaced by a low sandy area covered with coarse grass. At the beginning of this sandy stretch, which is also the narrowest part of the island, is located the extensive kitchen midden which marks the site of the old village.

The last houses to be occupied were sunk into the top of the midden. They consisted of square excavations in which had been erected frameworks of whale bones and driftwood logs; there are 14 house pits besides numerous underground caches on the midden. The narrow tunnel-like entrances to the houses faced the sea, sometimes to the north, sometimes to the south. Of the logs which formed part of the framework scarcely any remain on the surface, but whale ribs and jaw bones are more plentiful.

The area covered by the Punuk midden is approximately 400 feet by 130 feet. The average depth is around 12 feet and the greatest depth, 16 feet. It is of particular interest to note that the lower parts of the midden are below the present beach level—at one place as much as six feet—and that at the very bottom were found houses and house entrances, six in number, all of which were below the reach of storm waves. The sinking of the land to this extent, together with the enormous accumulation of refuse, must undoubtedly indicate the passage of a considerable period of time. As a definite criterion of age, however, such a geological phenomenon is of questionable value at the present time, since there are not available any comparative data on recent subsidence and elevation in the Bering Sea region which might be interpreted in terms of years. The problem of the antiquity, at least the comparative antiquity, of the Punuk village site must rest mainly on cultural evidence.

To the west of the midden, near the end of the island, are four recent houses with roofs still partly intact, which were occupied up to about 40 years ago. It is not clear whether these were built by families who settled on Punuk after the abandonment of the main village or whether they were occupied by the last remnants of the original population.

Excavations were carried on at Punuk from June 23 to August 17, 1928. Assisting me were Mr. Harry E. Manca of Seattle and two, later three, Eskimos from St. Lawrence Island. Three of the recent houses toward the end of the island were excavated and two of the older houses on the midden, in addition to extensive cuts made through the refuse at various places. The midden sections and the two old house pits on the midden were taken down systematically, the material from the successive levels being kept separate.¹ Except for a surface layer which thaws out in summer, the ground is permanently frozen, making the work of excavation difficult and slow. The cuts were taken down in layers of a few inches, the process being repeated daily as the newly exposed frozen surface thawed by contact with the atmosphere.

The many specimens excavated from the midden village stood in striking contrast to the material from the three recent house ruins at the western end of the island. The latter yielded iron, glass, and only

¹In the following description of certain decorated objects from Punuk Island and Cape Kialegak, reference will not be made to the location and depth at which individual specimens were found, as this would only add unnecessary detail and call for a fuller description of the sites and method of excavation than is necessary at the present time, when the purpose is to describe only the art of the two sites.

modern types of artifacts of ivory, bone and wood, identical to those still being used on St. Lawrence or having been used there in recent years. At the old village, however, among the several thousand specimens excavated, there were only four small fragments of iron and two glass beads, although every inch of the soil was gone over with trowels. There was likewise not a single modern type closed socket harpoon head found, and the blades of the harpoons, lances, knives and adzes were all of slate. However, the presence of even these few pieces of iron and, more significant even, an occasional file mark on some of the specimens, indicates that at least during the later years of their stay on the island the people of the Punuk village were in possession of small quantities of European metal.

Late in July, I made a brief trip in an Eskimo whale boat to Cape Kialegak on the southeastern end of St. Lawrence Island where there was a deserted village with a kitchen midden even higher than the one at Punuk. The Kialegak people had occupied two villages; the older and smaller village was entirely prehistoric, judging from the objects dug from the midden, while the later and more extensive settlement only a few hundred yards distant had been established apparently at about the time of the abandonment of the earlier village and occupied until about 40 years ago. Proof of this was found in the midden, the lower levels of which yielded only ancient types of artifacts, including harpoon heads with open sockets and some with side blades, while in the upper levels, beginning at about 10 feet, were implements of the modern type accompanied by glass beads and numerous pieces of iron. The objects from the lower levels of the later village and all of those from the older site were of the types we had been finding at the old Punuk village. Cape Kialegak thus afforded valuable supplementary evidence, for the occupancy of the later village began at a period contemporaneous with Punuk but continued without break until recent years, whereas the old village on Punuk was abandoned at some unknown time within the proto-historic period and was succeeded, perhaps after a considerable interval, by the few recent houses at the end of the island.

This will serve as an outline of the conditions under which the specimens to be described were found and removed, and no further details of the procedure will be entered into at this time. Instead, discussion will be limited, with a few necessary exceptions, to the decorative designs on the objects themselves, to their relation with those previously described and those of the modern Eskimo, and to the bearing that they are believed to have on the larger problem of the

spread and relationships of early Eskimo culture in the Bering Sea and elsewhere.

On plate 9, *a*, *b*, *c* and *d*, are shown four fragmentary harpoon heads from Punuk and Cape Kialegak, the only specimens from these localities that belong, from their decoration, with the type of material illustrated on plates 1 to 8. Plate 9, *c* and *d*, are two closed socket harpoon heads, both water-worn to such an extent that the designs are almost obliterated. The harpoon head, *c*, has the same ornamentation as those shown on plate 1, but unlike them the blade slit runs parallel with the line hole. The circles are raised. Plate 9, *d*, in addition to being badly worn, shows evidence of having been trimmed down, the only part retaining the original decoration being that shown in the illustration. The remaining circle is elevated. This specimen

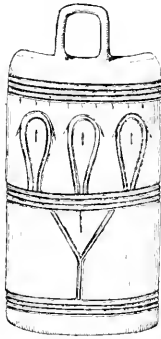

FIG. 2.—An ivory object of unknown use from Punuk Island.

was found at the base of the larger Kialegak midden. The two fragments, *a*, and *b*, also bear curvilinear decoration. These, as well as *c*, were found at depths of from three to ten feet in the Punuk midden.

With the exception of these four fragmentary specimens another and quite distinct type of decoration was found to prevail on Punuk and at Cape Kialegak. This occurs in such abundance and so nearly in isolation at these sites that it seems proper to refer to it as the Punuk type or phase of the old Bering Sea art. Plates 10 to 15 illustrate its various aspects. The exact distribution of the decorated objects from Punuk and Cape Kialegak is as follows: old curvilinear, 4 (those shown in pl. 9, *a-d*); Punuk type, 117; modern, 7; indeterminable, 13. The last group comprizes objects decorated so carelessly, or of which such a small fragment remains that it could not be determined whether they were of the Punuk or the modern type of ornamentation.

In figure 2 is shown an ivory object of unknown use found at a depth of 13 feet in the Punuk midden. It is thin and convex, and in

general shape is somewhat like the St. Lawrence Island wrist guard, although it has no slots or other openings through which a thong might pass except the handle-like loop at the top. This specimen is of particular interest in that the design combines features typical of the several stages of art in the Bering Sea region. The three petaloid figures are most suggestive of the older phase, while the deeply incised parallel lines in bands of four and the Y-shaped figure are characteristic of the Punuk and recent stages. The spurs attached to the lines and curves are common to all three stages, having been retained in the art of the Alaskan Eskimo from the earliest known times to the present.

Plate 10, *a-b*, represents an object of unknown use gracefully decorated in the style typical of Punuk. One wing is broken off. A complete specimen similar to this is shown on plate 13, *f*, from Cape Kialegak. In the present specimen there is a rectangular socket in the base 16 mm. deep which was made by drilling. From the socket a round hole 7 mm. in diameter extends through the base of each wing. The depression at the top of the central upright section and the socket at the base are features that were seen also in the object on plate 6. Lines terminating in dots, short converging lines enclosing dots, and small squares form the design, which is often found recurring in the Punuk style of the old Bering Sea art. The designs on the two sides are made continuous by the single connecting line that crosses over at the center of the wing on the inner side. The object from Point Hope¹ illustrated by Mathiassen is very similar in outline and practically identical as to the general style of ornamentation. In form it is intermediate between the present specimen and that shown on plate 6.

The two objects shown in *c-d* and *e*, plate 10, while not from Punuk Island or Cape Kialegak, are introduced for the reason that they represent a common St. Lawrence type and a variant of the class of objects illustrated by *a-b* of this plate, *a-b*, plate 6, and *a-b*, plate 7, and corresponding specimens described by Gordon, Jenness, and Mathiassen. In *c-d* are shown two views of one of these objects from St. Lawrence Island, purchased by Mr. H. W. Krieger. Like the specimen just described it has a basal socket and a small depression in the top of the central projection which, however, is joined to the wings. This socket is round and only 12 mm. in diameter, and in it is the broken end of the wooden shaft which probably formed its handle. The decoration on both sides consists of deeply and evenly

¹ Indian Notes, Vol. 6, No. 1, fig. 19.

incised straight and slightly curving lines, single or in bands of from two to four, with small spurs attached. Red ochre had been rubbed into the incisions and some of it still remains in place. The object shown in *e* differs only in minor details from the other. It came from Kukuliak, on the north side of St. Lawrence Island, and is owned by Mr. C. L. Andrews of Seattle.

These three specimens and the one on plate 6 seem to represent three rather widely variant forms of the same object. All have a basal socket, a central projection in the top of which is a shallow depression, and two wings, the latter especially being extremely variable as to size, shape, and position. My Eskimo workmen were unable to say definitely what had been the use of these objects, but one of them thought they might have been ornaments for the war helmets formerly used on St. Lawrence Island. However, I am more inclined to accept the explanation given by Gordon for the specimens he described—that they are charms used in ceremonies in connection with whale hunting. As to which of these forms is the oldest, the evidence seems to favor the type shown on plate 6. These bear the old Bering Sea curvilinear patterns, while the others are ornamented after the Punuk style, which, as will be shown later, appears without doubt to be more recent, at least on St. Lawrence, than the curvilinear. A further indication that the type shown on plate 10, *a-b*, is fairly recent is the fact that an unfinished specimen was found in the refuse from one of the last houses to be occupied on Punuk Island.

On plate 11 are illustrated a number of artifacts from Punuk and St. Lawrence Island bearing decorations typical of the Punuk style of art, with nucleated circles, straight or slightly curved lines, dots and spurs.

Plate 11, *a* and *b*, are two broken harpoon heads of the open socket type with slots for the lashing and with line hole parallel with the blade slit. This is the form of harpoon head most common on Punuk although a number of closed socket heads of a distinctive type, always ornamented, were also found. The decoration on the two specimens consists of lines extending from the barb toward the point, terminating in evenly inscribed nucleated circles, and similar lines, together with smaller cross lines and spurs, around the central line hole. The ornamentation of the upper portion, above the line hole, is the same on both sides; but on account of the open socket on the inner or under side, the decoration beneath the line hole is restricted almost entirely to the outer side.

The harpoon heads represented by *d* and *e* are of the same type as the two preceding. In *d* the circles are smaller and there are more

lines and spurs, while in *e* there are more circles on the barb than are necessary to balance the design.

These harpoon heads are intermediate in type between those bearing the curvilinear patterns such as illustrated on plates 1 and 2 and the modern, shown on plate 20. The open socket, flat shape, and rectangular slots for lashing are old; the decoration, although somewhat profuse, is more rigid and lacks the graceful flowing lines of the earlier period. A pattern of lines, circles, dots and spurs is never present on modern harpoon heads, although circles alone are found on a restricted type from the Nunivak-Kuskokwim region, and crude lines and triangles on others from the north coast of Alaska (see pl. 20). However, in shape as well as design these modern decorated harpoon heads differ essentially from the Punuk type.

In plate 11, *c*, is shown the end of a box handle simply decorated with the circle and dot, which might occur in either the Punuk or the recent period.

Plate 11, *f*, shows the upper end of a dart foreshaft from Kukuliak, St. Lawrence Island. In the top is a cavity 19 mm. deep and 12 mm. in diameter. The object has been used secondarily as a drill or reamer. The surface etching consists of lines, dots, circles and spurs.

In *g* is shown an object of unknown use. It is broken at one end, but the remaining decoration at this point, as well as the shape, suggests that there was originally a second wing similarly ornamented. The incisions are deeply and evenly cut and had been filled with red ochre. The design is made up of circles and spurs and straight or slightly curved lines, some of them forming bold Y-shaped figures. The opposite side is not ornamented.

The object illustrated by *h* is a wrist guard purchased at Gambell, St. Lawrence Island. The leather thong is modern. The design is very simple, consisting only of nucleated circles enclosed in panels formed by straight lines.

An ivory drill rest with a rather closely applied decoration of lines, dots, circles, and spurs is shown in *i*.

Comparison of the circles on the objects just described with those shown on previous plates reveals the significant fact that they are mechanically perfect as well as flat, while the circles and ellipses previously shown were usually raised above the surface and were always somewhat irregular, having been made free hand. The Punuk circles were engraved mechanically with an implement of some kind, probably a two-pointed compass of metal. The dots are usually from 2 to 3 mm. deep and the circles slightly less than 1 mm. The extreme pre-

cision of the cutting and the uniform depth and width of the lines, circles, and dots, give every appearance of having been produced with steel tools. On the other hand, no metal was found in the Punuk midden except four small fragments in the upper section. Furthermore, the great number of slate blades for harpoons, lances, knives, and adzes proves beyond a doubt that the Punuk people still depended on stone for their cutting, thrusting, and hewing implements, even though they may have possessed a few treasured tools of iron with which they decorated their ivory and bone implements. There is thus reason for believing that the Punuk settlement dates from the time when small quantities of European metal were first obtained through the Chukchi and Siberian Eskimo following the arrival of the Russians in Northeastern Siberia in the seventeenth century.

On plate 12 are illustrated eight specimens which differ from those on the preceding plate in that the decoration is made up of lines and dots instead of lines and circles.

In *a*, *b*, and *c* are represented three different types of harpoon heads bearing a similar ornamentation. The first two, *a* and *b*, have closed sockets, but *b* is flat and has the line hole parallel with the blade slit, while in *a* the line hole is at right angles and there is a sharp high longitudinal ridge on both sides above the line hole, as was seen also on plate 1. It is an interesting fact that every closed socket harpoon head found at the old sections of Punuk and Cape Kialegak was decorated, whereas the more common open socket heads were usually undecorated.

Plate 12, *c*, is of bone; it has an open socket, rectangular slots for lashing the foreshaft in place, and two deep slots for side blades. These were of shell and the lower parts are still in place. The slight projection brought about by cutting away a section of the edge at the end of the outer line below the lateral blade slots is a feature that was observed on several of the harpoon heads on plates 1 and 2.

The designs on *a* and *b* are in general very similar, despite the difference in shape of the two harpoon heads. Both have incised lines on the barb, around the line hole, and up toward the point. On *b* the dots are placed at the end of short lines while on *a* they are free; *a* also has spurs attached to the lines. The dots on *c* are connected with the lines, though not always at the ends as in *b*, and the spurs are shorter and more numerous than in *a*.

The object represented by *d* is broken at both ends and hollowed out like a spoon on the opposite side. The lines are more curved than those on the harpoon heads just described. The dots are almost 4 mm. deep and three of them pass completely through the specimen.

The terminal barb of a large closed socket whaling harpoon head is shown in *e*. The arrangement of dots and short lines within a long two-pronged figure is common on the smaller seal and walrus harpoon heads of Punuk and Cape Kialegak.

In *f* is shown an ivory object of unknown use decorated only on one side. The dots are somewhat more numerous than on most of the specimens. Two pairs of pronged figures enclosing four dots are attached to the central band where the sides gradually widen. Between these are six small dotted squares, such as are also found in modern Alaskan Eskimo art (see pl. 18, *a*).

In *g* is shown an object which may possibly have been one section of a double knife handle. The under side is flat and at the large end is a rectangular groove 33 mm. long, 7 mm. wide and 12 mm. deep, too large to serve as a slot for any but a very thick stone blade. A wide sunken groove extends around the surface for the purpose of lashing. There is a narrow rectangular perforation at the lower end. The decoration is a simple pattern consisting of a large triangle with two Y-shaped figures terminating in dots, three vertical lines with similar dots, and two plain oblique lines.

A very slender harpoon socket piece or foreshaft, probably for a toy harpoon, is shown in *h*. At the upper end is a small round hole 4.5 mm. deep for receiving the foreshaft or dart head. Somewhat above the center is a small rectangular perforation. The ornamentation consists of lines and spurs, the latter being attached only to the curved lines which enclose the pattern at both sides. Within these are three pairs of straight lines meeting at acute angles, with the lower ends coinciding with slight bulges along the sides.

Plate 13 illustrates seven artifacts from Punuk Island and Cape Kialegak on which the decoration is restricted to lines and spurs.

A closed socket harpoon head with blade slit parallel with the line hole is shown in *a*. The tip of the barb has been roughly cut off, leaving serrations having somewhat the appearance of inverted barbs. The lines and spurs are incised very deeply and still contain some of the red ochre with which they were formerly filled. In addition to the absence of circles and dots the pattern differs from those on the harpoon heads previously described in having a greater number of lines on the lower portion and in having short cross incisions at several places.

The second head, *b*, while an open socket type, has the same arrangement of blade slit and line hole and bears essentially the same decoration. It also has red ochre rubbed into the deep incisions.

The broken object shown in *c* represents a type of artifact of which five specimens are known thus far, three in the present collection and two in the collection of Mr. C. L. Andrews; one of the latter is shown on plate 14. In the present specimen there were originally five transverse perforations through which lines may have passed, a circular one at the center and each end, with two rectangular ones between. The rectangular groove at the end suggests that the object was attached to something by lashing. This groove was cut before the decoration was applied, for the lines stop just before reaching the edge. The surface rises gradually toward the center where there is a small cylindrical hole bordered by a circle and four long spurs. Around this inner circle are three larger rings, all with spurs attached, then two others which are not completed but which extend from the two central notches toward the ends; and finally, beyond the groove at the end—the other end is broken—a similar curve and three long spurs.

In *d* is shown another object for which I can suggest no use. It is slightly convex and has been broken and partly smoothed off at the larger end. At the smaller end is a circular hole which passes through the object. The two holes at the center are 6 and 8 mm. deep. Toward the large end is another hole in which is the broken end of an ivory plug and just beyond this still another which barely misses meeting one drilled from the under side. The decoration is confined to lines, with spurs, arranged in reference to the projecting and incurving outline. On the under side the decoration is simpler, consisting of a narrow band down the center which widens and, at the larger end, divides into two ladder-shaped figures.

It is unfortunate that so many of the objects most elaborately decorated have no analogies in modern Eskimo culture from which it would be possible to determine the purpose for which they were made. This applies also to the next specimen, *e*, a propeller-shaped object with two wings and on the under side a central projection through which is drilled a transverse circular perforation. The designs on the two wings are unconnected; they differ only in that there is an additional enclosing line on the left side. The under side is plain.

The small ornament, *f*, is of the type shown on plate 10, *a-b*. The slot in the base is round and 9 mm. deep and the central projection lacks the customary indentation on the top. The two wings are perforated near the base. The decoration will be seen to be practically identical with that of the other object as to outline, lacking only the dots and such additional lines as were made possible by the greater surface to be covered on the larger specimen. As in that case, the

design here is in two parts, one a connected line reaching to the tip of each wing and descending to the base, and another occupying the upright central projection, then passing up along the inner sides of the wings to continue on the opposite side in a similar but simplified design.

The object illustrated by *g* is flat on the bottom and is broken at one end, but from the design it may be judged to have come to a point as at the opposite end. The short cross lines in pairs, such as were observed on the harpoon heads, *a* and *b*, are here still more prominent. They divide into segments the space within the four long curving bands and serve to tie these together. There are also somewhat longer cross lines in the central panel, connected by a single straight line and enclosed at one end by a pair of lines that come to a point near the large circular perforation. This was drilled after the decoration was completed and passes through a double lined triangular figure similar to the one below.

On plate 14 is illustrated an object similar to the fragmentary specimen shown on plate 13, *c*. It is from Kukuliak, St. Lawrence Island, and is owned by Mr. C. L. Andrews. The five circular and rectangular perforations noted on the former specimen are visible here. At the center, instead of an elevation, is a circular depression. Within this are placed two roughly crescent-shaped figures which touch at the centers. Pendant from these are two short lines ending in dots, and in each crescent a central dot and a short cross line at the ends. Encircling the central concavity is a single line and beyond, in both directions, three additional curving lines. Between these are slightly curved triangular figures enclosing a central dot, their apices pointing outward, with the exception of the first one to the right which points back toward the center. On both sides of the triangles are single detached dots. The triangles on this object are very similar to those shown on plate 12, *d*.

The harpoon head shown on plate 15, *a*, has an open socket and as usual the line hole parallel with the blade slit. The incised lines forming the decoration are lightly applied. It has on each side two pairs of lines extending up toward the point and between these other lines that enclose the circular line hole in a narrow triangular pattern.

Plate 15, *b*, is a closed socket harpoon head with the upper end broken away. The blade slit appears to have run parallel with the line hole. The broken end of the foreshaft remains wedged in the socket. The decoration of lines and dots is quite similar to those on the harpoon heads shown on plate 12. The lines are still filled with red ochre.

In *c* and *d* are illustrated two interesting harpoon heads with en-

closed slots for lateral blades; *c* is of bone. It has an open socket and a bifurcated terminal barb; it is broken on the right side and may originally have had an additional smaller barb. The slot for the side blades passes completely through. An interesting feature—not shown in the photograph—is that on both sides along the sharp edge opposite and below the blade slot are additional grooves. The upper groove is 2 mm. deep and 17 mm. long and below it are two still smaller triangular depressions. All of these seem too shallow to have held stone or shell blades, and since there was originally a serviceable blade in the larger central slot these side grooves were probably only ornamental. The decoration consists of a few rather carelessly incised lines.

The harpoon head, *d*, has an open socket and a slot for side blades like *c*, and one of these, a semi-circular piece of slate with a sharp edge, remains in place. As in *c*, there are also two additional grooves on the sides opposite the blade slot, and these are so shallow that there can be no doubt but that they are ornamental. The decoration, while almost as meagre as on the preceding specimen, is more neatly applied. It consists of a pair of converging straight lines within which are two Y-shaped figures.

The three points to bird darts illustrated in *e*, *f*, and *g* are typical of Punuk Island and Cape Kialegak. The characters that mark the type are the three barbs on one side and two on the other; two lines down the center or just at the base of the barbs; a curving, sharpened base; a rectangular line slot near the barb; and two or three small notched projections along one edge near the base. This last feature is of especial interest since it is present as a decorative motive in modern Alaskan Eskimo art (see pl. 18, *c*).

In *h* is shown a piece of a box handle bearing a simple but pleasing pattern of large Y-shaped figures with dots at their bases, enclosed within two parallel lines.

In *i* is shown the end of an object of the type shown on plate 13, *c*, and plate 14. It bears a typical Punuk design of lines terminating in dots and with short cross lines forming small rectangular spaces.

The object shown in *j* is a fragment of an elaborate wrist guard from Gambell. If we may judge from a similar complete specimen from the same locality, this had a second wing curving in the opposite direction. While the lines follow the contour, the design is very similar to that of plate 13, *g*, except for the addition of long sharp spurs attached to the pairs of short cross lines.

Examples of carving in the round were extremely rare among the finds from Punuk Island. That these Eskimo were capable of excellent workmanship along this line, however, is shown by the remarkable

ivory figurine illustrated on plate 16. This represents a woman with long torso, prominent abdomen, pendant breasts and very short legs and forearms. An incision has been made in the left breast as if for suspension, and striations are seen across the upper arms and shoulders. The well defined curves, especially of the lower part of the body and the breasts, and the realistic treatment of the figure as a whole, produce an effect quite unlike that seen in the simple and stiffly conventional dolls of the modern Alaskan Eskimo. It is, however, somewhat similar to the armless dolls of the Anmassalik Eskimo.

More significant even than the scarcity of carving in the round was the total absence on Punuk of the pictographic art that is so characteristic of the modern Alaskan Eskimo. Etched realistic designs have not been found at any ancient Alaskan site so that this type of art must for the present be considered as recent.

RELATION OF THE PUNUK ART TO THE CURVILINEAR ART OF THE OLD BERING SEA CULTURE

We have seen on plates 10 to 15 a number of objects from Punuk and St. Lawrence Islands decorated in the manner characteristic of what it seems proper to call the Punuk phase of the old Bering Sea art, as represented at these localities. It shows significant differences from as well as resemblances to the older phase of this art as represented by the objects on plates 1 to 8 and those figured by Jenness, Hrdlička, and Mathiassen.

It will be observed first that both the Punuk and the older Bering Sea cultures abound in highly decorated objects of unknown use. Such are the winged objects shown on plates 6; 7, *a-b*; 10, *a* to *e*; 13, *f*; all of which are apparently related forms of the same class of highly variable objects, used most likely in whaling ceremonies or as individual charms.

One of the most striking differences between the prehistoric and modern Eskimo cultures in Alaska is found in the harpoon head. The only type used in Alaska at the present time has a closed socket. It often has also a small hole in the tip for a rivet which holds the blade in place; and often a slightly sunken area leading from the line hole to the base. The prevailing type of harpoon head from the old Alaskan sites lacks the last two features and has an open socket, with rectangular slots for lashing on the foreshaft. The harpoon heads from the old villages on Punuk Island and Cape Kialegak are without exception either of this open socket type or belong to a decorated closed socket type related in form to the old closed socket heads shown on plate 1.

In form, therefore, the Punuk harpoon heads belong with the old Bering Sea culture.

Very few other types of artifacts from old Bering Sea sites have been described, so there is as yet little with which to compare the bulk of the material collected at Punuk and Cape Kialegak. However, the resemblances to the old Thule culture of Canada and Greenland, to which it bears undoubtedly a close relation, and the corresponding absence of many modern Alaskan types, indicate beyond a doubt that the old Punuk and Cape Kialegak culture belongs almost entirely to the prehistoric phase, that is, to a period preceding the actual discovery of Alaska by the Russians.

A somewhat different condition is observed in regard to the ornamentation. While the forms of the objects themselves are distinctly ancient the decorations they bear depart radically from the ancient patterns and at times approach very closely the designs employed by the modern Alaskan Eskimo. First in importance, perhaps, is the circle and dot. In the old form this was seen to be always slightly irregular and often elliptical, showing unmistakably that it had been made free hand. In addition, it was usually raised above the surface. The circles of the Punuk period are not raised and are without exception perfectly round, having been made with a compass or bit, probably of metal. In some cases pairs of circles on the barbs and tips of harpoon heads still carry out the suggestion of eyes but the effect is greatly lessened by the addition of straight lines and the absence of the cuts and enclosing lines along the edges that in the older art combined to produce the appearance of an animal's head. Curved lines become much less frequent. Small checked or hachured areas and lightly incised broken or dotted lines are absent.

In addition to the compass-made circle and dot the Punuk art brings deeply incised straight lines, often in bands; pairs of short straight cross lines or single cross lines forming small squares or rectangles; long deeply-cut spurs in contrast to the more delicate and pointed spurs of the old art; the use of dots applied free or at the end of lines; bold Y-shaped figures, though not detached; and pairs of serrations on bird dart points occupying a raised border near the base.

Besides these specific features distinguishing the two art styles there is a marked difference in appearance due to technique. The old curvilinear designs were deftly applied; some of the lines were lightly etched while others, for contrast, were deeper. The impression received is that the artist exercised selective judgment as well as manual skill in the harmonious arrangement of the lines, curves and panels

that make up the composition. The Punuk art, on the other hand, shows no such discrimination. The lines are all uniform and usually quite deep. There is still a slight tendency to utilize the outline of the object for the enhancement of the design but not to nearly such an extent as in the older art. Designs are much more formal and rigid; on harpoon heads, for example, the relatively simple ornamentation is repeated almost exactly over and over again. The same adherence to convention is seen in many of the other objects, resulting in a fixed mechanical style, which though symmetrical and graceful in its simplicity, distinctly lacks the elasticity and exuberance that mark the finer products of the older Bering Sea culture as works of real art.

While the carving and surface decoration of the older objects bear evidence of high skill there is no reason why they should not be regarded as the result of cutting with stone tools. There is direct evidence, on the other hand, that metal was employed during the Punuk stage. The possibility that the evenly inscribed circles were made with a stone bit is extremely remote. The invariable uniformity in depth and width of the circles shows plainly enough that they could only have been produced by a very narrow, sharp and smooth instrument. The extreme precision of the other lines is evidence in the same direction. Reference has been made to the four fragments of iron found in the upper levels of the Punuk midden and to the file marks on a few of the artifacts. File marks are of more definite value as an aid to chronology than small fragments of iron, for the latter, even after eliminating the possibility of its being of meteoric origin, might still have reached its destination as wreckage, to be salvaged and utilized by the Eskimo. A file, however, could hardly have come into their possession in such a manner but must almost certainly have been obtained, even though indirectly, from a European or, possibly, Oriental source. With the Punuk midden yielding objects from top to bottom (along the outer edges only, however; the bottom of the midden at the center was not reached) showing decorations apparently made with metal tools and with an occasional specimen also showing file marks, we are forced to the conclusion, if the metal be regarded as European, that the Punuk settlement cannot be older than three hundred years; for it was toward the middle of the 17th century that the Cossacks began to penetrate Northeast Siberia, bringing metal which the Chukchi received and passed on in trade to the Siberian and Alaskan Eskimos. It is quite possible that the greater number of objects from the old Punuk site were carved with stone tools; certainly the hundreds of stone knife, harpoon, and adz blades found show that stone played an important part in their industries. The first few tools of

iron received may have been such prized possessions that they were used only for fine cutting and for decorating implements and ornaments.

It is somewhat difficult to reconcile the many outward evidences of antiquity at the old Punuk site with an age of only three hundred years. Even the houses on the top of the midden are now represented by nothing more than shallow levelled pits and fallen whale bones. Wood is absent to a conspicuous degree. The tremendous pile of refuse, reaching a total height of sixteen feet, and most significant of all, old houses at the very bottom of the midden and six feet below the reach of storm tides, would appear without doubt to be *prima facie* evidence of a considerable antiquity. If the metal could have reached Punuk Island from some Oriental source before the arrival of Europeans in eastern Siberia or in the North Pacific, it would be possible to allow an antiquity to the site more in keeping with its appearance. At present, however, this can be mentioned only as a possibility; it seems safer to consider the age of the Punuk site, at least provisionally, as not greater than three hundred years.

Whatever the age in years of the Punuk site it is without doubt later than the sites from which come the curvilinear art of the old Bering Sea culture. This is indicated by the difference in technique referred to and the fact that the Punuk ornamentation at times approaches very closely that of the modern Alaskan Eskimo.

Distribution affords further evidence. The old curvilinear art has been found at Point Barrow, Point Hope, Cape Prince of Wales, Northeast Siberia, the Diomed Islands, Imaruk Basin, St Lawrence Island, and one specimen is reported from Nelson Island. The Punuk type occurs on St. Lawrence and Punuk Islands and one example comes from Point Hope. While the few decorated specimens from mainland sites that have found their way into collections are of the old Bering Sea style, this need not mean that it is the only type present, for with the exception of Wales and the Diomedes we have no detailed first hand knowledge of any northern Alaskan sites. For the present, therefore, we must turn to St. Lawrence Island for anything like a comprehensive or comparative view.

The old curvilinear art has been found at Gambell on the northwestern end of the Island and at Kukuliak on the north side, with traces of it—four out of 141 decorated specimens—on Punuk Island and Cape Kialegak. The Punuk type prevails at Punuk Island and Cape Kialegak and appears to be much more common than the curvilinear at Gambell and Kukuliak. The explanation that appears to best fit these facts is that the northern and western St. Lawrence sites, such

as Gambell and Kukuliak, are older, having passed successively through the stage when the curvilinear art flourished, into that of the Punuk type, and finally into the modern. Punuk Island and Cape Kialegak, however, appear to have been settled either after or near the close of the curvilinear period, the occupancy continuing until recent years. This eastward movement would be in keeping with the reasonable assumption that the first settlements of Siberian Eskimo on St. Lawrence were made at the western end of the Island.

By any chance, could the Punuk art have coexisted with the curvilinear? In view of the distribution and considerations of technique this seems very unlikely. The presence of two contemporaneous art styles as distinct as these are, one consisting of deftly incised free hand circles, ellipses, curves and lines, and the other of cleanly cut, straighter, and more rigid designs evidently produced with metal tools, both, furthermore, purely decorative in character and both present on the same types of artifacts, would be a most unusual situation and one without parallel in Eskimo history. We must await stratigraphic studies at the western sites where the two types are known to be present before definitely settling the question of their chronological positions. But even assuming the two styles to have coexisted on St. Lawrence Island it would still be extremely difficult to account for the presence of only the single type at Punuk and Cape Kialegak, since according to all available evidence there has always been close intercommunication between the different villages on the Island. This exists today and that it existed formerly is indicated by the identity of much of the archeological material from one end of the Island to the other. It must certainly be regarded as significant that at Punuk Island, the only St. Lawrence site where intensive and systematic excavations have been made, there were found among the several thousand specimens, including 141 decorated objects, only four examples of the old curvilinear art and those fragmentary and water-worn; while at Gambell and Kukuliak the random digging of the Eskimos has brought to light a considerable number of objects decorated in both styles. The evidence, therefore, though not yet as direct and conclusive as might be desired, points plainly to the two art styles as representing different periods, with the curvilinear style as the older.

The question as to whether the Punuk style represents a purely local development on St. Lawrence Island must for the present remain unanswered. As to its being a firmly established type on St. Lawrence there can be no doubt; a greater number of specimens of the Punuk type have been found there than of the curvilinear. It is also significant

that only one example of it has been described from a site outside of St. Lawrence—the winged object from Point Hope described by Mathiassen. Thus, the present evidence seems to indicate that the Punuk style of art, if not entirely restricted to St. Lawrence Island, at least played a more dominant rôle there than elsewhere. We must have further knowledge of other old north Alaskan sites before the actual range of the Punuk style of ornamentation can be determined.

OBJECTS FROM PUNUK AND ST. LAWRENCE ISLANDS SHOWING MODERN DESIGNS

Reference has been made on page 17 to the finding of seven specimens in the old sections of Punuk and Cape Kialegak showing modern decoration. On plate 17 are shown six of these, together with two similarly decorated specimens from Gambell.

Plate 17, *a*, is probably one piece of a double knife handle. The decoration is thoroughly modern, consisting of two narrow bands containing alternating spurs, two small Y-shaped figures, and pairs of parallel lines. It should be mentioned perhaps that this specimen was found on the surface at the old village, where it might possibly have been lost by the later people who occupied the houses at the end of the Island within recent years.

Plate 17, *e*, represents a cord handle of modern type from Punuk Island. It is carved in the shape of a seal with a longitudinal hole through the base for receiving the line. Short straight lines are the only decoration.

In *f* is shown a wrist guard collected by Dr. Riley D. Moore at Gambell. It is of deeply stained ivory and bears the decoration of narrow bands and numerous alternating spurs generally applied to St. Lawrence wrist guards.

In *g* is shown another object from Gambell, the use of which is doubtful. It is decorated like the preceding specimen but with larger and more widely spaced spurs.

The object shown in *h* is a ferrule used on the end of the dog whip handle for disentangling the harness lines. The ornamentation of lines and spurs is carelessly applied.

The three bone tubes, *b*, *c*, and *d*, plate 17, from Punuk Island and Cape Kialegak, are probably needle cases. The simple decoration consists of encircling lines, spurs, and detached dots. A similar specimen was purchased which had been excavated from the old village at Gambell. Assuming these tubes to have been used as needle cases, it will be observed that they are practically identical with those

in use by the present Eskimo of the Yukon-Kuskokwim district. Two of these modern needle cases are shown for comparison on plate 18. We seem to have evidence in the St. Lawrence and Punuk specimens of a definite association between a certain ornamental type and a particular class of objects. The same simple ornamentation was found on a few additional specimens, some of which are shown on plate 17, but the bone tubes represent the only class of objects in which every example bears this simplified modern decoration. Its presence at the old sites shows that at a comparatively early period the designs that we think of as characteristic of the modern Eskimo were already established, although submerged or overshadowed by the more elaborate designs typical of Punuk. It is merely a simplification of these designs, however, and not something apart, for spurred lines and dots are among the constant features of the Punuk style.

On plate 9, figure 3, is shown the upper part of an old needle case of different form excavated at Gambell. It is of especial interest in connection with Boas' interesting study of needle cases¹ and Mathiassen's recent references thereto.² Boas concluded that the flanged tubular needle case of the Norton Sound region in Alaska and the winged needle case of the eastern Eskimo were derived from the same origin: "It seems to me very plausible that the Alaskan type and the Eastern type represent specialized developments of the same older type of needlecase, and that the flanges and diminutive knobs of the Alaskan specimens are homologous to the flanges and large wings of the Eastern specimens." Furthermore, he showed conclusively that the animal heads and human figures found on some of the Alaskan specimens were secondary adaptations of the original flanges and knobs: "The conclusion which I draw from a comparison of the types of needlecases here represented is that the flanged needlecase represents an old conventional style, which is ever present in the mind of the Eskimo artist who sets about to carve a needlecase. The various parts of the flanged needlecase excite the imagination of the artist; and a geometrical element here or there is developed by him, in accordance with the general tendencies of Eskimo art, into the representation of whole animals or of parts of animals. In this manner small knobs or the flanges are developed into heads or animals." Mathiassen questioned the validity of this view

¹ Boas, Franz. *Decorative Designs of Alaskan Needlecases: A Study in the History of Conventional Designs. Based on Materials in the U. S. National Museum. No. 1616, Proc. U. S. Nat. Mus., Vol. XXXIV, pp. 321-344, 1908.*

² *Archeology of the Central Eskimo, Vol. II, pp. 92-97.*

and concluded that "The Alaskan type seems to be a very locally restricted, special form, which has hardly anything to do with the origin of the winged needle case." On the other hand he considered that the Alaskan type of needle case in human form was the prototype of the winged needle case of the East. As evidence of this he points to two ancient needle cases of a modified winged type from Point Barrow, one of which has on each wing two oblique lines which "are apparently intended to indicate the hands bent in front of the body." The interpretation of these lines as hands is extremely doubtful. No single feature of the two needle cases suggests the human form and as for the pairs of oblique lines, they may be compared much more readily with the similar oblique lines on the lower parts of the flanges of many of the Alaskan specimens. The significant point, however, is that these two Point Barrow needle cases are in reality intermediate between the winged needle case of the East and the Alaskan flanged needle case, and not, as Mathiassen has supposed, between the winged case and the Alaskan case in human form. Comparison of the three types will, I believe, bear this out. The upper portions of the Point Barrow specimens are widened out like the Alaskan forms although there are no distinct flanges. The bands and spurred lines are known to both regions but their arrangement is more suggestive of the Alaskan cases. The "wings" are of the Eastern type but are much longer and narrower than in the typical Eastern needle case.

In the fragmentary needle case from Gambell, plate 9, figure 3, we have a modification of the Point Barrow type still further in the direction of the Alaskan flanged type. The general shape is that of the Alaskan case except that there are no flanges at the enlarged end; the bands with alternate spurs are common to both types; the two long incurving lines down the sides are the same as those on the Point Barrow specimens but they do not contain "wings." I consider that the Point Barrow and Gambell needle cases furnish further and conclusive evidence of the relation between the Alaskan and Eastern needle cases as demonstrated by Boas. It appears to me also that we may have here a possible explanation of the origin of the Eskimo needle case. The Gambell form may have been the prototype from which developed on the one hand the restricted Alaskan form with its flanges and knobs and on the other the Eastern form with its prominent projecting wings, the Point Barrow specimens representing an early stage in the development of the winged type. I do not care to stress this hypothesis, however. The Gambell type might as reasonably have been derived from the Point Barrow type, having retained the long incurving lines while losing the wings. Whatever the expla-

nation may be, it now seems very probable that the origin of the needle case when fully traced, will be found to be in Alaska; and that whatever form it may have had originally it was not a human or animal form, the occurrence of which among the Eskimo, as Boas has shown, can so often be attributed to the strong tendency of the artist to enliven and vary his handiwork by the occasional replacement of existing simple or geometric elements by life forms.

RELATION BETWEEN THE ANCIENT AND MODERN ART OF THE BERING SEA REGION

The objects illustrated on plate 18 are from Nelson's collection of modern Alaskan Eskimo material and are included to show certain designs of the Punuk period that have continued in use to the present time.

Plate 18, *f* and *g*, are the two needle cases previously referred to from the Kuskokwim and the lower Yukon, respectively. They are shown for comparison with the old needle cases from St. Lawrence and Punuk Islands illustrated on plate 17.

An animal carving from Bristol Bay is shown in *a*. Opposite rows of six oblique lines suggest the ribs while the seven small squares with enclosed dots are no doubt supposed to represent the vertebral column. Squares of this kind were also seen on plate 12, *f*, from Punuk, but they were not employed in a manner to suggest a realistic meaning.

In *b* is shown the under side of a woman's hair ornament from Agiukchugumut, to the south of Nelson Island. Like the preceding specimen it has a row of small squares but no dots. This is a fairly common design among the Alaskan Eskimo; it is to be compared with similar designs from Punuk shown on plates 10, *a-b*, and 15, *i*.

Plate 18, *c*, is a bodkin from Sledge Island. Two of the edges are carved with a series of notches or serrations in the tops of seven small elevations. This is the principal decorative motive on the lower end of bird dart points from Punuk, plate 15, *e, f, g*. Other modern examples are given by Hoffman,¹ plates 37, 5; 38, 4; 39, 3-4; and by Nelson,² plate XLIII, 23; and figure 20.

In *d* is shown a woman's workbag fastener and bodkin from the lower Yukon. It is introduced here to show the continuation among the modern Eskimo of the familiar decoration of lines with spurs attached. It should be compared with many objects of both the Punuk and the curvilinear stages shown on previous plates.

¹ Hoffman, W. J., *The Graphic Art of the Eskimo*. Rep. U. S. Nat. Mus., 1897.

² Nelson, E. W., *The Eskimo about Bering Strait*. 18th Ann. Rep. Bur. Amer. Ethnol., 1899.

Another workbag fastener, from Norton Sound, is shown in *c*, on which the decoration is restricted to bands of parallel lines. Similar designs were observed on specimens from the Punuk period shown on plate 10, *c-d*, and figure 2.

On plate 19 are illustrated additional objects from the modern Alaskan Eskimo showing typical designs that occur also in the Punuk stage. It is of considerable interest to note that in the modern material from St. Lawrence Island there are very few decorated objects of any kind, so that in order to find modern examples with which to compare the old art of St. Lawrence we must turn to the Alaskan mainland. This poverty of decoration on St. Lawrence is paralleled on the Asiatic side of Bering Strait, where the Yuit, the Siberian kinsmen of the St. Lawrence Islanders, also exhibit a striking deficiency in art. The reduction of the modern St. Lawrence Island and Siberian Eskimo to such a low artistic level can perhaps be best explained as the result of a relatively late Chukchee influence. The Eskimo of the Alaskan mainland, practically free from such influence, have merely retained a more abundant residuum of the highly developed ancestral art common to the entire region.

Plate 19, *a*, *b*, and *c*, are three objects from the modern St. Lawrence Eskimo, collected by Dr. Moore. The first, *a*, is a broken wrist guard with decoration similar to the one shown on plate 17, *f*, but with the addition of pronged figures to the lines and spurs. The two small bird figures, *b* and *c*, are simply ornamented with dots.

In *d* and *e* are illustrated a workbag fastener and belt buckle from the Kuskokwim region collected by Nelson, showing the well known nucleated concentric circles which are directly comparable to the compass-made circles of the Punuk period. It will also be observed that the centers of the circles, as is so often the case, have wooden insets. This is a feature that was also observed in the old curvilinear art, but which was not present on any of the objects from Punuk or Cape Kialegak.

Plate 19, *f* and *g*, are two modern specimens from Norton and Kotzebue Sounds, on which the spurs within the bands are so evenly applied as to make the uncut space between them appear as a continuous zig-zag.

On plate 20 are illustrated six modern harpoon heads showing the nature of ornamentation applied to these objects by the modern Alaskan Eskimo. By far the greater number of modern harpoon heads are undecorated, in contrast to the old specimens which often bear elaborate designs.

The large whaling harpoon head of bone, *a*, is from Point Hope. It bears a simple ornamentation of lines and spurs arranged about

the line hole in the manner characteristic of the Point Hope region, and likewise of Punuk, though the decoration on the harpoon heads from the latter locality is much more elaborate.

The two smaller harpoon heads, *b* and *c*, from Point Barrow, are simply decorated with lines, and on *b*, small hachured triangles. Red pigment has been rubbed into the incisions.

In *d* is shown a small harpoon head from Nunivak Island. It has a three pronged barb and a decoration of two concentric circles with spurs attached. Nunivak Island and the neighboring mainland are the only localities where circles and dots are applied to harpoon heads at the present time.

The small bone harpoon head shown in *e* is from the Semidi Islands, south of the Alaska Peninsula. Across one barb and extending obliquely up toward the center is a decoration consisting of a narrow band enclosing six small lines.

In *f* is shown a bone harpoon head excavated at Metlatavik, 22 miles above Cape Prince of Wales. On both the upper and lower sides is an elongated depression bordered by two lines, the outer one continuing to the base where it follows the bifurcated barb. Immediately above the line hole are two small grooves 5 mm. long, one on each side, which from the position and shape may be regarded as representing ornamental remnants of grooves for side blades.

Two modern seal dart foreshafts from Southwest Alaska, carved to represent the sea otter, are illustrated on plate 21. These are introduced for the purpose of comparison with the ancient ivory object on plate 5 and the somewhat more recent foreshaft shown on plate 9, figure 2. These two modern foreshafts illustrate the well-known tendency of the Eskimo of the Bristol Bay-Nunivak region to utilize life forms for the embellishment of their implements and weapons. An animal with open mouth and exposed teeth is a favorite decoration applied to the foreshaft of the seal dart. In *a* the eyes and nostrils are small cylindrical plugs of baleen, but in *b* they are merely shallow depressions filled with a bluish clay.

Plate 9, figure 2, represents the foreshaft for a light dart. This was bought at Teller, Seward Peninsula, and was reported to have been excavated on one of the Diomedes. It is $8\frac{1}{2}$ cm. long, but the lower end is missing. There is a circular perforation on the lower side for holding a thong, and in the forward end a circular hole 8 mm. deep for the dart head. The projecting ears are suggestive of a land mammal but the curves about the head suggest the gills of a fish. Apparently there was no intention to clearly represent any particular animal. The discs forming the eyes are of baleen. The object is a rich chocolate

brown but the ornamentation shows no direct relation with the old Bering Sea art with the exception of the spurs bordering the curving lines. The decoration is also of neither the Punuk nor the modern type. It may be that it represents an intermediate stage of art on the Diomedes between the old curvilinear and the modern. On the other hand it may be largely the result of individual fancy and have little or no significance as an art type. Its shape, however, is of more importance, and along with the older object shown on plate 5, might be taken to indicate a closer connection in early times between the art of Bering Strait and Southwest Alaska, or even, as was suggested before, to point to a possible ancient connection between the Bering Strait region and the Northwest Pacific Coast. I would again stress, however, that these few specimens are wholly inadequate from either the standpoint of numbers or of closeness of form and design, to afford more than a suggestion that future archeological investigations may reveal more dependable evidences of such a possible contact. If no such evidence should be forthcoming the realistic and symbolic art of Southwest Alaska could no doubt be safely regarded as the result of comparatively late Indian influence that furnished life motives around and within which these Eskimos continued to employ the geometric elements they possessed in common with the Alaskan Eskimo to the northward.

Comparison of the decorative art of the Punuk period with that of the modern Alaskan Eskimo reveals numerous striking similarities as well as certain important differences. On plates 18 and 19 are shown examples in which individual designs have been carried over without change. However, these designs are differently applied on the modern objects. The decorative elements are usually detached, or, if connected, are repetitive. The decorated objects of the Punuk period, on the other hand, are generally marked by a certain continuity of design. This may be observed on practically all of the typical Punuk examples, whether as on plate 12, where the lines and dots are somewhat sparingly applied, or on plate 13, where the lines and spurs cover all of the available surface.

The three principal elements in Eskimo art: the spurred line, the Y figure, and circle and dot are seen to have been present, though usually in different form, in either or both the curvilinear stage of the old Bering Sea culture and the succeeding Punuk stage. The spurred line is a common feature to both stages; the Y figure does not appear in the earlier curvilinear art but in the more angular art of the Punuk period it is a common design although it differs from the modern pronged or Y figure in being larger and in being connected with a unit

design; whereas in the modern art it usually rises from a base line and stands detached. The nucleated circle occupies a most important place in the decorative scheme of early Eskimo art. It was shown to occur in the old Bering Sea culture as a slightly irregular, often elliptical figure, engraved free hand and apparently with stone tools. It then follows in the Punuk stage as a perfectly symmetrical, cleanly cut circle, made with a compass or bit which almost certainly was of metal. In the modern art it is made in exactly the same way, although it is usually represented as a more or less detached element instead of an integral part of a connected design as in the old curvilinear and Punuk stages.

The distribution of the circle and dot design in Northwestern America has recently been studied by Dr. Leslie Spier and Miss A. Dorothy Smith.¹ The following statement is made: "This has often been looked on as a typical Eskimo decoration. But we are able to show by its distribution that it is more clearly characteristic of the Indians of the northwest, with only a limited distribution among the Eskimo." In conclusion, the following statement is made: "In western Alaska the great elaboration of the dot and circle into a series of concentric circles numbering frequently five and six may be dependent upon iron tools. The extreme regularity of the circles speaks for the likelihood of the use of bits of various sizes. This, however, does not solve the problem of the simple nucleated circle which is probably older and, together with the alternate spur design, the basic unit from which the elaborate decorations are made. Two reasons can be given for this view. First, it is simple and possible to accomplish with stone implements. Second, in its simple form as a single dot and circle it has a wide and fairly continuous spread down the Pacific coast, and a wide if sporadic distribution in Eskimo territory. If the Alaskan decoration had been imitated, we would expect to find some similar examples elsewhere."

The principal value of such studies of spatial distribution lies in the light they may be able to throw on the problem of the origin and spread of culture traits when more dependable data revealing a direct time sequence are lacking. In the present case there was some justification for regarding the circle and dot in Alaska as derivative, in view of its greater spread among the Indian tribes to the southward and in the absence of conclusive archeological evidence to the contrary. Considered in the light of recent archeological developments in Alaska, however, the validity of this conclusion can no longer be upheld.

¹ The Dot and Circle Design in Northwestern America. *Journ. Soc. Americanistes de Paris*, XIX, pp. 47-53.

There is now clear evidence of the antiquity of the circle and dot design in northwestern Alaska where it is seen to have formed the basic element in a very old art style. There is, on the other hand, no evidence of the antiquity of the design over the wide area outside of Alaska where it is now found except possibly at certain sites excavated by Harlan I. Smith in British Columbia and Washington.¹ The antiquity of these finds was regarded as questionable, however, Smith being of the opinion that the design in this region was relatively recent. Wherever the circle and dot may have originated, among the Alaskan Eskimo at least it was indigenous, having developed from an earlier Alaskan culture. That this earliest known form of the Eskimo circle and dot may have had its origin to the southward is, of course, possible, but there is at present no evidence pointing in that direction.

The various elements that enter into the composition of the designs of the old curvilinear Bering Sea art, the later Punuk stage, and the modern have been examined. In order that these three stages may be directly compared the observed resemblances and differences are given below in tabular form. A + sign indicates the presence and a - sign the absence of a feature.

	Curvilinear Stage	Punuk Stage	Modern
Free hand circles.....	+	-	-
Compass made circles.....	-	+	+
Elliptical figures	+	-	-
Raised circles and ellipses.....	+	-	-
Circles suggesting a pair of eyes.....	+	+	-
Circles between converging lines.....	+	-	-
Small plugs at centers of circles.....	+	?	+
Curved liplike projections.....	+	-	-
Curving lines	+	+	Rare
Short cross lines.....	-	+	+
Broken lines	+	-	-
Deeply cut lines.....	+	+	+
Lightly cut lines.....	+	Rare	-
Lines in straight bands.....	-	+	+
Dots within circles.....	+	+	+
Dots at ends of lines.....	-	+	-
Dots detached	-	+	+
Straight and oblique spurs.....	+	+	+
Alternate spurs	-	Rare	+
Hachured areas	+	-	+
Y figure	-	+	+
Small squares or rectangles.....	-	+	+
Ornamental serrated edges.....	-	+	+
Red pigment rubbed in lines.....	?	+	+

¹ Archeology of the Yakima Valley. *Anthrop. Papers Amer. Mus. Nat. Hist.*, 6, Pt. 1, 1910, p. 131.

Archeology of Lytton, British Columbia. *Mem. Amer. Mus. Nat. Hist.*, 2, Pt. 3.

Of the 24 features listed above, the presence or absence of 19 among the three culture stages can be clearly recognized. The groups into which these are divided are as follows: from the old curvilinear alone, 6; from the Punuk stage alone, 1; common to all three stages, 3; to the old curvilinear and Punuk stages, 1; to the Punuk and the modern, 7; to the old curvilinear and the modern, 1.

The quantitative arrangement of such elements gives of course an imperfect picture of actual resemblances and differences, due to the varying value of the elements treated and the necessity of restricting it to the detached, objective elements of the art style considered apart from the total decorative scheme. There is also the difficulty that minor changes and gradations, which are of importance in revealing the interrelations of the several culture stages, cannot be adequately expressed. Nevertheless, it serves to emphasize the point brought out previously, that the Punuk phase of the old Bering Sea culture, while still characterized by the ancient types of implements and weapons, shows in its decorative art a closer relation to the modern Eskimo than to the preceding curvilinear stage of the old Bering Sea culture. On St. Lawrence Island, at least, it represents a transitional stage between the richer curvilinear art and the modern art of the western Eskimo. Its possible distribution beyond St. Lawrence and the place it may have had in the sequence of ancient Eskimo cultures elsewhere cannot be determined until more information is available on northern Alaskan sites.

RELATION OF THE OLD BERING SEA CULTURE TO THE BIRNIRK CULTURE OF NORTHERN ALASKA AND THE THULE CULTURE OF CANADA AND GREENLAND

One of the most important problems that arises in connection with the ancient Bering Sea culture is to determine its range and relationship to ancient Eskimo cultures elsewhere.

According to the rather scanty evidence available, the ancient Bering Sea culture appears to have extended from St. Lawrence Island and the northeastern coast of Siberia eastward beyond Bering Strait to Point Barrow, and typical harpoon heads have been found as far west as the Kolyma River. For the Point Barrow region we have Wissler's description of harpoons and darts collected by Stefansson in 1912, and in addition the later Van Valin collection from the same region. From Wissler's¹ paper and from Mathiassen's² references

¹ *Anthrop. Papers Amer. Mus. Nat. Hist.*, Vol. XIV, Pt. II, 1916.

² *Indian Notes*, Vol. 6, No. 7, p. 52.

to the Van Valin collection it is seen that the decorated artifacts from the Point Barrow region are of the type illustrated here on plates I to 8. More important than the decorative art in this instance, however, is the presence of a certain form of harpoon head, called by Mathiassen the Birnirk type, which appears to be characteristic of the oldest sites around Point Barrow. These harpoon heads have open shaft sockets and rectangular slots for lashing, but the features that most strikingly set them apart are one or more side blades of stone and two or more obliquely placed terminal barbs. At Birnirk, which from Stefansson's other data is regarded as the most ancient of the sites about Point Barrow, this harpoon head is the dominant type; at Cape Smythe, the next oldest site, it is also found but in association with later forms of harpoon heads and other artifacts; at the site of the modern Point Barrow village it is rarely found. Mathiassen considers that the Van Valin collection from near Point Barrow represents a still earlier period.

Jenness does not mention finding true Birnirk heads at Wales or the Diomedes, but in a plate illustrating the evolution of the harpoon head in northern Alaska he places it as the oldest form.¹ The finds at Punuk Island and Cape Kialegak bear out this interpretation, though in a somewhat indirect manner. I was not so fortunate as to obtain a direct sequence of harpoon types at either of these sites except that the modern closed socket harpoon head was found invariably restricted to modern ruins and the upper levels of the later Kialegak midden. Comparatively few Birnirk type heads were found, but it is significant that all of these came from the lower levels of the middens. It is also of interest to note that, while the great majority of the harpoon heads from these two sites were of ivory, only one of the Birnirk type was of this material, the others being of bone; and further that the only other bone harpoon heads found were very thin open socketed forms, with no blade slit and usually with an irregular or obliquely placed terminal barb, features all suggestive of the Birnirk heads, lacking only the side blades and the bifurcated or trifurcated barb. Of three Birnirk type heads purchased at Gambell two were of bone and one of ivory. It appears, therefore, that we have here a fairly definite association between material and form, the Birnirk and a possible immediate derivative type being of bone. The presence of these bone harpoon heads, restricted to the lower levels of sites yielding otherwise only those of ivory may be regarded as presumptive evidence in favor of their being one of the oldest if not the oldest type of

¹ Ann. Rep. for 1926, Nat. Mus., Canada, pl. XII.

harpoon head represented on St. Lawrence Island as well as on the Arctic coast of Alaska. The occurrence of the Birnirk type in practical isolation at the ancient sites around Point Barrow would seem to favor the view that these sites were older than the St. Lawrence sites where the type is associated with other forms. This cannot be stated with any degree of certainty, however, until it is possible to make more comprehensive comparisons between the material from the several sites.

To the east of Alaska, in Northern Canada, Baffin Land and Greenland, are found the ruined settlements of Eskimo who preceded those occupying the same regions today and whose culture has been so thoroughly described by Mathiassen. The ancient culture represented at these sites he has designated as Thule, from the locality in north-western Greenland where it was first found. Concerning the origin of the Thule culture and its relation to other Eskimo groups, Mathiassen makes the following statement:

When going through the elements of the Thule culture we have time after time had occasion to observe the close connection which apparently exists between the Central Eskimo Thule finds and certain groups of Western Eskimos, especially their most Arctic sub-groups at Pt. Barrow and East Siberia. That in former times there has here been a very close and intimate connection cannot be doubted. The question is then merely whether the migration has proceeded from the central regions towards the west or vice versa, whether the Thule culture has originated in the central regions or the western regions. As has already been stated, the Alaska culture has, in many respects, remained at a more primitive, more original stage than the culture in the central and eastern Eskimo regions. Now the question is whether in the time of the Thule culture too it did this or whether the opposite is the case. . . . In the Central Eskimo finds there are elements the prototypes of which we only know from the western regions and which consequently must have come from there; thus these are types which must have developed in the west from earlier forms and which have only wandered eastwards in their later form, where we now find them in the Thule culture. . . . We must therefore imagine that the Thule culture, with all its peculiar whaling culture, has originated somewhere in the western regions, in an Arctic area where whales were plentiful and wood abundant, and we are involuntarily led towards the coasts of Alaska and East Siberia north of Bering Strait, the regions to which we have time after time had to turn in order to find parallels to types from the Central Eskimo finds. There all the conditions have been present for the originating of such a culture, and from there it has spread eastwards right to Greenland, seeking everywhere to adapt itself to the local geographical conditions. And it can hardly have been a culture wave alone; it must have been a migration.¹

The evidence that leads Mathiassen to this view is, I believe, clear and convincing, and there can be no doubt that the interpretation advanced is in the main correct.

¹ Archeology of the Central Eskimo, Vol. II, pp. 183-184.

Comparison of the decorated objects and harpoon heads of the Thule culture with similar material from the new collections from old Bering Sea sites appears to throw additional light on the time relations involved. Comparatively few examples of decorative art are included in the Thule finds, and what there is shows but little resemblance to the ancient Alaskan art. It is, however, very similar to modern Alaskan art. Lines, spurs, the Y figure, and the dot are the geometric elements represented; the circle was not found. Most significant, however, is the presence in the Thule culture of a few crude examples of realistic etchings of animals and objects.¹ This type of art has never been found at an ancient site in Alaska, although it is a most characteristic feature of modern Alaskan Eskimo art. The Thule culture, therefore, with an art style very close to that of the modern Alaskan Eskimo can hardly have been older than the ancient Bering Sea culture which dates from a time when realistic art apparently had not yet appeared. A possible explanation of the origin of the realistic or graphic art of the modern western Eskimo might be that it was derived from the Thule culture through a return migration within the past few centuries, subsequent to the original eastward spread of the Thule culture. In this way could be explained the absence of realistic art at the old Alaskan sites and its presence at the old Thule sites to the eastward. But even if the realistic art of the Thule culture should be assigned a greater antiquity than in the western regions, the origin of the geometric art found at the same Thule sites would remain to be explained. It has been shown that the ancient Bering Sea art embodied the principal basic elements that are found in the simplified geometric art of the modern period—and of the Thule culture; the geometric art of the west, therefore, can be adequately explained as a local growth and there is no necessity in looking for its source elsewhere.

Among the harpoon heads from Thule sites there are many that show features known in the western regions only from a comparatively late period. First, it will be noted that even at the oldest Thule sites drilled holes for the lashing of the foreshaft are found, whereas Jenness finds this type of lashing to be later at Bering Strait than the use of rectangular slots. It is also late on St. Lawrence Island, and while it appears not to have been a common type, there is one example in the National Museum collection having an iron blade and a small peg at the upper end for holding it in place. On Punuk Island only one harpoon head with drilled holes was found, and this again

¹ *Archeology of the Central Eskimo*, Vol. II, pp. 120-125.

had a small hole for a peg at the upper end and a triangular line hole with groove leading to the base. This head was found at a depth of about three feet, but inasmuch as it was just below the wooden floor of a house it might possibly have fallen into that position while the house was still occupied.

The small peg for holding the blade in place is also an important feature. It is common in modern harpoon heads from Alaska and eastern regions and also from the Thule culture (see Mathiassen, Vol. 1, p. 25 and pls. 39, 40, and 67,) but is not found at the ancient Alaskan sites.

Decoration when present on the Thule harpoon heads is restricted to plain Y-shaped figures about the line hole, with an occasional enlargement of the figure into a triangular hachured area (see Mathiassen, Vol. 1, pls. 1, 37, 69, and 72). In Alaska designs of this simple type are found only on recent or moderately old harpoon heads from the Arctic coast (see pl. 20; and Wissler, figs. 7, 8, and 21).

Mathiassen describes certain Thule harpoon heads that have ornamental remnants of side blades, which he regards as an indication that they represent survivals of an earlier Alaskan form with side blades of full size. An additional example of residuary or ornamental side blade grooves is found in the small harpoon head illustrated on plate 20, *f*, excavated at Metlatavik, 22 miles north of Bering Strait. The material recovered from this site included iron and glass beads, showing that the settlement was probably not more than 200 years old. This example of residuary side blade grooves from a late Alaskan site may be regarded as further confirming the explanation advanced by Mathiassen for the Thule harpoon heads showing the same feature.

I am at present inclined to regard as also recent in Alaska the small ivory bird figures that are found in considerable numbers at the Thule sites. These were also numerous in the later Cape Kialegak midden and in the recent houses on Punuk Island, but in the Punuk midden, where much more excavating was done, only four were found. Furthermore, none that I have seen from other St. Lawrence or Alaskan sites has had the deep patination that always marks the ivory objects of the oldest Bering Sea period.

Of the features last named, drilled holes around the sockets of harpoon heads for lashing on the foreshaft, small pegs at the tip for holding the blade in place, and the ivory bird figures, may, like the realistic etchings, have had their origin in the east and been carried to Alaska by a late wave of migration. The important point to note, however, is that even though such features as these were derived from the Thule culture, they were nothing more than late additions

to the already highly developed Bering Sea culture. The Bering Sea culture appears without doubt to be the older culture. The Thule culture originated as a direct outgrowth from the other and whatever traits it may in turn have disseminated to the westward were late and had nothing to do with the origin of the Bering Sea culture as a whole.

Jenness speaks of a definite Thule stage in Alaska but also regards it as relatively late: "The writer may hazard an opinion, based, it is true, on evidence not altogether sufficient, that there were Eskimos living south of Bering Strait before the Thule culture established itself in Arctic Alaska whose culture attained a level as high as, or higher than, any known today and whose influence reached as far to the north as Point Barrow."¹

We have seen that Mathiassen in his Thule report recognized that the Thule culture was derived from Alaska. In his later publication, however, he discusses the relation between the Thule culture and the ancient culture represented at Birnirk, near Point Barrow, and concludes that the former is the more ancient: "Are the Birnirk or the Thule harpoon heads the older? . . . The simple shape and the geographic distribution speak in favor of the Thule heads being the older, the side blades (found only as remnants on Thule heads) and partly the patination speak in favor of the Birnirk heads."² The range of the Thule harpoon heads is then discussed and the following statement is made: "This seems to indicate that at a certain period these harpoon-heads were in use from East Siberia to Greenland. But in northern Alaska this continuous chain was broken and the Birnirk heads took their place; the Van Valin collection is from a period very close to the time this change occurred; later on we have the development indicated by the names Birnirk—Cape Smythe—Point Barrow, until we reach the recent culture stage. If the pure Thule culture has to be included in this chain it must be as the *oldest* link. Thus the Thule harpoon-heads must be older than the Birnirk heads."³

As to the first statement, that "the simple shape and the geographic distribution speak in favor of the Thule heads being the older," it seems to me that recent archeological discoveries in the North show above all else that the sequences that can as yet be traced in Eskimo culture have been in the line of simplification or even degeneration (especially in regard to art) and not of the development of simple into more complex forms. The further back Eskimo culture is traced the more intensified and complex it is seen to become. This observed

¹ Amer. Geogr. Soc., Special Publ. No. 7, pp. 170-171.

² Indian Notes, Vol. 6, No. 1, p. 52.

³ Indian Notes, Vol. 6, No. 1, p. 54.

tendency and the reasons previously given for considering the Bering Sea culture as more ancient than the Thule culture, appear to me to be quite sufficient to show that the point raised by Mathiassen, namely, that the simple shape of the Thule heads is an indication of their being older, is on the contrary another indication of their being later.

The attempt to place the Thule culture as earlier than that represented at Birnirk or any other ancient Alaskan site meets with the difficulty that certain characteristic features of the Thule culture are found in Alaska only as late developments or accretions. Typical Thule harpoon heads were found in abundance on Punuk and St. Lawrence Islands, but accompanying these were other types not known from the Thule culture, such as those with multiple barbs and real side blades which, according to stratigraphic evidence, appear to be the oldest of all. This seems to be the general situation in the vicinity of Bering Strait. Wherever sizable collections have been made, the harpoon heads appear in numerous forms, including the various Thule types, the closed socket highly ornamented heads, and those with multiple barbs and side blades, but never, unless at a fairly recent site, are there found harpoon heads with drilled holes for lashing, bone pegs through the upper end, and simple Y figures or hachured decoration about the line hole, such as belong to the Thule culture. According to the available evidence, therefore, the Thule culture of the East appears to have been derived from the ancient Bering Sea culture after the latter had become firmly established on the Islands and mainland of Alaska and Siberia about Bering Strait, to the eastward as far as Point Barrow, and to the westward possibly to the Kolyma. The possibility is recognized, however, that certain later features in Alaska may have been the result of a westward or return migration or of less direct Thule contact subsequent to the original eastward movement of the Thule culture.

In the foregoing review we have examined the art of the ancient Bering Sea culture, the features that distinguish it from the later Punuk phase on St. Lawrence Island, and its relation to that of the present Alaskan Eskimo and the extinct Thule culture of the East. Since it seems clearly to have antedated the Thule culture, the oldest of which we have definite knowledge in the eastern regions, it may be said to represent the oldest known stage of Eskimo culture. It is far from being a primitive culture, however. It is, on the contrary, the most highly developed culture especially in art, that has appeared in the Arctic or sub-Arctic regions; and its discovery, instead of clarifying the problem of the origin of Eskimo culture as a whole, has

only resulted in showing that we must go much further back before that origin is revealed.

The earlier stages leading up to the old Bering Sea culture are as yet unknown; to bring these to light is the most important immediate task that awaits archeological research in the Arctic. Hrdlička and Jenness, whose researches in 1926 brought to light the first definite evidences of this ancient Eskimo culture, are inclined to look toward Siberia as the most likely place of its origin. Jenness says: "We seem justified, therefore, in concluding that the shores and islands of Bering Sea were at one time the home of a distinct and highly developed Eskimo culture, a culture marked by special types of harpoon-heads and other objects that in many cases show the most skilful workmanship, marked too by a very original art, partly geometrical and partly realistic, that suggests in some of its features contact with the Indians of the northwest coast of America, although its roots more probably lie in northeastern Asia."¹

While it is too early yet to speak with any assurance on this important point, the evidence at hand attests the reasonableness of such a view. The close relation which has always been recognized between the St. Lawrence Island Eskimo and those of northeast Siberia is seen to have extended far back into the past. St. Lawrence Island, due perhaps to peculiarly favorable environmental conditions, was certainly one of the principal centers at which this old culture flourished, although from the scanty knowledge we have of the archeology of the Alaskan Arctic coast it seems that an equally high development may have taken place around Point Hope. The still more fragmentary data available from northeast Siberia show that the old Eskimo culture existed there also, not only within the restricted area occupied by the present Asiatic Eskimo, but far beyond this, even to the Kolyma River. The enormous and practically unknown stretch of coast from Indian Point northward to East Cape and thence westward to the Kolyma seems the most likely region in which to search for the beginnings of the ancient Bering Sea culture, which in its later stages produced in Alaska an Eskimo culture of unparalleled richness, gave rise to the highest Eskimo culture of the eastern regions, the Thule culture, and formed the basis of the existing culture of the Eskimo of Alaska and Siberia.

¹ Ann. Rep. for 1926, Nat. Mus. Canada, p. 78.

EXPLANATION OF PLATES

PLATE 1

- a-b*, Harpoon head, northern Alaska. 13.8 cm. long. Owned by Messrs. Albert and Wilfred Berry.
- c*, Harpoon head, northern Alaska. 9.4 cm. long. Washington State Museum.
- d*, Harpoon head, Sevuokok, St. Lawrence Island. 10.5 cm. long. Cat. No. 344580, U. S. Nat. Mus.
- e-f*, Harpoon head, northern Alaska. 15.2 cm. long. Washington State Museum.

PLATE 2

- a-b*, Harpoon head, northern Alaska. 9.8 cm. long. Washington State Museum.
- c-d*, Harpoon head, northern Alaska. 9.1 cm. long. Washington State Museum.
- e*, Harpoon head, Kukuliak, St. Lawrence Island. 10.2 cm. long. Cat. No. 341205, U. S. Nat. Mus.
- f*, Harpoon head, northern Alaska. 6.2 cm. long. Washington State Museum.
- g*, Harpoon head, St. Lawrence Island. 6.8 cm. long. Owned by Mr. C. L. Andrews.
- h*, Harpoon head, St. Lawrence Island. 9.5 cm. long. Owned by Mr. C. L. Andrews.

PLATE 3

- a*, Box handle of bone, Sevuokok, St. Lawrence Island. 21.7 cm. long. Cat. No. 344566, U. S. Nat. Mus.
- b*, Box handle of ivory, northern Alaska. 13 cm. long. Washington State Museum.

PLATE 4

- a*, Ivory object, Nelson Island. 18 cm. long. Washington State Museum.
- b*, Ivory object, northern Alaska, 14.3 cm. long. Owned by Messrs. Albert and Wilfred Berry.

PLATE 5

- Ivory object, Imaruk Basin, Seward Peninsula. 10.5 cm. long. Owned by Rev. C. K. Malmin.

PLATE 6

- Ivory object, Point Hope. 20.5 cm. long. Cat. No. 42927 U. S. Nat. Mus.

PLATE 7

- a-b*, Ivory object, broken, Alaska. 7 cm. long by 5.5 cm. high. Cat. No. 344675, U. S. Nat. Mus.
- c*, Part of harpoon socket piece, Sevuokok, St. Lawrence Island. 14.8 cm. long. Alaska Agricultural College, Fairbanks.

PLATE 8

- a-b*, Ivory object, Point Hope. 13.6 cm. long. Cat. No. 76680, U. S. Nat. Mus.
c, Part of harpoon socket piece. Alaska. 8.7 cm. long. Cat. No. 344676, U. S. Nat. Mus.

PLATE 9

- FIG. 1. *a*, Terminal barb of harpoon head, Punuk Island. 3.1 cm. long. Cat. No. 343225, U. S. Nat. Mus.
b, Middle section of harpoon head, Punuk Island. 3.5 cm. long. Cat. No. 344038, U. S. Nat. Mus.
c, Harpoon head, Punuk Island. 11.1 cm. long. Cat. No. 341164, U. S. Nat. Mus.
d, Harpoon head, Cape Kialegak, St. Lawrence Island. 7.7 cm. long. Cat. No. 342878, U. S. Nat. Mus.
- FIG. 2. Upper end of dart foreshaft, northern Alaska. 8.5 cm. long. Cat. No. 344674, U. S. Nat. Mus.
- FIG. 3. Upper end of ivory needle case, Sevuokok, St. Lawrence Island. 5.8 cm. long. Cat. No. 344543, U. S. Nat. Mus.

PLATE 10

- a-b*, Ivory object, Punuk Island. 9 cm. high. Cat. No. 343141, U. S. Nat. Mus.
c-d, Ivory object, Alaska. 6.5 cm. long by 8 cm. wide. Cat. No. 344677, U. S. Nat. Mus.
e, Ivory object, Kukuliak, St. Lawrence Island. 5.1 cm. long. Owned by Mr. C. L. Andrews.

PLATE 11

- a*, Harpoon head, Punuk Island. 7.1 cm. long. Cat. No. 344034, U. S. Nat. Mus.
b, Harpoon head, Punuk Island. 7 cm. long. Cat. No. 343945, U. S. Nat. Mus.
c, End of box handle, Punuk Island. 8.8 cm. long. Cat. No. 343199, U. S. Nat. Mus.
d, Harpoon head, Punuk Island. 9.1 cm. long. Cat. No. 344021, U. S. Nat. Mus.
e, Harpoon head, Cape Kialegak, St. Lawrence Island. 10 cm. long. Cat. No. 342962, U. S. Nat. Mus.
f, Upper end of dart foreshaft, Kukuliak, St. Lawrence Island. 7.7 cm. long. Cat. No. 344601, U. S. Nat. Mus.
g, Ivory object, Punuk Island. 10.8 cm. long. Cat. No. 343370, U. S. Nat. Mus.
h, Wrist guard, Sevuokok, St. Lawrence Island. 10 cm. long. Cat. No. 342744, U. S. Nat. Mus.
i, Drill rest, Punuk Island. 13.7 cm. long. Cat. No. 343427, U. S. Nat. Mus.

PLATE 12

- a*, Harpoon head, Punuk Island. 8.5 cm. long. Cat. No. 343215, U. S. Nat. Mus.
b, Harpoon head, Punuk Island. 9.1 cm. long. Cat. No. 343162, U. S. Nat. Mus.
c, Harpoon head, Cape Kialegak, St. Lawrence Island. 9.7 cm. long. Cat. No. 342961, U. S. Nat. Mus.
d, Ivory object, Punuk Island. 8.1 cm. long. Cat. No. 343716, U. S. Nat. Mus.
e, Base of harpoon head, Cape Kialegak, St. Lawrence Island. 8.8 cm. long. Cat. No. 342877, U. S. Nat. Mus.

- f*, Ivory object, Puduk Island. 17.2 cm. long. Cat. No. 343229, U. S. Nat. Mus.
g, Part of knife handle, Puduk Island. 15.8 cm. long. Cat. No. 343230, U. S. Nat. Mus.
h, Harpoon foreshaft, Puduk Island. 14.5 cm. long. Cat. No. 343231, U. S. Nat. Mus.

PLATE 13

- a*, Harpoon head, Puduk Island. 9.1 cm. long. Cat. No. 344110, U. S. Nat. Mus.
b, Harpoon head, Cape Kialegak, St. Lawrence Island. 7.1 cm. long. Cat. No. 342875, U. S. Nat. Mus.
c, Ivory object, Puduk Island. 14 cm. long. Cat. No. 343372, U. S. Nat. Mus.
d, Ivory object, Puduk Island. 16.2 cm. long. Cat. No. 343228, U. S. Nat. Mus.
e, Ivory object, Puduk Island. 15.6 cm. long. Cat. No. 343371, U. S. Nat. Mus.
f, Ivory object, Cape Kialegak, St. Lawrence Island. 4.4 cm. long. Cat. No. 342876, U. S. Nat. Mus.
g, Ivory object, Puduk Island. 12 cm. long. Cat. No. 343613, U. S. Nat. Mus.

PLATE 14

- Ivory object, Kukuliak, St. Lawrence Island. 14.2 cm. long. Owned by Mr. C. L. Andrews.

PLATE 15

- a*, Harpoon head, Cape Kialegak, St. Lawrence Island. 11.1 cm. long. Cat. No. 342993, U. S. Nat. Mus.
b, Harpoon head, Puduk Island. 8 cm. long. Cat. No. 344062, U. S. Nat. Mus.
c, Bone harpoon head, Puduk Island. 8 cm. long. Cat. No. 343160, U. S. Nat. Mus.
d, Harpoon head, Puduk Island. 7.4 cm. long. Cat. No. 343213, U. S. Nat. Mus.
e, Bird dart point, Puduk Island. 9 cm. long. Cat. No. 343173, U. S. Nat. Mus.
f, Bird dart point, Puduk Island. 8.6 cm. long. Cat. No. 343172, U. S. Nat. Mus.
g, Bird dart point, Cape Kialegak, St. Lawrence Island. 12.5 cm. long. Cat. No. 342991, U. S. Nat. Mus.
h, Piece of box handle, Puduk Island. 10.2 cm. long. Cat. No. 343681, U. S. Nat. Mus.
i, Broken ivory object, Puduk Island. 5.5 cm. long. Cat. No. 343076, U. S. Nat. Mus.
j, Piece of wrist guard, Sevuokok, St. Lawrence Island. 7.3 cm. long. Cat. No. 344530, U. S. Nat. Mus.

PLATE 16

- Ivory figurine, Puduk Island, 11.7 cm. long. Cat. No. 344107, U. S. Nat. Mus.

PLATE 17

- a*, Part of knife handle, Puduk Island. 10.2 cm. long. Cat. No. 344683, U. S. Nat. Mus.
b, Bone needle case, Puduk Island. 5.1 cm. long. Cat. No. 343472, U. S. Nat. Mus.

- c*, Bone needle case, Punuk Island. 7.2 cm. long. Cat. No. 343955, U. S. Nat. Mus.
d, Bone needle case, Cape Kialegak, St. Lawrence Island. 5.5 cm. long. Cat. No. 343017, U. S. Nat. Mus.
e, Cord handle, Punuk Island. 5 cm. long. Cat. No. 343956, U. S. Nat. Mus.
f, Wrist guard, Sevuokok, St. Lawrence Island. 8.7 cm. long. Cat. No. 280385, U. S. Nat. Mus.
g, Ivory object, Sevuokok, St. Lawrence Island. 9.7 cm. long. Cat. No. 344525, U. S. Nat. Mus.
h, Ferrule for dog whip, Punuk Island. 4.6 cm. long. Cat. No. 343430, U. S. Nat. Mus.

PLATE 18

- a*, Ivory object, Bristol Bay. 9.8 cm. long. Cat. No. 168626, U. S. Nat. Mus.
b, Hair ornament, Agiukchugumut, south of Nelson Island. 3.7 cm. long. Cat. No. 37008, U. S. Nat. Mus.
c, Bodkin, Sledge Island. 12.4 cm. long. Cat. No. 45339, U. S. Nat. Mus.
d, Workbag fastener, Lower Yukon. 12.6 cm. long. Cat. No. 48870, U. S. Nat. Mus.
e, Workbag fastener, Norton Sound. 12.5 cm. long. Cat. No. 33285, U. S. Nat. Mus.
f, Bone needle case, Lower Kuskokwim. 8.6 cm. long. Cat. No. 36787, U. S. Nat. Mus.
g, Bone needle case, Lower Yukon. 12.2 cm. long. Cat. No. 48604, U. S. Nat. Mus.

PLATE 19

- a*, Wrist guard, Gambell, St. Lawrence Island. 8.2 cm. long.
b, Bird figure, Gambell, St. Lawrence Island, 4.6 cm. long.
c, Bird figure, Gambell, St. Lawrence Island, 2.9 cm. long.
d, Workbag fastener, Lower Kuskokwim. 16.3 cm. long. Cat. No. 176225, U. S. Nat. Mus.
e, Belt buckle, Lower Kuskokwim. 6.4 cm. long. Cat. No. 37332, U. S. Nat. Mus.
f, Box handle, Kotzebue Sound. 8.6 cm. long. Cat. No. 48562, U. S. Nat. Mus.
g, Bodkin, Norton Sound. 12.4 cm. long. Cat. No. 43837, U. S. Nat. Mus.

PLATE 20

- a*, Harpoon head, Point Hope. 22.4 cm. long. Cat. No. 201058, U. S. Nat. Mus.
b, Harpoon head, Point Barrow. 10.8 cm. long. Cat. No. 56616, U. S. Nat. Mus.
c, Harpoon head, Point Barrow. 8.2 cm. long. Cat. No. 56611, U. S. Nat. Mus.
d, Harpoon head, Nunivak Island. 7.6 cm. long. Cat. No. 339598, U. S. Nat. Mus.
e, Harpoon head, Semidi Islands. 6.5 cm. long. Cat. No. 72547, U. S. Nat. Mus.
f, Harpoon head, Metlatavik, Seward Peninsula. 6 cm. long. Cat. No. 342617, U. S. Nat. Mus.

PLATE 21

- a. Dart foreshaft, Alaska Peninsula. 21.5 cm. long. Cat. No. 127766, U. S. Nat. Mus.
- b. Dart foreshaft, Lower Kuskokwim. 21.4 cm. long. Cat. No. 38442, U. S. Nat. Mus.

PLATE 22

- FIG. 1. View of the Punuk Island midden. Excavation along the outer edges showed that it extended as deep as six feet below the present beach line. Total height 16 feet.
- FIG. 2. Excavation in House No. 3, Punuk Island, recent, showing skeleton and partially exposed wooden floor.

PLATE 23

Section of the Punuk Island midden at Cut B, showing timbers and whalebones of an old house at bottom, now six feet below reach of storm tides.

PLATE 24

Recent house ruin at Cape Kialegak, St. Lawrence Island. Framework of drift-wood logs and whale ribs and jaws. Abandoned 50 to 60 years ago.

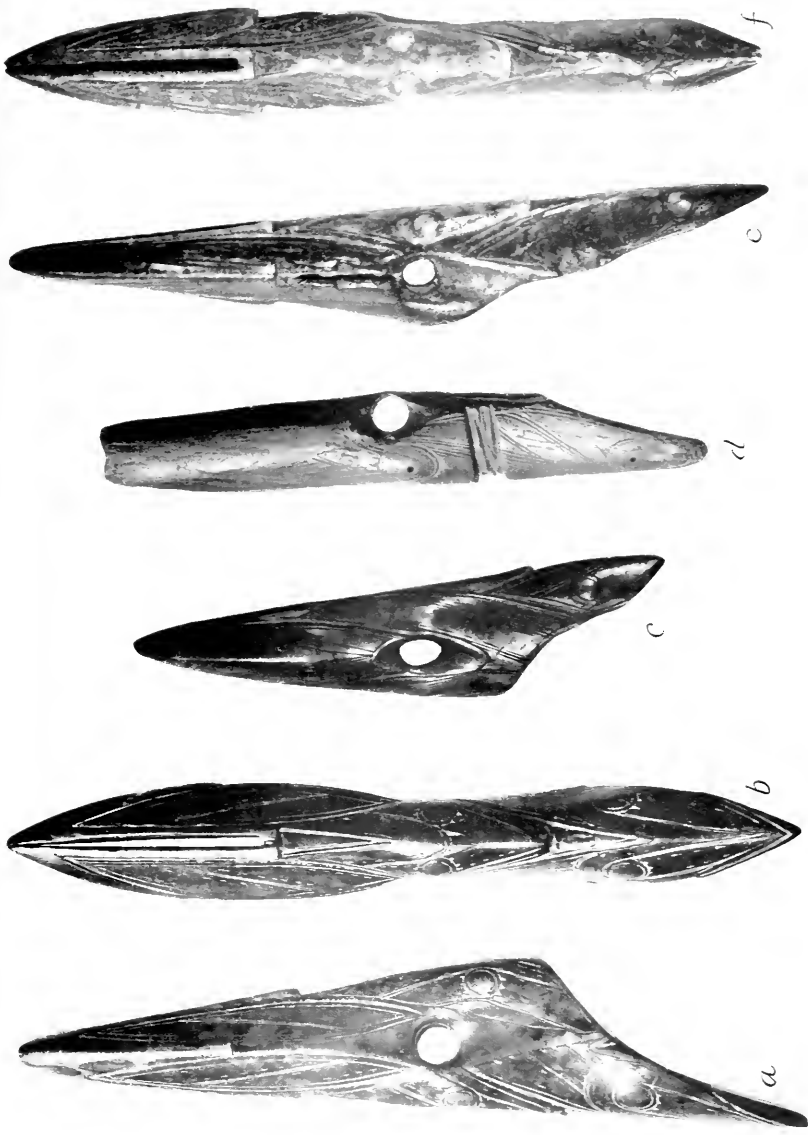

Harpoon heads of walrus ivory.
(For explanation see pages 3-4 and 18.)

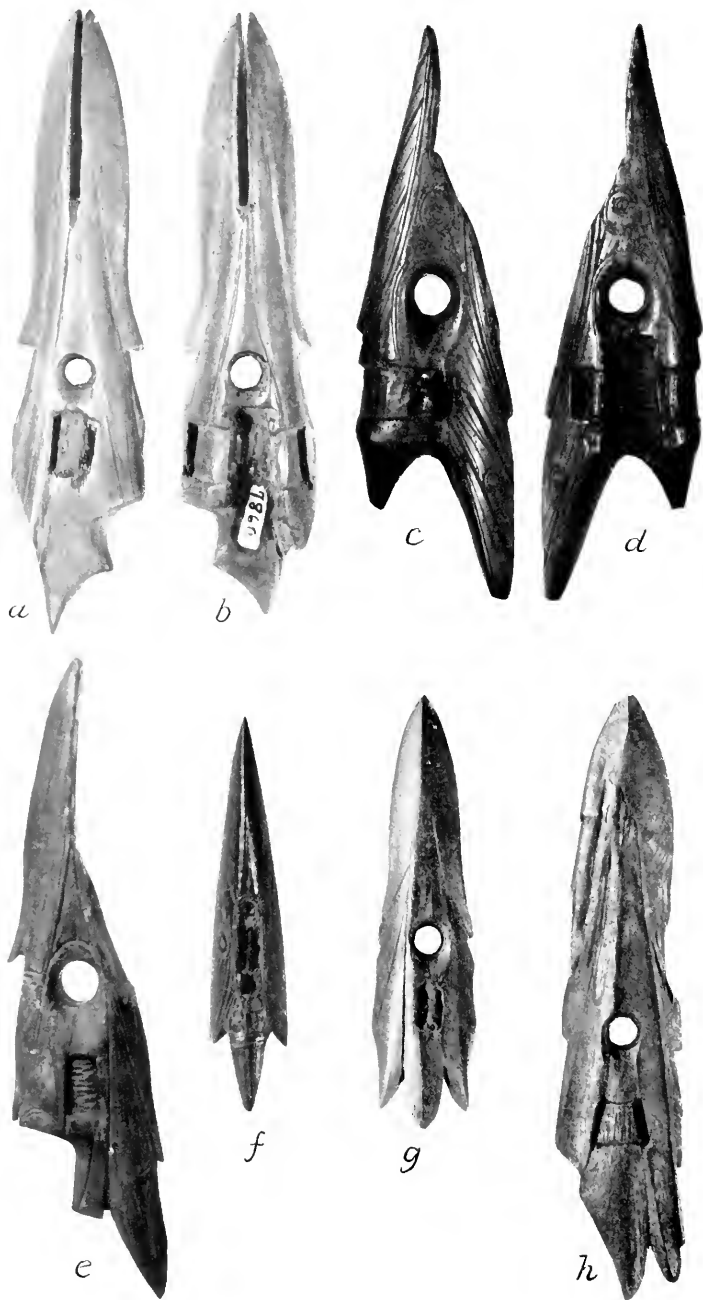

Harpoon heads of walrus ivory.
(For explanation see pages 3-6 and 48.)



b

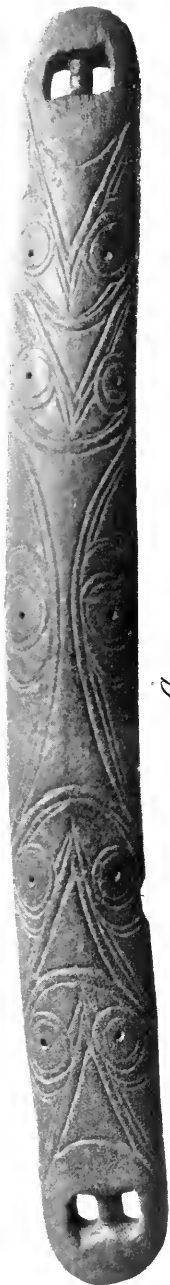

a

Box handles of bone and ivory.
(For explanation see pages 47 and 48.)

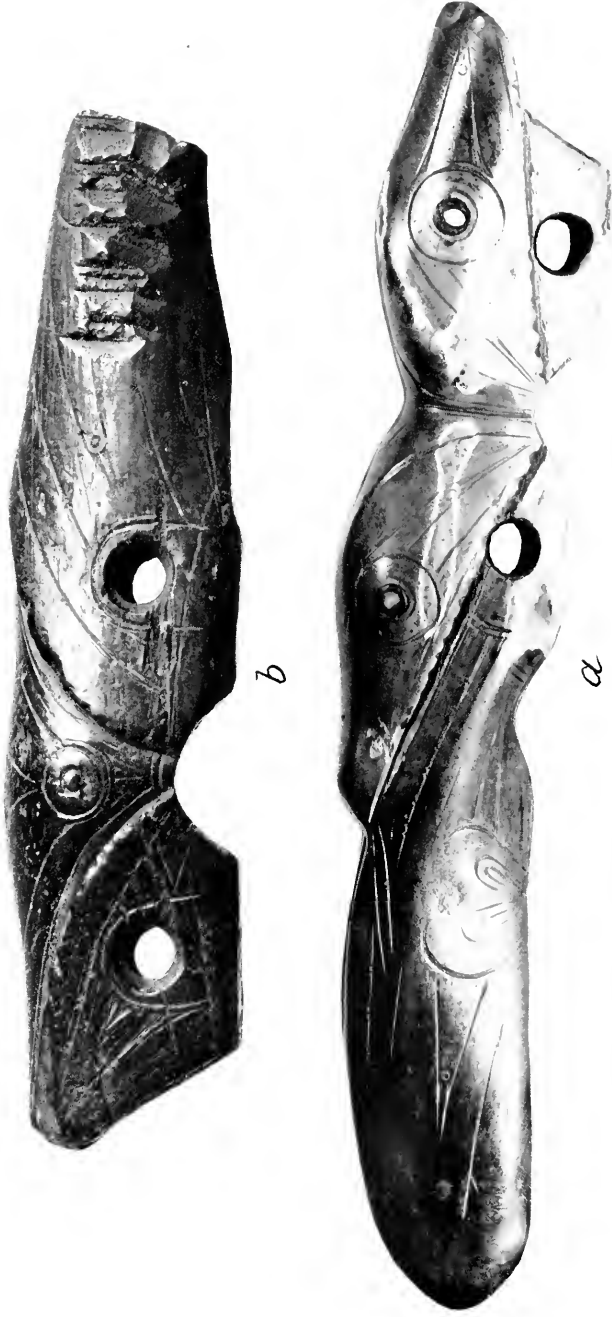

Ivory objects of unknown use.
(For explanation see pages 7 and 48.)



a



b

Ivory object carved to represent an animal's head.

(For explanation see pages 7-8 and 48.)

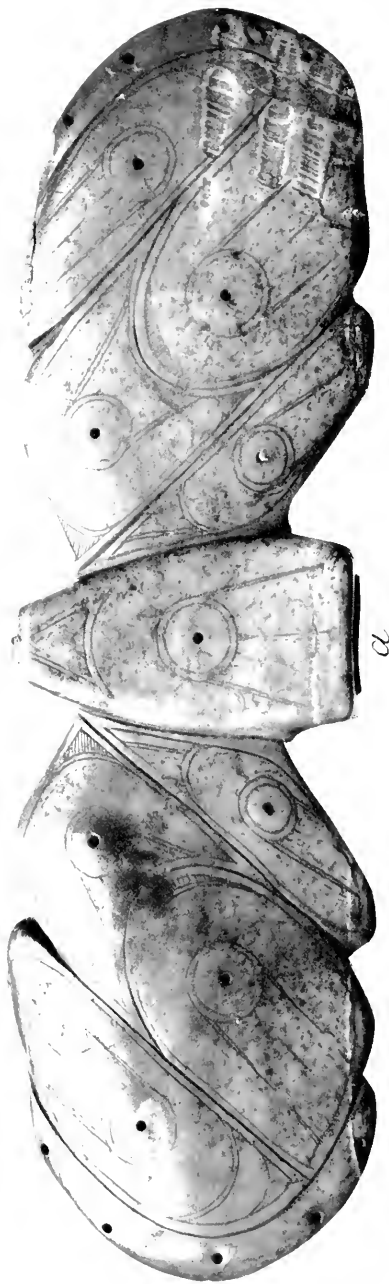

Ivory object of unknown use.

(For explanation see notes 8a and 8b.)

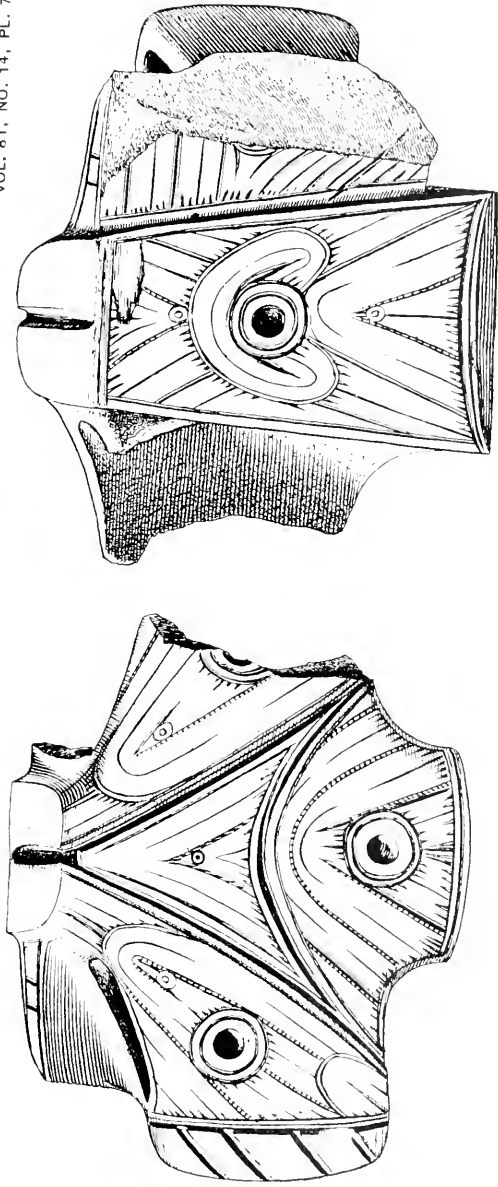

b

a

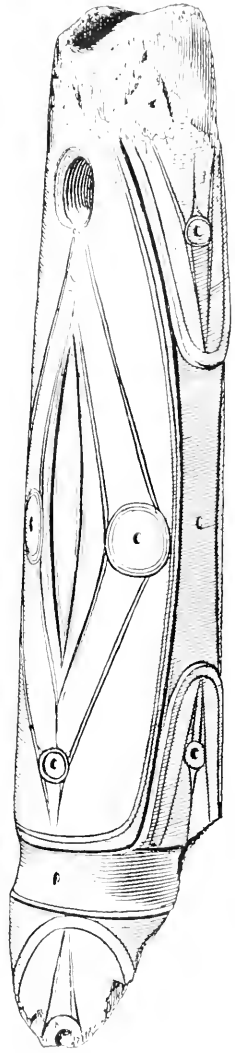

c

Broken ivory object of unknown use, and part of ivory harpoon socket-piece.
(For explanation see pages 9-10 and 48.)

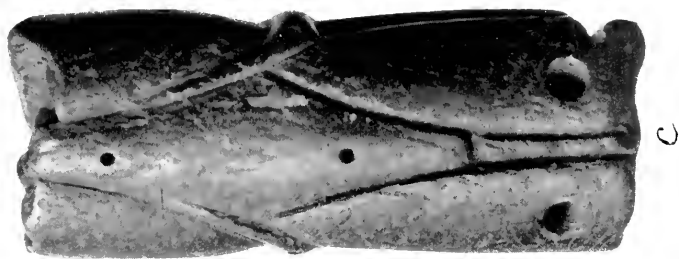

Ivory object carved to represent a seal and part of ivory harpoon socket-piece.
(For explanation see pages 10-11 and 49.)

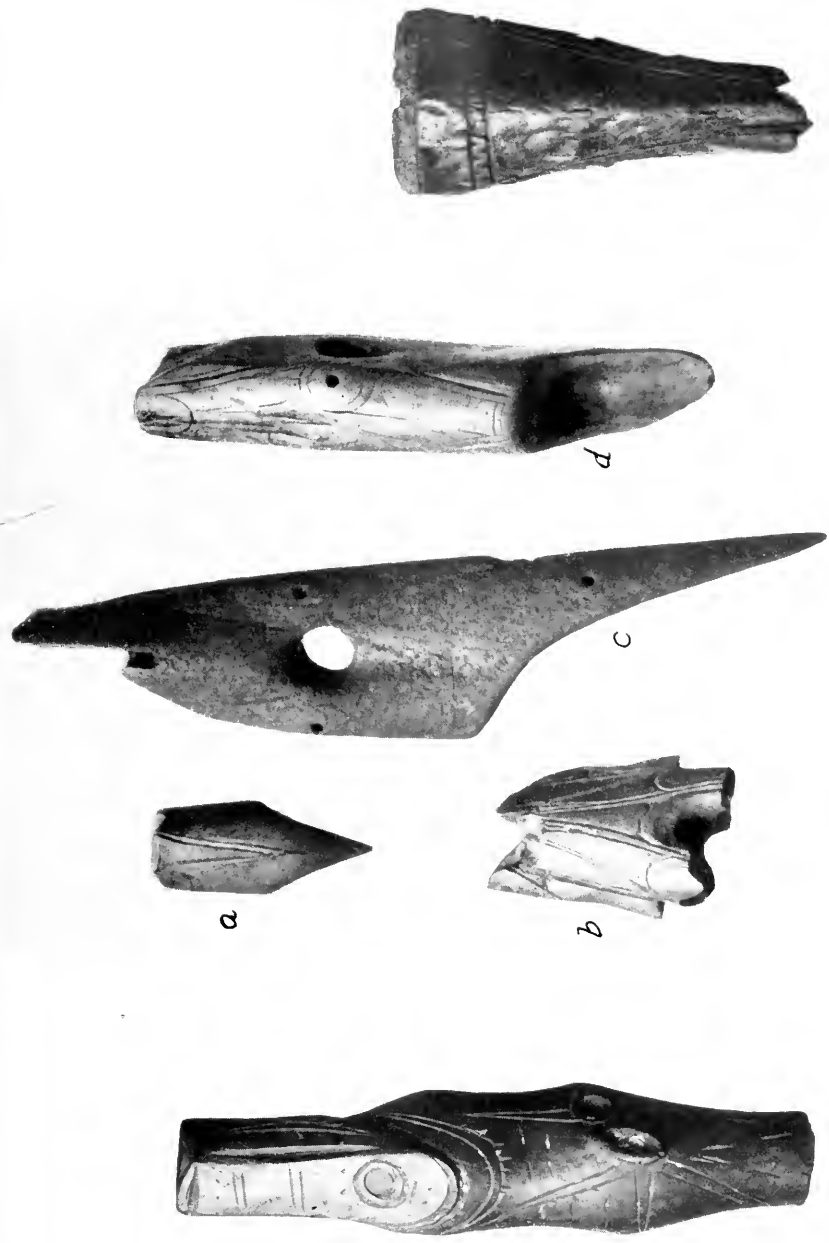

1

2

3

4

Ivory harpoon heads, dart shaft and needlecase, all fragmentary.
 (For explanation see pages 17, 32, 36 and 49.)



e



c



d



a



b

Ivory objects of unknown use.
(For explanation see pages 18-19 and 49.)

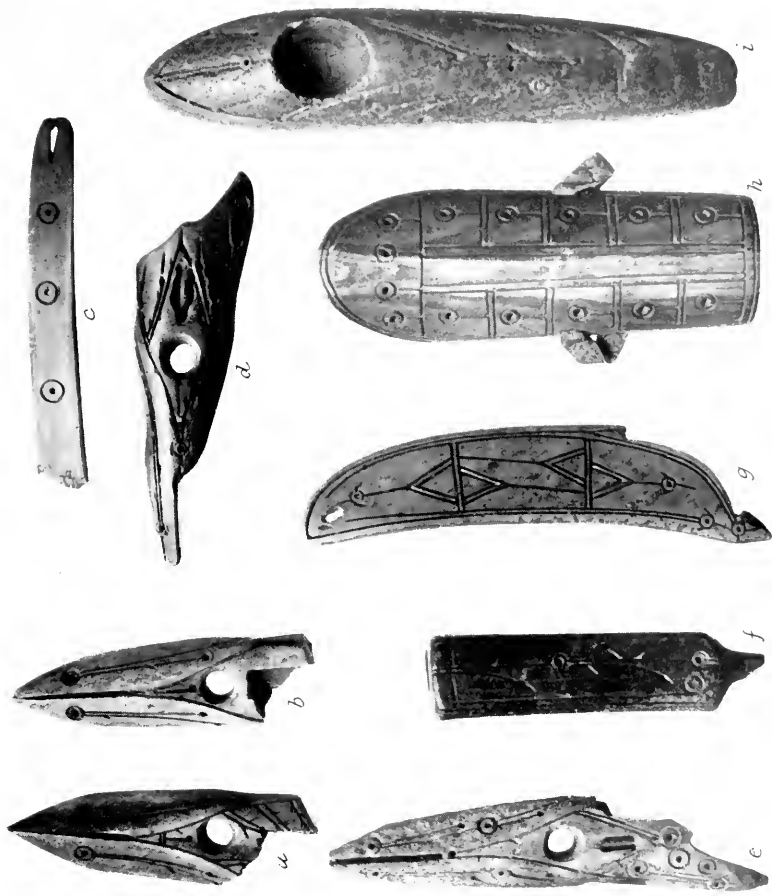

Ivory objects from Punnuk and St. Lawrence Islands.
(For explanation see pages 19, 20 and 49.)

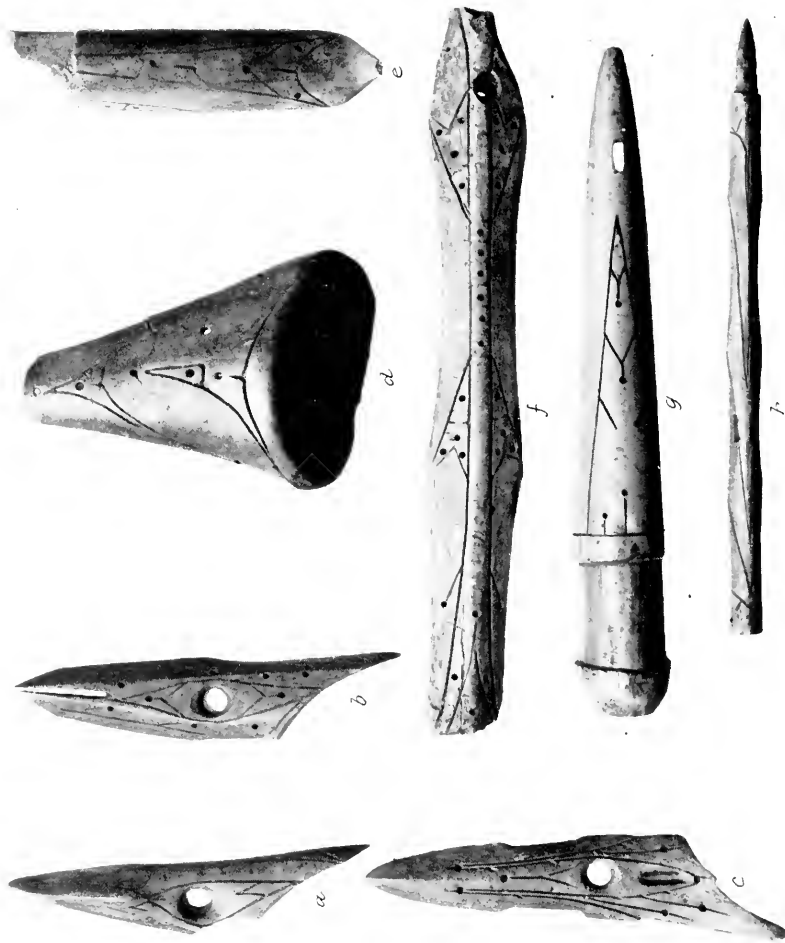

Ivory and bone objects from Punnik and St. Lawrence Islands.

(For explanation see pages 21-22 and 49.)

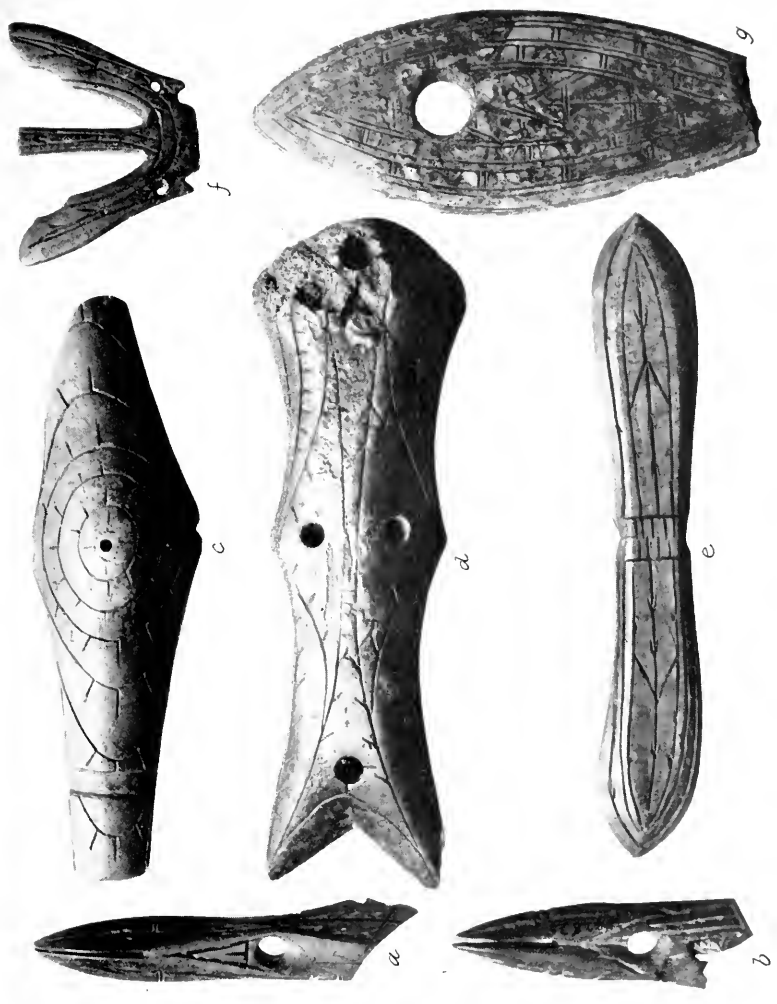

Ivory objects from Pimuk and St. Lawrence Islands.
(For explanation see pages 22-24 and 50.)

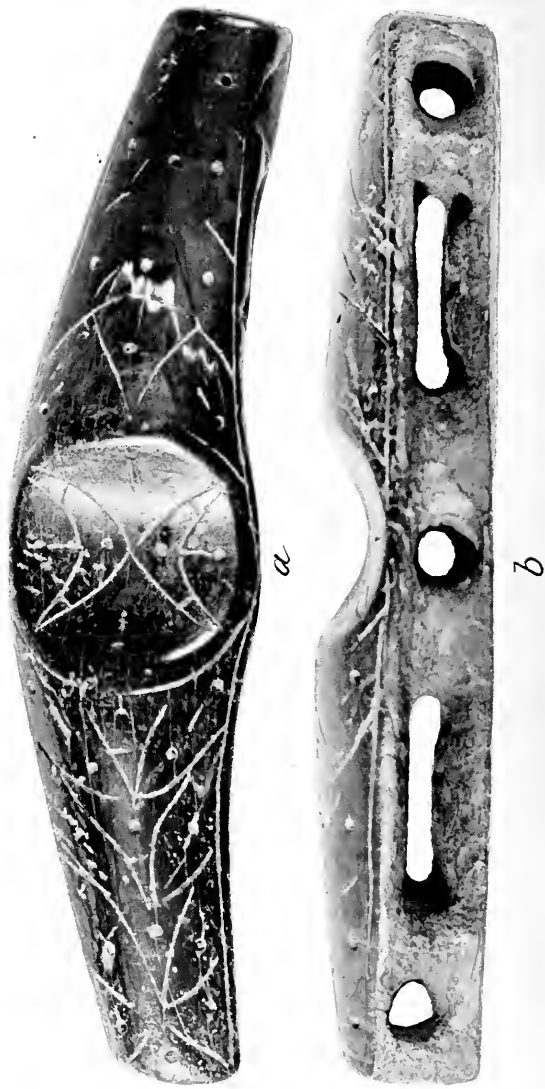

Ivory object of unknown use from Kukuliak, St. Lawrence Island.
(For explanation see pages 24 and 50.)

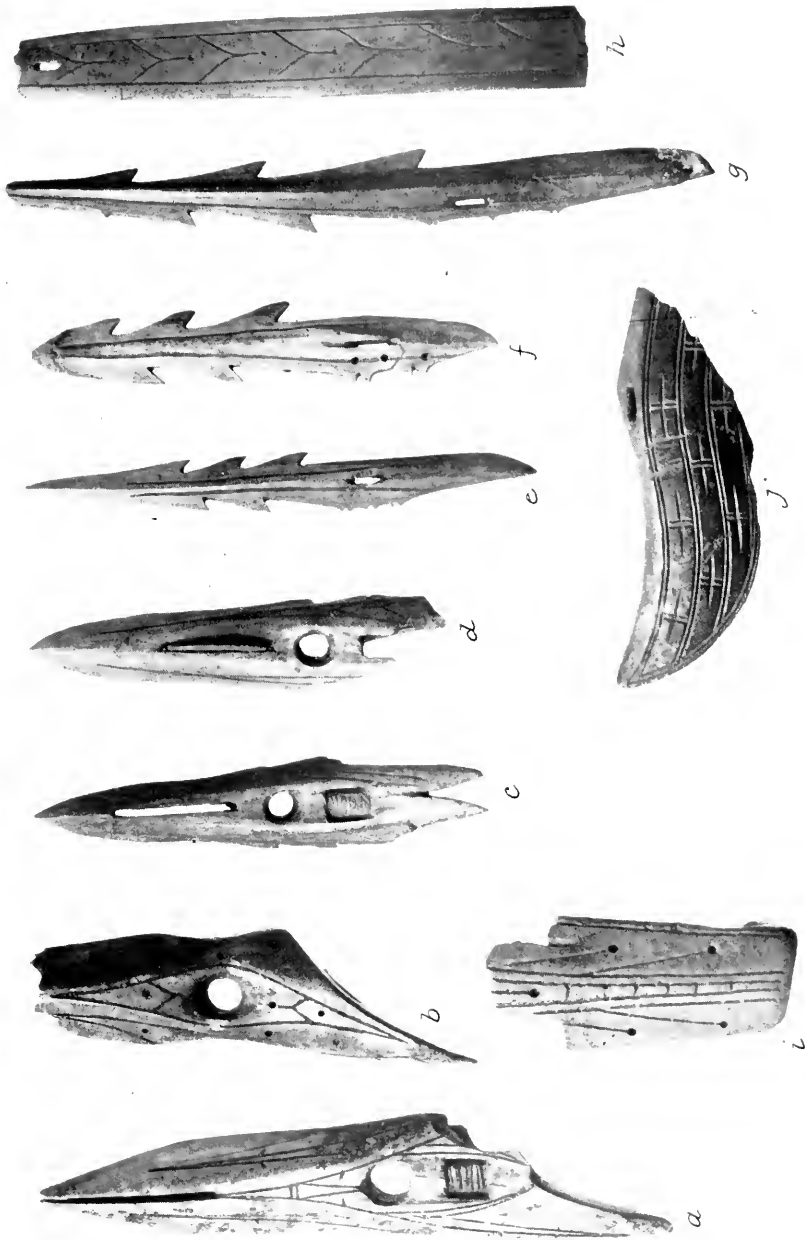

Ivory objects from Punuk and St. Lawrence Islands.
(For explanation see pages 24-25 and 50.)



Ivory figurine from Penuk Island.
(For explanation see pages 25-26 and 50.)

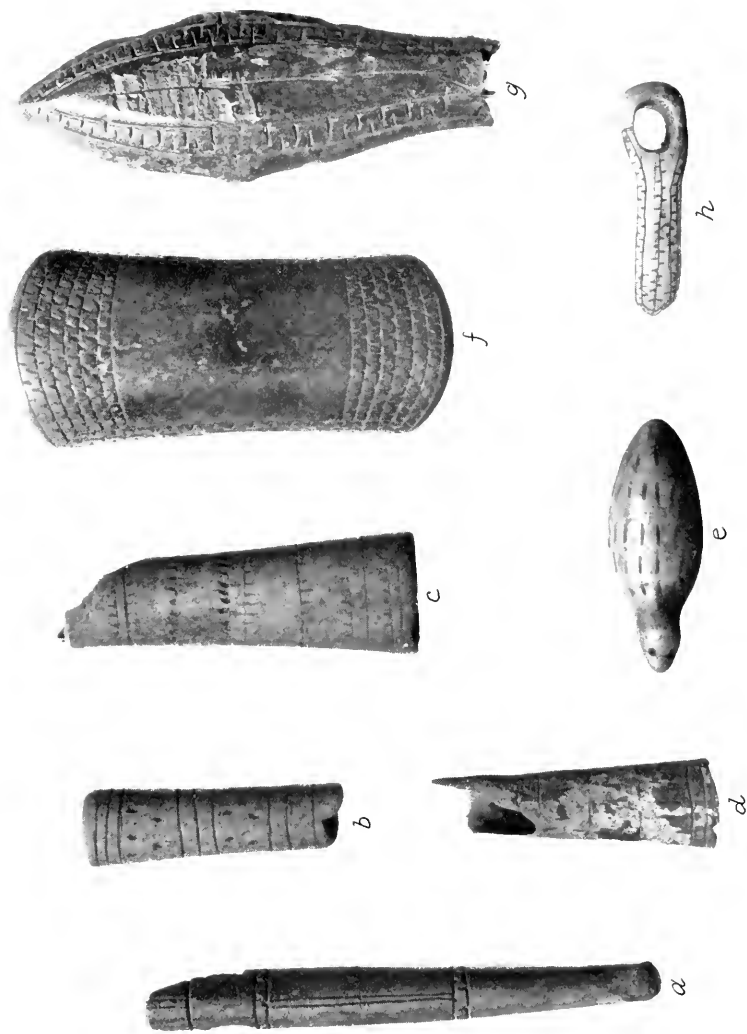

Ivory and bone objects from Panuk and St. Lawrence Islands.

(For explanation see pages 31-32 and 50.)

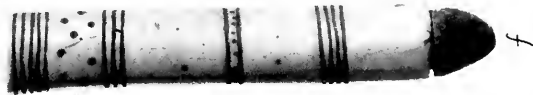
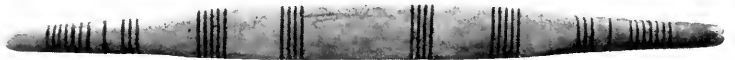
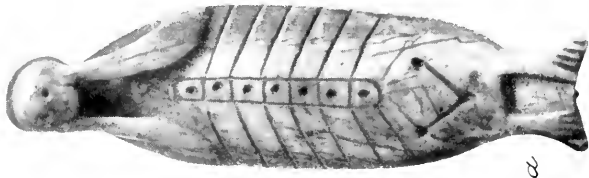

Modern Alaskan Eskimo objects of ivory and bone.
(For explanation see pages 34-35 and 51.)

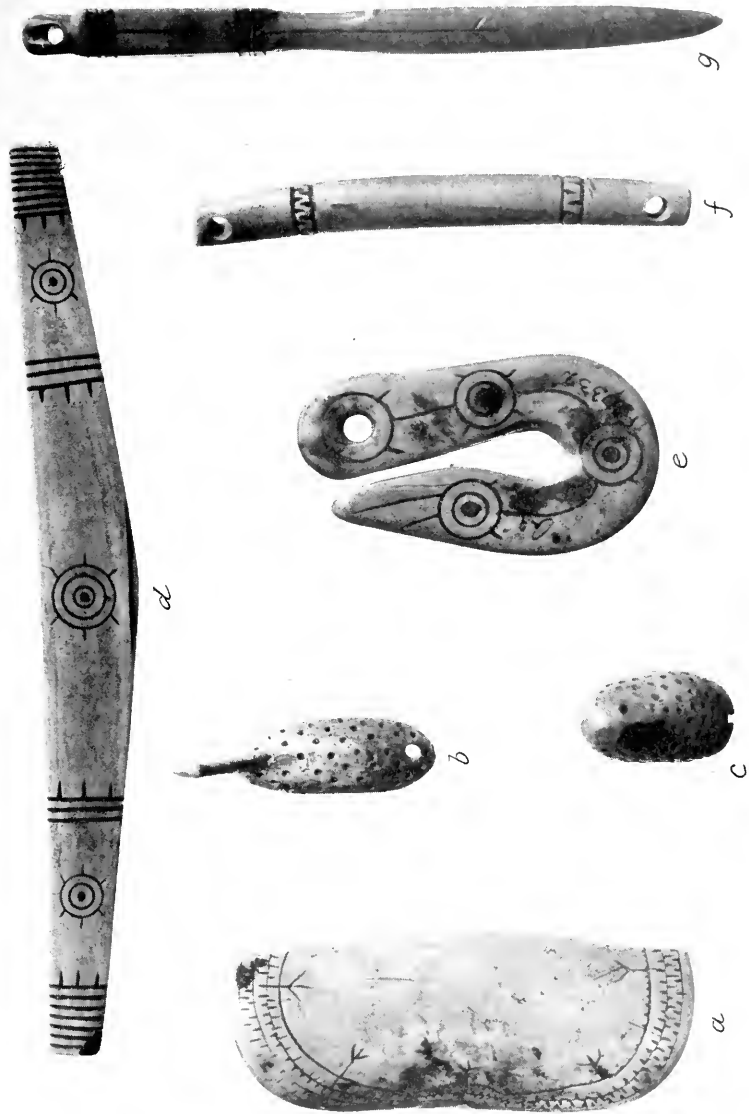

Modern Alaskan Eskimo objects of ivory.
(For explanation see pages 35 and 51.)

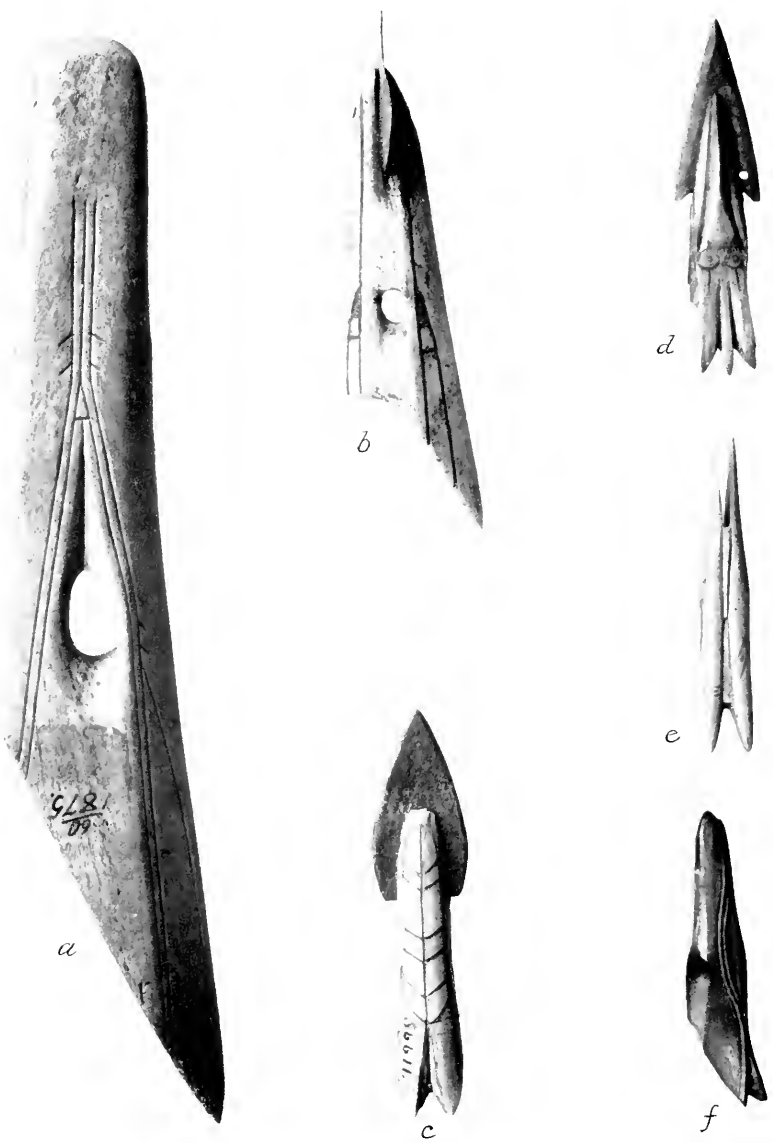

Modern Alaskan Eskimo harpoon heads of bone and ivory.
 (For explanation see pages 35-36 and 51.)



a



b

Modern seal dart foreshafts of ivory carved to represent the sea otter.
(For explanation, see pages 36 and 52.)



1

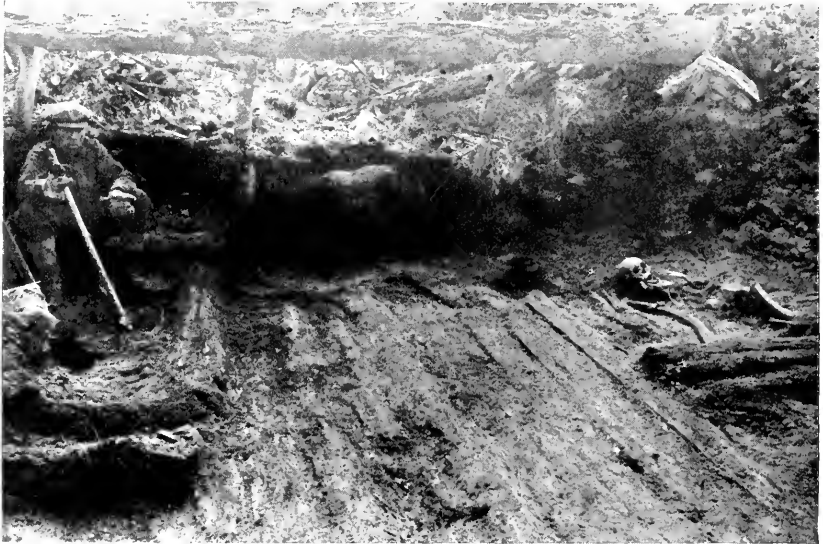

2

Excavations on Punuk Island.
(For explanation see pages 14-16 and 52.)



Section of Punuk Island midden.
(For explanation see page 52.)



Recent house ruin at Cape Kialagak, St. Lawrence Island.
(For explanation see page 52.)

SMITHSONIAN MISCELLANEOUS COLLECTIONS
VOLUME 81, NUMBER 15

(End of Volume)

ARTHROPODS AS INTERMEDIATE HOSTS OF HELMINTHS

BY

MAURICE C. HALL

Chief, Zoological Division, Bureau of Animal Industry, U. S. Department of Agriculture



(PUBLICATION 3024)

CITY OF WASHINGTON
PUBLISHED BY THE SMITHSONIAN INSTITUTION
SEPTEMBER 25, 1929

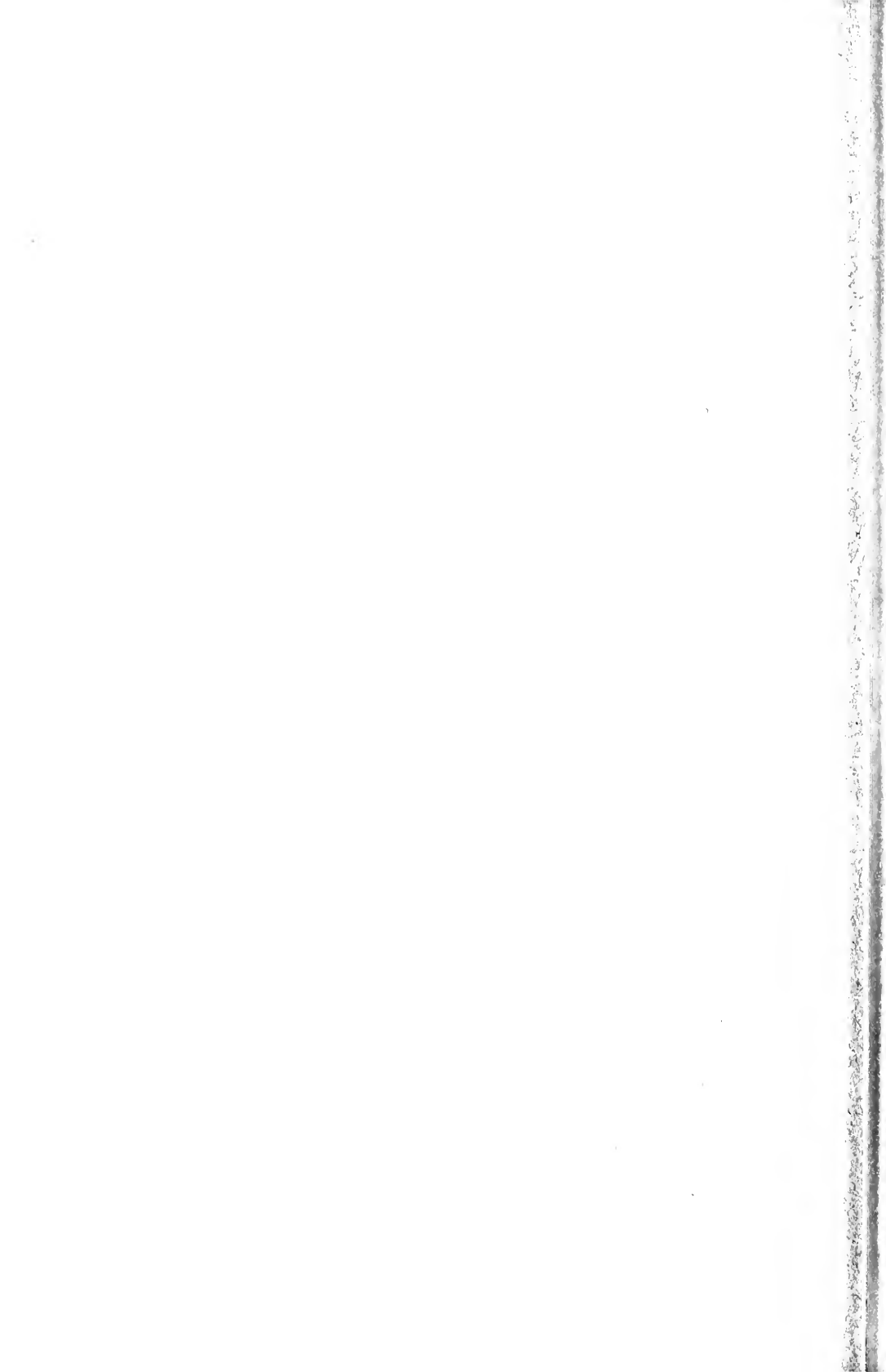

SMITHSONIAN MISCELLANEOUS COLLECTIONS

VOLUME 81, NUMBER 15

(End of Volume)

ARTHROPODS AS INTERMEDIATE HOSTS OF HELMINTHS

BY

MAURICE G. HALL

Chief, Zoological Division, Bureau of Animal Industry, U. S. Department of Agriculture



(PUBLICATION 3024)

CITY OF WASHINGTON
PUBLISHED BY THE SMITHSONIAN INSTITUTION
SEPTEMBER 25, 1929

The Lord Baltimore Press
BALTIMORE, MD., U. S. A.

ARTHROPODS AS INTERMEDIATE HOSTS OF HELMINTHS

By MAURICE C. HALL,

CHIEF, ZOOLOGICAL DIVISION, BUREAU OF ANIMAL INDUSTRY,
U. S. DEPARTMENT OF AGRICULTURE

INTRODUCTION

The phylum Arthropoda contains numerous forms which serve as intermediate hosts of many parasitic worms, including nematodes, acanthocephalids, flukes, and tapeworms. This fact follows naturally from the fact that the arthropods are an exceedingly large group of animals, including the ubiquitous insects and the numerous and widely distributed crustaceans. It also follows from the fact that these arthropods constitute the food supply, wholly or in part, for so many higher animals, especially for such forms as fish, many amphibians, some reptiles, numerous birds, and some mammals. To a lesser extent it follows from the fact that in feeding on various plants the higher animals are certain to swallow the arthropods habitually present on or in these plants. It follows from the fact that many insects feed on or breed in manure and consequently are exposed to infection from the eggs or larvae of worms parasitic in the hosts responsible for the manure. Last, but not least, the importance of arthropods as intermediate hosts of parasitic worms follows from the fact that large numbers of arthropods, especially the innumerable biting insects, whether transient or permanent ectoparasites, feed on blood and so serve as intermediate hosts of worms which have larval stages living in the blood of vertebrates.

The worm parasites may be classified from one point of view as monoxenous or heteroxenous. The monoxenous worms have life histories in which the worms pass from one host animal to a similar host animal without the intervention of an intermediate host. The heteroxenous worms have life histories in which in most cases the worms pass from mature stages in one host animal to larval stages in a host animal of a different sort, the intermediate host, and then return to a host animal of the first sort or a more or less closely related species and develop in this animal to maturity. In some instances two intermediate hosts are utilized in sequence for larval stages.

Of the four worm groups named, the cestodes are almost exclusively heteroxenous. We have the rare exception of *Hymenolepis nana* of the rat, which develops as an adult in the small intestine of the rat, produces eggs which pass out in the feces and by contamination of the rat's food infects the rat with the larval stage of the tapeworm, a small cysticercoid which develops in an intestinal villus of the rat, and which then returns to the lumen of the intestine to become an adult worm, the rat serving as both the primary and the intermediate host for the worm. Even in this case it has been claimed that rat fleas may act as intermediate hosts, but this has not yet been confirmed. This may be one of those cases in which a parasite can use an intermediate host or do without it. We seem to have similar cases in such parasites as the common gape-worm of poultry which can utilize the earthworm as an intermediate host or can infect chickens directly, and the blackhead organism which can use the cecum worm as an intermediate host or can infect turkeys directly. In the great majority of cases, the tapeworm is adult in an animal which eats the intermediate host animal and thereby becomes infested with the adult worm as the larval worm from the intermediate host comes to maturity in the primary host. In some of the bothriocephalids, in cases in which the life histories are well known, the eggs of the adult tapeworms present in the primary host, a higher vertebrate, hatch on entering water, infect such small animals as the copepods, and develop in the body cavity of these first intermediate hosts to an early larval stage, the proceroid. When such infested entomostracans are eaten by such intermediate hosts as fish, the proceroid undergoes further development and becomes a plerocercoid in the flesh of the fish. When infested fish are eaten by a suitable higher vertebrate, such as a human being or dog, the plerocercoid develops to the adult tapeworm in the small intestine of this host.

Among the flukes we have one large group, the Monogenea, which are usually ectoparasitic, mostly on fish, but sometimes endoparasitic, as in the respiratory tract of turtles or the urinary bladder of amphibians, and these flukes are monoxenous, developing without an intermediate host; another large group, the Digenea, are regularly endoparasitic and are heteroxenous. The digenetic flukes occurring in vertebrates produce eggs which pass out in the feces or urine and hatch after entering water. Usually the newly hatched worm (miracidium) attacks a mollusk host and develops in this host to the stage known as a cercaria. It may now be eaten by its primary host, or may escape and encyst in water or on vegetation and be swallowed by its primary host, developing in either case to an adult worm, or it may

enter a second intermediate host, an aquatic arthropod or a small fish, and encyst in this host. When such a second intermediate host is eaten by a primary host, the fluke develops to maturity in the new host.

Among the nematodes we have several groups which are usually monoxenous, although some of the ascarids, belonging to a superfamily, the *Ascaroidea*, which is ordinarily monoxenous, may be heteroxenous, as in the case of a seal ascarid having a larval stage encysted in fish. One large and important group, the *Filariata*, composed of two superfamilies, the *Filarioidea* and the *Spiruroidea*, is a heteroxenous group with larvae developing in blood-sucking arthropods or in arthropods which feed in some stage of development on the feces of the primary host or on food contaminated with these feces.

Among the acanthocephalids we know of the occurrence of intermediate hosts, but for the most part we must assume that this is the rule, as very few life histories are known in this group. In the known cases the worm eggs passing from the primary host infect secondary hosts, develop to a larva and infect primary hosts when these eat infected secondary hosts, or else re-encyst in another intermediate host and infect the primary host when it eats the second intermediate host.

The lists of heteroxenous worms and their arthropod hosts, given in this paper, are the most complete of those published and the omissions are probably few. The lists for certain groups have been compiled from time to time, some of the more important and more recent being those of Joyeux (1920), Ransom (1921), Van Zwaluwenburg (1928), Seurat (1916, 1919), MacGregor (1917), and Henninger (1928), and, of course, the indispensable catalogues of Stiles and Hassall, but no previous paper has attempted to cover all the arthropod hosts of the parasitic worms of vertebrates. On the basis of the lists given here this paper includes a consideration of the general facts and of the broad principles which may be derived from a correlation of these facts. While it will serve as a reference for the trained scientist in the groups involved, its principal value will be as a reference and guide to the younger worker and student and to the man who works in places remote from adequate library facilities and the specialized literature on arthropods or parasitic worms. The subject of the paper excludes from consideration the worms which have arthropods as primary hosts, and the arthropods which are intermediate hosts for Protozoa or animal parasites other than the worm

groups occurring as parasites in vertebrates. The intermediate arthropod hosts are listed here as completely as possible; the primary host list is frequently abbreviated to only representatives of groups.

In the lists arranged on a basis of parasite groups the names of hosts are given as they are found in the literature, regardless of spelling, synonymy, recognizable status, or validity. This is to enable the reader to trace the records if desired. In the final lists, arranged on a basis of intermediate host groups, the parasites are listed under the valid names of their arthropod hosts as far as possible. Synonyms of host names are indicated as synonyms, but names which cannot be recognized as valid or synonyms are retained. The insect host names have been checked by Dr. E. A. Chapin and the late Dr. H. G. Dyar of the Federal Bureau of Entomology through the courtesy of Mr. Harold Morrison, Chief of the Division of Taxonomy, and the crustacean host names have been checked by Dr. Waldo Schmitt of the U. S. National Museum, and I wish to acknowledge my indebtedness to these workers for their assistance.

ARTHROPODS AS INTERMEDIATE HOSTS OF CESTODES

The known number of arthropods acting as intermediate hosts for tapeworms is so small that this subject can be covered rather comprehensively. At the same time, one must generalize here as elsewhere rather carefully, since we know the life histories of only about 1 per cent of the known tapeworms. In addition to arthropods, the intermediate hosts of tapeworms include mammals, birds, reptiles, amphibia, fish, mollusks, annelids, and other animals. In all probability many worms now known only as having one intermediate host will be found to require two successive intermediate hosts. The following list will show the tapeworms, their primary hosts, and their intermediate hosts, for such tapeworms as have arthropods as intermediate hosts.

ANOPLOCEPHALIDAE

It is still true that the life histories of the anoplocephaline tapeworms are unknown. The larval cestode which has been reported from *Aphodius obscurus* and tentatively referred to *Cittotaenia marmotae* has not been definitely coupled with that worm by the test of successful feeding experiments, and the record is of value primarily as a possible clue to solving the unknown life histories in this group.

Arthropod Hosts of Cestodes

Family	Cestode	Primary host	Group	Secondary host	Group
ANOPLOCEPHALIDAE	<i>? Cittotaenia marmorata</i>	Arctomys marmota	Rodent	<i>Aphodius obscurus</i>	Colcoptera
		Dog	Carnivores	<i>Trichodectes latus</i>	Mallophaga
		Cat	Primate		
HYMENOLEPIDIDAE	<i>Diphyidium caninum</i>	Man		Primate	<i>Ctenocephalus canis</i>
				<i>Ctenocephalus felis</i>	
	<i>Hymenolepis diminuta</i>	Rat	Rodents	<i>Pulex irritans</i>	Siphonaptera
Mouse		Rodents	<i>Asopia farinalis</i>	Dermaptera	
Man			Primate		<i>Tinea granella</i>
				<i>Pyralis farinalis</i>	Lepidoptera
				<i>Aglossa dimidiata</i>	
				<i>Paralipsa gutularis</i>	Dermaptera
				<i>Anisolabis annulipes</i>	
				<i>Akis spinosa</i>	Dermaptera
				<i>Scaurus striatus</i>	
				<i>Tenebrio molitor</i>	Colcoptera
			<i>Tribolium ferrugineum</i>	Colcoptera	
			<i>Ceratophyllus fasciatus</i>		
			<i>Leptopsylla musculi</i>	Siphonaptera	
			<i>Xenopsylla cheopis</i>		
			<i>Ctenocephalus canis</i>	Siphonaptera	
			<i>Pulex irritans</i>		
			<i>Fontaria virginianensis</i>	Myriapoda	
			<i>Julus</i> sp.	Myriapoda	
	<i>Hymenolepis nana</i>	Rat	Rodents	<i>? Ceratophyllus fascia-</i>	Siphonaptera
Mouse		Rodents		<i>tus.</i>	
Man			Primate		<i>? Xenopsylla cheopis</i>
				<i>Tenebrio molitor</i>	Colcoptera

Arthropod Hosts of Cestodes.—Continued

Family	Cestode	Primary host	Group	Secondary host	Group
HYMENOLEPIDIDAE	<i>Hymenolepis arvicolae</i> . . .	<i>Arvicola campestris</i> . . .	Rodent	<i>Teuchobri molitor</i>	Coleoptera
	<i>Hymenolepis microstoma</i> . Mouse	Mouse	Rodent	<i>Teuchobri molitor</i> <i>Anisolabis annulipes</i> <i>Ceratophyllus fasciatus</i>	Coleoptera Dermoptera Siphonaptera
	<i>Weinlandia uncinata</i>	<i>Crocidura aranea</i> <i>Crocidura leucodon</i>	Insectivores	<i>Silpha lacrygata</i>	Coleoptera
	<i>Hymenolepis carioca</i>	Chicken	Galliformes	<i>Stomoxys calcitrans</i> <i>Aphodius granarius</i>	Diptera Coleoptera
	<i>Hymenolepis anatina</i>	<i>Anas</i> spp. Swan <i>Dafila acuta</i>	Anseriformes	<i>Euandona hungarica</i> <i>Cypris incongruus</i> <i>Cypris ovata</i> <i>Cypris compressa</i> <i>EuCypris crassa</i> <i>Cypris ophthalmica</i> <i>Cyclops vernalis</i> <i>Diaptomus alluaudi</i> <i>Diaptomus spinosus</i>	Ostracoda Copepoda
	<i>Hymenolepis brachycephala</i> .	<i>Paronocella pugnax</i> <i>Totanus pugnax</i> <i>Tringa</i> sp.	Charadriiformes	<i>Cyclops fimbriatus</i> <i>Cyclops crassicornis</i>	Copepoda

Arthropod Hosts of Cestodes.—Continued

Family	Cestode	Primary host	Group	Secondary host	Group
HYMENOLEPIDIDAE . . .	<i>Hymenolepis collaris</i> . . .	<i>Anas</i> spp.	Anseriformes	<i>Gammarus pulex</i>	Amphipoda
		<i>Anser</i> spp.		<i>Diaptomus coeruleus</i>	
<i>Aythya fuligula</i>	<i>Cyclops viridis</i>	Copepoda			
<i>Dafnia acuta</i>	<i>Cyclops agilis</i>				
				<i>Cyclops lucidulus</i>	Decapoda
				<i>Cyclops serrulatus</i>	
				<i>Cyclops vernalis</i>	
				? <i>Potamobius astacius</i>	
	<i>Hymenolepis gracilis</i>	Duck	Anseriformes	<i>Camdona rostrata</i>	Ostracoda
		Goose		<i>Camdona neglecta tuberculata</i> .	
		Wild water fowl	Columbiformes	<i>Dolerocypris fasciata</i>	
		Green pigeon		<i>Cypris compressa</i>	
				<i>Cypris ophthalmica</i>	
				<i>Cypris chieroa</i>	
				<i>Cypris viriens</i>	
				<i>Diaptomus coeruleus</i>	
				<i>Diaptomus spinosus</i>	
				<i>Cyclops viridis</i>	
	<i>Hymenolepis tenuirostris</i> .	Duck	Anseriformes	<i>Cyclops agilis</i>	Copepoda
		Goose		<i>Cyclops pulchellus</i>	
		<i>Merganser</i> spp.		<i>Cyclops serrulatus</i>	
		<i>Aythya</i> spp.		<i>Cyclops bicuspidatus</i>	
				<i>Diaptomus coeruleus</i>	
				<i>Gammarus pulex</i>	Amphipoda
				<i>Astacus fluviatilis</i>	

Arthropod Hosts of Cestodes.—Continued

Family	Cestode	Primary host	Group	Secondary host	Group
HYMENOLEPIDIDAE . . .	<i>Hymenolepis serpentulus</i> .	Duck Crow Magpie	Anseriformes Passeriformes	<i>Geotrueps sylvaticus</i>	Coleoptera
	<i>Drepanidotaenia lanco-</i> <i>lata</i> .	Goose Duck Wild water fowl.	Anseriformes	<i>Diaptomus spinosus</i> <i>Cyclops serratus</i>	Copepoda
	<i>Dicranotaenia dubia</i>	?	?	<i>Diaptomus alluaudi</i>	Copepoda
	<i>Choanotaenia infund-</i> <i>ibulum</i> .	Chicken	Galliformes	<i>Musca domestica</i> <i>Geotrueps sylvaticus</i>	Diptera Coleoptera
	<i>Aploparaksis dujardini</i> . (= <i>Cysticercus integrus</i> ?).	<i>Sturnus</i> spp. <i>Turdus</i> spp.	Passeriformes	<i>Gammarus pulex</i>	Amphipoda
	<i>Echinocotyle rosseteri</i>	Duck	Anseriformes	<i>Cypris cinerea</i> <i>Cypris ophthalmica</i> <i>Cyclocypris globosa</i>	Ostracoda
	<i>Echinocotyle linstorei</i>	?	?	<i>Diaptomus asiaticus</i> <i>Diaptomus spinosus</i>	Copepoda
	<i>Echinocotyle polyacantha</i> .?	?	?	<i>Diaptomus asiaticus</i>	Copepoda
	<i>Echinocotyle urazeki</i>	<i>Pyromelana franciscana</i> .	Passeriformes	<i>Gammarus pulex</i> <i>Boeckella brazilensis</i>	Amphipoda Copepoda

Arthropod Hosts of Cestodes.—Continued

Family	Cestode	Primary host	Group	Secondary host	Group
HYMENOLEPIDIDAE	<i>Fimbriaria fasciolaris</i> ..	Duck	Anseriformes	<i>Diaptomus vulgaris</i> ... <i>Cyclops</i> sp.	Copepoda
		Goose			
		Wild water fowl			
		? Chicken	Galliformes		
DAVAINIIDAE	<i>Davainea tetragona</i>	Chicken	Galliformes	<i>Musca domestica</i>	Diptera
		Turkey			
		Guinea fowl			
		Chicken			
AMABILIIDAE	<i>Davainea cesticillus</i>	Turkey	Galliformes	<i>Musca domestica</i>	Diptera
		Guinea fowl			
		<i>Phasianus colchicus</i>			
		Chicken			
PROTOCEPHALIDAE	<i>Tatria acanthorhyncha</i> ..	<i>Colymbus</i> spp.	Ralliformes	<i>Agriion puella</i>	Odonata
		<i>Alosa fuita</i>	Fish	<i>Leptodora kindtii</i> ... <i>Bythotrephes longi-</i> <i>manus</i> .	Cladocera
PROTOCEPHALIDAE	<i>Proteocephalus torulosus</i> .	<i>Aspius</i> spp.	Fish	<i>Cyclops serrulatus</i> ... <i>Cyclops brevecaudatus</i> . <i>Cyclops agilis</i>	Copepoda
		<i>Leuciscus</i> spp.			
		<i>Lota vulgaris</i>			
		<i>Idus melanotus</i>			
		<i>Abramis brama</i>			
<i>Alburnus lucidus</i>	<i>Diaptomus castor</i>				
<i>Coregonus fera</i>					

Arthropod Hosts of Cestodes.—Continued

Family	Cestode	Primary host	Group	Secondary host	Group
PROTEOCEPHALIDAE . .	<i>Proteocephalus filicollis</i> . .	<i>Gasterosteus aculeatus</i> . .	Fish	<i>Cyclops varius</i>	Copepoda
	<i>Proteocephalus longicollis</i> .	<i>Coregonus albula</i>	Fish	<i>Cyclops strenuus</i> <i>Cyclops serrulatus</i>	Copepoda
	<i>Proteocephalus percae</i> . .	<i>Gasterosteus aculeatus</i> . .	Fish	<i>Cyclops strenuus</i> <i>Cyclops serrulatus</i> <i>Cyclops oithonoides</i>	Copepoda
PROTEOCEPHALIDAE . .	<i>Proteocephalus ambloplitis</i> .	<i>Ambloplites rupestris</i> } <i>Micropterus dolomieu</i> . . }	Fish	<i>Cyclops leuckartii</i> <i>Cyclops prasinus</i> <i>Cyclops albidus</i>	Copepoda
	<i>Ichthyotaenia</i> sp. Fathmann, 1926.	?	?	<i>Cyclops strenuus</i>	Copepoda
CORALLOBOTHRIDIUM . .	<i>Corallobothrium giganteum</i> .	<i>Ameiurus nebulosus</i> <i>Leptopus olivarius</i> <i>Ictalurus punctatus</i>	Fish	<i>Cyclops serrulatus</i> <i>Cyclops prasinus</i>	Copepoda
	<i>Corallobothrium fimbriatum</i> .	<i>Ameiurus nebulosus</i> <i>Leptopus olivarius</i> <i>Ictalurus punctatus</i>	Fish	<i>Cyclops serrulatus</i> <i>Cyclops bicuspidatus</i>	Copepoda
DIPHYLLOBOTHRIDIIDAE .	<i>Schistocephalus solidus</i> . .	Duck Wild water fowl	Anseriformes	<i>Cyclops serrulatus</i> <i>Cyclops bicuspidatus</i>	Copepoda

Arthropod Hosts of Cestodes.—Continued

Family	Cestode	Primary host	Group	Secondary host	Group
DIPHYLLOBOTHRIDAÆ.	<i>Diphyllobothrium mansoni</i> .	Dog Cat	Carnivores	<i>Cyclops leuckartii</i>	Copepoda
	<i>Diphyllobothrium latum</i> .	Dog Cat Fox Wild carnivores Man	Carnivores Primate	<i>Diaptomus oregonensis</i> <i>Diaptomus gracilis</i> ... <i>Diaptomus graciloides</i> <i>Cyclops strenuus</i> <i>Cyclops brevispinosus</i> . <i>Cyclops prasinus</i>	Copepoda
	<i>Bothriocephalus cuspidatus</i> .	<i>Stizostedion vitreum</i> . <i>Hiodon tergisus</i>	Fish	<i>Cyclops prasinus</i> <i>Cyclops serrulatus</i> <i>Cyclops leuckartii</i>	Copepoda
	<i>Abothrium crassum</i>	<i>Percina caprodes</i>	Fish	<i>Cyclops bicuspudatus</i> . <i>Cyclops brevispinosus</i> .	Copepoda
	<i>Abothrium infundibuliformis</i> .	<i>Salmo</i> spp. <i>Coregonus</i> spp. <i>Thymallus thymallus</i> .	Fish	<i>Cyclops strenuus</i> <i>Cyclops serrulatus</i>	Copepoda
	<i>Triacnophorus nodulosus</i> .	<i>Trutta lacustris</i>	Fish	<i>Cyclops strenuus</i> <i>Cyclops serrulatus</i>	Copepoda
		<i>Salmo</i> spp. <i>Coregonus</i> spp. <i>Trutta</i> spp. <i>Thymallus thymallus</i> . <i>Esox lucius</i>	Fish	<i>Cyclops strenuus</i> <i>Cyclops fimbriatus</i> ...	Copepoda

Arthropod Hosts of Cestodes.—Continued

Family	Cestode	Primary host	Group	Secondary host	Group
RHYNCHOBOTHRIDAE.	<i>Rhynchobothrius ruficollis</i> .	<i>Mustelus vulgaris</i>	Fish	Marine decapods	Decapoda
UNCERTAIN	Proceroid (?) of Galli-Valerio, 1923.	?	?	<i>Agrion</i> sp.	Odonata
	Cysticercoid of Dampf, 1910.	?	?	<i>Mesopsylla eucta</i>	Siphonaptera
	Cysticercoid of Mrazek, 1896; 13.	?	?	<i>Diaptomus</i> sp.	Copepoda
	Cysticercoid of Mrazek, 1896; 14.	?	?	<i>Gammarus pulex</i>	Amphipoda
	Cysticercoid of Rossiter, 1890.	?	?	<i>Cypris cinerea</i>	Ostracoda
	Cysticercoid of Rossiter, 1893.	?	?	<i>Cyclops agilis</i>	Copepoda
	<i>Cysticercus bifurcus</i>	?	?	<i>Gammarus pulex</i>	Amphipoda
	<i>Cysticercus gruberi</i>	?	?	<i>Cyclops breviculatus</i> , <i>Cyclops agilis</i>	Copepoda
	<i>Cysticercus hananni</i>	?	?	<i>Cyclops strenuus</i>	Copepoda
	<i>Cysticercus taeniaepachy-acanthae</i> .	?	?	<i>Gammarus pulex</i>	Amphipoda
	<i>Cysticercus quadricuratus</i> .	?	?	<i>Gammarus pulex</i>	Amphipoda
		?	?	<i>Cyclops agilis</i>	Copepoda

Arthropod Hosts of Cestodes.—Continued

Family	Cestode	Primary host	Group	Secondary host	Group
UNCERTAIN	<i>Cysticercus</i> sp. of Luehe, 1910.	?	?	<i>Gammarus pulex</i>	Amphipoda
	<i>Cysticercus</i> sp. of Luehe, 1910.	?	?	<i>Cyclops serrulatus</i>	Copepoda
	<i>Cysticercus</i> sp. of Luehe, 1910.	?	?	Ostracod	Ostracoda
	<i>Cysticercus</i> sp. of Mrasek, 1910.	?	?	<i>Gammarus pulex</i>	Amphipoda
	<i>Cercocystis dendrocerus</i> .	?	?	<i>Diaptomus</i> sp.	Copepoda
	<i>Onchoscolex decipiens</i> ..	?	?	<i>Tenebrio molitor</i>	Coleoptera
	<i>Plerocercus africanus</i> ..	?	?	<i>Diaptomus africanus</i> ...	Copepoda
	<i>Taenia</i> sp. Daday, 1900; 167.	?	?	<i>Cypris elongata</i>	Ostracoda
	<i>Taenia</i> sp. Daday, 1900; 168.	?	?	<i>Gammarus pulex</i>	Amphipoda
	<i>Taenia sichyi</i>	?	?	<i>Diaptomus asiaticus</i>	Copepoda

HYMENOLEPIDIDAE

The hymenolepid tapeworms are predominantly parasitic in birds, the above list of species with known life histories including 22 species in birds and only 6 in mammals. An inspection of the intermediate hosts for hymenolepids in mammals shows that they include members of the Coleoptera, the Siphonaptera, the Mallophaga, Lepidoptera, Dermaptera and the Myriapoda, of which the Coleoptera seem at this time to be somewhat the more important. In the case of one tapeworm, *Hymenolepis diminuta*, members of all the groups named, with the exception of the Mallophaga, can function as intermediate hosts, but such a wide range of intermediate hosts is rather unusual.

In no case does the intermediate host appear to depend primarily for its function as host on a rôle as food for the primary host, but rather on the chance of being swallowed accidentally as a contaminating element in food, or occasionally on the fact that such primary hosts as dogs will root out and swallow the fleas which are annoying them. Of the 3 species of hymenolepids infesting man, all are particularly likely to occur in children, largely because children are less careful in their food habits and in matters of personal cleanliness, and are more disposed to be intimate with such tapeworm hosts as dogs and cats.

When we consider the hymenolepid tapeworms of birds, the case is somewhat clearer as to the predominance of certain arthropod groups as intermediate hosts and the reason for this predominance. The Entomostraca, especially the Copepoda, are very decidedly the predominant group of intermediate hosts known at present for hymenolepids in birds. The birds in these cases with entomostracan hosts are practically all members of the Anseriformes and the rôle of intermediate host in these cases is clearly also that of food for the primary host. The exceptional cases, such as that of the green pigeon as a host for *Hymenolepis gracilis*, or the chicken as a host for *Fimbriaria fasciolaris*, must be explained as probably due to accidental swallowing of an intermediate host. One can say from the available facts that the intermediate host of a hymenolepid in anseriform birds should be sought among the Entomostraca and that the chance of entomostracans being the intermediate hosts is very great. The one case of a malacostracan, *Potamobius astacus*, as a host of a hymenolepid, *Hymenolepis collaris*, occurring in anseriform birds is regarded by Railliet as doubtful, and in general the larger Crustacea are not yet incriminated as intermediate hosts of avian tapeworms.

As regards hymenolepid tapeworms occurring in the Galliformes, the intermediate hosts shift naturally to the insects, the Coleoptera and Diptera standing close together in importance at this time. The reports to date indicate that at least two tapeworms, *Hymenolcypis carioca* and *Choanotaenia infundibulum*, can utilize members of both of these insect groups as intermediate hosts, and that the beetle host of *C. infundibulum* will also serve as a host of *H. serpentulus*, the latter usually a parasite of passeriform birds. The rôle of these insects as intermediate hosts of tapeworms of galliform and passeriform birds follows from their rôle as food for these birds and from the fact that the beetles feed on excrement and the stable flies breed in straw which is readily contaminated with excrement. Aside from arthropods, the intermediate hosts of hymenolepids include such forms as earthworms and leeches.

Stafford (1927) reports in a preliminary note that a number of American amphibious insects serve as intermediate hosts for various flukes and for hymenolepid tapeworms. The record of these tapeworms in more definite form has not yet come to the attention of the present writer.

DAVAINIIDAE

The known life histories of tapeworms of the Davainiidae cover forms parasitic in birds and incriminate flies as intermediate hosts, the common house fly being reported as the host for *Davainca tetragona* and *D. cesticillus*. The possible rôle of ants and grasshoppers as intermediate hosts for *D. friedbergieri* is noted in the literature but has only the value of a surmise and has not been included in the list of hosts. Diptera would appear to be especially promising among the arthropods as intermediate hosts of davainid tapeworms, but these worms also utilize such intermediate hosts as snails and slugs, aside from arthropods, and the total number of known life histories does not warrant much generalization.

AMABILIIDAE

The only known life history for a tapeworm belonging in the *Amabiliidae* is that for *Tatria acanthorhyncha*, and this involves the Odonata or dragonflies as intermediate hosts. The only genera other than *Tatria* assigned to this family by Ransom are *Amabilia* and *Schistotaenia*, but until we have more information as to life histories we cannot assume that the Odonata have special importance as intermediate hosts in this family. In the one known life history, the dragon-

fly evidently plays the rôle of host for the tapeworm and food for the ralliform bird host.

PROTEOCEPHALIDAE

So far as final hosts and intermediate hosts are known, the copepods are outstandingly important as intermediate hosts of proteocephalid tapeworms in fish, the Cladocera serving as hosts in only one case. Apparently these tapeworms form a proceroid in the entomostracan host, and this develops to a second larval stage in small fish or other suitable hosts, and then to an adult when this second intermediate host is eaten by a suitable primary host.

DIPHYLLOBOTHRIIDAE

In the Diphyllbothriidae we have tapeworms in which the life history sometimes, though apparently not always, involves two intermediate hosts. For the known cases, the first intermediate host is always an entomostracan and the second intermediate host is a fish. The known entomostracan hosts are copepods. Since the rôle of intermediate host played by entomostracans in these life cycles is evidently based on the rôle of Entomostraca as fish food, it is obvious that the Entomostraca would be first choice as intermediate hosts of diphyllbothrids in a search for the first host, and the copepods would be first choice among the Entomostraca.

RHYNCHOBOTHRIIDAE

The life history is known for only one species of rhynchobothrid tapeworm, and in this case decapod crustaceans serve as intermediate hosts. Additional data are needed before one could safely generalize in regard to the intermediate hosts of tapeworms of the family Rhynchobothriidae.

ARTHROPODS AS INTERMEDIATE HOSTS OF TREMATODES

The following list will serve as a basis on which to draw some conclusions as to the rôle of arthropods as intermediate hosts of trematodes. In assigning flukes to various families, the writer has followed various authorities as there is considerable disagreement in regard to the taxonomy of fluke groups, and the arrangement used will not meet with anything like unanimous approval. It is only intended to serve as a tentative basis for a discussion within the scope of this paper.

Arthropod Hosts of Trematodes

Family	Trematode	Primary host	Group	Secondary host	Group
PLAGIORCHIIDAE	<i>Plagiorchis amciurensis</i> .	<i>Luciurus natalis</i>	Fish	Crayfish Dragon fly	Decapoda Odonata
		<i>Plagiorchis maculosus</i> ...	<i>Cyprinus apus</i>	Passeriformes	<i>Prunus trifidus</i>
	<i>Caprimulgus europaeus</i>		Plecoptera		
	<i>Hirundo riparia</i>				
	<i>Hirundo arbica</i>				
	<i>Lissorchis fairporti</i>	<i>Actiobus cyprinella</i>	Fish	<i>Cheironomus lobiferus</i>	Diptera
		<i>Actiobus bubalus</i>		<i>Tanyopus decoloratus</i> ..	
	<i>Pneumonocees variegatus</i> .	Frogs	Amphibians	<i>Colopteryx virgo</i>	Odonata
		Toads			
	<i>Pneumonocees simili-</i> <i>genus.</i>	Frogs	Amphibians	<i>Colopteryx virgo</i>	Odonata
		<i>Osthioglyphis endolo-</i> <i>bun.</i>	Frogs	Amphibians	<i>Phryganica grandis</i> ...
	Salamanders		<i>Anabolia nervosa</i>		
<i>Linnophilius rhombicus</i>					
<i>Linnophilius griseus</i> ..					
<i>Linnophilius lunatus</i> ..					
<i>Linnophilius flavicornis</i>					
<i>Ephemerella vulgata</i> ..	Ephemera				
<i>Plecoptera bicandata</i>	Plecoptera				
<i>Gononarius pulch</i>	Amphipoda				

Arthropod Hosts of Trematodes.—Continued

Family	Trematode	Primary host	Group	Secondary host	Group
PLAGIORCHIIDAE	<i>Haplometra cylindracea</i> .	Frogs	Amphibians	<i>Ilybius fuliginosus</i>	Coleoptera
	<i>Prosthogonimus</i> sp. Kottlan & Chandler.	Chicken Water fowl	Galliformes Anseriformes	<i>Tetragoneuria</i> spp.	Odonata
	<i>Prosthogonimus intercalandus</i> .	Chicken	Galliformes	<i>Libellula quadrimaculata</i> .	Odonata
	<i>Prosthogonimus pellucidus</i> .	Chicken	Galliformes	<i>Libellula quadrimaculata</i> .	Odonata
LECITHODENDRIDAE	<i>Lecithodendrium lagenia</i> .	Bats	Cheiroptera	Perfid larva	Plecoptera
	<i>Lecithodendrium chilostomum</i> .	Bats	Cheiroptera	Ephemeroïd larva	Ephemeroïd
	<i>Pleurogenes medians</i> ...	Frogs Toads	Amphibians	<i>Chironomus plumosus</i> ? <i>Anopheles maculipennis</i> .	Diptera
PLAGIORCHIIDAE	<i>Pleurogenes claviger</i>	Frogs Toads	Amphibians	<i>Phryganea grandis</i> ..	Trichoptera
	<i>Prostotocus confusus</i>	Frogs Toads	Amphibians	<i>Phryganea</i> sp.	Trichoptera
				Water beetles	Coleoptera
				<i>Agriou</i> sp.	Odonata
				Water beetles	Coleoptera
				Water beetles	Coleoptera
				<i>Arschnia</i> sp.	Odonata
				<i>Cordulia</i> sp.	Odonata

Arthropod Hosts of Trematodes.—Continued

Family	Trematode	Primary host	Group	Secondary host	Group
LECTHODENDRIIDAE	<i>Eumegacetes</i> sp.	?	?	Amphibious insects	Insecta
OPISTHORCHIIDAE	<i>Plagiophorus</i> sp.	?	?	Amphibious insects	Insecta
ALLOCREADIIDAE	<i>Allocreadium commune</i> ..	<i>Catostomus catostomus</i> <i>Fundulus diaphanus</i> <i>menona</i> , <i>Notropis cornutus</i>	Fish	<i>Blasturus cupidus</i>	Eplimerida
	<i>Allocreadium isoporum</i> ..	<i>Cyprinus carpio</i>		<i>Ephemera vulgata</i>	Eplimerida
		<i>Barbus barbuis</i>		<i>Anabolia nervosa</i>	Trichoptera
		<i>Rutilus rutilus</i>		<i>Chactopteryx villosa</i> . }	
		<i>Leuciscus cephalus</i>			
		<i>Phoxinus phoxinus</i>	Fish		
		<i>Tinca tinca</i>			
		<i>Abramis brama</i>			
		<i>Cobitis taenia</i>			
		<i>Esox lucius</i>			
	<i>Astacotrema cirrigerum</i> ..	? Swallow	Bird	<i>Astacus fluviatilis</i>	Decapoda
				Crayfish	
	<i>Crepidostomum cornutum</i> .	Black bass		<i>Cambarus</i> spp.	Decapoda
		Rock bass		<i>Hexagenia</i> sp.	Eplimerida
		Channel cat			
		Perch	Fish		
		Sunfish			
		Darter			

Arthropod Hosts of Trematodes.—Continued

Family	Trematode	Primary host	Group	Secondary host	Group				
ALLOCREADIDAE	<i>Acrolichanus petalosa</i> ..	<i>Acipenser rubicundus</i> ..	Fish	Crayfish	Decapoda				
	? <i>Sphaerostoma globi-</i> <i>porum</i> .	<i>Cyprinus erythrophthal-</i> <i>mus</i> .	Fish	<i>Anopheles maculipen-</i> <i>nis</i> .	Diptera				
	<i>Stephanophiala farionis</i> ..	<i>Trutta fario</i> ..	} <i>Hexagonia</i> spp. <i>Ephemera danica</i>	}	}	} Ephemera			
		<i>Trutta trutta</i> ..							
		<i>Epitomymis salvelinus</i>							
		<i>Thymallus thymallus</i> .							
		<i>Coregonus oxyrhyn-</i> <i>chus</i> .							
		<i>Salvelinus fontinalis</i> ..							
		<i>Perca flavescens</i> ..							
		<i>Eupomotis gibbosus</i> ..							
GORGODERIDAE	<i>Gorgoderia pagenstecheri</i> ..	<i>Balcosoma nigrum</i> ..	} Fish	}	}				
		<i>Ethcostoma torvae</i> ..							
		<i>Stizostedion vitreum</i> ..							
		<i>Salmo mykiss leucisii</i> ..							
		<i>Necturus maculatus</i> ..				Amphibians			
		Frogs				Amphibians			
		<i>Gorgoderia varsoviensis</i> ..				Frogs	Amphibians	<i>Agriion</i> sp. <i>Epitheca</i> sp.	} Odonata
						Frogs	Amphibians	<i>Agriion</i> sp. <i>Epitheca</i> sp.	
						Frogs	Amphibians	<i>Epitheca</i> sp.	
		<i>Gorgoderia vitelliloba</i> ..				Frogs	Amphibians	"Raubinsekten"	Insecta

Arthropod Hosts of Trematodes:—Continued

Family	Trematode	Primary host	Group	Secondary host	Group
GORGONIIDAE	<i>Microphallus opacus</i>	<i>Amia calva</i> <i>Ictalurus punctatus</i> <i>Perca flavescens</i>	Fish	<i>Cambarus propinquus</i>	Decapoda
HALIPEGIDAE	<i>Halipegus orocaudatus</i>	Frogs	Amphibians	<i>Calopteryx virgo</i>	Odonata
TROGLOTREMATIDAE	<i>Paragonimus westermani</i>	Man ? Dog ? Cat ? Swine	Primate Carnivores Ungulate	<i>Geothelphusa obtusipes</i> <i>Geothelphusa dehaanii</i> <i>Sesarma dehaanii</i> <i>Eriochelir japonicus</i> <i>Pseudothelphusa iturbei</i> ? <i>Cambaroides similis</i> ? <i>Astacus japonicus</i>	Decapoda
HEMIMURIDAE	<i>Hemimurus appendiculatus</i>	<i>Perca fluviatilis</i> <i>Coregonus oxyrrhynchus</i> <i>Lampetra fluviatilis</i> <i>Lota lota</i> <i>Isiox lucius</i> <i>Salmo fario</i> <i>Clupea finia</i> <i>Caspialosa kessleri</i> <i>Osmerus mordax</i>	Fish	<i>Acarita clausa</i>	Copepoda

Arthropod Hosts of Trematodes.—Continued

Family	Trematode	Primary host	Group	Secondary host	Group			
HEMURIDAE	<i>Derogoches varicus</i>	<i>Coregonus oxyrinchus</i> .	Fish	<i>Acartia</i> sp.	Copepoda			
		<i>Thymallus thymallus</i> ..						
		<i>Gadus callarias</i>						
		<i>Urophycis tenuis</i>						
		<i>Anarrhichas lupus</i>						
		<i>Hippoglossus hippoglossus</i> .						
		<i>Salmo salar</i>						
		<i>Coryphaena equisetis</i> ..				Fish	<i>Cerataspis monstrosa</i> ...	Decapoda
		<i>Coryphaena hippuris</i> ..						
		DICROCOELIIDAE				<i>Sinistroporus simplex</i> ..	<i>Gadus aeglefinus</i>	Fish
<i>Cottus scorpius</i>								
<i>Phobos ventralis</i>								
<i>Hemirhamphus americanus</i> .								
<i>Leptocephalus conger</i> ..								
<i>Limanda ferruginea</i>								
<i>Microgadus tomcod</i>								
<i>Microporogon undulatus</i> ..								
<i>Rana esculenta</i>	Amphibians		<i>Phryganica grandis</i>	Trichoptera				
<i>Rana hallowellii</i>								
UNCERTAIN	<i>Macroorchis spinulosus</i> ..	Dog	Carnivores	<i>Potamon detachii</i>	Decapoda			
		Cat						
		Small animals				Rodents		

Arthropod Hosts of Trematodes.—Continued

Family	Trematode	Primary host	Group	Secondary host	Group
UNCERTAIN	<i>Sicphanolecithus pareus</i> .	Dog	Carnivore	? <i>Potamon obtusifpes</i> .. ? <i>Potamon dehaanii</i> .. ? <i>Potamon sinensis</i> .. ? <i>Sasarna dehaanii</i> .. ? <i>Eriocheir japonicus</i> ..	Decapoda
	<i>Distomum kaiapāi</i>	Dog Cat	Carnivores	Crabs	Decapoda
	<i>Distomum aganos</i>	?	?	<i>Gammarus pulex</i>	Amphipoda
	<i>Distomum gammari</i> Rentsch.	?	?	<i>Gammarus ornatus</i>	Amphipoda
	<i>Distomum gammari</i> Linstow.	?	?	<i>Gammarus pulex</i>	Amphipoda
	<i>Distomum pulicis</i>	?	?	<i>Gammarus pulex</i>	Amphipoda
	<i>Distomum linnophili</i>	?	?	<i>Linnophilus (?) rhombicus</i>	Trichoptera
	<i>Distomum phryganeac</i>	?	?	<i>Phryganea grandis</i>	Trichoptera
	<i>Distomum mystacidis</i>	?	?	<i>Mystacides nigra</i>	Neuroptera
	<i>Distomum notidobiac</i>	?	?	<i>Sialis lutaria</i>	Neuroptera
	<i>Distomum reinhardi</i>	?	?	<i>Notidobia ciliaris</i>	Trichoptera
	<i>Distomum sialisidis</i>	?	?	<i>Astacus leptodactylus</i>	Decapoda
	<i>Distomum sialisidis</i>	?	?	<i>Sialis lutaria</i>	Neuroptera

Arthropod Hosts of Trematodes.—Continued

Family	Trematode	Primary host	Group	Secondary host	Group
UNCERTAIN	<i>Distomum</i> sp. Herrick..	?	?	<i>Cyclops tenuicornis</i>	Copepoda
	<i>Distomum</i> of Cooper, 1883.	?	?	Crayfish	Decapoda
	<i>Distomum</i> sp. of Villot..	?	?	<i>Agriou</i> sp.	Odonata
	<i>Distomum</i> of Linstow, 1892.	?	?	Crayfish	Decapoda
	<i>Agamodistomum apodis</i> ?	?	?	<i>Apus</i> sp.	Branchio- poda
	<i>Agamodistomum anopheli</i> ?	?	?	<i>Anopheles maculipennis</i> ..	Diptera
	<i>Agamodistomum sintoni</i> ?	?	?	<i>Anopheles funcstus</i> var. <i>listoni</i> <i>Anopheles culifacies</i> ..	Diptera
	<i>Agamodistomum marti- rani</i> .	?	?	<i>Anopheles claviger</i>	Diptera
	Cercaria of Soparkar, 1918.	?	?	<i>Anopheles rossi</i>	Diptera
	Cercaria of Stephens & Christophers, 1902.	?	?	<i>Anopheles rossi</i>	Diptera
	Cercaria of Joyeux, 1918.	?	?	<i>Culex hortensis</i>	Diptera

Arthropod Hosts of Trematodes.—Continued

Family	Trematode	Primary host	Group	Secondary host	Group
UNCERTAIN	<i>Cercaria prima</i>	?	?	<i>Corethra</i> sp. <i>Hybius</i> sp. Dragon fly	Diptera Coleoptera Odonata
	<i>Cercaria secunda</i> ...	?	?	<i>Corethra</i> sp. Ephemerid	Diptera Ephemerida
	Fluke	?	?	<i>Rhyacophila nubila</i>	Trichoptera
	Fluke	?	?	<i>Nymphula nymphacata</i>	Lepidoptera

An analysis of the records given shows the following:

PLAGIORCHIIDAE

In the Plagiorchiidae we have a group of flukes which have a wide range of intermediate hosts, including the insect groups Odonata, Diptera, Trichoptera, Plecoptera, Ephemera, and Coleoptera, and the crustacean groups, Decapoda and Amphipoda. This range of intermediate hosts is associated with the range of primary hosts, which include fish, amphibians, and birds. Considered on the basis of primary hosts, the plagiorchids in birds utilize Odonata as intermediate hosts, those in fish use the Diptera, Odonata, Trichoptera, Plecoptera and Decapoda; while those in frogs use the Odonata, Trichoptera, Coleoptera, Ephemera, Plecoptera, and Amphipoda. The Trichoptera and the Odonata appear to be the most important intermediate hosts.

LECITHODENDRIIDAE

In the Lecithodendriidae the insects serve as intermediate hosts and they include the Plecoptera, Ephemera, Coleoptera, Diptera, Trichoptera, Odonata and "amphibious insects." The frog flukes of this family use Odonata and Coleoptera as intermediate hosts; the bat flukes use Plecoptera, Ephemera, Diptera, and Trichoptera. Here also the insects have the double rôle of intermediate host for the fluke and of food for the primary host.

OPISTHORCHIIDAE

In the Opisthorchiidae, insects, specified by Stafford (1927), as amphibious insects, are the only reported hosts. Since this is a large family with a wide range of hosts, little of a general nature could be concluded from the foregoing.

ALLOCREADIIDAE

In the Allocreadiidae, parasitic for the most part in fish, the intermediate hosts include Ephemera, Trichoptera, Diptera, and Decapoda, the more important being the Ephemera and the Decapoda. The intermediate hosts probably serve as such by virtue of their rôle as food for fish. The record for *Astacotrema cirrigerum* of a bird as primary host is found in a footnote reference based apparently on correspondence and lacks evidence or detail.

GORGODERIDAE

In the Gorgoderidae, commonly parasitic in frogs, the intermediate hosts known at present are mostly Odonata, the rôle of intermediate host here being combined with the rôle of food for frogs. One of the Decapoda, a crayfish, is the host for a gorgoderid parasitic in fish.

HALIPEGIDAE

In the Halipegidae, the only reported life history involves the Odonata as intermediate hosts, the primary hosts here being frogs.

TROGLOTREMATIDAE

In the Troglotrematidae the only known life history, that of the human lung fluke, involves several species of decapods, crabs being known hosts and crayfish probable hosts.

HEMIURIDAE

In the Hemiuridae, which are fish parasites, all known intermediate hosts are crustaceans, those for two flukes being copepods and those for one fluke being decapods.

DICROCOELIIDAE

The one dicrocoelid with a known life history utilizes an amphipod as an intermediate host, the primary hosts being fish.

BRACHYCOELIIDAE

The one brachycoelid with a known life history has a trichopteran as an intermediate host, the primary hosts being amphibians.

FAMILY UNCERTAIN

The three flukes of uncertain relationship for which we know primary as well as secondary hosts, and not merely secondary hosts for larval stages, all have carnivores as primary hosts and crabs as secondary hosts.

ARTHROPODS AS INTERMEDIATE HOSTS OF
NEMATODES

In listing the nematodes having intermediate stages in arthropods, no attention has been paid to nematodes listed only as nematodes without reference to whether the nematodes were mature or immature. Nematodes occurring consistently as larvae in insects may be the

larvae of worms which will develop to maturity on reaching a suitable host, although larval nematodes specified as such with no further discussion may be the larvae of such worms as the mermithids which will develop to maturity as free-living forms. In this paper the mermithids and gordians are not considered, as they are not regarded as true parasites of vertebrates in the scope of treatment of that subject as limited here. The gordians may parasitize immature frogs in the course of development of the worms, but this topic is disregarded here owing to a lack of space for its consideration.

All records which are merely surmises to the effect that a certain arthropod is the intermediate host of some nematode are likewise disregarded. Such surmises have their value in directing exploratory research, but for the purpose of analyzing existing records to obtain valid data they are worthless. There is sufficient uncertainty in connection with a number of existing records to introduce certain elements of possible error as it is.

The following list covers the important cases of arthropod hosts for nematodes. The worms involved fall in the Filariata or Filarida and most of them fall in the superfamilies Spiruroidea and Filarioidea, two closely related superfamilies which are markedly heteroxenous and hence in sharp contrast with most of the other nematode groups which are usually monoxenous. In the exceptional cases in which members of other superfamilies utilize intermediate hosts, the hosts are never arthropods so far as the writer is aware, but are such forms as fish or earthworms.

SPIRURIDAE

As intermediate hosts of nematodes of the Spiruridae, which is made up predominantly of mammalian parasites and to a lesser extent of bird parasites, the Coleoptera are of outstanding importance. In this family the common mode of transmission of the larval worm to the primary host is by means of the ingestion of the secondary host, either as a deliberate act of eating or because of the more or less accidental presence of the secondary host in the food of the primary host. In general, dogs, sheep, cattle and horses cannot be called insectivorous animals, but the presence of beetles in their customary food seems to be sufficiently common to enable various spirurid parasites of these animals to maintain themselves with the aid of these beetle hosts. It is evident that some of the spirurids utilizing beetle hosts may have alternative life histories which are more complicated than the mere infection of the beetle host by means of infective worm eggs and the infection of the primary host as a result of swallowing infected beetles. Thus Seurat has shown that *Physocephalus*

Arthropod Hosts of Nematodes

Family	Nematode	Primary host	Group	Secondary host	Group
SPIRURIDAE	<i>Spirura gastrophila</i>	Dog	Carnivores	<i>Blatta orientalis</i>	Orthoptera
		Cat			
		Fox			
		Mongoose			
		Hedgehog	Insectivore	<i>Akis goryi</i>	Coleoptera
			<i>Blaps</i> sp.		
			<i>Blaps siranchi</i>		
			<i>Onthophagus</i> sp.		
			<i>Scarabaeus sacer</i>		
		<i>Spirura talpac</i>	Mole	Insectivore	<i>Ciconia aurata</i>
	<i>Spirocerca sanguinolenta</i> .	Dog	Carnivore	(?) <i>Blatta orientalis</i>	Orthoptera
				<i>Akis goryi</i>	Coleoptera
				<i>Copris hispanis</i>	
				<i>Geotrupes douei</i>	
				<i>Gymnopleurus sturmi</i> ..	
				<i>Scarabaeus sacer</i>	
				<i>Caulion</i> sp.	
	<i>Habronema microstoma</i> .	Horse	Ungulates	<i>Sarcophaga melanura</i> ..	Diptera
		Ass		<i>Lyperosia exigua</i>	
		Mule		<i>Stomoxys calcitrans</i> ..	
				<i>Musca domestica</i>	

Arthropod Hosts of Nematodes.—Continued

Family	Nematode	Primary host	Group	Secondary host	Group
SPIRURIDAE	<i>Habronema megastoma</i>	Horse	Ungulates	<i>Musca domestica</i> <i>Musca fergusonii</i> <i>Musca humilis</i> <i>Musca lusoria</i> <i>Musca terrae-reginae</i> <i>Musca ventrosa</i> <i>Musca vetustissima</i> <i>Pseudopyrellia</i> sp.	Diptera
		Ass			
		Mule			
	<i>Habronema muscae</i>	Horse	Ungulates	<i>Musca domestica</i> <i>Musca fergusonii</i> <i>Musca humilis</i> <i>Musca lusoria</i> <i>Musca terrae-reginae</i> <i>Musca ventrosa</i> <i>Musca vetustissima</i> <i>Sarcophaga misera</i> <i>Pseudopyrellia</i> sp.	Diptera
		Ass			
		Mule			
	<i>Habronema</i> spp.	Horse	Ungulates	<i>Anastellorhina aqur</i> <i>Musca bezzi</i>	Diptera
		Ass			
		Mule			
	<i>Protospirura muris</i>	Mouse	Rodents	<i>Tenebrio molitor</i> (?) <i>Xenopsylla cheopis</i>	Coleoptera Siphonoptera
Rat					
		<i>Apoelmus sylvaticus</i>			

Arthropod Hosts of Nematodes.—Continued

Family	Nematode	Primary host	Group	Secondary host	Group
SPIRURIDAE	<i>Protospirura gracilis</i>	Cat	Carnivore	<i>Aphodius finetarius</i>	Coleoptera
	<i>Protospirura columbiana</i> .	<i>Rattus norvegicus</i>	Rodent	<i>Blattella germanica</i>	Orthoptera
	<i>Hartertia gallinarum</i>	Chicken	Galliformes	<i>Uodotermes pretoricusis</i> .	Isoptera
	<i>Arducma strongylina</i>	Swine Cow	Ungulates	<i>Aphodius rufus</i> <i>Aphodius castaneus</i> <i>Onthophagus hecate</i>	Coleoptera
	<i>Physocephalus sexalatus</i> .	Swine <i>Sus cristatus</i>	Ungulates	<i>Geotrupes douci</i> <i>Geotrupes sterco-</i> <i>rarius</i> . (?) <i>Geotrupes sterco-</i> <i>rosus</i> . <i>Onthophagus bedeli</i> <i>Onthophagus hecate</i> <i>Onthophagus nebulosus</i> . <i>Scarabaeus sacer</i> <i>Scarabaeus variolosus</i> .	Coleoptera
	<i>Gongylonema neoplasticum</i> .	Rat Mouse	Rodents	<i>Blatta orientalis</i> <i>Blattella germanica</i> <i>Periplaneta americana</i> . <i>Tenebrio molitor</i>	Orthoptera Coleoptera

Arthropod Hosts of Nematodes.—Continued

Family	Nematode	Primary host	Group	Secondary host	Group	
SPIRURIDAE	<i>Gongylonema mucronatum.</i>	<i>Eriaceus algirus</i>	Insectivore	<i>Ateuchis sacer</i>	Coleoptera	
						<i>Onitis irroratus</i>
						<i>Orthopagus bedeli</i> ..
						<i>Geotrupes douei</i>
						<i>Gymnopleurus sturmi.</i>
THELAZIDAE	<i>Gongylonema pulchrum.</i>	Swine	Ungulate	<i>Blatella germanica</i>	Orthoptera	
						(?) <i>Aphodius haemor-</i>
						<i>rhoidalis.</i>
						<i>Caccobius schreberi</i> ..
						<i>Blaps strauschi</i>
THELAZIDAE	<i>Gongylonema brevispiculum.</i>	Jerboa	Rodent	<i>Blaps</i> sp.	Coleoptera	
						<i>Tenebrio obscurus</i>
						<i>Blatta orientalis</i>
						<i>Periplaneta americana.</i>
						<i>Pycnoscelus surinamensis.</i>
THELAZIDAE	<i>Gongylonema sp.,</i>	?	?	<i>Pycnoscelus surinamensis.</i>	Orthoptera	
						<i>Pycnoscelus surinamensis.</i>
						<i>Daphnia pulex</i>
						<i>Chickens</i>
						<i>Chickens</i>
ACUARIIDAE	<i>Oxyspirura maasoni</i>	Chicken	Galliformes	<i>Pycnoscelus surinamensis.</i>	Orthoptera	
						<i>Oxyspirura parvorum</i> ..
						<i>Chickens</i>
						<i>Anas boschas</i>
						<i>Anas penelope</i>
ACUARIIDAE	<i>Echinuria uncinata</i>	<i>Anas rubripes</i>	Galliformes	<i>Pycnoscelus surinamensis.</i>	Orthoptera	
						<i>Anser cinereus domesticus.</i>
						<i>Cygnus olor domesticus</i>
						<i>Nettion carolinense</i> ..
						<i>Nettion carolinense</i> ..

Arthropod Hosts of Nematodes.—Continued

Family	Nematode	Primary host	Group	Secondary host	Group					
ACUARIIDAE	<i>Dispharynx spiralis</i>	Chicken	Galliformes	<i>Forcellio lacris</i>	Isopoda					
		<i>Bouasa umbellus</i>								
		<i>Phasianus gallus</i>								
		Pea fowl								
		<i>Quiscalus quiscula</i>								
		Pigeon								
		PHYSALOPTERIDAE				<i>Physaloptera abbreviata</i>	<i>Lacerta ocellata</i>	Reptile	<i>Ateuchus</i> sp.	Coleoptera
							<i>Anas boschas fera</i>	Anseriformes	<i>Daphnia pulex</i>	Cladocera
							<i>Anas boschas domestica</i>		<i>Gammarus pulex</i>	Amphipoda
							<i>Cygnus melanocoryphus</i>			
<i>Fulica atra</i>										
TETRAMERIDAE	<i>Tetrameres fissishina</i>	<i>Mergus mergamser</i>	Anseriformes							
		<i>Nyroca ferina</i>								
		<i>Podiceps stewartii</i>								
		Chicken								
		Turkey								
		Pigeon								
		CUCULLANIDAE				<i>Cucullanus elegans</i>	<i>Esox lucius</i>	Galliformes	<i>Cyclops quadricornis</i>	Copepoda
							<i>Gadus lota</i>			
							<i>Perca stewartii</i>			
							<i>Anguillula vulgaris</i>			
<i>Aspius rapax</i>										
	<i>Silurus glanis</i>			<i>Asellus aquaticus</i>	Isopoda					

Arthropod Hosts of Nematodes.—Continued

Family	Nematode	Primary host	Group	Secondary host	Group
CAMALANIDAE	<i>Camallanus lacustris</i>	<i>Perca fluviatilis</i> <i>Lucioperca sandra</i> <i>Acerina cernua</i> <i>Aspro zingel</i> <i>Leuciscus rutilus</i> <i>Aspius rapax</i> <i>Barbus fluviatilis</i> <i>Tinca vulgaris</i> <i>Esox lucius</i> <i>Lota vulgaris</i> <i>Salmo salar</i> <i>Trutta trutta</i> <i>Salvelinus fontinalis</i> <i>Coregonus oxyrhynchus</i> . <i>Osmerus eperlanus</i> <i>Silurus glanis</i> <i>Anguilla vulgaris</i>	Fish	<i>Cyclops</i> sp. <i>Agriou</i> sp.	Copepoda Odonata
HEDERIDAE	<i>Camallanus microcephalus</i> . <i>Hederuris androphora</i>	<i>Emys lutaria</i> <i>Amblystoma mexicana</i> . <i>Triton taeniatus</i> <i>Bufo calamita</i> <i>Lissotriton punctatus</i> <i>Emys guttata</i>	Reptile Amphibians Reptile	? <i>Cyclops</i> sp. <i>Asellus aquaticus</i>	Copepoda Isopoda

Arthropod Hosts of Nematodes—Continued

Family	Nematode	Primary host	Group	Secondary host	Group
HEDRURIDAE	<i>Hedruris orcsitae</i>	<i>Orcesias muelleri</i> <i>Orcesias albus</i>	Fish	(?) <i>Allorchestes</i> sp.	Amphipoda
FILARIIDAE	<i>Filaria maris</i>	<i>Mustela martes</i> <i>Mustela foina</i> <i>Putorius putorius</i> <i>Hystrix cristata</i>	Carnivores Rodent	(?) <i>Ixodes ricinus</i>	Arachnida
	<i>Filaria ozzardi</i>	Man	Primate	<i>Aedes aegypti</i> <i>Anopheles albimanus</i> <i>Anopheles albitarsis</i> <i>Anopheles maculifemnis</i> <i>Anopheles tarsimaculatus</i> <i>Culex quinquefasciatus</i>	Diptera
	<i>Filaria cypseli</i>	<i>Cypselus affinis</i>	Passeriformes	Bird louse	Mallophaga
	<i>Filaria mitchelli</i>	<i>Heloderma suspectum</i>	Reptile	? Tick	Arachnida
	<i>Filaria</i> sp. of Fuelleborn, 1909.	?	?	<i>Anopheles maculipennis</i>	Diptera
	<i>Filaria</i> sp. of Castellani and Chalmers, 1913.	?	?	<i>Mansonioides uniformis</i>	Diptera
	<i>Filaria</i> sp. of Med. Rept., Lagos, Nigeria, 1918 (Lou?).	?	?	<i>Chrysops silaceus</i>	Diptera

Arthropod Hosts of Nematodes.—Continued

Family	Nematode	Primary host	Group	Secondary host	Group
FILARIIDAE	<i>Wuchereria bancrofti</i>	Man	Primate	<i>Aedes aegypti</i> <i>Aedes (Finlaya) togoi</i> <i>Aedes gracilis</i> <i>Aedes perplexus</i> <i>Aedes pseudoscutellaris</i> , <i>Aedes scutellaris</i> <i>Aedes variegatus</i> <i>Anopheles albimanus</i> . <i>Anopheles annulipes</i> .. <i>Anopheles argyrotarsus</i> . <i>Anopheles barroensis</i> . <i>Anopheles costalis</i> ... <i>Anopheles rossi</i> <i>Anopheles sinensis</i> ... <i>Anopheles sinensis</i> <i>vanus</i> . <i>Scutomyia albolineata</i> . <i>Taeniorhynchus annulipes</i> . <i>Taeniorhynchus domesticus</i> . <i>Culex gelidus</i>	Diptera

Arthropod Hosts of Nematodes.—Continued

Family	Nematode	Primary host	Group	Secondary host	Group
FILARIIDAE	<i>Wuchereria bancrofti</i> .. (continued)	Man	Primate	<i>Culex fatigans</i> <i>Culex fuscoccephalus</i> .. <i>Culex microannulatus</i> .. <i>Culex ciliaris</i> <i>Culex pipiens</i> <i>Culex procax</i> <i>Culex tenellus</i> <i>Culex sitiens</i> <i>Culex quinquefasciatus</i> <i>Culex vigilax</i> <i>Panoptiles africanus</i> .. <i>Howardina albolineata</i> . <i>Mansonia pseudotitillans</i> . <i>Mansonioides annulipes</i> . <i>Mansonioides pseudotitillans</i> . <i>Mansonioides unifornis</i> . <i>Stegomyia fasciata</i> ..	Diptera

Arthropod Hosts of Nematodes.—Continued

Family	Nematode	Primary host	Group	Secondary host	Group
FILARIIDAE	<i>Dirofilaria immitis</i>	Dog	Carnivore	<i>Aedes aegypti</i>	Diptera
				<i>Aedes punctatus</i>	
				<i>Aedes vagans</i>	
				<i>Aedes vexans</i>	
				<i>Anopheles algeriensis</i> ..	
				<i>Anopheles bifurcatus</i> ..	
				<i>Anopheles maculipennis</i> ..	
				<i>Anopheles palstinus</i> ..	
				<i>Anopheles sinensis</i> ...	
				<i>Anopheles subopictus</i> ..	
				<i>Culex malariae</i>	
				<i>Culex penicillaris</i>	
				<i>Culex pipiens</i>	
				<i>Culex quinquefasciatus</i> ..	
				<i>Culex fatigans</i>	
				<i>Myzorchynchus pseudopictus</i> ..	
				<i>Myzomyia superpicta</i> ..	
				<i>Ctenocephalus canis</i> ...	
				<i>Ctenocephalus felis</i> ...	
				<i>Rhipicephalus sanguineus</i> ..	
				<i>Aedes aegypti</i>	
				<i>Aedes fasciatus</i>	
				<i>Anopheles maculipennis</i> ..	
	<i>Dirofilaria repens</i>	Dog	Carnivore		Diptera

Siphonaptera

Arachnida

Arthropod Hosts of Nematodes.—Continued

Family	Nematode	Primary host	Group	Secondary host	Group
FILARIIDAE	<i>Oncocerca volkulus</i>	Man	Primate	<i>Simulium damnosum</i> ...	Diptera
	<i>Oncocerca cacciticens</i> ...	Man	Primate	(?) <i>Culex</i> sp. (?) <i>Simulids</i>	Diptera
	<i>Loa loa</i>	Man	Primate	<i>Chrysops centuriensis</i> .. <i>Chrysops dimidiatus</i> .. <i>Chrysops longicornis</i> .. <i>Chrysops silaceus</i> <i>Haematopota cordigera</i> <i>Hippocentrum trimaculatum</i> .	Diptera
	<i>Setaria labiata-papillosa</i> .	Cattle	Ungulate	(?) <i>Stomoxys calcitrans</i> .	Diptera
	<i>Dipetalonema reconditum</i> .	Dog	Carnivore	<i>Haematopinus filiferus</i> ..	Anopleura
				<i>Culex fatigans</i>	Diptera
				<i>Culex quinquefasciatus</i>	Diptera
				<i>Ctenocephalus canis</i> ...	Siphonaptera
				<i>Ctenocephalus felis</i>	Siphonaptera
				<i>Pulex irritans</i>	Siphonaptera
				? <i>Rhipicephalus siculus</i>	Araclnida
				? <i>Rhipicephalus sanguineus</i> .	Araclnida

Arthropod Hosts of Nematodes.—Continued

Family	Nematode	Primary host	Group	Secondary host	Group
FILARIIDAE	<i>Dipetalonema persians</i> ..	Man	Primate	<i>Aedes aegypti</i>	Diptera
				<i>Aedes suguens</i>	
				<i>Culex pipiens</i>	
				<i>Anopheles costalis</i> ...	
				<i>Anopheles maculipennis</i> .	
				<i>Chrysocoenops fusco-</i> <i>fematus</i> .	
				<i>Culicoides austeni</i>	
				<i>Culicoides grahami</i> ...	
				<i>Mansonioides uni-</i> <i>formis</i> .	
				<i>Panophiles</i> sp.	
				(?) <i>Chrysops centuri-</i> <i>onis</i> .	
				<i>Pulex irritans</i>	
				<i>Ornithodoros mou-</i> <i>bata</i> .	
				<i>Argas</i> sp.	Arachnida
	<i>Dipetalonema grassii</i> ...	Dog	Carnivore	<i>Rhipicephalus sou-</i> <i>guineus</i> .	Arachnida

Arthropod Hosts of Nematodes.—Continued

Family	Nematode	Primary host	Group	Secondary host	Group
DRACUNCULIDAE	<i>Dracunculus medinensis</i> .	Man	Primate	<i>Cyclops coronatus</i> <i>Cyclops leuckartii</i> <i>Cyclops quadricornis</i> .. <i>Cyclops viridis</i> <i>Cyclops prasinus</i> <i>Cyclops bicuspidatus</i> .. <i>Cyclops strenuus</i> <i>Cyclops</i> sp. <i>Cyclops bicuspidatus</i> <i>Cyclops</i> sp. <i>Diaptomus</i> sp.	Copepoda
		Dog	Carnivores		
		Leopard			
		Horse			
		Cattle	Ungulates		
		Sheep			
		Goat			
		<i>Gazella bennetii</i>			
		Indian cobra	Reptile		
		<i>Chelydra serpentina</i>	Reptile		
UNCERTAIN	<i>Dracunculus</i> sp. ?	Indian cobra	Reptile	<i>Cyclops</i> sp. <i>Diaptomus</i> sp. <i>Musca terrae-rygineae</i> <i>Tabanus circumdatus</i> <i>Ephemera vulgata</i> <i>Oligoneuria rheumata</i>	Copepoda
		<i>Carassius vulgaris</i>	Fish		
		<i>Abramis vimba</i>			
		<i>Galaxias scriba</i>			
		<i>Leuciscus rutilus</i>			
		<i>Osmereus eberlandi</i>			
		<i>Coltus gobio</i>			
		<i>Ayamospirura muscarum</i> ?	?		
		<i>Igamoifilaria tabanicola</i> .. ?	?		
		<i>Spiroptera ephemeridarum</i> .	?		

Arthropod Hosts of Nematodes.—Continued

Family	Nematode	Primary host	Group	Secondary host	Group
UNCERTAIN	<i>Cystopsis acipenseris</i> ...	<i>Acipenser huso</i> <i>Acipenser ruthenus</i> ... }	Fish	<i>Eusimulium reptans</i>	Diptera
	<i>Agamonematodum blaps-</i> <i>mortisagae</i> .	?	?	<i>Blaps mortisaga</i>	Coleoptera
	<i>Agamonema</i> sp. Johnston, 1913.	?	?	<i>Ceratophyllus fasciatus</i> } <i>Xenopsylla cheopis</i> ... }	Siphonaptera
	Larval nema of Cobb, 1922.	?	?	<i>Aphodius fmetarius</i>	Coleoptera
	Larval nema of Cram, 1924.	?	?	<i>Pinothus carolinus</i>	Coleoptera
	Larval nema of Johnston & Bancroft, 1920.	?	?	<i>Fannia</i> sp.	Diptera

scaxalatus, a spirurid parasite not uncommon in the stomachs of swine and peccaries, will develop to an infective third-stage larva in its beetle host, and when these beetles are fed to some unusual host, such as rodents, birds, or even cold-blooded animals, the larval worm will re-encyst as a third-stage larva in the unusual host; but if the infected unusual host is fed to a suitable primary host, the larva will continue its development to maturity. How extensive this device is we do not know, but it may prove to be a common means of transmitting the spirurid worms of rapacious birds, as Cram has suggested, the spirurids of these birds producing eggs which infect some arthropod host, such as a beetle, the beetle being eaten by a small mammal, bird, amphibian or reptile, which is infected in turn with the third-stage larva, and the bird of prey eating these animals and becoming infested with the adult worms. The investigation of these life histories is a thing on which the mammalogist, the ornithologist, the herpetologist, the entomologist and the parasitologist might collaborate to great advantage, and the results might show some very interesting and surprising biological interrelationships.

As intermediate hosts of spirurids, the Orthoptera are also of some importance. The arthropods in question are all cockroaches, and they are probably of special importance as intermediate hosts for parasites of such rodents as rats and mice. These rodents seem to eat cockroaches with dependable certainty, and the association of rats, mice and roaches in the household provides a suitable and, so to speak, natural combination of factors for the benefit of these spirurids. On the other hand, the development of spirurid parasites of sheep, cattle and horses in cockroaches must be regarded as a case in which the roach merely serves as a host for a worm which cannot depend on such a host for its transmission, but which is capable of developing in that host as a case of accidental parasitism. In this connection it may be noted that roaches will serve as intermediate hosts for so many worms in this way that these insects make excellent experiment animals for carrying out life-history experiments in the laboratory. The plentiful supply of these insects in winter, a thing so unfortunate from some points of view, is a fortunate thing for the parasitologist who obtains interesting worms in winter at a time when other insects are scarce, and wishes to carry out feeding experiments on some insect.

The Diptera appear as intermediate hosts of spirurids with 14 species serving as hosts for 3 known species of spirurids, all species of the genus *Habronema* and all parasitic in horses and other members of the Equidae. This association obviously depends in part on the importance of the manure of horses and other Equidae as a breeding

place for Diptera. The transmission of the worm from the fly to the horse appears to present several complications. It was surmised by Ransom that horses might swallow flies which had fallen in drinking troughs or were benumbed in feed troughs on cold mornings. Subsequent work has indicated that the worms may escape from the proboscis of flies as they feed on the moist lips of horses, and presumably these worms may get to the stomach and develop to adult worms. However, if the fly feeds on the conjunctiva of the eye the larval worms may escape to the eye, remaining there as larvae and causing a habronemic conjunctivitis. If the fly feeds on a wound, the worms may escape and remain in the wound as larvae, causing "summer sores" or cutaneous habronemiasis. Finally, the worms may be found as larvae in the lungs, causing pulmonary habronemiasis, but the precise method of infection here remains to be ascertained. These cases illustrate the fact that there are numerous deviations from the cut-and-dried rule that intermediate hosts either transmit worms by being eaten by the primary host, or else transmit the worms by biting the primary host.

One member of the Siphonaptera occurs as a somewhat doubtful host of a rat spirurid, *Protospirura muris*, but the case for this should be developed by feeding experiments.

The one bird nematode of the family Spiruridae having a known life history is *Hartertia gallinarum*, and this worm utilizes a termite as its intermediate host, the host here serving as food for chickens which devour them with great eagerness.

THELAZIIDAE

In the Thelaziidae, we have a member of the Orthoptera, the roach *Pycnoscelis surinamensis*, serving as the intermediate host of the chicken eyeworm, *Oxyspirura mansoni*, and also for the somewhat dubious species, *O. parvovum*, distinguished from *O. mansoni* only by the smaller size of the egg. This life history was worked out by Fielding in Australia and somewhat later, but independently, by Sanders in Florida in the United States. At present the eyeworm, *O. mansoni*, appears to be confined in the United States to Florida, so far as our records show, but the intermediate host now has a much wider range in this country and unless measures are taken to stamp out the worm in Florida we can confidently expect it to spread beyond the confines of that state. The movements of the infected primary and secondary hosts by the swift methods of modern transportation over wide areas can hardly fail to ensure this result. [Since the above was written, the eyeworm has been found outside of Florida in this country.]

ACUARIIDAE

In the Acuariidae, we are dealing with bird parasites. Of the two worm species involved, one is a parasite of water birds, Anseriformes, and it is not surprising to find that this worm, *Echinuria uncinata*, uses Cladocera as its intermediate hosts, the one known intermediate host being *Daphnia pulex*. The other worm is a parasite of land birds, Galliformes and Columbiformes, and utilizes an isopod, *Porcellio laevis*. [Cram has since found grasshoppers to be intermediate hosts for Acuariidae of terrestrial birds.]

TETRAMERIDAE

In the Tetrameridae we are again dealing with bird parasites, and here again the intermediate hosts are Entomostraca, a cladoceran, *Daphnia pulex*, and an amphipod, *Gammarus pulex*. The one worm for which we know the life history, *Tetrameres fissispina*, is usually and normally a parasite of water birds, Anseriformes, and its occurrence in land birds must be regarded as following from the accidental swallowing of the infected entomostracans while drinking, whereas in water birds we are dealing with a dependable arrangement, from the standpoint of the parasite, based on Entomostraca in the double rôle of food for the primary host and of secondary host for the worm. [Cram has recently found grasshoppers serving as intermediate host of tetramerids of terrestrial birds.]

CUCULLANIDAE

For the one cucullanid with a known life history, a fish nematode, copepods and aquatic isopods serve as intermediate hosts, the hosts also serving as food for fish.

CAMALLANIDAE

For the two camallanids with known life histories, one a fish nematode and one a turtle nematode, copepods are hosts for both and dragonflies also serve as hosts for one. These hosts are also food for the primary hosts.

HEDRURIDAE

Of two species of hedrurids, parasitic in reptiles, amphibians and fish, one uses aquatic isopods and one amphipods as intermediate hosts.

The foregoing families are regarded by many parasitologists as part of the superfamily Spiruroidea, and in this superfamily the life history is usually one in which the transfer of the larval nematode to the primary host is accomplished when this host swallows the sec-

ondary host, either as food or accidentally, such apparent exceptions as in the case of *Habronema* being the unusual thing. We now take up a group of worms which all fall in the family Filariidae, regarded by those who recognize the superfamily Spiruroidea as described above, as being part of the superfamily Filarioidea, the two superfamilies being grouped on their affinities as the Filariata.

FILARIIDAE

In the Filariidae the customary mode of transmission of the worm is by the bite of the secondary host, this host becoming infected when it bites an infested primary host and in turn infecting a primary host by biting it after an interval in which the worm develops to the infective stage in the secondary host. It is to be expected, then, that the biting Diptera will show up prominently in this list of intermediate hosts, and we find a long list of such hosts recorded as transmitting numerous species of filarid worms. Here we have a number of important worm parasites of man and dogs, including such filarids as *Wuchereria bancrofti* and *Loa loa* of man, and the heart worm, *Dirofilaria immitis*, a serious pest of dogs in the hunting field. Mosquitoes take first place in this group of Diptera, many species transmitting *W. bancrofti* and *D. immitis*, while the tabanids, especially *Chrysops* spp., function for *Loa loa*.

The Siphonaptera, Mallophaga, Anopleura, and Arachnida are all charged with the transmission of filarid worms.

DRACUNCULIDAE

In the peculiar genus *Dracunculus*, including the guinea worm of man, *D. medinensis*, the worms usually infest superficial body parts of the primary host, and when these come in contact with water, the worms release large numbers of embryos, some of which are swallowed by copepods. The larval worms develop in these hosts to the infective stage and when these hosts are swallowed by suitable primary hosts the worms develop to maturity.

ARTHROPODS AS INTERMEDIATE HOSTS OF ACANTHOCEPHALIDS

The acanthocephalids quite generally utilize at least one intermediate host, and sometimes two such hosts, the second one a fish, amphibian, or bird in some cases, in their life history. These first intermediate hosts are sometimes snails or leeches, but in most of the reported cases the first intermediate host is an arthropod. The following list shows the reported hosts for the species having known life histories:

Arthropod Hosts of Acanthocephalids

Family	Acanthocephalid	Primary host	Group	Secondary host	Group
NEOECHINORHYNCHI- DAE.	<i>Neoechinorhynchus rutili</i> .	<i>Abramis björkna</i> <i>Abramis brama</i> <i>Alburnus alburnus</i> ... <i>Acerina ceruua</i> <i>Anguilla anguilla</i> <i>Barbus barbus</i> <i>Carassius carassius</i> ... <i>Chondrostoma nasus</i> .. <i>Cobitis taenia</i> <i>Cyprinus carpio</i> <i>Esox lucius</i> <i>Gasterosteus aculeatus</i> <i>Gasterosteus pungitius</i> <i>Gobio gobio</i> <i>Leuciscus leuciscus</i> ... <i>Leuciscus idus</i> <i>Leuciscus erythroph-</i> <i>thalmus</i> . <i>Leuciscus phoxinus</i> .. <i>Leuciscus rutilus</i> <i>Lota lota</i> <i>Perca fluviatilis</i> <i>Salmo fario</i> <i>Tinca tinca</i>	Fish	<i>Sialis niger</i> <i>Sialis lutaria</i>	Neuroptera
		<i>Emys orbicularis</i> <i>Rana esculenta</i>	Reptile Amphibian		

Arthropod Hosts of Acanthocephalids.—Continued

Family	Acanthocephalid	Primary host	Group	Secondary host	Group	
GIGANTORHYNCHIDAE.	<i>Gigantorhynchus spirula.</i>	<i>Canis aureus</i>	Carnivores	<i>Blaps</i> sp.	Coleoptera	
		<i>Felis lynx</i>				
		<i>Procyon lotor</i>				
		<i>Cebus fatuellus</i>				
		<i>Inuus caudatus</i>				
		<i>Lemur brunneus</i>				
	<i>Eriaceus algirus</i>	Insectivore				
	OLIGACANTHORHYNCHIDAE.	<i>Macracanthorhynchus hiridiniaceus.</i>	Swine	Ungulates	<i>Cetonia aurata</i>	Coleoptera
			<i>Sus cristatus</i>			
			<i>Canis aureus</i>	Carnivores	<i>Melolontha melolontha</i> ..	
<i>Felis lynx</i>			<i>Melolontha vulgaris</i> ..			
<i>Cebus fatuellus</i>	Primates	<i>Diloboderus abderus</i> ..	<i>Phyllophaga reheniens</i> ..			
Man		<i>Phyllophaga ferrugosa</i> ..	<i>Phyllophaga rugosa</i> ..			
CORYNOSOMIDAE	<i>Polymorphus boschadisi.</i>	<i>Anas boschas domestica</i> ..	Anseriformes	<i>Strategus julianus</i>	Amphipoda	
		<i>Anser cyrenus domesticus.</i>		<i>Xyloryctes satyrus</i>		
		<i>Cygnus olor domesticus</i> Wild water fowl.....		<i>Gammarus pulcx</i>		<i>Gammarus locusta</i>
				<i>Potamobius astacus</i> ...	Decapoda	
				<i>Astacus fluviatilis</i>		

Arthropod Hosts of Acanthocephalids.—Continued

Family	Acanthocephalid	Primary host	Group	Secondary host	Group				
MONILIFORMIDAE	<i>Moniliformis moniliformis.</i>	Rat	Rodents	<i>Blaps gigas</i>	Coleoptera				
		Mouse				<i>Blaps mucronata</i>			
		<i>Mus fuscirostris</i>		Carnivore	<i>Periplaneta americana.</i>	Orthoptera			
		<i>Cricetus frumentarius</i>					<i>Blatta orientalis</i>		
		<i>Microtus arvalis</i>			Primate				
		<i>Myoxus quercinus</i>							
		<i>Arvicola arvalis</i>			Accipitriformes				
		<i>Mustela putorius</i>							
		Man							
		<i>Falco tinnunculus</i>							
		ECHINORHYNCHIDAE			<i>Pomphorhynchus laccis.</i>	<i>Abramis blicca</i>	Fish	<i>Gammarus pulcx</i>	Amphipoda
						<i>Abramis brama</i>			
				<i>Abramis tumba</i>					
<i>Acerina vulgaris</i>									
<i>Acipenser huso</i>									
<i>Anguilla vulgaris</i>									
<i>Belone acis</i>									
<i>Cobitis barbatula</i>									
<i>Coregonus wartmannii</i>									
<i>Cottus</i> spp.									
<i>Cyprinus idbarus</i>									
<i>Esox lucius</i>									
<i>Salmo</i> spp.									
Many other fish.									

An inspection of the tables indicates, first of all, that we have but limited knowledge of the life histories of acanthocephalids in any one family, and that it will not be possible to generalize to any great extent on such limited data. What may be said is as follows:

NEOECHINORHYNCHIDAE

In the Neoechinorhynchidae we know the life history of one acanthocephalid, a parasite occurring in a large number of fish and in some reptiles and amphibians, and the known intermediate hosts are species of *Sialis*, one an unrecognized species, in the Neuroptera, other hosts being leeches and snails.

GIGANTORHYNCHIDAE

In the Gigantorhynchidae we again have only one known life history. In this case the echinorhynch occurs as an adult in mammals of various groups, including primates, carnivores, and insectivores, and has a species of *Blaps*, a coleopteron, as an intermediate host.

OLIGACANTHORHYNCHIDAE

In the Oligacanthorhynchidae we again have one acanthocephalid with a known life history, the well-known thorn-headed worm of swine, occurring in such animals as swine, carnivores, and man and other primates. This worm has a number of species of scarabaeid beetles as its intermediate hosts.

CORYNOSOMIDAE

In the Corynosomidae we have one known life history, that of an acanthocephalid of water fowl, Anseriformes, using crustaceans, amphipods and crayfish, as intermediate hosts.

MONILIFORMIDAE

In the Moniliformidae we have a parasite with a wide range of primary hosts, from man, carnivores and rodents to rapacious birds, and having as its intermediate hosts two species of Coleoptera and two of Orthoptera.

ECHINORHYNCHIDAE

In the Echinorhynchidae we have three acanthocephalids parasitic in fish of numerous species, two of them with an amphipod as an intermediate host and one with an aquatic isopod as an intermediate host; and one acanthocephalid parasitic in various amphibians and with an amphipod as its intermediate host.

By way of summary it may be noted that of three acanthocephalids parasitic in mammals, all develop in insects, all with Coleoptera and one with Orthoptera also as intermediate hosts; the one acanthocephalid habitually parasitic in water birds uses crustaceans as intermediate hosts; and that of five acanthocephalids parasitic in fish and amphibians, four use crustaceans as intermediate hosts, these being amphipods in two cases, isopods in one case, and both amphipods and isopods in one case. In the case of one acanthocephalid in fish, the Neuroptera serve as hosts. Insects are apparently of major importance for acanthocephalids of mammals and crustaceans for acanthocephalids of fish.

In the foregoing lists of parasites arranged by orders and families, the names given for the arthropod hosts are those under which they are reported in the literature and no attempt is made in these lists to eliminate synonyms for the reason already given that it is easier to trace these references in the literature under the names quoted. In the following lists arranged on the basis of intermediate hosts, synonyms are cross-referenced to the names accepted by the authorities already mentioned in the first part of the paper.

ARTHROPOD HOSTS OF HELMINTHS, ARRANGED BY HOST GROUPS

INSECTA

ANOPLÉURA

Haematopinus piliferus. See *Linognathus piliferus*.
Linognathus piliferus
Dipetalonema reconditum

DERMAPTERA

Anisolabis amulipes
Hymenolepis diminuta
Hymenolepis microstoma

EPHEMERIDA

Blasturus cupidus. See *Leptophlebia cupida*.
Clocon dipterum
 ? *Opisthioglyphe endoloba*
Ephemera danica
Stephanophiala farionis
Ephemera vulgata
Allocreadium isoporum
Opisthioglyphe endoloba
Spiroptera ephemeridarum

Ephemerid

Lecithodendrium lagenae
Cercaria secunda
Hexagenia sp.
Crepidostomum cornutum
Stephanophiala farionis
Leptophlebia cupida
Allocreadium commune
Oligoneuria rhenana
Spiroptera ephemeridarum

COLEOPTERA

Ablattaria laevigata
Weinlandia uncinata
Akis goryi
Spirura gastrophila
Spirocercia sanguinolenta
Akis spinosa
Hymenolepis diminuta
Aphodius castaneus. See *Aphodius rufus castaneus*.
Aphodius coloradensis
Gongylonema scutatum

- Aphodius distinctus*
Gongylonema scutatum
Aphodius femoralis
Gongylonema scutatum
Aphodius fimetarius
Protospirura gracilis
Gongylonema scutatum
 Larval nema of Cobb, 1922
Aphodius granarius
Hymenolepis carioeca
Gongylonema scutatum
Aphodius haemorrhoidalis
 ? *Gongylonema pulchrum*
Aphodius obscurus
 ? *Cittotaenia marmotae*
Aphodius rubeolus
Gongylonema scutatum
Aphodius rufus
Arduenna strongylina
Aphodius rufus castaneus
Arduenna strongylina
Aphodius sp.
Gongylonema scutatum
Aphodius vittatus
Gongylonema scutatum
Ateuchus sacer. See *Scarabaeus sacer*.
Ateuchus sp.
Physaloptera abbreviata
Blaps appendiculata
Gongylonema scutatum
Blaps emondi
Gongylonema scutatum
Blaps gigas
Moniliformis moniliformis
Blaps mortisaga
Agamonematodum blapis-mortisagae
Blaps mucronata
Moniliformis moniliformis
Blaps spp.
Spirura gastrophila
Gongylonema scutatum
Gongylonema brevispiculum
Gigantorhynchus spirula
Blaps strauchi
Spirura gastrophila
Gongylonema scutatum
Gongylonema brevispiculum
Caccobius schreberi
 ? *Gongylonema pulchrum*
Canthon sp.
Spirocerca sanguinolenta
Cetonia aurata
Spirura talpac
Macracanthorhynchus hirudinaceus
Chironitis irroratus
Gongylonema mucronatum
Copris hispanus
Spirocerca sanguinolenta
Diloboderus abderus
Macracanthorhynchus hirudinaceus
Geotrupes douei. See *Geotrupes* (*Stereopyge*) *douei*.
Geotrupes (*Stereopyge*) *douei*
Spirocerca sanguinolenta
 ? *Physocephalus sexualatus*
Gongylonema mucronatum
Geotrupes (*Anoplotrupes*) *stercorosus*
Choanotaenia infundibulum
Hymenolepis serpentulus
 ? *Physocephalus sexualatus*
Geotrupes stercorarius
Physalocephalus sexualatus
Geotrupes stercorosus. See *Geotrupes* (*Anoplotrupes*) *stercorosus*.
Geotrupes sylvaticus
Choanotaenia infundibulum
Hymenolepis serpentulus
Gymnopleurus mopsus
Gongylonema mucronatum
Gymnopleurus sturmi
Spirocerca sanguinolenta
Gongylonema mucronatum
Ilybius fuliginosus
Haplometra cylindracea
Ilybius sp.
Cercaria prima
Melolontha melolontha
Macracanthorhynchus hirudinaceus
Melolontha vulgaris. See *Melolontha melolontha*.
Onticellus fulvus
Gongylonema scutatum
Onitis irroratus. See *Chironitis irroratus*.
Onthophagus bedeli
Physocephalus sexualatus
Gongylonema mucronatum

Onthophagus hecate
Arduenna strongylina
Physocephalus sexalatus
Gongylonema scutatum
Onthophagus nebulosus
Physocephalus sexalatus
Onthophagus pennsylvanicus
Gongylonema scutatum
Onthophagus sp.
Spirura gastrophila
Onthophagus taurus
 ? *Gongylonema scutatum*
Phyllophaga arcuata
Macracanthorhynchus hirudinaceus
Phyllophaga fervens. See *Phyllophaga fusca*.
Phyllophaga fusca
Macracanthorhynchus hirudinaceus
Phyllophaga rugosa
Macracanthorhynchus hirudinaceus
Phyllophaga vehemens
Macracanthorhynchus hirudinaceus
Pinotus carolinus
 Larval nema of Cram, 1924
Scarabaeus sacer
Spirura gastrophila
Spirocerca sanguinolenta
Physocephalus sexalatus
Gongylonema mucronatum
Scarabaeus variolosus
Spirocerca sanguinolenta
Physocephalus sexalatus
Scaurus striatus
Hymenolepis diminuta
Silpha laevigata. See *Ablattaria laevigata*.
Strategus julianus
Macracanthorhynchus hirudinaceus
Tenebrio molitor
Hymenolepis arvicolae
 ? *Hymenolepis nana*
Hymenolepis diminuta
Hymenolepis microstoma
Onchoscolex decipiens
Protospirura muris
Gongylonema neoplasticum
Tenebrio obscurus
Gongylonema sp.
Tribolium ferrugineum
Hymenolepis diminuta

“Water beetles”

Pleurogenes medians
Pleurogenes claviger
Pleurogenes confusus
Nyloryctes satyrus
Macracanthorhynchus hirudinaceus

DIPTERA

Aedes aegypti
Filaria ozzardi
Wuchereria bancrofti
Dirofilaria immitis
Dirofilaria repens
Dipetalonema perstans
Aedes albolineata
Wuchereria bancrofti
Aedes albopictus
Wuchereria bancrofti
Aedes caspius
Dirofilaria immitis
Aedes fasciatus. See *Aedes aegypti*.
Aedes (Finlaya) togoi
Wuchereria bancrofti
Aedes gracilis. See *Bironella gracilis*
 and *Anopheles gracilis*.
Aedes perplexus
Wuchereria bancrofti
Aedes pseudoscutellaris. See *Aedes variegatus*.
Aedes punctatus. See *Aedes caspius*.
Aedes scutellaris. See *Aedes albopictus*.
Aedes sugens. See *Aedes vittatus*.
Aedes vagans
Dirofilaria immitis
Aedes variegatus
Wuchereria bancrofti
Aedes vexans
Dirofilaria immitis
Aedes vigilax
Wuchereria bancrofti
Aedes vittatus
Dipetalonema perstans
Anastellorhina augur
Habronema sp.
Anopheles albimanus
Filaria ozzardi
Wuchereria bancrofti
Anopheles albitalarsis
Filaria ozzardi

- Anopheles algeriensis*
Dirofilaria immitis
Anopheles annulipes
Wuchereria bancrofti
Anopheles argyritarsis
Wuchereria bancrofti
Anopheles barbirostris
Wuchereria bancrofti
Anopheles bifurcatus
Dirofilaria immitis
Agamodistomum martiranoi
Anopheles claviger. See *Anopheles bifurcatus*.
Anopheles costalis. See *Anopheles gambiae*.
Anopheles culifaciens
Agamodistomum sintoni
Anopheles fuliginosus
 Cercaria of Stephens & Christophers, 1902
Anopheles funestus listoni. See *Anopheles listoni*.
Anopheles gambiae
Wuchereria bancrofti
Dipetalonema perstans
Anopheles gracilis
 ? *Wuchereria bancrofti*
Anopheles hyrcanus pseudopictus
Dirofilaria immitis
Anopheles hyrcanus sinensis
Wuchereria bancrofti
Dirofilaria immitis
Anopheles listoni
Agamodistomum sintoni
Anopheles maculipennis
Lecithodendrium lagena
Agamodistomum anophelis
Filaria ozzardi
Filaria sp. Fuelleborn, 1909
Dirofilaria immitis
Dirofilaria repens
Dipetalonema perstans
Anopheles palestinus. See *Anopheles superpictus*.
Anopheles rossi. See *Anopheles subpictus*.
Anopheles sinensis. See *Anopheles hyrcanus sinensis*.
Anopheles sinensis peditaeniatus
Wuchereria bancrofti
- Anopheles sinensis pseudopictus*
Dirofilaria immitis
Anopheles sinensis vanus. See *Anopheles barbirostris*.
Anopheles subpictus
 Cercaria of Soparkar, 1918
 Cercaria of Stephens & Christophers, 1902
Wuchereria bancrofti
Anopheles superpictus
Wuchereria bancrofti
Dirofilaria immitis
Anopheles tarsimaculatus
Filaria ozzardi
Bironella gracilis
 ? *Wuchereria bancrofti*
Chironomus libiferus
Lissorhis fairporti
Chironomus plumosus
Lecithodendrium lagena
Chrysoconops fuscopennatus. See *Mansonia fuscopennatus*.
Chrysops centurionis
Loa loa
 ? *Dipetalonema perstans*
Chrysops dimidiatus
Loa loa
Chrysops longicornis
Loa loa
Chrysops silaceus
Filaria sp. of Med. Rept., Lagos, Nigeria, 1918
Loa loa
Corethra sp.
Cercaria prima
Cercaria secunda
Culex ciliaris. (May be *Aedes cinereus*, fide Dyar.)
Wuchereria bancrofti
Culex fatigans. See *Culex quinquefasciatus*.
Culex fuscocephalus
Wuchereria bancrofti
Culex gelidus
Wuchereria bancrofti
Culex hortensis
 Cercaria of Joyeux, 1918
Culex malariae. See *Aedes vexans*.
Culex microannulatus. See *Culex sitiens*.

- Culex penicillaris*. See *Aedes caspius*.
Culex pipiens
Wuchereria bancrofti
Dirofilaria immitis
Dipetalonema perstans
Culex procax. See *Aedes vigilax*.
Culex quinquefasciatus
Filaria ozzardi
Wuchereria bancrofti
Dirofilaria immitis
Dipetalonema reconditum
Culex sitiens
Wuchereria bancrofti
Culex sp.
? *Onchocerca caecutiens*
Culex tenuatus. See *Aedes aegypti*.
Culex vigilax. See *Aedes vigilax*.
Culicoides austeni
Dipetalonema perstans
Culicoides grahani
Dipetalonema perstans
Eusimulium reptans
Cystopsis acipenseris
Fannia sp.
Larval neina of Johnston & Bancroft, 1920
Haematopota cordigera
Loa loa
Hippocentrum trimaculatum
Loa loa
Howardina albolineata. See *Aedes albolineata*.
Lyperosia exigua
Habronema microstoma
Mansonia africana
Wuchereria bancrofti
Mansonia annulipes
Wuchereria bancrofti
Mansonia fuscopematus
Dipetalonema perstans
Mansonia pseudotitillans
Wuchereria bancrofti
Mansonia sp.
Dipetalonema perstans
Mansonia uniformis
Filaria sp. Castellani & Chalmers, 1913
Wuchereria bancrofti
Dipetalonema perstans
- Mansonioides annulipes*. See *Mansonia annulipes*.
Mansonioides pseudotitillans. See *Mansonia pseudotitillans*.
Mansonioides uniformis. See *Mansonia uniformis*.
Musca bezzi
Habronema spp.
Musca domestica
Choanotacnia infundibulum
Darvainea tetragona
Darvainea cesticillus
Habronema microstoma
Habronema megastoma
Habronema muscae
Musca fergusonii
Habronema megastoma
Habronema muscae
Musca humilis
Habronema microstoma
Habronema muscae
Musca lusoria
Habronema megastoma
Habronema muscae
Musca terrae-reginae
Habronema megastoma
Habronema muscae
Agamospirura muscarum
Musca ventrosa
Habronema megastoma
Habronema muscae
Musca vetustissima
Habronema megastoma
Habronema muscae
Myzomyia superpicta. See *Anopheles superpictus*.
Myzorhynchus pseudopictus. See *Anopheles hyrcanus pseudopictus*.
Panoplites africanus. See *Mansonia africanus*.
Panoplites sp.
Dipetalonema perstans
Pseudopyrellia sp.
Habronema megastoma
Habronema muscae
Sarcophaga melanura
Habronema microstoma
Sarcophaga misera
Habronema muscae

Scutomyia albolineata. See *Aedes albolineata*.

Simuliids

Oncocerca caecutiens

Simulium damnosum

Oncocerca volvulus

Stegomyia fasciata. See *Aedes aegypti*.

Stomoxys calcitrans

Hymenolepis carioca

Habronema microstoma

? *Habronema muscae*

? *Setaria labiato-papillosa*

Tabanus circumdatas

Agamofilaria tabanicola

Taeniorhynchus annulipes. See *Mansonias annulipes*.

Taeniorhynchus domesticus. Probably

Culex pipiens, q. v.

Wuchereria bancrofti

Tanytus decoloratus

Lissorchis fairporti

ISOPTERA

Hodotermes pretoriensis. See *Macrohodotermes mossambicus transvaalensis*.

Macrohodotermes mossambicus transvaalensis

Hartertia gallinarum

LEPIDOPTERA

Aglossa dimidiata

Hymenolepis diminuta

Aphornia gularis

Hymenolepis diminuta

Asopia farinalis

Hymenolepis diminuta

Nymphula nymphacata

Fluke

Paralipsa gularis. See *Aphornia gularis*.

Pyralis farinalis. See *Asopia farinalis*.

Tinea granella

Hymenolepis diminuta

MALLOPHAGA

"Bird louse"

? *Filaria cypseli*

Trichodectes latus

Dipylidium caninum

NEUROPTERA

Mystacides nigra

Distomum mystacidis

Sialis lutaria. See *Sialis flavilatera*.

Sialis flavilatera

Distomum notidobiac

Distomum sialidis

Neoechinorhynchus rutili

Sialis niger

Neoechinorhynchus rutili

ODONATA

Aeschna sp.

Prostotocus confusus

Agrion puella. See *Coenagrion puella*.

Agrion spp.

Gorgodera pagenstecheri

Gorgodera varsoviensis

Pleurogenes medians

Distomum sp. of Villot

Procercoid of Galli-Valerio, 1923

Camallanus lacustris

Agrion virgo

Pneumonoeces variegatus

Pneumonoeces similigenus

Halipegus ovocaudatus

Calopteryx virgo. See *Agrion virgo*.

Coenagrion puella

Tatria acanthorhyncha.

Cordulia sp.

Prostotocus confusus

"Dragonfly"

Plagiorchis ameiurensis

Cercaria prima

Epitheca sp.

Gorgodera pagenstecheri

Gorgodera varsoviensis

Gorgodera cygnoides

Libellula quadrimaculata

Prosthogonimus intercalandus

Prosthogonimus pellucidus

Tetragoneuria sp.

Prosthogonimus sp. of Kotlan and

Chandler

PLECOPTERA

Perla bicaudata
Opisthioglyphe endolobum
 "Perlid larva"
Plagiorechis maculosus
Lecithodendrium layena

ORTHOPTERA

Blatta orientalis
Spirura gastrophila
 ? *Spirocerca sanguinolenta*
Gongylonema neoplasticum
Gongylonema sp.
Moniliformis moniliformis
Blattella germanica
Protospirura columbiana
Gongylonema neoplasticum
Gongylonema scutatum
Gongylonema pulchrum
Periplaneta americana
Gongylonema neoplasticum
Gongylonema orientale
Gongylonema sp.
Moniliformis moniliformis
Periplaneta australasiae
Gongylonema orientale
Pycnoscelus surinamensis
Oxyspirura mansoni
Oxyspirura parvorum

SIPHONAPTERA

Ceratophyllus fasciatus
Hymenolepis diminuta
 ? *Hymenolepis nana*
Hymenolepis microstoma
Agamonema sp. Johnston, 1913
Ctenocephalus canis
Dipylidium caninum
Hymenolepis diminuta
Dirofilaria immitis
Dipetalonema reconditum
Ctenocephalus felis
Dipylidium caninum
Dirofilaria immitis
Dipetalonema reconditum
Leptopsylla musculi
Hymenolepis diminuta

Mesopsylla eucta
 Cysticeroid of Dampf, 1910
Pulex irritans
Dipylidium caninum
Hymenolepis diminuta
Dipetalonema reconditum
Dipetalonema persians
Xenopsylla cheopis
Hymenolepis diminuta
 ? *Hymenolepis nana*
 ? *Protospirura muris*
Agamonema sp. Johnston, 1913

TRICHOPTERA

Anabolia nervosa
Allocreadium isoporum
Opisthioglyphe endolobum
Chaetopteryx villosa
Allocreadium isoporum
Drusus trifidus
Plagiorechis maculosus
Limnophilus flavicornis
Opisthioglyphe endolobum
Limnophilus griseus
Opisthioglyphe endolobum
Limnophilus lunatus
Opisthioglyphe endolobum
Limnophilus rhombicus
Opisthioglyphe endolobum
Distomum limnophili
Notidobia ciliaris
Distomum notidobiac
Phryganca grandis
Opisthioglyphe endolobum
Lecithodendrium cheilostomum
Brachycoelium retusum
Distomum phrygancae
Phryganca sp.
Lecithodendrium cheilostomum
Rhyacophila nubila
 Fluke

UNPLACED

"Amphibious insects"
Plagioporus sp.
Eumegacetes sp.
 "Raubinsekten"
Gorgodera vitelliloba

- Cyclops bicuspidatus*
Hymenolepis tenuirostris
Drepanidotacnia lanceolata
Schistocephalus solidus
Bothriocephalus cuspidatus
Corallobothrium fimbriatum
Dracunculus globocephalus
Cyclops brevicaudata. See *Cyclops strenuus*.
Cyclops brevispinosus
Bothriocephalus cuspidatus
Diphyllobothrium latum
Cyclops coronatus. See *Cyclops fuscus*.
Cyclops crassicornis
Hymenolepis brachycephala
Cyclops fimbriatus. See *Platycyclops fimbriatus*.
Cyclops fuscus
Dracunculus medinensis
Cyclops leuckarti
Proteocephalus ambloplitis
Bothriocephalus cuspidatus
Diphyllobothrium mansoni
Dracunculus medinensis
Cyclops lucidulus
Hymenolepis collaris
Cyclops oithonoides. See *Mesocyclops oithonoides*.
Cyclops prasinus
Proteocephalus ambloplitis
Corallobothrium giganteum
Bothriocephalus cuspidatus
Dracunculus medinensis
Cyclops pulchellus. See *Cyclops bicuspidatus*.
Cyclops quadricornis
Cucullanus elegans
Dracunculus medinensis
Cyclops robustus
Diphyllobothrium latum
Cyclops serratus. See *Cyclops bicuspidatus*.
Cyclops serrulatus
Hymenolepis collaris
Hymenolepis tenuirostris
Hymenolepis fasciculata
Hymenolepis microsoma
Proteocephalus torulosus
Proteocephalus longicollis
Proteocephalus percae
- Corallobothrium giganteum*
Corallobothrium fimbriatum
Bothriocephalus cuspidatus
Schistocephalus solidus
Abothrium infundibuliformis
Abothrium crassum
 Cysticercoid of Rossiter, 1893
Cysticercus quadricurvatus
Cysticercus gruberi
Cysticercus sp. Luehe, 1910
Cyclops sp.
Fimbriaria fasciolaris
Camallanus lacustris
Camallanus microcephalus
Dracunculus sp.
Philometra sanguineum
Cyclops strenuus
Proteocephalus torulosus
Proteocephalus longicollis
Proteocephalus percae
Ichthyotaenia sp. Fuhrmann, 1926
Hymenolepis setigera
Diphyllobothrium latum
Abothrium crassum
Abothrium infundibuliformis
Triacnophorus nodulosus
Cysticercus gruberi
Dracunculus medinensis
Cyclops tenuicornis. Probably *Cyclops albidus* q. v.
Distomum sp. Herrick
Cyclops varius. See *Cyclops serrulatus*.
Cyclops vernalis
Hymenolepis anatina
Hymenolepis collaris
Cyclops viridis
Hymenolepis collaris
Hymenolepis gracilis
Hymenolepis fasciculatus
Dracunculus medinensis
Diaptomus africanus
Plerocercus africanus
Diaptomus alluaudi
Hymenolepis anatina
Dicranotaenia dubia
Diaptomus asiaticus
Echinocotyle linstoevi
Echinocotyle polyacantha
Taenia zichyi

- Diaptomus castor*
Proteocephalus torulosus
Diaptomus coeruleus
Hymenolepis collaris
Hymenolepis gracilis
Hymenolepis tenuirostris
Hymenolepis fasciculatus
Hymenolepis setigera
Diaptomus gracilis
Diphyllobothrium latum
Diaptomus graciloides
Diphyllobothrium latum
Diaptomus oregonensis
Diphyllobothrium latum
Diaptomus sp.
Cysticercoides sp. Mrazek, 1898
Cercocystis dendrocercus
Philometra sanguineum
Diaptomus spinosus
Hymenolepis anatina
Hymenolepis gracilis
Drepanidotacnia lanceolata
Echinocotyle linstowi
Diaptomus vulgaris
Fimbriaria fasciolaris
Leptocyclops agilis. See *Cyclops scru-*
latus.
Mesocyclops oithonoides
Proteocephalus percae
Platycyclops fimbriatus
Hymenolepis brachycephala
Trienophorus nodulosus
Pseudoboeckella brazilensis
Echinocotyle mrazeki
- OSTRACODA
- Candona candida*
Hymenolepis coronula
Candona neglecta tuberculata
Hymenolepis gracilis
Candona rostrata
Hymenolepis gracilis
Cyclocypris globosa
Hymenolepis gracilis
Hymenolepis coronula
Hymenolepis liophallos
Hymenolepis venusta
Echinocotyle rosseteri
Cysticercoides sp. Rossiter, 1890
- Cyclocypris laevis*
Hymenolepis coronula
Cyclocypris ovum
Hymenolepis coronula
Cyprina ophthalmica
Hymenolepis anatina.
Hymenolepis gracilis
Hymenolepis coronula
Echinocotyle rosseteri
 "Cypris agilis"
Hymenolepis venusta
Cypris cinerea. See *Cyclocypris glo-*
bosa.
Cypris compressa. See *Cyprina ophthal-*
mica.
Cypris elongata
Tacnia sp. Daday, 1900
Cypris incongruens. See *Heterocypris*
incongruens.
Cypris ophthalmica. See *Cyprina oph-*
thalmica
Cypris ovata. See *Cypris pubera*.
Cypris ovum. See *Cyclocypris ovum*.
Cypris pubera
Hymenolepis anatina.
Cypris virens. See *Eucypris virens*.
Cypris virens. See *Eucypris virens*.
Dolerocypris fasciata
Hymenolepis gracilis
Eucandona hungarica
Hymenolepis anatina
Eucypris crassa
Hymenolepis anatina
Eucypris virens
Hymenolepis collaris
Hymenolepis coronula
Hymenolepis gracilis
Heterocypris incongruens
Hymenolepis anatina
 "Ostracod"
Cysticercus sp. Luehe, 1910
- DECAPODA
- Astacus astacus*
Astacotrena cirrigerum
Hymenolepis collaris
Hymenolepis tenuirostris
Polymorphus boschadis

- Astacus fluviatilis*. See *Astacus astacus*.
Astacus japonicus. See *Cambaroides japonicus*.
Astacus leptodactylus
Distomum reinhardi
Cambaroides japonicus
Paragonimus westermani
Cambaroides similis
 ? *Paragonimus westermani*
Cambarus propinquus
Microphallus opacus
Cambarus spp.
Crepidostomum cornutum
Cerataspis monstrosa
Dinurus tornatus
 "Crabs"
Distomum kalafai
 "Crayfish"
Astacotrema cirrigerum
Aerolichanus petalosa
Plagiorchis amoiwensis
Distoma of Cooper, 1883
Distomum of Linton, 1892
Eriocheir japonicus
Paragonimus westermani
Stephanolecithus parvus
Geothelphusa dehaani. See *Potamon*
 (*Geothelphusa*) *dehaani*.
Geothelphusa obtusipes. See *Potamon*
 (*Geothelphusa*) *obtusipes*.
 "Marine decapods"
Rhynchobothrius ruficollis
Potamobius astacus. See *Astacus astacus*.
Parathelphusa (*Parathelphusa*) *sinensis*
Stephanolecithus parvus
Potamon dehaanii. See *Potamon*
 (*Geothelphusa*) *dehaanii*.
Potamon obtusipes. See *Potamon*
 (*Geothelphusa*) *obtusipes*.
Potamon sinensis. See *Parathelphusa*
 (*Parathelphusa*) *sinensis*.
Potamon (*Geothelphusa*) *dehaanii*
Paragonimus westermani
Macroorchis spinulosus
Stephanolecithus parvus
Potamon (*Geothelphusa*) *obtusipes*
Paragonimus westermani
Stephanolecithus parvus
Pseudothelphusa iturbei
Paragonimus westermani
Sesarma dehaanii
Paragonimus westermani
Stephanolecithus parvus

ISOPODA

- Asellus aquaticus*
Camallanus elegans
Hedruris androphora
Acanthocephalus lucii
Echinorhynchus ranae
Porcellio laevis
Dispharynx spiralis

GENERAL DISCUSSION

On the basis of the foregoing lists, the arthropod hosts are arranged below in their approximate order of relative importance for each order of parasites, with a résumé of the numbers of host and parasite species involved.

As intermediate hosts for tapeworms with primary hosts living in water or feeding on arthropods which live in water, the Copepoda are of outstanding importance, the next most important group being the Ostracoda. The Amphipoda, Decapoda, and Cladocera are much less extensively involved as intermediate hosts for tapeworms so far as is known at the present time.

Cestoda

Intermediate host group	No. of host spp. involved	No. of parasite spp. with known hosts for adults	No. of parasite spp. reported as larvae without known hosts for adults
CRUSTACEA:			
Copepoda	27	29	8
Ostracoda	15	6	3
Amphipoda	1	5	7
Decapoda	2	3	0
Cladocera	2	1	0
INSECTA:			
Coleoptera	8	9	1
Siphonaptera	7	4	1
Diptera	2	4	0
Lepidoptera	4	1	0
Odonata	2	1	1
Dermaptera	1	2	0
Mallophaga	1	1	0
MYRIAPODA	2	1	0

As intermediate hosts for tapeworms of land animals, the Coleoptera are distinctly the most important group, other insect groups being of much less importance so far as we know.

Trematoda

Intermediate host group	No. of host spp. involved	No. of parasite spp. with known hosts for adults	No. of parasite spp. reported as larvae without known hosts for adults
CRUSTACEA:			
Decapoda	15	8	4
Amphipoda	3	1	4
Copepoda	3	2	1
Branchiopoda	1	0	1
INSECTA:			
Diptera	11	2	8
Trichoptera	11	2	4
Odonata	8	6	2
Ephemera	5	5	1
Coleoptera	3	3	1
Unplaced insects	2	4	0
Neuroptera	2	0	3
Plecoptera	2	1	0
Lepidoptera	1	0	1

Among the Crustacea, the Decapoda are of outstanding importance as hosts for flukes, some of these flukes occurring in land mammals which eat raw crabs or crayfish.

Among the Insecta, the apparent importance of the Diptera and Trichoptera is not well established. These groups rate high in number of species serving as hosts, but as the flukes reported from them are mostly larval forms of which the adults are not known and which may later prove to represent no more known species than are already known and recorded here from these hosts, or only a few more, these groups cannot be rated at the present time as any more important than the Odonata or Ephemera as hosts for flukes.

Nematoda

Intermediate host group	No. of host spp. involved	No. of parasite spp. with known hosts for adults	No. of parasite spp. reported as larvae without known hosts for adults
CRUSTACEA :			
Copepoda	8	7	0
Amphipoda	2	2	0
Isopoda	2	2	0
Cladocera	1	1	0
INSECTA :			
Diptera	67	17	4
Coleoptera	39	10	3
Orthoptera	5	5	0
Siphonaptera	5	4	1
Ephemera	2	0	1
Anopleura	1	1	0
Isoptera	1	1	0
Mallophaga	1	1	0
Odonata	1	1	0
ARACHNIDA	6	6	0

Among the Crustacea, the Copepoda are the important group as carriers of parasitic nematodes. Among the Insecta the Diptera are of striking importance, no less than 67 of the Diptera being reported as carriers for a total of 17 nematode species, this fact being the result largely of the rôle of the mosquitoes as carriers of filarids. The Coleoptera take first rank as carriers of spirurids. Of lesser importance are the Orthoptera and Siphonaptera, and the other groups of insects show but few host species and these accused of carrying but one nematode parasite. The Arachnida as a whole have been accused of carrying 6 nematodes, and but 6 arachnids are incriminated. The arachnids have not been reported as carriers of any parasitic worms other than nematodes.

Acanthocephala

Intermediate host group	No. of host spp. involved	No. of parasite spp. with known hosts for adults	No. of parasite spp. reported as larvae without known hosts for adults
CRUSTACEA:			
Amphipoda	4	4	0
Isopoda	1	2	0
Decapoda	1	1	0
INSECTA:			
Coleoptera	11	3	0
Neuroptera	2	1	0
Orthoptera	2	1	0

Among the Crustacea, the Amphipoda are of special significance as hosts for acanthocephalids of aquatic animals, so far as the life histories of such worms are known. The only other crustaceans involved are Isopoda and Decapoda.

Among the Insecta, the Coleoptera are of major importance as carriers of acanthocephalids with known life histories. The only other insects involved are Neuroptera and Orthoptera.

If we take the outstanding groups of intermediate hosts for each order of parasites, we have the following:

For Cestoda: Copepoda and Ostracoda; Coleoptera.

For Trematoda: Decapoda; Diptera, Trichoptera, Odonata, and Ephemera.

For Nematoda: Copepoda; Diptera and Coleoptera.

For Acanthocephala: Amphipoda; Coleoptera.

Among the insects, the importance of the Coleoptera is indicated by the fact that this group is of decided significance for Cestoda, Nematoda, and Acanthocephala. The Diptera are important as carriers of Trematoda and Nematoda. The Trichoptera, Odonata, and Ephemera only figure as outstandingly important for Trematoda.

Among the crustaceans, the Copepoda are the major group as hosts for both Cestoda and Nematoda. The Ostracoda are only known to be important as hosts for Cestoda, the Decapoda as hosts for Trematoda, and the Amphipoda as hosts for Acanthocephala.

The following table is inserted to give a rapid check on the known occurrence in the different arthropod hosts of parasites of the groups involved in this paper. If an arthropod group is known to contain intermediate hosts for the worm groups involved, an X is placed under the worm group and opposite the host group. If there are no such hosts known, an O is placed in the corresponding position.

LIST SHOWING RECORDS (X) OR LACK OF RECORDS (O) OF
PARASITE GROUPS IN HOST GROUPS

Arthropod group	Cestoda	Trematoda	Nematoda	Acanthocephala
Amphipoda	X	X	X	X
Branchiopoda	O	X	O	O
Cladocera	X	O	X	O
Copepoda	X	X	X	O
Decapoda	X	X	O	X
Isopoda	O	O	X	X
Ostracoda	X	O	O	O
Anopleura	O	O	X	O
Coleoptera	X	X	X	X
Dermaptera	X	O	O	O
Diptera	X	X	X	O
Ephemera	O	X	X	O
Isoptera	O	O	X	O
Lepidoptera	X	X	O	O
Mallophaga	X	O	X	O
Neuroptera	O	X	O	X
Odonata	X	X	X	O
Orthoptera	O	O	X	X
Plecoptera	O	X	O	O
Siphonaptera	X	O	X	O
Trichoptera	O	X	O	O
Insecta; unplaced	O	X	O	O
Myriapoda	X	O	O	O
Arachnida	O	O	X	O

It is of interest to note that of the 24 arthropod groups listed above, the number of groups used as hosts by cestodes, trematodes, and nematodes is the same or almost the same, namely, 13 by cestodes and trematodes and 14 by nematodes; only 6 are used by acanthocephalids.

From the foregoing something may be indicated as to the range of parasites on the part of the various intermediate host groups, as follows:

Hosts for 4 worm groups: Amphipoda and Coleoptera.

Hosts for Cestoda, Trematoda and Nematoda: Copepoda; Diptera and Odonata.

Hosts for Cestoda, Trematoda and Acanthocephala: Decapoda.

Hosts for Cestoda and Trematoda: Lepidoptera.

Hosts for Cestoda and Nematoda: Cladocera; Mallophaga and Siphonaptera.

Hosts for Trematoda and Nematoda: Ephemera.

Hosts for Trematoda and Acanthocephala: Neuroptera.

Hosts for Nematoda and Acanthocephala: Isopoda; Orthoptera.

Hosts for Cestoda only: Ostracoda; Dermaptera; Myriapoda.

Hosts for Trematoda only: Branchiopoda; Plecoptera, Trichoptera, and unplaced insects.

Hosts for Nematoda only: Anopleura and Isoptera; Arachnida.

No group is yet reported as a host group for Acanthocephala only.

Taking the major host groups, the Crustacea, Insecta, Myriapoda, and Arachnida, as a whole and the four worm groups as a whole, we may make the following summary:

There are 48 species in the Cestoda which have arthropods as intermediate hosts and for which we know the primary hosts; there are 22 larval forms in addition for which the primary hosts are not known.

There are 37 species in the Trematoda which have arthropods as intermediate hosts and for which we know the primary hosts; there are 27 larval forms in addition for which the primary hosts are not known.

There are 49 species in the Nematoda which have arthropods as intermediate hosts and for which we know the primary hosts; there are 12 larval forms in addition for which the primary hosts are unknown.

There are 9 species in the Acanthocephala which have arthropods as intermediate hosts and for which we know the primary hosts.

There are altogether 143 species of worms parasitic in vertebrates which have arthropods as intermediate hosts and for which the primary hosts are known; there are 61 larval forms in addition for which the primary host is unknown.

In the Crustacea there are 49 species which serve as intermediate hosts for Cestoda, 22 for Trematoda, 12 for Nematoda, and none for Acanthocephala.

In the Insecta there are 25 species which serve as intermediate hosts for Cestoda, 46 for Trematoda, 122 for Nematoda, and 15 for Acanthocephala.

In the Myriapoda there are 2 species which serve as intermediate hosts for Cestoda, and none for Trematoda, Nematoda, or Acanthocephala so far as we know at present.

In the Arachnida there are 6 species which serve as intermediate hosts for Nematoda, and none for Cestoda, Trematoda, or Acanthocephala so far as we know at present.

The Insecta are far in the lead as regards number of species known to serve as intermediate hosts for parasitic worms, as there are 186 species of insects, 77 species of crustaceans, 6 species of arachnids, and only 2 species of myriapods included in these lists of intermediate hosts. The total number of arthropod species listed here as intermediate hosts for the worm groups involved is 271.

CONCLUSION

It should be reiterated that one must not draw too sweeping conclusions in regard to the importance of host groups or in regard to

several other things at this time. For one thing, the lists given here are such as could be compiled in the time at the writer's disposal and while reasonably comprehensive must necessarily be incomplete. For another thing, our total knowledge in regard to the life histories of heteroxenous helminths is very slight. As already stated, we know the life histories of approximately 1 per cent of the known tapeworms, and this status is sufficiently representative of conditions for all heteroxenous worm groups to need no detailed statement in regard to the other groups. There may be important intermediate host groups of which no member has yet been incriminated. We know about 143 life histories involving arthropods; there are certainly hundreds, perhaps thousands, of such life histories still to be ascertained.

Admitting all of these defects in our data, we are nevertheless justified in saying that the lists presented here will be of value in affording the student a clue as to the probabilities in beginning a search for the intermediate host of a heteroxenous worm parasite, or in considering the probable identity of a larval worm found in an arthropod. This will fulfill one of the purposes of this paper—to aid the student. The young students of to-day will include among their ranks the competent scientists of to-morrow.

Another purpose of this paper is to point out the opportunities for cooperation among scientists in adding to our knowledge of the life histories of parasitic worms. Zwaluwenberg, an entomologist, has said recently: "The interrelationships of insects and nematodes is a subject of which most entomologists seem to have little adequate conception." Some months ago, in discussing the scope of this paper with Dr. L. O. Howard, the writer told him that he expected to call attention to the fact that our knowledge of these life histories had come almost entirely from the parasitologists, and that the workers on insects and crustaceans had aided very little in the process. Dr. Howard, characteristically, suggested that this be done very diplomatically. It is the writer's intention to do this diplomatically. It is primarily the business of the parasitologist to ascertain the life histories of the parasites with which he deals. It would not be in order to ask the specialist on insects or crustaceans to ascertain the life histories of the larval worms which he finds in these insects and crustaceans, nor would it add greatly to our knowledge to have persons unfamiliar with parasitic worms publish findings in an unfamiliar field.

Nevertheless, there is an opportunity for cooperation between the workers on parasitic helminths and the workers on their arthropod hosts, and little advantage has been taken of this fact in the past.

My friend, Dr. Wm. A. Riley, has called my attention to Stein's pioneer contributions; conceding the point, Stein's good example has not been followed by most entomologists. The competent worker in either field should be primarily a zoologist, and as such able to see the possibilities for cooperation with other zoologists in connection with incidental findings which come to his attention. The larval helminth in an arthropod is an animal which concerns the helminthologist in one direction and the "arthropodologist" in another. A sound consideration of the worm calls for a sound consideration of its host, and *vice versa*. Prophylactic measures directed against heteroxenous worms call for control measures for intermediate hosts, and if this host is an arthropod the helminthologist must draw on the knowledge of the man who knows about arthropods.

One of the promising developments in this connection is the fact that whereas the entomologist in the past has devoted his attention to the outside of the insects with only casual attention to the internal anatomy, there is now a tendency to devote more attention to the internal structures. In examining the interior of the insects, the entomologist is certain to find larval worms in some of them. In such cases he would be rendering a service if he would do one of the following things:

If the entomologist is well trained in zoology, and has the time, facilities, and inclination to carry out an adequate investigation of these worms, he can proceed with feeding experiments and ascertain the life history. Lacking the training, time, facilities, or inclination to do such work, he can turn the material over to a parasitologist for investigation, or call attention in his publications to his findings in order that they may serve as a guide to the parasitologist who is working along this line.

Some of the hosts given in this paper are not well established, but are included for completeness. In establishing a life history for a parasitic worm, one may be guided with profit by the remarks of Stiles in 1896 in connection with the life histories of bird tapeworms:

The known or supposed life history has been based upon four different methods of work, *i. e.*:

1. Experimental infection of the fowls by feeding to them known larval stages found in invertebrates, and thus raising the adult stage.
2. Experimental infection of invertebrates by feeding to them the eggs of tapeworms found in birds, and thus raising the larval stage.
3. Comparison of the hooks upon the heads of adult tapeworms of birds with the hooks of larvae found in invertebrates, and thus associating the young and the old stages.
4. Wild speculations as to the intermediate hosts, based upon negative results and totally devoid of any scientific foundation.

Of these four methods of work the first two give positive proof of the life history when the experiments are successful; the third gives a probability to the statements, but not a proof; the less said about the fourth method the better.

In this later epoch it is advisable to establish a life history by both of the first methods, not ignoring the third, if adequate evidence is desired. Raising *Diphyllobothrium latum* in dogs by feeding plerocercoids from fish did not show that a copepod was the first host; failure to infect fish with the tapeworm eggs necessitated further search and so led to the discovery of the copepod host. Another thing deserves emphasis: Finding that one arthropod is an intermediate host does not settle the problem of a life history of a worm. The worm may have a score of intermediate hosts, and the most important one may not be an arthropod.

ADDENDUM

Since the foregoing was written the following records have come to hand and are given here without discussion:

LIST BY PARASITES

(Crust. = Crustacea)

CESTODA

CESTODARIA

- Amphilina foliacea*—*Corophium curvispinum*; Crust.; Amphipoda
Dikerogammarus haemobaphes; Crust.; Amphipoda
Gammarus platycheir; Crust.; Amphipoda
Metamysis strauchi; Crust.; Mysidacea

DIPHYLLOBOTHRIDAE

- Diphyllobothrium ranarum*—*Cyclops fuscus*; Crust.; Copepoda
Diphyllobothrium decipiens—*Cyclops* sp.; Crust.; Copepoda
Diphyllobothrium erinacci—*Cyclops* sp.; Crust.; Copepoda
Diphyllobothrium mansoni—*Cyclops* sp.; Crust.; Copepoda
Cyclops strenuus; Crust.; Copepoda

PROTEOCEPHALIDAE

- Proteocephalus ambloplitis*—*Hyaella azteca*; Crust.; Amphipoda
Cyclops serrulatus; Crust.; Copepoda
Cyclops viridis; Crust.; Copepoda
Proteocephalus pinguis—*Cyclops serrulatus*; Crust.; Copepoda
Cyclops viridis; Crust.; Copepoda
Ophiotaenia testudo—*Cyclops* sp.; Crust.; Copepoda

CESTODA (*Continued*)

HYMENOLEPIDIDAE

- Hymenolepis collaris*—*Cypris* sp., Crust.; Ostracoda
Hymenolepis anatina—*Cypris* sp.; Crust.; Ostracoda
Hymenolepis coronula—*Cypris* sp.; Crust.; Ostracoda
Hymenolepis carioca—*Choeridium histeroides*; Insecta; Coleoptera
 Hister (Carcinops) 11-striatus; Insecta; Coleoptera
 Anisotarsus agilis; Insecta; Coleoptera
 ? *Choanotaenia infundibulum*—*Cratacanthus dubius*; Insecta; Coleoptera *

DAVAINIIDAE

- Railletina cesticillus*—*Anisotarsus agilis*; Insecta; Coleoptera
 Anisotarsus terminatus; Insecta; Coleoptera
 Choeridium histeroides; Insecta; Coleoptera
 Aphodius granarius; Insecta; Coleoptera *
 Selenophorus ovalis; Insecta; Coleoptera *
 Selenophorus pedicularis; Insecta; Coleoptera
 Triplectrus rusticus; Insecta; Coleoptera *

TREMATODA

PLAGIORCHIIDAE

- Plagiorchis maculosus*—*Chironomus plumosus*; Insecta; Diptera
 Chironomus sp.; Insecta; Diptera

HETEROPHYIDAE

- Microphallus minus*—*Macrobrachium nipponensis*; Crust.; Decapoda

TROGLOTREMATIDAE

- Paragonimus westermani*—*Cambaroides dauuricus*; Crust.; Decapoda
 Eriocheir sinensis; Crust.; Decapoda

FAMILY UNCERTAIN

- Distome of Eckstein—*Culex pipiens*; Insecta; Diptera
 Metacercaria of Joyeux, 1928—*Anopheles maculipennis*; Insecta; Diptera
 Cercaria X.1 of Harper, 1929—*Gammarus pulex*; Crust.; Amphipoda
 Orchestia littorea; Crust.; Amphipoda
 Chironomus plumosus; Insecta; Diptera
 Culex pipiens; Insecta; Diptera
 Tipula maxima; Insecta; Diptera
 Pedicia rivosa; Insecta; Diptera
 Dysticus marginalis; Insecta; Coleoptera
 Sialis lutarius; Insecta; Diptera
 Halesus sp.; Insecta; Trichoptera
 Limnophilus centralis; Insecta; Trichoptera
 Limnophilus rhombicus; Insecta; Trichoptera
 Plectrocnemia conspersa; Insecta; Trichoptera
 Rhyacophila dorsalis; Insecta; Trichoptera

* Unpublished work by M. F. Jones.

NEMATODA

SPIRURIDAE

- Gongylonema ingluvicola*—*Copris minutus*; Insecta; Coleoptera *
Phanaeus carnifex—Insecta; Coleoptera *
Physocephalus sexualatus—*Canthon lacvis*; Insecta; Coleoptera
Gymnopleurus simatus; Insecta; Coleoptera
Phanaeus carnifex; Insecta; Coleoptera
 Larval spirurid (?)—*Camfodea* sp.; Insecta; Thysanura

PHYSALOPTERIDAE

- Proleptus scillicola*—*Carcinus maenas*; Crust.; Decapoda
Eupagurus bernhardus; Crust.; Decapoda

ACUARIIDAE

- Cheilospirura hamulosa*—*Melanoplus femurrubrum*; Insecta; Orthoptera *
Cheilospirura spinosa—*Melanoplus femurrubrum*; Insecta; Orthoptera
Acuaria anthuris—*Melanoplus femurrubrum*; Insecta; Orthoptera *
 Crickets; Insecta; Orthoptera *

TETRAMERIDAE

- Tetrameres americana*—*Melanoplus differentialis*; Insecta; Orthoptera
Melanoplus femurrubrum; Insecta; Orthoptera *

FILARIIDAE

- Wuchereria bancrofti*—*Aedes albopictus*; Insecta; Diptera
Aedes chemulpoensis; Insecta; Diptera
Aedes galloisi; Insecta; Diptera
Aedes subpictus; Insecta; Diptera
Armigeres obturbans; Insecta; Diptera
Culex annulus; Insecta; Diptera
Culex bitaeniorhynchus karatsuensis; Insecta; Diptera
Culex japonicus; Insecta; Diptera
Culex pipiens pallens; Insecta; Diptera
Culex tipuliformis; Insecta; Diptera
Culex tripunctatus; Insecta; Diptera
Culex tritaeniorhynchus; Insecta; Diptera
Culex whitmorei; Insecta; Diptera

DRACUNCULIDAE

- Philometra nodulosa*—*Cyclops brevispinosus*; Crust.; Copepoda

FAMILY UNCERTAIN

- Cystopsis accipenseris*—*Dikerogammarus haemobaphes*; Crust.; Amphipoda
Gammarus platycheir; Crust.; Amphipoda
Cyclopsinema mordens—*Pachycyclops signatus*; Crust.; Copepoda

* Unpublished work of E. B. Cram.

LIST BY HOSTS

(Cest. = Cestoda; Trem. = Trematoda; Nem. = Nematoda)

CRUSTACEA

AMPHIPODA

- Corophium curvispinum*—*Amphilina foliacea*; Cest.; Cestodaria
Dikrogammarus haemobaphes—*Amphilina foliacea*; Cest.; Cestodaria
Cystopsis accipenseris; Nem.; Family?
Gammarus platycheir—*Amphilina foliacea*; Cest.; Cestodaria.
Cystopsis accipenseris; Nem.; Family?
Hyalella azteca—*Proteocephalus ambloplitis*; Cest.; Proteocephalidae

COPEPODA

- Cyclops brevispinosus*—*Philometra nodulosa*; Nem.; Dracunculidae
Cyclops fuscus—*Diphyllobothrium ranarum*; Cest.; Diphyllbothriidae
Cyclops serrulatus—*Proteocephalus pinguis*; Cest.; Proteocephalidae
Proteocephalus ambloplitis; Cest.; Proteocephalidae
Cyclops sp.—*Diphyllobothrium decipiens*; Cest.; Diphyllbothriidae
Diphyllobothrium erinacei; Cest.; Diphyllbothriidae
Ophiotaenia testudo; Cest.; Proteocephalidae
Cyclops strenuus—*Diphyllobothrium mansoni*; Cest.; Diphyllbothriidae
Cyclops viridis—*Proteocephalus pinguis*; Cest.; Proteocephalidae
Proteocephalus ambloplitis; Cest.; Proteocephalidae
Macrocylops signatus—*Cyclopsinema mordens*; Nem.; Family?
Pachycylops signatus—See *Macrocylops signatus*

DECAPODA

- Cambaroides dauuricus*—*Paragonimus westermanni*; Trem.; Troglotrematidae
Carcinides (Carcinus) maenas—*Proleptus scillicola*; Nem.; Physalopteridae
Carcinus maenas—See *Carcinides (Carcinus) maenas*
Eriocheir sinensis—*Paragonimus westermanni*; Trem.; Troglotrematidae
Eupagurus bernhardus—See *Pagurus bernhardus*.
Macrobrachium nipponensis—*Microphallus minus*; Trem.; Heterophyidae
Pagurus bernhardus—*Proleptus scillicola*; Nem.; Physalopteridae

MYSIDACEA

- Metamysis trauchi*—*Amphilina foliacea*; Cest.; Cestodaria

OSTRACODA

- Cypris* sp.—*Hymenolepis anatina*; Cest.; Hymenolepididae
Hymenolepis collaris; Cest.; Hymenolepididae
Hymenolepis coronula; Cest.; Hymenolepididae

INSECTA

COLEOPTERA

- Anisotarsus agilis*—*Raillietina cesticillus*; Cest.; Davainiidae
Hymenolepis carioca; Cest.; Hymenolepididae
Anisotarsus terminatus—*Raillietina cesticillus*; Cest.; Davainiidae
Aphodius granarius—*Raillietina cesticillus*; Cest.; Davainiidae
Canthon lacvís—*Physocephalus sexualatus*; Nem.; Spiruridae
Choeridium histeroides—*Raillietina cesticillus*; Cest.; Davainiidae
Hymenolepis carioca; Cest.; Hymenolepididae
Copris minutus—*Gongylonema ingluvicola*; Nem.; Spiruridae
Cratacanthus dubius—? *Choanotaenia infundibulum*; Cest.; Hymenolepididae
Dysticus marginalis—Cercaria X.1 of Harper, 1929; Trem.; Family?
Gymnopleurus sinuatus—See *Gymnopleurus sinuatus*
Gymnopleurus sinuatus—*Spirocerca sanguinolenta*; Nem.; Spiruridae
Hister (Carcinops) 14-striatus—*Hymenolepis carioca*; Cest.; Hymenolepididae
Phanaeus carnifex—See *Phanaeus vindex*
Phanaeus vindex—*Gongylonema ingluvicola*; Nem.; Spiruridae
Physocephalus sexualatus; Nem.; Spiruridae
Selenophorus ovalis—*Raillietina cesticillus*; Cest.; Davainiidae
Selenophorus pedicularis—*Raillietina cesticillus*; Cest.; Davainiidae
Triplectrus rusticus—*Raillietina cesticillus*; Cest.; Davainiidae

NEUROPTERA

- Sialis lutarius*—See *Sialis flavilatera*
Sialis flavilatera—Cercaria X.1 of Harper, 1929; Trem.; Family?

TRICHOPTERA

- Halesus* sp.—Cercaria X.1 of Harper, 1929; Trem.; Family?
Limnophilus centralis—Cercaria X.1 of Harper, 1929; Trem.; Family?
Limnophilus rhombicus—Cercaria X.1 of Harper, 1929; Trem.; Family?
Plectrocnemia conspersa—Cercaria X.1 of Harper, 1929; Trem.; Family?
Rhyacophila dorsalis—Cercaria X.1 of Harper, 1929; Trem.; Family?

DIPTERA

- Aedes albolateralis*—*Wuchereria bancrofti*; Nem.; Filariidae
Aedes chemulpoensis—*Wuchereria bancrofti*; Nem.; Filariidae
Aedes galloisi—*Wuchereria bancrofti*—Nem.; Filariidae
Anopheles maculipennis—*Metaecercaria* of Joyeux, 1928; Trem.; Family?
Anopheles rossi—See *Anopheles subpictus*
Anopheles subpictus—*Wuchereria bancrofti*; Nem.; Filariidae
Armigeres obturbans—See *Desvoidya obturbans*
Chironomus plumosus—*Plagiorchis maculosus*; Trem.; Plagiorchiidae
Cercaria X.1 of Harper, 1929; Trem.; Family?
Chironomus sp.—*Plagiorchis maculosus*; Trem.; Plagiorchiidae
Culex annulus—See *Culex tritaeniorhynchus*

INSECTA (*Continued*)DIPTERA (*Continued*)

Culex bitaeniorhynchus karatsucensis—*Wuchereria bancrofti*; Nem.; Filariidae

Culex japonicus—*Wuchereria bancrofti*; Nem.; Filariidae

Culex pipiens—Distome of Eckstein; Trem.; Family?

Cercaria X.1 of Harper, 1929; Trem.; Family?

Wuchereria bancrofti; Nem.; Filariidae

Culex pipiens pallens—See *Culex pipiens*

Culex tipuliformis—*Wuchereria bancrofti*; Nem.; Filariidae

Culex tripunctatus—*Wuchereria bancrofti*; Nem.; Filariidae

Culex tritaeniorhynchus—*Wuchereria bancrofti*; Nem.; Filariidae

Culex whitmorei—*Wuchereria bancrofti*; Nem.; Filariidae

Desvoidya obturbans—*Wuchereria bancrofti*; Nem.; Filariidae

Tipula maxima—Cercaria X.1 of Harper, 1929; Trem.; Family?

Pedicia rivosa—Cercaria X.1 of Harper, 1929; Trem.; Family?

THYSANURA

Campodea sp.—Larval spirurid (?); Nem.; Spiruridae?

ORTHOPTERA

Cricket—*Acuaria anthuris*; Nem.; Acuariidae

Melanoplus differentialis—*Tetrameres americana*; Nem.; Tetrameridae

Melanoplus femurrubrum—*Tetrameres americana*; Nem.; Tetrameridae

Cheilospirura hamulosa; Nem.; Acuariidae

Cheilospirura spinosa; Nem.; Acuariidae

Acuaria anthuris; Nem.; Acuariidae

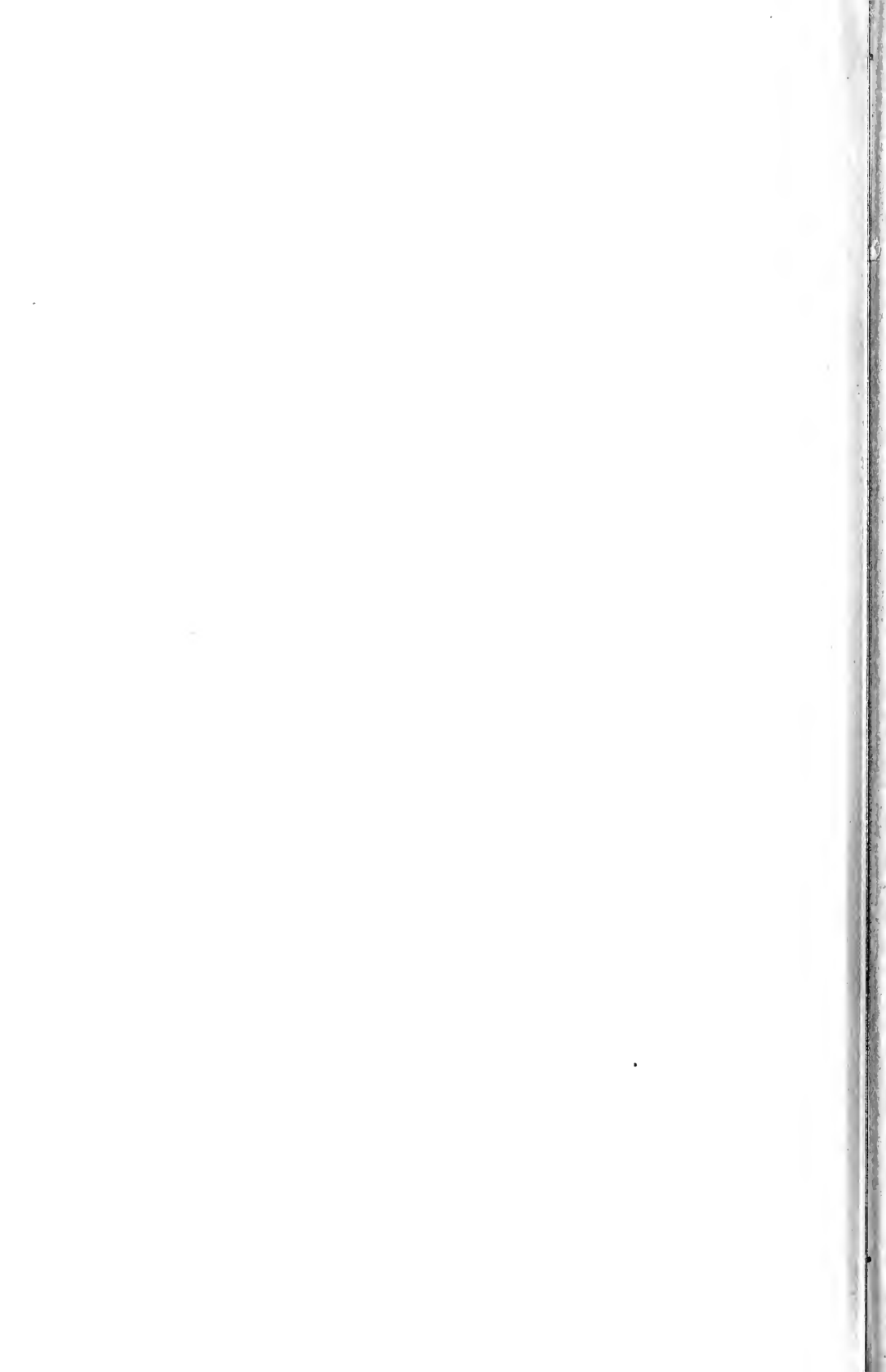



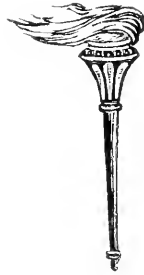

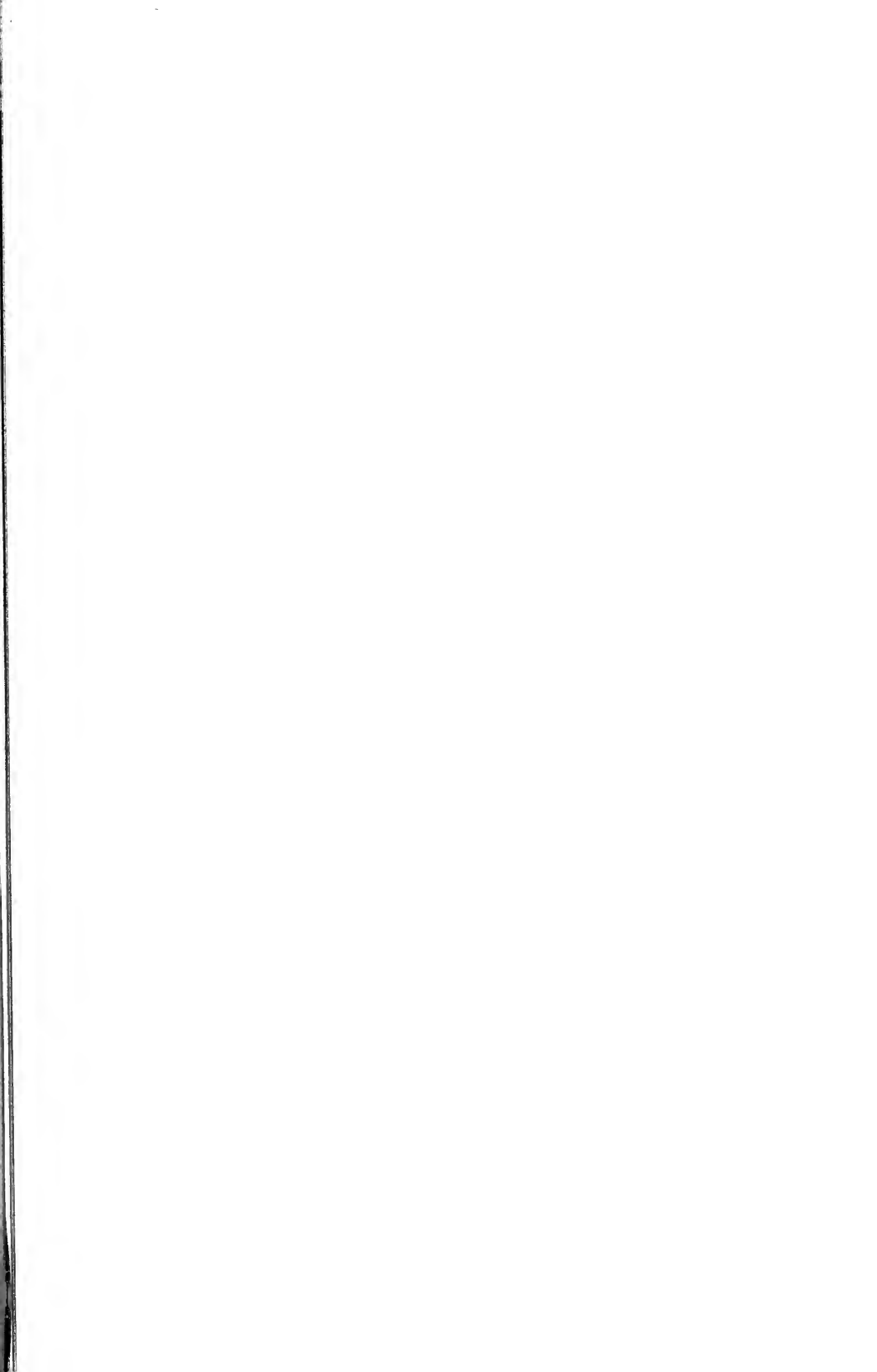





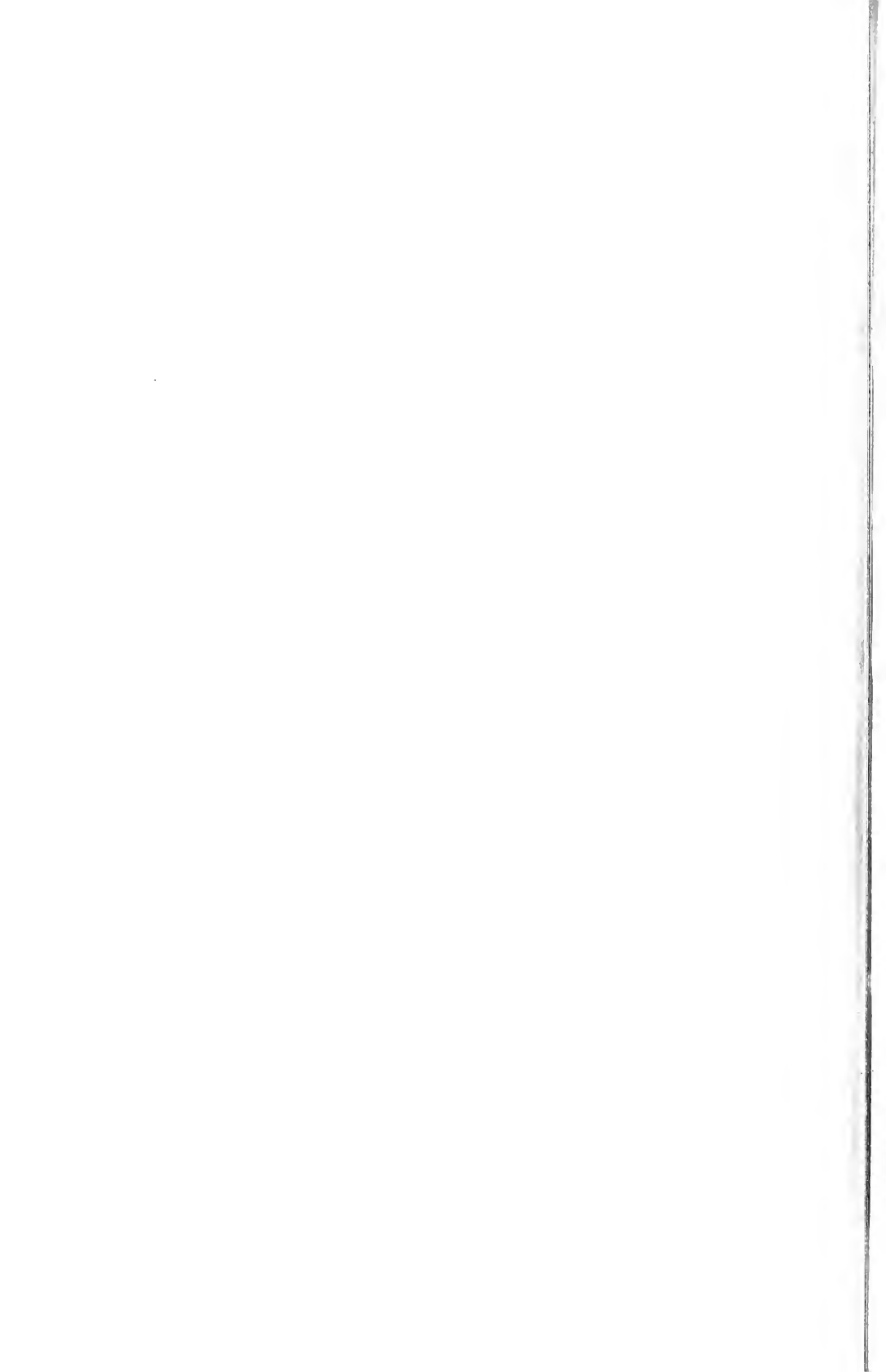



SMITHSONIAN INSTITUTION LIBRARIES



3 9088 00785 1447